

MARKS PUBLISHED FOR OPPOSITION

The following marks are published in compliance with section 12(a) of the Trademark Act of 1946. Applications for the registration of marks in more than one class have been filed as provided in section 30 of said act as amended by Public Law 772, 87th Congress, approved Oct. 9, 1962, 76 Stat. 769. Opposition under section 13 may be filed within thirty days of the date of this publication. See rules 2.101 to 2.105.

A separate fee of three hundred dollars (\$300.00) for opposing each mark in each class must accompany the opposition.

SECTION 1.— INTERNATIONAL CLASSIFICATION

The short titles associated below with the international class numbers are terms designed merely for quick identification and are not an official part of the international classification. The full names of international classes are given in section 6.1 of the trademark rules of practice.

The designation "U.S. Cl." appearing in this section refers to the U.S. class in effect prior to Sep. 1, 1973 rather than the international class which applies to applications filed on or after that date. For adoption of international classification see notice in the OFFICIAL GAZETTE of Jun. 26, 1973 (911 O.G. TM 210).

Application in more than one class

SN 76-543,084. EYEMART EXPRESS, LTD., CARROLLTON, TX. FILED 8-25-2003.

DR. BARNES' EYEMART EXPRESS

OWNER OF U.S. REG. NO. 1,999,527.
THE NAME IN THE MARK IDENTIFIES A PARTICULAR LIVING INDIVIDUAL WHOSE CONSENT IS OF RECORD.

CLASS 40—MATERIAL TREATMENT

FOR OPTICAL LENS GRINDING SERVICES (U.S. CLS. 100, 103 AND 106).
FIRST USE 1-31-1996; IN COMMERCE 1-31-1996.

CLASS 44—MEDICAL, BEAUTY AND AGRICULTURAL SERVICES

FOR FITTING OPTICAL LENSES, OPTICIAN SERVICES, AND OPTOMETRIC SERVICES, NAMELY, EYE EXAMINATIONS (U.S. CLS. 100 AND 101).
FIRST USE 1-31-1996; IN COMMERCE 1-31-1996.
LESLIE RICHARDS, EXAMINING ATTORNEY

SN 76-543,085. EYEMART EXPRESS, LTD., CARROLLTON, TX. FILED 8-25-2003.

DR. BARNES' VISION 4 LESS

OWNER OF U.S. REG. NOS. 3,022,421 AND 3,022,422.
THE MARK IDENTIFIES A PARTICULAR LIVING INDIVIDUAL WHOSE CONSENT IS OF RECORD.
SEC. 2(F) AS TO "VISION 4 LESS".

CLASS 40—MATERIAL TREATMENT

FOR OPTICAL LENS GRINDING SERVICES (U.S. CLS. 100, 103 AND 106).
FIRST USE 1-31-1996; IN COMMERCE 1-31-1996.

CLASS 44—MEDICAL, BEAUTY AND AGRICULTURAL SERVICES

FOR FITTING OPTICAL LENSES, OPTICIAN SERVICES, AND OPTOMETRIC SERVICES, NAMELY, EYE EXAMINATIONS (U.S. CLS. 100 AND 101).
FIRST USE 1-31-1996; IN COMMERCE 1-31-1996.
LESLIE RICHARDS, EXAMINING ATTORNEY

SN 76-658,813. ALTA VIA CONSULTING, LLC, KNOXVILLE, TN. FILED 4-21-2006.

ALTA VIA

THE MARK CONSISTS OF STANDARD CHARACTERS WITHOUT CLAIM TO ANY PARTICULAR FONT, STYLE, SIZE, OR COLOR.

OWNER OF U.S. REG. NO. 2,538,959.

CLASS 35—ADVERTISING AND BUSINESS

FOR MANAGEMENT AND BUSINESS CONSULTING SERVICES IN THE FIELD OF COMPUTER SOFTWARE DESIGN, DEVELOPMENT AND IMPLEMENTATION (U.S. CLS. 100, 101 AND 102).

CLASS 41—EDUCATION AND ENTERTAINMENT

FOR TRAINING IN THE USE OF COMPUTER SOFTWARE (U.S. CLS. 100, 101 AND 107).

CLASS 42—SCIENTIFIC AND COMPUTER SERVICES

FOR CONSULTING SERVICES IN THE FIELD OF DESIGN, SELECTION, IMPLEMENTATION AND USE OF COMPUTER HARDWARE AND SOFTWARE SYSTEMS FOR OTHERS; COMPUTER SOFTWARE DESIGN, COMPUTER PROGRAMMING AND MAINTENANCE OF SOFTWARE (U.S. CLS. 100 AND 101).
ROSELLE HERRERA, EXAMINING ATTORNEY

SN 76-677,035. HOME ELEMENTS, INC., MINNEAPOLIS, MN. FILED 5-18-2007.

IN YOUR ELEMENT

THE MARK CONSISTS OF STANDARD CHARACTERS WITHOUT CLAIM TO ANY PARTICULAR FONT, STYLE, SIZE, OR COLOR.

OWNER OF U.S. REG. NO. 3,071,323.

CLASS 20—FURNITURE AND ARTICLES NOT OTHERWISE CLASSIFIED

FOR FURNITURE, NAMELY, WALL SHELVES, WALL AND FLOOR CABINETS, SPACE SAVERS, NAMELY, SHELVING UNITS THAT FIT OVER THE TOILET, OTHERWISE KNOWN AS ETAGERES; PLATE RACKS; AND WINE RACKS (U.S. CLS. 2, 13, 22, 25, 32 AND 50).

CLASS 21—HOUSEWARES AND GLASS

FOR BREAD BASKETS; AND NAPKIN HOLDERS (U.S. CLS. 2, 13, 23, 29, 30, 33, 40 AND 50).

JULIE WATSON, EXAMINING ATTORNEY

SN 76-686,962. CARIBBEAN CRESCENT, INC., LAUREL, MD. FILED 2-20-2008.

CARIBBEAN CRESCENT

SEC. 2(F) AS TO "CARIBBEAN".

CLASS 29—MEATS AND PROCESSED FOODS

FOR FROZEN FOODS, NAMELY, PACKAGED ENTREES CONSISTING PRIMARILY OF MEAT, FISH, POULTRY OR VEGETABLES (U.S. CL. 46).

FIRST USE 9-0-1993; IN COMMERCE 12-0-1993.

CLASS 30—STAPLE FOODS

FOR FROZEN BREADS; SAUCES, NAMELY, HOT SAUCES AND CURRY SAUCES; CHUTNEYS; VEGETABLE CONCENTRATES USED FOR SEASONING; SEASONINGS, NAMELY, JERK SEASONING; TEA BASED BEVERAGES, NAMELY, MAUBY; CONFECTIONERIES, NAMELY, BAMMY WHICH IS CASSAVA BREAD (U.S. CL. 46).

FIRST USE 9-0-1993; IN COMMERCE 12-0-1993.

JACQUELINE A. LAVINE, EXAMINING ATTORNEY

SN 76-695,518. EVERHEALTH NATURAL VITAMIN COMPANY, LOS ANGELES, CA. FILED 1-30-2009.

EVERHEALTH

THE MARK CONSISTS OF STANDARD CHARACTERS WITHOUT CLAIM TO ANY PARTICULAR FONT, STYLE, SIZE, OR COLOR.

OWNER OF U.S. REG. NO. 3,061,485.

CLASS 3—COSMETICS AND CLEANING PREPARATIONS

FOR BODY LOTIONS, BODY CREAMS, HAIR SHAMPOO, HAIR CONDITIONER, HAIR GEL (U.S. CLS. 1, 4, 6, 50, 51 AND 52).

FIRST USE 1-1-1987; IN COMMERCE 1-1-1987.

CLASS 5—PHARMACEUTICALS

FOR VITAMINS, NUTRITIONAL SUPPLEMENTS, DIETARY SUPPLEMENTS, MEDICATED SKIN OILS CONTAINING VITAMINS (U.S. CLS. 6, 18, 44, 46, 51 AND 52).

FIRST USE 1-1-1987; IN COMMERCE 1-1-1987.

SALLY SHIH, EXAMINING ATTORNEY

SN 76-696,205. GCT GLOBAL CONTAINER TERMINALS INC., VANCOUVER, BRITISH COLUMBIA, CANADA, FILED 3-9-2009.

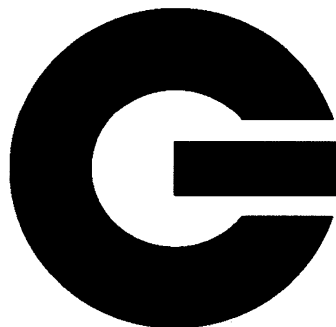

PRIORITY CLAIMED UNDER SEC. 44(D) ON CANADA APPLICATION NO. 1419189, FILED 11-21-2008, REG. NO. TMA760087, DATED 2-24-2010, EXPIRES 2-24-2025.

THE MARK CONSISTS OF A DESIGN OF THE LETTER "G" COMPOSED OF A PARTIAL CIRCLE WITH A BAR THAT BEGINS IN THE CENTER AND EXTENDS THROUGH TO THE EDGE OF THE RIGHT SIDE OF THE CIRCLE.

CLASS 35—ADVERTISING AND BUSINESS

FOR OPERATION OF A BUSINESS FOR OTHERS, NAMELY, MARINE TERMINALS AND MARINE CONTAINER TERMINALS; VESSEL HUSBANDING, NAMELY, THE COORDINATION OF AND ARRANGING FOR VESSEL-RELATED SERVICES ON BEHALF OF SEAFARING CLIENTS WHILE IN PORT; OPERATION OF PORT FACILITIES FOR OTHERS (U.S. CLS. 100, 101 AND 102).

CLASS 37—CONSTRUCTION AND REPAIR

FOR MAINTENANCE AND REPAIR OF CONTAINER AND CARGO HANDLING EQUIPMENT (U.S. CLS. 100, 103 AND 106).

CLASS 39—TRANSPORTATION AND STORAGE

FOR TRANSPORTATION AND DELIVERY SERVICES BY SEA AND RAIL; PROVIDING VESSEL MOORING FACILITIES; VESSEL TRANSPORT; CARGO HANDLING; CARGO UNLOADING; PROVIDING OCEAN TRANSPORTATION, STORAGE AND DELIVERY SERVICES; MARINE TRANSPORT (U.S. CLS. 100 AND 105).

LINDA ORNDORFF, EXAMINING ATTORNEY

SN 76-696,206. GCT GLOBAL CONTAINER TERMINALS INC., VANCOUVER, BRITISH COLUMBIA, V6A 1J9, CANADA, FILED 3-9-2009.

SN 76-696,208. GCT GLOBAL CONTAINER TERMINALS INC., VANCOUVER, BRITISH COLUMBIA, V6A 1J9, CANADA, FILED 3-9-2009.



PRIORITY CLAIMED UNDER SEC. 44(D) ON CANADA APPLICATION NO. 1419192, FILED 11-21-2008, REG. NO. TMA760.084, DATED 2-24-2010, EXPIRES 2-24-2025.

NO CLAIM IS MADE TO THE EXCLUSIVE RIGHT TO USE "GLOBAL CONTAINER TERMINALS", APART FROM THE MARK AS SHOWN.

THE MARK CONSISTS OF THE LETTER "G" COMPOSED OF A DESIGN OF A PARTIAL CIRCLE WITH A BAR THAT BEGINS IN THE CENTER AND EXTENDS THROUGH TO THE EDGE OF THE RIGHT SIDE OF THE CIRCLE. THE WORDS "GLOBAL", "CONTAINER" AND "TERMINALS" ARE TO THE RIGHT OF THE DESIGN, FROM TOP TO BOTTOM, RESPECTIVELY.

CLASS 35—ADVERTISING AND BUSINESS

FOR OPERATION OF A BUSINESS FOR OTHERS, NAMELY, MARINE TERMINALS AND MARINE CONTAINER TERMINALS; VESSEL HUSBANDING, NAMELY, THE COORDINATION OF AND ARRANGING FOR VESSEL-RELATED SERVICES ON BEHALF OF SEAFARING CLIENTS WHILE IN PORT; OPERATION OF PORT FACILITIES FOR OTHERS (U.S. CLS. 100, 101 AND 102).

CLASS 37—CONSTRUCTION AND REPAIR

FOR MAINTENANCE AND REPAIR OF CONTAINER AND CARGO HANDLING EQUIPMENT (U.S. CLS. 100, 103 AND 106).

CLASS 39—TRANSPORTATION AND STORAGE

FOR TRANSPORTATION AND DELIVERY SERVICES BY SEA AND RAIL; PROVIDING VESSEL MOORING FACILITIES; VESSEL TRANSPORT; CARGO HANDLING; CARGO UNLOADING; PROVIDING OCEAN TRANSPORTATION, STORAGE AND DELIVERY SERVICES; MARINE TRANSPORT (U.S. CLS. 100 AND 105). LINDA ORNDORFF, EXAMINING ATTORNEY

PRIORITY CLAIMED UNDER SEC. 44(D) ON CANADA APPLICATION NO. 1419191, FILED 11-21-2008, REG. NO. TMA760085, DATED 2-24-2010, EXPIRES 2-24-2025.

THE COLOR(S) BLUE AND RED IS/ARE CLAIMED AS A FEATURE OF THE MARK.

THE MARK CONSISTS OF A DESIGN OF THE LETTER "G" COMPOSED OF A PARTIAL CIRCLE WITH A BAR THAT BEGINS IN THE CENTER AND EXTENDS THROUGH TO THE EDGE OF THE RIGHT SIDE OF THE CIRCLE. THE PARTIAL CIRCLE IS BLUE AND THE BAR IS RED.

CLASS 35—ADVERTISING AND BUSINESS

FOR OPERATION OF A BUSINESS FOR OTHERS, NAMELY, MARINE TERMINALS AND MARINE CONTAINER TERMINALS; VESSEL HUSBANDING, NAMELY, THE COORDINATION OF AND ARRANGING FOR VESSEL-RELATED SERVICES ON BEHALF OF SEAFARING CLIENTS WHILE IN PORT; OPERATION OF PORT FACILITIES FOR OTHERS (U.S. CLS. 100, 101 AND 102).

CLASS 37—CONSTRUCTION AND REPAIR

FOR MAINTENANCE AND REPAIR OF CONTAINER AND CARGO HANDLING EQUIPMENT (U.S. CLS. 100, 103 AND 106).

CLASS 39—TRANSPORTATION AND STORAGE

FOR TRANSPORTATION AND DELIVERY SERVICES BY SEA AND RAIL; PROVIDING VESSEL MOORING FACILITIES; VESSEL TRANSPORT; CARGO HANDLING; CARGO UNLOADING; PROVIDING OCEAN TRANSPORTATION, STORAGE AND DELIVERY SERVICES; MARINE TRANSPORT (U.S. CLS. 100 AND 105). LINDA ORNDORFF, EXAMINING ATTORNEY

SN 76-696,209. GCT GLOBAL CONTAINER TERMINALS INC., VANCOUVER, BRITISH COLUMBIA, CANADA, FILED 3-9-2009.



PRIORITY CLAIMED UNDER SEC. 44(D) ON CANADA APPLICATION NO. 1419193, FILED 11-21-2008, REG. NO. TMA760.083, DATED 2-24-2010, EXPIRES 2-24-2025.

NO CLAIM IS MADE TO THE EXCLUSIVE RIGHT TO USE "GLOBAL CONTAINER TERMINALS", APART FROM THE MARK AS SHOWN.

THE COLOR(S) BLUE AND RED IS/ARE CLAIMED AS A FEATURE OF THE MARK.

THE MARK CONSISTS OF THE LETTER "G" COMPOSED OF A DESIGN OF A PARTIAL CIRCLE WITH A BAR THAT BEGINS IN THE CENTER AND EXTENDS THROUGH TO THE EDGE OF THE RIGHT SIDE OF THE CIRCLE. THE PARTIAL CIRCLE IS BLUE AND THE BAR IS RED. THE WORDS "GLOBAL", "CONTAINER" AND "TERMINALS" ARE TO THE RIGHT OF THE DESIGN, FROM TOP TO BOTTOM, RESPECTIVELY. THE COLOR BLUE APPEARS IN ALL THREE OF THE WORDS.

CLASS 35—ADVERTISING AND BUSINESS

FOR OPERATION OF A BUSINESS FOR OTHERS, NAMELY, MARINE TERMINALS AND MARINE CONTAINER TERMINALS; VESSEL HUSBANDING, NAMELY, THE COORDINATION OF AND ARRANGING FOR VESSEL-RELATED SERVICES ON BEHALF OF SEAFARING CLIENTS WHILE IN PORT; OPERATION OF PORT FACILITIES FOR OTHERS (U.S. CLS. 100, 101 AND 102).

CLASS 37—CONSTRUCTION AND REPAIR

FOR MAINTENANCE AND REPAIR OF CONTAINER AND CARGO HANDLING EQUIPMENT (U.S. CLS. 100, 103 AND 106).

CLASS 39—TRANSPORTATION AND STORAGE

FOR TRANSPORTATION AND DELIVERY SERVICES BY SEA AND RAIL; PROVIDING VESSEL MOORING FACILITIES; VESSEL TRANSPORT; CARGO HANDLING; CARGO UNLOADING; PROVIDING OCEAN TRANSPORTATION, STORAGE AND DELIVERY SERVICES; MARINE TRANSPORT (U.S. CLS. 100 AND 105).
LINDA ORNDORFF, EXAMINING ATTORNEY

SN 76-698,521. J & N AUTO ELECTRIC, INC., CINCINNATI, OH. FILED 7-20-2009.

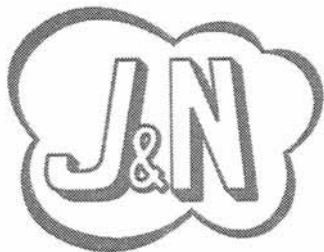

OWNER OF U.S. REG. NOS. 1,871,587 AND 1,893,459.
THE MARK CONSISTS OF THE STYLIZED TEXT "J&N" WITHIN A CLOUD DESIGN.

CLASS 7—MACHINERY

FOR AUTOMOTIVE COMPONENTS, NAMELY, ALTERNATORS; STARTERS FOR MOTORS AND ENGINES; GENERATORS FOR LAND VEHICLES AND REPLACEMENT PARTS THEREFOR, NAMELY, BRUSHES, STATORS, BEARINGS, SEALS, STARTER DRIVES, AND BRUSH HOLDERS (U.S. CLS. 13, 19, 21, 23, 31, 34 AND 35).
FIRST USE 2-0-1991; IN COMMERCE 2-0-1991.

CLASS 9—ELECTRICAL AND SCIENTIFIC APPARATUS

FOR AUTOMOTIVE COMPONENTS, NAMELY, VOLTAGE REGULATORS, FIELD COILS, CURRENT RECTIFIERS; ELECTRICAL ARMATURES, SOLENOIDS, AND DIODES (U.S. CLS. 21, 23, 26, 36 AND 38).
FIRST USE 2-0-1991; IN COMMERCE 2-0-1991.

CLASS 12—VEHICLES

FOR MOTORS FOR LAND VEHICLES (U.S. CLS. 19, 21, 23, 31, 35 AND 44).
FIRST USE 2-0-1991; IN COMMERCE 2-0-1991.
GEOFFREY FOSDICK, EXAMINING ATTORNEY

SN 76-698,849. HAVIS, INC., WARMINSTER, PA. FILED 8-7-2009.



CLASS 6—METAL GOODS

FOR METAL COMPUTER WALL AND CEILING MOUNTS; CONTAINERS OF METAL FOR TRANSPORT OF PRISONERS AND DOGS (U.S. CLS. 2, 12, 13, 14, 23, 25 AND 50).
FIRST USE 6-1-2009; IN COMMERCE 6-1-2009.

CLASS 9—ELECTRICAL AND SCIENTIFIC APPARATUS

FOR COMPUTER CONSOLES, NAMELY, COMPUTER HARDWARE, AND EMERGENCY SCENE LIGHTING (U.S. CLS. 21, 23, 26, 36 AND 38).
FIRST USE 6-1-2009; IN COMMERCE 6-1-2009.

CLASS 39—TRANSPORTATION AND STORAGE

FOR TRANSPORT BY VANS AND CARS OF PRISONERS AND DOGS (U.S. CLS. 100 AND 105).
FIRST USE 6-1-2009; IN COMMERCE 6-1-2009.
GEOFFREY FOSDICK, EXAMINING ATTORNEY

SN 76-699,795. RYLAND ORGANIZATION COMPANY, CALABASAS, CA. FILED 10-8-2009.

HOUSEWORKS

THE MARK CONSISTS OF STANDARD CHARACTERS WITHOUT CLAIM TO ANY PARTICULAR FONT, STYLE, SIZE, OR COLOR.

OWNER OF U.S. REG. NO. 3,468,476 AND OTHERS.

CLASS 37—CONSTRUCTION AND REPAIR

FOR CONSTRUCTION SERVICES, NAMELY, PLANNING, LAYING OUT AND CONSTRUCTION OF NEW RESIDENTIAL HOMES BASED ON DESIGN AND CONSTRUCTION CRITERIA THAT PROVIDES HIGHER ENERGY EFFICIENCY AND IMPROVED ENVIRONMENTAL QUALITY CONTROL FEATURES; PROVIDING INFORMATION VIA THE INTERNET AND WORLD WIDE WEB RELATING TO BUILDING CONSTRUCTION OPTIONS THAT PROVIDE HIGHER ENERGY EFFICIENCY AND IMPROVED ENVIRONMENTAL QUALITY FEATURES (U.S. CLS. 100, 103 AND 106).
FIRST USE 10-1-2007; IN COMMERCE 10-1-2007.

CLASS 42—SCIENTIFIC AND COMPUTER SERVICES

FOR PROVIDING ARCHITECTURAL CONSULTATION SERVICES TO NEW HOME BUYERS RELATING TO CONSTRUCTION DESIGNS THAT PROVIDE HIGHER ENERGY EFFICIENCIES AND IMPROVED ENVIRONMENTAL QUALITY CONTROL FEATURES; PROVIDING INFORMATION VIA THE INTERNET AND WORLD WIDE WEB ABOUT DESIGNING OF NEW RESIDENTIAL HOMES, SPECIALLY, INFORMATION RELATING TO DESIGN OPTIONS THAT PROVIDE HIGHER ENERGY EFFICIENCY AND IMPROVED ENVIRONMENTAL QUALITY CONTROL FEATURES (U.S. CLS. 100 AND 101).

FIRST USE 10-1-2007; IN COMMERCE 10-1-2007.
EVELYN BRADLEY, EXAMINING ATTORNEY

SN 76-700,984. ALZHEIMER'S FOUNDATION OF AMERICA, INC., NEW YORK, NY. FILED 12-24-2009.



OWNER OF U.S. REG. NOS. 3,179,067, 3,604,818 AND OTHERS.

NO CLAIM IS MADE TO THE EXCLUSIVE RIGHT TO USE "ALZHEIMER'S FOUNDATION", APART FROM THE MARK AS SHOWN.

THE COLOR(S) BLUE IS/ARE CLAIMED AS A FEATURE OF THE MARK.

THE MARK CONSISTS OF A ROUND BLUE IMAGE OF A FIGURE HOLDING A BLUE HEART OVER ITS HEAD, ALL OF WHICH IS ABOVE THE BLUE WORDING "ALZHEIMER'S FOUNDATION".

CLASS 35—ADVERTISING AND BUSINESS

FOR PROMOTING PUBLIC AWARENESS OF ALZHEIMER'S DISEASE AND RELATED ILLNESSES (U.S. CLS. 100, 101 AND 102).

CLASS 44—MEDICAL, BEAUTY AND AGRICULTURAL SERVICES

FOR PROVIDING MEDICAL INFORMATION RELATED TO DIAGNOSIS AND TREATMENT OF, AND CARE FOR PATIENTS WITH, ALZHEIMER'S DISEASE; HEALTHCARE SERVICES, NAMELY, PROVIDING HEALTHCARE FOR INDIVIDUALS WITH ALZHEIMER'S DISEASE AND RELATED DEMENTIAS AT ESTABLISHED FACILITIES (U.S. CLS. 100 AND 101).

SANJEEV VOHRA, EXAMINING ATTORNEY

SN 77-007,574. KABUSHIKI KAISHA SONY COMPUTER ENTERTAINMENT, TA SONY COMPUTER ENTERTAINMENT INC., TOKYO 107-0062, JAPAN, FILED 9-26-2006.

PLAYSTATION TV 

OWNER OF U.S. REG. NOS. 3,005,280, 3,024,900 AND 3,043,105.

NO CLAIM IS MADE TO THE EXCLUSIVE RIGHT TO USE "TV", APART FROM THE MARK AS SHOWN.

THE MARK CONSISTS OF THE WORDS "PLAYSTATION TV" AND RECTANGULAR DESIGN.

CLASS 9—ELECTRICAL AND SCIENTIFIC APPARATUS

FOR ACCELEROMETERS; ACCUMULATORS AND BATTERIES; ADAPTER PLUGS; ELECTRICITY ADAPTERS; AERONAUTICAL RADIO COMMUNICATION MACHINES AND APPARATUS; ALARM CENTRAL UNITS; ALTIMETERS; AMMETERS; AMPLIFIERS AND THEIR PARTS; ANGULAR SENSORS FOR REMOTE CONTROLLER; ANTENNAS FOR TELEVISION; ANTENNAS FOR WIRELESS COMMUNICATIONS APPARATUS; APPARATUS FOR RECORDING, TRANSMISSION OR REPRODUCTION OF SOUND AND IMAGES; APPARATUS FOR TRANSMISSION OF COMMUNICATION; APPARATUS FOR TRANSMITTING AND REPRODUCING SOUND OR IMAGES; AUDIO FREQUENCY APPARATUS, NAMELY, PUBLIC-ADDRESS SYSTEMS, JUKE BOXES, TAPE RECORDERS, ELECTRIC PHONOGRAPHS, RECORD PLAYERS, SOUND RECORDING APPARATUS; AUDIO-VIDEO COMPACT DISCS FEATURING MUSIC ENTERTAINMENT FILMS, ANIMATION AND COMPUTER GAMES; AUDIO-VIDEO RECEIVERS; AUTOMATIC ALTITUDE INDICATORS; AUTOMATIC CONTROL MACHINES AND INSTRUMENTS, NAMELY, AUTOMATIC TEMPERATURE CONTROL MACHINES AND INSTRUMENTS, AUTOMATIC CALORIE CONTROL MACHINES AND INSTRUMENTS, PROGRAM CONTROL MACHINES AND INSTRUMENTS; AUTOMATIC SWITCHING APPARATUS FOR TELECOMMUNICATION; AUTOMATIC TELEPHONE EXCHANGES; AUTOTRANSFORMERS; BAGS FOR CAMERAS AND PHOTOGRAPHIC EQUIPMENT; BAR-CODE SCANNERS; BATTERY CASES; BATTERY CHARGE DEVICES; BICYCLE SPEEDOMETERS; BINOCULARS; BLANK AUDIO TAPES; BLANK CD-ROMS FOR SOUND OR VIDEO RECORDING; BLANK OPTICAL DISCS; BLANK VIDEO TAPES; BROADCAST SATELLITE DOWNLINK TERMINALS; BROADCASTING APPARATUS, NAMELY, TELEVISION RECEIVERS, TELEVISION TRANSMITTERS, RADIO RECEIVERS, RADIO TRANSMITTERS; BROADCASTING SATELLITE TUNERS; CD PLAYERS; CD RECORDERS AND THEIR EXCLUSIVE CONTROLLERS; CD-ROMS (COMPACT DISC ROMS) ENCODED WITH VIDEO GAME PROGRAMS FOR PERSONAL OR BUSINESS USE; CABLES AND FIBERS FOR THE TRANSMISSION OF SOUNDS AND IMAGES; CABLES FOR OPTICAL SIGNAL TRANSMISSION; CAMERA CASES; CAMERA CONTAINING A LINEAR IMAGE SENSOR; CAMERA HOODS; CAMERAS; CAR AERIALS; CARD READERS FOR CREDIT CARDS; CARDS WITH INTEGRATED CIRCUITS; CASES FOR COMPACT DISKS AND OPTICAL DISCS; CASES FOR MOBILE PHONES; CELLULAR TELEPHONE APPARATUS; CENTRAL PROCESSING UNITS FOR PROCESSING INFORMATION, DATA, SOUND OR IMAGES; CHIP CARD READERS; ENCODED ELECTRONIC CHIP CARDS CONTAINING PROGRAMMING USED FOR CONTROLLING ACCESS TO PAY-TV AND VIDEO ON DEMAND CHANNELS; CINEMATOGRAPHIC APPARATUS AND INSTRUMENTS, NAMELY, MOVIE FILM PROJECTORS, TRANSPARENT SHEETS FOR OVERHEAD PROJECTORS, MOVIE FILM PROCESSING AND FINISHING APPARATUS, CINEMATOGRAPHIC CAMERAS, PROJECTION SCREENS FOR MOVIE FILMS, MOVIE FILM EDITING MACHINES, SOUND RECORDING APPARATUS FOR MOVIES; CIRCUIT BOARDS PROVIDED WITH INTEGRATED CIRCUITS; COIN COUNTING OR SORTING MACHINES; COLOR PRINTERS; COMPACT DISC PLAYERS; COMPUTER APPLICATION SOFTWARE FOR MOBILE PHONES; COMPUTER BASED APPARATUS AND SOFTWARE FOR CREATING, SCANNING, DISPLAYING, ANALYZING, EDITING, PROCESSING, RECORDING, TRANSMITTING, AND PRINTING DIGITAL IMAGES, NAMELY, DIGITAL COLOR PRINTERS, DIGITAL INPUT AND OUTPUT SCANNERS, OPTICAL SCANNERS, SCANNERS, DIGITAL CAMERAS, DIGITAL CAMERAS, DIGITAL SIGNAL PROCESSORS, DIGITAL TRANSMITTERS, COMPUTER SOFTWARE FOR ORGANIZING AND VIEWING DIGITAL IMAGES AND PHOTOGRAPHS, COMPUTER PROGRAMS FOR EDITING IMAGES, COMPUTER SOFTWARE FOR USE IN RELATION TO DIGITAL SPECIAL EFFECTS OF IMAGES,

SOFTWARE FOR PROCESSING IMAGES, GRAPHICS AND TEXT AND COMPUTER SOFTWARE FOR THE INTEGRATION OF TEXT, AUDIO, GRAPHICS, AND STILL IMAGES; COMPUTER BASED APPARATUS FOR DESIGNING THE LAYOUT OF ELECTRONIC CIRCUITS; COMPUTER HARD DISC DRIVES; COMPUTER MOUSE; COMPUTER NETWORK HUBS, SWITCHES AND ROUTERS; COMPUTER PROGRAMS FOR CONSUMER VIDEO GAME MACHINES; COMPUTER PROGRAMS FOR DOCUMENT MANAGEMENT; COMPUTER PROGRAMS FOR EDITING IMAGES, SOUND AND VIDEO; COMPUTER SOFTWARE FEATURING DOWNLOADABLE IMAGES AND CHARACTER DATA OF MAGAZINES AND BOOKS FEATURING MUSIC, VIDEO GAMES OR MOTION PICTURES, NEWSPAPERS, MAPS, PICTURES AND DRAWINGS; COMPUTER SOFTWARE FOR CONTROLLING AND MANAGING ACCESS SERVER APPLICATIONS; COMPUTER SOFTWARE FOR CONTROLLING SELF-SERVICE TERMINALS; COMPUTER SOFTWARE FOR CREATING AND DISPLAYING COMPUTER GRAPHICS; COMPUTER SOFTWARE FOR DOCUMENT IMAGING AND SCANNING, DOCUMENT IMAGE PROCESSING, DOCUMENT IMAGE MANAGEMENT, REPORT GENERATION, DOCUMENT INDEXING AND DATABASE MANAGEMENT; COMPUTER SOFTWARE FOR ENCRYPTION; COMPUTER SOFTWARE FOR ORGANIZING AND VIEWING DIGITAL IMAGES AND PHOTOGRAPHS; COMPUTER SOFTWARE FOR PROCESSING, TRANSMISSION AND GROUPING TEXT DATA, SOUND DATA AND IMAGE DATA; COMPUTER SOFTWARE FOR USE IN RELATION TO DIGITAL ANIMATION AND SPECIAL EFFECTS OF IMAGES; COMPUTERS; CONNECTING ELECTRICAL CABLES; CONNECTION CABLES; CONNECTORS FOR ELECTRONIC CIRCUITS; CONSUMER VIDEO GAME MACHINES ADAPTED FOR USE WITH TELEVISION RECEIVERS ONLY; CONSUMER VIDEO GAME PROGRAMS; CONTACT LENSES; CONTROLLERS, JOYSTICKS, MEMORY CARDS AND VOLUME CONTROLLERS FOR PERSONAL COMPUTERS; CONTROLLERS, JOYSTICKS, MEMORY CARDS, VOLUME CONTROLLERS AND MICE FOR CONSUMER VIDEO GAME MACHINES; DVD DRIVES; DVD PLAYERS AND THEIR EXCLUSIVE CONTROLLERS; DVD RECORDERS AND THEIR EXCLUSIVE CONTROLLERS; DVD VIDEO RECORDERS AND THEIR EXCLUSIVE CONTROLLERS; DVD-ROM PLAYERS AND THEIR EXCLUSIVE CONTROLLERS; DEVICES FOR HANDS-FREE USE OF MOBILE PHONES; DEVICES FOR WIRELESS RADIO TRANSMISSION; DIGITAL CAMERAS; DIGITAL COLOR PRINTERS; DIGITAL STILL CAMERAS; DIGITAL VERSATILE DISC ROMS (DVD-ROMS) ENCODED WITH VIDEO GAME PROGRAMS FOR PERSONAL OR BUSINESS USE; DOWNLOADABLE ELECTRONIC PUBLICATIONS IN THE NATURE OF TEXTBOOKS, ACTIVITY BOOKS, STORY BOOKS, PUZZLE BOOKS, MANUALS, POSTERS AND EDUCATIONAL BOOKLETS IN THE FIELD OF VIDEO GAMES AND THEIR SOFTWARE; DOWNLOADABLE GAME PROGRAMS FOR CELLULAR PHONES VIA THE INTERNET; DOWNLOADABLE GAME PROGRAMS VIA PERSONAL DIGITAL ASSISTANTS; DOWNLOADABLE IMAGE AND CHARACTER DATA OF MAGAZINES AND BOOKS FEATURING MUSIC, VIDEO GAMES OR MOTION PICTURES, NEWS PAPERS, MAPS, PICTURES AND DRAWINGS; DOWNLOADABLE RING TONES, GRAPHICS AND MUSIC VIA A GLOBAL COMPUTER NETWORK AND WIRELESS DEVICES; DOWNLOADABLE VIDEO GAME PROGRAMS FOR CONSUMER VIDEO GAME MACHINES; DOWNLOADABLE VIDEO IMAGES, DOWNLOADABLE VIDEO RECORDINGS FEATURING IMAGES OF VIDEO GAMES; DRY CELLS; EAR PLUGS FOR SLEEPING; EARPHONES; ELECTRIC CABLES; ELECTRIC CONNECTORS; ELECTRIC DIODES; ELECTRIC FLAT IRONS FOR HOUSEHOLD USE; ELECTRIC HAIRCURLERS FOR HOUSEHOLD USE; ELECTRIC NAVIGATIONAL INSTRUMENTS; ELECTRIC PLUGS; ELECTRIC POCKET TRANSLATORS; ELECTRIC WIRES; ELECTRONIC AND MAGNETIC ID CARDS FOR USE IN CONNECTION WITH PAYMENT FOR SERVICES; ELECTRONIC CARD READERS; ELECTRONIC CARDS FOR PROCESSING IMAGES; ELECTRONIC CIRCUIT BOARDS ENCODED WITH COMPUTER PROGRAMS FOR ENCRYPTING OR DECRYPTING INFORMATION DATA; ELECTRONIC CIRCUIT BOARDS ENCODED WITH VIDEO GAME PROGRAMS FOR BUSINESS USE; ELECTRONIC CIRCUITS RECORDING PROGRAMS FOR AMUSEMENT APPARATUS FOR USE WITH LI-

QUID CRYSTAL SCREENS; ELECTRONIC INTEGRATED CIRCUITS, CD-ROMS AND OTHER MEMORY MEDIUM RECORDED PROGRAMS, NAMELY, COMPUTER GAME PROGRAMS, FOR HAND-HELD GAMES WITH LIQUID CRYSTAL DISPLAYS; ELECTRONIC PAYMENT TERMINAL; ELECTRONIC PUBLICATIONS, NAMELY, MANUALS FOR VIDEO GAME MACHINES AND MAGAZINES FOR VIDEO GAMES RECORDED ON COMPUTER MEDIA; ELECTRONIC TAGS FOR ELECTRONIC DISCERNMENT; ENCRYPTING AND MICRO PROGRAMMING DEVICES FOR INFORMATION PROCESSING MACHINES, NAMELY, COMPUTERS AND COMPUTER PERIPHERALS; EYEGLASSES; FILM CAMERAS; FLASH LAMPS FOR CAMERAS; FLIGHT SIMULATORS FOR AIRCRAFT; FREQUENCY-CARRIER APPARATUS, NAMELY, AUDIO FREQUENCY TRANSMISSION APPARATUS, CABLE-TYPE FREQUENCY-CARRIER APPARATUS, POWER-LINE-TYPE FREQUENCY-CARRIER APPARATUS, OPEN-WIRE-TYPE FREQUENCY-CARRIER APPARATUS, CARRIER-FREQUENCY REPEATERS; GAME PROGRAMS FOR HAND-HELD GAMES WITH LIQUID CRYSTAL DISPLAYS; GATEWAY ROUTERS IN THE NATURE OF COMPUTER CONTROL HARDWARE; GOGGLES FOR SPORTS; HAND SCANNERS; COMPUTER HARD DISC DRIVE RECORDERS; COMPUTER HARD DISC DRIVE VIDEO RECORDERS; HEADPHONES; COMPUTER HARDWARE, NAMELY, INFORMATION GATHERING TERMINALS WITH FUNCTION OF PRESERVING DATA MEASURED BY REMOTE WATCHING AND OF TRANSMITTING THE PRESERVED DATA COMPLYING WITH DEMANDS, INFORMATION PROVIDING DEVICES, NAMELY, ENCRYPTING AND MICRO PROGRAMMING DEVICES FOR INFORMATION PROCESSING MACHINES; COMPUTERIZED INFORMATION TERMINALS WITH FUNCTION OF DATA COMMUNICATION BETWEEN COMPUTERS AND CONSUMER VIDEO GAME MACHINES; INTEGRATED CIRCUITS FOR IMAGE PROCESSING; INTERACTIVE MULTIMEDIA COMPUTER GAME PROGRAM; INTERACTIVE VIDEO GAME PROGRAMS; INTERACTIVE VIDEO GAMES OF VIRTUAL REALITY COMPRISED OF COMPUTER HARDWARE AND SOFTWARE; INTERFACE CARDS FOR DATA PROCESSING EQUIPMENT IN THE FORM OF PRINTED CIRCUITS; INTERFACE CIRCUITS FOR VIDEO CAMERAS; KEYBOARDS FOR COMPUTERS; LCD DISPLAY SCREENS FOR COMPUTERS; LARGE SCALE INTEGRATED CIRCUITS; LENS FILTERS FOR CAMERAS; LIFE BELTS; LIFE JACKETS; LIGHT PENS; LOUDSPEAKERS; MP3 PLAYERS; MAGNETIC CORES; MAGNETIC OPTICAL DISCS ENCODED WITH VIDEO GAME PROGRAMS FOR PERSONAL OR BUSINESS USE; METRONOMES; MICROCHIP CARDS; MICROPHONES FOR TELECOMMUNICATION APPARATUS; MICROWAVE ANTENNA; MICROWAVE TRANSMISSION APPARATUS FOR DELIVERING RADIO PROGRAMS AND MESSAGES; MOBILE PHONE STRAPS; MOBILE TELEPHONE APPARATUS WITH BUILT-IN FACSIMILE SYSTEMS; MOBILE TELEPHONE BATTERIES; MOBILE TELEPHONES; MODEMS FOR COMPUTERS; MOTION-PICTURE CAMERAS FOR SELF-DEVELOPING FILM; MOUSE PADS FOR COMPUTERS; MULTIFUNCTION KEYBOARDS; MUSIC-COMPOSITION SOFTWARE; NAVIGATION APPARATUS FOR VEHICLES IN THE NATURE OF ON-BOARD COMPUTERS; NICKEL-CADMIUM STORAGE BATTERIES; OPTICAL CABLES; OPTICAL DISC DRIVES; OPTICAL DISC PLAYERS AND THEIR EXCLUSIVE CONTROLLERS; OPTICAL DISC RECORDERS AND THEIR EXCLUSIVE CONTROLLERS; OPTICAL DISCS ENCODED WITH ASSEMBLERS, COMPILERS, AND COMPUTER PROGRAMS FOR SOFTWARE DEVELOPMENT AND COMPUTER PROGRAMMING IN THE NATURE OF VIDEO GAME AND VIDEO GAME SOFTWARE; OPTICAL DISCS ENCODED WITH VIDEO GAME PROGRAMS FOR PERSONAL OR BUSINESS USE; OPTICAL DISCS RECORDED COMPUTER PROGRAMS FOR VIDEO AND COMPUTER GAMES; OPTICAL DISK READERS; PARTS AND ACCESSORIES FOR ELECTRIC COMMUNICATION APPARATUS AND INSTRUMENTS, NAMELY, ANTENNAS, CABINETS LOUD SPEAKERS, ELECTRIC COILS FOR ELECTRICAL COMMUNICATION APPARATUS, MAGNETIC TAPE ERASERS, MAGNETIC TAPE CLEANERS, MAGNETIC HEAD ERASERS, MAGNETIC HEAD CLEANERS, LOUDSPEAKERS, ELECTRICAL CONNECTORS FOR ELECTRICAL COMMUNICATION APPARATUS, ELECTRIC COMMUNICATION APPARATUS SUPPORTING FRAMES, DIALS FOR ELECTRIC COMMUNICA-

TION APPARATUS, CAPACITORS FOR ELECTRICAL COMMUNICATION APPARATUS, FUSES FOR ELECTRICAL COMMUNICATION APPARATUS, RESISTORS FOR ELECTRICAL COMMUNICATION APPARATUS, BLANK VIDEO TAPES, PILOT LAMPS FOR ELECTRICAL COMMUNICATION APPARATUS, ELECTRICAL PHONOMOTORS, TRANSFORMERS FOR ELECTRICAL COMMUNICATION APPARATUS, VOLTAGE SURGE PROTECTORS FOR ELECTRICAL COMMUNICATION APPARATUS, MICROPHONES FOR ELECTRICAL COMMUNICATION APPARATUS, BLANK RECORDABLE DISCS, EXTENDED PLAY RECORDS FEATURING GAME MUSIC AND FILM MUSIC; PERSONAL DIGITAL ASSISTANTS AND THEIR PARTS AND FITTINGS; PERSONAL COMPUTERS; PERSONAL HEADPHONES FOR USE WITH SOUND TRANSMITTING SYSTEMS; PHOTO-COPYING MACHINES; PHOTOGRAPH MACHINES AND INSTRUMENTS EQUIPPED WITH COMPUTER BASED IMAGE PROCESSING DEVICES; PLUG CONNECTORS; PLUG-IN CONNECTORS; POCKET TRANSLATORS, ELECTRONIC; POCKET-SIZED ELECTRONIC CALCULATORS; PORTABLE VIDEO CAMERAS WITH BUILT-IN VIDEOCASSETTE RECORDERS; POWER AMPLIFIERS; POWER SWITCHES; PRE-RECORDED DVDS FEATURING CINEMA AND MUSIC; PRE-RECORDED COMPACT DISCS FEATURING MUSIC; PROGRAMS FOR PERSONAL DIGITAL ASSISTANTS; RADIO RECEIVERS AND MONITORS FOR REPRODUCTION OF SOUND AND SIGNALS; RADIO SETS; RADIO TRANSMITTERS AND RECEIVERS FOR REMOTE CONTROLS, RADIO CONTROLS; RECEIVERS FOR RECEIVING CABLE TELEVISION; RECEIVERS FOR SATELLITES; RECORDED COMPACT DISCS FEATURING MUSIC; RECORDED DVD-ROMS FEATURING MUSICAL ENTERTAINMENT FILMS, ANIMATION AND COMPUTER GAMES; RECORDED VIDEO DISCS AND TAPES FEATURING MUSICAL ENTERTAINMENT FILMS, ANIMATION AND COMPUTER GAMES; REFRACTOMETERS; REGULATORS FOR USE IN SCUBA DIVING; REMOTE CONTROL TELEMETERING APPARATUS; SHIELD CASES FOR MAGNETIC DISKS; SHOES FOR PROTECTION AGAINST ACCIDENTS AND FIRE; SHORT RANGE RADIOS; SHUTTERS FOR CAMERAS; SIDE GUARDS FOR EYEGLASSES; SILICON CARBIDE DIODES; SINGLE USE CAMERAS WITH UNEXPOSED PHOTOGRAPHIC FILM AND FITTINGS THEREOF; SINGLE-CHANNEL RADIO COMMUNICATION MACHINES AND APPARATUS FOR FIXED STATIONS; SKI GOGGLES; SOFTWARE FOR OPTICAL CHARACTER RECOGNITION; SOFTWARE FOR PROCESSING IMAGES, GRAPHICS AND TEXT; SOFTWARE FOR THE OPERATIONAL MANAGEMENT OF PORTABLE MAGNETIC AND ELECTRONIC CARDS; SOFTWARE TO CONTROL AND IMPROVE AUDIO EQUIPMENT SOUND QUALITY; SOUND AMPLIFIERS; SOUND MIXERS WITH INTEGRATED AMPLIFIERS; SOUND RECORDED OPTICAL DISCS FEATURING MUSIC AND SPECIAL EFFECTS; STRAPS FOR CELLULAR PHONES; SWIMMING GOGGLES; TELEPHONE APPARATUS, NAMELY, INTERCOMS, AUTOMATIC SWITCHING APPARATUS FOR TELECOMMUNICATION, MANUAL SWITCHING APPARATUS FOR TELECOMMUNICATION, TELEPHONE SETS; TELEPHONE TERMINALS; TELEPHONES; TELESCOPES; TELEVISION APPARATUS FOR PROJECTION PURPOSES; TELEVISION DECODER; TELEVISION MONITORS; TELEVISION RECEIVERS; TIME AND DATE STAMPING MACHINES; TIMERS; TOUCH PADS; TRIPODS FOR CAMERAS; VENDING MACHINES, NAMELY, AUTOMATIC DISTRIBUTION MACHINES; VIDEO CAMERAS; VIDEO FREQUENCY APPARATUS, NAMELY, VIDEO CAMERAS, VIDEODISC PLAYERS, VIDEOTAPE RECORDERS; VIDEO GAME INTERACTIVE REMOTE CONTROL UNITS; VIDEO RECORDED OPTICAL DISCS; VIDEO RECORDED OPTICAL MAGNETIC DISCS; VIRTUAL REALITY GAME SOFTWARE; WATER SKI SAFETY VESTS; WET CELLS; WIRE COMMUNICATION APPARATUS, NAMELY, TELETYPEWRITERS, AUTOMATIC TELEGRAPH APPARATUS, PHOTOTELEGRAPHY APPARATUS, MANUAL TELEGRAPH APPARATUS, TRUNK EXCHANGE APPARATUS, FACSIMILE MACHINES; WORD PROCESSORS; DOWNLOADABLE IMAGES AND SOUND FOR GAMES AND KARAOKE; DOWNLOADABLE GAME PROGRAMS FOR HAND-HELD GAMES WITH LIQUID CRYSTAL DISPLAY (U.S. CLS. 21, 23, 26, 36 AND 38).

CLASS 35—ADVERTISING AND BUSINESS

FOR ADDRESSING OF ENVELOPES; ADMINISTRATION OF A DISCOUNT PROGRAM FOR ENABLING PARTICIPANTS TO OBTAIN DISCOUNTS ON GOODS AND SERVICES THROUGH USE OF A DISCOUNT MEMBERSHIP CARD; ADMINISTRATIVE ACCOUNTING; ADMINISTRATIVE PROCESSING OF PURCHASE ORDERS WITHIN THE FRAMEWORK OF SERVICES PROVIDED BY MAIL-ORDER COMPANIES; ADVERTISING AGENCIES; ADVERTISING AND BUSINESS MANAGEMENT CONSULTANCY; ADVERTISING AND COMMERCIAL INFORMATION SERVICES, VIA THE INTERNET; ADVERTISING BY TRANSMISSION OF ONLINE PUBLICITY FOR THIRD PARTIES THROUGH ELECTRONIC COMMUNICATIONS NETWORKS; ADVERTISING, PARTICULARLY SERVICES FOR THE PROMOTION OF GOODS; ADVERTISING SERVICES, FOR THIRD PARTIES, IN CONNECTION WITH THE COMMERCIALIZATION AND SALE OF PERFUMERY AND COSMETIC ARTICLES, PRODUCTS FOR HOUSEHOLD PURPOSES, OPTICAL PRODUCTS, CLOCKS AND TIMEPIECES, JEWELRY, FURNISHING ARTICLES; ADVERTISING, INCLUDING PROMOTION RELATING TO THE SALE OF ARTICLES AND SERVICES FOR THIRD PARTIES BY THE TRANSMISSION OF ADVERTISING MATERIAL AND THE DISSEMINATION OF ADVERTISING MESSAGES ON COMPUTER NETWORKS; ADVERTISING, SERVICES OF A RADIO AND TELEVISION ADVERTISING AGENCY; ADVICE AND INFORMATION ABOUT CUSTOMER SERVICES AND PRODUCT MANAGEMENT AND PRICES ON INTERNET SITES IN CONNECTION WITH PURCHASES MADE OVER THE INTERNET; ADVICE ON THE ANALYSIS OF CONSUMER BUYING HABITS AND NEEDS PROVIDED WITH THE HELP OF SENSORY, QUALITY AND QUANTITY-RELATED DATA; ADVICE RELATING TO THE ORGANIZATION AND MANAGEMENT OF BUSINESS; ADVISORY AND CONSULTANCY SERVICES RELATING TO EXPORT, EXPORT SERVICES, EXPORT PROMOTION INFORMATION AND SERVICES; ADVISORY SERVICE FOR ORGANIZATIONAL ISSUES AND BUSINESS ADMINISTRATION, WITH AND WITHOUT THE HELP OF ELECTRONIC DATA BASES; ADVISORY SERVICES RELATING TO BUSINESS MANAGEMENT AND BUSINESS OPERATIONS; ANALYSES AND APPRAISALS OF ENTERPRISES, ARRANGING AND CONDUCTING OF FAIRS AND EXHIBITIONS FOR BUSINESS AND ADVERTISING PURPOSES; ARRANGING AND CONDUCTION OF AUCTION SALES; ASSISTANCE IN BUSINESS MANAGEMENT AND PRODUCT COMMERCIALIZATION, WITHIN THE FRAMEWORK OF A FRANCHISE CONTRACT; ASSISTANCE IN MANAGEMENT OF BUSINESS ACTIVITIES; ASSISTANCE TO INDUSTRIAL OR COMMERCIAL ENTERPRISES IN THE RUNNING OF THEIR BUSINESS; AUCTIONING VIA TELECOMMUNICATION NETWORKS; BIDDING QUOTATION; BILL STICKING; AGENCY FOR MAIL ORDER OF GOODS ON THE INTERNET IN THE NATURE OF BOOKS, VIDEO GAMES, SOFTWARE FOR VIDEO GAMES AND MUSIC; PROVIDING INFORMATION ABOUT TRADING GOODS VIA THE INTERNET SHOPPING MALLS; PROVIDING INFORMATION ABOUT TRADING GOODS USING COMMUNICATION BY MOBILE PHONE TERMINALS OR ELECTRONIC COMPUTER TERMINALS; BUSINESS ADMINISTRATION CONSULTANCY; BUSINESS ADVICE AND ANALYSIS OF MARKETS; BUSINESS ADVICE AND COMMERCIAL INFORMATION; BUSINESS CONSULTATION AND MANAGEMENT REGARDING MARKETING ACTIVITIES AND LAUNCHING OF NEW PRODUCTS; BUSINESS INTERMEDIARY AND ADVISORY SERVICES IN THE FIELD OF SELLING PRODUCTS AND RENDERING SERVICES; BUSINESS MANAGEMENT ASSISTANCE TO INDUSTRIAL OR COMMERCIAL COMPANIES; BUSINESS MANAGEMENT CONSULTING WITH RELATION TO STRATEGY, MARKETING, PRODUCTION, PERSONNEL AND RETAIL SALE MATTERS; BUSINESS OPERATION, BUSINESS ADMINISTRATION AND OFFICE FUNCTIONS; CAREER PLACEMENT; CLERICAL WORK AGENCIES FOR APPLICATION OF DOMAIN NAMES; CLERICAL WORK AGENCIES FOR COMMODITY SALES BY TELEVISION, CATALOG, MAIL, COMPUTER, CABLE AND NETWORK; CLERICAL WORK AGENCIES FOR ISSUING AND SENDING BILLS OF DATABASE USE AND INTERNET ACCESS; CLERICAL WORK AGENCIES FOR ORDER, RECEPTION AND DELIVERY CONCERNING MAIL ORDER BY THE INTERNET OR TELEVISION BROADCASTING; CLERICAL WORK AGENCIES OF

MAIL ORDER VIA ONLINE OF BOOKS, MUSIC, GAMES, COMPUTER SOFTWARE, PORTABLE COMPUTERS, FITTINGS OF COMPUTERS AND PERIPHERALS OF COMPUTERS; COMMERCIAL INFORMATION AGENCIES, NAMELY, PROVIDING BUSINESS INFORMATION IN THE FIELD OF VIDEO GAME MACHINES AND THEIR SOFTWARE; COMPILATION AND PROVISION OF TRADE AND BUSINESS PRICE AND STATISTICAL INFORMATION; COMPILATION AND SYSTEMATIZATION OF INFORMATION IN DATABASES; COMPILATION OF INFORMATION INTO COMPUTER DATABASES; COMPUTERIZED ACCOUNTING SERVICES; COMPUTERIZED ON-LINE GIFT ORDERING SERVICE WHICH MATCHES THE GIFT GIVER'S REQUIREMENTS WITH THE GIFT RECIPIENT'S WANTS AND NEEDS; COMPUTERIZED ON-LINE ORDERING SERVICES IN THE FIELD OF VIDEO GAME APPARATUS FOR USE WITH TELEVISION RECEIVER ONLY AND THEIR SOFTWARE; COMPUTERIZED ONLINE ORDERING FEATURING GENERAL MERCHANDISE AND GENERAL CONSUMER GOODS; COMPUTERIZED WORD PROCESSING; CONDUCTING AN ON-LINE TRADESHOW EXHIBITION IN THE FIELD OF VIDEO GAME MACHINES; CONSULTANCY CONCERNING COMMODITY SALES OF TOYS, GAME ARTICLES, AND GAME MACHINES; COPYING OF DOCUMENTS FOR OTHERS; CREATING AND UPDATING ADVERTISING MATERIAL; CUSTOMER LOYALTY SERVICES AND CUSTOMER CLUB SERVICES FOR COMMERCIAL, PROMOTIONAL AND/OR ADVERTISING PURPOSES; DATA INPUT INTO A COMPUTER FILE; DATABASE MANAGEMENT; DEMONSTRATION OF GOODS AND SERVICES BY ELECTRONIC MEANS, ALSO FOR THE BENEFIT OF THE SO-CALLED TELESOPPING AND HOMESHOPPING SERVICES; DISSEMINATION OF ADVERTISING FOR OTHERS VIA AN ONLINE COMMUNICATIONS NETWORK ON THE INTERNET; DISTRIBUTION OF ADVERTISEMENTS AND COMMERCIAL ANNOUNCEMENTS; DOCUMENT REPRODUCTION; DUPLICATION OF DOCUMENTS; ELECTRONIC COMMERCE SERVICES, NAMELY, PROVIDING INFORMATION ABOUT PRODUCTS VIA TELECOMMUNICATION NETWORKS FOR ADVERTISING AND SALES PURPOSES; FOREIGN TRADE INFORMATION AND CONSULTATION; FRANCHISING, NAMELY, CONSULTATION AND ASSISTANCE IN BUSINESS MANAGEMENT, ORGANIZATION AND PROMOTION; GOODS IMPORT-EXPORT AGENCIES; HUMAN RESOURCES CONSULTATION; INFORMATION AND EXPERT OPINIONS RELATING TO COMPANIES AND BUSINESS; INFORMATION, ADVISORY AND CONSULTANCY SERVICES RELATING TO BUSINESS AND MANAGEMENT OR BUSINESS ADMINISTRATION, INCLUDING SUCH SERVICES PROVIDED ON LINE OR VIA THE INTERNET; INTERNET ADVERTISING; INVESTIGATION OF CONSUMER'S CONSIDERATION AND CONSUMPTION TREND BY COLLECTING AND ANALYZING KEY WORD INPUT TO THE INTERNET SEARCH ENGINE; INVOICING SERVICES; PROMOTING THE SALE OF GOODS AND SERVICES OF OTHERS BY ISSUANCE OF POINT IMPROVEMENT CARDS USED ON THE INTERNET; PROMOTING THE SALE OF GOODS AND SERVICES OF OTHERS BY ISSUANCE OF TRADING STAMPS TO ENABLE USERS TO OBTAIN DISCOUNTS ON GOODS AND SERVICES FROM PARTICIPATING MERCHANTS; ISSUANCE OF TRADING STAMPS TO ENABLE USERS TO OBTAIN DISCOUNTS ON GOODS AND SERVICES FROM PARTICIPATING MERCHANTS; KEYPUNCHING; LEASING OF OFFICE EQUIPMENT; MAILING LIST PREPARATION; MANAGEMENT AND COMPILATION OF COMPUTERIZED DATABASES; MANAGEMENT OF COMPUTERIZED FILES; MANAGEMENT ON BEHALF OF INDUSTRIAL AND COMMERCIAL ENTERPRISES IN TERMS OF SUPPLYING THEM WITH OFFICE REQUISITES; MANAGEMENT OR ARRANGEMENT OF INTERNET AUCTIONEERING; NEGOTIATION AND SETTLEMENT OF COMMERCIAL TRANSACTIONS FOR THIRD PARTIES; NEWS CLIPPING SERVICES; OFFICE MACHINES AND EQUIPMENT RENTAL; ON-LINE ADVERTISING ON COMPUTER COMMUNICATION NETWORKS; ON-LINE RETAIL STORE SERVICES FEATURING DOWNLOADABLE PRE-RECORDED MUSIC AND VIDEO; ON-LINE RETAIL STORE SERVICES FEATURING DOWNLOADABLE PRE-RECORDED VIDEO GAME SOFTWARE; ON-LINE TRADING SERVICES IN WHICH SELLER POSTS PRODUCTS TO BE AUCTIONED AND BIDDING IS DONE VIA THE INTERNET; ORGANIZATION AND

HOLDING OF FAIRS FOR COMMERCIAL OR ADVERTISING PURPOSES; ORGANIZATION OF INTERNET AUCTIONS; ORGANIZATION OF PROMOTIONS USING AUDIOVISUAL MEDIA; ORGANIZATION OF TRADE EXHIBITIONS FOR VIDEO GAME MACHINES AND THEIR SOFTWARE; ORGANIZATION, MANAGEMENT OR ARRANGEMENT OF TRADE EXHIBITIONS AND ONLINE RETAIL STORES FEATURING BOOKS, IMAGE-RECORDED VIDEO DISCS AND IMAGE-RECORDED VIDEO TAPES ON THE INTERNET; ORGANIZATION, MANAGEMENT OR PROMOTION OF EVENTS FOR SALES PROMOTION OF VIDEO GAME MACHINE AND THEIR SOFTWARE; PERSONNEL PLACEMENT AND RECRUITMENT; PRODUCTION OF RADIO COMMERCIALS; PRODUCTION OF TELEVISION COMMERCIALS; PROMOTING THE GOODS AND SERVICES OF OTHERS BY ARRANGING FOR SPONSORS TO AFFILIATE THEIR GOODS AND SERVICES WITH AN AWARDS PROGRAM, A SPORTS COMPETITION AND SPORTING ACTIVITIES; PROMOTING THE GOODS AND SERVICES OF OTHERS THROUGH ON-LINE ORDERING AND CATALOGING OF THOSE GOODS AND SERVICES; PROMOTING THE GOODS AND SERVICES OF OTHERS THROUGH THE DISTRIBUTION OF DISCOUNT CARDS; PROMOTING THE SALE OF GOODS AND SERVICES OF OTHERS BY AWARDED PURCHASE POINTS FOR CREDIT CARD USE; PROMOTION USING AUDIOVISUAL MEDIA; PROMOTION, ADVERTISING AND MARKETING OF ON-LINE WEBSITES; PROVIDING A SEARCHABLE ON-LINE ADVERTISING GUIDE FEATURING THE GOODS AND SERVICES OF OTHER ONLINE VENDORS ON THE INTERNET; PROVIDING AN ONLINE COMMERCIAL INFORMATION DIRECTORY ON THE INTERNET; PROVIDING AND RENTAL OF ADVERTISING SPACE ON THE INTERNET; PROVIDING BUSINESS INFORMATION, ALSO VIA INTERNET, THE CABLE NETWORK OR OTHER FORMS OF DATA TRANSFER; PROVIDING COMMERCIAL INFORMATION ON SALES OF HAND-HELD GAMES WITH LIQUID CRYSTAL DISPLAYS AND ELECTRONIC CIRCUITS AND CD-ROMS FEATURING PROGRAMS FOR HAND-HELD GAMES WITH LIQUID CRYSTAL DISPLAYS; PROVIDING COMMERCIAL INFORMATION ON SALES OF MEMORY MEDIA FEATURING GAMES; PROVIDING COMMERCIAL INFORMATION ON SALES OF SOUND-RECORDED CD, SOUND-RECORDED MAGNETIC TAPES, IMAGE-RECORDED VIDEO DISCS AND IMAGE-RECORDED VIDEO TAPES USING TELECOMMUNICATION LIKE THE INTERNET; PROVIDING COMMERCIAL INFORMATION ON TREND OF VIDEO GAME INDUSTRY AND COMPUTER GAME INDUSTRY; PROVIDING INFORMATION ON SALES VOLUME OR SALES RANKING OF VIDEO GAME SOFTWARE; PROVISION OF ADVERTISING SPACE BY ELECTRONIC MEANS AND GLOBAL INFORMATION NETWORKS; PUBLICITY AND SALES PROMOTION RELATING TO GOODS AND SERVICES, OFFERED AND ORDERED BY TELECOMMUNICATION OR THE ELECTRONIC WAY; RENTAL OF ADVERTISING SPACE ON WEB SITES; RENTAL OF OFFICE MACHINERY AND EQUIPMENT; RENTAL OF PHOTOCOPYING MACHINES; RENTAL OF VENDING MACHINES; RETAIL SHOP WINDOW DISPLAY ARRANGEMENT SERVICES; RETAIL STORE SERVICES FEATURING VIDEO GAME MACHINES AND THEIR SOFTWARE, INCLUDING OVER THE INTERNET; SUBSCRIPTION TO A TELEVISION CHANNEL; SUBSCRIPTIONS TO ELECTRONIC JOURNALS; SYSTEMIZATION AND COMPILATION OF INFORMATION INTO COMPUTER DATABASES; SYSTEMIZATION AND COMPILATION OF INFORMATION INTO DATABASES OF COMPUTERS AND CONSUMER VIDEO GAME MACHINES; TELEVISION ADVERTISING; THE BRINGING TOGETHER, FOR THE BENEFIT OF OTHERS, OF A VARIETY OF GOODS EXCLUDING THE TRANSPORT THEREOF, ENABLING CUSTOMERS TO CONVENIENTLY VIEW AND PURCHASE THOSE GOODS; WORD PROCESSING AND TYPING SERVICES; WORK ANALYSIS TO DETERMINE WORKER SKILL SETS AND OTHER WORKER REQUIREMENTS; ON-LINE RETAIL STORE SERVICES FEATURING DOWNLOADABLE SOUNDS AND IMAGES; PROVIDING A DATABASE IN THE FIELD OF ADVERTISING (U.S. CLS. 100, 101 AND 102).

CLASS 38—COMMUNICATION

FOR AUTOMATIC OPERATION TRANSMITTING OF DIGITAL DATA; BROADCAST OF CABLE TELEVISION PROGRAMS; BROADCASTING SERVICES AND PROVISION OF TELECOMMUNICATION ACCESS TO VIDEO AND AUDIO CONTENT PROVIDED VIA A VIDEO-ON-DEMAND SERVICE VIA THE INTERNET; CELLULAR TELEPHONE COMMUNICATION; COMMUNICATION BY ELECTRONIC COMPUTER TERMINALS; COMMUNICATION BY MOBILE TELEPHONE; COMMUNICATION VIA ANALOGUE AND DIGITAL COMPUTER TERMINALS; COMMUNICATION VIA RADIO, TELEGRAPH, TELEPHONE AND TELEVISION TRANSMISSIONS; COMMUNICATIONS BY TELEVISION FOR MEETING; COMPUTER AIDED TRANSMISSION OF MESSAGES AND IMAGES; DATA COMMUNICATION BY ELECTRONIC MAIL; DATA TRANSMISSION AND RECEPTION SERVICES VIA TELECOMMUNICATION MEANS; ELECTRONIC BULLETIN BOARD SERVICES FOR TRANSMISSION OF MESSAGES AMONG COMPUTER USERS IN THE FIELD OF GENERAL INTEREST; ELECTRONIC DATA INTERCHANGE; ELECTRONIC DATA TRANSMISSION; ELECTRONIC EXCHANGE OF DATA STORED IN DATABASES ACCESSIBLE VIA TELECOMMUNICATION; ELECTRONIC MAIL; INFORMATION ABOUT PROGRAM TABLES FOR TELEVISION BROADCASTING, CABLE RADIO BROADCASTING OR RADIO BROADCASTING; INFORMATION ABOUT TELEVISION BROADCASTING, CABLE RADIO BROADCASTING AND RADIO BROADCASTING; INFORMATION TRANSMISSION VIA ELECTRONIC COMMUNICATIONS NETWORKS; INTERNET CAFE SERVICES, NAMELY, PROVIDING TELECOMMUNICATIONS CONNECTIONS TO THE INTERNET IN A CAFE ENVIRONMENT; LEASING OF TELECOMMUNICATIONS LINES; MAINTAINING AND MANAGING ELECTRONIC MAIL SERVERS; NEWS AGENCIES, NAMELY, THE TRANSMISSION OF NEWS ITEMS TO NEWS REPORTING ORGANIZATIONS; PROVIDING ACCESS TO TELECOMMUNICATION NETWORKS; PROVIDING CONNECT TERMINALS TO A GLOBAL COMPUTER NETWORK; PROVIDING MULTIPLE USE ACCESS TO GLOBAL COMPUTER INFORMATION NETWORKS FOR THE TRANSFER AND DISSEMINATION OF A WIDE RANGE OF INFORMATION; PROVIDING TELECOMMUNICATIONS CONNECTIONS TO A GLOBAL COMPUTER NETWORK; PROVIDING THIRD PARTY USERS WITH ACCESS TO TELECOMMUNICATION INFRASTRUCTURE; PROVIDING USER ACCESS TO A GLOBAL COMPUTER NETWORK; PROVISION OF ACCESS TO DATA OR DOCUMENTS STORED ELECTRONICALLY IN CENTRAL FILES FOR REMOTE CONSULTATION; PROVISION OF ACCESS TO ELECTRONIC SITES; RADIO BROADCASTING; RADIO BROADCASTING OF INFORMATION AND OTHER PROGRAMS; RENTAL OF APPARATUS FOR TRANSMITTING IMAGES; RENTAL OF MODEMS; RENTAL OF TELECOMMUNICATION EQUIPMENT INCLUDING TELEPHONES AND FACSIMILE APPARATUS; SATELLITE TELEVISION BROADCASTING; SATELLITE TRANSMISSION; SIGNAL TRANSMISSION FOR ELECTRONIC COMMERCE VIA TELECOMMUNICATION SYSTEMS AND DATA COMMUNICATION SYSTEMS; TRANSMISSION OF VOICE, DATA, GRAPHICS, SOUND AND VIDEO BY MEANS OF CONSUMER VIDEO GAME MACHINES, GAME MACHINES WITH LIQUID CRYSTAL DISPLAYS AND COMPUTER TERMINALS; TELECOMMUNICATION ROUTING AND JUNCTION SERVICES; TELECONFERENCE SERVICES; TELEVISION BROADCASTING; TELEVISION BROADCASTING SERVICES PROVIDED ON-LINE FROM A COMPUTER NETWORK; TRANSFER OF DATA BY TELECOMMUNICATIONS; TRANSMISSION OF DATA, SOUND AND IMAGES BY SATELLITE; TRANSMISSION OF DATABASE INFORMATION VIA TELECOMMUNICATIONS NETWORKS; TRANSMISSION OF INFORMATION BY ELECTRONIC COMMUNICATIONS NETWORKS; TRANSMISSION OF INFORMATION BY SATELLITE; TRANSMISSION OF INFORMATION IN THE AUDIO-VISUAL FIELD; TRANSMISSION OF INFORMATION ON OPTICAL TELECOMMUNICATION NETWORKS; TRANSMISSION OF INFORMATION THROUGH VIDEO COMMUNICATION SYSTEMS; TRANSMISSION OF MESSAGES AND PICTURES VIA COMPUTERS; TRANSMISSION OF NEWS; VIDEO-ON-DEMAND TRANSMISSION SERVICES; VIRTUAL CHAT ROOMS

ESTABLISHED VIA TEXT MESSAGING; WIRE SERVICE, NAMELY, TRANSMITTING OF NEWS (U.S. CLS. 100, 101 AND 104).

CLASS 40—MATERIAL TREATMENT

FOR DIGITAL IMAGE PROCESSING, NAMELY, DIGITAL IMAGE CORRECTION SERVICES OF VIDEOS (U.S. CLS. 100, 103 AND 106).

CLASS 41—EDUCATION AND ENTERTAINMENT

FOR AMUSEMENT PARKS; ARRANGEMENT OF TRAINING COURSES IN TEACHING INSTITUTES; ARRANGING AND CONDUCTING OF CONFERENCES; ARRANGING OF CONGRESSES; CONDUCTING CONGRESSES IN THE FIELD OF VIDEO GAMES; ARRANGING OF SEMINARS; CONDUCTING OF SEMINARS IN THE FIELD OF VIDEO GAMES; ARRANGING OF BEAUTY CONTESTS; ARRANGING OF CONTESTS; ARRANGING OF EXHIBITIONS; ARRANGING PROFESSIONAL WORKSHOP AND TRAINING COURSES IN THE FIELD OF VIDEO GAME; ART EXHIBITIONS; BEAUTY ARTS INSTRUCTION; BOOK AND REVIEW PUBLISHING; BOOK LOANING; BOOKING OF ENTERTAINMENT HALLS; BOOKING OF SEATS FOR SHOWS AND BOOKING OF THEATRE TICKETS; BOOKING OF SEATS FOR SHOWS BY ELECTRONIC TICKET SYSTEM; BOOKKEEPING INSTRUCTION; DIGITAL IMAGE PROCESSING; DIRECTION OF MAKING RADIO OR TELEVISION PROGRAMS; DIRECTION OR PRESENTATION OF PLAYS; DISCOTHEQUE SERVICES; DISTRIBUTION OF QUIZ PROGRAMS, PRIZE PROGRAMS, GAME PROGRAMS, AND VARIOUS ENTERTAINMENT PROGRAMS FOR TELEVISION PROGRAMS; DUBBING; DUBBING OF SOUND-RECORDED OR VIDEO-RECORDED DATA MEDIA; DUBBING OR EDITING OF VIDEO-RECORDED VIDEO TAPES; EDITING OR DUBBING OF SOUND-RECORDED MAGNETIC TAPES AND OPTICAL DISCS; EDITING OR RECORDING OF SOUNDS AND IMAGES; EDUCATIONAL EXAMINATION; ENTERTAINMENT SERVICES IN THE FIELD OF VIDEO GAMES, NAMELY, PROVIDING INFORMATION ON-LINE RELATING TO COMPUTER GAMES AND COMPUTER ENHANCEMENTS FOR GAMES; ENTERTAINMENT SERVICES, IN THE FIELD OF VIDEO GAMES, NAMELY, PROVIDING ON-LINE COMPUTER GAMES; FILM DISTRIBUTION; FILM PRODUCTION; ENTERTAINMENT SERVICES, NAMELY, PROVIDING AN ON-LINE COMPUTER GAME; GAME SERVICES USING COMMUNICATION PROVIDED ON-LINE FROM A COMPUTER NETWORK OR THE INTERNET; GARDENS FOR PUBLIC ADMISSION; INFORMATION ABOUT ARTICLES ON VIDEO GAMES AND COMPUTER GAMES PUBLISHED IN NEWSPAPERS, MAGAZINES, AND WEB SITES USING THE INTERNET WEB SITES, E-MAIL COMMUNICATION OR MAIL; INFORMATION ABOUT BOOKING OF SEATS FOR SHOWS USING HOMEPAGES AND ELECTRONIC BULLETIN BOARDS ACCESSED VIA COMPUTER TERMINAL COMMUNICATION OR CELLULAR PHONES; INFORMATION ABOUT EDUCATION; INFORMATION ABOUT GAME SERVICES, MUSIC SERVICES AND MOVIE SERVICES PROVIDED ON-LINE FROM COMPUTER NETWORKS; INSTRUCTION SERVICES IN THE FIELD OF VIDEO GAME MACHINES AND THEIR SOFTWARE, NAMELY, PROVIDING INSTRUCTION HOW TO PLAY; JUDO INSTRUCTION; MAGAZINE PUBLISHING; MEDICAL TRAINING AND TEACHING; MEDITATION TRAINING; MOBILE LIBRARY SERVICES; ENTERTAINMENT SERVICES, NAMELY, PROVIDING ON-LINE REVIEWS OF MOVIES; ENTERTAINMENT SERVICES, NAMELY, NON-DOWNLOADABLE PRE-RECORDED VIDEOS IN THE FIELD OF MUSIC, COMEDY, DRAMA, ACTION, ADVENTURE, AND ANIMATION VIA A GLOBAL COMPUTER NETWORK AND WIRELESS NETWORKS; MOVIE STUDIOS; ENTERTAINMENT SERVICES, NAMELY, PROVIDING PRE-RECORDED MUSIC ON-LINE VIA A GLOBAL COMPUTER NETWORK; ENTERTAINMENT SERVICES, NAMELY, NON-DOWNLOADABLE PRE-RECORDED MUSIC, VIA A GLOBAL COMPUTER NETWORK AND WIRELESS NETWORKS; NEWSPAPER PUBLISHING; OPERATING LOTTERIES; OPERATING OF FILM STUDIOS; OPERATION OF VIDEO EQUIPMENT OR AUDIO EQUIPMENT FOR PRODUCTION OF RADIO OR TELEVISION PRO-

GRAMS; ORGANIZATION OF GAMES; ORGANIZATION OF SPORTS EVENTS IN THE FIELD OF FOOTBALL; ORGANIZATION OF FASHION SHOWS; ORGANIZATION OF SPORTS COMPETITIONS IN THE FIELD OF SOCCER, BASE-BALL, TENNIS AND GOLF; ORGANIZATION AND ARRANGEMENT OF GAME SHOWS; ORGANIZATION AND ARRANGEMENT OF EDUCATIONAL WORK SYMPOSIUM CONCERNING PROGRAM DEVELOPMENT FOR COMPUTER GRAPHICS AND VIDEO GAMES; PHOTO EDITING; ON-LINE LIBRARY SERVICES, NAMELY, PROVIDING ELECTRONIC LIBRARY SERVICES WHICH FEATURE PHOTOGRAPHS AND PICTURES VIA AN ON-LINE COMPUTER NETWORK; PLANNING ARRANGEMENT OF SHOWING MOVIES, SHOWS, PLAYS OR MUSICAL PERFORMANCES; PRESENTATION OF MUSICAL PERFORMANCE; PRODUCTION OF RADIO OR TELEVISION PROGRAMS; PROVIDING AMUSEMENT ARCADE SERVICES; PROVIDING AMUSEMENT PARKS; PROVIDING AN ON-LINE COMPUTER DATABASE IN THE FIELD OF VIDEO GAME MACHINES AND THEIR SOFTWARE; PROVIDING ELECTRONIC PUBLICATIONS IN THE NATURE OF BOOKS AND MANUALS WHICH CARRY INFORMATION ON COMPUTER GAMES, SCIENCE FICTION, GAMES AND ENTERTAINMENT; PROVIDING ENTERTAINMENT INFORMATION IN THE FIELD OF VIDEO GAME MACHINES AND THEIR SOFTWARE; PROVIDING FACILITIES FOR MOVIES, SHOWS, PLAYS, MUSIC OR EDUCATIONAL TRAINING; PROVIDING NON-DOWNLOADABLE ON-LINE GAME PROGRAMS FOR HAND-HELD GAMES WITH LIQUID CRYSTAL DISPLAYS; PROVIDING INFORMATION ON-LINE RELATING TO COMPUTER GAMES AND COMPUTER ENHANCEMENTS FOR GAMES; PROVIDING ON-LINE COMPUTER GAME USING COMMUNICATION BY CONSUMER VIDEO GAME AND BY PERSONAL COMPUTER; PROVIDING ON-LINE PUBLICATIONS IN THE NATURE OF MAGAZINES, BOOKS IN THE FIELD OF VIDEO GAME, SCIENCE FICTION GAMES AND ENTERTAINMENT; PROVIDING NON-DOWNLOADABLE STILL PICTURES, ANIMATED CARTOONS, STILL PICTURES WITH VOICE, ANIMATED CARTOONS WITH VOICE AND PICTURES OF CHARACTERS BY INTERNET COMMUNICATION VIA CONSUMER VIDEO GAME MACHINES OR ARCADE VIDEO GAME MACHINES; PROVIDING NON-DOWNLOADABLE VIDEO IMAGES AND SOUNDS FOR KARAOKE BY COMPUTER TERMINAL COMMUNICATION; PROVIDING VIDEO IMAGES AND SOUNDS FOR KARAOKE BY COMPUTER TERMINAL COMMUNICATION; PROVIDING VIRTUAL REALITY GAME CENTER; PUBLICATION AND EDITING OF PRINTED MATTER FOR OTHERS; PUBLICATION OF BOOKS, OF MAGAZINES, OF JOURNALS, OF NEWSPAPERS, OF PERIODICALS, OF CATALOGS, OF BROCHURES; PUBLICATION OF ELECTRONIC BOOKS AND JOURNALS ON-LINE FROM A COMPUTER NETWORK; PUBLICATION OF ELECTRONIC MAGAZINES; PUBLICATION OF ELECTRONIC NEWSPAPERS ACCESSIBLE VIA A GLOBAL COMPUTER NETWORK; PUBLISHING OF ELECTRONIC PUBLICATIONS ABOUT THE FUTURE OF VIDEO GAME, CINEMA AND MUSIC; RENTAL OF AMUSEMENT MACHINES AND APPARATUS; RENTAL OF CAMCORDERS, RENTAL OF CAMERAS; RENTAL OF CINEMA FILMS; RENTAL OF CINEMATOGRAPHIC MACHINES AND APPARATUS; RENTAL OF CONSUMER VIDEO GAME MACHINES; RENTAL OF DIVING EQUIPMENT; RENTAL OF ELECTRONIC CIRCUITS, MAGNETIC DISCS, OPTICAL DISCS, MAGNETIC OPTICAL DISCS, CD-ROMS AND MAGNETIC TAPES RECORDED WITH VIDEO GAME PROGRAMS FOR PERSONAL USE; RENTAL OF GAME CARTRIDGES, ELECTRIC CIRCUITS, MAGNETIC DISCS, MAGNETIC TAPES, AND OPTICAL RECORDING MEDIA FEATURING GAME PROGRAMS; RENTAL OF GAME PROGRAMS FOR CONSUMER VIDEO GAME MACHINES; RENTAL OF IMAGE-RECORDED MAGNETIC TAPES; RENTAL OF MAGAZINES; RENTAL OF MOTION PICTURES; RENTAL OF MOVIE PROJECTORS; RENTAL OF PHONOGRAPHIC AND MUSIC RECORDINGS; RENTAL OF RADIO AND TELEVISION SETS; RENTAL OF RECORDS OR SOUND-RECORDED MAGNETIC TAPES; RENTAL OF SKI EQUIPMENT; RENTAL OF SKINDIVING EQUIPMENT; RENTAL OF SOUND RECORDINGS; RENTAL OF VIDEO CASSETTE RECORDERS; RENTAL OF VIDEO SCREENS; RENTAL OF VIDEOTAPES; TEACHING IN THE FIELD OF GAME; TELEVISION ENTERTAINMENT IN THE FIELD OF VIDEO GAMES; TENNIS INSTRUCTION; TRANSLATION; VI-

DEOTAPE EDITING; VIDEOTAPE FILM PRODUCTION; PROVIDING A DATABASE IN THE FIELD OF SPORTS, GAMES, MUSIC, EDUCATION AND CONSUMER VIDEO GAMES MACHINES (U.S. CLS. 100, 101 AND 107).

CLASS 42—SCIENTIFIC AND COMPUTER SERVICES

FOR AIRCRAFT DESIGN; CERTIFICATION OF THE INACCURACY OF SCALES; CHEMICAL, BIOCHEMICAL, BIOLOGICAL AND BACTERIOLOGICAL RESEARCH AND ANALYSIS; COMPUTER PROGRAMMING FOR OTHERS; COMPUTER SOFTWARE DESIGN FOR OTHERS; COMPUTER SOFTWARE DESIGN, COMPUTER PROGRAMMING, OR MAINTENANCE OF COMPUTER SOFTWARE FOR AMUSEMENT APPARATUS ADAPTED FOR USE WITH TELEVISION RECEIVERS ONLY; COMPUTER SOFTWARE DESIGN, COMPUTER PROGRAMMING, OR MAINTENANCE OF COMPUTER SOFTWARE FOR PROTECTING SECURITY OF COMPUTER NETWORKS BY DEFENDING THE SYSTEM FROM UNLAWFUL COMPUTER ACCESS; CONSULTANCY IN THE FIELD OF SOFTWARE DESIGN; CONSULTANCY PERTAINING TO PHARMACOLOGY; CREATION AND MAINTENANCE OF WEB SITES FOR OTHERS; CREATION OF CONTROL PROGRAMS FOR AUTOMATED MEASUREMENT, ASSEMBLY, ADJUSTMENT, AND RELATED VISUALISATION; CREATION OF CONTROL PROGRAMS FOR ELECTRIC OPERATION CONTROL AND DRIVE MODULES; DATA CONVERSION FROM PHYSICAL TO ELECTRONIC MEDIA; DATA CONVERSION OF COMPUTER PROGRAMS; DESIGN AND DEVELOPMENT OF INFORMATION AND DATA BASES; DESIGN AND DEVELOPMENT OF NETWORKS; DESIGN AND MAINTENANCE OF WEB SITES FOR THIRD PARTIES; DESIGN OF APPARATUS AND MACHINES FOR FILLING PURPOSES; DESIGN OF COMPUTER PROGRAMS AND SOFTWARE RELATING TO AIRCRAFT; DESIGN SKETCHING OF PACKAGING, CONTAINERS, DINERWARE AND TABLE UTENSILS; DESIGN, DEVELOPMENT AND IMPLEMENTATION OF SOFTWARE; DESIGN/PLANNING AND ENGINEERING OF COMPRESSED-AIR STATIONS; DESIGNING COMPUTER SOFTWARE FOR CONTROLLING SELF-SERVICE TERMINALS; DESIGNING OF CONSUMER VIDEO GAME MACHINES; DESIGNING OF MACHINES, APPARATUS, INSTRUMENTS OR SYSTEMS COMPOSED OF SUCH MACHINES, APPARATUS AND INSTRUMENTS; DEVELOPING COMPUTER PROGRAMS FOR ELECTRONIC CASH REGISTER SYSTEMS; DEVELOPING OF DRIVER AND OPERATING SYSTEM SOFTWARE; DEVELOPING PROGRAMS FOR SIMULATING EXPERIMENTS OR SERIES OF EXPERIMENTS IN A VIRTUAL OPTICAL LABORATORY; DEVELOPMENT OF SOFTWARE FOR SECURE NETWORK OPERATIONS; DEVELOPMENT OF TECHNOLOGIES FOR THE FABRICATION OF CIRCUITS FOR WIRELESS COMMUNICATION, ELECTRONIC DATA PROCESSING, CONSUMER ELECTRONIC, AUTOMOTIVE ELECTRONICS; DEVELOPMENT, MAINTENANCE AND UPDATING OF A TELECOMMUNICATION NETWORK SEARCH ENGINE; DEVELOPMENT, UPDATING AND MAINTENANCE OF SOFTWARE AND DATA BASES; DUPLICATION OF COMPUTER PROGRAMS; GEOLOGICAL SURVEYS OR RESEARCH; IMAGE PROCESSING SOFTWARE DESIGN; INFORMATION PROCESSING BY COMPUTER, NAMELY, CONVERSION OF DATA OR DOCUMENTS FROM PHYSICAL TO ELECTRONIC MEDIA; INSTALLATION OF COMPUTER SOFTWARE; LITIGATION CONSULTANCY; MAINTENANCE OF COMPUTER SOFTWARE USED FOR OPERATING FILLING APPARATUS AND MACHINES; MARINE, AERIAL AND LAND SURVEYING; PROGRAMMING OF MULTIMEDIA APPLICATIONS; PROVIDING ELECTRONIC VERIFICATION OF ON-LINE ORDERS OF DIGITAL CONTENT AND GENERATING ELECTRONIC PERMISSION CODES WHICH THEN ALLOW USERS TO ACCESS SAID DIGITAL CONTENT; PROVIDING INFORMATION RELATING TO LEGAL AFFAIRS; PROVIDING METEOROLOGICAL INFORMATION; RENTAL OF A DATABASE SERVER TO THIRD PARTIES; RENTAL OF APPLICATION SOFTWARE; RENTAL OF COMPUTERS; RENTAL OF LABORATORY APPARATUS AND INSTRUMENTS; RENTAL OF MAGNETIC TAPES, CD-ROMS AND DVD-ROMS ENCODED PROGRAMS FOR COMPUTER SYSTEM SECURITY FOR COMPUTERS AND FOR CONSUMER VIDEO GAMES; RENTAL OF

SERVER'S MEMORY; REPAIR OF DAMAGED COMPUTER PROGRAMS; SURVEYING; TOOL DESIGN; UPDATING OF COMPUTER PROGRAMS FOR THIRD PARTIES; WATER QUALITY CONTROL SERVICES; WORKING ON AND EVALUATION OF CHEMICAL ANALYSES; PROVIDING A DATABASE IN THE FIELD OF CONTROL OF COMPUTER HARDWARE USING TELEPHONES, CELLULAR PHONES, CONSUMER VIDEO MACHINES OR COMPUTER TERMINALS (U.S. CLS. 100 AND 101).

SN 77-007,944. WAVERLEY GLEN SYSTEMS LTD., VAUGHAN, ONTARIO, FILED 9-26-2006.

WAVERLEY GLEN



PRIORITY CLAIMED UNDER SEC. 44(D) ON CANADA APPLICATION NO. 1317886, FILED 9-25-2006, REG. NO. 756622, DATED 1-7-2010, EXPIRES 1-7-2025.

CLASS 43—HOTEL AND RESTAURANT SERVICES

FOR BOARDING FOR ANIMALS; BOOKING OF CAMPGROUND ACCOMMODATION; CAFE-RESTAURANTS; CATERING FOR THE PROVISION OF FOOD AND BEVERAGES; CHILD CARE SERVICES; COFFEEHOUSE AND SNACK-BAR SERVICES; FAST FOOD AND NON-STOP RESTAURANT SERVICES; GUESTHOUSE; HOTEL SERVICES; PROVIDING TEMPORARY ACCOMMODATION, NAMELY, OPERATION OF TOURIST HOMES; PREPARATION OF FOOD AND BEVERAGES; PRESCHOOLER AND INFANT CARE AT DAYCARE CENTERS; PROVIDING CONFERENCE ROOMS; PROVIDING FACILITIES FOR FAIRS AND EXHIBITIONS; PROVIDING FOODS AND BEVERAGES AT RESTAURANTS WITH THE INTERNET USE ENVIRONMENT; SERVING BEVERAGES, NAMELY, PROVIDING TEA, COFFEE, COCOA, CARBONATED DRINKS OR FRUIT JUICE BEVERAGES WHILE ALLOWING CUSTOMERS TO PLAY GAMES WITH INSTALLED VIDEO GAME MACHINES; PROVIDING TEMPORARY ACCOMMODATION; RESERVATION OF HOTEL ROOMS FOR TRAVELERS; RESERVATION OF RESTAURANTS; TEA ROOMS; TOURIST INNS (U.S. CLS. 100 AND 101).

CLASS 45—PERSONAL AND LEGAL SERVICES

FOR AUTHENTICATION, ISSUANCE AND VALIDATION OF DIGITAL CERTIFICATES; DAY AND NIGHT GUARDS; FASHION INFORMATION; FORTUNE-TELLING; FUNERAL SERVICE UNDERTAKING; HOROSCOPES; IDENTIFICATION VERIFICATION SERVICES, NAMELY, PROVIDING AUTHENTICATION OF PERSONAL IDENTIFICATION INFORMATION; IDENTIFICATION VERIFICATION SERVICES, NAMELY, PROVIDING AUTHENTICATION OF PERSONAL IDENTIFICATION INFORMATION VIA SECURE STORAGE AND TRANSMITTING SUCH INFORMATION VIA THE INTERNET; IDENTIFICATION VERIFICATION SERVICES, NAMELY, PROVIDING AUTHENTICATION OF PERSONAL IDENTIFICATION INFORMATION VIA SECURE STORAGE AND TRANSMITTING SUCH INFORMATION VIA THE INTERNET; INVESTIGATION OR SURVEILLANCE ON BACKGROUND PROFILES; MARRIAGE PARTNER INTRODUCTION OR DATING SERVICES; ON-LINE AUTHENTICATION OF USER IN ELECTRONIC COMMERCE FOR OTHERS; PERSONAL BODY GUARDING; PROVIDING GRAVE SPACES OR CHARNEL HOUSES; PROVIDING USER AUTHENTICATION SERVICES IN E-COMMERCE TRANSACTIONS; RENTAL OF ALTARS; SECURITY CONTROL OF PERSONS AND LUGGAGE IN AIRPORTS; SECURITY GUARDING FOR FACILITIES; LITIGATION CONSULTANCY AND PROVIDING INFORMATION RELATING TO LEGAL AFFAIR (U.S. CLS. 100 AND 101).
DAYNA BROWNE, EXAMINING ATTORNEY

CLASS 10—MEDICAL APPARATUS

FOR INVALID LIFTS, NAMELY, APPARATUS AND DEVICES FOR LIFTING AND MOVING MOBILITY IMPAIRED INDIVIDUALS, NAMELY, PORTABLE AND CEILING LIFTS, TRACKS FOR CEILING LIFTS, MOBILE FLOOR LIFTS AND SLINGS; TRANSFER AND REPOSITIONING PRODUCTS FOR USE WITH MEDICAL PATIENTS OR USE BY HANDICAPPED PERSONS, NAMELY, HANDLING BELTS, TRANSFER BOARDS, LOW FRICTION TURNING DISKS AND GLIDE SHEETS; BATH SAFETY EQUIPMENT SPECIALLY ADAPTED FOR USE BY MEDICAL PATIENTS OR HANDICAPPED PERSONS, NAMELY, BATH SEATS AND SHOWER SEATS; TOILET AIDS, NAMELY, TOILET SEATS AND TOILET SAFETY FRAMES FOR MEDICAL PATIENTS OR USE BY HANDICAPPED PERSONS (U.S. CLS. 26, 39 AND 44).
FIRST USE 9-18-2006; IN COMMERCE 9-18-2006.

CLASS 37—CONSTRUCTION AND REPAIR

FOR INSTALLATION AND SERVICING OF INVALID LIFTS, APPARATUS AND DEVICES FOR LIFTING AND MOVING MOBILITY IMPAIRED INDIVIDUALS, NAMELY, PORTABLE AND CEILING LIFTS, TRACKS FOR CEILING LIFTS, MOBILE FLOOR LIFTS AND SLINGS, TRANSFER AND REPOSITIONING PRODUCTS, NAMELY, HANDLING BELTS, TRANSFER BOARDS, LOW FRICTION TURNING DISKS AND GLIDE SHEETS, BATH SAFETY EQUIPMENT, NAMELY, BATH AND SHOWER SEATS, TOILET AIDS, NAMELY, TOILET SEATS AND TOILET SAFETY FRAMES FOR MEDICAL PATIENTS OR USE BY HANDICAPPED PERSONS (U.S. CLS. 100, 103 AND 106).
FIRST USE 9-18-2006; IN COMMERCE 9-18-2006.
MATTHEW EINSTEIN, EXAMINING ATTORNEY

SN 77-069,134. THE DANNON COMPANY, INC., WHITE PLAINS, NY. FILED 12-21-2006.

ONLY THE GOOD STUFF!

THE MARK CONSISTS OF STANDARD CHARACTERS WITHOUT CLAIM TO ANY PARTICULAR FONT, STYLE, SIZE, OR COLOR.

CLASS 29—MEATS AND PROCESSED FOODS

FOR YOGURT; YOGURT-BASED BEVERAGES; DAIRY-BASED SNACK FOODS EXCLUDING ICE CREAM, ICE MILK AND FROZEN YOGURT; DAIRY-BASED BEVERAGES; DAIRY PRODUCTS EXCLUDING ICE CREAM, ICE MILK AND FROZEN YOGURT (U.S. CL. 46).

CLASS 32—LIGHT BEVERAGES

FOR FRUIT-BASED BEVERAGES WITH YOGURT;
SMOOTHIES (U.S. CLS. 45, 46 AND 48).
DAVID YONTEF, EXAMINING ATTORNEY

SN 77-077,797. WHITEWATER LTD., TEL-AVIV, ISRAEL,
FILED 1-8-2007.

SN 77-076,060. RENTHAL LIMITED, STOCKPORT, CHE-
SIRE, ENGLAND, FILED 1-4-2007.

TWINRING

THE MARK CONSISTS OF STANDARD CHARACTERS
WITHOUT CLAIM TO ANY PARTICULAR FONT, STYLE,
SIZE, OR COLOR.

PRIORITY CLAIMED UNDER SEC. 44(D) ON ERP
CMNTY TM OFC APPLICATION NO. 005595608, FILED 1-
3-2007, REG. NO. 005595608, DATED 4-21-2009, EXPIRES 1-3-
2017.

OWNER OF U.S. REG. NO. 2,398,310.

CLASS 7—MACHINERY

FOR EXHAUST PIPES AND MUFFLERS; ENGINE
COMPONENTS FOR MOTORCYCLES EXCLUDING PIS-
TON RINGS, RIDER RINGS AND OTHER SEALING
DEVICES; PISTONS FOR VEHICLES (U.S. CLS. 13, 19, 21,
23, 31, 34 AND 35).

CLASS 12—VEHICLES

FOR BICYCLES AND STRUCTURAL PARTS THERE-
OF EXCLUDING PISTON RINGS, RIDER RINGS AND
OTHER SEALING DEVICES; MOTORCYCLES AND
STRUCTURAL PARTS THEREOF EXCLUDING PISTON
RINGS, RIDER RINGS AND OTHER SEALING DE-
VICES; TRICYCLES AND STRUCTURAL PARTS
THEREOF EXCLUDING PISTON RINGS, RIDER RINGS
AND OTHER SEALING DEVICES; MOTORIZED SCOO-
TERS AND STRUCTURAL PARTS THEREOF EXCLUD-
ING PISTON RINGS, RIDER RINGS AND OTHER
SEALING DEVICES; RECREATIONAL JET BOATS AND
STRUCTURAL PARTS THEREOF EXCLUDING PISTON
RINGS, RIDER RINGS AND OTHER SEALING DE-
VICES; HANDLE BARS AND HANDLES FOR BI-
CYCLES, MOTORCYCLES, TRICYCLES, MOTORIZED
SCOOTERS, RECREATIONAL JET BOATS, ALL-TER-
RAIN VEHICLES AND SNOWMOBILES; PARTS FOR
BICYCLES, MOTORCYCLES, TRICYCLES, MOTORIZED
SCOOTERS, RECREATIONAL JET BOATS, ALL TER-
RAIN VEHICLES AND SNOWMOBILES, NAMELY,
GRIPS, RIMS, SWINGING ARMS, CHAIN WHEELS,
SIDE PANELS, PROTECTION PADS, BRAKE PADS,
GEAR LEVERS, SUMP SHIELDS, BRACE-PADS, HAN-
DLE BAR CLAMPS, BRAKES, SUSPENSIONS, PINIONS,
SEATS, SUSPENSION SPRINGS, FAIRINGS IN THE
NATURE OF SPOILERS, BRAKE SHOES, HYDRAULICS
IN THE NATURE OF SHOCK ABSORBERS, CHAIN
LINKS, TRIPLE-TOP CLAMPS, BRAKE DISCS, TRAN-
SMISSIONS, CLUTCHES, FLY WHEELS, TANKS, CHAIN
GUIDES, BRAKE OR TRANSMISSION HYDRAULIC
LINES, TRANSMISSION SHAFTS, LEVERS FOR
BRAKES, LEVERS FOR CLUTCHES, FORKS, TIRES,
BRAKE OR TRANSMISSION CHAINS, WHEEL BEAR-
INGS, CHAIN ROLLERS, TWIST GRIPS, WHEELS,
FRAMES, SPROCKET CARRIERS, MUD GUARDS,
FOOT RESTS, SPINDLES, HUBS, AND SPOKES (U.S.
CLS. 19, 21, 23, 31, 35 AND 44).

ANDREA HACK, EXAMINING ATTORNEY



WHITE WATER

PRIORITY CLAIMED UNDER SEC. 44(D) ON ISRAEL
APPLICATION NO. 194856, FILED 10-24-2006, REG. NO.
194856, DATED 11-5-2008, EXPIRES 10-24-2016.

PRIORITY CLAIMED UNDER SEC. 44(D) ON ISRAEL
APPLICATION NO. 194857, FILED 10-24-2006, REG. NO.
194857, DATED 11-5-2008, EXPIRES 10-24-2016.

PRIORITY CLAIMED UNDER SEC. 44(D) ON ISRAEL
APPLICATION NO. 194858, FILED 10-24-2006, REG. NO.
194858, DATED 11-5-2008, EXPIRES 10-24-2016.

**CLASS 11—ENVIRONMENTAL CONTROL AP-
PARATUS**

FOR (BASED ON 1(B) AND (BASED ON 44(E)) WATER
TREATMENT INSTALLATIONS AND EQUIPMENT FOR
MUNICIPAL, INDUSTRIAL, AGRICULTURE, COM-
MERCIAL AND RESIDENTIAL APPLICATIONS,
NAMELY, FILTERING UNITS AND WATER FILTRA-
TION SYSTEMS COMPRISED OF WATER CONDI-
TIONERS AND GRANULAR ACTIVATED CARBON,
REVERSE OSMOSIS UNITS, ULTRAVIOLET WATER
STERILIZING UNITS, CHEMICAL FEED PUMPS, AIR
INJECTIONS UNITS AND ACID NEUTRALIZING
UNITS, ALL FOR PRODUCING POTABLE WATER
(U.S. CLS. 13, 21, 23, 31 AND 34).

CLASS 32—LIGHT BEVERAGES

FOR (BASED ON 1(B) AND (BASED ON 44(E)) AERA-
TED MINERAL WATER AND OTHER NON-ALCO-
HOLIC BEVERAGES, NAMELY, DRINKING WATER
(U.S. CLS. 45, 46 AND 48).

CLASS 35—ADVERTISING AND BUSINESS

FOR (BASED ON 1(B)) SUPPLY CHAIN MANAGE-
MENT; REMOTE DATA LOGGING, NAMELY, DATA
ENTRY; ALL FOR PRODUCING POTABLE WATER (U.S.
CLS. 100, 101 AND 102).

CLASS 40—MATERIAL TREATMENT

FOR (BASED ON 1(B) AND (BASED ON 44(E)) TREAT-
MENT OF WATER (U.S. CLS. 100, 103 AND 106).

**CLASS 42—SCIENTIFIC AND COMPUTER
SERVICES**

FOR (BASED ON 1(B)) REMOTE MONITORING OF
WATER TREATMENT PROCESSING APPARATUS FOR
PRODUCING POTABLE WATER (U.S. CLS. 100 AND
101).

KARANENDRA S. CHHINA, EXAMINING ATTORNEY

SN 77-084,428. DOWNRIGHT HEALTHY FOODS L.P., TORONTO, CANADA, FILED 1-17-2007.



PRIORITY CLAIMED UNDER SEC. 44(D) ON CANADA APPLICATION NO. 1329056, FILED 12-20-2006, REG. NO. TMA750245, DATED 10-14-2009, EXPIRES 10-14-2024.

NO CLAIM IS MADE TO THE EXCLUSIVE RIGHT TO USE "HEALTHY FOODS", APART FROM THE MARK AS SHOWN.

THE NAME(S), PORTRAIT(S), AND/OR SIGNATURE(S) SHOWN IN THE MARK DOES NOT IDENTIFY A PARTICULAR LIVING INDIVIDUAL.

THE MARK CONSISTS OF A PARTIAL CARICATURE OF A MAN, SHOWING HIS SHOULDERS AND HEAD, WEARING A HAT, ADJACENT TO THE CARICATURE IS THE WORDING "JOE'S" AND THE WORDING "DOWNRIGHT HEALTHY FOODS" ENCLOSED IN A RECTANGULAR CARRIER.

CLASS 29—MEATS AND PROCESSED FOODS

FOR DAIRY BASED BEVERAGES; EDIBLE NUTS, NAMELY, CANDIED NUTS, SHELLED NUTS, ROASTED NUTS AND PROCESSED NUTS; PROCESSED SALTED, UNSALTED AND FLAVORED NUTS; PROCESSED EDIBLE SEEDS; PROCESSED PUMPKIN AND SUNFLOWER SEEDS; DRIED FRUIT, DRIED FRUIT MIXES, DRIED FRUIT AND NUT MIXES, AND FRUIT CHIPS; TRAIL MIXES CONTAINING DRIED FRUITS, SEEDS AND NUTS; PRESERVED FRUITS; SUGARED FRUITS, NAMELY, CRYSTALLIZED FRUIT AND CANDIED FRUITS; DRIED PRUNES, DATES, RAISINS AND COCONUT; GLAZED FRUITS, GLAZED CHERRIES, JAMS AND JELLIES; SOUP MIXES; CONDIMENTS, NAMELY, PEPPER OIL; SAUCES, NAMELY, CRANBERRY SAUCE; SPREADS, NAMELY, CHEESE SPREADS, FRUIT-BASED SPREADS, VEGETABLE-BASED SPREADS, MEAT-BASED SPREADS, GARLIC-BASED SPREADS, HUMMUS; DIPS, NAMELY, BEAN DIP, DAIRY-BASED DIP, AND SNACK DIP; SNACK FOODS, NAMELY, POTATO CHIPS; BAKING GOODS, NAMELY, FRUIT-BASED FILLINGS FOR CAKES AND PIES; UNFLAVORED AND UNSWEETENED GELATINS; FROZEN ENTREES CONSISTING PRIMARILY OF MEAT, FISH, POULTRY OR VEGETABLES; FROZEN VEGETARIAN ENTREES CONSISTING PRIMARILY OF VEGETABLE-BASED ENTREES; FROZEN FRUITS AND VEGETABLES; PREPARED FOODS, NAMELY, PREPARED VEGETARIAN ENTREES CONSISTING PRIMARILY OF VEGETABLE-BASED ENTREES, PREPARED ENTREES CONSISTING PRIMARILY OF FISH, MEAT, POULTRY OR VEGETABLES; CANNED GOODS, NAMELY, CANNED VEGETABLES, CANNED FISH, CANNED FRUIT, AND CANNED COOKED MEAT; EDIBLE OILS FOR HUMAN CONSUMPTION; LENTILS; PULSES; PICKLED FRUITS AND VEGETABLES; PEANUT BUTTER AND NUT BUTTERS; SOY-BASED FOODS, NAMELY, SOY-BASED CHIPS, SOY-BASED FOOD BARS, SOY-BASED SNACK FOOD; BOUILLON CUBES; FRESH SALTED, UNSALTED AND FLAVORED NUTS; FRUIT BASED SNACK FOOD; POTATO CHIPS (U.S. CL. 46).

CLASS 30—STAPLE FOODS

FOR TEA-BASED BEVERAGES WITH FRUIT FLAVORING; COFFEE, COFFEE BEANS; COFFEE, ESPRESSO AND CAPPUCINO MIXES CONTAINING COFFEE POWDER; LOOSE AND BAGGED BLACK, GREEN AND HERBAL TEAS; CHOCOLATE COVERED NUTS; CONFECTIONERY, NAMELY, CHOCOLATE AND CANDY; SPICES AND SEASONINGS; CONDIMENTS, NAMELY, PEPPER SAUCE, KETCHUP, MUSTARD, MAYONNAISE, RELISH; SAUCES, NAMELY, CHILI SAUCE, HOT SAUCE, DIPPING SAUCES, BARBEQUE SAUCES, PIZZA SAUCE, FISH SAUCE, TOMATO SAUCE, TERIYAKI SAUCE, SOY SAUCE, TAMARI SAUCE, TARTAR SAUCE, STEAK SAUCE, AND READY-MADE SAUCES; VINEGAR, SALSA; UNCOOKED PASTA AND NOODLES, INCLUDING EGG NOODLES; SALAD DRESSINGS; SPREADS, NAMELY, COCOA SPREADS AND SPREADS CONTAINING CHOCOLATE AND NUTS; SNACK FOODS, NAMELY, PUFFED CORN SNACKS, SESAME STICKS, CRACKERS, WAFERS, CHEESE FLAVORED SNACKS, NAMELY, PUFFED CHEESE BALLS AND PUFFED RICE, CORN-BASED SNACKS, PRETZELS, COOKIES, BISCUITS, TORTILLA CHIPS, CORN CHIPS; CROUTONS; BAKING GOODS, NAMELY, CAKE MIXES, MUFFIN MIXES, BROWNIE MIXES, PASTRY MIXES, CHOCOLATE CHIPS, PEANUT BUTTER CONFECTIONERY CHIPS, CANDY MINTS, BAKING POWDER, BAKING SODA, CRUST MIXES FOR PIES, FRUIT JELLY POWDERS, GRAHAM CRACKER CRUMBS, CORN STARCH, VANILLA EXTRACTS USED AS A FLAVORING, YEAST, COCOA POWDER, FLOURS, AND WHITE, BROWN AND RAW SUGAR AND SUGAR SUBSTITUTES; BAKING GOODS, NAMELY, CANDY CAKE DECORATIONS; SYRUPS, NAMELY, CORN SYRUPS, MAPLE SYRUPS, PANCAKE SYRUPS, TABLE SYRUPS, TOPPING SYRUPS, MOLASSES, FLAVORING SYRUPS, CHOCOLATE SYRUPS; EXTRACTS, NAMELY, NATURAL AND ARTIFICIAL EXTRACTS USED AS A FLAVORING; FLAVORED AND SWEETENED GELATINS; MARSHMALLOWS; POPPED AND POPPING CORN OF VARIOUS FLAVORS, MICROWAVEABLE POPCORN, SEASONINGS FOR POPCORN; FROZEN ENTREES CONSISTING PRIMARILY OF PASTA OR RICE; PROCESSED GRAINS; PROCESSED CEREALS; ROLLED OATS AND OATMEAL; WHEAT GERM; RICE; PEANUT BRITTLE; HONEY; BREAD CRUMBS AND GRAHAM CRUMBS; READY TO EAT CEREALS; CEREAL DERIVED FOOD BARS; GRAVY MIXES AND BASES; CEREAL BASED SNACK FOOD; WHEAT BASED SNACK FOOD; RICE BASED SNACK FOOD (U.S. CL. 46).

CLASS 31—NATURAL AGRICULTURAL PRODUCTS

FOR EDIBLE NUTS, NAMELY, FRESH NUTS, RAW NUTS AND UNPROCESSED NUTS; UNPROCESSED EDIBLE SEEDS; UNPROCESSED GRAINS; UNPROCESSED CEREALS (U.S. CLS. 1 AND 46).

CLASS 32—LIGHT BEVERAGES

FOR NON-ALCOHOLIC BEVERAGES, NAMELY, CARBONATED BEVERAGES, BEVERAGES CONTAINING FRUIT JUICE, LOW CALORIE SOFT DRINKS, NON-ALCOHOLIC BEVERAGES WITH TEA FLAVOR, FRUIT JUICES, FRUIT DRINKS, VEGETABLE JUICES, VEGETABLE DRINKS, FRUIT AND VEGETABLE JUICES, FRUIT AND VEGETABLE DRINKS; BOTTLED WATER; BEVERAGE POWDERS AND CRYSTALS, NAMELY, USED IN THE PREPARATION OF FRUIT DRINKS; COLAS; SODAS IN THE NATURE OF SODA WATER, AND FLAVORED SODA WATER; CARBONATED AND NON-CARBONATED SOFT DRINKS; SYRUPS, NAMELY, SYRUPS FOR MAKING BEVERAGES; SOY-BASED BEVERAGES NOT BEING MILK SUBSTITUTES (U.S. CLS. 45, 46 AND 48).

CHRISTINA SOBRAL, EXAMINING ATTORNEY

SN 77-088,030. DOWNRIGHT HEALTHY FOODS L.P., TORONTO, CANADA, FILED 1-22-2007.

JOE'S DOWNRIGHT HEALTHY FOODS

THE MARK CONSISTS OF STANDARD CHARACTERS WITHOUT CLAIM TO ANY PARTICULAR FONT, STYLE, SIZE, OR COLOR.

PRIORITY CLAIMED UNDER SEC. 44(D) ON CANADA APPLICATION NO. 1331478, FILED 1-16-2007, REG. NO. TMA749909, DATED 10-9-2009, EXPIRES 10-9-2024.

NO CLAIM IS MADE TO THE EXCLUSIVE RIGHT TO USE "HEALTHY FOODS", APART FROM THE MARK AS SHOWN.

CLASS 29—MEATS AND PROCESSED FOODS

FOR DAIRY BASED BEVERAGES; EDIBLE NUTS, NAMELY, CANDIED NUTS, SHELLED NUTS, ROASTED NUTS AND PROCESSED NUTS; PROCESSED SALTED, UNSALTED AND FLAVORED NUTS; PROCESSED EDIBLE SEEDS; PROCESSED PUMPKIN AND SUNFLOWER SEEDS; DRIED FRUIT, DRIED FRUIT MIXES, DRIED FRUIT AND NUT MIXES, AND FRUIT CHIPS; TRAIL MIXES CONTAINING DRIED FRUITS, SEEDS AND NUTS; PRESERVED FRUITS; SUGARED FRUITS, NAMELY, CRYSTALLIZED FRUIT AND CANDIED FRUITS; DRIED PRUNES, DATES, RAISINS AND COCONUT; GLAZED FRUITS, GLAZED CHERRIES, JAMS AND JELLIES; SOUP MIXES; CONDIMENTS, NAMELY, PEPPER OIL; SAUCES, NAMELY, CRANBERRY SAUCE; SPREADS, NAMELY, CHEESE SPREADS, FRUIT-BASED SPREADS, VEGETABLE-BASED SPREADS, MEAT-BASED SPREADS, GARLIC-BASED SPREADS, HUMMUS; DIPS, NAMELY, BEAN DIP, DAIRY-BASED DIP, AND SNACK DIP; SNACK FOODS, NAMELY, POTATO CHIPS; BAKING GOODS, NAMELY, FRUIT-BASED FILLINGS FOR CAKES AND PIES; UNFLAVORED AND UNSWEETENED GELATINS; FROZEN ENTREES CONSISTING PRIMARILY OF MEAT, FISH, POULTRY OR VEGETABLES; FROZEN VEGETARIAN ENTREES CONSISTING PRIMARILY OF VEGETABLE-BASED ENTREES; FROZEN FRUITS AND VEGETABLES; PREPARED FOODS, NAMELY, PREPARED VEGETARIAN ENTREES CONSISTING PRIMARILY OF VEGETABLE-BASED ENTREES, PREPARED ENTREES CONSISTING PRIMARILY OF FISH, MEAT, POULTRY OR VEGETABLES; CANNED GOODS, NAMELY, CANNED VEGETABLES, CANNED FISH, CANNED FRUIT, AND CANNED COOKED MEAT; EDIBLE OILS FOR HUMAN CONSUMPTION; LENTILS; PULSES; PICKLED FRUITS AND VEGETABLES; PEANUT BUTTER AND NUT BUTTERS; SOY-BASED FOODS, NAMELY, SOY-BASED CHIPS, SOY-BASED FOOD BARS, SOY-BASED SNACK FOOD; BOUILLON CUBES; FRESH SALTED, UNSALTED AND FLAVORED NUTS; FRUIT BASED SNACK FOOD; POTATO CHIPS (U.S. CL. 46).

CLASS 30—STAPLE FOODS

FOR TEA-BASED BEVERAGES WITH FRUIT FLAVORING; COFFEE, COFFEE BEANS; COFFEE, ESPRESSO AND CAPPUCINO MIXES CONTAINING COFFEE POWDER; LOOSE AND BAGGED BLACK, GREEN AND HERBAL TEAS; CHOCOLATE COVERED NUTS; CONFECTIONERY, NAMELY, CHOCOLATE AND CANDY; SPICES AND SEASONINGS; CONDIMENTS, NAMELY, PEPPER SAUCE, KETCHUP, MUSTARD, MAYONNAISE, RELISH; SAUCES, NAMELY, CHILI SAUCE, HOT SAUCE, DIPPING SAUCES, BARBEQUE SAUCES, PIZZA SAUCE, FISH SAUCE, TOMATO SAUCE, TERIYAKI SAUCE, SOY SAUCE, TAMARI SAUCE, TARTAR SAUCE, STEAK SAUCE, AND READY-MADE SAUCES; VINEGAR, SALSA; UNCOOKED PASTA AND NOODLES, INCLUDING EGG NOODLES; SALAD DRESSINGS; SPREADS, NAMELY, COCOA SPREADS AND SPREADS CONTAINING CHOCOLATE AND NUTS; SNACK FOODS, NAMELY, PUFFED CORN SNACKS, SESAME STICKS, CRACKERS, WAFERS, CHEESE FLA-

VORED SNACKS, NAMELY, PUFFED CHEESE BALLS AND PUFFED RICE, CORN-BASED SNACKS, PRETZELS, COOKIES, BISCUITS, TORTILLA CHIPS, CORN CHIPS; CROUTONS; BAKING GOODS, NAMELY, CAKE MIXES, MUFFIN MIXES, BROWNIE MIXES, PASTRY MIXES; CHOCOLATE CHIPS, PEANUT BUTTER CONFECTIONERY CHIPS, CANDY MINTS, BAKING POWDER, BAKING SODA, CRUST MIXES FOR PIES, FRUIT JELLY POWDERS, GRAHAM CRACKER CRUMBS, CORN STARCH, VANILLA EXTRACTS USED AS A FLAVORING, YEAST, COCOA POWDER, FLOURS, AND WHITE, BROWN AND RAW SUGAR AND SUGAR SUBSTITUTES; BAKING GOODS, NAMELY, CANDY CAKE DECORATIONS; SYRUPS, NAMELY, CORN SYRUPS, MAPLE SYRUPS, PANCAKE SYRUPS, TABLE SYRUPS, TOPPING SYRUPS, MOLASSES, FLAVORING SYRUPS, CHOCOLATE SYRUPS; EXTRACTS, NAMELY, NATURAL AND ARTIFICIAL EXTRACTS USED AS A FLAVORING; FLAVORED AND SWEETENED GELATINS; MARSHMALLOWS; POPPED AND POPPING CORN OF VARIOUS FLAVORS, MICROWAVEABLE POPCORN, SEASONINGS FOR POPCORN; FROZEN ENTREES CONSISTING PRIMARILY OF PASTA OR RICE; PROCESSED GRAINS; PROCESSED CEREALS; ROLLED OATS AND OATMEAL; WHEAT GERM; RICE; PEANUT BRITTLE; HONEY; BREAD CRUMBS AND GRAHAM CRUMBS; READY TO EAT CEREALS; CEREAL DERIVED FOOD BARS; GRAVY MIXES AND BASES; CEREAL BASED SNACK FOOD; WHEAT BASED SNACK FOOD; RICE BASED SNACK FOOD (U.S. CL. 46).

CLASS 31—NATURAL AGRICULTURAL PRODUCTS

FOR EDIBLE NUTS, NAMELY, FRESH NUTS, RAW NUTS AND UNPROCESSED NUTS; UNPROCESSED EDIBLE SEEDS; UNPROCESSED GRAINS; UNPROCESSED CEREALS (U.S. CLS. 1 AND 46).

CLASS 32—LIGHT BEVERAGES

FOR NON-ALCOHOLIC BEVERAGES, NAMELY, CARBONATED BEVERAGES, BEVERAGES CONTAINING FRUIT JUICE, LOW CALORIE SOFT DRINKS, NON-ALCOHOLIC BEVERAGES WITH TEA FLAVOR, FRUIT JUICES, FRUIT DRINKS, VEGETABLE JUICES, VEGETABLE DRINKS, FRUIT AND VEGETABLE JUICES, FRUIT AND VEGETABLE DRINKS; BOTTLED WATER; BEVERAGE POWDERS AND CRYSTALS, NAMELY, USED IN THE PREPARATION OF FRUIT DRINKS; COLAS; SODAS IN THE NATURE OF SODA WATER, AND FLAVORED SODA WATER; CARBONATED AND NON-CARBONATED SOFT DRINKS; SYRUPS, NAMELY, SYRUPS FOR MAKING BEVERAGES; SOY-BASED BEVERAGES NOT BEING MILK SUBSTITUTES (U.S. CLS. 45, 46 AND 48).

CHRISTINA SOBRAL, EXAMINING ATTORNEY

SN 77-096,139. ZENTEL ELECTRONICS CORP., HSIN-CHU, TAIWAN, FILED 1-31-2007.



The logo for Zentel features the word "Zentel" in a bold, sans-serif font. To the right of the text is a stylized, curved graphic element that resembles a thick, grey brushstroke or a partial arc, starting from the bottom right and curving upwards and to the left.

THE WORDING "ZENTEL" DOES NOT HAVE ANY MEANING IN ANY FOREIGN LANGUAGE.

CLASS 9—ELECTRICAL AND SCIENTIFIC APPARATUS

FOR COMPUTER MEMORIES; DYNAMIC RANDOM ACCESS MEMORY, NAMELY, RANDOM ACCESS MEMORY CARD; INTEGRATED CIRCUITS; SILICON WAFERS; STRUCTURED SEMI-CONDUCTOR WAFERS; DYNAMIC RANDOM ACCESS MEMORY MODULE; FLASH MEMORY CARDS; SEMICONDUCTOR COMPONENTS, NAMELY, SEMICONDUCTOR CHIPS AND SEMICONDUCTOR DEVICE; COMPUTER INTERFACE CARD; MICRO-COMPUTERS; MICRO-PROCESSORS (U.S. CLS. 21, 23, 26, 36 AND 38).

CLASS 35—ADVERTISING AND BUSINESS

FOR EXPORT-IMPORT AGENCIES; COMMERCIAL INFORMATION AND DIRECTORY AGENCIES; BUSINESS RESEARCH AND SURVEYS; BUSINESS INVESTIGATIONS; COST/PRICE ANALYSIS; PRODUCT DEMONSTRATIONS (U.S. CLS. 100, 101 AND 102).
BRIDGETT SMITH, EXAMINING ATTORNEY

SN 77-158,638. GOURMEDAS INC., LAC DELAGE, CANADA, FILED 4-17-2007.

EDGE

THE MARK CONSISTS OF STANDARD CHARACTERS WITHOUT CLAIM TO ANY PARTICULAR FONT, STYLE, SIZE, OR COLOR.
PRIORITY CLAIMED UNDER SEC. 44(D) ON CANADA APPLICATION NO. 1336904, FILED 2-26-2007.

CLASS 29—MEATS AND PROCESSED FOODS

FOR DAIRY BASED CHOCOLATE FOOD BEVERAGES (U.S. CL. 46).

CLASS 30—STAPLE FOODS

FOR CHOCOLATE PRODUCTS, NAMELY, BARS, CANDIES, SAUCES, CHOCOLATE TOPPINGS, CHOCOLATE SYRUPS, CHOCOLATE FONDUE (U.S. CL. 46).
PAULA MAHONEY, EXAMINING ATTORNEY

SN 77-158,780. LIBERTY SHIPPING GROUP LLC, LAKE SUCCESS, NY. FILED 4-17-2007.

LIBERTY

THE MARK CONSISTS OF STANDARD CHARACTERS WITHOUT CLAIM TO ANY PARTICULAR FONT, STYLE, SIZE, OR COLOR.

CLASS 35—ADVERTISING AND BUSINESS

FOR (BASED ON INTENT TO USE) TRANSPORTATION LOGISTICS, NAMELY, ARRANGING THE TRANSPORTATION OF GOODS FOR OTHERS VIA MARINE SHIPPING (U.S. CLS. 100, 101 AND 102).

CLASS 39—TRANSPORTATION AND STORAGE

FOR (BASED ON USE IN COMMERCE) TRANSPORTATION SERVICES, NAMELY, CARGO SHIP TRANSPORT AND OPERATION OF VESSELS ENGAGED IN MARINE SHIPPING; CARGO VESSEL TRANSPORT; FREIGHT SHIP TRANSPORT (U.S. CLS. 100 AND 105).
FIRST USE 0-0-1988; IN COMMERCE 0-0-1988.
ANDREA K. NADELMAN, EXAMINING ATTORNEY

SN 77-208,698. EDMUNDS.COM, INC. D/B/A EDMUNDS INC., SANTA MONICA, CA. FILED 6-18-2007.

EMPOWERING AUTOMOTIVE CONSUMERS

THE MARK CONSISTS OF STANDARD CHARACTERS WITHOUT CLAIM TO ANY PARTICULAR FONT, STYLE, SIZE, OR COLOR.
NO CLAIM IS MADE TO THE EXCLUSIVE RIGHT TO USE "AUTOMOTIVE CONSUMERS", APART FROM THE MARK AS SHOWN.

CLASS 38—COMMUNICATION

FOR VIDEO AND AUDIO BROADCASTING IN THE FIELD OF VEHICLE PURCHASING, SALES AND CONSUMER ENTHUSIASM; PROVIDING ONLINE CHAT ROOMS AND ELECTRONIC TRANSMISSION OF MESSAGES AMONG USERS IN THE FIELD OF VEHICLE PURCHASING, SALES AND CONSUMER ENTHUSIASM (U.S. CLS. 100, 101 AND 104).

CLASS 42—SCIENTIFIC AND COMPUTER SERVICES

FOR COMPUTER SERVICES, NAMELY, HOSTING ONLINE WEB FACILITIES FOR OTHERS FOR ORGANIZING AND CONDUCTING ONLINE MEETINGS, GATHERINGS, AND INTERACTIVE DISCUSSIONS; AND COMPUTER SERVICES IN THE NATURE OF CUSTOMIZED WEB PAGES FEATURING USER-DEFINED INFORMATION, PERSONAL PROFILES, PHOTOGRAPHS AND INFORMATION (U.S. CLS. 100 AND 101).

CLASS 45—PERSONAL AND LEGAL SERVICES

FOR INTERNET BASED INTRODUCTION AND SOCIAL NETWORKING SERVICES (U.S. CLS. 100 AND 101).
DAVID TAYLOR, EXAMINING ATTORNEY

SN 77-217,194. STALKER SOFTWARE, INC., MILL VALLEY, CA. FILED 6-27-2007.

SN 77-279,857. VERIFONE, INC., SAN JOSE, CA. FILED 9-14-2007.



The logo for 'Pronto!' features the word 'Pronto!' in a bold, orange, sans-serif font. The exclamation point is also orange and has a thick underline that extends to the left. The background is transparent.



The Verifone logo consists of a stylized black icon on the left, resembling a series of overlapping geometric shapes that form a mountain-like profile. To the right of the icon, the word 'Verifone' is written in a bold, black, sans-serif font.

OWNER OF U.S. REG. NOS. 1,229,416 AND 1,729,013.

THE COLOR(S) ORANGE, BLACK AND GRAY IS/ARE CLAIMED AS A FEATURE OF THE MARK.

THE COLOR ORANGE APPEARS ON THE FACE OF ALL LETTERS, THE EXCLAMATION POINT AND THE UNDERLINE. THE COLOR BLACK APPEARS AS THE SHADOW AROUND ALL LETTERING. THE COLOR GRAY APPEARS ON THE SHADOW OF THE UNDERLINE. THE BACKGROUND IS TRANSPARENT.

CLASS 9—ELECTRICAL AND SCIENTIFIC APPARATUS

FOR SOFTWARE FOR COMMUNICATING AMONG ELECTRONIC DEVICES; SOFTWARE FOR COMMUNICATING WITH ELECTRONIC DEVICES (U.S. CLS. 21, 23, 26, 36 AND 38).

FIRST USE 5-22-2007; IN COMMERCE 5-22-2007.

CLASS 38—COMMUNICATION

FOR INFORMATION TRANSMISSION VIA ELECTRONIC COMMUNICATIONS NETWORKS (U.S. CLS. 100, 101 AND 104).

FIRST USE 5-22-2007; IN COMMERCE 5-22-2007.
BRENDAN MCCAULEY, EXAMINING ATTORNEY

SN 77-248,297. ZEERAY LLC, EATONTOWN, NJ. FILED 8-6-2007.



The logo for 'REAL AIR' features the words 'REAL AIR' in a bold, black, sans-serif font. The text is centered and has a simple, clean design.

THE MARK CONSISTS OF STANDARD CHARACTERS WITHOUT CLAIM TO ANY PARTICULAR FONT, STYLE, SIZE, OR COLOR.

NO CLAIM IS MADE TO THE EXCLUSIVE RIGHT TO USE "AIR", APART FROM THE MARK AS SHOWN.

CLASS 5—PHARMACEUTICALS

FOR AIR FRESHENERS; SANITIZING WIPES (U.S. CLS. 6, 18, 44, 46, 51 AND 52).

CLASS 11—ENVIRONMENTAL CONTROL APPARATUS

FOR DIFFUSERS FOR EMITTING SCENT; NON-ELECTRIC AIR DIFFUSERS COMPRISED OF A WICK AND OIL IN A CONTAINER USED TO EMIT SCENT WHEN LIT; ELECTRIC NIGHT LIGHTS; FRAGRANCE DISPENSING UNIT WHICH ALSO FEATURES A NIGHT LIGHT (U.S. CLS. 13, 21, 23, 31 AND 34).

NELSON SNYDER, EXAMINING ATTORNEY

CLASS 40—MATERIAL TREATMENT

FOR CUSTOM MANUFACTURE OF PAYMENT TERMINALS AND PAYMENT TRANSACTION PROCESSING SYSTEMS; TECHNICAL SUPPORT SERVICES, NAMELY, PROVIDING TECHNICAL ADVICE IN CONNECTION WITH THE MANUFACTURE OF COMPUTER HARDWARE, COMPUTER SOFTWARE, PAYMENT TERMINALS, AND PAYMENT TRANSACTION PROCESSING SYSTEMS (U.S. CLS. 100, 103 AND 106).

CLASS 42—SCIENTIFIC AND COMPUTER SERVICES

FOR RESEARCH, DESIGN AND PRODUCT DEVELOPMENT SERVICES IN CONNECTION WITH PAYMENT TERMINALS AND ELECTRONIC PAYMENT SYSTEMS; COMPUTER SERVICES, NAMELY, MONITORING SERVICES IN CONNECTION WITH PAYMENT TERMINALS, PAYMENT TRANSACTION PROCESSING SYSTEMS, AND NETWORK SYSTEMS; PRODUCT RESEARCH AND DEVELOPMENT; DEVELOPMENT OF HANDHELD, WIRELESS AND LANDLINE POINT-OF-SALE (POS) TERMINALS, ELECTRONIC CASH REGISTERS, RETAIL ATM UNITS, KIOSKS WITH CARD PAYMENT CAPABILITIES INCLUDING VOUCHER PRINTING, PIN PADS, AND SMART CARD READERS, AS WELL AS INTEGRATED PIN AND SMART CARD SOLUTIONS; DEVELOPMENT OF COMPUTER SOFTWARE PLATFORMS FOR OTHERS OFFERING ON-SITE AND CALL-CENTER SUPPORT WITH REMOTE TERMINAL MANAGEMENT; DEVELOPMENT OF COMPUTER SOFTWARE FOR OTHERS IN THE FIELDS OF ATM MANAGEMENT, TOP-UP MANAGEMENT, PREPAID CARD MANAGEMENT AND BACK-OFFICE SOLUTIONS; DEVELOPMENT OF SOFTWARE FOR OTHERS FOR FACILITATING SECURE CREDIT CARD TRANSACTIONS AND FINANCIAL MANAGEMENT SOFTWARE; CONSULTANCY IN THE FIELD OF COMPUTER HARDWARE AND SOFTWARE; COMPUTER PROGRAMMING FOR OTHERS, COMPUTER SOFTWARE DESIGN FOR OTHERS IN CONNECTION WITH PAYMENT AND/OR FINANCE; MAINTENANCE AND UPDATING OF COMPUTER SOFTWARE FOR OTHERS IN CONNECTION WITH PAYMENT AND/OR FINANCE; COMPUTER SYSTEM DESIGN, COMPUTER SYSTEMS ANALYSIS IN CONNECTION WITH PAYMENT AND/OR FINANCE; TECHNICAL ASSISTANCE IN THE NATURE OF COMPUTER HARDWARE AND SOFTWARE TROUBLESHOOTING IN CONNECTION WITH PAYMENT TECHNOLOGY; COMPUTER SERVICES, NAMELY, PROVIDING TEMPORARY USE OF ONLINE NON-DOWNLOADABLE COMPUTER SOFTWARE FOR INFORMATION; INDUSTRIAL ANALYSIS AND RESEARCH SERVICES; DESIGN AND DEVELOPMENT OF COMPUTER HARDWARE AND SOFTWARE FOR OTHERS; TECHNICAL SUPPORT, NAMELY, PROVIDING TECHNICAL ADVICE IN CONNECTION WITH COMPUTER SOFTWARE; PROVIDING TECHNOLOGY INFORMATION UPDATES FOR COMPUTER HARDWARE, SOFTWARE, PAYMENT TERMINALS AND PAYMENT TRANSACTION PROCESSING SYSTEMS; MAINTENANCE AND REPAIR OF COMPUTER SOFTWARE AND TECHNICAL SUPPORT SERVICES, NAMELY, PROVIDING TECHNICAL ADVICE ON THE DESIGN OF COMPUTER HARDWARE, COMPUTER SOFTWARE, PAYMENT TERMINALS, AND PAYMENT TRANSACTION PROCESSING SYSTEMS (U.S. CLS. 100 AND 101).

FIRST USE 0-0-1987; IN COMMERCE 0-0-1987.

DEZMONA MIZELLE, EXAMINING ATTORNEY

SN 77-354,818. GOLD-GATE GMBH, UNTERFOEHRING,
FED REP GERMANY, FILED 12-18-2007.

EMOTIONALYSIS

THE MARK CONSISTS OF STANDARD CHARACTERS WITHOUT CLAIM TO ANY PARTICULAR FONT, STYLE, SIZE, OR COLOR.

PRIORITY CLAIMED UNDER SEC. 44(D) ON ERPN CMNTY TM OFC APPLICATION NO. 006521603, FILED 12-17-2007, REG. NO. 006521603, DATED 5-13-2009, EXPIRES 12-17-2017.

CLASS 9—ELECTRICAL AND SCIENTIFIC APPARATUS

FOR SCIENTIFIC APPARATUS AND INSTRUMENTS, NAMELY, ELECTRONIC WAVE GENERATORS, WAVE SENSORS AND WAVE ANALYZERS; ELECTRONIC DEVICES FOR THE GENERATION, MEASUREMENT AND ANALYSIS OF AUDIO SIGNALS, NAMELY, AUDIO ANALYZERS; SURVEYING APPARATUS AND INSTRUMENTS, NAMELY, ELECTRONIC ANALYZERS OF ACOUSTICAL WAVES AND LOUDNESS; OPTICAL APPARATUS AND INSTRUMENTS, NAMELY, ELECTRONIC ANALYZERS OF OPTICAL AND VISUAL SIGNALS; MEASURING APPARATUS AND INSTRUMENTS, NAMELY, ELECTRONIC EQUIPMENT FOR MEASURING ACOUSTICAL, OPTICAL AND VISUAL SIGNALS AS WELL AS PHYSICAL BODY REACTIONS TO PSYCHIC AND PHYSICAL STIMULUS; TEACHING APPARATUS AND INSTRUMENTS, NAMELY, ELECTRONIC WAVE GENERATORS, WAVE SENSORS, WAVE ANALYZERS; ELECTRONIC DEVICES FOR THE GENERATION, MEASUREMENT AND ANALYSIS OF OPTICAL SIGNALS AND AUDIO SIGNALS, ACOUSTICAL WAVES AND LOUDNESS; ELECTRONIC EQUIPMENT FOR THE DISPLAY OF LOUDNESS AND ACOUSTICAL FREQUENCIES FOR THE REPRODUCTION OF SOUND AND IMAGES; APPARATUS AND INSTRUMENTS FOR CONDUCTING, SWITCHING, TRANSFORMING, ACCUMULATING, REGULATING OR CONTROLLING ELECTRICITY, NAMELY, ELECTRICAL CONDUCTORS, ELECTRICAL CONTROLLERS, ELECTRICAL SWITCHES; APPARATUS FOR RECORDING, TRANSMISSION OR REPRODUCTION OF SOUND OR IMAGES; DATA PROCESSING EQUIPMENT AND COMPUTERS; COMPUTER SOFTWARE FOR RESEARCH AND ANALYSIS PURPOSES, NAMELY, SOFTWARE FOR THE EVALUATION AND ANALYSIS OF ACOUSTICAL INFORMATION AND INFORMATION TRANSPORTED BY THE HUMAN VOICE, SOFTWARE FOR THE SCIENTIFIC AND ECONOMIC EVALUATION AND ANALYSIS OF HUMAN EMOTIONS AND PHYSICAL REACTIONS, SOFTWARE FOR EMOTIONAL AND PSYCHOLOGICAL PROFILING AND COMPATIBILITY; COMPUTER SERVERS FOR WEB HOSTING (U.S. CLS. 21, 23, 26, 36 AND 38).

CLASS 10—MEDICAL APPARATUS

FOR SURGICAL APPARATUS AND INSTRUMENTS FOR MEDICAL AND DENTAL USE; MEDICAL ANALYSIS AND EVALUATION APPARATUS, NAMELY, APPARATUS FOR THE MEDICAL EVALUATION AND MEDICAL ANALYSIS OF ACOUSTICAL INFORMATION AND INFORMATION TRANSPORTED BY THE HUMAN VOICE, APPARATUS FOR THE MEDICAL EVALUATION AND ANALYSIS OF HUMAN EMOTIONS AND PHYSICAL REACTIONS (U.S. CLS. 26, 39 AND 44).

CLASS 35—ADVERTISING AND BUSINESS

FOR ADVERTISING CONSULTATION; BUSINESS MANAGEMENT AND ADMINISTRATION; PROVIDING OFFICE FUNCTIONS; PROVIDING AN ON-LINE COMMERCIAL INFORMATION DIRECTORY ON THE INTERNET; ON-LINE DATA PROCESSING SERVICES; BUSINESS INFORMATION SERVICES PROVIDED ON-LINE FROM A GLOBAL COMPUTER NETWORK OR THE INTERNET; COMPUTERIZED MARKETING AND ADVERTISING; MARKET RESEARCH, MARKET ANALYSIS, END-CONSUMER RESEARCH SERVICES, ALSO ON-LINE VIA THE INTERNET; PROVIDING A WEBSITE FEATURING MULTIMEDIA MATERIALS IN THE FIELD OF ECONOMIC EVALUATION IN THE NATURE OF ECONOMIC FEASIBILITY STUDIES OF ACOUSTICAL INFORMATION AND INFORMATION TRANSPORTED BY THE HUMAN VOICE AS WELL AS OF HUMAN EMOTIONS AND PHYSICAL REACTIONS (U.S. CLS. 100, 101 AND 102).

CLASS 38—COMMUNICATION

FOR TELECOMMUNICATIONS SERVICES, NAMELY, PROVIDING ACCESS TO WEBSITES ON THE INTERNET VIA BROADBAND OPTICAL OR WIRELESS NETWORKS; PROVIDING REMOTE INTERNET ACCESS; PROVIDING ONLINE FORUMS FOR TRANSMISSION OF MESSAGES AMONG COMPUTER SERVERS CONCERNING THE EVALUATION AND ANALYSIS OF HUMAN EMOTIONS AND PHYSICAL REACTIONS, EMOTIONAL AND PSYCHOLOGICAL PROFILING AND COMPATIBILITY; TRANSMISSION OF INFORMATION ON-LINE VIA ELECTRONIC COMMUNICATION NETWORKS FEATURING WEBPAGES, COMPUTER PROGRAMS AND DATA; PROVISION OF ON-LINE COMMUNICATION SERVICES, NAMELY, TRANSMISSION OF VOICE, AUDIO, VISUAL IMAGES AND DATA BY TELECOMMUNICATIONS NETWORKS, WIRELESS COMMUNICATION NETWORKS, THE INTERNET, INFORMATION SERVICE NETWORKS AND DATA NETWORKS; PROVIDING ACCESS TO AN ELECTRONIC ON-LINE NETWORK, NAMELY, TELECOMMUNICATION NETWORKS FOR INFORMATION RETRIEVAL (U.S. CLS. 100, 101 AND 104).

CLASS 41—EDUCATION AND ENTERTAINMENT

FOR EDUCATION SERVICES, NAMELY, PROVIDING LIVE AND ON-LINE CLASSES, SEMINARS AND WORKSHOPS IN THE FIELD OF EMOTIONAL AND PSYCHOLOGICAL PROFILING AND COMPATIBILITY, AND IN THE FIELD OF SCIENTIFIC AND ECONOMICAL EVALUATION AND ANALYSIS OF ACOUSTICAL INFORMATION AND INFORMATION TRANSPORTED BY THE HUMAN VOICE AS WELL AS OF HUMAN EMOTIONS AND PHYSICAL REACTIONS; EDUCATION SERVICES, NAMELY, PROVIDING A PROFESSIONAL TRAINING WEB SITE FEATURING MULTIMEDIA EDUCATIONAL AND TRAINING MATERIALS IN THE FIELD OF EMOTIONAL AND PSYCHOLOGICAL PROFILING AND COMPATIBILITY, AND IN THE FIELD OF SCIENTIFIC AND ECONOMICAL EVALUATION AND ANALYSIS OF ACOUSTICAL INFORMATION AND INFORMATION TRANSPORTED BY THE HUMAN VOICE AS WELL AS OF HUMAN EMOTIONS AND PHYSICAL REACTIONS; ENTERTAINMENT, NAMELY, LIVE SHOWS, TELEVISION PROGRAMS, BROADCASTING PROGRAMS, ALL IN THE FIELD OF PUBLIC EMOTIONAL AND PSYCHOLOGICAL PROFILING AND COMPATIBILITY IN FRONT OF AN AUDIENCE AND THE VIEWERS, AND IN THE FIELD OF SCIENTIFIC AND ECONOMICAL EVALUATION AND ANALYSIS OF ACOUSTICAL INFORMATION AND INFORMATION TRANSPORTED BY THE HUMAN VOICE AS WELL AS OF HUMAN EMOTIONS AND PHYSICAL REACTIONS IN FRONT OF AN AUDIENCE AND THE VIEWERS; ONLINE ELECTRONIC PUBLISHING SER-

VICES OF BOOKS, PERIODICALS, AND INFORMATION SHEETS VIA THE INTERNET; ONLINE PUBLISHING OF WEB MAGAZINES (U.S. CLS. 100, 101 AND 107).

CLASS 42—SCIENTIFIC AND COMPUTER SERVICES

FOR SCIENTIFIC AND TECHNOLOGICAL CONSULTATION SERVICES RELATING TO EMOTIONAL AND PSYCHOLOGICAL PROFILING AND COMPATIBILITY, AND TO SCIENTIFIC AND ECONOMICAL EVALUATION AND ANALYSIS OF ACOUSTICAL INFORMATION AND INFORMATION TRANSPORTED BY THE HUMAN VOICE AS WELL AS OF HUMAN EMOTIONS AND PHYSICAL REACTIONS; RESEARCH OF EMOTIONAL AND PSYCHOLOGICAL PROFILES AND COMPATIBILITY, OF ACOUSTICAL INFORMATION AND INFORMATION TRANSPORTED BY THE HUMAN VOICE AS WELL AS OF HUMAN EMOTIONS AND PHYSICAL REACTIONS; AND DESIGN OF DIGITAL DISPLAYS; INDUSTRIAL ANALYSIS AND RESEARCH SERVICES IN THE FIELD OF EMOTIONAL AND PSYCHOLOGICAL PROFILING AND COMPATIBILITY, AND IN THE FIELD OF SCIENTIFIC AND ECONOMICAL EVALUATION AND ANALYSIS OF ACOUSTICAL INFORMATION AND INFORMATION TRANSPORTED BY THE HUMAN VOICE AS WELL AS OF HUMAN EMOTIONS AND PHYSICAL REACTIONS; COMPUTER SERVICES NAMELY, MANAGING, CREATING, CUSTOMIZING, IMPLEMENTING AND MAINTAINING WEB SITES FOR OTHERS; HOSTING WEB SITES FOR OTHERS; COMPUTER SERVICES, NAMELY, INSTALLING WEB PAGES ON THE INTERNET FOR OTHERS; WEB SITE DESIGN SERVICES IN THE NATURE OF GRAPHIC DESIGN, DRAWING AND COMMISSIONED WRITING FOR THE COMPILATION OF WEB PAGES ON THE INTERNET; PROVIDING A WEBSITE FEATURING MULTIMEDIA MATERIALS IN THE FIELD OF SCIENTIFIC EVALUATION AND SCIENTIFIC ANALYSIS OF ACOUSTICAL INFORMATION AND INFORMATION TRANSPORTED BY THE HUMAN VOICE AS WELL AS OF HUMAN EMOTIONS AND PHYSICAL REACTIONS (U.S. CLS. 100 AND 101).

CLASS 44—MEDICAL, BEAUTY AND AGRICULTURAL SERVICES

FOR MEDICAL SERVICES; PROVIDING A WEBSITE FEATURING MULTIMEDIA MATERIALS IN THE FIELD OF PSYCHOLOGICAL PROFILING AND COMPATIBILITY IN THE NATURE OF PSYCHOLOGICAL ASSESSMENT (U.S. CLS. 100 AND 101).

JUSTINE D. PARKER, EXAMINING ATTORNEY

SN 77-358,174. HERBALSCIENCE, INC., NAPLES, FL. FILED 12-21-2007.

RHINOLOC

THE MARK CONSISTS OF STANDARD CHARACTERS WITHOUT CLAIM TO ANY PARTICULAR FONT, STYLE, SIZE, OR COLOR.

CLASS 29—MEATS AND PROCESSED FOODS

FOR MILK BEVERAGES, NAMELY, MILK, MILK BEVERAGES CONTAINING FRUITS, MILK BEVERAGES WITH HIGH MILK CONTENT, MILK BASED BEVERAGES CONTAINING FRUIT JUICE AND MILK BEVERAGES CONTAINING COFFEE; MILK POWDER; MILK POWDER FOR NUTRITIONAL PURPOSES; POWDERED MILK FOR FOOD PURPOSES (U.S. CL. 46).

CLASS 30—STAPLE FOODS

FOR PROCESSED HERBS; ORGANIC FOODS, NAMELY, CHOCOLATE, DAIRY-FREE CHOCOLATE, REDUCED FAT CHOCOLATE, REDUCED CALORIE CHOCOLATE, COCOA, CHOCOLATE CHIPS, CHOCOLATE FONDUE, CHOCOLATE TOPPING, REDUCED FAT CANDY, BAKERY PRODUCTS, NAMELY, COOKIES, CAKES, PIES AND MUFFINS, CRACKERS, BISCUITS, READY-TO-EAT CEREAL-DERIVED FOOD BARS, PRETZELS, CHEWING GUM, FROZEN YOGURT, FROZEN CUSTARD, FRUIT ICES, PANCAKE, WAFFLE AND BREAD MIXES, SALAD DRESSING, PASTA AND PASTA MIXES, RICE, CORNMEAL AND WHEAT BASED SNACK FOODS; AND HERBAL INFUSIONS (U.S. CL. 46).

LYDIA BELZER, EXAMINING ATTORNEY

SN 77-360,828. MAEDA METAL INDUSTRIES, LTD., OSAKA, JAPAN, FILED 12-28-2007.

DIGITORQON

THE MARK CONSISTS OF STANDARD CHARACTERS WITHOUT CLAIM TO ANY PARTICULAR FONT, STYLE, SIZE, OR COLOR.

CLASS 7—MACHINERY

FOR POWER TOOLS, NAMELY, ELECTRIC OR PNEUMATIC DRIVEN BOLT OR NUT TIGHTENING DEVICES WITH TIGHTENING TORQUE MEASURING DEVICE, NAMELY, ELECTRIC TORQUE CONTROL WRENCH, AND ELECTRIC TORQUE CONTROL WRENCH WITH DIGITAL TORQUE INDICATOR (U.S. CLS. 13, 19, 21, 23, 31, 34 AND 35).

CLASS 8—HAND TOOLS

FOR HAND TOOLS, NAMELY, WRENCHES WITH TIGHTENING TORQUE MEASURING DEVICE, NAMELY, TORQUE MULTIPLIER, AND TORQUE MULTIPLIER WITH DIGITAL TORQUE INDICATOR (U.S. CLS. 23, 28 AND 44).

CLASS 9—ELECTRICAL AND SCIENTIFIC APPARATUS

FOR FORCE MEASUREMENT PRODUCTS, NAMELY, DIGITAL TORQUE GAUGES, AND TIGHTENING TORQUE MEASURING DEVICES FOR BOLT OR NUT, NAMELY, DIGITAL TORQUE INDICATOR (U.S. CLS. 21, 23, 26, 36 AND 38).

DARRYL SPRUILL, EXAMINING ATTORNEY

SN 77-364,155. USEFUL NETWORKS, INC., BERWYN, PA.
FILED 1-4-2008.



NO CLAIM IS MADE TO THE EXCLUSIVE RIGHT TO USE "USEFUL NETWORKS", APART FROM THE MARK AS SHOWN.

THE MARK CONSISTS OF THE DESIGN OF A STYLIZED "U" UNDERNEATH AND INTERLOCKED WITH A STYLIZED "N" WITH THE WORD "USEFUL" ABOVE THE WORD "NETWORKS" TO THE RIGHT.

CLASS 9—ELECTRICAL AND SCIENTIFIC APPARATUS

FOR COMPUTER SOFTWARE APPLICATIONS WHICH EMPLOY THE USE OF LOCATION AND PRESENCE FOR USE IN LOCATING PERSONS; COMPUTER SOFTWARE PLATFORM FOR FACILITATING LOCATION AND PRESENCE INFORMATION EXCHANGE FOR USE IN LOCATING PERSONS (U.S. CLS. 21, 23, 26, 36 AND 38).

CLASS 42—SCIENTIFIC AND COMPUTER SERVICES

FOR COMPUTER SOFTWARE CONSULTING SERVICES FOR THE DEVELOPMENT OF SOFTWARE EMPLOYING THE USE OF LOCATION AND PRESENCE (U.S. CLS. 100 AND 101).

GEOFFREY FOSDICK, EXAMINING ATTORNEY

SN 77-402,556. SUSTAINABILITY FOR EDUCATORS AND THE ENVIRONMENT, INC., KENT, OH. FILED 2-21-2008.

TALK LESS. DO MORE.

THE MARK CONSISTS OF STANDARD CHARACTERS WITHOUT CLAIM TO ANY PARTICULAR FONT, STYLE, SIZE, OR COLOR.

CLASS 40—MATERIAL TREATMENT

FOR CONSULTING SERVICES IN THE FIELD OF WASTE MANAGEMENT, NAMELY, REDUCTION, REUSE AND RECYCLING OF WASTE (U.S. CLS. 100, 103 AND 106).

FIRST USE 5-15-2008; IN COMMERCE 5-15-2008.

CLASS 41—EDUCATION AND ENTERTAINMENT

FOR EDUCATIONAL SERVICES, NAMELY, CONDUCTING SEMINARS AND WORKSHOPS IN THE FIELD OF ENVIRONMENTAL AWARENESS, RECYCLING, REUSE AND REDUCTION OF WASTE, AND PROCESSES FOR BETTER MANAGEMENT OF NATURAL AND ENERGY RESOURCES AND DISTRIBUTING COURSE MATERIAL IN CONNECTION THEREWITH (U.S. CLS. 100, 101 AND 107).

FIRST USE 5-15-2008; IN COMMERCE 5-15-2008.

CIMMERIAN COLEMAN, EXAMINING ATTORNEY

SN 77-440,426. THE SPITFIRE AGENCY, INC., MILL VALLEY, CA. FILED 4-4-2008.

SPITFIRE

THE MARK CONSISTS OF STANDARD CHARACTERS WITHOUT CLAIM TO ANY PARTICULAR FONT, STYLE, SIZE, OR COLOR.

CLASS 35—ADVERTISING AND BUSINESS

FOR ADVERTISING, MARKETING AND PROMOTION SERVICES; BUSINESS CONSULTATION; PUBLIC RELATIONS; BUSINESS CONSULTING AND INFORMATION SERVICES; CONSULTING SERVICES IN THE AREA OF SUSTAINABLE BUSINESS SOLUTIONS; PROFESSIONAL BUSINESS CONSULTING; CHARITABLE SERVICES, NAMELY, ORGANIZING AND CONDUCTING VOLUNTEER PROGRAMS AND COMMUNITY SERVICE PROJECTS; SUSTAINABLE BUSINESS EVENT PLANNING (U.S. CLS. 100, 101 AND 102).

FIRST USE 3-10-2001; IN COMMERCE 3-10-2001.

CLASS 41—EDUCATION AND ENTERTAINMENT

FOR CONCERT BOOKING; CELEBRITY BOOKING; SPECIAL EVENT PLANNING; EDUCATIONAL AND ENTERTAINMENT TOUR BOOKING, NAMELY, PROVIDING MOTIVATIONAL AND EDUCATIONAL SPEAKERS; CONSULTATION SERVICES IN THE FIELD OF ENVIRONMENTAL EDUCATION (U.S. CLS. 100, 101 AND 107).

FIRST USE 7-15-1998; IN COMMERCE 7-15-1998.

FRED CARL, EXAMINING ATTORNEY

SN 77-494,482. ST. LUKE'S HOSPITAL & HEALTH NETWORK, BETHLEHEM, PA. FILED 6-9-2008.

MY HEALTH. MY HOSPITAL.

THE MARK CONSISTS OF STANDARD CHARACTERS WITHOUT CLAIM TO ANY PARTICULAR FONT, STYLE, SIZE, OR COLOR.

CLASS 41—EDUCATION AND ENTERTAINMENT

FOR EDUCATIONAL SERVICES, NAMELY, MEDICAL RESIDENCY PROGRAMS AND NURSING SCHOOLS; AND PROVIDING FITNESS AND EXERCISING FACILITIES (U.S. CLS. 100, 101 AND 107).
FIRST USE 1-15-2007; IN COMMERCE 1-15-2007.

CLASS 42—SCIENTIFIC AND COMPUTER SERVICES

FOR MEDICAL RESEARCH, NAMELY, CONDUCTING CLINICAL TRIALS (U.S. CLS. 100 AND 101).
FIRST USE 1-15-2007; IN COMMERCE 1-15-2007.

CLASS 44—MEDICAL, BEAUTY AND AGRICULTURAL SERVICES

FOR HEALTHCARE SERVICES, NAMELY, CARDIAC SURGERY SERVICES, ONCOLOGY SERVICES, RADIOLOGY SERVICES, NEUROSCIENCES SERVICES, TRAUMA AND EMERGENCY MEDICINE SERVICES, WOMEN'S AND CHILDREN'S MEDICAL SERVICES, ORTHOPEDICS SERVICES, MEDICAL CLINICS, HOSPITALS, MEDICAL SERVICES, MEDICAL IMAGING SERVICES, MEDICAL TESTING SERVICES, NURSING CARE, NURSING HOMES, EMERGENCY MEDICAL ASSISTANCE, AMBULATORY SURGERY CENTERS, HEALTH MAINTENANCE ORGANIZATIONS, HOME HEALTHCARE SERVICES, HOSPICES, MANAGED HEALTHCARE SERVICES, MEDICAL COUNSELING, PHYSICAL REHABILITATION, PHYSICAL THERAPY, OCCUPATIONAL THERAPY, PHYSICIAN SERVICES, PSYCHIATRIC CONSULTATION, AND COSMETIC BODY CARE SERVICES (U.S. CLS. 100 AND 101).
FIRST USE 1-15-2007; IN COMMERCE 1-15-2007.
AISHA SALEM, EXAMINING ATTORNEY

SN 77-504,435. DE BEERS CENTENARY AG, 6000 LUZERN 6, SWITZERLAND, FILED 6-20-2008.



OWNER OF EUROPEAN UNION REG. NO. 006866801, DATED 2-13-2009, EXPIRES 4-25-2018.
THE MARK CONSISTS OF A GENERALLY DIAMOND-SHAPED DESIGN COMPRISED OF THREE TRIANGULAR SECTIONS.

CLASS 14—JEWELRY

FOR JEWELRY AND IMITATION JEWELRY; PRECIOUS AND SEMI-PRECIOUS STONES; HOROLOGICAL AND CHRONOMETRIC INSTRUMENTS (U.S. CLS. 2, 27, 28 AND 50).

CLASS 35—ADVERTISING AND BUSINESS

FOR RETAIL STORE SERVICES, WHOLESALE ORDERING SERVICES AND ADVERTISING SERVICES, ALL OF THE FOREGOING IN THE FIELD OF PRECIOUS METALS AND THEIR ALLOYS, JEWELRY AND IMITATION JEWELRY, PRECIOUS AND SEMI-PRECIOUS STONES, AND HOROLOGICAL AND CHRONOMETRIC INSTRUMENTS (U.S. CLS. 100, 101 AND 102).
STEVEN R. FINE, EXAMINING ATTORNEY

SN 77-516,800. GARDENA CANADA LTD., BRAMPTON, ONTARIO, CANADA, FILED 7-8-2008.

POLARWAVE

THE MARK CONSISTS OF STANDARD CHARACTERS WITHOUT CLAIM TO ANY PARTICULAR FONT, STYLE, SIZE, OR COLOR.
PRIORITY CLAIMED UNDER SEC. 44(D) ON CANADA APPLICATION NO. 1400107, FILED 6-18-2008, REG. NO. TMA756,858, DATED 1-12-2010, EXPIRES 1-12-2025.

CLASS 8—HAND TOOLS

FOR SNOW SHOVELS; SNOW PUSHERS; SNOW ROOF RAKES; SNOW ICE PICKS (U.S. CLS. 23, 28 AND 44).

CLASS 21—HOUSEWARES AND GLASS

FOR SNOW BRUSHES FOR CLEANING A CAR (U.S. CLS. 2, 13, 23, 29, 30, 33, 40 AND 50).
DEIRDRE ROBERTSON, EXAMINING ATTORNEY

SN 77-517,451. ENPHASE ENERGY, INC., PETALUMA, CA. FILED 7-8-2008.



THE MARK CONSISTS OF THE LETTER "E" IN STYLIZED FORM BETWEEN TWO BRACKETS.

CLASS 9—ELECTRICAL AND SCIENTIFIC APPARATUS

FOR INVERTERS FOR RESIDENTIAL AND COMMERCIAL SOLAR POWER SYSTEMS (U.S. CLS. 21, 23, 26, 36 AND 38).

CLASS 35—ADVERTISING AND BUSINESS

FOR CONSULTATION IN THE FIELD OF ENERGY EFFICIENCY; BUSINESS CONSULTATION SERVICES IN THE FIELDS OF RENEWABLE ENERGY, NAMELY, ENERGY USE MANAGEMENT; PROVIDING BUSINESS CONSULTATION IN THE RENEWABLE ENERGY FIELDS OF ENERGY CONSUMPTION, ENERGY CONSERVATION, ENERGY EFFICIENCY, ENERGY GENERATION, AND ENERGY USE MANAGEMENT (U.S. CLS. 100, 101 AND 102).

CLASS 42—SCIENTIFIC AND COMPUTER SERVICES

FOR PROVIDING TEMPORARY USE OF NON-DOWNLOADABLE COMPUTER SOFTWARE FOR USE IN CONNECTION WITH ENERGY MANAGEMENT; CONSULTING SERVICES PROVIDED TO LOCAL GOVERNMENTS IN THE FIELDS OF DEVELOPMENT OF ELECTRICAL SERVICES AND RENEWABLE ENERGY RESOURCES (U.S. CLS. 100 AND 101).

FLORENTINA BLANDU, EXAMINING ATTORNEY

SN 77-523,713, LUXURY GOODS INTERNATIONAL (LGI) SA, 6814 CADEMPINO, SWITZERLAND, FILED 7-16-2008.

EASY

THE MARK CONSISTS OF STANDARD CHARACTERS WITHOUT CLAIM TO ANY PARTICULAR FONT, STYLE, SIZE, OR COLOR.

CLASS 6—METAL GOODS

FOR METAL CLASPS FOR BAGS, FERRULES OF METAL FOR CANES AND WALKING STICKS (U.S. CLS. 2, 12, 13, 14, 23, 25 AND 50).

CLASS 18—LEATHER GOODS

FOR LEATHER AND IMITATION LEATHER, ANIMAL SKINS AND HIDES; PRODUCTS MADE OF LEATHER AND IMITATIONS OF LEATHER, NAMELY, HANDBAGS, LUGGAGE, WALLETS, PURSES, ATTACHE CASES, SCHOOL SATCHELS; BEACH BAGS, SADDLEBAGS, VALISES, TRUNKS AND TRAVELLING BAGS, CHANGE PURSES, RUCKSACKS, LEATHER, REUSABLE, TEXTILE AND MESH SHOPPING BAGS, VANITY CASES SOLD EMPTY, UMBRELLAS, PARASOLS, WALKING STICKS, TOILETRY BAGS SOLD EMPTY, SUITCASES, MATCHING SETS OF LUGGAGE FOR TRAVEL, BUSINESS CASES, KEY CASES, HARNESS FOR ANIMALS, WHIPS, SADDLERY (U.S. CLS. 1, 2, 3, 22 AND 41).

NAAKWAMA ANKRAH, EXAMINING ATTORNEY

SN 77-529,107, EDMUNDS.COM, INC., SANTA MONICA, CA, FILED 7-23-2008.



OWNER OF U.S. REG. NOS. 2,106,713 AND 2,498,032.

THE MARK CONSISTS OF THE WORD "EDMUNDS" AND THE WORD ".COM" IN A STYLIZED FONT, WITH "COM" CONTAINED WITHIN A DRAWING OF A CAR. THE DOT OR PERIOD BEFORE THE WORD "COM" IS DEPICTED AS A HEADLIGHT OF THE CAR, WITH A FURTHER DOT OR PERIOD FOLLOWING THE WORD ".COM" DEPICTED AS A HEADLIGHT OF THE CAR.

CLASS 35—ADVERTISING AND BUSINESS

FOR PROVIDING INFORMATION AND ADVICE TO CONSUMERS REGARDING THE SELECTION OF PRODUCTS AND SERVICES TO BE PURCHASED IN THE FIELD OF AUTOMOTIVE DEALERSHIPS, MOTOR VEHICLES, AND MOTOR VEHICLE SERVICES; PROVIDING REVIEWS OF AUTOMOTIVE DEALERSHIPS, MOTOR VEHICLES, AND MOTOR VEHICLE SERVICES FOR BUSINESS PURPOSES; PROVIDING PRODUCT RATINGS OF THE CONSUMER GOODS AND SERVICES OF OTHERS IN THE FIELD OF AUTOMOTIVE DEALERSHIPS, MOTOR VEHICLES, AND MOTOR VEHICLE SERVICES; COST ANALYSIS OF OWNING NEW AND USED VEHICLES (U.S. CLS. 100, 101 AND 102).

FIRST USE 9-0-1999; IN COMMERCE 9-0-1999.

CLASS 36—INSURANCE AND FINANCIAL

FOR PROVIDING INFORMATION ABOUT AUTOMOBILES AND MOTOR VEHICLES, NAMELY, FINANCING AND EVALUATION OF THE MARKET VALUE OF VEHICLES (U.S. CLS. 100, 101 AND 102).

FIRST USE 9-0-1999; IN COMMERCE 9-0-1999.

CLASS 38—COMMUNICATION

FOR PROVIDING ONLINE FACILITIES FOR REAL-TIME INTERACTION WITH OTHER COMPUTER USERS AND ELECTRONIC TRANSMISSION OF MESSAGES AMONG COMPUTER USERS IN THE AUTOMOTIVE FIELD; ONLINE VIDEO AND AUDIO BROADCASTING IN THE AUTOMOTIVE FIELD (U.S. CLS. 100, 101 AND 104).

FIRST USE 9-0-1999; IN COMMERCE 9-0-1999.

CLASS 41—EDUCATION AND ENTERTAINMENT

FOR ONLINE JOURNALS, NAMELY, BLOGS IN THE AUTOMOTIVE FIELD; PROVIDING RECOGNITION AND INCENTIVES BY WAY OF AWARDS TO DEMONSTRATE EXCELLENCE IN THE AUTOMOTIVE FIELD; PROVIDING EDITORIAL CONTENT TO CONSUMERS IN THE FIELD OF MOTOR VEHICLES, NAMELY, ONLINE PUBLICATIONS IN THE NATURE OF ARTICLES AND NEWSLETTERS CONTAINING EDITORIAL REPORTING ON MOTOR VEHICLES AND THE AUTOMOBILE INDUSTRY (U.S. CLS. 100, 101 AND 107).

FIRST USE 10-0-1999; IN COMMERCE 10-0-1999.

CLASS 42—SCIENTIFIC AND COMPUTER SERVICES

FOR COMPUTER SERVICES, NAMELY, HOSTING ONLINE WEB FACILITIES FOR OTHERS FOR ORGANIZING AND CONDUCTING ONLINE MEETINGS, GATHERINGS, AND INTERACTIVE DISCUSSIONS; COMPUTER SERVICES IN THE NATURE OF CUSTOMIZED WEB PAGES FEATURING USER-DEFINED CONTENT IN THE AUTOMOTIVE FIELD (U.S. CLS. 100 AND 101).

FIRST USE 9-0-1999; IN COMMERCE 9-0-1999.

CLASS 45—PERSONAL AND LEGAL SERVICES

FOR ONLINE INTRODUCTION AND SOCIAL NETWORKING SERVICES (U.S. CLS. 100 AND 101).

FIRST USE 2-6-2006; IN COMMERCE 2-6-2006.
GISELLE AGOSTO, EXAMINING ATTORNEY

SN 77-529,287. EDMUNDS.COM, INC., SANTA MONICA, CA.
FILED 7-23-2008.



THE MARK CONSISTS OF A FRONT VIEW OF A CAR,
WITH HEADLIGHTS .

CLASS 35—ADVERTISING AND BUSINESS

FOR PROVIDING INFORMATION AND ADVICE TO CONSUMERS REGARDING THE SELECTION OF PRODUCTS AND SERVICES TO BE PURCHASED IN THE FIELD OF AUTOMOTIVE DEALERSHIPS, MOTOR VEHICLES, AND MOTOR VEHICLE SERVICES; PROVIDING REVIEWS OF AUTOMOTIVE DEALERSHIPS, MOTOR VEHICLES, AND MOTOR VEHICLE SERVICES FOR BUSINESS PURPOSES; PROVIDING PRODUCT RATINGS OF THE CONSUMER GOODS AND SERVICES OF OTHERS IN THE FIELD OF AUTOMOTIVE DEALERSHIPS, MOTOR VEHICLES, AND MOTOR VEHICLE SERVICES; COST ANALYSIS OF OWNING NEW AND USED VEHICLES (U.S. CLS. 100, 101 AND 102).
FIRST USE 9-0-1999; IN COMMERCE 9-0-1999.

CLASS 36—INSURANCE AND FINANCIAL

FOR PROVIDING INFORMATION ABOUT AUTOMOBILES AND MOTOR VEHICLES, NAMELY, FINANCING AND EVALUATION OF THE MARKET VALUE OF VEHICLES (U.S. CLS. 100, 101 AND 102).
FIRST USE 9-0-1999; IN COMMERCE 9-0-1999.

CLASS 41—EDUCATION AND ENTERTAINMENT

FOR ONLINE JOURNALS, NAMELY, BLOGS IN THE AUTOMOTIVE FIELD; PROVIDING RECOGNITION AND INCENTIVES BY WAY OF AWARDS TO DEMONSTRATE EXCELLENCE IN THE AUTOMOTIVE FIELD; PROVIDING EDITORIAL CONTENT TO CONSUMERS IN THE FIELD OF MOTOR VEHICLES, NAMELY, ONLINE PUBLICATIONS IN THE NATURE OF ARTICLES AND NEWSLETTERS CONTAINING EDITORIAL REPORTING ON MOTOR VEHICLES AND THE AUTOMOBILE INDUSTRY (U.S. CLS. 100, 101 AND 107).
FIRST USE 10-0-1999; IN COMMERCE 10-0-1999.
GISELLE AGOSTO, EXAMINING ATTORNEY

SN 77-547,373. SMITH, IAN, HALIFAX, W, YORKSHIRE, UNITED KINGDOM, AND FURNESS, ANTHONY, HALIFAX, W, YORKSHIRE, UNITED KINGDOM, FILED 8-14-2008.

FEATURE SEAL

THE MARK CONSISTS OF STANDARD CHARACTERS WITHOUT CLAIM TO ANY PARTICULAR FONT, STYLE, SIZE, OR COLOR.
OWNER OF ERPN CMNTY TM OFC REG. NO. 006671473, DATED 1-22-2009, EXPIRES 2-15-2018.

CLASS 9—ELECTRICAL AND SCIENTIFIC APPARATUS

FOR OPTICAL APPARATUS AND INSTRUMENTS, NAMELY, OPTICAL CHARACTER RECOGNITION APPARATUS, OPTICAL INSPECTION APPARATUS FOR INDUSTRIAL USE, OPTICAL MIRRORS, IMAGE CAPTURE DEVICES, NAMELY, DIGITAL CAMERAS, AND CAMERA CONTAINING A LINEAR IMAGE SENSOR; MEASURING APPARATUS AND INSTRUMENTS, NAMELY, LASER SCANNERS AND SCANNERS USING NON-LASER LIGHT SOURCES; SIGNALING APPARATUS AND INSTRUMENTS, NAMELY, DATA CARRIER DEVICES COMPRISED OF BLANK MAGNETIC DATA CARRIERS, LINEAR BAR CARRIERS AND READERS, TWO DIMENSIONAL MULTI-ROW BAR CODE AND MATRIX CODE DATA CARRIERS AND READERS, ELECTRONIC DATA CARRIER AND READERS/WRITERS, RADIO FREQUENCY IDENTIFICATION CARRIERS OR TAGS AND ASSOCIATED READERS/WRITERS; DATA PROCESSING EQUIPMENT AND COMPUTERS; COMPUTERS AND WIRELESS APPARATUS FOR TRANSMITTING AND RECEIVING DATA, NAMELY, MOBILE TELEPHONES AND PDAS; ELECTRONIC TAGS FOR GOODS; ENCODED MAGNETIC CARDS CONTAINING SECURITY CHARACTERISTICS FOR IDENTIFICATION PURPOSES AND ANTI-COUNTERFEITING PURPOSES; ELECTRONIC MONITORING AND CONTROL APPARATUS FOR THE IDENTIFICATION OF GOODS, NAMELY, TRANSMITTERS OF ELECTRONIC SIGNALS AND AUDIOVISUALS RECEIVERS; RADIO FREQUENCY IDENTIFICATION TAG READERS; LASER WRITERS, CD-ROM WRITERS; ELECTRONIC AND OPTICAL ANTI-COUNTERFEITING CARDS, BADGES, TAGS, AND LABELS, NAMELY, ELECTRONICALLY ENCODED BADGES FOR USE WITH TIME CLOCKS, ELECTRONIC CIRCUIT CARDS, ELECTRONIC TAGS FOR USE WITH GOODS (U.S. CLS. 21, 23, 26, 36 AND 38).

CLASS 16—PAPER GOODS AND PRINTED MATTER

FOR ADHESIVES FOR STATIONERY OR HOUSEHOLD PURPOSES; PLASTIC MATERIALS FOR PACKAGING, NAMELY, PLASTIC BAGS, PLASTIC BUBBLE PACKS FOR WRAPPING; PAPER LABELS AND PAPER TAGS FOR USE IN MARKING PRODUCTS FOR IDENTIFICATION AND ANTI-COUNTERFEITING PURPOSES; PAPER IDENTIFICATION AND ANTI-COUNTERFEITING TAGS, CARDS, BADGES AND LABELS FOR USE IN MARKING TEXTILE PRODUCTS; SELF ADHESIVE LABELS AND TAGS (U.S. CLS. 2, 5, 22, 23, 29, 37, 38 AND 50).

CLASS 20—FURNITURE AND ARTICLES NOT OTHERWISE CLASSIFIED

FOR PLASTIC LABELS; PLASTIC HANG TAGS FOR USE IN MARKING PRODUCTS FOR IDENTIFICATION AND ANTI-COUNTERFEITING PURPOSES (U.S. CLS. 2, 13, 22, 25, 32 AND 50).

CLASS 35—ADVERTISING AND BUSINESS

FOR BUSINESS MANAGEMENT; BUSINESS ADMINISTRATION; OFFICE FUNCTIONS; MERCHANDISE PACKAGING; PACKAGING ARTICLES TO THE ORDER AND SPECIFICATION OF OTHERS; PROVIDING, MAINTAINING AND OPERATING AN ANTI-COUNTERFEITING AND IDENTIFICATION SERVICE, NAMELY, MONITORING CONSUMER CREDIT REPORTS AND PROVIDING AN ALERT AS TO ANY CHANGES THEREIN; BUSINESS CONSULTATION SERVICES IN THE FIELD OF COUNTERFEIT DETECTION (U.S. CLS. 100, 101 AND 102).

CLASS 39—TRANSPORTATION AND STORAGE

FOR PACKAGING ARTICLES FOR TRANSPORTATION; STORAGE OF GOODS (U.S. CLS. 100 AND 105).

CLASS 42—SCIENTIFIC AND COMPUTER SERVICES

FOR DATA SEARCHING COMPUTER FILES FOR OTHERS, NAMELY, SEARCHING AND RETRIEVING INFORMATION, SITES, AND OTHER RESOURCES AVAILABLE ON COMPUTER NETWORKS FOR OTHERS (U.S. CLS. 100 AND 101).

SANJEEV VOHRA, EXAMINING ATTORNEY

CLASS 45—PERSONAL AND LEGAL SERVICES

FOR PROVIDING, MAINTAINING AND OPERATING AN ANTI-COUNTERFEITING AND IDENTIFICATION SERVICE AND DATABASE, NAMELY, PROVIDING AUTHENTICATION OF PERSONAL IDENTIFICATION INFORMATION; MONITORING CREDIT REPORTS, THE INTERNET, AND PUBLIC RECORDS TO FACILITATE THE DETECTION AND PREVENTION IDENTITY THEFT AND FRAUD; CONSULTING SERVICES, NAMELY, CONSULTATION IN THE FIELDS OF PRODUCT AND DOCUMENT AUTHENTICATION AND TRACKING, AND BRAND MONITORING AND PROTECTION, TO PROTECT AGAINST COUNTERFEITING, TAMPERING, AND DIVERSION, AND TO ENSURE THE INTEGRITY OF GENUINE PRODUCTS AND DOCUMENTS (U.S. CLS. 100 AND 101).

JANICE KIM, EXAMINING ATTORNEY

SN 77-558,796. ROOTS CANADA LTD., TORONTO, CANADA, FILED 8-29-2008.



NO CLAIM IS MADE TO THE EXCLUSIVE RIGHT TO USE "GREEN", APART FROM THE MARK AS SHOWN.

THE MARK CONSISTS OF THE WORDS "ROOTS GREEN" IN STYLIZED LETTERING WITH "ROOTS" APPEARING IN DARKER LETTERING AND "GREEN" IN LIGHTER LETTERING, BOTH BELOW THE DESIGN OF A PLANT SEEDLING WITHIN A SHADED SQUARE.

SN 77-555,051. WELCOME HOME SOCIETY, SURREY, CANADA, FILED 8-25-2008.

PRICEPRO

THE MARK CONSISTS OF STANDARD CHARACTERS WITHOUT CLAIM TO ANY PARTICULAR FONT, STYLE, SIZE, OR COLOR.

CLASS 35—ADVERTISING AND BUSINESS

FOR RETAIL STORE SERVICES IN THE FIELD OF GENERAL MERCHANDISE, NAMELY, GROCERIES, HEALTH AND BEAUTY AIDS, FURNITURE, MATRESSES, ELECTRICAL AND ELECTRONIC GOODS AND ACCESSORIES, HOUSEHOLD AND KITCHEN WARES, BABY PRODUCTS, PET PRODUCTS, TOYS AND NOVELTIES, PAPER GOODS, CLOTHING AND FOOTWEAR, FILM AND SNACKS (U.S. CLS. 100, 101 AND 102).

CLASS 36—INSURANCE AND FINANCIAL

FOR CHARITABLE FUNDRAISING, NAMELY, PROVIDING PROFITS FROM RETAIL STORE SERVICES TO FUND OPERATION OF LONG TERM RECOVERY RESIDENCES FOR PERSONS IN NEED OF REHABILITATION ASSISTANCE (U.S. CLS. 100, 101 AND 102).

CLASS 41—EDUCATION AND ENTERTAINMENT

FOR CHARITABLE SERVICES, NAMELY, PROVIDING TRAINING IN THE FIELD OF RETAIL STORE SERVICES TO PERSONS IN NEED OF REHABILITATION ASSISTANCE; PERSONAL COACHING IN THE FIELD OF RETAIL STORE JOB SKILLS DEVELOPMENT TO PERSONS IN NEED OF REHABILITATION ASSISTANCE; EDUCATIONAL SERVICES, NAMELY, PROVIDING PERSONAL COACHING IN THE FIELDS OF DEALING WITH AUTHORITY, BASIC SOCIAL SKILLS FOR THE WORKPLACE, OPERATION OF RETAIL STORE EQUIPMENT, PROVIDING CUSTOMER SERVICE, PRODUCT KNOWLEDGE AND LEADERSHIP SKILLS (U.S. CLS. 100, 101 AND 107).

CLASS 9—ELECTRICAL AND SCIENTIFIC APPARATUS

FOR PROTECTIVE COVERS AND CASES FOR CELL PHONES, LAPTOPS, PORTABLE MEDIA PLAYERS, MP3 PLAYERS, AND PERSONAL DIGITAL ASSISTANTS; CARRYING CASES FOR CELL PHONES; CAMERA ACCESSORIES, NAMELY, CAMERA CASES, CAMERA BAGS (U.S. CLS. 21, 23, 26, 36 AND 38).

CLASS 18—LEATHER GOODS

FOR LEATHER GOODS, NAMELY, LUGGAGE, WALLETS, PURSES; BAGS, NAMELY, ATHLETIC BAGS, CARRYING CASES, TRAVEL BAGS, LEATHER BAGS, PURSES, WALLETS, BACK PACKS, MESSENGER BAGS, AND TOTE BAGS (U.S. CLS. 1, 2, 3, 22 AND 41).

JILL C. ALT, EXAMINING ATTORNEY

SN 77-561,354. BEV-LYN ENTERPRISES, INC., JACKSONVILLE, FL. FILED 9-3-2008.

GYM LIFE

THE MARK CONSISTS OF STANDARD CHARACTERS WITHOUT CLAIM TO ANY PARTICULAR FONT, STYLE, SIZE, OR COLOR.

NO CLAIM IS MADE TO THE EXCLUSIVE RIGHT TO USE "GYM", APART FROM THE MARK AS SHOWN.

CLASS 16—PAPER GOODS AND PRINTED MATTER

FOR DECALS AND STICKERS (U.S. CLS. 2, 5, 22, 23, 29, 37, 38 AND 50).

CLASS 25—CLOTHING

FOR CLOTHING, NAMELY, T-SHIRTS, TANK TOPS, SHORTS AND HATS (U.S. CLS. 22 AND 39).

ALICE BENMAMAN, EXAMINING ATTORNEY

SN 77-568,177. TDT MEDIA INC., NEW YORK, NY. FILED 9-11-2008.

TASTING TABLE

THE MARK CONSISTS OF STANDARD CHARACTERS WITHOUT CLAIM TO ANY PARTICULAR FONT, STYLE, SIZE, OR COLOR.

CLASS 9—ELECTRICAL AND SCIENTIFIC APPARATUS

FOR DOWNLOADABLE ELECTRONIC PUBLICATIONS, SENT VIA E-MAIL, IN THE NATURE OF ELECTRONIC NEWSLETTERS, ARTICLES, MAGAZINES, MAPS, RESTAURANT GUIDES AND LISTINGS IN THE FIELD OF EPICUREAN TOPICS, NAMELY, FOOD, WINE, COCKTAILS, COOKING, RECIPES, COOKING TECHNIQUES, RESTAURANTS, RESTAURANT PERSONALITIES, NAMELY, CHEFS AND OTHER RESTAURANT PERSONNEL, PUBLISHED TO A WEBSITE, BLOG, RSS OR OTHER DATA FEED (U.S. CLS. 21, 23, 26, 36 AND 38).

FIRST USE 8-5-2008; IN COMMERCE 8-5-2008.

CLASS 41—EDUCATION AND ENTERTAINMENT

FOR NON-DOWNLOADABLE ELECTRONIC PUBLICATIONS, SENT VIA E-MAIL, IN THE NATURE OF ELECTRONIC NEWSLETTERS, ARTICLES, MAGAZINES, MAPS, RESTAURANT GUIDES AND LISTINGS, IN THE FIELD OF EPICUREAN TOPICS, NAMELY, FOOD, WINE, COCKTAILS, COOKING, RECIPES AND COOKING TECHNIQUES, RESTAURANTS, RESTAURANT PERSONALITIES, NAMELY, CHEFS AND OTHER RESTAURANT PERSONNEL, PUBLISHED TO A WEBSITE, BLOG, RSS OR OTHER DATA FEED (U.S. CLS. 100, 101 AND 107).

FIRST USE 8-5-2008; IN COMMERCE 8-5-2008.
MORGAN WYNNE, EXAMINING ATTORNEY

SN 77-573,809. BRULINES LIMITED, STOCKTON ON TESS, UNITED KINGDOM, FILED 9-18-2008.

I-DRAUGHT

THE MARK CONSISTS OF STANDARD CHARACTERS WITHOUT CLAIM TO ANY PARTICULAR FONT, STYLE, SIZE, OR COLOR.

OWNER OF ERPN CMNTY TM OFC REG. NO. 7242291, DATED 7-1-2009, EXPIRES 9-18-2018.

CLASS 9—ELECTRICAL AND SCIENTIFIC APPARATUS

FOR SCIENTIFIC, WEIGHING, MEASURING AND CHECKING (SUPERVISION) APPARATUS AND INSTRUMENTS FOR MEASURING THERMAL PROPERTIES SUCH AS THE RESISTANCE TO ELECTRICAL CONDUCTIVITY AT A GIVEN TEMPERATURE; FLOW METERS; SENSING AND MONITORING APPARATUS AND INSTRUMENTS AND APPARATUS AND INSTRUMENTS FOR MEASURING ELECTRICAL PROPERTIES, NAMELY, FOR SENSING THE FLOW OF LIQUIDS AND MONITORING FOR QUALITY CONTROL THE FLOW OF LIQUIDS AND FOR MEASURING THE RESISTANCE TO ELECTRICAL CONDUCTIVITY AT A GIVEN TEMPERATURE; APPARATUS AND INSTRUMENTS FOR IDENTIFYING, MEASURING, SENSING AND CHECKING THE VOLUME, TEMPERATURE AND CONDUCTIVITY OF LIQUIDS; APPARATUS AND INSTRUMENTS FOR AUTOMATICALLY CONTROLLING AND/OR MONITORING THE LEVEL AND/OR FLOW OF LIQUIDS, NAMELY, THE FLOW METER TURBINE, THERMISTOR AND ELECTRICAL NODES TO MEASURE THE VOLUMETRIC, THERMAL AND RESISTANCE TO AN ELECTRICAL INPUT, NOT FOR MEDICAL USE; SCIENTIFIC, ELECTRIC AND ELECTRONIC APPARATUS AND INSTRUMENTS ALL FOR RECEIVING, PROCESSING, TRANSMITTING, STORING, RELAYING, INPUTTING OR OUTPUTTING OF DATA IN THE NATURE OF TIME, VOLUME, THERMAL AND ELECTRIC RESISTANCE DATA; MONITORING APPARATUS FOR USE WITH THE AFORESAID GOODS, NAMELY, CONTROL UNITS AND INSPECTION CONTROL PANELS FOR MONITORING AND CONTROLLING THE FLOW OF LIQUIDS; COMMUNICATIONS AND TELECOMMUNICATIONS APPARATUS AND INSTRUMENTS, NAMELY, WIRELESS RECEIVERS AND WIRED MODEMS; DATA LOGGING AND STORAGE DEVICES, NAMELY, EMBEDDED MICROCONTROLLERS, FLASH MEMORY CARDS, MEMORY BOARDS AND EPROM CIRCUITS; COMPUTER PROGRAMS AND COMPUTER SOFTWARE FOR IDENTIFICATION OF FLOW LIQUID STATE, TEMPERATURE AND VOLUME WITHIN THE FIELD OF DISPENSING AND QUALITY MONITORING; SIGNAL AND DATA MEDIA, NAMELY, DOWNLOADABLE AUDIO AND VIDEO RECORDINGS IN THE FIELD OF TEMPORAL, VOLUMETRIC, THERMAL AND ELECTRICAL RESISTANCE OF LIQUIDS; PARTS AND FITTINGS FOR ALL THE AFORESAID GOODS (U.S. CLS. 21, 23, 26, 36 AND 38).

CLASS 37—CONSTRUCTION AND REPAIR

FOR REPAIR, MAINTENANCE, AND INSTALLATION OF ELECTRICAL AND ELECTRONIC APPARATUS AND INSTRUMENTS FOR DATA PROCESSING, COMMUNICATIONS SYSTEMS AND APPARATUS, AND COMPUTER NETWORKS; CONSULTING IN THE FIELD OF COMPUTER SYSTEM INSTALLATION (U.S. CLS. 100, 103 AND 106).

CLASS 41—EDUCATION AND ENTERTAINMENT

FOR TRAINING IN THE FIELD OF INSTALLATION, MAINTENANCE AND OPERATION OF COMPUTER HARDWARE COMMUNICATION SYSTEMS AND APPARATUS, COMPUTER NETWORK SYSTEMS AND COMPUTER SUPPORT SOFTWARE (U.S. CLS. 100, 101 AND 107).

CLASS 42—SCIENTIFIC AND COMPUTER SERVICES

FOR DEVELOPMENT AND CONSULTANCY SERVICES IN THE FIELD OF COMPUTER SOFTWARE AND COMPUTER DATABASE SYSTEMS; COMPUTER HARDWARE DEVELOPMENT; CONSULTANCY IN THE FIELD OF EMBEDDED HARDWARE FOR THE PURPOSE OF FLOW DEVELOPMENT, COMMUNICATIONS AND MONITORING TECHNOLOGY; CONSULTANCY AND TECHNICAL SUPPORT SERVICES IN RELATION TO COMPUTER MANAGEMENT SUPPORT SOFTWARE; CONSULTING IN THE FIELD OF COMPUTER HARDWARE; CONSULTING IN THE FIELD OF LIQUID FLOW MONITORING (U.S. CLS. 100 AND 101).
KIMBERLY FRYE, EXAMINING ATTORNEY

SN 77-576,734. STEMSOFT SOFTWARE INC., VANCOUVER, CANADA, FILED 9-23-2008.

STEMSOFT

THE MARK CONSISTS OF STANDARD CHARACTERS WITHOUT CLAIM TO ANY PARTICULAR FONT, STYLE, SIZE, OR COLOR.
PRIORITY CLAIMED UNDER SEC. 44(D) ON CANADA APPLICATION NO. 1407457, FILED 8-15-2008, REG. NO. TMA759,108, DATED 2-9-2010, EXPIRES 2-9-2025.
OWNER OF U.S. REG. NOS. 1,890,889, 2,818,843 AND OTHERS.

CLASS 41—EDUCATION AND ENTERTAINMENT

FOR COMPUTER SOFTWARE EDUCATION TRAINING (U.S. CLS. 100, 101 AND 107).

CLASS 42—SCIENTIFIC AND COMPUTER SERVICES

FOR CONSULTING SERVICES RELATING TO SOFTWARE; COMPUTER SERVICES, NAMELY, TECHNICAL SUPPORT IN THE NATURE OF TROUBLESHOOTING SOFTWARE PROBLEMS; DEVELOPMENT AND DESIGN OF SOFTWARE; COMPUTER PROGRAMMING SERVICES (U.S. CLS. 100 AND 101).
FIRST USE 12-2-1993; IN COMMERCE 12-2-1993.
JESSICA A. POWERS, EXAMINING ATTORNEY

SN 77-582,492. LOGITECH INTERNATIONAL S.A., CH-1143 APPLS, SWITZERLAND, FILED 9-30-2008.

GET INTO IT

THE MARK CONSISTS OF STANDARD CHARACTERS WITHOUT CLAIM TO ANY PARTICULAR FONT, STYLE, SIZE, OR COLOR.

CLASS 9—ELECTRICAL AND SCIENTIFIC APPARATUS

FOR COMPUTER AND ELECTRONIC EQUIPMENT, NAMELY, COMPUTER HARDWARE; COMPUTER PERIPHERALS, NAMELY, KEYBOARDS, MICE, TRACKBALLS AND WIRELESS ELECTRONIC CONTROLLERS ALL FOR USE WITH CONSUMER ELECTRONIC EQUIPMENT; COMPUTER CONTROL AND INPUT DEVICES, NAMELY, KEYBOARDS, MICE, TRACKBALLS AND WIRELESS ELECTRONIC CONTROLLERS TO MONITOR AND CONTROL THE FUNCTIONING OF OTHER ELECTRONIC DEVICES; VIDEO GAME CONTROL DEVICES, NAMELY, REMOTE CONTROLS, JOYSTICKS, INTERACTIVE CONTROL FLOOR PADS, VIDEO GAME STEERING WHEELS, HEADSETS, KEYBOARDS AND MICE ALL FOR USE WITH COMPUTER AND VIDEO GAME CONSOLE PLATFORMS; VIDEO DEVICES, NAMELY, DIGITAL CAMERAS AND WEB CAMERAS; AUDIO AND SOUND SYSTEM DEVICES, NAMELY, AUDIO SPEAKERS, HEADSETS, HEADPHONES, EARBUDS AND MICROPHONES; TELEPHONY EQUIPMENT, NAMELY, HEADSETS, HEADPHONES, EARBUDS AND MICROPHONES FOR USE WITH COMPUTERS AND TELEPHONES; TELEPHONES, MOBILE PHONES, VIDEOPHONES; DIGITAL WRITING SYSTEMS FOR COMPUTERS AND MOBILE PHONES PRIMARILY COMPOSED OF DIGITAL LIGHT PEN AND COMPUTER SOFTWARE; REMOTE CONTROLS FOR CONTROLLING TVS, VIDEO PLAYERS, VIDEO RECORDERS, STEREOS, SPEAKERS, AMPLIFIERS, ENTERTAINMENT SYSTEMS, HOME LIGHTING SYSTEMS, PERSONAL COMPUTERS; CARRYING CASES FOR COMPUTER PERIPHERALS; COMPUTER SOFTWARE AND COMPUTER PROGRAMS FOR USE IN CONNECTION WITH PROVIDING AN INTERFACE BETWEEN A COMPUTER AND A PERIPHERAL DEVICE; COMPUTER SOFTWARE AND COMPUTER PROGRAMS FOR MANIPULATING AND CONTROLLING IMAGES FROM WEB CAMERAS AND DIGITAL CAMERAS; COMPUTER SOFTWARE AND COMPUTER PROGRAMS FOR PRODUCING SOUND; COMPUTER SOFTWARE AND COMPUTER PROGRAMS FOR HANDWRITING AND CHARACTER RECOGNITION; COMPUTER SOFTWARE AND COMPUTER PROGRAMS FOR USE IN CONNECTION WITH ELECTRONIC TRANSMISSION OF VIDEO, AUDIO AND DATA ACROSS LOCAL AREA, WIDE AREA AND GLOBAL COMPUTER NETWORKS; DOWNLOADABLE SOFTWARE FOR PROGRAMMING A REMOTE CONTROL FOR RADIOS, TELEVISION, STEREOS, AUDIO-VISUAL EQUIPMENT, APPLIANCES, AND LIGHTING; COMPUTER MONITORS; AUDIO, VIDEO AND RADIO TRANSMITTERS; AUDIO, VIDEO AND RADIO RECEIVERS; STEREO TUNERS AND RADIO SIGNAL TUNERS; AUDIO AND VIDEO RECORDERS; AUDIO AND VIDEO PLAYERS, DVD PLAYERS AND MP3 PLAYERS; RADIOS; MICROPHONES; WIRELESS PRESENTERS IN THE NATURE OF WIRELESS REMOTE POINTERS; NOTEBOOK COMPUTER STANDS; NOTEBOOK COMPUTER DOCKING STATIONS; COMPUTER DOCKING STATIONS; NUMBER KEYPADS; BATTERY PACKS; ELECTRIC AND ELECTRONIC CABLES; WIRELESS DIGITAL PHOTO FRAMES; FIRE ALARMS AND ANTI-INTRUSION ALARMS; ELECTRONIC TEMPERATURE SENSORS; LIGHTING CONTROL SYSTEMS COMPRISED OF MOTION-SENSITIVE SECURITY LIGHTS AND COMPUTER HARDWARE AND SOFTWARE FOR USE IN ACTIVATING AND DEACTIVATING ELECTRICAL LIGHTS; MOTION-SENSITIVE SECURITY LIGHTS; AND INSTRUCTION MANUALS SOLD AS A UNIT WITH THE AFOREMENTIONED GOODS (U.S. CLS. 21, 23, 26, 36 AND 38).

CLASS 38—COMMUNICATION

FOR STREAMING OF AUDIO AND VIDEO MATERIAL ON THE INTERNET; TELECOMMUNICATIONS SERVICES, NAMELY, TRANSMISSION OF PODCASTS AND VIDEOCONFERENCING (U.S. CLS. 100, 101 AND 104).

CLASS 41—EDUCATION AND ENTERTAINMENT

FOR ENTERTAINMENT SERVICES, NAMELY, DIGITAL AUDIO, PHOTOGRAPHIC AND VIDEO PRODUCTION SERVICES, NAMELY, PHOTOGRAPHIC AND VIDEO CAPTURE, PRODUCTION OF VIDEO AND TEXT CONTENT AND PRODUCTION OF PRERECORDED MUSIC AND VIDEO IMAGES FOR STREAMING PROVIDED VIA A WEBSITE FEATURING SUCH CONTENT; PROVIDING AN ONLINE COMPUTER DATABASE FEATURING MUSICAL AND AUDIOVISUAL RECORDINGS; PROVIDING AN ONLINE COMPUTER DATABASE FEATURING INFORMATION PERTAINING TO MUSIC AND ENTERTAINMENT; PROVIDING INFORMATION ABOUT MUSIC BASED ON PERSONAL PREFERENCES BY MEANS OF ANALYSIS OF MUSICAL PREFERENCES AND INTERESTS OF WEBSITE USERS VIA A GLOBAL COMPUTER NETWORK; PROVIDING AN INTERNET WEBSITE FEATURING LINKS TO WEBSITES OF OTHERS FEATURING MUSIC AND ENTERTAINMENT; ALL VIA THE INTERNET AND ELECTRONIC COMMUNICATIONS NETWORKS (U.S. CLS. 100, 101 AND 107).

CLASS 42—SCIENTIFIC AND COMPUTER SERVICES

FOR COMPUTER HARDWARE AND SOFTWARE CONSULTING SERVICES (U.S. CLS. 100 AND 101).
JULIE VEPPIUMTHARA, EXAMINING ATTORNEY

SN 77-587,866. NGH JAPAN CO., LTD., TOKYO, JAPAN,
FILED 10-7-2008.



NO CLAIM IS MADE TO THE EXCLUSIVE RIGHT TO USE "NGH JAPAN", APART FROM THE MARK AS SHOWN.

THE COLOR(S) RED AND BLUE IS/ARE CLAIMED AS A FEATURE OF THE MARK.

THE MARK CONSISTS OF THE WORDS "NGH JAPAN" IN RED LOCATED IN THE CENTER OF TWO OVERLAPPING ELLIPSES, THE LONG AXES OF THE ELLIPSES HAVING DIFFERENT LENGTHS WITH EACH LONG AXIS ORIENTED FROM 2:00 O'CLOCK TO 8:00 O'CLOCK AND EACH HAVING A SHORT AXIS OF THE SAME LENGTH. THE PORTION FORMED BETWEEN THE TWO ELLIPSES AT THE 2:00 O'CLOCK POSITION BEING COLORED RED AND THE PORTION FORMED BETWEEN THE TWO ELLIPSES AT THE 8:00 O'CLOCK POSITION BEING COLORED BLUE.

CLASS 4—LUBRICANTS AND FUELS

FOR NATURAL GAS AND NATURAL GAS-HYDRATE (U.S. CLS. 1, 6 AND 15).

CLASS 6—METAL GOODS

FOR GAS STORAGE TANKS OF METAL, HIGH PRESSURE GAS CONTAINERS AND MANIFOLDS OF METAL FOR PIPELINES; METAL PIPELINE COCKS; APPARATUS IN THE NATURE OF METAL CONTAINERS FOR STORING GAS-HYDRATE PELLETS (U.S. CLS. 2, 12, 13, 14, 23, 25 AND 50).

CLASS 7—MACHINERY

FOR GASIFIERS; APPARATUS FOR MOLDING GAS-HYDRATE TO PELLETS AND APPARATUS FOR CONVEYING GAS-HYDRATE PELLETS; DRILLING RIGS FOR OIL OR GAS, AND THEIR SPARE PARTS (U.S. CLS. 13, 19, 21, 23, 31, 34 AND 35).

CLASS 9—ELECTRICAL AND SCIENTIFIC APPARATUS

FOR SCIENTIFIC INSTRUMENTS, NAMELY, GAS ANALYZING INSTRUMENTS IN THE NATURE OF TECHNICAL MEASURING, TESTING AND CHECKING APPARATUS AND INSTRUMENTS FOR MEASURING, TESTING AND CHECKING THE TEMPERATURE, PRESSURE, QUANTITY AND CONCENTRATION OF COMPONENTS OF GAS AND GAS-HYDRATES; AND DOWNLOADABLE ELECTRONIC PUBLICATIONS IN THE NATURE OF BOOKS, MAGAZINES, MANUALS, IN THE FIELD OF NATURAL GAS-HYDRATES (U.S. CLS. 21, 23, 26, 36 AND 38).

CLASS 11—ENVIRONMENTAL CONTROL APPARATUS

FOR ELECTRICAL GAS GENERATORS; GAS-HYDRATE PRODUCING APPARATUS, NAMELY, APPARATUS FOR CONVERTING WATER AND GAS TO HYDRATE (U.S. CLS. 13, 21, 23, 31 AND 34).

CLASS 12—VEHICLES

FOR SHIPS AND TRANSPORT SHIPS (U.S. CLS. 19, 21, 23, 31, 35 AND 44).

CLASS 16—PAPER GOODS AND PRINTED MATTER

FOR PRINTED MATTER, NAMELY, PAMPHLETS, CATALOGS, NEWSLETTERS, ACADEMIC PAPERS, IN THE FIELD OF NATURAL GAS INDUSTRIES (U.S. CLS. 2, 5, 22, 23, 29, 37, 38 AND 50).

CLASS 20—FURNITURE AND ARTICLES NOT OTHERWISE CLASSIFIED

FOR GAS STORAGE TANKS OTHER THAN TANKS OF METAL OR MASONRY (U.S. CLS. 2, 13, 22, 25, 32 AND 50).

CLASS 35—ADVERTISING AND BUSINESS

FOR CONSULTATION, ADVICE AND PROVIDING INFORMATION RELATING TO THE MANAGEMENT OF GAS-HYDRATE BUSINESS; COMMERCIAL MANAGEMENT OF BUSINESS LICENSES RELATING TO GAS-HYDRATE BUSINESS; COMMERCIAL SUPERVISION OF TRANSPORTATION LOGISTIC SERVICES OF GAS OR OIL BY RAILWAY, VEHICLES, SHIPS, AIRPLANES AND PIPELINES; COMMERCIAL SUPERVISION OF PIPELINE CONSTRUCTION AND PIPELINE MAINTENANCE; COMMERCIAL SUPERVISION OF DRILLING CONSTRUCTION RELATING TO OIL AND GAS WELLS; INVESTIGATION IN THE NATURE OF BUSINESS INVESTIGATIONS OF OIL AND NATURAL GAS RESOURCES; INVESTIGATION IN THE NATURE OF BUSINESS INVESTIGATIONS ON GAS-HYDRATION OF NATURAL GAS; INVESTIGATION IN THE NATURE OF BUSINESS INVESTIGATIONS ON OIL AND NATURAL GAS; BUSINESS MANAGEMENT OF BUSINESS INTERMEDIARY AND ADVISORY SERVICES RELATING TO THE NEGOTIATING OF LICENSE AGREEMENTS IN THE FIELD OF GAS-HYDRATE BUSINESS AND PROVIDING BUSINESS INFORMATION ABOUT NEGOTIATING LICENSE AGREEMENTS IN THE FIELD OF GAS-HYDRATE BUSINESS (U.S. CLS. 100, 101 AND 102).

CLASS 37—CONSTRUCTION AND REPAIR

FOR PROVIDING INFORMATION ABOUT DRILLING RIGS FOR OIL OR GAS; CONSTRUCTION SUPERVISION OF PIPELINE CONSTRUCTION, PIPELINE MAINTENANCE; CONSTRUCTION SUPERVISION OF DRILLING CONSTRUCTION RELATING TO OIL AND GAS WELLS; PROVIDING INFORMATION CONCERNING REPAIR OR MAINTENANCE FOR GAS-PURIFICATION PLANTS; PROVIDING INFORMATION ON THE RENTAL OF DRILLING RIGS (U.S. CLS. 100, 103 AND 106).

CLASS 39—TRANSPORTATION AND STORAGE

FOR CONSULTING SERVICES CONCERNING SUPPLY AND DISTRIBUTION OF NATURAL GAS (U.S. CLS. 100 AND 105).

CLASS 41—EDUCATION AND ENTERTAINMENT

FOR EDUCATIONAL SERVICES, NAMELY, PLANNING AND HOLDING OF SEMINARS, SYMPOSIUMS AND CONFERENCES IN THE FIELD OF NATURAL GAS INDUSTRIES; PUBLICATION OF BOOKS; AND PUBLISHING ELECTRONIC PUBLICATIONS (U.S. CLS. 100, 101 AND 107).

CLASS 42—SCIENTIFIC AND COMPUTER SERVICES

FOR INVESTIGATION IN THE NATURE OF SCIENTIFIC RESEARCH SERVICES AND EXPLORATION OF OIL AND NATURAL GAS RESOURCES; ENGINEERING RELATING TO OIL AND NATURAL GAS PURIFICATION PLANTS; GEOLOGICAL SURVEYS FOR OIL AND NATURAL GAS DIGGING; ENGINEERING RELATING TO OIL AND NATURAL GAS DIGGING PLANTS; TESTING, INVESTIGATION IN THE NATURE OF SCIENTIFIC RESEARCH SERVICES AND RESEARCH ON GAS-HYDRATION OF NATURAL GAS; TESTING, INVESTIGATION IN THE NATURE OF SCIENTIFIC RESEARCH SERVICES AND RESEARCH ON OIL AND NATURAL GAS; CHEMICAL ANALYSIS OF NATURAL GAS-HYDRATE; AND RESEARCH ON STANDARDIZATION OF NATURAL GAS-HYDRATE (U.S. CLS. 100 AND 101).

AMEEN IMAM, EXAMINING ATTORNEY

SN 77-590,367. UNDERGROUND VAULTS & STORAGE, INC., HUTCHINSON, KS. FILED 10-10-2008.



NO CLAIM IS MADE TO THE EXCLUSIVE RIGHT TO USE "VAULTS & STORAGE" IN CLASS 39, APART FROM THE MARK AS SHOWN.

THE MARK CONSISTS OF THE WORDS "UNDERGROUND VAULTS & STORAGE" WITH A STYLIZED "U" TO THE LEFT MADE UP OF A DOWNWARD POINTING ARROW AND A RECTANGLE WITH A PARTIALLY CURVED BOTTOM PORTION.

SEC. 2(F) AS TO "UNDERGROUND VAULTS & STORAGE".

CLASS 35—ADVERTISING AND BUSINESS

FOR DOCUMENT MANAGEMENT, NAMELY, DOCUMENT INDEXING, INSPECTION, REFILE, INTERFILING AND ORGANIZATION FOR OTHERS; MEDICAL RECORDS MANAGEMENT SERVICES, NAMELY, RETRIEVAL OF MEDICAL RECORDS FOR OTHERS; AND INFORMATION MANAGEMENT, NAMELY, BUSINESS INFORMATION MANAGEMENT, MEDICAL INFORMATION MANAGEMENT, AND LEGAL INFORMATION MANAGEMENT (U.S. CLS. 100, 101 AND 102).

FIRST USE 4-0-1959, THE MARK WAS FIRST USED ANYWHERE IN A DIFFERENT FORM OTHER THAN THAT SOUGHT TO BE REGISTERED AT LEAST AS EARLY AS 04/01/1965.; IN COMMERCE 4-0-1959, THE MARK WAS FIRST USED IN COMMERCE IN A DIFFERENT FORM OTHER THAN THAT SOUGHT TO BE REGISTERED AT LEAST AS EARLY AS 04/01/1965..

CLASS 39—TRANSPORTATION AND STORAGE

FOR WAREHOUSE STORAGE; STORAGE SERVICES, NAMELY, ELECTRONIC STORAGE OF GOVERNMENT, LEGAL, BUSINESS AND MEDICAL RECORDS; AND WAREHOUSE STORAGE OF HARD COPIES OF DOCUMENTS, DIGITAL MEDIA, HISTORICAL ARTIFACTS, AND MOVIE FILM; AND TRANSPORTATION OF STORED DOCUMENTS, DIGITAL MEDIA AND MOVIE FILMS BY TRUCK (U.S. CLS. 100 AND 105).

FIRST USE 4-0-1960, THE MARK WAS FIRST USED ANYWHERE IN A DIFFERENT FORM OTHER THAN THAT SOUGHT TO BE REGISTERED AT LEAST AS EARLY AS 04/01/1965.; IN COMMERCE 6-0-1960, THE MARK WAS FIRST USED IN COMMERCE IN A DIFFERENT FORM OTHER THAN THAT SOUGHT TO BE REGISTERED AT LEAST AS EARLY AS 04/01/1965..

CLASS 40—MATERIAL TREATMENT

FOR ELECTRONIC SCANNING OF LEGAL, BUSINESS AND MEDICAL RECORDS (U.S. CLS. 100, 103 AND 106).

FIRST USE 1-0-2005, THE MARK WAS FIRST USED ANYWHERE IN A DIFFERENT FORM OTHER THAN THAT SOUGHT TO BE REGISTERED AT LEAST AS EARLY AS 04/01/1965.; IN COMMERCE 4-0-2005, THE MARK WAS FIRST USED IN COMMERCE IN A DIFFERENT FORM OTHER THAN THAT SOUGHT TO BE REGISTERED AT LEAST AS EARLY AS 04/01/1965..

KATINA MISTER, EXAMINING ATTORNEY

SN 77-593,577. CHILDREN'S JUSTICE ALLIANCE, PORTLAND, OR. FILED 10-15-2008.

PARENTING INSIDE OUT

THE MARK CONSISTS OF STANDARD CHARACTERS WITHOUT CLAIM TO ANY PARTICULAR FONT, STYLE, SIZE, OR COLOR.
 NO CLAIM IS MADE TO THE EXCLUSIVE RIGHT TO USE "PARENTING", APART FROM THE MARK AS SHOWN.

CLASS 16—PAPER GOODS AND PRINTED MATTER

FOR (BASED ON USE IN COMMERCE) EDUCATIONAL PUBLICATIONS, NAMELY, TRAINING MANUALS IN THE FIELDS OF PARENTING EDUCATION AND PARENTING SKILLS (U.S. CLS. 2, 5, 22, 23, 29, 37, 38 AND 50).
 FIRST USE 12-31-2001; IN COMMERCE 5-13-2008.

CLASS 41—EDUCATION AND ENTERTAINMENT

FOR (BASED ON USE IN COMMERCE) EDUCATION SERVICES, NAMELY, TRAINING EDUCATORS TO TEACH PARENTING SKILLS AND PROVIDING CURRICULA IN CONNECTION THEREWITH; PROVIDING ONLINE EDUCATIONAL INFORMATION ABOUT PARENTING EDUCATION AND EDUCATION IN PARENTING SKILLS (U.S. CLS. 100, 101 AND 107).
 FIRST USE 5-13-2008; IN COMMERCE 5-13-2008.

CLASS 42—SCIENTIFIC AND COMPUTER SERVICES

FOR (BASED ON INTENT TO USE) COMPUTER SERVICES, NAMELY, HOSTING ON-LINE WEB FACILITIES FOR ORGANIZING AND CONDUCTING ONLINE MEETINGS, AND INTERACTIVE DISCUSSIONS IN THE FIELDS OF PARENTING EDUCATION AND PARENTING SKILLS (U.S. CLS. 100 AND 101).
 LESLEY LAMOTHE, EXAMINING ATTORNEY

SN 77-594,177. DGAN DEUTSCHE GESELLSCHAFT FÜR AKADEMISCHE NACHWUCHSFOERDERUNG MBH, FRANKFURT AM MAIN, FED REP GERMANY, FILED 10-16-2008.

youtrex

THE MARK CONSISTS OF STANDARD CHARACTERS WITHOUT CLAIM TO ANY PARTICULAR FONT, STYLE, SIZE, OR COLOR.

CLASS 35—ADVERTISING AND BUSINESS

FOR BUSINESS NETWORKING; BUSINESS NETWORKING OF PEER TO PEER LEARNING GROUPS OF HIGH NET WORTH INDIVIDUALS; CAREER PLACEMENT; DEVELOPING AND COORDINATING VOLUNTEER PROJECTS FOR CHARITABLE ORGANIZATIONS; EDUCATION LEADERSHIP DEVELOPMENT; EMPLOYMENT COUNSELING AND RECRUITING; ON-LINE BUSINESS NETWORKING SERVICES; PROVIDING CAREER INFORMATION; PUBLIC ADVOCACY TO PROMOTE AWARENESS OF CAREER AND EDUCATION; RECRUITMENT OF STUDENTS FOR HIGHER EDUCATION INSTITUTIONS (U.S. CLS. 100, 101 AND 102).

CLASS 41—EDUCATION AND ENTERTAINMENT

FOR ARRANGING AND CONDUCTING EDUCATIONAL CONFERENCES; CONDUCTING WORKSHOPS AND SEMINARS IN THE FIELD OF CAREER AND EDUCATION; EDUCATION INFORMATION; INFORMATION RELATING TO ENTERTAINMENT AND EDUCATION, PROVIDED ON-LINE FROM A COMPUTER DATABASE OR THE INTERNET; PROVIDING INFORMATION ON-LINE RELATING TO EDUCATIONAL OPPORTUNITIES (U.S. CLS. 100, 101 AND 107).

CLASS 42—SCIENTIFIC AND COMPUTER SERVICES

FOR COMPUTER SERVICES, NAMELY, CREATING AN ON-LINE COMMUNITY FOR REGISTERED USERS TO PARTICIPATE IN COMPETITIONS, SHOWCASE THEIR SKILLS, GET FEEDBACK FROM THEIR PEERS, FORM VIRTUAL COMMUNITIES, ENGAGE IN SOCIAL NETWORKING AND IMPROVE THEIR TALENT; COMPUTER SERVICES, NAMELY, INTERACTIVE HOSTING SERVICES WHICH ALLOW THE USER TO PUBLISH AND SHARE THEIR OWN CONTENT AND IMAGES ON-LINE (U.S. CLS. 100 AND 101).

CLASS 45—PERSONAL AND LEGAL SERVICES

FOR ON-LINE SOCIAL NETWORKING SERVICES (U.S. CLS. 100 AND 101).
 COLLEEN KEARNEY, EXAMINING ATTORNEY

SN 77-596,533. OEM GROUP, INC., GILBERT, AZ. FILED 10-20-2008.



THE COLOR(S) RED AND WHITE IS/ARE CLAIMED AS A FEATURE OF THE MARK.
 THE MARK CONSISTS OF THE WORDS "OEM GROUP" IN A STYLIZED RAISED FONT, THE WORD "GROUP" APPEARS SMALLER THAN THE LETTERS "OEM". THE LETTER "O" IN "OEM" IS RED AND THE REMAINDER OF THE LETTERING IN THE MARK IS WHITE.

CLASS 37—CONSTRUCTION AND REPAIR

FOR REMANUFACTURE OF SEMICONDUCTOR EQUIPMENT, NAMELY, FRONT END PROCESS MANUFACTURING EQUIPMENT INVOLVED IN PVD, CVD, ETCH, CMP, IMPLANT AND OTHER SEMICONDUCTOR PROCESSES AND ASSOCIATED PARTS TO THE ORDER OR SPECIFICATIONS OF OTHERS; UPDATING OF SEMICONDUCTOR EQUIPMENT, NAMELY, THE REARRANGEMENT OR RESTRUCTURING AND OPTIMIZATION OF ELEMENTS, COMPONENTS, DESIGNS OR SETTINGS OF SEMICONDUCTOR EQUIPMENT, NAMELY, FRONT END PROCESS MANUFACTURING EQUIPMENT INVOLVED IN PVD, CVD, ETCH, CMP, IMPLANT AND OTHER SEMICONDUCTOR PROCESSES; INSTALLATION OF SEMICONDUCTOR EQUIPMENT, NAMELY, FRONT END PROCESS MANUFACTURING EQUIPMENT INVOLVED IN PVD, CVD, ETCH, CMP, IMPLANT AND OTHER SEMICONDUCTOR PROCESSES AND ASSOCIATED PARTS, CONSUMABLES, UPGRADE KITS AND PERIPHERAL EQUIPMENT, NAMELY, VACUUM PUMPS, HEAT EXCHANGERS AND POINT OF USE GAS ABATEMENT; TECHNICAL SUPPORT SERVICES, NAMELY, TROUBLESHOOTING IN THE NATURE OF REPAIR AND MODIFICATION OF SEMICONDUCTOR MANUFACTURING EQUIPMENT (U.S. CLS. 100, 103 AND 106).

CLASS 37—CONSTRUCTION AND REPAIR

FOR REMANUFACTURE OF SEMICONDUCTOR EQUIPMENT, NAMELY, FRONT END PROCESS MANUFACTURING EQUIPMENT INVOLVED IN PVD, CVD, ETCH, CMP, IMPLANT AND OTHER SEMICONDUCTOR PROCESSES AND ASSOCIATED PARTS TO THE ORDER OR SPECIFICATIONS OF OTHERS; UPDATING OF SEMICONDUCTOR EQUIPMENT, NAMELY, THE REARRANGEMENT OR RESTRUCTURING AND OPTIMIZATION OF ELEMENTS, COMPONENTS, DESIGNS OR SETTINGS OF SEMICONDUCTOR EQUIPMENT, NAMELY, FRONT END PROCESS MANUFACTURING EQUIPMENT INVOLVED IN PVD, CVD, ETCH, CMP, IMPLANT AND OTHER SEMICONDUCTOR PROCESSES; INSTALLATION OF SEMICONDUCTOR EQUIPMENT, NAMELY, FRONT END PROCESS MANUFACTURING EQUIPMENT INVOLVED IN PVD, CVD, ETCH, CMP, IMPLANT AND OTHER SEMICONDUCTOR PROCESSES AND ASSOCIATED PARTS, CONSUMABLES, UPGRADE KITS AND PERIPHERAL EQUIPMENT, NAMELY, VACUUM PUMPS, HEAT EXCHANGERS AND POINT OF USE GAS ABATEMENT; TECHNICAL SUPPORT SERVICES, NAMELY, TROUBLESHOOTING IN THE NATURE OF REPAIR AND MODIFICATION OF SEMICONDUCTOR MANUFACTURING EQUIPMENT (U.S. CLS. 100, 103 AND 106).

CLASS 40—MATERIAL TREATMENT

FOR OPTIMIZATION SERVICES, NAMELY, TECHNICAL CONSULTATION IN THE NATURE OF THE SELECTION OF SEMICONDUCTOR MANUFACTURING EQUIPMENT (U.S. CLS. 100, 103 AND 106).
MAYUR VAGHANI, EXAMINING ATTORNEY

CLASS 40—MATERIAL TREATMENT

FOR OPTIMIZATION SERVICES, NAMELY, TECHNICAL CONSULTATION IN THE NATURE OF THE SELECTION OF SEMICONDUCTOR MANUFACTURING EQUIPMENT (U.S. CLS. 100, 103 AND 106).
MAYUR VAGHANI, EXAMINING ATTORNEY

SN 77-596,542. OEM GROUP, INC., GILBERT, AZ. FILED 10-20-2008.

SN 77-596,549. OEM GROUP, INC., GILBERT, AZ. FILED 10-20-2008.



THE COLOR(S) RED AND WHITE IS/ARE CLAIMED AS A FEATURE OF THE MARK.
THE MARK CONSISTS OF THE WORDS "OEM GROUP" IN A STYLIZED FONT, THE WORD "GROUP" APPEARS SMALLER THAN THE LETTERS "OEM". THE LETTER "O" IN "OEM" IS RED AND THE REMAINDER OF THE LETTERING IN THE MARK IS WHITE.

THE COLOR(S) BLACK AND RED IS/ARE CLAIMED AS A FEATURE OF THE MARK.
THE MARK CONSISTS OF THE WORDS "OEM GROUP" IN A STYLIZED RAISED FONT, THE WORD "GROUP" APPEARS SMALLER THAN THE LETTERS "OEM". THE LETTER "O" IN "OEM" IS RED AND THE REMAINDER OF THE LETTERING IN THE MARK IS BLACK.

CLASS 37—CONSTRUCTION AND REPAIR

FOR REMANUFACTURE OF SEMICONDUCTOR EQUIPMENT, NAMELY, FRONT END PROCESS MANUFACTURING EQUIPMENT INVOLVED IN PVD, CVD, ETCH, CMP, IMPLANT AND OTHER SEMICONDUCTOR PROCESSES AND ASSOCIATED PARTS TO THE ORDER OR SPECIFICATIONS OF OTHERS; UPDATING OF SEMICONDUCTOR EQUIPMENT, NAMELY, THE REARRANGEMENT OR RESTRUCTURING AND OPTIMIZATION OF ELEMENTS, COMPONENTS, DESIGNS OR SETTINGS OF SEMICONDUCTOR EQUIPMENT, NAMELY, FRONT END PROCESS MANUFACTURING EQUIPMENT INVOLVED IN PVD, CVD, ETCH, CMP, IMPLANT AND OTHER SEMICONDUCTOR PROCESSES; INSTALLATION OF SEMICONDUCTOR EQUIPMENT, NAMELY, FRONT END PROCESS MANUFACTURING EQUIPMENT INVOLVED IN PVD, CVD, ETCH, CMP, IMPLANT AND OTHER SEMICONDUCTOR PROCESSES AND ASSOCIATED PARTS, CONSUMABLES, UPGRADE KITS AND PERIPHERAL EQUIPMENT, NAMELY, VACUUM PUMPS, HEAT EXCHANGERS AND POINT OF USE GAS ABATEMENT; TECHNICAL SUPPORT SERVICES, NAMELY, TROUBLESHOOTING IN THE NATURE OF REPAIR AND MODIFICATION OF SEMICONDUCTOR MANUFACTURING EQUIPMENT (U.S. CLS. 100, 103 AND 106).

CLASS 40—MATERIAL TREATMENT

FOR OPTIMIZATION SERVICES, NAMELY, TECHNICAL CONSULTATION IN THE NATURE OF THE SELECTION OF SEMICONDUCTOR MANUFACTURING EQUIPMENT (U.S. CLS. 100, 103 AND 106).
MAYUR VAGHANI, EXAMINING ATTORNEY

CLASS 37—CONSTRUCTION AND REPAIR

FOR REMANUFACTURE OF SEMICONDUCTOR EQUIPMENT, NAMELY, FRONT END PROCESS MANUFACTURING EQUIPMENT INVOLVED IN PVD, CVD, ETCH, CMP, IMPLANT AND OTHER SEMICONDUCTOR PROCESSES AND ASSOCIATED PARTS TO THE ORDER OR SPECIFICATIONS OF OTHERS; UPDATING OF SEMICONDUCTOR EQUIPMENT, NAMELY, THE REARRANGEMENT OR RESTRUCTURING AND OPTIMIZATION OF ELEMENTS, COMPONENTS, DESIGNS OR SETTINGS OF SEMICONDUCTOR EQUIPMENT, NAMELY, FRONT END PROCESS MANUFACTURING EQUIPMENT INVOLVED IN PVD, CVD, ETCH, CMP, IMPLANT AND OTHER SEMICONDUCTOR PROCESSES; INSTALLATION OF SEMICONDUCTOR EQUIPMENT, NAMELY, FRONT END PROCESS MANUFACTURING EQUIPMENT INVOLVED IN PVD, CVD, ETCH, CMP, IMPLANT AND OTHER SEMICONDUCTOR PROCESSES AND ASSOCIATED PARTS, CONSUMABLES, UPGRADE KITS AND PERIPHERAL EQUIPMENT, NAMELY, VACUUM PUMPS, HEAT EXCHANGERS AND POINT OF USE GAS ABATEMENT; TECHNICAL SUPPORT SERVICES, NAMELY, TROUBLESHOOTING IN THE NATURE OF REPAIR AND MODIFICATION OF SEMICONDUCTOR MANUFACTURING EQUIPMENT (U.S. CLS. 100, 103 AND 106).

CLASS 40—MATERIAL TREATMENT

FOR OPTIMIZATION SERVICES, NAMELY, TECHNICAL CONSULTATION IN THE NATURE OF THE SELECTION OF SEMICONDUCTOR MANUFACTURING EQUIPMENT (U.S. CLS. 100, 103 AND 106).
MAYUR VAGHANI, EXAMINING ATTORNEY

SN 77-596,555. OEM GROUP, INC., GILBERT, AZ. FILED 10-20-2008.



The logo for OEM GROUP features the letters 'OEM' in a large, bold, black font. The letter 'O' is a solid red circle. To the right of 'OEM', the word 'GROUP' is written in a smaller, black, sans-serif font.

THE COLOR(S) BLACK AND RED IS/ARE CLAIMED AS A FEATURE OF THE MARK.

THE MARK CONSISTS OF THE WORDS "OEM GROUP" IN A STYLIZED FONT, THE WORD "GROUP" APPEARS SMALLER THAN THE LETTERS "OEM". THE LETTER "O" IN "OEM" IS RED AND THE REMAINDER OF THE LETTERING IN THE MARK IS BLACK.

SN 77-604,694. WOLFSBERGER, CLARK, ST. LOUIS, MO. FILED 10-30-2008.



The logo for SmartShot features the word 'SmartShot' in a large, black, serif font. The 'S' is significantly larger than the other letters and has a unique, rounded shape.

THE MARK CONSISTS OF STANDARD CHARACTERS WITHOUT CLAIM TO ANY PARTICULAR FONT, STYLE, SIZE, OR COLOR.

CLASS 5—PHARMACEUTICALS

FOR ANALGESIC AND MUSCLE RELAXANT PHARMACEUTICAL PREPARATIONS; BABY FOODS; DIETARY AND NUTRITIONAL SUPPLEMENTS; DIETARY SUPPLEMENTAL DRINKS; DIETETIC FOODS ADAPTED FOR MEDICAL USE; HERBAL SUPPLEMENTS; INTRAVENOUS FLUIDS USED FOR REHYDRATION, NUTRITION AND THE DELIVERY OF PHARMACEUTICAL PREPARATIONS; LIQUID NUTRITIONAL SUPPLEMENT; MUSCLE RELAXANTS; NUTRITIONAL DRINKS USED FOR MEAL REPLACEMENT; NUTRITIONAL ENERGY BARS FOR USE AS A MEAL SUBSTITUTE; NUTRITIONAL SUPPLEMENTS; PHARMACEUTICAL PREPARATIONS AND SUBSTANCES FOR THE TREATMENT OF DAMAGED SKIN AND TISSUE; PHARMACEUTICAL PREPARATIONS FOR SKIN CARE; PHARMACEUTICAL PREPARATIONS NAMELY, APPETITE SUPPRESSANTS; VITAMIN AND MINERAL SUPPLEMENTS; VITAMIN FORTIFIED BEVERAGES; VITAMIN SUPPLEMENT IN TABLET FORM FOR USE IN MAKING AN EFFERVESCENT BEVERAGE WHEN ADDED TO WATER; VITAMIN SUPPLEMENTS; VITAMINS (U.S. CLS. 6, 18, 44, 46, 51 AND 52).

CLASS 32—LIGHT BEVERAGES

FOR CONCENTRATES, SYRUPS OR POWDERS USED IN THE PREPARATION OF SOFT DRINKS; ENERGY DRINKS; FLAVORED WATERS; ISOTONIC BEVERAGES; NON-ALCOHOLIC BEVERAGES WITH TEA FLAVOR; NON-ALCOHOLIC BEVERAGES, NAMELY, CARBONATED BEVERAGES; POWDERS USED IN THE PREPARATION OF ISOTONIC SPORTS DRINKS AND SPORTS BEVERAGES; SPORTS DRINKS, NAMELY, ENERGY DRINKS (U.S. CLS. 45, 46 AND 48).

FRED CARL, EXAMINING ATTORNEY

CLASS 38—COMMUNICATION

FOR TELECOMMUNICATIONS SERVICES, NAMELY, PROVIDING ACCESS TO COMPUTER DATABASES; PROVIDING ON-LINE FACILITIES IN THE NATURE OF CHAT ROOMS AND ELECTRONIC BULLETIN BOARDS TO PARTICIPATE IN LIVE DEBATES IN THE FIELD OF POLITICAL AND SOCIAL POLLING VIA E-MAIL OR THE INTERNET; ELECTRONIC TRANSMISSION OF PETITIONS IN THE FORM OF QUESTIONNAIRES ON MARKET RESEARCH VIA E-MAIL OR THE INTERNET; ELECTRONIC VOTING VIA E-MAIL OR THE INTERNET, NAMELY, TRANSMISSION OF VOTES FOR LOCAL, REGIONAL OR NATIONAL ELECTIONS VIA E-MAIL OR THE INTERNET; PROVIDING, VIA THE INTERNET, ON-LINE CHAT ROOMS AND ELECTRONIC BULLETIN BOARDS WHERE USERS CAN SEND E-MAIL MESSAGES IN THE FIELD OF BRAND STATISTICS; PROVISION OF TELECOMMUNICATIONS ACCESS TO COMPUTER DATABASES; ELECTRONIC MESSAGE SENDING; NEWS AGENCIES, NAMELY, THE TRANSMISSION OF NEWS ITEMS TO NEWS REPORTING ORGANIZATIONS; NEWS AGENCIES, NAMELY, THE TRANSMISSION OF NEWS ITEMS TO NEWS REPORTING ORGANIZATIONS VIA THE INTERNET (U.S. CLS. 100, 101 AND 104).

SN 77-606,127. YOUGOV PLC, LONDON, UNITED KINGDOM, FILED 11-3-2008.

CLASS 41—EDUCATION AND ENTERTAINMENT

FOR ON-LINE INFORMATION SERVICES RELATING TO CURRENT EVENT NEWS, ENTERTAINMENT AND SPORTS (U.S. CLS. 100, 101 AND 107).

DAVID HOFFMAN, EXAMINING ATTORNEY

YouGov Omnibus

SN 77-609,887. THE NEIL JONES FOOD COMPANY, VANCOUVER, WA. FILED 11-7-2008.

THE MARK CONSISTS OF STANDARD CHARACTERS WITHOUT CLAIM TO ANY PARTICULAR FONT, STYLE, SIZE, OR COLOR.

OWNER OF ERPN CMNTY TM OFC REG. NO. 007354509, DATED 3-1-2010, EXPIRES 3-1-2020.

CLASS 35—ADVERTISING AND BUSINESS

FOR ADVERTISING; BUSINESS MANAGEMENT; BUSINESS ADMINISTRATION; BUSINESS ADVICE AND INFORMATION; OPINION POLLING, NAMELY, PUBLIC OPINION POLLING AND MARKET OPINION POLLING STUDIES; MARKET RESEARCH; MARKET RESEARCH SURVEYS; AUCTIONEERING SERVICES PROVIDED ON-LINE; COMPILATION OF INFORMATION INTO COMPUTER DATABASES; STATISTICAL MODELING SERVICES, NAMELY, CONDUCTING PUBLIC OPINION POLLS AND PREPARING REPORTS BASED UPON THE RESULTS COLLECTED; BRAND TRACKING SERVICES, NAMELY, BRAND DEVELOPMENT IN THE CONSUMER MARKET FIELD; COST/PRICE ANALYSIS; INFORMATION AND ADVISORY SERVICES RELATING TO THE AFORESAID SERVICES; PROVIDING INFORMATION AND ADVICE REGARDING LOCAL, REGIONAL OR NATIONAL GOVERNMENT AFFAIRS ON-LINE FROM A COMPUTER DATABASE OR VIA THE INTERNET; POLITICAL CONSULTANCY, NAMELY, PROVIDING POLITICAL INFORMATION ON-LINE FROM A COMPUTER DATABASE OR VIA THE INTERNET; ORGANIZING OF VOTING FACILITIES, NAMELY, RENTAL OF ELECTRONIC VOTING SYSTEMS AND PROVIDING OPERATORS THEREFOR; LOBBYING SERVICES, NAMELY, PROMOTING THE INTERESTS OF THE PUBLIC SECTOR IN THE FIELDS OF LEGISLATION AND REGULATION; ON-LINE MARKET RESEARCH SERVICES AND PUBLIC OPINION POLLING (U.S. CLS. 100, 101 AND 102).



OWNER OF U.S. REG. NOS. 2,744,714 AND 2,948,347. THE MARK CONSISTS OF A LEAF DESIGN ABOVE THE WORD "EARTHPURE".

CLASS 29—MEATS AND PROCESSED FOODS

FOR PROCESSED ORGANIC TOMATOES; CANNED, COOKED OR OTHERWISE PROCESSED TOMATOES; ORGANIC TOMATO PASTE; ORGANIC TOMATO PUREE (U.S. CL. 46).

CLASS 30—STAPLE FOODS

FOR ORGANIC TOMATO SAUCE (U.S. CL. 46).
JEFFREY LOOK, EXAMINING ATTORNEY

SN 77-611,218. GEOSOLUTIONS B.V., AMSTERDAM, NETHERLANDS, FILED 11-10-2008.

PLACERANK

THE MARK CONSISTS OF STANDARD CHARACTERS WITHOUT CLAIM TO ANY PARTICULAR FONT, STYLE, SIZE, OR COLOR.

CLASS 38—COMMUNICATION

FOR COMMUNICATION SERVICES, NAMELY, TRANSMISSION AND RECEPTION OF VISUAL IMAGES AND DATA BY TELECOMMUNICATIONS NETWORKS, WIRELESS COMMUNICATION NETWORKS, THE INTERNET, INFORMATION SERVICES NETWORKS AND DATA NETWORKS FOR PROVIDING SEARCH ENGINE SERVICES AND FOR DELIVERING SEARCH RESULTS BASED ON ACTUAL LOCATION OF USE AND BEHAVIORAL DATA OF A USER; DATA TRANSMISSION AND RECEPTION SERVICES FOR ADVERTISING THE GOODS AND SERVICES OF OTHERS (U.S. CLS. 100, 101 AND 104).

CLASS 45—PERSONAL AND LEGAL SERVICES

FOR SOCIAL NETWORKING SERVICES (U.S. CLS. 100 AND 101).
DOMINICK J. SALEMI, EXAMINING ATTORNEY

SN 77-616,560. SYNTHES (U.S.A.), WEST CHESTER, PA. FILED 11-18-2008.



THE MARK CONSISTS OF A MOUNTAIN DESIGN.

CLASS 1—CHEMICALS

FOR CHEMICAL PREPARATIONS USED IN SCIENCE FOR, OR IN CONNECTION WITH BONE IMPLANTS AND IMPLANTATION, NAMELY, BONE CEMENTS, PASTES, PUTTIES AND CERAMICS AND BONE GROWTH FACTORS; UNPROCESSED PLASTICS, NAMELY, BIORESORBABLE PLASTICS FOR USE IN CONNECTION WITH OSTEOSYNTHESIS, MUSCULO-SKELETAL, MAXILLO-FACIAL, AND SPINE SURGERY; UNPROCESSED POLYLACTATES FOR USE IN OSTEOSYNTHESIS, MUSCULO-SKELETAL, MAXILLOFACIAL, AND SPINE SURGERY (U.S. CLS. 1, 5, 6, 10, 26 AND 46).
FIRST USE 12-0-1991; IN COMMERCE 12-0-1991.

CLASS 10—MEDICAL APPARATUS

FOR INSTRUMENTS AND APPARATUS FOR SURGICAL, MEDICAL, AND VETERINARY PURPOSES SOLELY FOR BONE SURGERY, NAMELY, INSTRUMENTS AND IMPLANTS COMPRISED PRIMARILY OF ARTIFICIAL AND/OR NON-LIVING MATERIALS FOR OSTEOSYNTHESIS, INCLUDING BONE SCREWS, BONE NAILS, BONE PLATES AND SPLINTS; INJECTION NEEDLES, AND GUM PLATES FOR MEDICAL USE; SURGICAL AND MEDICAL EQUIPMENT, NAMELY, HANDHELD POWER DRILLS, BONE MILLING CUTTERS, SAW, AND LOCKING BOLTS FOR MEDICAL AND SURGICAL PURPOSES AND ELECTRONIC MOTORS FOR USE WITH THE AFOREMENTIONED EQUIPMENT; SURGICAL, MEDICAL, AND VETERINARY INSTRUMENTS FOR USE IN OSTEOSYNTHESIS, MUSCULO-SKELETAL, MAXILLOFACIAL, AND SPINE SURGERY, NAMELY, SAWS AND RASPS FOR BONES, PROBES, SURGICAL KNIVES, BONE DRILLS, SURGICAL DRILLS, DRILL GUIDES, AIMING GUIDES FOR DIRECTING BONE SCREWS AND SIMILAR DEVICES INTO BONE PLATES, RETRACTORS, CHISELS, BONE FORCEPS, BONE CLAMPS, PELVIC CLAMPS, INTERNAL AND EXTERNAL FIXATORS, ELEVATORS AND IMPACTORS; DEVICES FOR USE AND INSERTION DURING SURGERY AND RECOVERY, NAMELY, INTRAMEDULLARY NAILS AND PLUGS, BONE STAPLES, BONE PINS, BONE CLAMPS, PELVIC CLAMPS, ANGULATED PLATES, COMPRESSION PLATES, PEDICLE SCREWS, PEDICLE HOOKS, CERCLAGE WIRES, DISC REPLACEMENTS, SPINAL RODS AND PLATES, ARTIFICIAL BONES FOR SURGICAL IMPLANTATION, SURGICAL IMPLANTS COMPRISING ARTIFICIAL NON-BIODEGRADABLE AND BIODEGRADABLE MATERIALS, NAMELY, BONE CEMENTS, BONE PASTES, AND PUTTIES, AND CERAMICS, BONE SUBSTITUTES, ALLOGRAFT IMPLANTS, CHIPS, STRIPS, HIP SCREWS; PARTS OF ARTIFICIAL BONES FOR AUGMENTING NATURAL BONES; BONE GRAFT EXTENDERS AND BONE GROWTH FACTORS ALL USED FOR BONE VOID FILLERS AND BONE REGENERATION; STERILIZING TRAYS FOR SURGICAL AND MEDICAL USE, TRAYS AND CASES FOR SURGICAL AND MEDICAL INSTRUMENTS AND IMPLANTS; APPARATUS FOR CLASSIFYING AND KEEPING INVENTORY OF SCIENTIFIC DOCUMENTATION AND SURGICAL AND MEDICAL INSTRUMENTS AND IMPLANTS, NAMELY, METAL MEDICAL STORAGE CABINETS FOR STORING SURGICAL AND MEDICAL INSTRUMENTS AND IMPLANTS, FEATURING A CPU FOR KEEPING INVENTORY OF SURGICAL AND MEDICAL INSTRUMENTS AND IMPLANTS (U.S. CLS. 26, 39 AND 44).
FIRST USE 12-0-1991; IN COMMERCE 12-0-1991.

CLASS 11—ENVIRONMENTAL CONTROL APPARATUS

FOR WATER BATH HEATERS FOR MEDICAL INSTRUMENTS AND FOR CONTOURING BIOLOGICAL IMPLANTS (U.S. CLS. 13, 21, 23, 31 AND 34).
FIRST USE 3-6-2001; IN COMMERCE 3-6-2001.
LAURIE MAYES, EXAMINING ATTORNEY

SN 77-623,814. PEEPOOPLE AB, 116 41 STOCKHOLM, SWEDEN, FILED 12-1-2008.

PEEPOOPLE

THE MARK CONSISTS OF STANDARD CHARACTERS WITHOUT CLAIM TO ANY PARTICULAR FONT, STYLE, SIZE, OR COLOR.

PRIORITY CLAIMED UNDER SEC. 44(D) ON ERPN CMNTY TM OFC APPLICATION NO. 006952261, FILED 5-30-2008, REG. NO. 006952261, DATED 3-26-2009, EXPIRES 5-30-2018.

CLASS 5—PHARMACEUTICALS

FOR SANITARY PREPARATIONS FOR MEDICAL PURPOSES; SANITARY DISINFECTANTS FOR HYGIENE PURPOSES; MATERIALS FOR DRESSINGS, NAMELY, GAUZE, BANDAGES, MEDICAL ADHESIVE TAPES, MEDICAL PLASTERS; SANITARY TOWELS (U.S. CLS. 6, 18, 44, 46, 51 AND 52).

CLASS 16—PAPER GOODS AND PRINTED MATTER

FOR EDUCATIONAL PRINTED MATERIALS, NAMELY, BOOKS, FLASH CARDS, TRAINING MANUALS, INSTRUCTIONAL BOOKS, FOLDERS, BROCHURES, NEWSLETTERS AND MAGAZINES REGARDING HYGIENIC AND SANITARY PRODUCTS, SANITATION FACILITIES AND SINGLE-USE TOILETS (U.S. CLS. 2, 5, 22, 23, 29, 37, 38 AND 50).

CLASS 35—ADVERTISING AND BUSINESS

FOR RETAIL STORE SERVICES FEATURING SANITARY PREPARATIONS FOR MEDICAL PURPOSES, SANITARY FLANNEL, SANITARY DISINFECTANTS FOR HYGIENE PURPOSES, MATERIALS FOR DRESSINGS, SANITARY TOWELS, PORTABLE TOILETS, SINGLE-USE TOILETS, TOILET SEATS, STERILE DISPOSABLE BAGS, TOILET GLOWS, COVERS FOR TOILET SEATS, TOILETRIES, EDUCATIONAL MATERIALS; PROVIDING CONSUMER PRODUCT INFORMATION IN CONNECTION WITH RETAIL STORE SERVICES IN THE FIELD OF SANITARY PREPARATIONS FOR MEDICAL PURPOSES, SANITARY FLANNEL, SANITARY DISINFECTANTS FOR HYGIENE PURPOSES, MATERIALS FOR DRESSINGS, SANITARY TOWELS, SANITARY NAPKINS, SANITARY WET WIPES, PORTABLE TOILETS, SINGLE-USE TOILETS, TOILET SEATS, STERILE DISPOSABLE BAGS, TOILET GLOWS, COVERS FOR TOILET SEATS, TOILETRIES (U.S. CLS. 100, 101 AND 102).

CLASS 41—EDUCATION AND ENTERTAINMENT

FOR EDUCATIONAL SERVICES, NAMELY, PROVIDING CLASSES, SEMINARS AND WORKSHOPS IN THE FIELD OF HYGIENIC AND SANITARY PRODUCTS, PERSONAL HYGIENE, HEALTH CARE, SANITATION FACILITIES AND SINGLE-USE TOILETS, AND DISTRIBUTION OF COURSE MATERIAL IN CONNECTION THEREWITH; PROVIDING ONLINE NON-DOWNLOADABLE EDUCATIONAL MATERIALS, NAMELY, INSTRUCTIONAL BOOKS, FOLDERS, BROCHURES, TRAINING MANUALS, VIDEOS, TEXT BOOKS, NEWSLETTERS AND MAGAZINES REGARDING HYGIENIC AND SANITARY PRODUCTS, SANITATION FACILITIES AND SINGLE-USE TOILETS (U.S. CLS. 100, 101 AND 107).

CLASS 44—MEDICAL, BEAUTY AND AGRICULTURAL SERVICES

FOR HEALTH CARE SERVICES, NAMELY, HYGIENE CARE; RENTAL OF SANITATION FACILITIES AND SINGLE-USE TOILETS (U.S. CLS. 100 AND 101).
APRIL HESIK, EXAMINING ATTORNEY

SN 77-626,630. OLYMPUS CORPORATION, TOKYO, JAPAN,
FILED 12-4-2008.



OLYMPUS

THE COLOR(S) BLUE AND WHITE IS/ARE CLAIMED AS A FEATURE OF THE MARK.
THE MARK CONSISTS OF THE WORD "OLYMPUS" IN WHITE, WITH A BAR BACKGROUND IN BLUE.

CLASS 7—MACHINERY

FOR CLEANING MACHINES AND ULTRASONIC CLEANING MACHINES FOR MEDICAL AND SURGICAL ENDOSCOPES AND TREATMENT INSTRUMENTS; MAINTENANCE UNITS FOR WASHING ENDOSCOPES; MAINTENANCE UNITS IN THE NATURE OF A WATER PUMP FOR REMOVING WATER FROM ENDOSCOPES (U.S. CLS. 13, 19, 21, 23, 31, 34 AND 35).

CLASS 9—ELECTRICAL AND SCIENTIFIC APPARATUS

FOR MONITOR PHOTOGRAPHING DEVICES, VIDEO PRINTERS, COMPUTER SYSTEM CONTROLLERS, DATA PROCESSING DEVICES, COMPUTER DISPLAY PANELS AND OPERATING PANELS FOR USE WITH MEDICAL AND SURGICAL ENDOSCOPES; IMAGE RECORDING DEVICES AND COMPUTER SERVER UNITS FOR PRESERVING AND MANAGING IMAGE DATA AND MEDICAL CONDITION INFORMATION FROM ENDOSCOPIC EXAMINATIONS; MAINTENANCE UNITS FOR LEAKAGE TESTING OF ENDOSCOPES; IMAGE AND VIDEO MIXERS FOR USE WITH MEDICAL AND SURGICAL ENDOSCOPES (U.S. CLS. 21, 23, 26, 36 AND 38).

CLASS 10—MEDICAL APPARATUS

FOR MEDICAL AND SURGICAL ENDOSCOPES WITH LIGHT SOURCES, MONITOR PHOTOGRAPHING DEVICES, VIDEO PRINTERS, SYSTEM CONTROLLERS, PROCESSING DEVICES, DISPLAY PANELS, OPERATING PANELS, TROLLEYS, CABINETS AND CARRYING CARTS FOR USE THEREWITH, SOLD AS A UNIT, FOR MEDICAL DIAGNOSTIC USE; ENDOSCOPE POSITION DETECTING UNITS; STERILIZERS FOR MEDICAL AND SURGICAL ENDOSCOPES; MAINTENANCE UNITS FOR STERILIZING ENDOSCOPES; HIGH-FREQUENCY ELECTROCAUTERIES FOR MEDICAL AND SURGICAL ENDOSCOPES; LASER DEVICES FOR MEDICAL AND SURGICAL TREATMENT; HEAT PROBE DEVICES FOR USE IN THE MEDICAL TREATMENT OF HEMOSTASIS; BALLOON INFLATING AND DEFLATING UNITS FOR MEDICAL AND SURGICAL ENDOSCOPES; ULTRASONIC SURGICAL DEVICES FOR CUTTING AND COAGULATING TISSUE BY TRANSMITTING ULTRASONIC VIBRATIONS IN SURGICAL PROCEDURES; MEDICAL ULTRASOUND IMAGING APPARATUS FOR OBSERVING AND STORING ULTRASOUND IMAGES FOR USE WITH ULTRASOUND ENDOSCOPES AND ULTRASOUND PROBES; INSUFFLATION DEVICES; TREATMENT INSTRUMENTS CONTROLLING DEVICES, NAMELY, BIOPSY FORCEPS, GRASPING FORCEPS, RETRIEVABLE BASKETS, SUTURE CUTTING FORCEPS, HOT BIOPSY FORCEPS, POLYPECTOMY SNARES, COAGULATION ELECTRODES, MONOPOLAR PROBES, BIPOLAR PROBES, CLIP FIXING DEVICES, INJECTION NEEDLES, MEASURING DEVICES, WASHING PIPES, CYTOLOGY BRUSHES, ERCP CANNULAE, SPHINCTEROTOMES, MECHANICAL LITHOTRIPTORS, BALLOON DILATORS, EXTRACTION BALLOONS, BILIARY/PANCREATIC STENTS, CURETTES, ASPIRATION NEEDLES, GUIDEWIRES, METALLIC STENTS (U.S. CLS. 26, 39 AND 44).

CLASS 11—ENVIRONMENTAL CONTROL APPARATUS

FOR LED, XENON AND HALOGEN LIGHT SOURCE APPARATUS FOR USE WITH MEDICAL AND SURGICAL ENDOSCOPES; TELESCOPIC HEATERS FOR USE WITH SURGICAL ENDOSCOPES (U.S. CLS. 13, 21, 23, 31 AND 34).

CLASS 12—VEHICLES

FOR TROLLEYS, WHEELED CABINETS AND CARRYING CARTS FOR USE WITH MEDICAL AND SURGICAL ENDOSCOPES (U.S. CLS. 19, 21, 23, 31, 35 AND 44).
HOWARD B. LEVINE, EXAMINING ATTORNEY

SN 77-631,347. IBODD, INC., DURHAM, NC. FILED 12-11-2008.

PERSONAL PROTOCOL

THE MARK CONSISTS OF STANDARD CHARACTERS WITHOUT CLAIM TO ANY PARTICULAR FONT, STYLE, SIZE, OR COLOR.

CLASS 35—ADVERTISING AND BUSINESS

FOR PROVIDING INFORMATION TO OTHERS PERTAINING TO THE FIELDS OF ECONOMICS AND BUSINESS VIA COMPUTER SYSTEMS REGARDING THE CORRELATION BETWEEN A SET OF VARIABLES AND SPECIFIC EVENTS; INFORMATION AND DATA COMPILATION FOR OTHERS RELATING TO THE FIELDS OF ECONOMICS AND BUSINESS; PROVIDING DATA COMPILATION FOR OTHERS IN THE FIELDS OF MEDICINE AND LIFE SCIENCES; PROVIDING DATA COMPILATION FOR OTHERS RELATING TO THE FIELDS OF FINANCE AND FINANCIAL INVESTMENTS FOR BUSINESS PURPOSES (U.S. CLS. 100, 101 AND 102).

CLASS 36—INSURANCE AND FINANCIAL

FOR PROVIDING INFORMATION TO OTHERS PERTAINING TO THE FIELDS OF FINANCE AND FINANCIAL INVESTMENTS VIA COMPUTER SYSTEMS REGARDING THE CORRELATION BETWEEN A SET OF VARIABLES AND SPECIFIC EVENTS; INFORMATION AND DATA COMPILATION FOR OTHERS RELATING TO THE FIELDS OF FINANCE AND FINANCIAL INVESTMENTS; PROVIDING FINANCIAL INFORMATION (U.S. CLS. 100, 101 AND 102).

CLASS 38—COMMUNICATION

FOR COMMUNICATION SERVICES, NAMELY, TRANSMISSION OF VISUAL IMAGES, DATA AND DOCUMENTS BY TELECOMMUNICATIONS NETWORKS, WIRELESS COMMUNICATION NETWORKS, THE INTERNET, AND DATA NETWORKS; PROVIDING SUBSCRIPTION BASED ACCESS TO A COMPUTER SYSTEM CONSISTING PRIMARILY OF COMPUTER SOFTWARE, PRIVATE NETWORKS, COMMERCIAL NETWORKS, COMPUTER SERVERS AND COMPUTER DRIVEN DEVICES THAT COLLECTS, ANALYZES AND DISSEMINATES INFORMATION REGARDING THE CORRELATION BETWEEN A SET OF VARIABLES AND SPECIFIC EVENTS IN THE FIELDS ECONOMICS AND BUSINESS, FINANCE AND FINANCIAL INVESTMENTS, MEDICINE AND LIFE SCIENCES AND SAFETY AND SECURITY (U.S. CLS. 100, 101 AND 104).

CLASS 42—SCIENTIFIC AND COMPUTER SERVICES

FOR PROVIDING MEDICAL AND SCIENTIFIC RESEARCH INFORMATION IN THE FIELDS OF PHARMACEUTICALS AND CLINICAL TRIALS; PHARMACEUTICAL DRUG DEVELOPMENT SERVICES; PHARMACEUTICAL RESEARCH SERVICES; RESEARCH ON THE SUBJECT OF PHARMACEUTICALS; PROVIDING INFORMATION TO OTHERS PERTAINING TO THE FIELDS OF LIFE SCIENCES VIA COMPUTER SYSTEMS REGARDING THE CORRELATION BETWEEN VARIOUS EVENTS AND THE PRESENTATION OF SYMPTOMS (U.S. CLS. 100 AND 101).

CLASS 44—MEDICAL, BEAUTY AND AGRICULTURAL SERVICES

FOR PROVIDING INFORMATION TO OTHERS PERTAINING TO THE FIELD OF MEDICINE VIA COMPUTER SYSTEMS REGARDING THE CORRELATION BETWEEN VARIOUS EVENTS AND THE PRESENTATION OF SYMPTOMS (U.S. CLS. 100 AND 101).

CLASS 45—PERSONAL AND LEGAL SERVICES

FOR PROVIDING INFORMATION TO OTHERS PERTAINING TO THE FIELD OF PERSONAL SAFETY AND SECURITY VIA COMPUTER SYSTEMS REGARDING THE CORRELATION BETWEEN A SET OF VARIABLES AND SPECIFIC EVENTS; INFORMATION AND DATA COMPILATION RELATING TO THE FIELD OF PERSONAL SAFETY AND SECURITY (U.S. CLS. 100 AND 101).
LINDA ORNDORFF, EXAMINING ATTORNEY

SN 77-631,825. BOYSVILLE OF MICHIGAN, INCORPORATED, DBA HOLY CROSS CHILDREN'S SERVICES, CLINTON, MI. FILED 12-12-2008.



NO CLAIM IS MADE TO THE EXCLUSIVE RIGHT TO USE "CHILDREN'S SERVICES", APART FROM THE MARK AS SHOWN.

THE MARK CONSISTS OF THE LITERAL ELEMENT "HOLYCROSS", WITH THE WORDING "CHILDREN'S SERVICES" BELOW AND THE DRAWING OF AN ANCHOR ON THE LEFT.

CLASS 43—HOTEL AND RESTAURANT SERVICES

FOR PROVIDING SHORT- AND LONG-TERM RESIDENTIAL HOUSING FOR DELINQUENT, NEGLECTED, AND ABUSED YOUTHS (U.S. CLS. 100 AND 101).

FIRST USE 7-0-2008, THE MARK WAS FIRST USED ANYWHERE IN A DIFFERENT FORM OTHER THAN THAT SOUGHT TO BE REGISTERED AT LEAST AS EARLY AS 12/31/2001.; IN COMMERCE 7-0-2008.

CLASS 45—PERSONAL AND LEGAL SERVICES

FOR FOSTER CARE SERVICES (U.S. CLS. 100 AND 101).

FIRST USE 7-0-2008, THE MARK WAS FIRST USED ANYWHERE IN A DIFFERENT FORM OTHER THAN THAT SOUGHT TO BE REGISTERED AT LEAST AS EARLY AS 12/31/2001. ; IN COMMERCE 7-0-2008.

SARA THOMAS, EXAMINING ATTORNEY

SN 77-635,000. WORKFORCE ENGINE, LLC, NEW YORK, NY. FILED 12-17-2008.

WORKFORCE ENGINE

THE MARK CONSISTS OF STANDARD CHARACTERS WITHOUT CLAIM TO ANY PARTICULAR FONT, STYLE, SIZE, OR COLOR.

NO CLAIM IS MADE TO THE EXCLUSIVE RIGHT TO USE "WORKFORCE", APART FROM THE MARK AS SHOWN.

CLASS 16—PAPER GOODS AND PRINTED MATTER

FOR PRINTED MATERIALS, NAMELY, MANUALS, CONTRACTS AND FORMS IN THE FIELDS OF PERSONNEL MANAGEMENT AND EMPLOYMENT LAW (U.S. CLS. 2, 5, 22, 23, 29, 37, 38 AND 50).

CLASS 35—ADVERTISING AND BUSINESS

FOR DEVELOPMENT OF CUSTOM PERSONNEL MANAGEMENT MATERIALS FOR OTHERS, NAMELY, DEVELOPMENT OF CUSTOM EMPLOYEE MANUALS AND HANDBOOKS (U.S. CLS. 100, 101 AND 102).

CLASS 41—EDUCATION AND ENTERTAINMENT

FOR CONDUCTING EDUCATIONAL AND TRAINING SEMINARS AND TUTORIAL SESSIONS IN THE FIELDS OF PERSONNEL MANAGEMENT AND EMPLOYMENT LAW (U.S. CLS. 100, 101 AND 107).

CYNTHIA TRIPI, EXAMINING ATTORNEY

SN 77-636,757. XAVIER, TANIA-MARIA C., HOUSTON, TX. FILED 12-19-2008.



THE COLOR(S) BLUE, YELLOW, RED, GREEN, DARK GREY, BURGUNDY, LIGHT BLUE, ECRU, PURPLE, BEIGE, LIGHT GREY IS/ARE CLAIMED AS A FEATURE OF THE MARK.

THE MARK CONSISTS OF THE WORD "COLORED" WITH THE COLOR BLUE APPEARING IN THE LETTER "C", THE COLOR YELLOW APPEARING IN THE LETTERS "OLO", THE COLOR RED APPEARING IN THE LETTERS "RED", THE COLOR GREEN APPEARING IN THE WORD "PEOPLE" AND DASHES BELOW THE TEXT IN FOLLOWING ORDER FROM LEFT TO RIGHT: DARK GREY, BURGUNDY, LIGHT BLUE, YELLOW, ECRU, PURPLE, BEIGE, AND LIGHT GREY; AND THE COLOR BLACK REPRESENTS BACKGROUND AND IS NOT PART OF THE MARK.

CLASS 25—CLOTHING

FOR CAPS; TOPS (U.S. CLS. 22 AND 39).
FIRST USE 1-29-2009; IN COMMERCE 1-29-2009.

CLASS 35—ADVERTISING AND BUSINESS

FOR RETAIL CLOTHING STORES (U.S. CLS. 100, 101 AND 102).
FIRST USE 1-29-2009; IN COMMERCE 1-29-2009.

CLASS 42—SCIENTIFIC AND COMPUTER SERVICES

FOR COMPUTER SERVICES, NAMELY, CREATING AN ON-LINE COMMUNITY FOR REGISTERED USERS TO PARTICIPATE IN COMPETITIONS, SHOWCASE THEIR SKILLS, GET FEEDBACK FROM THEIR PEERS, FORM VIRTUAL COMMUNITIES, ENGAGE IN SOCIAL NETWORKING AND IMPROVE THEIR TALENT; COMPUTER SERVICES, NAMELY, CREATING AN ON-LINE COMMUNITY FOR REGISTERED USERS TO PARTICIPATE IN DISCUSSIONS, GET FEEDBACK FROM THEIR PEERS, FORM VIRTUAL COMMUNITIES, AND ENGAGE IN SOCIAL NETWORKING (U.S. CLS. 100 AND 101).

FIRST USE 12-20-2008; IN COMMERCE 12-26-2008.

CLASS 45—PERSONAL AND LEGAL SERVICES

FOR ON-LINE SOCIAL NETWORKING SERVICES (U.S. CLS. 100 AND 101).

FIRST USE 12-20-2008; IN COMMERCE 12-26-2008.

JOHN KELLY, EXAMINING ATTORNEY

SN 77-638,747. PETER DIGLIO, GLEN RIDGE, NJ. FILED 12-23-2008.

DNA FIRST

THE MARK CONSISTS OF STANDARD CHARACTERS WITHOUT CLAIM TO ANY PARTICULAR FONT, STYLE, SIZE, OR COLOR.

NO CLAIM IS MADE TO THE EXCLUSIVE RIGHT TO USE "DNA", APART FROM THE MARK AS SHOWN.

CLASS 35—ADVERTISING AND BUSINESS

FOR COMPILATION OF INFORMATION INTO COMPUTER DATABASES FOR OTHERS (U.S. CLS. 100, 101 AND 102).

CLASS 42—SCIENTIFIC AND COMPUTER SERVICES

FOR PROVIDING AN ON-LINE COMPUTER DATABASE IN THE FIELD OF DNA AND DNA PROFILES FOR USE IN RESEARCH (U.S. CLS. 100 AND 101).

FRANK LATTUCA, EXAMINING ATTORNEY

SN 77-642,419. AMROAD TECHNOLOGY INC., TAIPEI COUNTY, TAIWAN, FILED 1-1-2009.



THE COLOR(S) BLUE AND RED IS/ARE CLAIMED AS A FEATURE OF THE MARK.

THE MARK CONSISTS OF STYLIZED AND ITALICIZED LETTERS "AR" IN BLUE WITH A SOLID RED CIRCLE CENTERED ABOVE THE LETTERS.

SN 77-642,990. WORD & BROWN INSURANCE ADMINISTRATORS, INC., ORANGE, CA. FILED 1-4-2009.

CLASS 9—ELECTRICAL AND SCIENTIFIC APPARATUS

FOR TELECOMMUNICATION TRANSMITTERS; TRANSMITTERS OF ELECTRONIC SIGNALS; TELEPHONE APPARATUS; TELEPHONE RECEIVERS; TELEPHONE TRANSMITTERS; ELECTRIC LOCKS; INTERCOMMUNICATION APPARATUS, NAMELY, INTERCOMS, CELLULAR PHONES, DOOR-PHONES; DOWNLOADABLE ELECTRONIC PUBLICATIONS IN THE NATURE OF NEWSLETTERS, BOOKS, MAGAZINE IN THE FIELD OF MEDICAL CARE AND FOOD INDUSTRY; CAMCORDERS; VIDEO CAMERAS; VIDEO MONITORS; VIDEO PHONES; VIDEO TRANSMISSION APPARATUS; ELECTRONIC LOCKS; COMMUNICATIONS SERVER HARDWARE; NETWORK ACCESS SERVER HARDWARE; COMPUTER NETWORK ADAPTERS; COMPUTER NETWORK HUBS, SWITCHES AND ROUTERS; COMPUTER NETWORKING HARDWARE; LOCAL AREA NETWORK HARDWARE; DOWNLOADABLE MUSICAL SOUND RECORDINGS; DIGITAL MUSIC DOWNLOADABLE VIA INTERNET; ELECTRONICALLY OPERATED HIGH SECURITY LOCK CYLINDERS; PERSONAL SECURITY ALARMS; SATELLITE TELEPHONES; MAGNETIC CARDS; MAGNETIC IDENTIFYING CARDS; MAGNETIC CODED CARD READERS; ELECTRONIC WARNING BELLS; COMPUTER WORKSTATIONS APPARATUS, NAMELY, COMPUTERS, COMPUTER CABLES AND PRINTERS; COMPUTER WORKSTATIONS COMPRISING COMPUTERS, COMPUTER CABLES, COMPUTER DOCKING STATION AND PRINTER (U.S. CLS. 21, 23, 26, 36 AND 38).

CLASS 35—ADVERTISING AND BUSINESS

FOR IMPORT AND EXPORT AGENCIES; COMMERCIAL INFORMATION SERVICES VIA VIDEO-PHONE, NAMELY, PROVIDING PRODUCT PRICE LISTS, PRODUCT SPECIFICATIONS, AND COMPANY INFORMATION IN THE FIELD OF FOOD AND CLOTHING INDUSTRY; MANAGEMENT OF ELECTRONIC FILES; ELECTRONIC DATA SEARCH SERVICES VIA VIDEO-PHONE, NAMELY, PROVIDING AN SEARCHABLE COMMERCIAL INFORMATION DATABASE; DATA MANAGEMENT SERVICES FOR USE IN PATIENTS' MEDICAL INFORMATION, NAMELY, ELECTRONIC DATA COLLECTION AND MANAGEMENT OF PATIENTS' MEDICAL INFORMATION; RETAIL STORE SERVICES FEATURING TELECOMMUNICATIONS HARDWARE AND COMPUTER ELECTRONICS (U.S. CLS. 100, 101 AND 102).

CLASS 42—SCIENTIFIC AND COMPUTER SERVICES

FOR CONSULTANCY SERVICES IN THE FIELD OF COMPUTER HARDWARE; CONVERSION OF PHYSICAL DOCUMENTS TO ELECTRONIC MEDIA; INDUSTRIAL DESIGN IN THE FIELD OF COMMUNICATION EQUIPMENT DESIGN; COMPUTER RENTAL SERVICES; SECURITY SERVICES FOR COMPUTER NETWORKS, NAMELY, PROVIDING SECURED ELECTRONIC TRANSACTION AND ANONYMITY FOR ELECTRONICALLY TRANSMITTED CREDIT CARD TRANSACTIONS; COMPUTER SECURITY SERVICE, NAMELY, RESTRICTING ACCESS TO AND BY COMPUTER NETWORKS TO AND OF UNDESIRE WEB SITES, MEDIA AND INDIVIDUALS AND FACILITIES (U.S. CLS. 100 AND 101).

KATHERINE CONNOLLY, EXAMINING ATTORNEY

AGENCYWOW

THE MARK CONSISTS OF STANDARD CHARACTERS WITHOUT CLAIM TO ANY PARTICULAR FONT, STYLE, SIZE, OR COLOR.

CLASS 35—ADVERTISING AND BUSINESS

FOR CUSTOMER RELATIONSHIP MANAGEMENT SERVICES, NAMELY, PROVIDING A WEBSITE AT WHICH HEALTH INSURANCE AGENTS, CARRIERS, BROKERS, AND EMPLOYERS CAN MANAGE CONTACTS, CUSTOMER RELATIONSHIPS, ENROLLMENT, INVOICING, ACCOUNTING, RECRUITMENT, MARKETING, CALENDARS, AND TASK LISTS (U.S. CLS. 100, 101 AND 102).

CLASS 36—INSURANCE AND FINANCIAL

FOR CLAIMS ADMINISTRATION SERVICES IN THE FIELD OF HEALTH INSURANCE (U.S. CLS. 100, 101 AND 102).

MORGAN WYNNE, EXAMINING ATTORNEY

SN 77-643,641. DEHLSSEN ASSOCIATES, LLC, SANTA BARBARA, CA. FILED 1-5-2009.

CENTIPOD

THE MARK CONSISTS OF STANDARD CHARACTERS WITHOUT CLAIM TO ANY PARTICULAR FONT, STYLE, SIZE, OR COLOR.

CLASS 37—CONSTRUCTION AND REPAIR

FOR CONSTRUCTION, INSTALLATION, MAINTENANCE AND REPAIR OF WAVE ENERGY CONVERTERS AND OTHER WAVE-OPERATED MACHINES (U.S. CLS. 100, 103 AND 106).

CLASS 42—SCIENTIFIC AND COMPUTER SERVICES

FOR DESIGN AND DEVELOPMENT OF EQUIPMENT, DEVICES, AND SYSTEMS FOR CONVERTING ENERGY INTO MECHANICAL AND ELECTRICAL ENERGY; DESIGN AND DEVELOPMENT OF ELECTRICAL POWER GENERATING SYSTEMS; DEVELOPMENT OF POWER GENERATING EQUIPMENT AND SYSTEMS; DESIGN RESEARCH, DEVELOPMENT AND TESTING OF ENERGY CONVERTERS; TECHNICAL PLANNING OF POWER PLANTS; RESEARCH AND DEVELOPMENT SERVICES IN RELATION TO POWER GENERATION AND ELECTRICITY FROM TIDAL AND WAVE POWER SOURCES (U.S. CLS. 100 AND 101).

KHANH LE, EXAMINING ATTORNEY

SN 77-645,108. COLGATE-PALMOLIVE COMPANY, NEW YORK, NY. FILED 1-7-2009.

PRO-ALIVIO

THE MARK CONSISTS OF STANDARD CHARACTERS WITHOUT CLAIM TO ANY PARTICULAR FONT, STYLE, SIZE, OR COLOR.

PRIORITY CLAIMED UNDER SEC. 44(D) ON PERU APPLICATION NO. 359924, FILED 7-10-2008.

PRIORITY CLAIMED UNDER SEC. 44(D) ON PERU APPLICATION NO. 359923, FILED 7-10-2008.

PRIORITY CLAIMED UNDER SEC. 44(D) ON PERU APPLICATION NO. 359922, FILED 7-10-2008.

THE ENGLISH TRANSLATION OF "ALIVIO" IN THE MARK IS "RELIEF."

CLASS 3—COSMETICS AND CLEANING PREPARATIONS

FOR NON-MEDICATED ORAL CARE PRODUCTS, NAMELY, TOOTHPASTE, MOUTHWASH, DENTAL RINSES (U.S. CLS. 1, 4, 6, 50, 51 AND 52).

CLASS 5—PHARMACEUTICALS

FOR MEDICATED ORAL CARE PRODUCTS, NAMELY, MEDICATED TOOTHPASTE, MEDICATED MOUTHWASH, MEDICATED DENTAL RINSES, PROPHY PASTE (U.S. CLS. 6, 18, 44, 46, 51 AND 52).

CLASS 21—HOUSEWARES AND GLASS

FOR TOOTHBRUSHES (U.S. CLS. 2, 13, 23, 29, 30, 33, 40 AND 50).

SALLY SHIH, EXAMINING ATTORNEY

SN 77-645,111. RESACKEL LIMITED, CENTRAL, HONG KONG, FILED 1-7-2009.

RESACKEL

THE MARK CONSISTS OF STANDARD CHARACTERS WITHOUT CLAIM TO ANY PARTICULAR FONT, STYLE, SIZE, OR COLOR.

CLASS 16—PAPER GOODS AND PRINTED MATTER

FOR PAPER, CARDBOARD AND GOODS MADE FROM THESE MATERIALS, NAMELY, CARDBOARD BOXES, STORAGE BOXES, SHIPPING/POSTAL BOXES AND BAGS, PACKAGING POUCHES AND PAPER BAGS; PRINTED MATTER, NAMELY, BOOKS, MAGAZINES, PAMPHLETS AND BROCHURES FEATURING INFORMATION PERTAINING TO RECYCLING, THE ENVIRONMENT AND CLIMATE CHANGE; BOOK BINDING MATERIAL; STATIONERY; GIFT TAGS, WRAPPING PAPER; GENERAL PURPOSE PLASTIC BAGS (U.S. CLS. 2, 5, 22, 23, 29, 37, 38 AND 50).

CLASS 18—LEATHER GOODS

FOR LEATHER AND IMITATION LEATHER, AND GOODS MADE FROM THESE MATERIALS, NAMELY, LEATHER BAGS, TOTE BAGS, HAND BAGS, STORAGE BOXES AND CONTAINERS, PURSES, RUCKSACKS; ANIMAL SKINS, HIDES; TRUNKS AND TRAVELING BAGS; HANDBAGS, TOTE BAGS, RUCKSACKS AND PURSES; REUSABLE SHOPPING BAGS; TEXTILE BAGS FOR USE AS SHOPPING BAGS AND GROCERY BAGS (U.S. CLS. 1, 2, 3, 22 AND 41).

CLASS 22—CORDAGE AND FIBERS

FOR SACKS MADE FROM RECYCLED MATERIALS, NAMELY, PLASTIC, ROPE, STRING, TENTS, AWNINGS AND RAW FIBROUS TEXTILE MATERIALS, FOR TRANSPORTING BULK MATERIALS; SACKS FOR THE STORAGE OF MATERIALS IN BULK; GARMENT BAGS FOR STORAGE; TEXTILE BAGS FOR STORAGE; LAUNDRY BAGS (U.S. CLS. 1, 2, 7, 19, 22, 42 AND 50).

FLORENTINA BLANDU, EXAMINING ATTORNEY

SN 77-645,875. MICHALAK, JOEL EVAN, DBA THERAPY SESSION, GLENDALE, CA. FILED 1-8-2009.

Therapy Session

THE MARK CONSISTS OF STANDARD CHARACTERS WITHOUT CLAIM TO ANY PARTICULAR FONT, STYLE, SIZE, OR COLOR.

CLASS 9—ELECTRICAL AND SCIENTIFIC APPARATUS

FOR COMPACT DISCS FEATURING MUSIC; DIGITAL MUSIC DOWNLOADABLE FROM THE INTERNET (U.S. CLS. 21, 23, 26, 36 AND 38).

FIRST USE 1-30-2005; IN COMMERCE 11-14-2006.

CLASS 41—EDUCATION AND ENTERTAINMENT

FOR ENTERTAINMENT, NAMELY, LIVE PERFORMANCES BY A MUSICAL BAND (U.S. CLS. 100, 101 AND 107).

FIRST USE 1-30-2005; IN COMMERCE 11-14-2006.

LINDSEY RUBIN, EXAMINING ATTORNEY

SN 77-646,360. NYSE GROUP INC., NEW YORK, NY. FILED 1-9-2009.

PUT THE WHOLE WORLD IN YOUR PORTFOLIO WITH ONE TRADE

THE MARK CONSISTS OF STANDARD CHARACTERS WITHOUT CLAIM TO ANY PARTICULAR FONT, STYLE, SIZE, OR COLOR.

CLASS 35—ADVERTISING AND BUSINESS

FOR COMPILING AND DISSEMINATING TRADE, QUOTE, STOCK PRICE, INDEX VALUE AND OTHER FINANCIAL MARKET INFORMATION FOR BUSINESS PURPOSES (U.S. CLS. 100, 101 AND 102).
FIRST USE 12-18-2008; IN COMMERCE 12-18-2008.

CLASS 36—INSURANCE AND FINANCIAL

FOR FINANCIAL SERVICES OFFERED BY A SECURITIES EXCHANGE, NAMELY, INDEX FUNDS INVESTMENT; FINANCIAL INFORMATION PROCESSING, NAMELY, PROVIDING STOCK EXCHANGE PRICE QUOTATION INFORMATION (U.S. CLS. 100, 101 AND 102).

FIRST USE 12-18-2008; IN COMMERCE 12-18-2008.
AISHA SALEM, EXAMINING ATTORNEY

SN 77-647,856. GONTHIER GROUP, SA, MONTREUX, SWITZERLAND, FILED 1-12-2009.

SWISS STRATEGIC LIFE
INSURANCE

THE MARK CONSISTS OF STANDARD CHARACTERS WITHOUT CLAIM TO ANY PARTICULAR FONT, STYLE, SIZE, OR COLOR.

NO CLAIM IS MADE TO THE EXCLUSIVE RIGHT TO USE "SWISS" AND "LIFE INSURANCE", APART FROM THE MARK AS SHOWN.

CLASS 35—ADVERTISING AND BUSINESS

FOR PROMOTION OF FOREIGN INSURANCE POLICIES; DISSEMINATION OF INFORMATION IN THE NATURE OF ADVERTISING MATERIAL REGARDING FOREIGN INSURANCE POLICIES (U.S. CLS. 100, 101 AND 102).

CLASS 36—INSURANCE AND FINANCIAL

FOR PROVIDING INFORMATION IN THE FIELD OF FOREIGN INSURANCE POLICIES (U.S. CLS. 100, 101 AND 102).

APRIL ROACH, EXAMINING ATTORNEY

SN 77-647,858. GONTHIER GROUP, SA, MONTREUX, SWITZERLAND, FILED 1-12-2009.

LIECHTENSTEIN STRATEGIC
LIFE INSURANCE

THE MARK CONSISTS OF STANDARD CHARACTERS WITHOUT CLAIM TO ANY PARTICULAR FONT, STYLE, SIZE, OR COLOR.

NO CLAIM IS MADE TO THE EXCLUSIVE RIGHT TO USE "LIECHTENSTEIN" AND "LIFE INSURANCE", APART FROM THE MARK AS SHOWN.

CLASS 35—ADVERTISING AND BUSINESS

FOR PROMOTION OF FOREIGN INSURANCE POLICIES; DISSEMINATION OF INFORMATION IN THE NATURE OF ADVERTISING MATERIAL REGARDING FOREIGN INSURANCE POLICIES (U.S. CLS. 100, 101 AND 102).

CLASS 36—INSURANCE AND FINANCIAL

FOR PROVIDING INFORMATION IN THE FIELD OF FOREIGN INSURANCE POLICIES (U.S. CLS. 100, 101 AND 102).

APRIL ROACH, EXAMINING ATTORNEY

SN 77-648,648. SAFARILAND, LLC, JACKSONVILLE, FL. FILED 1-13-2009.

TOGETHER, WE SAVE LIVES

THE MARK CONSISTS OF STANDARD CHARACTERS WITHOUT CLAIM TO ANY PARTICULAR FONT, STYLE, SIZE, OR COLOR.

CLASS 1—CHEMICALS

FOR FINGERPRINT DEVELOPING CHEMICALS, FINGERPRINT DUSTING POWDER, NARCOTIC IDENTIFICATION REAGENTS, ANALYTICAL REAGENTS FOR IN-LABORATORY AND FIELD USE (U.S. CLS. 1, 5, 6, 10, 26 AND 46).

CLASS 3—COSMETICS AND CLEANING PREPARATIONS

FOR DEGREASING PREPARATIONS AND CLEANERS FOR USE ON VEHICLES; FIREARM CLEANING PREPARATIONS IN THE NATURE OF SOLVENTS FOR REMOVING CARBON BUILDUP (U.S. CLS. 1, 4, 6, 50, 51 AND 52).

CLASS 4—LUBRICANTS AND FUELS

FOR FOOTPRINT IMPRESSION FORMULATIONS FOR FORENSIC USE, NAMELY, CHEMICAL BASED WAXES AND ORGANIC-BASE WAXES; GUN OIL; LUBRICATING OILS AND ALL-PURPOSE LUBRICANTS (U.S. CLS. 1, 6 AND 15).

CLASS 5—PHARMACEUTICALS

FOR KITS CONTAINING MEDICAL DIAGNOSTIC REAGENTS FOR DRUG TESTING (U.S. CLS. 6, 18, 44, 46, 51 AND 52).

CLASS 6—METAL GOODS

FOR HANDCUFFS; HANDCUFF CASES; LEG RESTRAINTS OF METAL; STRUCTURAL STEEL GUARD BOOTHS AND FORTIFIED ARMORED POSITIONS PRIMARILY COMPRISING STEEL TUBING AND ARMOR PLATE FOR EXTERIOR WALL AND ROOF SYSTEMS AND ALSO CONTAINING GLASS POLYCARBONATE COMPOSITE ARMOR FOR WINDOWS; BULLET-RESISTANT MODULAR WALL SYSTEMS PRIMARILY COMPRISING STEEL TUBING AND ARMOR PLATE AND ALSO CONTAINING GLASS POLYCARBONATE ARMOR FOR WINDOWS (U.S. CLS. 2, 12, 13, 14, 23, 25 AND 50).

CLASS 8—HAND TOOLS

FOR UTILITY KNIFE CASES; LEATHER TOOL BELTS; BATONS FOR SELF-DEFENSE; POLICE BATONS AND METAL TIPS FOR POLICE BATONS SOLD AS A UNIT (U.S. CLS. 23, 28 AND 44).

CLASS 9—ELECTRICAL AND SCIENTIFIC APPARATUS

FOR BODY ARMOR; BALLISTIC VESTS; RADIO HOLDERS; CASSETTE RECORDER CASES; GAS MASK POUCHES; CONCEALED BULLET-RESISTANT PANELS USED IN BODY ARMOR; PORTABLE BALLISTIC SHIELDS; NIGHT VISION SCOPES; REFLECTIVE ULTRA-VIOLET IMAGING SYSTEMS COMPRISED OF NIGHT VISION SCOPES, SHORTWAVE ULTRA-VIOLET LIGHTS AND LENSES; SCALES; PLASTIC SAFETY RESTRAINTS (U.S. CLS. 21, 23, 26, 36 AND 38).

CLASS 10—MEDICAL APPARATUS

FOR DISPOSABLE MASKS FOR MOUTH-TO-MOUTH RESUSCITATION; BLOOD DRAWING APPARATUS FOR USE IN DRUG TESTING KITS (U.S. CLS. 26, 39 AND 44).

CLASS 13—FIREARMS

FOR HOLSTERS; MILITARY AND POLICE DUTY GEAR, NAMELY, HOLSTERS, AMMUNITION CARRIERS, NAMELY, REVOLVER SPEEDLOADER HOLDERS, AMMO CADDIES, MAGAZINE FOR WEAPONS HOLDERS, GUN CASES, CARTRIDGE POUCHES, MOUNTING DEVICES, NAMELY, BASES, RINGS AND APPROPRIATE FASTENERS FOR MOUNTING SCOPES ON HANDGUNS AND RIFLES, SOLD AS INDIVIDUAL PIECES AND AS ASSEMBLIES; AMMO CADDIES; CARTRIDGE POUCHES; GUN CASES; CARTRIDGE BELTS; HOLSTER ADAPTERS; MAGAZINE HOLDERS FOR WEAPONS; NON-EXPLOSIVE DEFENSIVE WEAPONS IN THE NATURE OF AN IRRITANT PACKAGED IN AEROSOL CONTAINERS; KITS FOR CLEANING AND PRESERVING FIREARMS, NAMELY, KITS CONTAINING BRUSHES AND RODS AND ALSO CONTAINING CLEANING RAGS AND GUN-CLEANING PREPARATIONS; CASES SOLD EMPTY FOR CANISTERS OF PEPPER GAS AND OTHER DEFENSIVE IRRITANTS (U.S. CLS. 2 AND 9).

CLASS 16—PAPER GOODS AND PRINTED MATTER

FOR POLICE NOTEBOOK AND CITATION HOLDERS; ID CASES; FINGERPRINT KITS; PAPER TAGS, FLAGS AND MARKERS FOR EVIDENCE IDENTIFICATION; PRE-INKED FINGERPRINT PADS; FINGERPRINT PAPER; ADHESIVE-BACKED EVIDENCE TAPES AND LABELS; PLASTIC EVIDENCE BAGS; PLASTIC EVIDENCE TAPE (U.S. CLS. 2, 5, 22, 23, 29, 37, 38 AND 50).

CLASS 18—LEATHER GOODS

FOR ALL-PURPOSE UTILITY BAGS AND GEAR BAGS (U.S. CLS. 1, 2, 3, 22 AND 41).

CLASS 20—FURNITURE AND ARTICLES NOT OTHERWISE CLASSIFIED

FOR NONMETAL KEY HOLDERS; PLASTIC LEG RESTRAINTS (U.S. CLS. 2, 13, 22, 25, 32 AND 50).

CLASS 24—FABRICS

FOR PROTECTIVE FABRIC FOR BODY ARMOR (U.S. CLS. 42 AND 50).

CLASS 25—CLOTHING

FOR GLOVES; APPAREL, NAMELY, SHIRTS, HATS, CAPS, T-SHIRTS, PANTS AND OUTERWEAR, NAMELY, JACKETS, COATS AND WIND-RESISTANT JACKETS (U.S. CLS. 22 AND 39).

CLASS 28—TOYS AND SPORTING GOODS

FOR MICRO FILAMENT FISHING LINE (U.S. CLS. 22, 23, 38 AND 50).

CLASS 41—EDUCATION AND ENTERTAINMENT

FOR PROVIDING EDUCATIONAL INSTRUCTION WITH RESPECT TO USE OF A DRUG TESTING KIT IN CONNECTION WITH SUBSTANCE ABUSE SERVICES (U.S. CLS. 100, 101 AND 107).

MARCIE MILONE, EXAMINING ATTORNEY

SN 77-649,372. HONDA MOTOR CO., LTD., TOKYO, JAPAN, FILED 1-14-2009.

THE POWER OF DREAMS

THE MARK CONSISTS OF STANDARD CHARACTERS WITHOUT CLAIM TO ANY PARTICULAR FONT, STYLE, SIZE, OR COLOR.

CLASS 7—MACHINERY

FOR POWER EQUIPMENT, NAMELY, ELECTRIC-POWER GENERATORS; LAWNMOWERS; GASOLINE OR ELECTRICALLY POWERED PUMPS USED FOR EVACUATING SPACES OF OR FILLING SPACES WITH LIQUIDS, LIQUIDS CONTAINING WASTE, OR SOLID OR SEMI-SOLID MATERIALS; SNOWBLOWERS; POWER-OPERATED TILLERS; POWER-OPERATED TRIMMERS USED FOR CUTTING GRASS AND BRUSH; OUTBOARD MOTORS AND ENGINES NOT FOR LAND VEHICLES (U.S. CLS. 13, 19, 21, 23, 31, 34 AND 35).

FIRST USE 12-28-2000; IN COMMERCE 11-29-2001.

CLASS 12—VEHICLES

FOR MOTOR VEHICLES, NAMELY, AUTOMOBILES, SPORTS UTILITY VEHICLES, TRUCKS, MOTORCYCLES, ALL-TERRAIN VEHICLES, SCOOTERS, WATERCRAFT, NAMELY, RECREATIONAL JET BOATS, AND AIRCRAFT, NAMELY, JET AIRPLANES, AND STRUCTURAL PARTS THEREFOR (U.S. CLS. 19, 21, 23, 31, 35 AND 44).

FIRST USE 12-28-2000; IN COMMERCE 11-29-2001.
WENDY GOODMAN, EXAMINING ATTORNEY

SN 77-649,642. INKEDSTUDIOS, SAN FRANCISCO, CA.
FILED 1-14-2009.

SN 77-649,789. MICROSOFT CORPORATION, REDMOND,
WA. FILED 1-14-2009.

BECAUSE IT'S EVERYBODY'S BUSINESS

OUR PASSION, YOUR BRAND

THE MARK CONSISTS OF STANDARD CHARACTERS WITHOUT CLAIM TO ANY PARTICULAR FONT, STYLE, SIZE, OR COLOR.

CLASS 35—ADVERTISING AND BUSINESS

FOR SPECIALTY MERCHANDISING SERVICES, NAMELY, PROMOTING THE GOODS AND SERVICES OF OTHERS THROUGH THE DISTRIBUTION OF CUSTOMIZED MATERIALS, NAMELY, CLOTHING, HEADWEAR, FOOTWEAR, BEVERAGeware, APRONS, PETWEAR, MAGNETS, BUTTONS, MESSENGER BAGS, COMPUTER PERIPHERALS, CANVAS BAGS, ORNAMENTS, CALENDARS, TOYS, PILLOWS, CLOCKS, BOOKS, CD-ROMS, BLANK DVDS AND COMPACT DISCS, FRAMED PRINTS, GREETING CARDS, JOURNALS, LICENSE PLATE FRAMES, TILE BOXES, TILE COASTERS, OVAL AND ROUND KEEPSAKES, CALENDAR PRINTS, POSTER PRINTS, POSTCARDS, STICKERS, POSTERS, AND PENS; COMPUTERIZED ONLINE RETAIL STORES FEATURING CLOTHING, HEADWEAR, FOOTWEAR, BEVERAGeware, APRONS, PETWEAR, MAGNETS, BUTTONS, MESSENGER BAGS, COMPUTER PERIPHERALS, CANVAS BAGS, ORNAMENTS, CALENDARS, TOYS, PILLOWS, CLOCKS, BOOKS, CD-ROMS, BLANK DVDS AND COMPACT DISCS, FRAMED PRINTS, GREETING CARDS, JOURNALS, LICENSE PLATE FRAMES, TILE BOXES, TILE COASTERS, OVAL AND ROUND KEEPSAKES, CALENDAR PRINTS, POSTER PRINTS, POSTCARDS, STICKERS, POSTERS, AND PENS; BUSINESS CONSULTATION, NAMELY, RETAIL AND STORE-FRONT DEVELOPMENT SERVICES; SUPPLYING AND ORDER FULFILLMENT SERVICES AND CUSTOMER SERVICE IN THE FIELD OF SPECIALTY MERCHANDISING; DISSEMINATION OF ADVERTISING FOR OTHERS VIA THE INTERNET; CONSULTANCY SERVICES REGARDING BUSINESS STRATEGIES (U.S. CLS. 100, 101 AND 102).

CLASS 40—MATERIAL TREATMENT

FOR MANUFACTURING TO THE ORDER AND SPECIFICATION OF OTHERS, NAMELY, CLOTHING, HEADWEAR, FOOTWEAR, BEVERAGeware, APRONS, PETWEAR, MAGNETS, BUTTONS, MESSENGER BAGS, COMPUTER PERIPHERALS, CANVAS BAGS, ORNAMENTS, CALENDARS, TOYS, PILLOWS, CLOCKS, BOOKS, CD-ROMS, BLANK DVDS AND COMPACT DISCS, FRAMED PRINTS, GREETING CARDS, JOURNALS, LICENSE PLATE FRAMES, TILE BOXES, TILE COASTERS, OVAL AND ROUND KEEPSAKES, CALENDAR PRINTS, POSTER PRINTS, POSTCARDS, STICKERS, POSTERS, AND PENS (U.S. CLS. 100, 103 AND 106).

CLASS 42—SCIENTIFIC AND COMPUTER SERVICES

FOR LOGO DESIGN SERVICES (U.S. CLS. 100 AND 101).
CHARLOTTE CORWIN, EXAMINING ATTORNEY

THE MARK CONSISTS OF STANDARD CHARACTERS WITHOUT CLAIM TO ANY PARTICULAR FONT, STYLE, SIZE, OR COLOR.

PRIORITY CLAIMED UNDER SEC. 44(D) ON SOUTH AFRICA APPLICATION NO. 2008/16,283, FILED 7-15-2008.
PRIORITY CLAIMED UNDER SEC. 44(D) ON SOUTH AFRICA APPLICATION NO. 2008/16,282, FILED 7-15-2008.
PRIORITY CLAIMED UNDER SEC. 44(D) ON SOUTH AFRICA APPLICATION NO. 2008/16,281, FILED 7-15-2008.
PRIORITY CLAIMED UNDER SEC. 44(D) ON SOUTH AFRICA APPLICATION NO. 2008/16,280, FILED 7-15-2008.

CLASS 9—ELECTRICAL AND SCIENTIFIC APPARATUS

FOR A FULL LINE OF COMPUTER SOFTWARE FOR BUSINESS APPLICATIONS AND SALES SUPPORT APPLICATIONS; COMPUTER SOFTWARE FOR PROVIDING CUSTOMER AND SALES SUPPORT, NAMELY, CUSTOMER RELATIONSHIP MANAGEMENT (CRM) SOFTWARE; AND COMPUTER SOFTWARE FOR ANALYZING CUSTOMER DATA AND SALES DATA (U.S. CLS. 21, 23, 26, 36 AND 38).

CLASS 35—ADVERTISING AND BUSINESS

FOR PROVIDING INFORMATION CONCERNING BUSINESS AND BUSINESS PRACTICES; BUSINESS CONSULTING SERVICES (U.S. CLS. 100, 101 AND 102).

CLASS 38—COMMUNICATION

FOR TELECOMMUNICATION SERVICES, NAMELY, STREAMING OF VIDEO MATERIAL ON THE INTERNET (U.S. CLS. 100, 101 AND 104).

CLASS 42—SCIENTIFIC AND COMPUTER SERVICES

FOR PROVIDING TECHNICAL INFORMATION ABOUT COMPUTER SOFTWARE SOLUTIONS; PROVIDING ONLINE NON-DOWNLOADABLE SOFTWARE IN THE FIELD OF CUSTOMER AND SALES SUPPORT, NAMELY, CUSTOMER RELATIONSHIP MANAGEMENT (CRM) SOFTWARE; PROVIDING ONLINE NON-DOWNLOADABLE SOFTWARE FOR ANALYZING CUSTOMER DATA AND SALES DATA; TECHNICAL CONSULTING SERVICES IN THE FIELD OF COMPUTER SOFTWARE; AND COMPUTER SOFTWARE AND SYSTEMS DESIGN FOR OTHERS (U.S. CLS. 100 AND 101).
KHANH LE, EXAMINING ATTORNEY

SN 77-650,259. FRESH CITY SYSTEMS, LLC, NEEDHAM, MA. FILED 1-15-2009.



OWNER OF U.S. REG. NOS. 2,925,101, 3,501,890 AND OTHERS.

NO CLAIM IS MADE TO THE EXCLUSIVE RIGHT TO USE "EATERY", APART FROM THE MARK AS SHOWN.

THE COLOR(S) RED, WHITE, BLUE AND GREEN IS/ARE CLAIMED AS A FEATURE OF THE MARK.

THE MARK CONSISTS OF THE STYLIZED, BLOCK LETTER WORDS "FRESH CITY" IN RED BORDERED IN WHITE, ON A GENERALLY TRAPEZOIDAL SHAPE IN BLUE, WHICH IS SUPERIMPOSED OVER A GREEN TRAPEZOID. IN WHITE LETTERS BENEATH THE BLUE TRAPEZOID, ON TOP OF THE GREEN ONE, ARE THE WORDS "YOUR DAILY EATERY". THE "I" IN "CITY" IS DOTTED WITH A WEDGE OF LIME IN GREEN AND WHITE.

CLASS 25—CLOTHING

FOR CLOTHING, NAMELY, T-SHIRTS AND HATS (U.S. CLS. 22 AND 39).

FIRST USE 10-13-2008; IN COMMERCE 10-13-2008.

CLASS 30—STAPLE FOODS

FOR SAUCES AND SALAD DRESSINGS, PITA BREAD, TORTILLAS, MUFFINS, BREADS, PASTRY, BAGELS, COFFEE, PREPARED FOODS, NAMELY, SANDWICHES (U.S. CL. 46).

FIRST USE 9-20-2008; IN COMMERCE 9-20-2008.

CLASS 35—ADVERTISING AND BUSINESS

FOR RESTAURANT FRANCHISING SERVICES, NAMELY, OFFERING BUSINESS MANAGEMENT ASSISTANCE IN THE ESTABLISHMENT AND OPERATION OF FAST-FOOD RESTAURANTS (U.S. CLS. 100, 101 AND 102).

FIRST USE 9-20-2008; IN COMMERCE 9-20-2008.

CLASS 43—HOTEL AND RESTAURANT SERVICES

FOR RESTAURANT AND TAKE-OUT RESTAURANT SERVICES; FOOD CATERING SERVICES (U.S. CLS. 100 AND 101).

FIRST USE 10-13-2008; IN COMMERCE 10-13-2008.

EUGENIA MARTIN, EXAMINING ATTORNEY

SN 77-652,749. CLASSEN VERTRIEBS GMBH, KAISERSESCH, FED REP GERMANY, FILED 1-20-2009.

SENSA-FLOORING

THE MARK CONSISTS OF STANDARD CHARACTERS WITHOUT CLAIM TO ANY PARTICULAR FONT, STYLE, SIZE, OR COLOR.

PRIORITY CLAIMED UNDER SEC. 44(D) ON ERN CMNTY TM OFC APPLICATION NO. 007527138, FILED 1-15-2009, REG. NO. 007527138, DATED 3-17-2010, EXPIRES 3-17-2020.

CLASS 17—RUBBER GOODS

FOR BUILDING ELEMENTS AND BUILDING MATERIALS FOR INSULATION; ALL THE AFORESAID GOODS NOT MADE OF STONE (U.S. CLS. 1, 5, 12, 13, 35 AND 50).

CLASS 19—NON-METALLIC BUILDING MATERIALS

FOR BUILDING MATERIALS, NAMELY, NON-METAL FLOORS, NON-METAL FLOOR BOARDS, NON-METAL FLOOR PANELS, NON-METAL FLOOR SLABS, NON-METAL FLOOR TILES, NON-METAL FLOORING UNDERLAYMENTS, NON-METAL WALL BOARDS, NON-METAL WALL PANELS, NON-METAL WALL TILES, NON-METAL WALL SLABS, NON-METAL CEILING BOARDS, NON-METAL CEILING PANELS, NON-METAL CEILING TILES, NON-METAL CEILING SLABS, NON-METAL ROOFING BOARDS, NON-METAL ROOFING PANELS, NON-METAL ROOFING TILES, NON-METAL ROOFING SLABS, NON-METAL ROOF COVERINGS, ALL OF WOOD, LAMINATE, WOOD SUBSTITUTE MATERIALS, PLASTIC, LEATHER, CORK, VINYL, RUBBER AND/OR COMPOSITES PRIMARILY OF NON-METAL MATERIALS; BUILDING MATERIALS, NAMELY, NON-METAL FLOORS, NON-METAL FLOOR BOARDS, NON-METAL FLOOR PANELS, NON-METAL FLOOR SLABS, NON-METAL FLOOR TILES, NON-METAL FLOORING UNDERLAYMENTS, NON-METAL WALL BOARDS, NON-METAL WALL PANELS, NON-METAL WALL TILES, NON-METAL WALL SLABS, NON-METAL CEILING BOARDS, NON-METAL CEILING TILES, NON-METAL CEILING SLABS, NON-METAL ROOFING BOARDS, NON-METAL ROOFING TILES, NON-METAL ROOFING SLABS, NON-METAL ROOF COVERINGS, ALL OF WOOD, LAMINATE, WOOD SUBSTITUTE MATERIALS, PLASTIC, LEATHER, CORK, VINYL, RUBBER AND/OR COMPOSITES PRIMARILY OF NON-METAL MATERIALS AND ALL FITTED WITH INTEGRATED LOCKING ELEMENTS; RIGID NON-METAL PIPES FOR BUILDING; TRANSPORTABLE NON-METAL BUILDINGS; PREFABRICATED NON-METAL BUILDINGS; NON-METAL ARCHITECTURAL MOULDINGS AND FINISH TRIMS; NON-METAL DECORATIVE MOLDINGS AND DECORATIVE TRIMS FOR USE IN BUILDING CONSTRUCTION, WOOD MOLDINGS, MOLDINGS OF LAMINATE OR WOOD SUBSTITUTE MATERIALS; BEADINGS OF WOOD, LAMINATE OR WOOD SUBSTITUTE MATERIALS FOR USE AS DECORATIVE TRIMS IN BUILDING CONSTRUCTION; EDGINGS OF WOOD, LAMINATE OR WOOD SUBSTITUTE MATERIALS IN THE NATURE OF TRIMS NOT OF METAL, FOR BUILDING MATERIALS; WOOD FOR BUILDING AND CONSTRUCTION, NAMELY, BOARDS OF WOOD, FLOOR TILES OF WOOD, SEMI-WORKED WOODS BEING BUILDING MATERIALS, WOOD BEAMS, BUILDING TIMBER; WOOD, GLUE-LAMINATED; VENEER WOOD; ALL THE AFORESAID GOODS NOT MADE OF STONE (U.S. CLS. 1, 12, 33 AND 50).

CLASS 20—FURNITURE AND ARTICLES NOT OTHERWISE CLASSIFIED

FOR CONNECTING AND FASTENING ELEMENTS OF PLASTIC, NAMELY, CLAMPS, CRAMPS, CLIPS, WASHERS, NUTS, SPRINGS, PULLEYS, BOLTS AND RIVETS, ALL FOR USE IN CONNECTING AND FASTENING FLOOR TILES, FLOOR SLABS, FLOOR BOARDS, FLOOR PANELS, WALL AND CEILING PANELS, WALL AND CEILING TILES AND WALL AND CEILING SLAB COVERINGS; PEGS AND DOWELS, NOT OF METAL; HINGES, NOT OF METAL; AND, NON-METAL PROFILES FOR ARRANGING DEVICES ON AND IN WALLS, CEILINGS, AND OTHER SURFACES; BUILDING ELEMENTS AND BUILDING MATERIALS FOR INSULATION; ALL THE AFORESAID GOODS NOT MADE OF STONE (U.S. CLS. 2, 13, 22, 25, 32 AND 50).

CLASS 27—FLOOR COVERINGS

FOR CARPETS, RUGS, MATS AND MATTING, LINOLEUM AND OTHER MATERIALS IN THE NATURE OF WOOD, WOOD SUBSTITUTE MATERIALS, PLASTIC, LEATHER, CORK, VINYL, RUBBER AND/OR COMPOSITES PRIMARILY OF NON-METAL MATERIALS NOT MADE OF STONE FOR COVERING EXISTING FLOORS; COVERINGS OF PLASTIC FOR EXISTING FLOORS; WALL HANGINGS, NON-TEXTILE; FLOOR COVERINGS; INSULATING FLOOR COVERINGS; ALL THE AFORESAID GOODS NOT MADE OF STONE (U.S. CLS. 19, 20, 37, 42 AND 50).

MATTHEW KLINE, EXAMINING ATTORNEY

SN 77-652,755. CLASSEN VERTRIEBS GMBH, KAISER-
SESCH, FED REP GERMANY, FILED 1-20-2009.



The logo for SENS A flooring. The word "SENSA" is written in a large, bold, sans-serif font. Below it, the word "flooring" is written in a smaller, lowercase, sans-serif font. A horizontal line is positioned above the word "flooring".

PRIORITY CLAIMED UNDER SEC. 44(D) ON ERP N
CMNTY TM OFC APPLICATION NO. 007527039, FILED 1-
15-2009, REG. NO. 007527039, DATED 3-1-2010, EXPIRES 3-1-
2020.

NO CLAIM IS MADE TO THE EXCLUSIVE RIGHT TO
USE "FLOORING", APART FROM THE MARK AS SHOWN.

THE MARK CONSISTS OF THE WORD "SENSA", WITH
THE LETTER "E" NOT SHOWING THE VERTICAL LINE
AND THE LETTER "A" WITH A SQUARE DOT IN THE
MIDDLE OF THE LETTER INSTEAD OF A LINE CON-
NECTING FROM ONE SIDE TO THE OTHER WITH THE
WORD "FLOORING" UNDERNEATH.

CLASS 17—RUBBER GOODS

FOR BUILDING ELEMENTS AND BUILDING MATERI-
ALS FOR INSULATION; ALL THE AFORESAID
GOODS NOT MADE OF STONE (U.S. CLS. 1, 5, 12, 13,
35 AND 50).

CLASS 19—NON-METALLIC BUILDING MA- TERIALS

FOR BUILDING MATERIALS, NAMELY, NON-ME-
TAL FLOORS, NON-METAL FLOOR BOARDS, NON-
METAL FLOOR PANELS, NON-METAL FLOOR SLABS,
NON-METAL FLOOR TILES, NON-METAL FLOORING
UNDERLAYMENTS, NON-METAL WALL BOARDS,
NON-METAL WALL PANELS, NON-METAL WALL
TILES, NON-METAL WALL SLABS, NON-METAL CEIL-
ING BOARDS, NON-METAL CEILING PANELS, NON-
METAL CEILING TILES, NON-METAL CEILING SLABS,
NON-METAL ROOFING BOARDS, NON-METAL ROOF-
ING PANELS, NON-METAL ROOFING TILES, NON-
METAL ROOFING SLABS, NON-METAL ROOF COVER-
INGS, ALL OF WOOD, LAMINATE, WOOD SUBSTI-
TUTE MATERIALS, PLASTIC, LEATHER, CORK,
VINYL, RUBBER AND/OR COMPOSITES PRIMARILY
OF NON-METAL MATERIALS; BUILDING MATERIALS,
NAMELY, NON-METAL FLOORS, NON-METAL FLOOR
BOARDS, NON-METAL FLOOR PANELS, NON-METAL
FLOOR SLABS, NON-METAL FLOOR TILES, NON-
METAL FLOORING UNDERLAYMENTS, NON-METAL
WALL BOARDS, NON-METAL WALL PANELS, NON-
METAL WALL TILES, NON-METAL WALL SLABS,
NON-METAL CEILING BOARDS, NON-METAL CEIL-
ING PANELS, NON-METAL CEILING TILES, NON-
METAL CEILING SLABS, NON-METAL ROOFING
BOARDS, NON-METAL ROOFING PANELS, NON-ME-
TAL ROOFING TILES, NON-METAL ROOFING SLABS,
NON-METAL ROOF COVERINGS, ALL OF WOOD,
LAMINATE, WOOD SUBSTITUTE MATERIALS, PLAS-
TIC, LEATHER, CORK, VINYL, RUBBER AND/OR
COMPOSITES PRIMARILY OF NON-METAL MATERI-
ALS AND ALL FITTED WITH INTEGRATED LOCKING
ELEMENTS; RIGID NON-METAL PIPES FOR BUILD-
ING; TRANSPORTABLE NON-METAL BUILDINGS;
PREFABRICATED NON-METAL BUILDINGS; NON-ME-
TAL ARCHITECTURAL MOULDINGS AND FINISH
TRIMS; NON-METAL DECORATIVE MOLDINGS AND
DECORATIVE TRIMS FOR USE IN BUILDING CON-
STRUCTION, WOOD MOLDINGS, MOLDINGS OF LA-
MINATE OR WOOD SUBSTITUTE MATERIALS;
BEADINGS OF WOOD, LAMINATE OR WOOD SUBSTI-
TUTE MATERIALS FOR USE AS DECORATIVE TRIMS
IN BUILDING CONSTRUCTION; EDGINGS OF WOOD,
LAMINATE OR WOOD SUBSTITUTE MATERIALS IN
THE NATURE OF TRIMS NOT OF METAL, FOR

BUILDING MATERIALS; WOOD FOR BUILDING AND
CONSTRUCTION, NAMELY, BOARDS OF WOOD,
FLOOR TILES OF WOOD, SEMI-WORKED WOODS
BEING BUILDING MATERIALS, WOOD BEAMS,
BUILDING TIMBER; WOOD, GLUE-LAMINATED; VE-
NEER WOOD; ALL THE AFORESAID GOODS NOT
MADE OF STONE (U.S. CLS. 1, 12, 33 AND 50).

CLASS 20—FURNITURE AND ARTICLES NOT OTHERWISE CLASSIFIED

FOR CONNECTING AND FASTENING ELEMENTS OF
PLASTIC, NAMELY, CLAMPS, CRAMPS, CLIPS,
WASHERS, NUTS, SPRINGS, PULLEYS, BOLTS AND
RIVETS, ALL FOR USE IN CONNECTING AND FAS-
TENING FLOOR TILES, FLOOR SLABS, FLOOR
BOARDS, FLOOR PANELS, WALL AND CEILING PA-
NELS, WALL AND CEILING TILES AND WALL AND
CEILING SLAB COVERINGS; PEGS AND DOWELS, NOT
OF METAL; HINGES, NOT OF METAL; AND, NON-
METAL PROFILES FOR ARRANGING DEVICES ON
AND IN WALLS, CEILINGS, AND OTHER SURFACES;
ALL THE AFORESAID GOODS NOT MADE OF STONE
(U.S. CLS. 2, 13, 22, 25, 32 AND 50).

CLASS 27—FLOOR COVERINGS

FOR CARPETS, RUGS, MATS AND MATTING, LINO-
LEUM AND OTHER MATERIALS IN THE NATURE OF
WOOD, WOOD SUBSTITUTE MATERIALS, PLASTIC,
LEATHER, CORK, VINYL, RUBBER AND/OR COM-
POSITES PRIMARILY OF NON-METAL MATERIALS NOT
MADE OF STONE FOR COVERING EXISTING FLOORS;
COVERINGS OF PLASTIC FOR EXISTING FLOORS;
WALL HANGINGS, NON-TEXTILE; FLOOR COVER-
INGS; INSULATING FLOOR COVERINGS; ALL THE
AFORESAID GOODS NOT MADE OF STONE (U.S. CLS.
19, 20, 37, 42 AND 50).

MATTHEW KLINE, EXAMINING ATTORNEY

SN 77-655,778. APPLIED MATERIALS, INC., SANTA CLARA,
CA. FILED 1-23-2009.

APPLIED MATERIALS SOLAR

THE MARK CONSISTS OF STANDARD CHARACTERS
WITHOUT CLAIM TO ANY PARTICULAR FONT, STYLE,
SIZE, OR COLOR.

OWNER OF U.S. REG. NOS. 1,943,850 AND 1,980,572.

NO CLAIM IS MADE TO THE EXCLUSIVE RIGHT TO
USE "SOLAR", APART FROM THE MARK AS SHOWN.

CLASS 7—MACHINERY

FOR EQUIPMENT AND SYSTEMS COMPRISED OF
MACHINERY FOR MAKING SOLAR INSTRUMENTS
AND MATERIALS, NAMELY, FOR MAKING PHOTO-
VOLTAIC SOLAR GENERATORS, FOR MAKING PHOTO-
VOLTAIC SOLAR CELLS, FOR MAKING INVER-
TERS, FOR MAKING DIRECT CURRENT CABLES AND
FOR MAKING SOLAR RADIATION-RELATED MONI-
TORING AND TRACKING SYSTEMS, ALL FOR THE
CONSTRUCTION AND MANUFACTURING OF MA-
CHINES AND INSTRUMENTS FOR THE GENERATION
AND TRANSFORMATION OF ELECTRICITY FROM
SOLAR ENERGY; SEMICONDUCTOR WAFER PROCES-
SING EQUIPMENT; EQUIPMENT AND SYSTEMS COM-
PRISED OF MACHINERY FOR MAKING FLAT PANEL
DISPLAYS; PLASMA ETCHERS AND CHEMICAL ME-
CHANICAL POLISHERS (U.S. CLS. 13, 19, 21, 23, 31, 34
AND 35).

CLASS 9—ELECTRICAL AND SCIENTIFIC APPARATUS

FOR SOLAR CELLS; ELECTRONIC SENSORS FOR MEASURING SOLAR RADIATION; PHOTOVOLTAIC CELLS AND MODULES; INTEGRATED CIRCUITS; FLAT PANEL DISPLAYS; SEMICONDUCTOR WAFER PROCESSING COMPONENTS, NAMELY, EPITAXIAL REACTORS, CHEMICAL VAPOR DEPOSITION REACTORS, PHYSICAL VAPOR DEPOSITION REACTORS, ION IMPLANTERS; AND OPERATIONAL SOFTWARE SOLD AS A COMPONENT OF THE FOREGOING; ALL FOR THE PROCESSING AND PRODUCTION OF SEMICONDUCTOR SUBSTRATES, THIN FILMS, SILICON DISCS AND WAFERS (U.S. CLS. 21, 23, 26, 36 AND 38).

CLASS 37—CONSTRUCTION AND REPAIR

FOR MAINTENANCE AND REPAIR OF SEMICONDUCTOR PROCESSING AND PRODUCTION EQUIPMENT; MAINTENANCE AND REPAIR OF SOLAR PRODUCTION EQUIPMENT (U.S. CLS. 100, 103 AND 106).

CLASS 40—MATERIAL TREATMENT

FOR PROVIDING ON LINE INFORMATION AND A WIDE RANGE OF DATA IN THE FIELD OF ELECTRICITY GENERATION AND TRANSFORMATION FROM SOLAR ENERGY THROUGH ELECTRONIC TRANSMISSION OVER A GLOBAL COMPUTER INFORMATION NETWORK (U.S. CLS. 100, 103 AND 106).

CLASS 42—SCIENTIFIC AND COMPUTER SERVICES

FOR TECHNOLOGY PLANNING AND CONSULTING IN THE FIELD OF SOLAR ENERGY, NAMELY, PHOTOVOLTAIC SOLAR MODULE MANUFACTURING EQUIPMENT, SUBSTRATES FOR ELECTRICAL OR THERMAL INSULATION OF SOLAR CELLS, PHOTOVOLTAIC CELLS, AND SOLAR COLLECTORS; ENGINEERING SERVICES, NAMELY, ENGINEERING, DESIGN AND SIMULATION FOR THE CONSTRUCTION AND MANAGEMENT OF SOLAR MATERIALS AND APPLIANCE PRODUCTION FACILITIES (U.S. CLS. 100 AND 101).
STEVEN JACKSON, EXAMINING ATTORNEY

SN 77-657,812. NATIONAL RESTAURANT GROUP, INC., PROVO, UT. FILED 1-27-2009.

CAFE PAESAN ITALIAN BISTRO

THE MARK CONSISTS OF STANDARD CHARACTERS WITHOUT CLAIM TO ANY PARTICULAR FONT, STYLE, SIZE, OR COLOR.
NO CLAIM IS MADE TO THE EXCLUSIVE RIGHT TO USE "CAFE" AND "ITALIAN BISTRO", APART FROM THE MARK AS SHOWN.
THE ENGLISH TRANSLATION OF "PAESAN" IN THE MARK IS "COUNTRYMAN, BROTHER OR PAL".

CLASS 30—STAPLE FOODS

FOR FOOD CONSISTING PRIMARILY OF PIZZA, SANDWICHES, RICE AND PASTA SALADS, PASTA MEALS CONSISTING OF MEATS AND SAUCES; TOMATO SAUCES, OR PASTA SAUCES; PREPARED ENTREES, FOOD STAPLES AND INGREDIENTS CONSISTING PRIMARILY OF PASTA, TOMATO SAUCES AND PASTA SAUCES; GELATO; COCOA, COFFEE AND TEA BASED BEVERAGES; BAKERY GOODS, NAMELY, BREADS, SWEET BAKERY GOODS, BAKERY DESSERTS; ALL OF THE FOREGOING BEING DISTRIBUTED IN ITALIAN THEMED RESTAURANTS AND BAKERIES (U.S. CL. 46).

CLASS 32—LIGHT BEVERAGES

FOR BEVERAGES, NAMELY, FRESH FRUIT BEVERAGES; NON-ALCOHOLIC BEVERAGES, NAMELY SOFT DRINKS OF ALL VARIETIES FOR CONSUMPTION ON OR OFF THE PREMISES (U.S. CLS. 45, 46 AND 48).
MARGERY A. TIERNEY, EXAMINING ATTORNEY

SN 77-657,813. NATIONAL RESTAURANT GROUP, INC., PROVO, UT. FILED 1-27-2009.

CAFE PAESAN ITALIAN BISTRO

THE MARK CONSISTS OF STANDARD CHARACTERS WITHOUT CLAIM TO ANY PARTICULAR FONT, STYLE, SIZE, OR COLOR.
NO CLAIM IS MADE TO THE EXCLUSIVE RIGHT TO USE "CAFE AND ITALIAN BISTRO", APART FROM THE MARK AS SHOWN.
THE ENGLISH TRANSLATION OF "PAESAN" IN THE MARK IS "COUNTRYMAN, BROTHER OR PAL".

CLASS 21—HOUSEWARES AND GLASS

FOR CONTAINERS AND HOLDERS FOR FOOD AND BEVERAGES, INSULATED CONTAINERS AND INSULATED BAGS FOR FOOD OR BEVERAGES, DISPOSABLE CUPS, MUGS AND LIDS FOR FOOD SERVICE CONTAINERS, AND FOOD SERVING TRAYS (U.S. CLS. 2, 13, 23, 29, 30, 33, 40 AND 50).

CLASS 29—MEATS AND PROCESSED FOODS

FOR COMPLETE PREPARED MEALS FOR CONSUMPTION ON OR OFF THE PREMISES CONSISTING PRIMARILY OF MEAT, FISH, POULTRY AND VEGETABLES; PREPARED ENTREES, FOOD STAPLES AND INGREDIENTS CONSISTING PRIMARILY OF MEAT, FISH, POULTRY AND VEGETABLES; SALADS MADE FROM MEAT, FISH, POULTRY, OR VEGETABLES; DAIRY BASED FOOD BEVERAGES AND VEGETABLE BASED FOOD BEVERAGES; BOTTLED PEPPERS AND VEGETABLES; ALL OF THE FOREGOING BEING DISTRIBUTED IN ITALIAN THEMED RESTAURANTS AND BAKERIES (U.S. CL. 46).
MARGERY A. TIERNEY, EXAMINING ATTORNEY

SN 77-657,821. NATIONAL RESTAURANT GROUP, INC.,
PROVO, UT. FILED 1-27-2009.

PAESAN ITALIAN CAFE

THE MARK CONSISTS OF STANDARD CHARACTERS WITHOUT CLAIM TO ANY PARTICULAR FONT, STYLE, SIZE, OR COLOR.

NO CLAIM IS MADE TO THE EXCLUSIVE RIGHT TO USE "ITALIAN CAFE", APART FROM THE MARK AS SHOWN.

THE ENGLISH TRANSLATION OF "PAESAN" IN THE MARK IS "COUNTRYMAN, BROTHER OR PAL".

CLASS 30—STAPLE FOODS

FOR FOOD CONSISTING PRIMARILY OF PIZZA, SANDWICHES, RICE AND PASTA SALADS, PASTA MEALS CONSISTING OF MEATS AND SAUCES; TOMATO SAUCES, OR PASTA SAUCES; PREPARED ENTREES, FOOD STAPLES AND INGREDIENTS CONSISTING PRIMARILY OF PASTA, TOMATO SAUCES AND PASTA SAUCES; GELATO; COCOA, COFFEE AND TEA BASED BEVERAGES; BAKERY GOODS, NAMELY, BREADS, SWEET BAKERY GOODS, BAKERY DESSERTS; ALL OF THE FOREGOING BEING DISTRIBUTED IN ITALIAN THEMED RESTAURANTS AND BAKERIES (U.S. CL. 46).

CLASS 32—LIGHT BEVERAGES

FOR BEVERAGES, NAMELY, FRESH FRUIT BEVERAGES; NON-ALCOHOLIC BEVERAGES, NAMELY, SOFT DRINKS OF ALL VARIETIES FOR CONSUMPTION ON OR OFF THE PREMISES (U.S. CLS. 45, 46 AND 48).

MARGERY A. TIERNEY, EXAMINING ATTORNEY

SN 77-657,824. NATIONAL RESTAURANT GROUP, INC.,
PROVO, UT. FILED 1-27-2009.

PAESAN ITALIAN CAFE

THE MARK CONSISTS OF STANDARD CHARACTERS WITHOUT CLAIM TO ANY PARTICULAR FONT, STYLE, SIZE, OR COLOR.

NO CLAIM IS MADE TO THE EXCLUSIVE RIGHT TO USE "ITALIAN CAFE", APART FROM THE MARK AS SHOWN.

THE ENGLISH TRANSLATION OF "PAESAN" IN THE MARK IS "COUNTRYMAN, BROTHER OR PAL".

CLASS 21—HOUSEWARES AND GLASS

FOR CONTAINERS AND HOLDERS FOR FOOD AND BEVERAGES, INSULATED CONTAINERS AND INSULATED BAGS FOR FOOD OR BEVERAGES, DISPOSABLE CUPS, MUGS AND LIDS FOR FOOD SERVICE CONTAINERS, AND FOOD SERVING TRAYS (U.S. CLS. 2, 13, 23, 29, 30, 33, 40 AND 50).

CLASS 29—MEATS AND PROCESSED FOODS

FOR COMPLETE PREPARED MEALS FOR CONSUMPTION ON OR OFF THE PREMISES CONSISTING PRIMARILY OF MEAT, FISH, POULTRY AND VEGETABLES; PREPARED ENTREES, FOOD STAPLES AND INGREDIENTS CONSISTING PRIMARILY OF MEAT, FISH, POULTRY AND VEGETABLES; SALADS MADE FROM MEAT, FISH, POULTRY, OR VEGETABLES; DAIRY BASED FOOD BEVERAGES AND VEGETABLE BASED FOOD BEVERAGES; BOTTLED PEPPERS AND VEGETABLES; ALL OF THE FOREGOING BEING DISTRIBUTED IN ITALIAN THEMED RESTAURANTS AND BAKERIES (U.S. CL. 46).

MARGERY A. TIERNEY, EXAMINING ATTORNEY

SN 77-659,271. MANNATECH, INCORPORATED, COPPELL,
TX. FILED 1-29-2009.

SHARE THE GIFT

THE MARK CONSISTS OF STANDARD CHARACTERS WITHOUT CLAIM TO ANY PARTICULAR FONT, STYLE, SIZE, OR COLOR.

CLASS 35—ADVERTISING AND BUSINESS

FOR BUSINESS DEVELOPMENT SERVICES, NAMELY, PROVIDING START-UP SUPPORT FOR BUSINESS OF OTHERS IN THE FIELDS OF DIETARY AND NUTRITIONAL SUPPLEMENTS AND SKIN CARE PRODUCTS (U.S. CLS. 100, 101 AND 102).

FIRST USE 10-27-2008; IN COMMERCE 10-27-2008.

CLASS 41—EDUCATION AND ENTERTAINMENT

FOR EDUCATIONAL SERVICES, NAMELY, TRAINING SERVICES FOR THE DEVELOPMENT OF BUSINESS OPPORTUNITIES IN THE FIELDS OF DIETARY AND NUTRITIONAL SUPPLEMENTS AND SKIN CARE PRODUCTS (U.S. CLS. 100, 101 AND 107).

FIRST USE 10-27-2008; IN COMMERCE 10-27-2008.

CYNTHIA SLOAN, EXAMINING ATTORNEY

SN 77-659,599. APPLIED MATERIALS, INC., SANTA CLARA,
CA. FILED 1-29-2009.

APPLIED MATERIALS

THE MARK CONSISTS OF STANDARD CHARACTERS WITHOUT CLAIM TO ANY PARTICULAR FONT, STYLE, SIZE, OR COLOR.

OWNER OF U.S. REG. NOS. 1,588,182, 1,980,572 AND OTHERS.

CLASS 7—MACHINERY

FOR EQUIPMENT AND SYSTEMS COMPRISED OF MACHINERY FOR MAKING SOLAR INSTRUMENTS AND MATERIALS, NAMELY, FOR MAKING PHOTOVOLTAIC SOLAR GENERATORS, FOR MAKING PHOTOVOLTAIC SOLAR CELLS, FOR MAKING INVERTERS, FOR MAKING DIRECT CURRENT CABLES AND FOR MAKING SOLAR RADIATION-RELATED MONITORING AND TRACKING SYSTEMS, ALL FOR THE CONSTRUCTION AND MANUFACTURING OF MACHINES AND INSTRUMENTS FOR THE GENERATION AND TRANSFORMATION OF ELECTRICITY FROM SOLAR ENERGY; SEMICONDUCTOR WAFER PROCESSING EQUIPMENT; EQUIPMENT AND SYSTEMS COMPRISED OF MACHINERY FOR MAKING FLAT PANEL DISPLAYS; PLASMA ETCHERS AND CHEMICAL MECHANICAL POLISHERS (U.S. CLS. 13, 19, 21, 23, 31, 34 AND 35).

CLASS 9—ELECTRICAL AND SCIENTIFIC APPARATUS

FOR SOLAR CELLS; ELECTRONIC SENSORS FOR MEASURING SOLAR RADIATION; PHOTOVOLTAIC CELLS AND MODULES; INTEGRATED CIRCUITS; FLAT PANEL DISPLAYS; SEMICONDUCTOR WAFER PROCESSING COMPONENTS, NAMELY, EPITAXIAL REACTORS, CHEMICAL VAPOR DEPOSITION REACTORS, PHYSICAL VAPOR DEPOSITION REACTORS, ION IMPLANTERS; AND OPERATIONAL SOFTWARE SOLD AS A COMPONENT OF THE FOREGOING; ALL FOR THE PROCESSING AND PRODUCTION OF SEMICONDUCTOR SUBSTRATES, THIN FILMS, SILICON DISCS AND WAFERS (U.S. CLS. 21, 23, 26, 36 AND 38).

CLASS 37—CONSTRUCTION AND REPAIR

FOR MAINTENANCE AND REPAIR OF SEMICONDUCTOR PROCESSING AND PRODUCTION EQUIPMENT; MAINTENANCE AND REPAIR OF SOLAR PRODUCTION EQUIPMENT (U.S. CLS. 100, 103 AND 106).

CLASS 40—MATERIAL TREATMENT

FOR PROVIDING ON LINE INFORMATION AND A WIDE RANGE OF DATA IN THE FIELD OF ELECTRICITY GENERATION AND TRANSFORMATION FROM SOLAR ENERGY THROUGH ELECTRONIC TRANSMISSION OVER A GLOBAL COMPUTER INFORMATION NETWORK (U.S. CLS. 100, 103 AND 106).

CLASS 42—SCIENTIFIC AND COMPUTER SERVICES

FOR TECHNOLOGY PLANNING AND CONSULTING IN THE FIELD OF SOLAR ENERGY, NAMELY, PHOTOVOLTAIC SOLAR MODULE MANUFACTURING EQUIPMENT, SUBSTRATES FOR ELECTRICAL OR THERMAL INSULATION OF SOLAR CELLS, PHOTOVOLTAIC CELLS, AND SOLAR COLLECTORS; ENGINEERING SERVICES, NAMELY, ENGINEERING, DESIGN AND SIMULATION FOR THE CONSTRUCTION AND MANAGEMENT OF SOLAR MATERIALS AND APPLIANCE PRODUCTION FACILITIES (U.S. CLS. 100 AND 101).

STEVEN JACKSON, EXAMINING ATTORNEY

SN 77-659,607. APPLIED MATERIALS, INC., SANTA CLARA, CA. FILED 1-29-2009.



OWNER OF U.S. REG. NOS. 1,588,182, 1,980,572 AND OTHERS.

THE MARK CONSISTS OF THE WORDS "APPLIED MATERIALS" WITH A STYLIZED "A".

CLASS 7—MACHINERY

FOR EQUIPMENT AND SYSTEMS COMPRISED OF MACHINERY FOR MAKING SOLAR INSTRUMENTS AND MATERIALS, NAMELY, FOR MAKING PHOTOVOLTAIC SOLAR GENERATORS, FOR MAKING PHOTOVOLTAIC SOLAR CELLS, FOR MAKING INVERTERS, FOR MAKING DIRECT CURRENT CABLES AND FOR MAKING SOLAR RADIATION-RELATED MONITORING AND TRACKING SYSTEMS, ALL FOR THE CONSTRUCTION AND MANUFACTURING OF MACHINES AND INSTRUMENTS FOR THE GENERATION AND TRANSFORMATION OF ELECTRICITY FROM SOLAR ENERGY; SEMICONDUCTOR WAFER PROCESSING EQUIPMENT; EQUIPMENT AND SYSTEMS COMPRISED OF MACHINERY FOR MAKING FLAT PANEL DISPLAYS; PLASMA ETCHERS AND CHEMICAL MECHANICAL POLISHERS (U.S. CLS. 13, 19, 21, 23, 31, 34 AND 35).

CLASS 9—ELECTRICAL AND SCIENTIFIC APPARATUS

FOR SOLAR CELLS; ELECTRONIC SENSORS FOR MEASURING SOLAR RADIATION; PHOTOVOLTAIC CELLS AND MODULES; INTEGRATED CIRCUITS; FLAT PANEL DISPLAYS; SEMICONDUCTOR WAFER PROCESSING COMPONENTS, NAMELY, EPITAXIAL REACTORS, CHEMICAL VAPOR DEPOSITION REACTORS, PHYSICAL VAPOR DEPOSITION REACTORS, ION IMPLANTERS; AND OPERATIONAL SOFTWARE SOLD AS A COMPONENT OF THE FOREGOING; ALL FOR THE PROCESSING AND PRODUCTION OF SEMICONDUCTOR SUBSTRATES, THIN FILMS, SILICON DISCS AND WAFERS (U.S. CLS. 21, 23, 26, 36 AND 38).

CLASS 37—CONSTRUCTION AND REPAIR

FOR MAINTENANCE AND REPAIR OF SEMICONDUCTOR PROCESSING AND PRODUCTION EQUIPMENT; MAINTENANCE AND REPAIR OF SOLAR PRODUCTION EQUIPMENT (U.S. CLS. 100, 103 AND 106).

CLASS 40—MATERIAL TREATMENT

FOR PROVIDING ON LINE INFORMATION AND A WIDE RANGE OF DATA IN THE FIELD OF ELECTRICITY GENERATION AND TRANSFORMATION FROM SOLAR ENERGY THROUGH ELECTRONIC TRANSMISSION OVER A GLOBAL COMPUTER INFORMATION NETWORK (U.S. CLS. 100, 103 AND 106).

CLASS 42—SCIENTIFIC AND COMPUTER SERVICES

FOR TECHNOLOGY PLANNING AND CONSULTING IN THE FIELD OF SOLAR ENERGY, NAMELY, PHOTOVOLTAIC SOLAR MODULE MANUFACTURING EQUIPMENT, SUBSTRATES FOR ELECTRICAL OR THERMAL INSULATION OF SOLAR CELLS, PHOTOVOLTAIC CELLS, AND SOLAR COLLECTORS; ENGINEERING SERVICES, NAMELY, ENGINEERING, DESIGN AND SIMULATION FOR THE CONSTRUCTION AND MANAGEMENT OF SOLAR MATERIALS AND APPLIANCE PRODUCTION FACILITIES (U.S. CLS. 100 AND 101).

STEVEN JACKSON, EXAMINING ATTORNEY

SN 77-663,760. COMASEC SAS, 92238 GENNEVILLIERS, FRANCE, FILED 2-5-2009.

EASYGRIP

THE MARK CONSISTS OF STANDARD CHARACTERS WITHOUT CLAIM TO ANY PARTICULAR FONT, STYLE, SIZE, OR COLOR.

OWNER OF ERPN CMNTY TM OFC REG. NO. 007269616, DATED 6-12-2009, EXPIRES 9-29-2018.

CLASS 9—ELECTRICAL AND SCIENTIFIC APPARATUS

FOR PROTECTIVE GLOVES FOR INDUSTRIAL USE; PROTECTIVE WORK GLOVES (U.S. CLS. 21, 23, 26, 36 AND 38).

CLASS 17—RUBBER GOODS

FOR GLOVES FOR INSULATION (U.S. CLS. 1, 5, 12, 13, 35 AND 50).

CLASS 21—HOUSEWARES AND GLASS

FOR GLOVES FOR LIGHT DUTY UTILITY USE, GLOVES FOR DOMESTIC USE FOR COOKING, CLEANING, MAINTENANCE OR HOUSEHOLD PURPOSES, GARDENING GLOVES; PROTECTIVE WORK GLOVES TO PROTECT ARTICLES HANDLED BY THE WEARER FOR INDUSTRIAL OR LABORATORY USE (U.S. CLS. 2, 13, 23, 29, 30, 33, 40 AND 50).

CAROLINE WOOD, EXAMINING ATTORNEY

SN 77-663,976. COMMONWEALTH COMMERCIAL PARTNERS, INC., RICHMOND, VA. FILED 2-5-2009.

SYSTEMATICALLY PROACTIVE

THE MARK CONSISTS OF STANDARD CHARACTERS WITHOUT CLAIM TO ANY PARTICULAR FONT, STYLE, SIZE, OR COLOR.

CLASS 35—ADVERTISING AND BUSINESS

FOR BUSINESS MANAGEMENT, BUSINESS ADMINISTRATION, AND BUSINESS CONSULTING SERVICES, ALL IN THE FIELD OF REAL ESTATE; ACCOUNTING; MARKET ANALYSIS AND RESEARCH SERVICES; MARKET ANALYSIS SERVICES, NAMELY, ANALYSIS OF REAL ESTATE DISPOSITION AND MARKET POSITION (U.S. CLS. 100, 101 AND 102).

FIRST USE 5-23-2008; IN COMMERCE 5-23-2008.

CLASS 36—INSURANCE AND FINANCIAL

FOR REAL ESTATE ASSET INVESTMENT AND MANAGEMENT SERVICES, NAMELY, REAL ESTATE CONSULTING, REAL ESTATE MANAGEMENT CONSULTING; REAL ESTATE FINANCING SERVICES, NAMELY, COORDINATION OF FINANCING AND REFINANCING; ASSESSMENT AND MANAGEMENT OF REAL ESTATE; FINANCIAL ANALYSIS OF REAL ESTATE AND REAL ESTATE PORTFOLIOS; FINANCIAL DUE DILIGENCE; FINANCIAL MANAGEMENT SERVICES (U.S. CLS. 100, 101 AND 102).

FIRST USE 5-23-2008; IN COMMERCE 5-23-2008.
TASNEEM HUSSAIN, EXAMINING ATTORNEY

SN 77-664,310. AUTOMATIC LAUNDRY SERVICES CO., INC., NEWTON, MA. FILED 2-5-2009.



NO CLAIM IS MADE TO THE EXCLUSIVE RIGHT TO USE "LAUNDRY", APART FROM THE MARK AS SHOWN. THE MARK CONSISTS OF THE WORDS "AUTOMATIC LAUNDRY" IN STYLIZED FORM.

CLASS 35—ADVERTISING AND BUSINESS

FOR DISTRIBUTORSHIP SERVICES FEATURING COMMERCIAL LAUNDRY EQUIPMENT; MANAGEMENT OF COMMERCIAL LAUNDRY FACILITIES FOR OTHERS (U.S. CLS. 100, 101 AND 102).

FIRST USE 0-0-1981; IN COMMERCE 0-0-1981.

CLASS 37—CONSTRUCTION AND REPAIR

FOR PROVIDING COMMERCIAL LAUNDRY ROOM SERVICES, NAMELY, PROVIDING INSTALLATION, SERVICING, REPAIR AND MAINTENANCE OF COMMERCIAL LAUNDRY EQUIPMENT, WASHERS AND DRYERS, DRYER VENTS, AND PARTS AND ACCESSORIES THEREOF (U.S. CLS. 100, 103 AND 106).

FIRST USE 0-0-1981; IN COMMERCE 0-0-1981.
DANNEAN HETZEL, EXAMINING ATTORNEY

SN 77-664,431. MIO COMPANY, LLC, PHILADELPHIA, PA. FILED 2-5-2009.

MIO

THE MARK CONSISTS OF STANDARD CHARACTERS WITHOUT CLAIM TO ANY PARTICULAR FONT, STYLE, SIZE, OR COLOR.

THE ENGLISH TRANSLATION OF "MIO" IN THE MARK IS "MINE".

CLASS 11—ENVIRONMENTAL CONTROL APPARATUS

FOR LIGHTING FIXTURES AND LAMPS, NAMELY, PENDANT LIGHTING FIXTURES, SCONCES, TABLE LAMPS, CHANDELIERS, SOLAR LIGHTING FIXTURES, NAMELY, INDOOR AND OUTDOOR SOLAR POWERED LIGHTING UNITS AND FIXTURES, AND PORTABLE LIGHTING, NAMELY, ELECTRIC VOTIVE AND NIGHT LIGHTS AND FLASHLIGHTS (U.S. CLS. 13, 21, 23, 31 AND 34).

FIRST USE 5-0-2004; IN COMMERCE 5-0-2004.

CLASS 19—NON-METALLIC BUILDING MATERIALS

FOR NON-METAL TILES, CORK TILES AND TILES OF CORK-BASED CONGLOMERATES FOR FLOOR, WALL AND CEILING COVERINGS (U.S. CLS. 1, 12, 33 AND 50).

FIRST USE 5-0-2007; IN COMMERCE 5-0-2007.

CLASS 20—FURNITURE AND ARTICLES NOT OTHERWISE CLASSIFIED

FOR SEATING FURNITURE, NAMELY, INDOOR/OUTDOOR SEATING FURNITURE AND SOFAS; TEXTILE FITTED FURNITURE COVERS; BEDS AND PILLOWS; TABLES, NAMELY, WORK TABLES, SIDE TABLES AND END TABLES; CABINETS AND SHELVES FOR STORAGE; TRADE EVENT AND RETAIL POINT OF PURCHASE DISPLAYS; PARTITIONS, NAMELY, FREE STANDING OFFICE PARTITIONS AND MOVABLE OFFICE PARTITIONS; ROOM DIVIDERS; SCREENS (U.S. CLS. 2, 13, 22, 25, 32 AND 50).

FIRST USE 1-0-2007; IN COMMERCE 1-0-2007.

CLASS 21—HOUSEWARES AND GLASS

FOR WATERING CANS; BIRD FEEDERS; PLANTERS FOR FLOWERS AND PLANTS; BOWLS, NAMELY, BIODEGRADABLE BOWLS AND BOWLS MADE OF FELT; CORK TRIVETS; CLOTHES PINS (U.S. CLS. 2, 13, 23, 29, 30, 33, 40 AND 50).

FIRST USE 5-0-2006; IN COMMERCE 5-0-2006.

CLASS 24—FABRICS

FOR TEXTILE SUBSTITUTE MATERIALS MADE FROM SYNTHETIC MATERIALS; BEDDING, NAMELY, BED SHEETS, FITTED BED SHEET COVERS, BED FLAT SHEETS, AND PILLOW CASES USED IN THE BEDDING; BATH TOWELS; REVERSIBLE, NON-WOVEN TEXTILE FABRICS, NOT FOR CONSTRUCTION PURPOSES (U.S. CLS. 42 AND 50).

FIRST USE 5-0-2008; IN COMMERCE 5-0-2008.

CLASS 27—FLOOR COVERINGS

FOR WALLPAPER AND WALLCOVERINGS, NAMELY, MODULAR WALLCOVERINGS; CORK FOR USE AS A FLOOR OR WALL COVERING; CORK MATS (U.S. CLS. 19, 20, 37, 42 AND 50).

FIRST USE 5-0-2004; IN COMMERCE 5-0-2004.

CLASS 35—ADVERTISING AND BUSINESS

FOR COMPUTERIZED ON-LINE RETAIL STORE SERVICES FEATURING ENVIRONMENTALLY-FRIENDLY FURNISHINGS; WHOLESALE AND RETAIL STORE SERVICES FEATURING ENVIRONMENTALLY-FRIENDLY FURNISHINGS; BUSINESS CONSULTATION; BRANDING SERVICES, NAMELY, CONSULTING, DEVELOPMENT, MANAGEMENT, AND MARKETING OF BRANDS FOR BUSINESSES; CONSULTING SERVICES IN THE AREA OF SUSTAINABLE BUSINESS SOLUTIONS AND STRATEGY (U.S. CLS. 100, 101 AND 102).

FIRST USE 5-0-2003; IN COMMERCE 5-0-2003.

CLASS 42—SCIENTIFIC AND COMPUTER SERVICES

FOR CONSULTING SERVICES IN THE FIELDS OF SUSTAINABLE PRODUCT DESIGN, INTERIORS AND ARCHITECTURAL DESIGN, WEBSITE AND GRAPHIC DESIGN; NEW PRODUCT DESIGN SERVICES AND INTERIOR DESIGN SERVICES (U.S. CLS. 100 AND 101).

FIRST USE 11-0-2002; IN COMMERCE 11-0-2002.
ALICE BENMAMAN, EXAMINING ATTORNEY

SN 77-664,451. MIO COMPANY, LLC, PHILADELPHIA, PA.
FILED 2-5-2009.



THE MARK CONSISTS OF THE WORD "MIO" FORMED OF BLOCKS.

THE ENGLISH TRANSLATION OF "MIO" IN THE MARK IS "MINE".

CLASS 11—ENVIRONMENTAL CONTROL APPARATUS

FOR LIGHTING FIXTURES AND LAMPS, NAMELY, PENDANT LIGHTING FIXTURES, SCONCES, TABLE LAMPS, CHANDELIERS, SOLAR LIGHTING FIXTURES, NAMELY, INDOOR AND OUTDOOR SOLAR POWERED LIGHTING UNITS AND FIXTURES, AND PORTABLE LIGHTING, NAMELY, ELECTRIC VOTIVE AND NIGHT LIGHTS AND FLASHLIGHTS (U.S. CLS. 13, 21, 23, 31 AND 34).

FIRST USE 5-0-2004; IN COMMERCE 5-0-2004.

CLASS 19—NON-METALLIC BUILDING MATERIALS

FOR NON-METAL TILES, CORK TILES AND TILES OF CORK-BASED CONGLOMERATES FOR FLOOR, WALL AND CEILING COVERINGS (U.S. CLS. 1, 12, 33 AND 50).

FIRST USE 5-0-2007; IN COMMERCE 5-0-2007.

CLASS 20—FURNITURE AND ARTICLES NOT OTHERWISE CLASSIFIED

FOR SEATING FURNITURE, NAMELY, INDOOR/OUTDOOR SEATING FURNITURE AND SOFAS; TEXTILE FITTED FURNITURE COVERS; BEDS AND PILLOWS; TABLES, NAMELY, WORK TABLES, SIDE TABLES AND END TABLES; CABINETS AND SHELVES FOR STORAGE; TRADE EVENT AND RETAIL POINT OF PURCHASE DISPLAYS; PARTITIONS, NAMELY, FREE STANDING OFFICE PARTITIONS AND MOVABLE OFFICE PARTITIONS; ROOM DIVIDERS; SCREENS (U.S. CLS. 2, 13, 22, 25, 32 AND 50).

FIRST USE 1-0-2007; IN COMMERCE 1-0-2007.

CLASS 21—HOUSEWARES AND GLASS

FOR WATERING CANS; BIRD FEEDERS; PLANTERS FOR FLOWERS AND PLANTS; BOWLS, NAMELY, BIODEGRADABLE BOWLS AND BOWLS MADE OF FELT; CORK TRIVETS; CLOTHES PINS (U.S. CLS. 2, 13, 23, 29, 30, 33, 40 AND 50).

FIRST USE 5-0-2006; IN COMMERCE 5-0-2006.

CLASS 24—FABRICS

FOR TEXTILE SUBSTITUTE MATERIALS MADE FROM SYNTHETIC MATERIALS; BEDDING, NAMELY, BED SHEETS, FITTED BED SHEET COVERS, BED FLAT SHEETS, AND PILLOW CASES USED IN THE BEDDING; BATH TOWELS; REVERSIBLE, NON-WOVEN TEXTILE FABRICS, NOT FOR CONSTRUCTION PURPOSES (U.S. CLS. 42 AND 50).

FIRST USE 5-0-2008; IN COMMERCE 5-0-2008.

CLASS 27—FLOOR COVERINGS

FOR WALLPAPER AND WALLCOVERINGS, NAMELY, MODULAR WALLCOVERINGS; CORK FOR USE AS A FLOOR OR WALL COVERING; CORK MATS (U.S. CLS. 19, 20, 37, 42 AND 50).

FIRST USE 5-0-2004; IN COMMERCE 5-0-2004.

CLASS 35—ADVERTISING AND BUSINESS

FOR COMPUTERIZED ON-LINE RETAIL STORE SERVICES FEATURING ENVIRONMENTALLY-FRIENDLY FURNISHINGS; WHOLESALE AND RETAIL STORE SERVICES FEATURING ENVIRONMENTALLY-FRIENDLY FURNISHINGS; BUSINESS CONSULTATION; BRANDING SERVICES, NAMELY, CONSULTING; DEVELOPMENT, MANAGEMENT, AND MARKETING OF BRANDS FOR BUSINESSES; CONSULTING SERVICES IN THE AREA OF SUSTAINABLE BUSINESS SOLUTIONS AND STRATEGY (U.S. CLS. 100, 101 AND 102).

FIRST USE 3-0-2003; IN COMMERCE 3-0-2003.

CLASS 42—SCIENTIFIC AND COMPUTER SERVICES

FOR CONSULTING SERVICES IN THE FIELDS OF SUSTAINABLE PRODUCT DESIGN, INTERIORS AND ARCHITECTURAL DESIGN, WEBSITE AND GRAPHIC DESIGN; NEW PRODUCT DESIGN SERVICES AND INTERIOR DESIGN SERVICES (U.S. CLS. 100 AND 101).

FIRST USE 3-0-2003; IN COMMERCE 3-0-2003.
ALICE BENMAMAN, EXAMINING ATTORNEY

SN 77-664,899. AUTOMATIC LAUNDRY SERVICES CO., INC., NEWTON, MA. FILED 2-6-2009.

AUTOMATIC LAUNDRY

THE MARK CONSISTS OF STANDARD CHARACTERS WITHOUT CLAIM TO ANY PARTICULAR FONT, STYLE, SIZE, OR COLOR.

NO CLAIM IS MADE TO THE EXCLUSIVE RIGHT TO USE "LAUNDRY", APART FROM THE MARK AS SHOWN.

CLASS 35—ADVERTISING AND BUSINESS

FOR DISTRIBUTORSHIP SERVICES FEATURING COMMERCIAL LAUNDRY EQUIPMENT; MANAGEMENT OF COMMERCIAL LAUNDRY FACILITIES FOR OTHERS (U.S. CLS. 100, 101 AND 102).

FIRST USE 0-0-1964; IN COMMERCE 0-0-1964.

CLASS 37—CONSTRUCTION AND REPAIR

FOR PROVIDING COMMERCIAL LAUNDRY ROOM SERVICES, NAMELY, PROVIDING INSTALLATION, SERVICING, REPAIR AND MAINTENANCE OF COMMERCIAL LAUNDRY EQUIPMENT, WASHERS AND DRYERS, DRYER VENTS, AND PARTS AND ACCESSORIES THEREOF (U.S. CLS. 100, 103 AND 106).

FIRST USE 0-0-1964; IN COMMERCE 0-0-1964.

DANNEAN HETZEL, EXAMINING ATTORNEY

SN 77-665,014. SONY COMPUTER ENTERTAINMENT EUROPE LIMITED, LONDON, UNITED KINGDOM, FILED 2-6-2009.

SACKGIRL

THE MARK CONSISTS OF STANDARD CHARACTERS WITHOUT CLAIM TO ANY PARTICULAR FONT, STYLE, SIZE, OR COLOR.

PRIORITY CLAIMED UNDER SEC. 44(D) ON UNITED KINGDOM APPLICATION NO. 2494574, FILED 8-7-2008, REG. NO. 2494574, DATED 8-7-2008, EXPIRES 8-7-2018.

CLASS 9—ELECTRICAL AND SCIENTIFIC APPARATUS

FOR COMPUTER AND VIDEO GAME SOFTWARE; COMPUTER AND VIDEO GAME PROGRAMS; COMPUTER AND VIDEO GAME APPARATUS, NAMELY, COMPUTER AND VIDEO GAME JOYSTICKS, GAME CONTROLLERS FOR COMPUTER AND VIDEO GAMES, COMPUTER AND VIDEO GAME CONSOLES FOR USE WITH AN EXTERNAL DISPLAY SCREEN OR MONITOR; COMPUTER SOFTWARE FOR VIDEO GAMING; COMPUTER HARDWARE; COMPUTER PERIPHERALS; COMPUTER SOFTWARE FOR USING DIGITAL IMAGES AS WALLPAPERS OR SCREENSAVERS FOR COMPUTERS AND FOR HANDHELD ELECTRONIC GAMES; CAMERAS; EXPOSED CAMERA FILMS; AUDIO AND/OR VIDEO APPARATUS, NAMELY, APPARATUS FOR THE RECORDING, TRANSMISSION AND REPRODUCTION OF SOUND AND IMAGES; BAGS AND CASES ADAPTED OR SHAPED TO CONTAIN COMPUTER AND VIDEO GAME SOFTWARE, COMPUTER AND VIDEO GAME PROGRAMS, COMPUTER AND VIDEO GAME APPARATUS, NAMELY, COMPUTER AND VIDEO GAME JOYSTICKS, GAME CONTROLLERS FOR COMPUTER AND VIDEO GAMES, COMPUTER AND VIDEO GAME CONSOLES, COMPUTER SOFTWARE FOR VIDEO GAMING, COMPUTER HARDWARE, COMPUTER PERIPHERALS, COMPUTER SOFTWARE FOR USING DIGITAL IMAGES AS WALLPAPERS OR SCREENSAVERS FOR COMPUTERS AND FOR HANDHELD ELECTRONIC GAMES, CAMERAS, EXPOSED CAMERA FILMS, AUDIO AND/OR VIDEO APPARATUS, NAMELY, APPARATUS FOR THE RECORDING, TRANSMISSION AND REPRODUCTION OF SOUND AND IMAGES; HANDHELD UNIT FOR PLAYING ELECTRONIC GAMES FOR USE WITH EXTERNAL DISPLAY SCREEN OR MONITOR (U.S. CLS. 21, 23, 26, 36 AND 38).

CLASS 14—JEWELRY

FOR HOROLOGICAL AND CHRONOMETRIC INSTRUMENTS (U.S. CLS. 2, 27, 28 AND 50).

CLASS 16—PAPER GOODS AND PRINTED MATTER

FOR PRINTED MATTER, NAMELY, PRINTED CALENDARS, PHOTOS, POSTERS, MAGAZINES, BOOKLETS, BROCHURES, HANDOUTS IN THE FIELD OF COMPUTER AND VIDEO GAMES; BOOKS IN THE FIELD OF COMPUTER AND VIDEO GAMES; STATIONERY; PAPER BADGES (U.S. CLS. 2, 5, 22, 23, 29, 37, 38 AND 50).

CLASS 18—LEATHER GOODS

FOR BAGS, NAMELY, TOTE BAGS, ATHLETIC BAGS, BAGGAGE IN THE NATURE OF CARRY-ON BAGS; LUGGAGE; PURSES; WALLETS; UMBRELLAS (U.S. CLS. 1, 2, 3, 22 AND 41).

CLASS 24—FABRICS

FOR TEXTILES AND TEXTILE GOODS, NAMELY, TOWELS; BEDDING, NAMELY, BED SHEETS, BED LINEN (U.S. CLS. 42 AND 50).

CLASS 25—CLOTHING

FOR CLOTHING, NAMELY, SHIRTS, T-SHIRTS, SWEAT SHIRTS, DRESSES, PANTS, SOCKS; FOOTWEAR; HEADWEAR, NAMELY, CAPS, HATS; GOODS MADE FROM LEATHER OR IMITATION LEATHER, NAMELY, BELTS (U.S. CLS. 22 AND 39).

CLASS 26—FANCY GOODS

FOR BUTTONS; ORNAMENTAL NOVELTY BADGES (U.S. CLS. 37, 39, 40, 42 AND 50).

CLASS 28—TOYS AND SPORTING GOODS

FOR TOYS, GAMES AND PLAYTHINGS, NAMELY, TOY FIGURINES; HANDHELD UNIT FOR PLAYING ELECTRONIC GAMES OTHER THAN THOSE ADAPTED FOR USE WITH AN EXTERNAL DISPLAY OR MONITOR; SPORTING EQUIPMENT AND APPARATUS, NAMELY, SPORTS, RUBBER AND PLAYGROUND BALLS; BAGS AND CASES ADAPTED OR SHAPED TO CONTAIN HANDHELD UNIT FOR PLAYING ELECTRONIC GAMES OTHER THAN THOSE ADAPTED FOR USE WITH AN EXTERNAL DISPLAY OR MONITOR (U.S. CLS. 22, 23, 38 AND 50).

CLASS 41—EDUCATION AND ENTERTAINMENT

FOR ELECTRONIC GAMES SERVICES PROVIDED BY MEANS OF THE INTERNET, NAMELY, PROVIDING REVIEWS OF COMPUTER GAMES AND PROVIDING INFORMATION IN THE FIELD OF COMPUTER GAMES; PROVIDING ON-LINE COMPUTER GAMES; PROVIDING A WEB-BASED SYSTEM AND ON-LINE PORTAL FOR CUSTOMERS TO PARTICIPATE IN ON-LINE GAMING, OPERATION AND COORDINATION OF GAME TOURNAMENTS (U.S. CLS. 100, 101 AND 107).

CLASS 42—SCIENTIFIC AND COMPUTER SERVICES

FOR HOSTING ON-LINE WEB FACILITIES FOR OTHERS FOR ORGANIZING AND CONDUCTING ON-LINE MEETINGS, GATHERINGS, INTERACTIVE DISCUSSIONS AND INTERACTIVE GAME PLAY; COMPUTER SERVICES IN THE NATURE OF CUSTOMIZED WEBPAGES FEATURING GAME PLAYER INFORMATION, INCLUDING INFORMATION REGARDING A PLAYER'S IDENTITY AND THE PLAYER'S PREFERENCES; PROVIDING A WEB SITE FEATURING TEMPORARY USE OF NON-DOWNLOADABLE SOFTWARE ALLOWING WEB SITE USERS TO UPLOAD, POST AND DISPLAY ONLINE MUSIC, VIDEO AND AUDIO RECORDINGS FOR SHARING WITH OTHERS FOR ENTERTAINMENT PURPOSES; COMPUTER PROGRAMMING SERVICES, NAMELY, CONTENT CREATION AND DEVELOPMENT OF VIRTUAL AND INTERACTIVE IMAGES AND ENVIRONMENTS; HOSTING COMPUTER NETWORKS FEATURING AN ON-LINE 3D VIRTUAL ENVIRONMENT FEATURING A WIDE VARIETY OF USER-DEFINED SUBJECT MATTER (U.S. CLS. 100 AND 101).

WON TEAK OH, EXAMINING ATTORNEY

SN 77-670,127. HOOKED MEDIA GROUP, INC., SAN FRANCISCO, CA. FILED 2-13-2009.

HOOKED MEDIA GROUP

THE MARK CONSISTS OF STANDARD CHARACTERS WITHOUT CLAIM TO ANY PARTICULAR FONT, STYLE, SIZE, OR COLOR.

NO CLAIM IS MADE TO THE EXCLUSIVE RIGHT TO USE "MEDIA GROUP", APART FROM THE MARK AS SHOWN.

CLASS 35—ADVERTISING AND BUSINESS

FOR ADVERTISING SERVICES, NAMELY, PROMOTING ONLINE GAMES OF OTHERS BY WHICH THESE ONLINE GAMES ARE PLACED ON CONTENT PUBLISHERS TO GENERATE ADVERTISING REVENUE THROUGH AN INTERACTION OF GAME USERS, ADVERTISERS, GAME DEVELOPERS, AND CONTENT PUBLISHERS (U.S. CLS. 100, 101 AND 102).

FIRST USE 11-15-2008; IN COMMERCE 11-15-2008.

CLASS 42—SCIENTIFIC AND COMPUTER SERVICES

FOR SOFTWARE AS A SERVICE (SAAS), NAMELY, HOSTING SOFTWARE FOR USE BY OTHERS TO DISTRIBUTE ONLINE AND ELECTRONIC GAMES, FOR THE PURPOSE OF GENERATING REVENUE FROM THESE ONLINE AND ELECTRONIC GAMES THROUGH THE INTERACTION OF GAME USERS, ADVERTISERS, GAME DEVELOPERS AND CONTENT PUBLISHERS (U.S. CLS. 100 AND 101).

FIRST USE 2-5-2010; IN COMMERCE 2-5-2010.

MARY CRAWFORD, EXAMINING ATTORNEY

SN 77-670,321. DILLARD'S, INC., LITTLE ROCK, AR. FILED 2-13-2009.

JOHN A. BROWN'S

THE MARK CONSISTS OF STANDARD CHARACTERS WITHOUT CLAIM TO ANY PARTICULAR FONT, STYLE, SIZE, OR COLOR.

THE NAME(S), PORTRAIT(S), AND/OR SIGNATURE(S) SHOWN IN THE MARK DOES NOT IDENTIFY A PARTICULAR LIVING INDIVIDUAL.

CLASS 35—ADVERTISING AND BUSINESS

FOR RETAIL DEPARTMENT STORES; RETAIL STORE SERVICES AVAILABLE VIA THE GLOBAL COMPUTER INFORMATION NETWORK FEATURING A WIDE VARIETY OF CONSUMER GOODS; AND CONSUMER SERVICES, NAMELY, PROVIDING INFORMATION TO CONSUMERS REGARDING THE SELECTION OF PRODUCTS AND ITEMS TO BE PURCHASED (U.S. CLS. 100, 101 AND 102).

CLASS 45—PERSONAL AND LEGAL SERVICES

FOR PERSONALIZED SHOPPING SERVICES (U.S. CLS. 100 AND 101).

NORA BUCHANAN WILL, EXAMINING ATTORNEY

SN 77-671,535. GREAT CANADIAN RAILTOUR COMPANY LTD., VANCOUVER, CANADA, FILED 2-16-2009.

FRASER THE BEAR

THE MARK CONSISTS OF STANDARD CHARACTERS WITHOUT CLAIM TO ANY PARTICULAR FONT, STYLE, SIZE, OR COLOR.

PRIORITY CLAIMED UNDER SEC. 44(D) ON CANADA APPLICATION NO. 1425672, FILED 1-26-2009.

OWNER OF CANADA REG. NO. TMA759218, DATED 2-10-2010, EXPIRES 2-10-2025.

NO CLAIM IS MADE TO THE EXCLUSIVE RIGHT TO USE "BEAR", APART FROM THE MARK AS SHOWN.

CLASS 16—PAPER GOODS AND PRINTED MATTER

FOR PRINTED PUBLICATION, NAMELY, CHILDREN'S BOOKS (U.S. CLS. 2, 5, 22, 23, 29, 37, 38 AND 50).

CLASS 28—TOYS AND SPORTING GOODS

FOR PLUSH TOYS (U.S. CLS. 22, 23, 38 AND 50).
SUNG IN, EXAMINING ATTORNEY

SN 77-671,992. HAGOPJANIAN, ARMEN, ENCINO, CA. FILED 2-17-2009.



OWNER OF U.S. REG. NO. 3,298,390.
THE MARK CONSISTS OF THE LETTER "M" WITH A ROUNDED BASE.

CLASS 16—PAPER GOODS AND PRINTED MATTER

FOR GAME EQUIPMENT IN THE NATURE OF GAME BOOK MANUALS (U.S. CLS. 2, 5, 22, 23, 29, 37, 38 AND 50).

CLASS 28—TOYS AND SPORTING GOODS

FOR ROLE-PLAYING GAME PLAYED WITH CARDS AND GAME COMPONENTS; DECKS OF PLAYING CARDS (U.S. CLS. 22, 23, 38 AND 50).

CLASS 41—EDUCATION AND ENTERTAINMENT

FOR SOCIAL CLUB SERVICES, NAMELY, ARRANGING, ORGANIZING AND HOSTING SOCIAL EVENTS, GET-TOGETHERS AND GAME PARTIES FOR CLUB MEMBERS; ENTERTAINMENT, NAMELY, PRODUCTION OF TELEVISION SHOWS (U.S. CLS. 100, 101 AND 107).

KEVIN DINALLO, EXAMINING ATTORNEY

SN 77-674,201. SQUIRREL SYSTEMS, G.P., BURNABY, CANADA, FILED 2-19-2009.

SQUIRREL IN A BOX

THE MARK CONSISTS OF STANDARD CHARACTERS WITHOUT CLAIM TO ANY PARTICULAR FONT, STYLE, SIZE, OR COLOR.

PRIORITY CLAIMED UNDER SEC. 44(D) ON CANADA APPLICATION NO. 1,427,953, FILED 2-16-2009, REG. NO. TMA764268, DATED 4-14-2010, EXPIRES 4-14-2025.

CLASS 9—ELECTRICAL AND SCIENTIFIC APPARATUS

FOR POINT OF SALE SOFTWARE, NAMELY, ELECTRONIC CASH REGISTER SOFTWARE; SUPPORTING SOFTWARE COMPONENTS, NAMELY, ANTI-VIRUS SOFTWARE; POINT OF SALE TERMINALS FOR PROCESSING DEBIT AND CREDIT CARD TRANSACTIONS (U.S. CLS. 21, 23, 26, 36 AND 38).

FIRST USE 11-1-2008; IN COMMERCE 11-1-2008.

CLASS 16—PAPER GOODS AND PRINTED MATTER

FOR BROCHURES, PAMPHLETS, BOOKLETS, TRAINING MANUALS, OPERATIONAL MANUALS IN THE FIELD OF POINT OF SALE SOFTWARE, NAMELY, IN THE AREA OF ELECTRONIC CASH REGISTER SOFTWARE (U.S. CLS. 2, 5, 22, 23, 29, 37, 38 AND 50).

FIRST USE 11-1-2008; IN COMMERCE 11-1-2008.

CLASS 41—EDUCATION AND ENTERTAINMENT

FOR EDUCATIONAL SERVICES, NAMELY, DEVELOPING AND CONDUCTING TRAINING SERVICES RELATED TO THE IMPLEMENTATION, INTEGRATION, OPERATION, CUSTOMIZATION AND ADMINISTRATION OF POINT OF SALE SOFTWARE (U.S. CLS. 100, 101 AND 107).

FIRST USE 11-1-2008; IN COMMERCE 11-1-2008.

CLASS 42—SCIENTIFIC AND COMPUTER SERVICES

FOR DEVELOPING AND CUSTOMIZING SOFTWARE AND INFORMATION TECHNOLOGY SERVICES IN THE FIELD OF POINT OF SALE SOFTWARE, NAMELY, IN THE AREA OF ELECTRONIC CASH REGISTER SOFTWARE; INSTALLATION AND MAINTENANCE OF POINT OF SALE SOFTWARE (U.S. CLS. 100 AND 101).

FIRST USE 11-1-2008; IN COMMERCE 11-1-2008.

KAREN K. BUSH, EXAMINING ATTORNEY

SN 77-675,915. THE VASCULAR DISEASE FOUNDATION, INC., LAKEWOOD, CO. FILED 2-23-2009.



NO CLAIM IS MADE TO THE EXCLUSIVE RIGHT TO USE "P.A.D. PERIPHERAL ARTERIAL DISEASE COALITION", APART FROM THE MARK AS SHOWN.

THE MARK CONSISTS OF A FANCIFUL DEPICTION OF A PERSON CIRCUMSCRIBED BY TWO TWISTING FLOURISHES, TO THE RIGHT OF WHICH CONTAINS THE PHRASE "P.A.D. PERIPHERAL ARTERIAL DISEASE COALITION" IN STYLIZED FONT.

CLASS 16—PAPER GOODS AND PRINTED MATTER

FOR PRINTED MATERIALS, NAMELY, EDUCATIONAL PAMPHLETS, BROCHURES, LEAFLETS, NEWSLETTERS, JOURNALS, BOOKLETS, BOOKS, REFERENCE GUIDES, AND WALL CHARTS PUBLICIZING RESEARCH, PREVENTION, DIAGNOSIS, TREATMENT AND LEGISLATION RELATING TO PERIPHERAL ARTERIAL DISEASE (U.S. CLS. 2, 5, 22, 23, 29, 37, 38 AND 50).

FIRST USE 3-20-2006; IN COMMERCE 3-20-2006.

CLASS 35—ADVERTISING AND BUSINESS

FOR ADVOCACY, NAMELY, PROMOTING THE INTERESTS OF THOSE WITH PERIPHERAL ARTERIAL DISEASE AND THOSE AFFECTED BY IT BY RAISING AWARENESS ABOUT PERIPHERAL ARTERIAL DISEASE BEFORE THE GENERAL PUBLIC, POLITICAL ENTITIES, AND HEALTH CARE PROVIDERS; PROMOTING THE INTERESTS OF THOSE CONCERNED WITH THE PREVENTION, EARLY DIAGNOSIS, TREATMENT, AND ELIMINATION OF PERIPHERAL ARTERIAL DISEASE; PROMOTING PUBLIC AWARENESS OF THE IMPORTANCE OF RESEARCH, PREVENTION, EARLY DIAGNOSIS, AND TREATMENT OF PERIPHERAL ARTERIAL DISEASE VIA MULTI MEDIA WEBSITES; PROMOTING PUBLIC AWARENESS OF RESEARCH IN THE FIELDS OF PREVENTION, EARLY DIAGNOSIS, TREATMENT AND LEGISLATION RELATING TO PERIPHERAL ARTERIAL DISEASE; CONSULTING SERVICES RELATING TO THE ADMINISTRATIVE COORDINATION OF ORGANIZATIONS TO PROVIDE AWARENESS AND EDUCATION ACTIVITIES RELATING TO PERIPHERAL ARTERIAL DISEASE; CONSULTING SERVICES RELATING TO PUBLICITY; ADMINISTRATION OF MEMBERSHIP PROGRAMS FOR HEALTH CARE PROVIDERS, PROFESSIONAL SOCIETIES, AND GOVERNMENT AGENCIES, WHICH PROVIDE PARTICIPANTS WITH EDUCATIONAL AND AWARENESS RESOURCES REGARDING PERIPHERAL ARTERIAL DISEASE, A NETWORK OF HEALTHCARE PROVIDERS, AND DISCOUNTS ON PROFESSIONAL AND PATIENT RESOURCES; DISSEMINATION OF ADVERTISEMENTS RELATING TO PERIPHERAL ARTERIAL DISEASE; DISSEMINATION OF ADVERTISING FOR OTHERS VIA THE INTERNET; PROVIDING ONLINE DIRECTORY INFORMATION SERVICES, ALSO FEATURING HYPERLINKS TO OTHER WEBSITES; DEVELOPING AND MANAGING CHARITABLE COLLECTIONS AND CHARITABLE FUNDRAISING FOR OTHERS; RETAIL STORE SERVICES AND ONLINE RETAIL STORE SERVICES FEATURING PRINTED EDUCATIONAL MATERIALS, BOOKS, DVDS, PINS, TIES, AND PROMOTIONAL GIFT ITEMS; PROVIDING A WEBSITE FEATURING INFORMATION REGARDING LEGISLATION RELATING TO PERIPHERAL ARTERIAL DISEASE (U.S. CLS. 100, 101 AND 102).

FIRST USE 3-20-2006; IN COMMERCE 3-20-2006.

CLASS 36—INSURANCE AND FINANCIAL

FOR CHARITABLE FUNDRAISING; RAISING MONEY TO SUPPORT EDUCATIONAL AND INFORMATIONAL PROGRAMS ON PERIPHERAL ARTERIAL DISEASE, AND TO SUPPORT SCIENTIFIC RESEARCH ON PERIPHERAL ARTERIAL DISEASE (U.S. CLS. 100, 101 AND 102).

FIRST USE 3-20-2006; IN COMMERCE 3-20-2006.

CLASS 41—EDUCATION AND ENTERTAINMENT

FOR EDUCATIONAL SERVICES, NAMELY, PROVIDING LECTURES, CLASSES, SEMINARS, WORKSHOPS, CONFERENCES, EDUCATIONAL PROGRAMS IN THE AREA OF PERIPHERAL ARTERIAL DISEASE; PUBLICATION OF PAMPHLETS, BROCHURES, LEAFLETS, NEWSLETTERS, JOURNALS, BOOKLETS, BOOKS, REFERENCE GUIDES, WALL CHARTS, AND OTHER PRINTED MATERIALS, ALL IN THE AREA OF PERIPHERAL ARTERIAL DISEASE; PUBLICATION OF EDUCATIONAL MATERIALS ONLINE, NAMELY, ELECTRONIC JOURNALS, NEWSLETTERS, AND NEWS ALERTS IN THE AREA OF PERIPHERAL ARTERIAL DISEASE; MULTI-MEDIA PUBLISHING SERVICES; ONLINE LIBRARY SERVICES, NAMELY, PROVIDING ELECTRONIC LIBRARY SERVICES WHICH FEATURE NEWSPAPERS, MAGAZINES, PHOTOGRAPHS AND PICTURES VIA AN ON-LINE COMPUTER NETWORK; ENTERTAINMENT SERVICES, NAMELY, ORGANIZING COMMUNITY SPORTING ACTIVITIES AND CULTURAL PROGRAMS IN SUPPORT OF PERIPHERAL ARTERIAL DISEASE AWARENESS AND RESEARCH (U.S. CLS. 100, 101 AND 107).

FIRST USE 3-20-2006; IN COMMERCE 3-20-2006.

ANN E. SAPPENFIELD, EXAMINING ATTORNEY

SN 77-676,185. REDW BUSINESS & FINANCIAL RESOURCES, LLC, ALBUQUERQUE, NM. FILED 2-23-2009.

INTEGRITY COUNTS

THE MARK CONSISTS OF STANDARD CHARACTERS WITHOUT CLAIM TO ANY PARTICULAR FONT, STYLE, SIZE, OR COLOR.

CLASS 35—ADVERTISING AND BUSINESS

FOR ACCOUNTING SERVICES (U.S. CLS. 100, 101 AND 102).

FIRST USE 3-1-2007; IN COMMERCE 3-1-2007.

CLASS 36—INSURANCE AND FINANCIAL

FOR BUSINESS, STOCK OPTION AND PENSION VALUATION SERVICES; INVESTMENT SERVICES, NAMELY, ASSET ACQUISITION, CONSULTATION, DEVELOPMENT AND MANAGEMENT SERVICES; PROCESSING, ADMINISTERING AND MANAGING EMPLOYEE BENEFIT PLANS CONCERNING INSURANCE AND FINANCE (U.S. CLS. 100, 101 AND 102).

FIRST USE 3-1-2007; IN COMMERCE 3-1-2007.

CLASS 41—EDUCATION AND ENTERTAINMENT

FOR INFORMATION TECHNOLOGY TRAINING SERVICES (U.S. CLS. 100, 101 AND 107).

FIRST USE 3-1-2007; IN COMMERCE 3-1-2007.

CLASS 45—PERSONAL AND LEGAL SERVICES

FOR LITIGATION SUPPORT IN ECONOMICS, ACCOUNTING AND FINANCE (U.S. CLS. 100 AND 101).
FIRST USE 3-1-2007; IN COMMERCE 3-1-2007.
WILLIAM VERHOSEK, EXAMINING ATTORNEY

SN 77-678,989. CATURANO AND COMPANY, P.C., BOSTON, MA. FILED 2-26-2009.

Rapid Assessment

THE MARK CONSISTS OF STANDARD CHARACTERS WITHOUT CLAIM TO ANY PARTICULAR FONT, STYLE, SIZE, OR COLOR.

NO CLAIM IS MADE TO THE EXCLUSIVE RIGHT TO USE "ASSESSMENT", APART FROM THE MARK AS SHOWN.

SN 77-678,064. THE ACTIVE NETWORK, INC., SAN DIEGO, CA. FILED 2-25-2009.

ACTIVEEVENTS

THE MARK CONSISTS OF STANDARD CHARACTERS WITHOUT CLAIM TO ANY PARTICULAR FONT, STYLE, SIZE, OR COLOR.

OWNER OF U.S. REG. NO. 2,692,201.

CLASS 9—ELECTRICAL AND SCIENTIFIC APPARATUS

FOR COMPUTER HARDWARE AND SOFTWARE FOR PROCESSING EVENT REGISTRATION TRANSACTIONS AND FOR RETRIEVING LEADS FOR PROSPECTIVE CUSTOMERS; DATABASE MANAGEMENT SOFTWARE FOR MANAGING EVENTS (U.S. CLS. 21, 23, 26, 36 AND 38).

CLASS 35—ADVERTISING AND BUSINESS

FOR PROVIDING ONLINE EVENT REGISTRATION SERVICES FOR OTHERS, NAMELY, PROVIDING ONE OR MORE WEBSITES FOR THE REGISTRATION, COLLECTION, TRANSCRIPTION, COMPILATION AND SYSTEMIZATION OF WRITTEN EVENT REGISTRATION COMMUNICATIONS AND DATA (U.S. CLS. 100, 101 AND 102).

CLASS 36—INSURANCE AND FINANCIAL

FOR PROVIDING EVENT MANAGEMENT SERVICES IN THE NATURE OF PROVIDING ELECTRONIC PROCESSING OF CREDIT AND DEBIT CARD TRANSACTIONS AND ELECTRONIC PAYMENTS VIA A GLOBAL COMPUTER NETWORK (U.S. CLS. 100, 101 AND 102).

CLASS 42—SCIENTIFIC AND COMPUTER SERVICES

FOR COMPUTER SERVICES, NAMELY, CREATING AN ONLINE COMMUNITY FOR REGISTERED USERS TO PARTICIPATE IN DISCUSSIONS, BLOGGING, FORM VIRTUAL COMMUNITIES, AND SOCIAL NETWORKING; PROVIDING EVENT MANAGEMENT SERVICES FOR OTHERS, NAMELY, PROVIDING ONE OR MORE WEBSITES FEATURING TECHNOLOGY THAT ENABLES INTERNET USERS TO PUBLISH EVENT INFORMATION, MANAGE EXHIBITOR LISTS, MANAGE SPEAKER LISTS, MANAGE EVENT CONTENT LISTS, MANAGE REQUEST FOR PROPOSAL (RFP) PROCESSES, MANAGE CALL FOR PAPERS (CFP) PROCESSES, FINANCIALLY MANAGE EVENT BUDGETS, MANAGE LEAD RETRIEVALS AND PROVIDE EVENT DATA BUSINESS REPORTS (U.S. CLS. 100 AND 101).
LAURIE MAYES, EXAMINING ATTORNEY

CLASS 35—ADVERTISING AND BUSINESS

FOR ACQUISITION AND MERGER CONSULTATION; ASSISTANCE WITH BUSINESS MANAGEMENT AND PLANNING; BUSINESS ACQUISITION AND MERGER CONSULTATION; BUSINESS CONSULTING SERVICES IN THE FIELD OF ORGANIZATIONAL CHANGE MANAGEMENT; BUSINESS MANAGEMENT CONSULTANCY AND ADVISORY SERVICES; BUSINESS MANAGEMENT CONSULTANCY AS WELL AS DEVELOPMENT OF PROCESSES FOR THE ANALYSIS AND THE IMPLEMENTATION OF STRATEGY PLANS AND MANAGEMENT PROJECTS; BUSINESS MANAGEMENT CONSULTANCY SERVICES; BUSINESS MANAGEMENT CONSULTATION IN THE FIELD OF EXECUTIVE AND LEADERSHIP DEVELOPMENT; BUSINESS MANAGEMENT CONSULTING; BUSINESS MANAGEMENT CONSULTING AND ADVISORY SERVICES; BUSINESS MERGER CONSULTATION; BUSINESS ORGANIZATION AND MANAGEMENT CONSULTING; BUSINESS RISK MANAGEMENT CONSULTATION; CONSULTING SERVICES IN BUSINESS ORGANIZATION AND MANAGEMENT (U.S. CLS. 100, 101 AND 102).

FIRST USE 12-22-2008; IN COMMERCE 12-22-2008.

CLASS 42—SCIENTIFIC AND COMPUTER SERVICES

FOR CONSULTING SERVICES IN THE FIELD OF IDENTIFICATION, SUPPORT, AND IMPLEMENTATION OF COMPUTER-BASED INFORMATION SYSTEMS FOR BUSINESSES; INFORMATION TECHNOLOGY CONSULTATION; IT CONSULTING SERVICES (U.S. CLS. 100 AND 101).

FIRST USE 12-22-2008; IN COMMERCE 12-22-2008.

DAWN FELDMAN, EXAMINING ATTORNEY

SN 77-682,982. IONBOND AG OLTEN, OLTEN, SWITZERLAND, FILED 3-4-2009.

YOU MAKE IT FIRST - WE MAKE IT LAST

THE MARK CONSISTS OF STANDARD CHARACTERS WITHOUT CLAIM TO ANY PARTICULAR FONT, STYLE, SIZE, OR COLOR.

PRIORITY CLAIMED UNDER SEC. 44(D) ON ERPNCMNTY TM OFC APPLICATION NO. 007212863, FILED 9-4-2008, REG. NO. 007212863, DATED 7-21-2009, EXPIRES 9-4-2018.

CLASS 1—CHEMICALS

FOR NITROGEN COMPOUNDS CONTAINING METALS, NAMELY, TITANIUM NITRIDE (U.S. CLS. 1, 5, 6, 10, 26 AND 46).

CLASS 2—PAINTS

FOR COATINGS, NAMELY, WEAR-RESISTANT, ANTI-CORROSION, SURFACE PROTECTIVE AND LOW FRICTION COATING FOR USE ON A VARIETY OF SUBSTRATES; NON-METAL VAPOR-DEPOSITED MATERIAL COATINGS, NAMELY, WEAR RESISTANT, ANTI-CORROSION, SURFACE PROTECTIVE AND LOW FRICTION COATINGS FOR USE ON A VARIETY OF DIFFERENT SUBSTRATES (U.S. CLS. 6, 11 AND 16).

SN 77-688,774. ROSETTA STONE LTD., ARLINGTON, VA. FILED 3-11-2009.

ROSETTA STUDIO**CLASS 6—METAL GOODS**

FOR METALS AND METAL ALLOYS (U.S. CLS. 2, 12, 13, 14, 23, 25 AND 50).

THE MARK CONSISTS OF STANDARD CHARACTERS WITHOUT CLAIM TO ANY PARTICULAR FONT, STYLE, SIZE, OR COLOR.

OWNER OF U.S. REG. NOS. 3,454,358, 3,570,015 AND OTHERS.

NO CLAIM IS MADE TO THE EXCLUSIVE RIGHT TO USE "STUDIO", APART FROM THE MARK AS SHOWN.

CLASS 7—MACHINERY

FOR SURFACE-COATING MACHINERY INSTALLATIONS, NAMELY, CHEMICAL VAPOR DEPOSITION (CVD) SYSTEMS COMPRISED OF REACTOR CHAMBER, GAS MONITORING SYSTEM, FURNACE, PROCESS CONTROL, VACUUM PUMP AND EXHAUST SYSTEM; PLASMA ASSISTED CHEMICAL VAPOR DEPOSITION (PA-CVD) SYSTEMS COMPRISED OF PLASMA GENERATOR; PHYSICAL VAPOR DEPOSITION (PVD) SYSTEMS COMPRISED OF PLASMA GENERATOR, CATHODES; CHEMICAL VAPOR ALUMINIZING (CVA) SYSTEMS COMPRISED OF REACTOR CHAMBER, GAS MONITORING SYSTEM, FURNACE, PROCESS CONTROL, VACUUM PUMP AND EXHAUST SYSTEM (U.S. CLS. 13, 19, 21, 23, 31, 34 AND 35).

CLASS 38—COMMUNICATION

FOR COMPUTER SERVICES, NAMELY, PROVIDING ON-LINE FACILITIES FOR REAL-TIME INTERACTION WITH OTHER COMPUTER USERS IN THE FIELD OF FOREIGN LANGUAGES (U.S. CLS. 100, 101 AND 104).

CLASS 37—CONSTRUCTION AND REPAIR

FOR APPLICATION OF COATINGS TO SUBSTRATES BY VAPOR DEPOSITION WITH METALLIC AND CERAMIC COMPOUNDS (U.S. CLS. 100, 103 AND 106).
PAUL CROWLEY, EXAMINING ATTORNEY

CLASS 41—EDUCATION AND ENTERTAINMENT

FOR EDUCATION SERVICES, NAMELY, PROVIDING LIVE AND ON-LINE CLASSES IN THE FIELD OF FOREIGN LANGUAGES (U.S. CLS. 100, 101 AND 107).
MATTHEW EINSTEIN, EXAMINING ATTORNEY

SN 77-685,871. CAP JULUCA HOLDINGS LIMITED, MAUNDAYS BAY, LEEWARD ISLANDS, ANGUILLA, FILED 3-6-2009.

CAP JULUCA

THE MARK CONSISTS OF STANDARD CHARACTERS WITHOUT CLAIM TO ANY PARTICULAR FONT, STYLE, SIZE, OR COLOR.

OWNER OF U.S. REG. NOS. 3,274,022 AND 3,315,694.

THE WORDING "CAP JULUCA" HAS NO MEANING IN A FOREIGN LANGUAGE.

SN 77-691,138. RUDINGER, RICHARD F., FREDERICK, MD. FILED 3-14-2009.



The logo for "NANO GLIDE" features the word "NANO" in a bold, italicized, black sans-serif font. To its right, the word "GLIDE" is written in a larger, blue, italicized sans-serif font with horizontal lines through the bottom of the letters.

CLASS 43—HOTEL AND RESTAURANT SERVICES

FOR RESTAURANT, BAR, AND LOUNGE SERVICES; PROVIDING HOTEL, RESORT AND LODGING SERVICES, NAMELY, MAKING HOTEL, RESORT HOTEL AND TEMPORARY LODGING RESERVATIONS FOR OTHERS (U.S. CLS. 100 AND 101).

FIRST USE 3-1-1989; IN COMMERCE 3-1-1989.

THE COLOR(S) WHITE, BLUE AND BLACK IS/ARE CLAIMED AS A FEATURE OF THE MARK.

THE MARK CONSISTS OF THE WORD "NANO" IN BLACK WRITTEN IN SMALLER TEXT IN THE UPPER LEFT POSITION. THE WORD "GLIDE" IS WRITTEN IN LARGER TEXT IS IN BLUE AND HAS THREE WHITE LINES THROUGH THE BASE OF THE TEXT.

CLASS 44—MEDICAL, BEAUTY AND AGRICULTURAL SERVICES

FOR HEALTH SPA SERVICES, NAMELY, PROVIDING FACIALS, MANICURES, PEDICURES, BODY POLISHES, BODY WRAPS, MASSAGES AND COSMETIC BODY CARE SERVICES (U.S. CLS. 100 AND 101).

FIRST USE 3-1-1989; IN COMMERCE 3-1-1989.

ELISSA GARBER KON, EXAMINING ATTORNEY

CLASS 24—FABRICS

FOR VINYL AND CLOTH TEXTILES FOR USE IN THE MANUFACTURE OF CLOTHING AND FOOTWEAR; WOVEN FABRICS AND KNITTED FABRICS (U.S. CLS. 42 AND 50).

FIRST USE 5-1-2007; IN COMMERCE 8-1-2008.

CLASS 25—CLOTHING

FOR (BASED ON INTENT TO USE) A-SHIRTS; BELTS; BIB TIGHTS; BIBS NOT OF CLOTH OR PAPER; CAPS; CHILDREN'S AND INFANTS' CLOTH BIBS; CHILDREN'S CLOTH EATING BIBS; CLOTH BIBS; CLOTH BIBS FOR ADULT DINERS; CLOTH BIBS FOR USE BY SENIOR CITIZENS OR PHYSICALLY- OR MENTALLY-CHALLENGED PERSONS; CLOTH DIAPERS; CLOTHING FOR ATHLETIC USE, NAMELY, PADDED ELBOW COMPRESSION SLEEVES; CLOTHING FOR ATHLETIC USE, NAMELY, PADDED PANTS; CLOTHING FOR ATHLETIC USE, NAMELY, PADDED SHIRTS; CLOTHING FOR ATHLETIC USE, NAMELY, PADDED SHORTS; CLOTHING FOR WEAR IN JUDO PRACTICES; CLOTHING FOR WEAR IN WRESTLING GAMES; CLOTHING, NAMELY, ARM WARMERS; CLOTHING, NAMELY, BASE LAYERS; CLOTHING, NAMELY, FOLK COSTUMES; CLOTHING, NAMELY, HAND-WARMERS; CLOTHING, NAMELY, KHAKIS; CLOTHING, NAMELY, KNEE WARMERS; CLOTHING, NAMELY, NECK TUBES; CLOTHING, NAMELY, THOBES; CLOTHING, NAMELY, WRAP-AROUNDS; CORSETS; DUSTERS; EYESHADES; FABRIC BELTS; FOULARDS; FOUNDATION GARMENTS WORN AROUND THE MIDSECTION OR THIGHS TO KEEP THE STOMACH IN AND CREATE A SLIMMING EFFECT; HOODS; INFANT AND TODDLER ONE PIECE CLOTHING; INFANT CLOTH DIAPERS; JERSEYS; LEATHER BELTS; LEOTARDS AND TIGHTS FOR WOMEN, MEN AND CHILDREN OF NYLON, COTTON OR OTHER TEXTILE FIBERS; LINGERIE ACCESSORIES, NAMELY, REMOVABLE SILICONE BREAST ENHANCER PADS USED IN A BRA; MANTLES; MUFFLERS; NON-DISPOSABLE CLOTH TRAINING PANTS; PAPER HATS FOR USE AS CLOTHING ITEMS; PARTS OF CLOTHING, NAMELY, GUSSETS FOR TIGHTS, GUSSETS FOR STOCKINGS, GUSSETS FOR BATHING SUITS, GUSSETS FOR UNDERWEAR, GUSSETS FOR LEOTARDS AND GUSSETS FOR FOOTLETS; PARTS OF CLOTHING, NAMELY, UNDERARM GUSSETS; PARTY HATS; PERSPIRATION ABSORBENT UNDERWEAR CLOTHING; PUMPS; SHIRTS; SHORT SETS; SHOULDER WRAPS; SWADDLING CLOTHES; TIES; TIGHTS; TOPS; TRAVEL CLOTHING CONTAINED IN A PACKAGE COMPRISING REVERSIBLE JACKETS, PANTS, SKIRTS, TOPS AND A BELT OR SCARF; TRIATHLON CLOTHING, NAMELY, TRIATHLON TIGHTS, TRIATHLON SHORTS, TRIATHLON SINGLET, TRIATHLON SHIRTS, TRIATHLON SUITS; UNDERARM CLOTHING SHIELDS; WEARABLE GARMENTS AND CLOTHING, NAMELY, SHIRTS; WRAPS; WRISTBANDS CONTAINING A COOLING SUBSTANCE TO COOL THE WEARER (U.S. CLS. 22 AND 39).

EUGENIA MARTIN, EXAMINING ATTORNEY

SN 77-698,179. ROBINSON, MARK A., BRIGHTON, MI. FILED 3-24-2009.



NO CLAIM IS MADE TO THE EXCLUSIVE RIGHT TO USE "CONSULTING GROUP, LLC", APART FROM THE MARK AS SHOWN.

THE MARK CONSISTS OF THE STYLIZED WORDING "KOIOS CONSULTING GROUP, LLC"

CLASS 35—ADVERTISING AND BUSINESS

FOR BUSINESS CONSULTATION SERVICES; BUSINESS CONSULTING SERVICES, NAMELY, PROVIDING ASSISTANCE IN DEVELOPMENT OF BUSINESS STRATEGIES AND CREATIVE IDEATION; BUSINESS MANAGEMENT CONSULTANCY SERVICES; CONSULTANCY SERVICES REGARDING BUSINESS STRATEGIES; CONSULTING SERVICES IN THE FIELD OF MANAGING INTELLECTUAL PROPERTIES; CONSULTING SERVICES, NAMELY, EXPERT ANALYSIS AND MANAGEMENT CONSULTING IN ECONOMICS AND ACCOUNTING (U.S. CLS. 100, 101 AND 102).
FIRST USE 11-7-2007; IN COMMERCE 11-7-2007.

CLASS 36—INSURANCE AND FINANCIAL

FOR BUSINESS, STOCK OPTION AND PENSION VALUATION SERVICES (U.S. CLS. 100, 101 AND 102).
FIRST USE 11-7-2007; IN COMMERCE 11-7-2007.

CLASS 45—PERSONAL AND LEGAL SERVICES

FOR FRAUD DETECTION SERVICES IN THE FIELD OF HEALTH CARE INSURANCE; INTELLECTUAL PROPERTY CONSULTATION; LITIGATION CONSULTANCY; LITIGATION SUPPORT IN ECONOMICS, ACCOUNTING AND FINANCE; LITIGATION SUPPORT SERVICES; MONITORING MONETARY CHARITABLE DONATIONS FOR FRAUD PREVENTION PURPOSES; PATENT AND INDUSTRIAL PROPERTY CONSULTATION; PROVIDING FRAUD DETECTION SERVICES FOR ELECTRONIC FUNDS TRANSFER, CREDIT AND DEBIT CARD AND ELECTRONIC CHECK TRANSACTIONS VIA A GLOBAL COMPUTER NETWORK (U.S. CLS. 100 AND 101).

FIRST USE 11-7-2007; IN COMMERCE 11-7-2007.
BERYL GARDNER, EXAMINING ATTORNEY

SN 77-702,528. YAHOO! INC., SUNNYVALE, CA. FILED 3-30-2009.



THE COLOR(S) BLACK, PURPLE AND GRAY IS/ARE CLAIMED AS A FEATURE OF THE MARK.

THE MARK CONSISTS OF HALF BLACK AND HALF GRAY LETTERING OF A STYLIZED CAPITAL LETTER "S" AND STYLIZED LETTERS IN LOWER CASE, "H", "I", "N", AND "E", AND AN ITALICIZED LETTER "I" TOPPED BY A PURPLE DOT, ORDERED TO FORM THE WORD "SHINE".

CLASS 36—INSURANCE AND FINANCIAL

FOR PROVIDING A WEBSITE FEATURING TEXT AND NON-DOWNLOADABLE AUDIO, VIDEO AND GRAPHIC WORKS ONLINE IN THE FIELD OF FINANCE AND INVESTING (U.S. CLS. 100, 101 AND 102).
FIRST USE 3-31-2008; IN COMMERCE 3-31-2008.

CLASS 41—EDUCATION AND ENTERTAINMENT

FOR PROVIDING A WEBSITE FEATURING TEXT AND NON-DOWNLOADABLE AUDIO, VIDEO AND GRAPHIC WORKS ONLINE IN THE FIELDS OF PHYSICAL FITNESS, PARENTING CONCERNING THE EDUCATION OF CHILDREN, AND PET TRAINING; ONLINE JOURNALS, NAMELY, BLOGS POSTING COMMENTARY AND INFORMATION IN THE FIELDS OF HOME AND PERSONAL CAREER MANAGEMENT, FINANCE, AND INVESTING, PERSONAL AND CELEBRITY FASHION, PERSONAL BEAUTY CARE, PHYSICAL FITNESS, PARENTING, PERSONAL RELATIONSHIPS, FOOD, HOROSCOPE INFORMATION, AND PETS (U.S. CLS. 100, 101 AND 107).

FIRST USE 3-31-2008; IN COMMERCE 3-31-2008.

CLASS 43—HOTEL AND RESTAURANT SERVICES

FOR PROVIDING A WEBSITE FEATURING TEXT AND NON-DOWNLOADABLE AUDIO, VIDEO AND GRAPHIC WORKS ONLINE IN THE FIELD OF RECIPES AND COOKING INFORMATION (U.S. CLS. 100 AND 101).

FIRST USE 3-31-2008; IN COMMERCE 3-31-2008.

CLASS 44—MEDICAL, BEAUTY AND AGRICULTURAL SERVICES

FOR PROVIDING A WEBSITE FEATURING TEXT AND NON-DOWNLOADABLE AUDIO, VIDEO AND GRAPHIC WORKS ONLINE IN THE FIELDS OF PERSONAL BEAUTY CARE, PARENTING CONCERNING THE HEALTH OF CHILDREN, FOOD NUTRITION, AND PET HEALTH (U.S. CLS. 100 AND 101).

FIRST USE 3-31-2008; IN COMMERCE 3-31-2008.

CLASS 45—PERSONAL AND LEGAL SERVICES

FOR PROVIDING A WEBSITE FEATURING TEXT AND NON-DOWNLOADABLE AUDIO, VIDEO AND GRAPHIC WORKS ONLINE IN THE FIELDS OF PERSONAL RELATIONSHIPS, HOROSCOPES AND PERSONAL AND CELEBRITY FASHION (U.S. CLS. 100 AND 101).

FIRST USE 3-31-2008; IN COMMERCE 3-31-2008.
LINDA ORNDORFF, EXAMINING ATTORNEY

SN 77-703,806. SEASIDE COMMUNITY DEVELOPMENT CORPORATION, SANTA ROSA BEACH, FL. FILED 3-31-2009.

CAMP SEASIDE

THE MARK CONSISTS OF STANDARD CHARACTERS WITHOUT CLAIM TO ANY PARTICULAR FONT, STYLE, SIZE, OR COLOR.

NO CLAIM IS MADE TO THE EXCLUSIVE RIGHT TO USE "CAMP", APART FROM THE MARK AS SHOWN.

CLASS 36—INSURANCE AND FINANCIAL

FOR REAL ESTATE SERVICES, NAMELY, REAL ESTATE BROKERAGE SERVICES; REAL ESTATE SERVICES, NAMELY, VACATION RENTALS; REAL ESTATE SERVICES, NAMELY, LEASING OF REAL ESTATE (U.S. CLS. 100, 101 AND 102).

CLASS 37—CONSTRUCTION AND REPAIR

FOR REAL ESTATE DEVELOPMENT SERVICES (U.S. CLS. 100, 103 AND 106).

CLASS 41—EDUCATION AND ENTERTAINMENT

FOR ENTERTAINMENT SERVICES, NAMELY, PROVIDING DAY CAMP, RECREATIONAL FACILITIES FOR CHILDREN WHERE SWIMMING AND TENNIS LESSONS, SPORTS TOURNAMENTS, ARTS AND CRAFTS ACTIVITIES AND ADULT-GUIDED BICYCLE AND KAYAK EXPEDITIONS ARE PROVIDED; EVENT AND PARTY PLANNING SERVICES (U.S. CLS. 100, 101 AND 107).

FIRST USE 0-0-1993; IN COMMERCE 0-0-1993.
JILL C. ALT, EXAMINING ATTORNEY

SN 77-704,298. PROFOUND WELLNESS, LLC, ALBUQUERQUE, NM. FILED 4-1-2009.

Profound Wellness

THE MARK CONSISTS OF STANDARD CHARACTERS WITHOUT CLAIM TO ANY PARTICULAR FONT, STYLE, SIZE, OR COLOR.

NO CLAIM IS MADE TO THE EXCLUSIVE RIGHT TO USE "WELLNESS", APART FROM THE MARK AS SHOWN.

CLASS 35—ADVERTISING AND BUSINESS

FOR PROVIDING ASSISTANCE, FITNESS EVALUATION AND CONSULTATION TO CORPORATE CLIENTS TO HELP THEIR EMPLOYEES MAKE HEALTH, WELLNESS AND NUTRITIONAL CHANGES IN THEIR DAILY LIVING TO INCREASE PRODUCTIVITY AND LOWER HEALTH CARE COSTS (U.S. CLS. 100, 101 AND 102).

FIRST USE 4-1-2007; IN COMMERCE 4-1-2009.

CLASS 41—EDUCATION AND ENTERTAINMENT

FOR HEALTH CLUB SERVICES, NAMELY, PROVIDING INSTRUCTION AND EQUIPMENT IN THE FIELD OF PHYSICAL EXERCISE (U.S. CLS. 100, 101 AND 107).

FIRST USE 4-1-2007; IN COMMERCE 4-1-2009.

CLASS 44—MEDICAL, BEAUTY AND AGRICULTURAL SERVICES

FOR COUNSELING SERVICES IN THE FIELDS OF HEALTH, NUTRITION AND LIFESTYLE WELLNESS; PROVIDING ASSISTANCE, FITNESS EVALUATION AND CONSULTATION TO CORPORATE CLIENTS TO HELP THEIR EMPLOYEES MAKE HEALTH, WELLNESS AND NUTRITIONAL CHANGES IN THEIR DAILY LIVING TO IMPROVE HEALTH; PROVIDING ASSISTANCE, FITNESS EVALUATION AND CONSULTATION TO INDIVIDUALS TO HELP THEM MAKE HEALTH, WELLNESS AND NUTRITIONAL CHANGES IN THEIR DAILY LIVING TO IMPROVE HEALTH; PROVIDING WELLNESS SERVICES, NAMELY, PERSONAL ASSESSMENTS, PERSONALIZED ROUTINES, MAINTENANCE SCHEDULES, AND COUNSELING (U.S. CLS. 100 AND 101).

FIRST USE 4-1-2007; IN COMMERCE 4-1-2009.
YAT SYE, LEE, EXAMINING ATTORNEY

SN 77-704,576. GRUPO DE DIARIOS AMERICA S.A., CORAL GABLES, FL. FILED 4-1-2009.

SN 77-709,235. NATIONAL WILDLIFE FEDERATION, RESTON, VA. FILED 4-8-2009.

GDA

THE MARK CONSISTS OF STANDARD CHARACTERS WITHOUT CLAIM TO ANY PARTICULAR FONT, STYLE, SIZE, OR COLOR.

CLASS 35—ADVERTISING AND BUSINESS

FOR ADVERTISING SERVICES, NAMELY, PROVIDING ADVERTISEMENT SPACES IN DIFFERENT NEWSPAPERS THROUGH THE INTERNET (U.S. CLS. 100, 101 AND 102).

FIRST USE 9-16-1996; IN COMMERCE 9-16-1996.

CLASS 41—EDUCATION AND ENTERTAINMENT

FOR PUBLICATION OF ELECTRONIC NEWSPAPERS ACCESSIBLE VIA A GLOBAL COMPUTER NETWORK; CONTENT SYNDICATION AND DISTRIBUTION, NAMELY, NEWS SYNDICATION REPORTING (U.S. CLS. 100, 101 AND 107).

FIRST USE 9-16-1996; IN COMMERCE 9-16-1996.
WARREN L. OLANDRIA, EXAMINING ATTORNEY

SN 77-707,625. PACKAGING PRODUCTS CORPORATION, NEW BEDFORD, MA. FILED 4-6-2009.



THE MARK CONSISTS OF THREE TOUCHING DIAMOND SHAPES CONTAINING THE LETTERS "P", "P" AND "C", RESPECTIVELY.

CLASS 16—PAPER GOODS AND PRINTED MATTER

FOR PACKAGING, NAMELY, CARDBOARD BOXES FOR INDUSTRIAL AND CONSUMER PRODUCTS AND PAPERBOARD BOXES FOR INDUSTRIAL PACKAGING, INSULATED BOXES OF CARDBOARD OR PAPERBOARD, INSULATED FOR THERMALLY-SENSITIVE PRODUCTS, ALL FOR FOOD, MEDICINE AND INDUSTRIAL PURPOSES (U.S. CLS. 2, 5, 22, 23, 29, 37, 38 AND 50).

FIRST USE 11-0-1961; IN COMMERCE 11-0-1961.

CLASS 20—FURNITURE AND ARTICLES NOT OTHERWISE CLASSIFIED

FOR PLASTIC LIDS, PLASTIC STORAGE BOXES, PLASTIC STORAGE CONTAINERS FOR COMMERCIAL OR INDUSTRIAL USE (U.S. CLS. 2, 13, 22, 25, 32 AND 50).

FIRST USE 11-0-1961; IN COMMERCE 11-0-1961.
WANDA KAY PRICE, EXAMINING ATTORNEY



THE MARK CONSISTS OF THE WORDS "BE OUT THERE", WITH A SILHOUETTE OF A YOUNG GIRL AND THREE BUTTERFLIES, WITH THE GIRL STANDING ON THE "T" AND THE "H".

CLASS 25—CLOTHING

FOR SHORT-SLEEVED OR LONG-SLEEVED T-SHIRTS (U.S. CLS. 22 AND 39).

FIRST USE 3-2-2009; IN COMMERCE 3-31-2009.

CLASS 41—EDUCATION AND ENTERTAINMENT

FOR PROVIDING ADVICE AND INFORMATION IN THE FIELD OF EDUCATIONAL AND ENTERTAINMENT ACTIVITIES AND EVENTS FOR CHILDREN TO ENCOURAGE THEIR INTEREST IN THE OUTDOORS AND OUTDOOR ACTIVITIES RELATING TO WILDLIFE, ENVIRONMENTAL AWARENESS AND ENVIRONMENTAL CONSERVATION VIA THE INTERNET AND THE DISTRIBUTION OF PRINTED MATTER IN CONNECTION THEREWITH (U.S. CLS. 100, 101 AND 107).

FIRST USE 3-2-2009; IN COMMERCE 3-2-2009.
REGINA DRUMMOND, EXAMINING ATTORNEY

SN 77-709,237. NATIONAL WILDLIFE FEDERATION, RESTON, VA. FILED 4-8-2009.

BE OUT THERE

THE MARK CONSISTS OF STANDARD CHARACTERS WITHOUT CLAIM TO ANY PARTICULAR FONT, STYLE, SIZE, OR COLOR.

CLASS 25—CLOTHING

FOR SHORT-SLEEVED OR LONG-SLEEVED T-SHIRTS (U.S. CLS. 22 AND 39).

FIRST USE 3-2-2009; IN COMMERCE 3-31-2009.

CLASS 41—EDUCATION AND ENTERTAINMENT

FOR PROVIDING ADVICE AND INFORMATION IN THE FIELD OF EDUCATIONAL AND ENTERTAINMENT ACTIVITIES AND EVENTS FOR CHILDREN TO ENCOURAGE THEIR INTEREST IN THE OUTDOORS AND OUTDOOR ACTIVITIES RELATING TO WILDLIFE, ENVIRONMENTAL AWARENESS AND ENVIRONMENTAL CONSERVATION VIA THE INTERNET AND THE DISTRIBUTION OF PRINTED MATTER IN CONNECTION THEREWITH (U.S. CLS. 100, 101 AND 107).

FIRST USE 3-2-2009; IN COMMERCE 3-2-2009.
REGINA DRUMMOND, EXAMINING ATTORNEY

SN 77-711,007. MARIO LAVANDEIRA, LOS ANGELES, CA. FILED 4-9-2009.

PEREZCIOUS TUNES

THE MARK CONSISTS OF STANDARD CHARACTERS WITHOUT CLAIM TO ANY PARTICULAR FONT, STYLE, SIZE, OR COLOR.

NO CLAIM IS MADE TO THE EXCLUSIVE RIGHT TO USE "TUNES", APART FROM THE MARK AS SHOWN.

CLASS 9—ELECTRICAL AND SCIENTIFIC APPARATUS

FOR COMPACT DISCS, DVDS, SOUND RECORDINGS, AND VIDEO RECORDINGS CONTAINING MUSIC; DOWNLOADABLE DIGITAL FILES CONTAINING MUSIC VIDEOS AND MUSIC (U.S. CLS. 21, 23, 26, 36 AND 38).

CLASS 41—EDUCATION AND ENTERTAINMENT

FOR MUSIC PRODUCTION; MUSIC PUBLISHING; MUSIC VIDEO PRODUCTION; INTERNET WEB SITE IN THE FIELD OF MUSIC; ENTERTAINMENT SERVICES, NAMELY, MULTIMEDIA PRODUCTION SERVICES; DISTRIBUTION OF RADIO PROGRAMS FEATURING MUSIC; TELEVISION PRODUCTION (U.S. CLS. 100, 101 AND 107).

DAVID TOOLEY, EXAMINING ATTORNEY

SN 77-711,033. BHEARST, LLC, CHARLESTON, SC. FILED 4-9-2009.

GOOD 4 WOMEN FOUNDATION

THE MARK CONSISTS OF STANDARD CHARACTERS WITHOUT CLAIM TO ANY PARTICULAR FONT, STYLE, SIZE, OR COLOR.

NO CLAIM IS MADE TO THE EXCLUSIVE RIGHT TO USE "FOUNDATION", APART FROM THE MARK AS SHOWN.

CLASS 18—LEATHER GOODS

FOR HANDBAGS, TOTE BAGS, BOOKBAGS, PURSES, WALLETS (U.S. CLS. 1, 2, 3, 22 AND 41).

CLASS 24—FABRICS

FOR BED LINENS, TABLE LINENS, TOWELS, CLOTH COASTERS (U.S. CLS. 42 AND 50).

CLASS 25—CLOTHING

FOR SHIRTS, T-SHIRTS, POLO SHIRTS, TANK TOPS, TEE SHIRTS, DRESSES, BLOUSES, SWEATERS, PANTS, JACKETS, SCARVES, SHOES, SANDALS (U.S. CLS. 22 AND 39).

CLASS 36—INSURANCE AND FINANCIAL

FOR CHARITABLE SERVICES, NAMELY, PROVIDING MICRO LOANS TO PROMOTE SELF-RELIANCE AND FINANCIAL INDEPENDENCE FOR WOMEN IN NEED (U.S. CLS. 100, 101 AND 102).

CLASS 41—EDUCATION AND ENTERTAINMENT

FOR CHARITABLE SERVICES, NAMELY, PROVIDING EDUCATIONAL COURSES AND JOB TRAINING SKILLS TO PROMOTE SELF-RELIANCE AND FINANCIAL INDEPENDENCE FOR WOMEN IN NEED (U.S. CLS. 100, 101 AND 107).

AISHA CLARKE, EXAMINING ATTORNEY

SN 77-711,037. BHEARST, LLC, CHARLESTON, SC. FILED 4-9-2009.



NO CLAIM IS MADE TO THE EXCLUSIVE RIGHT TO USE "FOUNDATION", APART FROM THE MARK AS SHOWN.

THE MARK CONSISTS OF THE STYLIZED TEXT "GOOD 4 WOMEN FOUNDATION" CENTERED BELOW A GRAPHIC DESIGN ELEMENT CONSISTING OF THREE (3) FEMALE VENUS SYMBOLS POSITIONED IN ALIGNMENT SIDE-BY-SIDE AND PARALLEL TO EACH OTHER WITHIN A RECTANGLE.

CLASS 18—LEATHER GOODS

FOR HANDBAGS, TOTE BAGS, BOOKBAGS, PURSES, WALLETS (U.S. CLS. 1, 2, 3, 22 AND 41).

CLASS 24—FABRICS

FOR BED LINENS, TABLE LINENS, TOWELS, CLOTH COASTERS (U.S. CLS. 42 AND 50).

CLASS 25—CLOTHING

FOR SHOES, SANDALS, AND CLOTHING, NAMELY, SHIRTS, T-SHIRTS, POLO SHIRTS, TANK TOPS, TEE SHIRTS, DRESSES, BLOUSES, SWEATERS, PANTS, JACKETS, SCARVES (U.S. CLS. 22 AND 39).

SN 77-714,663. LENNOX NATIONAL ACCOUNT SERVICES LLC, RICHARDSON, TX. FILED 4-15-2009.

CLASS 36—INSURANCE AND FINANCIAL

FOR CHARITABLE SERVICES, NAMELY, PROVIDING MICRO LOANS TO PROMOTE SELF-RELIANCE AND FINANCIAL INDEPENDENCE FOR WOMEN IN NEED (U.S. CLS. 100, 101 AND 102).



CLASS 41—EDUCATION AND ENTERTAINMENT

FOR CHARITABLE SERVICES, NAMELY, PROVIDING EDUCATIONAL COURSES AND JOB TRAINING TO PROMOTE SELF-RELIANCE AND FINANCIAL INDEPENDENCE FOR WOMEN IN NEED (U.S. CLS. 100, 101 AND 107).

AISHA CLARKE, EXAMINING ATTORNEY

OWNER OF U.S. REG. NOS. 695,435, 3,238,720 AND OTHERS.

NO CLAIM IS MADE TO THE EXCLUSIVE RIGHT TO USE "NATIONAL ACCOUNT SERVICES", APART FROM THE MARK AS SHOWN.

THE MARK CONSISTS OF A STYLIZED USE OF THE TERM "LENNOX", WITH THE TERM "NATIONAL ACCOUNT SERVICES" PLACED UNDERNEATH IT IN ITALICIZED TEXT.

SN 77-713,436. CAPSTONE TRADE PARTNERS, LTD., NEW YORK, NY. FILED 4-14-2009.

CLASS 36—INSURANCE AND FINANCIAL

FOR PROVIDING EXTENDED SERVICE WARRANTIES ON PLUMBING, ELECTRICAL, AIR CONDITIONING, HEATING, REFRIGERATION, AND VENTILATION APPARATUSES AND SERVICES (U.S. CLS. 100, 101 AND 102).

CLASS 37—CONSTRUCTION AND REPAIR

FOR PLUMBING SERVICES; ELECTRICAL CONTRACTING; INSTALLATION, REPAIR AND MAINTENANCE OF AIR CONDITIONING APPARATUSES, HEATING APPARATUSES, REFRIGERATION APPARATUSES, VENTILATING APPARATUSES, ELECTRICAL APPARATUSES AND AIR CONDITIONING APPARATUSES; GENERAL CONTRACTING SERVICES FOR CONSTRUCTION AND BUILDING RENOVATION; INSTALLATION, MAINTENANCE AND REPAIR OF AUTOMATION SYSTEMS, NAMELY, HEATING, AIR CONDITIONING, VENTILATING, ELECTRICAL, AND REFRIGERATION (U.S. CLS. 100, 103 AND 106).

ALEXANDER L. POWERS, EXAMINING ATTORNEY

CATCH THE DRIFT

THE MARK CONSISTS OF STANDARD CHARACTERS WITHOUT CLAIM TO ANY PARTICULAR FONT, STYLE, SIZE, OR COLOR.

SN 77-714,667. NORTHERN TOOL & EQUIPMENT COMPANY, INC., BURNSVILLE, MN. FILED 4-15-2009.

CLASS 9—ELECTRICAL AND SCIENTIFIC APPARATUS

FOR EYEGGLASS FRAMES (U.S. CLS. 21, 23, 26, 36 AND 38).

ULTRATOW

THE MARK CONSISTS OF STANDARD CHARACTERS WITHOUT CLAIM TO ANY PARTICULAR FONT, STYLE, SIZE, OR COLOR.

CLASS 18—LEATHER GOODS

FOR HANDBAGS, TRAVEL BAGS (U.S. CLS. 1, 2, 3, 22 AND 41).

CLASS 6—METAL GOODS

FOR TRAILER U-BOLTS MADE OF METAL; METAL LOCKS FOR USE ON TRAILER HITCHES AND TRAILER WHEELS; METAL CHAINS; WHEEL CHOCKS MADE PRIMARILY OF METAL; METAL TIE DOWNS (U.S. CLS. 2, 12, 13, 14, 23, 25 AND 50).

CLASS 25—CLOTHING

FOR MEN'S, WOMEN'S AND CHILDREN'S WEARING APPAREL AND CLOTHING, NAMELY, T-SHIRTS, DRESS AND CASUAL SHIRTS, TANK TOPS, SWEATERS, SWEATSHIRTS, SHORTS, PANTS, JEANS, DRESSES, SKIRTS, JACKETS, JOGGING SUITS, VESTS, RAINWEAR, SLEEPWEAR, HATS AND BELTS (U.S. CLS. 22 AND 39).

WANDA KAY PRICE, EXAMINING ATTORNEY

CLASS 7—MACHINERY

FOR TRAILER MOUNTED HYDRAULIC JACKS (U.S. CLS. 13, 19, 21, 23, 31, 34 AND 35).

CLASS 8—HAND TOOLS

FOR HAND-OPERATED WINCHES FOR TRAILERS; TRAILER MOUNTED NON-HYDRAULIC JACKS; RATCHET HANDLES (U.S. CLS. 23, 28 AND 44).

CLASS 9—ELECTRICAL AND SCIENTIFIC APPARATUS

FOR VEHICLE SAFETY EQUIPMENT, NAMELY, CAMERAS FOR USE IN TRAILER ALIGNMENT (U.S. CLS. 21, 23, 26, 36 AND 38).

CLASS 11—ENVIRONMENTAL CONTROL APPARATUS

FOR LIGHTS FOR VEHICLE TRAILERS; TOWING LIGHTS FOR VEHICLE TRAILERS (U.S. CLS. 13, 21, 23, 31 AND 34).

CLASS 12—VEHICLES

FOR TRAILERS; TRAILER DOLLIES; CARGO CARRIERS FOR VEHICLES; BICYCLE RACKS FOR VEHICLES; MOTORCYCLE CARRIERS FOR VEHICLES; MOTORCYCLE DOLLIES; TRUCK EXTENSION ATTACHMENT, NAMELY, VEHICLE TOW BARS; TRAILER FENDERS; METAL LOCKING DEVICES FOR TRAILER HITCH COUPLER; METAL LOCKING DEVICE FOR TRAILER HITCH; TRAILER SHACKLE KITS COMPRISED OF METAL BOLTS AND BRACKETS FOR MOUNTING TRAILER SPRINGS; BALL MOUNTS; SUSPENSION SPRINGS FOR VEHICLE TRAILERS; WHEEL HUBS FOR VEHICLE TRAILERS; TRAILER BRAKES; TRAILER BRAKE ACTUATORS; WHEEL BEARING PROTECTORS FOR VEHICLE TRAILERS; TRAILER AXLES; LAND VEHICLE TRAILER PARTS IN THE NATURE OF WIRE HARNESES, NAMELY, WIRES, TERMINALS AND CONNECTORS BUNDLED TOGETHER TO TRANSMIT ELECTRIC POWER AND SIGNALS TO ELECTRIC OR ELECTRONIC EQUIPMENT MOUNTED ON THE BODY PARTS OF VEHICLE TRAILERS; TRAILER RECEIVER HITCHES; TRAILER BALL MOUNTS; ADJUSTABLE TRAILER BALL MOUNTS; MULTI-BALL TRAILER BALL MOUNTS; TRAILER BALL-MOUNT KITS COMPRISING BALL MOUNTS, BALLS, AND HITCH PINS; LAND VEHICLE TRAILER SUSPENSION PARTS, NAMELY, TORSION/SWAY BARS; TRAILER WEIGHT DISTRIBUTION HITCHES; MUD FLAPS FOR VEHICLE TRAILERS; MUD FLAPS FOR VEHICLES PULLING TRAILERS; SPARE TIRE CARRIERS FOR TRAILERS; EQUIPMENT TRAILERS FOR COOLER, LAWN TRIMMERS, GAS CANS, LEAF BLOWERS, AND LONG-HANDLED GARDEN TOOLS (U.S. CLS. 19, 21, 23, 31, 35 AND 44).

CLASS 17—RUBBER GOODS

FOR RUBBER WHEEL CHOCKS (U.S. CLS. 1, 5, 12, 13, 35 AND 50).

CLASS 20—FURNITURE AND ARTICLES NOT OTHERWISE CLASSIFIED

FOR PLASTIC WHEEL CHOCKS (U.S. CLS. 2, 13, 22, 25, 32 AND 50).

CLASS 22—CORDAGE AND FIBERS

FOR TOWING STRAPS; TIE DOWN STRAPS; NON-METAL STRAPPING OR TIE DOWNS (U.S. CLS. 1, 2, 7, 19, 22, 42 AND 50).

CLASS 27—FLOOR COVERINGS

FOR CARPETS FOR USE ON BOAT TRAILERS (U.S. CLS. 19, 20, 37, 42 AND 50).
ALEXANDER L. POWERS, EXAMINING ATTORNEY

SN 77-716,151. WILLIAMS, REON, BROOKLYN, NY. FILED 4-17-2009.



NO CLAIM IS MADE TO THE EXCLUSIVE RIGHT TO USE ".COM", APART FROM THE MARK AS SHOWN.

THE MARK CONSISTS OF THE TERM "PROVIDE1" UNDERLINED WITH A RECTANGLE WITH THE BOTTOM OF THE NUMBER "1" EXTENDING INSIDE THE RECTANGLE, AND THE TERM ".COM" WRITTEN VERTICALLY TO THE RIGHT OF THE NUMBER "1" AND OUTSIDE OF THE RECTANGLE.

CLASS 35—ADVERTISING AND BUSINESS

FOR PROVIDING ON-LINE COMPUTER DATABASES AND ON-LINE SEARCHABLE DATABASES CONTAINING BULLETINS FEATURING EMPLOYMENT ANNOUNCEMENTS; BUSINESS SERVICES, NAMELY, PROVIDING AN ONLINE COMPUTER DATABASE FEATURING BULLETINS REGARDING THE PURCHASE AND SALE OF ADULT-THEMED PRODUCTS OF OTHERS; PROVIDING A WEBSITE WHERE USERS CAN POST RATINGS, REVIEWS, AND RECOMMENDATIONS ON PRODUCTS AND SERVICES (U.S. CLS. 100, 101 AND 102).

CLASS 42—SCIENTIFIC AND COMPUTER SERVICES

FOR PROVISION OF SEARCH ENGINES FOR THE INTERNET FOR OBTAINING DATA IN THE FIELD OF ADULT-THEMED ENTERTAINMENT PRODUCTS AND SERVICES (U.S. CLS. 100 AND 101).

TARA PATE, EXAMINING ATTORNEY

SN 77-716,346. ALIBABA GROUP HOLDING LIMITED, GRAND CAYMAN, CAYMAN ISLANDS, FILED 4-17-2009.

NEWPRENEUR

THE MARK CONSISTS OF STANDARD CHARACTERS WITHOUT CLAIM TO ANY PARTICULAR FONT, STYLE, SIZE, OR COLOR.

CLASS 9—ELECTRICAL AND SCIENTIFIC APPARATUS

FOR APPARATUS FOR RECORDING, TRANSMISSION OR REPRODUCTION OF SOUND OR IMAGES; BLANK MAGNETIC DATA CARRIERS, BLANK RECORDING DISCS; AUTOMATIC VENDING MACHINES AND MECHANISMS FOR COIN-OPERATED APPARATUS; CASH REGISTERS, CALCULATING MACHINES, DATA PROCESSING EQUIPMENT AND COMPUTERS; COMPUTERS; COMPUTER PROGRAMS FOR BUSINESS USE, NAMELY, FINANCIAL MANAGEMENT PROGRAMS, FINANCIAL PLANNING PROGRAMS AND E-COMMERCE PROGRAMS TO ALLOW USERS TO PERFORM BUSINESS TRANSACTIONS VIA A GLOBAL COMPUTER NETWORK; COMPUTER SOFTWARE FOR BUSINESS USE, NAMELY, FINANCIAL MANAGEMENT SOFTWARE, FINANCIAL PLANNING SOFTWARE AND E-COMMERCE SOFTWARE TO ALLOW USERS TO PERFORM ELECTRONIC BUSINESS TRANSACTIONS VIA A GLOBAL COMPUTER NETWORK; COMPUTER PERIPHERAL DEVICES; BLANK OPTICAL DISCS; ELECTRONIC POCKET TRANSLATORS; TELEPHONE APPARATUS; PUNCH CLOCKS; TIME RECORDING DEVICES, NAMELY, TIME CLOCKS; FACSIMILE MACHINES; WEIGHING APPARATUS AND INSTRUMENTS, NAMELY, SCALES AND BALANCES; SCALED GRADUATED RULERS; SOUND RECORDING APPARATUS, NAMELY, BLANK SOUND RECORDING STRIPS; NEON SIGNS; ELECTRONIC NOTICE BOARDS; TRANSPARENCY PROJECTION APPARATUS; KILOMETER RECORDERS FOR VEHICLES; TELESCOPES; ELECTRIC WIRES; ELECTRIC SWITCHES; MECHANISMS FOR COUNTER-OPERATED APPARATUS, NAMELY, POINT-OF-SALE TERMINALS; BATTERIES; COMPUTER HARDWARE AND FIRMWARE FOR USE IN THE FIELD OF BUSINESS FOR FINANCIAL MANAGEMENT AND FINANCIAL PLANNING; COMPUTER SOFTWARE DOWNLOADABLE FROM THE INTERNET FOR USE IN THE FIELD OF BUSINESS, NAMELY, FINANCIAL MANAGEMENT SOFTWARE, FINANCIAL PLANNING SOFTWARE, AND E-COMMERCE SOFTWARE TO ALLOW USERS TO PERFORM ELECTRONIC BUSINESS TRANSACTIONS VIA A GLOBAL COMPUTER NETWORK; COMPACT DISCS FEATURING COMPUTER PROGRAMS AND COMPUTER SOFTWARE FOR BUSINESS, NAMELY, FINANCIAL MANAGEMENT SOFTWARE, FINANCIAL PLANNING SOFTWARE, AND E-COMMERCE SOFTWARE TO ALLOW USERS TO PERFORM ELECTRONIC BUSINESS TRANSACTIONS VIA A GLOBAL COMPUTER NETWORK; DIGITAL MUSIC DOWNLOADABLE FROM THE INTERNET; TELECOMMUNICATIONS APPARATUS, NAMELY, NETWORK TELEPHONE, ELECTRONIC FACSIMILE, PORTABLE DEVICE FOR SENDING AND RECEIVING ELECTRONIC MAILS, AND INSTANT MESSAGING COMMUNICATION TOOL IN THE NATURE OF PORTABLE TELECOMMUNICATION INSTANT MESSAGING DEVICES (U.S. CLS. 21, 23, 26, 36 AND 38).

CLASS 16—PAPER GOODS AND PRINTED MATTER

FOR PAPER, CARDBOARD AND GOODS MADE FROM THESE MATERIALS, NOT INCLUDED IN OTHER CLASSES, NAMELY, COMPUTER PAPER AND CARDBOARD BOXES; PRINTED MATTER, NAMELY, PRINTED CALENDARS, PRINTED CHARTS, AND BOOKS IN THE FIELD OF ENTREPRENEURSHIP AND E-COMMERCE; BOOKBINDING MATERIAL; PHOTOGRAPHS; STATIONERY; ADHESIVES FOR STATIONERY OR HOUSEHOLD PURPOSES; ARTISTS' MATERIALS, NAMELY, EASELS, ARTISTS' BRUSHES, PASTELS, PENCILS AND PENS; PAINT BRUSHES; TYPEWRITERS AND OFFICE REQUISITES EXCLUDING FURNITURE, NAMELY, STAPLERS; PRINTED INSTRUCTIONAL AND TEACHING MATERIAL, EXCLUDING APPARATUS, IN THE FIELD OF ENTREPRENEURSHIP AND E-COMMERCE; PLASTIC MATERIALS FOR PACKAGING NOT INCLUDED IN OTHER CLASSES, NAMELY, PLASTIC BAGS FOR PACKING AND PLASTIC BUBBLE PACKS FOR PACKAGING; PRINTERS' TYPE; PRINTING BLOCKS (U.S. CLS. 2, 5, 22, 23, 29, 37, 38 AND 50).

CLASS 35—ADVERTISING AND BUSINESS

FOR ADVERTISING; BUSINESS MANAGEMENT; BUSINESS ADMINISTRATION; PROVIDING OFFICE FUNCTIONS (U.S. CLS. 100, 101 AND 102).

CLASS 38—COMMUNICATION

FOR TELECOMMUNICATION SERVICES, NAMELY, PROVISION OF NETWORK TELEPHONE, ELECTRONIC FACSIMILE, ELECTRONIC MAILS, INSTANT MESSAGING COMMUNICATION SERVICES; MESSAGE SENDING; CELLULAR TELEPHONE COMMUNICATION; COMPUTER AIDED TRANSMISSION OF MESSAGES AND IMAGES; ELECTRONIC MAIL SERVICES; ELECTRONIC BULLETIN BOARD SERVICES, NAMELY, PROVIDING ONLINE ELECTRONIC BULLETIN BOARDS FOR TRANSMISSION OF MESSAGES AMONG USERS IN THE FIELD OF GENERAL INTEREST; PROVIDING TELECOMMUNICATIONS CONNECTIONS TO A GLOBAL COMPUTER NETWORK; TELECONFERENCING SERVICES; PROVIDING USER ACCESS TO A GLOBAL COMPUTER NETWORK; PROVIDING INFORMATION ABOUT TELECOMMUNICATIONS (U.S. CLS. 100, 101 AND 104).

CLASS 42—SCIENTIFIC AND COMPUTER SERVICES

FOR SCIENTIFIC AND TECHNOLOGICAL SERVICES, NAMELY, PROVIDING ONLINE NON-DOWNLOADABLE SOFTWARE FOR PLANNING AND MANAGEMENT OF PERSONAL AND BUSINESS FINANCES AND E-COMMERCE SOFTWARE TO ALLOW USERS TO PERFORM ELECTRONIC BUSINESS TRANSACTIONS VIA A GLOBAL COMPUTER NETWORK; SCIENTIFIC AND TECHNOLOGICAL SERVICES, NAMELY, SOFTWARE DESIGN AND DEVELOPMENT FOR OTHERS, AND DESIGNING, IMPLEMENTING, MAINTAINING AND HOSTING WEB SITES FOR OTHERS; INDUSTRIAL ANALYSIS AND RESEARCH SERVICES IN THE FIELD OF E-COMMERCE (U.S. CLS. 100 AND 101).

AARON BRODSKY, EXAMINING ATTORNEY

SN 77-717,573. MODULAR SPACE CORPORATION, BERYN, PA. FILED 4-20-2009.

MODSAFE

THE MARK CONSISTS OF STANDARD CHARACTERS WITHOUT CLAIM TO ANY PARTICULAR FONT, STYLE, SIZE, OR COLOR.

OWNER OF U.S. REG. NOS. 1,123,065, 3,133,642 AND 3,151,456.

CLASS 39—TRANSPORTATION AND STORAGE

FOR PROVIDING SELF-STORAGE FACILITIES FOR OTHERS (U.S. CLS. 100 AND 105).

CLASS 43—HOTEL AND RESTAURANT SERVICES

FOR LEASING OF PORTABLE METAL AND PORTABLE NON-METAL BUILDINGS (U.S. CLS. 100 AND 101).

TIMOTHY FINNEGAN, EXAMINING ATTORNEY

SN 77-718,474. MINISTRY HEALTH CARE, INC., MILWAUKEE, WI. FILED 4-21-2009.

SN 77-722,593. KAGI MEDIA LLC, DBA KAGI MEDIA, LYNCHBURG, TN. FILED 4-26-2009.

MinistryConnect

THE MARK CONSISTS OF STANDARD CHARACTERS WITHOUT CLAIM TO ANY PARTICULAR FONT, STYLE, SIZE, OR COLOR.

OWNER OF U.S. REG. NO. 2,190,072.

CLASS 35—ADVERTISING AND BUSINESS

FOR HOSPITAL ADMINISTRATION SERVICES, NAMELY, FACILITATING AND ADVISING REGARDING PATIENT REFERRALS AND FACILITATING AND ADVISING REGARDING HOSPITAL OPERATIONS MANAGEMENT PROCEDURES AND LOGISTICS OF TRANSFERRING PATIENTS (U.S. CLS. 100, 101 AND 102).

FIRST USE 3-15-2008; IN COMMERCE 3-15-2008.

CLASS 44—MEDICAL, BEAUTY AND AGRICULTURAL SERVICES

FOR CONSULTING SERVICES IN THE FIELD OF HEALTH CARE, NAMELY, PROVIDING MEDICAL CONSULTATION REGARDING THE TRANSFER AND ADMISSION OF PATIENTS TO HOSPITALS FROM REFERRING PROVIDERS (U.S. CLS. 100 AND 101).

FIRST USE 3-15-2008; IN COMMERCE 3-15-2008.
MICHELLE DUBOIS, EXAMINING ATTORNEY

SN 77-721,707. BLUE HORSE ASSOCIATES, NEUILLY-SUR-SEINE, FRANCE, FILED 4-24-2009.

CARBONOSTICS

THE MARK CONSISTS OF STANDARD CHARACTERS WITHOUT CLAIM TO ANY PARTICULAR FONT, STYLE, SIZE, OR COLOR.

CLASS 35—ADVERTISING AND BUSINESS

FOR BUSINESS CONSULTING SERVICES FOR THE ENVIRONMENTAL ANALYSIS INDUSTRY, SOCIAL ANALYSIS INDUSTRY, AND SUSTAINABILITY ANALYSIS INDUSTRY; COMPUTERIZED ON-LINE ANALYSIS OF BUSINESS OPERATIONS, NAMELY, LIFECYCLE ANALYSES OF FINISHED CONSUMER PRODUCTS (U.S. CLS. 100, 101 AND 102).

FIRST USE 3-26-2009; IN COMMERCE 3-26-2009.

CLASS 42—SCIENTIFIC AND COMPUTER SERVICES

FOR PROVIDING TEMPORARY USE OF ON-LINE NON-DOWNLOADABLE SOFTWARE FOR USE IN ANALYZING ENVIRONMENTAL, SOCIAL, FINANCIAL, AND SUSTAINABILITY FACTORS IN BUSINESS DECISIONS (U.S. CLS. 100 AND 101).

FIRST USE 3-26-2009; IN COMMERCE 3-26-2009.
MAYUR VAGHANI, EXAMINING ATTORNEY

Mix It Like A Record

THE MARK CONSISTS OF STANDARD CHARACTERS WITHOUT CLAIM TO ANY PARTICULAR FONT, STYLE, SIZE, OR COLOR.

CLASS 9—ELECTRICAL AND SCIENTIFIC APPARATUS

FOR DIGITAL MEDIA, NAMELY, PRE-RECORDED VIDEO CASSETTES, DIGITAL VIDEO DISCS, DIGITAL VERSATILE DISCS, DOWNLOADABLE AUDIO AND VIDEO RECORDINGS, DVDS, AND HIGH DEFINITION DIGITAL DISCS FEATURING AUDIO PRODUCTION, PRODUCING, ENGINEERING, MIXING, REMIXING, MASTERING, MUSIC BUSINESS AND RECORDING INDUSTRY INFORMATION PRESENTED BY INDUSTRY EXPERTS; DIGITAL MEDIA, NAMELY, AUDIO AND VIDEO RECORDINGS, DOWNLOADABLE AUDIO AND VIDEO RECORDINGS, DVDS AND DVD-ROM FEATURING AUDIO PRODUCTION, PRODUCING, ENGINEERING, MIXING, REMIXING, MASTERING, MUSIC BUSINESS AND RECORDING INDUSTRY INFORMATION PRESENTED BY NOTED AND FEATURED PROFESSIONALS; EDUCATIONAL SOFTWARE FEATURING INSTRUCTION IN AUDIO PRODUCTION, PRODUCING, ENGINEERING, MIXING, REMIXING, MASTERING, MUSIC BUSINESS AND RECORDING INDUSTRY; DOWNLOADABLE MULTIMEDIA FILE CONTAINING ARTWORK, TEXT, AUDIO, VIDEO, GAMES, AND INTERNET WEB LINKS RELATING TO PROFESSIONAL AUDIO PRODUCTION EDUCATION (U.S. CLS. 21, 23, 26, 36 AND 38).

FIRST USE 1-1-2004; IN COMMERCE 11-15-2004.

CLASS 41—EDUCATION AND ENTERTAINMENT

FOR PROVIDING ON-LINE TRAINING COURSES IN THE FIELD OF PROFESSIONAL AUDIO PRODUCTION AND DISTRIBUTING COURSE MATERIALS IN CONNECTION THEREWITH (U.S. CLS. 100, 101 AND 107).

FIRST USE 1-1-2004; IN COMMERCE 11-15-2004.
ALYSSA STEEL, EXAMINING ATTORNEY

SN 77-723,427. KINCH L.L.C., PHOENIX, AZ. FILED 4-27-2009.

KINCH

THE MARK CONSISTS OF STANDARD CHARACTERS WITHOUT CLAIM TO ANY PARTICULAR FONT, STYLE, SIZE, OR COLOR.

CLASS 9—ELECTRICAL AND SCIENTIFIC APPARATUS

FOR MUSICAL SOUND RECORDINGS (U.S. CLS. 21, 23, 26, 36 AND 38).

FIRST USE 8-1-2002; IN COMMERCE 11-15-2007.

CLASS 41—EDUCATION AND ENTERTAINMENT

FOR ENTERTAINMENT, NAMELY, LIVE PERFORMANCES BY A MUSICAL BAND (U.S. CLS. 100, 101 AND 107).

FIRST USE 4-23-2005; IN COMMERCE 8-15-2005.
CHARLES L. JENKINS, EXAMINING ATTORNEY

SN 77-725,418. M.J. CARLYLE AND COMPANY, CULVER CITY, CA. FILED 4-29-2009.



SN 77-724,107. JURLNNOV HOLDING LIMITED PARTNERSHIP, CLEVELAND, OH. FILED 4-28-2009.

ESIBYTES

THE MARK CONSISTS OF STANDARD CHARACTERS WITHOUT CLAIM TO ANY PARTICULAR FONT, STYLE, SIZE, OR COLOR.

CLASS 41—EDUCATION AND ENTERTAINMENT

FOR (BASED ON USE IN COMMERCE) PUBLICATION OF ELECTRONIC EDUCATIONAL MATERIALS, NAMELY, PROVIDING PODCASTS, ELECTRONIC DATA FILES, PRESENTATIONS, INTERVIEW TRANSCRIPTS AND PUBLICATIONS, NAMELY, ARTICLES, IN THE FIELD OF ELECTRONIC LEGAL DISCOVERY (BASED ON INTENT TO USE) PUBLICATION OF ELECTRONIC EDUCATIONAL MATERIALS, NAMELY, ARTICLES AND BLOGS IN THE FIELD OF ELECTRONIC LEGAL DISCOVERY (U.S. CLS. 100, 101 AND 107).

FIRST USE 3-0-2009; IN COMMERCE 3-0-2009.

CLASS 42—SCIENTIFIC AND COMPUTER SERVICES

FOR (BASED ON USE IN COMMERCE) PROVIDING TECHNICAL CONSULTING SERVICES IN THE FIELD OF ELECTRONIC LEGAL DISCOVERY; COMPUTER SERVICES, NAMELY, HOSTING AN INTERACTIVE WEB SITE THAT ALLOWS USERS TO READ, DOWNLOAD AND SCHEDULE THE USE OR REVIEW OF ELECTRONIC EDUCATIONAL MATERIALS IN THE FIELD OF ELECTRONIC LEGAL DISCOVERY; COMPUTER SERVICES, NAMELY, PROVIDING SEARCH ENGINES FOR OBTAINING ELECTRONIC EDUCATIONAL MATERIALS IN THE FIELD OF ELECTRONIC LEGAL DISCOVERY ON A GLOBAL COMPUTER NETWORK (BASED ON INTENT TO USE) COMPUTER SERVICES, NAMELY, HOSTING AN INTERACTIVE WEB SITE THAT ALLOWS USERS TO UPLOAD ELECTRONIC EDUCATIONAL MATERIALS IN THE FIELD OF ELECTRONIC LEGAL DISCOVERY (U.S. CLS. 100 AND 101).

FIRST USE 3-0-2009; IN COMMERCE 3-0-2009.
STEVEN JACKSON, EXAMINING ATTORNEY

NO CLAIM IS MADE TO THE EXCLUSIVE RIGHT TO USE "AUDIO", APART FROM THE MARK AS SHOWN.

THE MARK CONSISTS OF THE WORDS "LIFT AUDIO" BETWEEN THE DESIGN OF A PAIR OF HEADPHONES AND ARCS REPRESENTING SOUND WAVES, WITH THE WORDS "TAKING SOUND TO A HIGHER EXPERIENCE" APPEARING BELOW.

CLASS 9—ELECTRICAL AND SCIENTIFIC APPARATUS

FOR ELECTRONIC AND AUDIO EQUIPMENT, NAMELY, HEADPHONES, EARPHONES, HEADSETS FOR CELLULAR OR MOBILE PHONES, WIRELESS CELLULAR PHONE HEADSETS, AUDIO SPEAKERS, PORTABLE AUDIO SPEAKERS, WIRELESS SPEAKERS, ELECTRONIC DOCKING STATIONS, PORTABLE MUSIC PLAYER DOCKING STATIONS, MUSIC PLAYER CLOCK RADIOS, STANDS ADAPTED FOR MUSIC PLAYERS, POWER SUPPLY CONNECTORS AND ADAPTORS FOR USE WITH PORTABLE ELECTRONIC DEVICES AND PORTABLE MUSIC PLAYERS, CAR ADAPTORS FOR USE WITH PORTABLE ELECTRONIC DEVICES AND PORTABLE MUSIC PLAYERS, MUSIC PLAYER FM TRANSMITTER, MUSIC PLAYER POWER CHARGER; PROTECTIVE CARRYING CASES FOR PORTABLE MUSIC PLAYERS; PROTECTIVE CARRYING CASES FOR AUDIO EQUIPMENT, HEADPHONES, EARPHONES AND HEADSETS; MESSENGER BAGS AND WHEELED MESSENGER BAGS ESPECIALLY ADAPTED FOR HOLDING ELECTRONIC DEVICES; CD CASES (U.S. CLS. 21, 23, 26, 36 AND 38).

CLASS 18—LEATHER GOODS

FOR HANDBAGS; CARRYING CASES; ACCESSORIES, NAMELY, WAIST PACKS, TOTE BAGS, MESSENGER BAGS, BACKPACKS (U.S. CLS. 1, 2, 3, 22 AND 41).

CLASS 25—CLOTHING

FOR APPAREL, NAMELY, T-SHIRTS AND HEADWEAR (U.S. CLS. 22 AND 39).

KATHLEEN LORENZO, EXAMINING ATTORNEY

SN 77-725,720. COMPCO COMMUNICATIONS, INC., COLUMBIANA, OH. FILED 4-30-2009.

1080 Media

THE MARK CONSISTS OF STANDARD CHARACTERS WITHOUT CLAIM TO ANY PARTICULAR FONT, STYLE, SIZE, OR COLOR.

NO CLAIM IS MADE TO THE EXCLUSIVE RIGHT TO USE "MEDIA", APART FROM THE MARK AS SHOWN.

CLASS 35—ADVERTISING AND BUSINESS

FOR MARKETING SERVICES (U.S. CLS. 100, 101 AND 102).
FIRST USE 1-15-2009; IN COMMERCE 1-15-2009.

CLASS 41—EDUCATION AND ENTERTAINMENT

FOR PHOTOGRAPHY SERVICES (U.S. CLS. 100, 101 AND 107).
FIRST USE 1-15-2009; IN COMMERCE 1-15-2009.

CLASS 42—SCIENTIFIC AND COMPUTER SERVICES

FOR GRAPHIC DESIGN AND WEB SITE DEVELOPMENT FOR OTHERS (U.S. CLS. 100 AND 101).
FIRST USE 1-15-2009; IN COMMERCE 1-15-2009.
DAVID HOFFMAN, EXAMINING ATTORNEY

SN 77-726,120. MARY M. GOOLEY HEMOPHILIA CENTER, INC., ROCHESTER, NY. FILED 4-30-2009.



OWNER OF U.S. REG. NO. 2,607,283.
NO CLAIM IS MADE TO THE EXCLUSIVE RIGHT TO USE "HEMOPHILIA CENTER", APART FROM THE MARK AS SHOWN.
THE NAME "MARY M. GOOLEY" IDENTIFIES A LIVING INDIVIDUAL WHOSE CONSENT IS OF RECORD.
THE MARK CONSISTS OF THE WORDS "MARY M. GOOLEY HEMOPHILIA CENTER CARING IS IN OUR BLOOD" WITH A DROPLET DESIGN ENCOMPASSING THE WORD "CARING".

CLASS 44—MEDICAL, BEAUTY AND AGRICULTURAL SERVICES

FOR MEDICAL AND COUNSELING SERVICES IN THE FIELD OF INHERITED DISORDERS RELATED TO HEMATOLOGY (U.S. CLS. 100 AND 101).
FIRST USE 4-21-2009; IN COMMERCE 4-21-2009.

CLASS 45—PERSONAL AND LEGAL SERVICES

FOR PATIENT ADVOCACY SERVICES, NAMELY, PROVIDING PATIENT ADVOCATE SERVICES TO HOSPITAL PATIENTS AND PATIENTS IN LONG TERM CARE FACILITIES; PROVIDING PATIENT ADVOCATE SERVICES TO PEOPLE WITH LIMB-LOSS; PROVIDING PATIENT ADVOCATE AND CASE MANAGEMENT SERVICES, NAMELY, COORDINATING THE PROCUREMENT AND ADMINISTRATION OF MEDICATION (U.S. CLS. 100 AND 101).
FIRST USE 4-21-2009; IN COMMERCE 4-21-2009.
NAAKWAMA ANKRAH, EXAMINING ATTORNEY

SN 77-727,137. JAMIE DAMATO, DBA ANIMALSENSE CANINE TRAINING AND BEHAVIOR, CHICAGO, IL. FILED 5-1-2009.

ANIMALSENSE

THE MARK CONSISTS OF STANDARD CHARACTERS WITHOUT CLAIM TO ANY PARTICULAR FONT, STYLE, SIZE, OR COLOR.

CLASS 16—PAPER GOODS AND PRINTED MATTER

FOR PRINTED MATTER ON THE SUBJECTS OF PET TRAINING AND BEHAVIOR, NAMELY, PAMPHLETS AND HANDOUTS; PRINTED INSTRUCTIONAL, EDUCATIONAL AND TEACHING MATERIAL ON THE SUBJECTS OF PET TRAINING AND BEHAVIOR (U.S. CLS. 2, 5, 22, 23, 29, 37, 38 AND 50).
FIRST USE 1-31-2000; IN COMMERCE 1-31-2000.

CLASS 41—EDUCATION AND ENTERTAINMENT

FOR EDUCATIONAL SERVICES, NAMELY, PROVIDING ONE-ON-ONE INSTRUCTION, LIVE CLASSES, WORKSHOPS, SEMINARS AND PROGRAMS IN THE FIELDS OF LIVING WITH DOGS, DOG CARE, DOG OBEDIENCE AND DOG TRAINING, AND DISTRIBUTION OF COURSE MATERIALS IN CONNECTION THEREWITH; PROVIDING LIVE PERSONAL COACHING SERVICES IN THE FIELDS OF LIVING WITH DOGS, DOG CARE, DOG OBEDIENCE AND DOG TRAINING; EDUCATIONAL AND ENTERTAINMENT SERVICES, NAMELY, PROVIDING MOTIVATIONAL AND EDUCATIONAL SPEAKERS IN THE FIELDS OF LIVING WITH DOGS, DOG CARE, DOG OBEDIENCE AND DOG TRAINING; PROVIDING ON-LINE NEWSLETTERS ON THE SUBJECTS OF LIVING WITH DOGS, DOG CARE, DOG OBEDIENCE AND DOG TRAINING; EDUCATIONAL SERVICES, NAMELY, CONDUCTING A TRAINING ACADEMY IN THE FIELD OF PROFESSIONAL PET TRAINING, AND DEVELOPMENT OF A CURRICULUM AND DISTRIBUTION OF COURSE MATERIALS IN CONNECTION THEREWITH (U.S. CLS. 100, 101 AND 107).
FIRST USE 1-31-2000; IN COMMERCE 1-31-2000.
PAULA MAHONEY, EXAMINING ATTORNEY

SN 77-728,788. STELOR PRODUCTIONS, DARNESTOWN, MD. FILED 5-4-2009.

GOOKIDS

THE MARK CONSISTS OF STANDARD CHARACTERS WITHOUT CLAIM TO ANY PARTICULAR FONT, STYLE, SIZE, OR COLOR.

CLASS 16—PAPER GOODS AND PRINTED MATTER

FOR PAPER, CARDBOARD AND GOODS MADE FOR THESE MATERIALS, NAMELY, PRINTED MATTER IN THE NATURE OF BOOKS, AND MAGAZINES IN THE FIELD OF COMICS; PICTURE CARDS; STATIONERY; ARTISTS' MATERIALS, NAMELY, PENS, PENCILS, PASTELS, PALLETES, PAINT BRUSHES; OFFICE SUPPLIES, NAMELY, BINDERS; STICKERS; PRINTED INSTRUCTIONAL AND TEACHING MATERIAL IN THE FIELDS OF MATH, GEOGRAPHY, SPELLING, READING, HISTORY, HEALTH, AND ENTERTAINMENT; GEOGRAPHICAL MAPS, DRAWING BOARDS; CHILDREN'S AND ADOLESCENTS' MAGAZINES, BOOKS, AND PAMPHLETS IN THE FIELDS OF EDUCATION, MUSIC, AND ENTERTAINMENT (U.S. CLS. 2, 5, 22, 23, 29, 37, 38 AND 50).

CLASS 28—TOYS AND SPORTING GOODS

FOR PLAYING CARDS (U.S. CLS. 22, 23, 38 AND 50).
SALLY SHIH, EXAMINING ATTORNEY

SN 77-728,798. STELOR PRODUCTIONS, DARNESTOWN, MD. FILED 5-4-2009.

GOOBOP

THE MARK CONSISTS OF STANDARD CHARACTERS WITHOUT CLAIM TO ANY PARTICULAR FONT, STYLE, SIZE, OR COLOR.

CLASS 16—PAPER GOODS AND PRINTED MATTER

FOR PAPER, CARDBOARD AND GOODS MADE FOR THESE MATERIALS, NAMELY, PRINTED MATTER IN THE NATURE OF BOOKS, AND MAGAZINES IN THE FIELD OF COMICS; PICTURE CARDS; STATIONERY; ARTISTS' MATERIALS, NAMELY, PENS, PENCILS, PASTELS, PALLETES, PAINT BRUSHES; OFFICE SUPPLIES, NAMELY, BINDERS; STICKERS; PRINTED INSTRUCTIONAL AND TEACHING MATERIAL IN THE FIELDS OF MATH, GEOGRAPHY, SPELLING, READING, HISTORY, HEALTH, AND ENTERTAINMENT; GEOGRAPHICAL MAPS, DRAWING BOARDS; CHILDREN'S AND ADOLESCENTS' MAGAZINES, BOOKS, AND PAMPHLETS IN THE FIELDS OF EDUCATION, MUSIC, AND ENTERTAINMENT; INFORMATIONAL SHEETS ABOUT MATH, GEOGRAPHY, SPELLING, READING, HISTORY, HEALTH, AND ENTERTAINMENT; JAPANESE CEREMONIAL PAPER STRINGS (MIZUHIKI); JAPANESE HANDICRAFT PAPER; JAPANESE PAPER; JAPANESE PAPER (TORINOKO-GAMI); KRAFT PAPER; LABEL PAPER; LAMINATED PAPER; LAMINATED PAPERS TO BE AFFIXED TO THE SURFACE OF FURNITURE; LASER PRINT PAPER; LASER PRINTING PAPER; LEAFLETS ABOUT MATH, GEOGRAPHY, SPELLING, READING, HISTORY, HEALTH, AND ENTERTAINMENT (U.S. CLS. 2, 5, 22, 23, 29, 37, 38 AND 50).

CLASS 28—TOYS AND SPORTING GOODS

FOR PLAYING CARDS (U.S. CLS. 22, 23, 38 AND 50).
SALLY SHIH, EXAMINING ATTORNEY

SN 77-730,513. AUDITUDE, INC., PALO ALTO, CA. FILED 5-6-2009.

AUDITUDE

THE MARK CONSISTS OF STANDARD CHARACTERS WITHOUT CLAIM TO ANY PARTICULAR FONT, STYLE, SIZE, OR COLOR.

CLASS 35—ADVERTISING AND BUSINESS

FOR ADVERTISING SERVICES, ADVERTISING THE PRODUCTS AND SERVICES OF OTHERS VIA A WEB SITE ON THE INTERNET; PROVIDING ADVERTISING SERVICES THAT ENABLE THIRD PARTIES TO IMPROVE AD TARGETING, SIMPLIFY MULTI-PARTY AD SALES, PROVIDE REAL-TIME REPORTING AND MONITOR AND OPTIMIZE THE PERFORMANCE OF AD CAMPAIGNS; ELECTRONIC PUBLISHING SERVICES, NAMELY, PUBLICATION OF ADVERTISING AUDIO AND VIDEO CONTENT OF OTHERS ON-LINE AND PUBLICATION OF AUDIO AND VIDEO CONTENT OF OTHERS ON-LINE IN THE FIELD OF ADVERTISING AND PROMOTION, WHETHER DISTRIBUTED BY CREATORS OR USERS (U.S. CLS. 100, 101 AND 102).

CLASS 42—SCIENTIFIC AND COMPUTER SERVICES

FOR PROVIDING ON-LINE NON-DOWNLOADABLE COMPUTER SOFTWARE PLATFORM THAT ENABLES THIRD PARTIES TO IMPROVE AD TARGETING, SIMPLIFY MULTI-PARTY AD SALES, PROVIDE REAL-TIME REPORTING, AND MONITOR AND OPTIMIZE THE PERFORMANCE OF AD CAMPAIGNS; PROVIDING ON-LINE NON-DOWNLOADABLE COMPUTER SOFTWARE FOR PROVIDING VIDEO CONTENT RECOGNITION BY MATCHING THE CHARACTERISTIC SIGNATURES OF THE MASTER MEDIA AGAINST THOSE OF USER-UPLOADED OR OTHERWISE UNIDENTIFIED CONTENT (U.S. CLS. 100 AND 101).

JEAN IM, EXAMINING ATTORNEY

SN 77-732,216. VIVOLAC CULTURES CORPORATION, INDIANAPOLIS, IN. FILED 5-8-2009.

IMMUNOFLORA

THE MARK CONSISTS OF STANDARD CHARACTERS WITHOUT CLAIM TO ANY PARTICULAR FONT, STYLE, SIZE, OR COLOR.

CLASS 1—CHEMICALS

FOR BACTERIAL COMPOSITIONS WITH PROBIOTIC OR IMMUNE STIMULATING PROPERTIES, OR BOTH, FOR USE IN THE FOOD INDUSTRY; BACTERIAL DIGEST COMPONENTS, CRUDE AND PURIFIED, FOR USE IN THE FOOD INDUSTRY; ENZYMES DERIVED FROM BACTERIA, WITH PROBIOTIC AND IMMUNE STIMULATING PROPERTIES, FOR USE IN THE FOOD INDUSTRY; AND BACTERIA AND BACTERIAL COMPOSITIONS FOR USE AS ACTIVE INGREDIENTS IN DIETARY SUPPLEMENTS (U.S. CLS. 1, 5, 6, 10, 26 AND 46).

CLASS 5—PHARMACEUTICALS

FOR BACTERIAL COMPOSITIONS WITH PROBIOTIC OR IMMUNE STIMULATING PROPERTIES OR BOTH; BACTERIAL DIGEST COMPONENTS, CRUDE AND PURIFIED FOR HUMAN CONSUMPTION; AND ENZYMES DERIVED FROM BACTERIA, WITH PROBIOTIC AND IMMUNE STIMULATING PROPERTIES, FOR HUMAN CONSUMPTION (U.S. CLS. 6, 18, 44, 46, 51 AND 52).

DAVID C. REIHNER, EXAMINING ATTORNEY

SN 77-735,838. UNITED TOLL SYSTEMS, LLC, EMERALD MOUNTAIN, AL. FILED 5-13-2009.

TekTrak

THE MARK CONSISTS OF STANDARD CHARACTERS WITHOUT CLAIM TO ANY PARTICULAR FONT, STYLE, SIZE, OR COLOR.

SN 77-732,910. VARSITY SPIRIT CORPORATION, MEMPHIS, TN. FILED 5-8-2009.



OWNER OF U.S. REG. NOS. 1,752,630 AND 2,357,303.
THE MARK CONSISTS OF STYLIZED LETTER "V".

CLASS 9—ELECTRICAL AND SCIENTIFIC APPARATUS

FOR VIDEO GAME SOFTWARE; MEGAPHONES (U.S. CLS. 21, 23, 26, 36 AND 38).

CLASS 28—TOYS AND SPORTING GOODS

FOR TOYS, NAMELY, MODELED PLASTIC TOY FIGURINES, ELECTRONIC LEARNING TOYS AND ACTION FIGURES; GAMES, NAMELY, EDUCATIONAL CARD GAMES, BOARD GAMES, STAND ALONE VIDEO GAME MACHINES AND PUZZLES; DOLLS, STUFFED TOY ANIMALS AND PLAYTHINGS, NAMELY, CHEERLEADING POM-POMS, BALLS FOR GAMES (U.S. CLS. 22, 23, 38 AND 50).

CLASS 38—COMMUNICATION

FOR PROVIDING ELECTRONIC BULLETIN BOARDS FOR TRANSMISSION OF MESSAGES AMONG USERS IN THE FIELD OF CHEERLEADING AND DANCE, CHEERLEADING AND DANCE COMPETITIONS, PHOTOGRAPHS AND FASHION (U.S. CLS. 100, 101 AND 104).

CLASS 41—EDUCATION AND ENTERTAINMENT

FOR ENTERTAINMENT SERVICES, NAMELY, LIVE MUSICAL PERFORMANCES, PROVIDING A WEB SITE FEATURING AUDIO AND VIDEO PRESENTATIONS FEATURING CHEERLEADING AND DANCE, CHEERLEADING AND DANCE COMPETITIONS, PHOTOGRAPHS AND FASHION (U.S. CLS. 100, 101 AND 107).
CHRISTINA SOBRAL, EXAMINING ATTORNEY

CLASS 6—METAL GOODS

FOR RETRACTABLE GANTRY SYSTEM COMPRISED PRIMARILY OF PARALLEL CHANNEL METAL TRACKS HOUSING PRECONNECTED WIRING THAT ALLOWS A MAINTENANCE CREW TO WORK FROM BEHIND THE ROADWAY GUARD RAIL TO INSTALL AND MAINTAIN OVERHEAD OPEN ROAD TOLLING EQUIPMENT IN THE GANTRY OVER MULTIPLE TRAVEL LANES WITHOUT CREATING A SAFETY HAZARD AND WITHOUT THE NEED FOR ROADWAY CLOSURES (U.S. CLS. 2, 12, 13, 14, 23, 25 AND 50).
FIRST USE 10-8-2008; IN COMMERCE 10-8-2008.

CLASS 7—MACHINERY

FOR RETRACTABLE GANTRY SYSTEM COMPRISED PRIMARILY OF AN INTERNAL MECHANIZED TRANSFER STATION THAT TRANSFERS EQUIPMENT TO ITS FINAL OPERATIONAL DESTINATION AND ALLOWS A MAINTENANCE CREW TO WORK FROM BEHIND THE ROADWAY GUARD RAIL TO INSTALL AND MAINTAIN OVERHEAD OPEN ROAD TOLLING EQUIPMENT IN THE GANTRY OVER MULTIPLE TRAVEL LANES WITHOUT CREATING A SAFETY HAZARD AND WITHOUT THE NEED FOR ROADWAY CLOSURES (U.S. CLS. 13, 19, 21, 23, 31, 34 AND 35).
FIRST USE 10-8-2008; IN COMMERCE 10-8-2008.

RONALD MCMORROW, EXAMINING ATTORNEY

SN 77-735,842. CYCLEON INTERNATIONAL HOLDING B.V., UTRECHT, NETHERLANDS, FILED 5-13-2009.



PRIORITY CLAIMED UNDER SEC. 44(D) ON ERPNCMNTY TM OFC APPLICATION NO. 008121949, FILED 2-24-2009, REG. NO. 008121949, DATED 11-10-2009, EXPIRES 2-24-2019.

THE COLOR(S) GREEN AND ORANGE IS/ARE CLAIMED AS A FEATURE OF THE MARK.

THE MARK CONSISTS OF TWO CURVED BANDS FACING EACH OTHER, ONE APPEARING IN GREEN, THE OTHER IN ORANGE.

CLASS 16—PAPER GOODS AND PRINTED MATTER

FOR PRINTED MATTER, NAMELY, DATA SHEETS, BROCHURES, WHITE PAPERS, NEWSLETTERS, TECHNICAL MANUALS, PAMPHLETS, JOURNALS AND MAGAZINES IN THE FIELDS OF RECYCLING, REVERSE LOGISTICS, WASTE DISPOSAL, WASTE RE-USE AND ENVIRONMENTAL SCIENCE; DOCUMENTATION AND PUBLICATIONS IN THE FIELDS OF RECYCLING, REVERSE LOGISTICS, WASTE DISPOSAL, WASTE RE-USE AND ENVIRONMENTAL SCIENCE, NAMELY, USER MANUALS, INSTRUCTION GUIDES, REFERENCE GUIDES, REFERENCE MANUALS, DATA SHEETS, REFERENCE CARDS AND TEMPLATES AND BOOKS; PHOTOGRAPHS; STATIONERY; ADHESIVES FOR STATIONERY OR HOUSEHOLD PURPOSES; ARTISTS' MATERIALS, NAMELY, BRUSHES, PENS AND PENCILS; PAINT BRUSHES; TYPEWRITERS; INSTRUCTIONAL AND TEACHING MATERIAL IN THE FIELDS OF RECYCLING, REVERSE LOGISTICS, WASTE DISPOSAL, WASTE RE-USE AND ENVIRONMENTAL SCIENCE; PLASTIC BAGS FOR PACKAGING; PLASTIC BUBBLE BAGS FOR PACKAGING; PRINTERS' TYPE; PRINTING BLOCKS; DOCUMENTS FOR USE IN REVERSE LOGISTICS, NAMELY, PAPER LABELS, BAR CODE LABELS AND SHIPPING LABELS NOT OF TEXTILE, FOR THE IDENTIFICATION OF GOODS TO BE TRANSPORTED; BUSINESS FORMS, ORDER FORMS AND BOOKKEEPING FORMS TO BE USED IN REVERSE LOGISTICS; BOXES OF PAPER OR CARDBOARD USED IN REVERSE LOGISTICS (U.S. CLS. 2, 5, 22, 23, 29, 37, 38 AND 50).

CLASS 35—ADVERTISING AND BUSINESS

FOR LOGISTICS IN THE FIELD OF TRANSPORT, NAMELY, FREIGHT LOGISTICS MANAGEMENT; ELECTRONIC TRACKING OF GOODS AND COMPONENTS FOR OTHERS; ELECTRONIC TRACKING FOR OTHERS OF DOCUMENTS, PACKAGES, PARCELS, LETTERS AND PALLETS; MANAGEMENT OF STORAGE SPACE; BUSINESS CONSULTING SERVICES RELATING TO LOGISTICS FOR THE TRACKING AND TRACING OF GOODS AND PRODUCTS, BY ELECTRONIC OR OTHER MEANS (U.S. CLS. 100, 101 AND 102).

CLASS 39—TRANSPORTATION AND STORAGE

FOR TRANSPORT, IN PARTICULAR THE TRANSPORT OF GOODS AND PRODUCTS BY MEANS OF MOTOR VEHICLES, CARS, LORRIES, RAILWAY VEHICLES, SHIPS, AIRCRAFT; TRANSPORTATION AND STORAGE OF GOODS; MERCHANDISE PACKAGING FOR OTHERS; PACKAGING ARTICLES FOR TRANSPORTATION; TRANSPORTATION INFORMATION; PROVIDING INFORMATION ON THE STORAGE OF GOODS; PROVIDING INFORMATION ON WAREHOUSE STORAGE; COURIER SERVICES; COLLECTION, TRANSPORT AND DELIVERY OF GOODS, IN PARTICULAR DOCUMENTS, PACKAGES, PARCELS, LETTERS AND PALLETS; RENTAL OF WAREHOUSES; RENTAL OF STORAGE CONTAINERS; TRANSPORT CONSULTANCY; PROVIDING OF INFORMATION AND DATA VIA DATABASES AND/OR THE INTERNET IN THE FIELD OF THE TRANSPORT OF PACKAGES AND EXPRESS DELIVERY OF GOODS (U.S. CLS. 100 AND 105).

CLASS 42—SCIENTIFIC AND COMPUTER SERVICES

FOR SCIENTIFIC AND TECHNOLOGICAL SERVICES AND RESEARCH AND DESIGN RELATING THERETO IN THE FIELDS OF RECYCLING, REVERSE LOGISTICS, WASTE DISPOSAL, WASTE REUSE AND ENVIRONMENTAL SCIENCE; INDUSTRIAL ANALYSIS AND RESEARCH SERVICES IN THE FIELDS OF RECYCLING, REVERSE LOGISTICS, WASTE DISPOSAL, WASTE REUSE AND ENVIRONMENTAL SCIENCE; DESIGN AND DEVELOPMENT OF COMPUTER HARDWARE AND SOFTWARE; DEVELOPMENT OF LOGISTICS SOFTWARE; RENTAL OF LOGISTICS SOFTWARE (U.S. CLS. 100 AND 101).

GISELLE AGOSTO, EXAMINING ATTORNEY

SN 77-736,832. SIERRA BRAVO CORPORATION, BLOOMINGTON, MN. FILED 5-14-2009.

NERDERY

THE MARK CONSISTS OF STANDARD CHARACTERS WITHOUT CLAIM TO ANY PARTICULAR FONT, STYLE, SIZE, OR COLOR.

CLASS 35—ADVERTISING AND BUSINESS

FOR E-COMMERCE CONSULTING SERVICES, NAMELY, ASSISTING OTHERS WITH PROVIDING AN ONLINE STORE AND CUSTOMER SERVICE ENABLING ONLINE PURCHASING, REAL TIME ORDER PROCESSING AND INQUIRY, AND ACCOUNT SERVICES; ADVERTISING AND MARKETING FOR OTHERS, NAMELY, DISSEMINATION OF ADVERTISING FOR OTHERS VIA THE INTERNET (U.S. CLS. 100, 101 AND 102).

FIRST USE 9-1-2008; IN COMMERCE 9-1-2008.

CLASS 42—SCIENTIFIC AND COMPUTER SERVICES

FOR HOSTING WEB SITES FOR OTHERS, PROVIDING GLOBAL COMPUTER NETWORK CONTENT DEVELOPMENT FOR OTHERS, NAMELY, CUSTOM WEB SITE DEVELOPMENT SERVICES (U.S. CLS. 100 AND 101).

FIRST USE 9-1-2008; IN COMMERCE 9-1-2008.

GRETCHEN ULRICH, EXAMINING ATTORNEY

SN 77-736,872. MUSIC NET, INC., DBA MEDIANET DIGITAL, INC., NEW YORK, NY. FILED 5-14-2009.

MEDIANET

THE MARK CONSISTS OF STANDARD CHARACTERS WITHOUT CLAIM TO ANY PARTICULAR FONT, STYLE, SIZE, OR COLOR.

CLASS 9—ELECTRICAL AND SCIENTIFIC APPARATUS

FOR COMPUTER SOFTWARE FOR CONDUCTING AND COORDINATING ON DEMAND DOWNLOADS AND STREAMING OF TEXT AND AUDIO FILES OVER GLOBAL COMPUTER NETWORKS IN THE FIELD OF ENTERTAINMENT; COMPUTER SOFTWARE THAT ALLOWS THE IDENTIFYING, LOCATING, SEARCHING, BROWSING, INDEXING, RETRIEVING, TRANSMITTING, DOWNLOADING AND RECEIVING OF TEXT AND AUDIO FILES OVER GLOBAL COMPUTER NETWORKS IN THE FIELD OF ENTERTAINMENT; COMPUTER SOFTWARE FOR CONDUCTING AND COORDINATING ON DEMAND DOWNLOADS AND STREAMING OF VIDEO FILES OVER GLOBAL COMPUTER NETWORKS IN THE FIELD OF ENTERTAINMENT; COMPUTER SOFTWARE THAT ALLOWS THE IDENTIFYING, LOCATING, SEARCHING, BROWSING, INDEXING, RETRIEVING, TRANSMITTING, DOWNLOADING AND RECEIVING OF VIDEO FILES OVER GLOBAL COMPUTER NETWORKS IN THE FIELD OF ENTERTAINMENT (U.S. CLS. 21, 23, 26, 36 AND 38).

FIRST USE 7-12-2007; IN COMMERCE 7-12-2007.

CLASS 35—ADVERTISING AND BUSINESS

FOR ONLINE RETAIL STORE SERVICES FEATURING DIGITAL MUSICAL AND VIDEO CONTENT; ONLINE RETAIL STORE SERVICES FEATURING DOWNLOADABLE PRE-RECORDED MUSIC AND VIDEO (U.S. CLS. 100, 101 AND 102).

FIRST USE 7-12-2007; IN COMMERCE 7-12-2007.

CLASS 41—EDUCATION AND ENTERTAINMENT

FOR ENTERTAINMENT SERVICES, NAMELY, PROVIDING INFORMATION IN THE FIELD OF MUSIC VIA THE INTERNET AND, WIRELESS COMMUNICATION NETWORK; PROVIDING NON-DOWNLOADABLE PRE-RECORDED MUSIC AND VIDEO VIA THE INTERNET OR PRE-BUNDLED WITH COMPUTING DEVICES (U.S. CLS. 100, 101 AND 107).

FIRST USE 7-12-2007; IN COMMERCE 7-12-2007.

CLASS 42—SCIENTIFIC AND COMPUTER SERVICES

FOR INTERNET SERVICES, NAMELY, PROVIDING USERS OF GLOBAL COMPUTER NETWORKS WITH THE MEANS OF IDENTIFYING, LOCATING, SEARCHING, BROWSING, INDEXING, RETRIEVING, TRANSMITTING, STREAMING, DOWNLOADING AND RECEIVING OF VIDEO, TEXT AND AUDIO FILES VIA GLOBAL COMPUTER NETWORKS (U.S. CLS. 100 AND 101).

FIRST USE 7-12-2007; IN COMMERCE 7-12-2007.

CLASS 45—PERSONAL AND LEGAL SERVICES

FOR LICENSING OF COMPUTER SOFTWARE (U.S. CLS. 100 AND 101).

FIRST USE 7-12-2007; IN COMMERCE 7-12-2007.
MIDGE BUTLER, EXAMINING ATTORNEY

SN 77-739,982. OAKLAND RAIDERS, ALAMEDA, CA. FILED 5-19-2009.

OAKLAND RAIDERS

THE MARK CONSISTS OF STANDARD CHARACTERS WITHOUT CLAIM TO ANY PARTICULAR FONT, STYLE, SIZE, OR COLOR.

OWNER OF U.S. REG. NOS. 1,322,621, 1,891,012 AND 1,919,846.

NO CLAIM IS MADE TO THE EXCLUSIVE RIGHT TO USE "OAKLAND", APART FROM THE MARK AS SHOWN.

CLASS 9—ELECTRICAL AND SCIENTIFIC APPARATUS

FOR DECORATIVE MAGNETS, FOOTBALL HELMETS, AND PRE-RECORDED DVDS FEATURING THE SPORT OF FOOTBALL (U.S. CLS. 21, 23, 26, 36 AND 38).

FIRST USE 9-0-1991; IN COMMERCE 9-0-1991.

CLASS 14—JEWELRY

FOR JEWELRY, CLOCKS, COLLECTIBLE COINS, AND NON-MONETARY COINS OF PRECIOUS METAL (U.S. CLS. 2, 27, 28 AND 50).

FIRST USE 9-0-1991; IN COMMERCE 9-0-1991.

CLASS 16—PAPER GOODS AND PRINTED MATTER

FOR POSTERS, CALENDARS, SERIES OF BOOKS RELATING TO FOOTBALL, MAGAZINES RELATING TO FOOTBALL, PENS, PAPER GIFT BAGS, NOTEBOOKS, PAPER BOOK COVERS, AND SOUVENIR PROGRAMS FOR SPORTS EVENTS (U.S. CLS. 2, 5, 22, 23, 29, 37, 38 AND 50).

FIRST USE 9-0-1991; IN COMMERCE 9-0-1991.

CLASS 28—TOYS AND SPORTING GOODS

FOR TOYS, NAMELY, PLUSH TOYS, STUFFED ANIMALS, DART BOARDS, JIGSAW PUZZLES, BILLIARD BALLS, BOARD GAMES; AND SPORTING GOODS, NAMELY, GOLF BALLS, GOLF BAGS, FOOTBALLS, AND CHRISTMAS TREE ORNAMENTS (U.S. CLS. 22, 23, 38 AND 50).

FIRST USE 9-0-1991; IN COMMERCE 9-0-1991.

CLASS 41—EDUCATION AND ENTERTAINMENT

FOR EDUCATION AND ENTERTAINMENT SERVICES IN THE NATURE OF ORGANIZING AND PRESENTING FOOTBALL GAMES AND EXHIBITIONS; PROVIDING SPORTS AND ENTERTAINMENT INFORMATION VIA A GLOBAL COMPUTER NETWORK OR COMMERCIAL ON-LINE SERVICE (U.S. CLS. 100, 101 AND 107).

FIRST USE 9-0-1991; IN COMMERCE 9-0-1991.

GEORGE LORENZO, EXAMINING ATTORNEY

SN 77-740,978. LAVANDEIRA, MARIO, LOS ANGELES, CA. FILED 5-20-2009.

COCOPEREZ

THE MARK CONSISTS OF STANDARD CHARACTERS WITHOUT CLAIM TO ANY PARTICULAR FONT, STYLE, SIZE, OR COLOR.

OWNER OF U.S. REG. NO. 3,658,122.

THE NAME(S), PORTRAIT(S), AND/OR SIGNATURE(S) SHOWN IN THE MARK DOES NOT IDENTIFY A PARTICULAR LIVING INDIVIDUAL.

CLASS 41—EDUCATION AND ENTERTAINMENT

FOR ON-LINE JOURNALS, NAMELY, BLOGS FEATURING ENTERTAINMENT NEWS, FASHION AND CELEBRITY GOSSIP; PROVIDING A WEB SITE FEATURING INFORMATION, NEWS AND COMMENTARY IN THE FIELD OF ENTERTAINMENT, INCLUDING ENTERTAINMENT NEWS AND CELEBRITY GOSSIP (U.S. CLS. 100, 101 AND 107).

CLASS 45—PERSONAL AND LEGAL SERVICES

FOR PROVIDING A WEB SITE FEATURING FASHION INFORMATION (U.S. CLS. 100 AND 101).

ROBIN MITTLER, EXAMINING ATTORNEY

SN 77-741,282. LLO CONSULTING, LLC, ROCKVILLE, MD.
FILED 5-20-2009.

Intellectual Property Farming

THE MARK CONSISTS OF STANDARD CHARACTERS WITHOUT CLAIM TO ANY PARTICULAR FONT, STYLE, SIZE, OR COLOR.

NO CLAIM IS MADE TO THE EXCLUSIVE RIGHT TO USE "INTELLECTUAL PROPERTY", APART FROM THE MARK AS SHOWN.

CLASS 35—ADVERTISING AND BUSINESS

FOR ACQUISITION AND MERGER CONSULTATION; ADVERTISING AND BUSINESS MANAGEMENT CONSULTANCY; ASSISTANCE, ADVISORY SERVICES AND CONSULTANCY WITH REGARD TO BUSINESS PLANNING, BUSINESS ANALYSIS, BUSINESS MANAGEMENT, AND BUSINESS ORGANIZATION; ASSISTANCE, ADVISORY SERVICES AND CONSULTANCY WITH REGARD TO BUSINESS PLANNING, BUSINESS ANALYSIS, BUSINESS MANAGEMENT, AND BUSINESS ORGANIZATION RELATING TO MICRO CREDITS, MICRO FINANCE AND ENERGY PRODUCTS; ASSISTANCE, ADVISORY SERVICES AND CONSULTANCY WITH REGARD TO BUSINESS PLANNING, BUSINESS ANALYSIS, BUSINESS MANAGEMENT, BUSINESS ORGANIZATION, MARKETING AND CUSTOMER ANALYSIS; BRAND CONCEPT AND BRAND DEVELOPMENT SERVICES FOR CORPORATE CLIENTS; BRANDING SERVICES, NAMELY, CONSULTING, DEVELOPMENT, MANAGEMENT AND MARKETING OF BRANDS FOR BUSINESSES; BUSINESS ACQUISITION AND MERGER CONSULTATION; BUSINESS ACQUISITIONS CONSULTATION; BUSINESS ADMINISTRATION CONSULTANCY; BUSINESS ADVISORY SERVICES, CONSULTANCY AND INFORMATION; BUSINESS APPRAISAL CONSULTATION; BUSINESS CONSULTATION; BUSINESS CONSULTATION AND MANAGEMENT REGARDING MARKETING ACTIVITIES AND LAUNCHING OF NEW PRODUCTS; BUSINESS CONSULTATION IN THE FIELD OF BIOTECHNOLOGY; BUSINESS CONSULTATION SERVICES; BUSINESS CONSULTING SERVICES, NAMELY, PROVIDING ASSISTANCE IN DEVELOPMENT OF BUSINESS STRATEGIES AND CREATIVE IDEATION; BUSINESS CONSULTING, MANAGEMENT, PLANNING AND SUPERVISION; BUSINESS DEVELOPMENT SERVICES, NAMELY, PROVIDING START-UP SUPPORT FOR BUSINESSES OF OTHERS; BUSINESS CONSULTATION IN THE FIELD OF BUSINESS LEADERSHIP DEVELOPMENT; BUSINESS MANAGEMENT AND CONSULTATION; BUSINESS MANAGEMENT CONSULTANCY AND ADVISORY SERVICES; BUSINESS MANAGEMENT CONSULTANCY AS WELL AS DEVELOPMENT OF PROCESSES FOR THE ANALYSIS AND THE IMPLEMENTATION OF STRATEGY PLANS AND MANAGEMENT PROJECTS; BUSINESS MANAGEMENT CONSULTANCY SERVICES; BUSINESS MANAGEMENT CONSULTATION; BUSINESS MANAGEMENT CONSULTING; BUSINESS MANAGEMENT CONSULTING AND ADVISORY SERVICES; BUSINESS MANAGEMENT CONSULTING WITH RELATION TO STRATEGY, FINANCING, MARKETING, PRODUCTION, PERSONNEL AND SALE MATTERS FOR COMPANIES INVOLVED WITH THIN FILM AND NANO TECHNOLOGIES AND PLASMA PROCESSES; BUSINESS VENTURE DEVELOPMENT AND FORMATION CONSULTING SERVICES FOR THE RENEWABLE ENERGY INDUSTRY; COMMERCIAL CONSULTANCY; CONCEPT AND BRAND DEVELOPMENT SERVICES FOR CORPORATE CLIENTS; CONSULTANCY SERVICES REGARDING BUSINESS STRATEGIES; CONSULTATION IN THE FIELD OF BUSINESS ACQUISITIONS; CONSULTING SERVICES IN BUSINESS LEADERSHIP DEVELOPMENT AND BUSINESS MANAGEMENT; CONSULTING SERVICES IN THE FIELD OF MANAGING INTELLECTUAL PROPERTIES; DEVELOPMENT OF MARKETING STRATEGIES AND CONCEPTS; MARKET RESEARCH CONSULTATION; MARKET SEGMENTATION

CONSULTATION; MARKETING CONSULTING; MARKETING PLAN DEVELOPMENT; NEW BUSINESS VENTURE DEVELOPMENT AND FORMATION CONSULTING SERVICES; PROFESSIONAL BUSINESS CONSULTATION; PROFESSIONAL BUSINESS CONSULTING; PROMOTION AND MARKETING SERVICES AND RELATED CONSULTING; PROVIDING BUSINESS MANAGEMENT INFORMATION IN CONNECTION WITH CONSULTING AND ADVISORY SERVICES IN THE FIELD OF STRATEGIC PLANNING; PROVIDING ONLINE BUSINESS MANAGEMENT SERVICES INCLUDING ACCOUNTING, MARKETING, BUSINESS PROJECT MANAGEMENT, AND BUSINESS DEVELOPMENT; PROVIDING ORGANIZATIONAL DEVELOPMENT CONSULTING SERVICES (U.S. CLS. 100, 101 AND 102).

CLASS 42—SCIENTIFIC AND COMPUTER SERVICES

FOR CONSULTING SERVICES IN THE FIELDS OF BIOTECHNOLOGY, PHARMACEUTICAL RESEARCH AND DEVELOPMENT, LABORATORY TESTING, DIAGNOSTICS, AND PHARMACOGENETICS; DESIGN AND TESTING FOR NEW PRODUCT DEVELOPMENT; DEVELOPMENT OF NEW TECHNOLOGY FOR OTHERS IN THE FIELD OF BIOTECHNOLOGY; DEVELOPMENT OF PHARMACEUTICAL PREPARATIONS AND MEDICINES; PHARMACEUTICAL RESEARCH AND DEVELOPMENT; PRODUCT DEVELOPMENT; PRODUCT DEVELOPMENT AND ENGINEERING SERVICES FOR OTHERS; PRODUCT DEVELOPMENT CONSULTATION; PRODUCT DEVELOPMENT FOR OTHERS; PRODUCT RESEARCH AND DEVELOPMENT; RESEARCH AND DEVELOPMENT FOR NEW PRODUCTS FOR OTHERS; RESEARCH AND DEVELOPMENT OF NEW PRODUCTS; RESEARCH AND DEVELOPMENT OF PHARMACEUTICALS FOR THE TREATMENT OF AGE-RELATED DISEASES AND CANCER; RESEARCH AND DEVELOPMENT OF VACCINES AND MEDICINES; SCIENTIFIC RESEARCH AND DEVELOPMENT; TECHNICAL CONSULTANCY REGARDING THE FIELD OF ROAD CUTTING TECHNOLOGY (U.S. CLS. 100 AND 101).

AMEEN IMAM, EXAMINING ATTORNEY

SN 77-743,231. BEST FOOD SERVICES INC, CHICAGO, IL.
FILED 5-22-2009.

大發財
TAI FA CAI

NO CLAIM IS MADE TO THE EXCLUSIVE RIGHT TO USE "TAI" AND THE NON-LATIN CHARACTER THAT TRANSLITERATES TO "TAI", APART FROM THE MARK AS SHOWN.

THE MARK CONSISTS OF THREE STYLIZED CHINESE LETTERS ABOVE THE WORDS "TAI FA CAI".

THE ENGLISH TRANSLATION OF "TAI FA CAI" IN THE MARK IS "TAI HUGE FORTUNE".

THE NON-LATIN CHARACTERS IN THE MARK TRANSLITERATE TO "TAI FA CAI", AND THIS MEANS "TAI HUGE FORTUNE" IN ENGLISH.

CLASS 3—COSMETICS AND CLEANING PREPARATIONS

FOR (BASED ON INTENT TO USE) SOAP POWDER AND LIQUID SOAP (U.S. CLS. 1, 4, 6, 50, 51 AND 52).

CLASS 16—PAPER GOODS AND PRINTED MATTER

FOR (BASED ON INTENT TO USE) PAPER BAG (U.S. CLS. 2, 5, 22, 23, 29, 37, 38 AND 50).

CLASS 21—HOUSEWARES AND GLASS

FOR (BASED ON INTENT TO USE) CLEANING SPONGES, WASHING BRUSHES, AND STEEL WOOL (U.S. CLS. 2, 13, 23, 29, 30, 33, 40 AND 50).

CLASS 29—MEATS AND PROCESSED FOODS

FOR (BASED ON INTENT TO USE) MEAT, FISH, POULTRY, EGG, COOKED FRUITS AND VEGETABLES, AND MILK PRODUCTS EXCLUDING ICE CREAM, ICE MILK AND FROZEN YOGURT (U.S. CL. 46).

CLASS 30—STAPLE FOODS

FOR (BASED ON INTENT TO USE) SUGAR, RICE, FLOUR, SALT, MUSTARD, VINEGAR, SAUCES AND SPICES (U.S. CL. 46).

CLASS 31—NATURAL AGRICULTURAL PRODUCTS

FOR (BASED ON USE IN COMMERCE) FRESH FRUITS AND VEGETABLES (U.S. CLS. 1 AND 46).
FIRST USE 3-1-2009; IN COMMERCE 3-1-2009.
DAVID COLLIER, EXAMINING ATTORNEY

SN 77-745,155. H2Q WATER INDUSTRIES LTD., PETACH TIKVA 49517, ISRAEL, FILED 5-27-2009.

H2Q

THE MARK CONSISTS OF STANDARD CHARACTERS WITHOUT CLAIM TO ANY PARTICULAR FONT, STYLE, SIZE, OR COLOR.

OWNER OF ISRAEL REG. NO. 202112, DATED 4-23-2009, EXPIRES 4-23-2019.

OWNER OF ISRAEL REG. NO. 202110, DATED 4-23-2009, EXPIRES 4-23-2019.

OWNER OF ISRAEL REG. NO. 202106, DATED 4-23-2009, EXPIRES 4-23-2019.

CLASS 1—CHEMICALS

FOR CHEMICALS FOR THE TREATMENT, PURIFICATION AND FILTRATION OF DRINKING WATER (U.S. CLS. 1, 5, 6, 10, 26 AND 46).

CLASS 11—ENVIRONMENTAL CONTROL APPARATUS

FOR WATER FILTERS; CARTRIDGES FOR WATER FILTERS; WATER PURIFICATION AND FILTRATION APPARATUS FOR USE WITH DRINKING WATER; WATER TREATMENT APPARATUS FOR USE WITH DRINKING WATER, NAMELY, WATER DISPENSERS; DOMESTIC WATER PURIFICATION AND FILTRATION UNITS FOR DRINKING WATER; TREATMENT, PURIFICATION AND FILTRATION FILTERS AS PARTS OF EMPTY WATER BOTTLES SOLD AS A UNIT; WATER BARS, NAMELY, A WATER DISPENSING UNIT FOR FILTERED CHILLED AND BOILING WATER (U.S. CLS. 13, 21, 23, 31 AND 34).

CLASS 32—LIGHT BEVERAGES

FOR DRINKING WATER; BOTTLED DRINKING WATER (U.S. CLS. 45, 46 AND 48).
ELLEN BURNS, EXAMINING ATTORNEY

SN 77-748,703. FOUNTAIN OF YOU, INC., DBA PARISIAN SLIM, EXTON, PA. FILED 6-1-2009.

PARISIAN SLIM

THE MARK CONSISTS OF STANDARD CHARACTERS WITHOUT CLAIM TO ANY PARTICULAR FONT, STYLE, SIZE, OR COLOR.

CLASS 5—PHARMACEUTICALS

FOR READY-TO-EAT NUTRITIONAL FOOD BARS FOR USE AS MEAL REPLACEMENTS (U.S. CLS. 6, 18, 44, 46, 51 AND 52).

CLASS 30—STAPLE FOODS

FOR MILKSHAKE MIXES; CHOCOLATE BARS (U.S. CL. 46).
JAMES A. RAUEN, EXAMINING ATTORNEY

SN 77-749,002. NATIONAL ALLIANCE OF FAITH AND JUSTICE, WASHINGTON, DC. FILED 6-1-2009.

PEN OR PENCIL

THE MARK CONSISTS OF STANDARD CHARACTERS WITHOUT CLAIM TO ANY PARTICULAR FONT, STYLE, SIZE, OR COLOR.

CLASS 9—ELECTRICAL AND SCIENTIFIC APPARATUS

FOR PRE-RECORDED DVDS FEATURING EDUCATIONAL MATERIALS, TRAINING COURSES AND TRAINING MATERIALS IN CONNECTION WITH THE FOLLOWING: DROPOUT PREVENTION AND MENTORING; CURRICULUM FOR THE DEVELOPMENT OF LITERARY SKILLS, MENTORING, DROPOUT AND VIOLENCE REDUCTION, AND REDUCING DISPROPORTIONATE MINORITY CONTACT WITH POLICE; PROGRAMS AND COMMUNITY SERVICE PROJECTS AIMED AT REDUCING CRIME AND ANTI-SOCIAL BEHAVIOR, ESPECIALLY AMONG DISADVANTAGED YOUTH; PROGRAMS AND SERVICE LEARNING PROJECTS USING CIVIL RIGHTS AND UNDERGROUND RAILROAD HISTORY IN PARALLEL WITH MODERN DAY SOCIAL ISSUES (U.S. CLS. 21, 23, 26, 36 AND 38).
FIRST USE 1-1-2007; IN COMMERCE 1-1-2007.

CLASS 16—PAPER GOODS AND PRINTED MATTER

FOR BROCHURES, CURRICULUM GUIDE BOOKS, AND PAMPHLETS ON THE FOLLOWING SUBJECTS: DROPOUT PREVENTION AND MENTORING; CURRICULUM FOR THE DEVELOPMENT OF LITERARY SKILLS, MENTORING, DROPOUT AND VIOLENCE REDUCTION, AND REDUCING DISPROPORTIONATE MINORITY CONTACT WITH POLICE; PROGRAMS AND COMMUNITY SERVICE PROJECTS AIMED AT REDUCING CRIME AND ANTI-SOCIAL BEHAVIOR, ESPECIALLY AMONG INNER-CITY AND POOR YOUTH; PROGRAMS AND SERVICE LEARNING PROJECTS USING CIVIL RIGHTS AND UNDERGROUND RAILROAD HISTORY IN PARALLEL WITH MODERN DAY SOCIAL ISSUES; PRINTED FORMS IN THE NATURE OF AGREEMENTS FOR PARTICIPATION IN PROGRAMS (U.S. CLS. 2, 5, 22, 23, 29, 37, 38 AND 50).

FIRST USE 12-30-2006; IN COMMERCE 12-30-2006.

CLASS 35—ADVERTISING AND BUSINESS

FOR CHARITABLE SERVICES, NAMELY, ORGANIZING AND CONDUCTING VOLUNTEER PROGRAMS AND SERVICE LEARNING PROJECTS USING CIVIL RIGHTS AND UNDERGROUND RAILROAD HISTORY IN PARALLEL WITH MODERN DAY SOCIAL ISSUES; ORGANIZING AND CONDUCTING VOLUNTEER PROGRAMS AND COMMUNITY SERVICE PROJECTS AIMED AT REDUCING CRIME AND ANTI-SOCIAL BEHAVIOR, ESPECIALLY AMONG DISADVANTAGED YOUTH; PROMOTING PUBLIC AWARENESS OF PROGRAMS WHICH TARGET DISADVANTAGED YOUTH TO HELP THEM AVOID INCARCERATION; PROMOTING PUBLIC AWARENESS ABOUT POVERTY BY EMPHASIZING SERVICE PROJECTS WHICH OCCUR ALONG TRAVEL CORRIDORS; ORGANIZING YOUTH GROUPS TO UNDERTAKE PROJECTS TO BENEFIT THE COMMUNITY TO ENCOURAGE LEADERSHIP, CHARACTER, COMPASSION, AND GOOD CITIZENSHIP; PROMOTING PUBLIC AWARENESS OF THE NEED FOR MENTORING PROGRAMS FOR AT-RISK YOUTH WITH EMPHASIS ON CHILDREN OF PRISONERS; PROMOTING PUBLIC AWARENESS OF THE NEED FOR SOCIAL PROTESTS SUCH AS BOYCOTTS, SIT-INS, TEACH-INS, READ-INS WHICH DUPLICATE SOCIAL PROTESTS OF THE CIVIL RIGHTS MOVEMENT TO OPPOSE ADVERSE BEHAVIOR (U.S. CLS. 100, 101 AND 102).

FIRST USE 12-30-2007; IN COMMERCE 12-30-2007.

CLASS 41—EDUCATION AND ENTERTAINMENT

FOR EDUCATION SERVICES, NAMELY, MENTORING CHILDREN OF PRISONERS TO IMPROVE THEIR ACADEMIC PERFORMANCE, LIFE SKILLS AND SOCIAL BEHAVIOR; EDUCATIONAL SERVICES, NAMELY, DEVELOPING CURRICULUM FOR OTHERS IN THE DEVELOPMENT OF LITERARY SKILLS, MENTORING, DROPOUT AND VIOLENCE REDUCTION, REDUCING DISPROPORTIONATE MINORITY CONTACT; EDUCATIONAL SERVICES, NAMELY, DEVELOPING AND CONDUCTING TRAINING COURSES AND DISTRIBUTION OF TRAINING MATERIALS IN CONNECTION WITH DROPOUT PREVENTION AND MENTORING (U.S. CLS. 100, 101 AND 107).

FIRST USE 12-30-2007; IN COMMERCE 12-30-2007.
VIVIAN MICZNIK FIRST, EXAMINING ATTORNEY

SN 77-749,135. DELTA FUEL COMPANY, INC., FERRIDAY, LA. FILED S.R. 6-1-2009; AM. P.R. 3-9-2010.



NO CLAIM IS MADE TO THE EXCLUSIVE RIGHT TO USE "FUEL", APART FROM THE MARK AS SHOWN.

THE MARK CONSISTS OF THE WORDING "DELTA" WITH THE STYLIZED LETTER "A" DEPICTING A TRIANGLE OVERLAPPING THE PARALLELOGRAM IN THE BACKGROUND AND THE WORDING "FUEL" APPEARING BELOW THE WORDING "DELTA" AND AT THE BOTTOM OF THE PARALLELOGRAM.

CLASS 4—LUBRICANTS AND FUELS

FOR PETROLEUM PRODUCTS AND DERIVATIVES, NAMELY, GASOLINE, DIESEL FUEL, PROPANE GAS, LUBRICATING OILS, AND HYDRAULIC OILS (U.S. CLS. 1, 6 AND 15).

FIRST USE 1-1-2001; IN COMMERCE 1-1-2001.

CLASS 39—TRANSPORTATION AND STORAGE

FOR STORAGE, DISTRIBUTION, AND TRANSPORTATION OF LIQUEFIED PETROLEUM GAS (U.S. CLS. 100 AND 105).

FIRST USE 1-1-2001; IN COMMERCE 1-1-2001.

JENNY PARK, EXAMINING ATTORNEY

SN 77-753,558. DAIKIN INDUSTRIES, LTD., OSAKA-SHI, OSAKA, JAPAN, FILED 6-5-2009.

Navigation Remote Controller

THE MARK CONSISTS OF STANDARD CHARACTERS WITHOUT CLAIM TO ANY PARTICULAR FONT, STYLE, SIZE, OR COLOR.

NO CLAIM IS MADE TO THE EXCLUSIVE RIGHT TO USE "REMOTE CONTROLLER", APART FROM THE MARK AS SHOWN.

CLASS 9—ELECTRICAL AND SCIENTIFIC APPARATUS

FOR REMOTE CONTROLLERS FOR CONTROLLING AIR CONDITIONERS, AIR PURIFIERS, WATER HEATERS, OR HEATERS, ALL FOR HOUSEHOLD OR INDUSTRIAL USE (U.S. CLS. 21, 23, 26, 36 AND 38).

CLASS 11—ENVIRONMENTAL CONTROL APPARATUS

FOR AIR CONDITIONERS FOR HOUSEHOLD OR INDUSTRIAL PURPOSES; AIR PURIFIERS FOR HOUSEHOLD OR INDUSTRIAL PURPOSES; WATER HEATERS FOR HOUSEHOLD OR INDUSTRIAL PURPOSES; HEATERS FOR HOUSEHOLD OR INDUSTRIAL USE (U.S. CLS. 13, 21, 23, 31 AND 34).

FLORENTINA BLANDU, EXAMINING ATTORNEY

SN 77-755,383. PENTON BUSINESS MEDIA, INC., NEW YORK, NY. FILED 6-9-2009.

MARINE BLUE BOOK

THE MARK CONSISTS OF STANDARD CHARACTERS WITHOUT CLAIM TO ANY PARTICULAR FONT, STYLE, SIZE, OR COLOR.

OWNER OF U.S. REG. NOS. 861,985, 1,358,016 AND 1,590,834.

NO CLAIM IS MADE TO THE EXCLUSIVE RIGHT TO USE "BOOK", APART FROM THE MARK AS SHOWN. SEC. 2(F).

CLASS 9—ELECTRICAL AND SCIENTIFIC APPARATUS

FOR COMPACT DISCS FEATURING INFORMATION IN THE FIELD OF VALUATION, COLLECTION, SERVICE AND REPAIR OF MARINE VEHICLES (U.S. CLS. 21, 23, 26, 36 AND 38).

FIRST USE 1-0-1998; IN COMMERCE 1-0-1998.

CLASS 16—PAPER GOODS AND PRINTED MATTER

FOR MANUALS IN THE FIELD OF VALUATION, COLLECTION, SERVICE AND REPAIR OF MARINE VEHICLES; BOOKS IN THE FIELD OF VALUATION, COLLECTION, SERVICE AND REPAIR OF MARINE VEHICLES (U.S. CLS. 2, 5, 22, 23, 29, 37, 38 AND 50).

FIRST USE 1-10-1956; IN COMMERCE 1-10-1956.

INGA ERVIN, EXAMINING ATTORNEY

SN 77-755,431. GREAT AGREEMENTS LLC, KNOXVILLE, TN. FILED 6-9-2009.

ShakeTool

THE MARK CONSISTS OF STANDARD CHARACTERS WITHOUT CLAIM TO ANY PARTICULAR FONT, STYLE, SIZE, OR COLOR.

CLASS 39—TRANSPORTATION AND STORAGE

FOR STORAGE SERVICES FOR ARCHIVING ELECTRONIC DATA FOR TWO OR MORE PARTIES TO SHARE SINGULAR OR RESPECTIVE REQUIREMENTS, EXPECTATIONS, PROPOSALS, NEEDS, AVERSIONS OR COUNTER-PROPOSALS, AND IN DOING SO GAIN RESPONSIVE ACKNOWLEDGEMENT OF AGREEMENT, DISAGREEMENT OR RELATED REQUESTS (U.S. CLS. 100 AND 105).

FIRST USE 2-28-2009; IN COMMERCE 3-3-2009.

CLASS 42—SCIENTIFIC AND COMPUTER SERVICES

FOR PROVIDING A WEBSITE FEATURING ONLINE NON-DOWNLOADABLE SOFTWARE THAT ENABLES USERS TO CREATE AGREEMENTS BETWEEN TWO OR MORE PARTIES WHEREBY CONSUMERS PRESENT PROPOSALS, ACCEPT PROPOSALS, MAKE AGREEMENTS AND DOCUMENT AGREEMENTS IN ELECTRONIC FORMAT (U.S. CLS. 100 AND 101).

FIRST USE 2-28-2009; IN COMMERCE 3-3-2009.

CLASS 45—PERSONAL AND LEGAL SERVICES

FOR ONLINE SOCIAL NETWORKING SERVICES WHEREBY USERS EXCHANGE PROPOSALS, COUNTER PROPOSALS, MAKE AGREEMENTS AND DOCUMENT AGREEMENTS FOR THE EXPRESSION OF PREFERENCES, REQUIREMENTS, NEEDS, AVERSIONS AND OTHER INSTRUCTIVE COMMUNICATIONS IN SOCIAL SETTINGS SUCH AS, BUT NOT LIMITED TO, INTERPERSONAL, FAMILY, MARRIAGE, HEALTHCARE, ATHLETIC, TRANSACTIONAL OR SOCIETAL INTERACTIONS, INCLUSIVE OF MECHANISMS FOR OPTIONAL ACKNOWLEDGEMENT, FEEDBACK, COUNTER-PROPOSALS AND RESPECTIVE DOCUMENTATION (U.S. CLS. 100 AND 101).

FIRST USE 2-28-2009; IN COMMERCE 3-3-2009.

NAKIA HENRY, EXAMINING ATTORNEY

SN 77-755,484. B & S PLASTICS, INC., OXNARD, CA. FILED 6-9-2009.



OWNER OF U.S. REG. NO. 1,956,616.
THE MARK CONSISTS OF RIGHT SLANTED LETTER "W" IN BUBBLE FONT .

CLASS 7—MACHINERY

FOR HYDROTHERAPY SPA AND BATH WATER PUMPS (U.S. CLS. 13, 19, 21, 23, 31, 34 AND 35).

FIRST USE 8-0-2008; IN COMMERCE 8-0-2008.

CLASS 11—ENVIRONMENTAL CONTROL APPARATUS

FOR HYDROTHERAPY JETS, NAMELY, POOL, HOT TUB AND BATH TUB JETS; JET FITTINGS, NAMELY, PLUMBING FITTINGS FOR POOLS, HOT TUBS AND BATH TUBS; MANIFOLDS, NAMELY, HEATING SYSTEMS COMPOSED PRIMARILY OF TUBES, PIPES AND MANIFOLDS THROUGH WHICH WARM OR HIGH TEMPERATURE WATER CIRCULATES; CONDUITS AND CONDUIT FITTINGS, NAMELY, POOL, HOT TUB AND BATH TUB FITTINGS; SUCTION FITTINGS, NAMELY, FITTINGS FOR POOL, HOT TUB AND BATH TUB SUCTION PUMPS; AIR CONTROLS, NAMELY, POOL, HOT TUB AND BATH TUB AIR CONTROLS; AIR INJECTORS FOR POOLS, HOT TUBS AND BATH TUBS; VALVES FOR POOLS, HOT TUBS AND BATH TUBS; FILTERS FOR POOLS, HOT TUBS AND BATH TUBS; SKIMMERS FOR POOLS, HOT TUBS AND BATH TUBS; PLUMBING FITTINGS, NAMELY, DRAINS AND TRAPS FOR POOLS, HOT TUBS AND BATHS; POOL, HOT TUB AND BATH TUB LIGHTS (U.S. CLS. 13, 21, 23, 31 AND 34).

FIRST USE 8-0-2008; IN COMMERCE 8-0-2008.
DAVID I, EXAMINING ATTORNEY

CLASS 42—SCIENTIFIC AND COMPUTER SERVICES

FOR TESTING, ANALYSIS, AND EVALUATION OF THE KNOWLEDGE, SKILLS AND ABILITIES OF OTHERS FOR THE PURPOSE OF CERTIFICATION AND RE-CERTIFICATION OF FINANCIAL MANAGERS IN THE HEALTHCARE FIELD (U.S. CLS. 100 AND 101).

FIRST USE 7-1-1968; IN COMMERCE 7-1-1968.
HEATHER BIDDULPH, EXAMINING ATTORNEY

SN 77-757,620. NORTHCORE TECHNOLOGIES INC., ONTARIO, CANADA, FILED 6-11-2009.

SN 77-756,085. HEALTHCARE FINANCIAL MANAGEMENT ASSOCIATION, WESTCHESTER, IL. FILED 6-10-2009.



OWNER OF U.S. REG. NOS. 1,861,542 AND 1,861,549.

NO CLAIM IS MADE TO THE EXCLUSIVE RIGHT TO USE "CERTIFIED HEALTHCARE FINANCIAL PROFESSIONAL" AND "ASSOCIATION", APART FROM THE MARK AS SHOWN.

THE MARK CONSISTS OF THREE CONCENTRIC CIRCLES, WITH A NARROW BORDER SURROUNDING THE OUTERMOST CIRCLE. THE LETTERS "CHFP" APPEAR IN THE FOREGROUND OF THE INNERMOST CIRCLE, WITH A STYLIZED CADUCEUS IN THE BACKGROUND. THE WORDS "CERTIFIED HEALTHCARE FINANCIAL PROFESSIONAL" ARE CONTAINED IN THE ADJACENT CIRCLE, SEPARATED BY DOTS, AND THE WORDS "HEALTHCARE FINANCIAL MANAGEMENT ASSOCIATION" APPEAR IN THE OUTERMOST CIRCLE, WITH CROSS DESIGNS AT BOTTOM AND TOP.

SEC. 2(F) AS TO "HEALTHCARE FINANCIAL MANAGEMENT ASSOCIATION".

CLASS 41—EDUCATION AND ENTERTAINMENT

FOR EDUCATION SERVICES, NAMELY, PROVIDING INSTRUCTIONAL CLASSES, SEMINARS AND WORKSHOPS IN THE HEALTHCARE FIELD FOR FINANCIAL MANAGERS; DISTRIBUTION OF COURSE MATERIAL IN CONNECTION THEREWITH; PROVIDING TRAINING FOR CERTIFICATION OF FINANCIAL MANAGERS IN THE HEALTHCARE FIELD (U.S. CLS. 100, 101 AND 107).

FIRST USE 7-1-1968; IN COMMERCE 7-1-1968.



NO CLAIM IS MADE TO THE EXCLUSIVE RIGHT TO USE "WORKING CAPITAL", "BUYER", "TRACKER", "APPRAISER" AND "SELLER" AND, AS TO CLASSES 9 AND 42 "ENGINE", APART FROM THE MARK AS SHOWN.

THE MARK CONSISTS OF THE WORDING "NORTH-CORE WORKING CAPITAL ENGINE" IN A CIRCLE SURROUNDED ON THE BOTTOM BY A HALF-CIRCLE BORDER INCLUDING THE WORDS "BUYER TRACKER APPRAISER SELLER".

CLASS 9—ELECTRICAL AND SCIENTIFIC APPARATUS

FOR SOFTWARE, NAMELY, COMPUTER SOFTWARE FOR USE IN SOURCING ASSETS AND CAPITAL EQUIPMENT, INVENTORY MANAGEMENT, AND TRACKING AND DISPOSITION OF ASSETS AND CAPITAL EQUIPMENT (U.S. CLS. 21, 23, 26, 36 AND 38).

CLASS 35—ADVERTISING AND BUSINESS

FOR BUSINESS PROCESS CONSULTING SERVICES (U.S. CLS. 100, 101 AND 102).

CLASS 41—EDUCATION AND ENTERTAINMENT

FOR TRAINING SERVICES, NAMELY, CUSTOMER TRAINING SERVICES IN THE FIELDS OF SOURCING ASSETS AND CAPITAL EQUIPMENT, INVENTORY MANAGEMENT, AND TRACKING AND DISPOSITION OF ASSETS AND CAPITAL EQUIPMENT (U.S. CLS. 100, 101 AND 107).

CLASS 42—SCIENTIFIC AND COMPUTER SERVICES

FOR SOFTWARE TECHNICAL SUPPORT SERVICES, NAMELY, TROUBLESHOOTING OF COMPUTER SOFTWARE PROBLEMS; WEB-BASED SERVICES AND CUSTOM APPLICATION SERVICES, NAMELY, SOFTWARE DESIGN SERVICES THAT HELP CUSTOMERS WITH SOURCING, INVENTORY MANAGEMENT, TRACKING AND DISPOSITION OF THEIR ASSETS AND CAPITAL EQUIPMENT; PROVIDING WEB-BASED SOLUTIONS AND CUSTOM APPLICATIONS, NAMELY, APPLICATION DEVELOPMENT, SYSTEM INTEGRATION AND SOFTWARE CUSTOMIZATION THAT HELP CUSTOMERS WITH SOURCING, INVENTORY MANAGEMENT, TRACKING AND DISPOSITION OF THEIR ASSETS AND CAPITAL EQUIPMENT (U.S. CLS. 100 AND 101).

HEATHER BIDDULPH, EXAMINING ATTORNEY

SN 77-758,662. SUITE 850 LLC, NEW YORK, NY. FILED 6-12-2009.

BALLOONIES

THE MARK CONSISTS OF STANDARD CHARACTERS WITHOUT CLAIM TO ANY PARTICULAR FONT, STYLE, SIZE, OR COLOR.

CLASS 9—ELECTRICAL AND SCIENTIFIC APPARATUS

FOR PRERECORDED CDS, CD ROMS, DVDS, AND DOWNLOADABLE MP3 FORMATS, NAMELY, FILES AND RECORDINGS FEATURING MUSICAL ENTERTAINMENT FOR CHILDREN FEATURING STORIES, COSTUMED CHARACTERS AND ANIMATION; MOTION PICTURE FILMS FEATURING MUSICAL ENTERTAINMENT FOR CHILDREN; COMPUTER GAME AND VIDEO GAME DISCS AND CARTRIDGES (U.S. CLS. 21, 23, 26, 36 AND 38).

CLASS 16—PAPER GOODS AND PRINTED MATTER

FOR SERIES OF EDUCATIONAL BOOKS AND TEXTBOOKS FOR CHILDREN (U.S. CLS. 2, 5, 22, 23, 29, 37, 38 AND 50).

CLASS 28—TOYS AND SPORTING GOODS

FOR TOYS, NAMELY, STUFFED ANIMALS, PLAY SWIM MASKS AND DIVING MASKS, PLAY SWIMMING POOLS, SURF BOARDS, SPINNING TOPS, ACTION SKILL GAMES, CARD GAMES AND MANIPULATIVE GAMES, BOARD GAMES, PUZZLES, KITES, PUPPETS, BALLOONS, CHRISTMAS TREE DECORATIONS, DOLL HOUSES, JIGSAW PUZZLES, SKATEBOARDS, SPORT BALLS, BASEBALL AND LACROSSE GLOVES, BASEBALL BATS, TENNIS AND BADMINTON RACQUETS, INFLATABLE POOL TOYS, NAMELY, BALLS AND RECREATIONAL USE FLOATS, DOLLS AND PLUSH TOY ANIMALS, HALLOWEEN AND OTHER MASQUERADE COSTUMES (U.S. CLS. 22, 23, 38 AND 50).

CLASS 41—EDUCATION AND ENTERTAINMENT

FOR LIVE ENTERTAINMENT IN THE NATURE OF A MUSICAL GROUP; ONGOING TELEVISION PROGRAM FEATURING MUSICAL ENTERTAINMENT (U.S. CLS. 100, 101 AND 107).

KARANENDRA S. CHHINA, EXAMINING ATTORNEY

SN 77-763,954. GSMA LTD., ATLANTA, GA. FILED 6-19-2009.

MOBILE WORLD LIVE

THE MARK CONSISTS OF STANDARD CHARACTERS WITHOUT CLAIM TO ANY PARTICULAR FONT, STYLE, SIZE, OR COLOR.

NO CLAIM IS MADE TO THE EXCLUSIVE RIGHT TO USE "MOBILE" FOR ALL CLASSES AND "LIVE" FOR CLASS 41, APART FROM THE MARK AS SHOWN.

CLASS 35—ADVERTISING AND BUSINESS

FOR ADVERTISING SERVICES; BUSINESS DATA ANALYSIS OF TELECOMMUNICATIONS COMPANIES; PROVIDING BUSINESS INFORMATION ABOUT TELECOMMUNICATIONS COMPANIES (U.S. CLS. 100, 101 AND 102).

CLASS 38—COMMUNICATION

FOR TELECOMMUNICATIONS SERVICES, NAMELY, TRANSMISSION OF VOICE, DATA, GRAPHICS, IMAGES, AUDIO AND VIDEO; AUDIO AND VIDEO BROADCASTING SERVICES; PROVIDING INFORMATION IN THE FIELD OF TELECOMMUNICATIONS AND TELECOMMUNICATIONS SERVICES (U.S. CLS. 100, 101 AND 104).

CLASS 41—EDUCATION AND ENTERTAINMENT

FOR ENTERTAINMENT AND EDUCATIONAL SERVICES, NAMELY, PROVIDING ONLINE CLASSES, CONFERENCES, CONGRESSES, EXHIBITIONS, WEBINARS, SYMPOSIA AND WORKSHOPS IN THE FIELD OF TELECOMMUNICATIONS; ENTERTAINMENT SERVICES, NAMELY, PRODUCTION OF TELEVISION PROGRAMS; PROVIDING PODCASTS IN THE FIELD OF TELECOMMUNICATIONS; EDUCATIONAL SERVICES, NAMELY, ONLINE SEMINARS IN THE FIELD OF TELECOMMUNICATIONS (U.S. CLS. 100, 101 AND 107).

LINDA M. KING, EXAMINING ATTORNEY

SN 77-764,187. EMC CORPORATION, HOPKINTON, MA. FILED 6-19-2009.

KAZHOLD

THE MARK CONSISTS OF STANDARD CHARACTERS WITHOUT CLAIM TO ANY PARTICULAR FONT, STYLE, SIZE, OR COLOR.

CLASS 9—ELECTRICAL AND SCIENTIFIC APPARATUS

FOR COMPUTER SOFTWARE FOR ENTERPRISE DATA MANAGEMENT; COMPUTER SOFTWARE FOR COLLECTING, STORING, EDITING, ORGANIZING, ANALYZING, AUTHENTICATING, QUARANTINING, AUDITING AND TRANSMITTING ELECTRONIC DATA AND INFORMATION; COMPUTER SOFTWARE FOR ENCRYPTION AND DECRYPTION OF ELECTRONIC DATA AND INFORMATION; COMPUTER SOFTWARE FOR USE IN THE SAFEGUARDING OF ELECTRONIC DATA AND INFORMATION (U.S. CLS. 21, 23, 26, 36 AND 38).

CLASS 42—SCIENTIFIC AND COMPUTER SERVICES

FOR PROVIDING TEMPORARY USE OF NON-DOWNLOADABLE COMPUTER SOFTWARE FOR USE IN COLLECTING, STORING, EDITING, ORGANIZING, ANALYZING, AUTHENTICATING, QUARANTINING, AUDITING AND TRANSMITTING ELECTRONIC DATA AND INFORMATION; PROVIDING TEMPORARY USE OF NON-DOWNLOADABLE COMPUTER SOFTWARE FOR ENCRYPTION AND DECRYPTION OF ELECTRONIC DATA AND INFORMATION; PROVIDING TEMPORARY USE OF NON-DOWNLOADABLE COMPUTER SOFTWARE FOR USE IN THE SAFEGUARDING OF ELECTRONIC DATA AND INFORMATION (U.S. CLS. 100 AND 101).

SHAUNIA CARLYLE, EXAMINING ATTORNEY

SN 77-764,194. EMC CORPORATION, HOPKINTON, MA. FILED 6-19-2009.

KAZFORENSICS

THE MARK CONSISTS OF STANDARD CHARACTERS WITHOUT CLAIM TO ANY PARTICULAR FONT, STYLE, SIZE, OR COLOR.

CLASS 9—ELECTRICAL AND SCIENTIFIC APPARATUS

FOR COMPUTER SOFTWARE FOR ENTERPRISE DATA MANAGEMENT; COMPUTER SOFTWARE FOR COLLECTING, STORING, EDITING, ORGANIZING, ANALYZING, AUTHENTICATING, QUARANTINING, AUDITING AND TRANSMITTING ELECTRONIC DATA AND INFORMATION; COMPUTER SOFTWARE FOR ENCRYPTION AND DECRYPTION OF ELECTRONIC DATA AND INFORMATION; COMPUTER SOFTWARE FOR USE IN THE SAFEGUARDING OF ELECTRONIC DATA AND INFORMATION (U.S. CLS. 21, 23, 26, 36 AND 38).

CLASS 42—SCIENTIFIC AND COMPUTER SERVICES

FOR PROVIDING TEMPORARY USE OF NON-DOWNLOADABLE COMPUTER SOFTWARE FOR USE IN COLLECTING, STORING, EDITING, ORGANIZING, ANALYZING, AUTHENTICATING, QUARANTINING, AUDITING AND TRANSMITTING ELECTRONIC DATA AND INFORMATION; PROVIDING TEMPORARY USE OF NON-DOWNLOADABLE COMPUTER SOFTWARE FOR ENCRYPTION AND DECRYPTION OF ELECTRONIC DATA AND INFORMATION; PROVIDING TEMPORARY USE OF NON-DOWNLOADABLE COMPUTER SOFTWARE FOR USE IN THE SAFEGUARDING OF ELECTRONIC DATA AND INFORMATION (U.S. CLS. 100 AND 101).

SHAUNIA CARLYLE, EXAMINING ATTORNEY

SN 77-764,247. CARL FREUDENBERG KG, WEINHEIM, FED REP GERMANY, FILED 6-19-2009.



OWNER OF FED REP GERMANY REG. NO. 30548992, DATED 11-17-2005, EXPIRES 8-31-2015.

NO CLAIM IS MADE TO THE EXCLUSIVE RIGHT TO USE "REDUCED FRICTION BY NANO-TECHNOLOGY", APART FROM THE MARK AS SHOWN.

THE MARK CONSISTS OF A SQUARE WITH A BLACK BORDER CONTAINING THE WORDS "REDUCED FRICTION BY NANO-TECHNOLOGY" ABOVE THE LETTERS "RFN" IN BOLD FACE IN THE CENTER OF THE SQUARE WITH A SHADED BACKGROUND DESIGN CONSISTING OF ONE VERTICAL FULL COLUMN CONNECTED TO A VERTICAL COLUMN HALF THAT SIZE JOINED TO ONE ANOTHER IN THE CENTER.

CLASS 7—MACHINERY

FOR MACHINE PARTS, NAMELY, RUBBER PUMP IMPELLERS; IMPELLERS FOR PUMPS COMPOSED OF RUBBER AND METAL; VALVE COMPONENTS MADE OF RUBBER BEING PARTS OF MACHINES; VALVE COMPONENTS MADE OF RUBBER AND METAL BEING PARTS OF MACHINES; MACHINE PARTS, NAMELY, ROCKET GASKETS AND MEMBRANES; RUBBER PRESSURE ROLLERS BEING PARTS OF MACHINES; PRESSURE ROLLERS COMPOSED OF RUBBER AND METAL BEING PARTS OF MACHINES; RUBBER MOTOR COMPONENTS BEING PARTS OF MACHINES; MOTOR COMPONENTS COMPOSED OF RUBBER AND METAL BEING PARTS OF MACHINES; CABLE GROMMETS MADE OF RUBBER FOR THE PROTECTION OF ELECTRIC CABLES IN MACHINE COMPONENTS (U.S. CLS. 13, 19, 21, 23, 31, 34 AND 35).

CLASS 17—RUBBER GOODS

FOR GASKETS AND WIPERS FOR EXTENDING AND ROTATING RODS AND SHAFTS; PLUG GASKETS MADE OF RUBBER/METAL; PROFILE GASKETS, V-RING GASKETS, O-RING GASKETS, GROOVE RING GASKETS, BALL SOCK GASKETS, SEALING BOOTS, VALVE GASKETS, VALVE COVER GASKETS (U.S. CLS. 1, 5, 12, 13, 35 AND 50).

NORA BUCHANAN WILL, EXAMINING ATTORNEY

SN 77-765,052. OEHLER, MIKE, DBA HIPNET.TV, BONNERS FERRY, ID. FILED 6-22-2009.

Captain Miracles

THE MARK CONSISTS OF STANDARD CHARACTERS WITHOUT CLAIM TO ANY PARTICULAR FONT, STYLE, SIZE, OR COLOR.

CLASS 21—HOUSEWARES AND GLASS

FOR COFFEE CUPS, TEA CUPS, MUGS (U.S. CLS. 2, 13, 23, 29, 30, 33, 40 AND 50).

CLASS 25—CLOTHING

FOR SWEAT SHIRTS, HOODED SWEAT SHIRTS, TEE SHIRTS, JACKETS (U.S. CLS. 22 AND 39).
NORA BUCHANAN WILL, EXAMINING ATTORNEY

SN 77-765,396. WYMAN, LORI S., HOLLYWOOD, FL. FILED 6-22-2009.

THE ORGANIC ACTOR

THE MARK CONSISTS OF STANDARD CHARACTERS WITHOUT CLAIM TO ANY PARTICULAR FONT, STYLE, SIZE, OR COLOR.

NO CLAIM IS MADE TO THE EXCLUSIVE RIGHT TO USE "ORGANIC" FOR CLASS 25; "ACTOR" FOR CLASS 41, APART FROM THE MARK AS SHOWN.

CLASS 9—ELECTRICAL AND SCIENTIFIC APPARATUS

FOR PRERECORDED ELECTRONIC MEDIA, NAMELY, AUDIO AND VIDEO CASSETTES, CDS AND DVDS IN THE FIELD OF PERFORMANCE AND ACTING (U.S. CLS. 21, 23, 26, 36 AND 38).

CLASS 16—PAPER GOODS AND PRINTED MATTER

FOR PAPER GOODS AND PRINTED MATTER, NAMELY, A SERIES OF ARTICLES FOR PUBLICATION IN BOOKLETS, BROCHURES, CATALOGS, GUIDES, HANDOUTS, MAGAZINES, MANUALS AND NEWSLETTERS IN THE FIELD OF PERFORMANCE AND ACTING; PAPERWEIGHTS, PHOTOGRAPHS MOUNTED AND UNMOUNTED; POSTERS; POSTCARDS; PRINTED GREETING CARDS; PRINTED EDUCATIONAL, INSTRUCTIONAL AND TEACHING MATERIALS IN THE FIELD OF PERFORMANCE AND ACTING; SERIES OF NON-FICTION BOOKS IN THE FIELD OF PERFORMANCE AND ACTING; FOLDERS, PENS, PENCILS, STICKERS AND WRITING PADS (U.S. CLS. 2, 5, 22, 23, 29, 37, 38 AND 50).

CLASS 25—CLOTHING

FOR WEARING APPAREL MADE WHOLLY OR PREDOMINANTLY OF FABRICS MADE FROM ORGANICALLY GROWN MATERIALS OR NATURAL LEATHERS, NAMELY, CLOTHING ACCESSORIES, NAMELY, BANDANNAS, BELTS, BLOUSES, GLOVES, SCARVES, SWEAT BANDS, SUSPENDERS AND TIES; CLOTHING MADE WHOLLY OR PREDOMINANTLY FROM ORGANICALLY GROWN MATERIALS OR NATURAL LEATHERS, NAMELY, CLOTHING ACCESSORIES, NAMELY, BANDANNAS, BELTS, BLOUSES, GLOVES, SCARVES, SWEAT BANDS SUSPENDERS AND TIES; CLOTHING, NAMELY, APRONS, BEACHWEAR, BLOUSES, BOTTOMS, DRESSES, FOOTWEAR, GYM SUITS, JERSEYS, JUMPERS, JUMP SUITS, PANTS, PULLOVERS, SHIRTS, SHORTS, SKIRTS, SLEEPWEAR, SUITS, SWEATERS, SWEAT PANTS, SWEAT SHIRTS, SWEAT SUITS, TANK TOPS AND T-SHIRTS; UNDERWEAR; HEAD WEAR, NAMELY, CAPS, EAR MUFFS, HATS AND VISORS; OUTERWEAR, NAMELY, COATS, JACKETS, PONCHOS, VESTS AND WRAPS (U.S. CLS. 22 AND 39).

CLASS 35—ADVERTISING AND BUSINESS

FOR BUSINESS CONSULTATION AND ADVISORY SERVICES IN THE FIELD OF PERFORMANCE AND ACTING; WHOLESALE AND RETAIL STORE SERVICES FEATURING RECORDATIONS, WEARING APPAREL, AND BOOKS IN THE FIELD OF ACTING AND PERFORMANCE; ONLINE RETAIL STORE SERVICES FEATURING RECORDATIONS, WEARING APPAREL, AND BOOKS IN THE FIELD OF ACTING AND PERFORMANCE; MAIL ORDER AND CATALOG ORDERING SERVICES FEATURING RECORDATIONS, WEARING APPAREL, AND BOOKS IN THE FIELD OF ACTING AND PERFORMANCE (U.S. CLS. 100, 101 AND 102).

CLASS 41—EDUCATION AND ENTERTAINMENT

FOR EDUCATIONAL AND INSTRUCTIONAL SERVICES, NAMELY, CONDUCTING EDUCATIONAL CLASSES, CONFERENCES, RETREATS, SEMINARS AND WORKSHOPS IN THE FIELD OF ACTING AND PERFORMANCE, AND DISTRIBUTING INSTRUCTIONAL MATERIALS IN CONNECTION THEREWITH; ENTERTAINMENT SERVICES, NAMELY, LIVE SPEAKING PERFORMANCES AND SPEAKING ENGAGEMENTS IN THE FIELD OF PERFORMANCE AND ACTING; PROVIDING INFORMATION SERVICES VIA A GLOBAL COMPUTER NETWORK FEATURING INFORMATION IN THE FIELD OF PERFORMANCE AND ACTING (U.S. CLS. 100, 101 AND 107).

JILL C. ALT, EXAMINING ATTORNEY

SN 77-766,511. TEDDY SMITH USA (INC.), NEW YORK, NY. FILED 6-23-2009.

TEDDY SMITH

THE MARK CONSISTS OF STANDARD CHARACTERS WITHOUT CLAIM TO ANY PARTICULAR FONT, STYLE, SIZE, OR COLOR.

OWNER OF U.S. REG. NO. 3,241,283.

"TEDDY SMITH" DOES NOT IDENTIFY A LIVING INDIVIDUAL.

CLASS 3—COSMETICS AND CLEANING PREPARATIONS

FOR BLEACHING PREPARATIONS AND DETERGENTS FOR LAUNDRY USE; CLEANING, POLISHING, SCOURING AND ABRASIVE PREPARATIONS; SOAPS, PERFUMERY, ESSENTIAL OILS, COSMETICS, HAIR LOTIONS; DENTIFRICES (U.S. CLS. 1, 4, 6, 50, 51 AND 52).

CLASS 9—ELECTRICAL AND SCIENTIFIC APPARATUS

FOR PHOTOGRAPHIC APPARATUS AND INSTRUMENTS, NAMELY, CAMERAS, PHOTOGRAPHIC FILTERS; APPARATUS AND INSTRUMENTS FOR CONDUCTING, SWITCHING, TRANSFORMING, ACCUMULATING, REGULATING OR CONTROLLING ELECTRICITY, NAMELY, CONDUCTORS, SWITCHES, TRANSFORMERS, ACCUMULATORS, VOLTAGE REGULATORS AND CONTROLLERS; APPARATUS FOR RECORDING, TRANSMITTING AND REPRODUCING SOUND OR IMAGES; BLANK MAGNETIC DATA CARRIERS AND COMPACT DISCS; AUTOMATIC VENDING MACHINES AND MECHANISMS FOR COIN-OPERATED APPARATUS; CASH REGISTERS, CALCULATING MACHINES, DATA PROCESSING EQUIPMENT AND COMPUTERS; FIRE EXTINGUISHERS (U.S. CLS. 21, 23, 26, 36 AND 38).

CLASS 14—JEWELRY

FOR GOODS MADE OF PRECIOUS METALS AND THEIR ALLOYS AND PLATED THEREWITH, NAMELY, JEWELRY; JEWELRY, PRECIOUS STONES; HOROLOGICAL AND CHRONOMETRIC INSTRUMENTS (U.S. CLS. 2, 27, 28 AND 50).

CLASS 16—PAPER GOODS AND PRINTED MATTER

FOR PAPER, CARDBOARD; PRINTED MATTER, NAMELY, STATIONERY; BOOKBINDING MATERIAL; PHOTOGRAPHS, STATIONERY; ADHESIVES FOR STATIONERY OR HOUSEHOLD PURPOSES; ARTISTS' SUPPLIES, NAMELY, BRUSHES; PAINTBRUSHES; TYPEWRITERS AND OFFICE ARTICLES, NAMELY, PUNCHES; PRINTED INSTRUCTIONAL AND TEACHING MATERIALS IN THE FIELD OF JEWELRY; PLASTIC MATERIALS FOR PACKAGING, NAMELY, BAGS AND POUCHES; PLASTIC MATERIALS FOR PACKAGING, NAMELY, SHEETS AND FILMS FOR HOUSEHOLD, PERSONAL OR NON-COMMERCIAL/NON-INDUSTRIAL PURPOSES; PRINTERS' TYPE; PRINTING BLOCKS (U.S. CLS. 2, 5, 22, 23, 29, 37, 38 AND 50).

CLASS 18—LEATHER GOODS

FOR LEATHER AND IMITATION LEATHER, ANIMAL SKINS, AND ANIMAL HIDES; TRUNKS AND SUITCASES; UMBRELLAS, PARASOLS AND WALKING STICKS; WHIPS AND SADDLERY (U.S. CLS. 1, 2, 3, 22 AND 41).

CLASS 25—CLOTHING

FOR CLOTHING, NAMELY, SHIRTS; FOOTWEAR; HEADGEAR, NAMELY, HATS AND CAPS (U.S. CLS. 22 AND 39).

JENNIFER VASQUEZ, EXAMINING ATTORNEY

SN 77-768,820. DRINK DIGITAL PTY LTD, TAMARAMA NSW, AUSTRALIA, FILED 6-26-2009.

PEOPLE FOR HEALTHY

THE MARK CONSISTS OF STANDARD CHARACTERS WITHOUT CLAIM TO ANY PARTICULAR FONT, STYLE, SIZE, OR COLOR.

CLASS 5—PHARMACEUTICALS

FOR VITAMINS AND VITAMIN PREPARATIONS; NUTRITIONAL SUPPLEMENTS; MINERAL FOOD SUPPLEMENTS; ALL OF THESE GOODS IN CAPSULE, TABLET OR LIQUID FORM (U.S. CLS. 6, 18, 44, 46, 51 AND 52).

CLASS 35—ADVERTISING AND BUSINESS

FOR PROVIDING AN ONLINE MARKETPLACE FOR BUYERS OF GOODS AND SERVICES; PROVIDING EVALUATIVE FEEDBACK AND RATINGS OF THE SELLER'S GOODS AND SERVICES, THE VALUE AND PRICE OF THE SELLER'S GOODS, DELIVERY PERFORMANCE AND OVERALL EXPERIENCE IN CONNECTION THEREWITH; ADVERTISING AND ADVERTISEMENT SERVICES; CUSTOMER LOYALTY SERVICES AND CUSTOMER CLUB SERVICES FOR COMMERCIAL, PROMOTIONAL AND ADVERTISING PURPOSES; PROMOTING THE GOODS AND SERVICES OF THE SELLER (U.S. CLS. 100, 101 AND 102).

PAUL F. GAST, EXAMINING ATTORNEY

SN 77-771,233. STC.UNM, ALBUQUERQUE, NM. FILED 6-30-2009.

UNCONSIDER THIS

THE MARK CONSISTS OF STANDARD CHARACTERS WITHOUT CLAIM TO ANY PARTICULAR FONT, STYLE, SIZE, OR COLOR.

CLASS 41—EDUCATION AND ENTERTAINMENT

FOR ALCOHOL INFORMATION SERVICES, NAMELY, PROVIDING INFORMATION REGARDING THE TRAINING OF PROFESSIONALS THAT SERVE ALCOHOL TO GUESTS AND PATRONS (U.S. CLS. 100, 101 AND 107).

CLASS 42—SCIENTIFIC AND COMPUTER SERVICES

FOR ALCOHOL INFORMATION SERVICES, NAMELY, PROVIDING SCIENTIFIC INFORMATION REGARDING THE CHEMISTRY AND PHYSIOLOGICAL EFFECTS OF ALCOHOL (U.S. CLS. 100 AND 101).

CLASS 43—HOTEL AND RESTAURANT SERVICES

FOR ALCOHOL INFORMATION SERVICES, NAMELY, PROVIDING INFORMATION REGARDING ALCOHOL SERVICE ETIQUETTE BY PROFESSIONALS TO GUESTS AND PATRONS (U.S. CLS. 100 AND 101).

CLASS 44—MEDICAL, BEAUTY AND AGRICULTURAL SERVICES

FOR ALCOHOL INFORMATION SERVICES, NAMELY, PROVIDING HEALTH INFORMATION REGARDING THE CHEMISTRY AND PHYSIOLOGICAL EFFECTS OF ALCOHOL (U.S. CLS. 100 AND 101).

KARANENDRA S. CHHINA, EXAMINING ATTORNEY

SN 77-771,835. CITY OF BEVERLY HILLS, BEVERLY HILLS, CA. FILED 6-30-2009.



OWNER OF U.S. REG. NOS. 2,677,651, 2,768,789 AND OTHERS.

NO CLAIM IS MADE TO THE EXCLUSIVE RIGHT TO USE "BEVERLY HILLS", APART FROM THE MARK AS SHOWN.

THE MARK CONSISTS OF A STYLIZED SHIELD WITH THE STACKED WORDING "BEVERLY HILLS" WITHIN THE SHIELD.

CLASS 6—METAL GOODS

FOR METAL GOODS, NAMELY, METAL KEY CHAINS (U.S. CLS. 2, 12, 13, 14, 23, 25 AND 50).
FIRST USE 9-1-2007; IN COMMERCE 9-1-2007.

CLASS 9—ELECTRICAL AND SCIENTIFIC APPARATUS

FOR WIRELESS EXTERNAL COMPUTER STORAGE DEVICES, NAMELY, BLANK USB FLASH DRIVES; LAPTOP BAGS (U.S. CLS. 21, 23, 26, 36 AND 38).
FIRST USE 9-1-2007; IN COMMERCE 9-1-2007.

CLASS 16—PAPER GOODS AND PRINTED MATTER

FOR NOTEBOOKS; LOOSE-LEAF DIARIES AND AGENDA BOOKS; WRITING INSTRUMENTS, NAMELY, BALL-POINT PENS AND ROLLER-BALL PENS, PENS AND KEY CHAIN FOBS SOLD AS A SET; DIRECTORIES FEATURING LISTS OF MEMBERS AND REFERENCE INFORMATION; BOOKS AND PAMPHLETS FEATURING BUSINESS INFORMATION AND BUSINESS PRACTICES; PRINTED MATERIALS, NAMELY, PAMPHLETS FEATURING INFORMATION ON RESIDENCES, SHOPPING, DINING AND PERSONAL CARE SERVICES, MAPS, CALENDARS, STATIONERY, STATIONERY NOTES CONTAINING ADHESIVE ON ONE SIDE FOR ATTACHMENT TO SURFACES AND POSTCARDS; DOCUMENT PORTFOLIOS; PASSPORT CASES (U.S. CLS. 2, 5, 22, 23, 29, 37, 38 AND 50).
FIRST USE 9-1-2007; IN COMMERCE 9-1-2007.

CLASS 21—HOUSEWARES AND GLASS

FOR BEVERAGE CONTAINERS, NAMELY, COFFEE MUGS, TRAVEL MUGS, GLASS WATER BOTTLES SOLD EMPTY AND PLASTIC WATER BOTTLES SOLD EMPTY (U.S. CLS. 2, 13, 23, 29, 30, 33, 40 AND 50).
FIRST USE 9-1-2007; IN COMMERCE 9-1-2007.

CLASS 35—ADVERTISING AND BUSINESS

FOR ONLINE RETAIL STORE SERVICES FEATURING GENERAL MERCHANDISE INCLUDING BUSINESS ACCESSORIES AND GIFT SETS, LEATHER GOODS, NOTEBOOKS, KEY-CHAINS, WIRELESS EXTERNAL COMPUTER STORAGE DEVICES, WRITING INSTRUMENTS, DIARIES, AGENDA BOOKS, DOCUMENT PORTFOLIOS, STATIONERY, LAPTOP BAGS, MESSENGER BAGS, BUSINESS-CARD CASES, BEVERAGE CONTAINERS, HEADWEAR AND CLOTHING; PROMOTING THE BUSINESS, COMMUNITY, CULTURAL, MUNICIPAL AND CIVIC INTERESTS OF THE CITY OF BEVERLY HILLS, CALIFORNIA; PROMOTING TOURISM, BUSINESS, RESIDENTIAL AND COMMERCIAL GROWTH, ECONOMIC DEVELOPMENT, CULTURAL AND ENTERTAINMENT ATTRACTIONS, AND GOVERNMENT SERVICES OF THE CITY OF BEVERLY HILLS, CALIFORNIA; PROVIDING BUSINESS INFORMATION SERVICES AND PROVIDING INFORMATION IN THE FIELD OF COMMERCIAL GROWTH, ECONOMIC DEVELOPMENT AND EMPLOYMENT OPPORTUNITIES VIA A GLOBAL COMPUTER NETWORK (U.S. CLS. 100, 101 AND 102).
FIRST USE 9-1-2007; IN COMMERCE 9-1-2007.

CLASS 38—COMMUNICATION

FOR CABLE TELEVISION BROADCASTING (U.S. CLS. 100, 101 AND 104).
FIRST USE 9-1-2007; IN COMMERCE 9-1-2007.

CLASS 39—TRANSPORTATION AND STORAGE

FOR PROVIDING TRAVEL AND TOUR INFORMATION SERVICES VIA A GLOBAL COMPUTER NETWORK (U.S. CLS. 100 AND 105).
FIRST USE 9-1-2007; IN COMMERCE 9-1-2007.

CLASS 41—EDUCATION AND ENTERTAINMENT

FOR EDUCATION AND ENTERTAINMENT SERVICES, NAMELY, ORGANIZING AND CONDUCTING COMMUNITY CULTURAL, RECREATIONAL, AND SAFETY-PREPAREDNESS EVENTS; EDUCATIONAL CLASSES AND EVENTS FOR ADULTS AND YOUTHS IN THE FIELDS OF ART, DANCE, MUSIC, FINE ARTS, FOREIGN LANGUAGE, COPING WITH DISABILITIES, ATHLETICS, HOMEMAKING, COMPUTERS, LEISURE ACTIVITIES, PERSONAL DEVELOPMENT, GOVERNMENT, POLITICS, AND SCIENCE; AND PROVIDING COMMUNITY INFORMATION ABOUT COMMUNITY, CULTURAL, AND CIVIC EVENTS, EDUCATION SERVICES AND ENTERTAINMENT ATTRACTIONS VIA THE COMPUTER OR COMPUTER NETWORKS; CABLE TELEVISION PROGRAMMING (U.S. CLS. 100, 101 AND 107).
FIRST USE 9-1-2007; IN COMMERCE 9-1-2007.

CLASS 45—PERSONAL AND LEGAL SERVICES

FOR PROVIDING LEGAL INFORMATION IN RELATION TO GOVERNMENT SERVICES AND MUNICIPAL REGULATIONS VIA A GLOBAL COMPUTER NETWORK (U.S. CLS. 100 AND 101).
FIRST USE 9-1-2007; IN COMMERCE 9-1-2007.
PAULA MAHONEY, EXAMINING ATTORNEY

SN 77-771,838. CITY OF BEVERLY HILLS, BEVERLY HILLS, CA. FILED 6-30-2009.



OWNER OF U.S. REG. NOS. 2,677,651, 2,768,789 AND OTHERS.

NO CLAIM IS MADE TO THE EXCLUSIVE RIGHT TO USE "BEVERLY HILLS", APART FROM THE MARK AS SHOWN.

THE COLOR(S) BLUE AND YELLOW IS/ARE CLAIMED AS A FEATURE OF THE MARK.

THE MARK CONSISTS OF A DARK BLUE STYLIZED SHIELD WITH A YELLOW INTERNAL BORDER AND A LIGHTER BLUE REGION ON THE UPPER LEFT PORTION OF THE SHIELD. THE STACKED WORDING "BEVERLY HILLS" IS IN YELLOW INSIDE THE INTERNAL BORDER.

CLASS 16—PAPER GOODS AND PRINTED MATTER

FOR BOOKS AND PAMPHLETS FEATURING BUSINESS INFORMATION AND BUSINESS PRACTICES; PRINTED MATERIALS, NAMELY, PAMPHLETS FEATURING INFORMATION ON RESIDENCES, SHOPPING, DINING AND PERSONAL CARE SERVICES AND MAPS (U.S. CLS. 2, 5, 22, 23, 29, 37, 38 AND 50).

FIRST USE 9-1-2007; IN COMMERCE 9-1-2007.

CLASS 35—ADVERTISING AND BUSINESS

FOR ONLINE RETAIL STORE SERVICES FEATURING GENERAL MERCHANDISE INCLUDING BUSINESS ACCESSORIES AND GIFT SETS, LEATHER GOODS, NOTEBOOKS, KEY-CHAINS, WIRELESS EXTERNAL COMPUTER STORAGE DEVICES, WRITING INSTRUMENTS, DIARIES, AGENDA BOOKS, DOCUMENT PORTFOLIOS, STATIONERY, LAPTOP BAGS, MESSENGER BAGS, BUSINESS-CARD CASES, BEVERAGE CONTAINERS, HEADWEAR AND CLOTHING; PROMOTING THE BUSINESS, COMMUNITY, CULTURAL, MUNICIPAL AND CIVIC INTERESTS OF THE CITY OF BEVERLY HILLS, CALIFORNIA; PROMOTING TOURISM, BUSINESS, RESIDENTIAL AND COMMERCIAL GROWTH, ECONOMIC DEVELOPMENT, CULTURAL AND ENTERTAINMENT ATTRACTIONS, AND GOVERNMENT SERVICES OF THE CITY OF BEVERLY HILLS, CALIFORNIA; PROVIDING BUSINESS INFORMATION SERVICES AND PROVIDING INFORMATION IN THE FIELD OF COMMERCIAL GROWTH, ECONOMIC DEVELOPMENT AND EMPLOYMENT OPPORTUNITIES VIA A GLOBAL COMPUTER NETWORK (U.S. CLS. 100, 101 AND 102).

FIRST USE 9-1-2007; IN COMMERCE 9-1-2007.

CLASS 38—COMMUNICATION

FOR CABLE TELEVISION BROADCASTING (U.S. CLS. 100, 101 AND 104).

FIRST USE 9-1-2007; IN COMMERCE 9-1-2007.

CLASS 39—TRANSPORTATION AND STORAGE

FOR PROVIDING TRAVEL AND TOUR INFORMATION SERVICES VIA A GLOBAL COMPUTER NETWORK (U.S. CLS. 100 AND 105).

FIRST USE 9-1-2007; IN COMMERCE 9-1-2007.

CLASS 41—EDUCATION AND ENTERTAINMENT

FOR EDUCATION AND ENTERTAINMENT SERVICES, NAMELY, ORGANIZING AND CONDUCTING COMMUNITY CULTURAL, RECREATIONAL, AND SAFETY-PREPAREDNESS EVENTS; EDUCATIONAL CLASSES AND EVENTS FOR ADULTS AND YOUTHS IN THE FIELDS OF ART, DANCE, MUSIC, FINE ARTS, FOREIGN LANGUAGE, COPING WITH DISABILITIES, ATHLETICS, HOMEMAKING, COMPUTERS, LEISURE ACTIVITIES, PERSONAL DEVELOPMENT, GOVERNMENT, POLITICS, AND SCIENCE; AND PROVIDING COMMUNITY INFORMATION ABOUT COMMUNITY, CULTURAL, AND CIVIC EVENTS, EDUCATION SERVICES AND ENTERTAINMENT ATTRACTIONS VIA THE COMPUTER OR COMPUTER NETWORKS; CABLE TELEVISION PROGRAMMING (U.S. CLS. 100, 101 AND 107).

FIRST USE 9-1-2007; IN COMMERCE 9-1-2007.

CLASS 45—PERSONAL AND LEGAL SERVICES

FOR PROVIDING LEGAL INFORMATION IN RELATION TO GOVERNMENT SERVICES AND MUNICIPAL REGULATIONS VIA A GLOBAL COMPUTER NETWORK (U.S. CLS. 100 AND 101).

FIRST USE 9-1-2007; IN COMMERCE 9-1-2007.
PAULA MAHONEY, EXAMINING ATTORNEY

SN 77-772,873. T.D.C. USA, INC., LYNDHURST, NJ. FILED 7-1-2009.

CHEF ELECT

THE MARK CONSISTS OF STANDARD CHARACTERS WITHOUT CLAIM TO ANY PARTICULAR FONT, STYLE, SIZE, OR COLOR.

NO CLAIM IS MADE TO THE EXCLUSIVE RIGHT TO USE "CHEF", APART FROM THE MARK AS SHOWN.

CLASS 7—MACHINERY

FOR ELECTRIC KITCHEN TOOLS, NAMELY, KNIVES, MIXERS, ELECTRIC FOOD CHOPPERS, ELECTRIC CAN OPENERS, ELECTRIC JUICE EXTRACTORS (U.S. CLS. 13, 19, 21, 23, 31, 34 AND 35).

CLASS 8—HAND TOOLS

FOR NON-ELECTRIC KITCHEN TOOLS, NAMELY, POTATO PEELERS, AND PARING KNIVES (U.S. CLS. 23, 28 AND 44).

CLASS 11—ENVIRONMENTAL CONTROL APPARATUS

FOR ELECTRIC COOKING UTENSILS, NAMELY, COFFEE MAKERS, TOASTERS, SLOW COOKERS, IRONS (U.S. CLS. 13, 21, 23, 31 AND 34).

CLASS 21—HOUSEWARES AND GLASS

FOR KITCHEN UTENSILS, NAMELY, SPATULAS, FOOD TONGS, SKEWERS, VEGETABLE TOPPERS, AND BASTING BRUSHES; COOKING UTENSILS, NAMELY, GRILLS, WOKS, FISH BASKETS, BURGER BASKETS, AND HOT DOG BASKETS; BAKEWARE; AND DINNERWARE; NON-ELECTRIC KITCHEN TOOLS, NAMELY, HAND MIXERS (U.S. CLS. 2, 13, 23, 29, 30, 33, 40 AND 50).

GISELLE AGOSTO, EXAMINING ATTORNEY

SN 77-773,369. MS MANAGEMENT, LOS ANGELES, CA. FILED 7-2-2009.

YUMMEE

THE MARK CONSISTS OF STANDARD CHARACTERS WITHOUT CLAIM TO ANY PARTICULAR FONT, STYLE, SIZE, OR COLOR.

CLASS 16—PAPER GOODS AND PRINTED MATTER

FOR SERIES OF GUIDE BOOKS FEATURING RESTAURANT, HOTEL, TRAVEL AND SHOPPING INFORMATION (U.S. CLS. 2, 5, 22, 23, 29, 37, 38 AND 50).

CLASS 35—ADVERTISING AND BUSINESS

FOR ON-LINE RETAIL STORE SERVICES FEATURING MAPS, COMPUTER SOFTWARE AND BOOKS, RELATING TO RESTAURANTS, HOTEL, AND TRAVEL SERVICES, BY MEANS OF A GLOBAL COMPUTER NETWORK; PROVIDING AN ON-LINE COMPUTER DATABASE IN THE FIELD OF LOCATING RESTAURANTS, HOTELS AND TRAVEL AMENITIES, NAMELY, SAFETY EQUIPMENT, COSMETICS, RAZOR, COMB, TOOTHBRUSH, TOOTHPASTE, SHAMPOO, SHAVING CREAM, AND AFTER-SHAVE LOTION (U.S. CLS. 100, 101 AND 102).

SN 77-773,751. MIND INFORMATION PTE LTD., SINGAPORE, SINGAPORE, FILED 7-2-2009.

Mind InFormation

CLASS 39—TRANSPORTATION AND STORAGE

FOR TRAVEL INFORMATION SERVICES (U.S. CLS. 100 AND 105).

THE MARK CONSISTS OF STANDARD CHARACTERS WITHOUT CLAIM TO ANY PARTICULAR FONT, STYLE, SIZE, OR COLOR.

CLASS 43—HOTEL AND RESTAURANT SERVICES

FOR PROVIDING ON-LINE REVIEWS OF RESTAURANTS (U.S. CLS. 100 AND 101).
SKYE YOUNG, EXAMINING ATTORNEY

CLASS 41—EDUCATION AND ENTERTAINMENT

FOR EDUCATION AND ENTERTAINMENT SERVICES, NAMELY, PROVIDING INTERACTIVE ON-LINE TRAINING AND PROVIDING TEMPORARY USE OF NON-DOWNLOADABLE INTERACTIVE GAMES IN THE FIELD OF LANGUAGE-BASED LEARNING DISORDERS (U.S. CLS. 100, 101 AND 107).

CLASS 44—MEDICAL, BEAUTY AND AGRICULTURAL SERVICES

FOR PROVIDING ONLINE HEALTHCARE SERVICES FOR TREATING LANGUAGE-BASED LEARNING DISORDERS (U.S. CLS. 100 AND 101).
DAWN HAN, EXAMINING ATTORNEY

SN 77-773,454. MIND INFORMATION PTE LTD., SINGAPORE, SINGAPORE, FILED 7-2-2009.

LEXERCISE

SN 77-773,764. USI, OKA, NEW YORK, NY. FILED 7-2-2009.

THE MARK CONSISTS OF STANDARD CHARACTERS WITHOUT CLAIM TO ANY PARTICULAR FONT, STYLE, SIZE, OR COLOR.

GROUP FIRMITAS
CLARIFYING CLIMATE CHANGE

CLASS 41—EDUCATION AND ENTERTAINMENT

FOR EDUCATION AND ENTERTAINMENT SERVICES, NAMELY, PROVIDING INTERACTIVE ON-LINE TRAINING AND PROVIDING TEMPORARY USE OF NON-DOWNLOADABLE INTERACTIVE GAMES IN THE FIELD OF LANGUAGE-BASED LEARNING DISORDERS (U.S. CLS. 100, 101 AND 107).
FIRST USE 7-31-2008; IN COMMERCE 7-31-2008.

THE MARK CONSISTS OF STANDARD CHARACTERS WITHOUT CLAIM TO ANY PARTICULAR FONT, STYLE, SIZE, OR COLOR.

NO CLAIM IS MADE TO THE EXCLUSIVE RIGHT TO USE "GROUP" AND "CLIMATE CHANGE", APART FROM THE MARK AS SHOWN.

THE WORDING "FIRMITAS" HAS NO MEANING IN A FOREIGN LANGUAGE.

CLASS 44—MEDICAL, BEAUTY AND AGRICULTURAL SERVICES

FOR PROVIDING ONLINE HEALTHCARE SERVICES FOR TREATING LANGUAGE-BASED LEARNING DISORDERS (U.S. CLS. 100 AND 101).
FIRST USE 7-31-2008; IN COMMERCE 7-31-2008.
DAWN HAN, EXAMINING ATTORNEY

CLASS 35—ADVERTISING AND BUSINESS

FOR BUSINESS CONSULTANCY AND ADVISORY SERVICES; BUSINESS INVESTIGATION AND RESEARCH SERVICES; PROVIDING OF BUSINESS INFORMATION (U.S. CLS. 100, 101 AND 102).

CLASS 36—INSURANCE AND FINANCIAL

FOR BANKING SERVICES; MERCHANT BANKING SERVICES; INVESTMENT BANKING SERVICES; INVESTMENT RESEARCH SERVICES; INVESTMENT MANAGEMENT AND ADVISORY SERVICES; FINANCIAL SERVICES IN THE NATURE OF AGENCIES OR BROKERAGE FOR TRADING FUTURES, CURRENCIES, OPTIONS, FOREIGN EXCHANGE AND COMMODITIES; MUTUAL FUND INVESTMENT; DERIVATIVE INVESTMENT SECURITIES SERVICES; FINANCIAL RISK MANAGEMENT SERVICES; INVESTMENT BROKERAGE SERVICES; SECURITIES BROKERAGE SERVICES; FINANCIAL PLANNING SERVICES; FINANCIAL ADVICE AND RESEARCH SERVICES; PROVISION OF FINANCIAL INFORMATION VIA PERSONAL CONTACT OR ELECTRONIC MEANS; SERVICES FOR THE PROVIDING OF WORKING CAPITAL; FINANCING SERVICES; FINANCIAL ANALYSIS SERVICES (U.S. CLS. 100, 101 AND 102).

CLASS 42—SCIENTIFIC AND COMPUTER SERVICES

FOR INDUSTRIAL RESEARCH IN THE FIELD OF ENVIRONMENTAL PROTECTION; CONSULTING SERVICES IN THE FIELD OF ENVIRONMENTAL ASSESSMENT AND PLANNING (U.S. CLS. 100 AND 101).
THOMAS MANOR, EXAMINING ATTORNEY

CLASS 41—EDUCATION AND ENTERTAINMENT

FOR PROVIDING FITNESS PROGRAMS FOR CORPORATE CLIENTS AND INDIVIDUALS TO PROMOTE ACTIVE AND HEALTHY LIFESTYLES AND PREVENT OR REDUCE HEALTH RISK FACTORS, NAMELY, PROVIDING ASSISTANCE, PERSONAL TRAINING AND PHYSICAL FITNESS CONSULTATION TO CORPORATE CLIENTS TO HELP THEIR EMPLOYEES MAKE PHYSICAL FITNESS, STRENGTH, CONDITIONING, AND EXERCISE ALTERATIONS IN THEIR DAILY LIVING; PROVIDING COACHING AND CONSULTING SERVICES IN THE FIELD OF PHYSICAL FITNESS; PROVIDING FITNESS TRAINING TO PREPARE FOR PARTICIPATORY SPORTS EVENTS; PROVIDING ON-LINE INFORMATION AND GUIDANCE IN THE FIELDS OF PHYSICAL FITNESS AND SPORTS EVENTS; PROVIDING A WEB SITE FEATURING INFORMATION ON EXERCISE AND FITNESS (U.S. CLS. 100, 101 AND 107).
FIRST USE 4-20-2007; IN COMMERCE 1-15-2008.
MARLENE BELL, EXAMINING ATTORNEY

SN 77-774,524. JOULE UNLIMITED, INC., CAMBRIDGE, MA. FILED 7-6-2009.

SN 77-774,073. LVS HEALTH INNOVATIONS, INC., DBA MYFINISHLINE, LOS ANGELES, CA. FILED 7-3-2009.

FUNCTICE

THE MARK CONSISTS OF STANDARD CHARACTERS WITHOUT CLAIM TO ANY PARTICULAR FONT, STYLE, SIZE, OR COLOR.

THE WORDING "FUNCTICE" HAS NO MEANING IN A FOREIGN LANGUAGE.

CLASS 35—ADVERTISING AND BUSINESS

FOR PROVIDING FITNESS PROGRAMS FOR EMPLOYEES AND MEMBERS OF ORGANIZATIONS TO INCENTIVIZE ACTIVE AND HEALTHY LIFESTYLES AND PREVENT OR REDUCE HEALTH RISK FACTORS, NAMELY, PROVIDING ONLINE AND IN-PERSON ASSISTANCE, FITNESS EVALUATION AND CONSULTATION TO CORPORATE CLIENTS TO HELP THEIR EMPLOYEES MAKE HEALTH, WELLNESS AND NUTRITIONAL CHANGES IN THEIR DAILY LIVING AND PREPARE FOR PARTICIPATORY SPORTS EVENTS TO INCREASE PRODUCTIVITY AND LOWER HEALTH CARE COSTS (U.S. CLS. 100, 101 AND 102).
FIRST USE 4-20-2007; IN COMMERCE 1-15-2008.

THE MARK CONSISTS OF STANDARD CHARACTERS WITHOUT CLAIM TO ANY PARTICULAR FONT, STYLE, SIZE, OR COLOR.

CLASS 35—ADVERTISING AND BUSINESS

FOR MARKETING IN CONNECTION WITH BIOCONVERSION OR DIRECT BIOCONVERSION USING MICROORGANISMS, BIOLOGICAL MATERIALS, BIOLOGICAL MOLECULES AND/OR ENZYMES TO PRODUCE CHEMICALS, INDUSTRIAL CHEMICALS, FUELS, BIOFUELS AND CHEMICAL AND NON-CHEMICAL FUEL ADDITIVES; MARKETING OF BIOLOGICAL MATERIALS, MICROORGANISMS, BIOLOGICAL MOLECULES AND ENZYMES FOR USE IN THE MANUFACTURE OF CHEMICALS, INDUSTRIAL CHEMICALS, FUELS, BIOFUELS AND CHEMICAL AND NON-CHEMICAL FUEL ADDITIVES USING BIOCONVERSION OR DIRECT BIOCONVERSION; MARKETING OF CHEMICALS, INDUSTRIAL CHEMICALS, FUELS, BIOFUELS AND CHEMICAL AND NON-CHEMICAL FUEL ADDITIVES PRODUCED BY DIRECT BIOCONVERSION OR BIOCONVERSION USING MICROORGANISMS, BIOLOGICAL MATERIALS, BIOLOGICAL MOLECULES AND/OR ENZYMES; AND MARKETING IN CONNECTION WITH CONVERTING WASTE GASES, FLUE GASES AND EMISSIONS INTO RENEWABLE ENERGY (U.S. CLS. 100, 101 AND 102).

CLASS 40—MATERIAL TREATMENT

FOR PRODUCTION OF FUELS, BIOFUELS, FUEL ADDITIVES AND CHEMICALS FOR OTHERS UTILIZING BIOCONVERSION OR DIRECT BIOCONVERSION USING BIOLOGICAL MATERIALS, MICROORGANISMS, BIOLOGICAL MOLECULES AND/OR ENZYMES; PRODUCTION OF BIOLOGICAL MATERIALS, MICROORGANISMS, BIOLOGICAL MOLECULES, AND ENZYMES FOR OTHERS FOR USE IN THE MANUFACTURE OF CHEMICALS, INDUSTRIAL CHEMICALS, FUELS, BIOFUELS AND CHEMICAL AND NON-CHEMICAL FUEL ADDITIVES; AND CONVERTING WASTE GASES, FLUE GASES AND EMISSIONS FOR OTHERS INTO RENEWABLE ENERGY (U.S. CLS. 100, 103 AND 106).

Direct-to-Product

CLASS 42—SCIENTIFIC AND COMPUTER SERVICES

FOR SCIENTIFIC RESEARCH AND DEVELOPMENT IN THE FIELD OF CHEMICALS, MICROORGANISMS, BIOLOGICAL MATERIALS, BIOLOGICAL MOLECULES, ENZYMES, FUELS, BIOFUELS AND FUEL ADDITIVES; RESEARCH AND DEVELOPMENT OF SCIENTIFIC APPARATUS AND METHODS FOR DEVELOPING MICROORGANISMS, BIOLOGICAL MATERIALS, BIOLOGICAL MOLECULES AND ENZYMES USEFUL IN THE FIELD OF BIOCONVERSION OR DIRECT BIOCONVERSION, FOR USE IN THE MANUFACTURE OF CHEMICALS, INDUSTRIAL CHEMICALS, FUELS, BIOFUELS AND CHEMICAL AND NON-CHEMICAL FUEL ADDITIVES; RESEARCH AND DEVELOPMENT OF MICROORGANISMS, BIOLOGICAL MATERIALS, BIOLOGICAL MOLECULES AND ENZYMES USEFUL IN THE FIELD OF BIOCONVERSION OR DIRECT BIOCONVERSION FOR USE IN THE MANUFACTURE OF CHEMICALS, INDUSTRIAL CHEMICALS, FUELS, BIOFUELS AND CHEMICAL AND NON-CHEMICAL FUEL ADDITIVES; AND SCIENTIFIC AND TECHNOLOGICAL SERVICES, NAMELY, SCIENTIFIC AND TECHNOLOGICAL RESEARCH SERVICES IN THE FIELD OF BIOCONVERSION OR DIRECT BIOCONVERSION TO PRODUCE CHEMICALS, INDUSTRIAL CHEMICALS, FUELS, BIOFUELS AND CHEMICAL AND NON-CHEMICAL FUEL ADDITIVES; AND RESEARCH AND DEVELOPMENT OF SCIENTIFIC APPARATUS AND METHODS FOR CONVERTING WASTE GASES, FLUE GASES AND EMISSIONS INTO RENEWABLE ENERGY (U.S. CLS. 100 AND 101).

BRIDGETT SMITH, EXAMINING ATTORNEY

SN 77-775,456. PANAMA JACK INTERNATIONAL, INC., ORLANDO, FL. FILED 7-7-2009.

PANAMA JACK

THE MARK CONSISTS OF STANDARD CHARACTERS WITHOUT CLAIM TO ANY PARTICULAR FONT, STYLE, SIZE, OR COLOR.

OWNER OF U.S. REG. NOS. 1,673,955, 2,972,884 AND OTHERS.

CLASS 9—ELECTRICAL AND SCIENTIFIC APPARATUS

FOR MOTION PICTURE FILMS AND FILMS FOR TELEVISION FEATURING MUSICAL, FICTIONAL AND NON-FICTIONAL ENTERTAINMENT; DOWNLOADABLE MOTION PICTURE FILMS AND FILMS FOR TELEVISION FEATURING MUSICAL, FICTIONAL AND NON-FICTIONAL ENTERTAINMENT; VIDEO DISCS, DIGITAL VIDEO DISCS, COMPUTER SOFTWARE AND CD-ROMS FEATURING MUSICAL, FICTIONAL AND NON-FICTIONAL ENTERTAINMENT (U.S. CLS. 21, 23, 26, 36 AND 38).

CLASS 41—EDUCATION AND ENTERTAINMENT

FOR MOTION PICTURE AND TELEVISION PROGRAM PRODUCTION AND DISTRIBUTION SERVICES; ENTERTAINMENT SERVICES IN THE NATURE OF AN ON-GOING TELEVISION PROGRAM FEATURING MUSICAL, FICTIONAL AND NON-FICTIONAL ENTERTAINMENT BROADCAST OVER TELEVISION, SATELLITE, AUDIO, THE INTERNET AND VIDEO MEDIA (U.S. CLS. 100, 101 AND 107).

ANDREW LEASER, EXAMINING ATTORNEY

SN 77-775,662. UNIVERSITY OF CONNECTICUT, STORRS, CT. FILED 7-7-2009.

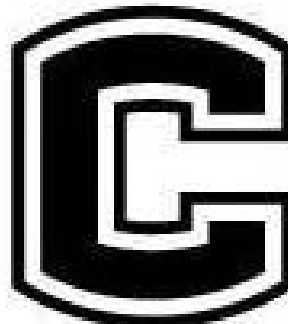

THE MARK CONSISTS OF THE LETTER "C" IN BLOCK FORM.

CLASS 25—CLOTHING

FOR CAPS, JACKETS, REPLICATED FOOTBALL JERSEYS, KNIT HATS, PANTS, PULLOVERS, RUGBY SHIRTS, SWEATSHIRTS, AND TODDLER SWEATSHIRTS (U.S. CLS. 22 AND 39).

FIRST USE 12-0-2003; IN COMMERCE 12-0-2003.

CLASS 28—TOYS AND SPORTING GOODS

FOR MINIATURE TOY REPLICATED HELMETS (U.S. CLS. 22, 23, 38 AND 50).

FIRST USE 12-0-2003; IN COMMERCE 12-0-2003.
VERNA BETH RIRIE, EXAMINING ATTORNEY

SN 77-775,843. NEWS GROUP NEWSPAPERS LIMITED, LONDON, UNITED KINGDOM, FILED 7-7-2009.

THE MILLIES

THE MARK CONSISTS OF STANDARD CHARACTERS WITHOUT CLAIM TO ANY PARTICULAR FONT, STYLE, SIZE, OR COLOR.

PRIORITY CLAIMED UNDER SEC. 44(D) ON UNITED KINGDOM APPLICATION NO. 2509990, FILED 3-2-2009, REG. NO. 2509990, DATED 9-11-2009, EXPIRES 3-2-2019.

CLASS 6—METAL GOODS

FOR TROPHIES OF COMMON METAL; METAL KEY RINGS AND KEY FOBS (U.S. CLS. 2, 12, 13, 14, 23, 25 AND 50).

CLASS 9—ELECTRICAL AND SCIENTIFIC APPARATUS

FOR SOUND AND VIDEO RECORDINGS IN THE FORM OF DIGITALLY VERSATILE DISCS, COMPACT DISCS, CD-ROMS, CASSETTES AND CARTRIDGES OF TAPES, ALL FEATURING ENTERTAINMENT PROGRAMS ABOUT AWARDS, THE ARMED FORCES, ARMED FORCES HISTORY, ARMED FORCES SERVICE, PRESENTATION OF AWARDS, CHARITABLE SERVICES FOR ARMED FORCES MEMBERS AND FAMILIES; MOTION PICTURE FILMS ABOUT AWARDS, THE ARMED FORCES, ARMED FORCES HISTORY, ARMED FORCES SERVICE, PRESENTATION OF AWARDS, CHARITABLE SERVICES FOR ARMED FORCES MEMBERS AND FAMILIES; DIGITALLY VERSATILE DISCS, COMPACT DISCS, CASSETTES AND CARTRIDGES OF TAPES, ALL FEATURING ENTERTAINMENT PROGRAMS ABOUT AWARDS, THE ARMED FORCES, ARMED FORCES HISTORY, AND ARMED FORCES SERVICE, PRESENTATION OF AWARDS, CHARITABLE SERVICES FOR ARMED FORCES MEMBERS AND FAMILIES; DIGITALLY VERSATILE DISC RECORDERS, COMPACT DISC RECORDERS AND TAPE RECORDERS; RECORD PLAYERS; CAMERAS AND PROJECTORS; VIDEO CASSETTE RECORDERS, RADIOS AND TELEVISIONS; COMPUTER SOFTWARE AND COMPUTER PROGRAMS FOR THE MANAGEMENT OF DATABASES FEATURING PHOTOGRAPHS, CALENDARS, NEWS AND INFORMATION; DOWNLOADABLE PUBLICATIONS, NAMELY, NEWSPAPERS, MAGAZINES, BOOKS, REFERENCE BOOKS, CATALOGUES, BROCHURES, ARTICLES, POSTERS, AND INTERVIEWS IN ELECTRONICALLY, MAGNETICALLY OR OPTICALLY RECORDED AND RECORDABLE FORMS, ALL CONCERNING AWARDS, THE ARMED FORCES, ARMED FORCES HISTORY, ARMED FORCES SERVICE, PRESENTATION OF AWARDS, AWARDS PROGRAMS, AND CHARITABLE SERVICES FOR ARMED FORCES MEMBERS AND FAMILIES; DOWNLOADABLE ELECTRONIC PUBLICATIONS AND ONLINE PUBLICATIONS IN ELECTRONICALLY, MAGNETICALLY OR OPTICALLY RECORDED AND RECORDABLE FORMS, NAMELY, NEWSPAPERS, MAGAZINES, BOOKS, REFERENCE BOOKS, CATALOGUES, BROCHURES, ARTICLES, POSTERS, AND INTERVIEWS, ALL CONCERNING AWARDS, THE ARMED FORCES, ARMED FORCES HISTORY, ARMED FORCES SERVICE, PRESENTATION OF AWARDS, AWARDS PROGRAMS, AND CHARITABLE SERVICES FOR ARMED FORCES MEMBERS AND FAMILIES; DOWNLOADABLE PODCASTS IN THE FIELDS OF THE ARMED FORCES, ARMED FORCES HISTORY, ARMED FORCES SERVICE, PRESENTATION OF AWARDS, AWARDS PROGRAMS, AND CHARITABLE SERVICES FOR ARMED FORCES MEMBERS AND FAMILIES; DOWNLOADABLE GIFT CERTIFICATES (U.S. CLS. 21, 23, 26, 36 AND 38).

CLASS 14—JEWELRY

FOR TROPHIES, KEY RINGS AND KEY FOBS OF PRECIOUS METALS, OR COATED THEREWITH (U.S. CLS. 2, 27, 28 AND 50).

CLASS 16—PAPER GOODS AND PRINTED MATTER

FOR PRINTED AWARDS; PRINTED GIFT CERTIFICATES; GIFT BAGS; PRINTED MATTER IN THE FORM OF PUBLICATIONS, NAMELY, GENERAL FEATURE NEWSPAPERS, MAGAZINES AND ARTICLES IN THE FIELD OF CURRENT EVENT NEWS; CALENDARS; PHOTOGRAPHS; POSTERS (U.S. CLS. 2, 5, 22, 23, 29, 37, 38 AND 50).

CLASS 20—FURNITURE AND ARTICLES NOT OTHERWISE CLASSIFIED

FOR NON-METALLIC TROPHIES; NON-METAL KEY RINGS AND KEY FOBS; PICTURE FRAMES (U.S. CLS. 2, 13, 22, 25, 32 AND 50).

CLASS 21—HOUSEWARES AND GLASS

FOR GLASSWARE, NAMELY, TUMBLERS, BOWLS, PLATES, CUPS AND VASES FOR HOUSEHOLD PURPOSES (U.S. CLS. 2, 13, 23, 29, 30, 33, 40 AND 50).

CLASS 41—EDUCATION AND ENTERTAINMENT

FOR ENTERTAINMENT SERVICES, NAMELY, HOSTING AND ORGANIZING AWARDS SHOWS IN THE FIELDS OF ARMED FORCES SERVICE AND HISTORY, PROVISION OF INFORMATION RELATING TO LIVE ENTERTAINMENT, PROVISION OF ENTERTAINMENT INFORMATION RELATING TO FASHION, EDUCATION, CURRENT EVENTS, THE ARMED FORCES, ARMED FORCES HISTORY, ARMED FORCES SERVICE, SPORTING, OR CULTURAL EVENTS, ARRANGING OF COMPETITIONS, GAMES AND QUIZZES RELATING TO THE ARMED FORCES, ARMED FORCES HISTORY, AND ARMED FORCES SERVICE, PRESENTATION OF AWARDS FOR ARMED FORCES MEMBERS AND FAMILIES, ALL THE AFORESAID SERVICES ALSO PROVIDED ONLINE FROM A COMPUTER DATABASE AND FROM THE INTERNET; EDUCATIONAL SERVICES, NAMELY, PROVIDING CLASSES, SEMINARS, AND WORKSHOPS IN THE FIELDS OF THE ARMED FORCES AND ARMED FORCES HISTORY; ONLINE PUBLICATIONS, NAMELY, ARTICLES, NEWSPAPERS, MAGAZINES, BOOKS, REFERENCE BOOKS, CATALOGUES, BROCHURES, ARTICLES, POSTERS, AND INTERVIEWS ALL IN THE FIELDS OF THE ARMED FORCES, ARMED FORCES HISTORY, AND ARMED FORCES SERVICE; PUBLICATION OF ELECTRONIC BOOKS AND JOURNALS ONLINE ABOUT THE ARMED FORCES, ARMED FORCES HISTORY, ARMED FORCES SERVICE, PRESENTATION OF AWARDS, AWARDS PROGRAMS AND CHARITABLE SERVICES FOR ARMED FORCES MEMBERS AND FAMILIES; PUBLICATION OF TEXTBOOKS (U.S. CLS. 100, 101 AND 107).

CURTIS FRENCH, EXAMINING ATTORNEY

SN 77-776.315. ADVANCE MAGAZINE PUBLISHERS INC, NEW YORK, NY. FILED 7-8-2009.

WHAT MATTERS CONDÉ NAST TRAVELER REPORT NOW?

OWNER OF U.S. REG. NOS. 1,568,296, 2,831,488 AND OTHERS.

NO CLAIM IS MADE TO THE EXCLUSIVE RIGHT TO USE "TRAVELER REPORT", APART FROM THE MARK AS SHOWN.

THE NAME "CONDE NAST" DOES NOT IDENTIFY A LIVING INDIVIDUAL.

THE MARK CONSISTS OF THE WORDS "WHAT MATTERS NOW" WITH THE WORDS "CONDE NAST TRAVELER REPORT" IN A NARROW RECTANGLE BETWEEN THE WORDS "WHAT MATTERS" AND "NOW?".

CLASS 16—PAPER GOODS AND PRINTED MATTER

FOR PRINTED MATTER, NAMELY, RESEARCH REPORTS FEATURING TRAVEL (U.S. CLS. 2, 5, 22, 23, 29, 37, 38 AND 50).

CLASS 35—ADVERTISING AND BUSINESS

FOR MARKET REPORTS AND STUDIES (U.S. CLS. 100, 101 AND 102).

LINDSEY RUBIN, EXAMINING ATTORNEY

SN 77-776,466. SILLA AUTOMOTIVE, L.L.C., COMPTON, CA. FILED 7-8-2009.



OWNER OF U.S. REG. NO. 3,588,881.
THE MARK CONSISTS OF A RECTANGLE WITH PARALLELED ANGLED SIDES AND CURVED CORNERS WITH A STYLIZED "S" DEPICTING A HIGHWAY WITH LINES OR DIVIDERS, INTERSECTION OR STREETS (ROADS) IN THE UNSHADED AREA, TO THE LEFT OF THE LETTERS COMPRISING THE WORD "SILLA" IN THE SHADED AREA.

CLASS 7—MACHINERY

FOR RADIATORS FOR COOLING AUTOMOBILE MOTORS AND ENGINES; AIR-CONDITIONING CONDENSERS FOR COOLING AUTOMOBILE MOTORS AND ENGINES (U.S. CLS. 13, 19, 21, 23, 31, 34 AND 35).
FIRST USE 4-1-2000; IN COMMERCE 4-1-2000.

CLASS 12—VEHICLES

FOR GAS TANKS FOR AUTOMOBILES; SENDING UNITS FOR FUEL SYSTEMS FOR AUTOMOBILES (U.S. CLS. 19, 21, 23, 31, 35 AND 44).
FIRST USE 4-1-2000; IN COMMERCE 4-1-2000.

CLASS 35—ADVERTISING AND BUSINESS

FOR WHOLESALE ORDERING SERVICES IN THE FIELD OF AUTOMOTIVE PARTS AND ACCESSORIES; WHOLESALE DISTRIBUTORSHIPS FEATURING AUTOMOTIVE PARTS AND ACCESSORIES; RETAIL AUTOMOBILE PARTS AND ACCESSORIES STORES; CUSTOMER SERVICE IN THE FIELD OF RETAIL AND WHOLESALE STORE SERVICES AND ON-LINE RETAIL AND WHOLESALE STORE SERVICES; ON-LINE WHOLESALE AND RETAIL STORE SERVICES FEATURING AUTOMOTIVE PARTS AND ACCESSORIES; COMPUTERIZED ON-LINE RETAIL AND WHOLESALE STORE SERVICES IN THE FIELD OF AUTOMOTIVE PARTS AND ACCESSORIES (U.S. CLS. 100, 101 AND 102).
FIRST USE 4-1-2000; IN COMMERCE 4-1-2000.
LESLIE RICHARDS, EXAMINING ATTORNEY

SN 77-776,510. FUHU, INC., EL SEGUNDO, CA. FILED 7-8-2009.



THE COLOR(S) WHITE, RED, YELLOW, BLUE, TEAL AND BLACK IS/ARE CLAIMED AS A FEATURE OF THE MARK.

THE MARK CONSISTS OF DESIGN ELEMENTS ONLY. THE DESIGN IS OF THREE OVERLAPPING MISCELLANEOUS OVAL SHAPES THAT RESEMBLE THE SHAPE OF BEANS. THE OVAL LOCATED IN THE UPPER LEFT PORTION OF THE MARK APPEARS IN THE COLOR RED, THE OVAL LOCATED IN THE RIGHT PORTION OF THE MARK APPEARS IN THE COLOR BLUE, THE OVAL LOCATED IN THE BOTTOM PORTION OF THE MARK APPEARS IN THE COLOR YELLOW, THE OVERLAPPING AREA OF THE YELLOW AND BLUE OVALS IS TEAL, AND THE LOCATION WHERE THE THREE OVALS OVERLAP APPEARS IN THE COLOR BLACK. THE BACKGROUND COLOR IS WHITE.

CLASS 9—ELECTRICAL AND SCIENTIFIC APPARATUS

FOR DOWNLOADABLE SOFTWARE THAT ALLOWS PERSONALIZED INTERACTION OVER NETWORKED MEDIA BY ENABLING THE USER TO ORGANIZE, ACCESS, AND SHARE WITH OTHERS A PERSONALIZED WEB PAGE WHICH FUNCTIONS AS A ONE-STOP ACCESS AND DISTRIBUTION POINT TO A USER'S FAVORITE NEWS, INFORMATION, INTERNET APPLICATIONS, AND MULTIMEDIA CONTENT (U.S. CLS. 21, 23, 26, 36 AND 38).

CLASS 42—SCIENTIFIC AND COMPUTER SERVICES

FOR PROVIDING TEMPORARY USE OF ON-LINE NON-DOWNLOADABLE SOFTWARE THAT ALLOWS PERSONALIZED INTERACTION OVER NETWORKED MEDIA BY ENABLING THE USER TO ORGANIZE, ACCESS, AND SHARE WITH OTHERS A PERSONALIZED WEB PAGE WHICH FUNCTIONS AS A ONE-STOP ACCESS AND DISTRIBUTION POINT TO A USER'S FAVORITE NEWS, INFORMATION, INTERNET APPLICATIONS, AND MULTIMEDIA CONTENT (U.S. CLS. 100 AND 101).
JUDITH HELFMAN, EXAMINING ATTORNEY

SN 77-776,637. CERACASA, S.A., L'ALCORA, CASTELLON, SPAIN, FILED 7-8-2009.



PRIORITY CLAIMED UNDER SEC. 44(D) ON SPAIN APPLICATION NO. 2859949, FILED 1-20-2009, REG. NO. 2859949, DATED 5-20-2009, EXPIRES 1-20-2019.
OWNER OF U.S. REG. NOS. 2,783,929 AND 3,491,490.
THE MARK CONSISTS OF A ROUNDED RECTANGLE WITH INCOMPLETE CIRCLES ABOVE IT, INSIDE OF WHICH IS THE WORDING "BIONICTILE BY CERACASA".
THE WORDING "CERACASA" HAS NO MEANING IN A FOREIGN LANGUAGE.

CLASS 19—NON-METALLIC BUILDING MATERIALS

FOR NON-METAL WALL TILES EXCLUDING THOSE MADE WITH ADDITIVES, MORTAR AND CONCRETE; CERAMIC, STONEWARE AND PORCELAIN COVERINGS IN THE NATURE OF PAVING TILES AND NON-METAL FLOOR TILES, EXCLUDING THOSE MADE WITH ADDITIVES, MORTAR AND CONCRETE (U.S. CLS. 1, 12, 33 AND 50).

CLASS 27—FLOOR COVERINGS

FOR MATERIALS FOR COVERING EXISTING FLOORS, NAMELY, CARPETS, RUGS, DOOR AND BATH MATS, CARPET PADDING, LINOLEUM; NON-TEXTILE WALL HANGINGS (U.S. CLS. 19, 20, 37, 42 AND 50).

CLASS 35—ADVERTISING AND BUSINESS

FOR RETAIL SHOPS FEATURING ALL TYPES OF WALL TILES, CERAMIC PAVINGS, CERAMIC WALL AND FLOOR COVERINGS, STONEWARE PAVINGS, STONEWARE WALL AND FLOOR COVERINGS, AND FLOOR TILES; AND ONLINE RETAIL STORE SERVICES FEATURING ALL TYPES OF WALL TILES, CERAMIC PAVINGS, CERAMIC WALL AND FLOOR COVERINGS, STONEWARE PAVINGS, STONEWARE WALL AND FLOOR COVERINGS, AND FLOOR TILES (U.S. CLS. 100, 101 AND 102).

LESLIE RICHARDS, EXAMINING ATTORNEY

CLASS 9—ELECTRICAL AND SCIENTIFIC APPARATUS

FOR CABLES FOR ELECTRICAL OR OPTICAL TRANSMISSION; CABLE CONNECTORS; ELECTRICAL CABLE PATCH CORDS; OPTICAL PATCH CORDS; COMMUNICATION RACKS, CABINETS, ENCLOSURES, AND PATCH PANELS FOR USE IN CABLING OR WIRING OR FOR USE IN HOUSING COMMUNICATIONS EQUIPMENT; CABLE REELS; FACE PLATES FOR USE IN CABLING OR WIRING; ELECTRICAL CABLE OUTLETS; OPTICAL CABLE OUTLETS; MULTI-MEDIA BOXES AND ENCLOSURES FOR CABLING OR WIRING, FOR CONNECTING MULTIMEDIA DEVICES OR INPUT STREAMS, OR FOR HOUSING COMMUNICATIONS EQUIPMENT; CABLE OR CONNECTIVITY MANAGEMENT AND INSTALLATION ACCESSORIES, NAMELY, FILLER PANELS, GROUNDING BARS, POWER PANELS, REDUCERS, PATCH PANEL KITS, AND LINE SIGNAL SPLITTERS; CABLE OR CONNECTIVITY MANAGEMENT AND INSTALLATION ACCESSORIES, NAMELY, SEISMIC ANCHORING KITS SPECIALLY DESIGNED FOR COMMUNICATIONS RACKS AND COMMUNICATIONS EQUIPMENT CABINETS (U.S. CLS. 21, 23, 26, 36 AND 38).

FIRST USE 1-1-2010; IN COMMERCE 1-1-2010.
STEPHEN AQUILA, EXAMINING ATTORNEY

SN 77-777,473. OPTICAL CABLE CORPORATION, ROANOKE, VA. FILED 7-9-2009.



NO CLAIM IS MADE TO THE EXCLUSIVE RIGHT TO USE "OPTICAL CABLE CORPORATION", APART FROM THE MARK AS SHOWN.

THE COLOR(S) BLACK, RED, AND WHITE IS/ARE CLAIMED AS A FEATURE OF THE MARK.

THE MARK CONSISTS OF A STYLIZED DESIGN CONSISTING OF A TRIANGLE WITH THE UPPER PORTION OF THE TRIANGLE IN THE COLOR BLACK, THE MIDDLE PORTION OF THE TRIANGLE IN THE COLOR WHITE, AND THE BOTTOM PORTION OF THE TRIANGLE IN THE COLOR RED. IN THE MIDDLE OF THE TRIANGLE IS A BLACK DESIGN IN THE SHAPE OF THE LETTER "C". TO THE RIGHT OF THE TRIANGLE ARE THE LETTERS "OCC" IN UPPER CASE STYLIZED FONT AND IN THE COLOR RED. BENEATH THE DESIGN AND "OCC" ARE THE WORDS "OPTICAL CABLE CORPORATION" IN ALL UPPER CASE LETTERS IN A STYLIZED FONT AND IN THE COLOR BLACK. EACH OF THE "A'S" IN "OPTICAL CABLE CORPORATION" ARE INCOMPLETELY WRITTEN, EXCEPT FOR THE WHITE AREA WITHIN THE TRIANGLE, THE WHITE AREAS REPRESENT TRANSPARENT BACKGROUND AREAS.

CLASS 8—HAND TOOLS

FOR HAND TOOLS FOR USE WITH CABLES OR CONNECTIVITY PRODUCTS, NAMELY, FIBER STRIPPERS, FIBER CLEAVERS, AND FIBER CLEANERS (U.S. CLS. 23, 28 AND 44).

FIRST USE 1-1-2010; IN COMMERCE 1-1-2010.

SN 77-777,478. OPTICAL CABLE CORPORATION, ROANOKE, VA. FILED 7-9-2009.



THE COLOR(S) BLACK, RED, AND WHITE IS/ARE CLAIMED AS A FEATURE OF THE MARK.

THE MARK CONSISTS OF A STYLIZED DESIGN CONSISTING OF A TRIANGLE WITH THE UPPER PORTION OF THE TRIANGLE IN THE COLOR BLACK, THE MIDDLE PORTION OF THE TRIANGLE IN THE COLOR WHITE, AND THE BOTTOM PORTION OF THE TRIANGLE IN THE COLOR RED. IN THE MIDDLE OF THE TRIANGLE IS A BLACK DESIGN IN THE SHAPE OF THE LETTER "C". TO THE RIGHT OF THE TRIANGLE ARE THE LETTERS "OCC" IN UPPER CASE STYLIZED FONT AND IN THE COLOR RED. EXCEPT FOR THE WHITE AREA WITHIN THE TRIANGLE, THE WHITE AREAS REPRESENT TRANSPARENT BACKGROUND AREAS.

CLASS 8—HAND TOOLS

FOR HAND TOOLS FOR USE WITH CABLES OR CONNECTIVITY PRODUCTS, NAMELY, FIBER STRIPPERS, FIBER CLEAVERS, AND FIBER CLEANERS (U.S. CLS. 23, 28 AND 44).

FIRST USE 1-1-2010; IN COMMERCE 1-1-2010.

CLASS 9—ELECTRICAL AND SCIENTIFIC APPARATUS

FOR CABLES FOR ELECTRICAL OR OPTICAL TRANSMISSION; CABLE CONNECTORS; ELECTRICAL CABLE PATCH CORDS; OPTICAL PATCH CORDS; COMMUNICATION RACKS, CABINETS, ENCLOSURES, AND PATCH PANELS FOR USE IN CABLING OR WIRING OR FOR USE IN HOUSING COMMUNICATIONS EQUIPMENT; CABLE REELS; FACE PLATES FOR USE IN CABLING OR WIRING; ELECTRICAL CABLE OUTLETS; OPTICAL CABLE OUTLETS; MULTI-MEDIA BOXES AND ENCLOSURES FOR CABLING OR WIRING, FOR CONNECTING MULTIMEDIA DEVICES OR INPUT STREAMS, OR FOR HOUSING COMMUNICATIONS EQUIPMENT; CABLE OR CONNECTIVITY MANAGEMENT AND INSTALLATION ACCESSORIES, NAMELY, FILLER PANELS, GROUNDING BARS, POWER PANELS, REDUCERS, PATCH PANEL KITS, AND LINE SIGNAL SPLITTERS; CABLE OR CONNECTIVITY MANAGEMENT AND INSTALLATION ACCESSORIES, NAMELY, SEISMIC ANCHORING KITS SPECIALLY DESIGNED FOR COMMUNICATIONS RACKS AND COMMUNICATIONS EQUIPMENT CABINETS (U.S. CLS. 21, 23, 26, 36 AND 38).

FIRST USE 1-1-2010; IN COMMERCE 1-1-2010.
STEPHEN AQUILA, EXAMINING ATTORNEY

SN 77-778,196. BITTER BRILLIANCE, LLC, SMYRNA, GA. FILED 7-10-2009.



THE NAME(S), PORTRAIT(S), AND/OR SIGNATURE(S) SHOWN IN THE MARK DOES NOT IDENTIFY A PARTICULAR LIVING INDIVIDUAL.

THE MARK CONSISTS OF A PICTURE OF A MAN'S FACE WEARING GLASSES WITH THE WORDS "FRANK LEE" UNDERNEATH IT.

CLASS 25—CLOTHING

FOR CLOTHING, NAMELY, T-SHIRTS (U.S. CLS. 22 AND 39).

SN 77-778,178. BITTER BRILLIANCE, LLC, SMYRNA, GA. FILED 7-10-2009.

CLASS 41—EDUCATION AND ENTERTAINMENT

FOR ENTERTAINMENT SERVICES, NAMELY, PROVIDING A WEBSITE FEATURING PHOTOGRAPHIC, AUDIO, VIDEO AND PROSE PRESENTATIONS ON CURRENT EVENTS, CELEBRITY GOSSIP, POLITICS, AND SOCIAL ISSUES; ONLINE JOURNALS, NAMELY, BLOGS FEATURING COMMENTARY AND ADVICE ON CURRENT EVENTS, CELEBRITY GOSSIP, POLITICS, AND SOCIAL ISSUES; PROVIDING A WEBSITE PORTAL IN THE FIELD OF ENTERTAINMENT, CULTURAL AND SPORTING EVENTS (U.S. CLS. 100, 101 AND 107).
LAKEISHA LEWIS, EXAMINING ATTORNEY



THE COLOR(S) RED AND BLACK IS/ARE CLAIMED AS A FEATURE OF THE MARK.

THE MARK CONSISTS OF THE WORD "THAT'S" IN THE COLOR RED. THE WORD "TORN" IS UNDERNEATH IT IN BLACK WITH A RED EXCLAMATION POINT AFTER IT.

SN 77-778,768. INNER KNOWING, INC., LOS ANGELES, CA. FILED 7-10-2009.

CLASS 25—CLOTHING

FOR CLOTHING, NAMELY, T-SHIRTS (U.S. CLS. 22 AND 39).

The Simplicity of Stillness

THE MARK CONSISTS OF STANDARD CHARACTERS WITHOUT CLAIM TO ANY PARTICULAR FONT, STYLE, SIZE, OR COLOR.

CLASS 41—EDUCATION AND ENTERTAINMENT

FOR ENTERTAINMENT SERVICES, NAMELY, PROVIDING A WEBSITE FEATURING PHOTOGRAPHIC, AUDIO, VIDEO AND PROSE PRESENTATIONS ON CURRENT EVENTS, CELEBRITY GOSSIP, POLITICS, AND SOCIAL ISSUES; ONLINE JOURNALS, NAMELY, BLOGS FEATURING COMMENTARY AND ADVICE ON CURRENT EVENTS, CELEBRITY GOSSIP, POLITICS, AND SOCIAL ISSUES; PROVIDING A WEBSITE PORTAL IN THE FIELD OF ENTERTAINMENT, CULTURAL AND SPORTING EVENTS (U.S. CLS. 100, 101 AND 107).
LAKEISHA LEWIS, EXAMINING ATTORNEY

CLASS 9—ELECTRICAL AND SCIENTIFIC APPARATUS

FOR CDS, DVDS, DOWNLOADABLE MP3 FILES, DOWNLOADABLE MP3 RECORDINGS AND DOWNLOADABLE PODCASTS IN THE FIELD OF MEDITATION AND SPIRITUALITY (U.S. CLS. 21, 23, 26, 36 AND 38).

FIRST USE 4-20-2009; IN COMMERCE 5-7-2009.

CLASS 16—PAPER GOODS AND PRINTED MATTER

FOR A SERIES OF BOOKS, WRITTEN ARTICLES, HAND-OUTS, WORK-SHEETS, IN THE FIELD OF MEDITATION AND SPIRITUALITY; PRINTED MATTER, NAMELY, PAMPHLETS, NEWS RELEASES, BROCHURES, MEDIA KITS COMPRISED OF NEWS RELEASES AND EVENT SCHEDULES, ALL IN THE FIELD OF MEDITATION AND SPIRITUALITY; PHOTOGRAPHS AND STATIONERY (U.S. CLS. 2, 5, 22, 23, 29, 37, 38 AND 50).

FIRST USE 4-20-2009; IN COMMERCE 5-7-2009.

CLASS 41—EDUCATION AND ENTERTAINMENT

FOR EDUCATION SERVICES, NAMELY, PROVIDING CLASSES, SEMINARS, PROGRAMS, WORKSHOPS IN THE FIELD OF MEDITATION PRACTICES FOR ALL AGES; ENTERTAINMENT SERVICES, NAMELY, PROVIDING PODCASTS FEATURING MEDITATION PRACTICES FOR ALL AGES (U.S. CLS. 100, 101 AND 107).

FIRST USE 4-20-2009; IN COMMERCE 5-7-2009.

KATHRYN COWARD, EXAMINING ATTORNEY

SN 77-779,709. PENGUIN BRANDS, INC., SHARON HILL, PA. FILED 7-13-2009.



OWNER OF U.S. REG. NO. 3,312,108.

THE MARK CONSISTS OF A RECTANGULAR SHAPE WITH ROUNDED OFF UPPER CORNERS AND WITH AN INTERNAL TRIANGLE CUTOUT DEFINING TWO INWARDLY POINTING ARROWS THAT CREATE AN OPTICAL ILLUSION OF AN ARROW POINTING UPWARDS AND TWO HALF ARROWS EACH ONE POINTING TO AN ALTERNATE SIDE, ALL ABOVE THE WORD "NATHAN".

CLASS 9—ELECTRICAL AND SCIENTIFIC APPARATUS

FOR SAFETY PRODUCTS, NAMELY, REFLECTIVE AND ILLUMINATED CLOTHING FOR SAFETY PURPOSES, NAMELY, REFLECTIVE, FLUORESCENT AND L.E.D. VESTS, SLEEVES, SASHES, BELTS, GLOVES, HEADBANDS, WRIST BANDS, ARM BANDS, ANKLE BANDS, WRIST POCKETS, SHOE POCKETS; PROTECTIVE CARRYING CASES, NAMELY, CARRIERS, HOLDERS AND HOLSTERS FOR PORTABLE MUSIC PLAYERS (U.S. CLS. 21, 23, 26, 36 AND 38).

FIRST USE 1-15-2007; IN COMMERCE 1-15-2007.

CLASS 18—LEATHER GOODS

FOR BACKPACKS; KNAPSACKS; RUCKSACKS; HIP PACKS; LUMBAR PACKS; WAIST PACKS; FANNY PACKS; DUFFLE BAGS; ALL-PURPOSE SPORT GEAR BAGS; TRANSITION BAGS, NAMELY, SPORTS BAGS; POUCHES AND BAGS SOLD EMPTY FOR ATTACHMENT TO BACKPACKS, NAMELY, BACKPACK BOTTLE POCKETS, WATER BOTTLE CARRIERS, POUCHES FOR HYDRATION UNITS, AND REMOVABLE POCKETS (U.S. CLS. 1, 2, 3, 22 AND 41).

FIRST USE 1-15-2007; IN COMMERCE 1-15-2007.

CLASS 21—HOUSEWARES AND GLASS

FOR CONTAINERS FOR HOUSEHOLD USE, NAMELY, HOLDERS AND HOLSTERS SPECIALLY ADAPTED TO HOLD WATER BOTTLES, FLASKS AND HANDHELD BOTTLE HOLDERS; PERSONAL FLUID HYDRATION SYSTEMS COMPRISED OF A CARRYING PACK, A FLUID RESERVOIR, A DRINKING TUBE AND A MOUTHPIECE; BOTTLES SOLD EMPTY; PLASTIC SQUEEZE BOTTLES SOLD EMPTY; PLASTIC FLASKS SOLD EMPTY; BLADDER PACKS AND BACKPACK-STYLE CANTEENS, NAMELY, PERSONAL FLUID HYDRATION SYSTEMS COMPRISING A FLUID RESERVOIR, A DELIVERY TUBE, A MOUTHPIECE AND A CARRYING PACK; HYDRATION PACKS AND FLUID RESERVOIRS SOLD EMPTY, NAMELY, PERSONAL FLUID HYDRATION SYSTEMS COMPRISING A FLUID RESERVOIR AND A CARRYING PACK (U.S. CLS. 2, 13, 23, 29, 30, 33, 40 AND 50).

FIRST USE 1-15-2007; IN COMMERCE 1-15-2007.

CLASS 25—CLOTHING

FOR CLOTHING BELTS FEATURING THE ABILITY TO HOLD WATER BOTTLES AND FLASKS; RACE NUMBER BELTS (U.S. CLS. 22 AND 39).

FIRST USE 1-15-2007; IN COMMERCE 1-15-2007.

MARGARET POWER, EXAMINING ATTORNEY

SN 77-780,252. CAPITAL AREA FOOD BANK, WASHINGTON, DC 20017, DC. FILED 7-14-2009.

CAPITAL AREA FOOD BANK

THE MARK CONSISTS OF STANDARD CHARACTERS WITHOUT CLAIM TO ANY PARTICULAR FONT, STYLE, SIZE, OR COLOR.

NO CLAIM IS MADE TO THE EXCLUSIVE RIGHT TO USE "FOOD BANK", APART FROM THE MARK AS SHOWN.

SEC. 2(F).

CLASS 35—ADVERTISING AND BUSINESS

FOR CHARITABLE SERVICES, NAMELY, COORDINATION OF THE PROCUREMENT AND DISTRIBUTION OF FOOD DONATIONS FROM MANUFACTURERS, WHOLESALERS, RETAILERS, THE PUBLIC, AND GOVERNMENT AGENCIES AND PROVIDING FREE FOOD TO NEEDY PEOPLE (U.S. CLS. 100, 101 AND 102).

FIRST USE 9-0-1999; IN COMMERCE 9-0-1999.

CLASS 41—EDUCATION AND ENTERTAINMENT

FOR TRAINING SERVICES AND EDUCATIONAL SERVICES, NAMELY, CONDUCTING CLASSES AND WORKSHOPS IN THE FIELD OF CHARITABLE SERVICES, FOOD BANK SERVICES, HUNGER AND POVERTY AWARENESS AND DISTRIBUTING COURSE MATERIALS IN CONNECTION THEREWITH (U.S. CLS. 100, 101 AND 107).

FIRST USE 9-0-1999; IN COMMERCE 9-0-1999.

SHARON MEIER, EXAMINING ATTORNEY

SN 77-780,348. AMERICAN MAP CORPORATION, LONG ISLAND CITY, NY. FILED 7-14-2009.

SN 77-781,007. LOGISTICS MANAGEMENT INSTITUTE, MCLEAN, VA. FILED 7-14-2009.



THE MARK CONSISTS OF THE LETTERS "QNY" IN STYLIZED FORM, CONTAINED WITHIN A RECTANGULAR DOUBLE BORDER.

CLASS 9—ELECTRICAL AND SCIENTIFIC APPARATUS

FOR ELECTRONIC BOOKS AND NEWSLETTERS FEATURING GENERAL-INTEREST TOPICS, NAMELY, MEMOIR AND BIOGRAPHY, RELIGION AND SPIRITUALITY, SELF-HELP, HUMOR, RELATIONSHIPS, BUSINESS, GEOGRAPHY, LIFESTYLE, TRAVEL, ENGLISH-LANGUAGE TEACHING AND REFERENCE MATERIALS, RECORDED ON COMPUTER MEDIA; MAPS AND ATLASES RECORDED ON ELECTRONIC MEDIA; MAPPING SOFTWARE; FOREIGN LANGUAGE INSTRUCTION MATERIALS, NAMELY, AUDIO, AUDIO-VISUAL AND ELECTRONIC FOREIGN-LANGUAGE DICTIONARIES RECORDED ON ELECTRONIC MEDIA; AUDIO-VISUAL REFERENCE WORKS FEATURING GENERAL-INTEREST TOPICS, NAMELY, MEMOIR AND BIOGRAPHY, RELIGION AND SPIRITUALITY, SELF-HELP, HUMOR, RELATIONSHIPS, BUSINESS, GEOGRAPHY, LIFESTYLE, TRAVEL, ENGLISH-LANGUAGE TEACHING AND REFERENCE MATERIALS, ON FILM, AUDIO AND VIDEO TAPES, MICROCHIPS, HARD DRIVE, AND ELECTRONIC MEDIA; AUDIO REFERENCE WORKS FEATURING GENERAL-INTEREST TOPICS, NAMELY, MEMOIR AND BIOGRAPHY, RELIGION AND SPIRITUALITY, SELF-HELP, HUMOR, RELATIONSHIPS, BUSINESS, GEOGRAPHY, LIFESTYLE, TRAVEL, ENGLISH-LANGUAGE TEACHING AND REFERENCE MATERIALS, ON AUDIO AND VIDEO TAPES, MICROCHIPS, HARD DRIVE, AND ELECTRONIC MEDIA (U.S. CLS. 21, 23, 26, 36 AND 38).

CLASS 16—PAPER GOODS AND PRINTED MATTER

FOR PRINTED BOOKS AND NEWSLETTERS FEATURING INFORMATION ABOUT GENERAL-INTEREST TOPICS, NAMELY, MEMOIR AND BIOGRAPHY, RELIGION AND SPIRITUALITY, SELF-HELP, HUMOR, RELATIONSHIPS, BUSINESS, GEOGRAPHY, LIFESTYLE, TRAVEL, ENGLISH-LANGUAGE TEACHING AND REFERENCE MATERIALS; PRINTED MAPS AND ATLASES; PRINTED FOREIGN LANGUAGE INSTRUCTION MATERIALS AND DICTIONARIES; PHRASE BOOKS AND PRONUNCIATION GUIDES USED IN TEACHING FOREIGN LANGUAGES; GRAMMAR BOOKS; POSTCARDS (U.S. CLS. 2, 5, 22, 23, 29, 37, 38 AND 50).

MARTHA FROMM, EXAMINING ATTORNEY



THE COLOR(S) ORANGE, WHITE AND BLACK IS/ARE CLAIMED AS A FEATURE OF THE MARK.

THE MARK CONSISTS OF A TRIANGLE INSIDE A CIRCLE, EACH WITH A BLACK BORDER, AND EACH JOINT OF THE TRIANGLE CONNECTS TO A SOLID ORANGE SPHERE OR CIRCLE. AN ORANGE, JAGGED-EDGED, CIRCULAR SHAPE RESTS INSIDE THE LETTER "C" IN THE LITERAL TERM "OCEN" APPEARING IN BLACK BELOW THE AFOREMENTIONED TRIANGLE AND CIRCLE SHAPES WHICH APPEAR IN WHITE.

THE WORDING "OCEN" HAS NO MEANING IN A FOREIGN LANGUAGE.

CLASS 35—ADVERTISING AND BUSINESS

FOR BUSINESS CONSULTATION IN THE FIELDS OF BUSINESS ORGANIZATION AND MANAGEMENT, STRATEGIC PLANNING FOR BUSINESSES, ORGANIZATIONAL DEVELOPMENT, BUSINESS MODELING AND BUSINESS STRENGTHENING IN THE NATURE OF ASSISTING MANAGERS AND SENIOR EXECUTIVES WITH THEIR PARTICIPATION IN CROSS-ORGANIZATIONAL COLLABORATION AND COMMUNICATION, RESOLVING INFORMATION MANAGEMENT NETWORK ISSUES, NOT INVOLVING COMPUTER NETWORKS AND IMPLEMENTING COMPLEX BUSINESS POLICIES; BUSINESS CONSULTING SERVICES RELATING TO THE INTEGRATION OF THE AREAS OF BUSINESS PROCESS TECHNOLOGY, ORGANIZATIONAL LEARNING, CHANGE MANAGEMENT, BUSINESS RISK ASSESSMENT, SOCIAL NETWORK ANALYSIS OF RELATIONSHIPS WITHIN BUSINESSES AND OPERATIONAL SUSTAINABILITY; BUSINESS CONSULTING RELATING TO ASSESSING, DESIGNING AND MANAGING BUSINESS NETWORKS OF PEOPLE AND ORGANIZATIONS AND IMPROVING INTERAGENCY AND PUBLIC-PRIVATE INTERACTION EFFECTIVENESS; BUSINESS CONSULTING IN THE FIELD OF ESTABLISHING CORPORATE GOVERNANCE POLICIES AND STRUCTURES AND INSTITUTING AND ENHANCING COLLABORATIVE PARTICIPATION IN THE ORGANIZATION; BUSINESS SUCCESSION PLANNING; CONSULTING SERVICES IN THE FIELD OF HUMAN RESOURCES DEVELOPMENT, NAMELY, CONSULTING ON EMPLOYEE CAREER PATHS AND CAREER GROWTH; BUSINESS CONSULTING SERVICES RELATING TO LEADERSHIP STYLE ASSESSMENTS; CONDUCTING BUSINESS MANAGEMENT WORKFORCE RESEARCH SURVEYS FOR OTHERS FOR PURPOSES OF BUSINESS PROCESS IMPROVEMENT AND MANAGING AND ASSESSING EMPLOYEE INTERACTION NETWORKS (U.S. CLS. 100, 101 AND 102).

CLASS 41—EDUCATION AND ENTERTAINMENT

FOR PROFESSIONAL EXECUTIVE COACHING SERVICES AND COACHING AND LEARNING FORUMS IN THE FIELD OF LEADERSHIP DEVELOPMENT; EDUCATIONAL SERVICES, NAMELY, PROVIDING TRAINING IN THE NATURE OF CLASSES, SEMINARS, WORKSHOPS AND LECTURES FOR MANAGERS AND SENIOR EXECUTIVES ON THE SUCCESSFUL DESIGN, ASSESSMENT AND MANAGEMENT OF ORGANIZATIONAL NETWORKS; CAREER COUNSELING (U.S. CLS. 100, 101 AND 107).

DAVID COLLIER, EXAMINING ATTORNEY

SN 77-781,025. LOGISTICS MANAGEMENT INSTITUTE, MCLEAN, VA. FILED 7-14-2009.

SN 77-781,179. FACEFILE, INC., LAKEWOOD, CO. FILED 7-15-2009.

OCEN

THE MARK CONSISTS OF STANDARD CHARACTERS WITHOUT CLAIM TO ANY PARTICULAR FONT, STYLE, SIZE, OR COLOR.

THE WORDING "OCEN" HAS NO MEANING IN A FOREIGN LANGUAGE.

CLASS 35—ADVERTISING AND BUSINESS

FOR BUSINESS CONSULTATION IN THE FIELDS OF BUSINESS ORGANIZATION AND MANAGEMENT, STRATEGIC PLANNING FOR BUSINESSES, ORGANIZATIONAL DEVELOPMENT, BUSINESS MODELING AND BUSINESS STRENGTHENING IN THE NATURE OF ASSISTING MANAGERS AND SENIOR EXECUTIVES WITH THEIR PARTICIPATION IN CROSS-ORGANIZATIONAL COLLABORATION AND COMMUNICATION, RESOLVING INFORMATION MANAGEMENT NETWORK ISSUES, NOT INVOLVING COMPUTER NETWORKS AND IMPLEMENTING COMPLEX BUSINESS POLICIES; BUSINESS CONSULTING SERVICES RELATING TO THE INTEGRATION OF THE AREAS OF BUSINESS PROCESS TECHNOLOGY, ORGANIZATIONAL LEARNING, CHANGE MANAGEMENT, BUSINESS RISK ASSESSMENT, SOCIAL NETWORK ANALYSIS OF RELATIONSHIPS WITHIN BUSINESSES AND OPERATIONAL SUSTAINABILITY; BUSINESS CONSULTING RELATING TO ASSESSING, DESIGNING AND MANAGING BUSINESS NETWORKS OF PEOPLE AND ORGANIZATIONS AND IMPROVING INTERAGENCY AND PUBLIC-PRIVATE INTERACTION EFFECTIVENESS; BUSINESS CONSULTING IN THE FIELD OF ESTABLISHING CORPORATE GOVERNANCE POLICIES AND STRUCTURES AND INSTITUTING AND ENHANCING COLLABORATIVE PARTICIPATION IN THE ORGANIZATION; BUSINESS SUCCESSION PLANNING; CONSULTING SERVICES IN THE FIELD OF HUMAN RESOURCES DEVELOPMENT, NAMELY, CONSULTING ON EMPLOYEE CAREER PATHS AND CAREER GROWTH; BUSINESS CONSULTING SERVICES RELATING TO LEADERSHIP STYLE ASSESSMENTS; CONDUCTING BUSINESS MANAGEMENT WORKFORCE RESEARCH SURVEYS FOR OTHERS FOR PURPOSES OF BUSINESS PROCESS IMPROVEMENT AND MANAGING AND ASSESSING EMPLOYEE INTERACTION NETWORKS (U.S. CLS. 100, 101 AND 102).

CLASS 41—EDUCATION AND ENTERTAINMENT

FOR PROFESSIONAL EXECUTIVE COACHING SERVICES AND COACHING AND LEARNING FORUMS IN THE FIELD OF LEADERSHIP DEVELOPMENT; EDUCATIONAL SERVICES, NAMELY, PROVIDING TRAINING IN THE NATURE OF CLASSES, SEMINARS, WORKSHOPS AND LECTURES FOR MANAGERS AND SENIOR EXECUTIVES ON THE SUCCESSFUL DESIGN, ASSESSMENT AND MANAGEMENT OF ORGANIZATIONAL NETWORKS; CAREER COUNSELING (U.S. CLS. 100, 101 AND 107).

DAVID COLLIER, EXAMINING ATTORNEY

MY FACEFILE

THE MARK CONSISTS OF STANDARD CHARACTERS WITHOUT CLAIM TO ANY PARTICULAR FONT, STYLE, SIZE, OR COLOR.

OWNER OF U.S. REG. NO. 3,775,699.

CLASS 39—TRANSPORTATION AND STORAGE

FOR ON-LINE COMPUTER SERVICES FOR STORING CONTENT ITEMS SENT BY USERS FROM WIRELESS TELECOMMUNICATION NETWORKS; AND PROVIDING A WEB SITE FOR THE ELECTRONIC STORAGE OF DIGITAL PHOTOGRAPHS, VIDEOS AND DATA (U.S. CLS. 100 AND 105).

CLASS 45—PERSONAL AND LEGAL SERVICES

FOR SECURITY SERVICES, NAMELY, PROVIDING ELECTRONIC ALERTS NOTIFYING CONTACT PERSONS SELECTED BY THE USER WHEN AN ELECTRONIC FILE CONTAINING PHOTOGRAPHS OF POTENTIALLY THREATENING LOCATIONS AND/OR PEOPLE HAS BEEN ELECTRONICALLY STORED FOR THE PURPOSE OF PERSONAL SECURITY (U.S. CLS. 100 AND 101).

EUGENIA MARTIN, EXAMINING ATTORNEY

SN 77-781,381. RECKITT BENCKISER INC., PARSIPPANY, NJ. FILED 7-15-2009.

LEMON & LIME BLOSSOM

THE MARK CONSISTS OF STANDARD CHARACTERS WITHOUT CLAIM TO ANY PARTICULAR FONT, STYLE, SIZE, OR COLOR.

PRIORITY CLAIMED UNDER SEC. 44(D) ON ERPNCMNTY TM OFC APPLICATION NO. 8427171, FILED 7-15-2009, REG. NO. 8427171, DATED 1-27-2010, EXPIRES 7-15-2019.

NO CLAIM IS MADE TO THE EXCLUSIVE RIGHT TO USE "LEMON & LIME", APART FROM THE MARK AS SHOWN.

CLASS 3—COSMETICS AND CLEANING PREPARATIONS

FOR GENERAL PURPOSE CLEANERS WITH DISINFECTING PROPERTIES; ALL PURPOSE CLEANERS; CLEANING, POLISHING, ABRASIVE AND SCOURING PREPARATIONS FOR HOUSEHOLD, COMMERCIAL, INDUSTRIAL AND INSTITUTIONAL USE; LAUNDRY DETERGENTS; LAUNDRY ADDITIVES, NAMELY, LAUNDRY STARCH, LAUNDRY BLEACH, LAUNDRY BLUEING, LAUNDRY PRE-SOAK AND FABRIC SOFTENERS; LAUNDRY DRYER SHEETS; ALL PURPOSE TOILET AND BATHROOM CLEANING PREPARATIONS; DRAIN OPENING PREPARATIONS; LIME, RUST AND STAIN REMOVERS FOR TOILETS, BATH-TUBS, SINKS, TILES AND FLOORS; CLOTHS IMPREGNATED WITH CLEANING PREPARATIONS; DISPOSABLE WIPES IMPREGNATED WITH CLEANING PREPARATIONS FOR USE ON HOUSEHOLD SURFACES; SHAVING PREPARATIONS; DEODORANTS FOR PERSONAL USE; DENTIFRICES, MOUTHWASHES (U.S. CLS. 1, 4, 6, 50, 51 AND 52).

CLASS 5—PHARMACEUTICALS

FOR ALL PURPOSE DISINFECTING AND DEODORIZING PREPARATIONS; ALL PURPOSE DISINFECTANT SPRAY; ALL PURPOSE DISINFECTANTS FOR TOILET AND BATHROOM USE; GERMICIDES; SANITIZING PREPARATIONS FOR HOUSEHOLD, COMMERCIAL, INDUSTRIAL AND INSTITUTIONAL USE; ANTI-BACTERIAL PREPARATIONS; DISINFECTANTS FOR NEUTRALIZING, CONTROLLING OR REDUCING ALLERGENS; MITICIDES FOR DOMESTIC USE; PARASITICIDES FOR DOMESTIC USE; ROOM DEODORIZERS; AIR FRESHENERS, CARPET DEODORIZERS, ODOR NEUTRALIZING PREPARATIONS FOR USE ON CARPETS, SOFT FURNISHING, HOUSEHOLD SURFACES AND IN THE AIR (U.S. CLS. 6, 18, 44, 46, 51 AND 52).

LINDA M. KING, EXAMINING ATTORNEY

SN 77-781,704. DEUTSCHE WINDGUARD GMBH, VAREL, FED REP GERMANY, FILED 7-15-2009.

WindGuard

THE MARK CONSISTS OF STANDARD CHARACTERS WITHOUT CLAIM TO ANY PARTICULAR FONT, STYLE, SIZE, OR COLOR.

CLASS 39—TRANSPORTATION AND STORAGE

FOR CONSULTING SERVICES REGARDING THE DISTRIBUTION OF WIND ENERGY (U.S. CLS. 100 AND 105).

FIRST USE 0-0-2001; IN COMMERCE 0-0-2001.

CLASS 40—MATERIAL TREATMENT

FOR CONSULTING SERVICES REGARDING THE PRODUCTION OF WIND ENERGY (U.S. CLS. 100, 103 AND 106).

FIRST USE 0-0-2001; IN COMMERCE 0-0-2001.

CLASS 42—SCIENTIFIC AND COMPUTER SERVICES

FOR SCIENTIFIC TECHNICAL RESEARCH IN THE FIELD OF WIND ENERGY AND CONSULTING THEREOF (U.S. CLS. 100 AND 101).

FIRST USE 0-0-2001; IN COMMERCE 0-0-2001.

VERNA BETH RIRIE, EXAMINING ATTORNEY

SN 77-781,944. ACTIVECARE, INC., SALT LAKE CITY, UT. FILED 7-15-2009.

ACTIVECARE

THE MARK CONSISTS OF STANDARD CHARACTERS WITHOUT CLAIM TO ANY PARTICULAR FONT, STYLE, SIZE, OR COLOR.

CLASS 9—ELECTRICAL AND SCIENTIFIC APPARATUS

FOR PERSONAL TRANSMITTING AND RECEIVING UNITS FOR PROVIDING REMOTE ACCESS TO EMERGENCY, SAFETY AND CONVENIENCE SERVICES, NAMELY, PERSONNEL TRACKING DEVICES; PERSONAL SECURITY ALARMS; ELECTRONIC PERSONAL ALARM DEVICES; GPS TRACKING AND LOCATION DEVICES; TRANSMITTING AND RECEIVING UNITS FOR PROVIDING REMOTE ACCESS TO EMERGENCY, SAFETY AND CONVENIENCE SERVICES, NAMELY, HOME SECURITY SYSTEMS COMPRISING WINDOW SENSORS, DOOR SENSORS, MOTION DETECTORS AND TRANSMITTING AND RECEIVING UNITS; HOME SECURITY ALARMS (U.S. CLS. 21, 23, 26, 36 AND 38).

CLASS 10—MEDICAL APPARATUS

FOR PERSONAL TRANSMITTING AND RECEIVING UNITS FOR REMOTELY MONITORING THE HEALTH OR CONDITION OF AN INDIVIDUAL OR GROUP OF INDIVIDUALS AND FOR PROVIDING REMOTE ACCESS TO EMERGENCY, SAFETY AND CONVENIENCE SERVICES, NAMELY, ELECTRONIC PERSONAL MONITORS TO REMOTELY MONITOR PHYSIOLOGICAL DATA AND HAVING CELLULAR OR RADIO FREQUENCY COMMUNICATION CAPABILITIES (U.S. CLS. 26, 39 AND 44).

CLASS 44—MEDICAL, BEAUTY AND AGRICULTURAL SERVICES

FOR REMOTE EMERGENCY, CONVENIENCE AND MONITORING SUPPORT SERVICES, NAMELY, REMOTE MONITORING OF THE HEALTH OR CONDITION OF AN INDIVIDUAL OR GROUP OF INDIVIDUALS (U.S. CLS. 100 AND 101).

CLASS 45—PERSONAL AND LEGAL SERVICES

FOR REMOTE EMERGENCY, CONVENIENCE AND MONITORING SUPPORT SERVICES, NAMELY, REMOTE MONITORING OF THE LOCATION AND STATUS OF AN INDIVIDUAL OR GROUP OF INDIVIDUALS FOR SECURITY AND SAFETY PURPOSES AND PROVIDING REMOTE ACCESS TO EMERGENCY AND CONVENIENCE SUPPORT SERVICES; MONITORING SERVICES, NAMELY, REMOTE MEDICAL ALARM MONITORING SERVICES (U.S. CLS. 100 AND 101).

TRACY FLETCHER, EXAMINING ATTORNEY

SN 77-782,021. ACTIVECARE, INC., SALT LAKE CITY, UT.
FILED 7-15-2009.

SN 77-782,032. ACTIVECARE, INC., SALT LAKE CITY, UT.
FILED 7-15-2009.

ACTIVEONE

ACTIVEONE+

THE MARK CONSISTS OF STANDARD CHARACTERS WITHOUT CLAIM TO ANY PARTICULAR FONT, STYLE, SIZE, OR COLOR.

THE MARK CONSISTS OF STANDARD CHARACTERS WITHOUT CLAIM TO ANY PARTICULAR FONT, STYLE, SIZE, OR COLOR.

CLASS 9—ELECTRICAL AND SCIENTIFIC APPARATUS

FOR PERSONAL TRANSMITTING AND RECEIVING UNITS FOR PROVIDING REMOTE ACCESS TO EMERGENCY, SAFETY AND CONVENIENCE SERVICES, NAMELY, PERSONNEL TRACKING DEVICES; PERSONAL SECURITY ALARMS; ELECTRONIC PERSONAL ALARM DEVICES; GPS TRACKING AND LOCATION DEVICES; TRANSMITTING AND RECEIVING UNITS FOR PROVIDING REMOTE ACCESS TO EMERGENCY, SAFETY AND CONVENIENCE SERVICES, NAMELY, HOME SECURITY SYSTEMS COMPRISING WINDOW SENSORS, DOOR SENSORS, MOTION DETECTORS AND TRANSMITTING AND RECEIVING UNITS; HOME SECURITY ALARMS (U.S. CLS. 21, 23, 26, 36 AND 38).

CLASS 9—ELECTRICAL AND SCIENTIFIC APPARATUS

FOR PERSONAL TRANSMITTING AND RECEIVING UNITS FOR PROVIDING REMOTE ACCESS TO EMERGENCY, SAFETY AND CONVENIENCE SERVICES, NAMELY, PERSONNEL TRACKING DEVICES; PERSONAL SECURITY ALARMS; ELECTRONIC PERSONAL ALARM DEVICES; GPS TRACKING AND LOCATION DEVICES; TRANSMITTING AND RECEIVING UNITS FOR PROVIDING REMOTE ACCESS TO EMERGENCY, SAFETY AND CONVENIENCE SERVICES, NAMELY, HOME SECURITY SYSTEMS COMPRISING WINDOW SENSORS, DOOR SENSORS, MOTION DETECTORS AND TRANSMITTING AND RECEIVING UNITS; HOME SECURITY ALARMS (U.S. CLS. 21, 23, 26, 36 AND 38).

CLASS 10—MEDICAL APPARATUS

FOR PERSONAL TRANSMITTING AND RECEIVING UNITS FOR REMOTELY MONITORING THE HEALTH OR CONDITION OF AN INDIVIDUAL OR GROUP OF INDIVIDUALS AND FOR PROVIDING REMOTE ACCESS TO EMERGENCY, SAFETY AND CONVENIENCE SERVICES, NAMELY, ELECTRONIC PERSONAL MONITORS TO REMOTELY MONITOR PHYSIOLOGICAL DATA AND HAVING CELLULAR OR RADIO FREQUENCY COMMUNICATION CAPABILITIES (U.S. CLS. 26, 39 AND 44).

CLASS 10—MEDICAL APPARATUS

FOR PERSONAL TRANSMITTING AND RECEIVING UNITS FOR REMOTELY MONITORING THE HEALTH OR CONDITION OF AN INDIVIDUAL OR GROUP OF INDIVIDUALS AND FOR PROVIDING REMOTE ACCESS TO EMERGENCY, SAFETY AND CONVENIENCE SERVICES, NAMELY, ELECTRONIC PERSONAL MONITORS TO REMOTELY MONITOR PHYSIOLOGICAL DATA AND HAVING CELLULAR OR RADIO FREQUENCY COMMUNICATION CAPABILITIES (U.S. CLS. 26, 39 AND 44).

CLASS 44—MEDICAL, BEAUTY AND AGRICULTURAL SERVICES

FOR REMOTE EMERGENCY, CONVENIENCE AND MONITORING SUPPORT SERVICES, NAMELY, REMOTE MONITORING OF THE HEALTH OR CONDITION OF AN INDIVIDUAL OR GROUP OF INDIVIDUALS (U.S. CLS. 100 AND 101).

CLASS 44—MEDICAL, BEAUTY AND AGRICULTURAL SERVICES

FOR REMOTE EMERGENCY, CONVENIENCE AND MONITORING SUPPORT SERVICES, NAMELY, REMOTE MONITORING OF THE HEALTH OR CONDITION OF AN INDIVIDUAL OR GROUP OF INDIVIDUALS (U.S. CLS. 100 AND 101).

CLASS 45—PERSONAL AND LEGAL SERVICES

FOR REMOTE EMERGENCY, CONVENIENCE AND MONITORING SUPPORT SERVICES, NAMELY, REMOTE MONITORING OF THE LOCATION AND STATUS OF AN INDIVIDUAL OR GROUP OF INDIVIDUALS FOR SECURITY AND SAFETY PURPOSES AND PROVIDING REMOTE ACCESS TO EMERGENCY AND CONVENIENCE SUPPORT SERVICES; MONITORING SERVICES, NAMELY, REMOTE MEDICAL ALARM MONITORING SERVICES (U.S. CLS. 100 AND 101).

CLASS 45—PERSONAL AND LEGAL SERVICES

FOR REMOTE EMERGENCY, CONVENIENCE AND MONITORING SUPPORT SERVICES, NAMELY, REMOTE MONITORING OF THE LOCATION AND STATUS OF AN INDIVIDUAL OR GROUP OF INDIVIDUALS FOR SECURITY AND SAFETY PURPOSES AND PROVIDING REMOTE ACCESS TO EMERGENCY AND CONVENIENCE SUPPORT SERVICES; MONITORING SERVICES, NAMELY, REMOTE MEDICAL ALARM MONITORING SERVICES (U.S. CLS. 100 AND 101).

TRACY FLETCHER, EXAMINING ATTORNEY

TRACY FLETCHER, EXAMINING ATTORNEY

SN 77-782,259. WORLD TENPIN BOWLING ASSOCIATION, ARLINGTON, TX. FILED 7-16-2009.

SN 77-782,340. AFFILIATE SUMMIT, INC., NEW PROVIDENCE, NJ. FILED 7-16-2009.

WTBA WORLD BOWLING TOUR

THE MARK CONSISTS OF STANDARD CHARACTERS WITHOUT CLAIM TO ANY PARTICULAR FONT, STYLE, SIZE, OR COLOR.

NO CLAIM IS MADE TO THE EXCLUSIVE RIGHT TO USE "WORLD BOWLING TOUR", APART FROM THE MARK AS SHOWN.

CLASS 35—ADVERTISING AND BUSINESS

FOR PROMOTIONAL SPONSORSHIP OF BOWLING TOURNAMENTS AND EXHIBITIONS (U.S. CLS. 100, 101 AND 102).

CLASS 36—INSURANCE AND FINANCIAL

FOR FINANCIAL SPONSORSHIP OF BOWLING TOURNAMENTS AND EXHIBITIONS (U.S. CLS. 100, 101 AND 102).

CLASS 41—EDUCATION AND ENTERTAINMENT

FOR ENTERTAINMENT SERVICES, NAMELY, ARRANGING, ORGANIZING, AND CONDUCTING BOWLING TOURNAMENTS AND EXHIBITIONS (U.S. CLS. 100, 101 AND 107).

LEIGH CAROLINE CASE, EXAMINING ATTORNEY

SN 77-782,331. AFFILIATE SUMMIT, INC., NEW PROVIDENCE, NJ. FILED 7-16-2009.

FEEDFRONT

THE MARK CONSISTS OF STANDARD CHARACTERS WITHOUT CLAIM TO ANY PARTICULAR FONT, STYLE, SIZE, OR COLOR.

CLASS 9—ELECTRICAL AND SCIENTIFIC APPARATUS

FOR ELECTRONIC PUBLICATIONS, NAMELY, MAGAZINES FEATURING ARTICLES, COLUMNS AND POSTS IN THE FIELD OF ONLINE AFFILIATE MARKETING RECORDED ON COMPUTER MEDIA (U.S. CLS. 21, 23, 26, 36 AND 38).

FIRST USE 5-1-2008; IN COMMERCE 5-1-2008.

CLASS 16—PAPER GOODS AND PRINTED MATTER

FOR MAGAZINES FEATURING ARTICLES AND COLUMNS IN THE FIELD OF ONLINE AFFILIATE MARKETING (U.S. CLS. 2, 5, 22, 23, 29, 37, 38 AND 50).

FIRST USE 5-1-2008; IN COMMERCE 5-1-2008.
AMEEN IMAM, EXAMINING ATTORNEY



THE COLOR(S) BLUE AND WHITE IS/ARE CLAIMED AS A FEATURE OF THE MARK.

THE MARK CONSISTS OF THE STYLIZED WORD "FEEDFRONT"; THE WORD "FEED" IS OUTLINED IN DARK BLUE WITH A LIGHTER BLUE FILING THAT BECOMES LIGHTER FROM THE BOTTOM OF THE LETTERS TO THE TOP; THE STYLIZED WORD "FRONT" IS OUTLINED IN WHITE WITH THE LETTERS "FR" AND "NT" IN SOLID BLUE FILLING; A STYLIZED DRAWING OF TWO MOUNTAIN PEAKS IN LIGHT BLUE IS IN THE LETTER "O".

CLASS 9—ELECTRICAL AND SCIENTIFIC APPARATUS

FOR ELECTRONIC PUBLICATIONS, NAMELY, MAGAZINES FEATURING ARTICLES, COLUMNS AND POSTS IN THE FIELD OF ONLINE AFFILIATE MARKETING RECORDED ON COMPUTER MEDIA (U.S. CLS. 21, 23, 26, 36 AND 38).

FIRST USE 5-1-2008; IN COMMERCE 5-1-2008.

CLASS 16—PAPER GOODS AND PRINTED MATTER

FOR MAGAZINES FEATURING ARTICLES AND COLUMNS IN THE FIELD OF ONLINE AFFILIATE MARKETING (U.S. CLS. 2, 5, 22, 23, 29, 37, 38 AND 50).

FIRST USE 5-1-2008; IN COMMERCE 5-1-2008.

AMEEN IMAM, EXAMINING ATTORNEY

SN 77-782,914. THERMO STRUCTURE INC., MASCOCHE, QUEBEC, CANADA, FILED 7-16-2009.

TIMBER BLOCK

THE MARK CONSISTS OF STANDARD CHARACTERS WITHOUT CLAIM TO ANY PARTICULAR FONT, STYLE, SIZE, OR COLOR.

OWNER OF CANADA REG. NO. 716254, DATED 6-10-2008, EXPIRES 6-10-2023.

NO CLAIM IS MADE TO THE EXCLUSIVE RIGHT TO USE "TIMBER", APART FROM THE MARK AS SHOWN.

CLASS 19—NON-METALLIC BUILDING MATERIALS

FOR PRE-FABRICATED WOOD HOUSES AND LOG HOUSES; COMPOSITES AND COMPONENTS SOLD AS KITS FOR WOODEN HOUSES AND LOG HOUSES (U.S. CLS. 1, 12, 33 AND 50).

CLASS 37—CONSTRUCTION AND REPAIR

FOR CONSTRUCTION OF WOOD HOUSES AND LOG HOUSES; TECHNICAL SUPPORT SERVICES, NAMELY, TECHNICAL ADVICE RELATED TO THE INSTALLATION OF LOG AND WOOD HOUSES AND OF COMPOSITES AND COMPONENTS SOLD AS KITS FOR WOODEN HOUSES AND LOG HOUSES (U.S. CLS. 100, 103 AND 106).

SHAUNIA CARLYLE, EXAMINING ATTORNEY

SN 77-783,408. ALLRECIPES.COM, INC., SEATTLE, WA. FILED 7-17-2009.

STIR THINGS UP

THE MARK CONSISTS OF STANDARD CHARACTERS WITHOUT CLAIM TO ANY PARTICULAR FONT, STYLE, SIZE, OR COLOR.

CLASS 16—PAPER GOODS AND PRINTED MATTER

FOR PUBLICATIONS, NAMELY, BOOKS, MAGAZINES, NEWSLETTERS, MANUALS, PERIODICALS AND BROCHURES FEATURING INFORMATION, ARTICLES, AND DISCUSSION ABOUT FOOD, COOKING, RECIPES, COOKING TIPS, RECIPE REVIEWS, WINE, BEVERAGES, NUTRITION, ENTERTAINING, DINING, KITCHENWARE AND COOKING EQUIPMENT AND ACCESSORIES (U.S. CLS. 2, 5, 22, 23, 29, 37, 38 AND 50).

CLASS 35—ADVERTISING AND BUSINESS

FOR COMPUTERIZED ON-LINE WHOLESALE AND RETAIL STORE SERVICES FEATURING KITCHENWARE, COOKING EQUIPMENT AND ACCESSORIES, SPECIALTY FOODS, COOKING PUBLICATIONS, AND FURNITURE (U.S. CLS. 100, 101 AND 102).

CLASS 43—HOTEL AND RESTAURANT SERVICES

FOR PROVIDING INFORMATION ABOUT COOKING, RECIPES, WINE CHARACTERISTICS AND FOOD, BEVERAGE AND BAKING PREPARATION VIA A GLOBAL COMPUTER NETWORK (U.S. CLS. 100 AND 101).

GENE MACIOL, EXAMINING ATTORNEY

SN 77-782,926. ST. LOUIS SOCCER UNITED, LLC, EAST ALTON, IL. FILED 7-16-2009.



THE MARK CONSISTS OF THE SHAPE OF A SHIELD, WITH A SYMBOL IN THE MIDDLE OF THE SHIELD WHICH IS A CROWN WITH A SWORD COMING UP THROUGH IT.

CLASS 16—PAPER GOODS AND PRINTED MATTER

FOR PRINTED MATTER RELATED TO A PROFESSIONAL SOCCER TEAM, NAMELY, POSTERS, STICKERS, TRADING CARDS, PROGRAMS, TICKETS AND MAGAZINES REGARDING SOCCER (U.S. CLS. 2, 5, 22, 23, 29, 37, 38 AND 50).

CLASS 18—LEATHER GOODS

FOR BACKPACKS, DUFFEL BAGS AND CARRY ALL BAGS (U.S. CLS. 1, 2, 3, 22 AND 41).

CLASS 25—CLOTHING

FOR APPAREL, NAMELY, T-SHIRTS, JERSEYS, SHORTS, PANTS, JACKETS, SWEATSHIRTS, HATS, SWEATERS AND FOOTWEAR (U.S. CLS. 22 AND 39).

CLASS 41—EDUCATION AND ENTERTAINMENT

FOR ENTERTAINMENT SERVICES, NAMELY, ORGANIZING, CONDUCTING AND STAGING PROFESSIONAL SOCCER GAMES AND EXHIBITIONS; PRODUCTION OF RADIO AND TELEVISION PROGRAMS IN THE NATURE OF PROFESSIONAL SOCCER GAMES AND EXHIBITIONS; PROVIDING INFORMATION VIA A GLOBAL INFORMATION NETWORK FOR THE TRANSFER AND DISSEMINATION OF INFORMATION ON EDUCATION, ENTERTAINMENT AND SPORTS (U.S. CLS. 100, 101 AND 107).

JACQUELINE A. LAVINE, EXAMINING ATTORNEY

SN 77-783,468. NANTAHALA OUTDOOR CENTER, INC., BRYSON CITY, NC. FILED 7-17-2009.

THE GREAT OUTPOST

THE MARK CONSISTS OF STANDARD CHARACTERS WITHOUT CLAIM TO ANY PARTICULAR FONT, STYLE, SIZE, OR COLOR.

CLASS 25—CLOTHING

FOR CLOTHING, NAMELY, SHIRTS, T-SHIRTS, HEADWEAR, FOOTWEAR, PANTS, SHORTS, JACKETS, TOPS, AND BOTTOMS (U.S. CLS. 22 AND 39).

CLASS 35—ADVERTISING AND BUSINESS

FOR ON-LINE AND RETAIL STORE SERVICES FEATURING OUTDOOR AND WILDERNESS EQUIPMENT, CLOTHING, FOOTWEAR, GIFTS AND LOGO ITEMS, EYEWEAR, PERSONAL ITEMS, GROCERIES, PUBLICATIONS, BOOKS, MAPS, VIDEOS, AND DVDS; PROMOTING THE GOODS AND SERVICES OF OTHERS THROUGH THE DISTRIBUTION OF PURCHASE INCENTIVE GIFT CERTIFICATES AND PARTNERSHIP PROMOTIONS; PROMOTING THE GOODS AND SERVICES OF OTHERS BY ARRANGING FOR SPONSORS TO AFFILIATE THEIR GOODS AND SERVICES WITH ORGANIZED OUTDOOR EVENTS, ACTIVITIES, AND VENUES (U.S. CLS. 100, 101 AND 102).

CLASS 39—TRANSPORTATION AND STORAGE

FOR TRAVEL GUIDE SERVICES, NAMELY, ORGANIZING AND LEADING TRIPS INVOLVING KAYAKING, RIVER RUNNING, WHITEWATER RIVER RAFTING, LAKE TOURS, FLY FISHING, BIKING, HIKING, AND OTHER OUTDOOR ADVENTURES WITHIN THE UNITED STATES AND ABROAD; ORGANIZING AND LEADING CUSTOMIZED GROUP ADVENTURE OUTDOOR EXCURSIONS, DAY TRIPS AND SIGHTSEEING TOURS; WHITEWATER AND FLAT-WATER CANOE AND KAYAK RENTALS, INFLATABLE KAYAK AND RAFT RENTALS, ROAD AND MOUNTAIN BIKE RENTALS, CAMPING TRAILER AND VAN RENTALS (U.S. CLS. 100 AND 105).

CLASS 41—EDUCATION AND ENTERTAINMENT

FOR INSTRUCTIONAL AND EDUCATIONAL SERVICES, NAMELY, OFFERING COURSES IN CANOEING, KAYAKING, WHITEWATER RIVER RUNNING, RIVER GUIDE TRAINING, AND WILDERNESS MEDICINE, OUTDOOR LEADERSHIP; OFFERING OUTDOOR EDUCATION PROGRAMS TO HELP YOUTH GROUPS EARN MERIT BADGES AND INTEREST PROJECT AWARDS; OFFERING OUTDOOR GROUP ADVENTURE AND EDUCATION PROGRAMS, NAMELY, ROPES COURSES, AN ALPINE CLIMBING TOWER, PERSONAL DEVELOPMENT AND TEAM BUILDING THROUGH OUTDOOR ACTIVITIES; PROVIDING NEWSLETTERS IN THE FIELD OF RECREATION SERVICES VIA E-MAIL; RECREATIONAL SERVICES, NAMELY, PROVIDING MOUNTAIN BIKING TRAILS; ENTERTAINMENT IN THE NATURE OF FOOT AND WATERCRAFT RACES AND COMMUNITY FESTIVALS FEATURING ENVIRONMENTAL EDUCATION AND CUSTOMER APPRECIATION FESTIVITIES (U.S. CLS. 100, 101 AND 107).

CYNTHIA SLOAN, EXAMINING ATTORNEY

SN 77-783,527. ALCHEMY WORLDWIDE, LLC, SHERMAN OAKS, CA. FILED 7-17-2009.

FAT LOSS SOLOS

THE MARK CONSISTS OF STANDARD CHARACTERS WITHOUT CLAIM TO ANY PARTICULAR FONT, STYLE, SIZE, OR COLOR.

NO CLAIM IS MADE TO THE EXCLUSIVE RIGHT TO USE "FAT LOSS", APART FROM THE MARK AS SHOWN.

CLASS 9—ELECTRICAL AND SCIENTIFIC APPARATUS

FOR PRE-RECORDED VIDEOTAPES, DIGITAL VIDEO DISCS AND DVDS FEATURING EXERCISE, NUTRITION AND WEIGHT LOSS (U.S. CLS. 21, 23, 26, 36 AND 38).

CLASS 16—PAPER GOODS AND PRINTED MATTER

FOR PRINTED MATERIALS, NAMELY, BOOKS, MAGAZINES, PERIODICALS AND NEWSLETTERS IN THE FIELDS OF HEALTH, NUTRITION AND WEIGHT LOSS, AND RELATED PRODUCTS AND SERVICES (U.S. CLS. 2, 5, 22, 23, 29, 37, 38 AND 50).

CLASS 35—ADVERTISING AND BUSINESS

FOR PRODUCING AUDIO OR VIDEO FOR INFORMATIONALS FEATURING EXERCISE, NUTRITION, CONSUMER PRODUCT AND SERVICES INFORMATION AND WEIGHT LOSS PRODUCTS; PROVIDING CONSUMER INFORMATION IN THE FIELDS OF HEALTH, NUTRITION AND WEIGHT LOSS PRODUCTS AND SERVICES VIA THE GLOBAL COMPUTER NETWORK (U.S. CLS. 100, 101 AND 102).

CLASS 41—EDUCATION AND ENTERTAINMENT

FOR ENTERTAINMENT IN THE NATURE OF ONGOING TELEVISION PROGRAMS IN THE FIELD OF EXERCISE, NUTRITION AND WEIGHT LOSS (U.S. CLS. 100, 101 AND 107).

ROBERT C. CLARK JR., EXAMINING ATTORNEY

SN 77-783,533. ALCHEMY WORLDWIDE, LLC, SHERMAN OAKS, CA. FILED 7-17-2009.

21 DAYS THAT WILL CHANGE
YOUR BODY... AND YOUR LIFE

THE MARK CONSISTS OF STANDARD CHARACTERS WITHOUT CLAIM TO ANY PARTICULAR FONT, STYLE, SIZE, OR COLOR.

CLASS 9—ELECTRICAL AND SCIENTIFIC APPARATUS

FOR PRE-RECORDED VIDEOTAPES, DIGITAL VIDEO DISCS AND DVDS FEATURING EXERCISE, NUTRITION AND WEIGHT LOSS (U.S. CLS. 21, 23, 26, 36 AND 38).

CLASS 16—PAPER GOODS AND PRINTED MATTER

FOR PRINTED MATERIALS, NAMELY, BOOKS, MAGAZINES, PERIODICALS AND NEWSLETTERS IN THE FIELDS OF HEALTH, NUTRITION AND WEIGHT LOSS, AND RELATED PRODUCTS AND SERVICES (U.S. CLS. 2, 5, 22, 23, 29, 37, 38 AND 50).

CLASS 35—ADVERTISING AND BUSINESS

FOR PRODUCING AUDIO OR VIDEO FOR INFO-MERCIALS FEATURING EXERCISE, NUTRITION, CONSUMER PRODUCT AND SERVICES INFORMATION AND WEIGHT LOSS PRODUCTS; PROVIDING CONSUMER INFORMATION IN THE FIELDS OF HEALTH, NUTRITION AND WEIGHT LOSS PRODUCTS AND SERVICES VIA THE GLOBAL COMPUTER NETWORK (U.S. CLS. 100, 101 AND 102).

CLASS 41—EDUCATION AND ENTERTAINMENT

FOR ENTERTAINMENT IN THE NATURE OF ONGOING TELEVISION PROGRAMS IN THE FIELD OF EXERCISE, NUTRITION AND WEIGHT LOSS (U.S. CLS. 100, 101 AND 107).

ROBERT C. CLARK JR., EXAMINING ATTORNEY

SN 77-783,767. SOUTHERN FOODS USA, INC., ASTORIA, NY. FILED 7-17-2009.

RUPSHA

THE MARK CONSISTS OF STANDARD CHARACTERS WITHOUT CLAIM TO ANY PARTICULAR FONT, STYLE, SIZE, OR COLOR.

THE WORDING "RUPSHA" HAS NO MEANING IN A FOREIGN LANGUAGE.

CLASS 29—MEATS AND PROCESSED FOODS

FOR BUTTER; CANNED FRUIT; CANNED VEGETABLES; DRIED LENTILS; EDIBLE OILS; FISH, NAMELY, FROZEN FISH; FROZEN FRUIT; FROZEN VEGETABLES; GHEE; PICKLES; SEAFOOD, NAMELY, FROZEN SEAFOOD (U.S. CL. 46).

FIRST USE 6-20-2007; IN COMMERCE 6-20-2007.

CLASS 30—STAPLE FOODS

FOR RICE; EDIBLE SPICES; COFFEE; TEA; COOKIES (U.S. CL. 46).

FIRST USE 6-20-2007; IN COMMERCE 6-20-2007.
KRISTIN CARLSON, EXAMINING ATTORNEY

SN 77-783,804. SOUTHERN FOODS USA, INC., ASTORIA, NY. FILED 7-17-2009.

RUPSHA BRAND

THE MARK CONSISTS OF STANDARD CHARACTERS WITHOUT CLAIM TO ANY PARTICULAR FONT, STYLE, SIZE, OR COLOR.

NO CLAIM IS MADE TO THE EXCLUSIVE RIGHT TO USE "BRAND", APART FROM THE MARK AS SHOWN.

THE WORDING "RUPSHA" HAS NO MEANING IN A FOREIGN LANGUAGE.

CLASS 29—MEATS AND PROCESSED FOODS

FOR BUTTER; CANNED FRUIT; CANNED VEGETABLES; DRIED LENTILS; EDIBLE OILS; FISH, NAMELY, FROZEN FISH; FROZEN FRUIT; FROZEN VEGETABLES; GHEE; PICKLES; SEAFOOD, NAMELY, FROZEN SEAFOOD (U.S. CL. 46).

FIRST USE 6-20-2007; IN COMMERCE 6-20-2007.

CLASS 30—STAPLE FOODS

FOR RICE; EDIBLE SPICES; COFFEE; TEA; COOKIES (U.S. CL. 46).

FIRST USE 6-20-2007; IN COMMERCE 6-20-2007.
KRISTIN CARLSON, EXAMINING ATTORNEY

SN 77-784,053. REMINISCENT CONFECTIONS HOLDINGS, LLC, COLORADO SPRINGS, CO. FILED 7-17-2009.

REMINISCENT CONFECTIONS

THE MARK CONSISTS OF STANDARD CHARACTERS WITHOUT CLAIM TO ANY PARTICULAR FONT, STYLE, SIZE, OR COLOR.

NO CLAIM IS MADE TO THE EXCLUSIVE RIGHT TO USE "CONFECTIONS", APART FROM THE MARK AS SHOWN.

CLASS 30—STAPLE FOODS

FOR (BASED ON INTENT TO USE) CAKES; CANDY; ICE CREAM (U.S. CL. 46).

CLASS 35—ADVERTISING AND BUSINESS

FOR (BASED ON USE IN COMMERCE) RETAIL CANDY STORES (U.S. CLS. 100, 101 AND 102).

FIRST USE 8-20-2009; IN COMMERCE 8-20-2009.
WON TEAK OH, EXAMINING ATTORNEY

SN 77-784,435. CHESSCUBE (PROPRIETARY) LIMITED, CENTURY CITY, SOUTH AFRICA, FILED 7-20-2009.

CHESSCUBE

THE MARK CONSISTS OF STANDARD CHARACTERS WITHOUT CLAIM TO ANY PARTICULAR FONT, STYLE, SIZE, OR COLOR.

CLASS 41—EDUCATION AND ENTERTAINMENT

FOR ENTERTAINMENT SERVICES IN THE NATURE OF CONDUCTING ON-LINE CHESS TOURNAMENTS; PROVIDING A WEBBASED SYSTEM AND ON-LINE PORTAL FOR CUSTOMERS TO PARTICIPATE IN ON-LINE CHESS GAMES AND CHALLENGE OTHER PLAYERS; ENTERTAINMENT AND EDUCATIONAL SERVICES IN THE NATURE OF ON-LINE COMPETITIONS IN THE FIELD OF CHESS; EDUCATIONAL AND ENTERTAINMENT SERVICES, NAMELY ANALYZING ON-LINE CHESS GAMESCORES AND DATA FOR OTHERS (U.S. CLS. 100, 101 AND 107).

FIRST USE 4-29-2007; IN COMMERCE 4-29-2007.

CLASS 42—SCIENTIFIC AND COMPUTER SERVICES

FOR COMPUTER SERVICES, NAMELY, CREATING AN ON-LINE COMMUNITY FOR REGISTERED USERS TO PARTICIPATE IN CHESS COMPETITIONS, SHOW-CASE THEIR SKILLS, GET FEEDBACK FROM THEIR PEERS, FORM VIRTUAL COMMUNITIES, ENGAGE IN SOCIAL NETWORKING AND IMPROVE THEIR TALENT (U.S. CLS. 100 AND 101).

FIRST USE 4-29-2007; IN COMMERCE 4-29-2007.
JEFF DEFORD, EXAMINING ATTORNEY

SN 77-784,470, JOHNSON & JOHNSON, NEW BRUNSWICK, NJ, FILED 7-20-2009.



THE MARK CONSISTS OF A SMILEY FACE IN BETWEEN TWO STARS WITH THE STYLIZED WORDS "FRIENDS FOR LIFE" UNDERNEATH IT.

CLASS 16—PAPER GOODS AND PRINTED MATTER

FOR PRINTED MATERIALS, NAMELY, PAMPHLETS AND BROCHURES, IN THE FIELD OF DIABETES (U.S. CLS. 2, 5, 22, 23, 29, 37, 38 AND 50).

FIRST USE 7-17-2002; IN COMMERCE 7-17-2002.

CLASS 41—EDUCATION AND ENTERTAINMENT

FOR EDUCATION SERVICES, NAMELY, PROVIDING WORKSHOPS AND SEMINARS IN THE FIELD OF DIABETES (U.S. CLS. 100, 101 AND 107).

FIRST USE 7-17-2002; IN COMMERCE 7-17-2002.
WON TEAK OH, EXAMINING ATTORNEY

SN 77-785,658. AVM, L.P., BOCA RATON, FL. FILED 7-21-2009.

AVM RPX

THE MARK CONSISTS OF STANDARD CHARACTERS WITHOUT CLAIM TO ANY PARTICULAR FONT, STYLE, SIZE, OR COLOR.

CLASS 35—ADVERTISING AND BUSINESS

FOR BUSINESS SERVICES, NAMELY, MATCHING COLLATERAL PROVIDERS AND CASH PROVIDERS IN CONNECTION WITH SECURITIES TRADING; PROVIDING A SECURED-ACCESS WEBSITE THAT BRINGS TOGETHER COLLATERAL PROVIDERS AND CASH PROVIDERS IN CONNECTION WITH SECURITIES TRADING (U.S. CLS. 100, 101 AND 102).

FIRST USE 10-30-2008; IN COMMERCE 10-30-2008.

CLASS 36—INSURANCE AND FINANCIAL

FOR INVESTING SERVICES AND SECURITIES FINANCING FOR OTHERS VIA THE INTERNET; PROVIDING FIXED INCOME SECURITIES MARKET INFORMATION; FINANCIAL SERVICES, NAMELY, ASSISTING OTHERS WITH THE COMPLETION OF FINANCIAL TRANSACTIONS FOR BONDS AND FIXED INCOME SECURITIES; PROVIDING A SECURED-ACCESS WEBSITE THAT PROVIDES FIXED INCOME SECURITIES MARKET INFORMATION (U.S. CLS. 100, 101 AND 102).

FIRST USE 10-30-2008; IN COMMERCE 10-30-2008.
JEFF DEFORD, EXAMINING ATTORNEY

SN 77-786,160. ZOUNDS HEARING, INC., PHOENIX, AZ. FILED 7-21-2009.

THE COLOR(S) ORANGE IS/ARE CLAIMED AS A FEATURE OF THE MARK.

THE MARK CONSISTS OF THE STYLIZED LETTERS "CLAREZA" COLORED ORANGE.

THE ENGLISH TRANSLATION OF THE WORD "CLAREZA" IN THE MARK IS "CLARITY".

CLASS 9—ELECTRICAL AND SCIENTIFIC APPARATUS

FOR HEARING AID BATTERIES, BATTERY CHARGERS AND REMOTE CONTROLS FOR ADJUSTING SOUND LEVELS IN HEARING AIDS (U.S. CLS. 21, 23, 26, 36 AND 38).

CLASS 10—MEDICAL APPARATUS

FOR HEARING AIDS AND HEARING AID COVERS; RECEIVERS, TRANSMITTERS AND AMPLIFIERS FOR USE WITH HEARING AIDS (U.S. CLS. 26, 39 AND 44).
EMILY CARLSEN, EXAMINING ATTORNEY

SN 77-786,167. SPERIAN HEARING PROTECTION, LLC,
SAN DIEGO, CA. FILED 7-21-2009.

HEARFOREVER

THE MARK CONSISTS OF STANDARD CHARACTERS WITHOUT CLAIM TO ANY PARTICULAR FONT, STYLE, SIZE, OR COLOR.

CLASS 9—ELECTRICAL AND SCIENTIFIC APPARATUS

FOR AUDIO AND VIDEO RECORDINGS FEATURING PUBLIC SERVICE ANNOUNCEMENTS TO RAISE AWARENESS ABOUT, EXPLAIN THE CONSEQUENCES OF, AND PROMOTE METHODS OF PREVENTING NOISE-INDUCED HEARING LOSS (U.S. CLS. 21, 23, 26, 36 AND 38).

CLASS 16—PAPER GOODS AND PRINTED MATTER

FOR PRINTED MATERIALS TO RAISE AWARENESS ABOUT NOISE-INDUCED HEARING LOSS AND METHODS OF PREVENTION, NAMELY, POSTERS, DECALS, STICKERS, PRINTED ADVERTISEMENTS AND PRINTED PUBLICATIONS, NAMELY MAGAZINES, NEWSPAPERS, BROCHURES, LEAFLETS, PAMPHLETS, BOOKLETS, BULLETINS, FLYERS, WORKSHEETS AND POSTCARDS (U.S. CLS. 2, 5, 22, 23, 29, 37, 38 AND 50).

CLASS 44—MEDICAL, BEAUTY AND AGRICULTURAL SERVICES

FOR PROVIDING INFORMATION ABOUT NOISE-INDUCED HEARING LOSS AND METHODS OF PREVENTION (U.S. CLS. 100 AND 101).

LESLEY LAMOTHE, EXAMINING ATTORNEY

SN 77-787,721. DENIM VALLEY, S.A., VALENCIA, SPAIN,
FILED 7-23-2009.

HYBRIDENIM

THE MARK CONSISTS OF STANDARD CHARACTERS WITHOUT CLAIM TO ANY PARTICULAR FONT, STYLE, SIZE, OR COLOR.

PRIORITY CLAIMED UNDER SEC. 44(D) ON ERPNCMNTY TM OFC APPLICATION NO. 008337743, FILED 6-3-2009, REG. NO. 008337743, DATED 1-31-2010, EXPIRES 6-3-2019.

CLASS 23—YARNS AND THREADS

FOR THREADS FOR TEXTILE USE (U.S. CL. 43).

CLASS 24—FABRICS

FOR TEXTILES AND TEXTILE GOODS, NAMELY, TEXTILES FOR UPHOLSTERY AND DRAPERIES MADE IN WHOLE OR IN SIGNIFICANT PART OF DENIM; BED AND TABLE TEXTILE GOODS, NAMELY, BED LINEN, BED COVERS, QUILTS, DUVETS AND BED BLANKETS MADE IN WHOLE OR IN SIGNIFICANT PART OF DENIM; CURTAINS OF TEXTILE, CUSHION COVERS, TEXTILE NAPKINS, TOWELS AND TRAVELING RUGS MADE IN WHOLE OR IN SIGNIFICANT PART OF DENIM (U.S. CLS. 42 AND 50).

CLASS 25—CLOTHING

FOR CLOTHING, NAMELY, SHIRTS, SUITS, BLOUSES, T-SHIRTS, SWEATERS, SLEEP WEAR, STOCKINGS, NECKTIES, GLOVES, SCARVES, SHORTS, BELTS, UNDERWEAR, PANTIES, BATHING SUITS; FOOTWEAR, NAMELY, SHOES, SANDALS, BOOTS AND SLIPPERS; AND HEADGEAR, NAMELY, HEADBANDS; CLOTHING, NAMELY, JACKETS, COATS, DRESSES, SKIRTS, VESTS, TROUSERS, JEANS, HATS AND HEADWEAR MADE IN WHOLE OR IN SIGNIFICANT PART OF DENIM (U.S. CLS. 22 AND 39).

CLASS 39—TRANSPORTATION AND STORAGE

FOR STORAGE AND DISTRIBUTION OF TEXTILES AND TEXTILE PRODUCTS (U.S. CLS. 100 AND 105).
FRED CARL, EXAMINING ATTORNEY

SN 77-787,723. ALDI INC., BATAVIA, IL. FILED 7-23-2009.

HUNTINGTON

THE MARK CONSISTS OF STANDARD CHARACTERS WITHOUT CLAIM TO ANY PARTICULAR FONT, STYLE, SIZE, OR COLOR.

OWNER OF U.S. REG. NO. 2,875,266.

CLASS 11—ENVIRONMENTAL CONTROL APPARATUS

FOR DECORATIVE TABLE TOP WATER FOUNTAINS (U.S. CLS. 13, 21, 23, 31 AND 34).

CLASS 20—FURNITURE AND ARTICLES NOT OTHERWISE CLASSIFIED

FOR MIRRORS; PICTURE FRAMES; SHELVING (U.S. CLS. 2, 13, 22, 25, 32 AND 50).

CLASS 21—HOUSEWARES AND GLASS

FOR PLANTERS FOR FLOWERS AND PLANTS; WALL ART MADE OF GLASS (U.S. CLS. 2, 13, 23, 29, 30, 33, 40 AND 50).

CLASS 24—FABRICS

FOR FABRIC FLAGS (U.S. CLS. 42 AND 50).

CLASS 26—FANCY GOODS

FOR ARTIFICIAL PLANTS (U.S. CLS. 37, 39, 40, 42 AND 50).
JORDAN BAKER, EXAMINING ATTORNEY

SN 77-787,945. NATICK AUTO SALES, INC., MARLBOROUGH, MA. FILED 7-23-2009.

SN 77-789,593. GENERAL AVIATION MODIFICATIONS, INC., ADA, OK. FILED 7-25-2009.

MHQ

Turbo Density-Normalized

THE MARK CONSISTS OF STANDARD CHARACTERS WITHOUT CLAIM TO ANY PARTICULAR FONT, STYLE, SIZE, OR COLOR.

THE MARK CONSISTS OF STANDARD CHARACTERS WITHOUT CLAIM TO ANY PARTICULAR FONT, STYLE, SIZE, OR COLOR.

NO CLAIM IS MADE TO THE EXCLUSIVE RIGHT TO USE "TURBO", APART FROM THE MARK AS SHOWN.

CLASS 35—ADVERTISING AND BUSINESS

FOR RESELLER SERVICES, NAMELY, RESELLER SERVICES IN THE FIELD OF NEW AND USED VEHICLES FOR MUNICIPAL, GOVERNMENTS AND INSTITUTIONAL ENTITIES, AND RETAIL STORE SERVICES FEATURING EMERGENCY AND SAFETY EQUIPMENT FOR EMERGENCY AND SAFETY VEHICLES (U.S. CLS. 100, 101 AND 102).

FIRST USE 10-24-2008; IN COMMERCE 10-24-2008.

CLASS 7—MACHINERY

FOR AIRCRAFT ENGINES (U.S. CLS. 13, 19, 21, 23, 31, 34 AND 35).

CLASS 9—ELECTRICAL AND SCIENTIFIC APPARATUS

FOR COMPUTERS FOR MANAGING CONTROL DEVICES FOR AIRCRAFT (U.S. CLS. 21, 23, 26, 36 AND 38). ELLEN PERKINS, EXAMINING ATTORNEY

CLASS 37—CONSTRUCTION AND REPAIR

FOR VEHICLE CUSTOMIZATION SERVICES, NAMELY, INSTALLATION OF EMERGENCY AND SAFETY EQUIPMENT INTO EMERGENCY AND SAFETY VEHICLES; MAINTENANCE AND REPAIR OF EMERGENCY AND SAFETY EQUIPMENT IN EMERGENCY AND SAFETY VEHICLES; MOTOR VEHICLE MAINTENANCE AND REPAIR; MOTOR VEHICLE DETAILING (U.S. CLS. 100, 103 AND 106).

FIRST USE 10-24-2008; IN COMMERCE 10-24-2008.

ANNE MADDEN, EXAMINING ATTORNEY

SN 77-789,913. THE DONS' WOOD-FIRED PIZZA, LLC, STERLING, VA. FILED 7-27-2009.

SN 77-788,732. DOUBLE-COLA CO.-USA, CHATTANOOGA, TN. FILED 7-24-2009.

The Dons' Wood-Fired Pizza

DOUBLE ZERO

THE MARK CONSISTS OF STANDARD CHARACTERS WITHOUT CLAIM TO ANY PARTICULAR FONT, STYLE, SIZE, OR COLOR.

NO CLAIM IS MADE TO THE EXCLUSIVE RIGHT TO USE "WOOD-FIRED PIZZA", APART FROM THE MARK AS SHOWN.

THE MARK CONSISTS OF STANDARD CHARACTERS WITHOUT CLAIM TO ANY PARTICULAR FONT, STYLE, SIZE, OR COLOR.

OWNER OF U.S. REG. NOS. 572,477, 2,343,672 AND OTHERS.

CLASS 30—STAPLE FOODS

FOR PIZZA FOR CONSUMPTION ON OR OFF THE PREMISES (U.S. CL. 46).

FIRST USE 7-1-2009; IN COMMERCE 7-1-2009.

CLASS 30—STAPLE FOODS

FOR FLAVORINGS FOR NON-ALCOHOLIC SOFT DRINKS (U.S. CL. 46).

CLASS 43—HOTEL AND RESTAURANT SERVICES

FOR RESTAURANT SERVICES (U.S. CLS. 100 AND 101).

FIRST USE 7-1-2009; IN COMMERCE 7-1-2009.

LEIGH LOWRY, EXAMINING ATTORNEY

CLASS 32—LIGHT BEVERAGES

FOR NON-ALCOHOLIC BEVERAGES, NAMELY, SOFT DRINKS (U.S. CLS. 45, 46 AND 48).

KRISTIN DAHLING, EXAMINING ATTORNEY

SN 77-790,611. MAYORAS CREATIVE SERVICES, LLC,
WEST BLOOMFIELD, MI. FILED 7-27-2009.

SN 77-790,791. GLAMOUR SALES HOLDING LIMITED,
CENTRAL., HONG KONG, FILED 7-28-2009.

TRIAL & HEIRS

THE MARK CONSISTS OF STANDARD CHARACTERS WITHOUT CLAIM TO ANY PARTICULAR FONT, STYLE, SIZE, OR COLOR.

CLASS 9—ELECTRICAL AND SCIENTIFIC APPARATUS

FOR DIGITAL MEDIA, NAMELY, CDS, DVDS, LASER DISKS, VIDEO TAPES, AND DOWNLOADABLE AUDIO AND AUDIO-VIDEO FILES FEATURING LEGAL INFORMATION; DOWNLOADABLE ELECTRONIC NEWSLETTERS IN THE FIELD OF LEGAL INFORMATION; DOWNLOADABLE PODCASTS IN THE FIELD OF LEGAL INFORMATION; ELECTRONIC PUBLICATIONS, NAMELY, BOOKS, MAGAZINES, ARTICLES, NEWSLETTERS, AND MANUALS FEATURING LEGAL INFORMATION RECORDED ON COMPUTER MEDIA; MULTIMEDIA SOFTWARE RECORDED ON CD-ROM FEATURING LEGAL INFORMATION; PRE-RECORDED CDS, VIDEO TAPES, LASER DISKS AND DVDS FEATURING LEGAL INFORMATION (U.S. CLS. 21, 23, 26, 36 AND 38).

CLASS 16—PAPER GOODS AND PRINTED MATTER

FOR A SERIES OF BOOKS, WRITTEN ARTICLES, HANDOUTS AND WORKSHEETS IN THE FIELD OF LEGAL INFORMATION; BOOKS IN THE FIELD OF LEGAL INFORMATION; EDUCATIONAL PUBLICATIONS, NAMELY, BOOKS, MAGAZINES, ARTICLES, NEWSLETTERS, AND MANUALS IN THE FIELD OF LEGAL INFORMATION; PUBLICATIONS, NAMELY, BOOKS, MAGAZINES, ARTICLES, NEWSLETTERS, AND MANUALS IN THE FIELD OF LEGAL INFORMATION; SERIES OF NON-FICTION BOOKS IN THE FIELD OF LEGAL INFORMATION (U.S. CLS. 2, 5, 22, 23, 29, 37, 38 AND 50).

CLASS 41—EDUCATION AND ENTERTAINMENT

FOR CONDUCTING WORKSHOPS AND SEMINARS IN THE LEGAL FIELD; EDUCATION SERVICES, NAMELY, PROVIDING CLASSES, LECTURES, WORKSHOPS, SEMINARS, TUTORING, AND TELECLASSES IN THE FIELDS OF THE LAW; EDUCATIONAL AND ENTERTAINMENT SERVICES, NAMELY, A CONTINUING PROGRAM ABOUT THE LAW ACCESSIBLE BY RADIO, TELEVISION, SATELLITE, AUDIO, VIDEO AND COMPUTER NETWORKS; EDUCATIONAL SERVICES, NAMELY, PROVIDING ON-LINE CLASSES, LECTURES, WORKSHOPS, SEMINARS, TUTORING, AND TELECLASSES IN THE FIELD OF THE LAW; ENTERTAINMENT AND EDUCATIONAL SERVICES, NAMELY, THE PRESENTATION OF SEMINARS, LECTURES, WORKSHOPS AND PANEL DISCUSSIONS, AND ONGOING TELEVISION AND RADIO TALK SHOWS ALL IN THE FIELD OF PUBLIC INTEREST CONCERNING THE LAW; ENTERTAINMENT SERVICES, NAMELY, AN ON-GOING SERIES FEATURING THE LAW PROVIDED THROUGH TELEVISION, RADIO, INTERNET, WEBCASTS, AND PODCASTS; ENTERTAINMENT SERVICES, NAMELY, PROVIDING PODCASTS IN THE FIELD OF LEGAL INFORMATION; ON-LINE JOURNALS, NAMELY, BLOGS FEATURING LEGAL INFORMATION (U.S. CLS. 100, 101 AND 107).

WILLIAM VERHOSEK, EXAMINING ATTORNEY



THE LIKENESS (OR, "PORTRAIT") IN THE MARK DOES NOT IDENTIFY A LIVING INDIVIDUAL.

THE MARK CONSISTS OF THE STYLIZED WORDING "LAMOUR-SALES.COM" AND A DESIGN OF A KEYHOLE WITH A WOMAN HOLDING A ROSE APPEARING INSIDE.

CLASS 35—ADVERTISING AND BUSINESS

FOR ADVERTISING AND PROMOTION SERVICES AND RELATED CONSULTING; PREPARATION OF CUSTOM OR NON-CUSTOM ADVERTISING FOR BUSINESSES FOR DISSEMINATION VIA THE WEB; DISSEMINATION OF ADVERTISING FOR OTHERS VIA A GLOBAL COMMUNICATIONS NETWORK; ONLINE ADVERTISING SERVICES FOR OTHERS, NAMELY, PROVIDING ADVERTISING SPACE ON INTERNET WEB SITES; ONLINE TRADING SERVICES TO FACILITATE THE SALE OF GOODS AND SERVICES BY OTHERS VIA A GLOBAL COMMUNICATIONS NETWORK, NAMELY, ON-LINE TRADING SERVICES IN WHICH SELLER POSTS PRODUCTS TO BE AUCTIONED AND BIDDING IS DONE VIA THE INTERNET; AND PROVIDING EVALUATIVE FEEDBACK AND RATINGS OF SELLERS' GOODS AND SERVICES, THE VALUE AND PRICES OF SELLERS' GOODS AND SERVICES, BUYERS' AND SELLERS' PERFORMANCE, EVALUATIVE FEEDBACK AND RATINGS OF SELLERS' DELIVERY SERVICES, AND OVERALL TRADING EXPERIENCE IN CONNECTION THEREWITH, NAMELY, CONSUMER SURVEY SERVICES (U.S. CLS. 100, 101 AND 102).

CLASS 42—SCIENTIFIC AND COMPUTER SERVICES

FOR PROVIDING CUSTOMIZED ONLINE WEB PAGES FEATURING USER-DEFINED INFORMATION, WHICH INCLUDES SEARCH ENGINES AND ONLINE WEB LINKS TO OTHER WEB SITES; DESIGNING ONLINE WEB PAGES FOR ADVERTISING PURPOSES (U.S. CLS. 100 AND 101).

ROBERT STRUCK, EXAMINING ATTORNEY

SN 77-790,907. SCIENTIFIC STRATEGY PARTNERS LLC,
NEW YORK, NY. FILED 7-28-2009.

SCIENTIFIC STRATEGY PARTNERS

THE MARK CONSISTS OF STANDARD CHARACTERS WITHOUT CLAIM TO ANY PARTICULAR FONT, STYLE, SIZE, OR COLOR.

CLASS 35—ADVERTISING AND BUSINESS

FOR ADVERTISING AGENCY SERVICES IN THE HEALTHCARE AND PHARMACEUTICAL FIELDS; MARKETING CONSULTING SERVICES IN THE HEALTHCARE AND PHARMACEUTICAL FIELDS; INTERACTIVE MARKETING AND ADVERTISING IN THE HEALTHCARE AND PHARMACEUTICAL FIELDS; MARKET RESEARCH AND ANALYSIS SERVICES IN THE HEALTHCARE AND PHARMACEUTICAL FIELDS; BUSINESS CONSULTING IN THE AREAS OF PUBLIC RELATIONS AND PUBLIC AFFAIRS SERVICES IN THE HEALTHCARE AND PHARMACEUTICAL FIELDS; ORGANIZING TRADESHOWS AND EVENTS FOR BUSINESS PURPOSES IN THE HEALTHCARE AND PHARMACEUTICAL FIELDS (U.S. CLS. 100, 101 AND 102).

SN 77-791,066. KIRPAL LIGHT SATSANG, INC., UMPQUA, OR. FILED 7-28-2009.

Lighthouse Center Bakery

CLASS 41—EDUCATION AND ENTERTAINMENT

FOR MEDICAL EDUCATIONAL SERVICES, NAMELY, DEVELOPING, ORGANIZING AND CONDUCTING EDUCATIONAL PROGRAMS, SYMPOSIA, CONFERENCES, SEMINARS, AND MEETINGS ON BEHALF OF OTHERS TO EDUCATE PATIENTS IN THE HEALTHCARE AND PHARMACEUTICAL FIELDS; DEVELOPMENT AND DISSEMINATION OF EDUCATIONAL MATERIALS FOR OTHERS IN THE HEALTHCARE AND PHARMACEUTICAL FIELDS IN CONNECTION WITH THE AFOREMENTIONED EDUCATIONAL PROGRAMS, SYMPOSIA, CONFERENCES, SEMINARS, AND MEETINGS; MEDICAL ARTICLE WRITING FOR OTHERS IN THE HEALTHCARE AND PHARMACEUTICAL FIELDS (U.S. CLS. 100, 101 AND 107).
JANET LEE, EXAMINING ATTORNEY

THE MARK CONSISTS OF STANDARD CHARACTERS WITHOUT CLAIM TO ANY PARTICULAR FONT, STYLE, SIZE, OR COLOR.

NO CLAIM IS MADE TO THE EXCLUSIVE RIGHT TO USE "BAKERY", APART FROM THE MARK AS SHOWN.

CLASS 30—STAPLE FOODS

FOR BAKERY PRODUCTS (U.S. CL. 46).
FIRST USE 9-0-2008; IN COMMERCE 9-0-2008.

CLASS 43—HOTEL AND RESTAURANT SERVICES

FOR CAFE AND RESTAURANT SERVICES (U.S. CLS. 100 AND 101).
FIRST USE 9-0-2008; IN COMMERCE 9-0-2008.
ALICE BENMAMAN, EXAMINING ATTORNEY

SN 77-791,057. KIRPAL LIGHT SATSANG, INC., UMPQUA, OR. FILED 7-28-2009.

SN 77-791,368. PREMIER AGENDAS, INC., BELLINGHAM, WA. FILED 7-28-2009.

Lighthouse Center Bakery & Cafe

UGO365

THE MARK CONSISTS OF STANDARD CHARACTERS WITHOUT CLAIM TO ANY PARTICULAR FONT, STYLE, SIZE, OR COLOR.

NO CLAIM IS MADE TO THE EXCLUSIVE RIGHT TO USE "BAKERY & CAFE", APART FROM THE MARK AS SHOWN.

THE MARK CONSISTS OF STANDARD CHARACTERS WITHOUT CLAIM TO ANY PARTICULAR FONT, STYLE, SIZE, OR COLOR.

CLASS 9—ELECTRICAL AND SCIENTIFIC APPARATUS

CLASS 30—STAPLE FOODS

FOR BAKERY PRODUCTS (U.S. CL. 46).
FIRST USE 9-0-2008; IN COMMERCE 9-0-2008.

FOR ONLINE, DOWNLOADABLE MATERIALS, NAMELY, NEWSLETTERS, VIDEOS, ARTICLES THAT PROVIDE RESOURCE MATERIALS, NAMELY, NEWSLETTERS, VIDEOS, ARTICLES TO HELP STUDENTS PLAN AND SCHEDULE THEIR TIME, HELP TEACHERS HELP STUDENTS PLAN AND SCHEDULE THEIR TIME, AND HELP PARENTS HELP THEIR STUDENTS PLAN AND SCHEDULE THEIR TIME; PRE-RECORDED ELECTRONIC VIDEOS THAT PROVIDE RESOURCE MATERIALS, NAMELY, EXECUTIVE FUNCTION SKILLS, JOURNALING INFORMATION AND SKILLS, TO HELP STUDENTS PLAN AND SCHEDULE THEIR TIME, HELP TEACHERS HELP STUDENTS PLAN AND SCHEDULE THEIR TIME, AND HELP PARENTS HELP THEIR STUDENTS PLAN AND SCHEDULE THEIR TIME (U.S. CLS. 21, 23, 26, 36 AND 38).

CLASS 43—HOTEL AND RESTAURANT SERVICES

FOR CAFE AND RESTAURANT SERVICES (U.S. CLS. 100 AND 101).
FIRST USE 9-0-2008; IN COMMERCE 9-0-2008.
ALICE BENMAMAN, EXAMINING ATTORNEY

CLASS 16—PAPER GOODS AND PRINTED MATTER

FOR PRINTED MATERIALS, NAMELY, STUDENT PLANNERS THAT HELP STUDENTS PLAN AND SCHEDULE THEIR TIME, AND TEACHER MATERIALS, NAMELY, PLANNERS, CALENDARS, NOTEBOOKS, PRESENTATIONS, AND NEWSLETTERS THAT HELP TEACHERS HELP STUDENTS PLAN AND SCHEDULE THEIR TIME, AND PARENT MATERIALS, NAMELY, PLANNERS, CALENDARS, NOTEBOOKS, NEWSLETTERS, AND PRESENTATIONS SENT BY TEACHERS TO PARENTS TO HELP THEIR STUDENTS PLAN AND SCHEDULE THEIR TIME; PAPER BANNERS THAT PROMOTE STUDENT PLANNING; PLASTIC PAGE FINDERS IN THE NATURE OF BOOKMARKS THAT HELP STUDENTS PLAN AND SCHEDULE THEIR TIME (U.S. CLS. 2, 5, 22, 23, 29, 37, 38 AND 50).

CLASS 24—FABRICS

FOR CLOTH BANNERS THAT PROMOTE STUDENT PLANNING (U.S. CLS. 42 AND 50).
LEIGH CAROLINE CASE, EXAMINING ATTORNEY

SN 77-791,625. PLATINUM EQUITY, LLC, BEVERLY HILLS, CA. FILED 7-28-2009.

Platinum Waterfall

THE MARK CONSISTS OF STANDARD CHARACTERS WITHOUT CLAIM TO ANY PARTICULAR FONT, STYLE, SIZE, OR COLOR.

NO CLAIM IS MADE TO THE EXCLUSIVE RIGHT TO USE "WATERFALL" IN CLASS 36, APART FROM THE MARK AS SHOWN.

CLASS 35—ADVERTISING AND BUSINESS

FOR BUSINESS MANAGEMENT SERVICES, NAMELY, MANAGEMENT AND ORGANIZATIONAL DEVELOPMENT, ASSESSMENTS, STRATEGIES AND PROCESSES; HOLDING COMPANY SERVICES, NAMELY, PROVIDING BUSINESS MANAGEMENT AND BUSINESS MANAGEMENT CONSULTATION TO SUBSIDIARIES AND AFFILIATES, AND ACCOUNTING SERVICES, ADMINISTRATIVE BUSINESS MANAGEMENT, AND HUMAN RESOURCES SERVICES IN THE NATURE OF PERSONNEL MANAGEMENT SERVICES PERFORMED FOR RELATED COMPANIES (U.S. CLS. 100, 101 AND 102).

CLASS 36—INSURANCE AND FINANCIAL

FOR FINANCIAL SERVICES, NAMELY, MANAGEMENT BUYOUT SERVICES, CORPORATE BUYOUT SERVICES, LEVERAGED BUYOUT SERVICES, PRIVATE EQUITY INVESTMENT SERVICES AND INVESTMENT TRUST SERVICES (U.S. CLS. 100, 101 AND 102).
JAMES LOVELACE, EXAMINING ATTORNEY

SN 77-791,832. BIOENERGY TECHNOLOGIES, LLC, SUMTER, SC. FILED 7-29-2009.



NO CLAIM IS MADE TO THE EXCLUSIVE RIGHT TO USE "BIOENERGY TECHNOLOGIES", APART FROM THE MARK AS SHOWN.

THE MARK CONSISTS OF THE WORD "BIOENERGY", WITH THE STYLIZED DESIGN OF A TURBINE BLADE SURROUNDING THE LETTER "O", ABOVE THE WORD "TECHNOLOGIES".

CLASS 1—CHEMICALS

FOR FERTILIZERS (U.S. CLS. 1, 5, 6, 10, 26 AND 46).

CLASS 4—LUBRICANTS AND FUELS

FOR BIOENERGY, NAMELY, ELECTRICAL ENERGY PRODUCED FROM BIOMASS CONVERSION (U.S. CLS. 1, 6 AND 15).

CLASS 37—CONSTRUCTION AND REPAIR

FOR CONSTRUCTION OF BIOGAS POWER SYSTEMS; CONSULTATION IN THE FIELD OF BIOENERGY, NAMELY, CONSTRUCTION CONSULTING FOR BIOENERGY PLANTS (U.S. CLS. 100, 103 AND 106).

CLASS 40—MATERIAL TREATMENT

FOR PRODUCTION OF BIOENERGY; CONVERTING BIOMASS INTO USEABLE FUELS; CONSULTATION IN THE FIELD OF BIOENERGY, NAMELY, IN CONVERTING BIOMASS INTO USEABLE FUELS (U.S. CLS. 100, 103 AND 106).

CLASS 42—SCIENTIFIC AND COMPUTER SERVICES

FOR DESIGN OF BIOGAS POWER SYSTEMS; CONDUCTING FEASIBILITY STUDIES FOR BIOENERGY; CONSULTATION IN THE FIELD OF BIOENERGY, NAMELY, CONSULTATION IN THE DESIGN OF BIOGAS POWER SYSTEMS (U.S. CLS. 100 AND 101).
BRIAN PINO, EXAMINING ATTORNEY

SN 77-792,539. WASHINGTON CONSULTING GROUP, INC., BETHESDA, MD. FILED 7-29-2009.

WCG

THE MARK CONSISTS OF STANDARD CHARACTERS WITHOUT CLAIM TO ANY PARTICULAR FONT, STYLE, SIZE, OR COLOR.

CLASS 35—ADVERTISING AND BUSINESS

FOR BUSINESS MANAGEMENT CONSULTING, STATISTICAL ANALYSIS AND REPORTING SERVICES FOR BUSINESS PURPOSES; ECONOMIC FORECASTING AND ANALYSIS; COST ANALYSIS (U.S. CLS. 100, 101 AND 102).
FIRST USE 8-27-1979; IN COMMERCE 8-27-1979.

CLASS 39—TRANSPORTATION AND STORAGE

FOR AIR TRAFFIC CONTROL MANAGEMENT CONSULTING (U.S. CLS. 100 AND 105).
FIRST USE 8-27-1979; IN COMMERCE 8-27-1979.

CLASS 41—EDUCATION AND ENTERTAINMENT

FOR EDUCATIONAL SERVICES, NAMELY, CONDUCTING CONFERENCES, LECTURES AND SEMINARS IN THE FIELDS OF TRANSPORTATION, EDUCATION, ENERGY, DEFENSE AND HEALTH CARE (U.S. CLS. 100, 101 AND 107).
FIRST USE 8-27-1979; IN COMMERCE 8-27-1979.
KELLEY WELLS, EXAMINING ATTORNEY

SN 77-792,966. GINSEY INDUSTRIES, INC., BELLMAWR, NJ. FILED 7-30-2009.

BEBE STAGES

THE MARK CONSISTS OF STANDARD CHARACTERS WITHOUT CLAIM TO ANY PARTICULAR FONT, STYLE, SIZE, OR COLOR.

NO CLAIM IS MADE TO THE EXCLUSIVE RIGHT TO USE "BEBE", APART FROM THE MARK AS SHOWN.

THE ENGLISH TRANSLATION OF THE WORD "BEBE" IN THE MARK IS "BABY".

CLASS 20—FURNITURE AND ARTICLES NOT OTHERWISE CLASSIFIED

FOR NON-METAL STEP STOOL, BOOSTER SEAT (U.S. CLS. 2, 13, 22, 25, 32 AND 50).

CLASS 21—HOUSEWARES AND GLASS

FOR POTTIES FOR CHILDREN (U.S. CLS. 2, 13, 23, 29, 30, 33, 40 AND 50).
STEVEN JACKSON, EXAMINING ATTORNEY

SN 77-793,071. DOOSAN INFRACORE AMERICA CORPORATION, SUWANEE, GA. FILED 7-30-2009.

DOOSAN ELITE PLUS

THE MARK CONSISTS OF STANDARD CHARACTERS WITHOUT CLAIM TO ANY PARTICULAR FONT, STYLE, SIZE, OR COLOR.

CLASS 35—ADVERTISING AND BUSINESS

FOR PROVIDING GPS TRACKING SERVICES CONCERNING TRACKING OF ASSETS IN TRANSIT, NAMELY, VEHICLES (U.S. CLS. 100, 101 AND 102).
FIRST USE 7-1-2009; IN COMMERCE 7-1-2009.

CLASS 36—INSURANCE AND FINANCIAL

FOR PROVIDING EXTENDED WARRANTIES FOR CONSTRUCTION EQUIPMENT (U.S. CLS. 100, 101 AND 102).
FIRST USE 7-1-2009; IN COMMERCE 7-1-2009.

CLASS 37—CONSTRUCTION AND REPAIR

FOR PROVIDING MAINTENANCE SERVICES FOR CONSTRUCTION EQUIPMENT, NAMELY, PARTS AND FLUID TESTING, MONITORING AND REPLACEMENT (U.S. CLS. 100, 103 AND 106).
FIRST USE 7-1-2009; IN COMMERCE 7-1-2009.
MEGHAN REINHART, EXAMINING ATTORNEY

SN 77-793,446. COUGAR LIFE INC., TORONTO, ONTARIO, CANADA, FILED 7-30-2009.

COUGAR LIFE

THE MARK CONSISTS OF STANDARD CHARACTERS WITHOUT CLAIM TO ANY PARTICULAR FONT, STYLE, SIZE, OR COLOR.

NO CLAIM IS MADE TO THE EXCLUSIVE RIGHT TO USE "COUGAR", APART FROM THE MARK AS SHOWN.

CLASS 38—COMMUNICATION

FOR PROVIDING ON-LINE CHAT ROOMS FOR TRANSMISSION OF MESSAGES AMONG COMPUTER USERS CONCERNING EROTIC AND ADULT FANTASY; PROVIDING INTERNET VOICE COMMUNICATION SERVICES VIA THE INTERNET (U.S. CLS. 100, 101 AND 104).

CLASS 45—PERSONAL AND LEGAL SERVICES

FOR INTERNET BASED DATING, MATCHMAKING AND SOCIAL INTRODUCTION SERVICES (U.S. CLS. 100 AND 101).
BRIAN CALLAGHAN, EXAMINING ATTORNEY

SN 77-794,123. OPTICAL CABLE CORPORATION, ROANOKE, VA. FILED 7-31-2009.

From the Battlefield to the Football Field

THE MARK CONSISTS OF STANDARD CHARACTERS WITHOUT CLAIM TO ANY PARTICULAR FONT, STYLE, SIZE, OR COLOR.

CLASS 9—ELECTRICAL AND SCIENTIFIC APPARATUS

FOR CABLES FOR ELECTRICAL OR OPTICAL TRANSMISSION; CABLE CONNECTORS; ELECTRICAL CABLE PATCH CORDS; OPTICAL PATCH CORDS; COMMUNICATION RACKS, CABINETS, ENCLOSURES, AND PATCH PANELS FOR USE IN CABLING OR WIRING OR FOR USE IN HOUSING COMMUNICATIONS EQUIPMENT; CABLE REELS; FACE PLATES FOR USE IN CABLING OR WIRING; ELECTRICAL CABLE OUTLETS; OPTICAL CABLE OUTLETS; MULTI-MEDIA BOXES AND ENCLOSURES FOR CABLING OR WIRING, FOR CONNECTING MULTIMEDIA DEVICES OR INPUT STREAMS, OR FOR HOUSING COMMUNICATIONS EQUIPMENT; CABLE OR CONNECTIVITY MANAGEMENT AND INSTALLATION ACCESSORIES, NAMELY, FILLER PANELS, GROUNDING BARS, POWER PANELS, REDUCERS, PATCH PANEL KITS, AND LINE SIGNAL SPLITTERS; CABLE OR CONNECTIVITY MANAGEMENT AND INSTALLATION ACCESSORIES, NAMELY, SEISMIC ANCHORING KITS SPECIALLY DESIGNED FOR COMMUNICATIONS RACKS AND COMMUNICATIONS EQUIPMENT CABINETS (U.S. CLS. 21, 23, 26, 36 AND 38).

CLASS 35—ADVERTISING AND BUSINESS

FOR WHOLESALE ORDERING SERVICES, FEATURING COPPER AND FIBER OPTIC CABLES FOR ELECTRICAL OR OPTICAL TRANSMISSION AND CONNECTIVITY PRODUCTS IN THE NATURE OF CABLE CONNECTORS, ELECTRICAL CABLE PATCH CORDS, OPTICAL PATCH CORDS, CABLE REELS, FACE PLATES FOR USE IN CABLING OR WIRING, ELECTRICAL CABLE OUTLETS, OPTICAL CABLE OUTLETS; WHOLESALE ORDERING SERVICES, FEATURING CONNECTIVITY PRODUCTS IN THE NATURE OF COMMUNICATION RACKS, CABINETS, ENCLOSURES, AND PATCH PANELS FOR USE IN CABLING OR WIRING OR FOR USE IN HOUSING COMMUNICATIONS EQUIPMENT; WHOLESALE ORDERING SERVICES, FEATURING CONNECTIVITY PRODUCTS IN THE NATURE OF MULTI-MEDIA BOXES AND ENCLOSURES FOR CABLING OR WIRING, FOR CONNECTING MULTIMEDIA DEVICES OR INPUT STREAMS, OR FOR HOUSING COMMUNICATIONS EQUIPMENT; WHOLESALE ORDERING SERVICES, FEATURING CONNECTIVITY PRODUCTS IN THE NATURE OF MANAGEMENT AND INSTALLATION ACCESSORIES, NAMELY, FILLER PANELS, GROUNDING BARS, POWER PANELS, REDUCERS, PATCH PANEL KITS, AND LINE SIGNAL SPLITTERS; AND WHOLESALE ORDERING SERVICES, FEATURING CONNECTIVITY PRODUCTS IN THE NATURE OF SEISMIC ANCHORING KITS SPECIALLY DESIGNED FOR COMMUNICATIONS RACKS AND COMMUNICATIONS EQUIPMENT CABINETS (U.S. CLS. 100, 101 AND 102).

STEPHEN AQUILA, EXAMINING ATTORNEY

SN 77-794,455. DBD, INC., CONSHOHOCKEN, PA. FILED 7-31-2009.

SABEL | STUDIOS

THE MARK CONSISTS OF STANDARD CHARACTERS WITHOUT CLAIM TO ANY PARTICULAR FONT, STYLE, SIZE, OR COLOR.

NO CLAIM IS MADE TO THE EXCLUSIVE RIGHT TO USE "STUDIOS", APART FROM THE MARK AS SHOWN.

CLASS 35—ADVERTISING AND BUSINESS

FOR ON-LINE RETAIL STORE SERVICES FEATURING PHOTOGRAPHY SERVICES (U.S. CLS. 100, 101 AND 102).

FIRST USE 6-1-2009; IN COMMERCE 7-1-2009.

CLASS 41—EDUCATION AND ENTERTAINMENT

FOR PHOTOGRAPHY SERVICES (U.S. CLS. 100, 101 AND 107).

FIRST USE 6-1-2009; IN COMMERCE 7-1-2009.
THOMAS MANOR, EXAMINING ATTORNEY

SN 77-794,513. PM REALTY GROUP, L.P., HOUSTON, TX. FILED 7-31-2009.

PM

THE MARK CONSISTS OF STANDARD CHARACTERS WITHOUT CLAIM TO ANY PARTICULAR FONT, STYLE, SIZE, OR COLOR.

CLASS 36—INSURANCE AND FINANCIAL

FOR REAL ESTATE SERVICES, NAMELY, LEASING, PROPERTY MANAGEMENT, FACILITY MANAGEMENT, AND PROJECT MANAGEMENT FOR OTHERS IN THE FIELD OF COMMERCIAL REAL ESTATE, NAMELY, OFFICE, MEDICAL OFFICE, INDUSTRIAL, RETAIL, MIXED USE, RESIDENTIAL, DISTRIBUTION, HEALTHCARE, STUDENT HOUSING, AND RECEIVERSHIP REO PROPERTIES; FINANCIAL AND INVESTMENT SERVICES IN THE NATURE OF PURCHASING AND SELLING REAL ESTATE FOR OTHERS; REAL ESTATE BROKERAGE; FINANCIAL DUE DILIGENCE SERVICES IN THE FIELD OF REAL ESTATE (U.S. CLS. 100, 101 AND 102).

FIRST USE 12-31-1991; IN COMMERCE 12-31-1991.

CLASS 37—CONSTRUCTION AND REPAIR

FOR REAL ESTATE DEVELOPMENT IN THE FIELD OF COMMERCIAL REAL ESTATE, NAMELY, OFFICE, MEDICAL OFFICE, INDUSTRIAL, RETAIL, MIXED USE, RESIDENTIAL, DISTRIBUTION, HEALTHCARE, STUDENT HOUSING, AND RECEIVERSHIP REO PROPERTIES; REAL ESTATE CONSTRUCTION PROJECT MANAGEMENT (U.S. CLS. 100, 103 AND 106).

FIRST USE 12-31-1991; IN COMMERCE 12-31-1991.
ZACHARY BELLO, EXAMINING ATTORNEY

SN 77-794,710. COMPETE, INC., ROLLING HILLS, CA. FILED 7-31-2009.

ALWAYS COMPETE

THE MARK CONSISTS OF STANDARD CHARACTERS WITHOUT CLAIM TO ANY PARTICULAR FONT, STYLE, SIZE, OR COLOR.

CLASS 9—ELECTRICAL AND SCIENTIFIC APPARATUS

FOR PRE-RECORDED AUDIO TAPES, VIDEO TAPES AND DVDS FEATURING MOTIVATIONAL SPEECHES, RECORDED LECTURES AND SPORTS COACHING AND TRAINING; MAGNETS (U.S. CLS. 21, 23, 26, 36 AND 38).

SN 77-795,192. ALLURE BOUDOIR, LLC, PLANO, TX. FILED 8-3-2009.

ALLURE BOUDOIR**CLASS 16—PAPER GOODS AND PRINTED MATTER**

FOR BOOKS IN THE FIELDS OF PERSONAL GROWTH, PERSONAL MOTIVATION, AND SPORTS COACHING AND TRAINING; PAPER PRODUCTS, NAMELY, BEVERAGE COASTERS; APPOINTMENT BOOKS, ADDRESS BOOKS, POSTERS, TEMPORARY TATTOOS, STATIONERY, BOND AND WRITING PAPER, PENS, ENVELOPES, ERASERS, STICKERS, PAPER NAPKINS (U.S. CLS. 2, 5, 22, 23, 29, 37, 38 AND 50).

THE MARK CONSISTS OF STANDARD CHARACTERS WITHOUT CLAIM TO ANY PARTICULAR FONT, STYLE, SIZE, OR COLOR.

NO CLAIM IS MADE TO THE EXCLUSIVE RIGHT TO USE "BOUDOIR", APART FROM THE MARK AS SHOWN.

CLASS 18—LEATHER GOODS

FOR BAGS, NAMELY, DUFFLE BAGS, BACKPACKS, FANNY PACKS, ALL PURPOSE SPORTS BAGS, TOTE BAGS, BOOK BAGS AND OVERNIGHT BAGS; IMITATION LEATHER KEY CHAINS (U.S. CLS. 1, 2, 3, 22 AND 41).

CLASS 35—ADVERTISING AND BUSINESS

FOR RETAIL STORE SERVICES FEATURING PHOTOGRAPHS, NAMELY, ONLINE RETAIL STORE SERVICES FEATURING PHOTOGRAPHS (U.S. CLS. 100, 101 AND 102).

CLASS 25—CLOTHING

FOR CLOTHING, NAMELY, SHIRTS, T-SHIRTS, JERSEYS, TANK-TOPS, SWEATERS, SWEATSHIRTS, PANTS, JEANS, SHORTS, SWEAT SUITS, SUITS, BLAZERS, DRESSES, SKIRTS, BLOUSES, PAJAMAS, NIGHTWEAR, BATHING SUITS, UNDERWEAR, SOCKS, SCARVES, JACKETS, COATS, GLOVES, BELTS, HEADWEAR AND FOOTWEAR; WRISTBANDS; NECKBANDS; SWEATBANDS; HEADBANDS (U.S. CLS. 22 AND 39).

CLASS 41—EDUCATION AND ENTERTAINMENT

FOR PHOTOGRAPHY SERVICES (U.S. CLS. 100, 101 AND 107).

ELLEN BURNS, EXAMINING ATTORNEY

CLASS 35—ADVERTISING AND BUSINESS

FOR ONLINE RETAIL STORE SERVICES FEATURING PRE-RECORDED AUDIO TAPES, VIDEO TAPES AND DVDS, BAGS, TAILGATE PARTY EQUIPMENT, FURNITURE, TABLEWARE, HOUSEWARES, DRINKWARE, HOUSEHOLD UTENSILS, CLOTHING, ACCESSORIES, HEADWEAR, FOOTWEAR, BOOKS, STATIONERY, OFFICE AND SCHOOL SUPPLIES, PAPER PRODUCTS AND SPORTS MEMORABILIA (U.S. CLS. 100, 101 AND 102).

SN 77-795,482. NORTHERN TOOL & EQUIPMENT COMPANY, INC., BURNSVILLE, MN. FILED 8-3-2009.



OWNER OF U.S. REG. NO. 3,699,907.

NO CLAIM IS MADE TO THE EXCLUSIVE RIGHT TO USE "GEAR", APART FROM THE MARK AS SHOWN.

THE MARK CONSISTS OF THE OUTLINE OF A RECTANGLE CONTAINING FOUR STYLIZED GEARS ON A DARK BACKGROUND TO THE LEFT OF THE WORDS "GRAVEL GEAR" WHICH APPEAR IN STYLIZED LETTERS ON A LIGHT BACKGROUND WITH THE WORD "GRAVEL" PLACED ABOVE THE WORD "GEAR".

CLASS 38—COMMUNICATION

FOR STREAMING OF SPORTS RELATED VIDEO MATERIAL AND RELATED SPORTS INFORMATION ON A GLOBAL COMPUTER NETWORK; ELECTRONIC DELIVERY OF IMAGES, PHOTOGRAPHS AND INFORMATION VIA A GLOBAL COMPUTER NETWORK IN THE FIELD OF SPORTS (U.S. CLS. 100, 101 AND 104).

CLASS 9—ELECTRICAL AND SCIENTIFIC APPARATUS

FOR PROTECTIVE CLOTHING AND HEADGEAR (U.S. CLS. 21, 23, 26, 36 AND 38).

CLASS 41—EDUCATION AND ENTERTAINMENT

FOR EDUCATIONAL AND ENTERTAINMENT SERVICES, NAMELY, PROVIDING MOTIVATIONAL AND EDUCATIONAL SPEAKERS; PREPARING SPEECHES AND ORAL PRESENTATIONS FOR OTHERS FOR USE IN THE FIELD OF MOTIVATION; ENTERTAINMENT IN THE NATURE OF ON-GOING TELEVISION PROGRAMS IN THE FIELD OF SPORTS AND NEWS; WEBSITE FEATURING INFORMATION OF INTEREST TO SPORTS ENTHUSIASTS, INCLUDING, INFORMATION RELATED TO COLLEGE FOOTBALL COACHES, FAN CLUB SERVICES, PHOTOGRAPHS AND GAME PRIZE OPPORTUNITIES (U.S. CLS. 100, 101 AND 107).

TRICIA SONNEBORN, EXAMINING ATTORNEY

CLASS 18—LEATHER GOODS

FOR BACKPACKS, KNAPSACKS, DUFFEL BAGS, TOTE BAGS, TRAVEL BAGS, SPORT BAGS, ALL PURPOSE CARRYING BAGS, HUNTING BAGS, AND TOOL BAGS SOLD EMPTY (U.S. CLS. 1, 2, 3, 22 AND 41).

CLASS 25—CLOTHING

FOR CLOTHING AND APPAREL, NAMELY, PANTS, JEANS, OVERALLS, SHORTS, SHORT-SLEEVED AND LONG-SLEEVED TEE SHIRTS, SHIRTS, SWEATSHIRTS, JACKETS, HOODS, VESTS, SOCKS, FOOTWEAR, HEADWEAR, BELTS FOR CLOTHING (U.S. CLS. 22 AND 39).

AMY KERTGATE, EXAMINING ATTORNEY

SN 77-795,502. NORTHERN TOOL & EQUIPMENT COMPANY, INC., BURNSVILLE, MN. FILED 8-3-2009.



OWNER OF U.S. REG. NO. 3,699,907.

NO CLAIM IS MADE TO THE EXCLUSIVE RIGHT TO USE "GEAR", APART FROM THE MARK AS SHOWN.

THE MARK CONSISTS OF THE OUTLINE OF A RECTANGLE CONTAINING FOUR STYLIZED GEARS ON A DARK BACKGROUND ABOVE THE WORDS "GRAVEL GEAR" WHICH APPEAR IN STYLIZED LETTERS ON A LIGHT BACKGROUND WITH THE WORD "GRAVEL" PLACED ABOVE THE WORD "GEAR".

CLASS 9—ELECTRICAL AND SCIENTIFIC APPARATUS

FOR PROTECTIVE CLOTHING AND HEADGEAR (U.S. CLS. 21, 23, 26, 36 AND 38).

CLASS 18—LEATHER GOODS

FOR BACKPACKS, KNAPSACKS, DUFFEL BAGS, TOTE BAGS, TRAVEL BAGS, SPORT BAGS, ALL PURPOSE CARRYING BAGS, HUNTING BAGS, AND TOOL BAGS SOLD EMPTY (U.S. CLS. 1, 2, 3, 22 AND 41).

CLASS 25—CLOTHING

FOR CLOTHING AND APPAREL, NAMELY, PANTS, JEANS, OVERALLS, SHORTS, SHORT-SLEEVED AND LONG-SLEEVED TEE SHIRTS, SHIRTS, SWEATSHIRTS, JACKETS, HOODS, VESTS, SOCKS, FOOTWEAR, HEADWEAR, BELTS FOR CLOTHING (U.S. CLS. 22 AND 39).
AMY KERTGATE, EXAMINING ATTORNEY

SN 77-795,508. NORTHERN TOOL & EQUIPMENT COMPANY, INC., BURNSVILLE, MN. FILED 8-3-2009.

GRAVEL GEAR

THE MARK CONSISTS OF STANDARD CHARACTERS WITHOUT CLAIM TO ANY PARTICULAR FONT, STYLE, SIZE, OR COLOR.

OWNER OF U.S. REG. NO. 3,699,907.

NO CLAIM IS MADE TO THE EXCLUSIVE RIGHT TO USE "GEAR", APART FROM THE MARK AS SHOWN.

CLASS 9—ELECTRICAL AND SCIENTIFIC APPARATUS

FOR PROTECTIVE CLOTHING AND HEADGEAR (U.S. CLS. 21, 23, 26, 36 AND 38).

CLASS 18—LEATHER GOODS

FOR BACKPACKS, KNAPSACKS, DUFFEL BAGS, TOTE BAGS, TRAVEL BAGS, SPORT BAGS, ALL PURPOSE CARRYING BAGS, HUNTING BAGS, AND TOOL BAGS SOLD EMPTY (U.S. CLS. 1, 2, 3, 22 AND 41).

CLASS 25—CLOTHING

FOR CLOTHING AND APPAREL, NAMELY, PANTS, JEANS, OVERALLS, SHORTS, SHORT-SLEEVED AND LONG-SLEEVED TEE SHIRTS, SHIRTS, SWEATSHIRTS, JACKETS, HOODS, VESTS, SOCKS, FOOTWEAR, HEADWEAR, BELTS FOR CLOTHING (U.S. CLS. 22 AND 39).
AMY KERTGATE, EXAMINING ATTORNEY

SN 77-795,565. THIRD EYE KITTY EXPRESSIONS, LLC, SANTA MONICA, CA. FILED 8-3-2009.



THE MARK CONSISTS OF THE WORDS "THIRD EYE KITTY" IN UPPERCASE STYLIZED FONT CENTERED ABOVE THE WORD "EXPRESSIONS" IN UPPERCASE STYLIZED FONT. CENTERED ABOVE THE WORDS IS AN IMAGE OF A CAT HEAD WITH THREE (3) EYES ABOVE TWO (2) DIAGONALLY CROSSED BONES FORMING AN "X".

CLASS 16—PAPER GOODS AND PRINTED MATTER

FOR BLANK JOURNALS; BLANK NOTE CARDS; BLANK PAPER NOTEBOOKS; BOOKS IN THE FIELD OF FICTION GRAPHIC NOVELS; CALENDARS; CARDS BEARING UNIVERSAL GREETINGS; COMIC BOOKS; FOLDERS; GENERAL FEATURE MAGAZINES; GIFT CARDS; GREETING CARDS; NOTE CARDS; NOTEBOOKS; NOTEPADS; PERSONAL ORGANIZERS; POST CARDS; STATIONERY; STICKERS AND STICKER ALBUMS; TEMPORARY TATTOOS; IRON-ON TRANSFERS (U.S. CLS. 2, 5, 22, 23, 29, 37, 38 AND 50).
FIRST USE 7-28-2009; IN COMMERCE 7-28-2009.

CLASS 25—CLOTHING

FOR CAPRI PANTS; CAPS; DRESSES; HALTER TOPS; HATS; HEADWEAR; HOODED SWEAT SHIRTS; JACKETS; PANTS; SHIRTS; SHORTS; SKIRTS; SKULLIES; SLEEPWEAR; SOCKS; SWEAT SHIRTS; SWEATERS; T-SHIRTS; TANK-TOPS; TOPS; UNDERWEAR (U.S. CLS. 22 AND 39).

FIRST USE 7-28-2009; IN COMMERCE 7-28-2009.

B. PARADEWELAI, EXAMINING ATTORNEY

SN 77-795,664. IL RISO BERETTA S.R.L., ZERBOLO' DI PAVIA, ITALY, FILED 8-3-2009.



NO CLAIM IS MADE TO THE EXCLUSIVE RIGHT TO USE "ORIGINAL SELECT ITALIAN RICE", APART FROM THE MARK AS SHOWN.

THE COLOR(S) RED, GREEN, WHITE AND BLACK IS/ARE CLAIMED AS A FEATURE OF THE MARK.

THE MARK CONSISTS OF THE PHRASE "ORIGINAL SELECT ITALIAN RICE" IN THREE HORIZONTAL LINES AND A DRAWING OF TWO GRAINS OF RICE ON THE LEFT SIDE OF THE PHRASE. THE WORDING "ORIGINAL SELECT" IS IN COLOR RED AND THE WORDING "ITALIAN RICE" IS IN COLOR WHITE INSIDE THE RECTANGLE FILLED WITH COLOR GREEN. TWO GRAINS OF RICE ARE TRIMMED WITH COLOR BLACK.

CLASS 29—MEATS AND PROCESSED FOODS

FOR DRIED AND PRESERVED MUSHROOMS (U.S. CL. 46).
FIRST USE 11-22-1995; IN COMMERCE 11-22-1995.

CLASS 30—STAPLE FOODS

FOR PREPARED RICE PRODUCTS, NAMELY, PROCESSED RICE CEREAL AND PRECOOKED AND FREEZE-DRIED RISOTTO; PROCESSED CEREALS, FARINA, MAIZE FLAKES AND CORN FLAKES; POPPED POPCORN; PROCESSED SAFFRON FOR USE AS A SPICE OR FLAVORING; PROCESSED MAIZE (U.S. CL. 46).
FIRST USE 11-22-1995; IN COMMERCE 11-22-1995.
MARC LEIPZIG, EXAMINING ATTORNEY

SN 77-795,758. CAREER STEP HOLDINGS, LLC, PROVO, UT. FILED 8-3-2009.

Career Step

THE MARK CONSISTS OF STANDARD CHARACTERS WITHOUT CLAIM TO ANY PARTICULAR FONT, STYLE, SIZE, OR COLOR.
OWNER OF U.S. REG. NOS. 2,382,195 AND 3,598,304.

CLASS 16—PAPER GOODS AND PRINTED MATTER

FOR PRINTED INSTRUCTIONAL AND EDUCATIONAL MATERIALS, NAMELY, COURSE BOOKS, WORKBOOKS, WORKSHEETS, FLASH CARDS, DIAGRAMS, AND STUDY GUIDES PROVIDED WITH COURSES OF INSTRUCTION IN THE FIELDS OF MEDICAL TRANSCRIPTION, MEDICAL TRANSCRIPTION EDITING, OUTPATIENT AND INPATIENT MEDICAL CODING AND BILLING, AND MEDICAL TERMINOLOGY (U.S. CLS. 2, 5, 22, 23, 29, 37, 38 AND 50).
FIRST USE 11-0-1992; IN COMMERCE 3-0-1993.

CLASS 41—EDUCATION AND ENTERTAINMENT

FOR EDUCATION SERVICES, NAMELY, PROVIDING ONLINE CLASSES AND STUDY COURSES IN THE FIELDS OF MEDICAL TRANSCRIPTION, MEDICAL TRANSCRIPTION EDITING, OUTPATIENT AND INPATIENT MEDICAL CODING AND BILLING, AND MEDICAL TERMINOLOGY, AND DISTRIBUTION OF COURSE MATERIALS IN CONNECTION THEREWITH (U.S. CLS. 100, 101 AND 107).
FIRST USE 11-0-1992; IN COMMERCE 3-0-1993.
RONALD MCMORROW, EXAMINING ATTORNEY

SN 77-795,776. CAREER STEP HOLDINGS, LLC, PROVO, UT. FILED 8-3-2009.



THE MARK CONSISTS OF THE TOP SECTION OF A PILLAR WITH A SCROLL DESIGN ON THE TOP OF THE PILLAR, SUPPORTING THE CORNER SECTION OF A ROOF.

CLASS 16—PAPER GOODS AND PRINTED MATTER

FOR PRINTED INSTRUCTIONAL AND EDUCATIONAL MATERIALS, NAMELY, COURSE BOOKS, WORKBOOKS, WORKSHEETS, FLASH CARDS, DIAGRAMS, AND STUDY GUIDES PROVIDED WITH COURSES OF INSTRUCTION IN THE FIELDS OF MEDICAL TRANSCRIPTION, MEDICAL TRANSCRIPTION EDITING, OUTPATIENT AND INPATIENT MEDICAL CODING AND BILLING, AND MEDICAL TERMINOLOGY (U.S. CLS. 2, 5, 22, 23, 29, 37, 38 AND 50).
FIRST USE 11-0-1992; IN COMMERCE 3-0-1993.

CLASS 41—EDUCATION AND ENTERTAINMENT

FOR EDUCATION SERVICES, NAMELY, PROVIDING ONLINE CLASSES AND STUDY COURSES IN THE FIELDS OF MEDICAL TRANSCRIPTION, MEDICAL TRANSCRIPTION EDITING, OUTPATIENT AND INPATIENT MEDICAL CODING AND BILLING, AND MEDICAL TERMINOLOGY, AND DISTRIBUTION OF COURSE MATERIALS IN CONNECTION THEREWITH (U.S. CLS. 100, 101 AND 107).
FIRST USE 11-0-1992; IN COMMERCE 3-0-1993.
RONALD MCMORROW, EXAMINING ATTORNEY

SN 77-795,830. LDNA LLC, TEMECULA, CA. FILED 8-3-2009.

SN 77-795,919. KNOX, LESLIE FULLER, PEOTONE, IL. FILED 8-3-2009.

DEFTFAMILY

THE MARK CONSISTS OF STANDARD CHARACTERS WITHOUT CLAIM TO ANY PARTICULAR FONT, STYLE, SIZE, OR COLOR.

CLASS 9—ELECTRICAL AND SCIENTIFIC APPARATUS

FOR EYEWEAR; GOGGLES, NAMELY, GOGGLES FOR SPORTS; AND SUNGLASSES; COMPONENT PARTS FOR THE FOREGOING GOODS ALL SOLD AS A UNIT; CASES FOR THE FOREGOING GOODS (U.S. CLS. 21, 23, 26, 36 AND 38).

CLASS 25—CLOTHING

FOR CLOTHING, NAMELY, TOPS, BOTTOMS, T-SHIRTS, BUTTON UP SHIRTS, HOODED SWEATSHIRTS, SWEATSHIRTS, PANTS, JEANS, UNDERWEAR, BOXERS, BANDANAS, SOCKS; WRIST BANDS; BELTS; GLOVES; BEANIES; HATS; HEADWEAR; FOOTWEAR (U.S. CLS. 22 AND 39).

LAURIE KAUFMAN, EXAMINING ATTORNEY

SN 77-795,858. LDNA LLC, TEMECULA, CA. FILED 8-3-2009.



THE MARK CONSISTS OF A MIRRORED "@" SYMBOL AND THE TERM "FAMILY".

CLASS 9—ELECTRICAL AND SCIENTIFIC APPARATUS

FOR EYEWEAR; GOGGLES, NAMELY, GOGGLES FOR SPORTS; AND SUNGLASSES; COMPONENT PARTS FOR THE FOREGOING GOODS ALL SOLD AS A UNIT; CASES FOR THE FOREGOING GOODS (U.S. CLS. 21, 23, 26, 36 AND 38).

CLASS 25—CLOTHING

FOR CLOTHING, NAMELY, TOPS, BOTTOMS, T-SHIRTS, BUTTON UP SHIRTS, HOODED SWEATSHIRTS, SWEATSHIRTS, PANTS, JEANS, UNDERWEAR, BOXERS, BANDANAS, SOCKS; WRIST BANDS; BELTS; GLOVES; BEANIES; HATS; HEADWEAR; FOOTWEAR (U.S. CLS. 22 AND 39).

LAURIE KAUFMAN, EXAMINING ATTORNEY



THE COLOR(S) BLACK, WHITE, PINK AND SKIN COLOR IS/ARE CLAIMED AS A FEATURE OF THE MARK.

THE MARK CONSISTS OF THE FOLLOWING: PART OF A WOMAN'S FACE AND FINGER APPEARING IN THE COLOR OF SKIN AND BLACK, LIPS IN PINK, AND A FINGERNAIL IN WHITE." THE WORDS "SNEAKY MOMMY" APPEAR IN BLACK. THE WHITE AROUND THE WOMAN'S FACE AND THE WORDS REPRESENT BACKGROUND.

CLASS 9—ELECTRICAL AND SCIENTIFIC APPARATUS

FOR ELECTRONIC PUBLICATIONS, NAMELY, NEWSLETTERS, MAGAZINES, COMPILATIONS FEATURING ESSAYS, BLOGS, ARTICLES RECORDED ON COMPUTER MEDIA (U.S. CLS. 21, 23, 26, 36 AND 38).

CLASS 41—EDUCATION AND ENTERTAINMENT

FOR ON-LINE JOURNALS, NAMELY, BLOGS FEATURING THEMES ABOUT MOTHERHOOD, PARENTING, RAISING CHILDREN, HIGH SCHOOL AGE CHILDREN, EXCEPTIONAL CHILDREN, PRESCHOOLERS, INFANTS AND JUNIOR HIGH CHILDREN AS WELL AS ELEMENTARY SCHOOL AGED CHILDREN AND HOW TO NAVIGATE RELATIONSHIPS WITH MEDICAL, EDUCATIONAL AND SPIRITUAL/THEOLOGICAL AUTHORITY FIGURES IN THE LIFE OF A FAMILY (U.S. CLS. 100, 101 AND 107).

KHANH LE, EXAMINING ATTORNEY

SN 77-795,931. MELAN-INC., DBA MEL-CO, INDIO, CA. FILED 8-3-2009.



THE COLOR(S) GREEN, ORANGE, PURPLE, AND WHITE IS/ARE CLAIMED AS A FEATURE OF THE MARK.

THE MARK CONSISTS OF THE WORDS "MEL-CO" APPEAR IN GREEN, WITH A GREEN TEST TUBE REPRESENTING THE LETTER "L" IN THE WORD "MEL-CO". TEST TUBE IS HOLDING A FLOWER THAT APPEARS IN THE COLORS PURPLE, WHITE, AND ORANGE. UNDERNEATH THE DESIGN IS THE WORDING "HANDCRAFTED FROM NATURE", WHICH APPEARS IN THE COLOR ORANGE.

SN 77-796,647. IVERIFY.US INC., CHARLOTTE, NC. FILED 8-4-2009.

I-SERVE

CLASS 3—COSMETICS AND CLEANING PREPARATIONS

FOR COSMETIC PREPARATIONS FOR SKIN RENEWAL; NON-MEDICATED PREPARATIONS ALL FOR THE CARE OF SKIN, HAIR AND SCALP (U.S. CLS. 1, 4, 6, 50, 51 AND 52).

FIRST USE 2-29-2008; IN COMMERCE 2-29-2008.

CLASS 5—PHARMACEUTICALS

FOR PHARMACEUTICAL PREPARATIONS FOR SKIN CARE (U.S. CLS. 6, 18, 44, 46, 51 AND 52).

FIRST USE 2-29-2008; IN COMMERCE 2-29-2008. JAY FLOWERS, EXAMINING ATTORNEY

THE MARK CONSISTS OF STANDARD CHARACTERS WITHOUT CLAIM TO ANY PARTICULAR FONT, STYLE, SIZE, OR COLOR.

CLASS 37—CONSTRUCTION AND REPAIR

FOR INSTALLING SECURITY SYSTEMS (U.S. CLS. 100, 103 AND 106).

CLASS 45—PERSONAL AND LEGAL SERVICES

FOR SECURITY SERVICES, NAMELY, PROTECTING PEOPLE, PROPERTY AND ASSETS FOR BUSINESSES AND GOVERNMENTAL AGENCIES BY PROVIDING SECURITY ASSESSMENTS, DEVELOPING AND IMPLEMENTING CUSTOMIZED BUSINESS SOLUTIONS FOR IMPROVING SECURITY AND PREVENTING CRIMINAL ACTIVITY, PROVIDING AUDIO AND VIDEO MONITORING OF PREMISES, PROVIDING DISCREET MONITORING OF EMPLOYEES OF BUSINESSES AND GOVERNMENTAL AGENCIES FOR SECURITY PURPOSES, ALARM RESPONSE AND VERIFICATION SERVICES, NAMELY, PROVIDING ANNOUNCED MONITORING OF PREMISES ALERTING PERSONS ON THE PREMISES OF THE MONITORING, RESPONDING TO ALARM ACTIVATIONS, AND DETERMINING THE CAUSE OF ALARM ACTIVATIONS; SECURITY SERVICES, NAMELY, PROVIDING REAL-TIME VOICE INTERACTION WITH PERSONS ON THE PREMISES VIA SPEAKERS AND MICROPHONES, CONDUCTING VISUAL OPERATIONAL AUDITS OF PREMISES, AND ESCORTING EMPLOYEES WALKING TO AND FROM THEIR VEHICLES BY CONDUCTING AUDIO AND VIDEO MONITORING OF THE EMPLOYEES AND PROVIDING SIMULTANEOUS VOICE INTERACTION WITH SAID EMPLOYEES (U.S. CLS. 100 AND 101).

SUE LAWRENCE, EXAMINING ATTORNEY

SN 77-796,604. HINE, BRETT, HENDERSON, NV. FILED 8-4-2009.

GIRLS ROCK

THE MARK CONSISTS OF STANDARD CHARACTERS WITHOUT CLAIM TO ANY PARTICULAR FONT, STYLE, SIZE, OR COLOR.

OWNER OF U.S. REG. NO. 2,835,941.

NO CLAIM IS MADE TO THE EXCLUSIVE RIGHT TO USE "GIRLS", APART FROM THE MARK AS SHOWN.

CLASS 41—EDUCATION AND ENTERTAINMENT

FOR ENTERTAINMENT SERVICES, NAMELY, PROVIDING A WEBSITE FEATURING ONLINE DIGITAL CONTENT IN THE NATURE OF NON-DOWNLOADABLE AUDIO RECORDINGS, NAMELY, MUSICAL SOUND RECORDINGS AND SOUND EFFECTS, TEXT AND GRAPHICS; ENTERTAINMENT SERVICES, NAMELY, PROVIDING ONLINE INTERACTIVE COMPUTER GAMES AND CONDUCTING ONLINE CONTESTS (U.S. CLS. 100, 101 AND 107).

FIRST USE 7-15-2002; IN COMMERCE 7-15-2002.

CLASS 45—PERSONAL AND LEGAL SERVICES

FOR ONLINE SOCIAL NETWORKING SERVICES (U.S. CLS. 100 AND 101).

FIRST USE 7-15-2009; IN COMMERCE 7-15-2009. RONALD DELGIZZI, EXAMINING ATTORNEY

SN 77-796,763. LEGEND FILMS, INC., SAN DIEGO, CA. FILED 8-4-2009.

LEGEND 3D

THE MARK CONSISTS OF STANDARD CHARACTERS WITHOUT CLAIM TO ANY PARTICULAR FONT, STYLE, SIZE, OR COLOR.

OWNER OF U.S. REG. NOS. 2,834,541 AND 2,929,710.

NO CLAIM IS MADE TO THE EXCLUSIVE RIGHT TO USE "3D", APART FROM THE MARK AS SHOWN.

CLASS 9—ELECTRICAL AND SCIENTIFIC APPARATUS

FOR DVDS FEATURING TWO-DIMENSIONAL STILL AND MOVING IMAGES CONVERTED TO THREE-DIMENSIONAL STILL AND MOVING IMAGES IN THE NATURE OF DOCUMENTARIES, FEATURE FILMS FEATURING COMEDY, DRAMA, ADVENTURE, AND SCIENCE FICTION, AND TELEVISION SHOW FEATURING COMEDY, DRAMA, ADVENTURE, AND SCIENCE FICTION (U.S. CLS. 21, 23, 26, 36 AND 38).

CLASS 41—EDUCATION AND ENTERTAINMENT

FOR FILM EDITING AND PRODUCTION SERVICES, NAMELY, PERFORMING IMAGE PROCESSING SERVICES EMPLOYING HARDWARE AND SOFTWARE TO CONVERT TWO-DIMENSIONAL STILL AND MOVING IMAGES INTO THREE-DIMENSIONAL STILL AND MOVING IMAGES (U.S. CLS. 100, 101 AND 107).
KRISTINA MORRIS, EXAMINING ATTORNEY

SN 77-796,947. MELAN-INC., DBA MEL-CO, INDIO, CA. FILED 8-4-2009.



THE MARK CONSISTS OF TYPE-WRITTEN TERM "MEL-CO", WITH FLOWER GROWING OUT OF TEST TUBE. IN ADDITION, THE PHRASE "HANDCRAFTED FROM NATURE" IS BELOW THE TERM "MEL-CO".

SN 77-796,837. 1-REX, INC., FORT WORTH, TX. FILED 8-4-2009.

RXCLASSROOM

THE MARK CONSISTS OF STANDARD CHARACTERS WITHOUT CLAIM TO ANY PARTICULAR FONT, STYLE, SIZE, OR COLOR.
OWNER OF U.S. REG. NO. 3,464,093.

CLASS 9—ELECTRICAL AND SCIENTIFIC APPARATUS

FOR COMPUTER SOFTWARE FOR CONNECTING COMPUTER NETWORK USERS FOR USE IN THE FIELD OF ONLINE AND WEB-BASED LEARNING; COMPUTER SOFTWARE FOR ASSESSING STUDENT PERFORMANCE, MANAGING AND REPORTING ON STUDENT ASSIGNMENTS AND STUDENT PROGRESS, FACILITATING ONLINE COMMUNICATIONS FOR PROVIDING ONLINE ASSESSMENTS AND INFRASTRUCTURE DEVELOPMENT FOR WEB-BASED LEARNING (U.S. CLS. 21, 23, 26, 36 AND 38).

CLASS 41—EDUCATION AND ENTERTAINMENT

FOR EDUCATIONAL TRAINING, NAMELY, CLASSES, SEMINARS, CONFERENCES, AND WORKSHOPS IN THE FIELD OF ONLINE AND WEB-BASED LEARNING; EDUCATIONAL CONSULTING IN THE FIELD OF ONLINE AND WEB-BASED LEARNING; EDUCATIONAL SUPPORT SERVICES, NAMELY, DEVELOPING CURRICULUM FOR OTHERS IN THE FIELD OF HEALTHCARE, PROVIDING CONTINUING PROFESSIONAL EDUCATION COURSES IN THE FIELD OF HEALTHCARE (U.S. CLS. 100, 101 AND 107).
LINDSEY RUBIN, EXAMINING ATTORNEY

CLASS 3—COSMETICS AND CLEANING PREPARATIONS

FOR COSMETIC PREPARATIONS FOR SKIN RENEWAL; NON-MEDICATED PREPARATIONS ALL FOR THE CARE OF SKIN, HAIR AND SCALP (U.S. CLS. 1, 4, 6, 50, 51 AND 52).
FIRST USE 2-29-2008; IN COMMERCE 2-29-2008.

CLASS 5—PHARMACEUTICALS

FOR PHARMACEUTICAL PREPARATIONS FOR SKIN CARE (U.S. CLS. 6, 18, 44, 46, 51 AND 52).
FIRST USE 2-29-2008; IN COMMERCE 2-29-2008.
JAY FLOWERS, EXAMINING ATTORNEY

SN 77-796,968. SONY COMPUTER ENTERTAINMENT AMERICA LLC, FOSTER CITY, CA. FILED 8-4-2009.

EYEPET

THE MARK CONSISTS OF STANDARD CHARACTERS WITHOUT CLAIM TO ANY PARTICULAR FONT, STYLE, SIZE, OR COLOR.

CLASS 9—ELECTRICAL AND SCIENTIFIC APPARATUS

FOR COMPUTER GAME SOFTWARE AND VIDEO GAME SOFTWARE (U.S. CLS. 21, 23, 26, 36 AND 38).

CLASS 41—EDUCATION AND ENTERTAINMENT

FOR PROVIDING A REAL-TIME COMPUTER GAME FOR OTHERS THAT MAY BE ACCESSED OVER GLOBAL AND LOCAL AREA COMPUTER NETWORKS BY NETWORK USERS (U.S. CLS. 100, 101 AND 107).
CHRISTINA SOBRAL, EXAMINING ATTORNEY

SN 77-797,081. OREGON CLIMATE TRUST, FORMERLY THE CLIMATE TRUST, PORTLAND, OR. FILED 8-4-2009.

SN 77-797,093. LIGHTS OUT HOLDINGS, LLC, SAN DIEGO, CA. FILED 8-4-2009.

The Climate Trust

THE MARK CONSISTS OF STANDARD CHARACTERS WITHOUT CLAIM TO ANY PARTICULAR FONT, STYLE, SIZE, OR COLOR.

NO CLAIM IS MADE TO THE EXCLUSIVE RIGHT TO USE "TRUST", APART FROM THE MARK AS SHOWN. SEC. 2(F).

CLASS 35—ADVERTISING AND BUSINESS

FOR CONSULTING AND ADVISORY SERVICES WITH REGARD TO BUSINESS PLANNING, BUSINESS ANALYSIS, BUSINESS MANAGEMENT, BUSINESS ORGANIZATION, MARKETING AND CUSTOMER ANALYSIS, NAMELY, ADVISING BUSINESSES AND GOVERNMENTS IN THE AREAS OF COMPLIANCE AND VOLUNTARY GREENHOUSE GAS OFFSET MARKETS, NAMELY, CARBON CREDITS, GREENHOUSE GAS REDUCTION, AND CLIMATE CHANGE POLICY (U.S. CLS. 100, 101 AND 102).

FIRST USE 9-0-2000; IN COMMERCE 9-0-2000.

CLASS 36—INSURANCE AND FINANCIAL

FOR TRUST SERVICES, NAMELY, INVESTMENT AND TRUST COMPANY SERVICES FOR GREENHOUSE GAS MITIGATION PAYMENTS FROM ENERGY FACILITIES; AND FINANCIAL SERVICES, NAMELY, ACQUIRING AND MANAGING OFFSET FUNDS, NAMELY, CARBON CREDIT FUNDS, FUNDING EMISSION REDUCTION PROJECTS THAT CREATE GREENHOUSE GAS REDUCTIONS, OFFSETS OR CARBON CREDITS, AND CONSULTING AND ADVISORY SERVICES RELATIVE TO THE ABOVE (U.S. CLS. 100, 101 AND 102).

FIRST USE 9-0-2000; IN COMMERCE 9-0-2000.

CLASS 42—SCIENTIFIC AND COMPUTER SERVICES

FOR SCIENTIFIC SERVICES AND RESEARCH IN THE FIELD OF ENVIRONMENTAL PROTECTION FEATURING RESOURCES AND PROGRAMS ON ENVIRONMENTAL QUALITY, MEASUREMENT METHODS, MONITORING AND VERIFICATION, AND ECONOMIC MODELING TO REDUCE, ELIMINATE, SEQUESTER OR AVOID GREENHOUSE GAS EMISSIONS FROM ENERGY FACILITIES AND OTHER SOURCES OF GREENHOUSE GASES; UNDERTAKING SCIENTIFIC RESEARCH ON THE REDUCTION, ELIMINATION, SEQUESTRATION OR AVOIDANCE OF GREENHOUSE GAS EMISSIONS AND THE MONITORING AND VERIFICATION OF GREENHOUSE GAS REDUCTIONS AND OFFSETS, INCLUDING CARBON CREDITS (U.S. CLS. 100 AND 101).

FIRST USE 9-0-2000; IN COMMERCE 9-0-2000.

CLASS 45—PERSONAL AND LEGAL SERVICES

FOR CONSULTING AND ADVISORY SERVICES ON ENVIRONMENTAL REGULATORY MATTERS, NAMELY, ADVISING BUSINESSES AND GOVERNMENTS IN THE AREAS OF COMPLIANCE AND VOLUNTARY GREENHOUSE GAS OFFSET MARKETS, GREENHOUSE GAS REDUCTION, AND CLIMATE CHANGE POLICY (U.S. CLS. 100 AND 101).

FIRST USE 9-0-2000; IN COMMERCE 9-0-2000. TASNEEM HUSSAIN, EXAMINING ATTORNEY



OWNER OF U.S. REG. NO. 2,885,212. THE NAME(S), PORTRAIT(S), AND/OR SIGNATURE(S) SHOWN IN THE MARK IDENTIFIES "SHAWNE MERRIMAN", WHOSE CONSENT(S) TO REGISTER IS MADE OF RECORD.

THE MARK CONSISTS OF A STYLIZED SIGNATURE "SHAWNE MERRIMAN" WITH THE NUMBER SYMBOL AND THE NUMBER "56" WRITTEN IN SMALLER FONT BETWEEN "SHAWNE MERRIMAN" AND THE PHRASE "LIGHTS OUT".

CLASS 12—VEHICLES

FOR VEHICLE SEAT COVERS (U.S. CLS. 19, 21, 23, 31, 35 AND 44).

CLASS 16—PAPER GOODS AND PRINTED MATTER

FOR PENS; POSTERS; TEMPORARY TATTOOS (U.S. CLS. 2, 5, 22, 23, 29, 37, 38 AND 50).

CLASS 21—HOUSEWARES AND GLASS

FOR SPORTS BOTTLES SOLD EMPTY (U.S. CLS. 2, 13, 23, 29, 30, 33, 40 AND 50).

CLASS 25—CLOTHING

FOR HATS; T-SHIRTS; WRIST BANDS (U.S. CLS. 22 AND 39).

LINDA LAVACHE, EXAMINING ATTORNEY

SN 77-797,543. FAST SLOW CONCEPTS, LLC, BERKELEY, CA. FILED 8-5-2009.

PIZZAVORE

THE MARK CONSISTS OF STANDARD CHARACTERS WITHOUT CLAIM TO ANY PARTICULAR FONT, STYLE, SIZE, OR COLOR.

CLASS 21—HOUSEWARES AND GLASS

FOR BEVERAGE GLASSWARE (U.S. CLS. 2, 13, 23, 29, 30, 33, 40 AND 50).

CLASS 25—CLOTHING

FOR CLOTHING, NAMELY, T-SHIRTS, SWEAT-SHIRTS, BOXER SHORTS, AND WOMEN'S UNDERWEAR; HEADGEAR, NAMELY, CAPS AND HATS (U.S. CLS. 22 AND 39).

CLASS 43—HOTEL AND RESTAURANT SERVICES

FOR RESTAURANT AND CATERING SERVICES (U.S. CLS. 100 AND 101).
MICHELLE DUBOIS, EXAMINING ATTORNEY

SN 77-797,856. NOZE, INCORPORATED, SAN FRANCISCO, CA. FILED 8-5-2009.

MASS TRANSIT FOR ONE

THE MARK CONSISTS OF STANDARD CHARACTERS WITHOUT CLAIM TO ANY PARTICULAR FONT, STYLE, SIZE, OR COLOR.

SN 77-797,681. SAINT-GOBAIN ABRASIVES, INC., WORCESTER, MA. FILED 8-5-2009.

POWERLOCK

THE MARK CONSISTS OF STANDARD CHARACTERS WITHOUT CLAIM TO ANY PARTICULAR FONT, STYLE, SIZE, OR COLOR.

OWNER OF U.S. REG. NO. 857,294.

CLASS 12—VEHICLES

FOR BICYCLES AND BICYCLE ACCESSORIES, NAMELY, BICYCLE PUMPS, INNER TUBES, SADDLES, GRIPS, HANDLEBAR PADS, HANDLEBAR TAPE, BRAKE LEVERS, SEAT POSTS AND WATER BOTTLE CAGES (U.S. CLS. 19, 21, 23, 31, 35 AND 44).

CLASS 25—CLOTHING

FOR CLOTHING FOR BICYCLING, NAMELY, SHORTS, SHIRTS, JERSEYS, CAPS, GLOVES, SHOES, AND SOCKS (U.S. CLS. 22 AND 39).

CLASS 3—COSMETICS AND CLEANING PREPARATIONS

FOR ABRASIVE DISCS AND HOLDERS FOR THE ABRASIVE DISCS (U.S. CLS. 1, 4, 6, 50, 51 AND 52).
FIRST USE 3-1-1964; IN COMMERCE 3-1-1964.

CLASS 35—ADVERTISING AND BUSINESS

FOR RETAIL STORES AND ONLINE RETAIL STORES FEATURING BICYCLES, BICYCLE ACCESSORIES AND BICYCLE CLOTHING (U.S. CLS. 100, 101 AND 102).
LINDA LAVACHE, EXAMINING ATTORNEY

CLASS 7—MACHINERY

FOR COATED ABRASIVE DISCS USED ON HANDHELD POWER-OPERATED PORTABLE MACHINES (U.S. CLS. 13, 19, 21, 23, 31, 34 AND 35).
FIRST USE 3-1-1964; IN COMMERCE 3-1-1964.
MARIA-VICTORIA SUAREZ, EXAMINING ATTORNEY

SN 77-797,928. CAMPERO INTERNATIONAL LIMITED, BRIDGETOWN, BARBADOS, FILED 8-5-2009.

SN 77-797,774. JAB DISTRIBUTORS, LLC, DBA PROTECT-A-BED, NORTHBROOK, IL. FILED 8-5-2009.

FLAVOR YOU CAN'T CAMPERO**PROTECT-A-BED SENSITIVESKIN**

THE MARK CONSISTS OF STANDARD CHARACTERS WITHOUT CLAIM TO ANY PARTICULAR FONT, STYLE, SIZE, OR COLOR.

OWNER OF U.S. REG. NOS. 2,741,608, 2,741,659 AND 3,617,210.

NO CLAIM IS MADE TO THE EXCLUSIVE RIGHT TO USE "SENSITIVE SKIN", APART FROM THE MARK AS SHOWN.

THE MARK CONSISTS OF STANDARD CHARACTERS WITHOUT CLAIM TO ANY PARTICULAR FONT, STYLE, SIZE, OR COLOR.

OWNER OF U.S. REG. NOS. 3,005,932, 3,161,568 AND OTHERS.

THE ENGLISH TRANSLATION OF "CAMPERO" IN THE MARK IS "COUNTRY".

CLASS 20—FURNITURE AND ARTICLES NOT OTHERWISE CLASSIFIED

FOR MATTRESSES; PILLOWS (U.S. CLS. 2, 13, 22, 25, 32 AND 50).

CLASS 25—CLOTHING

FOR MEN'S AND WOMEN'S SPORTSWEAR AND ACTIVE WEAR; NAMELY, JACKETS, HATS, KNIT SHIRTS, DRESS SHIRTS, SPORT SHIRTS, T-SHIRTS, SHORTS AND PANTS (U.S. CLS. 22 AND 39).

CLASS 24—FABRICS

FOR BED BLANKETS; BED SHEETS; MATTRESS COVERS; PILLOW COVERS (U.S. CLS. 42 AND 50).
KIMBERLY PERRY, EXAMINING ATTORNEY

CLASS 29—MEATS AND PROCESSED FOODS

FOR COOKED POULTRY, COLE SLAW, PROCESSED POTATOES, SALADS, NAMELY, VEGETABLE SALADS, GARDEN SALADS, PROCESSED BEANS, COOKED VEGETABLES, FRENCH FRIED POTATOES, AND ENTREES CONSISTING OF POULTRY OR PREPARED VEGETABLES (U.S. CL. 46).

CLASS 30—STAPLE FOODS

FOR BREADS, PASTRIES, SALSA, GRAIN-BASED BEVERAGES, AND BAKERY DESSERTS (U.S. CL. 46).

CLASS 32—LIGHT BEVERAGES

FOR BEVERAGES, NAMELY, FRUIT DRINKS, FRUIT PUNCH, LEMONADE AND DRINKING WATER (U.S. CLS. 45, 46 AND 48).

SN 77-798,275. STORM RECONSTRUCTION SERVICES, INC., MOBILE, AL. FILED 8-6-2009.

CLASS 43—HOTEL AND RESTAURANT SERVICES

FOR RESTAURANT SERVICES (U.S. CLS. 100 AND 101).

DAWN FELDMAN, EXAMINING ATTORNEY

SRS

THE MARK CONSISTS OF STANDARD CHARACTERS WITHOUT CLAIM TO ANY PARTICULAR FONT, STYLE, SIZE, OR COLOR.

CLASS 37—CONSTRUCTION AND REPAIR

FOR BUILDING CONSTRUCTION AND REPAIR, CONSULTING SERVICES FOR REPAIR AND RESTORATION OF BUILDINGS AND STRUCTURES, HOUSE AND BUILDING DEMOLITION, SOLID WASTE LANDFILL SERVICES, HAZARDOUS WASTE DISPOSAL SERVICES (U.S. CLS. 100, 103 AND 106).

FIRST USE 8-20-1993; IN COMMERCE 8-20-1993.

CLASS 40—MATERIAL TREATMENT

FOR HAZARDOUS WASTE MANAGEMENT (U.S. CLS. 100, 103 AND 106).

FIRST USE 8-20-1993; IN COMMERCE 8-20-1993.

CLASS 42—SCIENTIFIC AND COMPUTER SERVICES

FOR ENGINEERING SERVICES FOR FACILITY MANAGEMENT, REPAIR AND RESTORATION, AND ENVIRONMENTAL CONSULTING (U.S. CLS. 100 AND 101).

FIRST USE 8-20-1993; IN COMMERCE 8-20-1993.

KELLY TRUSILO, EXAMINING ATTORNEY

SN 77-797,991. INTEK AMERICA, INC., RANCHO DOMINGUEZ, CA. FILED 8-5-2009.

GOECOLIFE

THE MARK CONSISTS OF STANDARD CHARACTERS WITHOUT CLAIM TO ANY PARTICULAR FONT, STYLE, SIZE, OR COLOR.

CLASS 2—PAINTS

FOR INK CARTRIDGES FOR PRINTERS, INK JET CARTRIDGES, INK JET PRINTER INK, TONER, TONER CARTRIDGES (U.S. CLS. 6, 11 AND 16).

SN 77-798,395. XANTHUS COMMUNICATIONS LLC, SEATTLE, WA. FILED 8-6-2009.

PR FOR PEOPLE

CLASS 4—LUBRICANTS AND FUELS

FOR PAPER AND/OR PLASTIC SHEETS CONTAINING LUBRICATING OIL FOR USE IN PAPER AND MEDIA SHREDDERS FOR THE PURPOSE OF LUBRICATING THE SHREDDER (U.S. CLS. 1, 6 AND 15).

THE MARK CONSISTS OF STANDARD CHARACTERS WITHOUT CLAIM TO ANY PARTICULAR FONT, STYLE, SIZE, OR COLOR.

NO CLAIM IS MADE TO THE EXCLUSIVE RIGHT TO USE "PR", APART FROM THE MARK AS SHOWN.

CLASS 9—ELECTRICAL AND SCIENTIFIC APPARATUS

FOR VOLTAGE SURGE PROTECTORS, VOLTAGE SURGE SUPPRESSORS, ELECTRICAL POWER CONTROLLER (U.S. CLS. 21, 23, 26, 36 AND 38).

CLASS 16—PAPER GOODS AND PRINTED MATTER

FOR A SERIES OF BOOKS AND WRITTEN ARTICLES IN THE FIELD OF ADVERTISING SERVICES, PUBLIC RELATIONS AND MARKETING SERVICES (U.S. CLS. 2, 5, 22, 23, 29, 37, 38 AND 50).

CLASS 16—PAPER GOODS AND PRINTED MATTER

FOR PAPER AND MEDIA SHREDDERS FOR HOME AND OFFICE USE; TRASH BAGS; TRASH BAGS FOR DISPOSING OF PET WASTE; TRASH BAGS ESPECIALLY DESIGNED FOR USE WITH HOME OR OFFICE PAPER AND MEDIA SHREDDERS; BIODEGRADABLE BAGS, NAMELY, TRASH BAGS, TRASH BAGS FOR DISPOSING OF PET WASTE, AND TRASH BAGS ESPECIALLY DESIGNED FOR USE WITH HOME OR OFFICE PAPER AND MEDIA SHREDDERS (U.S. CLS. 2, 5, 22, 23, 29, 37, 38 AND 50).

LINDA LAVACHE, EXAMINING ATTORNEY

CLASS 41—EDUCATION AND ENTERTAINMENT

FOR EDUCATIONAL AND ENTERTAINMENT SERVICES, NAMELY, A CONTINUING PROGRAM ABOUT ADVERTISING SERVICES, MARKETING SERVICES AND PUBLIC RELATIONS ACCESSIBLE BY RADIO, TELEVISION, SATELLITE, AUDIO, VIDEO AND COMPUTER NETWORKS (U.S. CLS. 100, 101 AND 107).

RUSS HERMAN, EXAMINING ATTORNEY

SN 77-798,488. YAMAHA HATSUDOKI KABUSHIKI KAISHA, SHIZUOKA-KEN, JAPAN, FILED 8-6-2009.

SN 77-798,600. RINK RAT INTERNATIONAL, LLC, HOPE, RI. FILED 8-6-2009.

Y-COP

THE MARK CONSISTS OF STANDARD CHARACTERS WITHOUT CLAIM TO ANY PARTICULAR FONT, STYLE, SIZE, OR COLOR.

CLASS 7—MACHINERY

FOR OUTBOARD MOTORS FOR BOATS AND PERSONAL WATERCRAFTS (U.S. CLS. 13, 19, 21, 23, 31, 34 AND 35).

CLASS 9—ELECTRICAL AND SCIENTIFIC APPARATUS

FOR ANTI-THEFT DEVICES FOR OUTBOARD MOTORS, NAMELY, ELECTRONIC LOCKS (U.S. CLS. 21, 23, 26, 36 AND 38).

CLASS 12—VEHICLES

FOR WATER VEHICLES, NAMELY, BOATS AND PERSONAL JET BOATS; ANTI-THEFT DEVICES FOR WATER VEHICLES, NAMELY, BOATS AND PERSONAL JET BOATS (U.S. CLS. 19, 21, 23, 31, 35 AND 44).
RONALD MCMORROW, EXAMINING ATTORNEY

SN 77-798,491. ASIA PACIFIC JEWELRY, L.L.C., NEW YORK, NY. FILED 8-6-2009.

ENGLISH KISS

THE MARK CONSISTS OF STANDARD CHARACTERS WITHOUT CLAIM TO ANY PARTICULAR FONT, STYLE, SIZE, OR COLOR.

CLASS 14—JEWELRY

FOR JEWELRY (U.S. CLS. 2, 27, 28 AND 50).

CLASS 25—CLOTHING

FOR CLOTHING, NAMELY, SHIRTS, PANTS, JEANS, JACKETS, HATS, SUITS, COATS, BELTS, GLOVES, T-SHIRTS, SCARVES, FOOTWEAR, TIES, DRESSES, UNDERWEAR, SHORTS, SOCKS AND SWEATERS (U.S. CLS. 22 AND 39).
RONALD MCMORROW, EXAMINING ATTORNEY



OWNER OF U.S. REG. NOS. 2,858,912 AND 2,949,841.
THE MARK CONSISTS OF A STYLIZED REPRESENTATION OF THE UPPER TORSO OF A RAT WEARING A PROTECTIVE HELMET AND CARRYING A HOCKEY STICK. THE SWIRLING DESIGN ON THE LEFT HAND SIDE AND LOWER PERIMETER OF THE RAT'S TORSO INDICATES MOVEMENT.

CLASS 9—ELECTRICAL AND SCIENTIFIC APPARATUS

FOR AUDIO AND VIDEO RECORDINGS ABOUT HOCKEY; HOCKEY HELMETS (U.S. CLS. 21, 23, 26, 36 AND 38).

CLASS 28—TOYS AND SPORTING GOODS

FOR FANTASY CHARACTER TOYS; MECHANICAL TOYS; PLUSH TOYS; STUFFED TOYS; TOY ANIMALS; TOY FIGURES; TOY VEHICLES; WATER TOYS; BOBBLE HEAD DOLLS; ACTION SKILL GAMES; TABLETOP GAMES; TRADING CARD GAMES; SPORTS BALLS; BALLS FOR GAMES; RUBBER BALLS; HOCKEY PUCKS; HOCKEY EQUIPMENT, NAMELY, GLOVES AND STICKS; BALL BEARINGS FOR IN-LINE SKATES (U.S. CLS. 22, 23, 38 AND 50).
CURTIS FRENCH, EXAMINING ATTORNEY

SN 77-798,686. FERRER, SEAN HEPBURN, SANTA MONICA, CA. AND DOTTI, LUCA, SANTA MONICA, CA. FILED 8-6-2009.

AUDREY HEPBURN

THE MARK CONSISTS OF STANDARD CHARACTERS WITHOUT CLAIM TO ANY PARTICULAR FONT, STYLE, SIZE, OR COLOR.

OWNER OF U.S. REG. NO. 2,891,477.
THE NAME(S), PORTRAIT(S), AND/OR SIGNATURE(S) SHOWN IN THE MARK DOES NOT IDENTIFY A PARTICULAR LIVING INDIVIDUAL.

CLASS 3—COSMETICS AND CLEANING PREPARATIONS

FOR AFTER-SHAVE LOTIONS, AFTER-SUN LOTIONS, ARTIFICIAL EYELASHES, ASTRINGENTS FOR COSMETIC PURPOSES, BABY HAIR CONDITIONER, BABY LOTIONS, BABY OIL, BABY POWDER, BABY SHAMPOO, BATH BEADS, BATH CRYSTALS, BATH FOAM, BATH GELS, BATH OIL, BATH PEARLS, BATH POWDER, NON-MEDICATED BATH SALTS, BEAUTY MASKS, BLUSH, BLUSHER, BODY CREAM, BODY OIL, BODY POWDER, BODY SCRUBS, BUBBLE BATH, COLD CREAM, COLOGNE, COSMETICS, NAMELY, COMPACTS, COMPACTS CONTAINING MAKEUP, CONCEALERS, SKIN CONDITIONERS, COSMETIC PENCILS, COTTON PUFFS FOR COSMETIC PURPOSES, COTTON STICKS FOR COSMETIC PURPOSES, COTTON SWABS FOR COSMETIC PURPOSES, NIGHT CREAM, VANISHING CREAM, DEODORANT SOAP, PERSONAL DEODORANTS, DEPILATORY CREAMS, HAIR DYES, EAU DE TOILETTE, EMERY BOARDS, ESSENTIAL OILS FOR PERSONAL USE, EYE CREAM, EYE GELS, EYE MAKEUP, EYE MAKEUP REMOVER, EYE PENCILS, EYE SHADOW, EYEBROW PENCILS, EYE LINERS, FACE CREAM, FACE POWDER, FACIAL CLEANSERS, FACIAL CREAM, FACIAL MASKS, FACIAL SCRUBS, NON-MEDICATED FOOT POWDER, FOUNDATION, FOUNDATION MAKEUP, NON-MEDICATED HAIR CARE PREPARATIONS, HAIR CONDITIONERS, HAIR GEL, HAIR LIGHTENERS, HAIR LOTIONS, HAIR MOUSSE, HAIR POMADES, HAIR RELAXERS, HAIR RELAXING PREPARATIONS, HAIR REMOVING CREAM, HAIR RINSES, HAIR STYLING PREPARATIONS, HAIR WAVYING LOTION, HAND CREAM, NON-MEDICATED LIP BALM, LIP CREAM, LIP GLOSS, LIP LINER, LIPSTICK, MAKEUP REMOVER, MAKEUP, FACIAL MAKEUP, MASCARA, SKIN MOISTURIZER, SKIN AND FACIAL MOUSSE, NAIL ENAMELS, NAIL POLISH, PERFUME, POTPOURRI, PRE-MOISTENED COSMETIC TISSUES, PRE-MOISTENED COSMETIC TOWELETTES, PRE-MOISTENED COSMETIC WIPES, ROOM FRAGRANCES, ROUGE, SACHETS, SCENTED BODY SPRAY, SCULPTING GEL, HAIR SHAMPOO, SHAMPOO-CONDITIONERS, SHAVING BALM, SHAVING CREAM, SHAVING FOAM, SHAVING GEL, SHAVING LOTION, SHAVING PREPARATIONS, SHAVING SOAP, SHOWER GEL, SKIN CLEANSERS, SKIN CLEANSING CREAM, SKIN CLEANSING LOTION, SKIN CREAM, SKIN LOTION, SKIN MASKS, SKIN MOISTURIZER, SKIN MOISTURIZER MASKS, SKIN SOAP, SKIN TONERS, LIQUID SOAPS FOR HANDS, FACE AND BODY, STYLING GELS, STYLING LOTIONS, SUN BLOCK, SUN BLOCK PREPARATIONS, SUN CREAMS, SUN SCREEN, SUN SCREEN PREPARATIONS, SUN TAN GEL, SUN TAN LOTION, SUN TAN OIL, SUN TANNING PREPARATIONS, TALCUM POWDER, TOILET SOAP, TOILET WATER, TONERS, WRINKLE REMOVING SKIN CARE PREPARATIONS (U.S. CLS. 1, 4, 6, 50, 51 AND 52).

CLASS 14—JEWELRY

FOR WATCH BANDS, DECORATIVE BOXES MADE OF PRECIOUS METAL, JEWELRY BRACELETS, BRACELETS OF PRECIOUS METAL, BROOCHES, JEWELRY CASES OF PRECIOUS METAL, JEWELRY CHAINS, WATCH CHAINS, CHARMS, CHRONOGRAPHS FOR USE AS WATCHES, CLOCKS, ALARM CLOCKS, NON-MONETARY COINS OF PRECIOUS METAL, COSTUME JEWELRY, CUFF-LINKS, DIAMONDS, EAR CLIPS, EARRINGS, EMERALDS, FIGURINES OF PRECIOUS METAL, JEWELRY, JEWELRY LAPEL PINS, MEDALLIONS, NECKLACES, NECKTIE FASTENERS, PEARLS, POCKET WATCHES, RINGS BEING JEWELRY, STATUES OF PRECIOUS METAL, STATUETTES OF PRECIOUS METAL, WATCH STRAPS, TIE CLIPS, TIE FASTENERS, PRECIOUS METAL TROPHIES, WATCHES, WEDDING BANDS, WRISTWATCHES (U.S. CLS. 2, 27, 28 AND 50).

CLASS 18—LEATHER GOODS

FOR ALL PURPOSE ATHLETIC BAGS, ATTACHE CASES, BABY BACKPACKS, BACKPACKS, DIAPER BAGS, BARREL BAGS, BEACH BAGS, BILLFOLDS, BOOK BAGS, BOSTON BAGS, BRIEFCASES, WALKING CANES FOR NON-MEDICAL PURPOSES, CANVAS WOOD CARRIERS, BUSINESS CARD CASES, CALLING CARD CASES, CARRY-ON BAGS, KEY CASES, CHANGE PURSES, CLUTCH BAGS, CLUTCH PURSES, COIN PURSES, COSMETIC CASES SOLD EMPTY, CREDIT CARD CASES, DOCUMENT CASES, DOG COLLARS, DOG LEASHES, DRAWSTRING POUCHES, DUFFEL BAGS, FANNY PACKS, FELT POUCHES, FRAMES FOR UMBRELLAS, GARMENT BAGS FOR TRAVEL, GYM BAGS, HANDBAGS, HAT BOXES FOR TRAVEL NOT OF PAPER OR CARDBOARD, KEY CASES, KNAPSACKS, LEASHES FOR ANIMAL, LUGGAGE, NON-MOTORIZED, COLLAPSIBLE LUGGAGE CARTS, LUGGAGE TAGS, OVERNIGHT BAGS, OVERNIGHT CASES, WAIST PACKS, PARASOLS, PATIO UMBRELLAS, POCKETBOOKS, BRIEFCASE-TYPE PORTFOLIOS, FELT POUCHES, PURSES, RUCKSACKS, SATCHELS, SCHOOL BAGS, SCHOOL BOOK BAGS, SHOE BAGS FOR TRAVEL, LEATHER SHOPPING BAGS, MESH SHOPPING BAGS, TEXTILE SHOPPING BAGS, SHOULDER BAGS, ALL PURPOSE SPORTS BAGS, SUITCASES, THONGS, TOILETRY CASES SOLD EMPTY, TOOL BAGS SOLD EMPTY, TOTE BAGS, TRAVEL BAGS, TRAVELING BAGS, TRAVELING TRUNKS, TRUNKS FOR TRAVELING, UMBRELLA COVERS, UMBRELLA HANDLES, UMBRELLA RING, UMBRELLAS, BEACH UMBRELLAS, GOLF UMBRELLAS, VALISES, VANITY CASES SOLD EMPTY, WAIST PACKS, WALLETS (U.S. CLS. 1, 2, 3, 22 AND 41).

CLASS 24—FABRICS

FOR BATH LINEN, BED BLANKETS, BED CANOPIES, BED LINEN, BED SHEETS, BED SPREADS, FABRIC FOR BOOTS AND SHOES, BROCADE, CALICO, CRIB CANOPIES, FABRIC CASCADES, PILLOW CASES, CLOTH LABELS, CLOTH NAPKINS FOR REMOVING MAKEUP, TABLE CLOTHS NOT OF PAPER, COMFORTERS, COTTON FABRIC, MATTRESS COVERS, UNFITTED FABRIC FURNITURE COVERS, CURTAIN FABRIC, WINDOW CURTAINS, DUVET COVERS, DUVETS, EIDERDOWN QUILTS, SILK FABRIC FOR PRINTING PATTERNS, LINEN LINING FABRIC FOR SHOES, HANDKERCHIEFS, FABRIC JERSEY MATERIAL, KITCHEN TOWELS, LINEN, HOUSEHOLD LINEN; TABLE LINEN, NAMELY, COASTERS, NAPKINS, PLACE MATS AND TABLE CLOTHS; NET CURTAINS, POT HOLDERS, TEXTILE PRINTERS BLANKETS, QUILTS, DUST RUFFLES, TABLE MATS NOT OF PAPER, TEA TOWELS, TEXTILE NAPKINS, TEXTILE PLACE MATS, TOWELS, TEXTILE WALL HANGINGS, WASHCLOTHS, WASHING MITTS (U.S. CLS. 42 AND 50).

CLASS 30—STAPLE FOODS

FOR BAKERY GOODS, GRAIN-BASED FOOD BEVERAGES, CHOCOLATE FOOD BEVERAGES NOT BEING DAIRY-BASED OR VEGETABLE BASED, BISCUITS, BREAD, BREAD STICKS, BREAKFAST CEREALS, BRIOCHES, BUBBLE GUM, BUNS, CAKE MIXES, CAKES, CANDY, CANDY COATED POPCORN, CARAMEL POPCORN, CARAMELS, CEREAL BASED SNACK FOOD, READY TO EAT CEREAL DERIVED FOOD BARS, PROCESSED CEREALS, CHEWING GUM, CHOCOLATE, CHOCOLATE CHIPS, CHOCOLATE COVERED NUTS, CHOCOLATE POWDER, CHOCOLATE SYRUP, CHOCOLATE TOPPING, CHOCOLATE TRUFFLES, CHOCOLATE-BASED FILLINGS FOR CAKES AND PIES, SEASONED COATING FOR MEAT, FISH AND POULTRY, COCOA, COCOA MIXES, COFFEE, GRAIN OR CHICORY BASED COFFEE SUBSTITUTES, COOKIES, CRACKERS, CREPES, CRUMPETS, CURRY, CUSTARD-BASED FILLINGS FOR CAKES AND PIES, CUSTARDS, DESSERT SOUFFLES, ECLAIRS, FROZEN PREPARED AND PACKAGED ENTREES CONSISTING PRIMARILY OF PASTA OR RICE, FLAVORING SYRUP, HERBAL FOOD BEVERAGES, FROSTING MIXES, FROSTINGS, FROZEN CONFECTIONS, FROZEN CUSTARDS, FROZEN YOGURT, FRUIT ICE, FLAVORED AND SWEETENED GELATINS, GINGERBREAD, FLOUR BASED GNOCCHI, PROCESSED GRAINS, GRANOLA, GRANO-

LA-BASED SNACK BARS, HERB TEA FOR FOOD PURPOSES, PROCESSED HERBS, HONEY, HORSERADISH, HOT CHOCOLATE, ICE CREAMS, ICE MILK, FLAVORED ICES, ICING, ICING MIXES, LASAGNA, NON-MEDICATED LOZENGES, MACARONI, MACARONI AND CHEESE, MAPLE SYRUP, MARINADES, MARSHMALLOWS, MAYONNAISE, MILK SHAKES, BASES FOR MAKING MILK SHAKES, CANDY MINTS, MIXES FOR BAKERY GOODS, MUFFINS, NATURAL SWEETENER, CHOW MEIN NOODLES, PACKAGED FOOD COMBINATIONS CONSISTING PRIMARILY OF BREAD, CRACKERS AND/OR COOKIES, PANCAKE MIXES, PANCAKE SYRUP, PANCAKES, PARFAITS, PASTA, PASTA SHELLS, DANISH PASTRIES, PIES, FRUIT PIES, PIZZA, PIZZA CRUST, PIZZA DOUGH, PIZZA SAUCE, PUDDINGS, QUICHE, RAVIOLI, RICE SALAD, BREAD ROLLS, PASTA SALAD, SALAD DRESSINGS, SANDWICHES, ARTICHOKE SAUCE, CHEESE SAUCE, SAUCES, SEASONINGS, SHERBET, RICE-BASED SNACK FOODS, SNACK MIX CONSISTING PRIMARILY OF CRACKERS, PRETZELS, CANDIED NUTS AND/OR POPPED POPCORN, SORBET, SOY SAUCE, SOY-BASED ICE CREAM SUBSTITUTE, SPAGHETTI, SPAGHETTI SAUCE, SPICES, TARTAR SAUCE, TEA, TEA-BASED BEVERAGES WITH FRUIT FLAVORING, TOMATO SAUCE, MARSHMALLOW TOPPING, TOPPING SYRUP, VINEGAR, WAFERS, WHEAT-BASED SNACK FOODS, WON-TON WRAPPERS, WON TONS (U.S. CL. 46).

CLASS 34—SMOKERS' ARTICLES

FOR CIGARETTE CASES MADE OF PRECIOUS METAL, CIGARETTE HOLDERS OF PRECIOUS METAL, CIGARETTE LIGHTERS OF PRECIOUS METAL (U.S. CLS. 2, 8, 9 AND 17).

THEODORE MCBRIDE, EXAMINING ATTORNEY

CLASS 16—PAPER GOODS AND PRINTED MATTER

FOR MAGAZINES AND NEWSLETTERS FEATURING MOTORSPORTS; STATIONERY, PENS, DECALS, STICKERS AND POSTERS (U.S. CLS. 2, 5, 22, 23, 29, 37, 38 AND 50).

FIRST USE 9-19-1996; IN COMMERCE 9-19-1996.

CLASS 21—HOUSEWARES AND GLASS

FOR MUGS, INSULATING JACKETS FOR USE WITH BEVERAGE CANS; STAINED GLASS DECORATIONS (U.S. CLS. 2, 13, 23, 29, 30, 33, 40 AND 50).

FIRST USE 9-19-1996; IN COMMERCE 9-19-1996.

CLASS 24—FABRICS

FOR CLOTH FLAGS (U.S. CLS. 42 AND 50).

FIRST USE 9-19-1996; IN COMMERCE 9-19-1996.

CLASS 25—CLOTHING

FOR CLOTHES, NAMELY, SHIRTS, T-SHIRTS, HATS, JACKETS, CAPS, SWEATSHIRTS (U.S. CLS. 22 AND 39).

FIRST USE 9-19-1996; IN COMMERCE 9-19-1996.

CLASS 28—TOYS AND SPORTING GOODS

FOR TOYS AND GAMES, NAMELY, MODEL CARS, DIE CAST CARS (U.S. CLS. 22, 23, 38 AND 50).

FIRST USE 9-19-1996; IN COMMERCE 9-19-1996.

KEVIN DINALLO, EXAMINING ATTORNEY

SN 77-798,855. PENSKE SYSTEM, INC., BLOOMFIELD HILLS, MI. FILED 8-6-2009.



OWNER OF U.S. REG. NOS. 2,132,515, 2,566,860 AND OTHERS.

NO CLAIM IS MADE TO THE EXCLUSIVE RIGHT TO USE "RACING", APART FROM THE MARK AS SHOWN.

THE MARK CONSISTS OF MISCELLANEOUS DESIGN CALLED TURN 4 ICON DESIGN WITH THE WORDS "PENSKE RACING" TO THE RIGHT OF THE DESIGN.

CLASS 6—METAL GOODS

FOR METAL KEY CHAIN, METAL LICENSE PLATES (U.S. CLS. 2, 12, 13, 14, 23, 25 AND 50).

FIRST USE 9-19-1996; IN COMMERCE 9-19-1996.

CLASS 12—VEHICLES

FOR METAL HOLDERS FOR LICENSE PLATES (U.S. CLS. 19, 21, 23, 31, 35 AND 44).

FIRST USE 9-19-1996; IN COMMERCE 9-19-1996.

CLASS 14—JEWELRY

FOR JEWELRY, ORNAMENTAL PINS AND WATCHES (U.S. CLS. 2, 27, 28 AND 50).

FIRST USE 9-19-1996; IN COMMERCE 9-19-1996.

SN 77-798,863. PENSKE SYSTEM, INC., BLOOMFIELD HILLS, MI. FILED 8-6-2009.



OWNER OF U.S. REG. NOS. 2,132,515, 2,566,860 AND OTHERS.

THE MARK CONSISTS OF A RACING FLAG CONNECTED TO AN OUTLINE OF A HIGHWAY.

CLASS 6—METAL GOODS

FOR METAL KEY CHAIN, METAL LICENSE PLATES (U.S. CLS. 2, 12, 13, 14, 23, 25 AND 50).

FIRST USE 9-19-1996; IN COMMERCE 9-19-1996.

CLASS 12—VEHICLES

FOR METAL HOLDERS FOR LICENSE PLATES (U.S. CLS. 19, 21, 23, 31, 35 AND 44).

FIRST USE 9-19-1996; IN COMMERCE 9-19-1996.

CLASS 14—JEWELRY

FOR JEWELRY, ORNAMENTAL PINS AND WATCHES (U.S. CLS. 2, 27, 28 AND 50).

FIRST USE 9-19-1996; IN COMMERCE 9-19-1996.

CLASS 16—PAPER GOODS AND PRINTED MATTER

FOR MAGAZINES AND NEWSLETTERS FEATURING MOTORSPORTS; STATIONERY, PENS, DECALS, STICKERS AND POSTERS (U.S. CLS. 2, 5, 22, 23, 29, 37, 38 AND 50).

FIRST USE 9-19-1996; IN COMMERCE 9-19-1996.

CLASS 21—HOUSEWARES AND GLASS

FOR MUGS, INSULTING JACKETS FOR USE WITH BEVERAGE CANS; STAINED GLASS DECORATIONS (U.S. CLS. 2, 13, 23, 29, 30, 33, 40 AND 50).

FIRST USE 9-19-1996; IN COMMERCE 9-19-1996.

CLASS 24—FABRICS

FOR CLOTH FLAGS (U.S. CLS. 42 AND 50).

FIRST USE 9-19-1996; IN COMMERCE 9-19-1996.

CLASS 25—CLOTHING

FOR CLOTHES, NAMELY, SHIRTS, T-SHIRTS, HATS, JACKETS, CAPS, SWEATSHIRTS (U.S. CLS. 22 AND 39).

FIRST USE 9-19-1996; IN COMMERCE 9-19-1996.

CLASS 28—TOYS AND SPORTING GOODS

FOR TOYS AND GAMES, NAMELY, MODEL CARS, DIE CAST CARS (U.S. CLS. 22, 23, 38 AND 50).

FIRST USE 9-19-1996; IN COMMERCE 9-19-1996.

KEVIN DINALLO, EXAMINING ATTORNEY

SN 77-799,140. SUNPOWER CORPORATION, SAN JOSE, CA. FILED 8-6-2009.

OASIS

THE MARK CONSISTS OF STANDARD CHARACTERS WITHOUT CLAIM TO ANY PARTICULAR FONT, STYLE, SIZE, OR COLOR.

CLASS 37—CONSTRUCTION AND REPAIR

FOR INSTALLATION, REPAIR, AND MAINTENANCE OF SOLAR ENERGY BASED POWER PLANTS; INSTALLATION, REPAIR, AND MAINTENANCE OF SOLAR ENERGY SYSTEMS, SOLAR COLLECTORS AND SOLAR HEAT COLLECTION PANELS FOR POWER PLANTS; INSTALLATION OF POWER PLANT FACILITIES TO PRODUCE SOLAR ENERGY; INSTALLATION OF GROUND-MOUNTED AND ROOF-MOUNTED SOLAR PANELS FOR POWER PLANTS (U.S. CLS. 100, 103 AND 106).

CLASS 42—SCIENTIFIC AND COMPUTER SERVICES

FOR TECHNICAL PLANNING OF SOLAR ENERGY BASED POWER PLANTS; TECHNOLOGY CONSULTATION FOR POWER PLANTS IN THE USE OF PHOTOVOLTAIC CELLS, PHOTOVOLTAIC MODULES AND SOLAR CELL MODULES (U.S. CLS. 100 AND 101).

TOBY BULLOFF, EXAMINING ATTORNEY

SN 77-799,364. GREENBRIER IA, INC, WHITE SULPHUR SPRINGS, WV. FILED 8-7-2009.

THE GREENBRIER CLASSIC

THE MARK CONSISTS OF STANDARD CHARACTERS WITHOUT CLAIM TO ANY PARTICULAR FONT, STYLE, SIZE, OR COLOR.

OWNER OF U.S. REG. NOS. 1,634,426, 1,978,470 AND OTHERS.

NO CLAIM IS MADE TO THE EXCLUSIVE RIGHT TO USE "CLASSIC", APART FROM THE MARK AS SHOWN.

CLASS 16—PAPER GOODS AND PRINTED MATTER

FOR POSTERS (U.S. CLS. 2, 5, 22, 23, 29, 37, 38 AND 50).

CLASS 18—LEATHER GOODS

FOR ATHLETIC BAGS, TOTE BAGS, UMBRELLAS, LUGGAGE TAGS, TOILETRY CASES SOLD EMPTY, WALLETS, CREDIT CARD CASES AND KEY CASES (U.S. CLS. 1, 2, 3, 22 AND 41).

CLASS 21—HOUSEWARES AND GLASS

FOR PLASTIC CUPS, DRINKING GLASSES, INSULATING SLEEVE HOLDERS FOR BEVERAGES MADE OUT OF FOAM, NYLON, NEOPRENE AND/OR PLASTIC (U.S. CLS. 2, 13, 23, 29, 30, 33, 40 AND 50).

CLASS 24—FABRICS

FOR GOLF TOWELS (U.S. CLS. 42 AND 50).

CLASS 25—CLOTHING

FOR CLOTHING, NAMELY, SHIRTS, JACKETS, SWEATERS, PANTS, SOCKS, HATS, VISORS AND RAINWEAR (U.S. CLS. 22 AND 39).

CLASS 28—TOYS AND SPORTING GOODS

FOR SPORTING GOODS, NAMELY, GOLF CLUBS, GOLF BAGS, GOLF GLOVES, GOLF BAG TAGS, GOLF CLUB HEAD COVERS, GOLF BALLS, GOLF BALL MARKERS, GOLF FLAGS, AND DIVOT REPAIR TOOL FOR GOLFERS (U.S. CLS. 22, 23, 38 AND 50).

CLASS 41—EDUCATION AND ENTERTAINMENT

FOR ENTERTAINMENT SERVICES, NAMELY, ORGANIZING AND CONDUCTING AN ANNUAL GOLF TOURNAMENT (U.S. CLS. 100, 101 AND 107).

EDWARD FENNESSY, EXAMINING ATTORNEY

SN 77-799,447. DIVA INTERNATIONAL S.R.L., SPELLO (PERUGIA), ITALY, FILED 8-7-2009.



THE MARK CONSISTS OF THE WORD "FRIA" DEPICTED WITH A THREE-LEAF FLOWER ATOP THE LETTER "I". THE LONG STEM OF THE FLOWER COMES DOWN BEHIND THE WORD "FRIA", AND ENDS AT THE BOTTOM OF SUCH WORD, WHERE IT TWINES.

THE ENGLISH TRANSLATION OF "FRIA" IN THE MARK IS "COLD".

CLASS 3—COSMETICS AND CLEANING PREPARATIONS

FOR PRE-MOISTENED COSMETIC WIPES IMPREGNATED WITH WATER AND PERFUME FOR PERSONAL USE; DISPOSABLE WIPES IMPREGNATED WITH CLEANING CHEMICALS FOR USE IN CLEANING EYEGLASSES LENSES; PRE-MOISTENED COSMETIC WIPES FOR PERSONAL HYGIENE; PRE-MOISTENED COTTON SWABS FOR COSMETIC PURPOSES (U.S. CLS. 1, 4, 6, 50, 51 AND 52).

CLASS 16—PAPER GOODS AND PRINTED MATTER

FOR DISPOSABLE PAPER WIPES NOT IMPREGNATED WITH CHEMICALS OR COMPOUNDS (U.S. CLS. 2, 5, 22, 23, 29, 37, 38 AND 50).

CLASS 21—HOUSEWARES AND GLASS

FOR NON-WOVEN DISPOSABLE TEXTILE WIPES NOT IMPREGNATED WITH CHEMICALS OR COMPOUNDS (U.S. CLS. 2, 13, 23, 29, 30, 33, 40 AND 50).
WON TEAK OH, EXAMINING ATTORNEY

SN 77-799,732. TEMO, INC., CLINTON TOWNSHIP, MI. FILED 8-7-2009.

ASA

THE MARK CONSISTS OF STANDARD CHARACTERS WITHOUT CLAIM TO ANY PARTICULAR FONT, STYLE, SIZE, OR COLOR.

CLASS 11—ENVIRONMENTAL CONTROL APPARATUS

FOR PRODUCTS FOR USE IN THE FIELD OF BUILDING CONSTRUCTION, RENOVATION, AND REMODELING, NAMELY, FABRICATED AND PREFABRICATED SOLAR THERMAL AIR SYSTEMS FOR HEATING PURPOSES, AND SOLAR HEAT COLLECTION PANELS TO ENHANCE ENERGY EFFICIENCY (U.S. CLS. 13, 21, 23, 31 AND 34).

CLASS 37—CONSTRUCTION AND REPAIR

FOR INSTALLATION, CONSTRUCTION RENOVATION, REMODELING, REPAIR, AND CONSTRUCTION IMPROVEMENTS OF RESIDENTIAL, COMMERCIAL, AND INDUSTRIAL PROPERTIES, SUNROOMS, AND LIVING SPACES UTILIZING SOLAR SYSTEMS AND SOLAR PANELS TO ENHANCE ENERGY EFFICIENCY (U.S. CLS. 100, 103 AND 106).

JORDAN BAKER, EXAMINING ATTORNEY

SN 77-799,757. 9072-9799 QUEBEC INC., MONTREAL, QUEBEC, CANADA, FILED 8-7-2009.

WIENSTEIN & GAVINOS PASTA
BAR CO. LTD.

THE MARK CONSISTS OF STANDARD CHARACTERS WITHOUT CLAIM TO ANY PARTICULAR FONT, STYLE, SIZE, OR COLOR.

OWNER OF CANADA REG. NO. TMA546970, DATED 6-21-2001, EXPIRES 6-21-2016.

NO CLAIM IS MADE TO THE EXCLUSIVE RIGHT TO USE "PASTA BAR CO. LTD.", APART FROM THE MARK AS SHOWN.

CLASS 25—CLOTHING

FOR T-SHIRTS, BASE-BALL CAPS, SWEAT SHIRTS, SWEAT PANTS, SWEATERS, HATS, AND JACKETS (U.S. CLS. 22 AND 39).

CLASS 35—ADVERTISING AND BUSINESS

FOR RESTAURANT FRANCHISING, NAMELY, OFFERING BUSINESS MANAGEMENT ASSISTANCE IN THE ESTABLISHMENT AND/OR OPERATION OF RESTAURANTS (U.S. CLS. 100, 101 AND 102).

CLASS 43—HOTEL AND RESTAURANT SERVICES

FOR BAR, RESTAURANT, CATERING, AND RESTAURANT CARRY-OUT SERVICES (U.S. CLS. 100 AND 101).

ALEXANDER L. POWERS, EXAMINING ATTORNEY

SN 77-800,264. CADY, BONNIE K., LAKEWOOD, CO. FILED 8-8-2009.

PEEZLE

THE MARK CONSISTS OF STANDARD CHARACTERS WITHOUT CLAIM TO ANY PARTICULAR FONT, STYLE, SIZE, OR COLOR.

THE WORDING "PEEZLE" HAS NO MEANING IN A FOREIGN LANGUAGE.

CLASS 35—ADVERTISING AND BUSINESS

FOR PROVIDING A WEBSITE FEATURING ONLINE DATABASES AND ONLINE BUSINESS DIRECTORIES FEATURING COMMERCIAL INFORMATION AND ADVICE FOR CONSUMERS TO AID CONSUMERS IN COMPARING AND SELECTING GOODS AND SERVICES FOR PEOPLE OVER THE AGE OF 55; PROMOTING THE GOODS AND SERVICES OF OTHERS BY DISTRIBUTING ADVERTISING ON THE INTERNET, INCLUDING ON SOCIAL NETWORKING SITES THAT ALLOW PHOTO SHARING AND VIDEO SHARING; PROVIDING AN ONLINE SEARCHABLE DATABASE FEATURING CLASSIFIED ADVERTISING LISTINGS; PROMOTING THE GOODS AND SERVICES OF OTHERS BY PROVIDING HYPERTEXT LINKS TO CONNECT CONSUMERS TO THE WEBSITES OF OTHERS; BUSINESS NETWORKING, NAMELY, BUSINESS INTRODUCTION SERVICES REGARDING GOODS, SERVICES AND INFORMATION SPECIFIC TO PEOPLE AGED 55 YEARS AND OLDER RENDERED THROUGH GLOBAL COMPUTER NETWORKS (U.S. CLS. 100, 101 AND 102).

CLASS 38—COMMUNICATION

FOR PROVIDING ONLINE INTERACTIVE CHAT-ROOMS, ELECTRONIC BULLETIN BOARDS, AND ONLINE FORUMS FOR TRANSMISSION OF MESSAGES AMONG COMPUTER USERS IN THE FIELD OF GENERAL INTEREST, TRAVEL, ENTERTAINMENT, SOCIAL NETWORKING, HEALTH AND WELL BEING, MEDICAL CARE AND DEVICES, ASSISTED LIVING AND HOUSING, DEATH AND DYING, FINANCIAL PLANNING AND HOME IMPROVEMENT, AND THE GOODS, SERVICES AND INFORMATION SPECIFIC TO PEOPLE AGED 55 YEARS AND OLDER (U.S. CLS. 100, 101 AND 104).

CLASS 42—SCIENTIFIC AND COMPUTER SERVICES

FOR CREATING AND MAINTAINING BLOGS FOR OTHERS (U.S. CLS. 100 AND 101).

CLASS 45—PERSONAL AND LEGAL SERVICES

FOR PROVIDING SOCIAL NETWORKING SERVICES RENDERED THROUGH GLOBAL COMPUTER NETWORKS REGARDING GOODS, SERVICES AND INFORMATION SPECIFIC TO PEOPLE AGED 55 YEARS AND OLDER (U.S. CLS. 100 AND 101).

MICHAEL LITZAU, EXAMINING ATTORNEY

SN 77-800,453. EASTLAND, DAVID C, BOWEN, AUSTRALIA, AND EASTLAND, PATRICIA A, BOWEN, AUSTRALIA, FILED 8-10-2009.

Senelow

THE MARK CONSISTS OF STANDARD CHARACTERS WITHOUT CLAIM TO ANY PARTICULAR FONT, STYLE, SIZE, OR COLOR.

PRIORITY CLAIMED UNDER SEC. 44(D) ON AUSTRALIA APPLICATION NO. 12239465, FILED 8-10-2009, REG. NO. 1314150, DATED 8-10-2009, EXPIRES 8-9-2019.

CLASS 29—MEATS AND PROCESSED FOODS

FOR BEEF; BEEF JERKY; BEEF PATTIES; BEEF SLICES; BEEF STEW; BEEF STOCK; BEEF TALLOW; CORNED BEEF; CORNED BEEF HASH; DRIED BEEF; PREPARED BEEF; ROAST BEEF (U.S. CL. 46).

CLASS 31—NATURAL AGRICULTURAL PRODUCTS

FOR LIVE ANIMALS, NAMELY, CATTLE; LIVESTOCK, NAMELY, CATTLE (U.S. CLS. 1 AND 46).

CLASS 44—MEDICAL, BEAUTY AND AGRICULTURAL SERVICES

FOR BREEDING AND STUD SERVICES FOR CATTLE; STUD AND BREEDING SERVICES FOR CATTLE; STUD SERVICES FOR CATTLE (U.S. CLS. 100 AND 101).

KATHERINE CONNOLLY, EXAMINING ATTORNEY

SN 77-800,455. EASTLAND, DAVID C, BOWEN, AUSTRALIA, AND EASTLAND, PATRICIA A, BOWEN, AUSTRALIA, FILED 8-10-2009.

Senemeater

THE MARK CONSISTS OF STANDARD CHARACTERS WITHOUT CLAIM TO ANY PARTICULAR FONT, STYLE, SIZE, OR COLOR.

PRIORITY CLAIMED UNDER SEC. 44(D) ON AUSTRALIA APPLICATION NO. 12240331, FILED 8-10-2009, REG. NO. 1314280, DATED 8-10-2009, EXPIRES 8-10-2019.

CLASS 29—MEATS AND PROCESSED FOODS

FOR BEEF; BEEF JERKY; BEEF PATTIES; BEEF SLICES; BEEF STEW; BEEF STOCK; BEEF TALLOW; CORNED BEEF; CORNED BEEF HASH; DRIED BEEF; PREPARED BEEF; ROAST BEEF (U.S. CL. 46).

CLASS 31—NATURAL AGRICULTURAL PRODUCTS

FOR LIVE ANIMALS, NAMELY, CATTLE; LIVESTOCK, NAMELY, CATTLE (U.S. CLS. 1 AND 46).

CLASS 44—MEDICAL, BEAUTY AND AGRICULTURAL SERVICES

FOR BREEDING AND STUD SERVICES FOR CATTLE; STUD AND BREEDING SERVICES FOR CATTLE; STUD SERVICES FOR CATTLE (U.S. CLS. 100 AND 101).

KATHERINE CONNOLLY, EXAMINING ATTORNEY

SN 77-800,527. TEMO, INC., CLINTON TOWNSHIP, MI, FILED 8-10-2009.

TEMGUARD

THE MARK CONSISTS OF STANDARD CHARACTERS WITHOUT CLAIM TO ANY PARTICULAR FONT, STYLE, SIZE, OR COLOR.

OWNER OF U.S. REG. NO. 3,397,033.

CLASS 2—PAINTS

FOR PRODUCTS FOR USE IN THE FIELD OF BUILDING CONSTRUCTION, RENOVATION, AND REMODELING, NAMELY, SEALER COATINGS FOR USE IN PREVENTING THE GROWTH OF MOLD AND ENTOMOLOGICAL INFESTATION (U.S. CLS. 6, 11 AND 16).

CLASS 37—CONSTRUCTION AND REPAIR

FOR INSTALLATION, CONSTRUCTION, RENOVATION, REMODELING, REPAIR, AND CONSTRUCTION IMPROVEMENTS OF RESIDENTIAL, COMMERCIAL, AND INDUSTRIAL PROPERTIES, SUNROOMS, AND LIVING SPACES UTILIZING COATINGS, COMPOUNDS, AND MATERIALS TO REDUCE MOLD AND ENTOMOLOGICAL INFESTATION (U.S. CLS. 100, 103 AND 106).
JORDAN BAKER, EXAMINING ATTORNEY

CLASS 42—SCIENTIFIC AND COMPUTER SERVICES

FOR MEDICAL AND SCIENTIFIC RESEARCH FEATURING THE DEVELOPMENT OF THERAPIES AND CURES FOR MULTIPLE MYELOMA THROUGH SCIENTIFIC COLLABORATION, ACCELERATED RESEARCH EFFORTS, AND THE ADVANCEMENT OF TECHNOLOGIES; AND PROVIDING ON-LINE INFORMATION ABOUT MEDICAL RESEARCH RELATING TO MYELOMA VIA A GLOBAL COMPUTER NETWORK (U.S. CLS. 100 AND 101).

FIRST USE 4-0-2007; IN COMMERCE 4-0-2007.

CLASS 44—MEDICAL, BEAUTY AND AGRICULTURAL SERVICES

FOR PROVIDING MEDICAL INFORMATION ABOUT THE TREATMENT OF MULTIPLE MYELOMA VIA A GLOBAL COMPUTER NETWORK (U.S. CLS. 100 AND 101).

FIRST USE 4-0-2007; IN COMMERCE 4-0-2007.

ELI HELLMAN, EXAMINING ATTORNEY

SN 77-800,808. THE MULTIPLE MYELOMA RESEARCH FOUNDATION, INC., NORWALK, CT. FILED 8-10-2009.

SN 77-800,832. THE MULTIPLE MYELOMA RESEARCH FOUNDATION, INC., NORWALK, CT. FILED 8-10-2009.



OWNER OF U.S. REG. NOS. 2,702,004 AND 2,925,067.
NO CLAIM IS MADE TO THE EXCLUSIVE RIGHT TO USE "RESEARCH CONSORTIUM", APART FROM THE MARK AS SHOWN.

THE MARK CONSISTS OF THE LETTERS "MMRC" ABOVE THE WORDS "MULTIPLE MYELOMA RESEARCH CONSORTIUM," BOTH APPEARING TO THE RIGHT OF A TREE AND LEAF DESIGN.

SEC. 2(F) AS TO "MULTIPLE MYELOMA RESEARCH CONSORTIUM".

CLASS 16—PAPER GOODS AND PRINTED MATTER

FOR PRINTED PUBLICATIONS, NAMELY, NEWSLETTERS, PATIENT BROCHURES, AND PATIENT INFORMATION PACKETS COMPOSED OF PRINTED DOCUMENTS FEATURING INFORMATION ABOUT CHARITABLE FUNDRAISING ACTIVITIES FOR THE RESEARCH, TREATMENT AND CURE OF MULTIPLE MYELOMA (U.S. CLS. 2, 5, 22, 23, 29, 37, 38 AND 50).

CLASS 36—INSURANCE AND FINANCIAL

FOR CHARITABLE FUNDRAISING; CHARITABLE FUNDRAISING SERVICES FEATURING THE PROVISION OF INFORMATION ABOUT TREATMENT AND CURE OF MULTIPLE MYELOMA, WHICH EDUCATES THE INDIVIDUAL, AND GIVES THEM THE OPPORTUNITY TO MAKE MONETARY DONATIONS; AND PROVIDING MEDICAL GRANTS TO THOSE RESEARCHING THE TREATMENT AND CURE OF MULTIPLE MYELOMA (U.S. CLS. 100, 101 AND 102).

FIRST USE 4-0-2007; IN COMMERCE 4-0-2007.

OWNER OF U.S. REG. NOS. 2,699,774 AND 2,702,004.
NO CLAIM IS MADE TO THE EXCLUSIVE RIGHT TO USE "RESEARCH FOUNDATION", APART FROM THE MARK AS SHOWN.

THE MARK CONSISTS OF THE LETTERS "MMRF" ABOVE THE WORDS "MULTIPLE MYELOMA RESEARCH FOUNDATION," BOTH APPEARING TO THE RIGHT OF AN ACORN AND LEAF DESIGN.

SEC. 2(F) AS TO "MULTIPLE MYELOMA RESEARCH FOUNDATION".

CLASS 16—PAPER GOODS AND PRINTED MATTER

FOR PRINTED PUBLICATIONS, NAMELY, NEWSLETTERS, PATIENT BROCHURES, AND PATIENT INFORMATION PACKETS COMPOSED OF PRINTED DOCUMENTS FEATURING INFORMATION ABOUT CHARITABLE FUNDRAISING ACTIVITIES FOR THE RESEARCH, TREATMENT AND CURE OF MULTIPLE MYELOMA (U.S. CLS. 2, 5, 22, 23, 29, 37, 38 AND 50).

FIRST USE 4-0-2007; IN COMMERCE 4-0-2007.

CLASS 36—INSURANCE AND FINANCIAL

FOR CHARITABLE FUNDRAISING; CHARITABLE FUNDRAISING SERVICES FEATURING THE PROVISION OF INFORMATION ABOUT TREATMENT AND CURE OF MULTIPLE MYELOMA, WHICH EDUCATES THE INDIVIDUAL, AND GIVES THEM THE OPPORTUNITY TO MAKE MONETARY DONATIONS; AND PROVIDING MEDICAL GRANTS TO THOSE RESEARCHING THE TREATMENT AND CURE OF MULTIPLE MYELOMA (U.S. CLS. 100, 101 AND 102).

FIRST USE 4-0-2007; IN COMMERCE 4-0-2007.

CLASS 41—EDUCATION AND ENTERTAINMENT

FOR ORGANIZING AND CONDUCTING A RUNNING EVENT THE PROCEEDS OF WHICH ARE DONATED TO CHARITY (U.S. CLS. 100, 101 AND 107).

FIRST USE 4-0-2007; IN COMMERCE 4-0-2007.

CLASS 42—SCIENTIFIC AND COMPUTER SERVICES

FOR MEDICAL AND SCIENTIFIC RESEARCH FEATURING THE DEVELOPMENT OF THERAPIES AND CURES FOR MULTIPLE MYELOMA THROUGH SCIENTIFIC COLLABORATION, ACCELERATED RESEARCH EFFORTS, AND THE ADVANCEMENT OF TECHNOLOGIES; AND PROVIDING ON-LINE INFORMATION ABOUT MEDICAL RESEARCH RELATING TO MULTIPLE MYELOMA VIA GLOBAL A COMPUTER NETWORK (U.S. CLS. 100 AND 101).

FIRST USE 4-0-2007; IN COMMERCE 4-0-2007.

CLASS 44—MEDICAL, BEAUTY AND AGRICULTURAL SERVICES

FOR PROVIDING MEDICAL INFORMATION ABOUT THE TREATMENT OF MULTIPLE MYELOMA VIA A GLOBAL COMPUTER NETWORK (U.S. CLS. 100 AND 101).

FIRST USE 4-0-2007; IN COMMERCE 4-0-2007.

ELI HELLMAN, EXAMINING ATTORNEY

SN 77-800,883. SPORTSHEETS INTERNATIONAL, INC., HUNTINGTON BEACH, CA. FILED 8-10-2009.

NAUGHTY NIGHT OUT

THE MARK CONSISTS OF STANDARD CHARACTERS WITHOUT CLAIM TO ANY PARTICULAR FONT, STYLE, SIZE, OR COLOR.

CLASS 16—PAPER GOODS AND PRINTED MATTER

FOR NOVELTY ITEMS, NAMELY, KITS COMPRISED OF POSTERS AND STICKERS; KITS COMPRISED OF CALENDARS AND STICKERS; PLAYING CARDS; BUSINESS CARDS (U.S. CLS. 2, 5, 22, 23, 29, 37, 38 AND 50).

CLASS 17—RUBBER GOODS

FOR NOVELTY PENIS ITEMS, NAMELY, LARGE FOAM PENIS CUTOUTS AND PLASTIC PENIS DECORATIONS (U.S. CLS. 1, 5, 12, 13, 35 AND 50).

CLASS 21—HOUSEWARES AND GLASS

FOR NOVELTY ITEMS, NAMELY, KITS COMPRISED OF SHOT GLASSES AND DRINK RECIPES (U.S. CLS. 2, 13, 23, 29, 30, 33, 40 AND 50).

CLASS 26—FANCY GOODS

FOR NOVELTY ITEMS, NAMELY, NOVELTY BUTTONS (U.S. CLS. 37, 39, 40, 42 AND 50).

CLASS 30—STAPLE FOODS

FOR NOVELTY ITEMS, NAMELY, KITS COMPRISED OF CANDY, SASHES AND SAFETY PINS (U.S. CL. 46). KATINA MISTER, EXAMINING ATTORNEY

SN 77-801,103. ALEXANDRIA REAL ESTATE EQUITIES, INC., PASADENA, CA. FILED 8-10-2009.

THE ALEXANDRIA CENTER FOR SCIENCE AND TECHNOLOGY

THE MARK CONSISTS OF STANDARD CHARACTERS WITHOUT CLAIM TO ANY PARTICULAR FONT, STYLE, SIZE, OR COLOR.

OWNER OF U.S. REG. NOS. 2,300,323, 2,817,752 AND OTHERS.

NO CLAIM IS MADE TO THE EXCLUSIVE RIGHT TO USE "CENTER FOR SCIENCE AND TECHNOLOGY", APART FROM THE MARK AS SHOWN.

CLASS 35—ADVERTISING AND BUSINESS

FOR BUSINESS ADMINISTRATION AND MANAGEMENT; BUSINESS MANAGEMENT CONSULTING; BUSINESS INCUBATOR SERVICES, NAMELY, BUSINESS MARKETING, BUSINESS MANAGEMENT, AND BUSINESS DEVELOPMENT SERVICES IN THE FORM OF START-UP SUPPORT FOR BUSINESSES OF OTHERS; RENTAL AND LEASING OF OFFICE MACHINERY AND EQUIPMENT; BUSINESS NETWORKING SERVICES; BUSINESS COMMUNICATIONS SERVICES, NAMELY, PUBLIC RELATIONS, ADVERTISING, MARKETING AND PUBLICITY SERVICES (U.S. CLS. 100, 101 AND 102).

CLASS 36—INSURANCE AND FINANCIAL

FOR REAL ESTATE MANAGEMENT; FINANCIAL SERVICES, NAMELY, FINANCIAL CONSULTATION, FINANCIAL ANALYSIS, FINANCIAL PLANNING, FINANCIAL MANAGEMENT, FINANCING SERVICES, PROVIDING WORKING CAPITAL, NAMELY, DEBT AND EQUITY CAPITAL, TANGIBLE AND INTANGIBLE ASSET FINANCING, AND FINANCIAL PORTFOLIO MANAGEMENT; BUSINESS INCUBATOR SERVICES, NAMELY, PROVIDING DEBT AND EQUITY FINANCING TO EMERGING AND START-UP COMPANIES (U.S. CLS. 100, 101 AND 102).

CLASS 37—CONSTRUCTION AND REPAIR

FOR REAL ESTATE DEVELOPMENT; BUILDING CONSTRUCTION AND REPAIR; MAINTENANCE AND REPAIR OF BUILDINGS, ELECTRICAL SYSTEMS, HEATING AND AIR CONDITIONING SYSTEMS AND PLUMBING SYSTEMS, ALL IN THE FIELD OF REAL ESTATE (U.S. CLS. 100, 103 AND 106).

CLASS 38—COMMUNICATION

FOR PROVIDING AN ONLINE FORUM FOR COMPANIES TO FORM VIRTUAL COMMUNITIES AND SPACES; PROVIDING AN ONLINE FORUM FOR COMPANIES TO OPERATE AND MANAGE VIRTUAL OFFICE, LABORATORY AND RESEARCH SPACES; PROVIDE AN ONLINE FORUM FOR COMPANIES TO SHOWCASE, DISPLAY, DEMONSTRATE AND PROMOTE NEW AND INNOVATIVE IDEAS AND TECHNOLOGIES, PRODUCTS AND SERVICES; PROVIDING ONLINE FORUMS FOR TRANSMISSION OF MESSAGES AMONG USERS IN THE SCIENTIFIC, RESEARCH AND TECHNOLOGY FIELDS (U.S. CLS. 100, 101 AND 104).

CLASS 42—SCIENTIFIC AND COMPUTER SERVICES

FOR ARCHITECTURAL DESIGN SERVICES; ENGINEERING SERVICES; RENTAL AND LEASING OF COMPUTERS; COMPUTER SERVICES, NAMELY, CREATING AN ONLINE COMMUNITY FOR USERS TO FORM VIRTUAL COMMUNITIES (U.S. CLS. 100 AND 101).

LANA PHAM, EXAMINING ATTORNEY

SN 77-801,214. SKINNY NUTRITIONAL CORPORATION,
BALA CYNWYD, PA. FILED 8-10-2009.

Skinny Java

THE MARK CONSISTS OF STANDARD CHARACTERS WITHOUT CLAIM TO ANY PARTICULAR FONT, STYLE, SIZE, OR COLOR.

OWNER OF U.S. REG. NOS. 2,557,075, 2,657,083 AND OTHERS.

NO CLAIM IS MADE TO THE EXCLUSIVE RIGHT TO USE "JAVA", APART FROM THE MARK AS SHOWN.

CLASS 5—PHARMACEUTICALS

FOR DIETARY FOOD SUPPLEMENT, MADE WITH COFFEE PRODUCTS OR COFFEE EXTRACTS, NAMELY, A LIQUID OR CONCENTRATE CONTAINING COFFEE, COFFEE FLAVORING, ESPRESSO OR CAFFEINE ACTIVATED INGREDIENTS; NUTRICEUTICALS IN CONCENTRATE OR LIQUID FORM, CONTAINING COFFEE, ESPRESSO, COFFEE FLAVORING OR CAFFEINE, FOR USE AS A DIETARY SUPPLEMENT (U.S. CLS. 6, 18, 44, 46, 51 AND 52).

CLASS 32—LIGHT BEVERAGES

FOR READY TO DRINK SOFT DRINKS CONTAINING COFFEE, COFFEE FLAVORING, ESPRESSO OR CAFFEINE ACTIVATED INGREDIENTS; ISOTONIC DRINKS CONTAINING COFFEE, COFFEE FLAVORING, ESPRESSO OR CAFFEINE ACTIVATED INGREDIENTS; LIQUID, CONCENTRATE OR POWDERED MIX USED TO MAKE ISOTONIC DRINKS CONTAINING COFFEE, COFFEE FLAVORING, ESPRESSO, OR CAFFEINE ACTIVATED INGREDIENTS; DRINKING WATER CONTAINING COFFEE, COFFEE FLAVORING, ESPRESSO OR CAFFEINE ACTIVATED INGREDIENTS (U.S. CLS. 45, 46 AND 48).

SUSAN LESLIE DUBOIS, EXAMINING ATTORNEY

SN 77-801,262. BUFFINI & COMPANY, CARLSBAD, CA.
FILED 8-10-2009.

BRIAN BUFFINI

THE MARK CONSISTS OF STANDARD CHARACTERS WITHOUT CLAIM TO ANY PARTICULAR FONT, STYLE, SIZE, OR COLOR.

THE NAME(S), PORTRAIT(S), AND/OR SIGNATURE(S) SHOWN IN THE MARK IDENTIFIES "BRIAN BUFFINI", WHOSE CONSENT(S) TO REGISTER IS MADE OF RECORD.

CLASS 16—PAPER GOODS AND PRINTED MATTER

FOR PRINTED INSTRUCTIONAL, EDUCATIONAL AND TEACHING MATERIALS IN THE FIELD OF BUSINESS DEVELOPMENT AND PERSONAL GROWTH (U.S. CLS. 2, 5, 22, 23, 29, 37, 38 AND 50).

CLASS 41—EDUCATION AND ENTERTAINMENT

FOR EDUCATIONAL SERVICES, NAMELY, CONDUCTING BUSINESS DEVELOPMENT AND PERSONAL GROWTH SEMINARS AND DISTRIBUTING COURSE MATERIALS IN CONNECTION THEREWITH; AND PROVIDING TRAINING AND PERSONAL COACHING IN THE FIELD OF BUSINESS DEVELOPMENT (U.S. CLS. 100, 101 AND 107).

FLORENTINA BLANDU, EXAMINING ATTORNEY

SN 77-801,572. STINKY MONKEY ENTERTAINMENT, VALLEY VILLAGE, CA. FILED 8-11-2009.

CREEPIOSITY

THE MARK CONSISTS OF STANDARD CHARACTERS WITHOUT CLAIM TO ANY PARTICULAR FONT, STYLE, SIZE, OR COLOR.

CLASS 16—PAPER GOODS AND PRINTED MATTER

FOR A SERIES OF HUMOR AND ENTERTAINMENT BOOKS (U.S. CLS. 2, 5, 22, 23, 29, 37, 38 AND 50).

CLASS 41—EDUCATION AND ENTERTAINMENT

FOR ENTERTAINMENT SERVICES, NAMELY, PROVIDING A WEBSITE FEATURING PHOTOGRAPHIC, AUDIO, VIDEO, AND PROSE PRESENTATIONS IN THE FIELDS OF HUMOR AND ENTERTAINMENT (U.S. CLS. 100, 101 AND 107).

MICHELE SWAIN, EXAMINING ATTORNEY

SN 77-802,521. LOVE THE MUSIC, LLC, SPRINGFIELD, IL.
FILED 8-12-2009.

Love The Music

THE MARK CONSISTS OF STANDARD CHARACTERS WITHOUT CLAIM TO ANY PARTICULAR FONT, STYLE, SIZE, OR COLOR.

CLASS 25—CLOTHING

FOR CLOTHING, NAMELY, SHIRTS, BOTTOMS, TOPS AND HEAD-WEAR (U.S. CLS. 22 AND 39).

CLASS 42—SCIENTIFIC AND COMPUTER SERVICES

FOR PROVIDING A WEBSITE ALLOWING USERS TO UPLOAD AND DOWNLOAD MUSIC AND MUSIC VIDEOS (U.S. CLS. 100 AND 101).

FIRST USE 9-10-2007; IN COMMERCE 9-10-2007.
LAURIE MAYES, EXAMINING ATTORNEY

SN 77-803,056. ARTHUR H. JESKE, HOUSTON, TX. FILED 8-12-2009.

ZERO TO GENERAL DENTISTRY
IN

THE MARK CONSISTS OF STANDARD CHARACTERS WITHOUT CLAIM TO ANY PARTICULAR FONT, STYLE, SIZE, OR COLOR.

CLASS 9—ELECTRICAL AND SCIENTIFIC APPARATUS

FOR PRERECORDED VIDEO CASSETTES, COMPUTER DISKS, COMPACT DISKS, DIGITAL VIDEO DISKS, LASER DISKS REGARDING DENTISTRY; COMPUTER PROGRAMS REGARDING DENTISTRY FOR THE PURPOSE OF EDUCATION (U.S. CLS. 21, 23, 26, 36 AND 38).

CLASS 16—PAPER GOODS AND PRINTED MATTER

FOR BOOKS, MANUALS, BROCHURES, PAMPHLETS, PRINTED TEACHING MATERIALS, PRINTED GUIDES AND NEWSLETTERS IN THE FIELD OF DENTISTRY (U.S. CLS. 2, 5, 22, 23, 29, 37, 38 AND 50).

CLASS 41—EDUCATION AND ENTERTAINMENT

FOR CONDUCTING WORKSHOPS AND SEMINARS IN THE FIELD OF DENTISTRY; CONTINUING EDUCATION SERVICES, NAMELY, PROVIDING LIVE AND ON-LINE CONTINUING PROFESSIONAL EDUCATION SEMINARS IN THE FIELD OF DENTISTRY; EDUCATIONAL SERVICES, NAMELY, CONDUCTING CLASSES, SEMINARS, CONFERENCES AND WORKSHOPS IN THE FIELD OF DENTISTRY AND DISTRIBUTION OF COURSE MATERIAL IN CONNECTION THEREWITH; EDUCATIONAL SERVICES, NAMELY, CONDUCTING CLASSES, SEMINARS, CONFERENCES AND WORKSHOPS IN THE FIELD OF DENTISTRY AND DISTRIBUTION OF TRAINING MATERIAL IN CONNECTION THEREWITH; EDUCATIONAL SERVICES, NAMELY, PROVIDING ON-LINE CLASSES, SEMINARS, CONFERENCES AND WORKSHOPS IN THE FIELD OF DENTISTRY; EDUCATIONAL SERVICES, NAMELY, PROVIDING TUTORIAL SESSIONS IN THE FIELD OF DENTISTRY (U.S. CLS. 100, 101 AND 107).

DEIRDRE ROBERTSON, EXAMINING ATTORNEY

SN 77-803,277. SCHRADER-BRIDGEPORT INTERNATIONAL, INC., ALTAVISTA, VA. FILED 8-12-2009.

AIRAWARE

THE MARK CONSISTS OF STANDARD CHARACTERS WITHOUT CLAIM TO ANY PARTICULAR FONT, STYLE, SIZE, OR COLOR.

CLASS 6—METAL GOODS

FOR METAL NUTS; METAL GROMMETS; VALVES OF METAL OTHER THAN PARTS OF MACHINES; METAL SEALING CAPS; METAL SEALING VALVE CAPS; SEALS OF METAL FOR AUTOMOTIVE APPLICATIONS; THE AFOREMENTIONED GOODS ALSO SOLD AS PART OF VEHICLE-SPECIFIC SERVICE PACKS AND VEHICLE SERVICE STARTER PACKS (U.S. CLS. 2, 12, 13, 14, 23, 25 AND 50).
FIRST USE 12-8-2006; IN COMMERCE 12-8-2006.

CLASS 9—ELECTRICAL AND SCIENTIFIC APPARATUS

FOR VEHICLE SAFETY EQUIPMENT, NAMELY, ELECTRONIC TIRE PRESSURE SENSORS; VEHICLE SAFETY EQUIPMENT, NAMELY, DIRECT TIRE PRESSURE MONITORING SYSTEM (TPMS) COMPRISING PRESSURE SENSORS INSIDE EACH TIRE TO TRANSMIT DATA TO A DASHBOARD DISPLAY ALERTING DRIVERS TO TIRE PRESSURE ISSUES; REPLACEMENT TPMS SENSORS; VEHICLE-SPECIFIC TPMS SENSORS SOLD IN SERVICE PACKS; VEHICLE SAFETY EQUIPMENT, NAMELY, WIRED AND WIRELESS TPMS RETRO FIT KITS COMPRISING A DASH MOUNTED RECEIVER AND DISPLAY AND WHEEL MOUNTED TRANSMITTERS (U.S. CLS. 21, 23, 26, 36 AND 38).
FIRST USE 12-8-2006; IN COMMERCE 12-8-2006.

CLASS 12—VEHICLES

FOR TIRE VALVES; PNEUMATIC TIRE VALVES; TIRE VALVE CORES; TIRE VALVE SLEEVES, EXTENSIONS AND CAPS; LUG NUTS FOR VEHICLE WHEELS; GROMMETS FOR TIRES; VEHICLE TIRE STEM CAPS; PNEUMATIC TIRE VALVE CAPS; NICKEL-PLATED VALVE CORES FOR AUTOMOTIVE TIRE VALVES; THE AFOREMENTIONED GOODS ALSO SOLD AS PART OF VEHICLE SPECIFIC SERVICE PACKS AND VEHICLE SERVICE STARTER PACKS (U.S. CLS. 19, 21, 23, 31, 35 AND 44).
FIRST USE 12-8-2006; IN COMMERCE 12-8-2006.

CLASS 20—FURNITURE AND ARTICLES NOT OTHERWISE CLASSIFIED

FOR NON-METALLIC SEALING CAPS; PLASTIC SEALING CAPS; PLASTIC SEALING VALVE CAPS; PLASTIC CAPS; PLASTIC GROMMETS; STORAGE CABINETS; THE AFOREMENTIONED GOODS ALSO SOLD AS PART OF VEHICLE-SPECIFIC SERVICE PACKS AND VEHICLE SERVICE STARTER PACKS (U.S. CLS. 2, 13, 22, 25, 32 AND 50).
FIRST USE 12-8-2006; IN COMMERCE 12-8-2006.
ALEX KEAM, EXAMINING ATTORNEY

SN 77-803,537. LYZER DIAGNOSTICS, INC., DBA EVEIA MEDICAL, INC., BOULDER, CO. FILED 8-13-2009.

Better Diagnostics...
Better Outcomes

THE MARK CONSISTS OF STANDARD CHARACTERS WITHOUT CLAIM TO ANY PARTICULAR FONT, STYLE, SIZE, OR COLOR.

CLASS 1—CHEMICALS

FOR DIAGNOSTIC PREPARATIONS FOR SCIENTIFIC OR RESEARCH USE; DIAGNOSTIC PREPARATIONS FOR CLINICAL OR MEDICAL LABORATORY USE; DIAGNOSTIC PREPARATIONS FOR SCIENTIFIC USE; DIAGNOSTIC PREPARATIONS USED IN SCIENCE; DIAGNOSTIC REAGENTS FOR CLINICAL OR MEDICAL LABORATORY USE; DIAGNOSTIC REAGENTS FOR IN VITRO USE IN BIOCHEMISTRY, CLINICAL CHEMISTRY AND MICROBIOLOGY; LABORATORY CHEMICALS, NAMELY, AN ANTIBODY REAGENT USED FOR THE DETECTION OF ANTIGENS IN CELL AND TISSUE ANALYSIS FOR IN VITRO DIAGNOSTIC USE; REAGENTS FOR RESEARCH PURPOSES (U.S. CLS. 1, 5, 6, 10, 26 AND 46).

CLASS 9—ELECTRICAL AND SCIENTIFIC APPARATUS

FOR CLINICAL LABORATORY ANALYZERS FOR MEASURING, TESTING AND ANALYZING BLOOD AND OTHER BODILY FLUIDS (U.S. CLS. 21, 23, 26, 36 AND 38).

KEVIN DINALLO, EXAMINING ATTORNEY

SN 77-804,247. MADISON SQUARE GARDEN, L.P., NEW YORK, NY. FILED 8-13-2009.

GAMEVITE

THE MARK CONSISTS OF STANDARD CHARACTERS WITHOUT CLAIM TO ANY PARTICULAR FONT, STYLE, SIZE, OR COLOR.

CLASS 38—COMMUNICATION

FOR ELECTRONIC MAIL AND MESSAGING SERVICES FOR CONSUMERS TO SHARE TICKET RESERVATION AND BOOKING INFORMATION FOR SPORTING EVENTS (U.S. CLS. 100, 101 AND 104).

CLASS 41—EDUCATION AND ENTERTAINMENT

FOR PROVIDING AN INTERNET WEBSITE FOR ARRANGING TICKET RESERVATIONS FOR SPORTING EVENTS FOR CONSUMERS AND PROVIDING BOOKING INFORMATION FOR SPORTING EVENTS (U.S. CLS. 100, 101 AND 107).

CLASS 42—SCIENTIFIC AND COMPUTER SERVICES

FOR COMPUTER SERVICES, NAMELY, CREATING AN ON-LINE COMMUNITY FOR REGISTERED USERS TO PARTICIPATE IN DISCUSSIONS REGARDING SHARING THEIR CONSUMER TICKET RESERVATIONS, PLAN TICKET PURCHASES AND BOOKING INFORMATION FOR SPORTING EVENTS, ENGAGE IN SOCIAL NETWORKING, AND ELECTRONIC INVITATION CREATION AND DELIVERY (U.S. CLS. 100 AND 101).

ANTHONY RINKER, EXAMINING ATTORNEY

SN 77-805,094. BED BATH & BEYOND PROCUREMENT CO. INC., FARMINGDALE, NY. FILED 8-14-2009.

ARCTIC GEAR

THE MARK CONSISTS OF STANDARD CHARACTERS WITHOUT CLAIM TO ANY PARTICULAR FONT, STYLE, SIZE, OR COLOR.

NO CLAIM IS MADE TO THE EXCLUSIVE RIGHT TO USE "GEAR", APART FROM THE MARK AS SHOWN.

CLASS 8—HAND TOOLS

FOR SNOW SHOVELS; ICE SCRAPERS (U.S. CLS. 23, 28 AND 44).

CLASS 9—ELECTRICAL AND SCIENTIFIC APPARATUS

FOR BATTERY CHARGERS (U.S. CLS. 21, 23, 26, 36 AND 38).

CLASS 11—ENVIRONMENTAL CONTROL APPARATUS

FOR ELECTRIC BLANKETS NOT FOR MEDICAL PURPOSES; ELECTRICALLY-HEATED LOCK DE-ICERS (U.S. CLS. 13, 21, 23, 31 AND 34).

CLASS 17—RUBBER GOODS

FOR HEAT REFLECTIVE PLASTIC FILM TO BE APPLIED TO WINDOWS (U.S. CLS. 1, 5, 12, 13, 35 AND 50).

CLASS 20—FURNITURE AND ARTICLES NOT OTHERWISE CLASSIFIED

FOR DRAFT-BLOCKING PILLOWS; WINDOW SHADES (U.S. CLS. 2, 13, 22, 25, 32 AND 50).

CLASS 21—HOUSEWARES AND GLASS

FOR NON-METAL BOOT TRAYS FOR DOMESTIC USE (U.S. CLS. 2, 13, 23, 29, 30, 33, 40 AND 50).

CLASS 24—FABRICS

FOR BEDDING SHEETS; COMFORTERS; DUVETS; THROWS; BED BLANKETS (U.S. CLS. 42 AND 50).

CLASS 25—CLOTHING

FOR HATS; GLOVES; ICE SHOES (U.S. CLS. 22 AND 39).

CLASS 27—FLOOR COVERINGS

FOR DOORMATS (U.S. CLS. 19, 20, 37, 42 AND 50).

DAVID H. STINE, EXAMINING ATTORNEY

SN 77-805,134. BED BATH & BEYOND PROCUREMENT CO. INC., FARMINGDALE, NY. FILED 8-14-2009.

SN 77-805,846. GALDERMA LABORATORIES, L.P., FORTH WORTH, TX. FILED 8-17-2009.



NO CLAIM IS MADE TO THE EXCLUSIVE RIGHT TO USE "GEAR", APART FROM THE MARK AS SHOWN.

THE COLOR(S) LIGHT BLUE AND BLUE IS/ARE CLAIMED AS A FEATURE OF THE MARK.

THE MARK CONSISTS OF THE WORDING "ARCTIC GEAR" IN STYLIZED TEXT SHOWN UNDER A DRAWING OF A MOUNTAIN RANGE. THE COLOR LIGHT BLUE APPEARS IN THE WORDING "ARCTIC". THE COLOR BLUE APPEARS IN THE WORDING "GEAR" AND IN THE DRAWING OF A MOUNTAIN RANGE.

CLASS 8—HAND TOOLS

FOR SNOW SHOVELS; ICE SCRAPERS (U.S. CLS. 23, 28 AND 44).

CLASS 9—ELECTRICAL AND SCIENTIFIC APPARATUS

FOR BATTERY CHARGERS (U.S. CLS. 21, 23, 26, 36 AND 38).

CLASS 11—ENVIRONMENTAL CONTROL APPARATUS

FOR ELECTRIC BLANKETS NOT FOR MEDICAL PURPOSES; ELECTRICALLY-HEATED LOCK DE-ICERS (U.S. CLS. 13, 21, 23, 31 AND 34).

CLASS 17—RUBBER GOODS

FOR HEAT REFLECTIVE PLASTIC FILM TO BE APPLIED TO WINDOWS (U.S. CLS. 1, 5, 12, 13, 35 AND 50).

CLASS 20—FURNITURE AND ARTICLES NOT OTHERWISE CLASSIFIED

FOR DRAFT-BLOCKING PILLOWS; WINDOW SHADES (U.S. CLS. 2, 13, 22, 25, 32 AND 50).

CLASS 21—HOUSEWARES AND GLASS

FOR NON-METAL BOOT TRAYS FOR DOMESTIC USE (U.S. CLS. 2, 13, 23, 29, 30, 33, 40 AND 50).

CLASS 24—FABRICS

FOR BEDDING SHEETS; COMFORTERS; DUVETS; THROWS; BED BLANKETS (U.S. CLS. 42 AND 50).

CLASS 25—CLOTHING

FOR HATS; GLOVES; ICE SHOES (U.S. CLS. 22 AND 39).

CLASS 27—FLOOR COVERINGS

FOR DOORMATS (U.S. CLS. 19, 20, 37, 42 AND 50).
DAVID H. STINE, EXAMINING ATTORNEY

RESTORADERM

THE MARK CONSISTS OF STANDARD CHARACTERS WITHOUT CLAIM TO ANY PARTICULAR FONT, STYLE, SIZE, OR COLOR.

CLASS 3—COSMETICS AND CLEANING PREPARATIONS

FOR COSMETICS AND SKIN CARE PREPARATIONS, NAMELY, FACE, HAND AND BODY SOAPS, CLEANSERS AND MOISTURIZERS; HAIR SHAMPOOS AND CONDITIONERS; SUNBLOCKS AND SUNSCREENS (U.S. CLS. 1, 4, 6, 50, 51 AND 52).

CLASS 5—PHARMACEUTICALS

FOR PHARMACEUTICAL AND MEDICAL PREPARATIONS, NAMELY, ORAL AND TOPICAL DRUGS FOR THE TREATMENT OF INFLAMMATORY DISORDERS OF THE SKIN, NAMELY, ACNE, DERMATITIS, PSORIASIS, ECZEMA, ROSACEA, AND RELATED DISORDERS (U.S. CLS. 6, 18, 44, 46, 51 AND 52).

CLASS 10—MEDICAL APPARATUS

FOR MEDICAL DEVICES, NAMELY, SYRINGES, AUTO-INJECTORS AND NEEDLES TO BE USED IN THE FIELD OF DERMATOLOGY (U.S. CLS. 26, 39 AND 44).

STEPHANIE ALI, EXAMINING ATTORNEY

SN 77-806,050. ALTICOR INC., ADA, MI. FILED 8-17-2009.



OWNER OF U.S. REG. NOS. 845,472, 3,641,152 AND OTHERS.

NO CLAIM IS MADE TO THE EXCLUSIVE RIGHT TO USE "CENTER", APART FROM THE MARK AS SHOWN.

THE MARK CONSISTS OF THE WORD "AMWAY" WITH A CURVED LINE UNDER THE WORD, THE WORD "CENTER" UNDER THE CURVED LINE, AND THE OUTLINE OF A BUILDING SURROUNDING THE LETTER "A" IN "AMWAY".

CLASS 9—ELECTRICAL AND SCIENTIFIC APPARATUS

FOR MAGNETICALLY ENCODED CREDIT CARDS (U.S. CLS. 21, 23, 26, 36 AND 38).

CLASS 14—JEWELRY

FOR JEWELRY AND WATCHES (U.S. CLS. 2, 27, 28 AND 50).

CLASS 16—PAPER GOODS AND PRINTED MATTER

FOR POSTERS, CALENDARS, TRADING CARDS, PHOTOGRAPHS, STATIONERY, BOOKS RELATING TO SPORTS, MAGAZINES RELATING TO SPORTS, NOTE-PADS, STICKERS, BUMPER STICKERS, PENS, PENCILS, AND GREETING CARDS (U.S. CLS. 2, 5, 22, 23, 29, 37, 38 AND 50).

CLASS 18—LEATHER GOODS

FOR LUGGAGE ITEMS MADE OF LEATHER AND NON-LEATHER, NAMELY, SPORTS BAGS, SUITCASES, PULLMAN CASES, GARMENT BAGS FOR TRAVEL, CARRY ON BAGS, DUFFLE BAGS, PURSES, BRIEF CASES, BACK PACKS, FANNY PACKS, LUGGAGE TAGS AND UMBRELLAS (U.S. CLS. 1, 2, 3, 22 AND 41).

CLASS 21—HOUSEWARES AND GLASS

FOR HOUSEWARES AND DRINKING GLASSES, NAMELY, PAPER CUPS, PLASTIC CUPS, GLASS CUPS, MUGS, PORTABLE BEVERAGE COOLERS AND SHOT GLASSES (U.S. CLS. 2, 13, 23, 29, 30, 33, 40 AND 50).

CLASS 25—CLOTHING

FOR MEN'S, WOMEN'S AND CHILDREN'S CLOTHING, NAMELY, FLEECE TOPS AND BOTTOMS, CAPS, T-SHIRTS, SWEATSHIRTS, SHORTS, TANK TOPS, SWEATERS, PANTS, JACKETS, TURTLENECKS, JUMPSUITS, JERSEYS, WARM UP SUITS, SWIMWEAR, WIND RESISTANT JACKETS AND PARKAS; SLEEPWEAR, NAMELY, ROBES AND PAJAMAS; GLOVES, SCARVES AND APRONS; FOOTWEAR, NAMELY, BOOTS, SNEAKERS AND ATHLETIC SHOES (U.S. CLS. 22 AND 39).

CLASS 28—TOYS AND SPORTING GOODS

FOR PLAYING CARDS, GOLF BALLS, GOLF BAGS, GOLF CLUB COVERS, BOWLING BALLS, BOWLING BAGS, BASKETBALLS, EXERCISE EQUIPMENT, NAMELY, STATIONERY EXERCISE BICYCLES, BAR BELLS AND FREE WEIGHTS (U.S. CLS. 22, 23, 38 AND 50).

CLASS 29—MEATS AND PROCESSED FOODS

FOR POTATO CHIPS, PROCESSED NUTS (U.S. CL. 46).

CLASS 30—STAPLE FOODS

FOR PREPARED FOODS, NAMELY, HAMBURGER SANDWICHES, HOT DOG SANDWICHES, PIZZA AND NACHOS; BEVERAGES, NAMELY, COFFEE, TEA AND COCOA; SNACK FOODS, NAMELY, CHEESE FLAVORED PUFFED CORN SNACKS, CORN TORTILLA SNACKS, PRETZELS, POPPED POPCORN; GRANOLA BASED SNACK BARS; CANDY AND CANDY BARS; VINEGAR, SAUCES; SPICES; ICE (U.S. CL. 46).

CLASS 32—LIGHT BEVERAGES

FOR LIGHT BEVERAGES, NAMELY, BEER, SOFT DRINKS, FRUIT JUICES AND BOTTLED WATER; SPORTS DRINKS AND ENERGY DRINKS (U.S. CLS. 45, 46 AND 48).

CLASS 41—EDUCATION AND ENTERTAINMENT

FOR ENTERTAINMENT IN THE NATURE OF BASKETBALL GAMES, BASEBALL GAMES, FOOTBALL GAMES, HOCKEY GAMES, SOCCER GAMES, SOFTBALL GAMES, GOLF GAMES, BOWLING, GYMNASTICS, WRESTLING MATCHES, FIGURE SKATING, SKATEBOARDING, BICYCLE AND FREESTYLE MOTOCROSS, CIRCUS PERFORMANCES, PERFORMANCES BY LIVE MUSICAL GROUPS, ICE SHOWS, AND BULL RIDING COMPETITIONS; ENTERTAINMENT SERVICES, NAMELY, PROFESSIONAL BASKETBALL GAMES AND EXHIBITIONS (U.S. CLS. 100, 101 AND 107).

KATHERINE CONNOLLY, EXAMINING ATTORNEY

SN 77-806,053. ALTICOR INC., ADA, MI. FILED 8-17-2009.



OWNER OF U.S. REG. NOS. 845,472, 3,641,152 AND OTHERS.

NO CLAIM IS MADE TO THE EXCLUSIVE RIGHT TO USE "CENTER", APART FROM THE MARK AS SHOWN.

THE MARK CONSISTS OF THE WORD "AMWAY" WITH A CURVED LINE UNDER THE WORD, THE WORD "CENTER" UNDER THE CURVED LINE, AND THE OUTLINE OF A BUILDING ABOVE THE WORD "AMWAY".

CLASS 9—ELECTRICAL AND SCIENTIFIC APPARATUS

FOR MAGNETICALLY ENCODED CREDIT CARDS (U.S. CLS. 21, 23, 26, 36 AND 38).

CLASS 14—JEWELRY

FOR JEWELRY AND WATCHES (U.S. CLS. 2, 27, 28 AND 50).

CLASS 16—PAPER GOODS AND PRINTED MATTER

FOR POSTERS, CALENDARS, TRADING CARDS, PHOTOGRAPHS, STATIONERY, BOOKS RELATING TO SPORTS, MAGAZINES RELATING TO SPORTS, NOTE-PADS, STICKERS, BUMPER STICKERS, PENS, PENCILS, AND GREETING CARDS (U.S. CLS. 2, 5, 22, 23, 29, 37, 38 AND 50).

CLASS 18—LEATHER GOODS

FOR LUGGAGE ITEMS MADE OF LEATHER AND NON-LEATHER, NAMELY, SPORTS BAGS, SUITCASES, PULLMAN CASES, GARMENT BAGS FOR TRAVEL, CARRY ON BAGS, DUFFLE BAGS, PURSES, BRIEF CASES, BACK PACKS, FANNY PACKS, LUGGAGE TAGS AND UMBRELLAS (U.S. CLS. 1, 2, 3, 22 AND 41).

CLASS 21—HOUSEWARES AND GLASS

FOR HOUSEWARES AND DRINKING GLASSES, NAMELY, PAPER CUPS, PLASTIC CUPS, GLASS CUPS, MUGS, PORTABLE BEVERAGE COOLERS AND SHOT GLASSES (U.S. CLS. 2, 13, 23, 29, 30, 33, 40 AND 50).

SN 77-806,076. NATIONAL ASSOCIATION OF MUSIC MERCHANTS, INC., CARLSBAD, CA. FILED 8-17-2009.

CLASS 25—CLOTHING

FOR MEN'S, WOMEN'S AND CHILDREN'S CLOTHING, NAMELY, FLEECE TOPS AND BOTTOMS, CAPS, T-SHIRTS, SWEATSHIRTS, SHORTS, TANK TOPS, SWEATERS, PANTS, JACKETS, TURTLENECKS, JUMPSUITS, JERSEYS, WARM UP SUITS, SWIMWEAR, WIND RESISTANT JACKETS AND PARKAS; SLEEPWEAR, NAMELY, ROBES AND PAJAMAS; GLOVES, SCARVES AND APRONS; FOOTWEAR, NAMELY, BOOTS, SNEAKERS AND ATHLETIC SHOES (U.S. CLS. 22 AND 39).

WANNA PLAY

THE MARK CONSISTS OF STANDARD CHARACTERS WITHOUT CLAIM TO ANY PARTICULAR FONT, STYLE, SIZE, OR COLOR.

OWNER OF U.S. REG. NOS. 1,862,894, 2,070,596 AND 3,606,586.

CLASS 28—TOYS AND SPORTING GOODS

FOR PLAYING CARDS, GOLF BALLS, GOLF BAGS, GOLF CLUB COVERS, BOWLING BALLS, BOWLING BAGS, BASKETBALLS, EXERCISE EQUIPMENT, NAMELY, STATIONERY EXERCISE BICYCLES, BAR BELLS AND FREE WEIGHTS (U.S. CLS. 22, 23, 38 AND 50).

CLASS 35—ADVERTISING AND BUSINESS

FOR ORGANIZING AND CONDUCTING COMMUNITY SERVICE PROJECTS AND VOLUNTEER PROGRAMS; PROMOTING PUBLIC AWARENESS OF MUSIC EDUCATION PROJECTS, MUSIC AND MUSICAL INSTRUMENT INSTRUCTION; PUBLIC EDUCATION CAMPAIGN IN THE NATURE OF PUBLIC ADVOCACY TO PROMOTE AWARENESS OF THE IMPORTANCE OF MUSIC EDUCATION, MUSICAL INSTRUMENT INSTRUCTION AND THE BENEFITS OF PLAYING MUSIC; RETAIL STORE SERVICES IN THE FIELD OF ENTERTAINMENT FEATURING GENERAL CONSUMER MERCHANDISE, AUDIOVISUAL WORKS, AND RELATED PRODUCTS, PROVIDED VIA THE INTERNET AND OTHER ELECTRONIC AND GLOBAL COMMUNICATIONS NETWORKS; PROMOTION SERVICES FOR THIRD PARTIES IN THE NATURE OF ONLINE DIRECTORIES IN THE FIELDS OF MUSIC LESSONS AND MUSIC RETAILING (U.S. CLS. 100, 101 AND 102).

CLASS 29—MEATS AND PROCESSED FOODS

FOR POTATO CHIPS, PROCESSED NUTS (U.S. CL. 46).

CLASS 30—STAPLE FOODS

FOR PREPARED FOODS, NAMELY, HAMBURGER SANDWICHES, HOT DOG SANDWICHES, PIZZA AND NACHOS; BEVERAGES, NAMELY, COFFEE, TEA AND COCOA; SNACK FOODS, NAMELY, CHEESE FLAVORED PUFFED CORN SNACKS, CORN TORTILLA SNACKS, PRETZELS, POPPED POPCORN; GRANOLA BASED SNACK BARS; CANDY AND CANDY BARS; VINEGAR, SAUCES; SPICES; ICE (U.S. CL. 46).

CLASS 36—INSURANCE AND FINANCIAL

FOR CHARITABLE SERVICES, NAMELY, SOLICITING DONATIONS, FUND RAISING AND PROVIDING GRANTS IN THE FIELD OF MUSIC EDUCATION AND PERFORMANCE; CHARITABLE FUNDRAISING SERVICES, NAMELY, ORGANIZING AND CONDUCTING FUNDRAISING IN THE NATURE OF SALE OF MERCHANDISE (U.S. CLS. 100, 101 AND 102).

DOUGLAS LEE, EXAMINING ATTORNEY

CLASS 32—LIGHT BEVERAGES

FOR LIGHT BEVERAGES, NAMELY, BEER, SOFT DRINKS, FRUIT JUICES AND BOTTLED WATER; SPORTS DRINKS AND ENERGY DRINKS (U.S. CLS. 45, 46 AND 48).

SN 77-806,090. NATIONAL ASSOCIATION OF MUSIC MERCHANTS, INC., CARLSBAD, CA. FILED 8-17-2009.

CLASS 41—EDUCATION AND ENTERTAINMENT

FOR ENTERTAINMENT IN THE NATURE OF BASKETBALL GAMES, BASEBALL GAMES, FOOTBALL GAMES, HOCKEY GAMES, SOCCER GAMES, SOFTBALL GAMES, GOLF GAMES, BOWLING, GYMNASTICS, WRESTLING MATCHES, FIGURE SKATING, SKATEBOARDING, BICYCLE AND FREESTYLE MOTOCROSS, CIRCUS PERFORMANCES, PERFORMANCES BY LIVE MUSICAL GROUPS, ICE SHOWS, AND BULL RIDING COMPETITIONS; ENTERTAINMENT SERVICES, NAMELY, PROFESSIONAL BASKETBALL GAMES AND EXHIBITIONS (U.S. CLS. 100, 101 AND 107).

KATHERINE CONNOLLY, EXAMINING ATTORNEY

WANNA PLAY FUND

THE MARK CONSISTS OF STANDARD CHARACTERS WITHOUT CLAIM TO ANY PARTICULAR FONT, STYLE, SIZE, OR COLOR.

OWNER OF U.S. REG. NOS. 1,862,894, 2,070,596 AND 3,606,586.

NO CLAIM IS MADE TO THE EXCLUSIVE RIGHT TO USE "FUND", APART FROM THE MARK AS SHOWN.

CLASS 35—ADVERTISING AND BUSINESS

FOR ORGANIZING AND CONDUCTING COMMUNITY SERVICE PROJECTS AND VOLUNTEER PROGRAMS; PROMOTING PUBLIC AWARENESS OF MUSIC EDUCATION PROJECTS, MUSIC AND MUSICAL INSTRUMENT INSTRUCTION; PUBLIC EDUCATION CAMPAIGN IN THE NATURE OF PUBLIC ADVOCACY TO PROMOTE AWARENESS OF THE IMPORTANCE OF MUSIC EDUCATION, MUSICAL INSTRUMENT INSTRUCTION AND THE BENEFITS OF PLAYING MUSIC; RETAIL STORE SERVICES IN THE FIELD OF ENTERTAINMENT FEATURING GENERAL CONSUMER MERCHANDISE, AUDIOVISUAL WORKS, AND RELATED PRODUCTS, PROVIDED VIA THE INTERNET AND OTHER ELECTRONIC AND GLOBAL COMMUNICATIONS NETWORKS; PROMOTION SERVICES FOR THIRD PARTIES IN THE NATURE OF ONLINE DIRECTORIES IN THE FIELDS OF MUSIC LESSONS AND MUSIC RETAILING (U.S. CLS. 100, 101 AND 102).

CLASS 36—INSURANCE AND FINANCIAL

FOR CHARITABLE SERVICES, NAMELY, SOLICITING DONATIONS, FUND RAISING AND PROVIDING GRANTS IN THE FIELD OF MUSIC EDUCATION AND PERFORMANCE; CHARITABLE FUNDRAISING SERVICES, NAMELY, ORGANIZING AND CONDUCTING FUNDRAISING IN THE NATURE OF SALE OF MERCHANDISE (U.S. CLS. 100, 101 AND 102).

DOUGLAS LEE, EXAMINING ATTORNEY

SN 77-806,117. J. CREW INTERNATIONAL, INC., WILMINGTON, DE. FILED 8-17-2009.



OWNER OF U.S. REG. NOS. 2,929,166, 3,107,778 AND 3,163,866.

THE MARK CONSISTS OF "CREWCUTS" BELOW THE DEPICTION OF AN ELEPHANT.

CLASS 14—JEWELRY

FOR JEWELRY; NECKLACES, BRACELETS, RINGS, PINS BEING JEWELRY (U.S. CLS. 2, 27, 28 AND 50).

CLASS 16—PAPER GOODS AND PRINTED MATTER

FOR PACKAGING, NAMELY, PAPER AND CARDBOARD BOXES, TISSUE PAPER, PAPER AND PLASTIC BAGS FOR PACKAGING SHOES, FABRIC GIFT BAGS (U.S. CLS. 2, 5, 22, 23, 29, 37, 38 AND 50).

CLASS 18—LEATHER GOODS

FOR BAGS, NAMELY, TOTE BAGS, BACKPACKS, WALLETS, SCHOOL BAGS, SCHOOL BOOK BAGS, SPORTS BAGS, ALL PURPOSE CARRYING BAGS FOR SHOES (U.S. CLS. 1, 2, 3, 22 AND 41).

CLASS 25—CLOTHING

FOR APPAREL, NAMELY, SHIRTS, SWEATERS, SWEATSHIRTS, JACKETS, PANTS, SKIRTS, COATS, CAPS, HATS, SOCKS, BELTS AND FOOTWEAR, SCARVES, TIES, BOW TIES, BATHING SUITS, TIGHTS, ROMPERS, VESTS (U.S. CLS. 22 AND 39).

CLASS 26—FANCY GOODS

FOR HAIR ACCESSORIES, NAMELY, TWISTERS, CLAW CLIPS; SNAP CLIPS; CLAM CLIPS FOR HAIR; BARRETTES; HAIR BANDS; HAIR BOWS; HAIR BUCKLES; HAIR CLIPS; HAIR ORNAMENTS IN THE FORM OF COMBS; HAIR RIBBONS; HAIR SCRUNCHIES (U.S. CLS. 37, 39, 40, 42 AND 50).

DOMINIC FATHY, EXAMINING ATTORNEY

SN 77-806,268. AIR NEW ZEALAND LIMITED, AUCKLAND, NEW ZEALAND, FILED 8-17-2009.



OWNER OF NEW ZEALAND REG. NO. 684596, DATED 2-19-2004, EXPIRES 8-19-2013.

OWNER OF NEW ZEALAND REG. NO. 684594, DATED 2-19-2004, EXPIRES 8-19-2013.

OWNER OF U.S. REG. NO. 2,303,185.

THE MARK CONSISTS OF STYLIZED ARROWS.

CLASS 39—TRANSPORTATION AND STORAGE

FOR AIRLINE TRANSPORTATION SERVICES; TRANSPORTATION AND DELIVERY OF GOODS AND PEOPLE BY AIR; STORAGE OF GOODS; PROVIDING INFORMATION AND DATA RELATING TO THE TRANSPORTATION OF GOODS AND PEOPLE; TOURIST AGENCY SERVICES, NAMELY, ARRANGING EXCURSIONS FOR TOURISTS; PROVIDING TRANSPORTATION INFORMATION ABOUT TARIFFS, TIMETABLES AND METHODS OF TRANSPORT FOR GOODS AND PEOPLE; ARRANGING OF TOURS AND THE OPERATION OF TOURIST OFFICES; MAKING RESERVATIONS AND BOOKINGS FOR AIRLINE TRANSPORTATION SERVICES VIA TELEVISION, THE INTERNET AND ELECTRONIC MAIL; ALL THE AFORESAID BEING IN RELATION TO AIRLINE SERVICES; RESERVATION SERVICES FOR TRAVELLERS, NAMELY, TRAVEL AND TOUR TICKET RESERVATION SERVICE (U.S. CLS. 100 AND 105).

CLASS 43—HOTEL AND RESTAURANT SERVICES

FOR PROVIDING TEMPORARY ACCOMMODATION, FOOD AND BEVERAGES; TRAVEL AGENCY SERVICES, NAMELY, MAKING RESERVATIONS FOR TEMPORARY ACCOMMODATIONS AND MEALS; RESERVATION SERVICES FOR TRAVELLERS, NAMELY, RESERVATION OF HOTEL ROOMS FOR TRAVELERS (U.S. CLS. 100 AND 101).

KATHERINE STOIDES, EXAMINING ATTORNEY

SN 77-806,468. LIFEFORCE, LLC, BURR RIDGE, IL. FILED 8-17-2009.

SN 77-807,292. ROBIN, MICHELLE, SHAWNEE, KS. FILED 8-18-2009.

JIM PETERIK'S LIFEFORCE

THE MARK CONSISTS OF STANDARD CHARACTERS WITHOUT CLAIM TO ANY PARTICULAR FONT, STYLE, SIZE, OR COLOR.

THE NAME "JIM PETERIK" IDENTIFIES A LIVING INDIVIDUAL WHOSE CONSENT IS OF RECORD.

CLASS 9—ELECTRICAL AND SCIENTIFIC APPARATUS

FOR MUSICAL SOUND RECORDINGS; MUSICAL VIDEO RECORDINGS; PRE-RECORDED CDS, VIDEO TAPES, LASER DISKS AND DVDS FEATURING MUSICAL PERFORMANCES (U.S. CLS. 21, 23, 26, 36 AND 38).

CLASS 25—CLOTHING

FOR HATS; JACKETS; PANTS; SHIRTS; SWEAT SHIRTS; T-SHIRTS (U.S. CLS. 22 AND 39).
MARY CRAWFORD, EXAMINING ATTORNEY

SN 77-806,637. HARVARD AMERICA, INC., STAMFORD, CT. FILED 8-18-2009.



NO CLAIM IS MADE TO THE EXCLUSIVE RIGHT TO USE "HYGIENIC", APART FROM THE MARK AS SHOWN.

THE MARK CONSISTS OF THE WORD "HYGENIK" IN A SPECIFIC FONT WITH THE IMAGE OF A SPLASH OF THREE DROPLETS OF FLUID EMANATING FROM THE LETTER "K" OF "HYGENIK".

CLASS 5—PHARMACEUTICALS

FOR HAND SANITIZER AND DISINFECTING PREPARATION WITH ANTI-BACTERIAL AND ANTI-MICROBIAL PROPERTIES (U.S. CLS. 6, 18, 44, 46, 51 AND 52).

CLASS 21—HOUSEWARES AND GLASS

FOR TOUCH-FREE AUTOMATED DISPENSER FOR HAND SANITIZER SOLUTIONS (U.S. CLS. 2, 13, 23, 29, 30, 33, 40 AND 50).
AMY HELLA, EXAMINING ATTORNEY

WELLNESS ON A SHOESTRING

THE MARK CONSISTS OF STANDARD CHARACTERS WITHOUT CLAIM TO ANY PARTICULAR FONT, STYLE, SIZE, OR COLOR.

CLASS 9—ELECTRICAL AND SCIENTIFIC APPARATUS

FOR COMPUTER SOFTWARE USED FOR TRACKING, COLLECTING, AND MONITORING INFORMATION RELATING TO HEALTH, WELLNESS, NUTRITION, DIET, HEALTH CONDITIONS, EXERCISE ACTIVITY; DOWNLOADABLE DATABASE MANAGEMENT SOFTWARE FOR USE IN THE FIELD OF HEALTH AND WELLNESS (U.S. CLS. 21, 23, 26, 36 AND 38).

CLASS 14—JEWELRY

FOR CLOCKS (U.S. CLS. 2, 27, 28 AND 50).

CLASS 16—PAPER GOODS AND PRINTED MATTER

FOR PENS, PENCILS, PRINTED AWARDS (U.S. CLS. 2, 5, 22, 23, 29, 37, 38 AND 50).

CLASS 21—HOUSEWARES AND GLASS

FOR CUPS AND MUGS (U.S. CLS. 2, 13, 23, 29, 30, 33, 40 AND 50).

CLASS 25—CLOTHING

FOR CLOTHING, NAMELY, SHIRTS, T-SHIRTS, POLO SHIRTS, SWEATSHIRTS, CAPS, HATS, SOCKS, SHOES, SWEATERS (U.S. CLS. 22 AND 39).

CLASS 35—ADVERTISING AND BUSINESS

FOR ONLINE BUSINESS NETWORKING SERVICES (U.S. CLS. 100, 101 AND 102).

CLASS 41—EDUCATION AND ENTERTAINMENT

FOR TRAINING, COACHING AND EDUCATION SERVICES, NAMELY, CONDUCTING CLASSES, SEMINARS, WORKSHOPS, COURSES, CONFERENCES, AND FOCUS GROUPS, IN PERSON AND ONLINE, ALL IN THE FIELDS OF HEALTH AND WELLNESS; PROVIDING INFORMATION ON-LINE IN THE NATURE OF ONLINE BLOGS FEATURING INFORMATION ABOUT HEALTH AND WELLNESS (U.S. CLS. 100, 101 AND 107).
KEVIN DINALLO, EXAMINING ATTORNEY

SN 77-807,327. MADISON SQUARE GARDEN, L.P., NEW YORK, NY. FILED 8-18-2009.

SHOWVITE

THE MARK CONSISTS OF STANDARD CHARACTERS WITHOUT CLAIM TO ANY PARTICULAR FONT, STYLE, SIZE, OR COLOR.

CLASS 38—COMMUNICATION

FOR ELECTRONIC MAIL AND MESSAGING SERVICES FOR CONSUMERS TO SHARE TICKET RESERVATION AND BOOKING INFORMATION FOR ENTERTAINMENT AND CULTURAL EVENTS (U.S. CLS. 100, 101 AND 104).

CLASS 41—EDUCATION AND ENTERTAINMENT

FOR PROVIDING AN INTERNET WEBSITE FOR ARRANGING TICKET RESERVATIONS FOR ENTERTAINMENT AND CULTURAL EVENTS FOR CONSUMERS AND PROVIDING BOOKING INFORMATION FOR ENTERTAINMENT AND CULTURAL EVENTS (U.S. CLS. 100, 101 AND 107).

CLASS 42—SCIENTIFIC AND COMPUTER SERVICES

FOR COMPUTER SERVICES, NAMELY, CREATING AN ON-LINE COMMUNITY FOR REGISTERED USERS TO PARTICIPATE IN DISCUSSIONS REGARDING SHARING THEIR CONSUMER TICKET RESERVATIONS, PLAN TICKET PURCHASES AND BOOKING INFORMATION FOR ENTERTAINMENT AND CULTURAL EVENTS, ENGAGE IN SOCIAL NETWORKING, AND ELECTRONIC INVITATION CREATION AND DELIVERY (U.S. CLS. 100 AND 101).

ANTHONY RINKER, EXAMINING ATTORNEY

SN 77-811,243. DAVIDS TEA INC., QUEBEC, CANADA, FILED 8-24-2009.

DAVIDsTEA

THE MARK CONSISTS OF STANDARD CHARACTERS WITHOUT CLAIM TO ANY PARTICULAR FONT, STYLE, SIZE, OR COLOR.

CLASS 16—PAPER GOODS AND PRINTED MATTER

FOR PLASTIC BAGS FOR PACKAGING OF TEA; TEA FILTERS MADE OF PAPER (U.S. CLS. 2, 5, 22, 23, 29, 37, 38 AND 50).

CLASS 21—HOUSEWARES AND GLASS

FOR TEA STORAGE TINS FOR DOMESTIC USE SOLD EMPTY; TEA CANISTERS; ACCESSORIES FOR THE PREPARATION AND SERVING OF TEA, NAMELY, TEA POTS, TEA SCOOPS, BAMBOO WHISKS, TEA BOWLS, TEA STRAINERS, TEA BALLS, TEA INFUSERS, TEA SETS, CUPS, MUGS, SAUCERS, TEA KETTLES, TEA TRIVETS (U.S. CLS. 2, 13, 23, 29, 30, 33, 40 AND 50).

CLASS 30—STAPLE FOODS

FOR TEA, LOOSE LEAF TEAS, BREWED TEAS, ROASTED TEAS, TEA BEVERAGES, GOURMET TEA, ORGANIC TEA, POWDERED TEA AND MIXES IN THE NATURE OF SYRUPS OR POWDERS USED IN THE PREPARATION OF TEA BASED BEVERAGES; HERBAL INFUSIONS, NAMELY, LOOSE LEAF TEAS AND BREWED TEAS INFUSED WITH HERBS, FLOWERS AND FRUITS; HERBAL TEA; CHOCOLATES, TEA TRUFFLES IN THE NATURE OF CANDY, SHORT-BREADS, SEASONABLE BAKED GOODS, NAMELY, TEA INFUSED COOKIES, SHORTBREAD AND TEA TRUFFLE CHOCOLATES; GIFT SETS AND GIFT BASKETS COMPRISED PRIMARILY OF TEA LEAVES AND ALSO INCLUDING TEA-RELATED ACCESSORIES SUCH AS TEA COZIES, TEA INFUSERS, TEA MUGS AND TEAPOTS; TEA BAGS; GIFT BASKETS CONTAINING TEA AND PROCESSED HERBS (U.S. CL. 46).

CLASS 32—LIGHT BEVERAGES

FOR NON-ALCOHOLIC BEVERAGES, NAMELY, CARBONATED BEVERAGES; JUICES, NAMELY, FRUIT JUICES, HERBAL JUICES, FRUIT JUICES FLAVORED WITH TEA (U.S. CLS. 45, 46 AND 48).

CLASS 35—ADVERTISING AND BUSINESS

FOR RETAIL STORE SERVICES FEATURING PACKAGED TEA AND TEA IN BULK, TEA ACCESSORIES AND HERBS; IMPORTING AGENCY SERVICES IN THE FIELD OF TEA; WHOLESALE ORDER SERVICES IN THE FIELD OF TEA, TINS AND CANISTERS, GIFT BOXES CONTAINING TEA AND HERBS (U.S. CLS. 100, 101 AND 102).

CLASS 36—INSURANCE AND FINANCIAL

FOR BROKERAGE SERVICES IN THE FIELD OF TEA (U.S. CLS. 100, 101 AND 102).

CLASS 43—HOTEL AND RESTAURANT SERVICES

FOR RESTAURANT SERVICES (U.S. CLS. 100 AND 101).

STEVEN PEREZ, EXAMINING ATTORNEY

SN 77-811,288. KAPAK CORPORATION, CRYSTAL, MN. FILED 8-24-2009.

E·Z SHAKE

THE MARK CONSISTS OF STANDARD CHARACTERS WITHOUT CLAIM TO ANY PARTICULAR FONT, STYLE, SIZE, OR COLOR.

CLASS 16—PAPER GOODS AND PRINTED MATTER

FOR PLASTIC BAGS FOR GRANULAR PRODUCTS FOR HOUSEHOLD USE; RESEALABLE PLASTIC BAGS FOR GRANULAR PRODUCTS FOR HOUSEHOLD USE; PLASTIC BAGS WITH PERFORATED BOTTOM FOR METERED RELEASE OF GRANULAR PRODUCTS FOR HOUSEHOLD USE (U.S. CLS. 2, 5, 22, 23, 29, 37, 38 AND 50).

CLASS 22—CORDAGE AND FIBERS

FOR PLASTIC BAGS FOR GRANULAR PRODUCTS FOR INDUSTRIAL USE; RESEALABLE PLASTIC BAGS FOR GRANULAR PRODUCTS FOR INDUSTRIAL USE; PLASTIC BAGS WITH PERFORATED BOTTOM FOR METERED RELEASE OF GRANULAR PRODUCTS FOR INDUSTRIAL USE (U.S. CLS. 1, 2, 7, 19, 22, 42 AND 50).
REBECCA GILBERT, EXAMINING ATTORNEY

SN 77-811,414. ALLISON TRANSMISSION, INC., INDIANAPOLIS, IN. FILED 8-24-2009.

DRIVING EXCELLENCE FOR THE
WARFIGHTER

THE MARK CONSISTS OF STANDARD CHARACTERS WITHOUT CLAIM TO ANY PARTICULAR FONT, STYLE, SIZE, OR COLOR.

CLASS 9—ELECTRICAL AND SCIENTIFIC APPARATUS

FOR TRANSMISSIONS FOR LAND VEHICLES AND REPLACEMENT PARTS (U.S. CLS. 21, 23, 26, 36 AND 38).

CLASS 42—SCIENTIFIC AND COMPUTER SERVICES

FOR ENGINEERING AND DESIGN SERVICES FOR AUTOMATIC TRANSMISSIONS (U.S. CLS. 100 AND 101).
KELLEY WELLS, EXAMINING ATTORNEY

SN 77-811,520. MEDIMEDIA EDUCATIONAL GROUP, LLC, CHATHAM, NJ. FILED 8-24-2009.

SMARTEVENT

THE MARK CONSISTS OF STANDARD CHARACTERS WITHOUT CLAIM TO ANY PARTICULAR FONT, STYLE, SIZE, OR COLOR.

CLASS 35—ADVERTISING AND BUSINESS

FOR ADVERTISING AND PROMOTIONAL SERVICES IN THE FIELD OF HEALTHCARE (U.S. CLS. 100, 101 AND 102).
FIRST USE 5-1-2009; IN COMMERCE 5-1-2009.

CLASS 38—COMMUNICATION

FOR COMMUNICATION SERVICES, NAMELY, ELECTRONIC TRANSMISSION OF DATA AND DOCUMENTS AMONG USERS OF COMPUTERS AND STREAMING OF DATA AND DOCUMENTS VIA SATELLITE (U.S. CLS. 100, 101 AND 104).

FIRST USE 5-1-2009; IN COMMERCE 5-1-2009.
KIMBERLY PERRY, EXAMINING ATTORNEY

SN 77-811,752. MILLER, RACHELLE, NEW YORK, NY. FILED 8-24-2009.

SUBLIME

THE MARK CONSISTS OF STANDARD CHARACTERS WITHOUT CLAIM TO ANY PARTICULAR FONT, STYLE, SIZE, OR COLOR.

CLASS 29—MEATS AND PROCESSED FOODS

FOR PROCESSED FRUIT- AND NUT-BASED SNACK BARS (U.S. CL. 46).

CLASS 30—STAPLE FOODS

FOR READY TO EAT, GRAIN-BASED FOOD BARS (U.S. CL. 46).
SIMON TENG, EXAMINING ATTORNEY

SN 77-812,131. ENDOCHOICE, INC., ALPHARETTA, GA. FILED 8-25-2009.

ENDOCHOICE

OWNER OF U.S. REG. NO. 3,531,495.
THE COLOR(S) BLUE AND GREEN IS/ARE CLAIMED AS A FEATURE OF THE MARK.
THE MARK CONSISTS OF THE WORD "ENDO" IN BLUE ATTACHED TO THE WORD "CHOICE" IN GREEN.

CLASS 3—COSMETICS AND CLEANING PREPARATIONS

FOR DETERGENTS FOR CLEANING MEDICAL DEVICES; ENZYMATICS, NAMELY, ENZYMATIC CLEANING PREPARATIONS FOR CLEANING MEDICAL DEVICES (U.S. CLS. 1, 4, 6, 50, 51 AND 52).
FIRST USE 8-20-2008; IN COMMERCE 8-20-2008.

CLASS 10—MEDICAL APPARATUS

FOR BIOPSY FORCEPS; SNARES, NAMELY, SURGICAL INSTRUMENTS WITH A WIRE LOOP CONTROLLED BY A MECHANISM IN THE HANDLE AND USED TO REMOVE GROWTHS, SUCH AS TUMORS AND POLYPS; INJECTION NEEDLES, ASPIRATION NEEDLES AND ENDOSCOPIC ULTRASOUND NEEDLES; BIPOLAR PROBES; PADS FOR HOLDING AND CARRYING ENDOSCOPY INSTRUMENTS; CYTOLOGY BRUSHES, AND ACCESSORIES THEREFOR, NAMELY, SPECIMEN TRAPS FOR CAPTURING MEDICAL SPECIMENS, FILTERS FOR AUTOMATIC ENDOSCOPE REPROCESSING MACHINES (U.S. CLS. 26, 39 AND 44).
FIRST USE 4-0-2008; IN COMMERCE 4-0-2008.

CLASS 12—VEHICLES

FOR MEDICAL DEVICES AND APPARATUS, NAMELY, SPECIAL MEDICAL CARTS FOR HOLDING ENDOSCOPY EQUIPMENT, INSTRUMENTS AND UTENSILS FOR AMBULATORY USE, USE IN DOCTOR'S OFFICES AND HOSPITALS (U.S. CLS. 19, 21, 23, 31, 35 AND 44).

FIRST USE 1-7-2008; IN COMMERCE 1-7-2008.

CLASS 21—HOUSEWARES AND GLASS

FOR BRUSHES FOR CLEANING MEDICAL INSTRUMENTS, SPONGES FOR CLEANING MEDICAL INSTRUMENTS (U.S. CLS. 2, 13, 23, 29, 30, 33, 40 AND 50).

FIRST USE 5-21-2008; IN COMMERCE 5-21-2008.

CLASS 44—MEDICAL, BEAUTY AND AGRICULTURAL SERVICES

FOR MEDICAL SERVICES (U.S. CLS. 100 AND 101).

FIRST USE 1-28-2008; IN COMMERCE 1-28-2008.

DORITT L. CARROLL, EXAMINING ATTORNEY

SN 77-812,213. ENDOCHOICE, INC., ALPHARETTA, GA. FILED 8-25-2009.

ENDOCHOICE

THE MARK CONSISTS OF STANDARD CHARACTERS WITHOUT CLAIM TO ANY PARTICULAR FONT, STYLE, SIZE, OR COLOR.

OWNER OF U.S. REG. NO. 3,531,495.

CLASS 3—COSMETICS AND CLEANING PREPARATIONS

FOR DETERGENTS FOR CLEANING MEDICAL DEVICES; ENZYMATICS, NAMELY, ENZYMATIC CLEANING PREPARATIONS FOR CLEANING MEDICAL DEVICES (U.S. CLS. 1, 4, 6, 50, 51 AND 52).

FIRST USE 8-20-2008; IN COMMERCE 8-20-2008.

CLASS 10—MEDICAL APPARATUS

FOR BIOPSY FORCEPS; SNARES, NAMELY, SURGICAL INSTRUMENTS WITH A WIRE LOOP CONTROLLED BY A MECHANISM IN THE HANDLE AND USED TO REMOVE GROWTHS, SUCH AS TUMORS AND POLYPS; INJECTION NEEDLES, ASPIRATION NEEDLES AND ENDOSCOPIC ULTRASOUND NEEDLES; BIPOLAR PROBES; PADS FOR HOLDING AND CARRYING ENDOSCOPY INSTRUMENTS; CYTOLOGY BRUSHES, AND ACCESSORIES THEREFOR, NAMELY, SPECIMEN TRAPS FOR CAPTURING MEDICAL SPECIMENS, FILTERS FOR AUTOMATIC ENDOSCOPE REPROCESSING MACHINES (U.S. CLS. 26, 39 AND 44).

FIRST USE 4-0-2008; IN COMMERCE 4-0-2008.

SN 77-812,164. UPMC, PITTSBURGH, PA. FILED 8-25-2009.

Via Oncology - the path
forward in cancer

THE MARK CONSISTS OF STANDARD CHARACTERS WITHOUT CLAIM TO ANY PARTICULAR FONT, STYLE, SIZE, OR COLOR.

CLASS 9—ELECTRICAL AND SCIENTIFIC APPARATUS

FOR DOWNLOADABLE SOFTWARE PROGRAM FOR USE BY PHYSICIANS TO AID IN THE SELECTION OF TREATMENT PLANS FOR PATIENTS IN THE FIELD OF ONCOLOGY (U.S. CLS. 21, 23, 26, 36 AND 38).

CLASS 35—ADVERTISING AND BUSINESS

FOR MEDICAL MANAGEMENT SERVICES FOR HEALTH INSURANCE COMPANIES AND HEALTHCARE FACILITIES IN THE FIELD OF ONCOLOGY CARE, NAMELY, MEDICAL COST MANAGEMENT; MEDICAL CLAIMS MANAGEMENT FOR HEALTH INSURANCE COMPANIES AND HEALTHCARE FACILITIES IN THE FIELD OF ONCOLOGY CARE, NAMELY, RECEIVING, DATA ENTERING, AND REPRICING OF TRANSACTIONS THAT ARE ORIGINATED BY PHYSICIANS, HOSPITALS AND ANCILLARY MEDICAL CARE PROVIDERS (U.S. CLS. 100, 101 AND 102).

MARK SPARACINO, EXAMINING ATTORNEY

CLASS 12—VEHICLES

FOR MEDICAL DEVICES AND APPARATUS, NAMELY, SPECIAL MEDICAL CARTS FOR HOLDING ENDOSCOPY EQUIPMENT, INSTRUMENTS AND UTENSILS FOR AMBULATORY USE, USE IN DOCTOR'S OFFICES AND HOSPITALS (U.S. CLS. 19, 21, 23, 31, 35 AND 44).

FIRST USE 1-7-2008; IN COMMERCE 1-7-2008.

CLASS 21—HOUSEWARES AND GLASS

FOR BRUSHES FOR CLEANING MEDICAL INSTRUMENTS, SPONGES FOR CLEANING MEDICAL INSTRUMENTS (U.S. CLS. 2, 13, 23, 29, 30, 33, 40 AND 50).

FIRST USE 5-21-2008; IN COMMERCE 5-21-2008.

DORITT L. CARROLL, EXAMINING ATTORNEY

SN 77-812,667. SELIT DÄMMTECHNIK GMBH, ERBESBÜDESHEIM, FED REP GERMANY, FILED 8-25-2009.

SELIT

THE MARK CONSISTS OF STANDARD CHARACTERS WITHOUT CLAIM TO ANY PARTICULAR FONT, STYLE, SIZE, OR COLOR.

OWNER OF FED REP GERMANY REG. NO. 2069025, DATED 6-24-1994, EXPIRES 11-30-2012.

OWNER OF FED REP GERMANY REG. NO. 2064158, DATED 5-5-1994, EXPIRES 1-31-2013.

CLASS 17—RUBBER GOODS

FOR SOUND-DAMPENING AND HEAT-INSULATING MATERIALS, IN PARTICULAR FOR THE INSULATION OF INTERIOR WALLS, CEILINGS, STRUCTURAL REVEALS, AREAS AROUND RADIATORS AND ROLLER-TYPE SHUTTER BOXES; CORK PANELS AND ROLLS FOR USE AS AN HEAT-INSULATING WALLPAPER UNDERCOAT AND SOUND DAMPENING UNDERLAYMENT; SOUND-DAMPING AND HEAT-INSULATING PARQUET AND LAMINATE UNDERLAYMENT (U.S. CLS. 1, 5, 12, 13, 35 AND 50).

CLASS 19—NON-METALLIC BUILDING MATERIALS

FOR NON METALLIC BUILDING MATERIALS, IN PARTICULAR PANELS AND BOARDS FOR USE ON WALLS, CEILINGS AND FLOORS; FLOOR COVERINGS, IN PARTICULAR PARQUET AND LAMINATE FLOORS; MOULDINGS AND CEILING MEDALLIONS MADE OF POLYSTYROL FOAM (U.S. CLS. 1, 12, 33 AND 50).

CLASS 27—FLOOR COVERINGS

FOR WALLPAPER NOT MADE OF TEXTILE, IN PARTICULAR INSULATING WALLPAPER; FLOOR COVERINGS (U.S. CLS. 19, 20, 37, 42 AND 50).

MARGERY A. TIERNEY, EXAMINING ATTORNEY

SN 77-813,713. EFX PERFORMANCE, INC, ALISO VIEJO, CA. FILED 8-27-2009.



THE MARK CONSISTS OF THE LETTERS "EFX" OUTLINED WITH A BORDER AND WHEREAS THE TOP OF LETTER "F" AND THE LEFT SIDE OF THE LETTER "X" ARE CONNECTED.

CLASS 14—JEWELRY

FOR BRACELETS; CHARITY BRACELETS; JEWELRY AND WATCHES; JEWELRY; RUBBER OR SILICON WRISTBANDS IN THE NATURE OF A BRACELET (U.S. CLS. 2, 27, 28 AND 50).

FIRST USE 3-17-2008; IN COMMERCE 3-17-2008.

CLASS 16—PAPER GOODS AND PRINTED MATTER

FOR PRINTED HOLOGRAMS (U.S. CLS. 2, 5, 22, 23, 29, 37, 38 AND 50).

FIRST USE 3-17-2008; IN COMMERCE 3-17-2008.

CLASS 24—FABRICS

FOR TEXTILE LABELS (U.S. CLS. 42 AND 50).

FIRST USE 3-17-2008; IN COMMERCE 3-17-2008.

CLASS 25—CLOTHING

FOR ATHLETIC APPAREL, NAMELY, SHIRTS, PANTS, JACKETS, FOOTWEAR, HATS AND CAPS, ATHLETIC UNIFORMS (U.S. CLS. 22 AND 39).

FIRST USE 3-17-2008; IN COMMERCE 3-17-2008.
MATTHEW PAPPAS, EXAMINING ATTORNEY

SN 77-813,920. SCRIBBOS, LLC, ALPHARETTA, GA. FILED 8-27-2009.

SCRIBBOS

THE MARK CONSISTS OF STANDARD CHARACTERS WITHOUT CLAIM TO ANY PARTICULAR FONT, STYLE, SIZE, OR COLOR.

CLASS 9—ELECTRICAL AND SCIENTIFIC APPARATUS

FOR SOFTWARE FOR COMPUTERS AND MOBILE DEVICES FOR ENCRYPTING COMMUNICATION AND DATA EXCHANGE (U.S. CLS. 21, 23, 26, 36 AND 38).

CLASS 42—SCIENTIFIC AND COMPUTER SERVICES

FOR SOFTWARE AS A SERVICE (SAAS) SERVICES FEATURING SOFTWARE FOR ENCRYPTION OF COMMUNICATION AND DATA EXCHANGE (U.S. CLS. 100 AND 101).

LEIGH CAROLINE CASE, EXAMINING ATTORNEY

SN 77-813,929. SCRIBBOS, LLC, ALPHARETTA, GA. FILED 8-27-2009.



THE MARK CONSISTS OF THE STYLIZED WORD "SCRIBBOS" WITH A SWISH MARK OVER THE LETTER "I". THE LETTER "I" APPEARS IN THE SHAPE OF A PENCIL. THE "B" AND THE "O" FORM INTERLOCKING CIRCLES.

CLASS 9—ELECTRICAL AND SCIENTIFIC APPARATUS

FOR SOFTWARE FOR COMPUTERS AND MOBILE DEVICES FOR ENCRYPTING COMMUNICATION AND DATA EXCHANGE (U.S. CLS. 21, 23, 26, 36 AND 38).

CLASS 42—SCIENTIFIC AND COMPUTER SERVICES

FOR SOFTWARE AS A SERVICE (SAAS) SERVICES FEATURING SOFTWARE FOR ENCRYPTION OF COMMUNICATION AND DATA EXCHANGE (U.S. CLS. 100 AND 101).

LEIGH CAROLINE CASE, EXAMINING ATTORNEY

SN 77-814,213. COMPASSIONATE BEAUTY LLC, GOOD-YEAR, AZ. FILED 8-27-2009.

SN 77-814,443. EKOHUB, LLC, TARRYTOWN, NY. FILED 8-27-2009.

Compassionate Beauty

THE MARK CONSISTS OF STANDARD CHARACTERS WITHOUT CLAIM TO ANY PARTICULAR FONT, STYLE, SIZE, OR COLOR.

NO CLAIM IS MADE TO THE EXCLUSIVE RIGHT TO USE "BEAUTY", APART FROM THE MARK AS SHOWN.

CLASS 35—ADVERTISING AND BUSINESS

FOR RETAIL STORE FEATURING HAIR CARE PREPARATIONS, HATS, WIGS, HAIRPIECES, SCARVES, SLEEP CAPS, WIG SHAMPOOS, CONDITIONERS, STYLING SPRAYS, STANDS, BRUSHES, LINERS, AND GRIP PRODUCTS, BREAST PROSTHESIS AND CLEANSERS, APPAREL, LINGERIE, BRAS, BATHING SUITS, COSMETICS, TOILETRIES, NAIL CARE PREPARATIONS, MUSICAL SOUND RECORDINGS, CANDLES, JOURNALS, PICTURE FRAMES, GIFT BOXES, AND AROMATHERAPY PRODUCTS, IN CLASS 35 (U.S. CLS. 100, 101 AND 102).

FIRST USE 5-2-2004; IN COMMERCE 5-2-2004.

CLASS 44—MEDICAL, BEAUTY AND AGRICULTURAL SERVICES

FOR BEAUTY SPA SERVICES, NAMELY, COSMETIC BODY CARE; DAY SPA SERVICES, NAMELY, NAIL CARE, MANICURES, PEDICURES AND NAIL ENHANCEMENTS; HEALTH SPA SERVICES FOR HEALTH AND WELLNESS OF THE BODY AND SPIRIT, NAMELY, PROVIDING MASSAGE, FACIAL AND BODY TREATMENT SERVICES, COSMETIC BODY CARE SERVICES (U.S. CLS. 100 AND 101).

FIRST USE 5-2-2004; IN COMMERCE 5-2-2004.

LINDA M. KING, EXAMINING ATTORNEY

SN 77-814,397. DBC, LLC, LEHI, UT. FILED 8-27-2009.



THE COLOR(S) GREEN, DARK GREEN, LIGHT GREEN, CHARTREUSE AND GRAY IS/ARE CLAIMED AS A FEATURE OF THE MARK.

THE MARK CONSISTS OF THE WORD "ELEVIV" WITH THE LETTERS SHADED WITH GRAY AND WITH A LEAF DESIGN IN GREEN, DARK GREEN, LIGHT GREEN AND CHARTREUSE AS THE ACCENT OVER THE "I" IN "ELEVIV".

CLASS 29—MEATS AND PROCESSED FOODS

FOR NUT AND SEED-BASED SNACK BARS; PROTEIN BASED, NUTRIENT-DENSE SNACK BARS (U.S. CL. 46).

CLASS 32—LIGHT BEVERAGES

FOR WHEY BEVERAGES (U.S. CLS. 45, 46 AND 48).
TARAH HARDY, EXAMINING ATTORNEY

CSRHUB

THE MARK CONSISTS OF STANDARD CHARACTERS WITHOUT CLAIM TO ANY PARTICULAR FONT, STYLE, SIZE, OR COLOR.

CLASS 35—ADVERTISING AND BUSINESS

FOR BUSINESS MANAGEMENT, NAMELY, RESEARCH OF, COLLECTING, CREATING, FILTERING, PROVIDING AND APPLYING INFORMATION CONCERNING BUSINESS AND ORGANIZATIONAL PERFORMANCE ON SOCIAL, ENVIRONMENTAL, GOVERNANCE, EMPLOYEE AND CORPORATE SOCIAL RESPONSIBILITY CRITERIA; ADVERTISING SERVICES; PROVIDING ONLINE COMPUTER DATABASES AND ONLINE SEARCHABLE DATABASES IN THE FIELD OF CORPORATE SOCIAL RESPONSIBILITY (U.S. CLS. 100, 101 AND 102).

CLASS 42—SCIENTIFIC AND COMPUTER SERVICES

FOR COMPUTER SERVICES, NAMELY, HOSTING ONLINE COMMUNITY WEBSITE FOR USERS TO PARTICIPATE IN DISCUSSIONS, GET FEEDBACK FROM THEIR PEERS, FORM VIRTUAL COMMUNITIES, AND ENGAGE IN SOCIAL NETWORKING IN THE FIELD OF BUSINESS AND ORGANIZATIONAL PERFORMANCE ON SOCIAL, ENVIRONMENTAL, GOVERNANCE, EMPLOYEE AND CORPORATE SOCIAL RESPONSIBILITY (U.S. CLS. 100 AND 101).

KATHLEEN LORENZO, EXAMINING ATTORNEY

SN 77-814,561. BIRD LOVERS ONLY RESCUE SERVICE INCORPORATED, SCHERERVILLE, IN. FILED 8-27-2009.

SNOWBALL THE DANCING COCKATOO

THE MARK CONSISTS OF STANDARD CHARACTERS WITHOUT CLAIM TO ANY PARTICULAR FONT, STYLE, SIZE, OR COLOR.

CLASS 16—PAPER GOODS AND PRINTED MATTER

FOR STICKERS; BUMPER STICKERS; CHILDREN'S WALL STICKERS AND MURALS; PENS; PENCILS; POST CARDS; PAPER STATIONERY; PENCIL ORNAMENTS; NOTEBOOKS; FOLDERS (U.S. CLS. 2, 5, 22, 23, 29, 37, 38 AND 50).

CLASS 18—LEATHER GOODS

FOR BAGS, NAMELY, MESSENGER BAGS AND TOTE BAGS; WALLETS; BACKPACKS; UMBRELLAS (U.S. CLS. 1, 2, 3, 22 AND 41).

CLASS 20—FURNITURE AND ARTICLES NOT OTHERWISE CLASSIFIED

FOR CUSHIONS, NAMELY, JAPANESE FLOOR CUSHIONS AND STADIUM CUSHIONS; PLASTIC KEY CHAINS (U.S. CLS. 2, 13, 22, 25, 32 AND 50).

CLASS 21—HOUSEWARES AND GLASS

FOR DINNERWARE, NAMELY, PLATES; PAPER PLATES; CUPS; MUGS; NONMETAL COIN BANKS; BEVERAGE GLASSWARE (U.S. CLS. 2, 13, 23, 29, 30, 33, 40 AND 50).

CLASS 24—FABRICS

FOR HANDKERCHIEFS; CLOTH FLAGS; TOWELS (U.S. CLS. 42 AND 50).
DAVID TAYLOR, EXAMINING ATTORNEY

SN 77-814,744. MXMD, INC., SAN JOSE, CA. FILED 8-28-2009.

FRIENDSQUARE

THE MARK CONSISTS OF STANDARD CHARACTERS WITHOUT CLAIM TO ANY PARTICULAR FONT, STYLE, SIZE, OR COLOR.

CLASS 38—COMMUNICATION

FOR PROVIDING VIRTUAL CHATROOMS FOR USERS TO ENGAGE IN AN INTERACTIVE CHAT SESSION USING MOBILE TEXT MESSAGES; PROVIDING ON-LINE ELECTRONIC BULLETIN BOARDS FOR TRANSMISSION OF MESSAGES AMONG COMPUTER USERS CONCERNING SOCIAL NETWORKING INFORMATION USING MOBILE TEXT MESSAGES; TELECOMMUNICATION SERVICES, NAMELY PROVIDING TEXT AND NUMERIC WIRELESS DIGITAL MESSAGING SERVICES FOR TRANSMISSION AND RECEPTION OF MOBILE TEXT MESSAGES FOR USERS TO ENGAGE IN SOCIAL NETWORKING; PROVIDING WORLDWIDE SWITCHED TEXT AND MESSAGE TRANSMISSION SERVICES FOR USERS TO ENGAGE IN SOCIAL NETWORKING USING MOBILE TEXT MESSAGES; PROVIDING VIRTUAL CHAT ROOM SERVICES FOR SOCIAL NETWORKING FOR ALLOWING USERS TO ENGAGE IN INTERACTIVE CHAT SESSIONS USING MOBILE TEXT MESSAGES (U.S. CLS. 100, 101 AND 104).

CLASS 42—SCIENTIFIC AND COMPUTER SERVICES

FOR COMPUTER SERVICES, NAMELY, CREATING AN ON-LINE COMMUNITY FOR REGISTERED USERS TO ENGAGE IN INTERACTIVE CHAT SESSIONS, GET FEEDBACK FROM THEIR PEERS, FORM VIRTUAL COMMUNITIES, AND ENGAGE IN SOCIAL NETWORKING; APPLICATION SERVICE PROVIDER (ASP), NAMELY, HOSTING COMPUTER SOFTWARE APPLICATIONS OF OTHERS TO ENABLE BUSINESS ENTITIES TO PROVIDE AN INTERACTIVE PLATFORM FOR USE BY THE BUSINESS ENTITY'S CUSTOMERS TO ENGAGE IN SOCIAL NETWORKING; SERVICES FOR ENABLING A BUSINESS ENTITY TO PROVIDE A PRIVATE SOCIAL NETWORKING PLATFORM FOR USE BY THE BUSINESS ENTITY'S CUSTOMERS, NAMELY, PROVIDING A SECURE, WEB-BASED SERVICE ENABLING INDIVIDUALS TO REMOTELY CREATE AND MANAGE THEIR OWN ACCOUNTS SO THAT WHATEVER PRIVATE CONTENT THEY UPLOAD CAN BE DELIVERED TO THEIR INTENDED RECIPIENTS, AT THE TIME AND IN THE MANNER REQUESTED (U.S. CLS. 100 AND 101).

CLASS 45—PERSONAL AND LEGAL SERVICES

FOR ONLINE SOCIAL NETWORKING SERVICES; PROVIDING ONLINE COMPUTER DATABASES AND ON-LINE SEARCHABLE DATABASES IN THE FIELD OF SOCIAL NETWORKING, ALSO ACCESSIBLE VIA MOBILE TEXT MESSAGING (U.S. CLS. 100 AND 101).
CHARISMA HAMPTON, EXAMINING ATTORNEY

SN 77-814,745. MXMD, INC., SAN JOSE, CA. FILED 8-28-2009.

UNLEASH THE POWER OF TEXTING

THE MARK CONSISTS OF STANDARD CHARACTERS WITHOUT CLAIM TO ANY PARTICULAR FONT, STYLE, SIZE, OR COLOR.

NO CLAIM IS MADE TO THE EXCLUSIVE RIGHT TO USE "TEXTING", APART FROM THE MARK AS SHOWN.

CLASS 38—COMMUNICATION

FOR PROVIDING VIRTUAL CHATROOMS FOR USERS TO ENGAGE IN AN INTERACTIVE CHAT SESSION USING MOBILE TEXT MESSAGES; PROVIDING ON-LINE ELECTRONIC BULLETIN BOARDS FOR TRANSMISSION OF MESSAGES AMONG COMPUTER USERS CONCERNING SOCIAL NETWORKING INFORMATION USING MOBILE TEXT MESSAGES; TELECOMMUNICATION SERVICES, NAMELY, PROVIDING TEXT AND NUMERIC WIRELESS DIGITAL MESSAGING SERVICES FOR TRANSMISSION AND RECEPTION OF MOBILE TEXT MESSAGES FOR USERS TO ENGAGE IN SOCIAL NETWORKING; PROVIDING WORLDWIDE SWITCHED TEXT AND MESSAGE TRANSMISSION SERVICES FOR USERS TO ENGAGE IN SOCIAL NETWORKING USING MOBILE TEXT MESSAGES; PROVIDING VIRTUAL CHAT ROOM SERVICES FOR SOCIAL NETWORKING FOR ALLOWING USERS TO ENGAGE IN INTERACTIVE CHAT SESSIONS USING MOBILE TEXT MESSAGES (U.S. CLS. 100, 101 AND 104).

CLASS 42—SCIENTIFIC AND COMPUTER SERVICES

FOR COMPUTER SERVICES, NAMELY, CREATING AN ON-LINE COMMUNITY FOR REGISTERED USERS TO ENGAGE IN INTERACTIVE CHAT SESSIONS, GET FEEDBACK FROM THEIR PEERS, FORM VIRTUAL COMMUNITIES, AND ENGAGE IN SOCIAL NETWORKING; APPLICATION SERVICE PROVIDER (ASP), NAMELY, HOSTING COMPUTER SOFTWARE APPLICATIONS OF OTHERS TO ENABLE BUSINESS ENTITIES TO PROVIDE AN INTERACTIVE PLATFORM FOR USE BY THE BUSINESS ENTITY'S CUSTOMERS TO ENGAGE IN SOCIAL NETWORKING; SERVICES FOR ENABLING A BUSINESS ENTITY TO PROVIDE A PRIVATE SOCIAL NETWORKING PLATFORM FOR USE BY THE BUSINESS ENTITY'S CUSTOMERS, NAMELY, PROVIDING A SECURE, WEB-BASED SERVICE ENABLING INDIVIDUALS TO REMOTELY CREATE AND MANAGE THEIR OWN ACCOUNTS SO THAT WHATEVER PRIVATE CONTENT THEY UPLOAD CAN BE DELIVERED TO THEIR INTENDED RECIPIENTS, AT THE TIME AND IN THE MANNER REQUESTED (U.S. CLS. 100 AND 101).

CHARISMA HAMPTON, EXAMINING ATTORNEY

SN 77-815,011. CURTIS SYSTEMS, HOCHHEIM/MAIN, FED REP GERMANY, FILED 8-28-2009.

CURTIS

THE MARK CONSISTS OF STANDARD CHARACTERS WITHOUT CLAIM TO ANY PARTICULAR FONT, STYLE, SIZE, OR COLOR.

CLASS 1—CHEMICALS

FOR CHEMICALS USED IN INDUSTRY; COOLANTS; FIRE EXTINGUISHING COMPOSITIONS; TEMPERING CHEMICALS FOR USE IN METALWORKING OR SOLDERING; UNPROCESSED ARTIFICIAL RESINS (U.S. CLS. 1, 5, 6, 10, 26 AND 46).

FIRST USE 1-1-1970; IN COMMERCE 1-1-1970.

CLASS 4—LUBRICANTS AND FUELS

FOR INDUSTRIAL LUBRICANTS; LUBRICATING OILS AND GREASES; MINERAL OILS AND GREASES FOR INDUSTRIAL PURPOSES; NON-MINERAL OILS AND GREASES FOR INDUSTRIAL PURPOSES (U.S. CLS. 1, 6 AND 15).

FIRST USE 1-1-1970; IN COMMERCE 1-1-1970.
ANDREA BUTLER, EXAMINING ATTORNEY

SN 77-815,494. DISC INTELLECTUAL PROPERTIES, LLC., BURBANK, CA. FILED 8-28-2009.



OWNER OF U.S. REG. NOS. 1,653,200, 2,804,842 AND 3,490,354.

NO CLAIM IS MADE TO THE EXCLUSIVE RIGHT TO USE "CASTING EST. 1925", APART FROM THE MARK AS SHOWN.

THE MARK CONSISTS OF THE WORDING "CENTRAL CASTING EST. 1925" INSIDE THREE CONCENTRIC CIRCLES. THE LETTERS "C" AND "G" IN THE WORD "CASTING" EXTENDS OUTSIDE THE CIRCLES. THERE ARE TWO FIVE POINT STARS, ONE ON EACH SIDE OF THE WORDING "EST. 1925". THE DESIGN ELEMENT OF BEAMS OF LIGHT APPEARS IN THE BACKGROUND INSIDE THE CIRCLE.

CLASS 25—CLOTHING

FOR HATS, T-SHIRTS, JACKETS AND SWEATSHIRTS (U.S. CLS. 22 AND 39).

CLASS 35—ADVERTISING AND BUSINESS

FOR TEMPORARY EMPLOYMENT AGENCY SERVICES, NAMELY, CASTING EXTRAS FOR MOTION PICTURES, TELEVISION AND ADVERTISING (U.S. CLS. 100, 101 AND 102).

WENDY JUN, EXAMINING ATTORNEY

SN 77-816,037. SCRIPTBAGS, LLC, NEW ALBANY, OH. FILED 8-30-2009.



THE MARK CONSISTS OF "SCRIPTBAGS.COM" WITH A STETHOSCOPE, WHERE THE "O" IN ".COM" IS THE CHESTPIECE OF THE STETHOSCOPE.

CLASS 10—MEDICAL APPARATUS

FOR PLASTIC BAGS, NAMELY, DRUG SAMPLE BAGS DISTRIBUTED EMPTY (U.S. CLS. 26, 39 AND 44).

CLASS 35—ADVERTISING AND BUSINESS

FOR ADVERTISING SERVICES, NAMELY, PROMOTING THE GOODS AND SERVICES OF OTHERS (U.S. CLS. 100, 101 AND 102).

SUSAN LESLIE DUBOIS, EXAMINING ATTORNEY

SN 77-816,146. CDC DEVELOPMENT SOLUTIONS, INC., WASHINGTON, DC. FILED 8-31-2009.

CDC DEVELOPMENT SOLUTIONS

THE MARK CONSISTS OF STANDARD CHARACTERS WITHOUT CLAIM TO ANY PARTICULAR FONT, STYLE, SIZE, OR COLOR.

NO CLAIM IS MADE TO THE EXCLUSIVE RIGHT TO USE "DEVELOPMENT SOLUTIONS", APART FROM THE MARK AS SHOWN.

CLASS 35—ADVERTISING AND BUSINESS

FOR PROMOTING ECONOMIC DEVELOPMENT AND SUSTAINABLE LIVELIHOODS IN THE DEVELOPING MARKET COUNTRIES OF LATIN AMERICA, EASTERN EUROPE, THE FORMER SOVIET UNION, SUB-SAHARAN AFRICA, THE MIDDLE EAST, NORTH AFRICA, AND ASIA, IN PARTICULAR, PROVIDING ASSISTANCE IN REBUILDING THE ECONOMIES OF COUNTRIES FACING POLITICAL OR ECONOMIC CRISIS OR ADDRESSING THE AFTERMATH OF NATURAL DISASTERS OR CONFLICT; PROVIDING BUSINESS ADVICE AND INFORMATION TO TOURISM-RELATED BUSINESSES AND INSTITUTIONS IN DEVELOPING MARKET COUNTRIES; PROVIDING BUSINESS CONSULTING ASSISTANCE PROVIDED TO SMALL AND MEDIUM BUSINESSES IN DEVELOPING MARKETS AND PROMOTING THOSE BUSINESSES BY LINKING THEM TO INTERNATIONAL SUPPLY CHAINS; PROVIDING BUSINESS CONSULTATION AND ADVICE TO HELP ASSIST PARTIES IN DEVELOPING MARKET ECONOMIES TO BUILD THE CAPACITY TO ADDRESS MARKET, FINANCIAL AND TECHNICAL CONSTRAINTS (U.S. CLS. 100, 101 AND 102).

FIRST USE 7-0-2009; IN COMMERCE 7-0-2009.

CLASS 41—EDUCATION AND ENTERTAINMENT

FOR BUSINESS CONSULTING AND TRAINING SERVICES, NAMELY, PROVIDING TRAINING TO INDIGENOUS BUSINESSES AND INDIVIDUALS IN DEVELOPING MARKET ECONOMIES IN THE FIELD OF LINKAGES INTO INTERNATIONAL SUPPLY CHAINS; PROVIDING BUSINESS TRAINING IN THE FIELD OF MARKET, FINANCIAL AND TECHNICAL CONSTRAINTS IN DEVELOPING MARKET ECONOMIES (U.S. CLS. 100, 101 AND 107).

FIRST USE 7-0-2009; IN COMMERCE 7-0-2009.

MARILYN IZZI, EXAMINING ATTORNEY

SN 77-816,662. THE AMERICAN ASSOCIATION OF TEACHERS OF SPANISH AND PORTUGUESE, INC., WALLED LAKE, MI. FILED 8-31-2009.



SN 77-816,147. CDC DEVELOPMENT SOLUTIONS, INC., WASHINGTON, DC. FILED 8-31-2009.



NO CLAIM IS MADE TO THE EXCLUSIVE RIGHT TO USE "DEVELOPMENT SOLUTIONS", APART FROM THE MARK AS SHOWN.

THE MARK CONSISTS OF UNEVEN CONCENTRIC OVALS OVER A HALF GLOBE WITH LATITUDINAL AND LONGITUDINAL LINES, TO THE LEFT OF THE LETTERS "CDC", WHICH ARE WRITTEN VERTICALLY AND HAVE A VERTICAL LINE TO THE RIGHT OF THEM. TO THE RIGHT OF THE VERTICAL LINE, THE WORD "DEVELOPMENT" APPEARS ON TOP OF THE WORD "SOLUTIONS" WITH A HORIZONTAL LINE APPEARING BETWEEN THE TWO WORDS.

CLASS 35—ADVERTISING AND BUSINESS

FOR PROMOTING ECONOMIC DEVELOPMENT AND SUSTAINABLE LIVELIHOODS IN THE DEVELOPING MARKET COUNTRIES OF LATIN AMERICA, EASTERN EUROPE, THE FORMER SOVIET UNION, SUB-SAHARAN AFRICA, THE MIDDLE EAST, NORTH AFRICA, AND ASIA, IN PARTICULAR, PROVIDING ASSISTANCE IN REBUILDING THE ECONOMIES OF COUNTRIES FACING POLITICAL OR ECONOMIC CRISIS OR ADDRESSING THE AFTERMATH OF NATURAL DISASTERS OR CONFLICT; PROVIDING BUSINESS ADVICE AND INFORMATION TO TOURISM-RELATED BUSINESSES AND INSTITUTIONS IN DEVELOPING MARKET COUNTRIES; PROVIDING BUSINESS CONSULTING ASSISTANCE PROVIDED TO SMALL AND MEDIUM BUSINESSES IN DEVELOPING MARKETS AND PROMOTING THOSE BUSINESSES BY LINKING THEM TO INTERNATIONAL SUPPLY CHAINS; PROVIDING BUSINESS CONSULTATION AND ADVICE TO HELP ASSIST PARTIES IN DEVELOPING MARKET ECONOMIES TO BUILD THE CAPACITY TO ADDRESS MARKET, FINANCIAL AND TECHNICAL CONSTRAINTS (U.S. CLS. 100, 101 AND 102).

FIRST USE 7-0-2009; IN COMMERCE 7-0-2009.

CLASS 41—EDUCATION AND ENTERTAINMENT

FOR BUSINESS CONSULTING AND TRAINING SERVICES, NAMELY, PROVIDING TRAINING TO INDIGENOUS BUSINESSES AND INDIVIDUALS IN DEVELOPING MARKET ECONOMIES IN THE FIELD OF LINKAGES INTO INTERNATIONAL SUPPLY CHAINS; PROVIDING BUSINESS TRAINING IN THE FIELD OF MARKET, FINANCIAL AND TECHNICAL CONSTRAINTS IN DEVELOPING MARKET ECONOMIES (U.S. CLS. 100, 101 AND 107).

FIRST USE 7-0-2009; IN COMMERCE 7-0-2009.

MARILYN IZZI, EXAMINING ATTORNEY

NO CLAIM IS MADE TO THE EXCLUSIVE RIGHT TO USE "ASSOCIATION" AND "1917", APART FROM THE MARK AS SHOWN.

THE MARK CONSISTS OF STYLIZED LETTERS "AATSP" OVER THE WORDS "THE AMERICAN ASSOCIATION OF TEACHERS OF SPANISH AND PORTUGUESE" NEXT TO A SEAL COMPRISED OF AN OUTLINED CIRCLE WITH THE WORDS "THE AMERICAN ASSOCIATION OF TEACHERS OF SPANISH AND PORTUGUESE" ON THE OUTER EDGE OF THE CIRCLE AND INSIDE THE CIRCLE A BANNER AT THE TOP CONTAINING THE WORDS "TODAS A UNA" AND BELOW THIS A SHIELD WITH TOP PORTION CONTAIN A STAR ENCOMPASSED BY HORIZONTAL STRIPES AND BELOW THIS A LION FIGURE TO THE RIGHT OF THE SHIELD AND A CASTLE ENCOMPASSED IN VERTICAL STRIPES TO THE RIGHT OF THE SHIELD WITH THE DATE "1917" BELOW THE SHIELD.

THE ENGLISH TRANSLATION OF "TODOS A UNA" IN THE MARK IS "ALL OF US TOGETHER".

SEC. 2(F) AS TO "THE AMERICAN ASSOCIATION OF TEACHERS OF SPANISH AND PORTUGUESE".

CLASS 9—ELECTRICAL AND SCIENTIFIC APPARATUS

FOR (BASED ON INTENT TO USE) PROVIDING DOWNLOADABLE ELECTRONIC PUBLICATIONS, NAMELY, MAGAZINES AND NEWSLETTERS IN THE FIELD OF FOREIGN LANGUAGES (U.S. CLS. 21, 23, 26, 36 AND 38).

CLASS 16—PAPER GOODS AND PRINTED MATTER

FOR (BASED ON INTENT TO USE) PROVIDING PRINTED PUBLICATIONS, NAMELY, BOOKS, BROCHURES, WORKBOOKS IN THE FIELD OF FOREIGN LANGUAGES (U.S. CLS. 2, 5, 22, 23, 29, 37, 38 AND 50).

CLASS 35—ADVERTISING AND BUSINESS

FOR (BASED ON USE IN COMMERCE) ASSOCIATION SERVICES, NAMELY, PROMOTING THE INTERESTS OF PEOPLE INTERESTED IN FOREIGN LANGUAGES (U.S. CLS. 100, 101 AND 102).

FIRST USE 12-0-1944; IN COMMERCE 12-0-1944.

CLASS 41—EDUCATION AND ENTERTAINMENT

FOR (BASED ON INTENT TO USE) CONDUCTING EDUCATIONAL CONFERENCES IN THE FIELD OF FOREIGN LANGUAGES; PROVIDING ONLINE PUBLICATIONS IN THE NATURE OF AN E-JOURNAL IN THE FIELD OF FOREIGN LANGUAGES (U.S. CLS. 100, 101 AND 107).

SAIMA MAKHDOOM, EXAMINING ATTORNEY

SN 77-817,219. BROOKE TREVITT, LOUISVILLE, KY. FILED 9-1-2009.

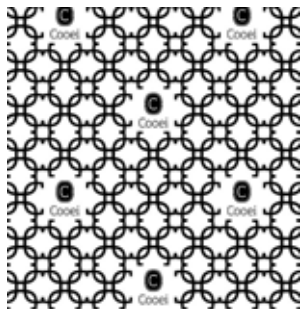

THE MARK CONSISTS OF A "C" IN THE CENTER OF A BLACK OVAL AND TWO BLACK "C'S" AND THE WORD "COOEI" AND AN INTERLOCKING "C" PATTERN.

CLASS 24—FABRICS

FOR FABRIC USED IN THE MANUFACTURE OF PURSES AND HANDBAGS (U.S. CLS. 42 AND 50).

CLASS 25—CLOTHING

FOR COMPONENTS OF FOOTWEAR, NAMELY, SHOE SOLES (U.S. CLS. 22 AND 39).

INGRID C. EULIN, EXAMINING ATTORNEY

CLASS 30—STAPLE FOODS

FOR CANDY; CHEESE FLAVORED PUFFED CORN SNACKS; CHOCOLATE; CHOCOLATE BARS; CHOCOLATE CANDIES; CHOCOLATE COVERED FRUIT; CHOCOLATE COVERED NUTS; CHOCOLATE COVERED RAISINS; COCOA; COFFEE; COOKIES; CORN CHIPS; CRACKERS; FILLED CHOCOLATE; FLOUR-BASED CHIPS; GRANOLA-BASED SNACK BARS; GRANOLA SNACKS; MIXES FOR MAKING BAKING BATTERS; POPCORN; PRETZELS; TACO CHIPS; TEA; TORTILLA CHIPS; WHEAT-BASED SNACK FOODS; AND PREPARATIONS FOR MAKING BEVERAGES, NAMELY, ICED TEA (U.S. CL. 46).

CLASS 32—LIGHT BEVERAGES

FOR BOTTLED WATER; PREPARATIONS FOR MAKING BEVERAGES, NAMELY, LEMONADE AND FRUIT PUNCH; SPARKLING WATER; SPRING WATER; STILL WATER; NON-ALCOHOLIC COCKTAIL MIXES (U.S. CLS. 45, 46 AND 48).

DAVID H. STINE, EXAMINING ATTORNEY

SN 77-817,882. JUNIPER NETWORKS, INC., SUNNYVALE, CA. FILED 9-1-2009.

SN 77-817,489. BED BATH & BEYOND PROCUREMENT CO. INC., FARMINGDALE, NY. FILED 9-1-2009.

MILLERTON MARKET

THE MARK CONSISTS OF STANDARD CHARACTERS WITHOUT CLAIM TO ANY PARTICULAR FONT, STYLE, SIZE, OR COLOR.

NO CLAIM IS MADE TO THE EXCLUSIVE RIGHT TO USE "MARKET", APART FROM THE MARK AS SHOWN.

CLASS 29—MEATS AND PROCESSED FOODS

FOR CANDIED FRUIT SNACKS; DEHYDRATED FRUIT SNACKS; DRIED FRUIT AND VEGETABLES; DRIED FRUITS; DRIED FRUIT-BASED SNACKS; FRUIT CHIPS; FRUIT-BASED ORGANIC FOOD BARS; FRUIT-BASED SNACK FOOD; NUT AND SEED-BASED SNACK BARS; POTATO CHIPS; POTATO CRISPS AND CHIPS; PREPARED NUTS; PROCESSED NUTS; ROASTED NUTS; SEASONED NUTS; SHELLED NUTS; SNACK MIX CONSISTING PRIMARILY OF PROCESSED FRUITS AND RAISINS; SOUPS; TRAIL MIX CONSISTING PRIMARILY OF PROCESSED NUTS, SEEDS, DRIED FRUIT AND ALSO INCLUDING CHOCOLATE (U.S. CL. 46).

JUNIPER
NETWORKS

OWNER OF U.S. REG. NOS. 2,255,921, 3,089,694 AND OTHERS.

NO CLAIM IS MADE TO THE EXCLUSIVE RIGHT TO USE "NETWORKS", APART FROM THE MARK AS SHOWN.

THE MARK CONSISTS OF THE STYLIZED WORDS "JUNIPER NETWORKS". "JUNIPER" APPEARS IN LARGE STYLIZED TEXT; THE TERM "NETWORKS" APPEARS IN SMALLER, STYLIZED TEXT BELOW.

CLASS 9—ELECTRICAL AND SCIENTIFIC APPARATUS

FOR COMPUTER HARDWARE AND SOFTWARE, USED ALONE OR IN COMBINATION, FOR INTERCONNECTING, ESTABLISHING, MANAGING, SECURING, MONITORING, TROUBLESHOOTING, CONTROLLING, OPERATING, AND ACCESSING LOCAL, WIDE, AND GLOBAL AREA NETWORKS AND NETWORK INFRASTRUCTURE; COMPUTER HARDWARE AND SOFTWARE, USED ALONE OR IN COMBINATION, FOR ROUTING, SWITCHING, TRANSMITTING, PROCESSING, FILTERING, ANALYZING, SECURING, AND STORING DATA, VIDEO OR VOICE TRAFFIC, PACKETS, OR OTHER FORMS OF COMMUNICATIONS; COMPUTER HARDWARE AND SOFTWARE, USED ALONE OR IN COMBINATION, FOR PROVIDING SECURITY FUNCTIONALITY FOR NETWORKS OR ELECTRONIC DEVICES OR ROUTERS IN NETWORKS, SUCH AS PROVIDING FIREWALL FILTERS, ACCESS CONTROL, VIRTUAL PRIVATE NETWORKS, INTEROPERABILITY WITH ROUTER SECURITY PROTOCOLS, AND PROTECTION AGAINST NETWORK INTRUSION AND VIRUSES; DOWNLOADABLE INSTRUCTIONAL MATERIALS, NAMELY, MANUALS AND GUIDES IN THE FIELDS OF NETWORKING, TELECOMMUNICATIONS, AND NETWORK SECURITY, AND ESTABLISHING, MANAGING, AND OPERATING LOCAL AND WIDE AREA NETWORKS; COMPUTER SOFTWARE, NAMELY, OPERATING SYSTEM SOFTWARE, OPERATING SYSTEM SOFTWARE THAT HOSTS COMPUTER SOFTWARE APPLICATIONS AND FACILITATES INTERACTIONS WITH OTHER COMPUTERS AND PERIPHERALS ACROSS ENTERPRISE NETWORKS; DATABASE MANAGEMENT SOFTWARE; COMPUTER SOFTWARE FOR ACCESSING, BROWSING AND SEARCHING DATABASES; COMPUTER PROGRAMS FOR USE IN ACCESSING, NAVIGATING, BROWSING, DELIVERING, AND TRANSFERRING INFORMATION, AND DISTRIBUTING AND VIEWING COMPUTER PROGRAMS; COMPUTER PROGRAMS FOR USE IN ACCESSING AND VIEWING COMPUTER NETWORK INFRASTRUCTURE AND SYSTEMS; PROGRAMMABLE AND CUSTOMIZABLE COMPUTER SOFTWARE APPLICATION FOR MOBILE DEVICES, TELEVISIONS, AND OTHER VIDEO DEVICES (U.S. CLS. 21, 23, 26, 36 AND 38).

CLASS 37—CONSTRUCTION AND REPAIR

FOR INSTALLATION, MAINTENANCE, AND REPAIR SERVICES IN THE FIELDS OF COMPUTERS, TELECOMMUNICATIONS, NETWORKING, COMMUNICATIONS, AND NETWORK SECURITY (U.S. CLS. 100, 103 AND 106).

CLASS 41—EDUCATION AND ENTERTAINMENT

FOR EDUCATIONAL SERVICES, NAMELY, PROVIDING OF TRAINING AND EDUCATIONAL COURSES ON INTERCONNECTING, ESTABLISHING, MANAGING, SECURING, MONITORING, TROUBLESHOOTING, OPERATING, AND ACCESSING COMPUTER HARDWARE AND SOFTWARE, PERIPHERALS, OPERATING SYSTEMS, DATABASES, LOCAL, WIDE, AND GLOBAL AREA NETWORKS, NETWORK INFRASTRUCTURE, WEB BROWSERS, AND ELECTRONIC DEVICES; PROVIDING ONLINE TUTORIAL AND TRAINING SESSIONS IN THE FIELD OF COMPUTER HARDWARE AND SOFTWARE, PERIPHERALS, OPERATING SYSTEMS, DATABASES, LOCAL, WIDE, AND GLOBAL AREA NETWORKS, NETWORK INFRASTRUCTURE, WEB BROWSERS, AND ELECTRONIC DEVICES; DEVELOPING EDUCATIONAL MANUALS FOR OTHERS IN THE FIELD OF COMPUTER HARDWARE AND SOFTWARE, PERIPHERALS, OPERATING SYSTEMS, DATABASES, LOCAL, WIDE, AND GLOBAL AREA NETWORKS, NETWORK INFRASTRUCTURE, WEB BROWSERS, AND ELECTRONIC DEVICES (U.S. CLS. 100, 101 AND 107).

CLASS 42—SCIENTIFIC AND COMPUTER SERVICES

FOR DESIGN AND DEVELOPMENT OF COMPUTER HARDWARE AND SOFTWARE; COMPUTER PROGRAMMING; PROVIDING CONSULTATION SERVICES FOR DEVELOPING COMPUTER SYSTEMS, DATABASES AND APPLICATIONS, AND COMPUTER SOFTWARE AND FIRMWARE, NAMELY, APPLICATION DEVELOPMENT COMPUTER SOFTWARE PROGRAMS; OPERATION, DESIGN AND DEVELOPMENT OF COMPUTER SOFTWARE APPLICATIONS, NAMELY, NETWORK EFFICIENCY IMPROVEMENT SOFTWARE; TECHNICAL SUPPORT SERVICES, NAMELY, TROUBLESHOOTING IN CONNECTION WITH HARDWARE AND SOFTWARE FOR INTERCONNECTING, MANAGING, SECURING, MONITORING, CONTROLLING, OPERATING, AND ACCESSING LOCAL AND WIDE AREA NETWORKS, COMPUTERS, AND TELEPHONY SYSTEMS; DESIGN, TESTING, ENGINEERING, RESEARCH AND ADVISORY SERVICES RELATING TO COMPUTERS, TELECOMMUNICATIONS TECHNOLOGY, TELEPHONY SYSTEMS, NETWORKS, COMPUTER SOFTWARE, COMPUTER HARDWARE, COMPUTER PROGRAMMING, AND NETWORK SECURITY (U.S. CLS. 100 AND 101).

KAREN K. BUSH, EXAMINING ATTORNEY

SN 77-817,891. JUNIPER NETWORKS, INC., SUNNYVALE, CA. FILED 9-1-2009.

JUNIPER NETWORKS

THE MARK CONSISTS OF STANDARD CHARACTERS WITHOUT CLAIM TO ANY PARTICULAR FONT, STYLE, SIZE, OR COLOR.

OWNER OF U.S. REG. NOS. 2,255,921, 3,089,694 AND OTHERS.

NO CLAIM IS MADE TO THE EXCLUSIVE RIGHT TO USE "NETWORKS", APART FROM THE MARK AS SHOWN.

CLASS 9—ELECTRICAL AND SCIENTIFIC APPARATUS

FOR COMPUTER HARDWARE AND SOFTWARE, USED ALONE OR IN COMBINATION, FOR INTERCONNECTING, ESTABLISHING, MANAGING, SECURING, MONITORING, TROUBLESHOOTING, CONTROLLING, OPERATING, AND ACCESSING LOCAL, WIDE, AND GLOBAL AREA NETWORKS AND NETWORK INFRASTRUCTURE; COMPUTER HARDWARE AND SOFTWARE, USED ALONE OR IN COMBINATION, FOR ROUTING, SWITCHING, TRANSMITTING, PROCESSING, FILTERING, ANALYZING, SECURING, AND STORING DATA, VIDEO OR VOICE TRAFFIC, PACKETS, OR OTHER FORMS OF COMMUNICATIONS; COMPUTER HARDWARE AND SOFTWARE, USED ALONE OR IN COMBINATION, FOR PROVIDING SECURITY FUNCTIONALITY FOR NETWORKS OR ELECTRONIC DEVICES OR ROUTERS IN NETWORKS, SUCH AS PROVIDING FIREWALL FILTERS, ACCESS CONTROL, VIRTUAL PRIVATE NETWORKS, INTEROPERABILITY WITH ROUTER SECURITY PROTOCOLS, AND PROTECTION AGAINST NETWORK INTRUSION AND VIRUSES; DOWNLOADABLE INSTRUCTIONAL MATERIALS, NAMELY, MANUALS AND GUIDES IN THE FIELDS OF NETWORKING, TELECOMMUNICATIONS, AND NETWORK SECURITY, AND ESTABLISHING, MANAGING, AND OPERATING LOCAL AND WIDE AREA NETWORKS; COMPUTER SOFTWARE, NAMELY, OPERATING SYSTEM SOFTWARE, OPERATING SYSTEM SOFTWARE THAT HOSTS COMPUTER SOFTWARE APPLICATIONS AND FACILITATES INTERACTIONS WITH OTHER COMPUTERS AND PERIPHERALS ACROSS ENTERPRISE NETWORKS; DATABASE MANAGEMENT SOFTWARE; COMPUTER SOFTWARE FOR ACCESSING, BROWSING AND SEARCHING DATABASES; COMPUTER PROGRAMS FOR USE IN ACCESSING, NAVIGATING, BROWSING, DELIVERING, AND TRANSFERRING INFORMATION, AND DISTRIBUTING AND VIEWING COMPUTER PROGRAMS; COMPUTER PROGRAMS FOR USE IN ACCESSING AND VIEWING COMPUTER NETWORK INFRASTRUCTURE AND SYSTEMS; PROGRAMMABLE AND CUSTOMIZABLE COMPUTER SOFTWARE APPLICATION FOR MOBILE DEVICES, TELEVISIONS, AND OTHER VIDEO DEVICES (U.S. CLS. 21, 23, 26, 36 AND 38).

CLASS 37—CONSTRUCTION AND REPAIR

FOR INSTALLATION, MAINTENANCE, AND REPAIR SERVICES IN THE FIELDS OF COMPUTERS, TELECOMMUNICATIONS, NETWORKING, COMMUNICATIONS, AND NETWORK SECURITY (U.S. CLS. 100, 103 AND 106).

CLASS 41—EDUCATION AND ENTERTAINMENT

FOR EDUCATIONAL SERVICES, NAMELY, PROVIDING OF TRAINING AND EDUCATIONAL COURSES ON INTERCONNECTING, ESTABLISHING, MANAGING, SECURING, MONITORING, TROUBLESHOOTING, OPERATING, AND ACCESSING COMPUTER HARDWARE AND SOFTWARE, PERIPHERALS, OPERATING SYSTEMS, DATABASES, LOCAL, WIDE, AND GLOBAL AREA NETWORKS, NETWORK INFRASTRUCTURE, WEB BROWSERS, AND ELECTRONIC DEVICES; PROVIDING ONLINE TUTORIAL AND TRAINING SESSIONS IN THE FIELD OF COMPUTER HARDWARE AND SOFTWARE, PERIPHERALS, OPERATING SYSTEMS, DATABASES, LOCAL, WIDE, AND GLOBAL AREA NETWORKS, NETWORK INFRASTRUCTURE, WEB BROWSERS, AND ELECTRONIC DEVICES; DEVELOPING EDUCATIONAL MANUALS FOR OTHERS IN THE FIELD OF COMPUTER HARDWARE AND SOFTWARE, PERIPHERALS, OPERATING SYSTEMS, DATABASES, LOCAL, WIDE, AND GLOBAL AREA NETWORKS, NETWORK INFRASTRUCTURE, WEB BROWSERS, AND ELECTRONIC DEVICES (U.S. CLS. 100, 101 AND 107).

CLASS 42—SCIENTIFIC AND COMPUTER SERVICES

FOR DESIGN AND DEVELOPMENT OF COMPUTER HARDWARE AND SOFTWARE; COMPUTER PROGRAMMING; PROVIDING CONSULTATION SERVICES FOR DEVELOPING COMPUTER SYSTEMS, DATABASES AND APPLICATIONS, AND COMPUTER SOFTWARE AND FIRMWARE, NAMELY, APPLICATION DEVELOPMENT COMPUTER SOFTWARE PROGRAMS; OPERATION, DESIGN AND DEVELOPMENT OF COMPUTER SOFTWARE APPLICATIONS, NAMELY, NETWORK EFFICIENCY IMPROVEMENT SOFTWARE; TECHNICAL SUPPORT SERVICES, NAMELY, TROUBLESHOOTING IN CONNECTION WITH HARDWARE AND SOFTWARE FOR INTERCONNECTING, MANAGING, SECURING, MONITORING, CONTROLLING, OPERATING, AND ACCESSING LOCAL AND WIDE AREA NETWORKS, COMPUTERS, AND TELEPHONY SYSTEMS; DESIGN, TESTING, ENGINEERING, RESEARCH AND ADVISORY SERVICES RELATING TO COMPUTERS, TELECOMMUNICATIONS TECHNOLOGY, TELEPHONY SYSTEMS, NETWORKS, COMPUTER SOFTWARE, COMPUTER HARDWARE, COMPUTER PROGRAMMING, AND NETWORK SECURITY (U.S. CLS. 100 AND 101).

KAREN K. BUSH, EXAMINING ATTORNEY

SN 77-818,100. PASO FINO HORSE ASSOCIATION, INC., PLANT CITY, FL. FILED 9-2-2009.

PASO FINO HORSE ASSOCIATION

THE MARK CONSISTS OF STANDARD CHARACTERS WITHOUT CLAIM TO ANY PARTICULAR FONT, STYLE, SIZE, OR COLOR.

NO CLAIM IS MADE TO THE EXCLUSIVE RIGHT TO USE "HORSE ASSOCIATION", APART FROM THE MARK AS SHOWN.

THE ENGLISH TRANSLATION OF "PASO FINO" IN THE MARK IS "FINE STEP".

SEC. 2(F).

CLASS 35—ADVERTISING AND BUSINESS

FOR ASSOCIATION SERVICES, NAMELY, PROMOTING THE INTERESTS OF OWNERS AND BREEDERS OF PASO FINO HORSES; MAINTAINING A REGISTRY OF PASO FINO HORSES (U.S. CLS. 100, 101 AND 102).

FIRST USE 0-0-1973; IN COMMERCE 0-0-1973.

CLASS 41—EDUCATION AND ENTERTAINMENT

FOR HORSE SHOWING SERVICES (U.S. CLS. 100, 101 AND 107).

FIRST USE 0-0-1987; IN COMMERCE 0-0-1987.

DAVID H. STINE, EXAMINING ATTORNEY

SN 77-818,781. PRINTOGRAPH, INC., DBA GOT PRINT, BURBANK, CA. FILED 9-2-2009.

PRINTOGRAPH

OWNER OF U.S. REG. NO. 3,488,323.

NO CLAIM IS MADE TO THE EXCLUSIVE RIGHT TO USE "INC.", APART FROM THE MARK AS SHOWN.

THE COLOR(S) BLACK AND RED IS/ARE CLAIMED AS A FEATURE OF THE MARK.

THE MARK CONSISTS OF THE WORDING "PRINTOGRAPH INC." WITH THE "O" IN RED AND ALL OTHER LETTERS IN BLACK. "INC." APPEARS VERTICALLY UP THE RIGHT SIDE OF THE MARK.

CLASS 35—ADVERTISING AND BUSINESS

FOR ADVERTISING, MARKETING AND PROMOTION SERVICES (U.S. CLS. 100, 101 AND 102).

FIRST USE 5-15-2001; IN COMMERCE 5-15-2001.

CLASS 41—EDUCATION AND ENTERTAINMENT

FOR DIGITAL IMAGING SERVICES (U.S. CLS. 100, 101 AND 107).

FIRST USE 5-15-2001; IN COMMERCE 5-15-2001.

ELISSA GARBER KON, EXAMINING ATTORNEY

SN 77-819,254. STONERIVER, INC., BROOKFIELD, WI. FILED 9-3-2009.

STREAM

THE MARK CONSISTS OF STANDARD CHARACTERS WITHOUT CLAIM TO ANY PARTICULAR FONT, STYLE, SIZE, OR COLOR.

CLASS 9—ELECTRICAL AND SCIENTIFIC APPARATUS

FOR COMPUTER SOFTWARE FOR ACCOUNTING, REPORTING, PROCESSING AND MANAGEMENT OF REINSURANCE CONTRACTS AND CLAIMS; COMPUTER SOFTWARE TO ENABLE INSURANCE COMPANIES TO MANAGE CLAIMS FOR THEIR LIFECYCLE, NAMELY, NOTICE OF LOSS THROUGH SALVAGE, SUBROGATION, AND LITIGATION; COMPUTER SOFTWARE TO TRACK POLICY HOLDER INFORMATION IN THE INSURANCE FIELD FOR USE BY THE INSURANCE INDUSTRY TO PROVIDE INFORMATION ABOUT INSURANCE POLICIES AND POLICY HOLDERS AND THEIR RELATIONSHIP WITH AN INSURANCE COMPANY; COMPUTER SOFTWARE USED BY THE INSURANCE INDUSTRY TO FACILITATE POLICY ENTRY AND QUOTATION, POLICY RATING AND UNDERWRITING, POLICY ISSUE AND ENDORSEMENT, POLICY ILLUSTRATION, POLICY CANCELLATION AND RENEWAL, CLAIMS ADMINISTRATION AND ASSIGNMENT, CLAIMS RESERVE MANAGEMENT, BILLING, COLLECTIONS, PAYMENTS, BUSINESS INTELLIGENCE, DOCUMENT PRINT, CUSTOMER RELATIONSHIP MANAGEMENT, REINSURANCE CONTRACT MANAGEMENT, CESSION, AND ASSUMPTION, ELECTRIC FUNDS TRANSFER, PREPARATION OF BILLING NOTICES, MANAGEMENT OF MEDICAL CLAIMS AND WORKERS COMPENSATION CLAIMS, BILLING, AND PAYMENT PROCESSING; COMPUTER SOFTWARE USED BY INSURANCE ADMINISTRATION FOR BILLING, CLAIMS ADMINISTRATION, UNDERWRITING, AND MANAGEMENT OF INSURANCE POLICIES AND APPLICATIONS; COMPUTER SOFTWARE USED BY INSURANCE COMPANIES, STATE WORKERS COMPENSATION INSURANCE FUNDS, AND THIRD PARTY ADMINISTRATORS FOR USE IN MANAGING AND ADMINSTRATING WORKERS COMPENSATION INSURANCE POLICIES, BILLING, AND CLAIMS; COMPUTER SOFTWARE FOR FACILITATING THE ELECTRONIC SUBMISSION OF BILLS (U.S. CLS. 21, 23, 26, 36 AND 38).

CLASS 35—ADVERTISING AND BUSINESS

FOR PROVIDING ONLINE INFORMATION IN THE FIELD OF MEDICAL BILLING (U.S. CLS. 100, 101 AND 102).

CLASS 36—INSURANCE AND FINANCIAL

FOR INSURANCE ADMINISTRATION SERVICES, NAMELY, MANAGING THE ADMINISTRATION OF INSURANCE POLICIES AND APPLICATIONS; PROVIDING ONLINE INFORMATION IN THE FIELD OF INSURANCE MATTERS, NAMELY, FINANCIAL COMPENSATION UNDER AN INSURANCE POLICY, WORKERS COMPENSATION AND MOTOR VEHICLE INSURANCE; INSURANCE CLAIM PROCESSING INFORMATION FOR EMPLOYERS WITH NOTIFICATION OF POTENTIAL WORKER'S COMPENSATION CLAIMS VIA FACSIMILE OR ELECTRONIC MAIL (U.S. CLS. 100, 101 AND 102).

CLASS 42—SCIENTIFIC AND COMPUTER SERVICES

FOR APPLICATION SERVICE PROVIDER (ASP) FEATURING SOFTWARE FOR USE BY INSURANCE COMPANIES, STATE WORKERS COMPENSATION INSURANCE FUNDS, AND THIRD PARTY ADMINISTRATORS FOR USE IN MANAGING AND ADMINSTRATING WORKERS COMPENSATION INSURANCE POLICIES, BILLING, AND CLAIMS; APPLICATION SERVICE PROVIDER (ASP), NAMELY, HOSTING COMPUTER SOFTWARE APPLICATIONS OF OTHERS; COMPUTER SOFTWARE DEVELOPMENT SERVICES IN THE FIELD OF INSURANCE MARKETING; DOCUMENT DATA TRANSFER FROM ONE COMPUTER MEDIA FORMAT TO ANOTHER MEDIA FORMAT (U.S. CLS. 100 AND 101).

BILL DAWÉ, EXAMINING ATTORNEY

SN 77-819,730. PENSKE SYSTEM, INC., BLOOMFIELD HILLS, MI. FILED 9-3-2009.

TEAM PENSKE

THE MARK CONSISTS OF STANDARD CHARACTERS WITHOUT CLAIM TO ANY PARTICULAR FONT, STYLE, SIZE, OR COLOR.

OWNER OF U.S. REG. NOS. 2,132,515, 2,566,860 AND OTHERS.

CLASS 14—JEWELRY

FOR JEWELRY, ORNAMENTAL PINS AND WATCHES (U.S. CLS. 2, 27, 28 AND 50).

FIRST USE 12-31-1992; IN COMMERCE 12-31-1992.

CLASS 16—PAPER GOODS AND PRINTED MATTER

FOR MAGAZINES AND NEWSLETTERS FEATURING MOTOR SPORTS; STATIONERY, PENS, DECALS, STICKERS AND POSTERS (U.S. CLS. 2, 5, 22, 23, 29, 37, 38 AND 50).

FIRST USE 12-31-1990; IN COMMERCE 12-31-1990.

CLASS 25—CLOTHING

FOR CLOTHES, NAMELY, SHIRTS, T-SHIRTS, HATS, JACKETS, CAPS, SWEATSHIRTS (U.S. CLS. 22 AND 39).

FIRST USE 12-31-1992; IN COMMERCE 12-31-1992.

CLASS 28—TOYS AND SPORTING GOODS

FOR TOYS AND GAMES, NAMELY, MODEL CARS, DIE CAST CARS (U.S. CLS. 22, 23, 38 AND 50). FIRST USE 5-31-2008; IN COMMERCE 5-31-2008. KEVIN DINALLO, EXAMINING ATTORNEY

SN 77-820,380. HOME BOX OFFICE, INC., NEW YORK, NY. FILED 9-4-2009.

SN 77-819,964. NINA CONRAD, TORONTO, ONTARIO, CANADA, FILED 9-3-2009.

ELEMENTAL ESSENCE

THE MARK CONSISTS OF STANDARD CHARACTERS WITHOUT CLAIM TO ANY PARTICULAR FONT, STYLE, SIZE, OR COLOR.

CLASS 1—CHEMICALS

FOR CHEMICALS FOR USE IN THE PREPARATION OF SOAP AND VITAMINS (U.S. CLS. 1, 5, 6, 10, 26 AND 46).

CLASS 32—LIGHT BEVERAGES

FOR NON-ALCOHOLIC BEVERAGES, NAMELY, AERATED WATERS, CARBONATED BEVERAGES, ENERGY DRINKS, MINERAL WATERS, SPORTS DRINKS, FRUIT DRINKS AND VEGETABLE DRINKS (U.S. CLS. 45, 46 AND 48).

MATTHEW PAPPAS, EXAMINING ATTORNEY

SN 77-820,344. INTERNATIONAL COUNCIL OF SHOPPING CENTERS, INC., NEW YORK, NY. FILED 9-4-2009.



OWNER OF U.S. REG. NO. 2,731,141. NO CLAIM IS MADE TO THE EXCLUSIVE RIGHT TO USE "SHOPPING CENTERS", APART FROM THE MARK AS SHOWN.

THE MARK CONSISTS OF THE LETTERS "SCT" IN STYLIZED FORMAT AND THE WORDS "SHOPPING CENTERS TODAY" IN STYLIZED LETTERS WRITTEN BETWEEN THE LETTERS "C" AND "T" IN "SCT".

CLASS 16—PAPER GOODS AND PRINTED MATTER

FOR MAGAZINES IN THE FIELD OF RETAIL SHOPPING CENTERS (U.S. CLS. 2, 5, 22, 23, 29, 37, 38 AND 50). FIRST USE 2-28-2007; IN COMMERCE 2-28-2007.

CLASS 41—EDUCATION AND ENTERTAINMENT

FOR PROVIDING ON-LINE MAGAZINES IN THE FIELD OF RETAIL SHOPPING CENTERS (U.S. CLS. 100, 101 AND 107). FIRST USE 2-28-2007; IN COMMERCE 2-28-2007. SUE LAWRENCE, EXAMINING ATTORNEY

TRUE BLOOD

THE MARK CONSISTS OF STANDARD CHARACTERS WITHOUT CLAIM TO ANY PARTICULAR FONT, STYLE, SIZE, OR COLOR.

OWNER OF U.S. REG. NOS. 3,531,720, 3,723,296 AND 3,731,812.

CLASS 9—ELECTRICAL AND SCIENTIFIC APPARATUS

FOR VIDEO GAME AND COMPUTER GAME DISKS, VIDEO AND COMPUTER GAME CARTRIDGES, VIDEO AND COMPUTER GAME CASSETTES, VIDEO AND COMPUTER GAME CD-ROMS, VIDEO AND COMPUTER GAME SOFTWARE, DOWNLOADABLE COMPUTER GAME PROGRAMS, VIDEO AND COMPUTER GAME PROGRAMS, INTERACTIVE VIDEO GAME PROGRAMS, DOWNLOADABLE ELECTRONIC GAMES VIA THE INTERNET, AMUSEMENT APPARATUS AND GAMES ADAPTED FOR USE WITH TELEVISION RECEIVERS OR WITH VIDEO OR COMPUTER MONITORS (U.S. CLS. 21, 23, 26, 36 AND 38).

CLASS 41—EDUCATION AND ENTERTAINMENT

FOR ENTERTAINMENT SERVICES, NAMELY, PROVIDING INTERACTIVE NON-DOWNLOADABLE ELECTRONIC GAMES OR VIDEO GAME PROGRAMS ACCESSIBLE ON THE INTERNET (U.S. CLS. 100, 101 AND 107).

ODESSA BIBBINS, EXAMINING ATTORNEY

SN 77-821,597. PROZONE SPORTS LIMITED, LEEDS, WEST YORKSHIRE, UNITED KINGDOM, FILED 9-8-2009.

PROZONE

THE MARK CONSISTS OF STANDARD CHARACTERS WITHOUT CLAIM TO ANY PARTICULAR FONT, STYLE, SIZE, OR COLOR.

PRIORITY CLAIMED UNDER SEC. 44(D) ON ERPN CMNTY TM OFC APPLICATION NO. 008532681, FILED 9-7-2009.

OWNER OF ERPN CMNTY TM OFC REG. NO. 008532681, DATED 3-1-2010, EXPIRES 9-7-2019.

OWNER OF U.S. REG. NO. 3,526,209.

CLASS 9—ELECTRICAL AND SCIENTIFIC APPARATUS

FOR COMPUTER HARDWARE; COMPUTER SOFTWARE FOR THE ANALYSIS AND INTERPRETATION OF SPORTS DATA; COMPUTER SOFTWARE FOR THE ANALYSIS AND INTERPRETATION OF SPORTS MATCH DATA; COMPUTER SOFTWARE TOOLS TO ASSIST SPORTS AND SPORTS TEAM MANAGEMENT; COMPUTER SOFTWARE TOOLS TO ASSIST SPORTS PSYCHOLOGISTS (U.S. CLS. 21, 23, 26, 36 AND 38).

CLASS 37—CONSTRUCTION AND REPAIR

FOR INSTALLATION OF COMPUTER SYSTEMS; INSTALLATION OF CLOSED CIRCUIT TELEVISION SYSTEMS (U.S. CLS. 100, 103 AND 106).

CLASS 41—EDUCATION AND ENTERTAINMENT

FOR SPORTS ENTERTAINMENT SERVICES, NAMELY, AMERICAN FOOTBALL, AUSTRALIAN RULES FOOTBALL, GAELIC FOOTBALL, SOCCER, RUGBY, FIELD HOCKEY, ICE HOCKEY, BASKETBALL, HANDBALL AND LACROSSE GAMES; PROVIDING INFORMATION IN THE FIELD OF SPORTS; PROVISION OF SPORTS INFORMATION IN THE FORM OF STATISTICS, MATCH DATA AND MATCH ANALYSIS; PROVISION OF SPORTS INFORMATION OBTAINED FROM TRACKING PARTICIPANTS IN SPORTS EVENTS; INFORMATION, ADVICE AND CONSULTANCY RELATING TO ALL OF THE AFORESAID SERVICES (U.S. CLS. 100, 101 AND 107).

CLASS 42—SCIENTIFIC AND COMPUTER SERVICES

FOR SCIENTIFIC RESEARCH SERVICES; TECHNOLOGICAL SERVICES, NAMELY, THE DEVELOPMENT OF COMPUTER HARDWARE AND SOFTWARE FOR SPORTS MATCH DATA ANALYSIS, CAPTURE AND INTERPRETATION; TECHNOLOGICAL RESEARCH IN THE FIELD OF SPORTS MATCH DATA ANALYSIS, CAPTURE AND INTERPRETATION; SCIENTIFIC AND TECHNICAL DESIGN, NAMELY, THE DESIGN OF COMPUTER HARDWARE AND SOFTWARE FOR SPORTS MATCH DATA ANALYSIS, CAPTURE AND INTERPRETATION; INDUSTRIAL ANALYSIS AND RESEARCH SERVICES; DESIGN AND DEVELOPMENT OF COMPUTER HARDWARE AND SOFTWARE (U.S. CLS. 100 AND 101).

SALLY SHIH, EXAMINING ATTORNEY

SN 77-821,682. DELSUREINC, DOVER, DE. FILED 9-8-2009.

BABYANOO



THE MARK CONSISTS OF THE STYLIZED WORDING "BABYANOO"; THE LETTERS "OO" ARE IN THE FORM OF A STYLIZED DRAWING OF TWO EYES WITH THREE EYE LASHES ABOVE EACH EYE AND A TEAR DROP UNDER EACH EYE.

CLASS 24—FABRICS

FOR COMFORTERS; CRIB BUMPERS; FITTED SHEETS IN THE NATURE OF BED SHEETS; DUST RUFFLES; CURTAINS; AND PILLOW CASES (U.S. CLS. 42 AND 50).

CLASS 27—FLOOR COVERINGS

FOR WALL BORDERS BEING WALL DECORATIONS IN THE NATURE OF WALL COVERINGS (U.S. CLS. 19, 20, 37, 42 AND 50).

AMEEN IMAM, EXAMINING ATTORNEY

SN 77-822,677. SHURE INCORPORATED, NILES, IL. FILED 9-9-2009.

ROSWELLITE

THE MARK CONSISTS OF STANDARD CHARACTERS WITHOUT CLAIM TO ANY PARTICULAR FONT, STYLE, SIZE, OR COLOR.

CLASS 1—CHEMICALS

FOR CHEMICAL COMPOSITE MATERIALS FOR USE IN THE MANUFACTURE OF ELECTROACOUSTIC TRANSDUCERS (U.S. CLS. 1, 5, 6, 10, 26 AND 46).

FIRST USE 10-0-2007; IN COMMERCE 10-0-2007.

CLASS 6—METAL GOODS

FOR METAL COMPOSITE MATERIALS IN THE FORM OF METALLIC FILM LAYERED WITH PLASTIC FILM FOR USE IN THE MANUFACTURE OF ELECTROACOUSTIC TRANSDUCERS (U.S. CLS. 2, 12, 13, 14, 23, 25 AND 50).

FIRST USE 10-0-2007; IN COMMERCE 10-0-2007.

TINA MAI, EXAMINING ATTORNEY

SN 77-822,781. DE BEERS CENTENARY AG, 6000 LUZERN 6, SWITZERLAND, FILED 9-9-2009.

ENCORDIA

THE MARK CONSISTS OF STANDARD CHARACTERS WITHOUT CLAIM TO ANY PARTICULAR FONT, STYLE, SIZE, OR COLOR.

PRIORITY CLAIMED UNDER SEC. 44(D) ON ERP CMNTY TM OFC APPLICATION NO. 008287633, FILED 5-8-2009, REG. NO. 008287633, DATED 12-1-2009, EXPIRES 5-8-2019.

CLASS 14—JEWELRY

FOR PRECIOUS METALS AND THEIR ALLOYS; JEWELLERY AND IMITATION JEWELLERY; PRECIOUS AND SEMI-PRECIOUS STONES; HOROLOGICAL AND CHRONOMETRIC INSTRUMENTS (U.S. CLS. 2, 27, 28 AND 50).

CLASS 35—ADVERTISING AND BUSINESS

FOR RETAIL STORE SERVICES, WHOLESALE ORDERING SERVICES, ADVERTISING AND MARKETING SERVICES, ALL IN THE FIELD OF PRECIOUS METALS AND THEIR ALLOYS AND GOODS IN PRECIOUS METALS OR COATED THEREWITH, JEWELLERY AND IMITATION JEWELLERY, PRECIOUS AND SEMI-PRECIOUS STONES, HOROLOGICAL AND CHRONOMETRIC INSTRUMENTS (U.S. CLS. 100, 101 AND 102).

HOWARD B. LEVINE, EXAMINING ATTORNEY

SN 77-823,054. TONCARO ENTERPRISES, LLC, AKA AMORE DEI CANI, STAMFORD, CT. FILED 9-9-2009.



THE MARK CONSISTS OF THE OUTLINE OF A CANINE DOG'S PAW PRINT WITH THE WORDS "AMORE DEI CANI" IN STYLIZED FONT WRITTEN ON THE METACARPAL PAD OF THE PAW PRINT.

THE ENGLISH TRANSLATION OF "AMORE DEI CANI" IN THE MARK IS "LOVE OF DOGS".

CLASS 18—LEATHER GOODS

FOR FASHION HANDBAGS; HANDBAGS; HANDBAGS, PURSES AND WALLETS; LEATHER HANDBAGS; TOTE BAGS (U.S. CLS. 1, 2, 3, 22 AND 41).

FIRST USE 5-1-2009; IN COMMERCE 6-15-2009.

CLASS 25—CLOTHING

FOR LEATHER SHOES; SHOES; WOMEN'S SHOES (U.S. CLS. 22 AND 39).

FIRST USE 5-1-2009; IN COMMERCE 6-15-2009.
SHANNON TWOHIG, EXAMINING ATTORNEY

SN 77-823,256. TATUAJE CIGARS, INC., LOS ANGELES, CA. FILED 9-9-2009.

AREA FUMADO

THE MARK CONSISTS OF STANDARD CHARACTERS WITHOUT CLAIM TO ANY PARTICULAR FONT, STYLE, SIZE, OR COLOR.

NO CLAIM IS MADE TO THE EXCLUSIVE RIGHT TO USE "FUMADO", APART FROM THE MARK AS SHOWN.

THE ENGLISH TRANSLATION OF "AREA FUMADO" IN THE MARK IS "SMOKING AREA".

CLASS 25—CLOTHING

FOR CLOTHING, NAMELY, JACKETS, HATS, SHIRTS AND SCARVES (U.S. CLS. 22 AND 39).

CLASS 34—SMOKERS' ARTICLES

FOR SMOKING ACCESSORIES, NAMELY, ASH-TRAYS; CIGAR AND CIGARETTE LIGHTERS NOT FOR LAND VEHICLES; CIGAR CUTTERS; MATCHES (U.S. CLS. 2, 8, 9 AND 17).

HANNO RITTNER, EXAMINING ATTORNEY

SN 77-823,706. TONCARO ENTERPRISES, LLC, AKA AMORE DEI CANI, STAMFORD, CT. FILED 9-10-2009.



THE MARK CONSISTS OF AN OVAL BROOCH STYLE EMBLEM WITH THE OUTLINE OF A LABRADOR RETRIEVER DOG IN STANDING POSE WITH ITS HEAD UPRIGHT AND TAIL POINTED DOWNWARD AT THE CENTER OF THE MARK WITH THE WORDS "AMORE DEI CANI" WRITTEN BELOW THE OUTLINE OF THE DOG IN A SLIGHT CURVING FASHION AND ENCIRCLING THE DOG AND "AMORE DEI CANI" ARE THREE OVAL LINES WITH THE INNER AND OUTER MOST BORDERS IN SOLID LINE AND THE MIDDLE BORDER IN DOTTED LINE PROVIDING A BRAIDED-EFFECT TO THE OVAL BORDER OF THE MARK.

THE ENGLISH TRANSLATION OF "AMORE DEI CANI" IN THE MARK IS "LOVE OF DOGS".

CLASS 18—LEATHER GOODS

FOR FASHION HANDBAGS; HANDBAGS; HANDBAGS, PURSES AND WALLETS; LEATHER HANDBAGS; TOTE BAGS (U.S. CLS. 1, 2, 3, 22 AND 41).

FIRST USE 7-1-2009; IN COMMERCE 7-1-2009.

CLASS 25—CLOTHING

FOR LEATHER SHOES; SHOES; WOMEN'S SHOES (U.S. CLS. 22 AND 39).

FIRST USE 7-1-2009; IN COMMERCE 7-1-2009.

CLASS 26—FANCY GOODS

FOR CHARMS FOR SHOES; FASTENERS FOR SHOES AND BOOTS; METAL FASTENERS FOR SHOES AND BOOTS; SHOE BUCKLES; SHOE ORNAMENTS NOT OF PRECIOUS METAL (U.S. CLS. 37, 39, 40, 42 AND 50).

FIRST USE 7-1-2009; IN COMMERCE 7-1-2009.
SHANNON TWOHIG, EXAMINING ATTORNEY

SN 77-824,361. QUANIS HOLDINGS, SAN FRANCISCO, CA. FILED 9-11-2009.

THE FUTURE OF GIVING

THE MARK CONSISTS OF STANDARD CHARACTERS WITHOUT CLAIM TO ANY PARTICULAR FONT, STYLE, SIZE, OR COLOR.

CLASS 9—ELECTRICAL AND SCIENTIFIC APPARATUS

FOR TECHNOLOGY PLATFORM, NAMELY, COMPUTER SOFTWARE AND HARDWARE FOR ENABLING CHARITIES TO INCREASE THEIR DONOR BASE, MATCH FUNDRAISING AND SERVICE NEEDS WITH DONORS, AND MANAGE EVENTS, DONORS, FUNDRAISING, SKILL NEEDS AND MARKETING; AND FOR ENABLING CHARITABLE DONORS TO MANAGE THEIR PROFILES AND DONATIONS (U.S. CLS. 21, 23, 26, 36 AND 38).

CLASS 35—ADVERTISING AND BUSINESS

FOR ASSOCIATION SERVICES, NAMELY, PROMOTING THE INTERESTS OF COMMUNITY-BASED CHARITIES; MATCHING INDIVIDUALS WITH LIKE-MINDED ORGANIZATIONS WHO PROVIDE CHARITABLE ACTIVITIES THROUGH AN ON-LINE PROFILING SURVEY AND ANALYSIS; CORPORATE EVENT MANAGEMENT SERVICES (U.S. CLS. 100, 101 AND 102).

SN 77-824,613. LITTS QUALITY TECHNOLOGIES, INC., PHILADELPHIA, PA. FILED 9-11-2009.

CLASS 36—INSURANCE AND FINANCIAL

FOR CHARITABLE FUNDRAISING SERVICES (U.S. CLS. 100, 101 AND 102).
SEAN CROWLEY, EXAMINING ATTORNEY



SN 77-824,570. ONE WORLD ENERGY CORP., LOUISVILLE, KY. FILED 9-11-2009.



NO CLAIM IS MADE TO THE EXCLUSIVE RIGHT TO USE "CLEAN ENERGY", APART FROM THE MARK AS SHOWN.

THE COLOR(S) BLUE, WHITE, GREEN AND YELLOW IS/ARE CLAIMED AS A FEATURE OF THE MARK.

THE MARK CONSISTS OF BLUE, WHITE AND GREEN DROPS WITH OVERLYING YELLOW SUN BURST. THE WORDS "ONE WORLD" AND "CLEAN" ARE IN BLUE TYPE AND THE WORD "ENERGY" IS IN GREEN TYPE.

NO CLAIM IS MADE TO THE EXCLUSIVE RIGHT TO USE "QUALITY TECHNOLOGIES", APART FROM THE MARK AS SHOWN.

THE COLOR(S) BLUE PANTONE 294 AND GOLD PANTONE 125 IS/ARE CLAIMED AS A FEATURE OF THE MARK.

THE MARK CONSISTS OF A STYLIZED "LQT" IN BLUE PANTONE 294 WRITTEN IN THE FONT MRS. EAVES. ABOVE AND TO THE RIGHT OF THE "T" ARE THREE DUCKS IN GOLD PANTONE 125 FLYING IN FORMATION. THE "LQT" AND DUCKS ARE UNDERLINED BY A GOLD PANTONE 125 COLORED LINE, WITH THE "Q" DIPPING THROUGH THE LINE. UNDER THAT LINE IS "LITTS QUALITY" WRITTEN IN BLUE PANTONE 294 IN MRS. EAVES FONT. UNDER THAT LINE IS "TECHNOLOGIES" WRITTEN IN BLUE PANTONE 294 MRS. EAVES FONT. "TECHNOLOGIES" IS UNDERLINED WITH A GOLD PANTONE 125 LINE.

CLASS 37—CONSTRUCTION AND REPAIR

FOR CONSULTING SERVICES FOR THE CONSTRUCTION OF ENERGY PRODUCTION FACILITIES FOR THE RECYCLING OF WASTE, USED OIL, USED COOKING OILS, STARCH CROPS AND THE LIKE IN THE PRODUCTION OF METHANE, ELECTRICITY, AND BIO-FUELS AND THE INSTALLATION OF ELECTRIC GENERATION MACHINERY (U.S. CLS. 100, 103 AND 106).

CLASS 35—ADVERTISING AND BUSINESS

FOR BUSINESS MANAGEMENT CONSULTING SERVICES IN THE FIELDS OF CONTINUAL IMPROVEMENT PROCESSES, SUPPLIER DEVELOPMENT PROCESSES, COST OF QUALITY ANALYSIS, PLACING SHORT-TERM OR ACTING CONTRACT QUALITY MANAGERS, PLACING SHORT-TERM OR ACTING CONTRACT METROLOGY MANAGERS, CONTRACT INSPECTIONS IN THE NATURE OF SOURCE ACCEPTANCE OF MECHANICAL COMPONENTS; BUSINESS AUDITING CONSULTING SERVICES IN THE AREAS OF INTERNAL AND EXTERNAL AUDITING, GAP ANALYSIS OF EXISTING QUALITY MANAGEMENT SERVICES, AND REGULATION COMPLIANCE (U.S. CLS. 100, 101 AND 102).

FIRST USE 7-0-2004; IN COMMERCE 8-0-2004.

CLASS 40—MATERIAL TREATMENT

FOR WASTE TO ENERGY GENERATION SERVICES, NAMELY, RECYCLING WASTE FOR THE PRODUCTION OF METHANE GAS, ELECTRICITY AND STARCH DERIVED BIO FUELS (U.S. CLS. 100, 103 AND 106).

CLASS 41—EDUCATION AND ENTERTAINMENT**CLASS 42—SCIENTIFIC AND COMPUTER SERVICES**

FOR ENGINEERING SERVICES IN THE FIELD OF RECYCLING OF WASTE, USED OIL, USED COOKING OILS, STARCH CROPS AND THE LIKE IN THE PRODUCTION OF METHANE GAS, ELECTRICITY, AND BIO-FUELS AND ENGINEERING CONSULTING SERVICES FOR THE INSTALLATION OF ELECTRICAL AND GENERATION MACHINERY (U.S. CLS. 100 AND 101).

JOHN DALIER, EXAMINING ATTORNEY

FOR TRAINING SERVICES IN THE FIELDS OF QUALITY SYSTEM OVERVIEW AND EMPLOYEE AWARENESS, INTERNAL AUDITING, PROBLEM SOLVING, GEOMETRIC DIMENSIONING AND TOLERANCING (GDANDT), SURFACE FINISH AND TEXTURE, ROOT CAUSE ANALYSIS, MECHANICAL DRAWING/BLUEPRINT READING, GAUGING-METROLOGY-MEASUREMENT TECHNIQUES, MEASUREMENT SYSTEM ANALYSIS, PPAP - CONTROL PLANS, STATISTICAL METHODS, STATISTICAL PROCESS CONTROL (SPC), FAILURE MODE AND EFFECT ANALYSIS (FMEA); PREPARING STUDENTS TO TAKE PROFESSIONAL SOCIETY CERTIFICATION EXAMINATIONS (U.S. CLS. 100, 101 AND 107).

FIRST USE 7-1-2004; IN COMMERCE 8-1-2004.

CLASS 42—SCIENTIFIC AND COMPUTER SERVICES

FOR PROVIDING QUALITY ASSURANCE SERVICES, NAMELY, CONSULTING SERVICES IN THE AREAS OF QUALITY MANUAL DEVELOPMENT, PROCEDURES DEVELOPMENT, WORK INSTRUCTIONS DEVELOPMENT, CORRECTIVE ACTION PROCESSES, PREVENTIVE ACTION PROCESSES, AND QUALITY MANAGEMENT SYSTEM IMPLEMENTATION; ENGINEERING CONSULTING SERVICES IN THE FIELDS OF PROCESS IMPROVEMENT STUDIES, CAPABILITY STUDIES, MACHINE ACCEPTANCE STUDIES, PROCESS FLOW ANALYSIS, PRODUCTION PART APPROVAL PROCESS (PPAP), AND INITIAL SAMPLE INSPECTION REPORTS (ISIR); METROLOGY CONSULTING SERVICES, NAMELY, MEASUREMENT SYSTEMS, CALIBRATION SYSTEMS, GAGE CAPABILITY STUDIES, MEASUREMENT METHODS RECOMMENDATIONS, INDEPENDENT MEASUREMENTS, AND RESEARCH PROJECT MEASUREMENTS (U.S. CLS. 100 AND 101).

FIRST USE 7-1-2004; IN COMMERCE 8-1-2004.
DAVID ELTON, EXAMINING ATTORNEY

SN 77-825,103, LIFETOUCH INC., EDEN PRAIRIE, MN.
FILED 9-11-2009.

NARRATING YOUR LIFE THROUGH PHOTOGRAPHY

THE MARK CONSISTS OF STANDARD CHARACTERS WITHOUT CLAIM TO ANY PARTICULAR FONT, STYLE, SIZE, OR COLOR.

NO CLAIM IS MADE TO THE EXCLUSIVE RIGHT TO USE "PHOTOGRAPHY", APART FROM THE MARK AS SHOWN.

CLASS 16—PAPER GOODS AND PRINTED MATTER

FOR PHOTOGRAPHS (U.S. CLS. 2, 5, 22, 23, 29, 37, 38 AND 50).

CLASS 41—EDUCATION AND ENTERTAINMENT

FOR PHOTOGRAPHY SERVICES (U.S. CLS. 100, 101 AND 107).

MEGHAN REINHART, EXAMINING ATTORNEY

SN 77-825,253, CISCO TECHNOLOGY, INC., SAN JOSE, CA.
FILED 9-11-2009.

CISCO SENSORBASE

THE MARK CONSISTS OF STANDARD CHARACTERS WITHOUT CLAIM TO ANY PARTICULAR FONT, STYLE, SIZE, OR COLOR.

OWNER OF U.S. REG. NOS. 1,542,339, 2,498,746 AND 3,709,076.

CLASS 9—ELECTRICAL AND SCIENTIFIC APPARATUS

FOR SOFTWARE FOR COLLECTING, AGGREGATING, FILTERING AND MONITORING INFORMATION, DATA AND STATISTICS RETRIEVED OR RECEIVED FROM COMPUTERS AND COMMUNICATIONS NETWORKS; COMPUTER SECURITY SOFTWARE; SOFTWARE FOR INTERNET AND E-MAIL SECURITY, THREAT IDENTIFICATION, VIRUS PROTECTION, SYSTEM OPTIMIZATION AND INTRUSION PREVENTION (U.S. CLS. 21, 23, 26, 36 AND 38).

CLASS 42—SCIENTIFIC AND COMPUTER SERVICES

FOR PROVIDING E-MAIL REPUTATION SERVICES, NAMELY, INFORMATION AND DATABASES REGARDING THE ASSOCIATION OF E-MAIL SENDER IDENTITY INFORMATION WITH NETWORK ABUSE; PROVIDING ON-LINE NON-DOWNLOADABLE SOFTWARE FOR COLLECTING, AGGREGATING, FILTERING AND MONITORING INFORMATION, DATA AND STATISTICS RETRIEVED OR RECEIVED FROM COMPUTERS AND COMMUNICATIONS NETWORKS; PROVIDING ON-LINE NON-DOWNLOADABLE SOFTWARE FOR INTERNET AND E-MAIL SECURITY, THREAT IDENTIFICATION, VIRUS PROTECTION, SYSTEM OPTIMIZATION AND INTRUSION PREVENTION; SOFTWARE AS A SERVICE (SAAS) SERVICES, NAMELY, HOSTING SOFTWARE FOR USE BY OTHERS FOR COLLECTING, AGGREGATING, FILTERING AND MONITORING INFORMATION, DATA AND STATISTICS RETRIEVED OR RECEIVED FROM COMPUTERS AND COMMUNICATIONS NETWORKS; SOFTWARE AS A SERVICE (SAAS) SERVICES, NAMELY, HOSTING SOFTWARE FOR USE BY OTHERS FOR INTERNET AND E-MAIL SECURITY, THREAT IDENTIFICATION, VIRUS PROTECTION, SYSTEM OPTIMIZATION AND INTRUSION PREVENTION (U.S. CLS. 100 AND 101).

HAI-LY LAM, EXAMINING ATTORNEY

SN 77-825,287, SONY COMPUTER ENTERTAINMENT AMERICA LLC, FOSTER CITY, CA. FILED 9-11-2009.

NUMBLAST

THE MARK CONSISTS OF STANDARD CHARACTERS WITHOUT CLAIM TO ANY PARTICULAR FONT, STYLE, SIZE, OR COLOR.

CLASS 9—ELECTRICAL AND SCIENTIFIC APPARATUS

FOR COMPUTER GAME SOFTWARE AND VIDEO GAME SOFTWARE (U.S. CLS. 21, 23, 26, 36 AND 38).

CLASS 41—EDUCATION AND ENTERTAINMENT

FOR PROVIDING A REAL-TIME COMPUTER GAME FOR OTHERS THAT MAY BE ACCESSED OVER GLOBAL AND LOCAL AREA COMPUTER NETWORKS BY NETWORK USERS (U.S. CLS. 100, 101 AND 107).

CHRISTINA SOBRAL, EXAMINING ATTORNEY

SN 77-825,893. KENT STATE UNIVERSITY, KENT, OH.
FILED 9-14-2009.

SN 77-827,656. AVERY DENNISON CORPORATION, PASA-
DENA, CA. FILED 9-16-2009.

THE TANNERY

THE MARK CONSISTS OF STANDARD CHARACTERS WITHOUT CLAIM TO ANY PARTICULAR FONT, STYLE, SIZE, OR COLOR.

CLASS 35—ADVERTISING AND BUSINESS

FOR ADVERTISING SERVICES, NAMELY, PROMOTING AND MARKETING THE GOODS AND SERVICES OF OTHERS THROUGH ALL PUBLIC COMMUNICATION MEANS (U.S. CLS. 100, 101 AND 102).

CLASS 42—SCIENTIFIC AND COMPUTER SERVICES

FOR VISUAL DESIGN SERVICES IN THE NATURE OF DESIGNING VISUAL ELEMENTS FOR ON-LINE, BROADCAST, PRINT, OUTDOOR AND OTHER COMMUNICATION MEDIA (U.S. CLS. 100 AND 101).
ANNE E. GUSTASON, EXAMINING ATTORNEY

SN 77-825,956. KENT STATE UNIVERSITY, KENT, OH.
FILED 9-14-2009.



THE MARK CONSISTS OF A LOWER CASE LETTER "T" INSIDE A CIRCLE FORMED FROM DOTS BELOW WHICH APPEAR THE WORDS "THE TANNERY".

CLASS 35—ADVERTISING AND BUSINESS

FOR ADVERTISING SERVICES, NAMELY, PROMOTING AND MARKETING THE GOODS AND SERVICES OF OTHERS THROUGH ALL PUBLIC COMMUNICATION MEANS (U.S. CLS. 100, 101 AND 102).

CLASS 42—SCIENTIFIC AND COMPUTER SERVICES

FOR VISUAL DESIGN SERVICES IN THE NATURE OF DESIGNING VISUAL ELEMENTS FOR ON-LINE, BROADCAST, PRINT, OUTDOOR AND OTHER COMMUNICATION MEDIA (U.S. CLS. 100 AND 101).
ANNE E. GUSTASON, EXAMINING ATTORNEY

THAT'S THE POWER OF A
GREAT LABEL

THE MARK CONSISTS OF STANDARD CHARACTERS WITHOUT CLAIM TO ANY PARTICULAR FONT, STYLE, SIZE, OR COLOR.

CLASS 16—PAPER GOODS AND PRINTED MATTER

FOR PAPER LABELS, NAMELY, ADDRESS LABELS, ADHESIVE LABELS, ADHESIVES STICKERS, ANTI-COUNTERFEITING AND SECURITY LABELS, BLANK COLOR IDENTIFICATION LABELS, BLANK LABELS, CHILD RESISTANT-SENIOR FRIENDLY LABELS, DECORATIVE LABELS BEARING PICTURES OR IMAGES FOR USE WITH AND/OR TO RESEMBLE POSTAGE STAMPS, HEAT TRANSFER LABELS MADE OF PAPER, HOLOGRAPHIC LABELS, IMAGE-BEARING LABELS, LABELS THAT ARE CHEMICALLY, ELECTRICALLY AND/OR BIOLOGICALLY RESPONSIVE THAT MEASURE THE FRESHNESS OF FOOD PRODUCTS, LABELS AND STICKERS FOR INFORMATION AND DECORATION PURPOSES MADE FROM PAPER, LABELS FOR BEVERAGE BOTTLES AND CONTAINERS, LABELS FOR COMMERCIAL AND INDUSTRIAL USES, LABELS FOR PRESCRIPTION MEDICINE BOTTLES, LABELS OF PAPER FOR IDENTIFICATION OF VEHICLE PARTS, LABELS OF PAPER FOR PERMANENT COMPONENT MARKING DURING INDUSTRIAL MANUFACTURING PROCESS OF COMPONENTS, LABELS OF PAPER FOR VEHICLE IDENTIFICATION, LABELS OF PAPER FOR WARNING AND TRACKING, LABELS WITH BUILT-IN INDICATORS, LABELS, TAGS, WRISTBAND LABELS BEARING IDENTIFICATION INFORMATION, PAPER LABELS FOR STORE SHELVES TO INDICATE PRICE, PRODUCTS AND/OR PROMOTIONS, PLASTIC RELEASE COATED PAPERS FOR COPYING, DISPLAYS, AND LABEL AND FILM PRODUCTION, POSTAGE LABELS, PREPRINTED ADHESIVE IDENTIFICATION LABELS BEARING ALPHANUMERIC SYMBOLS, PRESSURE-SENSITIVE-PRINTING PAPERS FOR LABELS AND DISPLAYS, PRINTED LABELS, RETURN ADDRESS LABELS, SECURITY PAPER LABELS THAT ENCODE IDENTIFICATION INFORMATION, SECURITY PAPER LABELS, NAMELY, LABELS WHICH ENCODE IDENTIFICATION INFORMATION, SELF-ADHESIVE LABEL HOLDERS, SELF-ADHESIVE LABELS, SELF-ADHESIVE PAPER IN SHEET AND ROLL FORM FOR MAKING LABELS, SELF-ADHESIVE SECURITY BADGE LABELS, TRANSPARENT AND TRANSLUCENT ADHESIVE LABELS, WATER-SOLUBLE PAPER LABELS AND FACESTOCK AND LABELS IN SHEET FORM, PADS OF ADHESIVE LABELS, SHIPPING LABELS AND PRINTED ADVERTISING BOARDS OF PAPER OR CARDBOARD (U.S. CLS. 2, 5, 22, 23, 29, 37, 38 AND 50).

CLASS 20—FURNITURE AND ARTICLES NOT OTHERWISE CLASSIFIED

FOR CARDBOARD FLOOR DISPLAY UNITS FOR MERCHANDISING PRODUCTS, DISPLAY BOARDS, DISPLAY RACKS, DISPLAY STANDS, POINT OF PURCHASE DISPLAYS, PADS OF PLASTIC ADHESIVE LABELS, PLASTIC ADHESIVE TABS AND PLASTIC TAB LABELS (U.S. CLS. 2, 13, 22, 25, 32 AND 50).

CLASS 35—ADVERTISING AND BUSINESS

FOR ADVERTISING, ADVERTISING IN PERIODICALS, BROCHURES AND NEWSPAPERS, ONLINE ADVERTISING VIA A COMPUTER COMMUNICATION NETWORK, ADVERTISING THROUGH RADIO, ADVERTISING FOR LABELS AND DISTRIBUTION OF PRODUCTS FOR ADVERTISING PURPOSES (U.S. CLS. 100, 101 AND 102).

MARK PILARO, EXAMINING ATTORNEY

CLASS 41—EDUCATION AND ENTERTAINMENT

FOR ENTERTAINMENT SERVICES, NAMELY, ORGANIZING AND CONDUCTING AN ANNUAL GOLF TOURNAMENT (U.S. CLS. 100, 101 AND 107).

EDWARD FENNESSY, EXAMINING ATTORNEY

SN 77-827,764. GREENBRIER IA, INC., WHITE SULPHUR SPRINGS, WV. FILED 9-16-2009.

SN 77-827,880. GENERAL BINDING CORPORATION, LINCOLNSHIRE, IL. FILED 9-16-2009.



NO CLAIM IS MADE TO THE EXCLUSIVE RIGHT TO USE "CLASSIC", APART FROM THE MARK AS SHOWN.

THE COLOR(S) GREEN IS/ARE CLAIMED AS A FEATURE OF THE MARK.

THE MARK CONSISTS OF A GREEN SPRING HOUSE WITH THE WORDS "THE GREENBRIER CLASSIC" IN GREEN TO THE LEFT AND BELOW THE HOUSE.

CLASS 16—PAPER GOODS AND PRINTED MATTER

FOR POSTERS (U.S. CLS. 2, 5, 22, 23, 29, 37, 38 AND 50).

CLASS 18—LEATHER GOODS

FOR ATHLETIC BAGS, TOTE BAGS, UMBRELLAS, LUGGAGE TAGS, TOILETRY CASES SOLD EMPTY, WALLETS, CREDIT CARD CASES AND KEY CASES (U.S. CLS. 1, 2, 3, 22 AND 41).

CLASS 21—HOUSEWARES AND GLASS

FOR PLASTIC CUPS, DRINKING GLASSES, INSULATING SLEEVE HOLDERS FOR BEVERAGES MADE OUT OF FOAM, NYLON, NEOPRENE AND/OR PLASTIC (U.S. CLS. 2, 13, 23, 29, 30, 33, 40 AND 50).

CLASS 24—FABRICS

FOR GOLF TOWELS (U.S. CLS. 42 AND 50).

CLASS 25—CLOTHING

FOR CLOTHING, NAMELY, SHIRTS, JACKETS, SWEATERS, PANTS, SOCKS, HATS, VISORS AND RAINWEAR (U.S. CLS. 22 AND 39).

CLASS 28—TOYS AND SPORTING GOODS

FOR SPORTING GOODS, NAMELY, GOLF CLUBS, GOLF BAGS, GOLF GLOVES, GOLF BAG TAGS, GOLF CLUB HEAD COVERS, GOLF BALLS, GOLF BALL MARKERS, GOLF FLAGS, AND DIVOT REPAIR TOOL FOR GOLFERS (U.S. CLS. 22, 23, 38 AND 50).

**QUARTET GREAT IDEAS START
HERE**

THE MARK CONSISTS OF STANDARD CHARACTERS WITHOUT CLAIM TO ANY PARTICULAR FONT, STYLE, SIZE, OR COLOR.

OWNER OF U.S. REG. NOS. 3,099,451, 3,254,326 AND OTHERS.

CLASS 6—METAL GOODS

FOR NON-LUMINOUS AND NON-MECHANICAL METAL SIGNS (U.S. CLS. 2, 12, 13, 14, 23, 25 AND 50).

CLASS 9—ELECTRICAL AND SCIENTIFIC APPARATUS

FOR ELECTRONIC SCANNING AND PRINTING APPARATUS, NAMELY, ELECTRONIC COPY BOARDS WITH AND WITHOUT CONNECTIONS TO COMPUTERS; PROJECTION SCREENS; BLACK MARKER BOARD WITH AN EXTERNAL LIGHT SOURCE INTEGRATE INTO SAME; MAGNETS; APPARATUS FOR RECORDING, TRANSMITTING, RECEIVING AND REPRODUCING IMAGES; DISPLAY BOARDS INCORPORATING SCANNERS; LUMINOUS SIGNS, ELECTRONIC OUTLETS; COMPONENT PARTS THEREOF (U.S. CLS. 21, 23, 26, 36 AND 38).

CLASS 12—VEHICLES

FOR TROLLEYS (U.S. CLS. 19, 21, 23, 31, 35 AND 44).

CLASS 16—PAPER GOODS AND PRINTED MATTER

FOR DRAWING BOARDS; CHART BOARDS; NOTICE BOARDS; DRY WIPE BOARDS; BULLETIN BOARDS; MESSAGE BOARDS; CORK BOARDS; DIRECTORY BOARDS; MAGNETIC BOARDS; COPY BOARDS; BLACK MARKER BOARDS; STANDS AND EASELS FOR ALL THE AFORESAID GOODS; STANDS, NAMELY, TABLE-TOP EASEL STANDS WHICH PROP AN EASEL; EASELS; PENS; MARKERS; WRITING AND DRAWING INSTRUMENTS; CHALKS; CRAYONS; PAPER CUTTERS AND TRIMMERS; STAPLES AND STAPLE PRESSES; ERASERS; CHALK HOLDERS; PASTELS; DRAWING CHARCOAL; PLASTIC LETTERS, NUMBERS AND CHARACTERS, ARTISTS' MATERIALS, NAMELY, WATER SOLUBLE TEMPERA CRAYONS, CAKES OF TEMPERA PAINT, MARKERS, PLASTIC PAINT TRAY, AND EASEL CLIPS; PAINT BRUSHES; ALL FOR USE ON BOARDS; PARTS AND FITTINGS FOR THE AFORESAID GOODS (U.S. CLS. 2, 5, 22, 23, 29, 37, 38 AND 50).

CLASS 19—NON-METALLIC BUILDING MATERIALS

FOR WALL LININGS, NAMELY, PORCELAIN ON STEEL PANELS APPLIED TO A WALL FOR WRITING; CORK PANELS APPLIED TO A WALL FOR TACKING; FABRIC PANELS APPLIED TO A WALL FOR TACKING (U.S. CLS. 1, 12, 33 AND 50).

CLASS 20—FURNITURE AND ARTICLES NOT OTHERWISE CLASSIFIED

FOR ARCHITECTURAL DISPLAY BOARD SYSTEMS, NAMELY, HANGERS AND MOUNTED TRACKS WHICH ACCOMMODATE SHELVING, BULLETIN BOARDS, EASELS, AND PROJECTION SCREENS (U.S. CLS. 2, 13, 22, 25, 32 AND 50).

JILL C. ALT, EXAMINING ATTORNEY

SN 77-828,513. VERBATIM AMERICAS LLC, CHARLOTTE, NC. FILED 9-17-2009.



OWNER OF U.S. REG. NOS. 1,675,734, 1,930,778 AND 2,765,962.

THE MARK CONSISTS OF THE WORD "VERBATIM" NEXT TO A STYLIZED "V" IN A SQUARE BOX.

CLASS 1—CHEMICALS

FOR PHOTOGRAPHIC PAPER (U.S. CLS. 1, 5, 6, 10, 26 AND 46).

CLASS 3—COSMETICS AND CLEANING PREPARATIONS

FOR CLEANING PREPARATIONS; DISPOSABLE WIPES IMPREGNATED WITH CLEANING COMPOUNDS FOR USE ON MAGNETIC AND OPTICAL DISKS (U.S. CLS. 1, 4, 6, 50, 51 AND 52).

CLASS 9—ELECTRICAL AND SCIENTIFIC APPARATUS

FOR AUDIO AND VIDEO RECORDING AND REPRODUCTION MACHINES, NAMELY, VIDEO DISC RECORDERS AND PLAYERS; BLANK RECORDING MEDIA, NAMELY, FLOPPY DISKS, CDS, DVDS, HD DVDS, OPTICAL DISKS, AND MAGNETO-OPTICAL DISKS; ELECTRONIC AND MAGNETIC CARD READERS; COMPACT DISC RECORDERS AND PLAYERS; COMPUTER HARDWARE; COMPUTER PERIPHERALS; COMPUTER AND OPTICAL DISK DRIVES FOR WRITING DATA ONTO RECORDING MEDIA; COMPUTER DISK DRIVES; DESKTOP HARD DRIVES FOR COMPUTERS; NAS DESKTOP HARD DRIVES FOR COMPUTERS; KEYBOARDS; LASER PRINTER TONER CARTRIDGES; MEMORY CARDS; COMPUTER MICE; PORTABLE HARD DRIVES FOR COMPUTERS; OPTICAL DISK DRIVES; OPTICAL AND MAGNETO-OPTICAL DISC PLAYERS AND RECORDERS FOR AUDIO, VIDEO AND COMPUTER DATA; DVD AND CD STORAGE CASES; AUDIO TAPE STORAGE CASES; USB ADAPTERS; USB CABLES; USB DRIVES; USB HUBS (U.S. CLS. 21, 23, 26, 36 AND 38).

CLASS 16—PAPER GOODS AND PRINTED MATTER

FOR PAPER FOR PRINTING PHOTOGRAPHS (U.S. CLS. 2, 5, 22, 23, 29, 37, 38 AND 50).

CLASS 21—HOUSEWARES AND GLASS

FOR CLEANING CLOTHS (U.S. CLS. 2, 13, 23, 29, 30, 33, 40 AND 50).

DAVID TOOLEY, EXAMINING ATTORNEY

SN 77-828,723. TEVA PHARMACEUTICALS USA, INC., NORTH WALES, PA. FILED 9-17-2009.



THE MARK CONSISTS OF STANDARD CHARACTERS WITHOUT CLAIM TO ANY PARTICULAR FONT, STYLE, SIZE, OR COLOR.

CLASS 5—PHARMACEUTICALS

FOR PHARMACEUTICAL PREPARATION AND SUBSTANCE FOR HUMAN USE IN THE EMERGENCY TREATMENT OF ANAPHYLAXIS; PHARMACEUTICAL PREPARATIONS AND SUBSTANCES FOR HUMAN USE IN THE PREVENTION AND TREATMENT OF CENTRAL NERVOUS SYSTEM AND NEUROLOGICAL DISEASES AND DISORDERS, MUSCULOSKELETAL DISEASES AND DISORDERS, ONCOLOGICAL AND MALIGNANT DISEASES AND DISORDERS, MIGRAINES, PAIN, INFLAMMATION AND INFLAMMATORY DISEASES AND DISORDERS, AUTOIMMUNE DISEASES, METABOLIC DISEASES AND DISORDERS, RESPIRATORY AND INFECTIOUS DISEASES AND DISORDERS, PSYCHIATRIC DISEASES AND DISORDERS, ALLERGIES, DIABETES, AND STROKE (U.S. CLS. 6, 18, 44, 46, 51 AND 52).

CLASS 10—MEDICAL APPARATUS

FOR PHARMACEUTICAL INJECTION DEVICE FOR HUMAN USE IN THE EMERGENCY TREATMENT OF ANAPHYLAXIS (U.S. CLS. 26, 39 AND 44).

YAT SYE, LEE, EXAMINING ATTORNEY

SN 77-829,480. ENUMAY CORP., ASTORIA, NY. FILED 9-18-2009.



THE MARK CONSISTS OF STANDARD CHARACTERS WITHOUT CLAIM TO ANY PARTICULAR FONT, STYLE, SIZE, OR COLOR.

CLASS 35—ADVERTISING AND BUSINESS

FOR PROVIDING INFORMATION ABOUT AND PROMOTING THE SALE OF THE GOODS AND SERVICES OF OTHERS IN VARIOUS LANGUAGES VIA A GLOBAL COMPUTER NETWORK; PROVIDING ONLINE AND FAX ORDERING SERVICES FOR DELIVERY AND PICK UP OF PREPARED, MADE TO ORDER AND PACKAGED FOOD AND DRINK DIRECTLY FROM THIRD PARTY SUBSCRIBING ADVERTISER RESTAURANTS (U.S. CLS. 100, 101 AND 102).

CLASS 38—COMMUNICATION

FOR PROVIDING ACCESS TO USER SEARCHABLE ONLINE RESTAURANT MENUS OF THIRD PARTY SUBSCRIBING ADVERTISER RESTAURANTS FEATURING AVAILABLE PREPARED, MADE TO ORDER AND PACKAGED FOOD AND DRINK, INCLUDING DESCRIPTIONS, PRICES, AND RETAILER CONTACT INFORMATION AND LOCATIONS OF SAME (U.S. CLS. 100, 101 AND 104).

SN 77-830,499. LOCKHEED MARTIN CORPORATION, BETHESDA, MD. FILED 9-19-2009.

CLASS 42—SCIENTIFIC AND COMPUTER SERVICES

FOR PROVIDING THE CAPABILITY VIA A GLOBAL COMPUTER NETWORK FOR WEB SITE VISITORS TO PLACE ORDERS ONLINE AND VIA FAX FOR DELIVERY AND PICK UP OF PREPARED, MADE TO ORDER AND PACKAGED FOOD AND DRINK DIRECTLY FROM THIRD PARTY SUBSCRIBING ADVERTISER RESTAURANTS (U.S. CLS. 100 AND 101).

LINDA ORNDORFF, EXAMINING ATTORNEY



SN 77-830,032. VITA-MIX CORPORATION, CLEVELAND, OH. FILED 9-18-2009.

NO CLAIM IS MADE TO THE EXCLUSIVE RIGHT TO USE "ON DEMAND" AND "LOGISTICS NETWORK", APART FROM THE MARK AS SHOWN.

THE MARK CONSISTS OF TWO ARROWS TO THE LEFT OF THE TERMS "ONLOGIN ON DEMAND LOGISTICS NETWORK".

VITAMIX

THE MARK CONSISTS OF STANDARD CHARACTERS WITHOUT CLAIM TO ANY PARTICULAR FONT, STYLE, SIZE, OR COLOR.

OWNER OF U.S. REG. NOS. 2,021,896, 3,078,357 AND OTHERS.

CLASS 7—MACHINERY

FOR ELECTRIC BLENDERS AND FOOD PROCESSORS AND STRUCTURAL PARTS THEREFOR, AND MACHINES FOR SHAVING AND DISPENSING ICE TO THE PITCHER OF A BLENDER WHICH THEREAFTER MAKES DRINKS AND STRUCTURAL PARTS THEREFOR (U.S. CLS. 13, 19, 21, 23, 31, 34 AND 35).

CLASS 16—PAPER GOODS AND PRINTED MATTER

FOR RECIPE BOOKS (U.S. CLS. 2, 5, 22, 23, 29, 37, 38 AND 50).

CLASS 21—HOUSEWARES AND GLASS

FOR COOKWARE, NAMELY, POTS AND PANS (U.S. CLS. 2, 13, 23, 29, 30, 33, 40 AND 50).

DORITT L. CARROLL, EXAMINING ATTORNEY

CLASS 35—ADVERTISING AND BUSINESS

FOR BUSINESS MANAGEMENT SERVICES, NAMELY, MANAGING LOGISTICS, REVERSE LOGISTICS, SUPPLY CHAIN SERVICES, SUPPLY CHAIN VISIBILITY AND SYNCHRONIZATION, SUPPLY AND DEMAND FORECASTING AND PRODUCT DISTRIBUTION PROCESSES FOR OTHERS; BUSINESS PROCESS RE-ENGINEERING SERVICES (U.S. CLS. 100, 101 AND 102).

FIRST USE 3-31-2009; IN COMMERCE 6-24-2009.

CLASS 39—TRANSPORTATION AND STORAGE

FOR SUPPLY CHAIN, LOGISTICS AND REVERSE LOGISTICS SERVICES, NAMELY, STORAGE, TRANSPORTATION AND DELIVERY OF DOCUMENTS, PACKAGES, RAW MATERIALS, AND OTHER FREIGHT FOR OTHERS BY AIR, RAIL, SHIP OR TRUCK (U.S. CLS. 100 AND 105).

FIRST USE 3-31-2009; IN COMMERCE 6-24-2009.

CLASS 42—SCIENTIFIC AND COMPUTER SERVICES

FOR COMPUTER SERVICES, NAMELY, PROVIDING A WEB-BASED SYSTEM AND ONLINE PORTAL FOR CUSTOMERS TO REMOTELY MANAGE, ADMINISTER, MODIFY AND CONTROL THEIR END USER SUPPLY CHAIN AND LOGISTICS COMPUTER DEVICES, DATA AND SOFTWARE APPLICATIONS; TECHNICAL SUPPORT SERVICES, NAMELY, TROUBLESHOOTING OF COMPUTER HARDWARE AND SOFTWARE PROBLEMS; COMPUTER CONSULTATION SERVICES; COMPUTER SYSTEMS INTEGRATION AND MONITORING OF COMPUTER AND COMMUNICATIONS SOFTWARE, HARDWARE AND NETWORKS FOR TECHNICAL PURPOSES; COMPUTER SUPPORT SERVICES, NAMELY, COMPUTER PROGRAMMING, COMPUTER SOFTWARE MAINTENANCE, COMPUTER SYSTEMS DEVELOPMENT, AND CONDUCTING FEASIBILITY STUDIES; COMPUTER PROGRAMMING FOR OTHERS (U.S. CLS. 100 AND 101).

FIRST USE 3-31-2009; IN COMMERCE 6-24-2009.

ASMAT KHAN, EXAMINING ATTORNEY

SN 77-830,500. LOCKHEED MARTIN CORPORATION, BETHESDA, MD. FILED 9-19-2009.

SN 77-830,785. OTIS REEVES, CORDOVA, TN. FILED 9-21-2009.

**ONLOGIN ON-DEMAND
LOGISTICS NETWORK**



THE MARK CONSISTS OF STANDARD CHARACTERS WITHOUT CLAIM TO ANY PARTICULAR FONT, STYLE, SIZE, OR COLOR.

NO CLAIM IS MADE TO THE EXCLUSIVE RIGHT TO USE "ON-DEMAND" AND "LOGISTICS NETWORK", APART FROM THE MARK AS SHOWN.

CLASS 35—ADVERTISING AND BUSINESS

FOR BUSINESS MANAGEMENT SERVICES, NAMELY, MANAGING LOGISTICS, REVERSE LOGISTICS, SUPPLY CHAIN SERVICES, SUPPLY CHAIN VISIBILITY AND SYNCHRONIZATION, SUPPLY AND DEMAND FORECASTING AND PRODUCT DISTRIBUTION PROCESSES FOR OTHERS; BUSINESS PROCESS RE-ENGINEERING SERVICES (U.S. CLS. 100, 101 AND 102).

FIRST USE 3-31-2009; IN COMMERCE 6-24-2009.

CLASS 39—TRANSPORTATION AND STORAGE

FOR SUPPLY CHAIN, LOGISTICS AND REVERSE LOGISTICS SERVICES, NAMELY, STORAGE, TRANSPORTATION AND DELIVERY OF DOCUMENTS, PACKAGES, RAW MATERIALS, AND OTHER FREIGHT FOR OTHERS BY AIR, RAIL, SHIP OR TRUCK (U.S. CLS. 100 AND 105).

FIRST USE 3-31-2009; IN COMMERCE 6-24-2009.

CLASS 42—SCIENTIFIC AND COMPUTER SERVICES

FOR COMPUTER SERVICES, NAMELY, PROVIDING A WEB-BASED SYSTEM AND ONLINE PORTAL FOR CUSTOMERS TO REMOTELY MANAGE, ADMINISTER, MODIFY AND CONTROL THEIR END USER SUPPLY CHAIN AND LOGISTICS COMPUTER DEVICES, DATA AND SOFTWARE APPLICATIONS; TECHNICAL SUPPORT SERVICES, NAMELY, TROUBLESHOOTING OF COMPUTER HARDWARE AND SOFTWARE PROBLEMS; COMPUTER CONSULTATION SERVICES; COMPUTER SYSTEMS INTEGRATION AND MONITORING OF COMPUTER AND COMMUNICATIONS SOFTWARE, HARDWARE AND NETWORKS FOR TECHNICAL PURPOSES; COMPUTER SUPPORT SERVICES, NAMELY, COMPUTER PROGRAMMING, COMPUTER SOFTWARE MAINTENANCE, COMPUTER SYSTEMS DEVELOPMENT, AND CONDUCTING FEASIBILITY STUDIES; COMPUTER PROGRAMMING FOR OTHERS (U.S. CLS. 100 AND 101).

FIRST USE 3-31-2009; IN COMMERCE 6-24-2009. ASMAT KHAN, EXAMINING ATTORNEY

NO CLAIM IS MADE TO THE EXCLUSIVE RIGHT TO USE "USA", APART FROM THE MARK AS SHOWN.

THE MARK CONSISTS OF THE LETTERS "U","S","A" THE LETTERS "U" AND "S" ENCLOSING STARS AND HORIZONTAL STRIPES, THE LETTER "A" ENCLOSING ONLY STRIPES - THE WORDS "UNITY STRENGTHENS AMERICA" UNDERNEATH, WITH HORIZONTAL BARS EXTENDING TO THE RIGHT OF EACH OF THESE WORDS, THE TOP BAR CONTAINING STARS.

CLASS 24—FABRICS

FOR FABRIC FLAGS (U.S. CLS. 42 AND 50).

CLASS 25—CLOTHING

FOR CAPS AND T-SHIRTS (U.S. CLS. 22 AND 39). KRISTIN DAHLING, EXAMINING ATTORNEY

SN 77-831,075. TRITON SYSTEMS OF DELAWARE, LLC, LONG BEACH, MS. FILED 9-21-2009.

ATMGURUS

THE MARK CONSISTS OF STANDARD CHARACTERS WITHOUT CLAIM TO ANY PARTICULAR FONT, STYLE, SIZE, OR COLOR.

CLASS 6—METAL GOODS

FOR AUTOMATED TELLER MACHINE (ATM) ACCESSORIES, NAMELY, METAL BRACKETS FOR CONNECTING AND MOUNTING AUTOMATIC TELLER MACHINE PARTS, METAL KEYS FOR LOCKS, AND METAL LOCKS (U.S. CLS. 2, 12, 13, 14, 23, 25 AND 50).

FIRST USE 9-1-2009; IN COMMERCE 9-1-2009.

CLASS 9—ELECTRICAL AND SCIENTIFIC APPARATUS

FOR AUTOMATED TELLER MACHINE (ATM) PARTS, NAMELY, CABINETRY SPECIALLY ADAPTED TO SERVE AS HOUSING FOR THE INTERNAL COMPONENTS OF AUTOMATED TELLER MACHINES (ATMS), ELECTRICAL CABLES, ELECTRONIC CARD READERS, ELECTRIC CONTROL PANELS, UPPER FASCIA SPECIALLY ADAPTED TO SERVE AS HOUSING FOR INTERNAL AUTOMATED TELLER MACHINE (ATM) COMPONENTS, CASH DISPENSERS, LIQUID CRYSTAL DISPLAYS, KEYPADS, MOTHERBOARDS, ELECTRONIC CIRCUITS, POWER SUPPLIES, PRINTERS, CASH DISPENSER CASSETTES, AND BATTERIES; COMPUTER SOFTWARE USED TO OPERATE AUTOMATED TELLER MACHINES (ATMS) (U.S. CLS. 21, 23, 26, 36 AND 38).

FIRST USE 9-1-2009; IN COMMERCE 9-1-2009.
ELLEN B. AWRICH, EXAMINING ATTORNEY

CLASS 41—EDUCATION AND ENTERTAINMENT

FOR EDUCATION SERVICES, NAMELY, PROVIDING CLASSES IN THE FIELD OF MAINTENANCE AND REPAIR OF AUTOMATED TELLER MACHINES (ATMS); TRAINING OF PERSONS TO MAINTAIN AND REPAIR AUTOMATED TELLER MACHINES (ATMS) AND TO TROUBLESHOOT AUTOMATED TELLER MACHINE (ATM) SOFTWARE (U.S. CLS. 100, 101 AND 107).
FIRST USE 9-1-2009; IN COMMERCE 9-1-2009.
ELLEN B. AWRICH, EXAMINING ATTORNEY

SN 77-831,080. TRITON SYSTEMS OF DELAWARE, LLC, LONG BEACH, MS. FILED 9-21-2009.

SN 77-831,289. LOCKHEED MARTIN CORPORATION, BETHESDA, MD. FILED 9-21-2009.



THE MARK CONSISTS OF THE WORDING "ATMGURUS" IN LOWER CASE LETTERS WITH SEVEN ROWS OF DOTS, IN PROGRESSION OF BIG TO SMALLER, ARISING OUT OF THE MIDDLE OF THE MARK ON TOP OF THE "G".

CLASS 6—METAL GOODS

FOR AUTOMATED TELLER MACHINE ACCESSORIES, NAMELY, METAL BRACKETS FOR CONNECTING AND MOUNTING AUTOMATED TELLER MACHINE (ATM) PARTS, METAL KEYS FOR LOCKS, AND METAL LOCKS (U.S. CLS. 2, 12, 13, 14, 23, 25 AND 50).

FIRST USE 9-1-2009; IN COMMERCE 9-1-2009.

CLASS 9—ELECTRICAL AND SCIENTIFIC APPARATUS

FOR AUTOMATED TELLER MACHINE (ATM) PARTS, NAMELY, CABINETRY SPECIALLY ADAPTED TO SERVE AS HOUSING FOR INTERNAL COMPONENTS OF AUTOMATED TELLER MACHINES (ATMS), ELECTRICAL CABLES, ELECTRONIC CARD READERS, ELECTRIC CONTROL PANELS, UPPER FASCIA SPECIALLY ADAPTED TO SERVE AS HOUSING FOR INTERNAL AUTOMATED TELLER MACHINE COMPONENTS, CASH DISPENSERS, LIQUID CRYSTAL DISPLAYS, KEYPADS, MOTHERBOARDS, ELECTRONIC CIRCUITS, POWER SUPPLIES, PRINTERS, CASH DISPENSER CASSETTES, AND BATTERIES; COMPUTER SOFTWARE USED TO OPERATE AUTOMATED TELLER MACHINES (ATMS) (U.S. CLS. 21, 23, 26, 36 AND 38).

FIRST USE 9-1-2009; IN COMMERCE 9-1-2009.

CLASS 37—CONSTRUCTION AND REPAIR

FOR REPAIR AND MAINTENANCE OF AUTOMATED TELLER MACHINES (ATMS) (U.S. CLS. 100, 103 AND 106).

FIRST USE 9-1-2009; IN COMMERCE 9-1-2009.



THE MARK CONSISTS OF THE STYLIZED WORD "OASIS" WITH THE DESIGN OF AN ARCHED LINE ABOVE AND TO THE RIGHT OF THE WORD "OASIS" AND FORMING AN UNDERLINE BELOW THE WORD "OASIS".

CLASS 9—ELECTRICAL AND SCIENTIFIC APPARATUS

FOR INTEGRATED TRADESPACING SOFTWARE FOR USE IN CONSOLIDATING, MANAGING AND PROVIDING ACCESS TO DISPARATE DATA SOURCES, PROVIDING DATA FUSION AND DATA MINING ACROSS AND WITHIN DATA DOMAINS, AND VISUALIZING CURRENT SITUATIONAL INTELLIGENCE FOR THE PURPOSE ENHANCING REAL TIME DECISION MAKING CAPABILITIES RELATED TO COST MANAGEMENT, SCHEDULE DEVELOPMENT, PERFORMANCE EVALUATION AND RISK ASSESSMENT OF VARIOUS ENTERPRISES; DOWNLOADABLE APPLICATION PROGRAM INTERFACE SOFTWARE ACCESSIBLE VIA THE WEB FOR USE IN CONSOLIDATING, MANAGING AND PROVIDING ACCESS TO DISPARATE DATA SOURCES, PROVIDING DATA FUSION AND DATA MINING ACROSS AND WITHIN DATA DOMAINS, AND VISUALIZING CURRENT SITUATIONAL INTELLIGENCE FOR THE PURPOSE OF ENHANCING REAL TIME DECISION MAKING CAPABILITIES RELATED TO COST MANAGEMENT, SCHEDULE DEVELOPMENT, PERFORMANCE EVALUATION AND RISK ASSESSMENT OF VARIOUS ENTERPRISES (U.S. CLS. 21, 23, 26, 36 AND 38).

FIRST USE 8-1-2008; IN COMMERCE 8-1-2008.

CLASS 42—SCIENTIFIC AND COMPUTER SERVICES

FOR PROVIDING TEMPORARY USE OF ON-LINE NON DOWNLOADABLE VALUE ENGINEERING SOFTWARE DEVELOPMENT TOOLS THAT ENABLE USERS TO CUSTOMIZE AND DEVELOP WEB PARTS FOR USE IN CONSOLIDATING, MANAGING AND PROVIDING ACCESS TO DISPARATE DATA SOURCES, PROVIDING DATA FUSION AND DATA MINING ACROSS AND WITHIN DATA DOMAINS, AND VISUALIZING CURRENT SITUATIONAL INTELLIGENCE FOR THE PURPOSE OF ENHANCING REAL TIME DECISION MAKING CAPABILITIES RELATED TO COST MANAGEMENT, SCHEDULE DEVELOPMENT, PERFORMANCE EVALUATION AND RISK ASSESSMENT OF VARIOUS ENTERPRISES; COMPUTER CONSULTATION SERVICES RELATED TO INTEGRATED TRADESPACING ENABLING INFORMED DECISION MAKING, NAMELY, COMPUTER SUPPORT SERVICES, COMPUTER PROGRAMMING, COMPUTER SOFTWARE MAINTENANCE, COMPUTER SYSTEMS DEVELOPMENT AND COMPUTER PROGRAMMING FOR OTHERS (U.S. CLS. 100 AND 101).

FIRST USE 8-1-2008; IN COMMERCE 8-1-2008.
 ASMAT KHAN, EXAMINING ATTORNEY

CLASS 42—SCIENTIFIC AND COMPUTER SERVICES

FOR PROVIDING TEMPORARY USE OF ON-LINE NON DOWNLOADABLE VALUE ENGINEERING SOFTWARE DEVELOPMENT TOOLS THAT ENABLE USERS TO CUSTOMIZE AND DEVELOP WEB PARTS FOR USE IN CONSOLIDATING, MANAGING AND PROVIDING ACCESS TO DISPARATE DATA SOURCES, PROVIDING DATA FUSION AND DATA MINING ACROSS AND WITHIN DATA DOMAINS, AND VISUALIZING CURRENT SITUATIONAL INTELLIGENCE FOR THE PURPOSE OF ENHANCING REAL TIME DECISION MAKING CAPABILITIES RELATED TO COST MANAGEMENT, SCHEDULE DEVELOPMENT, PERFORMANCE EVALUATION AND RISK ASSESSMENT OF VARIOUS ENTERPRISES; COMPUTER CONSULTATION SERVICES RELATED TO INTEGRATED TRADESPACING ENABLING INFORMED DECISION MAKING, NAMELY, COMPUTER SUPPORT SERVICES, COMPUTER PROGRAMMING, COMPUTER SOFTWARE MAINTENANCE, COMPUTER SYSTEMS DEVELOPMENT AND COMPUTER PROGRAMMING FOR OTHERS (U.S. CLS. 100 AND 101).

FIRST USE 11-1-2008; IN COMMERCE 11-1-2008.
 ASMAT KHAN, EXAMINING ATTORNEY

SN 77-831,327. LOCKHEED MARTIN CORPORATION, BETHESDA, MD. FILED 9-21-2009.

SN 77-831,345. LOCKHEED MARTIN CORPORATION, BETHESDA, MD. FILED 9-21-2009.



OASIS

OWNER OF U.S. REG. NO. 3,053,753.
 THE MARK CONSISTS OF THE STYLIZED LETTER "O" WITH THE DESIGN OF AN ARCHED LINE BEHIND THE LETTER "O" AND FORMING AN UNDERLINE BELOW THE LETTER "O".

THE MARK CONSISTS OF STANDARD CHARACTERS WITHOUT CLAIM TO ANY PARTICULAR FONT, STYLE, SIZE, OR COLOR.

CLASS 9—ELECTRICAL AND SCIENTIFIC APPARATUS

FOR INTEGRATED TRADESPACING SOFTWARE FOR USE IN CONSOLIDATING, MANAGING AND PROVIDING ACCESS TO DISPARATE DATA SOURCES, PROVIDING DATA FUSION AND DATA MINING ACROSS AND WITHIN DATA DOMAINS, AND VISUALIZING CURRENT SITUATIONAL INTELLIGENCE FOR THE PURPOSE ENHANCING REAL TIME DECISION MAKING CAPABILITIES RELATED TO COST MANAGEMENT, SCHEDULE DEVELOPMENT, PERFORMANCE EVALUATION AND RISK ASSESSMENT OF VARIOUS ENTERPRISES; DOWNLOADABLE APPLICATION PROGRAM INTERFACE SOFTWARE ACCESSIBLE VIA THE WEB FOR USE IN CONSOLIDATING, MANAGING AND PROVIDING ACCESS TO DISPARATE DATA SOURCES, PROVIDING DATA FUSION AND DATA MINING ACROSS AND WITHIN DATA DOMAINS, AND VISUALIZING CURRENT SITUATIONAL INTELLIGENCE FOR THE PURPOSE OF ENHANCING REAL TIME DECISION MAKING CAPABILITIES RELATED TO COST MANAGEMENT, SCHEDULE DEVELOPMENT, PERFORMANCE EVALUATION AND RISK ASSESSMENT OF VARIOUS ENTERPRISES (U.S. CLS. 21, 23, 26, 36 AND 38).

FIRST USE 11-1-2008; IN COMMERCE 11-1-2008.

CLASS 9—ELECTRICAL AND SCIENTIFIC APPARATUS

FOR INTEGRATED TRADESPACING SOFTWARE FOR USE IN CONSOLIDATING, MANAGING AND PROVIDING ACCESS TO DISPARATE DATA SOURCES, PROVIDING DATA FUSION AND DATA MINING ACROSS AND WITHIN DATA DOMAINS, AND VISUALIZING CURRENT SITUATIONAL INTELLIGENCE FOR THE PURPOSE ENHANCING REAL TIME DECISION MAKING CAPABILITIES RELATED TO COST MANAGEMENT, SCHEDULE DEVELOPMENT, PERFORMANCE EVALUATION AND RISK ASSESSMENT OF VARIOUS ENTERPRISES; DOWNLOADABLE APPLICATION PROGRAM INTERFACE SOFTWARE ACCESSIBLE VIA THE WEB FOR USE IN CONSOLIDATING, MANAGING AND PROVIDING ACCESS TO DISPARATE DATA SOURCES, PROVIDING DATA FUSION AND DATA MINING ACROSS AND WITHIN DATA DOMAINS, AND VISUALIZING CURRENT SITUATIONAL INTELLIGENCE FOR THE PURPOSE OF ENHANCING REAL TIME DECISION MAKING CAPABILITIES RELATED TO COST MANAGEMENT, SCHEDULE DEVELOPMENT, PERFORMANCE EVALUATION AND RISK ASSESSMENT OF VARIOUS ENTERPRISES (U.S. CLS. 21, 23, 26, 36 AND 38).

FIRST USE 12-27-2007; IN COMMERCE 12-27-2007.

CLASS 42—SCIENTIFIC AND COMPUTER SERVICES

FOR PROVIDING TEMPORARY USE OF ON-LINE NON DOWNLOADABLE VALUE ENGINEERING SOFTWARE DEVELOPMENT TOOLS THAT ENABLE USERS TO CUSTOMIZE AND DEVELOP WEB PARTS FOR USE IN CONSOLIDATING, MANAGING AND PROVIDING ACCESS TO DISPARATE DATA SOURCES, PROVIDING DATA FUSION AND DATA MINING ACROSS AND WITHIN DATA DOMAINS, AND VISUALIZING CURRENT SITUATIONAL INTELLIGENCE FOR THE PURPOSE OF ENHANCING REAL TIME DECISION MAKING CAPABILITIES RELATED TO COST MANAGEMENT, SCHEDULE DEVELOPMENT, PERFORMANCE EVALUATION AND RISK ASSESSMENT OF VARIOUS ENTERPRISES; COMPUTER CONSULTATION SERVICES RELATED TO INTEGRATED TRADESPACING ENABLING INFORMED DECISION MAKING, NAMELY, COMPUTER SUPPORT SERVICES, COMPUTER PROGRAMMING, COMPUTER SOFTWARE MAINTENANCE, COMPUTER SYSTEMS DEVELOPMENT AND COMPUTER PROGRAMMING FOR OTHERS (U.S. CLS. 100 AND 101).

FIRST USE 12-27-2007; IN COMMERCE 12-27-2007.
 ASMAT KHAN, EXAMINING ATTORNEY

SN 77-832,613. MEEST CORPORATION INC., TORONTO, CANADA, FILED 9-22-2009.

MICT

THE MARK CONSISTS OF STANDARD CHARACTERS WITHOUT CLAIM TO ANY PARTICULAR FONT, STYLE, SIZE, OR COLOR.

PRIORITY CLAIMED UNDER SEC. 44(D) ON CANADA APPLICATION NO. 1435267, FILED 4-14-2009.

THE ENGLISH TRANSLATION OF "MICT" IN THE MARK IS "BRIDGE".

CLASS 16—PAPER GOODS AND PRINTED MATTER

FOR NEWSPAPERS (U.S. CLS. 2, 5, 22, 23, 29, 37, 38 AND 50).

FIRST USE 0-0-1991; IN COMMERCE 0-0-1995.

CLASS 36—INSURANCE AND FINANCIAL

FOR MONEY TRANSMISSION SERVICES IN THE NATURE OF ELECTRONIC FUNDS TRANSFER SERVICES, NAMELY, ARRANGING FOR THE TRANSMISSION OF MONEY FROM ONE PARTY TO ANOTHER THROUGH WIRE TRANSFERS AND ELECTRONIC MEANS (U.S. CLS. 100, 101 AND 102).

FIRST USE 0-0-1991; IN COMMERCE 0-0-1995.

CLASS 39—TRANSPORTATION AND STORAGE

FOR DELIVERY AND COURIER SERVICES BY AIR, LAND, AND SEA, NAMELY, THE CONSOLIDATION AND DELIVERY OF PACKAGES AND PARCELS IN THE NATURE OF DOCUMENTS, LETTERS, FRESH FLOWERS, GIFTS, FOOD PRODUCTS, CARS, TRACTORS, APPLIANCES, FARM EQUIPMENT, COMPUTERS, AND OTHER ELECTRONICS (U.S. CLS. 100 AND 105).

FIRST USE 0-0-1991; IN COMMERCE 0-0-1995.
 DAVID MILLER, EXAMINING ATTORNEY

SN 77-832,950. AUDI AG, INGOLSTADT, FED REP GERMANY, FILED 9-23-2009.

S8

THE MARK CONSISTS OF STANDARD CHARACTERS WITHOUT CLAIM TO ANY PARTICULAR FONT, STYLE, SIZE, OR COLOR.

OWNER OF U.S. REG. NO. 2,534,302.

CLASS 21—HOUSEWARES AND GLASS

FOR TRAVEL TUMBLERS (U.S. CLS. 2, 13, 23, 29, 30, 33, 40 AND 50).

FIRST USE 4-30-2008; IN COMMERCE 4-30-2008.

CLASS 25—CLOTHING

FOR CLOTHING, NAMELY, CAPS (U.S. CLS. 22 AND 39).

FIRST USE 4-30-2008; IN COMMERCE 4-30-2008.
 JOHN KELLY, EXAMINING ATTORNEY

SN 77-833,147. KWU WEDDINGS, LLC, SANFORD, FL. FILED 9-23-2009.

PHOTOMINGLE

THE MARK CONSISTS OF STANDARD CHARACTERS WITHOUT CLAIM TO ANY PARTICULAR FONT, STYLE, SIZE, OR COLOR.

CLASS 9—ELECTRICAL AND SCIENTIFIC APPARATUS

FOR DIGITAL PHOTOGRAPHY SYSTEM COMPRISED OF DIGITAL CAMERAS, COMPUTER HARDWARE, COMPUTER TOUCHSCREEN AND COMPUTER SOFTWARE FOR USE IN TAKING, PROCESSING, DISPLAYING, ORGANIZING, PERSONALIZING, STORING AND REPRODUCING PHOTOGRAPHS FOR OTHERS (U.S. CLS. 21, 23, 26, 36 AND 38).

FIRST USE 9-23-2009; IN COMMERCE 9-23-2009.

CLASS 41—EDUCATION AND ENTERTAINMENT

FOR PHOTOGRAPHY SERVICES FOR OTHERS; DIGITAL PHOTOGRAPHY SERVICES FOR OTHERS, NAMELY, RENTAL OF DIGITAL PHOTOGRAPHIC EQUIPMENT IN THE NATURE OF A SYSTEM COMPRISED OF DIGITAL CAMERAS, COMPUTER TOUCHSCREEN, COMPUTER HARDWARE AND COMPUTER SOFTWARE FOR USE IN THE TAKING, DISPLAYING, ORGANIZING, AND PERSONALIZED EDITING OF PHOTOGRAPHS FOR OTHERS (U.S. CLS. 100, 101 AND 107).

FIRST USE 8-0-2009; IN COMMERCE 8-0-2009.
 NELSON SNYDER, EXAMINING ATTORNEY

SN 77-834,856. YALWA GMBH, WIESBADEN, FED REP GERMANY, FILED 9-25-2009.

askalo

THE MARK CONSISTS OF STANDARD CHARACTERS WITHOUT CLAIM TO ANY PARTICULAR FONT, STYLE, SIZE, OR COLOR.

PRIORITY CLAIMED UNDER SEC. 44(D) ON ERP CMNTY TM OFC APPLICATION NO. 008575871, FILED 9-25-2009, REG. NO. 008575871, DATED 3-1-2010, EXPIRES 9-25-2019.

CLASS 35—ADVERTISING AND BUSINESS

FOR BUSINESS CONSULTANCY; EMPLOYMENT AGENCIES; EMPLOYMENT AGENCIES FEATURING AN ONLINE VIRTUAL JOB MARKET ON THE INTERNET; BUSINESS MARKETING SERVICES; MARKETING CONSULTING; ADVERTISING, EMPLOYMENT AGENCIES, INCLUDING ON THE INTERNET; ELECTRONIC DATA PROCESSING FOR OTHERS; ADVERTISING AND PUBLICITY SERVICES, NAMELY, DISSEMINATING PRIVATE AND COMMERCIAL ADVERTISING MATERIAL INCLUDING CLASSIFIED ADVERTISEMENTS AND JOB ADVERTISEMENTS IN PRINTED OR ELECTRONIC MEDIA; SALES PROMOTION FOR THE GOODS AND SERVICES OF OTHERS, INCLUDING ON THE INTERNET; COMPUTER-AIDED DATABASE MANAGEMENT; UPDATING, NAMELY, COMPILING INFORMATION INTO DATABASES, AND PROVIDING INFORMATION ABOUT THE SAME VIA THE INTERNET; UPDATING, NAMELY, COMPILING INFORMATION INTO DATABASES VIA THE INTERNET AND OTHER DATA NETWORKS, AND PROVIDING INFORMATION ABOUT THE SAME VIA THE INTERNET; UPDATING, NAMELY, COMPILING INFORMATION INTO AN ONLINE COMPUTER DATABASE AND A SEARCHABLE ONLINE COMPUTER DATABASE CONTAINING INFORMATION ON HEALTH, ART, FAMILY, POLITICS, LEISURE TIME, ROMANCE AND WORK (U.S. CLS. 100, 101 AND 102).

CLASS 38—COMMUNICATION

FOR OPERATING AND PRESENTATION OF CHATLINES, NAMELY, PROVIDING VOICE CHAT SERVICES; PROVIDING INTERNET CHATROOMS; PROVIDING ON-LINE FORUMS FOR TRANSMISSION OF MESSAGES AMONG COMPUTER USERS CONCERNING NEWS, SPORTING-EVENTS, EDUCATIONAL COURSES, EDUCATIONAL ACTIVITIES, HOTEL ACCOMMODATION, REAL ESTATE, APARTMENT TIME SHARING, RENTAL OF REAL ESTATE, REAL ESTATE SALES NOTICES, JOB-SEARCH NOTICES, JOB-OFFER NOTICES, JOB HIRING SERVICES, JOB-HIRING CONFERENCES, EMPLOYMENT, CURRICULUM VITAE, VOLUNTEER WORK PROJECTS FOR CHARITABLE ORGANIZATIONS, JOB HIRING SERVICES, COMMUNITY ART FESTIVALS, MISCELLANEOUS SPORTING EVENTS, FAMILY, MOVIE ENTERTAINMENT, LEISURE TIME, ROMANCE, WORK, HEALTH, POLITICS AND ART; NEWS AGENCY AND PRESS REPORT SERVICES, NAMELY, THE TRANSMISSION OF NEWS ITEMS TO NEWS REPORTING ORGANIZATIONS; ELECTRONIC DATA TRANSMISSION OF PRIVATE AND COMMERCIAL ADVERTISEMENTS OF ALL KINDS INCLUDING CLASSIFIED ADVERTISEMENTS AND JOB ADVERTISEMENTS; WEB-MESSAGING; PROVIDING REMOTE INTERNET ACCESS, NAMELY, PROVIDING ACCESS TO ONLINE COMPUTER DATABASES AND ONLINE SEARCHABLE DATABASES CONTAINING CLASSIFIEDS, MESSAGE DIRECTORIES, EVENTS, EDUCATIONS COURSES, CONFERENCES, ACTIVITIES, APARTMENTS, REAL ESTATE, FLAT SHARING, RENTAL, ADVERTISEMENTS, JOB SEARCHES AND OFFERS, EMPLOYMENT, CURRICULA VITAE, VOLUNTARY ACTIVITIES, SERVICES, COMMUNITY, MISCELLANEOUS SUBJECTS, POLITICS, FAMILY, ART, HEALTH, RECREATION, ROMANCE, AND IN-

FORMATION ON A WIDE VARIETY OF TOPICS OF GENERAL INTEREST TO THE PUBLIC; PROVIDING INTERACTIVE ONLINE ELECTRONIC BULLETIN BOARDS FOR TRANSMISSION OF MESSAGES AMONG COMPUTER USERS CONCERNING LISTS OF JOBS, JOB HIRING, EVENT DIRECTORIES, BUSINESS NEWS, AND COLLECTIONS OF CURRICULUM VITAE; PROVIDING INTERACTIVE ONLINE ELECTRONIC BULLETIN BOARDS FOR TRANSMISSION OF MESSAGES AMONG COMPUTER USERS CONCERNING CLASSIFIED ADVERTISEMENTS, NEWS DIRECTORIES, JOB HIRING EVENTS, EDUCATIONAL COURSES, JOB HIRING CONFERENCES, EDUCATIONAL ACTIVITIES, HOTEL ACCOMMODATION, REAL ESTATE, APARTMENT TIME SHARING, RENTAL OF REAL ESTATE, REAL ESTATE SALES NOTICES, JOB SEARCH NOTICES, EMPLOYMENT, CURRICULUM VITAE, VOLUNTEER WORK PROJECTS FOR CHARITABLE ORGANIZATIONS, JOB HIRING SERVICES, COMMUNITY ART FESTIVALS, MISCELLANEOUS SPORTING EVENTS, POLITICS, FAMILY MOVIE ENTERTAINMENT AND ART; PROVIDING ELECTRONIC BULLETIN BOARDS FOR TRANSMISSION OF MESSAGES AMONG USERS IN THE FIELD OF GENERAL INTEREST TO THE PUBLIC; PROVIDING ON-LINE FORUMS FOR TRANSMISSION OF MESSAGES AMONG COMPUTER USERS CONCERNING THE TRANSMISSION OF NEWS IN RELATION TO HEALTH, FAMILY, ART, POLITICS, LEISURE TIME, ROMANCE AND WORK; ELECTRONIC MAIL SERVICES; ELECTRONIC MAIL SERVICES FOR SUBSCRIBERS; ELECTRONIC TRANSMISSION OF MESSAGES, DATA AND IMAGES; ONLINE TELEPHONE DIRECTORY SERVICES, NAMELY, TELEPHONE CALL COMPLETION SERVICES FOR DIRECTORY ASSISTANCE CUSTOMERS; PROVIDING ACCESS TO AN ONLINE COMPUTER DATABASE AND SEARCHABLE ONLINE COMPUTER DATABASES CONTAINING CLASSIFIED ADVERTISEMENTS AND DIRECTORIES WITH NEWS, SPORTING EVENTS, EDUCATIONAL COURSES, JOB HIRING CONFERENCES, EDUCATIONAL ACTIVITIES, HOTEL ACCOMMODATION, REAL ESTATE, APARTMENT TIME SHARING, RENTAL OF REAL ESTATE, REAL ESTATE SALES NOTICES, JOB SEARCH NOTICES, EMPLOYMENT, CURRICULUM VITAE, VOLUNTEER WORK PROJECT FOR CHARITABLE ORGANIZATIONS, JOB HIRING SERVICES, COMMUNITY ART FESTIVALS, MISCELLANEOUS SPORTING EVENTS, POLITICS, FAMILY MOVIE ENTERTAINMENT AND ART; PROVIDING ACCESS TO AN ONLINE COMPUTER DATABASE AND A SEARCHABLE ONLINE DATABASE CONTAINING INFORMATION ON HEALTH, ART, FAMILY, POLITICS, LEISURE TIME, ROMANCE AND WORK (U.S. CLS. 100, 101 AND 104).

CLASS 42—SCIENTIFIC AND COMPUTER SERVICES

FOR DESIGN, DEVELOPMENT AND IMPLEMENTATION OF COMPUTER SOFTWARE AND SOFTWARE SYSTEMS FOR WEBHOSTING AND FOR COMPUTER SYSTEMS FOR OTHERS, AND PROVIDING INFORMATION ABOUT THE SAME VIA THE INTERNET; DESIGN, DEVELOPMENT AND IMPLEMENTATION OF COMPUTER SOFTWARE AND SOFTWARE SYSTEMS FOR WEBHOSTING AND FOR COMPUTER SYSTEMS FOR OTHERS VIA THE INTERNET AND OTHER DATA NETWORKS, AND PROVIDING INFORMATION ABOUT THE SAME VIA THE INTERNET; DESIGN, DEVELOPMENT AND IMPLEMENTATION OF INTERNET WEBSITES FOR OTHERS, AND PROVIDING INFORMATION ABOUT THE SAME VIA THE INTERNET; CREATION AND MAINTENANCE OF INTERNET WEBSITES FOR OTHERS, AND PROVIDING INFORMATION ABOUT THE SAME VIA THE INTERNET; INSTALLATION OF COMPUTER SOFTWARE FOR OTHERS, AND PROVIDING INFORMATION ABOUT THE SAME VIA THE INTERNET; INSTALLATION OF COMPUTER SOFTWARE FOR OTHERS VIA THE INTERNET AND OTHER DATA NETWORKS, AND PROVIDING INFORMATION ABOUT THE SAME VIA THE INTERNET; MAINTENANCE OF COMPUTER SOFTWARE, AND PROVIDING INFORMATION ABOUT THE SAME VIA THE INTERNET, MAINTENANCE OF COMPUTER SOFTWARE VIA THE INTERNET AND OTHER DATA NETWORKS, AND PROVIDING INFORMATION ABOUT THE SAME VIA THE INTERNET; PROVIDING TEMPORARY USE OF ON-LINE NON-DOWNLOADABLE SOFTWARE FOR

USE IN DATABASE MANAGEMENT, AND PROVIDING INFORMATION ABOUT THE SAME VIA THE INTERNET; RENTAL OF COMPUTER SOFTWARE FOR WEB-HOSTING AND FOR COMPUTER SYSTEMS, AND PROVIDING INFORMATION ABOUT THE SAME VIA THE INTERNET; DESIGN, DEVELOPMENT, UPDATING IN THE NATURE OF COMPUTER PROGRAMMING, AND MAINTENANCE OF DATABASES, AND PROVIDING INFORMATION ABOUT THE SAME VIA THE INTERNET; DESIGN, DEVELOPMENT, UPDATING IN THE NATURE OF UPDATING IN THE NATURE OF COMPUTER PROGRAMMING AND MAINTENANCE OF DATABASES VIA THE INTERNET AND OTHER DATA NETWORKS, AND PROVIDING INFORMATION ABOUT THE SAME VIA THE INTERNET; COMPUTER PROGRAMMING, AND PROVIDING INFORMATION ABOUT THE SAME VIA THE INTERNET; SCIENTIFIC RESEARCH, AND PROVIDING INFORMATION ABOUT THE SAME VIA THE INTERNET; TECHNOLOGY CONSULTATION AND RESEARCH IN THE FIELD OF COMPUTER SCIENCE AND INTERNET SEARCH MACHINES AND INTERNET SEARCH STRATEGIES, AND PROVIDING INFORMATION ABOUT THE SAME VIA THE INTERNET; COMPUTER CODE CONVERSION FOR OTHERS, AND PROVIDING INFORMATION ABOUT THE SAME VIA THE INTERNET; DATA CONVERSION OF COMPUTER PROGRAM DATA, AND PROVIDING INFORMATION ABOUT THE SAME VIA THE INTERNET; CONSULTATION IN THE FIELD OF DEVELOPMENT OF ELECTRONIC DATA PROCESSING PROGRAMS BY ORDER OF THIRD PARTIES, AND PROVIDING INFORMATION ABOUT THE SAME VIA THE INTERNET; COMPUTER SOFTWARE CONSULTATION, AND PROVIDING INFORMATION ABOUT THE SAME VIA THE INTERNET; INFORMATION TECHNOLOGY CONSULTATION IN THE FIELD OF ELECTRONIC DATA PROCESSING, AND PROVIDING INFORMATION ABOUT THE SAME VIA INTERNET; TECHNICAL COMPUTER PROJECT MANAGEMENT SERVICES IN THE FIELD OF ELECTRONIC DATA PROCESSING, AND PROVIDING INFORMATION ABOUT THE SAME VIA THE INTERNET; DATABASE SERVICES, NAMELY, COMPUTER PROGRAMMING AND DEVELOPMENT OF SOFTWARE FOR DATABASES, AND PROVIDING INFORMATION ABOUT THE SAME VIA THE INTERNET; DEVELOPMENT OF AN ONLINE COMPUTER DATABASE AND SEARCHABLE ONLINE COMPUTER DATABASES FOR CLASSIFIED ADVERTISEMENTS, NEWS DIRECTORIES, JOB HIRING EVENTS, EDUCATIONAL COURSES, JOB HIRING CONFERENCES, EDUCATIONAL ACTIVITIES, HOTEL ACCOMMODATION, REAL ESTATE, APARTMENT TIME SHARING, RENTAL OF REAL ESTATE, REAL ESTATE SALES NOTICES, JOB SEARCH NOTICES, EMPLOYMENT, CURRICULUM VITAE, VOLUNTEER WORK PROJECTS FOR CHARITABLE ORGANIZATIONS, JOB HIRING SERVICES, COMMUNITY ART FESTIVALS, MISCELLANEOUS SPORTING EVENTS, POLITICS, FAMILY MOVIE ENTERTAINMENT AND ART; DEVELOPMENT AND UPDATING IN THE NATURE OF UPDATING IN THE NATURE OF COMPUTER PROGRAMMING OF AN ONLINE COMPUTER DATABASE AND A SEARCHABLE ONLINE COMPUTER DATABASE CONTAINING INFORMATION ON HEALTH, ART, FAMILY, POLITICS, LEISURE TIME, ROMANCE AND WORK; COMPUTER SERVICES, NAMELY, HOSTING ONLINE WEB FACILITIES FOR OTHERS FOR ORGANIZING AND CONDUCTING ONLINE MEETINGS, GATHERINGS AND INTERACTIVE ONLINE DISCUSSIONS; COMPUTER SERVICES IN THE FORM OF CUSTOMIZED WEBSITES WITH USER DEFINED INFORMATION, PERSONAL PROFILES AND INFORMATION (U.S. CLS. 100 AND 101).

CLASS 45—PERSONAL AND LEGAL SERVICES

FOR LICENSING OF COMPUTER PROGRAMS AND DATABASES FOR USE BY OTHERS AND ALSO FOR USE ON THE INTERNET AND OTHER DATA NETWORKS (U.S. CLS. 100 AND 101).
APRIL ROACH, EXAMINING ATTORNEY

SN 77-836,060. BICK GROUP, INC., DES PERES, MO. FILED 9-28-2009.

MISSION CRITICAL. VISION PRACTICAL.

THE MARK CONSISTS OF STANDARD CHARACTERS WITHOUT CLAIM TO ANY PARTICULAR FONT, STYLE, SIZE, OR COLOR.

CLASS 37—CONSTRUCTION AND REPAIR

FOR CONSTRUCTION OF COMMERCIAL BUILDINGS; CONSTRUCTION OF DATA CENTERS; CONSTRUCTION OF RAISED-ACCESS FLOORING; INSTALLATION, REPAIR, AND MAINTENANCE OF CONTROL SYSTEMS FOR BUILDINGS, NAMELY, ELECTRICAL SYSTEMS, LIGHTING SYSTEMS, AND HEATING, VENTILATING, AND AIR CONDITIONING SYSTEMS; INSTALLATION, REPAIR, AND MAINTENANCE OF DATA CENTER FACILITIES AND EQUIPMENT, NAMELY, MECHANICAL AND ELECTRICAL SYSTEMS, COMPUTER ROOM AIR CONDITIONING UNITS, UNINTERRUPTIBLE POWER SUPPLY SYSTEMS, GENERATORS, SWITCH GEARS, AND INFORMATION TECHNOLOGY INFRASTRUCTURE SYSTEMS, NAMELY, SERVERS, STORAGE UNITS, AND SECURITY SYSTEMS; INSTALLATION, REPAIR, AND MAINTENANCE OF FIRE ALARM, DETECTION, AND SUPPRESSION SYSTEMS; INSTALLATION OF CONTROL SYSTEMS FOR DATA CENTERS, NAMELY, INFRASTRUCTURE MONITORING SYSTEMS, CARD ACCESS SYSTEMS, CLOSED CIRCUIT TELEVISION SYSTEMS, AND HEATING, VENTILATING, AND AIR CONDITIONING SYSTEMS (U.S. CLS. 100, 103 AND 106).
FIRST USE 9-2-2008; IN COMMERCE 9-2-2008.

CLASS 42—SCIENTIFIC AND COMPUTER SERVICES

FOR ARCHITECTURAL AND ENGINEERING DESIGN; DESIGN OF DATA CENTERS; DESIGN OF HIGH TECHNOLOGY OFFICE SPACE; FACILITY ANALYSIS, NAMELY, ANALYSIS OF BUILDING INFRASTRUCTURE SECURITY SYSTEMS; DESIGN OF CONTROL SYSTEMS FOR BUILDINGS, NAMELY, ELECTRICAL SYSTEMS, LIGHTING SYSTEMS, AND HEATING, VENTILATING, AND AIR CONDITIONING SYSTEMS; DESIGN OF CONTROL SYSTEMS FOR DATA CENTERS, NAMELY, INFRASTRUCTURE MONITORING SYSTEMS, CARD ACCESS SYSTEMS, CLOSED CIRCUIT TELEVISION SYSTEMS, AND HEATING, VENTILATING, AND AIR CONDITIONING SYSTEMS; DESIGN AND INSPECTION OF FIRE ALARM, DETECTION, AND SUPPRESSION SYSTEMS; INSTALLATION, REPAIR, AND MAINTENANCE OF COMPUTER SOFTWARE (U.S. CLS. 100 AND 101).
FIRST USE 9-2-2008; IN COMMERCE 9-2-2008.
ROBIN CHOSID, EXAMINING ATTORNEY

SN 77-836,888. RAINBOW TREECARE SCIENTIFIC ADVANCEMENTS, INC., MINNETONKA, MN. FILED 9-29-2009.

TREECORE

THE MARK CONSISTS OF STANDARD CHARACTERS WITHOUT CLAIM TO ANY PARTICULAR FONT, STYLE, SIZE, OR COLOR.

CLASS 5—PHARMACEUTICALS

FOR CHEMICAL COMPOSITIONS, NAMELY, HERBICIDES, INSECTICIDES AND PESTICIDES FOR AGRICULTURAL OR DOMESTIC USE (U.S. CLS. 6, 18, 44, 46, 51 AND 52).

SN 77-839,011. PARK RIDGE SECURITIES CORP., NEW PROVIDENCE, BAHAMAS, FILED 10-1-2009.

CLASS 35—ADVERTISING AND BUSINESS

FOR PREPARING PROMOTIONAL AND MERCHANDISING MATERIALS FOR OTHERS IN THE FIELDS OF ARBORICULTURE, HORTICULTURE AND AGRICULTURE (U.S. CLS. 100, 101 AND 102).

THEODORE MCBRIDE, EXAMINING ATTORNEY

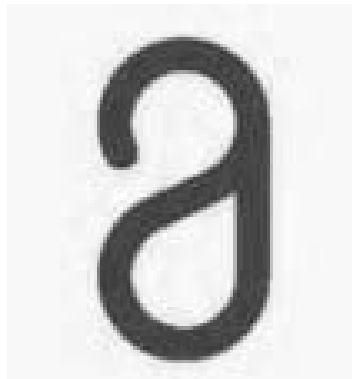

SN 77-837,927. PETRA INVENTUM, S.L., SANT CUGAT DEL VALLES, SPAIN, FILED 9-30-2009.

OWNER OF U.S. REG. NO. 3,374,456.
THE MARK CONSISTS OF A SMALL LETTER "A".

CLASS 16—PAPER GOODS AND PRINTED MATTER

FOR NON-METAL MONEY CLIPS (U.S. CLS. 2, 5, 22, 23, 29, 37, 38 AND 50).

**CLASS 18—LEATHER GOODS**

FOR UMBRELLAS AND GOLF UMBRELLAS; ATHLETIC BAGS, GARMENT BAGS FOR TRAVEL, TOTE BAGS, SHOE BAGS FOR TRAVEL, BACK PACKS, WAIST PACKS, AND FANNY PACKS; LEATHER BILFOLDS; LEATHER KEY CHAINS; ATTACHE CASES AND BRIEFCASES; HANDBAGS, PURSES, AND WALLET AND GOLF SHOE BAGS FOR TRAVEL (U.S. CLS. 1, 2, 3, 22 AND 41).

NO CLAIM IS MADE TO THE EXCLUSIVE RIGHT TO USE "SOLAR ITEM" FOR INTERNATIONAL CLASS 6, APART FROM THE MARK AS SHOWN.

THE COLOR(S) GREEN, YELLOW, BLACK, AND GRAY IS/ARE CLAIMED AS A FEATURE OF THE MARK.

THE MARK CONSISTS OF EIGHT PAIRS OF TWO LEAF-LIKE DESIGNS IN THE COLORS, YELLOW, GREEN AND GRAY. THE DESIGNS OVERLAP EACH OTHER IN A CIRCULAR-LIKE PATTERN, WITH THE WORDS "SOLAR ITEM" IN THE COLOR BLACK TO THE RIGHT OF THE DESIGN.

CLASS 20—FURNITURE AND ARTICLES NOT OTHERWISE CLASSIFIED

FOR GOLF STOOLS AND CHAIRS; CHAIR PADS; PILLOWS (U.S. CLS. 2, 13, 22, 25, 32 AND 50).

CLASS 6—METAL GOODS

FOR METAL BUILDING MATERIALS, NAMELY, GALVANIZED STEEL (U.S. CLS. 2, 12, 13, 14, 23, 25 AND 50).

CLASS 36—INSURANCE AND FINANCIAL

FOR REAL ESTATE BROKERAGE SERVICES (U.S. CLS. 100, 101 AND 102).

CLASS 40—MATERIAL TREATMENT

FOR GENERATION OF ENERGY AND ELECTRICITY, IN PARTICULAR IN THE FIELD OF RENEWABLE ENERGY (U.S. CLS. 100, 103 AND 106).

CLASS 39—TRANSPORTATION AND STORAGE

FOR MARINA SERVICES (U.S. CLS. 100 AND 105).

CLASS 42—SCIENTIFIC AND COMPUTER SERVICES

FOR RESEARCH AND DEVELOPMENT IN THE FIELD OF RENEWABLE ENERGIES (U.S. CLS. 100 AND 101).

JEAN IM, EXAMINING ATTORNEY

CLASS 41—EDUCATION AND ENTERTAINMENT

FOR HEALTH CLUB SERVICES, NAMELY, PROVIDING INSTRUCTION AND EQUIPMENT IN THE FIELD OF PHYSICAL EXERCISE; PROVIDING GOLF COURSE FACILITIES, PROVIDING GOLF INSTRUCTION AND ENTERTAINMENT IN THE NATURE OF GOLF TOURNAMENTS, AND PROVIDING EDUCATIONAL SERVICES, NAMELY, CONDUCTING SEMINARS, WORKSHOPS AND CLASSES IN THE FIELD OF GOLF; PROVIDING TENNIS COURT FACILITIES; PROVIDING HEALTH AND FITNESS INFORMATION AND CONSULTATION RELATING TO THE CONDUCTING OF CLASSES FEATURING HEALTH AND FITNESS (U.S. CLS. 100, 101 AND 107).

CLASS 43—HOTEL AND RESTAURANT SERVICES

FOR RESORT LODGING SERVICES, HOTEL, RESTAURANT AND BAR SERVICES (U.S. CLS. 100 AND 101).

CLASS 44—MEDICAL, BEAUTY AND AGRICULTURAL SERVICES

FOR HEALTH SPA SERVICES FEATURING SKIN CARE AND HAIR CARE SERVICES, FACIAL TREATMENTS, AROMA THERAPY, BODY AND FACIAL WAXING, BODY TREATMENTS, MASSAGE THERAPY, MANICURE AND PEDICURE SERVICES, BEAUTY SALON SERVICES; PROVIDING HEALTH AND FITNESS INFORMATION AND CONSULTATION RELATING TO THE PROVIDING OF HEALTH SPA SERVICES FEATURING SKIN CARE AND HAIR CARE SERVICES (U.S. CLS. 100 AND 101).

JENNY PARK, EXAMINING ATTORNEY

SN 77-839,190. DELTA AIR LINES, INC., ATLANTA, GA. FILED 10-1-2009.

SKY PRIORITY

THE MARK CONSISTS OF STANDARD CHARACTERS WITHOUT CLAIM TO ANY PARTICULAR FONT, STYLE, SIZE, OR COLOR.

NO CLAIM IS MADE TO THE EXCLUSIVE RIGHT TO USE "PRIORITY", APART FROM THE MARK AS SHOWN.

CLASS 35—ADVERTISING AND BUSINESS

FOR PROVIDING AN INCENTIVE AWARD PROGRAM FOR CUSTOMERS THROUGH THE ISSUANCE OF BONUS AWARDS AND SERVICE INCENTIVES FOR FREQUENT AIR TRAVEL, NAMELY, TRANSIT LOUNGE FACILITIES FOR PASSENGER RELAXATION, A SPECIALIZED PRIORITY AIRLINE SERVICE WITH RESERVATION SERVICES, ENHANCED AIRPORT TICKETING PROCESSING, EXPEDITED CALL WAITING PROCEDURES, PRIORITY CHECK-IN, PRIORITY LOBBY CHECK-IN, DEDICATED SERVICE CENTER AND CLUB LANES FOR ELITE PASSENGERS, SPECIALIZED PRIORITY AND EXPEDITED SECURITY PROCESSING, EXPEDITED GATE HANDLING AND AIRCRAFT BOARDING SERVICES, ENHANCED SEATING ACCOMMODATIONS, ENHANCED PERSONAL SPACE INCLUDING SPECIALIZED ENTERTAINMENT, COMPUTER CONNECTIONS, ENHANCED MEAL SERVICES AND VOUCHER VALUES FOR ELITE PASSENGERS, PRIORITY BAGGAGE DELIVERY, ENHANCED AND EXPEDITED CUSTOMER SERVICE RESPONSES FOR ELITE PASSENGERS (U.S. CLS. 100, 101 AND 102).

CLASS 39—TRANSPORTATION AND STORAGE

FOR AIR TRANSPORTATION SERVICES (U.S. CLS. 100 AND 105).

MARK PILARO, EXAMINING ATTORNEY

SN 77-840,448. TERRY ENTERPRISES, LLC, AUSTIN, TX. FILED 10-2-2009.

P. Terry's

THE MARK CONSISTS OF STANDARD CHARACTERS WITHOUT CLAIM TO ANY PARTICULAR FONT, STYLE, SIZE, OR COLOR.

THE NAME(S), PORTRAIT(S), AND/OR SIGNATURE(S) SHOWN IN THE MARK IDENTIFIES PATRICK "TERRY", WHOSE CONSENT(S) TO REGISTER IS MADE OF RECORD.

CLASS 25—CLOTHING

FOR ATHLETIC APPAREL, NAMELY, SHIRTS, PANTS, JACKETS, FOOTWEAR, HATS AND CAPS, ATHLETIC UNIFORMS; BASEBALL CAPS; HATS; SHIRTS; SHIRTS AND SHORT-SLEEVED SHIRTS; T-SHIRTS (U.S. CLS. 22 AND 39).

FIRST USE 3-15-2005; IN COMMERCE 7-15-2005.

CLASS 43—HOTEL AND RESTAURANT SERVICES

FOR CAFE-RESTAURANTS; CARRY-OUT RESTAURANTS; ICE CREAM SHOP SERVICES IN THE NATURE OF A RESTAURANT; RESTAURANT; RESTAURANT AND CATERING SERVICES; RESTAURANTS (U.S. CLS. 100 AND 101).

FIRST USE 3-15-2005; IN COMMERCE 7-15-2005.

SUNG IN, EXAMINING ATTORNEY

SN 77-842,047. E.W. HOWELL CO., LLC, WOODBURY, NY. FILED 10-6-2009.

EW HOWELL

THE COLOR(S) GRAY AND BLUE IS/ARE CLAIMED AS A FEATURE OF THE MARK.

THE MARK CONSISTS OF THE LETTERS "E" AND "W" IN GRAY AND THE WORD "HOWELL" IN BLUE. SEC. 2(F).

CLASS 37—CONSTRUCTION AND REPAIR

FOR PROJECT MANAGEMENT SERVICES FOR OTHERS IN THE FIELD OF BUILDING CONSTRUCTION; CONSTRUCTION PROGRAM MANAGEMENT; CONSTRUCTION PROJECT MANAGEMENT; BUILDING CONSTRUCTION SERVICES; GENERAL CONSTRUCTION CONTRACTING; CONSULTING IN THE FIELD OF BUILDING CONSTRUCTION; CONSTRUCTION MANAGEMENT; CONSTRUCTION PLANNING SERVICES; DESIGN-BUILD SERVICES, NAMELY, BUILDING CONSTRUCTION CONTRACTOR SERVICES (U.S. CLS. 100, 103 AND 106).

FIRST USE 2-0-2005; IN COMMERCE 2-0-2005.

CLASS 42—SCIENTIFIC AND COMPUTER SERVICES

FOR PROJECT MANAGEMENT SERVICES FOR OTHERS IN THE FIELD OF BUILDING DESIGN; CONSULTING SERVICES IN THE FIELD OF BUILDING DESIGN; DESIGN-BUILD SERVICES, NAMELY, BUILDING DESIGN CONTRACTOR SERVICES (U.S. CLS. 100 AND 101).

FIRST USE 2-0-2005; IN COMMERCE 2-0-2005.

CAROLINE WOOD, EXAMINING ATTORNEY

SN 77-844,423. PATRICK INDUSTRIES, INC., ELKHART, IN.
FILED 10-8-2009.SN 77-842,048. E.W. HOWELL CO., LLC, WOODBURY, NY.
FILED 10-6-2009.

E. W. HOWELL

SUDDEN CHANGE

THE MARK CONSISTS OF STANDARD CHARACTERS WITHOUT CLAIM TO ANY PARTICULAR FONT, STYLE, SIZE, OR COLOR.
SEC. 2(F).

CLASS 37—CONSTRUCTION AND REPAIR

FOR PROJECT MANAGEMENT SERVICES FOR OTHERS IN THE FIELD OF BUILDING CONSTRUCTION; CONSTRUCTION PROGRAM MANAGEMENT; CONSTRUCTION PROJECT MANAGEMENT; BUILDING CONSTRUCTION SERVICES; GENERAL CONSTRUCTION CONTRACTING; CONSULTING IN THE FIELD OF BUILDING CONSTRUCTION; CONSTRUCTION MANAGEMENT; CONSTRUCTION PLANNING SERVICES; DESIGN-BUILD SERVICES, NAMELY, BUILDING CONSTRUCTION CONTRACTOR SERVICES (U.S. CLS. 100, 103 AND 106).

FIRST USE 0-0-1891; IN COMMERCE 0-0-1891.

CLASS 42—SCIENTIFIC AND COMPUTER SERVICES

FOR PROJECT MANAGEMENT SERVICES FOR OTHERS IN THE FIELD OF BUILDING DESIGN; CONSULTING SERVICES IN THE FIELD OF BUILDING DESIGN; DESIGN-BUILD SERVICES, NAMELY, BUILDING DESIGN CONTRACTOR SERVICES (U.S. CLS. 100 AND 101).

FIRST USE 0-0-1891; IN COMMERCE 0-0-1891.
CAROLINE WOOD, EXAMINING ATTORNEY

THE MARK CONSISTS OF STANDARD CHARACTERS WITHOUT CLAIM TO ANY PARTICULAR FONT, STYLE, SIZE, OR COLOR.

CLASS 17—RUBBER GOODS

FOR ADHESIVE TAPE FOR INDUSTRIAL AND COMMERCIAL USE; NON-METAL CONSTRUCTION MATERIAL, NAMELY, COVERING TAPE AND TAPE APPLICATORS SOLD AS A UNIT USED IN COVERING AND CONSTRUCTING CEILINGS (U.S. CLS. 1, 5, 12, 13, 35 AND 50).

CLASS 19—NON-METALLIC BUILDING MATERIALS

FOR COMPONENTS FOR CONSTRUCTING CEILINGS, NAMELY, NON-METAL CEILING PANELS, NON-METAL MOLDINGS, NON-METAL CORNER BLOCKS (U.S. CLS. 1, 12, 33 AND 50).

ELISSA GARBER KON, EXAMINING ATTORNEY

SN 77-842,855. SONY COMPUTER ENTERTAINMENT
AMERICA LLC, FOSTER CITY, CA. FILED 10-6-2009.

SORCERY

SN 77-845,926. ANABEL HATFIELD, LLC, DBA ANABEL'S
KENNELS, HOUSTON, TX. FILED 10-9-2009.

THE MARK CONSISTS OF STANDARD CHARACTERS WITHOUT CLAIM TO ANY PARTICULAR FONT, STYLE, SIZE, OR COLOR.

CLASS 9—ELECTRICAL AND SCIENTIFIC APPARATUS

FOR COMPUTER GAME SOFTWARE AND VIDEO GAME SOFTWARE (U.S. CLS. 21, 23, 26, 36 AND 38).

CLASS 41—EDUCATION AND ENTERTAINMENT

FOR PROVIDING A REAL-TIME COMPUTER GAME FOR OTHERS THAT MAY BE ACCESSED OVER GLOBAL AND LOCAL AREA COMPUTER NETWORKS BY NETWORK USERS (U.S. CLS. 100, 101 AND 107).
CHRISTINA SOBRAL, EXAMINING ATTORNEY

THE TOOTHLESS PRINCESS

THE MARK CONSISTS OF STANDARD CHARACTERS WITHOUT CLAIM TO ANY PARTICULAR FONT, STYLE, SIZE, OR COLOR.

CLASS 9—ELECTRICAL AND SCIENTIFIC APPARATUS

FOR ELECTRICAL AND SCIENTIFIC APPARATUS, NAMELY, MOTION PICTURES, FILMS, TELEVISION PROGRAMS, AND INTERACTIVE PROGRAMS, ALL RELATING TO FICTIONAL RESCUE AND ADOPTED ANIMALS; PRERECORDED VIDEO AND AUDIO CASSETTES, VIDEO AND AUDIO TAPES, VIDEO AND AUDIO DISCS, CD ROMS, COMPACT DISCS, DIGITAL VERSATILE DISCS, MUSICAL VIDEO RECORDINGS, MUSICAL SOUND RECORDINGS AND PHONOGRAPH RECORDS, ALL RELATING TO FICTIONAL RESCUE AND ADOPTED ANIMALS; SOFTWARE AND MANUALS SOLD AS A UNIT IN THE FIELD OF ENTERTAINMENT, NAMELY, FOR USE IN CREATING, UPDATING AND MAINTAINING CALENDARS, FOR INFORMATION MANAGEMENT AND FOR USE AS COMPUTER SCREEN SAVERS; COMPUTER GAME SOFTWARE; COMPUTER AND VIDEO-GAME CASSETTES, CARTRIDGES, DISCS AND PROGRAMS; DOWNLOADABLE GAME SOFTWARE; DOWNLOADABLE COMPUTER GAMES; DOWNLOADABLE RING TONES, MUSIC AND GRAPHICS FOR WIRELESS COMMUNICATION DEVICES; DOWNLOADABLE AUDIO FILES AND VIDEO RECORDINGS FEATURING MUSIC AND MUSIC-RELATED ENTERTAINMENT; DOWNLOADABLE COMPUTER GAME PROGRAMS VIA A GLOBAL COMPUTER NETWORK; COMPUTER GAME AND VIDEO GAME EQUIPMENT CONTAINING MEMORY DEVICES, NAMELY, COMPUTER GAME AND VIDEO GAME SOFTWARE, TAPES, CARTRIDGES, CASSETTES, JOYSTICKS AND REMOTE CONTROL UNITS; HAND HELD UNITS FOR PLAYING ELECTRONIC GAMES ADAPTED FOR USE WITH AN EXTERNAL DISPLAY SCREEN OR MONITOR; GRADUATED MEASURING RULERS; AND SNORKELS (U.S. CLS. 21, 23, 26, 36 AND 38).

CLASS 16—PAPER GOODS AND PRINTED MATTER

FOR PAPER GOODS AND PRINTED MATTER, NAMELY, A SERIES OF FICTION BOOKS, CHILDREN'S BOOKS, COMIC BOOKS AND MAGAZINES FEATURING FICTIONAL RESCUE AND ADOPTED ANIMALS; REFERENCE GUIDE BOOKS; GRAPHIC NOVELS; PRINTED POSTCARDS; PICTURE POSTCARDS; COMIC POSTCARDS; POSTCARDS; TRADING CARDS AND COLLECTORS CARDS FEATURING FICTIONAL RESCUE AND ADOPTED ANIMALS; NOTEBOOKS; BINDERS; DECALS; STICKERS; POSTERS; PHOTOGRAPH AND SCRAPBOOK ALBUMS; CALENDARS; GREETING CARDS; FOLDERS; DESK PADS; WRITING PADS; STATIONERY FOLDERS; STATIONERY; PENS; PENCILS; ERASERS; VIDEO GAME STRATEGY MANUALS AND BOOKS; COMPUTER GAME INSTRUCTION MANUALS; PAPER TOWELS; PAPER STORAGE CONTAINERS; CHALK BOARDS; DRY ERASE WRITING BOARDS AND WRITING SURFACES; PAPER FLAGS; PAPER PENNANTS; GLUE FOR OFFICE USE; ADHESIVE TAPE FOR STATIONERY PURPOSES (U.S. CLS. 2, 5, 22, 23, 29, 37, 38 AND 50).

CLASS 24—FABRICS

FOR BED SHEETS; FITTED BED SHEET COVERS; BED FLAT SHEETS; PILLOW CASES; BED BLANKETS; BED SKIRTS; AND BED THROWS (U.S. CLS. 42 AND 50).

CLASS 25—CLOTHING

FOR CLOTHING, NAMELY, SHIRTS, SWEATSHIRTS, SWEATERS, VESTS, JACKETS, WARM-UP SUITS, ROBES, PANTS, SHORTS, CLOTHING BELTS, DRESSES, OVERALLS, INFANTWEAR, PLAYSUITS, CLOTH BIBS, HEADWEAR, FOOTWEAR, BOOTS, SOCKS, TIGHTS, BEACHWEAR, SWIMSUITS, SWIMWEAR, BATHING CAPS, TENNIS WEAR, RAINWEAR, JACKETS, COATS, GLOVES, MUFFLERS, HATS, SUN VISORS, NECKWEAR, CUMMERBUNDS, BANDANAS, SCARVES, PAJAMAS, NIGHTSHIRTS, NIGHTGOWNS, UNDERGARMENTS, APRONS, MASQUERADE COSTUMES, MASQUERADE COSTUMES WITH MASKS SOLD IN CONNECTION THEREWITH, TANK TOPS, UNDERWEAR, WRISTBANDS, T-SHIRTS, HOODED SWEATSHIRTS, CAPS AND POLO SHIRTS (U.S. CLS. 22 AND 39).

CLASS 28—TOYS AND SPORTING GOODS

FOR TOYS AND SPORTING GOODS, NAMELY, STUFFED ANIMALS AND ACCESSORIES THEREFOR, DOLLS AND ACCESSORIES THEREFOR, DOLL PLAYSETS, PLUSH TOYS, STUFFED TOYS, PUPPETS, WIND-UP TOYS, BOARD GAMES, CARD GAMES, DOMINOES, JIGSAW PUZZLES, MANIPULATIVE GAMES, MARBLES, PADDLE BALL GAMES, YO-YO'S, BALLOONS, JUMP ROPES, KITES AND ACCESSORIES THEREFOR, BUBBLE MAKING WANDS AND SOLUTION SETS, MAGIC TRICKS, BATH TOYS, PLAY SWIMMING POOLS, TOY VEHICLES AND ACCESSORIES THEREFOR, TOY MODEL HOBBY CRAFT KITS, TOY BANKS, TOY BOXES, TOY GUNS, TOY HOLSTERS, TOY ARCHERY BOWS AND ARROWS, TOY ROCKETS, TOY BUCKET AND SHOVEL SETS, CHILDREN'S PLAY COSMETICS, BABY RATTLES, BABY MULTIPLE ACTIVITY TOYS, TOY CONSTRUCTION BLOCKS, MUSICAL TOYS, TARGET GAMES, ACTION SKILL GAMES, BALLS, BASEBALLS, BASKETBALLS, FOOTBALLS, GOLF BALLS, TENNIS BALLS, PLAYGROUND BALLS, SPORT BALLS, SOCCER BALLS, VOLLEYBALLS, RUBBER BALLS, FOAM BALLS, BASEBALL BATS, BASEBALL GLOVES, FLYING DISKS, DISC TYPE TOSS TOYS, BODY BOARDS, BADMINTON SETS, DART FLIGHTS, GOLF CLUB HEAD COVERS, ROLLER SKATES, SKATEBOARDS, TOY SCOOTERS, SWIM FINNS, SWIM FLOATS FOR RECREATIONAL USE, FACE MASKS, PINBALL-TYPE GAMES, CHRISTMAS TREE DECORATIONS, EGG DECORATING KITS, HAND HELD UNITS FOR PLAYING ELECTRONIC GAMES OTHER THAN THOSE ADAPTED FOR USE WITH AN EXTERNAL DISPLAY SCREEN OR MONITOR, ARCADE GAME MACHINES, STAND-ALONE VIDEO GAME MACHINES, LCD GAME MACHINES, BEACH BALLS, IN-LINE SKATES, RIDE-ON TOYS, TOY SWORDS, PLAYING CARDS, CHARACTER TOYS AND TOY VEHICLES; TOY PURSES; TOY WALLET; TOY BACKPACKS; TOY LUGGAGE; TOY PET/DOG CARRIERS; TOY PET/DOG HOUSES; TOY PET/DOG BEDS; TOY PET BOWLS; TOY PET/DOG TOYS; TOY DECORATIVE PILLOWS; TOY TENTS; TOY STROLLERS; TOY TRUNKS; TOY CASES; TOY COVERED WAGONS (U.S. CLS. 22, 23, 38 AND 50).

CLASS 41—EDUCATION AND ENTERTAINMENT

FOR ENTERTAINMENT SERVICES, NAMELY, PRODUCTION AND DISTRIBUTION OF MOTION PICTURES, FILMS, TELEVISION PROGRAMS, AND RADIO PROGRAMS RELATING TO FICTIONAL RESCUE OR ADOPTED ANIMALS; ENTERTAINMENT SERVICES, NAMELY, PRODUCING AND PROVIDING ONLINE COMPUTER GAMES, ONLINE SOFTWARE GENERATED VIRTUAL WORLDS, AND ONLINE INTERACTIVE VIDEO GAME PROGRAMS; AUDIO RECORDING AND PRODUCTION OF ANIMATED AND LIVE ACTION ENTERTAINMENT RELATING TO FICTIONAL RESCUE OR ADOPTED ANIMALS; ENTERTAINMENT IN THE NATURE OF THEATER PRODUCTIONS RELATING TO FICTIONAL RESCUE OR ADOPTED ANIMALS; PUBLICATION OF BOOKS, MAGAZINES, CARTOONS, COMIC STRIPS AND COMIC BOOKS; FAN CLUBS; PROVIDING NON-DOWNLOADABLE ONLINE COMPUTER GAMES; PROVIDING ONLINE ELECTRONIC PUBLICATIONS, NAMELY, NEWSLETTERS AND BULLETINS IN THE FIELD OF

ENTERTAINMENT; VIDEOTAPE PRODUCTION; AUDIOTAPE PRODUCTION; ENTERTAINMENT SERVICES, NAMELY, PERSONAL APPEARANCES BY ANIMATED AND LIVE ACTION CHARACTERS, MUSICAL GROUPS, MUSICAL ARTISTS AND CELEBRITIES; ENTERTAINMENT SERVICES, NAMELY, PROVIDING A WEB SITE RELATING TO FICTIONAL RESCUE OR ADOPTED ANIMALS; CONDUCTING ENTERTAINMENT EXHIBITIONS IN THE NATURE OF FESTIVALS REGARDING FICTIONAL AND NON-FICTIONAL RESCUE OR ADOPTED ANIMALS; ORGANIZING EXHIBITIONS REGARDING FICTIONAL AND NON-FICTIONAL RESCUE OR ADOPTED ANIMALS (U.S. CLS. 100, 101 AND 107).

JOHN E. MICHO, EXAMINING ATTORNEY

SN 77-846,198. MANITO, NYM G, HOUSTON, TX. AND MANITO, GLAN KRISNI, HOUSTON, TX. FILED 10-11-2009.

Jesus > Life

THE MARK CONSISTS OF STANDARD CHARACTERS WITHOUT CLAIM TO ANY PARTICULAR FONT, STYLE, SIZE, OR COLOR.

CLASS 14—JEWELRY

FOR ANKLE BRACELETS; BANGLE BRACELETS; BRACELETS; BRACELETS; BRACELETS AND JEWELRY FEATURING ELECTRONIC CHIPS FOR ATTRACTING ENERGY TO THE BODY WHEREIN THE ELECTRONIC CHIPS INCREASE IN POWER IN THE PRESENCE OF ELECTROMAGNETIC FIELDS, FOR THE PURPOSE OF RE-BALANCING THE HUMAN ENERGY FIELD; BRACELETS OF PRECIOUS METAL; CHARITY BRACELETS; CHARMS FOR COLLAR JEWELRY AND BRACELET; IDENTIFICATION BRACELETS; NYLON ANKLE BRACELETS; NYLON BRACELETS; PLASTIC BRACELETS IN THE NATURE OF JEWELRY; RUBBER OR SILICON WRISTBANDS IN THE NATURE OF A BRACELET; STAINLESS STEEL JEWELRY BRACELETS; WATCH BRACELETS (U.S. CLS. 2, 27, 28 AND 50).

CLASS 22—CORDAGE AND FIBERS

FOR LANYARDS FOR HOLDING BADGES, KEYS, EYEGLASSES; MULTI-STRAND LANYARD USED TO ATTACH A CHILD'S TOYS, BOTTLES, BOOKS, SIPPY CUP AND OTHER SIMILAR ITEMS TO A STROLLER, CAR SEAT, HIGH CHAIR, STORE CART OR OTHER SIMILAR APPARATUS (U.S. CLS. 1, 2, 7, 19, 22, 42 AND 50).

CLASS 25—CLOTHING

FOR A-SHIRTS; ATHLETIC APPAREL, NAMELY, SHIRTS, PANTS, JACKETS, FOOTWEAR, HATS AND CAPS, ATHLETIC UNIFORMS; BODY SHIRTS; BUTTON-FRONT ALOHA SHIRTS; CAMOUFLAGE SHIRTS; CAMP SHIRTS; CLOTHING FOR ATHLETIC USE, NAMELY, PADDED SHIRTS; DRESS SHIRTS; FISHING SHIRTS; GOLF PANTS, SHIRTS AND SKIRTS; GOLF SHIRTS; HOODED SWEAT SHIRTS; HUNTING SHIRTS; KNIT SHIRTS; LONG-SLEEVED SHIRTS; MOISTURE-WICKING SPORTS SHIRTS; NIGHT SHIRTS; OPEN-NECKED SHIRTS; OVER SHIRTS; PIQUE SHIRTS; POLO SHIRTS; RUGBY SHIRTS; SCIENTIFIC AND TECHNOLOGICAL APPAREL, NAMELY, SHIRTS, PANTS, JACKETS, FOOTWEAR, HATS AND CAPS, UNIFORMS; SHIRT FRONTS; SHIRT YOKES; SHIRTS; SHIRTS AND SHORT-SLEEVED SHIRTS; SHIRTS FOR INFANTS, BABIES, TODDLERS AND CHILDREN; SHIRTS FOR SUITS; SHORT-SLEEVED OR LONG-SLEEVED T-SHIRTS; SHORT-SLEEVED SHIRTS; SLEEP SHIRTS; SPORT SHIRTS; SPORTS SHIRTS; SPORTS SHIRTS WITH SHORT SLEEVES; SWEAT SHIRTS; T-SHIRTS; TEE SHIRTS; TRIATHLON CLOTHING, NAMELY, TRIATHLON TIGHTS, TRIATHLON SHORTS, TRIATHLON SINGLETS, TRIATHLON SHIRTS, TRIATHLON SUITS; TURTLE NECK SHIRTS; WEARABLE GARMENTS AND CLOTHING, NAMELY, SHIRTS; WIND SHIRTS; YOGA SHIRTS (U.S. CLS. 22 AND 39).

DAWN FELDMAN, EXAMINING ATTORNEY

SN 77-846,415. PAGETRAFFIC WEB-TECH PRIVATE LIMITED, NEW DELHI 110024, INDIA, FILED 10-12-2009.

PAGETRAFFIC

THE MARK CONSISTS OF STANDARD CHARACTERS WITHOUT CLAIM TO ANY PARTICULAR FONT, STYLE, SIZE, OR COLOR.
SEC. 2(F).

CLASS 35—ADVERTISING AND BUSINESS

FOR PAY PER CLICK ADVERTISING MANAGEMENT SERVICES (U.S. CLS. 100, 101 AND 102).
FIRST USE 7-1-2002; IN COMMERCE 7-1-2002.

CLASS 42—SCIENTIFIC AND COMPUTER SERVICES

FOR CONSULTATION SERVICES IN THE FIELD OF SEARCH ENGINE OPTIMIZATION; COMPUTER SERVICES, NAMELY, SEARCH ENGINE OPTIMIZATION (U.S. CLS. 100 AND 101).
FIRST USE 7-1-2002; IN COMMERCE 7-1-2002.
SUE LAWRENCE, EXAMINING ATTORNEY

SN 77-847,030. AMGEN INC., THOUSAND OAKS, CA. FILED 10-12-2009.

A FORCE AGAINST FRACTURE

THE MARK CONSISTS OF STANDARD CHARACTERS WITHOUT CLAIM TO ANY PARTICULAR FONT, STYLE, SIZE, OR COLOR.

CLASS 16—PAPER GOODS AND PRINTED MATTER

FOR PRINTED MATERIAL, NAMELY, NEWSLETTERS, PAMPHLETS AND BROCHURES, DISPLAYS, NAMELY, POSTERS, CHARTS, BOOKLETS, CATALOGS, LEAFLETS, JOURNALS, BOOKS, MANUALS AND INFORMATION SHEETS ON THE SUBJECTS OF BONE DISEASE, HEALTH CARE AND PHARMACEUTICALS; PRINTED VISUALS IN THE NATURE OF FLYERS AND DISPLAYS, NAMELY, POSTERS, FEATURING INFORMATION ON THE SUBJECTS OF BONE DISEASE, HEALTH CARE AND PHARMACEUTICALS (U.S. CLS. 2, 5, 22, 23, 29, 37, 38 AND 50).

CLASS 44—MEDICAL, BEAUTY AND AGRICULTURAL SERVICES

FOR HEALTH CARE SERVICES, NAMELY, PROVIDING INFORMATION TO PHYSICIANS, HEALTH CARE PROFESSIONALS AND PATIENTS ON THE TOPICS OF BONE DISEASE, HEALTH ISSUES AND HEALTH AWARENESS; PROVIDING MEDICAL INFORMATION; PROVIDING HEALTH INFORMATION; PROVIDING ON-LINE MEDICAL INFORMATION SERVICES, INCLUDING PROVIDING INFORMATION ON THE SUBJECTS OF BONE DISEASE, HEALTH CARE AND PHARMACEUTICALS (U.S. CLS. 100 AND 101).
JESSICA A. POWERS, EXAMINING ATTORNEY

SN 77-847,774. MESA SAFE COMPANY, INC., ORANGE, CA. FILED 10-13-2009.

MESA SAFE COMPANY

THE MARK CONSISTS OF STANDARD CHARACTERS WITHOUT CLAIM TO ANY PARTICULAR FONT, STYLE, SIZE, OR COLOR.

NO CLAIM IS MADE TO THE EXCLUSIVE RIGHT TO USE "SAFE COMPANY", APART FROM THE MARK AS SHOWN.

CLASS 6—METAL GOODS

FOR METAL SAFES (U.S. CLS. 2, 12, 13, 14, 23, 25 AND 50).
FIRST USE 8-1-2003; IN COMMERCE 8-1-2003.

CLASS 35—ADVERTISING AND BUSINESS

FOR COMPUTERIZED ON-LINE ORDERING SERVICES IN THE FIELD OF SAFES (U.S. CLS. 100, 101 AND 102).
FIRST USE 8-1-2003; IN COMMERCE 8-1-2003.
CHRISIE B. KING, EXAMINING ATTORNEY

SN 77-848,258. BENEFITDECISIONS, INC., CHICAGO, IL. FILED 10-14-2009.

benefitdecisions

THE MARK CONSISTS OF STANDARD CHARACTERS WITHOUT CLAIM TO ANY PARTICULAR FONT, STYLE, SIZE, OR COLOR.

OWNER OF U.S. REG. NO. 2,546,605.

CLASS 35—ADVERTISING AND BUSINESS

FOR CONSULTING SERVICES IN THE FIELD OF HUMAN RESOURCES DEVELOPMENT, NAMELY, UTILIZING TECHNOLOGY FOR THE PROMOTION OF EMPLOYEE RETENTION, CAREER GROWTH AND INCREASED PRODUCTIVITY FOR EMPLOYEES AND EMPLOYERS (U.S. CLS. 100, 101 AND 102).
FIRST USE 3-19-2004; IN COMMERCE 3-19-2004.

CLASS 36—INSURANCE AND FINANCIAL

FOR INSURANCE BROKERAGE SERVICES; PROVIDING ONLINE INSURANCE BROKERAGE SERVICES; ADMINISTRATION OF EMPLOYEE BENEFIT PLANS CONCERNING INSURANCE AND FINANCE (U.S. CLS. 100, 101 AND 102).

FIRST USE 2-0-2000; IN COMMERCE 2-0-2000.

JULIE GUTTADAURO, EXAMINING ATTORNEY

SN 77-849,105. THE NEXT GREAT NETWORK, LLC, WESLEY CHAPEL, FL. FILED 10-15-2009.

CANTA Y GANA

THE MARK CONSISTS OF STANDARD CHARACTERS WITHOUT CLAIM TO ANY PARTICULAR FONT, STYLE, SIZE, OR COLOR.

THE ENGLISH TRANSLATION OF THE WORD "CANTA Y GANA" IN THE MARK IS "SING AND WIN".

CLASS 35—ADVERTISING AND BUSINESS

FOR PROVIDING ADVERTISING SERVICE TO DISTRIBUTE ADVERTISEMENTS FOR DISPLAYING ON TELEVISION AND RADIO AND IN SOCIAL CONVERSATIONS OVER THE INTERNET FOR CONSUMERS OF ALL AGES (U.S. CLS. 100, 101 AND 102).

CLASS 41—EDUCATION AND ENTERTAINMENT

FOR ENTERTAINMENT SERVICES IN THE NATURE OF ONGOING TELEVISION AND RADIO SHOWS FEATURING MUSIC FOR CONSUMERS OF ALL AGES (U.S. CLS. 100, 101 AND 107).

CLASS 45—PERSONAL AND LEGAL SERVICES

FOR PROVIDING A SOCIAL NETWORKING WEBSITE FOR ENTERTAINMENT PURPOSES FOR CONSUMERS OF ALL AGES (U.S. CLS. 100 AND 101).
RUSS HERMAN, EXAMINING ATTORNEY

SN 77-850,960. JONES, CHARLES, DEREK, STUDIO CITY, CA. AND ARNOLD, DANIEL, STUDIO CITY, CA. FILED 10-16-2009.

The Letterheads Make It Better With A Letter

THE MARK CONSISTS OF STANDARD CHARACTERS WITHOUT CLAIM TO ANY PARTICULAR FONT, STYLE, SIZE, OR COLOR.

CLASS 16—PAPER GOODS AND PRINTED MATTER

FOR PAPER GOODS AND PRINTED MATERIAL, NAMELY, POSTERS; BUMPER STICKERS; MARKERS; PARTY PAPER BAGS; CALENDARS; CHILDREN'S ACTIVITY BOOKS; READING BOOKS FEATURING CHILDREN'S EDUCATIONAL STORIES; SERIES OF FICTION BOOKS; NOTE PADS; NOTEBOOKS; PAPER GIFT WRAP; METALLIC GIFT WRAP; STICKERS; DECALS; PAPER NAPKINS; PAPER TABLE CLOTHS; TRADING CARDS; AND PAPER BANNERS (U.S. CLS. 2, 5, 22, 23, 29, 37, 38 AND 50).

CLASS 28—TOYS AND SPORTING GOODS

FOR TOYS, GAMES AND PLAYTHINGS, NAMELY, STUFFED TOYS; PLUSH TOYS; ACTION FIGURES; JIGSAW PUZZLES; INFANTS' RATTLES; MUSICAL TOYS; BOARD GAMES; TOY BUILDING BLOCKS; PAPER PARTY HATS; BALLOONS; AND PLAYGROUND BALLS (U.S. CLS. 22, 23, 38 AND 50).

CLASS 41—EDUCATION AND ENTERTAINMENT

FOR ENTERTAINMENT SERVICES, NAMELY, PRODUCTION OF A LIVE ACTION SERIES WITH ANIMATED COMPONENTS FOR TELEVISION OR CABLE BROADCAST (U.S. CLS. 100, 101 AND 107).

JUSTINE D. PARKER, EXAMINING ATTORNEY

SN 77-851,197. TECH SHAMAN, INC., HOUSTON, TX. FILED 10-18-2009.

Tech Shaman

NO CLAIM IS MADE TO THE EXCLUSIVE RIGHT TO USE "TECH", APART FROM THE MARK AS SHOWN.

CLASS 37—CONSTRUCTION AND REPAIR

FOR INSTALLATION OF COMPUTER NETWORKS; INSTALLATION, MAINTENANCE AND REPAIR OF COMPUTER HARDWARE; MAINTENANCE AND REPAIR OF COMPUTER NETWORKS; TECHNICAL SUPPORT SERVICES, NAMELY, TROUBLESHOOTING IN THE NATURE OF THE REPAIR OF COMPUTER HARDWARE; UPDATING OF COMPUTER HARDWARE; UPGRADING OF COMPUTER HARDWARE (U.S. CLS. 100, 103 AND 106).

FIRST USE 9-9-2009; IN COMMERCE 10-1-2009.

CLASS 42—SCIENTIFIC AND COMPUTER SERVICES

FOR COMPUTER SECURITY CONSULTANCY; COMPUTER SECURITY SERVICE, NAMELY, RESTRICTING ACCESS TO AND BY COMPUTER NETWORKS TO AND OF UNDESIRE WEB SITES, MEDIA AND INDIVIDUALS AND FACILITIES; COMPUTER SERVICES, NAMELY, ON-LINE SCANNING, DETECTING, QUARANTINING AND ELIMINATING VIRUSES, WORMS, TROJANS, SPYWARE, ADWARE, MALWARE AND UNAUTHORIZED DATA AND PROGRAMS ON COMPUTERS AND ELECTRONIC DEVICES; COMPUTER VIRUS PROTECTION SERVICES; CONSULTATION SERVICES IN THE FIELDS OF SELECTION, IMPLEMENTATION AND USE OF COMPUTER HARDWARE AND SOFTWARE SYSTEMS FOR OTHERS (U.S. CLS. 100 AND 101).

FIRST USE 9-9-2009; IN COMMERCE 10-1-2009.

MARIA-VICTORIA SUAREZ, EXAMINING ATTORNEY

SN 77-851,921. ENOUGH IS ENOUGH, INC., GREAT FALLS, VA. FILED 10-19-2009.

INTERNET SAFETY 101

THE MARK CONSISTS OF STANDARD CHARACTERS WITHOUT CLAIM TO ANY PARTICULAR FONT, STYLE, SIZE, OR COLOR.

NO CLAIM IS MADE TO THE EXCLUSIVE RIGHT TO USE "INTERNET SAFETY", APART FROM THE MARK AS SHOWN.

CLASS 35—ADVERTISING AND BUSINESS

FOR PROMOTING PUBLIC AWARENESS OF THE NEED FOR ON-LINE SAFETY RELATED TO THE RISKS ASSOCIATED WITH ONLINE PORNOGRAPHY, INAPPROPRIATE CONTENT, SEXUAL PREDATORS, SOCIAL NETWORKING SITES, CYBERCRIMES AND THE USE OF COMPUTERS AND ONLINE ENABLED DEVICES (U.S. CLS. 100, 101 AND 102).

FIRST USE 9-0-2005; IN COMMERCE 9-0-2005.

CLASS 45—PERSONAL AND LEGAL SERVICES

FOR PROVIDING SECURITY INFORMATION TO PARENTS, TEACHERS, TEENAGERS AND CHILDCARE GIVERS ABOUT INTERNET SAFETY TO REDUCE THE RISK OF CHILDREN AND TEENAGERS BEING EXPOSED TO ONLINE PORNOGRAPHY AND OTHER INAPPROPRIATE CONTENT, SEXUAL PREDATORS AND OTHER DANGEROUS PERSONS; PROVIDING SECURITY INFORMATION TO PARENTS, TEACHERS, TEENAGERS AND CHILDCARE GIVERS ABOUT THE SAFE AND RESPONSIBLE USE OF THE INTERNET, COMPUTERS AND INTERNET ENABLED DEVICES, NAMELY, THE EXERCISE OF CAUTION IN PROVIDING PERSONAL INFORMATION ONLINE, ACCESSING SITES THAT MAY CONTAIN PORNOGRAPHIC OR OFFENSIVE MATERIAL, PROTECTING AGAINST THE DANGERS OF SOCIAL NETWORKING SITES AND REPORTING CYBERCRIMES (U.S. CLS. 100 AND 101).

FIRST USE 9-0-2005; IN COMMERCE 9-0-2005.

JAMES LOVELACE, EXAMINING ATTORNEY

SN 77-851,993. CHRISTOPHER REEVE FOUNDATION, A NEW JERSEY NONPROFIT CORPORATION, SHORT HILLS, NJ. FILED 10-19-2009.

CHRISTOPHER & DANA REEVE
FOUNDATION

THE MARK CONSISTS OF STANDARD CHARACTERS WITHOUT CLAIM TO ANY PARTICULAR FONT, STYLE, SIZE, OR COLOR.

OWNER OF U.S. REG. NOS. 2,830,482 AND 3,417,015.

NO CLAIM IS MADE TO THE EXCLUSIVE RIGHT TO USE "FOUNDATION", APART FROM THE MARK AS SHOWN.

THE NAME(S), PORTRAIT(S), AND/OR SIGNATURE(S) SHOWN IN THE MARK DOES NOT IDENTIFY A PARTICULAR LIVING INDIVIDUAL.

CLASS 35—ADVERTISING AND BUSINESS

FOR ASSOCIATION SERVICES, NAMELY, PROMOTING THE INTERESTS OF THE PHYSICALLY CHALLENGED BY PROMOTING RESEARCH TO FIND A CURE FOR PARALYSIS (U.S. CLS. 100, 101 AND 102).
FIRST USE 9-1-2008; IN COMMERCE 9-1-2008.

CLASS 36—INSURANCE AND FINANCIAL

FOR CHARITABLE FUNDRAISING, AND PHILANTHROPIC SERVICES CONCERNING MONETARY DONATIONS, NAMELY, PROVIDING GRANTS TO NON-PROFIT ORGANIZATIONS THAT PROVIDE SERVICES TO INDIVIDUALS WITH PARALYSIS (U.S. CLS. 100, 101 AND 102).

FIRST USE 9-1-2008; IN COMMERCE 9-1-2008.

DOMINIC J. FERRAIUOLO, EXAMINING ATTORNEY

SN 77-852,097. GABE'S MY HEART, INC., SPRING HILL, TN. FILED 10-19-2009.



NO CLAIM IS MADE TO THE EXCLUSIVE RIGHT TO USE "CHEMO", APART FROM THE MARK AS SHOWN.

THE MARK CONSISTS OF A DUCK WEARING A HAT SURROUNDED BY THE WORDS "GABE'S CHEMO DUCK HUGGABLE HOPE" WITH A CIRCULAR BORDER.

CLASS 41—EDUCATION AND ENTERTAINMENT

FOR EDUCATIONAL SERVICES, NAMELY, PROVIDING PARENT-TO-PATENT GUIDES AND VIDEOS ONLINE, AND PROVIDING CURRICULA AND ELECTRONIC NEWSLETTERS, ALL IN THE FIELD OF UNDERSTANDING CHILDHOOD CANCER FOR CHILDREN LIVING WITH CANCER AND THEIR FAMILIES; PROVIDING TOYS AND COLORING AND QUIZ BOOK ACTIVITIES DESIGNED TO TEACH CHILDREN WITH CANCER AND TO HELP THEM COPE WITH LIVING WITH CANCER (U.S. CLS. 100, 101 AND 107).

FIRST USE 8-11-2009; IN COMMERCE 8-11-2009.

CLASS 44—MEDICAL, BEAUTY AND AGRICULTURAL SERVICES

FOR PROVIDING INFORMATION IN THE FIELD OF CANCER TREATMENT TO CHILDREN LIVING WITH CANCER AND THEIR FAMILIES (U.S. CLS. 100 AND 101).

FIRST USE 8-11-2009; IN COMMERCE 8-11-2009.

KATINA MISTER, EXAMINING ATTORNEY

SN 77-852,172. WAYPOINT, INC., WHITE BEAR LAKE, MN. FILED 10-19-2009.

KNOWLEDGE TO YOUR ADVANTAGE

THE MARK CONSISTS OF STANDARD CHARACTERS WITHOUT CLAIM TO ANY PARTICULAR FONT, STYLE, SIZE, OR COLOR.

CLASS 35—ADVERTISING AND BUSINESS

FOR BUSINESS INVESTIGATION SERVICES; BUSINESS RISK MITIGATION SERVICES; BUSINESS RISK MANAGEMENT AND FORENSIC ACCOUNTING SERVICES (U.S. CLS. 100, 101 AND 102).

CLASS 36—INSURANCE AND FINANCIAL

FOR FINANCIAL DUE DILIGENCE SERVICES; AND FINANCIAL RISK MANAGEMENT SERVICES (U.S. CLS. 100, 101 AND 102).

CLASS 45—PERSONAL AND LEGAL SERVICES

FOR INVESTIGATIVE SERVICES, NAMELY, FRAUD INVESTIGATION IN THE FIELDS OF BANKING, INSURANCE, SECURITIES, INVESTMENTS, HEALTHCARE, VENDORS AND INVENTORY; INVESTIGATION OF ASSETS; FISCAL ASSESSMENTS FOR DUE DILIGENCE AND AUTHENTICATION PURPOSES; BACKGROUND INVESTIGATION AND RESEARCH SERVICES AND INVESTIGATION OF INSURANCE CLAIMS; LITIGATION SUPPORT IN TAX, ACCOUNTING AND FINANCE; COUNTERFEITING INVESTIGATION SERVICES; SECURITY SERVICES, NAMELY, SECURITY ASSESSMENTS OF PHYSICAL LOCATIONS, INFORMATION SYSTEMS, AND WORKING ENVIRONMENTS; SECURITY CONSULTANCY (U.S. CLS. 100 AND 101).

MARK T. MULLEN, EXAMINING ATTORNEY

SN 77-853,536. SKINNY NUTRITIONAL CORPORATION, BALA CYNWYD, PA. FILED 10-21-2009.

Skinny Sport

THE MARK CONSISTS OF STANDARD CHARACTERS WITHOUT CLAIM TO ANY PARTICULAR FONT, STYLE, SIZE, OR COLOR.

OWNER OF U.S. REG. NOS. 2,557,075, 2,650,352 AND 2,657,083.

NO CLAIM IS MADE TO THE EXCLUSIVE RIGHT TO USE "SPORT", APART FROM THE MARK AS SHOWN.

CLASS 5—PHARMACEUTICALS

FOR NUTRICEUTICALS FOR USE AS A DIETARY SUPPLEMENT, NUTRICEUTICALS IN CONCENTRATE FORM FOR USE AS A DIETARY SUPPLEMENT (U.S. CLS. 6, 18, 44, 46, 51 AND 52).

CLASS 32—LIGHT BEVERAGES

FOR ISOTONIC DRINKS, ISOTONIC DRINKS IN CONCENTRATE FORM, DRINKING WATER (U.S. CLS. 45, 46 AND 48).

SUSAN LESLIE DUBOIS, EXAMINING ATTORNEY

SN 77-853,954. PRIMESTREAM CORPORATION, MIAMI, FL. FILED 10-21-2009.

Mobile2Air

THE MARK CONSISTS OF STANDARD CHARACTERS WITHOUT CLAIM TO ANY PARTICULAR FONT, STYLE, SIZE, OR COLOR.

CLASS 9—ELECTRICAL AND SCIENTIFIC APPARATUS

FOR COMMUNICATIONS COMPUTERS; COMPUTER HARDWARE AND COMPUTER SOFTWARE PROGRAMS FOR THE INTEGRATION OF TEXT, AUDIO, GRAPHICS, STILL IMAGES AND MOVING PICTURES INTO AN INTERACTIVE DELIVERY FOR MULTIMEDIA APPLICATIONS; COMPUTER HARDWARE AND SOFTWARE USED FOR THE CONTROL OF VOICE CONTROLLED INFORMATION AND COMMUNICATION DEVICES; COMPUTER HARDWARE FOR TELECOMMUNICATIONS; ENCODERS (U.S. CLS. 21, 23, 26, 36 AND 38).

CLASS 38—COMMUNICATION

FOR AUDIO TELECONFERENCING; BROADCASTING PROGRAMS VIA A GLOBAL COMPUTER NETWORK; BROADCASTING SERVICES AND PROVISION OF TELECOMMUNICATION ACCESS TO VIDEO AND AUDIO CONTENT PROVIDED VIA A VIDEO-ON-DEMAND SERVICE VIA THE INTERNET; COMMUNICATIONS SERVICES, NAMELY, TRANSMITTING STREAMED SOUND AND AUDIOVISUAL RECORDINGS VIA THE INTERNET; ELECTRONIC TRANSMISSION OF VOICE, DATA AND IMAGES BY TELEVISION AND VIDEO BROADCASTING; TRANSMISSION OF INFORMATION THROUGH VIDEO COMMUNICATION SYSTEMS; VIDEO BROADCASTING; VIDEO TELECONFERENCING; WEBCASTING SERVICES (U.S. CLS. 100, 101 AND 104).

CLASS 42—SCIENTIFIC AND COMPUTER SERVICES

FOR INTEGRATION OF COMPUTER SYSTEMS AND NETWORKS; TECHNOLOGICAL CONSULTATION IN THE TECHNOLOGY FIELD OF COMPUTER HARDWARE, BROADCASTING AND COMMUNICATION SYSTEMS (U.S. CLS. 100 AND 101).

STEVEN JACKSON, EXAMINING ATTORNEY

SN 77-854,946. JOHN RITCHIE LIMITED, KILMARNOCK, UNITED KINGDOM, FILED 10-22-2009.



OWNER OF UNITED KINGDOM REG. NO. 2514242, DATED 4-22-2009, EXPIRES 4-22-2019.

NO CLAIM IS MADE TO THE EXCLUSIVE RIGHT TO USE "BIBLE ART", APART FROM THE MARK AS SHOWN.

THE MARK CONSISTS OF THE WORD "EIKON", IN UPPERCASE WITH AN ACUTE ACCENT OVER THE "O" AND A LOWERCASE "N". THE ACCENTED "O" IS SUPERIMPOSED ON A PAINT SPATTER. THE WORDS "BIBLE ART" IN UPPERCASE APPEAR BELOW THE "N".

CLASS 9—ELECTRICAL AND SCIENTIFIC APPARATUS

FOR ELECTRONIC PUBLICATIONS, NAMELY, BOOKS, MAGAZINES, GAMES, AND SOFTWARE FEATURING BIBLE EVENTS, PARABLES AND PROPHECIES THAT ARE DOWNLOADABLE OR RECORDED ON COMPUTER MEDIA; ELECTRONIC PUBLICATIONS IN THE FORM OF ARTWORK AND ILLUSTRATIONS THAT ARE DOWNLOADABLE OR RECORDED ON COMPUTER MEDIA; ELECTRONIC PUBLICATIONS, NAMELY, THREE DIMENSIONAL DIGITAL IMAGES AND ARTWORK THAT ARE DOWNLOADABLE OR RECORDED ON COMPUTER MEDIA; ELECTRONIC PUBLICATIONS, NAMELY, BOOKS, MAGAZINES, GAMES, SOFTWARE FEATURING BIBLE EVENTS, PARABLES AND PROPHECIES THAT ARE DOWNLOADABLE FROM THE INTERNET; PRE-RECORDED COMPACT DISCS FEATURING SPOKEN WORD AND MUSIC; PRE-RECORDED DVDS FEATURING MOVIES, DOCUMENTARIES AND MUSICAL CONCERTS; ELECTRONIC RECORDING MEDIA, NAMELY, BLANK CDS AND BLANK DVDS (U.S. CLS. 21, 23, 26, 36 AND 38).

CLASS 16—PAPER GOODS AND PRINTED MATTER

FOR PRINTED MATTER, NAMELY, BOOKS, FLASHCARDS, POSTERS AND COMICS; PRINTED PUBLICATIONS, NAMELY, BOOKS AND MAGAZINES IN THE FIELD OF BIBLE EVENTS, PARABLES AND PROPHECIES; MAGAZINES IN THE FIELD OF BIBLE EVENTS, PARABLES AND PROPHECIES; JOURNALS IN THE FIELD OF BIBLE EVENTS, PARABLES AND PROPHECIES; ARTWORK, NAMELY, PAINTINGS AND PHOTOGRAPHS; PRINTED ARTWORK, NAMELY, ART PRINTS AND ILLUSTRATIONS; IMAGES, NAMELY, PHOTOGRAPHS AND PAINTINGS (U.S. CLS. 2, 5, 22, 23, 29, 37, 38 AND 50).

ALLISON SCHRODY, EXAMINING ATTORNEY

SN 77-855,119. BINDERER ST. URSULA WEINKELLEREI GMBH, 55411 BINGEN AM RHEIN, FED REP GERMANY, FILED 10-22-2009.

DR. REEZLING

THE MARK CONSISTS OF STANDARD CHARACTERS WITHOUT CLAIM TO ANY PARTICULAR FONT, STYLE, SIZE, OR COLOR.

CLASS 32—LIGHT BEVERAGES

FOR BEERS; MINERAL AND AERATED WATERS; NON-ALCOHOLIC DRINKS, NAMELY, ENERGY DRINKS; FRUIT DRINKS AND FRUIT JUICES; SYRUPS FOR MAKING BEVERAGES; PREPARATIONS, NAMELY, CONCENTRATES AND POWDERS FOR MAKING FRUIT JUICES (U.S. CLS. 45, 46 AND 48).

CLASS 33—WINES AND SPIRITS

FOR ALCOHOLIC BEVERAGES EXCEPT BEERS (U.S. CLS. 47 AND 49).

CLASS 43—HOTEL AND RESTAURANT SERVICES

FOR SERVICES FOR PROVIDING FOOD AND DRINK (U.S. CLS. 100 AND 101).

WILLIAM VERHOSEK, EXAMINING ATTORNEY

SN 77-855,327. FIVE THOUSAND FORMS, INC., FOGELSVILLE, PA. FILED 10-22-2009.

GIVEMEFIVE.COM

THE MARK CONSISTS OF STANDARD CHARACTERS WITHOUT CLAIM TO ANY PARTICULAR FONT, STYLE, SIZE, OR COLOR.

NO CLAIM IS MADE TO THE EXCLUSIVE RIGHT TO USE ".COM", APART FROM THE MARK AS SHOWN.

CLASS 35—ADVERTISING AND BUSINESS

FOR ONLINE SERVICES, NAMELY, ORDERING AND INVENTORY MONITORING FOR PRODUCTS, NAMELY, STATIONERY, ENVELOPES, LABELS, CARTRONS, BUSINESS CARDS, LABELS, DECALS, STICKERS, LASER PAPER, FORMS, WRAPS AND DECALS FOR VEHICLES AND DISPLAYS, PRINTED PRODUCTS, AUTOMOTIVE ACCESSORIES, NAMELY, KEY TAGS, BUMPER STRIPS, ROAD MAPS, FLOOR MATS AND WINDOW SHADES, BAGS SUCH AS TOTE BAGS, SHOPPING BAGS, SACHELS, GIFT BAGS, DRAWSTRING BAGS, COSMETIC BAGS, PAPER BAGS, DUFFEL BAGS, BRIEFCASES AND BACKPACKS, BAGS, BANNERS, UMBRELLAS, FLAGS, TOWELS, PENNANTS, BLANKETS, BANNERS, BUTTONS, BADGES, RIBBONS, LAPEL PINS, WRISTBANDS, CALENDARS, DESK DIARIES, POCKET SECRETARIES, CLOCKS, WATCHES, COMPUTER PRODUCTS, NAMELY, MOUSE PADS, MONITOR FRAMES, DISK CARRIERS, WRIST PADS AND SOFTWARE, DESK AND OFFICE ACCESSORIES, DRINKWARE, ELECTRONIC DEVICES AND ACCESSORIES, FOOD GIFTS, GAMES, TOYS, PLAYING CARDS, INFLATABLES, KITES, BALLS, PUZZLES, STUFFED ANIMALS, STRESS RELIEVERS, HOUSEWARES AND TOOLS, NAMELY, MEASURING DEVICES, KITCHEN PRODUCTS, PICTURE FRAMES, HOUSEHOLD DECORATIONS, ORNAMENTS, TOOL KITS, FIRST AID KITS, FURNITURE, FLASHLIGHTS, CUTLERY, WEATHER INSTRUMENTS, MAGNETS AND MAGNETIC PRODUCTS, LENS CLOTH CLEANERS, POCKET KNIVES, GROOMING AIDS, LIGHTERS, MATCHES, SUNGLASSES, WALLETTS, AWARDS, TROPHIES, PLAQUES, CERTIFICATES, FIGURINES, GOLF ITEMS, NAMELY, GOLF BALLS, TEES, DIVOT REPAIR TOOLS, GOLF BAGS, GOLF TOWELS, GOLF SHOES, SPORTING GOODS, TRAVEL ACCESSORIES, PICNIC AND PARTY PRODUCTS, CAMPING EQUIPMENT, BARBECUE ITEMS, BAR PRODUCTS, BINOCULARS, LUGGAGE, PASSPORT CASES, PENS, PENCILS, MARKERS, HIGHLIGHTERS, AND CLOTHING (U.S. CLS. 100, 101 AND 102).

FIRST USE 2-28-2009; IN COMMERCE 2-28-2009.

CLASS 40—MATERIAL TREATMENT

FOR DESIGN PRINTING FOR OTHERS (U.S. CLS. 100, 103 AND 106).

FIRST USE 12-31-2007; IN COMMERCE 12-31-2007.
STEVEN JACKSON, EXAMINING ATTORNEY

SN 77-855,849. MENDOZA, ANTOINETTE, MIAMI, FL. AND MENDOZA, RAFAEL EDEN, MIAMI, FL. FILED 10-23-2009.

CopaVin

THE MARK CONSISTS OF STANDARD CHARACTERS WITHOUT CLAIM TO ANY PARTICULAR FONT, STYLE, SIZE, OR COLOR.

THE WORDING COPAVIN HAS NO MEANING IN A FOREIGN LANGUAGE.

CLASS 16—PAPER GOODS AND PRINTED MATTER

FOR EDUCATIONAL PUBLICATIONS, NAMELY, BOOKS IN THE FIELDS OF MEDICINE (U.S. CLS. 2, 5, 22, 23, 29, 37, 38 AND 50).

FIRST USE 1-1-2007; IN COMMERCE 1-1-2007.

CLASS 41—EDUCATION AND ENTERTAINMENT

FOR EDUCATIONAL SERVICES, NAMELY, CONDUCTING DISTANCE LEARNING INSTRUCTION AT THE UNIVERSITY LEVEL (U.S. CLS. 100, 101 AND 107).
FIRST USE 1-1-2007; IN COMMERCE 1-1-2007.
SUNG IN, EXAMINING ATTORNEY

SN 77-856,123. LOCK-DOWN SECURITY, INC., CLEVELAND, OH. FILED 10-23-2009.

LOCKDOWN SECURITY

THE MARK CONSISTS OF STANDARD CHARACTERS WITHOUT CLAIM TO ANY PARTICULAR FONT, STYLE, SIZE, OR COLOR.

NO CLAIM IS MADE TO THE EXCLUSIVE RIGHT TO USE "SECURITY", APART FROM THE MARK AS SHOWN.

SN 77-855,921. D'FUENTES DISTRIBUTOR'S CORPORATION, DBA MARIA ELENA HEADPIECES, MIAMI, FL. FILED 10-23-2009.



NO CLAIM IS MADE TO THE EXCLUSIVE RIGHT TO USE "HEADPIECES", APART FROM THE MARK AS SHOWN.

THE NAME "MARIA ELENA" IDENTIFIES A LIVING INDIVIDUAL WHOSE CONSENT IS OF RECORD.

THE MARK CONSISTS OF THE CURSIVE SIGNATURE OF THE WORDS "MARIA ELENA" WITH THE FIRST LETTER OF THE WORDS "MARIA" AND "ELENA" IN LARGER CAPITAL LETTERS AND THE REST OF THE LETTERS IN SMALLER LOWER CASE CURSIVE LETTERS AND WITH THE WORD "HEADPIECES" IN ALL CAPITAL LETTERS WRITTEN IN SMALLER BLOCK LETTERS AND POSITIONED DIRECTLY UNDER THE LETTER "L" IN "ELENA".

CLASS 14—JEWELRY

FOR BRACELETS; BROACHES; JEWELRY BOXES; NECKLACES; TIARAS (U.S. CLS. 2, 27, 28 AND 50).
FIRST USE 1-1-1992; IN COMMERCE 1-1-1992.

CLASS 16—PAPER GOODS AND PRINTED MATTER

FOR ROSARIES (U.S. CLS. 2, 5, 22, 23, 29, 37, 38 AND 50).
FIRST USE 1-1-1992; IN COMMERCE 1-1-1992.

CLASS 18—LEATHER GOODS

FOR CLUTCH PURSES; COIN PURSES; PURSES (U.S. CLS. 1, 2, 3, 22 AND 41).
FIRST USE 1-1-1992; IN COMMERCE 1-1-1992.

CLASS 26—FANCY GOODS

FOR BARRETTES; HAIR ACCESSORIES, NAMELY, CLAW CLIPS; HAIR ACCESSORIES, NAMELY, JAW CLIPS; HAIR ACCESSORIES, NAMELY, SNAP CLIPS; HAIR BANDS; HAIR BARRETTES; HAIR CLAMPS; HAIR ORNAMENTS; HAIR ORNAMENTS IN THE FORM OF COMBS; HAIR PINS; HAIR RIBBONS (U.S. CLS. 37, 39, 40, 42 AND 50).
FIRST USE 1-1-1992; IN COMMERCE 1-1-1992.
WILLIAM VERHOSEK, EXAMINING ATTORNEY

CLASS 37—CONSTRUCTION AND REPAIR

FOR INSTALLATION OF SECURITY AND FIRE ALARM SYSTEMS; MAINTENANCE AND REPAIR OF SECURITY AND FIRE ALARM SYSTEMS (U.S. CLS. 100, 103 AND 106).
FIRST USE 12-4-2002; IN COMMERCE 12-4-2002.

CLASS 45—PERSONAL AND LEGAL SERVICES

FOR SECURITY AND FIRE ALARM SYSTEM MONITORING SERVICES (U.S. CLS. 100 AND 101).
FIRST USE 12-4-2002; IN COMMERCE 12-4-2002.
B. PARADEWELAI, EXAMINING ATTORNEY

SN 77-856,471. BRENFORD ENVIRONMENTAL SYSTEMS LP, PEARLAND, TX. FILED 10-23-2009.



NO CLAIM IS MADE TO THE EXCLUSIVE RIGHT TO USE "GRIT", APART FROM THE MARK AS SHOWN.

THE MARK CONSISTS OF CIRCULAR DESIGN INCLUDING A SCATTERING OF SMALL SQUARES IN THE LOWER SECTION OF THE CIRCLE TO THE LEFT OF THE STYLIZED WORDS "GRIT GATOR" AND BOTH ARE BISECTED BY A COMET TAIL LINE.

CLASS 7—MACHINERY

FOR CLEANING MACHINES FOR FLUSHING AND CLEANING THE INSIDE OF PIPES, TUBES, AND SIMILAR TUBULAR STRUCTURES, NAMELY, ENCLOSED SEALED UNITS THAT CAPTURE SAND, GRIT AND WATER PUMPED FROM WASTE COLLECTION SYSTEMS (U.S. CLS. 13, 19, 21, 23, 31, 34 AND 35).
FIRST USE 1-1-1997; IN COMMERCE 1-1-1997.

CLASS 37—CONSTRUCTION AND REPAIR

FOR CLEANING OF TUBULAR STRUCTURES USED IN CONNECTION WITH WASTE COLLECTION SYSTEMS, INCLUDING SEWER LINES, PIPES, AND TUBES (U.S. CLS. 100, 103 AND 106).
FIRST USE 1-1-1997; IN COMMERCE 1-1-1997.
DORITT L. CARROLL, EXAMINING ATTORNEY

SN 77-857,305. MASTER EMPIRE LIMITED, TSUEN WAN, HONG KONG, FILED 10-26-2009.

ARTISFRONT

THE MARK CONSISTS OF THE WORD "ARTISFRONT" WITH THE LETTER "O" BEING FULLY SHADED AND CONTAINING ARROWS FORMING A CIRCLE DIVIDED IN THE MIDDLE.

CLASS 9—ELECTRICAL AND SCIENTIFIC APPARATUS

FOR LAPTOP CARRYING CASES; MESSENGER BAGS ESPECIALLY ADAPTED FOR HOLDING LAPTOPS; DIGITAL CAMERA HOLDERS; MEMORY CARD HOLDERS; MP3 HOLDERS; PERSONAL DIGITAL ASSISTANT HOLDERS; MOBILE PHONE HOLDERS, NAMELY, CASES, HOLSTERS, STRAPS AND COVERS FOR MOBILE PHONES; ELECTRONIC DAY PLANNERS; ELECTRONIC PERSONAL ORGANIZERS; COMPACT DISC CASES; MOBILE PHONE POUCHES; BAGS FOR LAPTOP SLEEVES (U.S. CLS. 21, 23, 26, 36 AND 38).

CLASS 16—PAPER GOODS AND PRINTED MATTER

FOR LAP DESKS; DESKTOP PLANNERS; PERSONAL ORGANIZERS; PAD FOLIOS; NOTEBOOKS; DRY ERASE WRITING BOARDS AND WRITING SURFACES; MAGNETIC BOARDS; BINDERS; FOLDERS; PAPER EXPANDING FILES; FILE BOXES FOR STORING MAGAZINES; DOCUMENT FILE TRAYS; LETTER TRAYS; DESKTOP ORGANIZERS; ORGANIZERS FOR STATIONERY USE; STORAGE CONTAINERS MADE OF PAPER; PHOTO STORAGE BOXES; PAPER BOXES FOR STORAGE OF CHRISTMAS DECORATION ITEMS (U.S. CLS. 2, 5, 22, 23, 29, 37, 38 AND 50).

CLASS 18—LEATHER GOODS

FOR TOTE BAGS; BACK PACKS; MESSENGER BAGS; POUCHES FOR HOLDING KEYS; LEATHER POUCHES; COIN POUCHES; LUGGAGE TAGS; KIT BAGS (U.S. CLS. 1, 2, 3, 22 AND 41).

CLASS 35—ADVERTISING AND BUSINESS

FOR RETAIL STORE SERVICES AND ONLINE RETAIL STORE SERVICES FEATURING PRODUCTS, NAMELY, LAPTOP CARRYING CASES, MESSENGER BAGS ESPECIALLY ADAPTED FOR HOLDING LAPTOPS, DIGITAL CAMERA HOLDERS, MEMORY CARD HOLDERS, MP3 HOLDERS, PERSONAL DIGITAL ASSISTANT HOLDERS, PHONE HOLDERS, ELECTRONIC DAY PLANNERS, ELECTRONIC PERSONAL ORGANIZERS, COMPACT DISC CASES, PHONE POUCHES, LAP DESKS, DESKTOP PLANNERS, PERSONAL ORGANIZERS, PAD FOLIOS, NOTEBOOKS, DRY ERASE WRITING BOARDS AND WRITING SURFACES, MAGNETIC BOARDS, BINDERS, FOLDERS, PAPER EXPANDING FILES, FILE BOXES FOR STORING MAGAZINES, DOCUMENT FILE TRAYS, LETTER TRAYS, DESKTOP ORGANIZERS, ORGANIZERS FOR STATIONERY USE, STORAGE CONTAINERS MADE OF PAPER, PHOTO STORAGE BOXES, PAPER BOXES FOR STORAGE OF CHRISTMAS DECORATION ITEMS, BAGS FOR LAPTOP SLEEVES, TOTE BAGS, BACK PACKS, MESSENGER BAGS, POUCHES FOR HOLDING KEYS, LEATHER POUCHES, COIN POUCHES, LUGGAGE TAGS AND KIT BAGS (U.S. CLS. 100, 101 AND 102).

DEZMONA MIZELLE, EXAMINING ATTORNEY

SN 77-859,267. GB II CORPORATION, DBA COLUMBIA RIVER KNIFE & TOOL COMPANY, TUALATIN, OR. FILED 10-28-2009.

CRKT

OWNER OF U.S. REG. NO. 2,485,097.
THE MARK CONSISTS OF THE STYLIZED LETTERS "CRKT".

CLASS 8—HAND TOOLS

FOR FIXED BLADE KNIVES, FOLDING KNIVES, OPENING MECHANISMS FOR FOLDING KNIVES, KNIFE SHARPENERS, KNIFE HARNESSSES, NAMELY, KNIFE HOLDERS FOR WEARING ON THE BODY; KNIFE SHEATHS, SHEARS, TACTICAL DEFENSE WEAPON IN THE FORM OF A WRITING PEN MADE FROM STRONG MATERIALS CAPABLE OF STRIKING AN ASSAILANT; MULTI-PURPOSE HAND TOOLS COMPRISING A WRENCH HAVING A CARABINER FRAME WITH AN ATTACHED KNIFE BLADE; MULTI-FUNCTION HAND TOOLS COMPRISING A KNIFE BLADE AND LED LIGHT ATTACHED TO A CARABINER; MULTI-FUNCTION HAND TOOLS COMPRISING A CARABINER FRAME AND ONE OR MORE REMOVABLE TOOLS, NAMELY, A FOLDING KNIFE, ALONG WITH ONE OR MORE OF EACH OF THE FOLLOWING, A BIT CARRIER AND DRIVER, PLIERS, SCISSORS, A BOTTLE OPENER, A CORKSCREW, AN LED LIGHT, A FLASHLIGHT, A SCREWDRIVER HAVING AN LED LIGHT, A FLASH MEMORY, AND A WINE OPENER WITH WATERPROOF CONTAINER; MULTI-FUNCTION HAND TOOLS COMPRISING A SCREWDRIVER WITH A BIT CARRIER; MULTI-FUNCTION HAND TOOLS COMPRISING A KNIFE, SCISSORS, A BOTTLE OPENER AND AN LED LIGHT; MULTI-FUNCTION HAND TOOLS COMPRISING PLIERS, A KNIFE BLADE AND A SCREWDRIVER (U.S. CLS. 23, 28 AND 44).

CLASS 25—CLOTHING

FOR CLOTHING, NAMELY, HATS, SWEATERS, SWEATSHIRTS, T-SHIRTS AND COATS (U.S. CLS. 22 AND 39).

KAPIL BHANOT, EXAMINING ATTORNEY

SN 77-859,493. PLASTI-KOTE CO., INC., MEDINA, OH. FILED 10-28-2009.

PlastiKote

OWNER OF U.S. REG. NO. 856,353.
THE MARK CONSISTS OF THE WORDS "PLASTI-KOTE" AND AN UNDERSCORE.

CLASS 2—PAINTS

FOR PAINTS, ENAMEL PAINTS, PRIMERS, PAINT SEALERS, LACQUERS, BATTERY TERMINAL COATINGS, AND VINYL COATINGS (U.S. CLS. 6, 11 AND 16).

CLASS 3—COSMETICS AND CLEANING PREPARATIONS

FOR BATTERY CLEANER (U.S. CLS. 1, 4, 6, 50, 51 AND 52).

CLASS 4—LUBRICANTS AND FUELS

FOR ALL PURPOSE LUBRICANTS, SPRAY SILICONE
(U.S. CLS. 1, 6 AND 15).
PAUL F. GAST, EXAMINING ATTORNEY

SN 77-859,532. PLASTI-KOTE CO., INC., MEDINA, OH.
FILED 10-28-2009.

PlastiKote
THE PERFECT FINISH

OWNER OF U.S. REG. NO. 856,353.
NO CLAIM IS MADE TO THE EXCLUSIVE RIGHT TO
USE "FINISH", APART FROM THE MARK AS SHOWN.
THE MARK CONSISTS OF THE WORDS "PLASTI-KOTE"
AND AN UNDERScore AND BELOW THAT THE WORDS
"THE PERFECT FINISH".

CLASS 2—PAINTS

FOR PAINTS, ENAMEL PAINTS, PRIMERS, PAINT
SEALERS, LACQUERS, BATTERY TERMINAL COAT-
INGS, AND VINYL COATINGS (U.S. CLS. 6, 11 AND 16).

**CLASS 3—COSMETICS AND CLEANING PRE-
PARATIONS**

FOR BATTERY CLEANER (U.S. CLS. 1, 4, 6, 50, 51
AND 52).

CLASS 4—LUBRICANTS AND FUELS

FOR ALL PURPOSE LUBRICANTS, SPRAY SILICONE
(U.S. CLS. 1, 6 AND 15).
PAUL F. GAST, EXAMINING ATTORNEY

SN 77-860,061. EDIBLE ARRANGEMENTS, LLC, WALL-
INGFORD, CT. FILED 10-29-2009.

EDIBLE ARRANGEMENTS

THE MARK CONSISTS OF STANDARD CHARACTERS
WITHOUT CLAIM TO ANY PARTICULAR FONT, STYLE,
SIZE, OR COLOR.
OWNER OF U.S. REG. NOS. 2,356,362, 3,141,566 AND
OTHERS.
SEC. 2(F).

CLASS 29—MEATS AND PROCESSED FOODS

FOR FRUIT CUT INTO SHAPES AND ARRANGED IN
CONTAINERS AS FLORAL DESIGNS; FRUIT SALADS;
PROCESSED FRUITS; ARRANGEMENTS MADE OF
FRESH PROCESSED FRUIT; FRUIT CUT INTO SHAPES
AND AT LEAST PARTIALLY COATED WITH AN
EDIBLE TOPPING, NAMELY, COCONUT, PROCESSED
NUTS AND COMBINATIONS THEREOF; FRUIT CUT
INTO SHAPES AND AT LEAST PARTIALLY COATED
WITH AN EDIBLE TOPPING, NAMELY, COCONUT,
PROCESSED NUTS AND COMBINATIONS THEREOF
AND ARRANGED IN CONTAINERS AS FLORAL DE-
SIGNS; SALADS MADE OF LETTUCE AND FRESH
FRUIT; SALADS MADE WITH LETTUCE AND PRO-
CESSED FRUIT (U.S. CL. 46).
FIRST USE 10-0-1998; IN COMMERCE 10-0-1998.

CLASS 30—STAPLE FOODS

FOR FRUIT CUT INTO SHAPES AND AT LEAST
PARTIALLY COATED WITH AN EDIBLE TOPPING,
NAMELY, CHOCOLATE, CINNAMON AND COMBINA-
TIONS THEREOF; ARRANGEMENTS MADE OF PRO-
CESSED FRUIT AT LEAST PARTIALLY COATED WITH
AN EDIBLE TOPPING, NAMELY, CHOCOLATE, CIN-
NAMON AND COMBINATIONS THEREOF; SAUCES
CONTAINING CUT FRESH FRUIT (U.S. CL. 46).
FIRST USE 10-30-1999; IN COMMERCE 10-30-1999.

CLASS 32—LIGHT BEVERAGES

FOR SMOOTHIES; FRUIT SMOOTHIES; FRUIT
JUICES; FRUIT-BASED BEVERAGES; CHILLED
FRUIT-BASED BEVERAGES; FROZEN FRUIT-BASED
BEVERAGES (U.S. CLS. 45, 46 AND 48).
FIRST USE 5-12-2005; IN COMMERCE 5-12-2005.

CLASS 35—ADVERTISING AND BUSINESS

FOR ON-LINE AND RETAIL STORE SERVICES IN
THE FIELD OF FRESH FRUIT, NAMELY, FRUIT CUT
INTO SHAPES AND ARRANGED IN CONTAINERS AS
FLORAL DESIGNS; FRUIT SALADS; PROCESSED
FRUITS; ARRANGEMENTS MADE OF FRESH PRO-
CESSED FRUIT; FRUIT CUT INTO SHAPES AND AT
LEAST PARTIALLY COATED WITH AN EDIBLE TOP-
PING, NAMELY, CHOCOLATE, CINNAMON, COCO-
NUT, PROCESSED NUTS AND COMBINATIONS
THEREOF; FRUIT CUT INTO SHAPES AND AT LEAST
PARTIALLY COATED WITH AN EDIBLE TOPPING,
NAMELY, CHOCOLATE, CINNAMON, COCONUT, PRO-
CESSED NUTS AND COMBINATIONS THEREOF AND
ARRANGED IN CONTAINERS AS FLORAL DESIGNS;
SAUCES CONTAINING CUT FRESH FRUIT; SALADS
MADE OF LETTUCE AND FRESH FRUIT; SALADS
MADE WITH LETTUCE AND PROCESSED FRUIT;
ARRANGEMENTS MADE OF PROCESSED FRUIT AT
LEAST PARTIALLY COATED WITH AN EDIBLE TOP-
PING, NAMELY, CHOCOLATE, CINNAMON, COCO-
NUT, PROCESSED NUTS AND COMBINATIONS
THEREOF; FRUIT PIECES; FRUIT PIECES AT LEAST
PARTIALLY COATED WITH AN EDIBLE TOPPING;
FRUIT BASED BEVERAGES; SMOOTHIES; FROZEN
FRUIT BASED BEVERAGES (U.S. CLS. 100, 101 AND
102).
FIRST USE 10-31-1998; IN COMMERCE 10-31-1998.
BARBARA BROWN, EXAMINING ATTORNEY

SN 77-860,084. EDIBLE ARRANGEMENTS, LLC, WALLINGFORD, CT. FILED 10-29-2009.



OWNER OF U.S. REG. NOS. 2,356,362, 2,934,715 AND 3,141,566.

THE MARK CONSISTS OF THE WORDS "EDIBLE ARRANGEMENTS" AND A FRUIT AND BASKET DESIGN. SEC. 2(F) AS TO "EDIBLE ARRANGEMENTS".

CLASS 29—MEATS AND PROCESSED FOODS

FOR FRUIT CUT INTO SHAPES AND ARRANGED IN CONTAINERS AS FLORAL DESIGNS; FRUIT SALADS; PROCESSED FRUITS; ARRANGEMENTS MADE OF FRESH PROCESSED FRUIT; FRUIT CUT INTO SHAPES AND AT LEAST PARTIALLY COATED WITH AN EDIBLE TOPPING, NAMELY, COCONUT, PROCESSED NUTS AND COMBINATIONS THEREOF; FRUIT CUT INTO SHAPES AND AT LEAST PARTIALLY COATED WITH AN EDIBLE TOPPING, NAMELY, COCONUT, PROCESSED NUTS AND COMBINATIONS THEREOF AND ARRANGED IN CONTAINERS AS FLORAL DESIGNS; SALADS MADE OF LETTUCE AND FRESH FRUIT; SALADS MADE WITH LETTUCE AND PROCESSED FRUIT (U.S. CL. 46).

FIRST USE 10-0-1998; IN COMMERCE 10-0-1998.

CLASS 30—STAPLE FOODS

FOR FRUIT CUT INTO SHAPES AND AT LEAST PARTIALLY COATED WITH AN EDIBLE TOPPING, NAMELY, CHOCOLATE, CINNAMON AND COMBINATIONS THEREOF; FRUIT CUT INTO SHAPES AND AT LEAST PARTIALLY COATED WITH AN EDIBLE TOPPING, NAMELY, CHOCOLATE, CINNAMON AND COMBINATIONS THEREOF AND ARRANGED IN CONTAINERS AS FLORAL DESIGNS; ARRANGEMENTS MADE OF PROCESSED FRUIT AT LEAST PARTIALLY COATED WITH AN EDIBLE TOPPING, NAMELY, CHOCOLATE, CINNAMON AND COMBINATIONS THEREOF; SAUCES CONTAINING CUT FRESH FRUIT (U.S. CL. 46).

FIRST USE 10-30-1999; IN COMMERCE 10-30-1999.

CLASS 32—LIGHT BEVERAGES

FOR SMOOTHIES; FRUIT SMOOTHIES; FRUIT JUICES; FRUIT-BASED BEVERAGES; CHILLED FRUIT-BASED BEVERAGES; FROZEN FRUIT-BASED BEVERAGES (U.S. CLS. 45, 46 AND 48).

FIRST USE 5-12-2005; IN COMMERCE 5-12-2005.

CLASS 35—ADVERTISING AND BUSINESS

FOR ON-LINE AND RETAIL STORE SERVICES IN THE FIELD OF FRESH FRUIT, NAMELY, FRUIT CUT INTO SHAPES AND ARRANGED IN CONTAINERS AS FLORAL DESIGNS; FRUIT SALADS; PROCESSED FRUITS; ARRANGEMENTS MADE OF FRESH PROCESSED FRUIT; FRUIT CUT INTO SHAPES AND AT LEAST PARTIALLY COATED WITH AN EDIBLE TOPPING, NAMELY, CHOCOLATE, CINNAMON, COCONUT, PROCESSED NUTS AND COMBINATIONS THEREOF; FRUIT CUT INTO SHAPES AND AT LEAST PARTIALLY COATED WITH AN EDIBLE TOPPING, NAMELY, CHOCOLATE, CINNAMON, COCONUT, PROCESSED NUTS AND COMBINATIONS THEREOF AND ARRANGED IN CONTAINERS AS FLORAL DESIGNS; SAUCES CONTAINING CUT FRESH FRUIT; SALADS MADE OF LETTUCE AND FRESH FRUIT; SALADS MADE WITH LETTUCE AND PROCESSED FRUIT; ARRANGEMENTS MADE OF PROCESSED FRUIT AT LEAST PARTIALLY COATED WITH AN EDIBLE TOPPING, NAMELY, CHOCOLATE, CINNAMON, COCONUT, PROCESSED NUTS AND COMBINATIONS THEREOF; FRUIT PIECES; FRUIT PIECES AT LEAST PARTIALLY COATED WITH AN EDIBLE TOPPING; FRUIT BASED BEVERAGES; SMOOTHIES; FROZEN FRUIT BASED BEVERAGES (U.S. CLS. 100, 101 AND 102).

FIRST USE 10-31-1998; IN COMMERCE 10-31-1998.
BARBARA BROWN, EXAMINING ATTORNEY

SN 77-861,561. HALTER WINERY LLC, PASO ROBLES, CA. FILED 10-30-2009.

HALTER RANCH

THE MARK CONSISTS OF STANDARD CHARACTERS WITHOUT CLAIM TO ANY PARTICULAR FONT, STYLE, SIZE, OR COLOR.

OWNER OF U.S. REG. NO. 2,860,620.

NO CLAIM IS MADE TO THE EXCLUSIVE RIGHT TO USE "RANCH", APART FROM THE MARK AS SHOWN.

CLASS 33—WINES AND SPIRITS

FOR WINES (U.S. CLS. 47 AND 49).

FIRST USE 5-12-2005; IN COMMERCE 5-12-2005.

CLASS 35—ADVERTISING AND BUSINESS

FOR RETAIL STORES AND DISTRIBUTORSHIPS FEATURING WINE AND GRAPES (U.S. CLS. 100, 101 AND 102).

FIRST USE 5-12-2005; IN COMMERCE 5-12-2005.

LAURIE KAUFMAN, EXAMINING ATTORNEY

SN 77-862,865. KANEKA CORPORATION, KITA-KU, OSAKA, JAPAN, FILED 11-2-2009.

KANEKA

THE MARK CONSISTS OF STANDARD CHARACTERS WITHOUT CLAIM TO ANY PARTICULAR FONT, STYLE, SIZE, OR COLOR.

OWNER OF U.S. REG. NOS. 1,650,504, 3,159,574 AND 3,451,010.

SN 77-863,864. GOALS FOR AMERICANS FOUNDATION, ST. LOUIS, MO. FILED 11-3-2009.

CLASS 29—MEATS AND PROCESSED FOODS

FOR PROCESSED UBIQUINONE FOR FOODS PURPOSES; PROCESSED UBIQUINOL FOR FOODS PURPOSES (U.S. CL. 46).

THE DEPARTMENT OF NATIONAL GOALS

CLASS 30—STAPLE FOODS

FOR LICORICE EXTRACT FOR USE AS FLAVORING IN FOODS AND BEVERAGES; PROCESSED LICORICE FOR FOOD PURPOSES (U.S. CL. 46).

KELLEY WELLS, EXAMINING ATTORNEY

THE MARK CONSISTS OF STANDARD CHARACTERS WITHOUT CLAIM TO ANY PARTICULAR FONT, STYLE, SIZE, OR COLOR.

OWNER OF U.S. REG. NO. 2,355,893.

NO CLAIM IS MADE TO THE EXCLUSIVE RIGHT TO USE "NATIONAL", APART FROM THE MARK AS SHOWN.

SN 77-863,856. GOALS FOR AMERICANS FOUNDATION, ST. LOUIS, MO. FILED 11-3-2009.

CLASS 9—ELECTRICAL AND SCIENTIFIC APPARATUS

FOR PROVIDING DOWNLOADABLE ELECTRONIC PUBLICATIONS IN THE NATURE OF ARTICLES, BOOKLETS, PAMPHLETS, BROCHURES, MAGAZINES, AND BOOKS IN THE FIELDS OF WORLD PEACE, NATIONAL SECURITY, EDUCATION, ECOLOGY, MILITARY AFFAIRS, HUMAN RIGHTS, HEALTH AND NUTRITION, COMMERCE, NATURE AND THE ENVIRONMENT, HUMAN SERVICES, ECONOMICS AND BUSINESS, JUSTICE AND POLITICS (U.S. CLS. 21, 23, 26, 36 AND 38).

AMERICAN DEPARTMENT OF NATIONAL GOALS

CLASS 16—PAPER GOODS AND PRINTED MATTER

FOR PRINTED MATERIALS, NAMELY, ARTICLES, BOOKLETS, PAMPHLETS, BROCHURES, MAGAZINES, AND BOOKS PUBLISHED PERIODICALLY ON MATTERS RELATING TO WORLD PEACE, NATIONAL SECURITY, EDUCATION, ECOLOGY, MILITARY AFFAIRS, HUMAN RIGHTS, HEALTH AND NUTRITION, COMMERCE, NATURE AND THE ENVIRONMENT, HUMAN SERVICES ECONOMICS AND BUSINESS, JUSTICE AND POLITICS (U.S. CLS. 2, 5, 22, 23, 29, 37, 38 AND 50).

TRACY WHITTAKER-BROWN, EXAMINING ATTORNEY

THE MARK CONSISTS OF STANDARD CHARACTERS WITHOUT CLAIM TO ANY PARTICULAR FONT, STYLE, SIZE, OR COLOR.

OWNER OF U.S. REG. NO. 2,355,893.

NO CLAIM IS MADE TO THE EXCLUSIVE RIGHT TO USE "NATIONAL" AND "AMERICAN", APART FROM THE MARK AS SHOWN.

CLASS 9—ELECTRICAL AND SCIENTIFIC APPARATUS

FOR PROVIDING DOWNLOADABLE ELECTRONIC PUBLICATIONS IN THE NATURE OF ARTICLES, BOOKLETS, PAMPHLETS, BROCHURES, MAGAZINES, AND BOOKS IN THE FIELDS OF WORLD PEACE, NATIONAL SECURITY, EDUCATION, ECOLOGY, MILITARY AFFAIRS, HUMAN RIGHTS, HEALTH AND NUTRITION, COMMERCE, NATURE AND THE ENVIRONMENT, HUMAN SERVICES, ECONOMICS AND BUSINESS, JUSTICE AND POLITICS (U.S. CLS. 21, 23, 26, 36 AND 38).

SN 77-864,025. ALBERT EINSTEIN HEALTHCARE NETWORK, PHILADELPHIA, PA. FILED 11-3-2009.

INSIDE MOSSREHAB

CLASS 16—PAPER GOODS AND PRINTED MATTER

FOR PRINTED MATERIALS, NAMELY, ARTICLES, BOOKLETS, PAMPHLETS, BROCHURES, MAGAZINES, AND BOOKS PUBLISHED PERIODICALLY ON MATTERS RELATING TO WORLD PEACE, NATIONAL SECURITY, EDUCATION, ECOLOGY, MILITARY AFFAIRS, HUMAN RIGHTS, HEALTH AND NUTRITION, COMMERCE, NATURE AND THE ENVIRONMENT, HUMAN SERVICES ECONOMICS AND BUSINESS, JUSTICE AND POLITICS (U.S. CLS. 2, 5, 22, 23, 29, 37, 38 AND 50).

TRACY WHITTAKER-BROWN, EXAMINING ATTORNEY

THE MARK CONSISTS OF STANDARD CHARACTERS WITHOUT CLAIM TO ANY PARTICULAR FONT, STYLE, SIZE, OR COLOR.

OWNER OF U.S. REG. NOS. 2,238,452 AND 2,639,061.

CLASS 9—ELECTRICAL AND SCIENTIFIC APPARATUS

FOR ELECTRONIC DOWNLOADABLE NEWSLETTER IN THE FIELD OF MEDICINE AND REHABILITATION (U.S. CLS. 21, 23, 26, 36 AND 38).

FIRST USE 10-28-2009; IN COMMERCE 10-28-2009.

CLASS 16—PAPER GOODS AND PRINTED MATTER

FOR NEWSLETTER IN THE FIELD OF MEDICINE AND REHABILITATION (U.S. CLS. 2, 5, 22, 23, 29, 37, 38 AND 50).

FIRST USE 9-0-2005; IN COMMERCE 9-0-2005.

CLASS 44—MEDICAL, BEAUTY AND AGRICULTURAL SERVICES

FOR PROVIDING INFORMATION ON THE INTERNET REGARDING MEDICINE, AND PHYSICAL MEDICINE AND REHABILITATION (U.S. CLS. 100 AND 101).

FIRST USE 6-0-2007; IN COMMERCE 6-0-2007.

DEIRDRE ROBERTSON, EXAMINING ATTORNEY

SN 77-865,326. INCELL DX, INC., PALO ALTO, CA. FILED 11-4-2009.

CLASS 1—CHEMICALS

FOR REAGENTS FOR SCIENTIFIC OR MEDICAL RESEARCH USE; DIAGNOSTIC REAGENTS FOR CLINICAL OR MEDICAL LABORATORY USE; CHEMICAL SOLUTIONS AND PREPARATIONS CONSISTING OF PRE-MIXED REACTANTS AND REAGENTS FOR SCIENTIFIC AND RESEARCH USE IN CONNECTION WITH AMPLIFICATION, ANALYSIS OR LABELING OF NUCLEIC ACID (U.S. CLS. 1, 5, 6, 10, 26 AND 46).

CLASS 5—PHARMACEUTICALS

FOR DIAGNOSTIC REAGENTS FOR MEDICINAL USE; MEDICAL DIAGNOSTIC REAGENTS AND ASSAYS FOR TESTING OF BODY FLUIDS; REAGENTS AND MEDIA FOR MEDICAL AND VETERINARY DIAGNOSTIC PURPOSES AND REAGENTS FOR MEDICAL USE (U.S. CLS. 6, 18, 44, 46, 51 AND 52).

CLASS 44—MEDICAL, BEAUTY AND AGRICULTURAL SERVICES

FOR PROVIDING MEDICAL SAMPLE TESTING AND DIAGNOSTIC SERVICES (U.S. CLS. 100 AND 101).

JORDAN BAKER, EXAMINING ATTORNEY

SN 77-865,269. GLOBAL BRANDS LIMITED, DERBYSHIRE, UNITED KINGDOM. FILED 11-4-2009.

KICK STIMULATION

THE MARK CONSISTS OF STANDARD CHARACTERS WITHOUT CLAIM TO ANY PARTICULAR FONT, STYLE, SIZE, OR COLOR.

CLASS 25—CLOTHING

FOR ARTICLES OF CLOTHING AND SPORTS CLOTHING, NAMELY, SWEATSHIRTS, T-SHIRTS, FOOTWEAR, HEADWEAR, HATS, CAPS, SHOES, GLOVES, SCARVES, JACKETS, TROUSERS, SOCKS, SKIRTS, UNDERGARMENTS, SHOES AND BOOTS (U.S. CLS. 22 AND 39).

CLASS 32—LIGHT BEVERAGES

FOR NON-ALCOHOLIC DRINKS, NAMELY, MINERAL WATER, AERATED WATER, FRUIT JUICES, SYRUPS FOR MAKING BEVERAGES, PREPARATIONS FOR MAKING FRUIT DRINKS AND SOFT DRINKS, TABLETS AND POWDERS FOR MAKING ENERGY AND SPORTS DRINKS, NON-ALCOHOLIC COCKTAILS, NON-ALCOHOLIC ENERGY DRINKS; BEERS INCLUDING LAGER, BITTER, STOUT, ALE AND MILD (U.S. CLS. 45, 46 AND 48).

CLASS 33—WINES AND SPIRITS

FOR ALCOHOLIC DRINKS AND ALCOHOLIC BEVERAGES, NAMELY, WINES, DISTILLED SPIRITS, BRANDY, HARD CIDER, ALCOHOLIC COCKTAILS; ALCOHOLIC FRUIT-FLAVORED BEVERAGES CONTAINING, GIN, ONE OR MORE LIQUORS, MEAD, PERRY, RICE ALCOHOL, RUM, SAKE, VODKA, WHISKEY AND/OR WINE; ALCOHOLIC BEVERAGES BASED ON FRUIT FLAVORED, HERB FLAVORED, AND SPICE FLAVORED DISTILLED LIQUOR; ALCOHOLIC ENERGY DRINKS (U.S. CLS. 47 AND 49).

DAVID H. STINE, EXAMINING ATTORNEY

SN 77-865,447. STONEHOUSE SIGNS, INC., ARVADA, CO. FILED 11-4-2009.



THE MARK CONSISTS OF A LARGE CIRCLE SURROUNDING THE DESIGN OF A HAND WITH THE WORDS "SAFETY FIRST" APPEARING ON THE PALM OF THE HAND.

CLASS 16—PAPER GOODS AND PRINTED MATTER

FOR PAPER TAGS (U.S. CLS. 2, 5, 22, 23, 29, 37, 38 AND 50).

FIRST USE 0-0-1919; IN COMMERCE 0-0-1919.

CLASS 20—FURNITURE AND ARTICLES NOT OTHERWISE CLASSIFIED

FOR PLASTIC TAGS IN THE NATURE OF SMALL ACCIDENT PREVENTION AND HAZARD TAGS THAT MAY BE AFFIXED TO OBJECTS (U.S. CLS. 2, 13, 22, 25, 32 AND 50).

FIRST USE 0-0-1964; IN COMMERCE 0-0-1964.

JOHN DALIER, EXAMINING ATTORNEY

SN 77-866,118. BRECKENFELD, BETTINGA, CORONA, CA. AND BRECKENFELD, DARRELL, CORONA, CA. FILED 11-5-2009.

100% CERTIFIED COOL

THE MARK CONSISTS OF STANDARD CHARACTERS WITHOUT CLAIM TO ANY PARTICULAR FONT, STYLE, SIZE, OR COLOR.

OWNER OF U.S. REG. NO. 3,697,995.

CLASS 18—LEATHER GOODS

FOR CARRY-ALL BAGS; HANDBAGS; BEACH BAGS; TOTE BAGS; BACKPACKS; PURSES, ATHLETIC BAGS, GENERAL PURPOSE BAGS, FANNY PACKS, WALLETS, UMBRELLAS, DUFFEL BAGS (U.S. CLS. 1, 2, 3, 22 AND 41).

FIRST USE 11-1-2009; IN COMMERCE 11-1-2009.

CLASS 21—HOUSEWARES AND GLASS

FOR MUGS, CUPS; DISHES; LUNCH BOXES; BOTTLES SOLD EMPTY; BOWLS; PLATES; BOTTLE OPENERS, ALUMINUM WATER BOTTLES, SOLD EMPTY; PLASTIC DRINKING BOTTLES, SOLD EMPTY; FIGURINES OF GLASS (U.S. CLS. 2, 13, 23, 29, 30, 33, 40 AND 50).

FIRST USE 11-1-2009; IN COMMERCE 11-1-2009.

CLASS 28—TOYS AND SPORTING GOODS

FOR TOYS, NAMELY, DOLLS, BOARD GAMES, MODELED PLASTIC TOY FIGURINES AND BOBBLE HEADS DOLLS, DOG TOYS, TRADING CARD GAMES (U.S. CLS. 22, 23, 38 AND 50).

FIRST USE 11-1-2009; IN COMMERCE 11-1-2009.

MICHAEL KEATING, EXAMINING ATTORNEY

SN 77-869,624. TIBCO SOFTWARE INC., PALO ALTO, CA. FILED 11-10-2009.

FORMVINE

THE MARK CONSISTS OF STANDARD CHARACTERS WITHOUT CLAIM TO ANY PARTICULAR FONT, STYLE, SIZE, OR COLOR.

CLASS 9—ELECTRICAL AND SCIENTIFIC APPARATUS

FOR COMPUTER SOFTWARE THAT ASSISTS USERS IN DESIGNING, CREATING, EDITING, SHARING AND PUBLISHING DOCUMENTS OR COMPUTER PROGRAMS FOR THE DISPLAY OR CAPTURE OF INFORMATION; COMPUTER SOFTWARE THAT ASSISTS USERS IN GENERATING AND PUBLISHING REPORTS ON INFORMATION; COMPUTER SOFTWARE THAT ASSISTS USERS IN DEFINING, MANAGING, AND FOLLOWING PROCEDURES THROUGH WHICH USERS AND SYSTEMS INTERACT WITH INFORMATION; COMPUTER SOFTWARE FOR USE IN INTEGRATING DATABASES, EMAIL, SEARCH ENGINES, CONTENT MANAGEMENT, KNOWLEDGE MANAGEMENT, AND APPLICATIONS ON A GLOBAL COMPUTER NETWORK; COMPUTER SOFTWARE FOR USE IN ENTERPRISE APPLICATION INTEGRATION, NAMELY, TO ENABLE SECURE DELIVERY OF INFORMATION, DATA, SOFTWARE, AND NETWORK SERVICES BETWEEN DISPARATE SOFTWARE APPLICATIONS AND SYSTEMS OVER COMPUTER NETWORKS; COMPUTER SOFTWARE FOR USE IN CONDUCTING AND PROCESSING ONLINE BUSINESS TRANSACTIONS; COMPUTER SOFTWARE FOR USE IN AUTOMATING ONLINE BUSINESS NETWORKS; COMPUTER SOFTWARE FOR USE IN COMPUTER NETWORKING; COMPUTER SOFTWARE FOR NETWORK MONITORING AND MANAGEMENT; COMPUTER DATABASES IN THE FIELD OF BUSINESS RECORDED ON COMPUTER SERVERS; COMPUTER SOFTWARE FOR USE IN DEPLOYING AND ACCESSING INTERACTIVE BUSINESS SERVICES; COMPUTER SOFTWARE FOR USE IN DEVELOPMENT, CUSTOMIZATION, ADMINISTRATION, AND MAINTENANCE OF WEBSITES AND PORTALS (U.S. CLS. 21, 23, 26, 36 AND 38).

CLASS 41—EDUCATION AND ENTERTAINMENT

FOR EDUCATIONAL SERVICES, NAMELY, PROVIDING COURSES, SEMINARS, CONFERENCES, AND WORKSHOPS IN THE FIELD OF COMPUTER SOFTWARE; EDUCATIONAL SERVICES, NAMELY, PROVIDING COURSES, SEMINARS, CONFERENCES, AND WORKSHOPS IN THE FIELD OF BUSINESS MANAGEMENT, DEVELOPMENT, OPERATION, STRATEGY, CREATIVE IDEATION, MARKETING AND SALES (U.S. CLS. 100, 101 AND 107).

CLASS 42—SCIENTIFIC AND COMPUTER SERVICES

FOR PROVIDING ONLINE USE OF NON-DOWNLOADABLE SOFTWARE AS A SERVICE THAT ASSISTS USERS IN DESIGNING, CREATING, EDITING, SHARING AND PUBLISHING DOCUMENTS OR COMPUTER PROGRAMS FOR THE DISPLAY OR CAPTURE OF INFORMATION; PROVIDING ONLINE USE OF NON-DOWNLOADABLE SOFTWARE AS A SERVICE THAT ASSISTS USERS IN GENERATING AND PUBLISHING REPORTS ON INFORMATION; PROVIDING ONLINE USE OF NON-DOWNLOADABLE SOFTWARE AS A SERVICE THAT ASSISTS USERS IN DEFINING, MANAGING, AND FOLLOWING PROCEDURES THROUGH WHICH USERS AND SYSTEMS INTERACT WITH INFORMATION; COMPUTER SOFTWARE CONSULTING SERVICES; INSTALLATION, MAINTENANCE AND UPDATING OF COMPUTER SOFTWARE; TECHNICAL SUPPORT SERVICES, NAMELY, TROUBLESHOOTING IN THE NATURE OF DIAGNOSING COMPUTER SOFTWARE AND HARDWARE PROBLEMS; COMPUTER SERVICES, NAMELY, CREATING AN ON-LINE COMMUNITY FOR REGISTERED USERS TO PARTICIPATE IN DISCUSSIONS, GET FEEDBACK FROM THEIR PEERS, FORM VIRTUAL COMMUNITIES, SHARE DOCUMENTS AND REPORTS, AND COLLABORATE IN PROJECTS RELATING TO DEVELOPMENT OF ELECTRONIC DOCUMENTS, COMPUTER PROGRAMS AND REPORTS (U.S. CLS. 100 AND 101).

ANNE E. GUSTASON, EXAMINING ATTORNEY

SN 77-869,649. STONEHOUSE SIGNS, INC., ARVADA, CO.
FILED 11-10-2009.

STONEHOUSE SIGNS

THE MARK CONSISTS OF STANDARD CHARACTERS WITHOUT CLAIM TO ANY PARTICULAR FONT, STYLE, SIZE, OR COLOR.

NO CLAIM IS MADE TO THE EXCLUSIVE RIGHT TO USE "SIGNS", APART FROM THE MARK AS SHOWN.

CLASS 6—METAL GOODS

FOR NON-LUMINOUS, NON-MECHANICAL METAL SIGNS (U.S. CLS. 2, 12, 13, 14, 23, 25 AND 50).
FIRST USE 0-0-1926; IN COMMERCE 0-0-1926.

CLASS 16—PAPER GOODS AND PRINTED MATTER

FOR PAPER TAGS, DECALS (U.S. CLS. 2, 5, 22, 23, 29, 37, 38 AND 50).
FIRST USE 0-0-1926; IN COMMERCE 0-0-1926.

CLASS 19—NON-METALLIC BUILDING MATERIALS

FOR NON-LUMINOUS, NON-MECHANICAL PLASTIC SIGNS (U.S. CLS. 1, 12, 33 AND 50).
FIRST USE 0-0-1964; IN COMMERCE 0-0-1964.

CLASS 20—FURNITURE AND ARTICLES NOT OTHERWISE CLASSIFIED

FOR PLASTIC TAGS IN THE NATURE OF SMALL ACCIDENT PREVENTION AND HAZARD TAGS THAT MAY BE AFFIXED TO OBJECTS (U.S. CLS. 2, 13, 22, 25, 32 AND 50).
FIRST USE 0-0-1964; IN COMMERCE 0-0-1964.

CLASS 42—SCIENTIFIC AND COMPUTER SERVICES

FOR GRAPHIC DESIGN SERVICES (U.S. CLS. 100 AND 101).
FIRST USE 0-0-1990; IN COMMERCE 0-0-1990.
JOHN DALIER, EXAMINING ATTORNEY

SN 77-869,900. BALFOUR BEATTY PLC, LONDON, ENGLAND, FILED 11-11-2009.

BALFOUR BEATTY

THE MARK CONSISTS OF STANDARD CHARACTERS WITHOUT CLAIM TO ANY PARTICULAR FONT, STYLE, SIZE, OR COLOR.

OWNER OF U.S. REG. NO. 2,951,510.

CLASS 36—INSURANCE AND FINANCIAL

FOR REAL ESTATE SERVICES, NAMELY, LEASING AND MANAGEMENT OF MILITARY HOUSING FOR OTHERS; FINANCIAL ASSET MANAGEMENT (U.S. CLS. 100, 101 AND 102).
FIRST USE 11-10-2009; IN COMMERCE 11-10-2009.

CLASS 37—CONSTRUCTION AND REPAIR

FOR CONSTRUCTION OF BUILDINGS; CONSTRUCTION AND BUILDING OF HOUSES AND OTHER DOMESTIC DWELLINGS; CONSTRUCTION OF SCHOOLS, HOSPITALS AND OTHER MUNICIPAL BUILDINGS; CONSTRUCTION OF POWER PLANTS, WATER TREATMENT AND PURIFICATION PLANTS, SOLID WASTE TREATMENT PLANTS AND OTHER MUNICIPAL INFRASTRUCTURE FACILITIES; CONSTRUCTION, INSTALLATION, REPAIR AND MAINTENANCE OF POWER DISTRIBUTION SYSTEMS AND POWER TRANSMISSION LINES; INSTALLATION AND MAINTENANCE OF RENEWABLE ENERGY BASED POWER PLANTS; CONSULTING SERVICES IN THE FIELD OF CONSTRUCTION OF RENEWABLE ENERGY FACILITIES; CONSTRUCTION PROJECT MANAGEMENT SERVICES IN THE FIELD OF CONSTRUCTION OF RENEWABLE ENERGY FACILITIES (U.S. CLS. 100, 103 AND 106).
FIRST USE 11-10-2009; IN COMMERCE 11-10-2009.

CLASS 42—SCIENTIFIC AND COMPUTER SERVICES

FOR TECHNICAL PLANNING OF RENEWABLE ENERGY BASED POWER PLANTS; TECHNICAL CONSULTING AND ENGINEERING SERVICES IN THE FIELD OF ENERGY EFFICIENCY; ENVIRONMENTAL SERVICES, NAMELY, TECHNICAL CONSULTATION IN THE FIELD OF ENVIRONMENTAL SCIENCE, ENGINEERING SERVICES, DESIGN FOR OTHERS IN THE FIELD OF ENERGY ENGINEERING, DESIGNING AND TESTING OF ENERGY PRODUCTS FOR OTHERS (U.S. CLS. 100 AND 101).
FIRST USE 11-10-2009; IN COMMERCE 11-10-2009.
ROBIN CHOSID, EXAMINING ATTORNEY

SN 77-870,078. UNIVERSITY ATHLETIC ASSOCIATION, INC., GAINESVILLE, FL. FILED 11-11-2009.



NO CLAIM IS MADE TO THE EXCLUSIVE RIGHT TO USE "CLUB" FOR INTERNATIONAL CLASS 41, APART FROM THE MARK AS SHOWN.

THE MARK CONSISTS OF THE LETTER "F" AND THE WORD "CLUB" IN STYLIZED FORM.

CLASS 25—CLOTHING

FOR CLOTHING, NAMELY, CAPS, T-SHIRTS, AND POLO SHIRTS (U.S. CLS. 22 AND 39).
FIRST USE 6-6-2009; IN COMMERCE 6-6-2009.

CLASS 41—EDUCATION AND ENTERTAINMENT

FOR ENTERTAINMENT SERVICES, NAMELY, ORGANIZING AND ARRANGING SOCIAL AND RECREATIONAL ACTIVITIES FOR FORMER UNIVERSITY LETTERWINNERS (U.S. CLS. 100, 101 AND 107).
 FIRST USE 6-6-2009; IN COMMERCE 6-6-2009.
 JEAN IM, EXAMINING ATTORNEY

SN 77-872,575. BETTER PLACE, INC., PALO ALTO, CA. FILED 11-13-2009.

BTRPLC

SN 77-870,955. WITSTREAM LLC, ROSELAND, NM. FILED 11-12-2009.

WITSTREAM

THE MARK CONSISTS OF STANDARD CHARACTERS WITHOUT CLAIM TO ANY PARTICULAR FONT, STYLE, SIZE, OR COLOR.

THE MARK CONSISTS OF STANDARD CHARACTERS WITHOUT CLAIM TO ANY PARTICULAR FONT, STYLE, SIZE, OR COLOR.

CLASS 38—COMMUNICATION

FOR PROVIDING MULTI USER ACCESS TO PROPRIETARY COLLECTIONS OF INFORMATION VIA THE INTERNET; PROVIDING CHAT ROOM SERVICES FOR SOCIAL NETWORKING (U.S. CLS. 100, 101 AND 104).

CLASS 38—COMMUNICATION

FOR TELECOMMUNICATION SERVICES, NAMELY, PROVIDING ONLINE AND TELECOMMUNICATION FACILITIES FOR REAL-TIME INTERACTION BETWEEN AND AMONG USERS OF COMPUTERS, MOBILE AND HANDHELD COMPUTERS, AND WIRED AND WIRELESS COMMUNICATION DEVICES CONCERNING TOPICS OF COMEDY AND GENERAL INTEREST; ELECTRONIC MESSAGING SERVICES; INSTANT MESSAGING SERVICES; PROVIDING ON-LINE FORUMS FOR TRANSMISSION OF MESSAGES AMONG COMPUTER USERS; PROVIDING ON-LINE CHAT ROOMS AND ELECTRONIC BULLETIN BOARDS FOR TRANSMISSION OF MESSAGES AMONG USERS IN THE FIELDS OF COMEDY AND GENERAL INTEREST (U.S. CLS. 100, 101 AND 104).
 FIRST USE 2-1-2009; IN COMMERCE 2-1-2009.

CLASS 42—SCIENTIFIC AND COMPUTER SERVICES

FOR PROVIDING INFORMATION REGARDING ENVIRONMENTALLY CONSCIOUS AND GREEN-RELATED TOPICS AND TECHNOLOGIES; CREATING INDEXES OF INFORMATION, WEBS SITES AND OTHER INFORMATION VIA THE INTERNET; PROVIDING INFORMATION REGARDING AUTOMOTIVE, OIL, CLEAN-TECHNOLOGY AND CLIMATE RELATED ISSUES FROM SEARCHABLE DATABASES AND INDEXES, INCLUDING TEXT, ELECTRONIC DOCUMENTS, DATABASES, GRAPHIC AND AV INFORMATION, ALL VIA THE INTERNET; CREATING AN ONLINE COMMUNITY OF REGISTERED USERS TO EXCHANGE INFORMATION (U.S. CLS. 100 AND 101).

CLASS 41—EDUCATION AND ENTERTAINMENT

FOR PROVIDING ON-LINE JOURNALS, NAMELY, BLOGS FEATURING TOPICS OF COMEDY, POP CULTURE, NEWS, CURRENT EVENTS, AND SOCIAL AND POLITICAL COMMENTARY (U.S. CLS. 100, 101 AND 107).
 FIRST USE 2-1-2009; IN COMMERCE 2-1-2009.

CLASS 45—PERSONAL AND LEGAL SERVICES

FOR ONLINE SOCIAL NETWORKING SERVICES (U.S. CLS. 100 AND 101).
 HENRY S. ZAK, EXAMINING ATTORNEY

CLASS 42—SCIENTIFIC AND COMPUTER SERVICES

FOR COMPUTER SERVICES, NAMELY, CREATING AN ONLINE COMMUNITY FOR REGISTERED USERS TO SHARE INFORMATION, PHOTOS, AUDIO, AND VIDEO CONTENT ABOUT THEMSELVES, TO GET FEEDBACK FROM THEIR PEERS, FORM VIRTUAL COMMUNITIES, AND ENGAGE IN SOCIAL NETWORKING; CREATING AND MAINTAINING BLOG SITES FOR OTHERS' USE (U.S. CLS. 100 AND 101).
 FIRST USE 2-1-2009; IN COMMERCE 2-1-2009.

SN 77-872,726. LA POINTIQUE INTERNATIONAL LTD., TUKWILA, WA. FILED 11-14-2009.

X-TREMUS

CLASS 45—PERSONAL AND LEGAL SERVICES

FOR ON-LINE SOCIAL NETWORKING SERVICES (U.S. CLS. 100 AND 101).
 FIRST USE 2-1-2009; IN COMMERCE 2-1-2009.
 CORY BOONE, EXAMINING ATTORNEY

THE MARK CONSISTS OF STANDARD CHARACTERS WITHOUT CLAIM TO ANY PARTICULAR FONT, STYLE, SIZE, OR COLOR.

CLASS 10—MEDICAL APPARATUS

FOR ANKLE SUPPORTS, ELBOW SUPPORTS, KNEE SUPPORTS, WRIST SUPPORTS, HEAD GUARDS, CHEST GUARDS, BELLY GUARDS, WAIST GUARDS, BACK GUARDS, THIGH GUARDS, ALL IN THE NATURE OF SUPPORTS FOR MEDICAL PURPOSES; SUPPORTIVE BANDAGES; ELASTIC BANDAGES; COMPRESSION BANDAGES; BANDAGES FOR ANATOMICAL JOINTS; ORTHOPEDIC SUPPORT BANDAGES; ORTHOPEDIC SUPPORTS; ORTHOPEDIC BELTS; ELASTIC STOCKINGS; MEDICAL COMPRESSION STOCKINGS; ORTHOPEDIC FOOTWEAR; VIBROMASSAGE DEVICES; COMPRESSION BANDAGES, NAMELY, HERNIA BANDAGES; ELASTIC BANDAGES, NAMELY, HERNIA BANDAGES; GLOVES FOR MEDICAL PURPOSES; BELTS FOR MEDICAL PURPOSES; ABDOMINAL BELTS, NAMELY, MATERNITY BELTS; CUSHION LINERS FOR PROSTHETIC LIMBS; HEATING CUSHIONS FOR MEDICAL PURPOSES; HORSEHAIR GLOVES FOR MASSAGE; FINGER GUARDS FOR MEDICAL PURPOSES; WATER BAGS FOR MEDICAL PURPOSES; GLOVES FOR MASSAGE; ABDOMINAL PADS; ABDOMINAL BELTS; HYPOGASTRIC BELTS; ABDOMINAL CORSETS; ELASTIC STOCKINGS; ELASTIC STOCKINGS FOR SURGICAL PURPOSES; ELASTIC KNEE BANDAGES (U.S. CLS. 26, 39 AND 44).

CLASS 28—TOYS AND SPORTING GOODS

FOR SPORTING EQUIPMENT, NAMELY, ELASTIC AND NEOPRENE PROTECTIVE SUPPORTS FOR THE ANKLE, CALF, ELBOW, HAMSTRING, KNEE, SHIN, THIGH, WAIST AND WRIST; ATHLETIC PROTECTOR EQUIPMENT, NAMELY, BODY PROTECTORS FOR THE ANKLE, ARM, FOOT, KNEE AND ELBOW, LEG, SHIN, THIGH, WAIST AND WRIST FOR FOOTBALL; ATHLETIC TAPES (U.S. CLS. 22, 23, 38 AND 50).
SAMUEL E. SHARPER JR., EXAMINING ATTORNEY

SN 77-873,336. AMERICAN COUNCIL ON EXERCISE, SAN DIEGO, CA. FILED 11-16-2009.

**ACE INTEGRATED FITNESS
TRAINING**

THE MARK CONSISTS OF STANDARD CHARACTERS WITHOUT CLAIM TO ANY PARTICULAR FONT, STYLE, SIZE, OR COLOR.

OWNER OF U.S. REG. NOS. 1,884,858, 3,089,060 AND OTHERS.

NO CLAIM IS MADE TO THE EXCLUSIVE RIGHT TO USE "INTEGRATED FITNESS TRAINING", APART FROM THE MARK AS SHOWN.

CLASS 9—ELECTRICAL AND SCIENTIFIC APPARATUS

FOR PRE-RECORDED CDS AND DVDS IN THE FIELD OF HEALTH AND FITNESS (U.S. CLS. 21, 23, 26, 36 AND 38).

CLASS 16—PAPER GOODS AND PRINTED MATTER

FOR PRINTED MATTER, NAMELY, TRAINING MANUALS, COMBINED INFORMATIONAL BROCHURES, LOOSE LEAF MAGAZINES, EXAM MATERIALS, AND SAMPLE TEST QUESTIONS IN THE FIELD OF HEALTH AND FITNESS (U.S. CLS. 2, 5, 22, 23, 29, 37, 38 AND 50).

CLASS 41—EDUCATION AND ENTERTAINMENT

FOR EDUCATIONAL SERVICES, NAMELY, PROVIDING TRAINING SERVICES, CLASSES, SEMINARS, TESTING AND ON-LINE INFORMATION AND NEWS IN THE FIELD OF EXERCISE AND FITNESS (U.S. CLS. 100, 101 AND 107).

WENDY GOODMAN, EXAMINING ATTORNEY

SN 77-873,728. GENE SIMMONS COMPANY, PINE BROOK, NJ. FILED 11-16-2009.

COOL SPRINGS LIFE

THE MARK CONSISTS OF STANDARD CHARACTERS WITHOUT CLAIM TO ANY PARTICULAR FONT, STYLE, SIZE, OR COLOR.

NO CLAIM IS MADE TO THE EXCLUSIVE RIGHT TO USE "LIFE", APART FROM THE MARK AS SHOWN.

CLASS 35—ADVERTISING AND BUSINESS

FOR ADVERTISING AND MARKETING OF LIFE INSURANCE PRODUCTS (U.S. CLS. 100, 101 AND 102).

CLASS 36—INSURANCE AND FINANCIAL

FOR LIFE INSURANCE BROKERAGE SERVICES; FINANCING OF LIFE INSURANCE PRODUCTS (U.S. CLS. 100, 101 AND 102).

JANICE L. MCMORROW, EXAMINING ATTORNEY

SN 77-874,094. KEYSTONE PEER REVIEW ORGANIZATION, INC., HARRISBURG, PA. FILED 11-17-2009.



THE MARK CONSISTS OF A STAR WITHIN A SWIRL TO THE LEFT OF THE WORD "KEPRO" WITH AN ACCENT MARK OVER THE "E".

CLASS 35—ADVERTISING AND BUSINESS

FOR BUSINESS MANAGEMENT SERVICES, NAMELY, INTEGRATING BEHAVIORAL HEALTH MANAGEMENT AND BEHAVIORAL HEALTH WORK-LIFE MANAGEMENT PROGRAMS FOR EMPLOYERS, EMPLOYEES, GROUP MEMBERS, AND CONSUMERS WITH OUR CARE MANAGEMENT SERVICES (U.S. CLS. 100, 101 AND 102).

FIRST USE 10-5-2009; IN COMMERCE 10-5-2009.

CLASS 36—INSURANCE AND FINANCIAL

FOR REVIEW OF HEALTHCARE COVERAGE REQUESTS AND BENEFITS ELIGIBILITY, NAMELY, INSURANCE CLAIMS PROCESSING (U.S. CLS. 100, 101 AND 102).

FIRST USE 10-5-2009; IN COMMERCE 10-5-2009.

CLASS 44—MEDICAL, BEAUTY AND AGRICULTURAL SERVICES

FOR PROVIDING CHRONIC AND COMPLEX DISEASE MANAGEMENT PROGRAMS; ACUTE ILLNESS OR INJURY AND CARE COORDINATION PROGRAMS, NAMELY, PROVIDING MEDICAL, PHYSICAL REHABILITATION AND PHYSICAL THERAPY SERVICES; HEALTHCARE SERVICES, NAMELY, WELLNESS PROGRAMS AND DISEASE MANAGEMENT PROGRAMS; MANAGED HEALTHCARE SERVICES, NAMELY, 24/7 NURSE ADVOCACY HELPLINE, MATERNITY MANAGEMENT, CANCER MANAGEMENT, CANCER TREATMENT PLAN VALIDATION, AND END OF LIFE CARE MANAGEMENT SERVICES; MEDICAL SERVICES, NAMELY, PROVIDING PRIOR AUTHORIZATION, CONCURRENT AND RETROSPECTIVE MEDICAL REVIEW AND INDEPENDENT MEDICAL NECESSITY REVIEW OF HEALTH CARE PROVIDED IN ALL SETTINGS; PROVIDING INFORMATION ABOUT HEALTH CARE CONDITIONS AND DISEASES; MEDICAL SERVICES, NAMELY, INTEGRATING BEHAVIORAL HEALTH MANAGEMENT AND BEHAVIORAL HEALTH WORK-LIFE MANAGEMENT PROGRAMS FOR EMPLOYERS, EMPLOYEES, GROUP MEMBERS, AND CONSUMERS WITH OUR CARE MANAGEMENT SERVICES; PROVIDING PAPER-BASED AND ONLINE HEALTH-RISK EVALUATIONS, INDIVIDUAL SELF-HEALTH ASSESSMENTS AND SELF-HELP EVALUATION SERVICES, USING ADVANCED DATA ANALYTICS AND DATA MINING TO IDENTIFY MEMBERS ELIGIBLE FOR THE ABOVE MENTIONED SERVICES (U.S. CLS. 100 AND 101).

FIRST USE 10-5-2009; IN COMMERCE 10-5-2009.
JENNIFER VASQUEZ, EXAMINING ATTORNEY

SN 77-874,292. SOY BASICS, LLC, NEW HAMPTON, IA. FILED 11-17-2009.



NO CLAIM IS MADE TO THE EXCLUSIVE RIGHT TO USE "SOY", APART FROM THE MARK AS SHOWN.

THE MARK CONSISTS OF THE WRITTEN WORD "SEED", DEPICTING A FOUR CIRCLE DESIGN INSIDE THE LOWER PORTION OF THE "S"; THE WRITTEN WORD "BY" FOLLOWED BY THE WORDS "SOY INSPIRATIONS" ALL CENTERED ON THE SECOND LINE.

CLASS 3—COSMETICS AND CLEANING PREPARATIONS

FOR ALL-PURPOSE CLEANERS; HAND SOAP, SKIN SOAP, BODY LOTION; HAIR SHAMPOO; MASSAGE OIL; POTPOURRI; SHOWER GEL; BATH BEADS; BATH FOAM; BATH GEL; BATH MILKS; BATH OIL; BATH SALTS; BODY CREAM; BODY LOTION; BODY SCRUB; BODY SPRAYS; SCENTED BODY SPRAY; SCENTED ROOM SPRAYS; BATH POWDER, BODY WASH, FOOT CREAM, FOOT LOTION, FRAGRANT BODY SPRAY, FRAGRANT ROOM SPRAY, SALT SCRUB, HAIR CONDITIONER, EAU DE TOILETTE, FACE MASK, FACIAL CLEANSER (U.S. CLS. 1, 4, 6, 50, 51 AND 52).

CLASS 4—LUBRICANTS AND FUELS

FOR CANDLES (U.S. CLS. 1, 6 AND 15).

CLASS 5—PHARMACEUTICALS

FOR AIR DEODORIZERS; AIR FRESHENERS (U.S. CLS. 6, 18, 44, 46, 51 AND 52).

CLASS 11—ENVIRONMENTAL CONTROL APPARATUS

FOR CANDLE ACCESSORIES, NOT OF PRECIOUS METAL, NAMELY, LUMINARIES, LANTERNS (U.S. CLS. 13, 21, 23, 31 AND 34).

CLASS 21—HOUSEWARES AND GLASS

FOR CANDLE ACCESSORIES, NOT OF PRECIOUS METAL, NAMELY, CANDLE HOLDERS, CANDLE JARS, CANDLE VOTIVES, AND CANDLE RINGS (U.S. CLS. 2, 13, 23, 29, 30, 33, 40 AND 50).

KATINA MISTER, EXAMINING ATTORNEY

SN 77-874,472. G NEXT MEDIA PRIVATE LIMITED, NEW DELHI, INDIA, FILED 11-17-2009.



NO CLAIM IS MADE TO THE EXCLUSIVE RIGHT TO USE "PUNJABI", APART FROM THE MARK AS SHOWN.

THE COLOR(S) BLUE AND YELLOW IS/ARE CLAIMED AS A FEATURE OF THE MARK.

THE MARK CONSISTS OF A RECTANGLE OUTLINED IN BLUE CONTAINING THE STYLIZED LETTERS "PTC" IN BLUE COLOR ON A YELLOW BACKGROUND APPEARING ON TOP OF THE STYLIZED LETTERS "PUNJABI" IN YELLOW COLOR ON A BLUE BACKGROUND.

CLASS 38—COMMUNICATION

FOR BROADCASTING SERVICES VIA TELEVISION, SATELLITE TELEVISION AND AUDIO, CABLE AND INTERNET (U.S. CLS. 100, 101 AND 104).

FIRST USE 8-6-2008; IN COMMERCE 8-19-2009.

CLASS 41—EDUCATION AND ENTERTAINMENT

FOR ENTERTAINMENT SERVICES, NAMELY, PRODUCTION OF TELEVISION PROGRAMS FEATURING NEWS, DRAMA, COMEDIES, CONTESTS, GAME SHOWS, COMMENTARY, AND MUSIC (U.S. CLS. 100, 101 AND 107).

FIRST USE 8-6-2008; IN COMMERCE 8-19-2009.

DANIEL CAPSHAW, EXAMINING ATTORNEY

SN 77-875,201. LIL T LURES, JAKSONVILLE, FL. FILED 11-18-2009.



NO CLAIM IS MADE TO THE EXCLUSIVE RIGHT TO USE "LURES", APART FROM THE MARK AS SHOWN.

THE MARK CONSISTS OF THE STYLIZED TEXT "LIL T LURES" WITH A MARLIN, A WAHOO, AND A YELLOW-FIN TUNA.

CLASS 25—CLOTHING

FOR HATS; JACKETS; T-SHIRTS (U.S. CLS. 22 AND 39).

CLASS 28—TOYS AND SPORTING GOODS

FOR FISHING LURE PARTS; FISHING LURES (U.S. CLS. 22, 23, 38 AND 50).
EUGENIA MARTIN, EXAMINING ATTORNEY

SN 77-876,680. HUMANA INC., LOUISVILLE, KY. FILED 11-19-2009.

LIFELONG WELL-BEING

THE MARK CONSISTS OF STANDARD CHARACTERS WITHOUT CLAIM TO ANY PARTICULAR FONT, STYLE, SIZE, OR COLOR.

CLASS 41—EDUCATION AND ENTERTAINMENT

FOR ENTERTAINMENT SERVICES, NAMELY, PROVIDING ELECTRONIC, VIDEO, AND COMPUTER GAMES ONLINE AND IN MOBILE WIRELESS FORM; ENTERTAINMENT IN THE NATURE OF ONLINE COMPUTER GAMING COMPETITIONS; ENTERTAINMENT SERVICES, NAMELY, PROVIDING ON-LINE INTERACTIVE EDUCATIONAL VIDEO GAMES (U.S. CLS. 100, 101 AND 107).

CLASS 45—PERSONAL AND LEGAL SERVICES

FOR ONLINE SOCIAL NETWORKING SERVICES (U.S. CLS. 100 AND 101).
BRIAN PINO, EXAMINING ATTORNEY

SN 77-876,690. CORPORATE FAMILY NETWORK, INC., NEW YORK, NY. FILED 11-19-2009.



**CORPORATE FAMILY
NETWORK**

Where Inspiring Lives Meet Innovative Work

OWNER OF U.S. REG. NO. 2,802,409.

NO CLAIM IS MADE TO THE EXCLUSIVE RIGHT TO USE "CORPORATE FAMILY NETWORK", APART FROM THE MARK AS SHOWN.

THE COLOR(S) BLACK, BLUE, DARK BLUE, LIGHT BLUE AND WHITE IS/ARE CLAIMED AS A FEATURE OF THE MARK.

THE MARK CONSISTS OF THE WORDS "CORPORATE FAMILY" IN BLACK ABOVE THE WORD "NETWORK" IN BLUE, A HORIZONTAL BLUE LINE EXTENDING BELOW THE WORD "NETWORK", AND THE WORDS "WHERE INSPIRING LIVES MEET INNOVATIVE WORK" IN BLUE BELOW THE LINE. A HIGHLY STYLIZED COMBINATION OF THE LETTERS "CFN" IS LOCATED TO THE LEFT OF THE FOREGOING WITHIN A RECTANGULAR BLUE SQUARE WITH BLUE BACKGROUND, WITH THE LETTERS "C" AND "N" IN BLUE, AND THE LETTER "F" IN WHITE.

CLASS 35—ADVERTISING AND BUSINESS

FOR EMPLOYEE ADMINISTRATION SERVICES CONCERNING EMPLOYEE-EMPLOYER RELATIONS; PROVIDING ASSISTANCE AND CONSULTATION TO EMPLOYERS TO HELP THEIR EMPLOYEES MAKE HEALTH, WELLNESS AND NUTRITIONAL CHANGES IN THEIR DAILY LIVING TO INCREASE PRODUCTIVITY AND LOWER HEALTH CARE COSTS; BUSINESS CONSULTING SERVICES REGARDING EMPLOYER HEALTHCARE PLAN OPTIONS AND PRODUCTS, AND BENEFITS PROGRAMS; PROVIDING CONSUMER INFORMATION IN THE FIELDS OF HOUSEHOLD MAINTENANCE, AUTOMOBILE FALSE ADVERTISING, HOME RELOCATION, PET CARE AND PET TRAINING, DIET NUTRITION AND HEALTH; AND CONSULTING SERVICES IN THE FIELD OF HUMAN RESOURCE DEVELOPMENT, FOR THE PROMOTION OF EMPLOYEE WORK PRODUCTIVITY AND EMOTIONAL WELL BEING; ARRANGING AND CONDUCTING FAIRS FOR BUSINESS PURPOSES; CONDUCTING EMPLOYEE HEALTH AND BENEFIT FAIRS AND PROVIDING INFORMATION ABOUT AND MAKING ATTORNEY REFERRALS, MEDICAL REFERRALS, VETERINARIAN REFERRALS; PROVIDING REFERRALS TO EMPLOYEES IN THE FIELD OF FAMILY CONFLICT, STRESS, ANXIETY, MARITAL AND OTHER DOMESTIC DISCORD, ALCOHOL AND SUBSTANCE ABUSE, PARENTING, CHILDCARE AND ELDER CARE, PET CARE, EDUCATION, BUSINESS AND REAL ESTATE, EMPLOYEE RELOCATION, PERSONAL FINANCES; BUSINESS ADVICE AND INFORMATION; INFORMATION REGARDING EMPLOYEE RELOCATION (U.S. CLS. 100, 101 AND 102).

FIRST USE 1-0-2007; IN COMMERCE 1-0-2007.

CLASS 36—INSURANCE AND FINANCIAL

FOR ADMINISTERING EMPLOYEE WELFARE BENEFIT PROGRAMS FOR OTHERS, CONCERNING INSURANCE AND FINANCE; PROVIDING FINANCIAL PLANNING AND DEBT COUNSELING SERVICES AS PART OF AN EMPLOYEE ASSISTANCE PROGRAM; PROVIDING INFORMATION IN THE FIELD OF REAL ESTATE; PROVIDING FINANCIAL INFORMATION (U.S. CLS. 100, 101 AND 102).

FIRST USE 1-0-2007; IN COMMERCE 1-0-2007.

CLASS 44—MEDICAL, BEAUTY AND AGRICULTURAL SERVICES

FOR COUNSELING IN THE FIELDS OF HEALTH, NUTRITION AND LIFESTYLE WELLNESS; PROVIDING HEALTH, MENTAL HEALTH, AND WELLNESS INFORMATION; MENTAL HEALTH COUNSELING; PROVIDING HEALTH INFORMATION IN THE FIELD OF STRESS, ANXIETY, ALCOHOL AND SUBSTANCE ABUSE (U.S. CLS. 100 AND 101).

FIRST USE 1-0-2007; IN COMMERCE 1-0-2007.

CLASS 45—PERSONAL AND LEGAL SERVICES

FOR PROVIDING EMPLOYEE ASSISTANCE PROGRAMS, NAMELY, INFORMATION, ADVICE, AND PERSONAL SUPPORT COUNSELING PROGRAMS TO HELP EMPLOYEES AND THEIR FAMILY MEMBERS RESOLVE PERSONAL PROBLEMS IN THE FIELDS OF FAMILY CONFLICT, MARITAL AND OTHER DOMESTIC DISCORD; PROVIDING INFORMATION IN THE FIELD OF PERSONAL DEVELOPMENT, NAMELY, SELF-IMPROVEMENT, SELF-FULFILLMENT AND INTERPERSONAL COMMUNICATIONS; PROVIDING INFORMATION ABOUT ADOPTION; PROVIDING INFORMATION RELATING TO LEGAL AFFAIRS; GRIEF COUNSELING; MARRIAGE COUNSELING; PROVIDING INFORMATION CONCERNING PERSONAL AND FAMILY SAFETY; PROVIDING INFORMATION CONCERNING CONSUMER PRODUCT SAFETY (U.S. CLS. 100 AND 101).

FIRST USE 1-0-2007; IN COMMERCE 1-0-2007.
FONG HSU, EXAMINING ATTORNEY

SN 77-877,033. DOUBLEDOT MEDIA LTD, CHRISTCHURCH, NEW ZEALAND, FILED 11-19-2009.

Doubledot Media

THE MARK CONSISTS OF STANDARD CHARACTERS WITHOUT CLAIM TO ANY PARTICULAR FONT, STYLE, SIZE, OR COLOR.

NO CLAIM IS MADE TO THE EXCLUSIVE RIGHT TO USE "MEDIA", APART FROM THE MARK AS SHOWN.

CLASS 41—EDUCATION AND ENTERTAINMENT

FOR PROVIDING ON-LINE TRAINING COURSES IN THE FIELD OF ECOMMERCE (U.S. CLS. 100, 101 AND 107).

CLASS 42—SCIENTIFIC AND COMPUTER SERVICES

FOR SOFTWARE DESIGN AND DEVELOPMENT (U.S. CLS. 100 AND 101).
MARY CRAWFORD, EXAMINING ATTORNEY

SN 77-877,333. KANEKA CORPORATION, OSAKA, JAPAN, FILED 11-20-2009.

KANEKA

THE MARK CONSISTS OF STANDARD CHARACTERS WITHOUT CLAIM TO ANY PARTICULAR FONT, STYLE, SIZE, OR COLOR.

OWNER OF U.S. REG. NOS. 3,159,574, 3,165,580 AND 3,265,885.

CLASS 3—COSMETICS AND CLEANING PREPARATIONS

FOR COSMETICS; TOILETRIES, NAMELY, SOAP, ESSENTIAL OILS, HAIR SHAMPOO, HAIR CONDITIONER, HAIR RINSE, BATH OIL, BATH GEL, FACE POWDER, TALCUM POWDER, BODY LOTION, BODY CREAM, SKIN MOISTURIZER, DEODORANTS AND ANTIPERSPIRANTS; HYGIENIC GUM FOR ORAL USE, NAMELY, DENTIFRICES (U.S. CLS. 1, 4, 6, 50, 51 AND 52).

CLASS 5—PHARMACEUTICALS

FOR PHARMACEUTICAL PREPARATIONS FOR THE TREATMENTS OF FATIGUE, HEART DISEASE, HIGH BLOOD PRESSURE, DIABETES, PERIODONTAL DISEASE, NEUROLOGICAL DISEASE, IMMUNOLOGICAL DISEASE, ATHEROSCLEROSIS, CANCER, AGING PREVENTION, BRINGING MUSCLES BACK INTO HOMEOSTASIS; VETERINARY PREPARATIONS FOR TREATMENT OF FATIGUE, ANTIOXIDATION, HEART DISEASE, HIGH BLOOD PRESSURE, DIABETES, PERIODONTAL DISEASE, NEUROLOGICAL DISEASE, IMMUNOLOGICAL DISEASE, ATHEROSCLEROSIS, CANCER, AGING PREVENTION, BRINGING MUSCLES BACK INTO HOMEOSTASIS; SANITARY PREPARATIONS FOR MEDICAL USE; NUTRITIONAL SUPPLEMENTS (U.S. CLS. 6, 18, 44, 46, 51 AND 52).

CLASS 32—LIGHT BEVERAGES

FOR SPORTS DRINKS; ENERGY DRINKS; FRUIT JUICES AND FRUIT DRINKS, VEGETABLE JUICES AND VEGETABLE DRINKS; SYRUPS, POWDERS, CONCENTRATES AND EFFERVESCENT TABLETS FOR MAKING SOFT DRINKS AND FRUIT DRINKS AND BEVERAGES; MINERAL WATERS, AERATED WATERS, CARBONATED WATERS, FLAVORED WATERS AND OTHER NON-ALCOHOLIC BEVERAGES, NAMELY, PUNCHES, SOFT DRINKS, SMOOTHIES AND LEMONADE; SOY-BASED FOOD BEVERAGES NOT BEING MILK SUBSTITUTES (U.S. CLS. 45, 46 AND 48).

KELLEY WELLS, EXAMINING ATTORNEY

SN 77-877,572. DONNELLY MECHANICAL CORP., QUEENS VILLAGE, NY. FILED 11-20-2009.



NO CLAIM IS MADE TO THE EXCLUSIVE RIGHT TO USE "SUSTAINABLE ENERGY SERVICES" AND THE DEPICTION OF THE RECYCLING SYMBOL, APART FROM THE MARK AS SHOWN.

THE COLOR(S) BLUE/GREEN, GREEN, BLACK AND WHITE IS/ARE CLAIMED AS A FEATURE OF THE MARK.

THE MARK CONSISTS OF THE WORD "DONNELLY" IN BLUE/GREEN WITH A BLACK AND WHITE TURBINE WHEEL INSIDE THE LETTER "D" WITH A SMOKESTACK RISING OUT FROM THE LETTER "D" IN WIT THE SMOKE APPEARING IN BLACK AND WHITE, THE WORDS "GETTING GREENER EVERY DAY" ABOVE THE WORD, DONNELLY IN GREEN, AND THE WORDS "SUSTAINABLE ENERGY SERVICES" IN BLACK BELOW THE WORD "DONNELLY" WITH A GREEN AND GREEN/BLUE UNIVERSAL RECYCLING SYMBOL TO THE RIGHT OF THE WORD "DONNELLY" ALL ON A WHITE RECTANGULAR BACKGROUND. THE RECYCLING SYMBOL SURROUNDS A DEPICTION OF THE EARTH IN BLUE/GREEN, BLUE, AND WHITE.

CLASS 35—ADVERTISING AND BUSINESS

FOR CONSULTING SERVICES IN THE FIELDS OF ENERGY CONSUMPTION AND USAGE CONSERVATION TO IMPROVE ENERGY EFFICIENCY (U.S. CLS. 100, 101 AND 102).

CLASS 37—CONSTRUCTION AND REPAIR

FOR MAINTENANCE OF EQUIPMENT FOR COMMERCIAL BUILDING HVAC EQUIPMENT FOR ENERGY CONSERVATION FOR COMMERCIAL BUILDING OWNERS AND TENANTS; BUILDING MAINTENANCE AND REPAIR FOR ENERGY CONSERVATION PURPOSES FOR BUILDING OWNERS AND TENANTS (U.S. CLS. 100, 103 AND 106).

ANDREA HACK, EXAMINING ATTORNEY

SN 77-877,688. ROSS STORES, INC., PLEASANTON, CA.
FILED 11-20-2009.

SIMPLE FUNCTION

THE MARK CONSISTS OF STANDARD CHARACTERS WITHOUT CLAIM TO ANY PARTICULAR FONT, STYLE, SIZE, OR COLOR.

CLASS 18—LEATHER GOODS

FOR TOTE BAGS (U.S. CLS. 1, 2, 3, 22 AND 41).

CLASS 20—FURNITURE AND ARTICLES NOT OTHERWISE CLASSIFIED

FOR HAMPERS; STORAGE RACKS; NON-METAL FABRIC STORAGE BIN ORGANIZERS (U.S. CLS. 2, 13, 22, 25, 32 AND 50).

CLASS 21—HOUSEWARES AND GLASS

FOR WICKER STORAGE BASKETS; RATTAN STORAGE BASKETS; SHOWER CADDIES; BATH CADDIES; CONTAINERS FOR HOUSEHOLD OR KITCHEN USE; LAUNDRY CONTAINERS, NAMELY, LAUNDRY BASKETS; CANISTER SETS; PORTABLE COOLERS; LUNCH BOXES; CLEANING ACCESSORIES, NAMELY, TOILET BRUSHES, SPONGES, MOPS, BROOMS, DUSTERS, DUST PANS, AND CLEANING BRUSHES FOR HOUSEHOLD USE (U.S. CLS. 2, 13, 23, 29, 30, 33, 40 AND 50).

CLASS 22—CORDAGE AND FIBERS

FOR GARMENT BAGS FOR STORAGE; SHOE BAGS FOR STORAGE; CLOTH BAGS FOR STORAGE; LAUNDRY BAGS (U.S. CLS. 1, 2, 7, 19, 22, 42 AND 50).
H. M. FISHER, EXAMINING ATTORNEY

SN 77-877,782. RECRUIT MY GAME, LLC, DALLAS, TX.
FILED 11-20-2009.

WHOLE STUDENT

THE MARK CONSISTS OF STANDARD CHARACTERS WITHOUT CLAIM TO ANY PARTICULAR FONT, STYLE, SIZE, OR COLOR.

NO CLAIM IS MADE TO THE EXCLUSIVE RIGHT TO USE "STUDENT", APART FROM THE MARK AS SHOWN.

CLASS 35—ADVERTISING AND BUSINESS

FOR PROVIDING A WEBSITE FOR THE RECRUITING OF HIGH SCHOOL ATHLETES FEATURING THE REGISTRATION OF ATHLETE'S PROFILES AND THEIR STATISTICS (U.S. CLS. 100, 101 AND 102).

FIRST USE 11-15-2009; IN COMMERCE 11-15-2009.

CLASS 42—SCIENTIFIC AND COMPUTER SERVICES

FOR HOSTING AN ONLINE COMMUNITY WEBSITE FOR CONNECTING HIGH SCHOOL STUDENT-ATHLETES AND COLLEGE COACHES AND RECRUITERS (U.S. CLS. 100 AND 101).

FIRST USE 11-15-2009; IN COMMERCE 11-15-2009.

HOWARD B. LEVINE, EXAMINING ATTORNEY

SN 77-877,823. DST SYSTEMS, INC., KANSAS CITY, MO.
FILED 11-20-2009.

RICC

THE MARK CONSISTS OF STANDARD CHARACTERS WITHOUT CLAIM TO ANY PARTICULAR FONT, STYLE, SIZE, OR COLOR.

CLASS 9—ELECTRICAL AND SCIENTIFIC APPARATUS

FOR COMPUTER SOFTWARE, NAMELY, A CENTRALIZED PLATFORM THAT PROVIDES CLEARING AND RECORDKEEPING FUNCTIONALITY DESIGNED TO AID IN MANAGING GUARANTEED INCOME PRODUCTS AND ENABLES MUTUAL FUNDS AND INSURANCE PROVIDERS TO COMMUNICATE USING A STANDARDIZED SYSTEM IN ORDER TO RECORD-KEEP GUARANTEED INCOME ACCOUNTS (U.S. CLS. 21, 23, 26, 36 AND 38).

CLASS 35—ADVERTISING AND BUSINESS

FOR ACCOUNTING IN THE NATURE OF DATA MANIPULATION AND RECORDKEEPING DESIGNED TO AID IN MANAGING GUARANTEED INCOME PRODUCTS AND TO ENABLE MUTUAL FUNDS AND INSURANCE PROVIDERS TO COMMUNICATE BUSINESS INFORMATION TO OTHERS (U.S. CLS. 100, 101 AND 102).

CLASS 36—INSURANCE AND FINANCIAL

FOR FINANCIAL SERVICES, NAMELY, PROVIDING CLEARING HOUSES DESIGNED TO AID IN MANAGING GUARANTEED INCOME PRODUCTS AND TO ENABLE MUTUAL FUNDS AND INSURANCE PROVIDERS TO COMMUNICATE BUSINESS INFORMATION TO OTHERS (U.S. CLS. 100, 101 AND 102).

CLASS 39—TRANSPORTATION AND STORAGE

FOR ELECTRICAL STORAGE OF DATA (U.S. CLS. 100 AND 105).

VIVIAN MICZNIK FIRST, EXAMINING ATTORNEY

SN 77-877,977. SAUCENSPICE.COM LLC, EVERGREEN, CO.
FILED 11-20-2009.



NO CLAIM IS MADE TO THE EXCLUSIVE RIGHT TO USE "SAUCE AND SPICE.COM", APART FROM THE MARK AS SHOWN.

THE STIPPLING IS A FEATURE OF THE MARK AND DOES NOT INDICATE COLOR.

THE COLOR(S) RED, LIGHT BROWN, BROWN, AND WHITE IS/ARE CLAIMED AS A FEATURE OF THE MARK.

THE MARK CONSISTS OF THE STYLIZED WORDING "SAUCENSPICE.COM" ALL OUTLINED WITH WHITE SHADOWS, WITH "SAUCE" IN RED, "N" IN LIGHT BROWN, AND "SPICE.COM" IN BROWN. ABOVE THE WORDING IS THE DESIGN OF A RED AND WHITE SPICE SHAKER AND BROWN AND WHITE BOTTLE EACH OUTLINED WITH WHITE SHADOWS POURING INTO A FILLED BOWL WHICH IS BROWN AND FILLED WITH WHITE AND LIGHT BROWN INGREDIENTS AND ALSO OUTLINED WITH WHITE SHADOWS.

CLASS 30—STAPLE FOODS

FOR FOOD PRODUCTS, NAMELY, SAUCES, SALSAS, SPICES, SEASONINGS, PROCESSED HERBS (U.S. CL. 46).

FIRST USE 7-1-2008; IN COMMERCE 7-1-2008.

CLASS 35—ADVERTISING AND BUSINESS

FOR ON-LINE RETAIL STORE SERVICES FEATURING SAUCES, SALSAS, SPICES, CONDIMENTS, FLAVOR ADDITIVES, SEASONINGS, SALAD DRESSINGS, DRINK/COCKTAIL MIXERS, ETHNIC FOODS, SNACKS (U.S. CLS. 100, 101 AND 102).

FIRST USE 7-1-2008; IN COMMERCE 7-1-2008.

TOBY BULLOFF, EXAMINING ATTORNEY

SN 77-879,619. CONAGRA FOODS RDM, INC., OMAHA, NE.
FILED 11-24-2009.



OWNER OF U.S. REG. NOS. 2,358,741, 2,744,723 AND OTHERS.

THE MARK CONSISTS OF A CHEF'S FACE WITH THE IMAGE OF AN OVEN IN THE BACKGROUND ON TOP OF THE WORDS "THE MAX FROM THE HEART OF THE OVEN".

CLASS 29—MEATS AND PROCESSED FOODS

FOR FROZEN, PREPARED FOOD ITEMS, NAMELY, POTATO-BASED SNACK FOODS (U.S. CL. 46).

CLASS 30—STAPLE FOODS

FOR FROZEN, PREPARED FOOD ITEMS, NAMELY, QUESADILLAS; PANCAKES; DOUGH-ENROBED FOODS CONSISTING OF A DOUGH-BASED WRAPPER WITH FILLINGS CONSISTING PRIMARILY OF MEAT, VEGETABLES, CHEESE AND SAUCE; BREADSTICKS FILLED WITH MEAT, VEGETABLES, CHEESE AND SAUCE; TORTILLAS FILLED WITH MEAT, VEGETABLES, CHEESE AND SAUCE; SANDWICHES; SANDWICHES, NAMELY, HAND-HELD SANDWICH WRAPS; PIZZA AND PIZZA PRODUCTS, NAMELY, BITE SIZE PIZZA SNACKS, FLATBREAD PIZZAS, BREAKFAST PIZZA AND FRENCH BREAD PIZZA (U.S. CL. 46).

FIRST USE 6-30-2009; IN COMMERCE 7-1-2009.

SETH A. RAPPAPORT, EXAMINING ATTORNEY

SN 77-879,964. HEALTHE MID-AMERICA, INC., KANSAS CITY, MO. FILED 11-24-2009.



OWNER OF U.S. REG. NO. 3,632,159.

THE MARK CONSISTS OF A SWIRL DESIGN WITH THE WORD "CARENTRUST" BELOW.

CLASS 42—SCIENTIFIC AND COMPUTER SERVICES

FOR COMPUTER SERVICES, NAMELY, PROVIDING A SEARCH ENGINE FOR OBTAINING HEALTH CARE DATA ON A GLOBAL COMPUTER INFORMATION NETWORK; COMPUTER SERVICES, NAMELY, HOSTING AND MAINTAINING AN ONLINE WEBSITE FOR OTHERS TO PROVIDE A SECURE ON-LINE INTERFACE FOR STORAGE, ACCESS, MAINTENANCE, AND UTILIZATION OF ELECTRONIC HEALTH RECORDS (U.S. CLS. 100 AND 101).

FIRST USE 11-8-2008; IN COMMERCE 11-8-2008.

CLASS 44—MEDICAL, BEAUTY AND AGRICULTURAL SERVICES

FOR PROVIDING A WEBSITE FEATURING INFORMATION IN THE FIELD OF HEALTHCARE; PROVIDING HEALTHCARE INFORMATION IN THE FIELDS OF HEALTH MAINTENANCE ORGANIZATIONAL SERVICES AND PREFERRED HEALTHCARE PROVIDERS; PROVIDING AN INTERNET WEBSITE FOR MEDICAL PROFESSIONALS AND MEDICAL PATIENTS THAT ALLOWS FOR THE EXCHANGE OF INFORMATION FROM REMOTE LOCATIONS USING ELECTRONIC PATIENT MONITORING DEVICES THAT FEED INFORMATION TO THE WEBSITE THAT CAN BE ACCESSED IN REAL TIME BY MEDICAL PROFESSIONALS FOR PURPOSES OF MONITORING AND DIAGNOSING MEDICAL CONDITIONS (U.S. CLS. 100 AND 101).

FIRST USE 11-8-2008; IN COMMERCE 11-8-2008.

JAMES GRIFFIN, EXAMINING ATTORNEY

SN 77-880,062. UNITED SERVICES INNOVATIONS, S.L.,
08036 BARCELONA, SPAIN, FILED 11-24-2009.

SN 77-882,163. ANDREE'S CREATIONS, LLC, MANCHE-
STER, CT. FILED 11-30-2009.

WEKANUN

THE MARK CONSISTS OF STANDARD CHARACTERS WITHOUT CLAIM TO ANY PARTICULAR FONT, STYLE, SIZE, OR COLOR.
THE WORDING "WEKANUN" HAS NO MEANING IN A FOREIGN LANGUAGE.

CLASS 28—TOYS AND SPORTING GOODS

FOR EQUIPMENT WITH RULES OF PLAY SOLD AS A UNIT FOR PLAYING BOARD GAMES (U.S. CLS. 22, 23, 38 AND 50).

CLASS 35—ADVERTISING AND BUSINESS

FOR WHOLESALE AND RETAIL STORE SERVICES FEATURING GAMES AND PLAYTHINGS (U.S. CLS. 100, 101 AND 102).
LAKEISHA LEWIS, EXAMINING ATTORNEY

SN 77-881,409. ANTHONY TRISTER, VANCOUVER, BC,
CANADA, FILED 11-27-2009.

COFFEE SHOP MILLIONAIRE

THE MARK CONSISTS OF STANDARD CHARACTERS WITHOUT CLAIM TO ANY PARTICULAR FONT, STYLE, SIZE, OR COLOR.

CLASS 35—ADVERTISING AND BUSINESS

FOR CONSULTING SERVICES, NAMELY, INTERNET MARKETING ADVISORY AND STRATEGIC INTERNET MARKETING ADVISORY SERVICES FOR ENTREPRENEURS, BUSINESSSES, MARKETERS, AND ONLINE BUSINESS OWNERS OF ALL AGES (U.S. CLS. 100, 101 AND 102).
FIRST USE 6-1-2009; IN COMMERCE 11-1-2009.

CLASS 41—EDUCATION AND ENTERTAINMENT

FOR EDUCATIONAL SERVICES, NAMELY, PROVIDING ENTREPRENEUR TRAINING AND STRATEGIC ADVISORY SERVICES REGARDING ENTREPRENEUR TRAINING FOR ENTREPRENEURS, BUSINESSSES, MARKETERS, AND ONLINE BUSINESS OWNERS OF ALL AGES (U.S. CLS. 100, 101 AND 107).
FIRST USE 6-1-2009; IN COMMERCE 11-1-2009.
SANI KHOURI, EXAMINING ATTORNEY

ANDREE'S WAFFALOONS

THE MARK CONSISTS OF STANDARD CHARACTERS WITHOUT CLAIM TO ANY PARTICULAR FONT, STYLE, SIZE, OR COLOR.

THE NAME(S), PORTRAIT(S), AND/OR SIGNATURE(S) SHOWN IN THE MARK DOES NOT IDENTIFY A PARTICULAR LIVING INDIVIDUAL.

CLASS 30—STAPLE FOODS

FOR WAFFLES (U.S. CL. 46).
FIRST USE 1-29-2008; IN COMMERCE 1-29-2008.

CLASS 43—HOTEL AND RESTAURANT SERVICES

FOR PREPARATION OF FOOD AND BEVERAGES; RESTAURANT AND CATERING SERVICES; SERVING OF FOOD AND DRINK/BEVERAGES (U.S. CLS. 100 AND 101).
FIRST USE 1-29-2008; IN COMMERCE 1-29-2008.
TRACY CROSS, EXAMINING ATTORNEY

SN 77-882,337. ROCHE BROS. INC., WELLESLEY HILLS,
MA. FILED 11-30-2009.



NO CLAIM IS MADE TO THE EXCLUSIVE RIGHT TO USE "HOME DELIVERY", APART FROM THE MARK AS SHOWN.

THE MARK CONSISTS OF A STYLIZED "R" IN A SQUARE FOLLOWED BY "ROCHE", A COMPUTER MOUSE WITH CORD CONNECTED TO A STYLIZED APPLE, AND "BROS.COM" ABOVE "HOME DELIVERY".

CLASS 35—ADVERTISING AND BUSINESS

FOR COMPUTERIZED ONLINE ORDERING FEATURING GENERAL MERCHANDISE AND GENERAL CONSUMER GOODS; ONLINE RETAIL STORES FEATURING GROCERIES (U.S. CLS. 100, 101 AND 102).
FIRST USE 10-21-2005; IN COMMERCE 10-21-2005.

CLASS 39—TRANSPORTATION AND STORAGE

FOR FOOD DELIVERY; DELIVERY OF GOODS (U.S. CLS. 100 AND 105).
FIRST USE 10-21-2005; IN COMMERCE 10-21-2005.
JANICE KIM, EXAMINING ATTORNEY

SN 77-882,413. ROCHE BROS. INC., WELLESLEY HILLS, MA. FILED 11-30-2009.



THE MARK CONSISTS OF COMPUTER MOUSE WITH CORD CONNECTED TO A STYLIZED APPLE.

CLASS 35—ADVERTISING AND BUSINESS

FOR COMPUTERIZED ONLINE ORDERING FEATURING GENERAL MERCHANDISE AND GENERAL CONSUMER GOODS; ONLINE RETAIL STORES FEATURING GROCERIES (U.S. CLS. 100, 101 AND 102).
FIRST USE 10-21-2005; IN COMMERCE 10-21-2005.

CLASS 39—TRANSPORTATION AND STORAGE

FOR FOOD DELIVERY; DELIVERY OF GOODS (U.S. CLS. 100 AND 105).
FIRST USE 10-21-2005; IN COMMERCE 10-21-2005.
JANICE KIM, EXAMINING ATTORNEY

SN 77-883,082. SHELDON, CHRISTIE, OAK VIEW, CA. FILED 12-1-2009.

LOVE OR ABOVE

THE MARK CONSISTS OF STANDARD CHARACTERS WITHOUT CLAIM TO ANY PARTICULAR FONT, STYLE, SIZE, OR COLOR.

CLASS 9—ELECTRICAL AND SCIENTIFIC APPARATUS

FOR PRE-RECORDED CDS, VIDEO TAPES, LASER DISKS AND DVDS FEATURING INTUITIVE CONSULTATION SERVICES, A TYPE OF PSYCHIC SERVICE (U.S. CLS. 21, 23, 26, 36 AND 38).

CLASS 16—PAPER GOODS AND PRINTED MATTER

FOR PUBLICATIONS, NAMELY, WORKBOOKS IN THE FIELD OF INTUITIVE CONSULTATION SERVICES, A TYPE OF PSYCHIC SERVICE (U.S. CLS. 2, 5, 22, 23, 29, 37, 38 AND 50).

CLASS 45—PERSONAL AND LEGAL SERVICES

FOR PROVIDING A WEBSITE THAT PROVIDES PSYCHIC SERVICES (U.S. CLS. 100 AND 101).
WANDA KAY PRICE, EXAMINING ATTORNEY

SN 77-883,738. NAGUIT, JONATHAN A., GLENDALE, CA. FILED 12-1-2009.

PENSKEI MOTOR OIL

THE MARK CONSISTS OF STANDARD CHARACTERS WITHOUT CLAIM TO ANY PARTICULAR FONT, STYLE, SIZE, OR COLOR.

NO CLAIM IS MADE TO THE EXCLUSIVE RIGHT TO USE "MOTOR OIL", APART FROM THE MARK AS SHOWN.

CLASS 1—CHEMICALS

FOR ANTI-KNOCK SUBSTANCES FOR INTERNAL COMBUSTION ENGINES; BRAKE FLUID; CHEMICAL ADDITIVES FOR ENHANCING THE PERFORMANCE OF LUBRICATING OILS, GREASES AND INTERNAL COMBUSTION ENGINE FUELS; CHEMICAL ADDITIVES FOR FUEL TREATMENT; CHEMICAL ADDITIVES FOR OIL WELL DRILLING FLUID; CHEMICAL ADDITIVES FOR OILS; CHEMICAL ADDITIVES FOR USE WITH INTERNAL COMBUSTION ENGINE FUELS; CHEMICAL ADSORBENTS FOR REMOVING IMPURITIES FROM FUEL; CHEMICAL ENGINE TREATMENTS AND ADDITIVES FOR ENGINE OILS, GASOLINE AND DIESEL FUELS, TRANSMISSION FLUIDS AND COOLING SYSTEMS; CHEMICAL MOTOR OIL ADDITIVES; COOLANTS FOR VEHICLE ENGINES; DETERGENT ADDITIVE FOR USE WITH MOTOR OIL; ENGINE DECARBONISING CHEMICALS; ENGINE DECARBONIZING CHEMICALS; FLUSHING AGENTS FOR AUTOMOBILE RADIATORS; FUEL INJECTION CLEANER CHEMICAL ADDITIVE; HYDRAULIC FLUID; HYDRAULIC FLUIDS FOR GENERAL USE; POWER STEERING FLUID; TRANSMISSION FLUID (U.S. CLS. 1, 5, 6, 10, 26 AND 46).

CLASS 4—LUBRICANTS AND FUELS

FOR ALL PURPOSE LUBRICANTS; ALL PURPOSE PENETRATING OIL; AUTOMOBILE LUBRICANTS; AUTOMOTIVE GREASES; AUTOMOTIVE LUBRICANTS; DIESEL OIL; DRILLING LUBRICANTS; ENGINE OILS; GEAR OILS; GENERAL PURPOSE GREASES; GREASE FOR MACHINES; HYDRAULIC OILS; INDUSTRIAL AND VEHICULAR LUBRICANTS; INDUSTRIAL GREASES; INDUSTRIAL LUBRICANTS; INDUSTRIAL OILS; LUBRICANTS FOR AIRCRAFT ENGINES; LUBRICANTS FOR USE ON HOUSEHOLD ITEMS; LUBRICATING GREASES; LUBRICATING OIL FOR MOTOR VEHICLE ENGINES; LUBRICATING OILS; LUBRICATING OILS AND GREASES; LUBRICATION GREASE FOR VEHICLES; MARINE LUBRICANTS; MINERAL OILS AND GREASES FOR INDUSTRIAL PURPOSES; MOTOR OIL; MOTOR OILS; NON-CHEMICAL ADDITIVES FOR FUELS, LUBRICANTS AND GREASES; NON-CHEMICAL ADDITIVES FOR OILS AND FUELS; NON-CHEMICAL ENGINE TREATMENTS AND ADDITIVES FOR ENGINE OILS, GASOLINE AND DIESEL FUELS, TRANSMISSION FLUIDS AND COOLING SYSTEMS; NON-CHEMICAL MOTOR OIL ADDITIVES; NON-MINERAL OILS AND GREASES FOR INDUSTRIAL PURPOSES; PENETRATING OIL; TWO CYCLE ENGINE OIL (U.S. CLS. 1, 6 AND 15).

SANJEEV VOHRA, EXAMINING ATTORNEY

SN 77-883,789. NAGUIT, JONATHAN A., GLENDALE, CA.
FILED 12-1-2009.

PENSKEI TOOLS

THE MARK CONSISTS OF STANDARD CHARACTERS WITHOUT CLAIM TO ANY PARTICULAR FONT, STYLE, SIZE, OR COLOR.

NO CLAIM IS MADE TO THE EXCLUSIVE RIGHT TO USE "TOOLS", APART FROM THE MARK AS SHOWN.

CLASS 7—MACHINERY

FOR DRILLING MACHINES; DRILLING MACHINES AND PARTS THEREFOR; ELECTRIC CHAIN SAWS; ELECTRIC DRILLS; ELECTRIC HAMMERS; ELECTRIC HAND-HELD DRILLS; ELECTRIC SCREWDRIVERS; ELECTRICAL DRILLS; EXTENSION BARS FOR POWER TOOLS; EXTENSIONS FOR POWER DRILL BITS; EXTENSIONS FOR POWER TOOLS; IMPACT WRENCHES; MACHINE TOOL HOLDERS; MACHINES AND MACHINE TOOLS FOR THE CUTTING AND FORMING OF MATERIALS; PNEUMATIC DRILLS; PNEUMATIC HAMMERS; POWER DRILL ACCESSORIES, NAMELY, NON-ELECTRICAL ADAPTERS FOR USE IN JOINING EXTENSIONS AND POWER DRILL BITS; POWER DRILL BIT EXTENSIONS; POWER DRILL BITS; POWER DRILLS; POWER OPERATED TOOLS, NAMELY, DRILL HAMMERS; POWER SAW BLADES; POWER TOOLS, NAMELY, HAMMER DRILLS; POWER TOOLS, NAMELY, HAMMER DRIVERS; POWER-DRIVEN WRENCHES; POWER-OPERATED RATCHET WRENCHES; POWER-OPERATED RIVET GUNS; POWER-OPERATED SAWS; POWER-OPERATED SCREWDRIVERS; TOOL BITS FOR MACHINES; TOOL GRINDING MACHINES; WOOD DRILLING MACHINES (U.S. CLS. 13, 19, 21, 23, 31, 34 AND 35).

CLASS 8—HAND TOOLS

FOR HAMMERS; HAND TOOL, NAMELY, RIGID AND ROD HAND BENDERS FOR USE ON PIPES AND CONDUITS; HAND TOOLS, NAMELY, BOLT CUTTERS; HAND TOOLS, NAMELY, CLAMPS; HAND TOOLS, NAMELY, CRIMPING IRONS; HAND TOOLS, NAMELY, DRILLS; HAND TOOLS, NAMELY, FILES; HAND TOOLS, NAMELY, HAMMERS; HAND TOOLS, NAMELY, HAND BENDERS FOR USE ON PIPES AND CONDUITS; HAND TOOLS, NAMELY, HAND JACKS; HAND TOOLS, NAMELY, HAND-OPERATED DEVICE TO AID WITH TYING AND UNTYING KNOTS; HAND TOOLS, NAMELY, HAND-OPERATED PUMPS; HAND TOOLS, NAMELY, HATCHETS; HAND TOOLS, NAMELY, HEX KEYS WRENCHES; HAND TOOLS, NAMELY, MANUALLY-OPERATED GRINDSTONES; HAND TOOLS, NAMELY, MANUALLY-OPERATED SHARPENING WHEELS; HAND TOOLS, NAMELY, MAULS; HAND TOOLS, NAMELY, MITER BOXES; HAND TOOLS, NAMELY, MITRE BOXES; HAND TOOLS, NAMELY, NAIL SETS; HAND TOOLS, NAMELY, NIPPERS; HAND TOOLS, NAMELY, NUT DRIVERS; HAND TOOLS, NAMELY, PAINT SCRAPERS; HAND TOOLS, NAMELY, PICKS; HAND TOOLS, NAMELY, PIKES; HAND TOOLS, NAMELY, PINCERS; HAND TOOLS, NAMELY, PLANERS; HAND TOOLS, NAMELY, PLANES; HAND TOOLS, NAMELY, POST HOLE DIGGERS; HAND TOOLS, NAMELY, PRUNERS; HAND TOOLS, NAMELY, PRUNING SAWS; HAND TOOLS, NAMELY, PUNCHES; HAND TOOLS, NAMELY, PUTTY KNIVES; HAND TOOLS, NAMELY, RAMMERS; HAND TOOLS, NAMELY, RASPS; HAND TOOLS, NAMELY, RATCHET WRENCHES; HAND TOOLS, NAMELY, REAMERS; HAND TOOLS, NAMELY, RIPPING BARS; HAND TOOLS, NAMELY, SANDERS; HAND TOOLS, NAMELY, SAWS; HAND TOOLS, NAMELY, SCRAPERS; HAND TOOLS, NAMELY, SCREWDRIVERS; HAND TOOLS, NAMELY, SOCKET SETS; HAND TOOLS, NAMELY, SOCKET WRENCHES; HAND TOOLS, NAMELY, TOOLS FOR PLACING A ROPE OR OTHER FLEXIBLE MEMBER THROUGH AN

EYE OR AROUND A TARGET OBJECT; HAND TOOLS, NAMELY, VICES; HAND TOOLS, NAMELY, WEDGES; HAND TOOLS, NAMELY, WIRE CUTTERS; HAND TOOLS, NAMELY, WIRE NIPPERS; HAND TOOLS, NAMELY, WIRE STRIPPERS; HAND TOOLS, NAMELY, WRECKING BARS, STRIPPING BARS, SMALL BARS AND NAIL PULLERS, SAN ANGELO BARS, TAMPER BARS, WEDGE POINT BARS, PITCH POINT BARS; HAND TOOLS, NAMELY, WRENCHES; HAND-OPERATED CUTTING TOOLS; HAND-OPERATED CUTTING TOOLS, NAMELY, BOX CUTTERS; HAND-OPERATED CUTTING TOOLS, NAMELY, SAFETY CUTTERS; HAND-OPERATED RIVETING TOOLS; HAND-OPERATED SHARPENING TOOLS AND INSTRUMENTS; HAND-OPERATED TOOLS, NAMELY, CHISELS; HAND-POWERED ICE AUGERS USED FOR ICE FISHING; HAND-POWERED STAPLE GUNS; HAND-TOOLS, NAMELY, WIRE CRIMPERS; ICE HAMMERS; MANUAL DRILLS; MANUALLY-POWERED HOLE OPENERS USED TO ENLARGE HOLES IN THE GROUND; NUT WRENCHES; PIPE WRENCHES; RATCHET HANDLES; ROLL-UP FABRIC CONTAINER FOR HAND TOOLS; SANDING PADS FOR NON-ELECTRIC, HAND-OPERATED SANDERS; SCREW WRENCHES; SCULPTING TOOLS, NAMELY, LOOPS; SPARK WRENCHES; TOOL APRONS; TOOL BELTS; TOOL HOLDERS; TOOL POUCHES FOR ATTACHMENT TO TOOL BELTS; TORQUE WRENCHES; WRENCHES (U.S. CLS. 23, 28 AND 44).

SANJEEV VOHRA, EXAMINING ATTORNEY

SN 77-883,919. KITCHEN FUSIONS, LLC, MADEIRA BEACH, FL. FILED 12-2-2009.

KitchenFusions

THE MARK CONSISTS OF STANDARD CHARACTERS WITHOUT CLAIM TO ANY PARTICULAR FONT, STYLE, SIZE, OR COLOR.

CLASS 35—ADVERTISING AND BUSINESS

FOR WHOLESALE AND RETAIL STORE SERVICES AND ON-LINE RETAIL AND WHOLESALE STORE SERVICES FEATURING GOURMET FOODS, SEASONINGS, SPICES, HERBS, DIPS, AND MIXES (U.S. CLS. 100, 101 AND 102).

FIRST USE 4-1-2009; IN COMMERCE 4-1-2009.

CLASS 40—MATERIAL TREATMENT

FOR MANUFACTURING SERVICES FOR OTHERS IN THE FIELD OF GOURMET FOODS, SEASONINGS, SPICES, HERBS, DIPS, AND MIXES (U.S. CLS. 100, 103 AND 106).

FIRST USE 4-1-2009; IN COMMERCE 4-1-2009.
KHANH LE, EXAMINING ATTORNEY

SN 77-884,482. GRAFF, URI, 34988 HAIFA, ISRAEL, FILED
12-2-2009.

WALKISHOPPI

THE MARK CONSISTS OF STANDARD CHARACTERS WITHOUT CLAIM TO ANY PARTICULAR FONT, STYLE, SIZE, OR COLOR.

CLASS 9—ELECTRICAL AND SCIENTIFIC APPARATUS

FOR DOWNLOADABLE SOFTWARE AND SOFTWARE APPLICATIONS FOR MARKETING AND CONSUMER INFORMATION ACQUIRING, PROCESSING, AGGREGATING, ANALYZING, CONDUCTING, GENERATING, RETRIEVING, PROVIDING, RECOMMENDING AND EXCHANGING IN THE FIELDS OF MOBILE TARGET ADVERTISING AND MOBILE TARGET MARKETING, FOR MARKETING AND CONSUMER INFORMATION ACQUIRING, PROCESSING, AGGREGATING, ANALYZING, CONDUCTING, GENERATING, RETRIEVING, PROVIDING, RECOMMENDING AND EXCHANGING IN THE FIELD OF LOCAL-BASED MEDIA SERVICES, FOR DISSEMINATING OF TARGETED ADVERTISING CONTENT, DATA AND INFORMATION FOR OTHERS VIA WIRELESS AND MOBILE COMMUNICATION NETWORKS, FOR MARKETING AND CONSUMER INFORMATION ACQUIRING, PROCESSING, AGGREGATING, ANALYZING, CONDUCTING, GENERATING, RETRIEVING, PROVIDING, RECOMMENDING AND EXCHANGING IN THE FIELD OF ONLINE ADVERTISING SPACE FOR RETAILERS, WHOLESALERS, BRAND OWNERS, MEDIA AND ADVERTISING AGENCIES, DIRECTORY PUBLISHERS, WEB VENDORS AND CONTENT PROVIDERS IN LOCAL MARKETPLACES, FOR MEASURING AND REPORTING OF MARKET RESPONSE AND ADVERTISING CAMPAIGN EFFECTS, FOR MEASURING AND MONETIZING MOBILE ADVERTISING, FOR THE REGISTRATION, COLLECTION, TRANSCRIPTION, COMPILATION AND SYSTEMIZATION OF COMMUNICATIONS AND DATA RELATING TO SHOPPING BEHAVIOR, AND FOR DISSEMINATING IMMEDIATE AND RELEVANT SHOPPING INFORMATION TO SHOPPERS IN LOCAL MARKETPLACES; SOFTWARE APPLICATION ENABLING TO ACCESS A SEARCH PLATFORM TO ALLOW USERS TO REQUEST CONTENT FROM AND RECEIVE CONTENT TO A MOBILE DEVICE; SOFTWARE APPLICATION ENABLING PROVISION OF SEARCH ENGINE SERVICES FOR OBTAINING ELECTRONIC CONTENT, INFORMATION AND LOCAL SERVICES ON THE INTERNET TO BE VIEWED ON WIRELESS AND MOBILE DEVICES (U.S. CLS. 21, 23, 26, 36 AND 38).

CLASS 35—ADVERTISING AND BUSINESS

FOR MOBILE TARGET ADVERTISING AND MOBILE TARGET MARKETING; LOCAL-BASED MEDIA SERVICES, NAMELY, PROMOTING LOCAL GOODS AND SERVICES AND PROMOTING PUBLIC AWARENESS OF SHOPPING LOCALLY; DISSEMINATING OF TARGETED ADVERTISING CONTENT, DATA AND INFORMATION FOR OTHERS VIA WIRELESS AND MOBILE COMMUNICATION NETWORKS; PROVIDING ONLINE ADVERTISING SPACE FOR RETAILERS, WHOLESALERS, BRAND OWNERS, MEDIA AND ADVERTISING AGENCIES, DIRECTORY PUBLISHERS, WEB VENDORS AND CONTENT PROVIDERS IN LOCAL MARKETPLACES; ANALYSIS OF MARKET RESEARCH DATA AND STATISTICS, NAMELY, MEASURING AND REPORTING OF MARKET RESPONSE AND ADVERTISING CAMPAIGN EFFECTS; ANALYSIS OF MARKET RESEARCH DATA AND STATISTICS, NAMELY, MEASURING AND MONETIZING MOBILE ADVERTISING; ANALYSIS OF MARKET RESEARCH DATA AND STATISTICS, NAMELY, SERVICES CONSISTING OF THE REGISTRATION, COLLECTION, TRANSCRIPTION, COMPILATION AND SYSTEMIZATION OF COMMUNICATIONS AND DATA RELATING TO SHOPPING BEHAVIOR; DISSEMINATING IMMEDIATE AND RELEVANT SHOPPING INFORMATION TO SHOPPERS IN LOCAL MARKETPLACES (U.S. CLS. 100, 101 AND 102).

CLASS 42—SCIENTIFIC AND COMPUTER SERVICES

FOR COMPUTER SERVICES, NAMELY, PROVIDING A SEARCH PLATFORM TO ALLOW USERS TO REQUEST CONTENT FROM AND RECEIVE CONTENT TO A MOBILE DEVICE; SEARCH ENGINE SERVICES, NAMELY, PROVIDING A SEARCH ENGINE FOR OBTAINING AND RECOMMENDING OF ELECTRONIC CONTENT, INFORMATION AND LOCAL SERVICES ON THE INTERNET TO BE VIEWED ON WIRELESS AND MOBILE DEVICES; PROVIDING TEMPORARY USE OF ONLINE NON-DOWNLOADABLE SOFTWARE WHICH PROVIDES A USER INTERFACE FOR A SEARCH ENGINE ACCESSIBLE THROUGH MOBILE DEVICES; PROVIDING TEMPORARY USE OF ONLINE NON-DOWNLOADABLE SOFTWARE FOR DISSEMINATING OF TARGETED ADVERTISING CONTENT, DATA AND INFORMATION VIA WIRELESS AND MOBILE COMMUNICATION NETWORKS, FOR MARKETING AND CONSUMER INFORMATION ACQUIRING, PROCESSING, AGGREGATING, ANALYZING, CONDUCTING, GENERATING, RETRIEVING, PROVIDING, RECOMMENDING AND EXCHANGING IN THE FIELD OF ONLINE ADVERTISING SPACE BY RETAILERS, WHOLESALERS, BRAND OWNERS, MEDIA AND ADVERTISING AGENCIES, DIRECTORY PUBLISHERS, WEB VENDORS AND CONTENT PROVIDERS IN LOCAL MARKETPLACES, FOR MEASURING AND REPORTING OF MARKET RESPONSE AND ADVERTISING CAMPAIGN EFFECTS, FOR MEASURING AND MONETIZING MOBILE ADVERTISING, FOR REGISTRATION, COLLECTION, TRANSCRIPTION, COMPILATION AND SYSTEMIZATION OF COMMUNICATIONS AND DATA RELATING TO SHOPPING BEHAVIOR AND FOR DISSEMINATING IMMEDIATE AND RELEVANT SHOPPING INFORMATION TO SHOPPERS IN LOCAL MARKETPLACES (U.S. CLS. 100 AND 101).

LAURIE KAUFMAN, EXAMINING ATTORNEY

SN 77-884,485. GRAFF, URI, 34988 HAIFA, ISRAEL, FILED 12-2-2009.

MOBISHOPPI

THE MARK CONSISTS OF STANDARD CHARACTERS WITHOUT CLAIM TO ANY PARTICULAR FONT, STYLE, SIZE, OR COLOR.

CLASS 9—ELECTRICAL AND SCIENTIFIC APPARATUS

FOR DOWNLOADABLE SOFTWARE AND SOFTWARE APPLICATIONS FOR MARKETING AND CONSUMER INFORMATION ACQUIRING, PROCESSING, AGGREGATING, ANALYZING, CONDUCTING, GENERATING, RETRIEVING, PROVIDING, RECOMMENDING AND EXCHANGING IN THE FIELDS OF MOBILE TARGET ADVERTISING AND MOBILE TARGET MARKETING, FOR MARKETING AND CONSUMER INFORMATION ACQUIRING, PROCESSING, AGGREGATING, ANALYZING, CONDUCTING, GENERATING, RETRIEVING, PROVIDING, RECOMMENDING AND EXCHANGING IN THE FIELD OF LOCAL-BASED MEDIA SERVICES, FOR DISSEMINATING OF TARGETED ADVERTISING CONTENT, DATA AND INFORMATION FOR OTHERS VIA WIRELESS AND MOBILE COMMUNICATION NETWORKS, FOR MARKETING AND CONSUMER INFORMATION ACQUIRING, PROCESSING, AGGREGATING, ANALYZING, CONDUCTING, GENERATING, RETRIEVING, PROVIDING, RECOMMENDING AND EXCHANGING IN THE FIELD OF ONLINE ADVERTISING SPACE FOR RETAILERS, WHOLESALERS, BRAND OWNERS, MEDIA AND ADVERTISING AGENCIES, DIRECTORY PUBLISHERS, WEB VENDORS AND CONTENT PROVIDERS IN LOCAL MARKETPLACES, FOR MEASURING AND REPORTING OF MARKET RESPONSE AND ADVERTISING CAMPAIGN EFFECTS, FOR MEASURING AND MONETIZING MOBILE ADVERTISING, FOR THE REGISTRATION, COLLECTION, TRANSCRIPTION, COMPILATION AND SYSTEMIZATION OF COMMUNICATIONS AND DATA RELATING TO SHOPPING BEHAVIOR, AND FOR DISSEMINATING IMMEDIATE AND RELEVANT SHOPPING INFORMATION TO SHOPPERS IN LOCAL MARKETPLACES; SOFTWARE APPLICATION ENABLING TO ACCESS A SEARCH PLATFORM TO ALLOW USERS TO REQUEST CONTENT FROM AND RECEIVE CONTENT TO A MOBILE DEVICE; SOFTWARE APPLICATION ENABLING PROVISION OF SEARCH ENGINE SERVICES FOR OBTAINING ELECTRONIC CONTENT, INFORMATION AND LOCAL SERVICES ON THE INTERNET TO BE VIEWED ON WIRELESS AND MOBILE DEVICES (U.S. CLS. 21, 23, 26, 36 AND 38).

CLASS 35—ADVERTISING AND BUSINESS

FOR MOBILE TARGET ADVERTISING AND MOBILE TARGET MARKETING; LOCAL-BASED MEDIA SERVICES, NAMELY, PROMOTING LOCAL GOODS AND SERVICES AND PROMOTING PUBLIC AWARENESS OF SHOPPING LOCALLY; DISSEMINATING OF TARGETED ADVERTISING CONTENT, DATA AND INFORMATION FOR OTHERS VIA WIRELESS AND MOBILE COMMUNICATION NETWORKS; PROVIDING ONLINE ADVERTISING SPACE FOR RETAILERS, WHOLESALERS, BRAND OWNERS, MEDIA AND ADVERTISING AGENCIES, DIRECTORY PUBLISHERS, WEB VENDORS AND CONTENT PROVIDERS IN LOCAL MARKETPLACES; ANALYSIS OF MARKET RESEARCH DATA AND STATISTICS, NAMELY, MEASURING AND REPORTING OF MARKET RESPONSE AND ADVERTISING CAMPAIGN EFFECTS; ANALYSIS OF MARKET RESEARCH DATA AND STATISTICS, NAMELY, MEASURING AND MONETIZING MOBILE ADVERTISING; ANALYSIS OF MARKET RESEARCH DATA AND STATISTICS, NAMELY, SERVICES CONSISTING OF THE REGISTRATION, COLLECTION, TRANSCRIPTION, COMPILATION AND SYSTEMIZATION OF COMMUNICATIONS AND DATA RELATING TO SHOPPING BEHAVIOR; DISSEMINATING IMMEDIATE AND RELEVANT SHOPPING INFORMATION TO SHOPPERS IN LOCAL MARKETPLACES (U.S. CLS. 100, 101 AND 102).

CLASS 42—SCIENTIFIC AND COMPUTER SERVICES

FOR COMPUTER SERVICES, NAMELY, PROVIDING A SEARCH PLATFORM TO ALLOW USERS TO REQUEST CONTENT FROM AND RECEIVE CONTENT TO A MOBILE DEVICE; SEARCH ENGINE SERVICES, NAMELY, PROVIDING A SEARCH ENGINE FOR OBTAINING AND RECOMMENDING OF ELECTRONIC CONTENT, INFORMATION AND LOCAL SERVICES ON THE INTERNET TO BE VIEWED ON WIRELESS AND MOBILE DEVICES; PROVIDING TEMPORARY USE OF ONLINE NON-DOWNLOADABLE SOFTWARE WHICH PROVIDES A USER INTERFACE FOR A SEARCH ENGINE ACCESSIBLE THROUGH MOBILE DEVICES; PROVIDING TEMPORARY USE OF ONLINE NON-DOWNLOADABLE SOFTWARE FOR DISSEMINATING OF TARGETED ADVERTISING CONTENT, DATA AND INFORMATION VIA WIRELESS AND MOBILE COMMUNICATION NETWORKS, FOR MARKETING AND CONSUMER INFORMATION ACQUIRING, PROCESSING, AGGREGATING, ANALYZING, CONDUCTING, GENERATING, RETRIEVING, PROVIDING, RECOMMENDING AND EXCHANGING IN THE FIELD OF ONLINE ADVERTISING SPACE BY RETAILERS, WHOLESALERS, BRAND OWNERS, MEDIA AND ADVERTISING AGENCIES, DIRECTORY PUBLISHERS, WEB VENDORS AND CONTENT PROVIDERS IN LOCAL MARKETPLACES, FOR MEASURING AND REPORTING OF MARKET RESPONSE AND ADVERTISING CAMPAIGN EFFECTS, FOR MEASURING AND MONETIZING MOBILE ADVERTISING, FOR REGISTRATION, COLLECTION, TRANSCRIPTION, COMPILATION AND SYSTEMIZATION OF COMMUNICATIONS AND DATA RELATING TO SHOPPING BEHAVIOR AND FOR DISSEMINATING IMMEDIATE AND RELEVANT SHOPPING INFORMATION TO SHOPPERS IN LOCAL MARKETPLACES (U.S. CLS. 100 AND 101).

LAURIE KAUFMAN, EXAMINING ATTORNEY

SN 77-884,543. DIANA E. KELLY, INC, SARASOTA, FL.
FILED 12-2-2009.

DIANA E KELLY

THE NAME "DIANA E. KELLY" IDENTIFIES A LIVING INDIVIDUAL WHOSE CONSENT IS OF RECORD.

THE MARK CONSISTS OF THE NAME "DIANA E. KELLY" IN STYLIZED LETTERING WITH THE MIDDLE INITIAL "E" STYLIZED IN CAPITAL CURSIVE SCRIPT.

CLASS 18—LEATHER GOODS

FOR BACKPACKS, BOOK BAGS, SPORTS BAGS, WALLETS AND HANDBAGS; EVENING HANDBAGS; FASHION HANDBAGS; HANDBAGS; HANDBAGS, PURSES AND WALLETS; LEATHER HANDBAGS; SHOE BAGS FOR TRAVEL; STRAPS FOR HANDBAGS (U.S. CLS. 1, 2, 3, 22 AND 41).

CLASS 25—CLOTHING

FOR BEACH SHOES; CANVAS SHOES; CAPRI PANTS; COATS FOR MEN AND WOMEN; DECK-SHOES; DENIMS; DRESS SHIRTS; DRESS SUITS; DRESSES; EVENING DRESSES; FOOTWEAR FOR MEN AND WOMEN; FOOTWEAR FOR WOMEN; LEATHER SHOES; LEISURE SHOES; LOUNGE PANTS; MEN'S AND WOMEN'S JACKETS, COATS, TROUSERS, VESTS; MEN'S SUITS, WOMEN'S SUITS; PANTS; RUBBER SHOES; SANDALS AND BEACH SHOES; SHOES; SKIRT SUITS; SKIRTS; SKIRTS AND DRESSES; WOMEN'S SHOES; WOMEN'S TOPS, NAMELY, CAMIS; WORK SHOES AND BOOTS (U.S. CLS. 22 AND 39).

CLASS 26—FANCY GOODS

FOR CHARMS FOR SHOES; SHOE BUCKLES; SHOE ORNAMENTS NOT OF PRECIOUS METAL (U.S. CLS. 37, 39, 40, 42 AND 50).

JILL C. ALT, EXAMINING ATTORNEY

SN 77-884,612. TODOROO INC., FORMERLY GRACEFUL TOOLS, INC., PALO ALTO, CA. FILED 12-2-2009.

todoroo

THE MARK CONSISTS OF STANDARD CHARACTERS WITHOUT CLAIM TO ANY PARTICULAR FONT, STYLE, SIZE, OR COLOR.

CLASS 9—ELECTRICAL AND SCIENTIFIC APPARATUS

FOR COMPUTER SOFTWARE FOR USE IN TASK MANAGEMENT, PROVIDING REMINDERS, PERSONAL ORGANIZATION, TIME MANAGEMENT, FOR USE IN PERSONAL TRAINING, AND FOR USE IN PROVIDING AND RECEIVING MENTORING, COACHING, INSTRUCTION, AND/OR EDUCATIONAL SERVICES, BY UTILIZING DATA FROM THE INTERNET AND SENDING DATA TO THE INTERNET, FOR USE ON COMPUTERS, LAPTOPS, MOBILE PHONES, AND OTHER MOBILE ELECTRONIC DEVICES (U.S. CLS. 21, 23, 26, 36 AND 38).

FIRST USE 3-10-2009; IN COMMERCE 8-31-2009.

CLASS 42—SCIENTIFIC AND COMPUTER SERVICES

FOR PROVIDING A WEBSITE THAT ENABLES USERS TO SUBSCRIBE TO COACHING, MENTORING, AND/OR EDUCATIONAL SERVICES AND TO ENABLE USERS TO AUTHOR AND PUBLISH INSTRUCTIONAL CONTENT FOR OTHERS; NON-DOWNLOADABLE ON-LINE COMPUTER SOFTWARE FOR USE IN TASK MANAGEMENT, PROVIDING REMINDERS, PERSONAL ORGANIZATION, TIME MANAGEMENT, FOR USE IN PERSONAL TRAINING, AND FOR USE IN PROVIDING AND RECEIVING MENTORING, COACHING, INSTRUCTION, AND/OR EDUCATIONAL SERVICES FOR USE ON COMPUTERS, LAPTOPS, MOBILE PHONES, AND OTHER MOBILE ELECTRONIC DEVICES (U.S. CLS. 100 AND 101).

FIRST USE 3-10-2009; IN COMMERCE 8-31-2009.

JAY BESCH, EXAMINING ATTORNEY

SN 77-885,097. GSI COMMERCE SOLUTIONS, INC., KING OF PRUSSIA, PA. FILED 12-3-2009.

SHOPRUNNER

THE MARK CONSISTS OF STANDARD CHARACTERS WITHOUT CLAIM TO ANY PARTICULAR FONT, STYLE, SIZE, OR COLOR.

CLASS 35—ADVERTISING AND BUSINESS

FOR ADMINISTRATION OF A DISCOUNT PROGRAM FOR ENABLING PARTICIPANTS TO OBTAIN DISCOUNTS ON SHIPPING SERVICES; ARRANGING FOR PICKUP, DELIVERY, STORAGE AND TRANSPORTATION OF DOCUMENTS, PACKAGES, FREIGHT AND PARCELS VIA GROUND AND AIR CARRIERS; PRICE PROTECTION PLAN OFFERED IN CONNECTION WITH RETAIL AND ONLINE RETAIL PURCHASES, NAMELY, A PRICE GUARANTEE PROGRAM TO PROTECT AGAINST FLUCTUATIONS IN RETAIL PRICING; ADMINISTRATION OF A DISCOUNT PROGRAM FOR ENABLING PARTICIPANTS TO OBTAIN DISCOUNTS ON GOODS AND SERVICES THROUGH USE OF A DISCOUNT MEMBERSHIP CARD OR ACCOUNT (U.S. CLS. 100, 101 AND 102).

CLASS 36—INSURANCE AND FINANCIAL

FOR PROVIDING EXTENDED WARRANTY COVERAGE FOR A WIDE RANGE OF CONSUMER PRODUCTS (U.S. CLS. 100, 101 AND 102).

DAVID I, EXAMINING ATTORNEY

SN 77-885,788. CODA AUTOMOTIVE, INC., SANTA MONICA, CA. FILED 12-3-2009.

LIO

THE MARK CONSISTS OF STANDARD CHARACTERS WITHOUT CLAIM TO ANY PARTICULAR FONT, STYLE, SIZE, OR COLOR.

CLASS 9—ELECTRICAL AND SCIENTIFIC APPARATUS

FOR BATTERIES FOR USE IN THE AUTOMOTIVE VEHICLES AND POWER STORAGE INDUSTRIES; BATTERY MANAGEMENT SYSTEMS FOR MANAGING THE GENERATION AND STORAGE OF ELECTRICAL POWER COMPRISED OF VOLTAGE SENSORS AND MONITORS, COMPUTERS AND COMPUTER PROCESSORS FOR USE IN THE AUTOMOTIVE VEHICLES AND POWER STORAGE INDUSTRIES; BATTERY CHARGING SYSTEMS COMPRISED OF VOLTAGE SENSORS AND MONITORS, COMPUTERS AND COMPUTER PROCESSORS FOR USE IN THE AUTOMOTIVE VEHICLES AND POWER STORAGE INDUSTRIES; BATTERY THERMAL MANAGEMENT SYSTEMS COMPRISED OF HEAT SENSORS, TEMPERATURE MONITORS, DUCTING, COMPUTER HARDWARE AND COMPUTER PROCESSORS FOR USE IN THE AUTOMOTIVE VEHICLES AND POWER STORAGE INDUSTRIES (U.S. CLS. 21, 23, 26, 36 AND 38).

CLASS 40—MATERIAL TREATMENT

FOR CUSTOM MANUFACTURE OF ELECTRICAL ENERGY GENERATION AND STORAGE BATTERIES AND CHARGING AND RECHARGING UNITS USED IN CONNECTION THEREWITH (U.S. CLS. 100, 103 AND 106).

CLASS 42—SCIENTIFIC AND COMPUTER SERVICES

FOR RESEARCH AND DEVELOPMENT OF MATERIALS, CHEMICALS, AND PROCESSES FOR MANUFACTURING ELECTRICAL ENERGY GENERATION AND STORAGE BATTERIES AND CHARGING AND RECHARGING UNITS USED IN CONNECTION THEREWITH, ALL FOR USE IN THE AUTOMOTIVE VEHICLES AND POWER STORAGE INDUSTRIES (U.S. CLS. 100 AND 101).

RUSS HERMAN, EXAMINING ATTORNEY

SN 77-885,789. CODA AUTOMOTIVE, INC., SANTA MONICA, CA. FILED 12-3-2009.

LIO ENERGY SYSTEMS

THE MARK CONSISTS OF STANDARD CHARACTERS WITHOUT CLAIM TO ANY PARTICULAR FONT, STYLE, SIZE, OR COLOR.

NO CLAIM IS MADE TO THE EXCLUSIVE RIGHT TO USE "ENERGY SYSTEMS", APART FROM THE MARK AS SHOWN.

CLASS 9—ELECTRICAL AND SCIENTIFIC APPARATUS

FOR BATTERIES FOR USE IN THE AUTOMOTIVE VEHICLES AND POWER STORAGE INDUSTRIES; BATTERY MANAGEMENT SYSTEMS FOR MANAGING THE GENERATION AND STORAGE OF ELECTRICAL POWER COMPRISED OF VOLTAGE SENSORS AND MONITORS, COMPUTERS AND COMPUTER PROCESSORS FOR USE IN THE AUTOMOTIVE VEHICLES AND POWER STORAGE INDUSTRIES; BATTERY CHARGING SYSTEMS COMPRISED OF VOLTAGE SENSORS AND MONITORS, COMPUTERS AND COMPUTER PROCESSORS FOR USE IN THE AUTOMOTIVE VEHICLES AND POWER STORAGE INDUSTRIES; BATTERY THERMAL MANAGEMENT SYSTEMS COMPRISED OF HEAT SENSORS, TEMPERATURE MONITORS, DUCTING, COMPUTER HARDWARE AND COMPUTER PROCESSORS FOR USE IN THE AUTOMOTIVE VEHICLES AND POWER STORAGE INDUSTRIES (U.S. CLS. 21, 23, 26, 36 AND 38).

CLASS 40—MATERIAL TREATMENT

FOR CUSTOM MANUFACTURE OF ELECTRICAL ENERGY GENERATION AND STORAGE BATTERIES AND CHARGING AND RECHARGING UNITS USED IN CONNECTION THEREWITH (U.S. CLS. 100, 103 AND 106).

CLASS 42—SCIENTIFIC AND COMPUTER SERVICES

FOR RESEARCH AND DEVELOPMENT OF MATERIALS, CHEMICALS, AND PROCESSES FOR MANUFACTURING ELECTRICAL ENERGY GENERATION AND STORAGE BATTERIES AND CHARGING AND RECHARGING UNITS USED IN CONNECTION THEREWITH, ALL FOR USE IN THE AUTOMOTIVE VEHICLES AND POWER STORAGE INDUSTRIES (U.S. CLS. 100 AND 101).

RUSS HERMAN, EXAMINING ATTORNEY

SN 77-886,059. PET DRX VETERINARY GROUP, INC., BRENTWOOD, TN. FILED 12-4-2009.

Pet DRx

THE MARK CONSISTS OF STANDARD CHARACTERS WITHOUT CLAIM TO ANY PARTICULAR FONT, STYLE, SIZE, OR COLOR.

NO CLAIM IS MADE TO THE EXCLUSIVE RIGHT TO USE "PET", APART FROM THE MARK AS SHOWN.

CLASS 28—TOYS AND SPORTING GOODS

FOR PET TOYS (U.S. CLS. 22, 23, 38 AND 50).

CLASS 31—NATURAL AGRICULTURAL PRODUCTS

FOR PET FOODS AND TREATS (U.S. CLS. 1 AND 46).

CLASS 36—INSURANCE AND FINANCIAL

FOR PET INSURANCE BROKERAGE SERVICES (U.S. CLS. 100, 101 AND 102).

CLASS 44—MEDICAL, BEAUTY AND AGRICULTURAL SERVICES

FOR VETERINARY SERVICES (U.S. CLS. 100 AND 101).
FIRST USE 10-0-2004; IN COMMERCE 10-0-2004.
AISHA CLARKE, EXAMINING ATTORNEY

SN 77-886,610. FRANCE PUBLICATIONS, INC., ATLANTA, GA. FILED 12-4-2009.

NORTHEAST REAL ESTATE BUSINESS

THE MARK CONSISTS OF STANDARD CHARACTERS WITHOUT CLAIM TO ANY PARTICULAR FONT, STYLE, SIZE, OR COLOR.

NO CLAIM IS MADE TO THE EXCLUSIVE RIGHT TO USE "REAL ESTATE BUSINESS", APART FROM THE MARK AS SHOWN.
SEC. 2(F).

CLASS 16—PAPER GOODS AND PRINTED MATTER

FOR MAGAZINES FEATURING NEWS AND AREAS OF INTEREST TO THOSE INVOLVED IN THE OWNERSHIP, DEVELOPMENT AND OPERATION OF COMMERCIAL REAL ESTATE PROPERTIES (U.S. CLS. 2, 5, 22, 23, 29, 37, 38 AND 50).
FIRST USE 5-1-2004; IN COMMERCE 8-1-2004.

CLASS 35—ADVERTISING AND BUSINESS

FOR PROMOTING THE GOODS AND SERVICES OF OTHERS BY PREPARING AND PLACING ADVERTISEMENTS IN AN ELECTRONIC MAGAZINE ACCESSED THROUGH A GLOBAL COMPUTER NETWORK (U.S. CLS. 100, 101 AND 102).
FIRST USE 5-1-2004; IN COMMERCE 8-1-2004.
KATHLEEN LORENZO, EXAMINING ATTORNEY

SN 77-887,002. MINOMI PUBLICATIONS, INC., DBA WORDY WORM READING, NORTH FORT MYERS, FL. FILED 12-5-2009.

WORDY WORM

THE MARK CONSISTS OF STANDARD CHARACTERS WITHOUT CLAIM TO ANY PARTICULAR FONT, STYLE, SIZE, OR COLOR.

CLASS 9—ELECTRICAL AND SCIENTIFIC APPARATUS

FOR EDUCATIONAL PUBLICATIONS ON CD AND DVD. NAMELY, EDUCATIONAL LEARNING CARDS, WORKBOOKS, ACTIVITY BOOKS, TEXTBOOKS, STORY BOOKS, BOOKLETS, SONGBOOKS, POSTERS, CERTIFICATES, AND TEACHER GUIDES IN THE FIELD OF READING (U.S. CLS. 21, 23, 26, 36 AND 38).

CLASS 16—PAPER GOODS AND PRINTED MATTER

FOR EDUCATIONAL PUBLICATIONS IN PRINT AND PRINTED MATERIALS, NAMELY, EDUCATIONAL LEARNING CARDS, WORKBOOKS, ACTIVITY BOOKS, TEXTBOOKS, STORY BOOKS, BOOKLETS, SONGBOOKS, POSTERS, CERTIFICATES, AND TEACHER GUIDES IN THE FIELD OF READING (U.S. CLS. 2, 5, 22, 23, 29, 37, 38 AND 50).

CLASS 41—EDUCATION AND ENTERTAINMENT

FOR ON-LINE EDUCATIONAL PUBLICATIONS IN THE NATURE OF ELECTRONIC EDUCATIONAL LEARNING CARDS, WORKBOOKS, ACTIVITY BOOKS, TEXTBOOKS, STORY BOOKS, BOOKLETS, SONGBOOKS, POSTERS, ELECTRONIC CERTIFICATES, AND TEACHER GUIDES IN THE FIELD OF READING; EDUCATIONAL SERVICES, NAMELY, PROVIDING LIVE AND ON-LINE CLASSES, SEMINARS, WORKSHOPS, TRAININGS, AND TUTORING IN THE FIELD OF READING (U.S. CLS. 100, 101 AND 107).
THOMAS MANOR, EXAMINING ATTORNEY

SN 77-887,428. SERVICIO, INC., ALBANY, NY. FILED 12-7-2009.

FAST-CORP

OWNER OF U.S. REG. NO. 2,528,532.
THE MARK CONSISTS OF STYLIZED TEXT, "FAST-CORP".

CLASS 42—SCIENTIFIC AND COMPUTER SERVICES

FOR PROVIDING INFORMATIONAL RETRIEVAL SERVICES IN THE FIELD OF CORPORATE DOCUMENTATION FILED WITH GOVERNMENTAL AGENCIES (U.S. CLS. 100 AND 101).
FIRST USE 10-0-1982; IN COMMERCE 10-0-1982.

CLASS 45—PERSONAL AND LEGAL SERVICES

FOR LEGAL RESEARCH SERVICES FOR ATTORNEYS AND BUSINESSES, NAMELY, THE FILING OF INCORPORATION AND CORPORATE DOCUMENTS WITH GOVERNMENTAL AGENCIES AND RELATED PUBLIC ANNOUNCEMENTS (U.S. CLS. 100 AND 101).
FIRST USE 10-0-1982; IN COMMERCE 10-0-1982.
MARILYN IZZI, EXAMINING ATTORNEY

SN 77-889,344. ARZU, INC., CHICAGO, IL. FILED 12-9-2009.

SN 77-890,200. PREFERRED OFFICE PROPERTIES, LLC, DBA CARR WORKPLACES, WASHINGTON, DC. FILED 12-10-2009.



NO CLAIM IS MADE TO THE EXCLUSIVE RIGHT TO USE "DESIGN", APART FROM THE MARK AS SHOWN.

THE MARK CONSISTS OF THE WORDS "STUDIO HOPE WORLD DESIGN" WITH A GEOMETRICAL DESIGN COMPRISING THE "O" IN THE WORD "HOPE".

CLASS 27—FLOOR COVERINGS

FOR RUGS (U.S. CLS. 19, 20, 37, 42 AND 50).

CLASS 36—INSURANCE AND FINANCIAL

FOR CHARITABLE FUNDRAISING (U.S. CLS. 100, 101 AND 102).

WILLIAM VERHOSEK, EXAMINING ATTORNEY

CARR WORKPLACES

THE MARK CONSISTS OF STANDARD CHARACTERS WITHOUT CLAIM TO ANY PARTICULAR FONT, STYLE, SIZE, OR COLOR.

NO CLAIM IS MADE TO THE EXCLUSIVE RIGHT TO USE "WORKPLACES", APART FROM THE MARK AS SHOWN.

CLASS 35—ADVERTISING AND BUSINESS

FOR OFFICE ADMINISTRATION SERVICES (U.S. CLS. 100, 101 AND 102).

FIRST USE 12-8-2009; IN COMMERCE 12-8-2009.

CLASS 36—INSURANCE AND FINANCIAL

FOR REAL ESTATE LISTING; REAL ESTATE MANAGEMENT SERVICES; RENTAL OF OFFICE SPACE (U.S. CLS. 100, 101 AND 102).

FIRST USE 12-8-2009; IN COMMERCE 12-8-2009.

WENDY GOODMAN, EXAMINING ATTORNEY

SN 77-889,413. ONYXBRIDGE MEDIA LLC, ALEXANDRIA, VA. FILED 12-9-2009.

SN 77-890,788. MED SYSTEMS, SAN DIEGO, CA. FILED 12-10-2009.

TRIO TOOL BOX

THE MARK CONSISTS OF STANDARD CHARACTERS WITHOUT CLAIM TO ANY PARTICULAR FONT, STYLE, SIZE, OR COLOR.

NO CLAIM IS MADE TO THE EXCLUSIVE RIGHT TO USE "TOOL BOX", APART FROM THE MARK AS SHOWN.

CLASS 9—ELECTRICAL AND SCIENTIFIC APPARATUS

FOR DIGITAL MATERIALS, NAMELY, CDS FEATURING COLLEGE ACCESS PROGRAMS (U.S. CLS. 21, 23, 26, 36 AND 38).

FIRST USE 6-3-2008; IN COMMERCE 6-10-2008.

CLASS 42—SCIENTIFIC AND COMPUTER SERVICES

FOR APPLICATION SERVICE PROVIDER (ASP) FEATURING SOFTWARE FOR USE WITH COLLEGE ACCESS PROGRAMS (U.S. CLS. 100 AND 101).

FIRST USE 6-3-2008; IN COMMERCE 6-10-2008.

DEZMONA MIZELLE, EXAMINING ATTORNEY

NO CLAIM IS MADE TO THE EXCLUSIVE RIGHT TO USE "MED SYSTEMS", APART FROM THE MARK AS SHOWN.

THE MARK CONSISTS OF THE WORDS "MED" AND "SYSTEMS" ENCASED IN A RECTANGLE, WHICH IS SUPERIMPOSED OVER A CIRCLE.

CLASS 10—MEDICAL APPARATUS

FOR PERCUSSORS, ANATOMICAL MASKS, HEAD STRAPS FOR ANATOMICAL MASKS (U.S. CLS. 26, 39 AND 44).

FIRST USE 8-31-2007; IN COMMERCE 8-31-2007.

CLASS 35—ADVERTISING AND BUSINESS

FOR ON-LINE RETAIL AND WHOLESALE STORE SERVICES FEATURING PERCUSSORS, ANATOMICAL MASKS, AND HEAD STRAPS FOR ANATOMICAL MASKS (U.S. CLS. 100, 101 AND 102).

FIRST USE 8-31-2007; IN COMMERCE 8-31-2007.

DOMINICK J. SALEMI, EXAMINING ATTORNEY

SN 77-890,807. CODA AUTOMOTIVE, INC., SANTA MONICA, CA. FILED 12-10-2009.



THE MARK CONSISTS OF THE STYLIZED OUTLINE OF THE LETTERS "LIO".

CLASS 9—ELECTRICAL AND SCIENTIFIC APPARATUS

FOR BATTERIES FOR USE IN THE AUTOMOTIVE VEHICLES AND POWER STORAGE INDUSTRIES; BATTERY MANAGEMENT SYSTEMS FOR MANAGING THE GENERATION AND STORAGE OF ELECTRICAL POWER COMPRISED OF VOLTAGE SENSORS AND MONITORS, COMPUTERS AND COMPUTER PROCESSORS FOR USE IN THE AUTOMOTIVE VEHICLES AND POWER STORAGE INDUSTRIES; BATTERY CHARGING SYSTEMS COMPRISED OF VOLTAGE SENSORS AND MONITORS, COMPUTERS AND COMPUTER PROCESSORS FOR USE IN THE AUTOMOTIVE VEHICLES AND POWER STORAGE INDUSTRIES; BATTERY THERMAL MANAGEMENT SYSTEMS COMPRISED OF HEAT SENSORS, TEMPERATURE MONITORS, DUCTING, COMPUTER HARDWARE AND COMPUTER PROCESSORS FOR USE IN THE AUTOMOTIVE VEHICLES AND POWER STORAGE INDUSTRIES (U.S. CLS. 21, 23, 26, 36 AND 38).

CLASS 40—MATERIAL TREATMENT

FOR CUSTOM MANUFACTURE OF ELECTRICAL ENERGY GENERATION AND STORAGE BATTERIES AND CHARGING AND RECHARGING UNITS USED IN CONNECTION THEREWITH (U.S. CLS. 100, 103 AND 106).

CLASS 42—SCIENTIFIC AND COMPUTER SERVICES

FOR RESEARCH AND DEVELOPMENT OF MATERIALS, CHEMICALS, AND PROCESSES FOR MANUFACTURING ELECTRICAL ENERGY GENERATION AND STORAGE BATTERIES AND CHARGING AND RECHARGING UNITS USED IN CONNECTION THEREWITH, ALL FOR USE IN THE AUTOMOTIVE VEHICLES AND POWER STORAGE INDUSTRIES (U.S. CLS. 100 AND 101).

RUSS HERMAN, EXAMINING ATTORNEY

SN 77-890,811. CODA AUTOMOTIVE, INC., SANTA MONICA, CA. FILED 12-10-2009.



NO CLAIM IS MADE TO THE EXCLUSIVE RIGHT TO USE "ENERGY SYSTEMS", APART FROM THE MARK AS SHOWN.

THE MARK CONSISTS OF THE STYLIZED OUTLINE OF THE LETTERS "LIO ENERGY SYSTEMS".

CLASS 9—ELECTRICAL AND SCIENTIFIC APPARATUS

FOR BATTERIES FOR USE IN THE AUTOMOTIVE VEHICLES AND POWER STORAGE INDUSTRIES; BATTERY MANAGEMENT SYSTEMS FOR MANAGING THE GENERATION AND STORAGE OF ELECTRICAL POWER COMPRISED OF VOLTAGE SENSORS AND MONITORS, COMPUTERS AND COMPUTER PROCESSORS FOR USE IN THE AUTOMOTIVE VEHICLES AND POWER STORAGE INDUSTRIES; BATTERY CHARGING SYSTEMS COMPRISED OF VOLTAGE SENSORS AND MONITORS, COMPUTERS AND COMPUTER PROCESSORS FOR USE IN THE AUTOMOTIVE VEHICLES AND POWER STORAGE INDUSTRIES; BATTERY THERMAL MANAGEMENT SYSTEMS COMPRISED OF HEAT SENSORS, TEMPERATURE MONITORS, DUCTING, COMPUTER HARDWARE AND COMPUTER PROCESSORS FOR USE IN THE AUTOMOTIVE VEHICLES AND POWER STORAGE INDUSTRIES (U.S. CLS. 21, 23, 26, 36 AND 38).

CLASS 40—MATERIAL TREATMENT

FOR CUSTOM MANUFACTURE OF ELECTRICAL ENERGY GENERATION AND STORAGE BATTERIES AND CHARGING AND RECHARGING UNITS USED IN CONNECTION THEREWITH (U.S. CLS. 100, 103 AND 106).

CLASS 42—SCIENTIFIC AND COMPUTER SERVICES

FOR RESEARCH AND DEVELOPMENT OF MATERIALS, CHEMICALS, AND PROCESSES FOR MANUFACTURING ELECTRICAL ENERGY GENERATION AND STORAGE BATTERIES AND CHARGING AND RECHARGING UNITS USED IN CONNECTION THEREWITH, ALL FOR USE IN THE AUTOMOTIVE VEHICLES AND POWER STORAGE INDUSTRIES (U.S. CLS. 100 AND 101).

RUSS HERMAN, EXAMINING ATTORNEY

SN 77-891,656. HUSKY OIL OPERATIONS LIMITED, CALGARY, AB T2P3G7, CANADA, FILED 12-11-2009.



OWNER OF CANADA REG. NO. TMA641194, DATED 6-2-2005, EXPIRES 6-2-2020.

OWNER OF U.S. REG. NOS. 3,542,629, 3,703,990 AND OTHERS.

THE MARK CONSISTS OF THE WORD, "HUSKY", INSIDE A RECTANGLE UNDERNEATH A HUSKY DOG HEAD DESIGN THAT IS INSIDE A SQUARE WITH ROUNDED INSIDE CORNERS.

CLASS 4—LUBRICANTS AND FUELS

FOR PETROLEUM PRODUCTS, NAMELY, GASOLINE, INDUSTRIAL LUBRICANTS, ENGINE LUBRICATING OILS, VEHICULAR LUBRICATING OILS, VEHICULAR GREASES, HEATING FUEL OILS, DIESEL FUEL OILS, INDUSTRIAL FUEL OILS, TREATING OILS, KEROSENE, JET FUEL, PROPANE FUEL, BUTANE FUEL, PETROLEUM COKE, BENZENE, PROPYLENE, BUTYLENE AND ETHANOL BASED FUEL (U.S. CLS. 1, 6 AND 15).

CLASS 19—NON-METALLIC BUILDING MATERIALS

FOR ASPHALT PRODUCTS, NAMELY, PAVING ASPHALT, INDUSTRIAL ASPHALT, MODIFIED ASPHALT, ROOFING ASPHALT (U.S. CLS. 1, 12, 33 AND 50).
ROBIN CHOSID, EXAMINING ATTORNEY

SN 77-892,687. ENERGY OWL ENTERPRISES, INC., ORRVILLE, OH. FILED 12-14-2009.



NO CLAIM IS MADE TO THE EXCLUSIVE RIGHT TO USE "ENERGY" AS TO CLASSES 9 AND 11 AND "ENTERPRISES", APART FROM THE MARK AS SHOWN.

THE MARK CONSISTS OF THE LETTERS "EOE" OVER A STRAIGHT LINE WITH THE TEXT "ENERGY OWL ENTERPRISES" UNDERNEATH THE STRAIGHT LINE. TO THE RIGHT OF THE LETTERS AND TEXT IS A PICTURE OF AN OWL.

CLASS 3—COSMETICS AND CLEANING PREPARATIONS

FOR CLEANING AGENTS AND PREPARATIONS; HAND SOAP; LIQUID SOAP; AND HAND CLEANING PREPARATIONS (U.S. CLS. 1, 4, 6, 50, 51 AND 52).

CLASS 9—ELECTRICAL AND SCIENTIFIC APPARATUS

FOR BATTERY RECHARGERS (U.S. CLS. 21, 23, 26, 36 AND 38).

CLASS 11—ENVIRONMENTAL CONTROL APPARATUS

FOR LED (LIGHT EMITTING DIODES) LIGHTING FIXTURES; LED LIGHT ASSEMBLIES FOR STREET LIGHTS, SECURITY LIGHTS, INDUSTRIAL AND COMMERCIAL LIGHTING, BUILDINGS, AND OTHER ARCHITECTURAL USES; LED LIGHTING FIXTURES FOR INDOOR AND OUTDOOR LIGHTING APPLICATIONS; AND LED LIGHT BULBS; SOLAR COLLECTORS; SOLAR FLASHLIGHTS; SOLAR ENERGY RECEIVERS, NAMELY, SOLAR HATS AND SOLAR BACKPACKS; SOLAR WATER HEATERS; SOLAR POOL HEATERS; SOLAR AIR CONDITIONERS; SOLAR LIGHT FIXTURES, NAMELY, INDOOR AND OUTDOOR SOLAR POWERED LIGHTING UNITS AND FIXTURES; PLUMBING FIXTURES, NAMELY, SHOWER SPRAYERS, SINK SPRAYERS, FAUCETS, FAUCET AERATORS, WATER FAUCET SPOUTS, TOILETS; POOL SKIMMER DIVERTERS; AGRICULTURAL IRRIGATION UNITS FOR USE IN CHANNELING RAIN WATER; TOILET PARTS, NAMELY, BOWLS, TANKS, SEATS (U.S. CLS. 13, 21, 23, 31 AND 34).

CLASS 21—HOUSEWARES AND GLASS

FOR CLEANING SPONGES; CLEANING, DUSTING AND POLISHING CLOTHS; AEROSOL DISPENSERS NOT FOR MEDICAL USE; DUSTERS; NON-ELECTRIC CARPET SWEEPERS (U.S. CLS. 2, 13, 23, 29, 30, 33, 40 AND 50).

DAVID MURRAY, EXAMINING ATTORNEY

SN 77-893,588. NATIONAL OILWELL VARCO, L.P., HOUSTON, TX. FILED 12-15-2009.

RIGSTORE

THE MARK CONSISTS OF STANDARD CHARACTERS WITHOUT CLAIM TO ANY PARTICULAR FONT, STYLE, SIZE, OR COLOR.

CLASS 35—ADVERTISING AND BUSINESS

FOR SUPPLY CHAIN MANAGEMENT SERVICES (U.S. CLS. 100, 101 AND 102).

CLASS 39—TRANSPORTATION AND STORAGE

FOR SUPPLY CHAIN LOGISTICS SERVICES, NAMELY, STORAGE, TRANSPORTATION AND DELIVERY OF GOODS FOR OTHERS BY AIR, RAIL, SHIP OR TRUCK (U.S. CLS. 100 AND 105).

JULIE WATSON, EXAMINING ATTORNEY

SN 77-895,874. COMMON GOOD, DBA GOOD OF ALL, MERRIFIELD, VA. FILED 12-17-2009.

Good of All

THE MARK CONSISTS OF STANDARD CHARACTERS WITHOUT CLAIM TO ANY PARTICULAR FONT, STYLE, SIZE, OR COLOR.

CLASS 35—ADVERTISING AND BUSINESS

FOR PROMOTING PUBLIC AWARENESS OF POLITICS, CULTURE, EDUCATION, RELIGION, TECHNOLOGY AND EMPLOYMENT TO ENCOURAGE AND PROMOTE CIVILITY IN PUBLIC DISCOURSE AND CONVERSATION (U.S. CLS. 100, 101 AND 102).

CLASS 41—EDUCATION AND ENTERTAINMENT

FOR PROVIDING CURRENT EVENT NEWS AND INFORMATION VIA GLOBAL COMPUTER NETWORK IN THE FIELD OF NATIONAL AND INTERNATIONAL ISSUES; ONLINE NEWSLETTER FEATURING NEWS AND INFORMATION ON NATIONAL AND INTERNATIONAL ISSUES (U.S. CLS. 100, 101 AND 107).

KATHERINE E. HALMEN, EXAMINING ATTORNEY

SN 77-895,997. BGTM/ECC INC., ST. JAMES, MO. FILED 12-17-2009.

SN 77-896,057. ALO NETWORKS LLC, ROCKVILLE, MD. FILED 12-17-2009.

GREAT CIRCLE



The logo for Aló Networks features the word "Aló" in a bold, black, sans-serif font, followed by "Networks" in a white, sans-serif font inside a black rectangular box.

NO CLAIM IS MADE TO THE EXCLUSIVE RIGHT TO USE "NETWORKS", APART FROM THE MARK AS SHOWN.

THE ENGLISH TRANSLATION OF "ALÓ" IN THE MARK IS "HELLO".

THE MARK CONSISTS OF STANDARD CHARACTERS WITHOUT CLAIM TO ANY PARTICULAR FONT, STYLE, SIZE, OR COLOR.

CLASS 41—EDUCATION AND ENTERTAINMENT

FOR PROVIDING EDUCATIONAL SERVICES, NAMELY, PROVIDING PROGRAMS IN THE FIELD OF FAMILY COUNSELING; EDUCATIONAL SERVICES, NAMELY, PROVIDING PROGRAMS IN THE FIELD OF SPEECH, LANGUAGE, OCCUPATION, MUSIC, ART, FOREIGN LANGUAGE, AND PHYSICAL EDUCATION FOR CHILDREN AND ADOLESCENTS WITH LEARNING DISABILITIES, BEHAVIORAL DISORDERS, EMOTIONAL DISORDERS, COMMUNICATION DISORDERS, AUTISM, AND PSYCHOLOGICAL PROBLEMS (U.S. CLS. 100, 101 AND 107).

CLASS 43—HOTEL AND RESTAURANT SERVICES

FOR PROVIDING DAY CARE SERVICES FOR CHILDREN; CHILD WELFARE SERVICES, NAMELY, PROVIDING RESIDENTIAL HOMES AND HOUSING FOR AT-RISK CHILDREN AND YOUTH; PROVIDING JUVENILE CORRECTIONS SERVICES, NAMELY, SHORT TERM AND LONG TERM RESIDENTIAL SERVICES TO HELP COURT ORDERED YOUTH; PROVIDING EMERGENCY SHELTER TO HOMELESS YOUTH (U.S. CLS. 100 AND 101).

CLASS 44—MEDICAL, BEAUTY AND AGRICULTURAL SERVICES

FOR THERAPEUTIC SERVICES FOR AT-RISK ADOLESCENTS AND THEIR FAMILIES, PRIMARILY IN A WILDERNESS SETTING; PSYCHIATRIC SERVICES, NAMELY, PROVIDING RESIDENTIAL THERAPY PROGRAMS FOR AT-RISK YOUTH AND THEIR FAMILIES (U.S. CLS. 100 AND 101).

CLASS 45—PERSONAL AND LEGAL SERVICES

FOR FOSTER CARE SERVICES; FOSTER CARE CASE MANAGEMENT SERVICES; COMMUNITY OUTREACH SERVICES, NAMELY, PROVIDING COUNSELING AND EMOTIONAL SUPPORT SERVICES TO AT-RISK YOUTH AND THEIR FAMILIES; PROVIDING INFORMATION IN THE FIELD OF EMOTIONAL COUNSELING AND EMOTIONAL SUPPORT SERVICES FOR TROUBLED AND AT-RISK YOUTH AND THEIR FAMILIES (U.S. CLS. 100 AND 101).

MATTHEW KLINE, EXAMINING ATTORNEY

CLASS 35—ADVERTISING AND BUSINESS

FOR TELEMARKETING IN THE NATURE OF THE DISSEMINATION, MONITORING AND CONTROL OF TARGETED ADVERTISING INFORMATION AND COMMERCIAL ANNOUNCEMENTS BY TELEPHONE (U.S. CLS. 100, 101 AND 102).

FIRST USE 10-0-2009; IN COMMERCE 10-0-2009.

CLASS 38—COMMUNICATION

FOR PROVIDING CELLULAR TELEPHONE SERVICES FOR USE IN CONJUNCTION WITH PREPAID AIRTIME CELLULAR PHONES AND DEBIT CARDS; PROVIDING MOBILE TEXT MESSAGE SERVICES TO BROADCAST ADVERTISING INFORMATION AND COMMERCIAL ANNOUNCEMENTS TO OTHERS (U.S. CLS. 100, 101 AND 104).

FIRST USE 10-0-2009; IN COMMERCE 10-0-2009.

MARK SPARACINO, EXAMINING ATTORNEY

SN 77-896,311. LOOFAH ART, LLC, AVENEL, NJ. FILED 12-17-2009.



The logo for Gitadini features the word "Gitadini" in a large, black, serif font.

THE MARK CONSISTS OF STANDARD CHARACTERS WITHOUT CLAIM TO ANY PARTICULAR FONT, STYLE, SIZE, OR COLOR.

CLASS 21—HOUSEWARES AND GLASS

FOR ABRASIVE PADS FOR KITCHEN OR DOMESTIC PURPOSES; ABRASIVE PADS FOR KITCHEN PURPOSES; BABY BATH TUBS; BATH ACCESSORIES, NAMELY, CUP HOLDERS; BATH BRUSHES; BATH PRODUCTS, NAMELY, BODY SPONGES; BATH PRODUCTS, NAMELY, LOOFAH SPONGES; BATH PRODUCTS, NAMELY, NATURAL SEA SPONGES; BATH SPONGES; BIRD BATHS; BREAD-CASES; CHOPPING BOARDS FOR KITCHEN USE; CONTAINERS FOR HOUSEHOLD OR KITCHEN USE; CONTAINERS FOR HOUSEHOLD OR KITCHEN USE NOT OF PRECIOUS METAL; CONTAINERS FOR HOUSEHOLD OR KITCHEN USE OF PRECIOUS METAL; COOKING UTENSIL, NAMELY, BATTER DISPENSER; COOKING UTENSILS, NAMELY, GRILL COVERS; COOKING UTENSILS, NAMELY, GRILLS; COOKING UTENSILS, NAMELY, WIRE BASKETS; DENTURE BATHS; FABRIC AND TEXTILE PARTY FAVOR BOXES SOLD EMPTY; FIBERGLASS OTHER THAN FOR INSULATION OR TEXTILE USE; GLASS FIBERS AND GLASS FIBER ROVINGS FOR NON-TEXTILE PURPOSES; GLASS FIBERS FOR NON-TEXTILE PURPOSES; GLASS THREADS; HOUSEHOLD UTENSILS, NAMELY, GRATERS; HOUSEHOLD UTENSILS, NAMELY, KITCHEN TONGS; HOUSEHOLD UTENSILS, NAMELY, SIEVES; HOUSEHOLD UTENSILS, NAMELY, SKIMMERS; HOUSEHOLD UTENSILS, NAMELY, SPATULAS; HOUSEHOLD UTENSILS, NAMELY, STRAINERS; HOUSEHOLD UTENSILS, NAMELY, TURNERS; KITCHEN LADLES; KITCHEN URNS; KITCHEN UTENSIL, NAMELY, NON-METAL FLEXIBLE LID DESIGNED FOR DRAINING OR PRESSING LIQUIDS FROM A FOOD CAN; KITCHEN UTENSILS, NAMELY, POURING AND STRAINING SPOUTS; KITCHEN UTENSILS, NAMELY, SPLATTER SCREENS; LADLES, FOR KITCHEN USE; NON-ELECTRIC KITCHEN CONTAINERS NOT MADE OF PRECIOUS METAL; NON-WOVEN DISPOSABLE TEXTILE WIPES NOT IMPREGNATED WITH CHEMICALS OR COMPOUNDS; PLASTIC BATH RACKS; PLASTIC BUCKETS FOR STORING BATH TOYS; PORTABLE PLASTIC CONTAINERS FOR STORING HOUSEHOLD AND KITCHEN GOODS; UTENSILS FOR BARBECUES, NAMELY, FORKS, TONGS, TURNERS; WOOD CHOPPING BLOCKS; WOOD CHOPPING BOARDS FOR KITCHEN USE (U.S. CLS. 2, 13, 23, 29, 30, 33, 40 AND 50).

CLASS 24—FABRICS

FOR BATH GLOVES; BATH LINEN; BATH MITTS; BATH SHEETS; BATH TOWELS; BED AND TABLE LINEN; BED AND TABLE LINEN, WALL HANGINGS OF TEXTILE; BED BLANKETS; BED CANOPIES; BED COVERS; BED LINEN; BED LINEN AND TABLE LINEN; BED PADS; BED SHEETS; BED SHEETS OF PAPER; BED SHEETS, FITTED BED SHEET COVERS, BED FLAT SHEETS, AND PILLOW CASES USED IN THE BEDDING, HEALTH CARE, HOME-HEALTH CARE AND NURSING HOME INDUSTRIES MADE OF BIODEGRADABLE FILM CREATED FROM RENEWABLE BIO-POLYMER RESOURCES; BED SKIRTS; BED SPREADS; BED THROWS; COVERED RUBBER YARN FABRICS; CURTAIN LOOPS OF TEXTILE MATERIAL; CURTAINS MADE OF TEXTILE FABRICS; CURTAINS OF TEXTILE; CURTAINS OF TEXTILE OR PLASTIC; FABRIC FINISH OR SURFACE TREATMENT COMPOSITION SOLD AS A COMPONENT OF FINISHED TREATED OR COATED TEXTILES AND FABRICS TO ENHANCE PRINTING OF DESIGNS AND PATTERNS THEREON; FABRIC FINISH OR SURFACE TREATMENT COMPOSITION SOLD AS A COMPONENT OF FINISHED TREATED OR COATED TEXTILES AND FABRICS TO PRESERVE COLOR DYES AND INKS THEREON AND TO REDUCE OR ELIMINATE FADE; FABRICS FOR TEXTILE USE; FABRICS THAT MAY OR MAY NOT HAVE PRINTED PATTERNS AND DESIGNS THEREON FOR USE IN TEXTILE APPLICATIONS, NAMELY, THE MANUFACTURE OF APPAREL, UPHOLSTERY, SIGNAGE, FLAGS, BANNERS AND WALLPAPER; FACE TOWELS; FACE TOWELS OF TEXTILES; FELT AND NON-WOVEN TEXTILE FABRICS; FIBERGLASS FABRIC FOR TEXTILE USE; FIBERGLASS FABRICS FOR TEXTILE USE; FIBREGLASS FABRICS FOR TEXTILE USE; FLAME RETARDANT FABRICS FOR THE MANUFACTURE OF BEDDING AND UPHOLSTERED FURNITURE; GIFT WRAP OF TEXTILE; HAND TOWELS OF TEXTILE; HAND-TOWELS MADE OF TEXTILE FABRICS; HAND-

KERCHIEFS OF TEXTILE; HANDKERCHIEFS OF TEXTILES; KITCHEN LINENS; KITCHEN TOWELS; LABELS OF TEXTILE FOR IDENTIFYING CLOTHING; LAMINATED TEXTILES TO BE AFFIXED TO THE SURFACE OF FURNITURE; LARGE BATH TOWELS; NATURAL AND SYNTHETIC FABRICS AND TEXTILES, NAMELY, COTTON, SILK, POLYESTER AND NYLON FABRICS; NON-WOVEN TEXTILE FABRICS; PAPER BED COVERS; PILLOW-TOP, LOW-PROFILE BED SKIRTS; PLACE MATS OF TEXTILE MATERIAL; PRINTED TEXTILE LABELS; QUILTS OF TEXTILE; SERVIETTES OF TEXTILE; SILK BED BLANKETS; TABLE AND BED LINEN; TABLE CLOTH OF TEXTILE; TABLE LINEN OF TEXTILE; TABLE NAPKINS OF TEXTILE; TABLECLOTHS OF TEXTILES; TAPESTRIES OF TEXTILE; TEXTILE FABRIC INCORPORATING WATERPROOF AND GAS PERMEABLE MEMBRANE MADE OF EXPANDED POLYTETRAFLUOROETHYLENE (EPTFE) FOR THE PROTECTION OF SENSITIVE EQUIPMENT AND PACKAGING FROM CONTAMINATES; TEXTILE FABRIC OF ANIMAL SKINS IMITATIONS; TEXTILE FABRICS FOR HOME AND COMMERCIAL INTERIORS; TEXTILE FABRICS FOR LINGERIE; TEXTILE FABRICS FOR THE MANUFACTURE OF CLOTHING; TEXTILE FABRICS FOR USE IN MAKING CLOTHING AND HOUSEHOLD FURNISHINGS; TEXTILE FABRICS FOR USE IN THE MANUFACTURE OF GARMENTS, BAGS, JACKETS, GLOVES, AND APPAREL; TEXTILE GOODS, NAMELY, A SYNTHETIC SHEET WITH FRAGRANCE FOR THE PURPOSE OF INSERTING INTO PILLOW SLIP AND UNDER FITTED SHEET TO EMIT FRAGRANCE; TEXTILE HANDKERCHIEFS; TEXTILE HANG TAGS; TEXTILE LABELS; TEXTILE NAPKINS; TEXTILE NAPKINS FOR REMOVING MAKE-UP; TEXTILE PLACE MATS; TEXTILE PRINTERS' BLANKETS; TEXTILE SERVIETTES; TEXTILE SIGNAGE PANELS; TEXTILE SUBSTITUTE MATERIALS MADE FROM SYNTHETIC MATERIALS; TEXTILE TABLECLOTHS; TEXTILE TISSUES FOR REMOVING MAKE-UP; TEXTILE USED AS LINING FOR CLOTHING; TEXTILE WALL HANGINGS; TEXTILE WALL HANGINGS, NAMELY, CLOTH POSTERS; TEXTILE WRAPS FOR KNOBS AND HANDLES TO PROTECT USERS' HANDS FROM HEAT/COLD WHEN TOUCHING THE KNOBS OR HANDLES; TEXTILES FOR DYE-SUBLIMATION PRINTING; TEXTILES WITH INSPIRATIONAL MESSAGES IMPRINTED OR WOVEN INTO TEXTILES; TOWELS; UNFITTED SEAT COVERS OF TEXTILE; VINYL AND CLOTH TEXTILES FOR USE IN THE MANUFACTURE OF APPAREL, HOUSEWARE, AND BATHWARE; WALL HANGINGS OF TEXTILE; WAVY FIBER TEXTILES (U.S. CLS. 42 AND 50).

GINA HAYES, EXAMINING ATTORNEY

SN 77-896,557. ECOLAB USA INC., SAINT PAUL, MN. FILED 12-18-2009.



THE COLORS BLACK, WHITE AND/OR GREY REPRESENT BACKGROUND, OUTLINING, SHADING AND/OR TRANSPARENT AREAS AND ARE NOT PART OF THE MARK.

THE MARK CONSISTS OF A STYLIZED "U" WITH A SINGLE WING DESIGN BETWEEN THE WORDS "PURE" AND "FORCE".

CLASS 3—COSMETICS AND CLEANING PREPARATIONS

FOR ALL-PURPOSE CLEANERS, ANTI-STATIC DRYER BLOCKS, BRASS POLISHES, CARPET CLEANERS, CHROME POLISHES, CREAM CLEANSERS FOR CLEANING METALS, DEGREASING PREPARATIONS FOR USE ON HARD SURFACES AND MACHINERY, DELIMERS, DISH DETERGENTS, DISHWASHING DETERGENTS, DISHWASHING PRE-SOAKS, DISHWASHING RINSES, DISINFECTANT SOAPS, DRAIN CLEANERS, FLOOR BUFFING COMPOUNDS, FLOOR FINISHING PREPARATIONS, FLOOR POLISHES, FLOOR STRIPPER/CLEANING PREPARATIONS, FURNITURE POLISHES, GERMICIDAL DETERGENTS, GLASS CLEANERS, HAND CLEANERS, HAND LOTIONS, HAND SOAPS, LAUNDRY BLEACH, LAUNDRY DETERGENTS, LAUNDRY FABRIC CONDITIONERS, LAUNDRY PRE-SOAKS, LAUNDRY PRE-SPOTTING PREPARATIONS, LAUNDRY STARCH, LEATHER POLISHES, LIQUID SOAPS FOR HANDS, FACE AND BODY, OVEN, GRILL AND FRYER CLEANERS, RUST REMOVING PREPARATIONS, SCALE REMOVERS, SHAMPOOS, SHINING PREPARATIONS, SOAPS AND DETERGENTS, SPOT REMOVERS, STAIN REMOVERS, STAIN REMOVING PREPARATIONS, STAINLESS STEEL POLISHES AND TILE AND GROUT CLEANERS (U.S. CLS. 1, 4, 6, 50, 51 AND 52).

CLASS 5—PHARMACEUTICALS

FOR AIR DEODORIZERS, AIR FRESHENERS, AIR PURIFYING PREPARATIONS, ALL-PURPOSE DISINFECTANTS, ANTI-INSECT SPRAY, DISINFECTANT BATHROOM CLEANERS, DISINFECTANT TOILET BOWL CLEANERS, HAND SANITIZING PREPARATIONS AND PREPARATIONS TO DESTROY MILDEW, AND LAUNDRY SANITIZING LIQUID (U.S. CLS. 6, 18, 44, 46, 51 AND 52).

CLASS 9—ELECTRICAL AND SCIENTIFIC APPARATUS

FOR AUTOMATIC DISPENSERS FOR DISPENSING DETERGENTS, DISPENSERS THAT COUNT OR MEASURE OUTPUT FOR USE WITH CLEANING AND DISINFECTANT PRODUCTS AND PRE-RECORDED CDS, VIDEO TAPES, LASER DISKS AND DVDS FEATURING COMMERCIAL CLEANING INFORMATION (U.S. CLS. 21, 23, 26, 36 AND 38).

CLASS 11—ENVIRONMENTAL CONTROL APPARATUS

FOR ELECTRIC DISPENSER FOR AIR FRESHENER (U.S. CLS. 13, 21, 23, 31 AND 34).

CLASS 21—HOUSEWARES AND GLASS

FOR DISPENSERS FOR CLEANING AND DISINFECTING SOLUTIONS, MANUALLY ACTUATED PUMP DISPENSERS FOR ATTACHMENT TO CONTAINERS FOR USE IN DISPENSING LIQUIDS AND SOAP DISPENSERS (U.S. CLS. 2, 13, 23, 29, 30, 33, 40 AND 50).

CLASS 37—CONSTRUCTION AND REPAIR

FOR INSTALLATION, MAINTENANCE AND REPAIR OF COMMERCIAL CLEANING EQUIPMENT (U.S. CLS. 100, 103 AND 106).
PAUL F. GAST, EXAMINING ATTORNEY

SN 77-896,806. DEPENDABLE DEPOT, INC., SANTA ANA, CA. FILED 12-18-2009.

SealBoss

THE MARK CONSISTS OF STANDARD CHARACTERS WITHOUT CLAIM TO ANY PARTICULAR FONT, STYLE, SIZE, OR COLOR.

CLASS 1—CHEMICALS

FOR CHEMICALS, NAMELY, HYDROPHOBIC POLYURETHANE AND HYDROPHILIC POLYURETHANE, ACRYLATES, ACRYLAMIDES, POLYUREAS IN RESIN, MEMBRANES, POWDER AND GEL FORM, ALL FOR USE IN SEALING AND REPAIR OF CONCRETE, MAN-MADE AND NATURAL STRUCTURES AND PASSABLE SURFACES, SOIL STABILIZATION, WATERPROOFING, GENERAL PROTECTION AND COATINGS OF SURFACES, AND CONTAINERS; AND EPOXY RESINS FOR THE SAME; CONCRETE ADMIXTURES; WATERPROOFING CHEMICAL COMPOSITIONS FOR ARTICLES OF MASONRY, WOOD, OTHER BUILDING AND CONSTRUCTION SURFACES, INCLUDING CRACKS, VOIDS, AND HOLES IN SAID SURFACES (U.S. CLS. 1, 5, 6, 10, 26 AND 46).

FIRST USE 0-0-2005; IN COMMERCE 7-11-2008.

CLASS 7—MACHINERY

FOR HIGH AND LOW PRESSURE CHEMICAL INJECTION PUMPS, SINGLE AND MULTI-COMPONENT CONSTRUCTION CHEMICAL DISPENSING NON-MANUALLY OPERATED PUMPS, NAMELY, MEMBRANE, MANUAL, AIRLESS, PNEUMATIC, ELECTRIC, ELECTRIC SIPHON, AND PISTON PUMPS FOR SAID APPLICATIONS; SUPPLY LINES IN THE NATURE OF HIGH PRESSURE HOSES USED AS A COMPONENT PART OF HIGH AND LOW PRESSURE CHEMICAL INJECTION PUMPS FOR GENERAL CONSTRUCTION APPLICATIONS; INJECTION PACKERS USED AS A COMPONENT PART OF NON-MANUALLY OPERATED INJECTION PUMPS; MACHINE PARTS, NAMELY, COUPLERS OF SYNTHETIC MATERIAL; AND OTHER APPLICATOR TOOLS, NAMELY, PLASTIC AND STEEL MIXING MACHINES FOR GENERAL CONSTRUCTION CHEMICAL APPLICATIONS, SPECIAL CIVIL ENGINEERING, SOIL STABILIZATION, SHAFT CONSTRUCTIONS AND UNDERGROUND ENGINEERING; CONSTRUCTION REPAIR RELATED MACHINES AND MACHINE TOOLS, NAMELY, ELECTRIC AND PNEUMATIC PUMPS AND COMPONENT PARTS THEREOF IN THE NATURE OF PACKERS, NOZZLES AND INJECTORS, WHICH ARE USED IN SAID APPLICATIONS TO DISPENSE GENERAL CONSTRUCTION CHEMICALS (U.S. CLS. 13, 19, 21, 23, 31, 34 AND 35).

FIRST USE 0-0-2005; IN COMMERCE 7-11-2008.

ANDREA K. NADELMAN, EXAMINING ATTORNEY

SN 77-897,141. AFFINITY LABS INC., SAN FRANCISCO, CA. FILED 12-18-2009.



NO CLAIM IS MADE TO THE EXCLUSIVE RIGHT TO USE "NONPROFIT PEOPLE", APART FROM THE MARK AS SHOWN.

THE MARK CONSISTS OF A DESIGN OF THREE STICK FIGURES HOLDING HANDS IN A CIRCLE. THE DESIGN IS TO THE LEFT OF THE WORDING "NONPROFIT PEOPLE" IN STYLIZED FONT.

SN 77-898,765. HEALTHMEDIA, INC., ANN ARBOR, MI. FILED 12-22-2009.

CLASS 35—ADVERTISING AND BUSINESS

FOR PROVIDING INFORMATION ON JOB OPPORTUNITIES AND CAREERS TO PERSONS WORKING FOR AND SEEKING TO WORK FOR NON-PROFIT COMPANIES AND CHARITABLE ORGANIZATIONS; PROVIDING NEWS AND INFORMATION CONCERNING BUSINESS ACTIVITIES OF NON-PROFIT AND CHARITABLE ORGANIZATIONS; PROVIDING NEWS AND INFORMATION ON BUSINESS MANAGEMENT OF, AND PERSONNEL MANAGEMENT IN, NON-PROFIT AND CHARITABLE ORGANIZATIONS; PROVIDING NEWS AND INFORMATION ON PROMOTING PUBLIC AWARENESS OF NON-PROFIT AND CHARITABLE ORGANIZATIONS (U.S. CLS. 100, 101 AND 102).

FIRST USE 12-16-2009; IN COMMERCE 12-16-2009.

CLASS 45—PERSONAL AND LEGAL SERVICES

FOR ON-LINE SOCIAL NETWORKING SERVICES (U.S. CLS. 100 AND 101).

FIRST USE 12-16-2009; IN COMMERCE 12-16-2009.
NATALIE POLZER, EXAMINING ATTORNEY

SN 77-897,147. COMMON GOOD, DBA GOOD OF ALL, MERRIFIELD, VA. FILED 12-18-2009.



THE COLOR(S) WHITE SKIN TONE, WHITE, AND YELLOW IS/ARE CLAIMED AS A FEATURE OF THE MARK.

THE MARK CONSISTS OF A PHOTOGRAPH OF A PAIR OF WHITE SKIN TONE HANDS CUPPED TOGETHER HOLDING A CANDLE BURNING A WHITE FLAME AND EMITTING A YELLOW GLOW.

CLASS 35—ADVERTISING AND BUSINESS

FOR PROMOTING PUBLIC AWARENESS OF POLITICS, CULTURE, EDUCATION, RELIGION, TECHNOLOGY AND EMPLOYMENT TO ENCOURAGE AND PROMOTE CIVILITY IN PUBLIC DISCOURSE AND CONVERSATION (U.S. CLS. 100, 101 AND 102).

CLASS 41—EDUCATION AND ENTERTAINMENT

FOR PROVIDING CURRENT EVENT NEWS AND INFORMATION VIA GLOBAL COMPUTER NETWORK IN THE FIELD OF NATIONAL AND INTERNATIONAL ISSUES; ONLINE NEWSLETTER FEATURING NEWS AND INFORMATION ON NATIONAL AND INTERNATIONAL ISSUES (U.S. CLS. 100, 101 AND 107).

KATHERINE E. HALMEN, EXAMINING ATTORNEY

HEALTHMEDIA ACHIEVE

THE MARK CONSISTS OF STANDARD CHARACTERS WITHOUT CLAIM TO ANY PARTICULAR FONT, STYLE, SIZE, OR COLOR.

OWNER OF U.S. REG. NOS. 2,276,506 AND 2,577,770.

CLASS 16—PAPER GOODS AND PRINTED MATTER

FOR PUBLICATIONS, NAMELY, PRINTED MATERIALS IN THE NATURE OF QUESTIONNAIRES, GUIDEBOOKS, SUPPLEMENTAL GUIDES, PERSONALLY TAILORED GUIDES, AND NEWSLETTERS, ALL IN THE FIELD OF WELLNESS, HEALTH PROMOTION, PREVENTATIVE HEALTH CARE, DISEASE MANAGEMENT, BEHAVIOR CHANGE, AND HEALTH RISK ASSESSMENT (U.S. CLS. 2, 5, 22, 23, 29, 37, 38 AND 50).

CLASS 41—EDUCATION AND ENTERTAINMENT

FOR PROVIDING ONLINE QUESTIONNAIRES, GUIDEBOOKS, SUPPLEMENTAL GUIDES, AND NEWSLETTERS, ALL IN THE FIELDS OF WELLNESS, HEALTH PROMOTION, PREVENTATIVE HEALTH CARE, DISEASE MANAGEMENT, AND HEALTH RISK ASSESSMENT; AND PROVIDING ON-LINE TAILORED FOLLOW-UP MATERIALS, NAMELY, PERSONALLY TAILORED GUIDES AND NEWSLETTERS IN THE FIELDS OF WELLNESS, HEALTH PROMOTION, PREVENTATIVE HEALTH CARE, DISEASE MANAGEMENT, AND HEALTH RISK ASSESSMENT (U.S. CLS. 100, 101 AND 107).

CLASS 44—MEDICAL, BEAUTY AND AGRICULTURAL SERVICES

FOR COLLECTION AND ANALYSIS OF HEALTH, LIFESTYLE, AND PERSONAL INFORMATION AND CREATION OF PERSONAL GUIDES FOR USE BY INDIVIDUALS IN CONNECTION WITH THEIR OWN WELLNESS, PREVENTATIVE HEALTH CARE, DISEASE MANAGEMENT AND BEHAVIOR CHANGE, VIA A GLOBAL COMPUTER NETWORK; AND PROVIDING INFORMATION IN THE FIELDS OF WELLNESS, HEALTH PROMOTION, PREVENTATIVE HEALTH CARE, DISEASE MANAGEMENT, AND HEALTH RISK ASSESSMENT VIA ELECTRONIC MAIL (U.S. CLS. 100 AND 101).

WENDY GOODMAN, EXAMINING ATTORNEY

SN 77-898,767. HEALTHMEDIA, INC., ANN ARBOR, MI. FILED 12-22-2009.

HEALTHMEDIA CONTROL

THE MARK CONSISTS OF STANDARD CHARACTERS WITHOUT CLAIM TO ANY PARTICULAR FONT, STYLE, SIZE, OR COLOR.

OWNER OF U.S. REG. NOS. 2,276,506 AND 2,577,770.

CLASS 16—PAPER GOODS AND PRINTED MATTER

FOR PUBLICATIONS, NAMELY, PRINTED MATERIALS IN THE NATURE OF QUESTIONNAIRES, GUIDEBOOKS, SUPPLEMENTAL GUIDES, PERSONALLY TAILORED GUIDES, AND NEWSLETTERS, ALL IN THE FIELD OF WELLNESS, HEALTH PROMOTION, PREVENTATIVE HEALTH CARE, DISEASE MANAGEMENT, BEHAVIOR CHANGE, AND HEALTH RISK ASSESSMENT (U.S. CLS. 2, 5, 22, 23, 29, 37, 38 AND 50).

CLASS 41—EDUCATION AND ENTERTAINMENT

FOR PROVIDING ONLINE QUESTIONNAIRES, GUIDEBOOKS, SUPPLEMENTAL GUIDES, AND NEWSLETTERS, ALL IN THE FIELDS OF WELLNESS, HEALTH PROMOTION, PREVENTATIVE HEALTH CARE, DISEASE MANAGEMENT, AND HEALTH RISK ASSESSMENT; AND PROVIDING ON-LINE TAILORED FOLLOW-UP MATERIALS, NAMELY, PERSONALLY TAILORED GUIDES AND NEWSLETTERS IN THE FIELDS OF WELLNESS, HEALTH PROMOTION, PREVENTATIVE HEALTH CARE, DISEASE MANAGEMENT, AND HEALTH RISK ASSESSMENT (U.S. CLS. 100, 101 AND 107).

CLASS 44—MEDICAL, BEAUTY AND AGRICULTURAL SERVICES

FOR COLLECTION AND ANALYSIS OF HEALTH, LIFESTYLE, AND PERSONAL INFORMATION AND CREATION OF PERSONAL GUIDES FOR USE BY INDIVIDUALS IN CONNECTION WITH THEIR OWN WELLNESS, PREVENTATIVE HEALTH CARE, DISEASE MANAGEMENT AND BEHAVIOR CHANGE, VIA A GLOBAL COMPUTER NETWORK; AND PROVIDING INFORMATION IN THE FIELDS OF WELLNESS, HEALTH PROMOTION, PREVENTATIVE HEALTH CARE, DISEASE MANAGEMENT, AND HEALTH RISK ASSESSMENT VIA ELECTRONIC MAIL (U.S. CLS. 100 AND 101).

WENDY GOODMAN, EXAMINING ATTORNEY

SN 77-898,768. HEALTHMEDIA, INC., ANN ARBOR, MI. FILED 12-22-2009.

HEALTHMEDIA STRIDE

THE MARK CONSISTS OF STANDARD CHARACTERS WITHOUT CLAIM TO ANY PARTICULAR FONT, STYLE, SIZE, OR COLOR.

OWNER OF U.S. REG. NOS. 2,276,506 AND 2,577,770.

CLASS 16—PAPER GOODS AND PRINTED MATTER

FOR PUBLICATIONS, NAMELY, PRINTED MATERIALS IN THE NATURE OF QUESTIONNAIRES, GUIDEBOOKS, SUPPLEMENTAL GUIDES, PERSONALLY TAILORED GUIDES, AND NEWSLETTERS, ALL IN THE FIELD OF WELLNESS, HEALTH PROMOTION, PREVENTATIVE HEALTH CARE, DISEASE MANAGEMENT, BEHAVIOR CHANGE, AND HEALTH RISK ASSESSMENT (U.S. CLS. 2, 5, 22, 23, 29, 37, 38 AND 50).

CLASS 41—EDUCATION AND ENTERTAINMENT

FOR PROVIDING ONLINE QUESTIONNAIRES, GUIDEBOOKS, SUPPLEMENTAL GUIDES, AND NEWSLETTERS, ALL IN THE FIELDS OF WELLNESS, HEALTH PROMOTION, PREVENTATIVE HEALTH CARE, DISEASE MANAGEMENT, AND HEALTH RISK ASSESSMENT; AND PROVIDING ON-LINE TAILORED FOLLOW-UP MATERIALS, NAMELY, PERSONALLY TAILORED GUIDES AND NEWSLETTERS IN THE FIELDS OF WELLNESS, HEALTH PROMOTION, PREVENTATIVE HEALTH CARE, DISEASE MANAGEMENT, AND HEALTH RISK ASSESSMENT (U.S. CLS. 100, 101 AND 107).

CLASS 44—MEDICAL, BEAUTY AND AGRICULTURAL SERVICES

FOR COLLECTION AND ANALYSIS OF HEALTH, LIFESTYLE, AND PERSONAL INFORMATION AND CREATION OF PERSONAL GUIDES FOR USE BY INDIVIDUALS IN CONNECTION WITH THEIR OWN WELLNESS, PREVENTATIVE HEALTH CARE, DISEASE MANAGEMENT AND BEHAVIOR CHANGE, VIA A GLOBAL COMPUTER NETWORK; AND PROVIDING INFORMATION IN THE FIELDS OF WELLNESS, HEALTH PROMOTION, PREVENTATIVE HEALTH CARE, DISEASE MANAGEMENT, AND HEALTH RISK ASSESSMENT VIA ELECTRONIC MAIL (U.S. CLS. 100 AND 101).

WENDY GOODMAN, EXAMINING ATTORNEY

SN 77-899,303. POLYMED THERAPEUTICS, INC., HOUSTON, TX. FILED 12-22-2009.

FASTEP

THE MARK CONSISTS OF STANDARD CHARACTERS WITHOUT CLAIM TO ANY PARTICULAR FONT, STYLE, SIZE, OR COLOR.

CLASS 1—CHEMICALS

FOR DIAGNOSTIC PREPARATIONS AND KITS, SOLD AS A UNIT, CONSISTING OF A DIAGNOSTIC DEVICE IN THE NATURE OF A TESTING APPARATUS, DESICCANT AND INSTRUCTION MANUAL, FOR CLINICAL AND MEDICAL LABORATORY USE (U.S. CLS. 1, 5, 6, 10, 26 AND 46).

CLASS 5—PHARMACEUTICALS

FOR DIAGNOSTIC PREPARATIONS AND KITS, SOLD AS A UNIT, CONSISTING OF A DIAGNOSTIC DEVICE IN THE NATURE OF A TESTING APPARATUS, DESICCANT AND INSTRUCTION MANUAL, FOR MEDICAL USE (U.S. CLS. 6, 18, 44, 46, 51 AND 52).

KARANENDRA S. CHHINA, EXAMINING ATTORNEY

SN 77-899,400. QUALI-GROW GARDEN PRODUCTS INC.,
1 ORIGINAL, ONTARIO, CANADA, FILED 12-22-2009.

QUALI-GROW

THE MARK CONSISTS OF STANDARD CHARACTERS WITHOUT CLAIM TO ANY PARTICULAR FONT, STYLE, SIZE, OR COLOR.

PRIORITY CLAIMED UNDER SEC. 44(D) ON CANADA APPLICATION NO. 1442557, FILED 6-23-2009.

CLASS 1—CHEMICALS

FOR COMPOSTED MANURE, COMPOST, POTTING COMPOST, FERTILIZER, DOLOMITIC LIME FOR USE AS FERTILIZER (U.S. CLS. 1, 5, 6, 10, 26 AND 46).

CLASS 31—NATURAL AGRICULTURAL PRODUCTS

FOR HORTICULTURAL PRODUCTS, NAMELY, PEAT MOSS, TOP SOIL, SYNTHETIC TOP SOIL, MULCH, PINE BARK FOR USE AS MULCH, COCA SHELLS FOR USE AS MULCH (U.S. CLS. 1 AND 46).

DOMINIC J. FERRAIUOLO, EXAMINING ATTORNEY

SN 77-900,150. ALLIED ADVERTISING LIMITED PART-
NERSHIP, BOSTON, MA. FILED 12-23-2009.

BuzzBo

THE MARK CONSISTS OF STANDARD CHARACTERS WITHOUT CLAIM TO ANY PARTICULAR FONT, STYLE, SIZE, OR COLOR.

CLASS 35—ADVERTISING AND BUSINESS

FOR PROVIDING INFORMATION ABOUT AND MAKING REFERRALS IN THE FIELD OF CONSUMER PRODUCTS AND SERVICES FOR RETAIL SERVICES CONCERNING PRODUCTS, SERVICES, EVENTS, ACTIVITIES, ATTRACTIONS AND FACILITIES RELATING TO LEISURE ACTIVITIES, ARTS, CULTURE, ENTERTAINMENT, SPORTS AND RECREATION IN PARTICULAR GEOGRAPHIC LOCATIONS BY MEANS OF A GLOBAL COMPUTER NETWORK (U.S. CLS. 100, 101 AND 102).

CLASS 41—EDUCATION AND ENTERTAINMENT

FOR PROVIDING INFORMATION IN THE FIELDS OF RECREATION AND LEISURE ACTIVITIES, ARTS, SPORTS, CULTURAL AND ENTERTAINMENT PRODUCTS, CULTURAL AND ENTERTAINMENT EVENTS, CULTURAL AND ENTERTAINMENT EXHIBITIONS, ALL BY MEANS OF A GLOBAL COMPUTER NETWORK (U.S. CLS. 100, 101 AND 107).

CLASS 42—SCIENTIFIC AND COMPUTER SERVICES

FOR COMPUTER SERVICES, NAMELY, PROVIDING CUSTOMIZED ON-LINE WEB PAGES FEATURING USER-DEFINED INFORMATION, WHICH INCLUDES SEARCH ENGINES AND ON-LINE WEB LINKS TO OTHER WEB SITES; SEARCHING AND RETRIEVING INFORMATION, SITES, AND OTHER RESOURCES AVAILABLE ON COMPUTER NETWORKS FOR OTHERS (U.S. CLS. 100 AND 101).

JAY BESCH, EXAMINING ATTORNEY

SN 77-901,723. PURPLE FOUNDATION, DALLAS, TX.
FILED 12-28-2009.

PURPLE PARTY

THE MARK CONSISTS OF STANDARD CHARACTERS WITHOUT CLAIM TO ANY PARTICULAR FONT, STYLE, SIZE, OR COLOR.

NO CLAIM IS MADE TO THE EXCLUSIVE RIGHT TO USE "PARTY", APART FROM THE MARK AS SHOWN.

CLASS 9—ELECTRICAL AND SCIENTIFIC APPARATUS

FOR (BASED ON INTENT TO USE) DIGITAL MATERIALS, NAMELY, CDS, DVDS, DOWNLOADABLE AUDIO AND VIDEO FILES FEATURING MUSIC (U.S. CLS. 21, 23, 26, 36 AND 38).

CLASS 41—EDUCATION AND ENTERTAINMENT

FOR (BASED ON USE IN COMMERCE) ARRANGING AND CONDUCTING SPECIAL EVENTS; PARTY PLANNING; SPECIAL EVENT PLANNING (U.S. CLS. 100, 101 AND 107).

FIRST USE 1-1-2001; IN COMMERCE 1-1-2001.

SUSAN LESLIE DUBOIS, EXAMINING ATTORNEY

SN 77-901,903. GENE SIMMONS COMPANY, PINE BROOK,
NJ. FILED 12-29-2009.



THE MARK CONSISTS OF A SUN AND CHARIOT DESIGN.

CLASS 35—ADVERTISING AND BUSINESS

FOR ADVERTISING AND MARKETING OF LIFE INSURANCE PRODUCTS (U.S. CLS. 100, 101 AND 102).

CLASS 36—INSURANCE AND FINANCIAL

FOR LIFE INSURANCE BROKERAGE SERVICES; FINANCING OF LIFE INSURANCE PRODUCTS (U.S. CLS. 100, 101 AND 102).
 JANICE L. MCMORROW, EXAMINING ATTORNEY

SN 77-902,091. UNIVERSAL CONSUMER PRODUCTS, INC., GRAND RAPIDS, MI. FILED 12-29-2009.

DECKORAIL

SN 77-901,969. VT NUCLEAR SERVICES LIMITED, SOUTHAMPTON, HAMPSHIRE, UNITED KINGDOM, FILED 12-29-2009.

THE MARK CONSISTS OF STANDARD CHARACTERS WITHOUT CLAIM TO ANY PARTICULAR FONT, STYLE, SIZE, OR COLOR.
 OWNER OF U.S. REG. NO. 2,738,205.

RADSCAN

CLASS 6—METAL GOODS

FOR METAL POST CAPS (U.S. CLS. 2, 12, 13, 14, 23, 25 AND 50).
 FIRST USE 2-1-2008; IN COMMERCE 2-1-2008.

THE MARK CONSISTS OF STANDARD CHARACTERS WITHOUT CLAIM TO ANY PARTICULAR FONT, STYLE, SIZE, OR COLOR.
 OWNER OF ERPN CMNTY TM OFC REG. NO. 94003, DATED 6-15-1998, EXPIRES 4-1-2016.

CLASS 11—ENVIRONMENTAL CONTROL APPARATUS

FOR SOLAR POWERED LIGHT FIXTURES, NAMELY, POST CAPS CONTAINING LIGHTS (U.S. CLS. 13, 21, 23, 31 AND 34).
 FIRST USE 2-1-2008; IN COMMERCE 2-1-2008.

CLASS 9—ELECTRICAL AND SCIENTIFIC APPARATUS

FOR MEASURING, MONITORING, SURVEYING, DETECTING, ASSAYING, ANALYSIS, AND INFORMATION GATHERING APPARATUS AND INSTRUMENTS FOR USE IN RADIOACTIVE, FISSION PRODUCT, HEALTH PHYSICS, NAMELY, GAMMA DETECTORS, NEUTRON DETECTORS, ALPHA DETECTORS, BETA DETECTORS, SIGNAL PROCESSORS, AND NEUTRON SOURCE EMITTERS, NOT FOR MEDICAL USE; COMPUTERS AND COMPUTER SOFTWARE FOR USE WITH THE AFORESAID GOODS, NAMELY, COMPUTER SOFTWARE FOR PROCESSING AND ANALYZING ACTIVE NEUTRON COUNTS, ACTIVE NEUTRON MULTIPLICITY COUNTS, PASSIVE NEUTRON COUNTS, PASSIVE NEUTRON MULTIPLICITY COUNTS, GAMMA COUNTS, GAMMA ENERGY ANALYSIS, DETERMINING SPATIAL LOCATION OF RADIOACTIVE CONSTITUENTS, ISOTOPIC IDENTIFICATION, MATERIALS ASSAY CALIBRATION CHECKS, AND MAPPING OF THE THREE-DIMENSIONAL DOSE RATE ENVIRONMENT (U.S. CLS. 21, 23, 26, 36 AND 38).

CLASS 19—NON-METALLIC BUILDING MATERIALS

FOR NON-METAL POST CAPS (U.S. CLS. 1, 12, 33 AND 50).
 FIRST USE 2-1-2008; IN COMMERCE 2-1-2008.
 CURTIS FRENCH, EXAMINING ATTORNEY

CLASS 41—EDUCATION AND ENTERTAINMENT

FOR EDUCATION AND TRAINING SERVICES, NAMELY, ARRANGING AND CONDUCTING TRAINING CLASSES, SEMINARS, COURSES, AND DEMONSTRATIONS IN THE USE, APPLICATION, AND OPERATION OF MEASURING, MONITORING, SURVEYING, DETECTING, ASSAYING, ANALYSIS AND INFORMATION GATHERING APPARATUS AND INSTRUMENTS FOR USE IN RADIOACTIVE, FISSION PRODUCT, HEALTH PHYSICS; AND ARRANGING AND CONDUCTING TRAINING CLASSES, SEMINARS, COURSES, AND DEMONSTRATIONS IN THE FIELD OF COMPUTERS AND COMPUTER SOFTWARE FOR USE WITH ALL THE AFORESAID GOODS (U.S. CLS. 100, 101 AND 107).
 DAVID HOFFMAN, EXAMINING ATTORNEY

SN 77-902,884. TELMAR NETWORK TECHNOLOGY, INC., PLANO, TX. FILED 12-30-2009.



OWNER OF U.S. REG. NO. 2,958,902.
 NO CLAIM IS MADE TO THE EXCLUSIVE RIGHT TO USE "NETWORK TECHNOLOGY", APART FROM THE MARK AS SHOWN.
 THE COLOR(S) BLUE AND GREEN IS/ARE CLAIMED AS A FEATURE OF THE MARK.
 THE MARK CONSISTS OF THREE ROWS OF BLUE AND GREEN SHADED CIRCLES, THE BLUE CIRCLES FORM THE LETTER "T" NEXT TO THE WORDS "TELMAR NETWORK TECHNOLOGY" APPEARING IN THE COLOR BLUE, WITH THE LAST GREEN SHADED CIRCLE IN THE SECOND ROW IS MOVING/LEADING AWAY FROM THE ROW.

CLASS 9—ELECTRICAL AND SCIENTIFIC APPARATUS

FOR AUTOMATIC SWITCHING APPARATUS; BROADBAND WIRELESS EQUIPMENT, NAMELY, TELECOMMUNICATIONS BASE STATION EQUIPMENT FOR CELLULAR AND FIXED NETWORKING AND COMMUNICATIONS APPLICATIONS; COMPUTER HARDWARE FOR TELECOMMUNICATIONS; TELECOMMUNICATION SWITCHES; TELECOMMUNICATIONS AND DATA NETWORKING HARDWARE, NAMELY, DEVICES FOR TRANSPORTING AND AGGREGATING VOICE, DATA, AND VIDEO COMMUNICATIONS ACROSS MULTIPLE NETWORK INFRASTRUCTURES AND COMMUNICATIONS PROTOCOLS (U.S. CLS. 21, 23, 26, 36 AND 38).

FIRST USE 5-14-2009; IN COMMERCE 5-14-2009.

CLASS 37—CONSTRUCTION AND REPAIR

FOR MAINTENANCE AND REPAIR OF TELECOMMUNICATIONS NETWORKING HARDWARE, APPARATUS, AND INSTRUMENTS; REPAIR OF TELECOMMUNICATION MACHINES AND APPARATUS; REPAIR OR MAINTENANCE OF TELECOMMUNICATION MACHINES AND APPARATUS (U.S. CLS. 100, 103 AND 106).

FIRST USE 5-14-2009; IN COMMERCE 5-14-2009.

CLASS 38—COMMUNICATION

FOR TELECOMMUNICATIONS CONSULTATION (U.S. CLS. 100, 101 AND 104).

FIRST USE 5-14-2009; IN COMMERCE 5-14-2009.

CLASS 39—TRANSPORTATION AND STORAGE

FOR WAREHOUSE STORAGE (U.S. CLS. 100 AND 105).

FIRST USE 5-14-2009; IN COMMERCE 5-14-2009.

CLASS 42—SCIENTIFIC AND COMPUTER SERVICES

FOR CONSULTING IN THE FIELD OF TELECOMMUNICATIONS TECHNOLOGY; ENGINEERING SERVICES, NAMELY, ENGINEERING FOR THE SOFTWARE DEVELOPMENT AND PROGRAMMING FOR OTHERS; UPDATING SOFTWARE FOR OTHERS; SERVICES RENDERED TO THE TELEPHONE INDUSTRY, NAMELY, FUNCTIONAL TESTING OF TELEPHONE EQUIPMENT (U.S. CLS. 100 AND 101).

FIRST USE 5-14-2009; IN COMMERCE 5-14-2009.

ARETHA SOMERVILLE, EXAMINING ATTORNEY

CLASS 9—ELECTRICAL AND SCIENTIFIC APPARATUS

FOR AUTOMATIC SWITCHING APPARATUS; BROADBAND WIRELESS EQUIPMENT, NAMELY, TELECOMMUNICATIONS BASE STATION EQUIPMENT FOR CELLULAR AND FIXED NETWORKING AND COMMUNICATIONS APPLICATIONS; COMPUTER HARDWARE FOR TELECOMMUNICATIONS; TELECOMMUNICATION SWITCHES; TELECOMMUNICATIONS AND DATA NETWORKING HARDWARE, NAMELY, DEVICES FOR TRANSPORTING AND AGGREGATING VOICE, DATA, AND VIDEO COMMUNICATIONS ACROSS MULTIPLE NETWORK INFRASTRUCTURES AND COMMUNICATIONS PROTOCOLS (U.S. CLS. 21, 23, 26, 36 AND 38).

FIRST USE 5-14-2009; IN COMMERCE 5-14-2009.

CLASS 37—CONSTRUCTION AND REPAIR

FOR MAINTENANCE AND REPAIR OF TELECOMMUNICATIONS NETWORKING HARDWARE, APPARATUS, AND INSTRUMENTS; REPAIR OF TELECOMMUNICATION MACHINES AND APPARATUS; REPAIR OR MAINTENANCE OF TELECOMMUNICATION MACHINES AND APPARATUS (U.S. CLS. 100, 103 AND 106).

FIRST USE 5-14-2009; IN COMMERCE 5-14-2009.

CLASS 38—COMMUNICATION

FOR TELECOMMUNICATIONS CONSULTATION (U.S. CLS. 100, 101 AND 104).

FIRST USE 5-14-2009; IN COMMERCE 5-14-2009.

CLASS 39—TRANSPORTATION AND STORAGE

FOR WAREHOUSE STORAGE (U.S. CLS. 100 AND 105).

FIRST USE 5-14-2009; IN COMMERCE 5-14-2009.

CLASS 42—SCIENTIFIC AND COMPUTER SERVICES

FOR CONSULTING IN THE FIELD OF TELECOMMUNICATIONS TECHNOLOGY; ENGINEERING SERVICES, NAMELY, ENGINEERING FOR THE SOFTWARE DEVELOPMENT AND PROGRAMMING FOR OTHERS; UPDATING SOFTWARE FOR OTHERS; SERVICES RENDERED TO THE TELEPHONE INDUSTRY, NAMELY, FUNCTIONAL TESTING OF TELEPHONE EQUIPMENT.; RESEARCH SERVICES IN THE FIELD OF INFORMATION AND TELECOMMUNICATIONS TECHNOLOGY (U.S. CLS. 100 AND 101).

FIRST USE 5-14-2009; IN COMMERCE 5-14-2009.

ARETHA SOMERVILLE, EXAMINING ATTORNEY

SN 77-903,039. TELMAR NETWORK TECHNOLOGY, INC., PLANO, TX. FILED 12-30-2009.

SN 77-903,056. CONTINENTAL RESEARCH CORPORATION, ST. LOUIS, MO. FILED 12-30-2009.

Compelling Solutions for
the Communications World

3X:CHEMISTRY

THE MARK CONSISTS OF STANDARD CHARACTERS WITHOUT CLAIM TO ANY PARTICULAR FONT, STYLE, SIZE, OR COLOR.

THE MARK CONSISTS OF STANDARD CHARACTERS WITHOUT CLAIM TO ANY PARTICULAR FONT, STYLE, SIZE, OR COLOR.

CLASS 2—PAINTS

FOR METAL SEALERS, PAINT SEALERS; CLEAR COATING PROTECTANT FOR VEHICLES; CLEAR COATING PROTECTANT FOR ALUMINUM SURFACES; RUST CONVERTERS, NAMELY, CHEMICAL PREPARATIONS IN THE NATURE OF A PREPAINT COATING FOR METAL SURFACES (U.S. CLS. 6, 11 AND 16).

CLASS 3—COSMETICS AND CLEANING PREPARATIONS

FOR ALL-PURPOSE CLEANERS AND POLISHES FOR AUTOMOBILE, MOTORCYCLE AND RECREATIONAL VEHICLES; CARPET CLEANERS; RUST DISSOLVERS; FLOOR CARE, NAMELY, FLOOR POLISH, FLOOR WAX AND FLOOR FINISHING PREPARATION FOR MOTORCYCLES, AUTOMOTIVES AND RECREATIONAL VEHICLES; CLEANERS FOR GLASS COOKING SURFACES; CLEANERS FOR STAINLESS STEEL APPLIANCES; POLISHES FOR KITCHEN APPLIANCES AND KITCHEN SURFACES (U.S. CLS. 1, 4, 6, 50, 51 AND 52).

JANET LEE, EXAMINING ATTORNEY

SN 77-904,230. KIM'S LICENSING CO., LTD., SUNGNAM-SI, KYUNGKI-DO, REPUBLIC OF KOREA, FILED 1-4-2010.



OWNER OF ERPN CMNTY TM OFC REG. NO. 004763595, DATED 11-15-2006, EXPIRES 5-12-2015.

THE MARK CONSISTS OF A CABBAGE ANTHROPMORPHIZED TO A CARTOON CHARACTER WITH FIERY IMAGE LETTERS "MR. KIMCHI" BELOW WHERE DOTS OF THE TWO "I"'S ARE IN CANDLE FLAME.

CLASS 29—MEATS AND PROCESSED FOODS

FOR COMPOTES; EDIBLE OILS AND FATS; EGGS; JELLIES AND JAMS; MEAT EXTRACTS; MEAT, FISH, POULTRY AND GAME; MILK; MILK PRODUCTS EXCLUDING ICE CREAM, ICE MILK AND FROZEN YOGURT; PRESERVED, DRIED AND COOKED FRUIT AND VEGETABLES (U.S. CL. 46).

CLASS 43—HOTEL AND RESTAURANT SERVICES

FOR PROVIDING OF FOOD AND DRINK; PROVIDING TEMPORARY ACCOMMODATION (U.S. CLS. 100 AND 101).

JENNIFER VASQUEZ, EXAMINING ATTORNEY

SN 77-903,521. K. ROSE PUBLISHING, INC., NASHVILLE, TN. FILED 12-31-2009.

SOUTHERN TO THE CORE

THE MARK CONSISTS OF STANDARD CHARACTERS WITHOUT CLAIM TO ANY PARTICULAR FONT, STYLE, SIZE, OR COLOR.

NO CLAIM IS MADE TO THE EXCLUSIVE RIGHT TO USE "SOUTHERN", APART FROM THE MARK AS SHOWN.

CLASS 16—PAPER GOODS AND PRINTED MATTER

FOR A SERIES OF BOOKS AND WRITTEN ARTICLES IN THE FIELD OF COOKING AND RECIPES; PRINTED RECIPE CARDS (U.S. CLS. 2, 5, 22, 23, 29, 37, 38 AND 50).

CLASS 21—HOUSEWARES AND GLASS

FOR RECIPE BOXES (U.S. CLS. 2, 13, 23, 29, 30, 33, 40 AND 50).

DAWN HAN, EXAMINING ATTORNEY

SN 77-904,529. DOYLE, STEPHEN, WARWICK, RI. FILED 1-4-2010.

DNK

THE MARK CONSISTS OF STANDARD CHARACTERS WITHOUT CLAIM TO ANY PARTICULAR FONT, STYLE, SIZE, OR COLOR.

CLASS 5—PHARMACEUTICALS

FOR MEDICINAL HERB EXTRACTS; MEDICINAL HERBS (U.S. CLS. 6, 18, 44, 46, 51 AND 52).

CLASS 25—CLOTHING

FOR SHORT-SLEEVED AND LONG-SLEEVED T-SHIRTS MADE OF COTTON OR COTTON-POLY BLENDS (U.S. CLS. 22 AND 39).

WILLIAM P. SHANAHAN, EXAMINING ATTORNEY

SN 77-905,019. RUDOLPH FOODS COMPANY, INC., LIMA, OH. FILED 1-5-2010.



OWNER OF U.S. REG. NOS. 1,718,471, 3,023,388 AND OTHERS.

NO CLAIM IS MADE TO THE EXCLUSIVE RIGHT TO USE "FOODS", APART FROM THE MARK AS SHOWN.

THE MARK CONSISTS OF AN OVAL WHICH IS CUT IN HALF BY A QUADRILATERAL WITH THE WORD "RUDOLPH". THE BOTTOM OVAL HAS THE WORD "FOODS" ON IT AND THERE ARE THREE LINES TO THE LEFT OF THE QUADRILATERAL AND FIVE LINES TO THE RIGHT.

CLASS 29—MEATS AND PROCESSED FOODS

FOR PUFFED AND UNPUFFED PORK RINDS AND PORK CRACKLIN PELLETS FOR PREPARING SHELF STABLE PREPACKED SNACK FOODS (U.S. CL. 46).

FIRST USE 1-0-2010; IN COMMERCE 1-0-2010.

CLASS 30—STAPLE FOODS

FOR SNACK FOODS; NAMELY, PUFFED OR FORMED DOUGH MADE FROM CORN, POTATOES, CEREAL GRAIN AND/OR ANIMAL SKINS (U.S. CL. 46).

FIRST USE 1-0-2010; IN COMMERCE 1-0-2010.
JENNIFER MARTIN, EXAMINING ATTORNEY

SN 77-905,249. SOUTHEASTERN PRINTING COMPANY, INC., STUART, FL. FILED 1-5-2010.

SOUTHEASTERN PACKAGING

THE MARK CONSISTS OF STANDARD CHARACTERS WITHOUT CLAIM TO ANY PARTICULAR FONT, STYLE, SIZE, OR COLOR.

NO CLAIM IS MADE TO THE EXCLUSIVE RIGHT TO USE "PACKAGING", APART FROM THE MARK AS SHOWN.

CLASS 40—MATERIAL TREATMENT

FOR PRINTING SERVICES (U.S. CLS. 100, 103 AND 106).

FIRST USE 12-21-2009; IN COMMERCE 12-21-2009.

CLASS 42—SCIENTIFIC AND COMPUTER SERVICES

FOR GRAPHIC DESIGN SERVICES FOR OTHERS (U.S. CLS. 100 AND 101).

FIRST USE 12-21-2009; IN COMMERCE 12-21-2009.
GISELLE AGOSTO, EXAMINING ATTORNEY

SN 77-905,336. PIZZO & ASSOCIATES, LTD., LELAND, IL. FILED 1-5-2010.

GREENLINE

THE MARK CONSISTS OF STANDARD CHARACTERS WITHOUT CLAIM TO ANY PARTICULAR FONT, STYLE, SIZE, OR COLOR.

CLASS 42—SCIENTIFIC AND COMPUTER SERVICES

FOR ARCHITECTURAL DESIGN CONSULTING SERVICES RELATING TO ENVIRONMENTALLY CONSCIOUS DECISIONS FOR ARCHITECTURE PROJECTS (U.S. CLS. 100 AND 101).

CLASS 44—MEDICAL, BEAUTY AND AGRICULTURAL SERVICES

FOR LANDSCAPE DESIGN CONSULTING SERVICES RELATING TO ENVIRONMENTALLY CONSCIOUS DECISIONS FOR LANDSCAPE PROJECTS (U.S. CLS. 100 AND 101).

RONALD MCMORROW, EXAMINING ATTORNEY

SN 77-905,868. MIT TRADING, LLC, DULUTH, GA. FILED 1-6-2010.

Dr. Wolf Racing

THE MARK CONSISTS OF STANDARD CHARACTERS WITHOUT CLAIM TO ANY PARTICULAR FONT, STYLE, SIZE, OR COLOR.

NO CLAIM IS MADE TO THE EXCLUSIVE RIGHT TO USE "RACING", APART FROM THE MARK AS SHOWN.

THE NAME(S), PORTRAIT(S), AND/OR SIGNATURE(S) SHOWN IN THE MARK DOES NOT IDENTIFY A PARTICULAR LIVING INDIVIDUAL.

CLASS 9—ELECTRICAL AND SCIENTIFIC APPARATUS

FOR FIREPROOF AUTOMOBILE RACING SUITS FOR SAFETY PURPOSES, NAMELY, RACING SUITS, RACING GLOVES, RACING SHOES, RACING HELMETS, RACING BALACLAVA, RACING SAFETY HARNESS, AND RACING UNDERGARMENTS (U.S. CLS. 21, 23, 26, 36 AND 38).

FIRST USE 11-11-2009; IN COMMERCE 11-11-2009.

CLASS 25—CLOTHING

FOR SPORTSWEAR, NAMELY, COATS, WAIST-COATS, OVERCOATS, JACKETS, CAPS, HOODS, BALACLAVAS, KNIT FACE MASKS, SWEATERS, SWEATER VESTS, SWEATSHIRTS, VESTS, SHIRTS, T-SHIRTS, JUMPSUITS, TRACKSUITS, OVERALLS, SHOES, BOOTS, OVERSHOES, UNDERWEAR, AND GLOVES (U.S. CLS. 22 AND 39).

FIRST USE 11-11-2009; IN COMMERCE 11-11-2009.
AISHA CLARKE, EXAMINING ATTORNEY

SN 77-906,079. MIT TRADING, LLC, DULUTH, GA. FILED 1-6-2010.



THE MARK CONSISTS OF THE IMAGE OF A WOLF HEAD.

CLASS 9—ELECTRICAL AND SCIENTIFIC APPARATUS

FOR FIREPROOF AUTOMOBILE RACING SUITS FOR SAFETY PURPOSES, NAMELY, RACING SUITS, RACING GLOVES, RACING SHOES, RACING HELMETS, RACING BALACLAVA, RACING SAFETY HARNESS, AND RACING UNDERGARMENTS (U.S. CLS. 21, 23, 26, 36 AND 38).

FIRST USE 11-11-2009; IN COMMERCE 11-11-2009.

CLASS 25—CLOTHING

FOR SPORTSWEAR, NAMELY, COATS, WAIST-COATS, OVERCOATS, JACKETS, CAPS, HOODS, BALACLAVAS, KNIT FACE MASKS, SWEATERS, SWEATER VESTS, SWEATSHIRTS, VESTS, SHIRTS, T-SHIRTS, JUMPSUITS, TRACKSUITS, OVERALLS, SHOES, BOOTS, OVERSHOES, UNDERWEAR, AND GLOVES (U.S. CLS. 22 AND 39).

FIRST USE 11-11-2009; IN COMMERCE 11-11-2009.
AISHA CLARKE, EXAMINING ATTORNEY

SN 77-906,286. MIT TRADING, LLC, DULUTH, GA. FILED 1-6-2010.



NO CLAIM IS MADE TO THE EXCLUSIVE RIGHT TO USE "RACING", APART FROM THE MARK AS SHOWN.

THE NAME(S), PORTRAIT(S), AND/OR SIGNATURE(S) SHOWN IN THE MARK DOES NOT IDENTIFY A PARTICULAR LIVING INDIVIDUAL.

THE MARK CONSISTS OF "DR. WOLF" IN STYLIZED LETTERS WITH "RACING" IN SMALLER FONT UNDER THE WORD "WOLF".

CLASS 9—ELECTRICAL AND SCIENTIFIC APPARATUS

FOR FIREPROOF AUTOMOBILE RACING SUITS FOR SAFETY PURPOSES, NAMELY, RACING SUITS, RACING GLOVES, RACING SHOES, RACING HELMETS, RACING BALACLAVA, RACING SAFETY HARNESS, AND RACING UNDERGARMENTS (U.S. CLS. 21, 23, 26, 36 AND 38).

FIRST USE 11-11-2009; IN COMMERCE 11-11-2009.

CLASS 25—CLOTHING

FOR SPORTSWEAR, NAMELY, COATS, WAIST-COATS, OVERCOATS, JACKETS, CAPS, HOODS, BALACLAVAS, KNIT FACE MASKS, SWEATERS, SWEATER VESTS, SWEATSHIRTS, VESTS, SHIRTS, T-SHIRTS, JUMPSUITS, TRACKSUITS, OVERALLS, SHOES, BOOTS, OVERSHOES, UNDERWEAR, AND GLOVES (U.S. CLS. 22 AND 39).

FIRST USE 11-11-2009; IN COMMERCE 11-11-2009.
AISHA CLARKE, EXAMINING ATTORNEY

SN 77-906,717. W.K. KELLOGG FOUNDATION, BATTLE CREEK, MI. FILED 1-7-2010.



THE MARK CONSISTS OF STANDARD CHARACTERS WITHOUT CLAIM TO ANY PARTICULAR FONT, STYLE, SIZE, OR COLOR.

THE WORDING "NOI" HAS NO MEANING IN A FOREIGN LANGUAGE.

CLASS 9—ELECTRICAL AND SCIENTIFIC APPARATUS

FOR EDUCATIONAL SOFTWARE TOOLS FOR OUT OF SCHOOL YOUTHS SEEKING ALTERNATIVES TO HIGH SCHOOL DIPLOMAS AND ASSOCIATES DEGREES, NAMELY, SOFTWARE FOR ASSISTING OUT OF SCHOOL YOUTHS IN THEIR ONLINE JOB SEARCH AND APPLICATION PROCESS, AND FOR ASSISTING EMPLOYERS WITH THE PROCESS OF HIRING OUT OF SCHOOL YOUTHS, AND FOR ASSESSING THE OUT OF SCHOOL YOUTHS SKILLS, ACHIEVEMENTS, AND CAPABILITIES TO HELP MATCH WITH JOB POSTINGS AND SKILLS VALUED BY EMPLOYERS, AND FOR SUPPORTING EMPLOYERS IN RECRUITING OUT OF SCHOOL YOUTHS (U.S. CLS. 21, 23, 26, 36 AND 38).

CLASS 16—PAPER GOODS AND PRINTED MATTER

FOR EDUCATIONAL PUBLICATIONS, NAMELY, PRINTED PUBLICATIONS IN THE NATURE OF ACADEMIC JOURNALS, PHILANTHROPIC NEWSPAPERS AND MAGAZINES, BUSINESS JOURNALS AND CONFERENCE MATERIALS IN THE FIELD OF ISSUES RELATING TO OUT OF SCHOOL YOUTHS SEEKING ALTERNATIVES TO HIGH SCHOOL DIPLOMAS AND ASSOCIATES DEGREES (U.S. CLS. 2, 5, 22, 23, 29, 37, 38 AND 50).

CLASS 41—EDUCATION AND ENTERTAINMENT

FOR EDUCATIONAL PROGRAMS, NAMELY, EDUCATIONAL AND CAREER COUNSELING AND GUIDANCE, FOR OUT OF SCHOOL YOUTHS, THAT PROVIDE ALTERNATIVES TO HIGH SCHOOL DIPLOMAS AND ASSOCIATES DEGREES; PROVIDING ONLINE EDUCATIONAL PUBLICATIONS IN THE NATURE JOURNALS, NEWSLETTERS, CURRICULUM GUIDES IN THE FIELD OF ISSUES RELATING TO OUT OF SCHOOL YOUTHS SEEKING ALTERNATIVES TO HIGH SCHOOL DIPLOMAS AND ASSOCIATES DEGREES FOR ASSISTING COMMUNITY BASED ORGANIZATIONS AND SOCIAL ENTERPRISES FOR SUPPORTING OUT OF SCHOOL YOUTHS IN THE PROCESS OF SECURING ENTRY LEVEL EMPLOYMENT (U.S. CLS. 100, 101 AND 107).

RUDY R. SINGLETON, EXAMINING ATTORNEY

SN 77-906,740. W.K. KELLOGG FOUNDATION, BATTLE CREEK, MI. FILED 1-7-2010.

SN 77-906,749. W.K. KELLOGG FOUNDATION, BATTLE CREEK, MI. FILED 1-7-2010.

NEW OPTIONS INITIATIVE

THE MARK CONSISTS OF STANDARD CHARACTERS WITHOUT CLAIM TO ANY PARTICULAR FONT, STYLE, SIZE, OR COLOR.

NO CLAIM IS MADE TO THE EXCLUSIVE RIGHT TO USE "INITIATIVE", APART FROM THE MARK AS SHOWN.

CLASS 9—ELECTRICAL AND SCIENTIFIC APPARATUS

FOR EDUCATIONAL SOFTWARE TOOLS FOR OUT OF SCHOOL YOUTHS SEEKING ALTERNATIVES TO HIGH SCHOOL DIPLOMAS AND ASSOCIATES DEGREES, NAMELY, SOFTWARE FOR ASSISTING OUT OF SCHOOL YOUTHS IN THEIR ONLINE JOB SEARCH AND APPLICATION PROCESS, AND FOR ASSISTING EMPLOYERS WITH THE PROCESS OF HIRING OUT OF SCHOOL YOUTHS, AND FOR ASSESSING THE OUT OF SCHOOL YOUTHS SKILLS, ACHIEVEMENTS, AND CAPABILITIES TO HELP MATCH WITH JOB POSTINGS AND SKILLS VALUED BY EMPLOYERS, AND FOR SUPPORTING EMPLOYERS IN RECRUITING OUT OF SCHOOL YOUTHS (U.S. CLS. 21, 23, 26, 36 AND 38).

CLASS 16—PAPER GOODS AND PRINTED MATTER

FOR EDUCATIONAL PUBLICATIONS, NAMELY, PRINTED PUBLICATIONS IN THE NATURE OF ACADEMIC JOURNALS, PHILANTHROPIC NEWSPAPERS AND MAGAZINES, BUSINESS JOURNALS AND CONFERENCE MATERIALS IN THE FIELD OF ISSUES RELATING TO OUT OF SCHOOL YOUTHS SEEKING ALTERNATIVES TO HIGH SCHOOL DIPLOMAS AND ASSOCIATES DEGREES (U.S. CLS. 2, 5, 22, 23, 29, 37, 38 AND 50).

CLASS 41—EDUCATION AND ENTERTAINMENT

FOR EDUCATIONAL PROGRAMS, NAMELY, EDUCATIONAL AND CAREER COUNSELING AND GUIDANCE, FOR OUT OF SCHOOL YOUTHS, THAT PROVIDE ALTERNATIVES TO HIGH SCHOOL DIPLOMAS AND ASSOCIATES DEGREES; PROVIDING ONLINE EDUCATIONAL PUBLICATIONS IN THE NATURE JOURNALS, NEWSLETTERS, CURRICULUM GUIDES IN THE FIELD OF ISSUES RELATING TO OUT OF SCHOOL YOUTHS SEEKING ALTERNATIVES TO HIGH SCHOOL DIPLOMAS AND ASSOCIATES DEGREES FOR ASSISTING COMMUNITY BASED ORGANIZATIONS AND SOCIAL ENTERPRISES FOR SUPPORTING OUT OF SCHOOL YOUTHS IN THE PROCESS OF SECURING ENTRY LEVEL EMPLOYMENT (U.S. CLS. 100, 101 AND 107).

RUDY R. SINGLETON, EXAMINING ATTORNEY

NEW OPTIONS PROJECT

THE MARK CONSISTS OF STANDARD CHARACTERS WITHOUT CLAIM TO ANY PARTICULAR FONT, STYLE, SIZE, OR COLOR.

NO CLAIM IS MADE TO THE EXCLUSIVE RIGHT TO USE "PROJECT", APART FROM THE MARK AS SHOWN.

CLASS 9—ELECTRICAL AND SCIENTIFIC APPARATUS

FOR EDUCATIONAL SOFTWARE TOOLS FOR OUT OF SCHOOL YOUTHS SEEKING ALTERNATIVES TO HIGH SCHOOL DIPLOMAS AND ASSOCIATES DEGREES, NAMELY, SOFTWARE FOR ASSISTING OUT OF SCHOOL YOUTHS IN THEIR ONLINE JOB SEARCH AND APPLICATION PROCESS, AND FOR ASSISTING EMPLOYERS WITH THE PROCESS OF HIRING OUT OF SCHOOL YOUTHS, AND FOR ASSESSING THE OUT OF SCHOOL YOUTHS SKILLS, ACHIEVEMENTS, AND CAPABILITIES TO HELP MATCH WITH JOB POSTINGS AND SKILLS VALUED BY EMPLOYERS, AND FOR SUPPORTING EMPLOYERS IN RECRUITING OUT OF SCHOOL YOUTHS (U.S. CLS. 21, 23, 26, 36 AND 38).

CLASS 16—PAPER GOODS AND PRINTED MATTER

FOR EDUCATIONAL PUBLICATIONS, NAMELY, PRINTED PUBLICATIONS IN THE NATURE OF ACADEMIC JOURNALS, PHILANTHROPIC NEWSPAPERS AND MAGAZINES, BUSINESS JOURNALS AND CONFERENCE MATERIALS IN THE FIELD OF ISSUES RELATING TO OUT OF SCHOOL YOUTHS SEEKING ALTERNATIVES TO HIGH SCHOOL DIPLOMAS AND ASSOCIATES DEGREES (U.S. CLS. 2, 5, 22, 23, 29, 37, 38 AND 50).

CLASS 41—EDUCATION AND ENTERTAINMENT

FOR EDUCATIONAL PROGRAMS, NAMELY, EDUCATIONAL AND CAREER COUNSELING AND GUIDANCE, FOR OUT OF SCHOOL YOUTHS, THAT PROVIDE ALTERNATIVES TO HIGH SCHOOL DIPLOMAS AND ASSOCIATES DEGREES; PROVIDING ONLINE EDUCATIONAL PUBLICATIONS IN THE NATURE JOURNALS, NEWSLETTERS, CURRICULUM GUIDES IN THE FIELD OF ISSUES RELATING TO OUT OF SCHOOL YOUTHS SEEKING ALTERNATIVES TO HIGH SCHOOL DIPLOMAS AND ASSOCIATES DEGREES FOR ASSISTING COMMUNITY BASED ORGANIZATIONS AND SOCIAL ENTERPRISES FOR SUPPORTING OUT OF SCHOOL YOUTHS IN THE PROCESS OF SECURING ENTRY LEVEL EMPLOYMENT (U.S. CLS. 100, 101 AND 107).

RUDY R. SINGLETON, EXAMINING ATTORNEY

SN 77-906,753. W.K. KELLOGG FOUNDATION, BATTLE CREEK, MI. FILED 1-7-2010.

SN 77-906,797. COA YOUTH AND FAMILY CENTERS, INC., MILWAUKEE, WI. FILED 1-7-2010.

NEW OPTIONS @ WORK

THE MARK CONSISTS OF STANDARD CHARACTERS WITHOUT CLAIM TO ANY PARTICULAR FONT, STYLE, SIZE, OR COLOR.

CLASS 9—ELECTRICAL AND SCIENTIFIC APPARATUS

FOR EDUCATIONAL SOFTWARE TOOLS FOR OUT OF SCHOOL YOUTHS SEEKING ALTERNATIVES TO HIGH SCHOOL DIPLOMAS AND ASSOCIATES DEGREES, NAMELY, SOFTWARE FOR ASSISTING OUT OF SCHOOL YOUTHS IN THEIR ONLINE JOB SEARCH AND APPLICATION PROCESS, AND FOR ASSISTING EMPLOYERS WITH THE PROCESS OF HIRING OUT OF SCHOOL YOUTHS, AND FOR ASSESSING THE OUT OF SCHOOL YOUTHS SKILLS, ACHIEVEMENTS, AND CAPABILITIES TO HELP MATCH WITH JOB POSTINGS AND SKILLS VALUED BY EMPLOYERS, AND FOR SUPPORTING EMPLOYERS IN RECRUITING OUT OF SCHOOL YOUTHS (U.S. CLS. 21, 23, 26, 36 AND 38).

CLASS 16—PAPER GOODS AND PRINTED MATTER

FOR EDUCATIONAL PUBLICATIONS, NAMELY, PRINTED PUBLICATIONS IN THE NATURE OF ACADEMIC JOURNALS, PHILANTHROPIC NEWSPAPERS AND MAGAZINES, BUSINESS JOURNALS AND CONFERENCE MATERIALS IN THE FIELD OF ISSUES RELATING TO OUT OF SCHOOL YOUTHS SEEKING ALTERNATIVES TO HIGH SCHOOL DIPLOMAS AND ASSOCIATES DEGREES (U.S. CLS. 2, 5, 22, 23, 29, 37, 38 AND 50).

CLASS 41—EDUCATION AND ENTERTAINMENT

FOR EDUCATIONAL PROGRAMS, NAMELY, EDUCATIONAL AND CAREER COUNSELING AND GUIDANCE, FOR OUT OF SCHOOL YOUTHS, THAT PROVIDE ALTERNATIVES TO HIGH SCHOOL DIPLOMAS AND ASSOCIATES DEGREES; PROVIDING ONLINE EDUCATIONAL PUBLICATIONS IN THE NATURE JOURNALS, NEWSLETTERS, CURRICULUM GUIDES IN THE FIELD OF ISSUES RELATING TO OUT OF SCHOOL YOUTHS SEEKING ALTERNATIVES TO HIGH SCHOOL DIPLOMAS AND ASSOCIATES DEGREES FOR ASSISTING COMMUNITY BASED ORGANIZATIONS AND SOCIAL ENTERPRISES FOR SUPPORTING OUT OF SCHOOL YOUTHS IN THE PROCESS OF SECURING ENTRY LEVEL EMPLOYMENT (U.S. CLS. 100, 101 AND 107).
RUDY R. SINGLETON, EXAMINING ATTORNEY

HIP

THE MARK CONSISTS OF STANDARD CHARACTERS WITHOUT CLAIM TO ANY PARTICULAR FONT, STYLE, SIZE, OR COLOR.

CLASS 35—ADVERTISING AND BUSINESS

FOR CHARITABLE SERVICES, NAMELY, ORGANIZING AND CONDUCTING VOLUNTEER PROGRAMS RELATING TO K-12 EDUCATION; AND CHARITABLE SERVICES, NAMELY, ORGANIZING AND DEVELOPING PROGRAMS THAT AIM TO IMPROVE THE LIVES OF UNDERPRIVILEGED AND IMPOVERISHED PEOPLE (U.S. CLS. 100, 101 AND 102).
FIRST USE 8-2-2005; IN COMMERCE 8-2-2005.

CLASS 41—EDUCATION AND ENTERTAINMENT

FOR EDUCATIONAL SERVICES, NAMELY, CONDUCTING WORKSHOPS IN THE FIELD OF MATH AND SCIENCE; EDUCATIONAL DEMONSTRATIONS; CHARITABLE SERVICES, NAMELY, ACADEMIC MENTORING OF SCHOOL AGE CHILDREN; DEVELOPMENT AND DISSEMINATION OF EDUCATIONAL MATERIALS OF OTHERS IN THE FIELD OF ELEMENTARY SCHOOL EDUCATION; EDUCATIONAL RESEARCH; EDUCATIONAL SERVICES, NAMELY, PROVIDING INCENTIVES TO STUDENTS TO DEMONSTRATE EXCELLENCE IN THE FIELD OF ACADEMICS THROUGH THE ISSUANCE OF AWARDS; CONDUCTING EDUCATIONAL EXHIBITIONS IN THE NATURE OF WORKSHOPS IN THE FIELD OF MATH AND SCIENCE; AND CONSULTATION IN THE FIELD OF K-12 EDUCATIONAL SYSTEMS (U.S. CLS. 100, 101 AND 107).
FIRST USE 8-2-2005; IN COMMERCE 8-2-2005.
SHARON MEIER, EXAMINING ATTORNEY

SN 77-906,826. ARTISANAL EXPRESSIONS, INC., DBA CAFFE LUXXE, SANTA MONICA, CA. FILED 1-7-2010.



THE MARK CONSISTS OF A FANCIFUL DESIGN OF FLOWER WITH LEAVES INSIDE OF A CIRCLE WHICH IS NOT COMPLETELY CONNECTED.

CLASS 30—STAPLE FOODS

FOR COFFEE AND TEA; COFFEE BASED BEVERAGES; ESPRESSO; ROASTED COFFEE BEANS (U.S. CL. 46).

FIRST USE 3-31-2006; IN COMMERCE 6-29-2006.

CLASS 43—HOTEL AND RESTAURANT SERVICES

FOR COFFEE SHOPS (U.S. CLS. 100 AND 101).
FIRST USE 3-31-2006; IN COMMERCE 6-29-2006.
KRISTIN DAHLING, EXAMINING ATTORNEY

SN 77-907,029. THINKINGDOM MEDIA GROUP LIMITED, WANCHAI, HONG KONG, FILED 1-7-2010.

THINKINGDOM
新 经 典

NO CLAIM IS MADE TO THE EXCLUSIVE RIGHT TO USE THE NON-LATIN CHARACTERS THAT TRANSLITERATE TO "XIN JING DIAN", APART FROM THE MARK AS SHOWN.

THE MARK CONSISTS OF THE WORD "THINKINGDOM" WITH CHINESE CHARACTERS.

THE NON-LATIN CHARACTERS IN THE MARK TRANSLITERATE TO "XIN JING DIAN" AND THIS MEANS "NEW CLASSICS" IN ENGLISH.

CLASS 9—ELECTRICAL AND SCIENTIFIC APPARATUS

FOR DOWNLOADABLE MP3 FILES FEATURING AUDIO BOOKS IN THE FIELD OF SPOKEN WORD; PRERECORDED AUDIO TAPES AND CDS FEATURING AUDIO BOOKS; ELECTRONIC BOOK READERS; DOWNLOADABLE ELECTRONIC PUBLICATIONS IN THE NATURE OF BOOKS, MAGAZINES, NEWSPAPERS, AND COMIC BOOKS, IN THE FIELDS OF COMICS, FICTION, POETRY AND SPOKEN WORD; DOWNLOADABLE COMPUTER SOFTWARE FOR USE IN READING ELECTRONIC BOOK FILES; PRERECORDED TAPES, COMPACT DISCS, DIGITAL VIDEO DISCS, AND DVDS FEATURING AUDIO BOOKS IN THE FIELD OF SPOKEN WORD (U.S. CLS. 21, 23, 26, 36 AND 38).

CLASS 16—PAPER GOODS AND PRINTED MATTER

FOR BOOKS AND MAGAZINES IN THE FIELDS OF LITERATURE, AUTOBIOGRAPHY AND BIOGRAPHY, TEXTBOOKS IN THE FIELDS OF MATH, SCIENCE, ART, HISTORY AND LITERATURE; COMIC BOOKS; PRINTED MATTER AND PUBLICATIONS, NAMELY, MAGAZINES, NEWSPAPERS, PRINTED PERIODICALS, AND NEWSLETTERS, ALL IN THE FIELDS OF LITERATURE, AUTOBIOGRAPHY AND BIOGRAPHY; SPOKEN WORD BOOKS, NAMELY, PRINTED BOOKS FEATURING QUOTES; PRINTED MATTER, NAMELY, BOOKS FEATURING SPOKEN WORD QUOTES (U.S. CLS. 2, 5, 22, 23, 29, 37, 38 AND 50).

CLASS 41—EDUCATION AND ENTERTAINMENT

FOR PUBLICATION OF BOOKS, MAGAZINES, COMIC BOOKS; PUBLICATION OF ELECTRONIC BOOKS, MAGAZINES, COMIC BOOKS THROUGH THE INTERNET; TRANSLATION OF BOOKS, MAGAZINES AND COMIC BOOKS (U.S. CLS. 100, 101 AND 107).

APRIL ROACH, EXAMINING ATTORNEY

SN 77-907,066. TARGETSAFETY.COM, INC., SAN DIEGO, CA. FILED 1-7-2010.

PREVENTIONLINK

THE MARK CONSISTS OF STANDARD CHARACTERS WITHOUT CLAIM TO ANY PARTICULAR FONT, STYLE, SIZE, OR COLOR.

CLASS 35—ADVERTISING AND BUSINESS

FOR BUSINESS RISK MANAGEMENT; BUSINESS RISK MANAGEMENT CONSULTATION; INTERACTIVE RECORD KEEPING SERVICES FOR USE IN RISK MANAGEMENT AND REGULATORY COMPLIANCE REQUIREMENTS; PROMOTING THE GOODS AND SERVICES OF OTHERS BY PROVIDING HYPERTEXT LINKS TO THE WEB SITES OF OTHERS; PROMOTING A COMMUNITY-DRIVEN WEB SITE FEATURING USER-SUBMITTED CONTENT IN THE NATURE OF DOCUMENTS AND INTERACTIVE MATERIALS DESIGNED TO MEET THE NEEDS OF OTHER COMMUNITY MEMBERS TO REDUCE THE COST OF RISK, ALLOWING FOR MEMBER-TO-MEMBER COMMUNICATION, RATING OF CONTENT, ACCESS TO SOLUTIONS FROM THIRD PARTIES, AND OTHER SERVICES UNIQUE TO ORGANIZATIONS THAT RETAIN RISK, NAMELY, WEB MEETING TOOLS, MEMBERSHIP ROSTERS, FILES STORAGE, EVENT MANAGEMENT, ANNOUNCEMENTS, AND PERIODIC, AUTOMATED TARGETED EMAILS WITH RELEVANT INFORMATION AND CONTENT (U.S. CLS. 100, 101 AND 102).

FIRST USE 10-1-2007; IN COMMERCE 10-1-2007.

CLASS 41—EDUCATION AND ENTERTAINMENT

FOR EDUCATIONAL SERVICES, NAMELY, CONDUCTING ON-LINE TRAINING AND WEB-BASED RISK MANAGEMENT TRAINING TO PUBLIC ENTITIES AND PRIVATE ENTERPRISES FEATURING BOTH GENERAL AND CUSTOMIZED, SAFETY PROGRAMS, COMPLIANCE TASK MANAGEMENT, DOCUMENT DISTRIBUTION AND MANAGEMENT, AND SELF-ASSESSMENT, AND DISTRIBUTION OF COURSE MATERIALS IN CONNECTION THEREWITH; PROVIDING INDUSTRY CERTIFICATION AND CONTINUING EDUCATION COURSES IN THE FIELD OF RISK MANAGEMENT; DRIVER SAFETY TRAINING (U.S. CLS. 100, 101 AND 107).

FIRST USE 10-1-2007; IN COMMERCE 10-1-2007.

CLASS 42—SCIENTIFIC AND COMPUTER SERVICES

FOR WORKPLACE CERTIFICATION SERVICES, NAMELY, ASSIGNING AND DOCUMENTING SPECIFIC TASKS TO MAINTAIN COMPLIANCE WITH STATE AND FEDERAL REGULATIONS AND ORGANIZATIONAL POLICIES; WORKPLACE CERTIFICATION SERVICES, NAMELY, CONDUCTING SURVEYS AND TESTING FOR WORKPLACE EXCELLENCE; TESTING, ANALYSIS AND EVALUATING THE KNOWLEDGE, SKILLS AND ABILITIES OF OTHERS FOR THE PURPOSE OF CERTIFICATION IN THE FIELD OF RISK MANAGEMENT; TESTING, ANALYSIS AND EVALUATION OF THE GOODS AND SERVICES OF OTHERS FOR THE PURPOSE OF CERTIFICATION; COMPUTER SERVICES, NAMELY, CREATING AN ON-LINE COMMUNITY FOR REGISTERED USERS TO PARTICIPATE IN DISCUSSIONS, SHARE INFORMATION CONCERNING CERTIFIED TRAINING AND IDEAS TO MAINTAIN COMPLIANCE WITH INDUSTRY STANDARDS AND LEGAL REQUIREMENTS (U.S. CLS. 100 AND 101).

FIRST USE 10-1-2007; IN COMMERCE 10-1-2007.

CLASS 45—PERSONAL AND LEGAL SERVICES

FOR CONSULTING IN THE FIELD OF WORKPLACE AND JOBSITE SAFETY; CONSULTATION SERVICES IN THE FIELD OF SAFETY NEEDS OF COMMERCIAL AND INDUSTRIAL COMPANIES AND PUBLIC ENTITIES; REVIEWING STANDARDS AND PRACTICES TO ASSURE ENTERPRISE COMPLIANCE WITH FEDERAL AND STATE LAWS AND REGULATIONS, AND ORGANIZATIONAL POLICIES, AND SHARING SUCH INFORMATION VIA AN ON-LINE DATABASE TO ASSIST OTHER ORGANIZATIONS IN THEIR KNOWLEDGE AND UNDERSTANDING OF LAWS, RULES AND REGULATIONS (U.S. CLS. 100 AND 101).

FIRST USE 10-1-2007; IN COMMERCE 10-1-2007.
CURTIS FRENCH, EXAMINING ATTORNEY

SN 77-907,609. BROWNDOG LODGE, LLC, MEMPHIS, TN.
FILED 1-8-2010.



NO CLAIM IS MADE TO THE EXCLUSIVE RIGHT TO USE "LODGE LUXURY PET HOTEL DAYCARE SPA", APART FROM THE MARK AS SHOWN.

THE MARK CONSISTS OF A DOUBLE LINED OVAL SHAPE WHICH CONTAINS THE PHRASE "BROWNDOG" WHICH THE LETTER "O" HAS FOUR VARIOUS SIZED OVAL SHAPES THAT MAKE THE LETTER "O" LOOK LIKE A DOG PAW PRINT; WHICH IS ABOVE THE PHRASE "LODGE"; WHICH IS ABOVE A LINE; WHICH IS ABOVE THE PHRASES AND SHAPES "LUXURY PET HOTEL", SMALL CIRCLE SHAPE, "DAYCARE", SMALL CIRCLE SHAPE AND "SPA".

CLASS 43—HOTEL AND RESTAURANT SERVICES

FOR PET BOARDING SERVICES; PET DAY CARE SERVICES (U.S. CLS. 100 AND 101).

FIRST USE 12-1-2007; IN COMMERCE 12-1-2007.

CLASS 44—MEDICAL, BEAUTY AND AGRICULTURAL SERVICES

FOR PET GROOMING SERVICES (U.S. CLS. 100 AND 101).

FIRST USE 12-1-2007; IN COMMERCE 12-1-2007.
MARK SPARACINO, EXAMINING ATTORNEY

SN 77-907,661. CELGENE CORPORATION, SUMMIT, NJ.
FILED 1-8-2010.

DEDICATED. RESOURCEFUL.
PERSONAL.

THE MARK CONSISTS OF STANDARD CHARACTERS WITHOUT CLAIM TO ANY PARTICULAR FONT, STYLE, SIZE, OR COLOR.

CLASS 35—ADVERTISING AND BUSINESS

FOR ADMINISTRATION OF PATIENT REIMBURSEMENT PROGRAMS; ADMINISTERING PHARMACY REIMBURSEMENT PROGRAMS AND SERVICES; REVIEW AND EVALUATING HEALTH AND MEDICAL RECORDS FOR PATIENTS FOR PURPOSES OF ACCURACY AND COST MANAGEMENT; PROVIDING CONSUMER INFORMATION TO PATIENTS COMPARING HEALTH INSURANCE PROVIDERS AND BENEFITS VIA THE INTERNET (U.S. CLS. 100, 101 AND 102).

CLASS 36—INSURANCE AND FINANCIAL

FOR CONSULTING SERVICES IN THE FIELD OF EMPLOYEE BENEFITS, NAMELY, PROVIDING ASSISTANCE, EVALUATION AND CONSULTATION TO PATIENTS TO ASSIST THEM IN ENABLING ACCESS TO BENEFIT PROGRAMS; PROVIDING INFORMATION IN THE FIELD OF EMPLOYEE BENEFITS, NAMELY, THE BRINGING TOGETHER FOR THE BENEFIT OF OTHERS, OF A VARIETY OF INFORMATION RELATING TO EMPLOYEE BENEFITS, ENABLING EMPLOYEES TO CONVENIENTLY VIEW THEIR BENEFITS (U.S. CLS. 100, 101 AND 102).

CLASS 41—EDUCATION AND ENTERTAINMENT

FOR EDUCATIONAL PROGRAMS, NAMELY, SEMINARS, CLASSES, WORKSHOPS PROVIDING MEDICAL COUNSELING AND MEDICAL INFORMATION IN THE FIELD OF PHARMACEUTICALS AND SAFETY ISSUES PERTAINING TO PHARMACEUTICALS, AND PROVIDING MEDICAL INFORMATION IN THE AFOREMENTIONED FIELDS BY DISTRIBUTING WRITTEN MATERIALS IN CONNECTION THEREWITH; EDUCATIONAL PROGRAMS, NAMELY, CLASSES, SEMINARS AND WORKSHOPS PROVIDING MEDICAL COUNSELING AND MEDICAL INFORMATION IN THE FIELD OF LENALIDOMIDE AND SAFETY ISSUES PERTAINING TO LENALIDOMIDE, AND PROVIDING MEDICAL INFORMATION IN THE AFOREMENTIONED FIELDS BY DISTRIBUTING WRITTEN MATERIALS IN CONNECTION THEREWITH (U.S. CLS. 100, 101 AND 107).

DANNEAN HETZEL, EXAMINING ATTORNEY

SN 77-908,984. LEFT COAST MEDIA INC, PISMO BEACH, CA. FILED 1-11-2010.

GADGET GRRL

THE MARK CONSISTS OF STANDARD CHARACTERS WITHOUT CLAIM TO ANY PARTICULAR FONT, STYLE, SIZE, OR COLOR.

OWNER OF U.S. REG. NOS. 2,423,217, 2,903,283 AND OTHERS.

CLASS 9—ELECTRICAL AND SCIENTIFIC APPARATUS

FOR DOWNLOADABLE COMPUTER GAME SOFTWARE FOR USE ON WIRELESS DEVICES AND COMPUTERS (U.S. CLS. 21, 23, 26, 36 AND 38).

CLASS 41—EDUCATION AND ENTERTAINMENT

FOR ENTERTAINMENT SERVICES, NAMELY, PROVIDING ON-LINE COMPUTER GAMES (U.S. CLS. 100, 101 AND 107).

JOSETTE BEVERLY, EXAMINING ATTORNEY

SN 77-909,175. AMERICAN ASSOCIATION OF MOTORCYCLE INJURY LAWYERS, INC., PHOENIX, AZ. FILED 1-11-2010.

AMERICAN ASSOCIATION OF
MOTORCYCLE INJURY LAWYERS

THE MARK CONSISTS OF STANDARD CHARACTERS WITHOUT CLAIM TO ANY PARTICULAR FONT, STYLE, SIZE, OR COLOR.

OWNER OF U.S. REG. NOS. 2,833,423, 2,982,361 AND 3,003,467.

NO CLAIM IS MADE TO THE EXCLUSIVE RIGHT TO USE "ASSOCIATION", APART FROM THE MARK AS SHOWN.

SEC. 2(F).

CLASS 35—ADVERTISING AND BUSINESS

FOR ASSOCIATION SERVICES, NAMELY, PROMOTING THE INTERESTS OF LAWYERS WHO HAVE AN INTEREST IN PERSONAL INJURY AND ACCIDENT LAW; ASSOCIATION SERVICES, NAMELY, PROMOTING THE INTERESTS OF LAWYERS AND LAW PROFESSIONALS; ASSOCIATION SERVICES; NAMELY PROMOTING THE INTERESTS OF MOTORCYCLISTS AND MOTORCYCLE DRIVERS (U.S. CLS. 100, 101 AND 102).

FIRST USE 1-1-2001; IN COMMERCE 1-1-2001.

CLASS 45—PERSONAL AND LEGAL SERVICES

FOR LEGAL SERVICES, NAMELY, LEGAL SERVICES, LEGAL ADVISORY SERVICES, PROVISION OF LEGAL CONSULTATIONS, LEGAL ADVICE AND REPRESENTATION OF OTHERS IN LEGAL MATTERS, LEGAL RESEARCH, NOTARY PUBLIC SERVICES, AND PROVIDING INFORMATION IN THE FIELD OF PERSONAL INJURY AND ACCIDENT LAW (U.S. CLS. 100 AND 101).

FIRST USE 1-1-2001; IN COMMERCE 1-1-2001.

ASMAT KHAN, EXAMINING ATTORNEY

SN 77-909,738. LUKE OIL COMPANY, INC., HOBART, IN. FILED 1-12-2010.



THE COLOR(S) RED, WHITE AND YELLOW IS/ARE CLAIMED AS A FEATURE OF THE MARK.

THE MARK CONSISTS OF THE COLOR RED FOR THE BACKGROUND AND THE WORD "GO" IN WHITE AND THE WORD "LO" IN YELLOW.

CLASS 4—LUBRICANTS AND FUELS

FOR FUEL FOR MOTOR VEHICLES, NAMELY, GASOLINE AND DIESEL FUEL (U.S. CLS. 1, 6 AND 15).

FIRST USE 8-31-2009; IN COMMERCE 8-31-2009.

CLASS 37—CONSTRUCTION AND REPAIR

FOR VEHICLE SERVICE STATION SERVICES; FUELING SERVICES FOR AUTOMOTIVE VEHICLES (U.S. CLS. 100, 103 AND 106).

FIRST USE 8-31-2009; IN COMMERCE 8-31-2009.

MATTHEW PAPPAS, EXAMINING ATTORNEY

SN 77-910,029. WINC DESIGN LIMITED, JORDAN, HONG KONG, FILED 1-12-2010.



CHARLIE BANANA

THE MARK CONSISTS OF A BLACK-FILLED CIRCLE WITH A WHITE DESIGN, CONSISTING OF SEMICIRCLES AND LINES, IMPRINTED THEREON, AND THE WORDS "CHARLIE BANANA" BENEATH THE CIRCLE.

CLASS 5—PHARMACEUTICALS

FOR REUSABLE BREAST PADS, FEMININE HYGIENE PADS, PHARMACEUTICAL PREPARATIONS, NAMELY, ANTITUSSIVE COLD PREPARATIONS, ANALGESIC AND MUSCLE RELAXANT PREPARATIONS, CHEMOTHERAPY PREPARATIONS, PREPARATIONS FOR THE TREATMENT OF INFECTIOUS DISEASES, PREPARATIONS FOR THE TREATMENT OF WOUNDS, PHARMACEUTICAL SKIN CARE PREPARATIONS, VETERINARY PREPARATIONS, NAMELY, VETERINARY VACCINES, ANTI-INFECTIVE PRODUCTS FOR VETERINARY USE, PAIN RELIEF MEDICATIONS FOR VETERINARY USE, SANITARY PREPARATIONS FOR MEDICAL PURPOSES, DIETETIC SUBSTANCES, NAMELY, FOODS AND SUGAR FOR MEDICAL USE, FOOD FOR BABIES, PLASTERS, NAMELY, PLASTER FOR MEDICAL USE, MATERIALS FOR DRESSINGS, NAMELY, DRESSINGS FOR WOUNDS, BURNS OR SURGERY, GAUZE AND BANDAGES, MATERIAL FOR STOPPING TEETH, DENTAL WAX, DISINFECTANTS, NAMELY, ALL PURPOSE DISINFECTANTS AND DISINFECTANTS FOR SANITARY PURPOSES, PREPARATIONS FOR DESTROYING VERMIN, FUNGICIDES, HERBICIDES (U.S. CLS. 6, 18, 44, 46, 51 AND 52).

CLASS 16—PAPER GOODS AND PRINTED MATTER

FOR DISPOSABLE BABY TRAINING PANTS; BABY CLOTHS, NAMELY, DISPOSABLE DIAPERS, AND DISPOSABLE INSERTS FOR DIAPERS (U.S. CLS. 2, 5, 22, 23, 29, 37, 38 AND 50).

CLASS 25—CLOTHING

FOR REUSABLE CLOTH DIAPERS, BABY CLOTHES, AND BABY CLOTHS, NAMELY, CLOTH DIAPERS, CLOTH WIPES, CLOTH SWIM DIAPERS, CLOTH LEG WARMERS AND CLOTH BIBS, NON-DISPOSABLE TRAINING PANTS, NON-DISPOSABLE TRAINING SHORTS, NON-DISPOSABLE TRAINING SKIRTS, AND NON-DISPOSABLE WATERPROOF DIAPERS, BABY PAJAMAS, CLOTHING, FOOTWEAR AND HEADGEAR, NAMELY, LEG WARMERS, LEGGINGS, SOCKS, TIGHTS, PAJAMAS, INFANT WEAR, SKIRTS, PANTS, HATS AND CAPS (U.S. CLS. 22 AND 39).

CHRIS WELLS, EXAMINING ATTORNEY

SN 77-910,328. REVENUEWIRE INC., VICTORIA, BRITISH COL., CANADA, FILED 1-12-2010.

POWERING YOUR ONLINE TRANSACTIONS

THE MARK CONSISTS OF STANDARD CHARACTERS WITHOUT CLAIM TO ANY PARTICULAR FONT, STYLE, SIZE, OR COLOR.

CLASS 36—INSURANCE AND FINANCIAL

FOR PROVIDING ELECTRONIC PROCESSING OF ACH AND CREDIT CARD TRANSACTIONS AND ELECTRONIC PAYMENTS INCLUDING BUT NOT LIMITED TO MOBILE PAYMENT, PREPAID CARDS, DEBIT CARDS, GIFT CARDS, PIN-BASED CREDIT CARD AND ELECTRONIC CHECKS VIA A GLOBAL COMPUTER NETWORK (U.S. CLS. 100, 101 AND 102).

CLASS 42—SCIENTIFIC AND COMPUTER SERVICES

FOR PROVIDING TEMPORARY USE OF NON-DOWNLOADABLE CREDIT CARD TRANSACTION PROCESSING SOFTWARE FEATURING TOOLS FOR MONITORING WEBSITE TRANSACTIONS, MANAGING ACCOUNTS, MANAGING CATALOG OF PRODUCTS, ORDER MANAGEMENT AND PRODUCT SEARCHING AND PERFORMANCE REPORTING (U.S. CLS. 100 AND 101).

MARK SPARACINO, EXAMINING ATTORNEY

SN 77-910,453. MARTY JARAMILLO, PT, PC, NEW YORK, NY. FILED 1-12-2010.



NO CLAIM IS MADE TO THE EXCLUSIVE RIGHT TO USE "HEALTH AND WELLNESS TOOLS", APART FROM THE MARK AS SHOWN.

THE MARK CONSISTS OF THE STYLIZED WORDS "YINGO YANGO" TO THE RIGHT OF A STYLIZED SWIRL DESIGN. THE TERMS "HEALTH & WELLNESS TOOLS ON THE GO" ARE BELOW THE DESIGN AND "YINGO YANGO".

CLASS 9—ELECTRICAL AND SCIENTIFIC APPARATUS

FOR COMPUTER APPLICATION SOFTWARE FOR MOBILE PHONES THAT PROVIDES INFORMATION ON COMMON SPORTS INJURIES AND EXERCISES DESIGNED TO ALLEVIATE OR PREVENT SUCH INJURIES OR THEIR SYMPTOMS, STRENGTH AND CONDITIONING EXERCISES AND FITNESS REGIMES FOR RECREATIONAL SPORTS, AND GENERAL INFORMATION RELATING TO HEALTH AND WELLNESS (U.S. CLS. 21, 23, 26, 36 AND 38).

CLASS 28—TOYS AND SPORTING GOODS

FOR SPORTING GOODS, NAMELY, A SPORTS TRAINING DEVICE TO IMPROVE STRENGTH, TONING, CONDITIONING, BALANCE, AND PROPRIOCEPTION (U.S. CLS. 22, 23, 38 AND 50).

MICHAEL KEATING, EXAMINING ATTORNEY

SN 77-911,329. BENDAGO ADVISORY SERVICES, WESTLAKE VILLAGE, CA. FILED 1-13-2010.



THE STIPPLING IS FOR SHADING PURPOSES ONLY.

THE MARK CONSISTS OF A CIRCLE WITH A DOG INSIDE AND THE STYLIZED TEXT "FLAME SNIFFER" WITH A DESIGN DEPICTING RADIO/TELEMETRY WAVES ABOVE THE LETTER "R".

CLASS 6—METAL GOODS

FOR METAL ALARM POSTS (U.S. CLS. 2, 12, 13, 14, 23, 25 AND 50).

CLASS 9—ELECTRICAL AND SCIENTIFIC APPARATUS

FOR INFRARED SENSORS; CENTRAL CONTROL WILDFIRE ALARM SYSTEM (U.S. CLS. 21, 23, 26, 36 AND 38).

CLASS 19—NON-METALLIC BUILDING MATERIALS

FOR NON-METAL ALARM POSTS (U.S. CLS. 1, 12, 33 AND 50).

CLASS 45—PERSONAL AND LEGAL SERVICES

FOR MONITORING OF WILDFIRE ALARM SYSTEMS (U.S. CLS. 100 AND 101).

PRISCILLA MILTON, EXAMINING ATTORNEY

SN 77-911,632. DIXIE DEW PRODUCTS, INC., ERLANGER, KY. FILED 1-14-2010.

BC'S MAGIC POWDER

THE MARK CONSISTS OF STANDARD CHARACTERS WITHOUT CLAIM TO ANY PARTICULAR FONT, STYLE, SIZE, OR COLOR.

NO CLAIM IS MADE TO THE EXCLUSIVE RIGHT TO USE "POWDER", APART FROM THE MARK AS SHOWN.

CLASS 5—PHARMACEUTICALS

FOR NUTRITIONAL SUPPLEMENTS, NAMELY, SOLID, LIQUID AND POWDERED DIETARY SUPPLEMENTS; DIETARY SUPPLEMENT NUTRITIONAL BARS, GELS, POWDERS, AND LIQUID DRINKS CONTAINING PROTEINS, CARBOHYDRATES, VITAMINS AND MINERALS; MEAL REPLACEMENT SHAKES; PROTEIN, PREBIOTIC AND PROBIOTIC POWDERS AS NUTRITIONAL SUPPLEMENTS FOR HUMAN CONSUMPTION FOR USE AS A FOOD ADDITIVE (U.S. CLS. 6, 18, 44, 46, 51 AND 52).

CLASS 29—MEATS AND PROCESSED FOODS

FOR PROTEIN POWDERS FOR HUMAN CONSUMPTION FOR USE AS A FOOD ADDITIVE; PROTEIN BASED, NUTRIENT-DENSE SNACK BARS (U.S. CL. 46).
JUDITH HELFMAN, EXAMINING ATTORNEY

SN 77-911,692. LYRIX, INC., LOWELL, MA. FILED 1-14-2010.

MOBISO

THE MARK CONSISTS OF STANDARD CHARACTERS WITHOUT CLAIM TO ANY PARTICULAR FONT, STYLE, SIZE, OR COLOR.

CLASS 9—ELECTRICAL AND SCIENTIFIC APPARATUS

FOR DOWNLOADABLE COMPUTER SOFTWARE IN THE NATURE OF A MOBILE APPLICATION FOR USE IN THE FIELDS OF PERSONAL PRODUCTIVITY AND ACCOUNTABILITY, WIRELESS COMMUNICATION, MOBILE INFORMATION ACCESS, AND REMOTE DATA MANAGEMENT FOR WIRELESS DELIVERY OF CONTENT TO MOBILE ELECTRONIC DEVICES (U.S. CLS. 21, 23, 26, 36 AND 38).

CLASS 42—SCIENTIFIC AND COMPUTER SERVICES

FOR SOFTWARE AS A SERVICE, NAMELY, PROVIDING TEMPORARY USE OF NON-DOWNLOADABLE SOFTWARE IN THE NATURE OF A MOBILE APPLICATION FOR USE IN THE FIELDS OF PERSONAL PRODUCTIVITY AND ACCOUNTABILITY, WIRELESS COMMUNICATION, MOBILE INFORMATION ACCESS, AND REMOTE DATA MANAGEMENT FOR WIRELESS DELIVERY OF CONTENT TO MOBILE ELECTRONIC DEVICES (U.S. CLS. 100 AND 101).

MIDGE BUTLER, EXAMINING ATTORNEY

SN 77-911,912. GRADUNATION, INC., ENCINITAS, CA. FILED 1-14-2010.

gradUnation

THE MARK CONSISTS OF STANDARD CHARACTERS WITHOUT CLAIM TO ANY PARTICULAR FONT, STYLE, SIZE, OR COLOR.

CLASS 35—ADVERTISING AND BUSINESS

FOR BUSINESS MANAGEMENT SERVICES, NAMELY, PROVIDING CAREER MANAGEMENT IN THE NATURE OF CAREER PLACEMENT FOR OTHERS IN THE FIELD OF EMPLOYMENT; PROVIDING AN ON-LINE SEARCHABLE DATABASE FEATURING CLASSIFIED AD LISTINGS AND EMPLOYMENT OPPORTUNITIES; PROVIDING AN INTERACTIVE WEB SITE THAT FACILITATES PREPARATION FOR JOB INTERVIEWS; PROVIDING ON-LINE INFORMATION AND NEWS IN THE FIELD OF EMPLOYMENT INFORMATION; PROVIDING ON-LINE INFORMATION AND NEWS IN THE FIELD OF EMPLOYMENT OPPORTUNITIES (U.S. CLS. 100, 101 AND 102).

CLASS 41—EDUCATION AND ENTERTAINMENT

FOR BUSINESS MANAGEMENT SERVICES, NAMELY, PROVIDING CAREER MANAGEMENT IN THE NATURE OF CAREER COUNSELING FOR OTHERS IN THE FIELD OF EMPLOYMENT; PROVIDING ON-LINE INFORMATION AND NEWS IN THE FIELD OF EMPLOYMENT TRAINING (U.S. CLS. 100, 101 AND 107).

ERIN FALK, EXAMINING ATTORNEY

SN 77-912,081. KARBOODLE, LLC, DANVERS, MA. FILED 1-14-2010.

KARBOODLE

THE MARK CONSISTS OF STANDARD CHARACTERS WITHOUT CLAIM TO ANY PARTICULAR FONT, STYLE, SIZE, OR COLOR.

CLASS 35—ADVERTISING AND BUSINESS

FOR PROVIDING A SEARCHABLE WEBSITE FEATURING THE GOODS AND SERVICES OF OTHER VENDORS VIA THE INTERNET IN THE FIELD OF AUTOMOTIVE SERVICES AND REPAIRS; PROVIDING CONSUMER INFORMATION IN THE FIELD OF AUTOMOTIVE SERVICES, REPAIRS AND AUTOMOTIVE RELATED BUSINESSES; LEAD AGGREGATOR, NAMELY, PROVIDING SALES LEADS FOR OTHERS IN THE FIELDS OF AUTOMOTIVE SERVICE AND REPAIR; PROVIDING A WEBSITE FEATURING CONSUMER REVIEWS AND SERVICE RATINGS OF OTHERS IN THE FIELD OF AUTOMOTIVE SERVICE AND REPAIR (U.S. CLS. 100, 101 AND 102).

FIRST USE 1-11-2010; IN COMMERCE 1-11-2010.

CLASS 37—CONSTRUCTION AND REPAIR

FOR PROVIDING AN INTERNET WEBSITE THAT FEATURES INFORMATION ABOUT AUTOMOTIVE MAINTENANCE AND REPAIR SERVICE (U.S. CLS. 100, 103 AND 106).

FIRST USE 1-11-2010; IN COMMERCE 1-11-2010.
MATTHEW EINSTEIN, EXAMINING ATTORNEY

SN 77-912,179. KARBOODLE, LLC, DANVERS, MA. FILED 1-14-2010.

KARBOODLE.COM

THE MARK CONSISTS OF STANDARD CHARACTERS WITHOUT CLAIM TO ANY PARTICULAR FONT, STYLE, SIZE, OR COLOR.

CLASS 35—ADVERTISING AND BUSINESS

FOR PROVIDING A SEARCHABLE WEBSITE FEATURING THE GOODS AND SERVICES OF OTHER VENDORS VIA THE INTERNET IN THE FIELD OF AUTOMOTIVE SERVICES AND REPAIRS; PROVIDING CONSUMER INFORMATION IN THE FIELD OF AUTOMOTIVE SERVICES, REPAIRS AND AUTOMOTIVE RELATED BUSINESSES; LEAD AGGREGATOR, NAMELY, PROVIDING SALES LEADS FOR OTHERS IN THE FIELDS OF AUTOMOTIVE SERVICE AND REPAIR; PROVIDING A WEBSITE FEATURING CONSUMER REVIEWS AND SERVICE RATINGS OF OTHERS IN THE FIELD OF AUTOMOTIVE SERVICE AND REPAIR (U.S. CLS. 100, 101 AND 102).
FIRST USE 1-14-2010; IN COMMERCE 1-14-2010.

CLASS 37—CONSTRUCTION AND REPAIR

FOR PROVIDING AN INTERNET WEBSITE THAT FEATURES INFORMATION ABOUT AUTOMOTIVE MAINTENANCE AND REPAIR SERVICE (U.S. CLS. 100, 103 AND 106).
FIRST USE 1-14-2010; IN COMMERCE 1-14-2010.
MATTHEW EINSTEIN, EXAMINING ATTORNEY

SN 77-912,602. ON RITE CO., INC, FORT LAUDERDALE, FL. FILED 1-15-2010.

Recover With Confidence

THE MARK CONSISTS OF STANDARD CHARACTERS WITHOUT CLAIM TO ANY PARTICULAR FONT, STYLE, SIZE, OR COLOR.

CLASS 44—MEDICAL, BEAUTY AND AGRICULTURAL SERVICES

FOR HAIR REPLACEMENT, HAIR ADDITION AND HAIR EXTENSION SERVICES (U.S. CLS. 100 AND 101).
FIRST USE 10-13-2009; IN COMMERCE 10-13-2009.

CLASS 45—PERSONAL AND LEGAL SERVICES

FOR PERSONAL IMAGE CONSULTING SERVICES (U.S. CLS. 100 AND 101).
FIRST USE 10-13-2009; IN COMMERCE 10-13-2009.
JANICE L. MCMORROW, EXAMINING ATTORNEY

SN 77-912,805. MINDPETAL SOFTWARE SOLUTIONS, INC., DBA MINDPETAL, ROCKVILLE, MD. FILED 1-15-2010.



THE COLOR(S) ORANGE, YELLOW, GRAY AND BLACK IS/ARE CLAIMED AS A FEATURE OF THE MARK.

THE MARK CONSISTS OF THE WORD "MINDPETAL" IN BLACK BENEATH A DESIGN OF A SINGLE FLOWER PETAL WHICH IS COLORED DARK ORANGE ON THE OUTSIDE AND WHICH SHADES INTO LIGHT ORANGE AND YELLOWS WITHIN THE CENTER OF THE DESIGN, WITH A SHADOW COLORED GRAY APPEARING BELOW THE DESIGN.

CLASS 35—ADVERTISING AND BUSINESS

FOR BUSINESS CONSULTATION SERVICES; BUSINESS RESEARCH AND ANALYSIS SERVICES; BUSINESS MODELING, ECONOMIC BUSINESS FORECASTING AND ANALYSIS BUSINESS PROCESS MODELING, NAMELY, BUSINESS PROCESS RE-ENGINEERING SERVICES; BUSINESS MANAGEMENT CONSULTANCY, NAMELY, DEVELOPMENT OF PROCESSES FOR THE ANALYSIS AND THE IMPLEMENTATION OF BUSINESS STRATEGY PLANS AND MANAGEMENT PROJECTS; BUSINESS INFORMATION, INQUIRIES, INVESTIGATIONS AND RESEARCH; BUSINESS REPORTING SERVICES, NAMELY, PROVIDING STATISTICAL COMMERCIAL INFORMATION; COMPILATION OF COMMERCIAL INFORMATION DATABASES; MANAGEMENT AND COMPILATION OF COMPUTERIZED DATABASES; INPUT, COLLECTION, STORING, SORTING, CATEGORIZATION, CONTROLLING, MANAGING, TREATMENT, PROCESSING, MODELING, ANALYZING, COMPILING AND SYSTEMIZATION OF BUSINESS INFORMATION AND DATA; COMPUTERIZED AUTOMATION AND EFFICIENCY FILE MANAGEMENT FOR BUSINESS MANAGEMENT; COMPUTERIZED DATABASE AND DATA PROCESSING MANAGEMENT; BUSINESS MANAGEMENT AND ORGANIZATION ADVICE; BUSINESS ADMINISTRATION; DATABASE MANAGEMENT, NAMELY, INPUT, UPDATING, SORTING, CATEGORIZATION, TREATMENT, MODELING, ANALYZING, SYSTEMIZATION AND PRESENTATION OF INFORMATION, DATA INTO DATABASES (U.S. CLS. 100, 101 AND 102).

CLASS 42—SCIENTIFIC AND COMPUTER SERVICES

FOR COMPUTER HARDWARE AND SOFTWARE CONSULTING SERVICES; CONSULTING AND RESEARCH IN THE FIELD OF INFORMATION TECHNOLOGY AND TELECOMMUNICATIONS TECHNOLOGY; INFORMATION TECHNOLOGY PROJECT MANAGEMENT; CONSULTING AND RESEARCH IN THE FIELDS OF ENTERPRISE ARCHITECTURE, DATA AND DATABASE MANAGEMENT AND STORAGE, MIGRATION FROM CURRENT COMPUTER SYSTEM INFRASTRUCTURE TO OPEN SOURCE BASED PLATFORMS, ENTERPRISE COMPUTER SYSTEM ARCHITECTURE, SOFTWARE ENGINEERING, SERVICE ORIENTED ARCHITECTURE, AND ENTERPRISE SYSTEMS MANAGEMENT; IMPLEMENTATION OF COMPUTER SYSTEMS IN THE FIELDS OF ENTERPRISE ARCHITECTURE, DATA AND DATABASE MANAGEMENT AND STORAGE, MIGRATION FROM CURRENT COMPUTER SYSTEM INFRASTRUCTURE TO OPEN SOURCE BASED PLATFORMS, ENTERPRISE COMPUTER SYSTEM ARCHITECTURE, SOFTWARE ENGINEERING, SERVICE ORIENTED ARCHITECTURE, AND ENTERPRISE SYSTEMS MANAGEMENT; IMPLEMENTATION

OF COMPUTER SYSTEMS FOR SEARCHING DATA, RECORDING AND COMPILATION OF DATA, DATA MINING AND DATA RECOVERY, AND DATA ANALYSIS; SYSTEMS ENGINEERING AND STRATEGIC INFORMATION TECHNOLOGY PLANNING SERVICES; TECHNICAL SUPPORT SERVICES, NAMELY, TROUBLESHOOTING OF COMPUTER HARDWARE AND SOFTWARE PROBLEMS; COMPUTER SYSTEM ANALYSIS, INTEGRATION AND CONSULTING SERVICES; INTEGRATION OF COMPUTER SYSTEMS AND NETWORK, NAMELY, COMPUTER GLOBAL NETWORK AND SERVICE ORIENTED ARCHITECTURE; INSTALLATION, UPDATING AND MAINTENANCE OF COMPUTER SOFTWARE; TECHNOLOGY MIGRATION, NAMELY, MIGRATING EXISTING COMPUTER SYSTEMS TO REPLACEMENT COMPUTER SYSTEMS; COMPUTER PROGRAMMING FOR OTHERS; CUSTOMIZED SOFTWARE DEVELOPMENT SERVICES; DESIGN, DEVELOPMENT, DEPLOYMENT, IMPLEMENTATION, INTEGRATION AND MANAGEMENT OF COMPUTER SOFTWARE FOR OTHERS; MANAGED INFORMATION TECHNOLOGY SERVICES AND OPERATIONS FOR OTHERS, NAMELY, MANAGEMENT OF VIRTUAL INFRASTRUCTURE, NETWORKING AND STORAGE SERVICES; ADVICE REGARDING AUTOMATION AND INFORMATION SERVICES, NAMELY, INTEGRATION OF COMPUTER SYSTEMS AND COMPUTER NETWORKS; TECHNICAL CONSULTANCY AND DRAFTING TECHNICAL EXPERT REPORTS, NAMELY, COMPUTER SYSTEM ANALYSIS, CONSULTING SERVICES IN THE FIELD OF SELECTION AND DESIGN OF COMPUTER HARDWARE AND SOFTWARE SYSTEMS FOR OTHERS, AND PROVIDING AN ELECTRONIC AND TELEPHONE HELP DESK FOR OTHERS FOR COMPUTER HARDWARE AND COMPUTER SOFTWARE PROBLEMS (U.S. CLS. 100 AND 101).
HENRY S. ZAK, EXAMINING ATTORNEY

SN 77-913,493. VILLANOVA UNIVERSITY, VILLANOVA, PA. FILED 1-16-2010.



OWNER OF U.S. REG. NOS. 2,662,287, 3,708,098 AND OTHERS.

CLASS 6—METAL GOODS

FOR METAL NOVELTY LICENSE PLATES (U.S. CLS. 2, 12, 13, 14, 23, 25 AND 50).
FIRST USE 12-31-2007; IN COMMERCE 12-31-2007.

CLASS 16—PAPER GOODS AND PRINTED MATTER

FOR DECALS (U.S. CLS. 2, 5, 22, 23, 29, 37, 38 AND 50).
FIRST USE 12-31-2007; IN COMMERCE 12-31-2007.

CLASS 18—LEATHER GOODS

FOR TOTE BAGS AND BACKPACKS (U.S. CLS. 1, 2, 3, 22 AND 41).
FIRST USE 12-31-2007; IN COMMERCE 12-31-2007.

CLASS 20—FURNITURE AND ARTICLES NOT OTHERWISE CLASSIFIED

FOR CHAIRS (U.S. CLS. 2, 13, 22, 25, 32 AND 50).
FIRST USE 12-31-2007; IN COMMERCE 12-31-2007.

CLASS 21—HOUSEWARES AND GLASS

FOR HOUSEHOLD ITEMS, NAMELY, BEVERAGE GLASSWARE AND CUPS (U.S. CLS. 2, 13, 23, 29, 30, 33, 40 AND 50).
FIRST USE 12-31-2007; IN COMMERCE 12-31-2007.

CLASS 24—FABRICS

FOR TEXTILES, NAMELY, BANNERS AND TOWELS (U.S. CLS. 42 AND 50).
FIRST USE 12-31-2007; IN COMMERCE 12-31-2007.

CLASS 28—TOYS AND SPORTING GOODS

FOR SPORTING GOODS, NAMELY, BASKETBALLS, FOOTBALLS, GOLF CLUB COVERS, GOLF BAGS, AND GOLF BALLS (U.S. CLS. 22, 23, 38 AND 50).
FIRST USE 12-31-2007; IN COMMERCE 12-31-2007.
KATHERINE M. DUBRAY, EXAMINING ATTORNEY

SN 77-913,078. BROOKS SHOPPING CENTER, LLC, YONKERS, NY. FILED 1-15-2010.

CROSS COUNTY SHOPPING CENTER

THE MARK CONSISTS OF STANDARD CHARACTERS WITHOUT CLAIM TO ANY PARTICULAR FONT, STYLE, SIZE, OR COLOR.

NO CLAIM IS MADE TO THE EXCLUSIVE RIGHT TO USE "SHOPPING CENTER", APART FROM THE MARK AS SHOWN.

SEC. 2(F) AS TO "CROSS COUNTY".

CLASS 35—ADVERTISING AND BUSINESS

FOR ADVERTISING SERVICES FOR SHOPPING CENTER TENANTS (U.S. CLS. 100, 101 AND 102).
FIRST USE 10-10-1962; IN COMMERCE 10-10-1962.

CLASS 36—INSURANCE AND FINANCIAL

FOR SHOPPING CENTER SERVICES, NAMELY, RENTAL OF SHOPPING CENTER SPACE; REAL ESTATE MANAGEMENT (U.S. CLS. 100, 101 AND 102).
FIRST USE 10-10-1962; IN COMMERCE 10-10-1962.
GILBERT SWIFT, EXAMINING ATTORNEY

SN 77-914,354. NATIONAL OILWELL VARCO, L.P., HOUSTON, TX. FILED 1-19-2010.

NOV RIGSTORE

THE MARK CONSISTS OF STANDARD CHARACTERS WITHOUT CLAIM TO ANY PARTICULAR FONT, STYLE, SIZE, OR COLOR.

CLASS 35—ADVERTISING AND BUSINESS

FOR SUPPLY CHAIN MANAGEMENT SERVICES (U.S. CLS. 100, 101 AND 102).

CLASS 39—TRANSPORTATION AND STORAGE

FOR SUPPLY CHAIN LOGISTICS SERVICES, NAMELY, STORAGE, TRANSPORTATION AND DELIVERY OF GOODS FOR OTHERS BY AIR, RAIL, SHIP OR TRUCK (U.S. CLS. 100 AND 105).

JULIE WATSON, EXAMINING ATTORNEY

SN 77-914,429. THE OLD VIC THEATRE TRUST 2000, LONDON, UNITED KINGDOM, FILED 1-19-2010.

THE OLD VIC

THE MARK CONSISTS OF STANDARD CHARACTERS WITHOUT CLAIM TO ANY PARTICULAR FONT, STYLE, SIZE, OR COLOR.

OWNER OF UNITED KINGDOM REG. NO. 2490842, DATED 6-23-2008, EXPIRES 6-23-2018.

CLASS 16—PAPER GOODS AND PRINTED MATTER

FOR STATIONERY, PENS, PENCILS, PAPER WEIGHTS; THEATRE PROGRAMS (U.S. CLS. 2, 5, 22, 23, 29, 37, 38 AND 50).

CLASS 25—CLOTHING

FOR ARTICLES OF CLOTHING, NAMELY, SHIRTS, T-SHIRTS, SWEATSHIRTS, SWEATERS, TIES, BOW TIES, SCARVES, TROUSERS, SKIRTS, DRESSES, SOCKS, STOCKINGS AND TIGHTS; AND HEADGEAR, NAMELY, HATS AND CAPS (U.S. CLS. 22 AND 39).

CLASS 36—INSURANCE AND FINANCIAL

FOR CHARITABLE FUND RAISING SERVICES (U.S. CLS. 100, 101 AND 102).

CLASS 41—EDUCATION AND ENTERTAINMENT

FOR THEATRE SERVICES, NAMELY, PROVIDING LIVE PERFORMANCES OF PLAYS, OPERAS, DRAMAS, COMEDIES, REVIEWS AND CONCERTS; ARRANGING AND CONDUCTING OF EXHIBITIONS FOR ENTERTAINMENT PURPOSES; EDUCATIONAL SERVICES, NAMELY, CLASSES, WORKSHOPS, SEMINARS IN THE FIELD OF THEATER (U.S. CLS. 100, 101 AND 107).

CLASS 43—HOTEL AND RESTAURANT SERVICES

FOR BAR SERVICES; CATERING SERVICES; PROVISION OF FOOD AND DRINK (U.S. CLS. 100 AND 101).
FRED CARL, EXAMINING ATTORNEY

SN 77-914,540. SAVAL FOODS CORPORATION, ELK RIDGE, MD. FILED 1-19-2010.

BALTIMORE EATS

THE MARK CONSISTS OF STANDARD CHARACTERS WITHOUT CLAIM TO ANY PARTICULAR FONT, STYLE, SIZE, OR COLOR.

NO CLAIM IS MADE TO THE EXCLUSIVE RIGHT TO USE "EATS", APART FROM THE MARK AS SHOWN.
SEC. 2(F).

CLASS 9—ELECTRICAL AND SCIENTIFIC APPARATUS

FOR ELECTRONIC PUBLICATIONS, NAMELY, A MAGAZINE FEATURING INFORMATION RELATED TO RESTAURANTS, RECIPES, EVENTS, ARTICLES IN THE FIELD OF GROWING FARM TO TABLE MOVEMENT (U.S. CLS. 21, 23, 26, 36 AND 38).

FIRST USE 1-0-2005; IN COMMERCE 1-0-2005.

CLASS 16—PAPER GOODS AND PRINTED MATTER

FOR MAGAZINE FEATURING INFORMATION RELATED TO RESTAURANTS, RECIPES, EVENTS, ARTICLES IN THE FIELD OF GROWING FARM TO TABLE MOVEMENT (U.S. CLS. 2, 5, 22, 23, 29, 37, 38 AND 50).

FIRST USE 1-0-2005; IN COMMERCE 1-0-2005.

CLASS 43—HOTEL AND RESTAURANT SERVICES

FOR PROVIDING A WEBSITE FEATURING INFORMATION RELATED TO RESTAURANTS AND RECIPES IN THE FIELD OF GROWING FARM TO TABLE MOVEMENT (U.S. CLS. 100 AND 101).

FIRST USE 1-0-2005; IN COMMERCE 1-0-2005.

MATTHEW PAPPAS, EXAMINING ATTORNEY

SN 77-915,885. ROELICH, MOLLY S, LA CROSSE, WI. FILED 1-20-2010.

DoomsDay Tactical

THE MARK CONSISTS OF STANDARD CHARACTERS WITHOUT CLAIM TO ANY PARTICULAR FONT, STYLE, SIZE, OR COLOR.

NO CLAIM IS MADE TO THE EXCLUSIVE RIGHT TO USE "TACTICAL", APART FROM THE MARK AS SHOWN.

CLASS 13—FIREARMS

FOR BAGS SPECIALLY ADAPTED TO HOLD RIFLES; BANDOLIERS FOR HOLDING CARTRIDGES OR AMMUNITION CASES; CARTRIDGE BELTS; CARTRIDGE POUCHES; CASE COVERS FOR FIREARMS; CLEANING IMPLEMENTS FOR FIREARMS, NAMELY, PULL-THROUGHS; CLEANING RODS FOR FIREARMS; FIREARM ATTACHMENTS, NAMELY, MODULAR EXTERNAL RAIL SYSTEMS FOR ATTACHING ACCESSORIES TO FIREARMS; FIREARM ATTACHMENTS, NAMELY, MODULAR EXTERNAL RAIL SYSTEMS FOR FIREARMS; FIREARM ATTACHMENTS, NAMELY, MOUNTS FOR ATTACHING ACCESSORIES TO A FIREARM; FIREARM ATTACHMENTS, NAMELY, MOUNTS FOR ATTACHING ANCILLARY EQUIPMENT TO A FIREARM; FIREARM ATTACHMENTS, NAMELY, MOUNTS FOR ATTACHING GRIPS TO A FIREARM; FIREARM ATTACHMENTS, NAMELY, MOUNTS FOR ATTACHING GUN SIGHTS TO A FIREARM; FIREARM ATTACHMENTS, NAMELY, MOUNTS FOR ATTACHING LASER POINTING DEVICES TO A FIREARM; FIREARM ATTACHMENTS, NAMELY, MOUNTS FOR ATTACHING LIGHTS TO A FIREARM; FIREARM ATTACHMENTS, NAMELY, MOUNTS FOR ATTACHING NIGHT VISION DEVICES TO A FIREARM; FIREARM ATTACHMENTS, NAMELY, MOUNTS FOR ATTACHING TELESCOPIC SIGHTS TO A FIREARM; FIREARM HAND GUARDS; FIREARM SIGHTS; FIREARM SLINGS; GRIPS FOR SMALL ARMS; GUN AND RIFLE CASES; GUN CASES; GUN CLEANING BRUSHES; GUN MOUNTS; GUN STOCKS; GUNSIGHTS FOR FIREARMS; HOLSTERS; MAGAZINES FOR WEAPONS; MUZZLE BREAKS THAT SCREW ONTO A RIFLE BARREL; PISTOL CASES; PISTOL HOLSTERS; PULL-THROUGHS FOR SMALL ARMS; RIFLE CASES; RIFLE HAND GUARDS; RIFLE MOUNTS; RIFLE RAILS; RIFLE RINGS; RIFLE SHEATHS; RIFLE SLINGS; SHOOTING ACCESSORIES, NAMELY, GUN RESTS; SIGHTS, NAMELY, OPEN SIGHTS FOR USE ON FIREARMS; TRIPODS AND STANDS FOR FIREARMS (U.S. CLS. 2 AND 9).

CLASS 25—CLOTHING

FOR BASEBALL CAPS; BOOTS; CAMOUFLAGE GLOVES; CAMOUFLAGE JACKETS; CAMOUFLAGE PANTS; CAMOUFLAGE SHIRTS; CAMOUFLAGE VESTS; CAPS; CARGO PANTS; CLOTHING FOR ATHLETIC USE, NAMELY, PADDED ELBOW COMPRESSION SLEEVES BEING PART OF AN ATHLETIC GARMENT; CLOTHING FOR ATHLETIC USE, NAMELY, PADDED PANTS; CLOTHING FOR ATHLETIC USE, NAMELY, PADDED SHIRTS; CLOTHING FOR ATHLETIC USE, NAMELY, PADDED SHORTS; CLOTHING ITEMS, NAMELY, ADHESIVE POCKETS THAT MAY BE AFFIXED DIRECTLY TO THE BODY AS A DECORATIVE PIECE OF CLOTHING WITH UTILITY; CLOTHING ITEMS, NAMELY, ADHESIVE POCKETS THAT MAY BE AFFIXED DIRECTLY TO THE INSIDE OF CLOTHING FOR STORAGE AND SAFEKEEPING OF PERSONAL ITEMS; COMBATIVE SPORTS UNIFORMS; FLEECE PULLOVERS; FLEECE VESTS; GLOVES; HATS; HOODED PULLOVERS; HOODED SWEAT SHIRTS; HUNTING PANTS; HUNTING VESTS; JACKETS; OUTDOOR GLOVES; PANTS; POLO SHIRTS; PULLOVERS; RAINWEAR; SHIRTS; SHORTS; SPORTS PANTS; T-SHIRTS; TRAINING SUITS; UNIFORMS (U.S. CLS. 22 AND 39).

RUSS HERMAN, EXAMINING ATTORNEY

SN 77-916.061. IDEV TECHNOLOGIES, INC., WEBSTER, TX.
FILED 1-20-2010.

TRUTH IN TECHNOLOGY

THE MARK CONSISTS OF STANDARD CHARACTERS WITHOUT CLAIM TO ANY PARTICULAR FONT, STYLE, SIZE, OR COLOR.

NO CLAIM IS MADE TO THE EXCLUSIVE RIGHT TO USE "TECHNOLOGY", APART FROM THE MARK AS SHOWN.

CLASS 9—ELECTRICAL AND SCIENTIFIC APPARATUS

FOR DOWNLOADABLE ELECTRONIC PUBLICATIONS IN THE NATURE OF BROCHURES AND PAMPHLETS IN THE FIELD OF MEDICAL STENTS (U.S. CLS. 21, 23, 26, 36 AND 38).

CLASS 10—MEDICAL APPARATUS

FOR MEDICAL STENT, NAMELY, SELF EXPANDABLE NITINOL STENT (U.S. CLS. 26, 39 AND 44).

CLASS 25—CLOTHING

FOR CLOTHING, NAMELY, SHIRTS, T-SHIRTS, SWEAT SHIRTS, CAPS, HATS (U.S. CLS. 22 AND 39).

CLASS 41—EDUCATION AND ENTERTAINMENT

FOR EDUCATION SERVICES, NAMELY, PROVIDING ON-LINE VIDEOS IN THE FIELD OF MEDICAL STENTS (U.S. CLS. 100, 101 AND 107).

KYLE PEETE, EXAMINING ATTORNEY

SN 77-916.073. PROJECTS ABROAD INC., NEW YORK, NY.
FILED 1-20-2010.

Projects Abroad

THE MARK CONSISTS OF STANDARD CHARACTERS WITHOUT CLAIM TO ANY PARTICULAR FONT, STYLE, SIZE, OR COLOR.

SEC. 2(F).

CLASS 35—ADVERTISING AND BUSINESS

FOR ADVERTISING AND MARKETING SERVICES, NAMELY, PROMOTING THE GOODS AND SERVICES OF OTHERS (U.S. CLS. 100, 101 AND 102).

FIRST USE 1-1-2005; IN COMMERCE 1-1-2005.

CLASS 39—TRANSPORTATION AND STORAGE

FOR ORGANIZATION OF TRAVEL; ORGANIZATION OF EXCURSIONS, SIGHTSEEING TOURS, HOLIDAYS, AND TOURS (U.S. CLS. 100 AND 105).

FIRST USE 1-1-2005; IN COMMERCE 1-1-2005.

JILL C. ALT, EXAMINING ATTORNEY

SN 77-916,239. IDEV TECHNOLOGIES, INC., WEBSTER, TX.
FILED 1-20-2010.

TRUTH IN TECHNOLOGY

THE MARK CONSISTS OF STANDARD CHARACTERS WITHOUT CLAIM TO ANY PARTICULAR FONT, STYLE, SIZE, OR COLOR.

NO CLAIM IS MADE TO THE EXCLUSIVE RIGHT TO USE "TECHNOLOGY", APART FROM THE MARK AS SHOWN.

CLASS 16—PAPER GOODS AND PRINTED MATTER

FOR PRINTED MATERIALS, NAMELY, BROCHURES AND PAMPHLETS IN THE FIELD OF MEDICAL STENTS (U.S. CLS. 2, 5, 22, 23, 29, 37, 38 AND 50).

CLASS 44—MEDICAL, BEAUTY AND AGRICULTURAL SERVICES

FOR PROVIDING INFORMATION IN THE FIELD OF MEDICAL STENTS (U.S. CLS. 100 AND 101).
KYLE PEETE, EXAMINING ATTORNEY

SN 77-916,390. SIMPLE SELF DEFENSE FOR WOMEN,
DAYTONA BEACH SHORES, FL. FILED 1-20-2010.



NO CLAIM IS MADE TO THE EXCLUSIVE RIGHT TO USE "SELF DEFENSE FOR WOMEN", APART FROM THE MARK AS SHOWN.

THE COLOR(S) PINK, BLACK AND WHITE IS/ARE CLAIMED AS A FEATURE OF THE MARK.

THE MARK CONSISTS OF THE COLOR PINK IN THE LIP DESIGN, IN THE OUTER OUTLINE OF THE BOX, AND IN THE LETTERS AND WORDS "SIMPLE SELF DEFENSE FOR WOMEN", THE COLOR BLACK APPEARS IN THE HAIR, FACE, NECK AND EARRING DESIGNS, AND THE COLOR WHITE APPEARS IN THE BACKGROUND OF THE SQUARE BORDER DESIGN.

CLASS 9—ELECTRICAL AND SCIENTIFIC APPARATUS

FOR AUDIO RECORDINGS FEATURING SELF DEFENSE FOR WOMEN; DOWNLOADABLE VIDEO RECORDINGS FEATURING SELF DEFENSE FOR WOMEN; SOUND RECORDINGS FEATURING SELF DEFENSE FOR WOMEN; VIDEO RECORDINGS FEATURING SELF DEFENSE FOR WOMEN (U.S. CLS. 21, 23, 26, 36 AND 38).

CLASS 41—EDUCATION AND ENTERTAINMENT

FOR WORKSHOPS AND SEMINARS IN THE FIELD OF SELF DEFENSE FOR WOMEN (U.S. CLS. 100, 101 AND 107).

FIRST USE 9-26-2009; IN COMMERCE 9-26-2009.
ALEX KEAM, EXAMINING ATTORNEY

SN 77-916,565. CRODA INTERNATIONAL PLC, EAST YORKSHIRE, ENGLAND, FILED 1-21-2010.

SOLAVEIL SPEXTRA

THE MARK CONSISTS OF STANDARD CHARACTERS WITHOUT CLAIM TO ANY PARTICULAR FONT, STYLE, SIZE, OR COLOR.

CLASS 1—CHEMICALS

FOR CHEMICALS FOR USE IN INDUSTRY; CHEMICAL PRODUCTS FOR THE ATTENUATION OF ULTRAVIOLET RAYS (U.S. CLS. 1, 5, 6, 10, 26 AND 46).

CLASS 3—COSMETICS AND CLEANING PREPARATIONS

FOR COSMETIC PREPARATIONS AND SUBSTANCES ALL CONTAINING SUNSCREENS; SUNTANNING AND SUNSCREENING PREPARATIONS; NON-MEDICATED SUNBURN OINTMENTS; NON-MEDICATED SUNCARE PRODUCTS, NAMELY, NON-MEDICATED SUN CARE PREPARATIONS; COSMETIC SUN-PROTECTING PREPARATIONS, SUN BLOCK, SUN CREAMS, SUN SCREEN, AND SUN SCREEN PREPARATIONS; NON-MEDICATED PREPARATIONS FOR THE PREVENTION AND ALLEVIATION OF SUNBURN (U.S. CLS. 1, 4, 6, 50, 51 AND 52).

JANICE L. MCMORROW, EXAMINING ATTORNEY

SN 77-916,613. LINDA NICKEY ROSENTHAL, VILLANOVA, PA. FILED 1-21-2010.

PENNRose SERVICE COMPANY

THE MARK CONSISTS OF STANDARD CHARACTERS WITHOUT CLAIM TO ANY PARTICULAR FONT, STYLE, SIZE, OR COLOR.

NO CLAIM IS MADE TO THE EXCLUSIVE RIGHT TO USE "SERVICE COMPANY", APART FROM THE MARK AS SHOWN.

CLASS 35—ADVERTISING AND BUSINESS

FOR BUSINESS MANAGEMENT CONSULTANCY AS WELL AS DEVELOPMENT OF PROCESSES FOR THE ANALYSIS AND THE IMPLEMENTATION OF STRATEGY PLANS AND MANAGEMENT PROJECTS; PROJECT MANAGEMENT SERVICES (U.S. CLS. 100, 101 AND 102).

FIRST USE 4-18-1985; IN COMMERCE 4-18-1985.

CLASS 36—INSURANCE AND FINANCIAL

FOR REAL ESTATE SERVICES, NAMELY, RENTAL, BROKERAGE, LEASING, SALE AND MANAGEMENT OF COMMERCIAL PROPERTY, OFFICES AND OFFICE SPACE, HOMES, VACATION HOMES, CONDOMINIUMS, APARTMENTS; REAL ESTATE SERVICES, NAMELY, PROPERTY MANAGEMENT SERVICES FOR CONDOMINIUM ASSOCIATIONS, HOMEOWNER ASSOCIATIONS AND APARTMENT BUILDINGS (U.S. CLS. 100, 101 AND 102).

FIRST USE 4-18-1985; IN COMMERCE 4-18-1985.

CLASS 37—CONSTRUCTION AND REPAIR

FOR RESIDENTIAL AND BUILDING CONSTRUCTION CONSULTING; REAL ESTATE DEVELOPMENT AND CONSTRUCTION OF COMMERCIAL, RESIDENTIAL AND HOTEL PROPERTY; CONSTRUCTION, MAINTENANCE AND RENOVATION OF PROPERTY; CONSULTATION IN BUILDING CONSTRUCTION SUPERVISION; BUILDING CONSTRUCTION SUPERVISION (U.S. CLS. 100, 103 AND 106).

FIRST USE 4-18-1985; IN COMMERCE 4-18-1985.
ALICIA COLLINS, EXAMINING ATTORNEY

CLASS 25—CLOTHING

FOR (BASED ON INTENT TO USE) BOTTOMS; CLOTHING FOR WEAR IN JUDO PRACTICES; LEOTARDS AND TIGHTS FOR WOMEN, MEN AND CHILDREN OF NYLON, COTTON OR OTHER TEXTILE FIBERS; MAILLOTS; SHORT SETS; TIGHTS; TOPS (U.S. CLS. 22 AND 39).

CLASS 30—STAPLE FOODS

FOR (BASED ON INTENT TO USE) HERBAL FOOD BEVERAGES (U.S. CL. 46).

CLASS 44—MEDICAL, BEAUTY AND AGRICULTURAL SERVICES

FOR (BASED ON USE IN COMMERCE) CONSULTING TO INDIVIDUALS AND COMMUNITIES ENGAGED IN GROUP WEIGHT LOSS PROGRAMS; HEALTH ASSESSMENT SERVICES, NAMELY, PROVIDING METABOLIC ASSESSMENT PROFILES (MAP) TO CLIENTS OBTAINED BY USING A PORTABLE METABOLIC MEASUREMENT SYSTEM IN THE NATURE OF A UNIQUE, HEART-RATE BASED OVERVIEW OF THEIR OWN METABOLISM IN ORDER TO ASSIST IN REACHING WEIGHT LOSS, SPORTS PERFORMANCE, HEALTH, FITNESS, AND WELLNESS-RELATED GOALS; PROVIDING INFORMATION ON MAINTAINING A HEALTHY LIFESTYLE AND LOSING WEIGHT; PROVIDING LASER THERAPY FOR TREATING NICOTINE ADDICTION AND AIDING IN WEIGHT LOSS; PROVIDING WEIGHT LOSS PROGRAM SERVICES; WEIGHT REDUCTION DIET PLANNING AND SUPERVISION (BASED ON INTENT TO USE) PROVIDING INFORMATION IN THE FIELD OF SURGICAL WEIGHT LOSS (U.S. CLS. 100 AND 101).

FIRST USE 0-0-2008; IN COMMERCE 0-0-2008.
JESSICA A. POWERS, EXAMINING ATTORNEY

SN 77-916,688. SU, FENGSHUN, MAUMEE, OH. FILED 1-21-2010.



THE COLOR(S) GREEN AND VIOLET IS/ARE CLAIMED AS A FEATURE OF THE MARK.

THE MARK CONSISTS OF THE MAJOR LINE IN THE MARK IS GREEN, AND IT IS A VARIANT OF LETTER COMBINATION OF "QUZI". INSIDE OF THE GREEN CIRCLE IS A VIOLET FIGURE. IT SYMBOLIZES THE SHAPE OF A WOMAN.

THE ENGLISH TRANSLATION OF THE WORD "QUZI" IN THE MARK IS "CURVE" AND "APPEARANCE".

CLASS 3—COSMETICS AND CLEANING PREPARATIONS

FOR (BASED ON INTENT TO USE) AROMATHERAPY OIL; AROMATHERAPY OILS; BEAUTY CREAMS; BODY CREAMS; BODY OIL; COSMETIC OILS; ESSENTIAL OILS; MASSAGE CREAMS; MASSAGE LOTIONS; MASSAGE OIL; MASSAGE OILS (U.S. CLS. 1, 4, 6, 50, 51 AND 52).

CLASS 5—PHARMACEUTICALS

FOR (BASED ON INTENT TO USE) DIETARY AND NUTRITIONAL SUPPLEMENTS; DIETARY FOOD SUPPLEMENTS; NUTRITIONAL ADDITIVES FOR MEDICAL PURPOSES FOR USE IN FOODS AND DIETARY SUPPLEMENTS FOR HUMAN CONSUMPTION; RECTALLY ADMINISTERED AGENTS FOR WEIGHT CONTROL AND APPETITE SUPPRESSION; STIMULATORY MEDICATIONS FOR USE IN WEIGHT REDUCTION PROGRAMS; WEIGHT MANAGEMENT SUPPLEMENTS (U.S. CLS. 6, 18, 44, 46, 51 AND 52).

SN 77-917,315. GOURMET SPECIALTY FOODS, LAWTON, OK. FILED 1-21-2010.



NO CLAIM IS MADE TO THE EXCLUSIVE RIGHT TO USE "GOURMET SPECIALTY FOODS", APART FROM THE MARK AS SHOWN.

THE MARK CONSISTS OF TWO LIONS, ONE HOLDING A FORK AND ONE HOLDING A SPOON. THE LIONS ARE STANDING ON A PLATFORM, THE LITERAL ELEMENT OF THE MARK "GOURMET SPECIALTY FOODS" IS STYLIZED UNDERNEATH WITH STYLIZED LINING UNDERNEATH THE WORDING "SPECIALTY FOODS".

CLASS 29—MEATS AND PROCESSED FOODS

FOR CONDIMENTS, NAMELY, PEPPER OIL; FRUIT-BASED SPREADS; JAMS; JELLIES; PICKLED VEGETABLES; PROCESSED OLIVES WITH PEPPERCORNS (U.S. CL. 46).

CLASS 30—STAPLE FOODS

FOR BARBECUE SAUCE; BREAD MIXES; CAKE MIXES; CANDY; CANDY SPRINKLES; CHEESE SAUCE; CHUTNEYS; COCOA MIXES; COCOA-BASED CONDIMENTS AND SEASONINGS FOR FOOD AND DRINK; CONDIMENT, NAMELY, PEPPER SAUCE; COOKIE MIXES; DIPPING SAUCES; EDIBLE CUPCAKE LINERS THAT BAKE ONTO THE CUPCAKE ITSELF; FOOD CONDIMENT CONSISTING PRIMARILY OF KETCHUP AND SALSA; FOOD SEASONINGS; ICING; MUSTARD; PICKLED GINGER; PIMIENTO USED AS A CONDIMENT; PREPARED HORSERADISH; RELISH; SALSA; SAUCES; SEA SALT FOR COOKING; SOYA BEAN PASTE; SPICES; SUGAR (U.S. CL. 46).

ALICIA COLLINS, EXAMINING ATTORNEY

SN 77-917,475. MCGHEE, MELISSA, ENCINITAS, CA. FILED 1-22-2010.

OctoberBreast

THE MARK CONSISTS OF STANDARD CHARACTERS WITHOUT CLAIM TO ANY PARTICULAR FONT, STYLE, SIZE, OR COLOR.

CLASS 36—INSURANCE AND FINANCIAL

FOR CHARITABLE FUNDRAISING SERVICES BY MEANS OF SELLING T-SHIRTS TO RAISE FUNDS FOR BREAST CANCER RESEARCH AND SUPPORT (U.S. CLS. 100, 101 AND 102).

CLASS 41—EDUCATION AND ENTERTAINMENT

FOR ORGANIZING COMMUNITY FESTIVALS FEATURING A VARIETY OF ACTIVITIES, NAMELY, SPORTING EVENTS, ART EXHIBITIONS, FLEA MARKETS, ETHNIC DANCES AND THE LIKE (U.S. CLS. 100, 101 AND 107).

KEVIN CORWIN, EXAMINING ATTORNEY

SN 77-917,757. LUITPOLD PHARMACEUTICALS, INC., SHIRLEY, NY. FILED 1-22-2010.

DENTAGENETICS

THE MARK CONSISTS OF STANDARD CHARACTERS WITHOUT CLAIM TO ANY PARTICULAR FONT, STYLE, SIZE, OR COLOR.

OWNER OF U.S. REG. NO. 3,354,483.

CLASS 5—PHARMACEUTICALS

FOR NATURAL BONE MATERIAL FOR USE IN PERIODONTAL, MAXILLOFACIAL, DENTAL AND ORAL SURGERY AND PROCEDURES, NAMELY, HYDROXYAPATITE FROM AN ORGANIC BOVINE BONE; COLLAGEN MEMBRANE FOR GUIDED BONE AND TISSUE REGENERATION FOR DENTAL, PERIODONTAL AND ORTHOPEDIC APPLICATIONS (U.S. CLS. 6, 18, 44, 46, 51 AND 52).

CLASS 10—MEDICAL APPARATUS

FOR BIORESORBABLE PINS USED IN DENTAL, ORTHODONTIC, PERIODONTAL, MAXILLOFACIAL AND ORAL SURGERY AND PROCEDURES (U.S. CLS. 26, 39 AND 44).

JOSETTE BEVERLY, EXAMINING ATTORNEY

SN 77-917,985. LPKF LASER & ELECTRONICS AG, 30827 GARBSEN, FED REP GERMANY, FILED 1-22-2010.

LPKF PROTOMAT

THE MARK CONSISTS OF STANDARD CHARACTERS WITHOUT CLAIM TO ANY PARTICULAR FONT, STYLE, SIZE, OR COLOR.

OWNER OF FED REP GERMANY REG. NO. DE1130207, DATED 11-8-1988, EXPIRES 2-5-2018.

CLASS 7—MACHINERY

FOR MACHINERY AND MECHANICALLY OPERATED EQUIPMENT FOR THE MILLING AND DRILLING OF PRINTED CIRCUIT BOARDS, ALSO ELECTRONICALLY CONTROLLED; PARTS OF THE AFORESAID APPARATUS AND EQUIPMENT (U.S. CLS. 13, 19, 21, 23, 31, 34 AND 35).

CLASS 9—ELECTRICAL AND SCIENTIFIC APPARATUS

FOR MACHINE-READABLE DATA CARRIERS CONTAINING PROGRAMS FOR CONTROLLING MACHINERY AND MECHANICALLY OPERATED EQUIPMENT (ALSO ELECTRONICALLY CONTROLLED) FOR THE MILLING AND DRILLING OF PRINTED CIRCUIT BOARDS; ELECTRICAL PRINTED CIRCUIT BOARDS (U.S. CLS. 21, 23, 26, 36 AND 38).

WILLIAM P. SHANAHAN, EXAMINING ATTORNEY

SN 77-918,964. TOTAL STRATEGY LTD, LANCASTER, UNITED KINGDOM, FILED 1-25-2010.



THE MARK CONSISTS OF A DRAGON ON A SHADED OVAL BACKGROUND. THE WORDING "TOTAL STRATEGY" IS SUPERIMPOSED OVER THE LOWER PORTION OF THE DRAGON.

CLASS 9—ELECTRICAL AND SCIENTIFIC APPARATUS

FOR COMPUTER GAME PROGRAMS; COMPUTER GAME SOFTWARE; COMPUTER GAME SOFTWARE DOWNLOADABLE FROM A GLOBAL COMPUTER NETWORK; COMPUTER GAME SOFTWARE FOR PERSONAL COMPUTERS AND HOME VIDEO GAME CONSOLES; COMPUTER GAME SOFTWARE FOR USE ON MOBILE AND CELLULAR PHONES; COMPUTER SOFTWARE AND FIRMWARE FOR GAMES OF CHANCE ON ANY COMPUTERIZED PLATFORM, INCLUDING DEDICATED GAMING CONSOLES, VIDEO BASED SLOT MACHINES, REEL BASED SLOT MACHINES, AND VIDEO LOTTERY TERMINALS; COMPUTER SOFTWARE, NAMELY, GAME ENGINE SOFTWARE FOR VIDEO GAME DEVELOPMENT AND OPERATION; DOWNLOADABLE COMPUTER GAME PROGRAMS; DOWNLOADABLE COMPUTER GAME SOFTWARE VIA A GLOBAL COMPUTER NETWORK AND WIRELESS DEVICES; DOWNLOADABLE COMPUTER PROGRAMS FEATURING POSITIONABLE GAME PIECE FIGURES FOR USE IN THE FIELD OF COMPUTER GAMES; ELECTRONIC GAME SOFTWARE FOR CELLULAR TELEPHONES; ELECTRONIC GAME SOFTWARE FOR WIRELESS DEVICES; INTERACTIVE GAME SOFTWARE (U.S. CLS. 21, 23, 26, 36 AND 38).

CLASS 28—TOYS AND SPORTING GOODS

FOR BOARD GAMES (U.S. CLS. 22, 23, 38 AND 50).
ALICIA COLLINS, EXAMINING ATTORNEY

SN 77-919,090. TELMAR NETWORK TECHNOLOGY, INC., PLANO, TX. FILED 1-25-2010.



NO CLAIM IS MADE TO THE EXCLUSIVE RIGHT TO USE "SOLUTIONS", APART FROM THE MARK AS SHOWN.

THE MARK CONSISTS OF THE WORDS "OEM-EXL" AND "SOLUTIONS" WITH "OEM-EXL" APPEARING IN BLOCK LETTERING IMMEDIATELY ABOVE "SOLUTIONS." A DESIGN ELEMENT IS POSITIONED TO THE LEFT OF THOSE TERMS, COMPROMISING TWO CIRCLES. THE LARGER CIRCLE IS IN FRONT OF AND COVERING HALF OF THE SMALLER CIRCLE.

CLASS 9—ELECTRICAL AND SCIENTIFIC APPARATUS

FOR AUTOMATIC SWITCHING APPARATUS; BROADBAND WIRELESS EQUIPMENT, NAMELY, TELECOMMUNICATIONS BASE STATION EQUIPMENT FOR CELLULAR AND FIXED NETWORKING AND COMMUNICATIONS APPLICATIONS; COMPUTER HARDWARE FOR TELECOMMUNICATIONS; TELECOMMUNICATION SWITCHES; TELECOMMUNICATIONS AND DATA NETWORKING HARDWARE, NAMELY, DEVICES FOR TRANSPORTING AND AGGREGATING VOICE, DATA, AND VIDEO COMMUNICATIONS ACROSS MULTIPLE NETWORK INFRASTRUCTURES AND COMMUNICATIONS PROTOCOLS (U.S. CLS. 21, 23, 26, 36 AND 38).

FIRST USE 3-6-2009; IN COMMERCE 3-6-2009.

CLASS 37—CONSTRUCTION AND REPAIR

FOR MAINTENANCE AND REPAIR OF TELECOMMUNICATIONS NETWORKING HARDWARE, APPARATUS, AND INSTRUMENTS; REPAIR OF TELECOMMUNICATION MACHINES AND APPARATUS; REPAIR OR MAINTENANCE OF TELECOMMUNICATION MACHINES AND APPARATUS (U.S. CLS. 100, 103 AND 106).

FIRST USE 3-6-2009; IN COMMERCE 3-6-2009.

CLASS 38—COMMUNICATION

FOR TELECOMMUNICATIONS CONSULTATION (U.S. CLS. 100, 101 AND 104).

FIRST USE 3-6-2009; IN COMMERCE 3-6-2009.

CLASS 39—TRANSPORTATION AND STORAGE

FOR WAREHOUSE STORAGE (U.S. CLS. 100 AND 105).

FIRST USE 3-6-2009; IN COMMERCE 3-6-2009.

CLASS 42—SCIENTIFIC AND COMPUTER SERVICES

FOR CONSULTING IN THE FIELD OF TELECOMMUNICATIONS TECHNOLOGY; ENGINEERING SERVICES, NAMELY, ENGINEERING FOR THE SOFTWARE DEVELOPMENT AND PROGRAMMING FOR OTHERS; UPDATING SOFTWARE FOR OTHERS; SERVICES RENDERED TO THE TELEPHONE INDUSTRY, NAMELY, FUNCTIONAL TESTING OF TELEPHONE EQUIPMENT; RESEARCH SERVICES IN THE FIELD OF INFORMATION AND TELECOMMUNICATIONS TECHNOLOGY (U.S. CLS. 100 AND 101).

FIRST USE 3-6-2009; IN COMMERCE 3-6-2009.

ARETHA SOMERVILLE, EXAMINING ATTORNEY

SN 77-919,190. BOWERY BOY PRODUCTIONS LLC, GARWOOD, NJ. FILED 1-25-2010.



NO CLAIM IS MADE TO THE EXCLUSIVE RIGHT TO USE "BAKE", APART FROM THE MARK AS SHOWN.

THE MARK CONSISTS OF THE WORDS "THE BAKE SPOT" FOLLOWING THE FORM OF AN UPSIDE-DOWN "U" WITH A CUPCAKE IN THE CENTER OF IT. THE CUPCAKE HAS ICING WITH SPRINKLES LAYERED ON TOP OF A SCALLOPED CIRCLE. IN THE CENTER OF EVERY SINGLE SCALLOP, THERE IS A POLKA DOT. THERE IS AN OUTSIDE RING THAT ENCLOSES THE SCALLOPED EDGES.

CLASS 30—STAPLE FOODS

FOR CAKES; COOKIES; CUP CAKES; PIES (U.S. CL. 46).

CLASS 35—ADVERTISING AND BUSINESS

FOR RETAIL BAKERY SHOPS; TAKE-OUT BAKERY SERVICES (U.S. CLS. 100, 101 AND 102).
FRED CARL, EXAMINING ATTORNEY

SN 77-919,816. CONNECT THE DOTS FOUNDATION, SAN FRANCISCO, CA. FILED 1-25-2010.

TWESTIVAL

THE MARK CONSISTS OF STANDARD CHARACTERS WITHOUT CLAIM TO ANY PARTICULAR FONT, STYLE, SIZE, OR COLOR.

CLASS 35—ADVERTISING AND BUSINESS

FOR CHARITABLE SERVICES, NAMELY, ORGANIZING VOLUNTEER PARTICIPATION IN CHARITABLE EVENTS WORLDWIDE, INCLUDING NOTIFICATION OF VOLUNTEERS OF LOCAL OPPORTUNITIES TO CONTRIBUTE TO CHARITABLE INITIATIVES AND MATCHING SKILLS OF VOLUNTEERS WITH THE NEEDS OF CHARITABLE ORGANIZATIONS, VIA THE INTERNET AND THROUGH SOCIAL NETWORKING AND ELECTRONIC COMMUNICATIONS MEDIUMS; CHARITABLE SERVICES, NAMELY, ORGANIZING AND CONDUCTING CHARITABLE PROJECTS; BUSINESS CONSULTING AND INFORMATION SERVICES FOR NON-PROFIT AND CHARITABLE ORGANIZATIONS AND COORDINATING VOLUNTEER REFERRALS FOR THE SAME (U.S. CLS. 100, 101 AND 102).
FIRST USE 1-8-2009; IN COMMERCE 1-8-2009.

CLASS 36—INSURANCE AND FINANCIAL

FOR CHARITABLE FUNDRAISING SERVICES (U.S. CLS. 100, 101 AND 102).
FIRST USE 1-8-2009; IN COMMERCE 1-8-2009.
JORDAN BAKER, EXAMINING ATTORNEY

SN 77-920,192. PICTURETHIS ???, SOUTH KENT, CT. FILED 1-26-2010.

PERCEPTIONDECEPTION

THE MARK CONSISTS OF STANDARD CHARACTERS WITHOUT CLAIM TO ANY PARTICULAR FONT, STYLE, SIZE, OR COLOR.

CLASS 9—ELECTRICAL AND SCIENTIFIC APPARATUS

FOR ELECTRONIC PUBLICATIONS, NAMELY, BOOKS FEATURING PICTURES RECORDED ON COMPUTER MEDIA; DOWNLOADABLE ELECTRONIC PUBLICATIONS IN THE NATURE OF PICTURE BOOKS (U.S. CLS. 21, 23, 26, 36 AND 38).

CLASS 16—PAPER GOODS AND PRINTED MATTER

FOR COFFEE TABLE BOOKS FEATURING PICTURES; PICTURE BOOKS (U.S. CLS. 2, 5, 22, 23, 29, 37, 38 AND 50).
MARY CRAWFORD, EXAMINING ATTORNEY

SN 77-921,643. NEFF, SHAUN M., CAMARILLO, CA. AND NEFF, JOE W., CAMARILLO, CA. FILED 1-27-2010.



OWNER OF U.S. REG. NO. 3,569,666.
THE MARK CONSISTS OF A ROUND SMILING FACE SHOWING AN EXPOSED TONGUE, ROUND EYES, AN UP SLANTED SLIT NOSE AND SWEEPING HAIR WITH THE LETTERS "NEFF" IN STYLIZED LETTERING BELOW THE FACE.

CLASS 9—ELECTRICAL AND SCIENTIFIC APPARATUS

FOR EYEWEAR, EYEGLASSES, SUNGLASSES; FRAMES, LENSES AND PROTECTIVE CASES FOR EYEWEAR, EYEGLASSES, SUNGLASSES AND GOGGLES; SNOW GOGGLES; SPORT GOGGLES FOR USE IN SNOWBOARDING; SKI GLASSES; ANTI-GLARE GLASSES; EYEWEAR ACCESSORIES, NAMELY, STRAPS, NECK CORDS, CHAINS AND HEAD STRAPS; PROTECTIVE HELMETS FOR SNOWBOARDING AND SKATEBOARDING; HEADPHONES; EARPHONES; KNIT COVERS FOR HEADPHONES; MP3 PLAYERS; CD PLAYERS; PROTECTIVE CARRYING CASES FOR MP3 PLAYERS, CD PLAYERS, CELL PHONES, LAPTOPS, COMPUTERS, PORTABLE SATELLITE RADIOS AND PERSONAL DIGITAL ASSISTANTS; SPORTS EQUIPMENT FOR SNOWBOARDING, NAMELY, SNOWBOARD HELMETS (U.S. CLS. 21, 23, 26, 36 AND 38).

CLASS 14—JEWELRY

FOR JEWELRY, NAMELY, BRACELETS, RINGS, NECKLACES, PENDANTS, EARRINGS, PINS, AMULETS, BROOCHES, CHAINS AND CHARMS; GOODS IN PRECIOUS METALS OR COATED THEREWITH, NAMELY, JEWELRY BOXES, JEWELRY CASES; HOROLOGICAL AND CHRONOMETRIC INSTRUMENTS, NAMELY, WATCHES, WRIST WATCHES, POCKET WATCHES, STOP WATCHES, DIVING WATCHES, PENDANT WATCHES, BRACELET WATCHES AND CLOCKS; WATCH BANDS; WATCH STRAPS; WATCH CHAINS; CASES FOR WATCHES; CASES FOR CLOCKS (U.S. CLS. 2, 27, 28 AND 50).

CLASS 18—LEATHER GOODS

FOR BACKPACKS, KNAPSACKS, DAYPACKS, FANNY PACKS, MESSENGER BAGS, HANDBAGS, SHOULDER BAGS, TOTE BAGS, DUFFEL BAGS, OVERNIGHT BAGS, ATHLETIC BAGS, CARRY-ON BAGS AND LUGGAGE, WALLETS, PURSES, COIN PURSES, CLUTCH PURSES, KEY CASES, LEATHER KEY CHAINS, COSMETICS CASES SOLD EMPTY, TOILETRY BAGS SOLD EMPTY; GOODS IN PRECIOUS METALS OR COATED THEREWITH, NAMELY, VANITY CASES SOLD EMPTY (U.S. CLS. 1, 2, 3, 22 AND 41).

CLASS 28—TOYS AND SPORTING GOODS

FOR PROTECTIVE PADDING FOR SNOWBOARDING; PROTECTIVE PADDING FOR SKATEBOARDING; SPORTS EQUIPMENT FOR SNOWBOARDING; NAMELY, SNOWBOARD GLOVES; WINDSURFING GLOVES; SKI POLES; BAGS FOR SNOWBOARDS; BAGS FOR SURFBOARDS; BAGS FOR SKATEBOARDS; BAGS FOR WINDSURFING EQUIPMENT; SNOWBOARDS; SKATEBOARDS; SURFBOARDS; PADDLE BOARDS; SNOWBOARD BINDINGS; SNOWBOARD DECKS; SKATEBOARD DECKS; SKATEBOARD GRIP TAPES; SURFBOARD LEASHES; SKIS; WATER SKIS; WATERSKI TOW HARNESSSES; SNOWBOARD WAX; SKI WAX; SURFBOARD WAX (U.S. CLS. 22, 23, 38 AND 50).

JAMES A. RAUEN, EXAMINING ATTORNEY

SN 77-922,160. WILLOW HOTELS LLC, NEW YORK, NY. FILED 1-28-2010.

WILLOW HOTEL CLUB

THE MARK CONSISTS OF STANDARD CHARACTERS WITHOUT CLAIM TO ANY PARTICULAR FONT, STYLE, SIZE, OR COLOR.

NO CLAIM IS MADE TO THE EXCLUSIVE RIGHT TO USE "HOTEL CLUB", APART FROM THE MARK AS SHOWN.

CLASS 35—ADVERTISING AND BUSINESS

FOR OPERATING AND MANAGING HOTELS FOR OTHERS; MARKETING, STRATEGIC PLANNING AND BUSINESS MANAGEMENT CONSULTING SERVICES PROVIDED TO THE HOTEL, LODGING, RESORT, EXTENDED STAY FACILITIES, RESTAURANTS, CATERING AND BANQUET SERVICE INDUSTRIES; OPERATING AND MANAGING PROGRAMS IN THE NATURE OF DESTINATION CLUBS, VACATION CLUBS, AND EXTENDED STAY FACILITIES PROGRAMS (U.S. CLS. 100, 101 AND 102).

SN 77-921,697. KAIA F.I.T., MINDEN, NV. FILED 1-27-2010.

Kaia F.I.T.

THE MARK CONSISTS OF STANDARD CHARACTERS WITHOUT CLAIM TO ANY PARTICULAR FONT, STYLE, SIZE, OR COLOR.

CLASS 43—HOTEL AND RESTAURANT SERVICES

FOR CONSULTING SERVICES FOR OTHERS IN THE FIELD OF HOTEL SERVICES, RESORT LODGING SERVICES, EXTENDED STAY HOTEL SERVICES, RESTAURANT SERVICES, CATERING SERVICES, AND PROVIDING BANQUET FACILITIES FOR SPECIAL OCCASIONS (U.S. CLS. 100 AND 101).

JACQUELINE A. LAVINE, EXAMINING ATTORNEY

CLASS 5—PHARMACEUTICALS

FOR (BASED ON INTENT TO USE) DIETARY SUPPLEMENTS (U.S. CLS. 6, 18, 44, 46, 51 AND 52).

SN 77-922,166. WILLOW HOTELS LLC, NEW YORK, NY. FILED 1-28-2010.

WILLOW HOTEL CLUBS**CLASS 25—CLOTHING**

FOR (BASED ON INTENT TO USE) GOLF SHIRTS; LONG-SLEEVED SHIRTS; SHIRTS; SHORTS; SPORT SHIRTS; SPORTS BRA; SWEAT JACKETS; SWEAT PANTS; SWEAT SHIRTS; SWEAT SHORTS; SWEAT SUITS; T-SHIRTS; TANK TOPS; YOGA SHIRTS (U.S. CLS. 22 AND 39).

CLASS 28—TOYS AND SPORTING GOODS

FOR (BASED ON INTENT TO USE) EXERCISE WEIGHTS; PERSONAL EXERCISE MATS; STRETCH BANDS USED FOR YOGA AND PHYSICAL FITNESS PURPOSES; WEIGHT LIFTING GLOVES; YOGA MATS (U.S. CLS. 22, 23, 38 AND 50).

THE MARK CONSISTS OF STANDARD CHARACTERS WITHOUT CLAIM TO ANY PARTICULAR FONT, STYLE, SIZE, OR COLOR.

NO CLAIM IS MADE TO THE EXCLUSIVE RIGHT TO USE "HOTEL CLUBS", APART FROM THE MARK AS SHOWN.

CLASS 41—EDUCATION AND ENTERTAINMENT

FOR (BASED ON USE IN COMMERCE) EDUCATIONAL SERVICES, NAMELY, PROVIDING CERTIFICATION CLASSES IN THE FIELDS OF FITNESS AND PHYSICAL TRAINING; PHYSICAL FITNESS CONDITIONING CLASSES; PHYSICAL FITNESS INSTRUCTION; PHYSICAL FITNESS TRAINING SERVICES (U.S. CLS. 100, 101 AND 107).

FIRST USE 1-10-2010; IN COMMERCE 1-10-2010.
HENRY S. ZAK, EXAMINING ATTORNEY

CLASS 35—ADVERTISING AND BUSINESS

FOR OPERATING AND MANAGING HOTELS FOR OTHERS; MARKETING, STRATEGIC PLANNING AND BUSINESS MANAGEMENT CONSULTING SERVICES PROVIDED TO THE HOTEL, LODGING, RESORT, EXTENDED STAY FACILITIES, RESTAURANTS, CATERING AND BANQUET SERVICE INDUSTRIES; OPERATING AND MANAGING PROGRAMS IN THE NATURE OF DESTINATION CLUBS, VACATION CLUBS, AND EXTENDED STAY FACILITIES PROGRAMS (U.S. CLS. 100, 101 AND 102).

CLASS 43—HOTEL AND RESTAURANT SERVICES

FOR CONSULTING SERVICES FOR OTHERS IN THE FIELD OF HOTEL SERVICES, RESORT LODGING SERVICES, EXTENDED STAY HOTEL SERVICES, RESTAURANT SERVICES, CATERING SERVICES, AND PROVIDING BANQUET FACILITIES FOR SPECIAL OCCASIONS (U.S. CLS. 100 AND 101).
JACQUELINE A. LAVINE, EXAMINING ATTORNEY

SN 77-922,222. AMERICA'S CAPITAL PARTNERS, LLC, MIAMI, FL. FILED 1-28-2010.



THE MARK CONSISTS OF A WHITE CRESCENT LIKE DESIGN AGAINST A BLACK BACKGROUND.

CLASS 36—INSURANCE AND FINANCIAL

FOR REAL ESTATE BROKERAGE, REAL ESTATE INVESTMENT SERVICES, REAL ESTATE MANAGEMENT AND LEASING SERVICES; REAL ESTATE ASSET MANAGEMENT SERVICES (U.S. CLS. 100, 101 AND 102).
FIRST USE 6-30-1998; IN COMMERCE 6-30-1998.

CLASS 37—CONSTRUCTION AND REPAIR

FOR REAL ESTATE DEVELOPMENT AND CONSTRUCTION SERVICES (U.S. CLS. 100, 103 AND 106).
FIRST USE 6-30-1998; IN COMMERCE 6-30-1998.
LINDA MICKLEBURGH, EXAMINING ATTORNEY

SN 77-922,288. MIZ LOLA'S SPIRITS & GAMING, LLC, HENDERSON, NV. FILED 1-28-2010.



NO CLAIM IS MADE TO THE EXCLUSIVE RIGHT TO USE "SPIRITS & GAMING", APART FROM THE MARK AS SHOWN.

THE MARK CONSISTS OF A STYLIZED CASINO CHIP AND STYLIZED WORDS.

CLASS 41—EDUCATION AND ENTERTAINMENT

FOR CASINO SERVICES (U.S. CLS. 100, 101 AND 107).

CLASS 43—HOTEL AND RESTAURANT SERVICES

FOR COCKTAIL LOUNGE SERVICES (U.S. CLS. 100 AND 101).
LINDA ORNDORFF, EXAMINING ATTORNEY

SN 77-922,671. GAMAKATSU USA, INC., TACOMA, WA. FILED 1-28-2010.

GAMAKATSU

THE MARK CONSISTS OF STANDARD CHARACTERS WITHOUT CLAIM TO ANY PARTICULAR FONT, STYLE, SIZE, OR COLOR.

OWNER OF U.S. REG. NO. 2,067,199.

CLASS 25—CLOTHING

FOR SHIRTS, HATS, RAIN GEAR, JACKETS (U.S. CLS. 22 AND 39).
FIRST USE 0-0-1992; IN COMMERCE 0-0-1992.

CLASS 28—TOYS AND SPORTING GOODS

FOR FISHING HOOKS (01/24/1984), FISHING LINES (1997), FISHING FLOATS (2005), FISHING SWIVELS (2006) (U.S. CLS. 22, 23, 38 AND 50).
FIRST USE 1-24-1984; IN COMMERCE 1-24-1984.
REGINA DRUMMOND, EXAMINING ATTORNEY

SN 77-922,800. ANIMETWORK.TV LLC, NEW YORK, NY. FILED 1-28-2010.

ANIMETWORK

THE MARK CONSISTS OF STANDARD CHARACTERS WITHOUT CLAIM TO ANY PARTICULAR FONT, STYLE, SIZE, OR COLOR.

CLASS 41—EDUCATION AND ENTERTAINMENT

FOR ENTERTAINMENT SERVICES, NAMELY, AN ON-GOING SERIES FEATURING ANIMATION PROVIDED THROUGH CABLE TELEVISION AND WEBCASTS; MOTION PICTURE FILM PRODUCTION (U.S. CLS. 100, 101 AND 107).
FIRST USE 8-5-2009; IN COMMERCE 8-5-2009.

CLASS 42—SCIENTIFIC AND COMPUTER SERVICES

FOR PROVIDING AN INTERACTIVE WEB SITE FEATURING TEMPORARY USE OF NON-DOWNLOADABLE SOFTWARE ALLOWING WEB SITE USERS TO CREATE AND DIRECT THEIR OWN WEBISODE SERIES OF ANIMATION UTILIZING THE CHARACTERS AND TOOLS PROVIDED THROUGH THE NON-DOWNLOADABLE SOFTWARE, FOR ENTERTAINMENT PURPOSES (U.S. CLS. 100 AND 101).

FIRST USE 8-5-2009; IN COMMERCE 8-5-2009.

ADA HAN, EXAMINING ATTORNEY

SN 77-922,836. KIRKOU, NICK, ST. LOUIS, MO. FILED 1-28-2010.

AMERICA FIRST

THE MARK CONSISTS OF STANDARD CHARACTERS WITHOUT CLAIM TO ANY PARTICULAR FONT, STYLE, SIZE, OR COLOR.

CLASS 16—PAPER GOODS AND PRINTED MATTER

FOR PRINTED PROMOTIONAL ITEMS, NAMELY, CALENDARS, ART REPRODUCTIONS, ADVERTISING BOARDS, FORMS, STICKERS, BUMPER STICKERS, SIGNS, PROMOTIONAL MAGAZINES, BOOKS, NEWSLETTERS, PERIODICALS, AND BROCHURES CONTAINING ADVERTISING FOR PRODUCTS AND SERVICES, LABELS, AND TICKETS (U.S. CLS. 2, 5, 22, 23, 29, 37, 38 AND 50).

CLASS 25—CLOTHING

FOR CLOTHING, NAMELY, SHIRTS, T-SHIRTS, JACKETS, JERSEYS, POLO SHIRTS, PANTS, SHORTS, HEADBANDS, GLOVES, HATS, AND CAPS (U.S. CLS. 22 AND 39).

CLASS 35—ADVERTISING AND BUSINESS

FOR ADVERTISING AND PROMOTIONAL SERVICES (U.S. CLS. 100, 101 AND 102).
BRIAN NEVILLE, EXAMINING ATTORNEY

SN 77-922,990. WHATSAPP INC., SANTA CLARA, CA. FILED 1-28-2010.

Zap Messenger

THE MARK CONSISTS OF STANDARD CHARACTERS WITHOUT CLAIM TO ANY PARTICULAR FONT, STYLE, SIZE, OR COLOR.

NO CLAIM IS MADE TO THE EXCLUSIVE RIGHT TO USE "MESSENGER", APART FROM THE MARK AS SHOWN.

CLASS 9—ELECTRICAL AND SCIENTIFIC APPARATUS

FOR WIRELESS COMMUNICATION DEVICE FEATURING VOICE, DATA AND IMAGE TRANSMISSION INCLUDING VOICE, TEXT AND PICTURE MESSAGING, A VIDEO AND STILL IMAGE CAMERA, ALSO FUNCTIONAL TO PURCHASE MUSIC, GAMES, VIDEO AND SOFTWARE APPLICATIONS OVER THE AIR FOR DOWNLOADING TO THE DEVICE (U.S. CLS. 21, 23, 26 AND 38).

CLASS 42—SCIENTIFIC AND COMPUTER SERVICES

FOR APPLICATION SERVICE PROVIDER, NAMELY, PROVIDING, HOSTING, MANAGING, DEVELOPING, AND MAINTAINING APPLICATIONS, SOFTWARE, WEB SITES, AND DATABASES IN THE FIELDS OF PERSONAL PRODUCTIVITY, WIRELESS COMMUNICATION, MOBILE INFORMATION ACCESS, AND REMOTE DATA MANAGEMENT FOR WIRELESS DELIVERY OF CONTENT TO HANDHELD COMPUTERS, LAPTOPS AND MOBILE ELECTRONIC DEVICES (U.S. CLS. 100 AND 101).

DAVID I, EXAMINING ATTORNEY

SN 77-923,420. ALERE WOMEN'S AND CHILDREN'S HEALTH, LLC, ATLANTA, GA. FILED 1-29-2010.



NO CLAIM IS MADE TO THE EXCLUSIVE RIGHT TO USE "THE 24/7 OBSTETRIC NURSING COMPANY", APART FROM THE MARK AS SHOWN.

THE MARK CONSISTS OF A PREGNANT WOMAN'S PROFILE RUNNING VERTICALLY DOWN THE CENTER OF A CIRCLE, WITH THE LEFT HALF OF THE CIRCLE COMPRISING A NIGHT SKY AND A CRESCENT MOON AND THE RIGHT HALF COMPRISING HALF OF A SUN WITH RAYS, WITH THE TEXT "THE 24/7 OBSTETRIC NURSING COMPANY" RUNNING AROUND THE EDGE OF THE CIRCLE.

CLASS 36—INSURANCE AND FINANCIAL

FOR PROVIDING HEALTH INSURANCE AUTHORIZATION SERVICES TO HEALTH CARE PROVIDERS (U.S. CLS. 100, 101 AND 102).

CLASS 44—MEDICAL, BEAUTY AND AGRICULTURAL SERVICES

FOR HEALTH CARE; NURSING SERVICES; MEDICAL COUNSELING; GENETIC TESTING FOR MEDICAL PURPOSES; GENETIC COUNSELING; PROVIDING MEDICAL AND HEALTH CARE INFORMATION AND COUNSELING BY TELEPHONE AND THE INTERNET (U.S. CLS. 100 AND 101).

STEPHEN AQUILA, EXAMINING ATTORNEY

SN 77-923,578. DEVDESK, LLC, WOODINVILLE, WA. FILED 1-29-2010.



THE MARK CONSISTS OF STYLIZED LETTER "D" STANDING UPRIGHT ON A CIRCULAR BASE.

CLASS 9—ELECTRICAL AND SCIENTIFIC APPARATUS

FOR COMPUTER SOFTWARE FOR USE IN CUSTOMER RELATIONSHIP MANAGEMENT (CRM); COMPUTER SOFTWARE FOR USE IN MULTI-BUSINESS MANAGEMENT, RETAIL DEVELOPMENT AND BUSINESS NETWORKING, BUSINESS ADMINISTRATION, BUSINESS DEVELOPMENT, BUSINESS MANAGEMENT AND CUSTOMER RELATIONSHIP MANAGEMENT, CONTENT MANAGEMENT SYSTEM, ENTERPRISE DATA INTEGRATION AND ENTERPRISE RESOURCE PLANNING (U.S. CLS. 21, 23, 26, 36 AND 38).

CLASS 35—ADVERTISING AND BUSINESS

FOR BUSINESS CONSULTATION IN THE FIELD OF MULTI-BUSINESS MANAGEMENT, RETAIL DEVELOPMENT AND BUSINESS NETWORKING, BUSINESS ADMINISTRATION, BUSINESS DEVELOPMENT, BUSINESS MANAGEMENT AND CUSTOMER RELATIONSHIP MANAGEMENT, CONTENT MANAGEMENT SYSTEM, ENTERPRISE DATA INTEGRATION AND ENTERPRISE RESOURCE PLANNING; BUSINESS CONSULTATION SERVICES, NAMELY, BUSINESS PROCESS IMPROVEMENT AND ENTERPRISE ARCHITECTURE DESIGN; BUSINESS CONSULTING SERVICES RELATING TO THE INTEGRATION OF THE AREAS OF BUSINESS PROCESS TECHNOLOGY, ORGANIZATIONAL LEARNING, CHANGE MANAGEMENT, AND OPERATIONAL SUSTAINABILITY; BUSINESS MANAGEMENT AND CONSULTATION; BUSINESS MANAGEMENT AND CONSULTATION IN THE FIELD OF MULTI-BUSINESS MANAGEMENT, RETAIL DEVELOPMENT AND BUSINESS NETWORKING, BUSINESS ADMINISTRATION, BUSINESS DEVELOPMENT, BUSINESS MANAGEMENT AND CUSTOMER RELATIONSHIP MANAGEMENT, CONTENT MANAGEMENT SYSTEM, ENTERPRISE DATA INTEGRATION AND ENTERPRISE RESOURCE PLANNING; BUSINESS SERVICES, NAMELY, FORMULATION OF BEST PRACTICES FOR MULTI-BUSINESS MANAGEMENT, RETAIL DEVELOPMENT AND BUSINESS NETWORKING, BUSINESS ADMINISTRATION, BUSINESS DEVELOPMENT, BUSINESS MANAGEMENT AND CUSTOMER RELATIONSHIP MANAGEMENT, CONTENT MANAGEMENT SYSTEM, ENTERPRISE DATA INTEGRATION AND ENTERPRISE RESOURCE PLANNING; CUSTOMER RELATIONSHIP MANAGEMENT (U.S. CLS. 100, 101 AND 102).

CLASS 38—COMMUNICATION

FOR CHAT ROOM SERVICES FOR SOCIAL NETWORKING; COMPUTER SERVICES, NAMELY, PROVIDING ON-LINE FACILITIES FOR REAL-TIME INTERACTION WITH OTHER COMPUTER USERS CONCERNING TOPICS OF GENERAL INTEREST; PROVIDING ON-LINE CHAT ROOMS FOR TRANSMISSION OF MESSAGES AMONG COMPUTER USERS CONCERNING MULTI-BUSINESS MANAGEMENT, RETAIL DEVELOPMENT AND BUSINESS NETWORKING, BUSINESS ADMINISTRATION, BUSINESS DEVELOPMENT, BUSINESS MANAGEMENT AND CUSTOMER RELATIONSHIP MANAGEMENT, CONTENT MANAGEMENT SYSTEM, ENTERPRISE DATA INTEGRATION AND ENTERPRISE RESOURCE PLANNING; PROVIDING ON-LINE ELECTRONIC BULLETIN BOARDS FOR TRANSMISSION OF MESSAGES AMONG COMPUTER USERS CONCERNING MULTI-BUSINESS MANAGEMENT, RETAIL DEVELOPMENT AND BUSINESS NETWORKING, BUSINESS ADMINISTRATION, BUSINESS DEVELOPMENT, BUSINESS MANAGEMENT AND CUSTOMER RELATIONSHIP MANAGEMENT, CONTENT MANAGEMENT SYSTEM, ENTERPRISE DATA INTEGRATION AND ENTERPRISE RESOURCE PLANNING (U.S. CLS. 100, 101 AND 104).

CLASS 42—SCIENTIFIC AND COMPUTER SERVICES

FOR APPLICATION SERVICE PROVIDER (ASP) FEATURING SOFTWARE FOR USE IN MULTI-BUSINESS MANAGEMENT, RETAIL DEVELOPMENT AND BUSINESS NETWORKING, BUSINESS ADMINISTRATION, BUSINESS DEVELOPMENT, BUSINESS MANAGEMENT AND CUSTOMER RELATIONSHIP MANAGEMENT, CONTENT MANAGEMENT SYSTEM, ENTERPRISE DATA INTEGRATION AND ENTERPRISE RESOURCE PLANNING; APPLICATION SERVICE PROVIDER FEATURING APPLICATION PROGRAMMING INTERFACE (API) SOFTWARE FOR ALLOWING DATA RETRIEVAL, UPLOAD, ACCESS AND MANAGEMENT; CLOUD COMPUTING FEATURING SOFTWARE FOR USE IN MULTI-BUSINESS MANAGEMENT, RETAIL DEVELOPMENT AND BUSINESS NETWORKING, BUSINESS ADMINISTRATION, BUSINESS DEVELOPMENT, BUSINESS MANAGEMENT AND CUSTOMER RELATIONSHIP MANAGEMENT, CONTENT MANAGEMENT SYSTEM, ENTERPRISE DATA INTEGRATION AND ENTERPRISE RESOURCE PLANNING; COMPUTER SERVICES, NAMELY, CREATING AN ON-LINE COMMUNITY FOR REGISTERED USERS TO PARTICIPATE IN DISCUSSIONS, GET FEEDBACK FROM THEIR PEERS, FORM VIRTUAL COMMUNITIES, AND ENGAGE IN SOCIAL NETWORKING (U.S. CLS. 100 AND 101).

BRIDGETT SMITH, EXAMINING ATTORNEY

SN 77-923,583. DENA CO., LTD., TOKYO, JAPAN, FILED 1-29-2010.

PlanetNation

THE MARK CONSISTS OF STANDARD CHARACTERS WITHOUT CLAIM TO ANY PARTICULAR FONT, STYLE, SIZE, OR COLOR.

CLASS 9—ELECTRICAL AND SCIENTIFIC APPARATUS

FOR GAME PROGRAMS RUNNING ON MOBILE PHONES INCLUDING DOWNLOADABLE GAME PROGRAMS; GAME PROGRAMS RUNNING ON PERSONAL COMPUTERS INCLUDING DOWNLOADABLE GAME PROGRAMS; DOWNLOADABLE GAME PROGRAMS (U.S. CLS. 21, 23, 26, 36 AND 38).

CLASS 41—EDUCATION AND ENTERTAINMENT

FOR PROVIDING ON-LINE GAMES VIA MOBILE PHONES OR COMPUTER NETWORKS; PROVIDING ON-LINE GAMES (U.S. CLS. 100, 101 AND 107).
MICHAEL ENGEL, EXAMINING ATTORNEY

SN 77-923,602. DENA CO., LTD., TOKYO, JAPAN, FILED 1-29-2010.

BanditNation

THE MARK CONSISTS OF STANDARD CHARACTERS WITHOUT CLAIM TO ANY PARTICULAR FONT, STYLE, SIZE, OR COLOR.

CLASS 9—ELECTRICAL AND SCIENTIFIC APPARATUS

FOR GAME PROGRAMS RUNNING ON MOBILE PHONES INCLUDING DOWNLOADABLE GAME PROGRAMS; GAME PROGRAMS RUNNING ON PERSONAL COMPUTERS INCLUDING DOWNLOADABLE GAME PROGRAMS; DOWNLOADABLE GAME PROGRAMS (U.S. CLS. 21, 23, 26, 36 AND 38).

CLASS 41—EDUCATION AND ENTERTAINMENT

FOR PROVIDING ON-LINE GAMES VIA MOBILE PHONES OR COMPUTER NETWORKS; PROVIDING ON-LINE GAMES (U.S. CLS. 100, 101 AND 107).
MICHAEL ENGEL, EXAMINING ATTORNEY

SN 77-923,717. FRAZIER, CARLYN S., DBA CFI GLOBAL SOLUTIONS, INC., ATHENS, AL. FILED 1-29-2010.

Mission Oriented. Performance Driven!

THE MARK CONSISTS OF STANDARD CHARACTERS WITHOUT CLAIM TO ANY PARTICULAR FONT, STYLE, SIZE, OR COLOR.

CLASS 35—ADVERTISING AND BUSINESS

FOR BUSINESS CONSULTING SERVICES RELATING TO PRODUCT DISTRIBUTION, OPERATIONS MANAGEMENT SERVICES, LOGISTICS, REVERSE LOGISTICS, SUPPLY CHAIN, AND PRODUCTION SYSTEMS AND DISTRIBUTION SOLUTIONS; BUSINESS CONSULTING AND BUSINESS INFORMATION FOR ENTERPRISES; BUSINESS CONSULTING AND INFORMATION SERVICES; BUSINESS CONSULTING SERVICES IN THE FIELD OF ORGANIZATIONAL CHANGE MANAGEMENT; BUSINESS CONSULTING SERVICES, NAMELY, PROVIDING ASSISTANCE IN DEVELOPMENT OF BUSINESS STRATEGIES AND CREATIVE IDEATION; BUSINESS CONSULTING SERVICES IN THE FIELD OF INFORMATION ASSURANCE; BUSINESS CONSULTING SERVICES RELATING TO THE INTEGRATION OF THE AREAS OF BUSINESS PROCESS TECHNOLOGY, ORGANIZATIONAL LEARN-

ING, CHANGE MANAGEMENT, AND OPERATIONAL SUSTAINABILITY; BUSINESS CONSULTING, MANAGEMENT, PLANNING AND SUPERVISION; BUSINESS DEVELOPMENT CONSULTING SERVICES; BUSINESS MANAGEMENT CONSULTING AND ADVISORY SERVICES; BUSINESS MANAGEMENT CONSULTING IN THE FIELD OF TEAM DEVELOPMENT; BUSINESS MANAGEMENT CONSULTING WITH RELATION TO STRATEGY, MARKETING, SALES, OPERATION, PRODUCT DESIGN PARTICULARLY SPECIALIZING IN THE USE OF ANALYTIC AND STATISTIC MODELS FOR THE UNDERSTANDING AND PREDICTING OF CONSUMERS, BUSINESSES, AND MARKET TRENDS AND ACTIONS; BUSINESS MARKETING CONSULTING SERVICES; BUSINESS MONITORING AND CONSULTING SERVICES, NAMELY, TRACKING WEB SITES AND APPLICATIONS OF OTHERS TO PROVIDE STRATEGY, INSIGHT, MARKETING, SALES, OPERATION, PRODUCT DESIGN, PARTICULARLY SPECIALIZING IN THE USE OF ANALYTIC AND STATISTIC MODELS FOR THE UNDERSTANDING AND PREDICTING OF CONSUMERS, BUSINESSES, AND MARKET TRENDS AND ACTIONS; BUSINESS ORGANIZATION AND MANAGEMENT CONSULTING; BUSINESS SUPPORT SERVICES, NAMELY, BUSINESS CONSULTING TO FREELANCERS, START-UPS, EXISTING BUSINESSES AND NON-PROFIT ORGANIZATIONS; CONSULTING IN THE FIELD OF PROCURING GOVERNMENT CONTRACTS FOR THE PURCHASE OF GOODS AND LABOR CONTRACTING SERVICES; CONSULTING REGARDING INTELLECTUAL PROPERTY BUSINESS RISK MITIGATION PROCESSES; CONSULTING SERVICES IN THE FIELD OF MANAGING INTELLECTUAL PROPERTIES; CONSULTING SERVICES IN THE AREA OF SUSTAINABLE BUSINESS SOLUTIONS; CONSULTING SERVICES IN THE FIELD OF HUMAN RESOURCES DEVELOPMENT, NAMELY, UTILIZING TECHNOLOGY FOR THE PROMOTION OF EMPLOYEE RETENTION, CAREER GROWTH AND INCREASED PRODUCTIVITY FOR EMPLOYEES AND EMPLOYERS; CONSULTING SERVICES IN BUSINESS LEADERSHIP DEVELOPMENT AND BUSINESS MANAGEMENT; CONSULTING SERVICES IN THE FIELDS OF BUSINESS MANAGEMENT, HUMAN RESOURCES, AND BUSINESS ORGANIZATIONAL DESIGN; CONSUMER STRATEGY BUSINESS CONSULTING IN THE FIELDS OF MARKETING, SALES, OPERATION, AND PRODUCT DESIGN PARTICULARLY SPECIALIZING IN THE USE OF ANALYTIC MODELS FOR THE UNDERSTANDING AND PREDICTING OF CONSUMER, BUSINESS, AND RETAIL MARKET TRENDS AND ACTIONS; DISASTER RECOVERY SERVICES, NAMELY, BUSINESS PLANNING AND BUSINESS CONTINUITY CONSULTING; HUMAN RESOURCE ANALYSIS AND CONSULTING SERVICES; MANAGEMENT AND BUSINESS CONSULTING SERVICES IN THE FIELD OF TRAINING AND RECRUITMENT; MANAGEMENT CONSULTING AND ADVISORY SERVICES IN THE AREAS OF CORPORATE GROWTH STRATEGY, INNOVATION AND GROWTH PROCESSES, ORGANIZATIONAL TRANSFORMATION, AND TALENT MANAGEMENT AND DEVELOPMENT STRATEGIES; MARKETING CONSULTING; NEW BUSINESS VENTURE DEVELOPMENT AND FORMATION CONSULTING SERVICES; PROFESSIONAL BUSINESS CONSULTING; PROVIDING BUSINESS MANAGEMENT INFORMATION IN CONNECTION WITH CONSULTING AND ADVISORY SERVICES IN THE FIELD OF STRATEGIC PLANNING; PROVIDING ORGANIZATIONAL DEVELOPMENT CONSULTING SERVICES; BUSINESS PROCESS RE-ENGINEERING SERVICES; EDUCATION LEADERSHIP DEVELOPMENT; DEVELOPMENT OF CONCEPTS FOR BUSINESS ECONOMY (U.S. CLS. 100, 101 AND 102).

FIRST USE 1-13-2010; IN COMMERCE 1-13-2010.

CLASS 41—EDUCATION AND ENTERTAINMENT

FOR PROVIDING GROUP COACHING AND LEARNING FORUMS IN THE FIELD OF LEADERSHIP DEVELOPMENT; BUSINESS EDUCATION AND TRAINING SERVICES, NAMELY, DEVELOPING, AND FACILITATING CUSTOMIZED IN-COMPANY LEADERSHIP AND EXECUTIVE DEVELOPMENT PROGRAMS, PROVIDING EXECUTIVE COACHING SERVICES, AND PROVIDING PUBLIC AND IN-COMPANY KEYNOTE PRESENTATIONS TO BUSINESS LEADERS (U.S. CLS. 100, 101 AND 107).

FIRST USE 1-13-2010; IN COMMERCE 1-13-2010.

CLASS 42—SCIENTIFIC AND COMPUTER SERVICES

FOR ADVISORY SERVICES IN THE FIELD OF PRODUCT DEVELOPMENT AND QUALITY IMPROVEMENT OF SOFTWARE; COMPUTER SOFTWARE DEVELOPMENT; CUSTOMIZED SOFTWARE DEVELOPMENT SERVICES; DATABASE DESIGN AND DEVELOPMENT; DESIGN AND DEVELOPMENT OF MULTIMEDIA PRODUCTS; DESIGN AND DEVELOPMENT OF NETWORKS; DESIGN, DEVELOPMENT, INSTALLATION AND MAINTENANCE OF COMPUTER SOFTWARE; DESIGN, DEVELOPMENT, AND CONSULTING SERVICES IN THE FIELD OF HOME AND WORKPLACE AUTOMATION HARDWARE AND SOFTWARE; DESIGN, DEVELOPMENT AND IMPLEMENTATION OF SOFTWARE; DESIGN AND TESTING FOR NEW PRODUCT DEVELOPMENT; DEVELOPMENT OF NEW TECHNOLOGY FOR OTHERS IN THE FIELD OF RETAIL STORE SERVICES; DEVELOPMENT OF SOFTWARE FOR SECURE NETWORK OPERATIONS; PRODUCT DEVELOPMENT AND ENGINEERING SERVICES FOR OTHERS; PRODUCT DEVELOPMENT CONSULTATION; PRODUCT DEVELOPMENT; PRODUCT DEVELOPMENT FOR OTHERS; RESEARCH AND DEVELOPMENT FOR NEW PRODUCTS FOR OTHERS; RESEARCH AND DEVELOPMENT OF ADVANCED LEARNING TECHNOLOGIES AND TEACHING METHODS; RESEARCH AND DEVELOPMENT OF NEW PRODUCTS; RESEARCH AND DEVELOPMENT SERVICES IN CONNECTION WITH PHYSICS; SCIENTIFIC AND TECHNOLOGICAL SERVICES AND RESEARCH AND DESIGN IN THE FIELD OF INTEGRATED SYSTEM ARCHITECTURE THAT ALLOWS FOR THE RAPID DEVELOPMENT OF HIGHLY INTERACTIVE AND CUSTOMIZABLE LEARNING APPLICATIONS; SCIENTIFIC RESEARCH AND DEVELOPMENT; CONSULTING IN THE FIELD OF INFORMATION TECHNOLOGY; CONSULTING IN THE FIELD OF IT PROJECT MANAGEMENT; CONSULTING IN THE FIELD OF TELECOMMUNICATIONS TECHNOLOGY; COMPUTER SOFTWARE CONSULTING; CONSULTING SERVICES IN THE FIELD OF OFFICE AND WORKPLACE AUTOMATION; COMPUTER HARDWARE AND SOFTWARE CONSULTING SERVICES; CONSULTING SERVICES IN THE FIELD OF IMPROVEMENT OF ENGINEERING PROCESSES; PROVIDING PLANNING AND ENGINEERING SERVICES IN THE FIELD OF INFORMATION AND COMMUNICATIONS NETWORKS (U.S. CLS. 100 AND 101).

FIRST USE 1-13-2010; IN COMMERCE 1-13-2010.
CIMMERIAN COLEMAN, EXAMINING ATTORNEY

SN 77-923,788. TANGIBLE WORLDWIDE, LLC, CHICAGO, IL. FILED 1-29-2010.

GB

THE MARK CONSISTS OF STANDARD CHARACTERS WITHOUT CLAIM TO ANY PARTICULAR FONT, STYLE, SIZE, OR COLOR.

CLASS 9—ELECTRICAL AND SCIENTIFIC APPARATUS

FOR DOWNLOADABLE MULTIMEDIA FILES CONTAINING USER-CREATED ARTWORK (U.S. CLS. 21, 23, 26, 36 AND 38).

CLASS 16—PAPER GOODS AND PRINTED MATTER

FOR POSTERS, ART PRINTS, POSTCARDS, GREETING CARDS, STICKERS, AND PAPER STATIONERY (U.S. CLS. 2, 5, 22, 23, 29, 37, 38 AND 50).

CLASS 42—SCIENTIFIC AND COMPUTER SERVICES

FOR APPLICATION SERVICE PROVIDER (ASP) FEATURING SOFTWARE FOR USE IN GRAPHIC ILLUSTRATION AND DRAWING FEATURING GRAPHIC TEMPLATES AND GRAPHIC ELEMENTS FOR DESIGNING CUSTOM CARTOON CHARACTERS AND CREATURES, AND OUTPUTTING THE CHARACTERS AND CREATURES TO HARDCOPY AND COMPUTER FILES (U.S. CLS. 100 AND 101).

VERNA BETH RIRIE, EXAMINING ATTORNEY

SN 77-923,808. SAN FRANCISCO MERCANTILE COMPANY, INC., SAN FRANCISCO, CA. FILED 1-29-2010.

CLASSICS BY EILEEN WEST

THE MARK CONSISTS OF STANDARD CHARACTERS WITHOUT CLAIM TO ANY PARTICULAR FONT, STYLE, SIZE, OR COLOR.

OWNER OF U.S. REG. NOS. 1,431,188, 3,744,399 AND OTHERS.

NO CLAIM IS MADE TO THE EXCLUSIVE RIGHT TO USE "CLASSICS", APART FROM THE MARK AS SHOWN.

THE NAME(S), PORTRAIT(S), AND/OR SIGNATURE(S) SHOWN IN THE MARK IDENTIFIES "EILEEN WEST", WHOSE CONSENT(S) TO REGISTER IS MADE OF RECORD.

CLASS 9—ELECTRICAL AND SCIENTIFIC APPARATUS

FOR CASES FOR EYEGLASSES AND SUNGLASSES; READING GLASSES (U.S. CLS. 21, 23, 26, 36 AND 38).

FIRST USE 6-1-2009; IN COMMERCE 6-1-2009.

CLASS 24—FABRICS

FOR BED BLANKETS; BED COVERS; BED LINEN; BED SHEETS; BED SKIRTS; BED SPREADS; BED THROWS; COMFORTERS; CURTAINS; DRAPERIES; DUST RUFFLES; DUVET COVERS; EIDERDOWN COVERS; EIDERDOWNS; FABRIC TABLE RUNNERS; FABRIC WINDOW COVERINGS AND TREATMENTS, NAMELY, CURTAINS, DRAPERIES, SHEERS, SWAGS AND VALANCES; FABRICS THAT MAY OR MAY NOT HAVE PRINTED PATTERNS AND DESIGNS THEREON FOR USE IN TEXTILE APPLICATIONS, NAMELY, THE MANUFACTURE OF APPAREL, UPHOLSTERY, SIGNAGE, FLAGS, BANNERS AND WALLPAPER; FACE CLOTHS; KITCHEN TOWELS; MATTRESS COVERS; PILLOW CASES; PILLOW COVERS; PILLOW SHAMS; QUILTS; SHAMS; SHOWER CURTAIN LINERS; SHOWER CURTAINS; TABLE AND BED LINEN; TABLE CLOTHS NOT OF PAPER; TABLE NAPKINS OF TEXTILE; TABLECLOTHS OF TEXTILES; TEXTILE FABRICS FOR USE IN THE MANUFACTURE OF GARMENTS, BAGS, JACKETS, GLOVES, AND APPAREL; TEXTILE NAPKINS; TEXTILE TABLECLOTHS; TOWEL SETS; TOWELS (U.S. CLS. 42 AND 50).
FIRST USE 6-1-1997; IN COMMERCE 6-1-1997.

CLASS 25—CLOTHING

FOR BLOUSES; BRAS; CHILDREN'S AND INFANT'S APPAREL, NAMELY, JUMPERS, OVERALL SLEEPWEAR, PAJAMAS, ROMPERS AND ONE-PIECE GARMENTS; DRESSES; DRESSING GOWNS; DRESSING GOWNS AND BATH ROBES; JACKETS; LINGERIE; LOUNGE PANTS; NIGHT GOWNS; PAJAMAS; PANTIES; SHORTS AND BRIEFS; PANTS; ROBES; ROMPERS; SCARVES; SHIRTS; SHORTS; SKIRTS; SLEEPWEAR; SLIPPERS; SLIPS; SWEATERS; TAP PANTS; TEDDIES; TEE SHIRTS (U.S. CLS. 22 AND 39).
FIRST USE 1-1-1995; IN COMMERCE 1-1-1995.
PAUL E. FAHRENKOPF, EXAMINING ATTORNEY

SN 77-924,076. RIGHTHAVEN LLC, LAS VEGAS, NV. FILED 1-29-2010.

Righthaven

THE MARK CONSISTS OF STANDARD CHARACTERS WITHOUT CLAIM TO ANY PARTICULAR FONT, STYLE, SIZE, OR COLOR.

CLASS 42—SCIENTIFIC AND COMPUTER SERVICES

FOR SEARCHING AND RETRIEVING INFORMATION, SITES, AND OTHER RESOURCES AVAILABLE ON COMPUTER NETWORKS FOR OTHERS (U.S. CLS. 100 AND 101).

CLASS 45—PERSONAL AND LEGAL SERVICES

FOR LICENSING OF INTELLECTUAL PROPERTY (U.S. CLS. 100 AND 101).
MARK SPARACINO, EXAMINING ATTORNEY

SN 77-924,115. FRESHPLANET, NEW YORK, NY. FILED 1-29-2010.

Crazy Cow

THE MARK CONSISTS OF STANDARD CHARACTERS WITHOUT CLAIM TO ANY PARTICULAR FONT, STYLE, SIZE, OR COLOR.

CLASS 9—ELECTRICAL AND SCIENTIFIC APPARATUS

FOR COMPUTER GAME SOFTWARE; COMPUTER GAME SOFTWARE DOWNLOADABLE FROM A GLOBAL COMPUTER NETWORK; COMPUTER GAME SOFTWARE FOCUSING ON ACHIEVING A SET OF GOALS, POSITIONS, OWNERSHIP, AND CREDENTIALS, AND PROFESSIONAL AND SOCIAL STATUS, AND GOOD FORTUNE NECESSARY TO SUCCEED PROFESSIONALLY AND PERSONALLY, AND NOT REFERRING EITHER TO A GROUP OF SOFTWARE FOR USE IN COMMERCE OR TO A GROUP OF OFFICES; COMPUTER GAME SOFTWARE FOR GAMING MACHINES INCLUDING SLOT MACHINES OR VIDEO LOTTERY TERMINALS; COMPUTER GAME SOFTWARE FOR PERSONAL COMPUTERS AND HOME VIDEO GAME CONSOLES; COMPUTER GAME SOFTWARE FOR USE ON MOBILE AND CELLULAR PHONES; COMPUTER GAME SOFTWARE FOR USE WITH PERSONAL COMPUTERS, HOME VIDEO GAME CONSOLES USED WITH TELEVISIONS, AND FOR ARCADE-BASED VIDEO GAME CONSOLES; COMPUTER GAME SOFTWARE, NAMELY, A COMPUTER CRAPS GAME; COMPUTER GAME TAPES; COMPUTER PROGRAMS FOR PRE-RECORDED GAMES; COMPUTER PROGRAMS FOR VIDEO AND COMPUTER GAMES; COMPUTER SOFTWARE AND FIRMWARE FOR GAMES OF CHANCE ON ANY COMPUTERIZED PLATFORM, INCLUDING DEDICATED GAMING CONSOLES, VIDEO BASED SLOT MACHINES, REEL BASED SLOT MACHINES, AND VIDEO LOTTERY TERMINALS; COMPUTER SOFTWARE, NAMELY, GAME ENGINE SOFTWARE FOR VIDEO GAME DEVELOPMENT AND OPERATION; COMPUTER-GAMING SOFTWARE; COMPUTERIZED VIDEO GAME TABLES FOR GAMING PURPOSES, NAMELY, A COMPUTERIZED VIDEO CRAPS GAME TABLE; COMPUTERIZED VIDEO TABLE GAMES FOR GAMING PURPOSES; DOWNLOADABLE AUDIO FILES, MULTIMEDIA FILES, TEXT FILES, E-MAILS, WRITTEN DOCUMENTS, AUDIO MATERIAL, VIDEO MATERIAL AND GAMES FEATURING INFORMATION IN THE FORM OF DOWNLOADABLE SHORT EDUCATIONAL/TRAINING COMMUNICATIONS IN THE FIELD OF HUMAN RESOURCE DEVELOPMENT FOR THE PROMOTION OF EMPLOYEE RETENTION, CAREER GROWTH AND INCREASED PRODUCTIVITY FOR EMPLOYEES AND EMPLOYERS; DOWNLOADABLE COMPUTER GAME PROGRAMS; DOWNLOADABLE COMPUTER GAME SOFTWARE VIA A GLOBAL COMPUTER NETWORK AND WIRELESS DEVICES; DOWNLOADABLE COMPUTER PROGRAMS FEATURING POSITIONABLE GAME PIECE FIGURES FOR USE IN THE FIELD OF COMPUTER GAMES; DOWNLOADABLE ELECTRONIC GAME PROGRAMS; DOWNLOADABLE IMAGE FILE CONTAINING ARTWORK, TEXT, AUDIO, VIDEO, GAMES AND INTERNET WEB LINKS RELATING TO SPORTING AND CULTURAL ACTIVITIES; DOWNLOADABLE MULTIMEDIA FILE CONTAINING ARTWORK, TEXT, AUDIO, VIDEO, GAMES, AND INTERNET WEB LINKS RELATING TO COMPUTER GAMES; DOWNLOADABLE COMPUTER GAMES, TELEPHONE RING TONES AND MP3 FILES VIA THE INTERNET AND WIRELESS DEVICES; ELECTRICAL CIRCUITS FOR USE IN AMUSEMENT GAME MACHINES FOR REPRODUCING MUSIC, SPEECH AND SPECIAL EFFECTS; ELECTRONIC AND ELECTROMECHANICAL GAMING TABLES WITH VIDEO OUTPUT; ELECTRONIC AND VIDEO GAME CONTROLLERS INCORPORATED INTO EXERCISE MACHINES; ELECTRONIC GAME PROGRAMS; ELECTRONIC GAME

SOFTWARE; ELECTRONIC GAME SOFTWARE FOR CELLULAR TELEPHONES; ELECTRONIC GAME SOFTWARE FOR HANDHELD ELECTRONIC DEVICES; ELECTRONIC GAME SOFTWARE FOR WIRELESS DEVICES; ELECTRONIC GAME SOFTWARE, NAMELY, AN ELECTRONIC CRAPS GAME; ELECTRONIC GAME SOFTWARE, NAMELY, AN ELECTRONIC VIDEO CRAPS GAME; ELECTRONIC INTERACTIVE BOARD GAMES FOR USE WITH EXTERNAL MONITOR; FACE PLATES FOR VIDEO GAME CONSOLES FOR USE WITH EXTERNAL MONITORS; GAME CONTROLLERS FOR COMPUTER GAMES; GAME SOFTWARE; GAMES ADAPTED FOR USE WITH TELEVISION RECEIVERS; GAMING DEVICES, NAMELY, GAMING MACHINES, SLOT MACHINES, BINGO MACHINES, WITH OR WITHOUT VIDEO OUTPUT; GAMING EQUIPMENT, NAMELY, SLOT MACHINES WITH OR WITHOUT VIDEO OUTPUT; GAMING MACHINES; GAMING MACHINES FEATURING A DEVICE THAT ACCEPTS WAGERS; GAMING MACHINES INCLUDING SLOT MACHINES OR VIDEO LOTTERY TERMINALS; GAMING MACHINES THAT GENERATE OR DISPLAY WAGER OUTCOMES; GAMING MACHINES, NAMELY, SLOT MACHINES AND VIDEO LOTTERY TERMINALS; GAMING MACHINES, NAMELY, DEVICES WHICH ACCEPT A WAGER; GAMING MACHINES, NAMELY, ELECTRONIC SLOT AND BINGO MACHINES; GAMING SOFTWARE THAT GENERATES OR DISPLAYS WAGER OUTCOMES OF GAMING MACHINES; GUITAR SKINS FOR ELECTRONIC GUITAR GAME CONTROLLERS; HAND HELD JOY STICK UNITS FOR PLAYING VIDEO GAMES; HAND-HELD ELECTRONIC GAMES ADAPTED FOR USE WITH TELEVISION RECEIVERS ONLY; HAND-HELD UNITS FOR PLAYING ELECTRONIC GAMES FOR USE WITH EXTERNAL DISPLAY SCREEN OR MONITOR; HIGH PERFORMANCE COMPUTER HARDWARE WITH SPECIALIZED FEATURES FOR ENHANCED GAME PLAYING ABILITY; INTERACTIVE AUDIO GAME DISCS CONTAINING ENTERTAINMENT IN THE NATURE OF SOCIAL GAMES, ROLE PLAYING GAMES AND ACTION GAMES; INTERACTIVE GAME PROGRAMS; INTERACTIVE GAME SOFTWARE; INTERACTIVE MULTIMEDIA COMPUTER GAME PROGRAM; INTERACTIVE VIDEO GAME PROGRAM, NAMELY, A VIDEO CRAPS GAME; INTERACTIVE VIDEO GAME PROGRAMS; INTERACTIVE VIDEO GAMES OF VIRTUAL REALITY COMPRISED OF COMPUTER HARDWARE FOR USE WITH AN EXTERNAL MONITOR AND SOFTWARE; JOYSTICKS FOR VIDEO GAMES; MACHINE FOR PLAYING GAMES OF CHANCE, NAMELY, CRAPS; MACHINES FOR PLAYING GAMES OF CHANCE; PLAYER-OPERATED ELECTRONIC CONTROLLERS FOR ELECTRONIC VIDEO GAME MACHINES; PROTECTIVE CARRYING CASES SPECIALLY ADAPTED FOR VIDEO GAME CONSOLES FOR USE WITH AN EXTERNAL DISPLAY SCREEN OR MONITOR; RECONFIGURABLE CASINO AND LOTTERY GAMING EQUIPMENT, NAMELY, GAMING MACHINES AND OPERATIONAL COMPUTER GAME SOFTWARE THEREFOR; RECORDED COMPUTER GAME PROGRAMS; STAND ALONE VIDEO GAMING MACHINES, NAMELY, A VIDEO CRAPS GAME MACHINE; TABLETOP UNITS FOR PLAYING ELECTRONIC GAMES OTHER THAN IN CONJUNCTION WITH A TELEVISION OR COMPUTER, NAMELY, AN ELECTRONIC CRAPS GAME; VIDEO AND COMPUTER GAME PROGRAMS; VIDEO GAME CARTRIDGES; VIDEO GAME CARTRIDGES AND CASSETTES; VIDEO GAME CARTRIDGES AND DISCS; VIDEO GAME CONSOLES FOR USE WITH AN EXTERNAL DISPLAY SCREEN OR MONITOR; VIDEO GAME DISCS; VIDEO GAME INTERACTIVE CONTROL FLOOR PADS OR MATS; VIDEO GAME INTERACTIVE HAND HELD REMOTE CONTROLS FOR PLAYING ELECTRONIC GAMES; VIDEO GAME INTERACTIVE REMOTE CONTROL UNITS; VIDEO GAME JOYSTICKS; VIDEO GAME MACHINES FOR USE WITH EXTERNAL DISPLAY SCREEN OR MONITOR; VIDEO GAME MACHINES FOR USE WITH TELEVISIONS; VIDEO GAME SOFTWARE; VIDEO GAME SOFTWARE, NAMELY, A VIDEO CRAPS GAME; VIDEO GAME TAPE CASSETTES; VIDEO OUTPUT GAME MACHINES FOR USE WITH EXTERNAL DISPLAY SCREEN OR MONITOR; VIDEO OUTPUT GAME MACHINES FOR USE WITH TELEVISIONS; VIRTUAL REALITY GAME SOFTWARE; WIRELESS COMMUNICATION DEVICE FEATURING VOICE, DATA AND IMAGE TRANSMISSION INCLUDING VOICE, TEXT AND PICTURE MESSAGING, A VIDEO AND STILL IMAGE CAMERA, ALSO FUNCTIONAL TO PURCHASE

MUSIC, GAMES, VIDEO AND SOFTWARE APPLICATIONS OVER THE AIR FOR DOWNLOADING TO THE DEVICE (U.S. CLS. 21, 23, 26, 36 AND 38).

CLASS 28—TOYS AND SPORTING GOODS

FOR ACTION SKILL GAMES; ACTION TARGET GAMES; ACTION-TYPE TARGET GAMES; AMUSEMENT GAME MACHINES; ARCADE GAME MACHINES; ARCADE GAME MACHINES ACTIVATED BY MEDALS OR TOKENS; ARCADE GAME MACHINES FOR TEAM PLAY; ARCADE GAMES; BOARD GAMES; CARD GAMES; COIN-OPERATED VIDEO GAMES; ELECTRONIC GAMES FOR THE TEACHING OF CHILDREN; LCD GAME MACHINES; MEMORY GAMES; PUZZLE GAMES; ROLE PLAYING GAMES; STAND ALONE VIDEO GAME MACHINES; TRADING CARD GAMES (U.S. CLS. 22, 23, 38 AND 50).

CLASS 41—EDUCATION AND ENTERTAINMENT

FOR ENTERTAINMENT SERVICES, NAMELY, CONDUCTING ALTERNATE REALITY GAMES VIA THE INTERNET; ENTERTAINMENT SERVICES, NAMELY, PRODUCTION AND DISTRIBUTION OF A GAME SHOW; ENTERTAINMENT SERVICES, NAMELY, PROVIDING AN ON-LINE COMPUTER GAME; ENTERTAINMENT SERVICES, NAMELY, PROVIDING BRAIN TRAINING GAMES ON-LINE AND IN MOBILE WIRELESS FORM; ENTERTAINMENT SERVICES, NAMELY, PROVIDING GAMES OF CHANCE VIA THE INTERNET; ENTERTAINMENT SERVICES, NAMELY, PROVIDING ON-LINE COMPUTER GAMES; ENTERTAINMENT SERVICES, NAMELY, PROVIDING ON-LINE REVIEWS OF COMPUTER GAMES; ENTERTAINMENT SERVICES, NAMELY, PROVIDING ONLINE COMPUTER GAMES THAT HELP MAINTAIN AN ACTIVE BRAIN AND THUS IMPROVE MEMORY, SPEED OF PROCESSING, AND THAT PROVIDE A VARIETY OF COGNITIVE BENEFITS THAT POSITIVELY IMPACT QUALITY OF LIFE; ENTERTAINMENT SERVICES, NAMELY, PROVIDING ONLINE ELECTRONIC GAMES; ENTERTAINMENT SERVICES, NAMELY, PROVIDING ONLINE VIDEO GAMES; ENTERTAINMENT SERVICES, NAMELY, PROVIDING TEMPORARY USE OF NON-DOWNLOADABLE COMPUTER GAMES; ENTERTAINMENT SERVICES, NAMELY, PROVIDING TEMPORARY USE OF NON-DOWNLOADABLE ELECTRONIC GAMES; ENTERTAINMENT SERVICES, NAMELY, PROVIDING TEMPORARY USE OF NON-DOWNLOADABLE INTERACTIVE GAMES; ENTERTAINMENT SERVICES, NAMELY, PROVIDING TEMPORARY USE OF NON-DOWNLOADABLE VIDEO GAMES; MULTIMEDIA PUBLISHING OF BOOKS, MAGAZINES, JOURNALS, SOFTWARE, GAMES, MUSIC, AND ELECTRONIC PUBLICATIONS; MUSIC SELECTION SERVICES FOR USE IN TELEVISION, FILM, RADIO AND VIDEO GAMES; ORGANIZATION OF GAMES; PRODUCTION OF VIDEO AND COMPUTER GAME SOFTWARE; PROVIDING A WEB-BASED SYSTEM AND ON-LINE PORTAL FOR CUSTOMERS TO PARTICIPATE IN ON-LINE GAMING, OPERATION AND COORDINATION OF GAME TOURNAMENTS, LEAGUES AND TOURS; RENTAL OF COMPUTER GAME PROGRAMS; RENTAL OF COMPUTER GAME SOFTWARE; RENTAL OF VIDEO GAMES (U.S. CLS. 100, 101 AND 107).

CLASS 42—SCIENTIFIC AND COMPUTER SERVICES

FOR DESIGN AND DEVELOPMENT OF COMPUTER GAME SOFTWARE AND VIRTUAL REALITY SOFTWARE; DESIGNING AND DEVELOPING COMPUTER GAME SOFTWARE AND VIDEO GAME SOFTWARE FOR USE WITH COMPUTERS, VIDEO GAME PROGRAM SYSTEMS AND COMPUTER NETWORKS; VIDEO GAME DEVELOPMENT SERVICES; VIDEO GAME PROGRAMMING DEVELOPMENT SERVICES (U.S. CLS. 100 AND 101).

HEATHER THOMPSON, EXAMINING ATTORNEY

SN 77-924,269. EDWARDS, DARYLE A., OLATHE, KS.
FILED 1-30-2010.

SN 77-924,537. ASUKANET CO., LTD., HIROSHIMA-KEN,
JAPAN, FILED 2-1-2010.

MILLIONAIRE SUDOKU

THE MARK CONSISTS OF STANDARD CHARACTERS WITHOUT CLAIM TO ANY PARTICULAR FONT, STYLE, SIZE, OR COLOR.

NO CLAIM IS MADE TO THE EXCLUSIVE RIGHT TO USE "SUDOKU", APART FROM THE MARK AS SHOWN.

THE ENGLISH TRANSLATION OF "SUDOKU" IN THE MARK IS "ONLY SINGLE NUMBERS ALLOWED."

CLASS 9—ELECTRICAL AND SCIENTIFIC APPARATUS

FOR VIDEO AND COMPUTER GAME PROGRAMS (U.S. CLS. 21, 23, 26, 36 AND 38).

CLASS 41—EDUCATION AND ENTERTAINMENT

FOR ENTERTAINMENT, NAMELY, A CONTINUING GAME SHOW BROADCAST OVER TELEVISION AND RADIO (U.S. CLS. 100, 101 AND 107).

BRENDAN REGAN, EXAMINING ATTORNEY

SN 77-924,534. MSH SOUTH, INC., WILMINGTON, DE.
FILED 2-1-2010.

CHOCOLATE-COVERED FEBRUARY

THE MARK CONSISTS OF STANDARD CHARACTERS WITHOUT CLAIM TO ANY PARTICULAR FONT, STYLE, SIZE, OR COLOR.

CLASS 41—EDUCATION AND ENTERTAINMENT

FOR EDUCATIONAL AND ENTERTAINMENT SERVICES, NAMELY, PROVIDING CLASSES ABOUT CHOCOLATE, THE CLASSES INCORPORATING COOKING DEMONSTRATIONS AND BEVERAGE TASTINGS (U.S. CLS. 100, 101 AND 107).

FIRST USE 2-1-2005; IN COMMERCE 2-1-2005.

CLASS 43—HOTEL AND RESTAURANT SERVICES

FOR HOTEL, RESTAURANT AND BAR SERVICES (U.S. CLS. 100 AND 101).

FIRST USE 2-1-2005; IN COMMERCE 2-1-2005.
ALEX KEAM, EXAMINING ATTORNEY

ZEN LAYFLAT BOOK

THE MARK CONSISTS OF STANDARD CHARACTERS WITHOUT CLAIM TO ANY PARTICULAR FONT, STYLE, SIZE, OR COLOR.

NO CLAIM IS MADE TO THE EXCLUSIVE RIGHT TO USE "LAYFLAT BOOK", APART FROM THE MARK AS SHOWN.

CLASS 16—PAPER GOODS AND PRINTED MATTER

FOR BOOKS/ALBUMS COMPRISING CUSTOM PHOTOGRAPH COLLECTIONS FOR OTHERS (U.S. CLS. 2, 5, 22, 23, 29, 37, 38 AND 50).

CLASS 41—EDUCATION AND ENTERTAINMENT

FOR PUBLICATION OF CUSTOM PHOTOGRAPH COLLECTIONS OF OTHERS (U.S. CLS. 100, 101 AND 107).

ALEX KEAM, EXAMINING ATTORNEY

SN 77-924,554. NOBODY WORKS HARDER, INC., EAST ISLIP, NY. FILED 2-1-2010.

NOBODY WORKS HARDER

THE MARK CONSISTS OF STANDARD CHARACTERS WITHOUT CLAIM TO ANY PARTICULAR FONT, STYLE, SIZE, OR COLOR.

CLASS 21—HOUSEWARES AND GLASS

FOR CUPS AND MUGS, TRAVEL MUGS, COFFEE MUGS, COFFEE CUPS, TEA CUPS, TEA MUGS, PLASTIC BOTTLES SOLD EMPTY, PLASTIC DRINKING BOTTLES SOLD EMPTY, WATER BOTTLES SOLD EMPTY AND SPORTS BOTTLES SOLD EMPTY (U.S. CLS. 2, 13, 23, 29, 30, 33, 40 AND 50).

CLASS 25—CLOTHING

FOR CLOTHING, NAMELY, SHIRTS, SHORT-SLEEVED AND LONG-SLEEVED T-SHIRTS, GOLF SHIRTS, HOODED SHIRTS, POLO SHIRTS, RUGBY SHIRTS, SHORT AND LONG SLEEVED SHIRTS, SLEEP SHIRTS, SPORT SHIRTS, SWEAT SHIRTS, HOODED SWEAT SHIRTS, MEN'S AND WOMEN'S JACKETS; HEADGEAR, NAMELY, HATS AND CAPS, GOLF CAPS AND BASEBALL CAPS (U.S. CLS. 22 AND 39).

ANDREA SAUNDERS, EXAMINING ATTORNEY

SN 77-924,647. GABRIEL, TIMO, SULZFELD, FED REP GERMANY, AND GABRIEL, BJOERN, FRANKFURT AM MAIN, FED REP GERMANY, FILED 2-1-2010.

clothbox

THE MARK CONSISTS OF STANDARD CHARACTERS WITHOUT CLAIM TO ANY PARTICULAR FONT, STYLE, SIZE, OR COLOR.

CLASS 35—ADVERTISING AND BUSINESS

FOR ON-LINE RETAIL CONSIGNMENT STORES FEATURING MEN'S AND WOMEN'S CLOTHING, FOOTWEAR, EYEWEAR, BELTS, BAGS, WALLETS, NOTEBOOKS, COSTUME JEWELRY, AND ACCESSORIES; ON-LINE RETAIL STORE SERVICES FEATURING A WIDE VARIETY OF CONSUMER GOODS OF OTHERS; PROCUREMENT, NAMELY, PURCHASING MEN'S AND WOMEN'S CLOTHING, FOOTWEAR, EYEWEAR, BELTS, BAGS, WALLETS, NOTEBOOKS, COSTUME JEWELRY, AND ACCESSORIES FOR OTHERS; PROCURING OF CONTRACTS FOR THE PURCHASE AND SALE OF GOODS; PROVIDING A WEBSITE FOR CONNECTING SELLERS WITH BUYERS (U.S. CLS. 100, 101 AND 102).

CLASS 38—COMMUNICATION

FOR ELECTRONIC MAIL AND MESSAGING SERVICES; ELECTRONIC MESSAGE SENDING; MESSAGE SENDING, RECEIVING AND FORWARDING; PROVIDING E-MAIL AND INSTANT MESSAGING SERVICES; PROVIDING ON-LINE CHAT ROOMS AND ELECTRONIC BULLETIN BOARDS FOR TRANSMISSION OF MESSAGES AMONG USERS IN THE FIELD OF GENERAL INTEREST (U.S. CLS. 100, 101 AND 104).
TAMARA FRAZIER, EXAMINING ATTORNEY

SN 77-924,705. HOLLY GOLIGHTLY LLC, CAPE CORAL, FL. FILED 2-1-2010.

Holly Golightly

THE MARK CONSISTS OF STANDARD CHARACTERS WITHOUT CLAIM TO ANY PARTICULAR FONT, STYLE, SIZE, OR COLOR.

THE NAME "HOLLY GOLIGHTLY" DOES NOT IDENTIFY A LIVING INDIVIDUAL.

CLASS 4—LUBRICANTS AND FUELS

FOR CANDLES (U.S. CLS. 1, 6 AND 15).

CLASS 9—ELECTRICAL AND SCIENTIFIC APPARATUS

FOR SUNGLASSES (U.S. CLS. 21, 23, 26, 36 AND 38).

CLASS 14—JEWELRY

FOR JEWELRY (U.S. CLS. 2, 27, 28 AND 50).
FIRST USE 11-1-2009; IN COMMERCE 11-6-2009.

CLASS 18—LEATHER GOODS

FOR HANDBAGS, PURSES AND WALLETS (U.S. CLS. 1, 2, 3, 22 AND 41).

CLASS 25—CLOTHING

FOR SCARVES (U.S. CLS. 22 AND 39).
ELISSA GARBER KON, EXAMINING ATTORNEY

SN 77-924,805. TWO GRASS SKIRTS, SEATTLE, WA. FILED 2-1-2010.

TWO GRASS SKIRTS

THE MARK CONSISTS OF STANDARD CHARACTERS WITHOUT CLAIM TO ANY PARTICULAR FONT, STYLE, SIZE, OR COLOR.

CLASS 3—COSMETICS AND CLEANING PREPARATIONS

FOR BODY LOTIONS; SKIN SOAP (U.S. CLS. 1, 4, 6, 50, 51 AND 52).

CLASS 4—LUBRICANTS AND FUELS

FOR CANDLES (U.S. CLS. 1, 6 AND 15).

CLASS 21—HOUSEWARES AND GLASS

FOR COASTERS NOT OF PAPER AND NOT BEING TABLE LINEN; LEATHER COASTERS; PAPER PLATES; PLASTIC COASTERS (U.S. CLS. 2, 13, 23, 29, 30, 33, 40 AND 50).

DOMINIC J. FERRAIUOLO, EXAMINING ATTORNEY

SN 77-924,970. WONDER LLC, DEERFIELD, IL. FILED 2-1-2010.

PASSION FOR PARENTS

THE MARK CONSISTS OF STANDARD CHARACTERS WITHOUT CLAIM TO ANY PARTICULAR FONT, STYLE, SIZE, OR COLOR.

NO CLAIM IS MADE TO THE EXCLUSIVE RIGHT TO USE "PARENTS", APART FROM THE MARK AS SHOWN.

CLASS 35—ADVERTISING AND BUSINESS

FOR ONLINE RETAIL STORE AND WHOLESALE DISTRIBUTORSHIP SERVICES OFFERED VIA A MEMBERSHIP CLUB IN THE FIELDS OF TOYS, GAMES, EDUCATIONAL AND DEVELOPMENTAL PRODUCTS, SPORTING GOODS, CHILDREN'S CLOTHING, FURNITURE, ELECTRONICS, GROCERIES AND PRIVATE LABEL GOODS (U.S. CLS. 100, 101 AND 102).

CLASS 41—EDUCATION AND ENTERTAINMENT

FOR ENTERTAINMENT SERVICES, NAMELY, PROVIDING LIVE MAGIC SHOWS AND MUSICAL PERFORMANCES; PROVIDING RECREATIONAL AREAS IN THE NATURE OF CHILDREN'S PLAY AREAS; EDUCATIONAL SERVICES, NAMELY, PROVIDING CLASSES AND INSTRUCTION IN CRAFTS, ART, MUSIC TUMBLING, JUMPING, THE USE OF TRAMPOLINES, SPORTING ACTIVITIES, AND ADVANCED COMPUTING AND COMPUTER GAMES USING INTERACTIVE COMPUTER STATIONS; PROVIDING FACILITIES FOR MOVIES, MUSIC, SHOWS AND SPECIAL EVENTS (U.S. CLS. 100, 101 AND 107).

CLASS 43—HOTEL AND RESTAURANT SERVICES

FOR RESTAURANT AND COFFEE SHOP SERVICES FEATURING ITALIAN FOOD, MEXICAN FOOD, AMERICAN FOOD, SALADS, SANDWICHES, AND ORGANIC FOODS (U.S. CLS. 100 AND 101).
AMY HELLA, EXAMINING ATTORNEY

SN 77-924,989. BRACE, COLLIN, NASHVILLE, TN. AND AKERS, TROY, NASHVILLE, TN. FILED 2-1-2010.

The CO

THE MARK CONSISTS OF STANDARD CHARACTERS WITHOUT CLAIM TO ANY PARTICULAR FONT, STYLE, SIZE, OR COLOR.

CLASS 9—ELECTRICAL AND SCIENTIFIC APPARATUS

FOR MUSICAL SOUND RECORDINGS; MUSICAL VIDEO RECORDINGS (U.S. CLS. 21, 23, 26, 36 AND 38).
FIRST USE 12-7-2009; IN COMMERCE 12-7-2009.

CLASS 41—EDUCATION AND ENTERTAINMENT

FOR ENTERTAINMENT, NAMELY, LIVE MUSIC CONCERTS; MUSIC PUBLISHING SERVICES; PRODUCTION OF SOUND AND MUSIC VIDEO RECORDINGS (U.S. CLS. 100, 101 AND 107).
FIRST USE 12-7-2009; IN COMMERCE 12-7-2009.
NANCY CLARKE, EXAMINING ATTORNEY

SN 77-924,992. FREIGHTVIEW, LLC, TOPEKA, KS. FILED 2-1-2010.

QUALIFIED CAPACITY

THE MARK CONSISTS OF STANDARD CHARACTERS WITHOUT CLAIM TO ANY PARTICULAR FONT, STYLE, SIZE, OR COLOR.

CLASS 35—ADVERTISING AND BUSINESS

FOR INFORMATION MANAGEMENT SERVICES, NAMELY, SHIPMENT PROCESSING, PREPARING SHIPPING DOCUMENTS AND INVOICES, TRACKING DOCUMENTS, PACKAGES AND FREIGHT OVER COMPUTER NETWORKS, INTRANETS AND INTERNETS; LOGISTICS MANAGEMENT IN THE FIELD OF TRANSPORTED GOODS; PROVIDING ELECTRONIC TRACKING OF FREIGHT INFORMATION TO OTHERS; TRANSPORTATION LOGISTICS SERVICES, NAMELY, ARRANGING THE TRANSPORTATION OF GOODS FOR OTHERS, PLANNING AND SCHEDULING SHIPMENTS FOR USERS OF TRANSPORTATION SERVICES (U.S. CLS. 100, 101 AND 102).
FIRST USE 9-18-2008; IN COMMERCE 9-18-2008.

CLASS 39—TRANSPORTATION AND STORAGE

FOR FREIGHT BROKERAGE SERVICES (U.S. CLS. 100 AND 105).
FIRST USE 9-18-2008; IN COMMERCE 9-18-2008.
GIANCARLO CASTRO, EXAMINING ATTORNEY

SN 77-925,005. PLAS2FUEL CORPORATION, TIGARD, OR. FILED 2-1-2010.

AGILYX

THE MARK CONSISTS OF STANDARD CHARACTERS WITHOUT CLAIM TO ANY PARTICULAR FONT, STYLE, SIZE, OR COLOR.

CLASS 4—LUBRICANTS AND FUELS

FOR SYNTHETIC CRUDE OIL (U.S. CLS. 1, 6 AND 15).

CLASS 11—ENVIRONMENTAL CONTROL APPARATUS

FOR WASTE PROCESSING MACHINES USING HEAT AND CHEMICAL BREAKDOWN PROCESSES; MACHINERY FOR CONVERTING AND RECYCLING WASTE PLASTIC INTO SYNTHETIC CRUDE OIL AND OTHER PETROCHEMICAL PRODUCTS USING HEAT AND CHEMICAL BREAKDOWN PROCESSES (U.S. CLS. 13, 21, 23, 31 AND 34).

CLASS 37—CONSTRUCTION AND REPAIR

FOR INSTALLATION, MAINTENANCE AND REPAIR OF MACHINERY FOR CONVERTING AND RECYCLING WASTE PLASTIC INTO SYNTHETIC CRUDE OIL AND OTHER PETROCHEMICAL PRODUCTS (U.S. CLS. 100, 103 AND 106).

CLASS 40—MATERIAL TREATMENT

FOR CONVERSION AND RECYCLING OF PLASTIC INTO SYNTHETIC CRUDE OIL AND OTHER PETROCHEMICAL PRODUCTS; TECHNICAL SUPPORT SERVICES, NAMELY, PROVIDING TECHNICAL ADVICE RELATED TO CONVERTING AND RECYCLING PLASTIC INTO SYNTHETIC CRUDE OIL AND OTHER PETROCHEMICAL PRODUCTS; TECHNICAL ADVICE, INFORMATION AND CONSULTANCY IN RELATION TO CONVERSION AND RECYCLING OF PLASTIC INTO SYNTHETIC CRUDE OIL AND OTHER PETROCHEMICAL PRODUCTS; TECHNICAL SUPPORT SERVICES, NAMELY, TROUBLESHOOTING IN THE NATURE OF DIAGNOSING PROBLEMS WITH EQUIPMENT FOR THE CONVERSION AND RECYCLING OF PLASTIC INTO SYNTHETIC CRUDE OIL AND OTHER PETROCHEMICAL PRODUCTS (U.S. CLS. 100, 103 AND 106).

LYDIA BELZER, EXAMINING ATTORNEY

CLASS 38—COMMUNICATION

FOR PROVIDING ONLINE CHAT ROOMS FOR TRANSMISSION OF MESSAGES AMONG COMPUTER USERS CONCERNING TOPICS OF COMPUTER GAMING ENTERTAINMENT; PROVIDING ONLINE ELECTRONIC BULLETIN BOARDS FOR TRANSMISSION OF MESSAGES AMONG COMPUTER USERS CONCERNING TOPICS RELATED TO COMPUTER GAMES (U.S. CLS. 100, 101 AND 104).

CLASS 41—EDUCATION AND ENTERTAINMENT

FOR PROVIDING ONLINE NETWORKED AND INTERACTIVE COMPUTER GAMES VIA THE INTERNET (U.S. CLS. 100, 101 AND 107).

EDWARD FENNESSY, EXAMINING ATTORNEY

SN 77-925,019. AMERICA'S CAPITAL PARTNERS, LLC, MIAMI, FL. FILED 2-1-2010.

ACP

THE MARK CONSISTS OF STANDARD CHARACTERS WITHOUT CLAIM TO ANY PARTICULAR FONT, STYLE, SIZE, OR COLOR.

CLASS 36—INSURANCE AND FINANCIAL

FOR REAL ESTATE BROKERAGE, REAL ESTATE INVESTMENT SERVICES, REAL ESTATE MANAGEMENT AND LEASING SERVICES; REAL ESTATE ASSET MANAGEMENT SERVICES (U.S. CLS. 100, 101 AND 102).
FIRST USE 6-30-1998; IN COMMERCE 6-30-1998.

CLASS 37—CONSTRUCTION AND REPAIR

FOR REAL ESTATE DEVELOPMENT AND CONSTRUCTION SERVICES (U.S. CLS. 100, 103 AND 106).
FIRST USE 6-30-1998; IN COMMERCE 6-30-1998.
LINDA MICKLEBURGH, EXAMINING ATTORNEY

SN 77-925,025. WEBWARS, LLC, AUSTIN, TX. FILED 2-1-2010.

ELECTRIC BAT INTERACTIVE

THE MARK CONSISTS OF STANDARD CHARACTERS WITHOUT CLAIM TO ANY PARTICULAR FONT, STYLE, SIZE, OR COLOR.

NO CLAIM IS MADE TO THE EXCLUSIVE RIGHT TO USE "INTERACTIVE", APART FROM THE MARK AS SHOWN.

CLASS 9—ELECTRICAL AND SCIENTIFIC APPARATUS

FOR DOWNLOADABLE COMPUTER GAME SOFTWARE (U.S. CLS. 21, 23, 26, 36 AND 38).

SN 77-925,096. ST. HUBERT'S GIRALDA INC., DBA ST. HUBERT'S ANIMAL WELFARE CENTER, MADISON, NJ. FILED 2-1-2010.

St. Hubert's
Animal Welfare Center

NO CLAIM IS MADE TO THE EXCLUSIVE RIGHT TO USE "ANIMAL WELFARE CENTER", APART FROM THE MARK AS SHOWN.

THE MARK CONSISTS OF ABBREVIATION OF THE WORD SAINT, NAMELY, "ST" FOLLOWED BY A PAW PRINT WHICH IS THEN FOLLOWED BY THE WORD HUBERT'S IS IN UPPER AND LOWER CASE LETTERS, THE WORDS "ANIMAL WELFARE CENTER" APPEAR IN STYLIZED LETTERING AND ARE DIRECTLY UNDERNEATH THE WORD "HUBERT'S".

CLASS 36—INSURANCE AND FINANCIAL

FOR CHARITABLE FUNDRAISING SERVICES FOR ANIMAL WELFARE (U.S. CLS. 100, 101 AND 102).
FIRST USE 7-11-2002; IN COMMERCE 7-11-2002.

CLASS 39—TRANSPORTATION AND STORAGE

FOR ANIMAL RESCUE SERVICES (U.S. CLS. 100 AND 105).
FIRST USE 7-11-2002; IN COMMERCE 7-11-2002.

CLASS 41—EDUCATION AND ENTERTAINMENT

FOR ANIMAL OBEDIENCE TRAINING SERVICES; AND EDUCATIONAL CLASSES FOR CHILDREN REGARDING HUMANE TREATMENT OF ANIMALS (U.S. CLS. 100, 101 AND 107).

FIRST USE 7-11-2002; IN COMMERCE 7-11-2002.

CLASS 45—PERSONAL AND LEGAL SERVICES

FOR ANIMAL ADOPTION SERVICES, NAMELY, ARRANGING FOR DOGS AND CATS TO BE PLACED IN HOMES (U.S. CLS. 100 AND 101).

FIRST USE 7-11-2002; IN COMMERCE 7-11-2002.
MARC LEIPZIG, EXAMINING ATTORNEY

SN 77-925,154. REVIVA INC., MINNEAPOLIS, MN. FILED 2-1-2010.

SN 77-925,202. GOGARDENGO, LLC, ST. PAUL, MN. FILED 2-1-2010.

KORODY-COLYER

THE MARK CONSISTS OF STANDARD CHARACTERS WITHOUT CLAIM TO ANY PARTICULAR FONT, STYLE, SIZE, OR COLOR.

CLASS 7—MACHINERY

FOR DIESEL ENGINES FOR BOATS AND PARTS THEREFOR; REPLACEMENT PARTS FOR HEAVY DUTY DIESEL ENGINES USED SPECIFICALLY IN MARINE APPLICATIONS; DIESEL ENGINE PARTS FOR AUTOMOBILES AND LOCOMOTIVES, NAMELY, CAMSHAFTS, CYLINDERS, CYLINDER PISTONS; REPLACEMENT PARTS FOR HEAVY DUTY DIESEL ENGINES USED ON-HIGHWAY AND OFF-HIGHWAY, NAMELY, GRAVEL HAULERS, ROCK CRUSHERS, LUMBER PROCESSORS, AND SEMI-TRACTORS, AND IN AUTOMOTIVE AND NON-AUTOMOTIVE APPLICATIONS, NAMELY VEHICLES AND ELECTRICAL GENERATORS (U.S. CLS. 13, 19, 21, 23, 31, 34 AND 35).

CLASS 12—VEHICLES

FOR DIESEL ENGINES FOR AUTOMOBILES AND LOCOMOTIVES (U.S. CLS. 19, 21, 23, 31, 35 AND 44).
BERNICE MIDDLETON, EXAMINING ATTORNEY

SN 77-925,187. 21 DROPS LLC, DELRAY BEACH, FL. FILED 2-1-2010.

21 DROPS

THE MARK CONSISTS OF STANDARD CHARACTERS WITHOUT CLAIM TO ANY PARTICULAR FONT, STYLE, SIZE, OR COLOR.

CLASS 3—COSMETICS AND CLEANING PREPARATIONS

FOR ESSENTIAL OILS FOR USE IN AROMATHERAPY (U.S. CLS. 1, 4, 6, 50, 51 AND 52).

CLASS 35—ADVERTISING AND BUSINESS

FOR RETAIL STORE SERVICES FEATURING ESSENTIAL OILS FOR USE IN AROMATHERAPY (U.S. CLS. 100, 101 AND 102).
RENEE MCCRAY, EXAMINING ATTORNEY



THE MARK CONSISTS OF THE MARK "GOGARDENGO" WITH A PARTIAL CIRCLE BEFORE AROUND THE LETTERS "GARDEN" WITH A LEAF DESIGN ATTACHED TO THE LETTER "O" AND THE WORDS "A GROWING COMMUNITY" COMPLETING THE CIRCLE.

CLASS 35—ADVERTISING AND BUSINESS

FOR PRODUCT MERCHANDISING RELATED TO GARDENING; ONLINE RETAIL STORE SALES FEATURING GARDENING SUPPLIES (U.S. CLS. 100, 101 AND 102).

CLASS 42—SCIENTIFIC AND COMPUTER SERVICES

FOR COMPUTER SERVICES, NAMELY, PROVIDING INTERACTIVE ONLINE COMMUNITIES IN THE FIELD OF GARDENING (U.S. CLS. 100 AND 101).

CLASS 44—MEDICAL, BEAUTY AND AGRICULTURAL SERVICES

FOR PROVIDING GARDENING ADVICE AND PROVIDING INFORMATION RELATED TO GARDENING VIA THE INTERNET (U.S. CLS. 100 AND 101).
ANTHONY RINKER, EXAMINING ATTORNEY

SN 77-925,225. MUELLER SPORTS MEDICINE, INC., PRAIRIE DU SAC, WI. FILED 2-1-2010.

EXTREME CARE

THE MARK CONSISTS OF STANDARD CHARACTERS WITHOUT CLAIM TO ANY PARTICULAR FONT, STYLE, SIZE, OR COLOR.

CLASS 5—PHARMACEUTICALS

FOR TAPE AND TAPING SUPPLIES FOR MEDICAL PURPOSES, NAMELY, MEDICAL ADHESIVE TAPE, MEDICAL COHESIVE TAPE, MEDICAL PRETAPING FOAM UNDERWRAP, MEDICAL PRETAPING SPRAY ADHERENT; FIRST AID KITS; ATHLETIC TRAINERS' KITS COMPRISED PRIMARILY OF ADHESIVE BANDAGES, MEDICAL ADHESIVE TAPE, GAUZE PADS FOR DRESSINGS, MEDICAL COHESIVE TAPE, ANTI-BIOTIC OINTMENTS, ANTISEPTIC SPRAY, SPRAY-ON BANDAGES AND ICE BAGS FOR MEDICAL PURPOSES; ANALGESIC OINTMENTS AND BALMS; MEDICAL AND SURGICAL DRESSINGS, NAMELY, BLISTER PADS, WOUND DRESSINGS; NONMEDICATED TOPICAL GELS AND OINTMENTS FOR USE AS PERSONAL LUBRICANTS ON SKIN TO REDUCE CHAFING ON THE LEGS AND FEET OF ATHLETES AND RUNNERS; SPRAY ON BANDAGES FOR SKIN WOUNDS; ANTI-SEPTIC SPRAYS AND OINTMENTS FOR MEDICAL USE; ADHESIVE BANDAGES (U.S. CLS. 6, 18, 44, 46, 51 AND 52).

CLASS 10—MEDICAL APPARATUS

FOR COHESIVE SUPPORT BANDAGES, COHESIVE COMPRESSION BANDAGES; COLD-HOT THERAPY PRODUCTS FOR MEDICAL PURPOSES, NAMELY, ICE BAGS, CHEMICALLY ACTIVATED COLD PACKS, CHEMICALLY ACTIVATED INSTANT COLD PACKS, COLD-HOT THERMAL PACKS FOR FIRST AID PURPOSES, SPRAY COOLANT FOR SKIN FOR MEDICAL PURPOSES, MEDICAL COLD-HOT WRAPS; ELASTIC BANDAGES, ELASTIC SUPPORT WRAPS FOR MEDICAL PURPOSES; MEDICAL AND ORTHOPEDIC PRODUCTS, NAMELY, ORTHOPEDIC BRACES, ANKLE BRACES, ANKLE SUPPORTS, ANKLE STABILIZERS, KNEE BRACES, KNEE SUPPORTS, KNEE STABILIZERS, KNEE SLEEVES, KNEE STRAPS, ELBOW SLEEVES, ELBOW SUPPORTS, WRIST BRACES, WRIST SUPPORTS, WRIST STABILIZERS, WRIST SLEEVES, COMPRESSION GLOVES, BACK BRACES, BACK SUPPORTS, BACK STABILIZERS, THUMB STABILIZERS, SHOULDER BRACES, THIGH SLEEVES, THIGH SUPPORTS, CALF/SHIN SUPPORTS, ARM SLINGS (U.S. CLS. 26, 39 AND 44).

CLASS 28—TOYS AND SPORTING GOODS

FOR TAPE AND TAPING SUPPLIES FOR ATHLETIC PURPOSES, NAMELY, ATHLETIC ADHESIVE TAPE, ATHLETIC COHESIVE TAPE AND BANDAGES, ATHLETIC PRETAPING FOAM UNDERWRAP, ATHLETIC PRETAPING SPRAY ADHERENT; GLARE REDUCING UNDER EYE STRIPS, EYE BLACK PASTE FOR REDUCING SUN GLARE FOR SPORTS ACTIVITIES; ATHLETIC SPORTING GOODS, NAMELY, ATHLETIC WRIST AND JOINT SUPPORTS, ANKLE BRACES, ANKLE SUPPORTS, ANKLE STABILIZERS, KNEE BRACES, KNEE SUPPORTS, KNEE STABILIZERS, KNEE PADS FOR ATHLETIC USE, KNEE SLEEVES, KNEE STRAPS, ELBOW SLEEVES, ELBOW SUPPORTS, ELBOW PADS FOR ATHLETIC USE, WRIST BRACES, WRIST SUPPORTS, WRIST STABILIZERS, WRIST SLEEVES, BACK BRACES, BACK SUPPORTS, BACK STABILIZERS, THUMB STABILIZERS, SHOULDER BRACES, THIGH SLEEVES, THIGH SUPPORTS, CALF/SHIN SUPPORTS, ARM SLINGS; COMPRESSION GLOVES FOR ATHLETIC USE; NOSE GUARDS FOR ATHLETIC USE; ATHLETIC SUPPORTERS, JOCK STRAPS, PROTECTIVE ATHLETIC CUPS, ATHLETIC SUPPORT BRIEFS; PROTECTIVE COLLARS FOR FASTENING TO FOOTBALL SHOULDER PADS; NONMEDICATED LUBRICATING OINTMENTS AND GELS FOR REDUCING SKIN FRICTION IN SPORTS ACTIVITIES AND RUNNING; GRIP ENHANCERS FOR USE IN ATHLETIC ACTIVITIES, NAMELY, CHALK, CRUSHED AND POWDERED ROSIN, WATER REPELLING SPRAY FOR HANDS, ADHESIVE POWDER FOR HANDS, AEROSOL ADHESIVE NON-SLIP RESIN SPRAY FOR HANDS, AND PINE TAR FOR ATHLETIC EQUIPMENT (U.S. CLS. 22, 23, 38 AND 50).

LINDA POWELL, EXAMINING ATTORNEY

SN 77-925,226. AMERLUME, LLC, LOS ANGELES, CA. FILED 2-1-2010.

AMERLUME

THE MARK CONSISTS OF STANDARD CHARACTERS WITHOUT CLAIM TO ANY PARTICULAR FONT, STYLE, SIZE, OR COLOR.

THE WORDING "AMERLUME" HAS NO MEANING IN A FOREIGN LANGUAGE.

CLASS 9—ELECTRICAL AND SCIENTIFIC APPARATUS

FOR ELECTRIC OR ELECTRONIC SENSORS FOR AUTOMATICALLY ADJUSTING THE VERTICAL POSITIONING OF LIGHTING DEVICES; ELECTRICAL CONTROLLERS FOR AUTOMATING THE WAVE-LENGTH AND INTENSITY OF LIGHTING AND FOR AUTOMATICALLY ADJUSTING THE VERTICAL POSITIONING OF LIGHTING DEVICES (U.S. CLS. 21, 23, 26, 36 AND 38).

CLASS 11—ENVIRONMENTAL CONTROL APPARATUS

FOR ELECTRIC LIGHTING FIXTURES; ELECTRIC LUMINAIRES; LAMPS; LIGHTING FIXTURES (U.S. CLS. 13, 21, 23, 31 AND 34).

LINDA POWELL, EXAMINING ATTORNEY

SN 77-925,243. DROPBOX, INC., SAN FRANCISCO, CA. FILED 2-1-2010.

CLOUDTOP

THE MARK CONSISTS OF STANDARD CHARACTERS WITHOUT CLAIM TO ANY PARTICULAR FONT, STYLE, SIZE, OR COLOR.

CLASS 9—ELECTRICAL AND SCIENTIFIC APPARATUS

FOR COMPUTER SOFTWARE FOR DEVELOPING, DISCOVERING AND INSTALLING APPLICATIONS THAT CONNECT AND INTEGRATE INTERNET SERVICES AND SOFTWARE, AND MANUALS SUPPLIED THEREWITH (U.S. CLS. 21, 23, 26, 36 AND 38).

CLASS 39—TRANSPORTATION AND STORAGE

FOR STORAGE OF ELECTRONIC MEDIA, NAMELY, DATA, DOCUMENTS, FILES, TEXT, PHOTOS, IMAGES, GRAPHICS, MUSIC, AUDIO, VIDEO, AND MULTIMEDIA CONTENT (U.S. CLS. 100 AND 105).

CLASS 42—SCIENTIFIC AND COMPUTER SERVICES

FOR COMPUTER SERVICES, NAMELY, DESIGNING AND DEVELOPING COMPUTER SOFTWARE AND SOFTWARE APPLICATIONS FOR OTHERS; DESIGNING AND DEVELOPING COMPUTER SOFTWARE FOR DEVELOPING, DISCOVERING AND INSTALLING APPLICATIONS THAT CONNECT AND INTEGRATE INTERNET SERVICES AND SOFTWARE; PROVIDING TEMPORARY USE OF ONLINE NON-DOWNLOADABLE SOFTWARE FOR DEVELOPING, DISCOVERING AND INSTALLING APPLICATIONS THAT CONNECT AND INTEGRATE INTERNET SERVICES AND SOFTWARE (U.S. CLS. 100 AND 101).

JOSETTE BEVERLY, EXAMINING ATTORNEY

SN 77-925,444. SCOTT DAVID GREENBERG, LINCOLN-SHIRE, IL. FILED 2-1-2010.

VIPER ALLEY ROCK PIT

THE MARK CONSISTS OF STANDARD CHARACTERS WITHOUT CLAIM TO ANY PARTICULAR FONT, STYLE, SIZE, OR COLOR.

CLASS 25—CLOTHING

FOR CLOTHING AND HEADGEAR, NAMELY, T-SHIRTS, SHIRTS, JACKETS, SHORTS, SWEATSHIRTS, SWEATPANTS, HATS (U.S. CLS. 22 AND 39).

CLASS 41—EDUCATION AND ENTERTAINMENT

FOR PROVIDING FACILITIES FOR CONCERTS, DANCES, LIVE MUSIC PERFORMANCES, AND BOWLING; AND ENTERTAINMENT SERVICES, NAMELY, CONDUCTING PARTIES AND SOCIAL EVENTS; TICKET AGENCY SERVICES FOR ENTERTAINMENT EVENTS; SPECIAL EVENT AND PARTY PLANNING, COORDINATION AND CONSULTATION SERVICES (U.S. CLS. 100, 101 AND 107).

CLASS 43—HOTEL AND RESTAURANT SERVICES

FOR RESTAURANT, BAR AND CATERING SERVICES; AND PROVIDING SOCIAL MEETING AND PARTY FACILITIES (U.S. CLS. 100 AND 101).

JOHN E. MICHOS, EXAMINING ATTORNEY

SN 77-925,455. SCOTT DAVID GREENBERG, LINCOLN-SHIRE, IL. FILED 2-1-2010.



THE COLOR(S) BLACK, GREY, AND RUST RED IS/ARE CLAIMED AS A FEATURE OF THE MARK.

THE MARK CONSISTS OF RECTANGULAR GREY STEEL PLATES HELD TOGETHER WITH BLACK RIVETS. THE GREY PLATES HAVE RUST RED STREAKS AND A BLACK OUTLINE. THE WORDS "VIPER ALLEY ROCK PIT" ARE IN BLACK.

CLASS 25—CLOTHING

FOR CLOTHING AND HEADGEAR, NAMELY, T-SHIRTS, SHIRTS, JACKETS, SHORTS, SWEATSHIRTS, SWEATPANTS, HATS (U.S. CLS. 22 AND 39).

CLASS 41—EDUCATION AND ENTERTAINMENT

FOR PROVIDING FACILITIES FOR CONCERTS, DANCES, LIVE MUSIC PERFORMANCES, AND BOWLING; AND ENTERTAINMENT SERVICES, NAMELY, CONDUCTING PARTIES AND SOCIAL EVENTS; TICKET AGENCY SERVICES FOR ENTERTAINMENT EVENTS; SPECIAL EVENT AND PARTY PLANNING, COORDINATION AND CONSULTATION SERVICES (U.S. CLS. 100, 101 AND 107).

CLASS 43—HOTEL AND RESTAURANT SERVICES

FOR RESTAURANT, BAR AND CATERING SERVICES; AND PROVIDING SOCIAL MEETING AND PARTY FACILITIES (U.S. CLS. 100 AND 101).

JOHN E. MICHOS, EXAMINING ATTORNEY

SN 77-925,492. JOHN WILSON, DBA NAKEDBALM, HIGHLAND, UT. FILED 2-2-2010.

nakedbalm

THE MARK CONSISTS OF STANDARD CHARACTERS WITHOUT CLAIM TO ANY PARTICULAR FONT, STYLE, SIZE, OR COLOR.

CLASS 3—COSMETICS AND CLEANING PREPARATIONS

FOR NON-MEDICATED BALMS FOR USE ON SKIN TO RELIEVE SYMPTOMS OF DERMATITIS (U.S. CLS. 1, 4, 6, 50, 51 AND 52).

CLASS 35—ADVERTISING AND BUSINESS

FOR WHOLESALE AND RETAIL STORE SERVICES AND ON-LINE RETAIL AND WHOLESALE STORE SERVICES FEATURING SKIN CARE PRODUCTS (U.S. CLS. 100, 101 AND 102).

KAPIL BHANOT, EXAMINING ATTORNEY

SN 77-925,530. CRYSTAL ROCK LLC, WATERTOWN, CT.
FILED 2-2-2010.



OWNER OF U.S. REG. NOS. 2,423,046, 2,450,626 AND 2,786,852.

NO CLAIM IS MADE TO THE EXCLUSIVE RIGHT TO USE "WATERS", APART FROM THE MARK AS SHOWN.

THE MARK CONSISTS OF THE WORDING "CRYSTAL ROCK" AND THE DESIGN OF A POOL OF WATER FORMED BY THREE CONCENTRIC OVALS BELOW THE WORD "CRYSTAL" WITH THE LETTER "Y" EMANATING FROM THE CENTER OF THE POOL OF WATER AND THE WORD "WATERS" SPREAD OUT TO THE RIGHT OF THE POOL OF WATER.

CLASS 32—LIGHT BEVERAGES

FOR BOTTLED DRINKING WATER (U.S. CLS. 45, 46 AND 48).

CLASS 37—CONSTRUCTION AND REPAIR

FOR MAINTENANCE OF WATER FILTRATION SYSTEMS FOR HOMES AND OFFICES (U.S. CLS. 100, 103 AND 106).

CLASS 40—MATERIAL TREATMENT

FOR RENTAL OF WATER FILTRATION SYSTEMS FOR HOMES AND OFFICES (U.S. CLS. 100, 103 AND 106).

TOBY BULLOFF, EXAMINING ATTORNEY

SN 77-925,687. HOLCOMBE, JERRY, A., BIRMINGHAM, AL.
FILED 2-2-2010.

Trophy Husband

THE MARK CONSISTS OF STANDARD CHARACTERS WITHOUT CLAIM TO ANY PARTICULAR FONT, STYLE, SIZE, OR COLOR.

CLASS 14—JEWELRY

FOR BODY JEWELRY; BRACELETS; DIAMOND JEWELRY; IDENTIFICATION BRACELETS; JEWELRY; JEWELRY AND IMITATION JEWELRY; JEWELRY CHAINS; JEWELRY FOR ATTACHMENT TO CLOTHING; JEWELRY PINS FOR USE ON HATS; JEWELRY WATCHES; JEWELRY, NAMELY, CROSSES; LAPEL PINS; PINS BEING JEWELRY; PLASTIC BRACELETS IN THE NATURE OF JEWELRY; RINGS; STAINLESS STEEL JEWELRY BRACELETS; WATCHES AND JEWELRY (U.S. CLS. 2, 27, 28 AND 50).

CLASS 25—CLOTHING

FOR BELTS; BELTS FOR CLOTHING; BOTTOMS; CLOTHING, NAMELY, BASE LAYERS; CLOTHING, NAMELY, KHAKIS; GLOVES AS CLOTHING; HEADBANDS FOR CLOTHING; HOODS; JACKETS; JERSEYS; LEATHER BELTS; SHORT SETS; TIES; TOPS; WEARABLE GARMENTS AND CLOTHING, NAMELY, SHIRTS (U.S. CLS. 22 AND 39).

CLASS 26—FANCY GOODS

FOR BELT BUCKLES; BELT BUCKLES NOT OF PRECIOUS METAL; BELT BUCKLES OF PRECIOUS METAL; BUCKLES FOR CLOTHING; BUCKLES OF PRECIOUS METAL; CLOTHING BUCKLES; CLOTHING FASTENERS, NAMELY, SNAP BUTTONS (U.S. CLS. 37, 39, 40, 42 AND 50).

JUSTINE D. PARKER, EXAMINING ATTORNEY

SN 77-925,704. STRANAHAN-COAKLEY, CATHY, DUBLIN, CA. FILED 2-2-2010.



NO CLAIM IS MADE TO THE EXCLUSIVE RIGHT TO USE "WAXING PARLOR & BEAUTY BOUTIQUE", APART FROM THE MARK AS SHOWN.

THE MARK CONSISTS OF THE STYLIZED WORDING "WAXCRAFT WAXING PARLOR & BEAUTY BOUTIQUE 'FOR THE BEWITCHING BEAUTY IN YOU!'" AND THE IMAGE OF A GIRL ON A WAXING STICK ON A BACKGROUND OF STARS AND A FULL MOON.

CLASS 3—COSMETICS AND CLEANING PREPARATIONS

FOR BODY SCRUB; COSMETICS; EYE SHADOWS; LOTIONS FOR COSMETIC PURPOSES; PERFUMES (U.S. CLS. 1, 4, 6, 50, 51 AND 52).

FIRST USE 12-1-2009; IN COMMERCE 12-1-2009.

CLASS 44—MEDICAL, BEAUTY AND AGRICULTURAL SERVICES

FOR BODY WAXING SERVICES; COSMETIC SKIN CARE SERVICES; SERVICES OF A MAKE-UP ARTIST (U.S. CLS. 100 AND 101).

FIRST USE 12-1-2009; IN COMMERCE 12-1-2009.
CHRISTINE COOPER, EXAMINING ATTORNEY

SN 77-925,783. MICHAEL J. ROSENBLATT, NEW YORK, NY.
FILED 2-2-2010.

Paws For A Cure

THE MARK CONSISTS OF STANDARD CHARACTERS WITHOUT CLAIM TO ANY PARTICULAR FONT, STYLE, SIZE, OR COLOR.

CLASS 20—FURNITURE AND ARTICLES NOT OTHERWISE CLASSIFIED

FOR NON-METAL PET TAGS (U.S. CLS. 2, 13, 22, 25, 32 AND 50).

CLASS 25—CLOTHING

FOR HOODED SWEAT SHIRTS; LONG-SLEEVED SHIRTS; POLO SHIRTS; SWEAT SHIRTS; T-SHIRTS; TEE SHIRTS (U.S. CLS. 22 AND 39).

CARRIE GENOVESE, EXAMINING ATTORNEY

SN 77-925,845. MIRIAM E FRANCO, PC, PHOENIXVILLE, PA. FILED 2-2-2010.

SN 77-925,800. GANAN GROUP, ENCINITAS, CA. FILED 2-2-2010.



NO CLAIM IS MADE TO THE EXCLUSIVE RIGHT TO USE "GROUP", APART FROM THE MARK AS SHOWN.

CLASS 35—ADVERTISING AND BUSINESS

FOR ADVERTISING, MARKETING AND PROMOTION SERVICES (U.S. CLS. 100, 101 AND 102).

CLASS 36—INSURANCE AND FINANCIAL

FOR REAL ESTATE INVESTMENT SERVICES (U.S. CLS. 100, 101 AND 102).

CARRIE GENOVESE, EXAMINING ATTORNEY

SN 77-925,833. ENESCO, LLC, ITASCA, IL. FILED 2-2-2010.

HUGS 'N SUCH

THE MARK CONSISTS OF STANDARD CHARACTERS WITHOUT CLAIM TO ANY PARTICULAR FONT, STYLE, SIZE, OR COLOR.

CLASS 24—FABRICS

FOR FABRIC GREETING SIGNS IN THE NATURE OF ACCESSORIES FOR COLLECTIBLE PLUSH ANIMALS FOR ADULTS (U.S. CLS. 42 AND 50).

FIRST USE 1-6-2010; IN COMMERCE 1-6-2010.

CLASS 28—TOYS AND SPORTING GOODS

FOR COLLECTIBLE PLUSH ANIMALS FOR ADULTS (U.S. CLS. 22, 23, 38 AND 50).

FIRST USE 1-6-2010; IN COMMERCE 1-6-2010.
LINDA E. BLOHM, EXAMINING ATTORNEY

IMAGERYWORK

THE MARK CONSISTS OF STANDARD CHARACTERS WITHOUT CLAIM TO ANY PARTICULAR FONT, STYLE, SIZE, OR COLOR.

CLASS 9—ELECTRICAL AND SCIENTIFIC APPARATUS

FOR DIGITAL MATERIALS, NAMELY, CDS, AND DOWNLOADABLE AUDIO FILES FEATURING TRAINING MATERIALS IN THE FIELD OF STRESS REDUCTION AND GUIDED IMAGERY AND PERSONAL AND PROFESSIONAL DEVELOPMENT, MOTIVATIONAL IMPROVEMENTS, AND SELF-IMAGE IMPROVEMENT (U.S. CLS. 21, 23, 26, 36 AND 38).

FIRST USE 8-9-2002; IN COMMERCE 8-9-2002.

CLASS 41—EDUCATION AND ENTERTAINMENT

FOR EDUCATIONAL SERVICES, NAMELY, CONDUCTING TRAINING COURSES, CLASSES, SEMINARS, CONFERENCES, AND WORKSHOPS IN THE FIELD OF STRESS REDUCTION AND GUIDED IMAGERY SERVICES AND PERSONAL AND PROFESSIONAL DEVELOPMENT, MOTIVATIONAL IMPROVEMENTS, AND SELF-IMAGE IMPROVEMENT AND THE DISTRIBUTION OF COURSE AND TRAINING MATERIALS IN CONNECTION THEREWITH (U.S. CLS. 100, 101 AND 107).

FIRST USE 8-9-2002; IN COMMERCE 8-9-2002.

LINDA ORNDORFF, EXAMINING ATTORNEY

SN 77-925,889. FOYE, DARWIN, OAK PARK, CA. AND REGAN, PATRICK, SHERMAN OAKS, CA. FILED 2-2-2010.

ROCK COLLECTORS

THE MARK CONSISTS OF STANDARD CHARACTERS WITHOUT CLAIM TO ANY PARTICULAR FONT, STYLE, SIZE, OR COLOR.

CLASS 16—PAPER GOODS AND PRINTED MATTER

FOR A SERIES OF BOOKS AND WRITTEN ARTICLES IN THE FIELD OF CELEBRITY COLLECTIONS; BOOKS IN THE FIELD OF CELEBRITY COLLECTIONS; COFFEE TABLE BOOKS FEATURING CELEBRITY COLLECTIONS (U.S. CLS. 2, 5, 22, 23, 29, 37, 38 AND 50).

CLASS 41—EDUCATION AND ENTERTAINMENT

FOR ENTERTAINMENT IN THE NATURE OF ONGOING TELEVISION PROGRAMS IN THE FIELD OF CELEBRITY COLLECTIONS; ENTERTAINMENT IN THE NATURE OF SERIES OF TELEVISION SHOWS FEATURING CELEBRITY COLLECTIONS; ENTERTAINMENT SERVICES IN THE NATURE OF AN ONGOING REALITY BASED TELEVISION PROGRAM; ENTERTAINMENT SERVICES IN THE NATURE OF CREATION, DEVELOPMENT, AND PRODUCTION OF TELEVISION PROGRAMMING; PRODUCTION AND DISTRIBUTION OF TELEVISION SHOWS AND MOVIES; PRODUCTION OF CABLE TELEVISION PROGRAMS; PRODUCTION OF DVDS, VIDEOTAPES AND TELEVISION PROGRAMS FEATURING CELEBRITY COLLECTIONS; PRODUCTION OF TELEVISION PROGRAMS; TELEVISION SHOW PRODUCTION (U.S. CLS. 100, 101 AND 107).

KIM SAITO, EXAMINING ATTORNEY

SN 77-925,956. CHURCH & DWIGHT CO., INC., PRINCETON, NJ. FILED 2-2-2010.

CLOSE UP

THE MARK CONSISTS OF STANDARD CHARACTERS WITHOUT CLAIM TO ANY PARTICULAR FONT, STYLE, SIZE, OR COLOR.

OWNER OF U.S. REG. NOS. 818,419, 2,198,451 AND 3,767,053.

CLASS 3—COSMETICS AND CLEANING PREPARATIONS

FOR NON-MEDICATED MOUTH WASH (U.S. CLS. 1, 4, 6, 50, 51 AND 52).

FIRST USE 2-0-2009; IN COMMERCE 2-0-2009.

CLASS 21—HOUSEWARES AND GLASS

FOR ORAL HYGIENE DEVICES, NAMELY, NON-MEDICATED DENTAL FLOSS AND NON-MEDICATED DENTAL FLOSS PICKS (U.S. CLS. 2, 13, 23, 29, 30, 33, 40 AND 50).

FIRST USE 1-0-2010; IN COMMERCE 1-0-2010.

GEORGE LORENZO, EXAMINING ATTORNEY

SN 77-926,025. SDI HEALTH LLC, PLYMOUTH MEETING, PA. FILED 2-2-2010.

STATELINE

THE MARK CONSISTS OF STANDARD CHARACTERS WITHOUT CLAIM TO ANY PARTICULAR FONT, STYLE, SIZE, OR COLOR.

OWNER OF U.S. REG. NO. 2,806,712.

CLASS 35—ADVERTISING AND BUSINESS

FOR COMPUTERIZED DATABASE MANAGEMENT, DATA PROCESSING SERVICES AND PROVIDING BUSINESS INFORMATION ALL IN THE FIELDS OF HEALTH CARE, PUBLIC HEALTH, PHARMACEUTICALS, MEDICAL PHYSICIANS, MEDICAL PHYSICIAN GROUPS AND MEDICAL PRACTITIONERS; CUSTOMIZED MARKET ANALYSIS OF DATA FOR OTHERS IN THE FIELDS OF HEALTH CARE, PUBLIC HEALTH, PHARMACEUTICAL, MEDICAL PHYSICIANS, MEDICAL PHYSICIAN GROUPS AND MEDICAL PRACTITIONERS; BUSINESS MARKETING RESEARCH, AUDIT AND CONSULTING SERVICES IN THE FIELDS OF HEALTH CARE, PUBLIC HEALTH, PHARMACEUTICALS, MEDICAL PHYSICIANS, MEDICAL PHYSICIAN GROUPS AND MEDICAL PRACTITIONERS PROVIDED BY ELECTRONIC MEANS, INCLUDING BY MEANS OF WIDE AREA NETWORKS OR A GLOBAL COMPUTER NETWORK (U.S. CLS. 100, 101 AND 102).

FIRST USE 10-0-2009; IN COMMERCE 10-0-2009.

CLASS 44—MEDICAL, BEAUTY AND AGRICULTURAL SERVICES

FOR PROVIDING MEDICAL INFORMATION IN THE NATURE OF RESEARCHING, TRACKING AND REPORTING IN THE FIELDS OF HEALTH CARE, PUBLIC HEALTH, PHARMACEUTICALS, MEDICAL PHYSICIANS, MEDICAL PHYSICIAN GROUPS AND MEDICAL PRACTITIONERS BY ELECTRONIC MEANS, INCLUDING BY MEANS OF WIDE AREA NETWORKS OR A GLOBAL COMPUTER NETWORK; CONSULTING SERVICES IN THE FIELDS OF HEALTH CARE, PUBLIC HEALTH, PHARMACEUTICALS, MEDICAL PHYSICIANS, MEDICAL PHYSICIAN GROUPS AND MEDICAL PRACTITIONERS PROVIDED BY ELECTRONIC MEANS, INCLUDING BY MEANS OF WIDE AREA NETWORKS OR A GLOBAL COMPUTER NETWORK (U.S. CLS. 100 AND 101).

FIRST USE 10-0-2009; IN COMMERCE 10-0-2009.

KAREN SEVERSON, EXAMINING ATTORNEY

SN 77-926,185. NS412, LLC, GARLAND, TX. FILED 2-2-2010.

TRUE THIN

THE MARK CONSISTS OF STANDARD CHARACTERS WITHOUT CLAIM TO ANY PARTICULAR FONT, STYLE, SIZE, OR COLOR.

CLASS 29—MEATS AND PROCESSED FOODS

FOR PREPARED AND FROZEN ENTREES, SIDE DISHES AND MEALS CONSISTING PRIMARILY OF MEAT, POULTRY, SEAFOOD, EGGS, DAIRY OR VEGETABLES, NOT INCLUDING DESSERTS; READY-TO-EAT FRUIT, NUT AND SOY BASED FOOD BARS; DEHYDRATED MEATS; CHEESE AND CRACKER COMBINATIONS; PEANUT BUTTER AND CRACKER COMBINATIONS; PACKAGED PROCESSED NUTS AND PROCESSED BEANS AND PEAS (U.S. CL. 46).

CLASS 30—STAPLE FOODS

FOR READY-TO-EAT FOOD BARS AND SNACK FOODS MADE WITH GRAINS; BREAD; CRACKERS; POPCORN; COFFEE; CRACKER AND CHEESE COMBINATIONS; CRACKER AND PEANUT BUTTER COMBINATIONS (U.S. CL. 46).

CLASS 32—LIGHT BEVERAGES

FOR WATER MIXED WITH FRUIT JUICE; BOTTLED SPRING WATER; FLAVORED WATER; DRY MIXES FOR MAKING FLAVORED WATER (U.S. CLS. 45, 46 AND 48).

SN 77-926,460. OTIS, REBECCA ELAINE, AUSTIN, TX. FILED 2-2-2010.

CLASS 38—COMMUNICATION

FOR PROVIDING ONLINE FACILITIES FOR REAL-TIME INTERACTION AND ELECTRONIC TRANSMISSION OF MESSAGES AMONG COMPUTER USERS IN THE FIELD OF NUTRITION AND WEIGHT MANAGEMENT; ONLINE VIDEO AND AUDIO BROADCASTING IN THE FIELD OF NUTRITION AND WEIGHT MANAGEMENT (U.S. CLS. 100, 101 AND 104).

TheRebeccammendations

THE MARK CONSISTS OF STANDARD CHARACTERS WITHOUT CLAIM TO ANY PARTICULAR FONT, STYLE, SIZE, OR COLOR.

CLASS 41—EDUCATION AND ENTERTAINMENT

FOR EDUCATIONAL SERVICES, NAMELY, CONDUCTING CLASSES AND SEMINARS IN THE FIELD OF NUTRITION AND WEIGHT MANAGEMENT AND DISTRIBUTING COURSE MATERIALS THEREWITH (U.S. CLS. 100, 101 AND 107).

APRIL ROACH, EXAMINING ATTORNEY

CLASS 35—ADVERTISING AND BUSINESS

FOR ADVERTISING AND MARKETING SERVICES, NAMELY, PROMOTING THE GOODS AND SERVICES OF OTHERS; ADVERTISING, MARKETING AND PROMOTION SERVICES; ON-LINE ADVERTISING AND MARKETING SERVICES (U.S. CLS. 100, 101 AND 102).
FIRST USE 3-17-2009; IN COMMERCE 3-17-2009.

SN 77-926,299. LIVING ON THE EDGE WITH CHIP INGRAM, SUWANEE, GA. FILED 2-2-2010.

CLASS 41—EDUCATION AND ENTERTAINMENT

FOR ON-LINE JOURNALS, NAMELY, BLOGS FEATURING ENTERTAINING AND ENTERTAINMENT INFORMATION (U.S. CLS. 100, 101 AND 107).

FIRST USE 3-17-2009; IN COMMERCE 3-17-2009.
THEODORE MCBRIDE, EXAMINING ATTORNEY

r12

THE MARK CONSISTS OF STANDARD CHARACTERS WITHOUT CLAIM TO ANY PARTICULAR FONT, STYLE, SIZE, OR COLOR.

SN 77-926,502. CARPE CHAOS, LLC, SANTA CRUZ, CA. FILED 2-3-2010.

CLASS 9—ELECTRICAL AND SCIENTIFIC APPARATUS

FOR DIGITAL MEDIA, NAMELY, PRE-RECORDED VIDEO CASSETTES, DIGITAL VIDEO DISCS, DIGITAL VERSATILE DISCS, DOWNLOADABLE AUDIO AND VIDEO RECORDINGS, DVDS, AND HIGH DEFINITION DIGITAL DISCS FEATURING TEACHINGS IN THE FIELD OF SPIRITUAL FORMATION AND DEVELOPMENT (U.S. CLS. 21, 23, 26, 36 AND 38).

FIRST USE 9-1-2008; IN COMMERCE 12-1-2008.

CARPE CHAOS

THE MARK CONSISTS OF STANDARD CHARACTERS WITHOUT CLAIM TO ANY PARTICULAR FONT, STYLE, SIZE, OR COLOR.

CLASS 16—PAPER GOODS AND PRINTED MATTER

FOR PUBLICATIONS, NAMELY, BOOKS, BOOKLETS, WORKBOOKS, JOURNALS, STUDY GUIDES IN THE FIELDS OF SPIRITUAL FORMATION AND DEVELOPMENT (U.S. CLS. 2, 5, 22, 23, 29, 37, 38 AND 50).

FIRST USE 9-1-2008; IN COMMERCE 12-1-2008.

CLASS 16—PAPER GOODS AND PRINTED MATTER

FOR PRINTED MATERIALS, NAMELY, PRINTS, BUMPER STICKERS, POSTER, CARDBOARD CUTOUTS OF IMAGES FOR DECORATIVE PURPOSES (U.S. CLS. 2, 5, 22, 23, 29, 37, 38 AND 50).

CLASS 41—EDUCATION AND ENTERTAINMENT

FOR EDUCATIONAL SERVICES, NAMELY, CONDUCTING ONLINE TEACHING IN THE FIELD OF SPIRITUAL FORMATION AND DEVELOPMENT AND DISTRIBUTION OF PRINTED MATERIALS IN CONNECTION THEREWITH IN HARD COPY OR ELECTRONIC FORMAT ON THE SAME TOPICS (U.S. CLS. 100, 101 AND 107).

FIRST USE 9-1-2008; IN COMMERCE 12-1-2008.
KEVIN DINALLO, EXAMINING ATTORNEY

CLASS 41—EDUCATION AND ENTERTAINMENT

FOR ENTERTAINMENT SERVICES, NAMELY, PROVIDING AN ELECTRONIC PUBLICATION IN THE NATURE OF A COMIC STRIP AVAILABLE VIA THE INTERNET (U.S. CLS. 100, 101 AND 107).

KEVIN DINALLO, EXAMINING ATTORNEY

SN 77-926,503. CARPE CHAOS, LLC, SANTA CRUZ, CA.
FILED 2-3-2010.

SN 77-926,566. BELL LABORATORIES, INC., MADISON, WI.
FILED 2-3-2010.



THE MARK CONSISTS OF THE WORDS "CARPE CHAOS" IN CAPITAL LETTERS, WITH THE TERM "CARPE" ON TOP, AND THE TERM "CHAOS" IMMEDIATELY BENEATH IT, WITH AN IMAGE OF A SATURN LIKE PLANET BEHIND THE WORDS "CARPE CHAOS," WITH A DISTINCT RING AROUND THE PLANET.

CLASS 16—PAPER GOODS AND PRINTED MATTER

FOR PRINTED MATERIALS, NAMELY, PRINTS, BUMPER STICKERS, POSTER, CARDBOARD CUTOUTS OF IMAGES FOR DECORATIVE PURPOSES (U.S. CLS. 2, 5, 22, 23, 29, 37, 38 AND 50).

CLASS 41—EDUCATION AND ENTERTAINMENT

FOR ENTERTAINMENT SERVICES, NAMELY, PROVIDING AN ELECTRONIC PUBLICATION IN THE NATURE OF A COMIC STRIP AVAILABLE VIA THE INTERNET (U.S. CLS. 100, 101 AND 107).

KEVIN DINALLO, EXAMINING ATTORNEY

SN 77-926,563. FARE THEE WELL MEDIA INC., ROCKPORT, ME. FILED 2-3-2010.

Family Farewell

THE MARK CONSISTS OF STANDARD CHARACTERS WITHOUT CLAIM TO ANY PARTICULAR FONT, STYLE, SIZE, OR COLOR.

CLASS 16—PAPER GOODS AND PRINTED MATTER

FOR LIFE-STORY AND MEMORY BOOKS (U.S. CLS. 2, 5, 22, 23, 29, 37, 38 AND 50).

CLASS 42—SCIENTIFIC AND COMPUTER SERVICES

FOR COMPUTER SERVICE, NAMELY, PROVIDING INTERACTIVE WEBSITE FOR THE COLLECTION, EDITING, ORGANIZING, COMPOSING, STORAGE AND PRINTING OF BOOKS DOCUMENTING THE LIFE STORY OF THE AUTHOR (U.S. CLS. 100 AND 101).

HEATHER SAPP, EXAMINING ATTORNEY

FAMILY FRIENDLY, RODENT DEADLY

THE MARK CONSISTS OF STANDARD CHARACTERS WITHOUT CLAIM TO ANY PARTICULAR FONT, STYLE, SIZE, OR COLOR.

CLASS 5—PHARMACEUTICALS

FOR RODENTICIDES (U.S. CLS. 6, 18, 44, 46, 51 AND 52).

CLASS 21—HOUSEWARES AND GLASS

FOR BAIT STATIONS FOR RODENTS; GLUE TRAPS FOR CATCHING RODENTS AND INSECTS; MECHANICAL TRAPS FOR CATCHING RODENTS; LIVE CAPTURE RODENT TRAPS (U.S. CLS. 2, 13, 23, 29, 30, 33, 40 AND 50).

HEATHER SAPP, EXAMINING ATTORNEY

SN 77-926,593. KINETIC TECHNOLOGIES, LLC, LEXINGTON, KY. FILED 2-3-2010.

Equishield

THE MARK CONSISTS OF STANDARD CHARACTERS WITHOUT CLAIM TO ANY PARTICULAR FONT, STYLE, SIZE, OR COLOR.

CLASS 3—COSMETICS AND CLEANING PREPARATIONS

FOR SHAMPOO (U.S. CLS. 1, 4, 6, 50, 51 AND 52).

CLASS 5—PHARMACEUTICALS

FOR WOUND DRESSINGS (U.S. CLS. 6, 18, 44, 46, 51 AND 52).

CLASS 21—HOUSEWARES AND GLASS

FOR HORSE BRUSHES AND WATER BUCKETS (U.S. CLS. 2, 13, 23, 29, 30, 33, 40 AND 50).

KRISTINA MORRIS, EXAMINING ATTORNEY

SN 77-926,652. ALLEGRO MFG. INC., COMMERCE, CA. FILED 2-3-2010.

SN 77-926,681. DOMMERHOLT JOHAN, EPSE, NETHERLANDS, FILED 2-3-2010.

LUNCH BOX STUDIO

THE MARK CONSISTS OF STANDARD CHARACTERS WITHOUT CLAIM TO ANY PARTICULAR FONT, STYLE, SIZE, OR COLOR.

NO CLAIM IS MADE TO THE EXCLUSIVE RIGHT TO USE "LUNCH BOX", APART FROM THE MARK AS SHOWN.

CLASS 16—PAPER GOODS AND PRINTED MATTER

FOR LUNCH BAGS (U.S. CLS. 2, 5, 22, 23, 29, 37, 38 AND 50).

CLASS 21—HOUSEWARES AND GLASS

FOR THERMAL INSULATED BAGS FOR FOOD OR BEVERAGES; THERMAL INSULATED CONTAINERS FOR FOOD OR BEVERAGES (U.S. CLS. 2, 13, 23, 29, 30, 33, 40 AND 50).

AMY KERTGATE, EXAMINING ATTORNEY

SN 77-926,677. ASSOCIATED INDUSTRIES OF MASSACHUSETTS, INC., BOSTON, MA. FILED 2-3-2010.

AIM-IBC

THE MARK CONSISTS OF STANDARD CHARACTERS WITHOUT CLAIM TO ANY PARTICULAR FONT, STYLE, SIZE, OR COLOR.

CLASS 16—PAPER GOODS AND PRINTED MATTER

FOR EDUCATIONAL PUBLICATIONS, NAMELY, BOOKS, HAND-OUTS, WORKBOOKS, JOURNALS, PLAYBOOKS, WORKSHEETS, AND CARDS IN THE FIELDS OF INTERNATIONAL BUSINESS AND INTERNATIONAL TRADE (U.S. CLS. 2, 5, 22, 23, 29, 37, 38 AND 50).

CLASS 41—EDUCATION AND ENTERTAINMENT

FOR EDUCATIONAL SERVICES, NAMELY, CONDUCTING TRADE SEMINARS, CONFERENCES, WORKSHOPS, CLASSES, AND SYMPOSIA IN THE FIELD OF INTERNATIONAL BUSINESS AND INTERNATIONAL TRADE (U.S. CLS. 100, 101 AND 107).

CHRISTOPHER BUONGIORNO, EXAMINING ATTORNEY

ODOCARE

THE MARK CONSISTS OF STANDARD CHARACTERS WITHOUT CLAIM TO ANY PARTICULAR FONT, STYLE, SIZE, OR COLOR.

CLASS 16—PAPER GOODS AND PRINTED MATTER

FOR PLASTIC TRASH BAGS; PLASTIC TRASH COMPACTOR BAGS; TRASH BAGS; TRASH CAN LINERS (U.S. CLS. 2, 5, 22, 23, 29, 37, 38 AND 50).

CLASS 21—HOUSEWARES AND GLASS

FOR GARBAGE CANS; TRASH CANS; TRASH CONTAINERS FOR HOUSEHOLD USE (U.S. CLS. 2, 13, 23, 29, 30, 33, 40 AND 50).

MARIAM MAHMOUDI, EXAMINING ATTORNEY

SN 77-926,710. FIRST AMERICAN MUSIC AND ENTERTAINMENT, LLC, HOLLYWOOD, FL. FILED 2-3-2010.

WARRIORS ROCK 'N HOPE

THE MARK CONSISTS OF STANDARD CHARACTERS WITHOUT CLAIM TO ANY PARTICULAR FONT, STYLE, SIZE, OR COLOR.

CLASS 9—ELECTRICAL AND SCIENTIFIC APPARATUS

FOR MUSICAL SOUND RECORDINGS AND MUSICAL AUDIOVISUAL RECORDINGS; SOUND RECORDINGS AND AUDIOVIDEO RECORDINGS CONCERNING MUSICAL ARTISTS; DOWNLOADABLE MUSICAL SOUND RECORDINGS; DOWNLOADABLE SOUND RECORDINGS CONCERNING MUSICAL ARTISTS; DOWNLOADABLE VIDEO RECORDINGS FEATURING MUSIC; DOWNLOADABLE VIDEO RECORDINGS CONCERNING MUSICAL ARTISTS; DOWNLOADABLE ELECTRONIC PUBLICATIONS IN THE NATURE OF BOOKS, BOOKLETS, MAGAZINES, JOURNALS, MANUALS, BROCHURES, LEAFLETS, PAMPHLETS AND NEWSLETTERS, CONCERNING MUSICAL ARTISTS (U.S. CLS. 21, 23, 26, 36 AND 38).

CLASS 16—PAPER GOODS AND PRINTED MATTER

FOR PRINTED MATTER, NAMELY, POSTERS, SHEET MUSIC, TABLATURE BOOKS, SONG BOOKS, TOUR BOOKS RELATING TO A MUSIC ARTIST, MAGAZINES RELATING TO A MUSICAL ARTIST, STICKERS, BUMPER STICKERS, DECALS; PHOTOGRAPHS; AND LITHOGRAPHS (U.S. CLS. 2, 5, 22, 23, 29, 37, 38 AND 50).

CLASS 25—CLOTHING

FOR CLOTHING, NAMELY, SHIRTS, T-SHIRTS, TOPS, SWEAT SHIRTS, CAPS, HATS, WRIST BANDS AND UNDERWEAR (U.S. CLS. 22 AND 39).

CLASS 41—EDUCATION AND ENTERTAINMENT

FOR ENTERTAINMENT, NAMELY, LIVE MUSIC PERFORMANCES; PROVIDING ENTERTAINMENT INFORMATION VIA A COMPUTER COMMUNICATIONS NETWORK, NAMELY, INFORMATION ABOUT APPEARANCES, PERFORMANCES AND RECORDINGS OF MUSIC ARTISTS; INFORMATION SERVICES, NAMELY, PROVIDING A WEB SITE FEATURING MUSICAL PERFORMANCES, MUSICAL VIDEOS, RELATED FILM CLIPS, PHOTOGRAPHS AND OTHER MULTIMEDIA MATERIALS FEATURING MUSIC; FAN CLUB SERVICES; TELEVISION AND RADIO PROGRAM PRODUCTION SERVICES; PRODUCTION AND ORGANIZATION OF LIVE ENTERTAINMENT EVENTS, NAMELY, CONCERTS, CONCERT TOURS AND FESTIVALS IN THE MUSIC FIELD; AND PRODUCTION AND DISTRIBUTION OF MOTION PICTURES AND TELEVISION PROGRAMS, AND PRODUCTION OF SOUND RECORDINGS (U.S. CLS. 100, 101 AND 107).

JANICE L. MCMORROW, EXAMINING ATTORNEY

SN 77-926,735. DRASLER, CYNTHIA, PHOENIX, AZ. FILED 2-3-2010.

LIVING WITHOUT NOVOCAINE

THE MARK CONSISTS OF STANDARD CHARACTERS WITHOUT CLAIM TO ANY PARTICULAR FONT, STYLE, SIZE, OR COLOR.

CLASS 9—ELECTRICAL AND SCIENTIFIC APPARATUS

FOR ELECTRONIC PUBLICATIONS, NAMELY, BOOKS AND ARTICLES FEATURING TRUE STORIES ABOUT THRIVING THROUGH ADVERSITY RECORDED ON COMPUTER MEDIA (U.S. CLS. 21, 23, 26, 36 AND 38).

CLASS 16—PAPER GOODS AND PRINTED MATTER

FOR PUBLICATIONS, NAMELY, BOOKS AND ARTICLES IN THE FIELDS OF TRUE STORIES ABOUT THRIVING THROUGH ADVERSITY (U.S. CLS. 2, 5, 22, 23, 29, 37, 38 AND 50).

JULIE WATSON, EXAMINING ATTORNEY

SN 77-926,778. PARSLEY, DAVID R., OVERLAND PARK, KS. FILED 2-3-2010.

E's YOUR WAY TO EXCELLENCE

THE MARK CONSISTS OF STANDARD CHARACTERS WITHOUT CLAIM TO ANY PARTICULAR FONT, STYLE, SIZE, OR COLOR.

CLASS 35—ADVERTISING AND BUSINESS

FOR BUSINESS CONSULTATION IN THE FIELD OF BUSINESS LEADERSHIP DEVELOPMENT; CONSULTING SERVICES IN BUSINESS LEADERSHIP DEVELOPMENT AND BUSINESS MANAGEMENT; BUSINESS CONSULTING SERVICES IN THE FIELD OF ORGANIZATIONAL CHANGE MANAGEMENT; PROVIDING ORGANIZATIONAL DEVELOPMENT CONSULTING SERVICES (U.S. CLS. 100, 101 AND 102).

CLASS 41—EDUCATION AND ENTERTAINMENT

FOR PROVIDING GROUP COACHING AND LEARNING FORUMS IN THE FIELD OF LEADERSHIP DEVELOPMENT; PROFESSIONAL COACHING SERVICES IN THE FIELD OF BUSINESS MANAGEMENT AND LEADERSHIP DEVELOPMENT; EDUCATIONAL SERVICES, NAMELY, PROVIDING CLASSES, SEMINARS, WORKSHOPS, AND CONFERENCES IN THE FIELD OF BUSINESS MANAGEMENT AND LEADERSHIP DEVELOPMENT (U.S. CLS. 100, 101 AND 107).

KATHLEEN M. VANSTON, EXAMINING ATTORNEY

SN 77-926,797. LICENSE BRANDING, LLC, SAN ANTONIO, TX. FILED 2-3-2010.

ARMANDO MONTELONGO

THE MARK CONSISTS OF STANDARD CHARACTERS WITHOUT CLAIM TO ANY PARTICULAR FONT, STYLE, SIZE, OR COLOR.

THE NAME "ARMANDO MONTELONGO" IDENTIFIES A LIVING INDIVIDUAL WHOSE CONSENT IS OF RECORD.

CLASS 9—ELECTRICAL AND SCIENTIFIC APPARATUS

FOR PRE-RECORDED CDS AND DVDS IN THE FIELDS OF PURCHASING HOMES, SELLING HOMES, OBTAINING FINANCING, FINANCING REMODELING, PURCHASING HOMES FOR RESALE, OBTAINING CONTRACTOR AND SUBCONTRACTOR AGREEMENTS, HOME REPAIRS, WEALTH BUILDING, HOME FORECLOSURE; DOWNLOADABLE MP3 FILES, MP3 RECORDINGS, ON-LINE DISCUSSION BOARDS, WEBCASTS AND PODCASTS FEATURING INFORMATION IN THE FIELDS OF PURCHASING HOMES, SELLING HOMES, OBTAINING FINANCING, FINANCING REMODELING, PURCHASING HOMES FOR RESALE, OBTAINING CONTRACTOR AND SUBCONTRACTOR AGREEMENTS, HOME REPAIRS, WEALTH BUILDING, HOME FORECLOSURE; ELECTRONIC PUBLICATIONS, NAMELY, A SERIES OF BOOKS AND MANUALS ON COMPUTER MEDIA FEATURING INFORMATION IN THE FIELDS OF PURCHASING HOMES, SELLING HOMES, OBTAINING FINANCING, FINANCING REMODELING, PURCHASING HOMES FOR RESALE, OBTAINING CONTRACTOR AND SUBCONTRACTOR AGREEMENTS, HOME REPAIRS, WEALTH BUILDING, HOME FORECLOSURE (U.S. CLS. 21, 23, 26, 36 AND 38).

CLASS 16—PAPER GOODS AND PRINTED MATTER

FOR SERIES OF NON-FICTION BOOKS IN THE FIELDS OF PURCHASING HOMES, SELLING HOMES, OBTAINING FINANCING, FINANCING REMODELING, PURCHASING HOMES FOR RESALE, OBTAINING CONTRACTOR AND SUBCONTRACTOR AGREEMENTS, HOME REPAIRS, WEALTH BUILDING, HOME FORECLOSURE (U.S. CLS. 2, 5, 22, 23, 29, 37, 38 AND 50).

CLASS 36—INSURANCE AND FINANCIAL

FOR PROVIDING A WEB SITE FEATURING INFORMATION ON PURCHASING HOMES, SELLING HOMES, PURCHASING HOMES FOR RESALE, OBTAINING FINANCING, FINANCING REMODELING, WEALTH BUILDING, AND HOME FORECLOSURE (U.S. CLS. 100, 101 AND 102).

CLASS 41—EDUCATION AND ENTERTAINMENT

FOR ENTERTAINMENT AND EDUCATIONAL SERVICES, SERVICES, NAMELY, PROVIDING PODCASTS IN THE FIELD OF PURCHASING HOMES, SELLING HOMES, OBTAINING FINANCING, FINANCING REMODELING, PURCHASING HOMES FOR RESALE, OBTAINING CONTRACTOR AND SUBCONTRACTOR AGREEMENTS, HOME REPAIRS, WEALTH BUILDING, HOME FORECLOSURE; ENTERTAINMENT AND EDUCATIONAL SERVICES, NAMELY, A CONTINUING PROGRAM ABOUT PURCHASING HOMES, SELLING HOMES, OBTAINING FINANCING, FINANCING REMODELING, PURCHASING HOMES FOR RESALE, OBTAINING CONTRACTOR AND SUBCONTRACTOR AGREEMENTS, HOME REPAIRS, WEALTH BUILDING, HOME FORECLOSURE ACCESSIBLE BY RADIO, TELEVISION, SATELLITE, AUDIO, VIDEO AND COMPUTER NETWORKS; PRODUCTION OF TELEVISION SHOWS, PRODUCTION OF PROGRAMS ACCESSIBLE BY TELEVISION, SATELLITE, AUDIO, VIDEO AND COMPUTER NETWORKS; PERSONAL COACHING SERVICES IN THE FIELD OF PURCHASING HOMES, SELLING HOMES, OBTAINING FINANCING, FINANCING REMODELING, PURCHASING HOMES FOR RESALE, OBTAINING CONTRACTOR AND SUBCONTRACTOR AGREEMENTS, HOME REPAIRS, WEALTH BUILDING, HOME FORECLOSURE (U.S. CLS. 100, 101 AND 107).

SOPHIA S. KIM, EXAMINING ATTORNEY

CLASS 41—EDUCATION AND ENTERTAINMENT

FOR PROVIDING ON-LINE PUBLICATIONS IN THE NATURE OF ARTICLES, BOOKLETS, PAMPHLETS, BROCHURES, MAGAZINES, AND BOOKS IN THE FIELD OF INFORMATION RELATING TO WORLD PEACE, NATIONAL SECURITY, EDUCATION, ECOLOGY, MILITARY AFFAIRS, HUMAN RIGHTS, HEALTH AND NUTRITION, COMMERCE, NATURE AND THE ENVIRONMENT, HUMAN SERVICES ECONOMICS AND BUSINESS, JUSTICE AND POLITICS (U.S. CLS. 100, 101 AND 107).

REBECCA SMITH, EXAMINING ATTORNEY

SN 77-926,822. T2 BIOSYSTEMS, INC., CAMBRIDGE, MA.
FILED 2-3-2010.

T2BIO

SN 77-926,818. FLUM, PAUL L., ST. LOUIS, MO. FILED 2-3-2010.

WWPAC

THE MARK CONSISTS OF STANDARD CHARACTERS WITHOUT CLAIM TO ANY PARTICULAR FONT, STYLE, SIZE, OR COLOR.

OWNER OF U.S. REG. NO. 3,728,798.

CLASS 16—PAPER GOODS AND PRINTED MATTER

FOR PRINTED MATERIALS, NAMELY, ARTICLES, BOOKLETS, PAMPHLETS, BROCHURES, MAGAZINES, AND BOOKS PUBLISHED PERIODICALLY ON MATTERS RELATING TO WORLD PEACE, NATIONAL SECURITY, EDUCATION, ECOLOGY, MILITARY AFFAIRS, HUMAN RIGHTS, HEALTH AND NUTRITION, COMMERCE, NATURE AND THE ENVIRONMENT, HUMAN SERVICES ECONOMICS AND BUSINESS, JUSTICE AND POLITICS (U.S. CLS. 2, 5, 22, 23, 29, 37, 38 AND 50).

THE MARK CONSISTS OF STANDARD CHARACTERS WITHOUT CLAIM TO ANY PARTICULAR FONT, STYLE, SIZE, OR COLOR.

CLASS 1—CHEMICALS

FOR ASSAYS FOR USE IN BIOLOGICAL AND CHEMICAL RESEARCH (U.S. CLS. 1, 5, 6, 10, 26 AND 46).

CLASS 5—PHARMACEUTICALS

FOR DIAGNOSTIC REAGENTS FOR MEDICAL USE; MEDICAL DIAGNOSTIC ASSAYS FOR TESTING BIOLOGICAL FLUIDS; ASSAYS FOR USE IN MEDICAL AND CLINICAL DIAGNOSTICS (U.S. CLS. 6, 18, 44, 46, 51 AND 52).

CLASS 10—MEDICAL APPARATUS

FOR MEDICAL DIAGNOSTIC EQUIPMENT, NAMELY, PORTABLE NUCLEAR MAGNETIC RESONANCE INSTRUMENTS FOR IN VITRO DIAGNOSTICS (U.S. CLS. 26, 39 AND 44).

CLASS 44—MEDICAL, BEAUTY AND AGRICULTURAL SERVICES

FOR MEDICAL DIAGNOSTIC SERVICES (U.S. CLS. 100 AND 101).

HOWARD B. LEVINE, EXAMINING ATTORNEY

SN 77-926,827. LICENSE BRANDING, LLC, SAN ANTONIO, TX. FILED 2-3-2010.



THE MARK CONSISTS OF A STYLIZED SHIELD BOUND WITHIN A STYLIZED WREATH; THE LETTERS "A" AND "M" ARE PLACED IN THE CENTER OF THE SHIELD WITH THE LETTER "A" PLACED ABOVE THE LETTER "M".

CLASS 9—ELECTRICAL AND SCIENTIFIC APPARATUS

FOR PRE-RECORDED CDS AND DVDS IN THE FIELDS OF PURCHASING HOMES, SELLING HOMES, OBTAINING FINANCING, FINANCING REMODELING, PURCHASING HOMES FOR RESALE, OBTAINING CONTRACTOR AND SUBCONTRACTOR AGREEMENTS, HOME REPAIRS, WEALTH BUILDING, HOME FORECLOSURE; DOWNLOADABLE MP3 FILES, MP3 RECORDINGS, ON-LINE DISCUSSION BOARDS, WEBCASTS AND PODCASTS FEATURING INFORMATION IN THE FIELDS OF PURCHASING HOMES, SELLING HOMES, OBTAINING FINANCING, FINANCING REMODELING, PURCHASING HOMES FOR RESALE, OBTAINING CONTRACTOR AND SUBCONTRACTOR AGREEMENTS, HOME REPAIRS, WEALTH BUILDING, HOME FORECLOSURE; ELECTRONIC PUBLICATIONS, NAMELY, A SERIES OF BOOKS AND MANUALS ON COMPUTER MEDIA FEATURING INFORMATION IN THE FIELDS OF PURCHASING HOMES, SELLING HOMES, OBTAINING FINANCING, FINANCING REMODELING, PURCHASING HOMES FOR RESALE, OBTAINING CONTRACTOR AND SUBCONTRACTOR AGREEMENTS, HOME REPAIRS, WEALTH BUILDING, HOME FORECLOSURE (U.S. CLS. 21, 23, 26, 36 AND 38).

CLASS 16—PAPER GOODS AND PRINTED MATTER

FOR SERIES OF NON-FICTION BOOKS IN THE FIELDS OF PURCHASING HOMES, SELLING HOMES, OBTAINING FINANCING, FINANCING REMODELING, PURCHASING HOMES FOR RESALE, OBTAINING CONTRACTOR AND SUBCONTRACTOR AGREEMENTS, HOME REPAIRS, WEALTH BUILDING, HOME FORECLOSURE (U.S. CLS. 2, 5, 22, 23, 29, 37, 38 AND 50).

CLASS 36—INSURANCE AND FINANCIAL

FOR PROVIDING A WEB SITE FEATURING INFORMATION ON PURCHASING HOMES, SELLING HOMES, PURCHASING HOMES FOR RESALE, OBTAINING FINANCING, FINANCING REMODELING, WEALTH BUILDING, AND HOME FORECLOSURE (U.S. CLS. 100, 101 AND 102).

CLASS 41—EDUCATION AND ENTERTAINMENT

FOR ENTERTAINMENT AND EDUCATIONAL SERVICES, SERVICES, NAMELY, PROVIDING PODCASTS IN THE FIELD OF PURCHASING HOMES, SELLING HOMES, OBTAINING FINANCING, FINANCING REMODELING, PURCHASING HOMES FOR RESALE, OBTAINING CONTRACTOR AND SUBCONTRACTOR AGREEMENTS, HOME REPAIRS, WEALTH BUILDING, HOME FORECLOSURE; ENTERTAINMENT AND EDUCATIONAL SERVICES, NAMELY, A CONTINUING PROGRAM ABOUT PURCHASING HOMES, SELLING HOMES, OBTAINING FINANCING, FINANCING REMODELING, PURCHASING HOMES FOR RESALE, OBTAINING CONTRACTOR AND SUBCONTRACTOR AGREEMENTS, HOME REPAIRS, WEALTH BUILDING, HOME FORECLOSURE ACCESSIBLE BY RADIO, TELEVISION, SATELLITE, AUDIO, VIDEO AND COMPUTER NETWORKS; PRODUCTION OF TELEVISION SHOWS, PRODUCTION OF PROGRAMS ACCESSIBLE BY TELEVISION, SATELLITE, AUDIO, VIDEO AND COMPUTER NETWORKS; PERSONAL COACHING SERVICES IN THE FIELD OF PURCHASING HOMES, SELLING HOMES, OBTAINING FINANCING, FINANCING REMODELING, PURCHASING HOMES FOR RESALE, OBTAINING CONTRACTOR AND SUBCONTRACTOR AGREEMENTS, HOME REPAIRS, WEALTH BUILDING, HOME FORECLOSURE (U.S. CLS. 100, 101 AND 107).
SOPHIA S. KIM, EXAMINING ATTORNEY

SN 77-926,838. ESTATE SERVICES OF ILLINOIS, BENSENVILLE, IL. FILED 2-3-2010.

MESS OUT

THE MARK CONSISTS OF STANDARD CHARACTERS WITHOUT CLAIM TO ANY PARTICULAR FONT, STYLE, SIZE, OR COLOR.

CLASS 37—CONSTRUCTION AND REPAIR

FOR TRASH COLLECTION, REFUSE CLEAN-UP SERVICES (U.S. CLS. 100, 103 AND 106).

CLASS 39—TRANSPORTATION AND STORAGE

FOR JUNK REMOVAL (U.S. CLS. 100 AND 105).
SOPHIA S. KIM, EXAMINING ATTORNEY

SN 77-926,846. CRYSTAL ROCK LLC, WATERTOWN, CT. FILED 2-3-2010.



OWNER OF U.S. REG. NOS. 2,423,046, 2,450,626 AND 2,786,852.

THE MARK CONSISTS OF A DEPICTION OF MOUNTAINS ABOVE THE WORDS "CRYSTAL ROCK".

CLASS 32—LIGHT BEVERAGES

FOR BOTTLED DRINKING WATER (U.S. CLS. 45, 46 AND 48).

CLASS 35—ADVERTISING AND BUSINESS

FOR RETAIL STORE SERVICES AND COMPUTERIZED ON-LINE RETAIL STORE SERVICES IN THE FIELD OF BOTTLED DRINKING WATER, COFFEE, TEAS, CARBONATED AND NON-CARBONATED DRINKS, HOT AND COLD BEVERAGE CUPS, AND SNACKS; WHOLESALE DISTRIBUTORSHIP FEATURING BOTTLED DRINKING WATER, COFFEE, TEAS, CARBONATED AND NON-CARBONATED DRINKS, HOT AND COLD BEVERAGE CUPS, AND SNACKS; RETAIL STORE SERVICES FEATURING OFFICE SUPPLIES, JANITORIAL SUPPLIES, COMPUTERS, COMPUTER ACCESSORIES, FURNITURE AND OFFICE EQUIPMENT (U.S. CLS. 100, 101 AND 102).

CLASS 37—CONSTRUCTION AND REPAIR

FOR MAINTENANCE OF WATER FILTRATION SYSTEMS FOR HOMES AND OFFICES (U.S. CLS. 100, 103 AND 106).

CLASS 39—TRANSPORTATION AND STORAGE

FOR DELIVERY OF BOTTLED DRINKING WATER, COFFEE, TEA, CARBONATED AND NON-CARBONATED DRINKS, HOT AND COLD BEVERAGE CUPS, AND SNACKS (U.S. CLS. 100 AND 105).

CLASS 40—MATERIAL TREATMENT

FOR RENTAL OF WATER FILTRATION SYSTEMS FOR HOMES AND OFFICES (U.S. CLS. 100, 103 AND 106).

CLASS 43—HOTEL AND RESTAURANT SERVICES

FOR RENTAL OF FOOD SERVICE EQUIPMENT, NAMELY, HOT AND COLD WATER DISPENSERS, COFFEE MAKERS, REFRIGERATORS, MICROWAVE OVENS AND VENDING MACHINES (U.S. CLS. 100 AND 101).

TOBY BULLOFF, EXAMINING ATTORNEY

SN 77-926,909. JONATHAN J. KANDEL, NEW YORK, NY. FILED 2-3-2010.

BUY THE HALF

THE MARK CONSISTS OF STANDARD CHARACTERS WITHOUT CLAIM TO ANY PARTICULAR FONT, STYLE, SIZE, OR COLOR.

CLASS 35—ADVERTISING AND BUSINESS

FOR RETAIL STORE SERVICES, MAIL ORDER CATALOG SERVICES, AND COMPUTERIZED ON-LINE ORDERING SERVICES ALL IN THE FIELD OF WINE (U.S. CLS. 100, 101 AND 102).

CLASS 43—HOTEL AND RESTAURANT SERVICES

FOR WINE BARS (U.S. CLS. 100 AND 101).
KATHERINE CONNOLLY, EXAMINING ATTORNEY

SN 77-926,945. CAHABA SAFEGUARD ADMINISTRATORS, LLC, BIRMINGHAM, AL. FILED 2-3-2010.



OWNER OF U.S. REG. NOS. 2,818,130 AND 2,818,131.
NO CLAIM IS MADE TO THE EXCLUSIVE RIGHT TO USE "ADMINISTRATORS, LLC", APART FROM THE MARK AS SHOWN.

THE MARK CONSISTS OF THE STYLIZED WORDS "CAHABA SAFEGUARD ADMINISTRATORS, LLC" SITUATED ADJACENT TO A TRIANGLE WITH A VERTICAL LINE INSIDE, AND HAVING ITS LOWER POINT CENTERED IN A CIRCLE, THE CIRCLE BEING LOCATED INSIDE OF OPPOSING UPPER AND LOWER BRACKETS.

CLASS 35—ADVERTISING AND BUSINESS

FOR ACCOUNT AUDITING; BUSINESS DATA ANALYSIS; ELECTRONIC DATA COLLECTION AND DATA SUBMISSION SERVICES FOR BUSINESS PURPOSES IN THE FIELDS OF MEDICINE AND HEALTHCARE; INSURANCE CLAIMS AUDITING SERVICES (U.S. CLS. 100, 101 AND 102).

FIRST USE 1-25-2010; IN COMMERCE 1-25-2010.

CLASS 45—PERSONAL AND LEGAL SERVICES

FOR COMPILING AND ANALYZING STATISTICAL HEALTH DATA IN ORDER TO UNCOVER AND IDENTIFY HEALTH CARE FRAUD AND CLAIMS ERRORS; FRAUD DETECTION SERVICES IN THE FIELD OF HEALTH CARE INSURANCE (U.S. CLS. 100 AND 101).

FIRST USE 1-25-2010; IN COMMERCE 1-25-2010.
ANDREA K. NADELMAN, EXAMINING ATTORNEY

SN 77-926,951. NATURALLY NOVA SCOTIA HEALTH PRODUCTS LIMITED, DARTMOUTH, NOVA SCOTIA, CANADA, FILED 2-3-2010.

Auraganics

THE MARK CONSISTS OF STANDARD CHARACTERS WITHOUT CLAIM TO ANY PARTICULAR FONT, STYLE, SIZE, OR COLOR.

CLASS 1—CHEMICALS

FOR ANTIOXIDANTS AND PROTEINS USED IN THE MANUFACTURE OF COSMETICS, BEVERAGES, FOOD PRODUCTS AND FOOD SUPPLEMENTS (U.S. CLS. 1, 5, 6, 10, 26 AND 46).

CLASS 5—PHARMACEUTICALS

FOR DIETARY AND NUTRITIONAL SUPPLEMENTS; DIETARY AND NUTRITIONALLY FORTIFIED FOOD PRODUCTS ADAPTED FOR MEDICAL USE; DIETARY BEVERAGE SUPPLEMENTS FOR HUMAN CONSUMPTION IN LIQUID AND DRY MIX FORM FOR THERAPEUTIC PURPOSES; DIETARY FOOD SUPPLEMENTS; DIETARY SUPPLEMENT FOR ELIMINATING TOXINS FROM THE INTESTINAL TRACT; DIETARY SUPPLEMENTAL DRINKS; DIETARY SUPPLEMENTAL DRINKS IN THE NATURE OF VITAMIN AND MINERAL BEVERAGES; DIETARY SUPPLEMENTS; DIETARY SUPPLEMENTS FOR HUMAN CONSUMPTION; FOOD SUPPLEMENTS, NAMELY, ANTI-OXIDANTS; HEALTH FOOD SUPPLEMENTS; HERBAL SUPPLEMENTS; MINERAL FOOD SUPPLEMENTS; MINERAL NUTRITIONAL SUPPLEMENTS; MINERAL SUPPLEMENTS; NATURAL HERBAL SUPPLEMENTS; NUTRITIONAL SUPPLEMENT FOR ELIMINATING TOXINS FROM THE BODY; NUTRITIONAL SUPPLEMENT FOR ELIMINATING TOXINS FROM THE INTESTINAL TRACT; NUTRITIONAL SUPPLEMENT IN THE NATURE OF A NUTRIENT-DENSE, PROTEIN-BASED DRINK MIX; NUTRITIONAL SUPPLEMENTS; POWDERED FRUIT-FLAVORED DIETARY SUPPLEMENT DRINK MIX; POWDERED NUTRITIONAL SUPPLEMENT DRINK MIX; VITAMIN AND MINERAL SUPPLEMENTS; VITAMIN SUPPLEMENT IN TABLET FORM FOR USE IN MAKING AN EFFERVESCENT BEVERAGE WHEN ADDED TO WATER; VITAMIN SUPPLEMENTS; WEIGHT MANAGEMENT SUPPLEMENTS (U.S. CLS. 6, 18, 44, 46, 51 AND 52).

CHARLES L. JENKINS, EXAMINING ATTORNEY

SN 77-926,993. AMERICAN HUMAN DEVELOPMENT REPORT, INC., BROOKLYN, NY. FILED 2-3-2010.



NO CLAIM IS MADE TO THE EXCLUSIVE RIGHT TO USE "AMERICAN HUMAN DEVELOPMENT PROJECT", APART FROM THE MARK AS SHOWN.

THE COLOR(S) BLACK, ORANGE, BLUE AND GREEN IS/ARE CLAIMED AS A FEATURE OF THE MARK.

THE MARK CONSISTS OF THE WORDING "AMERICAN HUMAN DEVELOPMENT PROJECT" IN BLACK IN A STYLIZED FONT AND A DESIGN THAT CONSISTS OF SIX VERTICAL LINE SEGMENTS OF VARYING LENGTHS WITH DOTS AT THE ENDS THEREOF; THE FIRST LINE SEGMENT IS ORANGE, THE SECOND LINE SEGMENT IS BLUE, THE THIRD LINE SEGMENT IS GREEN, THE FOURTH LINE SEGMENT IS ORANGE, THE FIFTH LINE SEGMENT IS BLUE, AND THE SIXTH LINE SEGMENT IS GREEN.

CLASS 16—PAPER GOODS AND PRINTED MATTER

FOR PRINTED MATERIAL AND BOOKS, NAMELY, SURVEYS, REPORTS, AND INDICES IN THE FIELD OF HUMAN WELL-BEING; PRINTED MATERIAL AND BOOKS, NAMELY, SURVEYS, REPORTS, AND INDICES IN THE FIELDS OF HEALTH, EDUCATION, AND INCOME (U.S. CLS. 2, 5, 22, 23, 29, 37, 38 AND 50).

FIRST USE 6-0-2008; IN COMMERCE 6-0-2008.

CLASS 42—SCIENTIFIC AND COMPUTER SERVICES

FOR SCIENTIFIC RESEARCH IN THE FIELD OF HUMAN WELL-BEING INCLUDING SCIENTIFIC ANALYSIS OF DATA AND STATISTICS ON HEALTH, EDUCATION, AND INCOME, TO PRODUCE RANKINGS OF HUMAN WELL-BEING; PROVIDING AN ONLINE SEARCHABLE DATABASE CONTAINING SOCIOLOGICAL DATA RELATED TO HUMAN WELL-BEING FOR SCIENTIFIC RESEARCH PURPOSES; PROVIDING TEMPORARY USE OF ONLINE NON-DOWNLOADABLE COMPUTER SOFTWARE FOR CONDUCTING SURVEYS, AND OTHER FEEDBACK AND DATA COLLECTION ACTIVITIES VIA COMPUTER AND COMMUNICATION NETWORKS, AND FOR MAPPING OF DATA AND STATISTICS BY U.S. STATE, CONGRESSIONAL DISTRICT, AND COUNTY; PROVIDING TEMPORARY USE OF ONLINE NON-DOWNLOADABLE COMPUTER SOFTWARE FOR THE ADMINISTRATION, COLLECTION, REPORTING, ANALYSIS AND PRESENTATION OF SURVEY INFORMATION GATHERED VIA COMPUTER AND COMMUNICATION NETWORKS (U.S. CLS. 100 AND 101).

FIRST USE 6-0-2008; IN COMMERCE 6-0-2008.

RENEE MCCRAY, EXAMINING ATTORNEY

SN 77-927,019. IDEOM TECNOLOGIA LTDA., SÃO PAULO SP, BRAZIL, FILED 2-3-2010.

IDEOM

THE MARK CONSISTS OF STANDARD CHARACTERS WITHOUT CLAIM TO ANY PARTICULAR FONT, STYLE, SIZE, OR COLOR.

CLASS 41—EDUCATION AND ENTERTAINMENT

FOR TRAINING IN THE FIELDS OF CHEMICALS, PETROCHEMICALS, TEXTILE MATERIALS, POLYMERS, PLASTICS, AND RESINS (U.S. CLS. 100, 101 AND 107).

CLASS 42—SCIENTIFIC AND COMPUTER SERVICES

FOR RESEARCH, PRODUCT DEVELOPMENT, PROCESS DEVELOPMENT, TECHNOLOGY DEVELOPMENT, ENGINEERING SERVICES, AND CONSULTING, ALL IN THE FIELDS OF CHEMICALS, PETROCHEMICALS, TEXTILE MATERIALS, POLYMERS, PLASTICS, AND RESINS (U.S. CLS. 100 AND 101).

ASMAT KHAN, EXAMINING ATTORNEY

SN 77-927,020. GOLEARN TOYS, LLC, WESTON, FL. FILED 2-3-2010.



THE MARK CONSISTS OF AN ANIMATED FIGURE WEARING A CAP AND SHOES WITH A FACE IN THE FORM OF A CLOCK AND WEARING A PAIR OF SHORTS WITH ONE BUTTON ON THE RIGHT HAND SIDE AND A STARBURST ON THE LEFT HAND SIDE, AND FIGURE IS WAVING WITH ITS LEFT HAND AND IT'S RIGHT HAND IS FACING DOWNWARD.

CLASS 9—ELECTRICAL AND SCIENTIFIC APPARATUS

FOR COMPUTER GAME SOFTWARE DOWNLOADABLE FROM A GLOBAL COMPUTER NETWORK; DOWNLOADABLE COMPUTER GAME PROGRAMS; DOWNLOADABLE COMPUTER GAME SOFTWARE VIA A GLOBAL COMPUTER NETWORK AND WIRELESS DEVICES; DOWNLOADABLE COMPUTER SOFTWARE FOR TEACHING CHILDREN HOW TO TELL TIME; DOWNLOADABLE ELECTRONIC GAME PROGRAMS; DOWNLOADABLE ELECTRONIC GAMES VIA THE INTERNET AND WIRELESS DEVICES; ELECTRONIC GAME PROGRAMS; INTERACTIVE GAME PROGRAMS; INTERACTIVE GAME SOFTWARE (U.S. CLS. 21, 23, 26, 36 AND 38).

CLASS 28—TOYS AND SPORTING GOODS

FOR ACTION FIGURES; BOARD GAMES; ELECTRONIC GAMES FOR THE TEACHING OF CHILDREN; ELECTRONIC LEARNING TOYS; PLAY FIGURES; TOY ACTION FIGURES; TOY FIGURES; TOY, NAMELY, BATTERY-POWERED COMPUTER GAME WITH LCD SCREEN WHICH FEATURES ANIMATION AND SOUND EFFECTS (U.S. CLS. 22, 23, 38 AND 50).
ASMAT KHAN, EXAMINING ATTORNEY

SN 77-927,026. THE ENDANGERBLES, LC, PLYMOUTH, FL. FILED 2-3-2010.

ENDANGERBLES

THE MARK CONSISTS OF STANDARD CHARACTERS WITHOUT CLAIM TO ANY PARTICULAR FONT, STYLE, SIZE, OR COLOR.

CLASS 16—PAPER GOODS AND PRINTED MATTER

FOR CHILDREN'S BOOKS (U.S. CLS. 2, 5, 22, 23, 29, 37, 38 AND 50).
FIRST USE 1-12-2003; IN COMMERCE 1-12-2003.

CLASS 25—CLOTHING

FOR SHIRTS (U.S. CLS. 22 AND 39).
FIRST USE 1-12-2003; IN COMMERCE 1-12-2003.

CLASS 28—TOYS AND SPORTING GOODS

FOR STUFFED AND PLUSH TOYS; STUFFED DOLLS AND ANIMALS; STUFFED TOY ANIMALS (U.S. CLS. 22, 23, 38 AND 50).
FIRST USE 1-12-2003; IN COMMERCE 1-12-2003.
GIANCARLO CASTRO, EXAMINING ATTORNEY

SN 77-927,034. GOLEARN TOYS, LLC, WESTON, FL. FILED 2-3-2010.



THE MARK CONSISTS OF THE WORD "TIMEBUDDY" IN STYLIZED FONT WITH A CLOCK FACE OVER THE LETTER "U".

CLASS 9—ELECTRICAL AND SCIENTIFIC APPARATUS

FOR COMPUTER GAME SOFTWARE DOWNLOADABLE FROM A GLOBAL COMPUTER NETWORK; DOWNLOADABLE COMPUTER GAME PROGRAMS; DOWNLOADABLE COMPUTER GAME SOFTWARE VIA A GLOBAL COMPUTER NETWORK AND WIRELESS DEVICES; DOWNLOADABLE COMPUTER SOFTWARE FOR TEACHING CHILDREN HOW TO TELL TIME; DOWNLOADABLE ELECTRONIC GAME PROGRAMS; DOWNLOADABLE ELECTRONIC GAMES VIA THE INTERNET AND WIRELESS DEVICES; ELECTRONIC GAME PROGRAMS; INTERACTIVE GAME PROGRAMS; INTERACTIVE GAME SOFTWARE (U.S. CLS. 21, 23, 26, 36 AND 38).

CLASS 28—TOYS AND SPORTING GOODS

FOR BOARD GAMES; ELECTRONIC GAMES FOR THE TEACHING OF CHILDREN; ELECTRONIC LEARNING TOYS; TOY, NAMELY, BATTERY-POWERED COMPUTER GAME WITH LCD SCREEN WHICH FEATURES ANIMATION AND SOUND EFFECTS (U.S. CLS. 22, 23, 38 AND 50).
ASMAT KHAN, EXAMINING ATTORNEY

SN 77-927,053. DEVENDRA POPATLAL GOTHI, IRVINE, CA. AND MARY LOUISE GOTHI, IRVINE, CA. FILED 2-3-2010.



NO CLAIM IS MADE TO THE EXCLUSIVE RIGHT TO USE "MARRIAGE", APART FROM THE MARK AS SHOWN. THE MARK CONSISTS OF THE WORDS "THE SIGNIFICANT MARRIAGE" IN A STYLIZED FONT, ALONG WITH THE IMAGE OF A SUN SLIGHTLY BEHIND THE "S" IN "SIGNIFICANT" AND OVER THE "I" IN "SIGNIFICANT".

CLASS 16—PAPER GOODS AND PRINTED MATTER

FOR PUBLICATIONS, NAMELY, BOOKS, HAND-OUTS, BOOKLETS, WORKBOOKS, JOURNALS, AND STUDY GUIDES IN THE FIELDS OF MARRIAGE AND MARRIAGE ENRICHMENT (U.S. CLS. 2, 5, 22, 23, 29, 37, 38 AND 50).

CLASS 41—EDUCATION AND ENTERTAINMENT

FOR EDUCATION SERVICES, NAMELY, PROVIDING LIVE AND ON-LINE RETREATS, CLASSES, SEMINARS, WORKSHOPS AND ONE-ON-ONE TRAINING IN THE FIELD OF MARRIAGE AND MARRIAGE ENRICHMENT; LIFE COACHING SERVICES IN THE FIELD OF MARRIAGE AND MARRIAGE ENRICHMENT (U.S. CLS. 100, 101 AND 107).

STEPHANIE ALI, EXAMINING ATTORNEY

SN 77-927,108. TOTAL RENTAL SOLUTIONS, ORLANDO, FL. FILED 2-3-2010.

Total Rental Solutions

THE MARK CONSISTS OF STANDARD CHARACTERS WITHOUT CLAIM TO ANY PARTICULAR FONT, STYLE, SIZE, OR COLOR.

NO CLAIM IS MADE TO THE EXCLUSIVE RIGHT TO USE "RENTAL SOLUTIONS", APART FROM THE MARK AS SHOWN.

CLASS 35—ADVERTISING AND BUSINESS

FOR PROVIDING AND RENTAL OF EXHIBITION STANDS AND BOOTHS INCLUDING RESPECTIVE EQUIPMENT; RENTAL OF ADVERTISEMENT SPACE AND ADVERTISING MATERIAL; RENTAL OF ALL PUBLICITY AND MARKETING PRESENTATION MATERIALS; RENTAL OF OFFICE MACHINERY AND EQUIPMENT; RENTAL OF TYPEWRITERS AND COPYING MACHINES (U.S. CLS. 100, 101 AND 102).

FIRST USE 2-23-2004; IN COMMERCE 2-23-2004.

CLASS 41—EDUCATION AND ENTERTAINMENT

FOR RENTAL OF AUDIO EQUIPMENT; RENTAL OF AUDIOVISUAL EQUIPMENT; RENTAL OF RADIO AND TELEVISION SETS; RENTAL OF RADIOS; RENTAL OF RADIOS AND TELEVISIONS; RENTAL OF TELEVISION SETS; RENTAL OF VIDEO SCREENS; RENTAL SERVICES FOR AUDIO AND VIDEO EQUIPMENT (U.S. CLS. 100, 101 AND 107).

FIRST USE 2-23-2004; IN COMMERCE 2-23-2004.

CLASS 42—SCIENTIFIC AND COMPUTER SERVICES

FOR COMPUTER AND COMPUTER SOFTWARE RENTAL; RENTAL OF COMPUTER HARDWARE; RENTAL OF COMPUTER HARDWARE AND COMPUTER PERIPHERALS; RENTAL OF COMPUTER HARDWARE AND COMPUTER SOFTWARE; RENTAL OF COMPUTER SOFTWARE, DATA PROCESSING EQUIPMENT AND COMPUTER PERIPHERAL DEVICES; RENTAL OF COMPUTERS (U.S. CLS. 100 AND 101).

FIRST USE 2-23-2004; IN COMMERCE 2-23-2004.

RUSS HERMAN, EXAMINING ATTORNEY

SN 77-927,116. CITRUS SPORTS GROUP, LLC, WALTHAM, MA. FILED 2-3-2010.



THE MARK CONSISTS OF A BLOCK DRAWN IN A THREE-DIMENSIONAL PERSPECTIVE WITH A STAR IN THE CENTER.

CLASS 25—CLOTHING

FOR CLOTHING, NAMELY, T-SHIRTS, SWEAT-SHIRTS, JERSEYS, HATS, AND CAPS (U.S. CLS. 22 AND 39).

CLASS 38—COMMUNICATION

FOR INTERNET, RADIO, AND TELEVISION BROADCASTING SERVICES IN THE FIELD OF SPORTS; PROVIDING AN ONLINE USER DISCUSSION FORUM FOR TRANSMISSION OF MESSAGES AMONG COMPUTER USERS CONCERNING SPORTS (U.S. CLS. 100, 101 AND 104).

CLASS 41—EDUCATION AND ENTERTAINMENT

FOR ENTERTAINMENT SERVICES IN THE NATURE OF SPORTING EVENTS, NAMELY, GAMES, COMPETITIONS, AND TOURNAMENTS FEATURING THE SPORT OF SOCCER; ONLINE ENTERTAINMENT SERVICES, NAMELY, PROVISION OF A WEB SITE FEATURING INTERACTIVE QUIZZES IN THE FIELD OF SPORTS AND NON-DOWNLOADABLE SPORTS VIDEO CLIPS (U.S. CLS. 100, 101 AND 107).

STEPHEN AQUILA, EXAMINING ATTORNEY

SN 77-927,134. EASTAR INTERNATIONAL INC., TUCKER, GA. FILED 2-3-2010.

T-Box

THE MARK CONSISTS OF STANDARD CHARACTERS WITHOUT CLAIM TO ANY PARTICULAR FONT, STYLE, SIZE, OR COLOR.

CLASS 12—VEHICLES

FOR LUGGAGE SPECIALLY ADAPTED FOR USE ON MOTORCYCLES; MOTORCYCLE BAGS, NAMELY, TANK BAGS, SADDLE BAGS, SISSY BAR BAGS AND TAIL BAGS; MOTORCYCLE SADDLEBAGS; PANNIER BAGS FOR MOTORCYCLES (U.S. CLS. 19, 21, 23, 31, 35 AND 44).

FIRST USE 1-1-2006; IN COMMERCE 1-1-2006.

CLASS 18—LEATHER GOODS

FOR LUGGAGE AND TRUNKS; TRUNKS; TRUNKS AND SUITCASES (U.S. CLS. 1, 2, 3, 22 AND 41).

FIRST USE 1-1-2006; IN COMMERCE 1-1-2006.
EDWARD FENNESSY, EXAMINING ATTORNEY

SN 77-927,138. BERARDI, JOSEPH, PHILADELPHIA, PA. FILED 2-3-2010.



THE MARK CONSISTS OF THE STYLIZED WORDING "SCISSOR CANDY". THE LETTER "O" IN "SCISSOR" APPEARS WITH PAINT SPLATTERING OUT. THE TERM "CANDY" APPEARS INSIDE A RECTANGLE DESIGN WITH PAINT SPLATTERED ACROSS THE LETTERS "A" AND "N".

CLASS 3—COSMETICS AND CLEANING PREPARATIONS

FOR (BASED ON INTENT TO USE) 3-IN-1 HAIR CONDITIONERS; 3-IN-1 HAIR SHAMPOOS; ADHESIVES FOR AFFIXING FALSE HAIR; ADHESIVES FOR FALSE EYELASHES, HAIR AND NAILS; BABY HAIR CONDITIONER; CONDITIONERS; COSMETIC HAIR DRESSING PREPARATIONS; COSMETIC HAIR REGROWTH INHIBITING PREPARATIONS; COSMETIC PREPARATIONS FOR THE HAIR AND SCALP; EXFOLIANTS FOR HAIR, BODY; GEL FOR HAIR; HAIR BALSAM; HAIR BLEACH; HAIR BLEACHES; HAIR BLEACHING PREPARATIONS; HAIR CARE CREAMS; HAIR CARE KITS COMPRISING NON-MEDICATED HAIR CARE PREPARATIONS, NAMELY, SHAMPOO, CONDITIONER, GEL; HAIR CARE LOTIONS; HAIR CARE PREPARATIONS; HAIR CARE PREPARATIONS CONSISTING OF ORGANIC COCONUT VIRGIN OIL AND COCONUT VIRGIN OIL; HAIR CLEANING PREPARATIONS; HAIR COLOR; HAIR COLOR REMOVERS; HAIR COLORANTS; HAIR COLORING PREPARATIONS; HAIR COLOURANTS; HAIR COLOURING; HAIR COLOURING AND DYES; HAIR COLOURING PREPARATIONS; HAIR CONDITIONER; HAIR CONDITIONERS; HAIR CONDITIONERS FOR BABIES; HAIR CREAMS; HAIR CURLING PREPARATIONS; HAIR DECOLORANTS; HAIR DRESSINGS FOR MEN; HAIR DRESSINGS FOR WOMEN; HAIR DYE; HAIR DYES; HAIR EMOLLIENTS; HAIR FIXERS; HAIR FROSTS; HAIR GEL; HAIR GEL AND HAIR MOUSSE; HAIR GELS; HAIR GLAZE; HAIR LACQUERS; HAIR LIGHTENERS; HAIR LOTION; HAIR LOTIONS; HAIR MASCARA; HAIR MASKS; HAIR MOUSSE; HAIR MOUSSES; HAIR NOURISHERS; HAIR OILS; HAIR PIECE BONDING GLUE; HAIR POMADES; HAIR PRODUCTS, NAMELY, THICKENING CONTROL CREAMS; HAIR RELAXERS; HAIR RELAXING PREPARATIONS; HAIR REMOVING CREAM; HAIR RINSES; HAIR RINSES; HAIR SHAMPOO; HAIR SHAMPOOS AND CONDITIONERS; HAIR SHEEN SPRAY; HAIR SPRAY; HAIR SPRAYS; HAIR SPRAYS AND HAIR GELS; HAIR STRAIGHTENING PREPARATIONS; HAIR STYLING FIXATIVE IN THE NATURE OF HAIR WAX; HAIR STYLING GEL; HAIR STYLING PREPARATIONS; HAIR STYLING SPRAY; HAIR TONIC; HAIR TONICS; HAIR WAVING LOTION; HAIR WAVING PREPARATIONS; HAIR WAX; HAIR-WASHING POWDER; HYDROGEN PEROXIDE FOR USE ON THE HAIR; JAPANESE HAIR FIXING OIL (BINT-SUKE-ABURA); LOTIONS FOR HAIR, FACE AND BODY; MOUSSE FOR HAIR; NON-MEDICATED BALMS FOR USE ON HAIR; NON-MEDICATED HAIR RESTORATION LOTIONS; NON-MEDICATED HAIR SERUMS; NON-MEDICATED HAIR TREATMENT PREPARATIONS FOR COSMETIC PURPOSES; NON-MEDICATED PREPARATIONS ALL FOR THE CARE OF SKIN, HAIR AND SCALP; NON-MEDICATED SERUMS FOR USE ON HAIR AND SCALP; OIL BATHS FOR HAIR CARE; OILS FOR HAIR CONDITIONING; POMADES FOR HAIR; PREPARATIONS FOR PERMANENT HAIR WAVES; PREPARATIONS FOR SETTING HAIR; STYLING CLAY FOR HAIR; STYLING FOAM FOR HAIR; STYLING PASTE FOR HAIR; WAX FOR REMOVING BODY HAIR; WAX STRIPS FOR REMOVING BODY HAIR (U.S. CLS. 1, 4, 6, 50, 51 AND 52).

CLASS 44—MEDICAL, BEAUTY AND AGRICULTURAL SERVICES

FOR (BASED ON USE IN COMMERCE) BODY WAXING SERVICES FOR HAIR REMOVAL IN HUMANS; CHARITABLE SERVICES, NAMELY, PROVIDING BEAUTY AND HAIR CARE SERVICES TO PERSONS SEEKING EMPLOYMENT; COSMETIC SERVICES, NAMELY, NON-PERMANENT HAIR REMOVAL; DEPLATORY HAIR REMOVAL SERVICES; HAIR COLOR SALON SERVICES; HAIR COLOURING SERVICES; HAIR CUTTING; HAIR CUTTING SERVICES; HAIR IMPLANTATION; HAIR REPLACEMENT; HAIR REPLACEMENT, HAIR ADDITION, AND HAIR EXTENSION SERVICES; HAIR SALON SERVICES; HAIR SALON

SERVICES, NAMELY, HAIR CUTTING, STYLING, COLORING, AND HAIR EXTENSION SERVICES; HAIR SALON SERVICES, NAMELY, TREATMENTS TO PROTECT HAIR FROM EFFECTS OF EXPOSURE TO SUNLIGHT, HEAT, HUMIDITY AND CHLORINATED WATER; HAIR STYLING; LASER HAIR REMOVAL SERVICES; PERMANENT HAIR REMOVAL AND REDUCTION SERVICES; PROVIDING INFORMATION IN THE FIELD OF HAIR STYLING; PROVIDING ON-SITE BEAUTY SERVICES, NAMELY, HAIR STYLING AND MAKE-UP APPLICATION SERVICES (U.S. CLS. 100 AND 101).

FIRST USE 12-7-2008; IN COMMERCE 12-7-2008.
JEFFERY COWARD, EXAMINING ATTORNEY

SN 77-927,297. FOX CHAPEL PUBLISHING CO. INC., EAST PETERSBURG, PA. FILED 2-3-2010.

MANCRAFT

THE MARK CONSISTS OF STANDARD CHARACTERS WITHOUT CLAIM TO ANY PARTICULAR FONT, STYLE, SIZE, OR COLOR.

CLASS 16—PAPER GOODS AND PRINTED MATTER

FOR PRINTED MATTER, NAMELY, MAGAZINES AND A SERIES OF NON-FICTION BOOKS, ALL ON THE SUBJECT OF CRAFTS (U.S. CLS. 2, 5, 22, 23, 29, 37, 38 AND 50).

CLASS 28—TOYS AND SPORTING GOODS

FOR HOBBY CRAFT KITS COMPRISING MATERIALS, TOOLS AND INSTRUCTIONS FOR MAKING WOODEN CRAFT PROJECTS (U.S. CLS. 22, 23, 38 AND 50).

CLASS 41—EDUCATION AND ENTERTAINMENT

FOR EDUCATIONAL AND ENTERTAINMENT SERVICES, NAMELY, A CONTINUING TELEVISION PROGRAM FEATURING CRAFTS ACCESSIBLE BY BROADCAST, CABLE, AND SATELLITE TELEVISION AND THE INTERNET, AND PROVIDING EDUCATIONAL AND ENTERTAINMENT INFORMATION AND INSTRUCTION ABOUT MAKING CRAFTS VIA A WEBSITE ON THE INTERNET (U.S. CLS. 100, 101 AND 107).

JEFFERY COWARD, EXAMINING ATTORNEY

SN 77-927,298. ZEVEZ PAYMENTS, INC., DBA NVOICEPAY, PORTLAND, OR. FILED 2-3-2010.

NVOICEPAY AP ASSIST

THE MARK CONSISTS OF STANDARD CHARACTERS WITHOUT CLAIM TO ANY PARTICULAR FONT, STYLE, SIZE, OR COLOR.

NO CLAIM IS MADE TO THE EXCLUSIVE RIGHT TO USE "NVOICEPAY AP", APART FROM THE MARK AS SHOWN.

CLASS 9—ELECTRICAL AND SCIENTIFIC APPARATUS

FOR SOFTWARE FOR PROCESSING ACCOUNTS PAYABLE AND PAYING INVOICES BY CREDIT CARD, ELECTRONIC FUNDS TRANSFER OR CHECK (U.S. CLS. 21, 23, 26, 36 AND 38).

CLASS 36—INSURANCE AND FINANCIAL

FOR BILL PAYMENT SERVICES, ACCOUNTS PAYABLE DEBITING SERVICES (U.S. CLS. 100, 101 AND 102).

MARILYN IZZI, EXAMINING ATTORNEY

SN 77-927,321. ZEPHYR FARM L.L.C., PORTLAND, OR. FILED 2-3-2010.

GOLD PAW

THE MARK CONSISTS OF STANDARD CHARACTERS WITHOUT CLAIM TO ANY PARTICULAR FONT, STYLE, SIZE, OR COLOR.

OWNER OF U.S. REG. NO. 2,788,524.

CLASS 18—LEATHER GOODS

FOR ANIMAL HARNESSSES; COLLARS FOR PETS; LEASHES FOR ANIMALS; PET CLOTHING (U.S. CLS. 1, 2, 3, 22 AND 41).

CLASS 28—TOYS AND SPORTING GOODS

FOR PET TOYS (U.S. CLS. 22, 23, 38 AND 50).
B. PARADEWELAI, EXAMINING ATTORNEY

SN 77-927,339. SMISH, INC., MESA, AZ. FILED 2-3-2010.

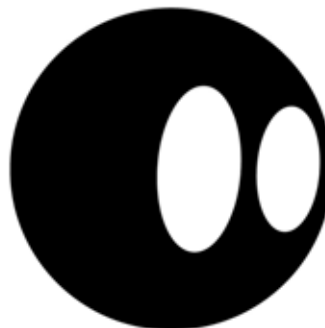

THE MARK CONSISTS OF A CIRCLE CONTAINING TWO OVALS POSITIONED OFF CENTER.

CLASS 9—ELECTRICAL AND SCIENTIFIC APPARATUS

FOR COMPUTER SOFTWARE FOR APPLICATION AND DATABASE INTEGRATION; COMPUTER SOFTWARE FOR THE COLLECTION, EDITING, ORGANIZING, MODIFYING, BOOK MARKING, TRANSMISSION, STORAGE AND SHARING OF DATA AND INFORMATION; COMPUTER SOFTWARE FOR USE IN COLLECTING SOCIAL MEDIA DATA FROM A PLURALITY OF LOCATIONS ON THE INTERNET FOR TRANSMISSION OR VIEWING FROM A SINGLE LOCATION AND IN POSTING SOCIAL MEDIA DATA TO A PLURALITY OF LOCATIONS FROM A SINGLE LOCATION; COMPUTER SOFTWARE FOR USE AS A PLATFORM FOR PLUG-IN APPLICATIONS FOR USE IN INTERFACING WITH A USER'S COMPUTER, INTERNET CONNECTION AND OTHER COMPUTER AND INTERNET SERVICES; COMPUTER SOFTWARE FOR USE IN PREVIEWING INTERNET SITES PRIOR TO VISITING THE SITES AND ACCESSING THOSE SITES THROUGH THE SOFTWARE; COMPUTER SOFTWARE FOR USE IN ACCESSING AND EXECUTING DATA, FILES, APPLICATIONS AND FUNCTIONS ON A USER'S COMPUTER; COMPUTER SOFTWARE FOR USE IN SENDING DATA TO AND RECEIVING AND REVIEWING DATA FROM SOCIAL CONVERSATIONS OVER THE INTERNET, EMAILS, CHAT STRINGS, MICROBLOGS, BLOGS, ELECTRONIC MESSAGES, INSTANT MESSAGES, TEXT MESSAGES, MULTIMEDIA MESSAGES, SOCIAL NETWORKS, STATUS UPDATES, PRODUCT REVIEWS, FORUMS, ELECTRONIC BULLETIN BOARDS, AND VOICE OVER IP; COMPUTER SOFTWARE FOR USE IN FINDING, ORGANIZING AND COMPARING PRICES ON ITEMS FOR SALE ON THE INTERNET AND FOR IDENTIFYING AND OBTAINING DISCOUNTS AND REBATES ON ITEMS PURCHASED; COMPUTER SOFTWARE FOR USE IN EARNING COMPANY CREDIT FOR INTERACTING WITH THE COMPUTER SOFTWARE FOR TRADING FOR PURCHASING GOODS OR TRADING FOR CASH; COMPUTER SOFTWARE FOR USE IN INTEGRATING CONTACTS RECORDS FROM MANY SOURCES INTO ONE INTERFACE; COMPUTER SOFTWARE FOR DISTRIBUTING AND DISPLAYING ADVERTISEMENTS ON A USER'S COMPUTER; COMPUTER SOFTWARE THAT PROVIDES WEB-BASED ACCESS TO APPLICATIONS AND SERVICES THROUGH A WEB OPERATING SYSTEM OR PORTAL INTERFACE (U.S. CLS. 21, 23, 26, 36 AND 38).

CLASS 35—ADVERTISING AND BUSINESS

FOR ADVERTISING VIA ELECTRONIC MEDIA AND SPECIFICALLY THE INTERNET; DISSEMINATION OF ADVERTISING FOR OTHERS VIA AN ON-LINE COMMUNICATIONS NETWORK ON THE INTERNET; ON-LINE ADVERTISING ON COMPUTER COMMUNICATION NETWORKS; PROMOTION, ADVERTISING AND MARKETING OF ON-LINE WEBSITES; PROVIDING ADVERTISING SERVICES (U.S. CLS. 100, 101 AND 102).
B. PARADEWELAI, EXAMINING ATTORNEY

SN 77-927,457. CORPNET, INCORPORATED, CALABASAS, CA. FILED 2-3-2010.



OWNER OF U.S. REG. NO. 3,776,034.
THE COLOR(S) BLACK AND ORANGE IS/ARE CLAIMED AS A FEATURE OF THE MARK.

THE MARK CONSISTS OF THE STYLIZED WORD "CORPNET" IN BLACK IN UPPER AND LOWER CASE, INCORPORATING A CAPITAL "C" AND A CAPITAL "N" TO THE LEFT OF AN ORANGE COLORED ARROW THAT ARCHES TO THE RIGHT OVER BLACK HORIZONTAL AND VERTICAL BARS DEPICTING A STYLIZED STACK OF DOCUMENTS IN A BOX.

CLASS 9—ELECTRICAL AND SCIENTIFIC APPARATUS

FOR DOWNLOADABLE ELECTRONIC PUBLICATIONS IN THE NATURE OF NEWSLETTERS, TEMPLATES AND FORMS, MAGAZINES, BROCHURES, PAMPHLETS AND REPORTS IN THE FIELD OF BUSINESS RESEARCH, INCORPORATION AND ORGANIZATION OF LEGAL ENTITIES, MAINTENANCE AND COMPLIANCE OF LEGAL ENTITIES, AND INTELLECTUAL PROPERTY SEARCHING AND CLEARANCE (U.S. CLS. 21, 23, 26, 36 AND 38).

CLASS 16—PAPER GOODS AND PRINTED MATTER

FOR PRINTED MATTER, NAMELY, NEWSLETTERS, TEMPLATES AND FORMS, MAGAZINES, BROCHURES, PAMPHLETS AND REPORTS IN THE FIELD OF BUSINESS RESEARCH, INCORPORATION AND ORGANIZATION OF LEGAL ENTITIES, MAINTENANCE AND COMPLIANCE OF LEGAL ENTITIES, AND INTELLECTUAL PROPERTY SEARCHING AND CLEARANCE (U.S. CLS. 2, 5, 22, 23, 29, 37, 38 AND 50).

CLASS 35—ADVERTISING AND BUSINESS

FOR BUSINESS SERVICES, NAMELY, NEW BUSINESS VENTURE DEVELOPMENT AND FORMATION CONSULTING SERVICES; SECRETARIAL AND DOCUMENT FILING SERVICES FOR BUSINESS ENTITIES; BUSINESS RESEARCH; COMMERCIAL REGISTERED AGENT SERVICES FOR OTHERS; PROVIDING A WEBSITE AND DATABASE FEATURING ARTICLES AND INFORMATION ON ESTABLISHING AND MAINTAINING A BUSINESS; BUSINESS TO BUSINESS REFERRAL AND NETWORKING PROGRAMS (U.S. CLS. 100, 101 AND 102).

CLASS 42—SCIENTIFIC AND COMPUTER SERVICES

FOR PROVIDING TEMPORARY USE OF NON-DOWNLOADABLE COMPUTER SOFTWARE FOR CORPORATE FILING INFORMATION AND CORPORATE RECORDS MANAGEMENT; PUBLIC CORPORATE DOCUMENT RETRIEVAL SERVICES (U.S. CLS. 100 AND 101).

CLASS 45—PERSONAL AND LEGAL SERVICES

FOR PREPARING AND FILING INCORPORATION PAPERS; PUBLIC CORPORATE DOCUMENT FILING SERVICES; PROVIDING PUBLIC DOCUMENT FILING INFORMATION TO CONSUMERS SEEKING TO CHANGE THEIR NAME; CORPORATE NAME AVAILABILITY SEARCHES (U.S. CLS. 100 AND 101).
LINDA LAVACHE, EXAMINING ATTORNEY

SN 77-927,471. GOLF INTERACT, LLC, THE WOODLANDS, TX. FILED 2-3-2010.

GOLF INTERACT

THE MARK CONSISTS OF STANDARD CHARACTERS WITHOUT CLAIM TO ANY PARTICULAR FONT, STYLE, SIZE, OR COLOR.

NO CLAIM IS MADE TO THE EXCLUSIVE RIGHT TO USE "GOLF", APART FROM THE MARK AS SHOWN.

CLASS 38—COMMUNICATION

FOR PROVIDING ONLINE CHAT ROOMS AND ELECTRONIC BULLETIN BOARDS FOR REGISTERED USERS WHO ARE GOLFERS FOR TRANSMISSION OF MESSAGES CONCERNING GOLF, GENERAL INTEREST, CLASSIFIEDS, VIRTUAL COMMUNITY, SOCIAL NETWORKING, PHOTO SHARING, AND TRANSMISSION OF PHOTOGRAPHIC IMAGES; ELECTRONIC TRANSMISSION OF INSTANT MESSAGES AND DATA FOR GOLFERS (U.S. CLS. 100, 101 AND 104).

CLASS 41—EDUCATION AND ENTERTAINMENT

FOR PROVIDING INFORMATION IN THE FIELD OF GOLF BY MEANS OF AN INTERACTIVE WEBSITE FEATURING CALENDARS OF GOLF-RELATED EVENTS, GOLF STATISTICS AND GOLF INFORMATION; PROVIDING ON-LINE COMPUTER DATABASES AND ON-LINE SEARCHABLE DATABASES IN THE FIELD OF GOLF AND RELATED TOPICS; ONLINE JOURNALS, NAMELY, BLOGS FEATURING GOLF AND GOLF RELATED TOPICS (U.S. CLS. 100, 101 AND 107).

CLASS 42—SCIENTIFIC AND COMPUTER SERVICES

FOR COMPUTER SERVICES IN THE NATURE OF CUSTOMIZED WEB PAGES FEATURING USER DEFINED INFORMATION, PERSONAL PROFILES AND INFORMATION, ALL IN THE FIELD OF GOLF; COMPUTER SERVICES, NAMELY, CREATING AN ONLINE COMMUNITY FOR REGISTERED USERS COMPRISING GOLFERS TO PARTICIPATE IN DISCUSSIONS, GET FEEDBACK FOR THEIR PEERS, FORM VIRTUAL COMMUNITIES, AND ENGAGE IN SOCIAL NETWORKING, ALL IN THE FIELD OF GOLF AND GOLF RELATED TOPICS (U.S. CLS. 100 AND 101).

KAREN SEVERSON, EXAMINING ATTORNEY

SN 77-927,474. ZOMBIE, INC., AKA ZOMBIE STUDIOS, SEATTLE, WA. FILED 2-3-2010.



THE MARK CONSISTS OF THE WORDS "TANGO DOWN" IN A SHADED RECTANGLE WITH A PLUS

SYMBOL ON THE BOTTOM RIGHT SIDE OF THE "O" IN "TANGO" AND WHERE THE "O" IN "DOWN" IS OVERLAID BY AN ARROW MADE OUT OF A SKULL POINTING DOWN. ADDITIONALLY THERE IS A PORTION OF A HORIZONTAL BAR CODE ALONGSIDE THE "N" IN "DOWN". THIS BAR CODE IS ACCOMPANIED BY A SERIES OF NUMBERS WHICH ARE ALIGNED THE SAME AS THE BAR CODE. THE LETTERING IS OVERLAID WITH SCRATCHES AND BRUSH MARKS AND THERE IS ONE DISTINCTIVE LONG SCRATCH ACROSS ALL LETTERS.

CLASS 9—ELECTRICAL AND SCIENTIFIC APPARATUS

FOR COMPUTER GAME SOFTWARE; COMPUTER GAME SOFTWARE FOR PERSONAL COMPUTERS AND HOME VIDEO GAME CONSOLES; COMPUTER GAME SOFTWARE FOR USE ON MOBILE AND CELLULAR PHONES; MOTION PICTURE FILMS ABOUT THE MILITARY, SCIENCE FICTION, ARMED CONFLICT, WAR, THE FUTURE, AND VIDEO GAMES; VIDEO GAME SOFTWARE (U.S. CLS. 21, 23, 26, 36 AND 38).

CLASS 16—PAPER GOODS AND PRINTED MATTER

FOR COMIC BOOKS; COMIC MAGAZINES; COMICS; GRAPHIC NOVELS (U.S. CLS. 2, 5, 22, 23, 29, 37, 38 AND 50).

CLASS 40—MATERIAL TREATMENT

FOR CUSTOM IMPRINTING OF LOGO ON CLOTHING, WEARING APPAREL AND ACCESSORIES (U.S. CLS. 100, 103 AND 106).

MATTHEW PAPPAS, EXAMINING ATTORNEY

SN 77-927,645. OPTIMUM SOURCE, INC., PASIG CITY, PHILIPPINES, FILED 2-4-2010.

SpeedyCourse

THE MARK CONSISTS OF STANDARD CHARACTERS WITHOUT CLAIM TO ANY PARTICULAR FONT, STYLE, SIZE, OR COLOR.

CLASS 35—ADVERTISING AND BUSINESS

FOR PROVIDING A SEARCHABLE ONLINE ADVERTISING WEBSITE AND INFORMATIONAL GUIDE FEATURING THE GOODS AND SERVICES OF OTHER VENDORS VIA THE INTERNET IN THE FIELD OF VOCATIONAL AND ACADEMIC COURSES, E-LEARNING COURSES, AND VARIOUS COURSES OFFERED BY PROFESSIONALS AND TRAINING CENTERS (U.S. CLS. 100, 101 AND 102).

FIRST USE 8-7-2009; IN COMMERCE 2-1-2010.

CLASS 41—EDUCATION AND ENTERTAINMENT

FOR EDUCATIONAL SERVICES, NAMELY, PROVIDING COURSES OF INSTRUCTION AT THE PRIMARY, SECONDARY, TERTIARY AND POST-GRADUATE LEVEL AND DISTRIBUTION OF COURSE MATERIAL IN CONNECTION THEREWITH; PROVIDING INFORMATION ON-LINE RELATING TO EDUCATIONAL OPPORTUNITIES (U.S. CLS. 100, 101 AND 107).

FIRST USE 8-7-2009; IN COMMERCE 2-1-2010.
VERNA BETH RIRIE, EXAMINING ATTORNEY

SN 77-927,727. GOLD RUSH BRANDS, LLC, SCARSDALE, NY. FILED 2-4-2010.

STERLING DRUG

THE MARK CONSISTS OF STANDARD CHARACTERS WITHOUT CLAIM TO ANY PARTICULAR FONT, STYLE, SIZE, OR COLOR.

NO CLAIM IS MADE TO THE EXCLUSIVE RIGHT TO USE "DRUG", APART FROM THE MARK AS SHOWN.

CLASS 3—COSMETICS AND CLEANING PREPARATIONS

FOR AFTER-SHAVE LOTIONS, BABY OIL, BATH GEL, BATH OIL, BATH POWDER, BODY CREAM, BODY OIL, BUBBLE BATH, COSMETICS COMPACTS, DEODORANT SOAP, EAU DE TOILETTE, EYE MAKE-UP, FACE POWDER, FACIAL CREAMS, HAIR CARE PREPARATIONS, HAIR CONDITIONERS, HAIR GEL, HAIR MOUSSE, HAIR SHAMPOO, HAIR STYLING PREPARATIONS, LIP GLOSS, LIPSTICK, SKIN LOTIONS, HAIR LOTIONS, FACIAL LOTIONS, BODY LOTIONS, HAIR WAVING LOTIONS, MAKEUP, MASCARA, NAIL GLITTER, NAIL POLISH, PERFUME, PERSONAL DEODORANTS, ROOM FRAGRANCES, SACHETS, SHAVING CREAM, SHAVING GEL, SHAVING LOTION, SHAVING PREPARATIONS, SHOWER GEL, SKIN CONDITIONERS, SKIN CREAM, SKIN LOTION; SOAPS FOR HANDS, FACE AND BODY; SUN SCREEN PREPARATIONS, AND TOOTHPASTE (U.S. CLS. 1, 4, 6, 50, 51 AND 52).

CLASS 5—PHARMACEUTICALS

FOR PHARMACEUTICAL PREPARATIONS, NAMELY, ANTICOAGULANTS, ANTIHISTAMINES, ACETAMINOPHEN, ACNE MEDICATION, ALLERGY MEDICATION, APPETITE SUPPRESSANTS, ORAL AND TOPICAL ANALGESICS, ANTACIDS, ANTIBIOTICS, ASPIRIN, IBUPROFEN FOR USE AS AN ORAL ANALGESIC; PREPARATIONS FOR TREATING COLDS; PREPARATIONS, NAMELY, PHARMACEUTICAL PREPARATIONS AND HERBAL SUPPLEMENTS FOR TREATING ARTHRITIS, DIABETES, HEART DISEASE, GASTROINTESTINAL DISEASES, CANCER, INFECTIOUS DISEASES AND AIDS; DECONGESTANT CAPSULES AND NASAL SPRAYS; EYE, EAR AND NOSE DROPS; GENERAL ANESTHETICS, TRANQUILIZERS; HEMORRHOID TREATMENT PREPARATIONS AND OINTMENTS, HERBAL SUPPLEMENTS, HYDROCORTISONE CREAM, ANALGESIC BALM, INSECT REPELLENTS, IODINE, LAXATIVES, LINIMENTS; MEDICATED THROAT LOZENGES, MEDICATED MOUTHWASH, MINERAL SUPPLEMENTS, MOTION SICKNESS TREATMENT PREPARATIONS, MUSCLE RELAXANTS, NOSE DROPS, ORAL ANALGESICS, HYDROGEN PEROXIDE FOR MEDICAL USE, PREPARATIONS FOR PAIN RELIEF, PREGNANCY TEST KITS FOR HOME USE, DENTAL RINSE, RUBBING ALCOHOL, EPSOM AND SMELLING SALTS, SEDATIVES; SINUS MEDICATION, NAMELY, ALLERGY RELIEF MEDICATIONS; THROAT LOZENGES, VITAMIN AND MINERAL SUPPLEMENTS, WITCH HAZEL; ANTIBIOTIC AND HYDROCORTISONE CREAM, CALAMINE LOTION; ADHESIVE AND SURGICAL BANDAGES; ATHLETES' FOOT LOTIONS, POWDERS AND PREPARATIONS; MEDICATED BATH SALTS; DIET CAPSULES AND PILLS; MEAL REPLACEMENT DRINKS; SANITARY NAPKINS AND PADS; TAMPONS (U.S. CLS. 6, 18, 44, 46, 51 AND 52).

CLASS 35—ADVERTISING AND BUSINESS

FOR MAIL ORDER CATALOG SERVICES FEATURING COSMETICS, PERFUME, GIFTS AND DRUGS; MAIL ORDER SERVICES FEATURING COSMETICS, PERFUME, GIFTS AND DRUGS; RETAIL STORE SERVICES FEATURING COSMETICS, PERFUME, GIFTS AND DRUGS; AND RETAIL STORE SERVICES AVAILABLE THROUGH COMPUTER COMMUNICATIONS AND INTERACTIVE TELEVISION FEATURING COSMETICS, PERFUME, GIFTS AND DRUGS (U.S. CLS. 100, 101 AND 102).

JAY BESCH, EXAMINING ATTORNEY

SN 77-927,730. SXSX, INC., AUSTIN, TX. FILED 2-4-2010.

SOUTH BY

THE MARK CONSISTS OF STANDARD CHARACTERS WITHOUT CLAIM TO ANY PARTICULAR FONT, STYLE, SIZE, OR COLOR.

OWNER OF U.S. REG. NOS. 2,273,216 AND 3,765,211.

CLASS 41—EDUCATION AND ENTERTAINMENT

FOR EDUCATIONAL AND ENTERTAINMENT SERVICES, NAMELY, CONDUCTING CONFERENCES, FESTIVALS AND SEMINARS IN THE FIELDS OF MUSIC, FILM, VIDEO, COMPUTER AND MULTIMEDIA (U.S. CLS. 100, 101 AND 107).

CLASS 43—HOTEL AND RESTAURANT SERVICES

FOR PROVIDING FOOD AND DRINK; MAKING RESERVATIONS FOR OTHERS FOR TEMPORARY LODGING ACCOMMODATIONS; PROVIDING A WEBSITE FOR BOOKING TEMPORARY LODGING; PROVIDING A WEBSITE FEATURING INFORMATION ON HOTEL AND TEMPORARY ACCOMMODATIONS FOR TRAVEL; CATERING SERVICES; PROVIDING BANQUET AND SOCIAL FUNCTION FACILITIES; PROVISION OF CONFERENCE AND MEETING FACILITIES (U.S. CLS. 100 AND 101).

JIM RINGLE, EXAMINING ATTORNEY

SN 77-927,741. AMERICA'S CAPITAL PARTNERS, LLC, MIAMI, FL. FILED 2-4-2010.

ACP MID-ATLANTIC

THE MARK CONSISTS OF STANDARD CHARACTERS WITHOUT CLAIM TO ANY PARTICULAR FONT, STYLE, SIZE, OR COLOR.

NO CLAIM IS MADE TO THE EXCLUSIVE RIGHT TO USE "MID-ATLANTIC", APART FROM THE MARK AS SHOWN.

CLASS 36—INSURANCE AND FINANCIAL

FOR REAL ESTATE BROKERAGE, REAL ESTATE INVESTMENT SERVICES, REAL ESTATE MANAGEMENT AND LEASING SERVICES; REAL ESTATE ASSET MANAGEMENT SERVICES (U.S. CLS. 100, 101 AND 102).
FIRST USE 12-31-2002; IN COMMERCE 12-31-2002.

CLASS 37—CONSTRUCTION AND REPAIR

FOR REAL ESTATE DEVELOPMENT AND CONSTRUCTION SERVICES (U.S. CLS. 100, 103 AND 106).
FIRST USE 12-31-2002; IN COMMERCE 12-31-2002.
LINDA MICKLEBURGH, EXAMINING ATTORNEY

SN 77-927,759. GUIER INTELLECTUAL PROPERTY, LLC, BLUE SPRINGS, MO. FILED 2-4-2010.



**GUIER
FENCE**
IT JUST MAKES SENSE

NO CLAIM IS MADE TO THE EXCLUSIVE RIGHT TO USE "FENCE", APART FROM THE MARK AS SHOWN.
THE MARK CONSISTS OF THE WORDS "GUIER FENCE IT JUST MAKES SENSE" WITH THE "I" IN "GUIER" HAVING THE SHAPE OF A FENCE POST.

CLASS 6—METAL GOODS

FOR METAL CHAINLINK FENCES; METAL CHAINLINK FENCING; METAL FENCE PANELS; METAL FENCE POSTS; METAL FENCE RAIL CLAMPS; METAL FENCE STAYS; METAL FENCING PANELS; METAL FENCING STAYS; METAL GATES AND FENCES; METAL GATES AND FENCING; METAL GATES AND FENCING PANELS; METAL WIRE FENCES; METAL WIRE FENCING; REMOVABLE METAL SAFETY SWIMMING POOL FENCING AND FENCING GATES; WIRE FENCES (U.S. CLS. 2, 12, 13, 14, 23, 25 AND 50).
FIRST USE 12-10-2009; IN COMMERCE 12-10-2009.

CLASS 19—NON-METALLIC BUILDING MATERIALS

FOR EROSION CONTROL FENCING; NON-METAL CHAINLINK FENCES; NON-METAL CHAINLINK FENCING; NON-METAL FENCE PANELS; NON-METAL FENCE POSTS; NON-METAL FENCE STAYS; NON-METAL FENCING PANELS; NON-METAL FENCING STAYS; NON-METAL GATES AND FENCES; NON-METAL GATES AND FENCING; NON-METAL GATES AND FENCING PANELS; NON-METAL WIRE FENCING (U.S. CLS. 1, 12, 33 AND 50).
FIRST USE 12-10-2009; IN COMMERCE 12-10-2009.

CLASS 35—ADVERTISING AND BUSINESS

FOR FRANCHISING, NAMELY, OFFERING BUSINESS MANAGEMENT ASSISTANCE IN THE ESTABLISHMENT AND/OR OPERATION OF FENCE COMPANIES (U.S. CLS. 100, 101 AND 102).
FIRST USE 12-10-2009; IN COMMERCE 12-10-2009.

CLASS 37—CONSTRUCTION AND REPAIR

FOR INSTALLING FENCING (U.S. CLS. 100, 103 AND 106).
FIRST USE 12-10-2009; IN COMMERCE 12-10-2009.
RUDY R. SINGLETON, EXAMINING ATTORNEY

SN 77-927,774. ENDO PHARMACEUTICALS INC., CHADDS FORD, PA. FILED 2-4-2010.



FORTESTA
(testosterone) Gel 2%

NO CLAIM IS MADE TO THE EXCLUSIVE RIGHT TO USE "(TESTOSTERONE) GEL 2% CIII", APART FROM THE MARK AS SHOWN.

THE COLOR(S) BLUE, GREY AND ORANGE IS/ARE CLAIMED AS A FEATURE OF THE MARK.

THE MARK CONSISTS OF THE "FORTESTA" TERM SHOWN IN BLUE, WITH "(TESTOSTERONE) GEL 2% CIII" SHOWN IN GREY, EXCEPT FOR "2%" WHICH IS SHOWN IN BLUE, POSITIONED BELOW "FORTESTA". TO THE RIGHT OF "FORTESTA" IS A GENERALLY SEMI-CIRCULAR DESIGN SHOWN IN ORANGE.

CLASS 5—PHARMACEUTICALS

FOR PHARMACEUTICAL PREPARATIONS, NAMELY, TRANSDERMAL GEL FOR HORMONE THERAPY; TESTOSTERONE GEL FOR THE TREATMENT OF HYPOGONADISM FOR TOPICAL USE, ALL IN GEL FORMULATION ONLY (U.S. CLS. 6, 18, 44, 46, 51 AND 52).

CLASS 16—PAPER GOODS AND PRINTED MATTER

FOR PRINTED EDUCATIONAL MATERIALS ON THE SUBJECT OF TESTOSTERONE DEFICIENCY (U.S. CLS. 2, 5, 22, 23, 29, 37, 38 AND 50).

CLASS 44—MEDICAL, BEAUTY AND AGRICULTURAL SERVICES

FOR PROVIDING ONLINE INFORMATION ON THE SUBJECT OF TESTOSTERONE DEFICIENCY (U.S. CLS. 100 AND 101).
ANNE E. GUSTASON, EXAMINING ATTORNEY

SN 77-927,785. ANDRIA'S FOOD GROUP, INC., O'FALLON, IL. FILED 2-4-2010.



ANDRIA'S

THE MARK CONSISTS OF STANDARD CHARACTERS WITHOUT CLAIM TO ANY PARTICULAR FONT, STYLE, SIZE, OR COLOR.

CLASS 30—STAPLE FOODS

FOR SALAD DRESSING, STEAK SAUCE (U.S. CL. 46).
FIRST USE 0-0-1980; IN COMMERCE 0-0-1980.

CLASS 43—HOTEL AND RESTAURANT SERVICES

FOR BAR AND RESTAURANT SERVICES (U.S. CLS. 100 AND 101).
FIRST USE 0-0-1980; IN COMMERCE 0-0-1980.
WILLIAM P. SHANAHAN, EXAMINING ATTORNEY

SN 77-927,792. AMERICA'S CAPITAL PARTNERS, LLC,
MIAMI, FL. FILED 2-4-2010.

America's Capital Partners Mid-Atlantic

THE MARK CONSISTS OF STANDARD CHARACTERS
WITHOUT CLAIM TO ANY PARTICULAR FONT, STYLE,
SIZE, OR COLOR.

NO CLAIM IS MADE TO THE EXCLUSIVE RIGHT TO
USE "AMERICA'S CAPITAL" AND "MID-ATLANTIC",
APART FROM THE MARK AS SHOWN.

CLASS 36—INSURANCE AND FINANCIAL

FOR REAL ESTATE BROKERAGE, REAL ESTATE
INVESTMENT SERVICES, REAL ESTATE MANAGE-
MENT AND LEASING SERVICES; REAL ESTATE ASSET
MANAGEMENT SERVICES (U.S. CLS. 100, 101 AND 102).
FIRST USE 12-31-2002; IN COMMERCE 12-31-2002.

CLASS 37—CONSTRUCTION AND REPAIR

FOR REAL ESTATE DEVELOPMENT AND CON-
STRUCTION SERVICES (U.S. CLS. 100, 103 AND 106).
FIRST USE 12-31-2002; IN COMMERCE 12-31-2002.
LINDA MICKLEBURGH, EXAMINING ATTORNEY

SN 77-927,828. PERSONAL COMMUNICATION SYSTEMS,
INC., WINSTON-SALEM, NC. FILED 2-4-2010.

PROVEN. PROFESSIONAL. TRUSTED.

THE MARK CONSISTS OF STANDARD CHARACTERS
WITHOUT CLAIM TO ANY PARTICULAR FONT, STYLE,
SIZE, OR COLOR.

CLASS 9—ELECTRICAL AND SCIENTIFIC APPARATUS

FOR AUTOMATIC TELEPHONE DIALERS; TELE-
PHONE CALLING MACHINES; COMPUTER COMMU-
NICATIONS SOFTWARE FOR THE RECORDING AND
SUBSEQUENT TRANSMISSION OF VOICE MESSAGES
BY TELEPHONE (U.S. CLS. 21, 23, 26, 36 AND 38).

CLASS 38—COMMUNICATION

FOR TELEPHONE VOICE MESSAGING SERVICES;
ELECTRONIC VOICE MESSAGING SERVICES,
NAMELY, THE RECORDING AND SUBSEQUENT
TRANSMISSION OF VOICE MESSAGES BY TELE-
PHONE (U.S. CLS. 100, 101 AND 104).
ANNE E. GUSTASON, EXAMINING ATTORNEY

SN 77-927,861. THE TRACOM CORPORATION, LITTLETON,
CO. FILED 2-4-2010.

THE CREATOR OF SOCIALSTYLE

THE MARK CONSISTS OF STANDARD CHARACTERS
WITHOUT CLAIM TO ANY PARTICULAR FONT, STYLE,
SIZE, OR COLOR.

CLASS 16—PAPER GOODS AND PRINTED MATTER

FOR EDUCATIONAL PUBLICATIONS, NAMELY,
BOOKS, MANUALS AND GUIDES REGARDING LEA-
DERSHIP, MANAGEMENT AND PERSONAL DEVELOP-
MENT (U.S. CLS. 2, 5, 22, 23, 29, 37, 38 AND 50).
FIRST USE 3-31-2006; IN COMMERCE 3-31-2006.

CLASS 41—EDUCATION AND ENTERTAINMENT

FOR EDUCATIONAL SERVICES, NAMELY, CON-
DUCTING CLASSES, SEMINARS AND WORKSHOPS IN
THE FIELD OF LEADERSHIP, MANAGEMENT, PERSONAL
DEVELOPMENT AND EDUCATION AND DISTRI-
BUTION OF TRAINING MATERIAL IN CONNECTION
THEREWITH (U.S. CLS. 100, 101 AND 107).
FIRST USE 3-31-2006; IN COMMERCE 3-31-2006.
MARK SHINER, EXAMINING ATTORNEY

SN 77-927,875. MK APPAREL, INC., EAST RUTHERFORD,
NJ. FILED 2-4-2010.

INTO human

THE MARK CONSISTS OF STANDARD CHARACTERS
WITHOUT CLAIM TO ANY PARTICULAR FONT, STYLE,
SIZE, OR COLOR.

CLASS 25—CLOTHING

FOR A-SHIRTS; APPAREL FOR DANCERS, NAMELY,
TEE SHIRTS, SWEATSHIRTS, PANTS, LEGGINGS,
SHORTS AND JACKETS; ATHLETIC APPAREL,
NAMELY, SHIRTS, PANTS, JACKETS, FOOTWEAR,
HATS AND CAPS, ATHLETIC UNIFORMS; BALLOON
PANTS; BATHING SUITS FOR MEN; BERMUDA
SHORTS; BIB SHORTS; BOARD SHORTS; BODY
SHIRTS; BODY SUITS; BOMBER JACKETS; BOXER
SHORTS; BOXING SHORTS; BUTTON-FRONT ALOHA
SHIRTS; CAMOUFLAGE JACKETS; CAMOUFLAGE
PANTS; CAMOUFLAGE SHIRTS; CAMOUFLAGE
VESTS; CAMP SHIRTS; CAPRI PANTS; CARGO PANTS;
CLOTHING FOR ATHLETIC USE, NAMELY, PADDED

PANTS; COATS; COATS FOR MEN AND WOMEN; COATS MADE OF COTTON; COATS OF DENIM; CREW NECK SWEATERS; DENIM JACKETS; DENIMS; DOWN JACKETS; DRESS SHIRTS; DRESS SUITS; DUST COATS; FLEECE SHORTS; FLEECE VESTS; FUR COATS AND JACKETS; GOLF PANTS, SHIRTS AND SKIRTS; GOLF SHIRTS; GOLF SHORTS; GYM PANTS; GYM SHORTS; GYM SUITS; HAT BANDS; HATS; HEAD SCARVES; HEAVY COATS; HEAVY JACKETS; HOODED PULL-OVERS; HOODED SWEAT SHIRTS; HOODS; HUNTING PANTS; JACKETS; JEANS; JOGGING PANTS; JOGGING SUITS; KNIT SHIRTS; LEATHER PANTS; LEG SHIELDING DEVICE, ATTACHABLE TO AND DETACHABLE FROM A PERSON'S PANTS, COMPRISED OF PADDING TO SHIELD THE LEGS FROM FLYING DEBRIS WHEN MOWING WITH A STRING TRIMMER; LEISURE SUITS; LIGHT-REFLECTING COATS; LONG SLEEVED VESTS; LONG-SLEEVED SHIRTS; LOUNGE PANTS; MEN'S AND WOMEN'S JACKETS, COATS, TROUSERS, VESTS; MEN'S SUITS; MOCK TURTLE-NECK SWEATERS; MOISTURE-WICKING SPORTS PANTS; MOISTURE-WICKING SPORTS SHIRTS; MORNING COATS; MOTORCYCLE JACKETS; NIGHT SHIRTS; NON-DISPOSABLE CLOTH TRAINING PANTS; ONE-PIECE PLAY SUITS; OPEN-NECKED SHIRTS; OUTER JACKETS; OVER COATS; OVER SHIRTS; PANTIES, SHORTS AND BRIEFS; PANTS; PERSPIRATION ABSORBENT STRAP TO BE USED IN THE BILL OF A HAT; PIQUE SHIRTS; POLO SHIRTS; QUILTED VESTS; RAIN COATS; RAIN JACKETS; RAINPROOF JACKETS; REVERSIBLE JACKETS; RIDING COATS; RUGBY SHIRTS; RUGBY SHORTS; SCARVES; SCIENTIFIC AND TECHNOLOGICAL APPAREL, NAMELY, SHIRTS, PANTS, JACKETS, FOOTWEAR, HATS AND CAPS, UNIFORMS; SHELL JACKETS; SHIRTS; SHIRTS AND SHORT-SLEEVED SHIRTS; SHIRTS FOR SUITS; SHORT SETS; SHORT TROUSERS; SHORT-SLEEVED OR LONG-SLEEVED T-SHIRTS; SHORT-SLEEVED SHIRTS; SHORTS; SHOULDER SCARVES; SILK SCARVES; SKI JACKETS; SKI PANTS; SKI SUITS; SLEEP PANTS; SLEEP SHIRTS; SLEEVED OR SLEEVELESS JACKETS; SLIDING SHORTS; SNOW BOARDING SUITS; SNOW PANTS; SNOW SUITS; SNOWBOARD PANTS; SPORT COATS; SPORT SHIRTS; SPORTS JACKETS; SPORTS PANTS; SPORTS SHIRTS; SPORTS SHIRTS WITH SHORT SLEEVES; STRETCH PANTS; SUIT COATS; SUITS; SWEAT JACKETS; SWEAT PANTS; SWEAT SHIRTS; SWEAT SHORTS; SWEAT SUITS; SWEATERS; T-SHIRTS; TAP PANTS; TEE SHIRTS; TOBOGGAN HATS, PANTS AND CAPS; TOP COATS; TRACK JACKETS; TRACK PANTS; TRACK SUITS; TRAINING SUITS; TRAVEL CLOTHING CONTAINED IN A PACKAGE COMPRISING REVERSIBLE JACKETS, PANTS, SKIRTS, TOPS AND A BELT OR SCARF; TRENCH COATS; TRIATHLON CLOTHING, NAMELY, TRIATHLON TIGHTS, TRIATHLON SHORTS, TRIATHLON SINGLET, TRIATHLON SHIRTS, TRIATHLON SUITS; TURTLE NECK SHIRTS; TURTLENECK SWEATERS; UNION SUITS; V-NECK SWEATERS; VESTED SUITS; VESTS; WALKING SHORTS; WARM UP SUITS; WATERPROOF JACKETS AND PANTS; WEARABLE GARMENTS AND CLOTHING, NAMELY, SHIRTS; WIND COATS; WIND PANTS; WIND RESISTANT JACKETS; WIND SHIRTS; WIND VESTS; WIND-JACKETS; WOMEN'S HATS AND HOODS; WOOLLY HATS; YOGA PANTS; YOGA SHIRTS (U.S. CLS. 22 AND 39).

CLASS 26—FANCY GOODS

FOR BELT BUCKLES; BELT BUCKLES; BELT BUCKLES NOT OF PRECIOUS METAL; BELT BUCKLES OF PRECIOUS METAL; BELT BUCKLES OF PRECIOUS METALS; BUCKLES FOR CLOTHING; BUCKLES OF PRECIOUS METAL; BUTTONS; BUTTONS FOR CLOTHING; CAMPAIGN BUTTONS; CLOTH PATCHES FOR CLOTHING; CLOTHING BUCKLES; CLOTHING FASTENERS, NAMELY, SNAP BUTTONS; CLOTHING FASTENERS, NAMELY, STUD BUTTONS; EMBROIDERED PATCHES FOR CLOTHING; EMBROIDERY; EMBROIDERY FOR GARMENTS; GOLD EMBROIDERY FOR GARMENTS; HAT ORNAMENTS NOT OF PRECIOUS METAL; HAT PINS; HAT PINS OF PRECIOUS METAL; LACES; LACES AND EMBROIDERY; METAL THREAD FOR EMBROIDERY; NOVELTY BUTTONS; ORNAMENTAL CLOTH PATCHES; ORNAMENTAL NOVELTY

BUTTONS; PATCHES FOR CLOTHING MADE OF RUBBER, PLASTIC AND VINYL; PRESS BUTTONS; REPAIR KITS FOR PERSONAL PROTECTIVE SAFETY AND SURVIVAL GARMENTS PROVIDING FLOTATION AND HYPOTHERMIA PROTECTION COMPRISING SWATCHES OR PATCHES OF GARMENT MATERIAL AND TUBES OF ADHESIVE AND/OR SEALANT; RIVET BUTTONS; SHIRT BUTTONS; SILVER AND/OR GOLD EMBROIDERY FOR GARMENTS; SILVER EMBROIDERY FOR GARMENTS; STRAP BUCKLES; SWEATER GUARDS; ZIPPER FASTENERS; ZIPPER PULLS; ZIP-PERS (U.S. CLS. 37, 39, 40, 42 AND 50).

RUSS HERMAN, EXAMINING ATTORNEY

SN 77-927,917. WOOT, INC., CARROLLTON, TX. FILED 2-4-2010.

SHIRT.WOOT!

THE MARK CONSISTS OF STANDARD CHARACTERS WITHOUT CLAIM TO ANY PARTICULAR FONT, STYLE, SIZE, OR COLOR.

OWNER OF U.S. REG. NOS. 3,012,788, 3,397,587 AND 3,499,780.

CLASS 25—CLOTHING

FOR CLOTHING, NAMELY, T-SHIRTS (U.S. CLS. 22 AND 39).

FIRST USE 7-20-2007; IN COMMERCE 7-20-2007.

CLASS 35—ADVERTISING AND BUSINESS

FOR ON-LINE RETAIL STORE SERVICES IN THE FIELD OF CLOTHING, NAMELY, T-SHIRTS (U.S. CLS. 100, 101 AND 102).

FIRST USE 7-20-2007; IN COMMERCE 7-20-2007.

REBECCA EISINGER, EXAMINING ATTORNEY

SN 77-927,984. BOARD OF CERTIFICATION FOR EMERGENCY NURSING, DES PLAINES, IL. FILED 2-4-2010.

BCEN

THE MARK CONSISTS OF STANDARD CHARACTERS WITHOUT CLAIM TO ANY PARTICULAR FONT, STYLE, SIZE, OR COLOR.

CLASS 16—PAPER GOODS AND PRINTED MATTER

FOR PUBLICATIONS, NAMELY, NEWSLETTERS, BROCHURES, BOOKLETS AND TEACHING MATERIALS IN THE FIELD OF EMERGENCY NURSING (U.S. CLS. 2, 5, 22, 23, 29, 37, 38 AND 50).

FIRST USE 7-1-1980; IN COMMERCE 7-1-1980.

CLASS 42—SCIENTIFIC AND COMPUTER SERVICES

FOR CERTIFICATION SERVICES, NAMELY, TESTING, ANALYSIS AND EVALUATION OF THE KNOWLEDGE, SKILLS AND ABILITIES OF OTHERS FOR THE PURPOSES OF CERTIFICATION IN THE FIELD OF EMERGENCY NURSING (U.S. CLS. 100 AND 101).

FIRST USE 7-1-1980; IN COMMERCE 7-1-1980.
DAVID TAYLOR, EXAMINING ATTORNEY

SN 77-928,026. LEAGUE ZONE, LLC., AKA LEAGUEZONE, FORT LAUDERDALE, FL. FILED 2-4-2010.



SN 77-927,986. HUNGRY HOWIE'S PIZZA & SUBS, INC., MADISON HEIGHTS, MI. FILED 2-4-2010.



NO CLAIM IS MADE TO THE EXCLUSIVE RIGHT TO USE "FLAVORED CRUST ORIGINAL PIZZA" AND "PIZZA & SUBS", APART FROM THE MARK AS SHOWN.

THE NAME(S), PORTRAIT(S), AND/OR SIGNATURE(S) SHOWN IN THE MARK DOES NOT IDENTIFY A PARTICULAR LIVING INDIVIDUAL.

THE MARK CONSISTS OF THE WORDS "FLAVORED CRUST PIZZA" INSIDE DOUBLE CIRCLE WITH CARTOON CHARACTER INSIDE WITH THE WORD "ORIGINAL" IN SCRIPT FONT ACROSS FRONT OF CIRCLE; THE WORDS "HUNGRY HOWIE'S PIZZA & SUBS" IN SPECIAL FONT ON TWO LINES.

CLASS 30—STAPLE FOODS

FOR FOODS, NAMELY, PIZZA, SANDWICHES AND BREADS (U.S. CL. 46).

FIRST USE 0-0-1990; IN COMMERCE 0-0-1990.

CLASS 43—HOTEL AND RESTAURANT SERVICES

FOR RESTAURANT SERVICES, CARRY-OUT RESTAURANT SERVICES, INCLUDING PIZZA, CHICKEN WINGS, SUBS, BREADS FOR CONSUMPTION ON OR OFF PREMISES (U.S. CLS. 100 AND 101).

FIRST USE 0-0-1990; IN COMMERCE 0-0-1990.
DAVID TAYLOR, EXAMINING ATTORNEY

THE COLOR(S) BLACK, WHITE, RED IS/ARE CLAIMED AS A FEATURE OF THE MARK.

THE MARK CONSISTS OF A LARGE LETTER "Z" WITH THE WORDING "LEAGUE ZONE.COM" WITHIN THE BOTTOM OF THE "Z". THE LOWER PORTION OF THE LETTER "Z" IS BLACK WITH THE WORDING "LEAGUE ZONE" IN WHITE TEXT. THE TOP PORTION OF THE "Z" IS SEPARATED BY A SMALL SPACE AND THE TOP ELEMENT IS IN RED. THE ".COM" LETTERING IN THE MARK EXTENDS BEYOND THE "Z" AND IS IN BLACK TEXT."

CLASS 35—ADVERTISING AND BUSINESS

FOR ONLINE ADVERTISING VIA A COMPUTER COMMUNICATIONS NETWORK (U.S. CLS. 100, 101 AND 102).

CLASS 42—SCIENTIFIC AND COMPUTER SERVICES

FOR COMPUTER SERVICES, NAMELY, CREATING AN ON-LINE COMMUNITY FOR REGISTERED USERS TO PARTICIPATE IN DISCUSSIONS, GET FEEDBACK FROM THEIR PEERS, FORM VIRTUAL COMMUNITIES, AND ENGAGE IN SOCIAL NETWORKING FEATURING SPORTS-RELATED COMMUNICATIONS, DIRECT COMMUNICATION BETWEEN FACILITY ADMINISTRATORS AND THE USERS, AND PRIVATE EXCHANGE OF PICTURE MEDIA AND FEEDBACK ON A CLOSED "TEAM" NETWORK (U.S. CLS. 100 AND 101).

JORDAN BAKER, EXAMINING ATTORNEY

SN 77-928,030. DWYER FRANCHISING LLC, WACO, TX. FILED 2-4-2010.



THE MARK CONSISTS OF THE WORDS "GROUNDS GUYS" WITH THE IMAGE OF A LEAF OVER THE "S" IN "GROUNDS".

CLASS 35—ADVERTISING AND BUSINESS

FOR FRANCHISE SERVICES, NAMELY, OFFERING BUSINESS MANAGEMENT ASSISTANCE IN THE ESTABLISHMENT AND OPERATION OF GROUNDS CARE COMPANIES (U.S. CLS. 100, 101 AND 102).

CLASS 37—CONSTRUCTION AND REPAIR

FOR SNOW REMOVAL SERVICES (U.S. CLS. 100, 103 AND 106).

CLASS 39—TRANSPORTATION AND STORAGE

FOR JUNK, TRASH AND DEBRIS REMOVAL (U.S. CLS. 100 AND 105).

CLASS 44—MEDICAL, BEAUTY AND AGRICULTURAL SERVICES

FOR LAWN CARE; LAWN MOWING AND TRIMMING SERVICES; TREE CARE SERVICES; LANDSCAPE DESIGN; LANDSCAPE GARDENING; HORTICULTURAL SERVICES, NAMELY, INSTALLING SOD AND LAWN AND VEGETATION FERTILIZATION AND TREATMENT (U.S. CLS. 100 AND 101).

GRETCHEN ULRICH, EXAMINING ATTORNEY

SN 77-928,318. PIU HOLDINGS, LLC, DBA PUMP IT UP, TEMPE, AZ. FILED 2-4-2010.

JUMP-N-ART

THE MARK CONSISTS OF STANDARD CHARACTERS WITHOUT CLAIM TO ANY PARTICULAR FONT, STYLE, SIZE, OR COLOR.

CLASS 25—CLOTHING

FOR (BASED ON USE IN COMMERCE) SHIRTS; T-SHIRTS(BASED ON INTENT TO USE) BASEBALL CAPS AND HATS; FLEECE PULLOVERS; HATS; HOODED PULLOVERS; LONG-SLEEVED SHIRTS; POLO SHIRTS; PULLOVERS; SHORTS; SWEAT SHIRTS (U.S. CLS. 22 AND 39).

FIRST USE 3-1-2009; IN COMMERCE 3-1-2009.

CLASS 41—EDUCATION AND ENTERTAINMENT

FOR ARRANGING, ORGANIZING, CONDUCTING AND HOSTING BIRTHDAY PARTIES; CHILDREN'S ENTERTAINMENT AND AMUSEMENT CENTERS, NAMELY, INTERACTIVE PLAY AREAS; DAY CAMP SERVICES; RECREATIONAL CAMPS; SUMMER CAMPS (U.S. CLS. 100, 101 AND 107).

FIRST USE 3-1-2009; IN COMMERCE 3-1-2009.

FLORENTINA BLANDU, EXAMINING ATTORNEY

SN 77-928,173. WORSHIP TOOLBOX, INC., LAS VEGAS, NV. FILED 2-4-2010.

Worship Toolbox

THE MARK CONSISTS OF STANDARD CHARACTERS WITHOUT CLAIM TO ANY PARTICULAR FONT, STYLE, SIZE, OR COLOR.

NO CLAIM IS MADE TO THE EXCLUSIVE RIGHT TO USE "WORSHIP", APART FROM THE MARK AS SHOWN.

CLASS 9—ELECTRICAL AND SCIENTIFIC APPARATUS

FOR AUDIO AND VIDEO RECORDINGS FEATURING INSTRUCTIONAL GUIDES ON CREATING, PRODUCING AND USING MUSIC IN A CHURCH OR RELIGIOUS SETTING; AUDIO RECORDINGS FEATURING INSTRUCTIONAL GUIDES ON CREATING, PRODUCING AND USING MUSIC IN A CHURCH OR RELIGIOUS SETTING; SOUND RECORDINGS FEATURING INSTRUCTIONAL GUIDES ON CREATING, PRODUCING AND USING MUSIC IN A CHURCH OR RELIGIOUS SETTING; VIDEO RECORDINGS FEATURING INSTRUCTIONAL GUIDES ON CREATING, PRODUCING AND USING MUSIC IN A CHURCH OR RELIGIOUS SETTING (U.S. CLS. 21, 23, 26, 36 AND 38).

CLASS 16—PAPER GOODS AND PRINTED MATTER

FOR PRINTED INSTRUCTIONAL, EDUCATIONAL, AND TEACHING MATERIALS IN THE FIELD OF CREATING, PRODUCING AND USING MUSIC IN A CHURCH OR RELIGIOUS SETTING (U.S. CLS. 2, 5, 22, 23, 29, 37, 38 AND 50).

NATALIE POLZER, EXAMINING ATTORNEY

SN 77-928,319. PN II, INC., BLOOMFIELD HILLS, MI. FILED 2-4-2010.



OWNER OF U.S. REG. NOS. 1,942,747, 3,676,026 AND OTHERS.

THE COLOR(S) BLUE, GOLD AND WHITE IS/ARE CLAIMED AS A FEATURE OF THE MARK.

THE MARK CONSISTS OF A BLUE HOUSE WITH ONE GOLD WINDOW, TWO WHITE WINDOWS, THE WORD "PULTE" IN BLUE AND THE WORD "GROUP" IN GOLD.

CLASS 36—INSURANCE AND FINANCIAL

FOR REAL ESTATE AGENCY SERVICES; PROPERTY AND CASUALTY INSURANCE AGENCY SERVICES; REAL ESTATE TITLE INSURANCE AGENCY SERVICES; MORTGAGE LENDING SERVICES (U.S. CLS. 100, 101 AND 102).

CLASS 37—CONSTRUCTION AND REPAIR

FOR PLANNING AND LAYING OUT OF RESIDENTIAL COMMUNITIES, RECREATIONAL FACILITIES, SOCIAL AND COMMUNITY FACILITIES; CONSTRUCTION OF RESIDENCES, RECREATIONAL FACILITIES, SOCIAL AND COMMUNITY FACILITIES; REAL ESTATE DEVELOPMENT AND BUILDING CONSTRUCTION SERVICES (U.S. CLS. 100, 103 AND 106).

CLASS 41—EDUCATION AND ENTERTAINMENT

FOR PROVIDING FACILITIES FOR RECREATION ACTIVITIES IN THE NATURE OF GOLF, SWIMMING, TENNIS, EXERCISE, CRAFTS, WALKING, CYCLING, FITNESS AND LAWN GAMES; RECREATIONAL SERVICES IN THE NATURE OF SWIMMING POOL, GOLF AND FITNESS CLUB SERVICES (U.S. CLS. 100, 101 AND 107).

TRICIA SONNEBORN, EXAMINING ATTORNEY

SN 77-928,370. OCHOA, DIEGO A., DBA AK47 OPERATIONS, EL CAJON, CA. AND ROBERTSON, JAKE N., DBA AK47 OPERATIONS, EL CAJON, CA. FILED 2-4-2010.



THE COLOR(S) BLACK, WHITE, AND GREY IS/ARE CLAIMED AS A FEATURE OF THE MARK.

THE MARK CONSISTS OF FIVE CARDS ACE, KING, FOUR AND SEVEN OF SPADES WITH A FIFTH CARD WITH STYLIZED "AK47".

CLASS 16—PAPER GOODS AND PRINTED MATTER

FOR BUMPER STICKERS; DECORATIVE STICKERS FOR HELMETS (U.S. CLS. 2, 5, 22, 23, 29, 37, 38 AND 50).

CLASS 25—CLOTHING

FOR BASEBALL CAPS AND HATS; SHORT-SLEEVED OR LONG-SLEEVED T-SHIRTS (U.S. CLS. 22 AND 39).
ELIZABETH KAJUBI, EXAMINING ATTORNEY

SN 77-928,444. PRINCE, ALAN, DOWNERS GROVE, IL. FILED 2-4-2010.

Imaginary Disasters

THE MARK CONSISTS OF STANDARD CHARACTERS WITHOUT CLAIM TO ANY PARTICULAR FONT, STYLE, SIZE, OR COLOR.

CLASS 9—ELECTRICAL AND SCIENTIFIC APPARATUS

FOR DIGITAL MATERIALS, NAMELY, CDS, DOWNLOADABLE AUDIO FILES FEATURING MUSIC (U.S. CLS. 21, 23, 26, 36 AND 38).

CLASS 41—EDUCATION AND ENTERTAINMENT

FOR ENTERTAINMENT, NAMELY, LIVE MUSIC CONCERTS; ENTERTAINMENT, NAMELY, LIVE PERFORMANCES BY A MUSICAL BAND (U.S. CLS. 100, 101 AND 107).

TRACY CROSS, EXAMINING ATTORNEY

SN 77-928,472. THE UNIVERSITY OF KANSAS, LAWRENCE, KS. FILED 2-4-2010.

ROCK CHALK JAYHAWK

THE MARK CONSISTS OF STANDARD CHARACTERS WITHOUT CLAIM TO ANY PARTICULAR FONT, STYLE, SIZE, OR COLOR.

OWNER OF U.S. REG. NOS. 1,109,715, 2,827,452 AND OTHERS.

CLASS 25—CLOTHING

FOR HATS, SHIRTS AND SWEATSHIRTS (U.S. CLS. 22 AND 39).

FIRST USE 7-1-1998; IN COMMERCE 7-1-1998.

CLASS 41—EDUCATION AND ENTERTAINMENT

FOR OFFERING COURSES AT THE COLLEGE AND GRADUATE LEVEL; PROVIDING INTERCOLLEGIATE ATHLETIC EXHIBITIONS; AND PRESENTING THEATER AND CONCERT PRODUCTIONS (U.S. CLS. 100, 101 AND 107).

FIRST USE 0-0-1886; IN COMMERCE 0-0-1886.

ELI HELLMAN, EXAMINING ATTORNEY

SN 77-928,476. BU HOLDINGS, LLC, DBA BOUNCEU, TEMPE, AZ. FILED 2-4-2010.

Create and Bounce

THE MARK CONSISTS OF STANDARD CHARACTERS WITHOUT CLAIM TO ANY PARTICULAR FONT, STYLE, SIZE, OR COLOR.

CLASS 25—CLOTHING

FOR (BASED ON USE IN COMMERCE) SHIRTS; T-SHIRTS (BASED ON INTENT TO USE) BASEBALL CAPS AND HATS; FLEECE PULLOVERS; HATS; HOODED PULLOVERS; HOODED SWEAT SHIRTS; POLO SHIRTS; SHORTS (U.S. CLS. 22 AND 39).

FIRST USE 3-1-2009; IN COMMERCE 3-1-2009.

CLASS 41—EDUCATION AND ENTERTAINMENT

FOR ARRANGING, ORGANIZING, CONDUCTING AND HOSTING BIRTHDAY PARTIES; CHILDREN'S ENTERTAINMENT AND AMUSEMENT CENTERS, NAMELY, INTERACTIVE PLAY AREAS; DAY CAMP SERVICES; HOLIDAY CAMP SERVICES; RECREATIONAL CAMPS; SUMMER CAMPS (U.S. CLS. 100, 101 AND 107).

FIRST USE 3-1-2009; IN COMMERCE 3-1-2009.
ELI HELLMAN, EXAMINING ATTORNEY

SN 77-928,494. CAREFAST PRODUCTS, INC., LAS VEGAS, NV. FILED 2-4-2010.



OWNER OF U.S. REG. NO. 3,739,882.
THE MARK CONSISTS OF THE WORD "CAREFAST" IN SCRIPT FORM PRECEDED BY THE LETTER "C" GRAPHICALLY DEPICTED BY A NUMBER OF INDIVIDUAL FILLED-IN CIRCLES AND OVALS.

CLASS 5—PHARMACEUTICALS

FOR POWDERED NUTRITIONAL SUPPLEMENT DRINK MIXES (U.S. CLS. 6, 18, 44, 46, 51 AND 52).

CLASS 32—LIGHT BEVERAGES

FOR ENERGY DRINK MIXES (U.S. CLS. 45, 46 AND 48).
LESLEY LAMOTHE, EXAMINING ATTORNEY

SN 77-928,547. SFERE, INC., UNION CITY, NJ. FILED 2-4-2010.

OBJEKTIVITY

THE MARK CONSISTS OF STANDARD CHARACTERS WITHOUT CLAIM TO ANY PARTICULAR FONT, STYLE, SIZE, OR COLOR.

CLASS 9—ELECTRICAL AND SCIENTIFIC APPARATUS

FOR DOWNLOADABLE MP3 FILES AND MP3 RECORDINGS FEATURING MUSIC; DOWNLOADABLE MUSICAL SOUND RECORDINGS; PHONOGRAPH RECORDS FEATURING MUSIC; PRE-RECORDED CDS FEATURING MUSIC; PRE-RECORDED CDS, VIDEO TAPES, LASER DISKS AND DVDS FEATURING MUSIC; PRE-RECORDED DIGITAL MEDIA FEATURING MUSIC (U.S. CLS. 21, 23, 26, 36 AND 38).

FIRST USE 10-1-2006; IN COMMERCE 10-1-2006.

CLASS 41—EDUCATION AND ENTERTAINMENT

FOR ENTERTAINMENT AND EDUCATION SERVICES IN THE NATURE OF LIVE DANCE AND MUSICAL PERFORMANCES; ENTERTAINMENT IN THE NATURE OF LIVE PERFORMANCES BY DISC JOCKEYS; ENTERTAINMENT IN THE NATURE OF LIVE PERFORMANCES BY DISC JOCKEYS, VOCALISTS, MUSICIANS, DANCERS; ENTERTAINMENT SERVICES IN THE NATURE OF LIVE MUSICAL PERFORMANCES; ENTERTAINMENT SERVICES, NAMELY, PROVIDING NON-DOWNLOADABLE PLAYBACK OF MUSIC VIA GLOBAL COMMUNICATIONS NETWORKS; ENTERTAINMENT, NAMELY, LIVE MUSIC CONCERTS; ENTERTAINMENT, NAMELY, LIVE PERFORMANCES BY MUSICAL BANDS; MUSIC PRODUCTION SERVICES (U.S. CLS. 100, 101 AND 107).

FIRST USE 10-1-2006; IN COMMERCE 10-1-2006.
ZACHARY BELLO, EXAMINING ATTORNEY

SN 77-928,587. BLUESWARM, LLC, WESTFORD, MA. FILED 2-4-2010.

BlueSwarm

THE MARK CONSISTS OF STANDARD CHARACTERS WITHOUT CLAIM TO ANY PARTICULAR FONT, STYLE, SIZE, OR COLOR.

CLASS 36—INSURANCE AND FINANCIAL

FOR CHARITABLE FUNDRAISING; POLITICAL FUND RAISING SERVICES; PROVIDING FUND RAISING SERVICES FOR OTHERS VIA A GLOBAL COMPUTER NETWORK (U.S. CLS. 100, 101 AND 102).
FIRST USE 8-1-2008; IN COMMERCE 3-1-2009.

CLASS 45—PERSONAL AND LEGAL SERVICES

FOR INTERNET-BASED SOCIAL NETWORKING SERVICES; ON-LINE SOCIAL NETWORKING SERVICES; PROVIDING ON-LINE COMPUTER DATABASES AND ON-LINE SEARCHABLE DATABASES IN THE FIELD OF SOCIAL NETWORKING (U.S. CLS. 100 AND 101).
FIRST USE 8-1-2008; IN COMMERCE 3-1-2009.
TRICIA SONNEBORN, EXAMINING ATTORNEY

SN 77-928,617. TUGBOAT, INC., LARKSPUR, CA. FILED 2-4-2010.

OWN

THE MARK CONSISTS OF STANDARD CHARACTERS WITHOUT CLAIM TO ANY PARTICULAR FONT, STYLE, SIZE, OR COLOR.

CLASS 3—COSMETICS AND CLEANING PREPARATIONS

FOR NON-MEDICATED SKINCARE PREPARATIONS; COSMETICS; NON-MEDICATED ACNE TREATMENT PREPARATIONS; SUN BLOCK; SUN SCREEN; NON-MEDICATED SUN CARE PREPARATIONS; SUN SCREEN PREPARATIONS; COSMETIC SUN-PROTECTING PREPARATIONS; SUN CARE LOTIONS; ANTI-AGING CREAMS; SPECIALIZED TABLETS AND POWDERS FOR DELIVERY OF PLANT AND HERB EXTRACTS FOR COSMETIC PURPOSES; HAIR CARE PREPARATIONS; NON-MEDICATED SCALP TREATMENT PREPARATIONS (U.S. CLS. 1, 4, 6, 50, 51 AND 52).

CLASS 5—PHARMACEUTICALS

FOR MEDICATED SKINCARE PREPARATIONS; ACNE TREATMENT PREPARATIONS; ACNE MEDICATIONS; MEDICATED SUN CARE PREPARATIONS; SPECIALIZED TABLETS AND POWDERS FOR DELIVERY OF PLANT AND HERB EXTRACTS FOR MEDICINAL PURPOSES; MEDICATED HAIR CARE PREPARATIONS; MEDICATED SCALP TREATMENT PREPARATIONS; FIRST AID OINTMENTS, NAMELY, ANTIBIOTIC, ANTI-INFLAMMATORY, AND ANTI-ITCH; PHARMACEUTICAL PREPARATIONS FOR THE PREVENTION AND TREATMENT OF THE IMMUNE SYSTEM, COUGHS, AND COLDS (U.S. CLS. 6, 18, 44, 46, 51 AND 52).

ERNEST SHOSHO, EXAMINING ATTORNEY

SN 77-928,652. DELINDA DEMITA WILLS, SHREVEPORT, LA. FILED 2-4-2010.

Aulelei

THE MARK CONSISTS OF STANDARD CHARACTERS WITHOUT CLAIM TO ANY PARTICULAR FONT, STYLE, SIZE, OR COLOR.

CLASS 35—ADVERTISING AND BUSINESS

FOR ON-LINE WHOLESALE AND RETAIL STORE SERVICES FEATURING HEALTHCARE, BEAUTY, COSMETIC, JEWELRY, CLOTHING, AND HOME ACCESSORY PRODUCTS (U.S. CLS. 100, 101 AND 102).

CLASS 44—MEDICAL, BEAUTY AND AGRICULTURAL SERVICES

FOR BEAUTY SPA SERVICES, NAMELY, COSMETIC BODY CARE; COSMETIC SKIN CARE SERVICES; HEALTH CARE; HEALTH SPA SERVICES FOR HEALTH AND WELLNESS OF THE BODY AND SPIRIT, NAMELY, PROVIDING MASSAGE, FACIAL AND BODY TREATMENT SERVICES, COSMETIC BODY CARE SERVICES; MEDICAL SKIN CARE SERVICES; MEDICAL, HYGIENIC AND BEAUTY CARE; PHYSICIAN SERVICES; PROVIDING HEALTH CARE INFORMATION BY TELEPHONE AND THE INTERNET (U.S. CLS. 100 AND 101).

DAVID MURRAY, EXAMINING ATTORNEY

SN 77-928,666. HOUSE, AARON J, CARUTHERSVILLE, MO. FILED 2-4-2010.

EliteCom

THE MARK CONSISTS OF STANDARD CHARACTERS WITHOUT CLAIM TO ANY PARTICULAR FONT, STYLE, SIZE, OR COLOR.

CLASS 9—ELECTRICAL AND SCIENTIFIC APPARATUS

FOR COMPUTER HARDWARE AND COMPUTER PERIPHERAL DEVICES (U.S. CLS. 21, 23, 26, 36 AND 38).

CLASS 16—PAPER GOODS AND PRINTED MATTER

FOR A SERIES OF BOOKS, WRITTEN ARTICLES, HANDOUTS AND WORKSHEETS IN THE FIELD OF INFORMATION TECHNOLOGY; BOOKS IN THE FIELD OF INFORMATION TECHNOLOGY (U.S. CLS. 2, 5, 22, 23, 29, 37, 38 AND 50).

JIM RINGLE, EXAMINING ATTORNEY

SN 77-928,677. MITCHELL, TYRA K., COLUMBIA, SC. FILED 2-5-2010.

CHRISTIAN UNDER CONSTRUCTION

THE MARK CONSISTS OF STANDARD CHARACTERS WITHOUT CLAIM TO ANY PARTICULAR FONT, STYLE, SIZE, OR COLOR.

CLASS 25—CLOTHING

FOR WEARABLE GARMENTS AND CLOTHING, NAMELY, SHIRTS (U.S. CLS. 22 AND 39).

CLASS 28—TOYS AND SPORTING GOODS

FOR STRESS RELIEF BALLS FOR HAND EXERCISE (U.S. CLS. 22, 23, 38 AND 50).

CAROL SPILS, EXAMINING ATTORNEY

SN 77-928,763. ATI PROPERTIES, INC., ALBANY, OR. FILED 2-5-2010.

THAT'S RIGHT UP OUR ALLOY

THE MARK CONSISTS OF STANDARD CHARACTERS WITHOUT CLAIM TO ANY PARTICULAR FONT, STYLE, SIZE, OR COLOR.

CLASS 9—ELECTRICAL AND SCIENTIFIC APPARATUS

FOR DOWNLOADABLE ELECTRONIC PUBLICATIONS IN THE NATURE OF BROCHURES, BOOKLETS, PAMPHLETS, PRESENTATIONS, AND PROMOTIONAL MATERIALS IN THE FIELD OF SPECIALTY METALS BUSINESS (U.S. CLS. 21, 23, 26, 36 AND 38).

CLASS 16—PAPER GOODS AND PRINTED MATTER

FOR PUBLICATIONS, NAMELY, BROCHURES, BOOKLETS, PAMPHLETS, PRESENTATIONS, AND PROMOTIONAL MATERIALS IN THE FIELD OF SPECIALTY METALS BUSINESS (U.S. CLS. 2, 5, 22, 23, 29, 37, 38 AND 50).

KEVIN DINALLO, EXAMINING ATTORNEY

CLASS 35—ADVERTISING AND BUSINESS

FOR ADVERTISING AND PUBLICITY SERVICES, NAMELY, PROMOTING THE GOODS, SERVICES, BRAND IDENTITY AND COMMERCIAL INFORMATION AND NEWS OF THIRD PARTIES THROUGH PRINT, AUDIO, VIDEO, DIGITAL AND ON-LINE MEDIUM; ADVERTISING BY TRANSMISSION OF ON-LINE PUBLICITY FOR THIRD PARTIES THROUGH ELECTRONIC COMMUNICATIONS NETWORKS; ADVERTISING SERVICES, NAMELY, COST-PER-ACTION ON-LINE ADVERTISING; CONDUCTING ON-LINE BUSINESS MANAGEMENT RESEARCH SURVEYS; DATABASE MANAGEMENT; ON-LINE ADVERTISING AND MARKETING SERVICES; ON-LINE ADVERTISING SERVICES FOR OTHERS; PROMOTING, ADVERTISING AND MARKETING OF THE ON-LINE WEB SITES OF OTHERS; PROMOTING, ADVERTISING AND MARKETING THE ON-LINE DATABASES AND ELECTRONIC PUBLICATIONS OF OTHERS; PROMOTION, ADVERTISING AND MARKETING OF ON-LINE WEBSITES (U.S. CLS. 100, 101 AND 102).

BARNEY CHARLON, EXAMINING ATTORNEY

SN 77-928,895. ZAMOR JR, RICHE C, DBA SOCIAL CONTXT, RANDOLPH, MA. FILED 2-5-2010.

SN 77-928,965. FOURSTAR GROUP INC., TAIPEI, TAIWAN, FILED 2-5-2010.

Social Contxt

THE MARK CONSISTS OF STANDARD CHARACTERS WITHOUT CLAIM TO ANY PARTICULAR FONT, STYLE, SIZE, OR COLOR.

CLASS 9—ELECTRICAL AND SCIENTIFIC APPARATUS

FOR COMPUTER DATABASE MANAGEMENT SOFTWARE FOR USE IN PERSONALIZING THE CONTENT OF E-MAIL COMMUNICATIONS; COMPUTER E-COMMERCE SOFTWARE TO ALLOW USERS TO PERFORM ELECTRONIC BUSINESS TRANSACTIONS VIA A GLOBAL COMPUTER NETWORK; COMPUTER GAME SOFTWARE FOCUSING ON ACHIEVING A SET OF GOALS, POSITIONS, OWNERSHIP, AND CREDENTIALS, AND PROFESSIONAL AND SOCIAL STATUS, AND GOOD FORTUNE NECESSARY TO SUCCEED PROFESSIONALLY AND PERSONALLY, AND NOT REFERRING EITHER TO A GROUP OF SOFTWARE FOR USE IN COMMERCE OR TO A GROUP OF OFFICES; COMPUTER SOFTWARE FOR APPLICATION AND DATABASE INTEGRATION; COMPUTER SOFTWARE FOR COMMUNICATING WITH USERS OF HAND-HELD COMPUTERS; COMPUTER SOFTWARE FOR CREATING SEARCHABLE DATABASES OF INFORMATION AND DATA; COMPUTER SOFTWARE FOR PROVIDING AN ON-LINE DATABASE IN THE FIELD OF TRANSACTION PROCESSING TO UPLOAD TRANSACTIONAL DATA, PROVIDE STATISTICAL ANALYSIS, AND PRODUCE NOTIFICATIONS AND REPORTS; DATABASE MANAGEMENT SOFTWARE FOR CONSTITUENT AND BUSINESS MANAGEMENT INFORMATION MANAGEMENT; DOWNLOADABLE MP3 FILES, MP3 RECORDINGS, ON-LINE DISCUSSION BOARDS, WEBCASTS, WEBINARS AND PODCASTS FEATURING MUSIC, AUDIO BOOKS AND NEWS BROADCASTS; WEB SITE DEVELOPMENT SOFTWARE (U.S. CLS. 21, 23, 26, 36 AND 38).

renewed energy

THE MARK CONSISTS OF STANDARD CHARACTERS WITHOUT CLAIM TO ANY PARTICULAR FONT, STYLE, SIZE, OR COLOR.

CLASS 9—ELECTRICAL AND SCIENTIFIC APPARATUS

FOR SCALES (U.S. CLS. 21, 23, 26, 36 AND 38).
FIRST USE 9-0-2005; IN COMMERCE 3-1-2006.

CLASS 10—MEDICAL APPARATUS

FOR ELECTRIC MASSAGE APPLIANCES, NAMELY, ELECTRIC VIBRATING MASSAGER (U.S. CLS. 26, 39 AND 44).
FIRST USE 9-0-2005; IN COMMERCE 3-1-2006.
DAVID COLLIER, EXAMINING ATTORNEY

SN 77-928,977. FIRST AMERICAN MUSIC AND ENTERTAINMENT, LLC, HOLLYWOOD, FL. FILED 2-5-2010.

The logo consists of the words "WARRIORS", "ROCK'N", and "HOPE" stacked vertically in a bold, distressed, sans-serif font. To the left of the word "HOPE" is a black handprint graphic with fingers spread, appearing to be stamped or pressed into the surface.

THE MARK CONSISTS OF A HANDPRINT WITH THE WORDS "WARRIORS ROCK N' HOPE" BESIDE IT.

CLASS 9—ELECTRICAL AND SCIENTIFIC APPARATUS

FOR MUSICAL SOUND RECORDINGS AND MUSICAL AUDIOVISUAL RECORDINGS; SOUND RECORDINGS AND AUDIOVIDEO RECORDINGS CONCERNING MUSICAL ARTISTS; DOWNLOADABLE MUSICAL SOUND RECORDINGS; DOWNLOADABLE SOUND RECORDINGS CONCERNING MUSICAL ARTISTS; DOWNLOADABLE VIDEO RECORDINGS FEATURING MUSIC; DOWNLOADABLE VIDEO RECORDINGS CONCERNING MUSICAL ARTISTS; DOWNLOADABLE ELECTRONIC PUBLICATIONS IN THE NATURE OF BOOKS, BOOKLETS, MAGAZINES, JOURNALS, MANUALS, BROCHURES, LEAFLETS, PAMPHLETS AND NEWSLETTERS, CONCERNING MUSICAL ARTISTS (U.S. CLS. 21, 23, 26, 36 AND 38).

CLASS 16—PAPER GOODS AND PRINTED MATTER

FOR PRINTED MATTER, NAMELY, POSTERS, SHEET MUSIC, TABLATURE BOOKS, SONG BOOKS, TOUR BOOKS RELATING TO A MUSIC ARTIST, MAGAZINES RELATING TO A MUSICAL ARTIST, STICKERS, BUMPER STICKERS, DECALS; PHOTOGRAPHS; AND LITHOGRAPHS (U.S. CLS. 2, 5, 22, 23, 29, 37, 38 AND 50).

CLASS 25—CLOTHING

FOR CLOTHING, NAMELY, SHIRTS, T-SHIRTS, TOPS, SWEAT SHIRTS, CAPS, HATS, WRIST BANDS AND UNDERWEAR (U.S. CLS. 22 AND 39).

CLASS 41—EDUCATION AND ENTERTAINMENT

FOR ENTERTAINMENT, NAMELY, LIVE MUSIC PERFORMANCES; PROVIDING ENTERTAINMENT INFORMATION VIA A COMPUTER COMMUNICATIONS NETWORK, NAMELY, INFORMATION ABOUT APPEARANCES, PERFORMANCES AND RECORDINGS OF MUSIC ARTISTS; INFORMATION SERVICES, NAMELY, PROVIDING A WEB SITE FEATURING MUSICAL PERFORMANCES, MUSICAL VIDEOS, RELATED FILM CLIPS, PHOTOGRAPHS AND OTHER MULTIMEDIA MATERIALS FEATURING MUSIC; FAN CLUB SERVICES; TELEVISION AND RADIO PROGRAM PRODUCTION SERVICES; PRODUCTION AND ORGANIZATION OF LIVE ENTERTAINMENT EVENTS, NAMELY, CONCERTS, CONCERT TOURS AND FESTIVALS IN THE MUSIC FIELD; AND PRODUCTION AND DISTRIBUTION OF MOTION PICTURES AND TELEVISION PROGRAMS, AND PRODUCTION OF SOUND RECORDINGS (U.S. CLS. 100, 101 AND 107).

JANICE L. MCMORROW, EXAMINING ATTORNEY

SN 77-929,096. DUTCH VALLEY FOOD DISTRIBUTORS INC., MYERSTOWN, PA. FILED 2-5-2010.



OWNER OF U.S. REG. NO. 3,734,017.

NO CLAIM IS MADE TO THE EXCLUSIVE RIGHT TO USE "BULK FOODS INC.", APART FROM THE MARK AS SHOWN.

THE COLOR(S) RED, WHITE, BLUE, YELLOW, AND BLACK IS/ARE CLAIMED AS A FEATURE OF THE MARK.

THE MARK CONSISTS OF THE WORD "BULK" WRITTEN IN CAPITAL LETTERS THAT ARE RED, OUTLINED IN BLACK, AND HAVE STIPPLED BLUE SHADING. IN FRONT OF THE WORD BULK IS A BLACK AND WHITE SACK OF GRAIN. THE SACK IS OPEN AT THE TOP, AND THERE IS A BLACK AND WHITE SHOVEL SCOOPING THE GRAIN, WHICH IS YELLOW. THE SACK HAS A DESIGN ON IT, CONSISTING OF TWO BIRDS AND A FLOWER. THE BASE OF THE FLOWER CONSISTS OF A RED HEART OUTLINED IN BLACK. WITHIN THE RED HEART, THERE IS AN OUTLINE OF A SMALLER HEART, WHICH IS YELLOW OUTLINED IN BLACK. THE STEM OF THE FLOWER IS BLUE, AND THE BLOSSOM IS RED AND YELLOW. THERE IS A BIRD ON EACH SIDE OF THE FLOWER. THE BIRDS ARE BLUE WITH RED LEGS AND RED AND YELLOW WINGS. THE BIRD TO THE RIGHT OF THE FLOWER HAS A RED AND YELLOW TAIL. THE BIRDS' BODIES, LEGS, WINGS, AND TAIL ARE OUTLINED IN BLACK. THE WORD "FOODS" IS WRITTEN IN CAPITAL LETTERS AND APPEARS IN FRONT OF THE BOTTOM OF THE SACK OF GRAIN. THE WORD "FOODS" IS WRITTEN IN RED LETTERS OUTLINED IN BLACK, WITH BLUE STIPPLED SHADING. THE WORD "INC." APPEARS BELOW THE LETTER "D" IN "FOODS" IN BLUE. THE BACKGROUND IS WHITE, OUTLINED BY A STIPPLED BLUE RECTANGULAR BORDER WITH ROUNDED CORNERS, FOLLOWED BY AN EXTERNAL RED RECTANGULAR BORDER.

CLASS 30—STAPLE FOODS

FOR ADOBO; ALLSPICE; ARROWROOT FOR USE AS A FOOD THICKENER; ARTIFICIAL RICE; BAGEL CHIPS; BAKERY GOODS; BAKERY PRODUCTS; BAKERY PRODUCTS, NAMELY, SWEET BAKERY GOODS; BAKING SPICES; BARBECUE DRY RUB; BEVERAGES MADE OF TEA; BISCUITS AND BREAD; BREAKFAST CEREALS; CANDIES; CANDY; CANDY FOR FOOD; CANDY WITH COCOA; CAPPUCINO; CELERY SALT; CEREAL BASED SNACK FOOD; CHAI TEA; CHEESE SAUCE; CHILI POWDERS; CHILI SEASONING; CHOCOLATE; CHOCOLATE AND CHOCOLATES; CHOCOLATE BARS; CHOCOLATE CANDIES; CHOCOLATE CHIPS; CHOCOLATE COVERED FRUIT; CHOCOLATE COVERED NUTS; CHOCOLATE COVERED RAISINS; CHOCOLATE COVERED ROASTED COFFEE BEANS; CHOCOLATE FOOD BEVERAGES NOT BEING DAIRY-BASED OR VEGETABLE BASED; CHOCOLATE POWDER; CHOCOLATE TRUFFLES; CINNAMON; CINNAMON POWDER; CLOVE POWDER; CLOVES; COCOA; COCOA BEVERAGES WITH MILK; COCOA POWDER; COCOA-BASED BEVERAGES; COCOA-BASED CONDIMENTS AND SEASONINGS FOR FOOD AND DRINK; CONFECTIONER'S COATINGS IN THE NATURE OF EDIBLE SHELLAC COATINGS FOR FOODS; CONFECTIONERY CHIPS FOR BAKING; COOKIE MIXES; COOKING SALT; CORN MEAL; CORNMEAL; CURRY; CURRY POWDER; DRIED CHIVES; DRY SEASONING MIXES FOR STEWS; DRY SPICE RUB FOR MEATS AND FISH; EDIBLE SALT; EDIBLE SPICES; EDIBLE TURMERIC; FLAVORED, SWEETENED GELATIN DESERTS; FLAVOURINGS AND SEASONINGS; GARDEN HERBS, PRESERVED; GARLIC SALT; GINGER; GRANOLA; GRANOLA SNACKS; GRAVIES; GRAVY; GRAVY MIXES; ICE CREAM MIXES; MEAT CURES; MEAT TENDERIZERS; MEAT TENDERIZERS FOR HOUSEHOLD PURPOSES; MILK CHOCOLATE; MINCED GARLIC; MIXES IN THE NATURE OF CONCENTRATES, SYRUPS OR POWDERS USED IN THE PREPARATION OF TEA BASED BEVERAGES; MUSTARD POWDER; NUTMEG; ONION SALT; PASTA; PEPPER; PEPPER POWDER; PEPPER SPICE; PILAF; POWDERED GARLIC; PROCESSED HERBS; PROCESSED SEMOLINA; READY-MADE SAUCES; READY-TO-EAT CEREALS; RICE; RICE AND SEASONING MIX COMBINED IN UNITARY PACKAGES; RICE, SEASONINGS, AND FLAVORINGS COMBINED IN UNITARY PACKAGES; SAGE; SALAD DRESSING; SALAD DRESSINGS; SALSA; SAUCE MIXES; SEASONING MIXES; SEASONING MIXES FOR SOUPS; SEASONINGS; SNACK FOODS, NAMELY, CHOCOLATE-BASED SNACK FOODS; SNACK MIX CONSISTING PRIMARILY OF CRACKERS, PRETZELS,

CANDIED NUTS AND/OR POPPED POPCORN; SPICE BLENDS; SPICE RUBS; SPICES; STEAK SEASONING; TACO SEASONING; TURMERIC (U.S. CL. 46).
FIRST USE 6-20-1997; IN COMMERCE 6-20-1997.

CLASS 32—LIGHT BEVERAGES

FOR FRUIT DRINKS; FRUIT DRINKS AND FRUIT JUICES; FRUIT DRINKS AND JUICES; FRUIT FLAVORED DRINKS; LEMONADE; LEMONADES; ORANGE JUICE BEVERAGES; POWDERS USED IN THE PREPARATION OF FRUIT-BASED BEVERAGES (U.S. CLS. 45, 46 AND 48).

FIRST USE 6-20-1997; IN COMMERCE 6-20-1997.
GILBERT SWIFT, EXAMINING ATTORNEY

SN 77-929,166. SOLUTIONS UNLIMITED LLC, WASHINGTON, DC. FILED 2-5-2010.

**I'M EVERYWHERE YOU'VE
NEVER BEEN**

THE MARK CONSISTS OF STANDARD CHARACTERS WITHOUT CLAIM TO ANY PARTICULAR FONT, STYLE, SIZE, OR COLOR.

CLASS 20—FURNITURE AND ARTICLES NOT OTHERWISE CLASSIFIED

FOR PLASTIC, NON-METAL AND NON-LEATHER KEY CHAINS (U.S. CLS. 2, 13, 22, 25, 32 AND 50).

CLASS 21—HOUSEWARES AND GLASS

FOR SHOT GLASSES (U.S. CLS. 2, 13, 23, 29, 30, 33, 40 AND 50).

CLASS 25—CLOTHING

FOR CLOTHING, NAMELY, T-SHIRTS AND POLO SHIRTS (U.S. CLS. 22 AND 39).
TRACY WHITTAKER-BROWN, EXAMINING ATTORNEY

SN 77-929,188. MONEY SAVVY GENERATION, LLC, LAKE BLUFF, IL. FILED 2-5-2010.

SAVINGS SPREE

THE MARK CONSISTS OF STANDARD CHARACTERS WITHOUT CLAIM TO ANY PARTICULAR FONT, STYLE, SIZE, OR COLOR.

CLASS 9—ELECTRICAL AND SCIENTIFIC APPARATUS

FOR COMPUTER GAME PROGRAMS, INCLUDING DOWNLOADABLE GAME PROGRAMS, IN THE FIELD OF FINANCIAL EDUCATION (U.S. CLS. 21, 23, 26, 36 AND 38).

CLASS 28—TOYS AND SPORTING GOODS

FOR BOARD GAMES IN THE FIELD OF FINANCIAL EDUCATION (U.S. CLS. 22, 23, 38 AND 50).
LINDSEY RUBIN, EXAMINING ATTORNEY

SN 77-929,218. STRAHM, PETER G., MILLTOWN, NJ. FILED 2-5-2010.

MÄKT

THE MARK CONSISTS OF STANDARD CHARACTERS WITHOUT CLAIM TO ANY PARTICULAR FONT, STYLE, SIZE, OR COLOR.

THE ENGLISH TRANSLATION OF "MÄKT" IN THE MARK IS "POWER."

CLASS 5—PHARMACEUTICALS

FOR DIETARY DRINK MIX FOR USE AS A MEAL REPLACEMENT; DIETARY SUPPLEMENTAL DRINKS IN THE NATURE OF VITAMIN AND MINERAL BEVERAGES; MEAL REPLACEMENT DRINKS (U.S. CLS. 6, 18, 44, 46, 51 AND 52).

CLASS 32—LIGHT BEVERAGES

FOR SPORTS DRINKS, NAMELY, ENERGY DRINKS (U.S. CLS. 45, 46 AND 48).
JOHN E. MICHOS, EXAMINING ATTORNEY

SN 77-929,239. STRAHM, PETER G., MILLTOWN, NJ. FILED 2-5-2010.

TRU BURNER

THE MARK CONSISTS OF STANDARD CHARACTERS WITHOUT CLAIM TO ANY PARTICULAR FONT, STYLE, SIZE, OR COLOR.

NO CLAIM IS MADE TO THE EXCLUSIVE RIGHT TO USE "BURNER", APART FROM THE MARK AS SHOWN.

CLASS 5—PHARMACEUTICALS

FOR DIETARY DRINK MIX FOR USE AS A MEAL REPLACEMENT; DIETARY SUPPLEMENTAL DRINKS IN THE NATURE OF VITAMIN AND MINERAL BEVERAGES; MEAL REPLACEMENT DRINKS (U.S. CLS. 6, 18, 44, 46, 51 AND 52).

CLASS 32—LIGHT BEVERAGES

FOR SPORTS DRINKS, NAMELY, ENERGY DRINKS (U.S. CLS. 45, 46 AND 48).
JOHN E. MICHOS, EXAMINING ATTORNEY

SN 77-929,257. STRAHM, PETER G., MILLTOWN, NJ. FILED 2-5-2010.

SN 77-929,270. STRAHM, PETER G., MILLTOWN, NJ. FILED 2-5-2010.

NTH DEGREE SPORT

THE MARK CONSISTS OF STANDARD CHARACTERS WITHOUT CLAIM TO ANY PARTICULAR FONT, STYLE, SIZE, OR COLOR.

NO CLAIM IS MADE TO THE EXCLUSIVE RIGHT TO USE "SPORT", APART FROM THE MARK AS SHOWN.

CLASS 5—PHARMACEUTICALS

FOR DIETARY SUPPLEMENTS; NUTRITIONAL DRINK MIX FOR USE AS A MEAL REPLACEMENT; NUTRITIONAL SHAKES FOR USE AS A MEAL SUBSTITUTE; NUTRITIONAL SUPPLEMENT IN THE NATURE OF A NUTRIENT-DENSE, PROTEIN-BASED DRINK MIX; NUTRITIONAL SUPPLEMENTS; POWDERED NUTRITIONAL SUPPLEMENT DRINK MIX; PROTEIN SUPPLEMENTS (U.S. CLS. 6, 18, 44, 46, 51 AND 52).

CLASS 32—LIGHT BEVERAGES

FOR BOTTLED WATER; DRINKING WATER WITH VITAMINS; FLAVORED WATERS; ISOTONIC BEVERAGES; ISOTONIC DRINKS; NON-ALCOHOLIC BEER; NON-ALCOHOLIC BEVERAGES CONTAINING FRUIT JUICES; NON-ALCOHOLIC BEVERAGES WITH TEA FLAVOR; NON-ALCOHOLIC BEVERAGES, NAMELY, CARBONATED BEVERAGES; NON-ALCOHOLIC CIDER; NON-ALCOHOLIC FRUIT JUICE BEVERAGES; NON-ALCOHOLIC HONEY-BASED BEVERAGES; SPARKLING WATER; SPORTS DRINKS; SPORTS DRINKS, NAMELY, ENERGY DRINKS; SPRING WATER (U.S. CLS. 45, 46 AND 48).

JOHN E. MICHOS, EXAMINING ATTORNEY

SN 77-929,266. PATHSTONE FAMILY OFFICE, LLC, ENGLEWOOD, NJ. FILED 2-5-2010.

PATHSTONE

THE MARK CONSISTS OF STANDARD CHARACTERS WITHOUT CLAIM TO ANY PARTICULAR FONT, STYLE, SIZE, OR COLOR.

CLASS 35—ADVERTISING AND BUSINESS

FOR BUSINESS SUCCESSION PLANNING; TAX AND TAXATION PLANNING, ADVICE, INFORMATION AND CONSULTANCY SERVICES (U.S. CLS. 100, 101 AND 102).

CLASS 36—INSURANCE AND FINANCIAL

FOR BILL PAYMENT SERVICES; ESTATE PLANNING; FINANCIAL CONSULTING AND ADVISING IN THE FIELD OF MERGERS AND ACQUISITIONS; FINANCIAL PLANNING AND INVESTMENT ADVISORY SERVICES; FINANCIAL SERVICES, NAMELY, WEALTH MANAGEMENT SERVICES (U.S. CLS. 100, 101 AND 102).

JAMES GRIFFIN, EXAMINING ATTORNEY

Nth^o

THE MARK CONSISTS OF STANDARD CHARACTERS WITHOUT CLAIM TO ANY PARTICULAR FONT, STYLE, SIZE, OR COLOR.

CLASS 5—PHARMACEUTICALS

FOR DIETARY SUPPLEMENTS; NUTRITIONAL DRINK MIX FOR USE AS A MEAL REPLACEMENT; NUTRITIONAL SHAKES FOR USE AS A MEAL SUBSTITUTE; NUTRITIONAL SUPPLEMENT IN THE NATURE OF A NUTRIENT-DENSE, PROTEIN-BASED DRINK MIX; NUTRITIONAL SUPPLEMENTS; POWDERED NUTRITIONAL SUPPLEMENT DRINK MIX; PROTEIN SUPPLEMENTS (U.S. CLS. 6, 18, 44, 46, 51 AND 52).

CLASS 32—LIGHT BEVERAGES

FOR BOTTLED WATER; DRINKING WATER WITH VITAMINS; FLAVORED WATERS; ISOTONIC BEVERAGES; ISOTONIC DRINKS; NON-ALCOHOLIC BEER; NON-ALCOHOLIC BEVERAGES CONTAINING FRUIT JUICES; NON-ALCOHOLIC BEVERAGES WITH TEA FLAVOR; NON-ALCOHOLIC BEVERAGES, NAMELY, CARBONATED BEVERAGES; NON-ALCOHOLIC CIDER; NON-ALCOHOLIC FRUIT JUICE BEVERAGES; NON-ALCOHOLIC HONEY-BASED BEVERAGES; SPARKLING WATER; SPORTS DRINKS; SPORTS DRINKS, NAMELY, ENERGY DRINKS; SPRING WATER (U.S. CLS. 45, 46 AND 48).

JOHN E. MICHOS, EXAMINING ATTORNEY

SN 77-929,296. PATHSTONE FAMILY OFFICE, LLC, ENGLEWOOD, NJ. FILED 2-5-2010.

PATHSTONE FAMILY OFFICE

THE MARK CONSISTS OF STANDARD CHARACTERS WITHOUT CLAIM TO ANY PARTICULAR FONT, STYLE, SIZE, OR COLOR.

NO CLAIM IS MADE TO THE EXCLUSIVE RIGHT TO USE "FAMILY OFFICE", APART FROM THE MARK AS SHOWN.

CLASS 35—ADVERTISING AND BUSINESS

FOR BUSINESS SUCCESSION PLANNING; TAX AND TAXATION PLANNING, ADVICE, INFORMATION AND CONSULTANCY SERVICES (U.S. CLS. 100, 101 AND 102).

CLASS 36—INSURANCE AND FINANCIAL

FOR BILL PAYMENT SERVICES; ESTATE PLANNING; FINANCIAL CONSULTING AND ADVISING IN THE FIELD OF MERGERS AND ACQUISITIONS; FINANCIAL PLANNING AND INVESTMENT ADVISORY SERVICES; FINANCIAL SERVICES, NAMELY, WEALTH MANAGEMENT SERVICES (U.S. CLS. 100, 101 AND 102).

JAMES GRIFFIN, EXAMINING ATTORNEY

SN 77-929,305. PATHSTONE FAMILY OFFICE, LLC, ENGLEWOOD, NJ. FILED 2-5-2010.

SN 77-929,310. PERRIGO FLORIDA, INC., LAKE WORTH, FL. FILED 2-5-2010.

PATHSTONE 360

THE MARK CONSISTS OF STANDARD CHARACTERS WITHOUT CLAIM TO ANY PARTICULAR FONT, STYLE, SIZE, OR COLOR.

CLASS 35—ADVERTISING AND BUSINESS

FOR BUSINESS SUCCESSION PLANNING; TAX AND TAXATION PLANNING, ADVICE, INFORMATION AND CONSULTANCY SERVICES (U.S. CLS. 100, 101 AND 102).

CLASS 36—INSURANCE AND FINANCIAL

FOR BILL PAYMENT SERVICES; ESTATE PLANNING; FINANCIAL CONSULTING AND ADVISING IN THE FIELD OF MERGERS AND ACQUISITIONS; FINANCIAL PLANNING AND INVESTMENT ADVISORY SERVICES; FINANCIAL SERVICES, NAMELY, WEALTH MANAGEMENT SERVICES (U.S. CLS. 100, 101 AND 102).
JAMES GRIFFIN, EXAMINING ATTORNEY

SN 77-929,306. STRAHM, PETER G., MILLTOWN, NJ. FILED 2-5-2010.

NTH DEGREE

THE MARK CONSISTS OF STANDARD CHARACTERS WITHOUT CLAIM TO ANY PARTICULAR FONT, STYLE, SIZE, OR COLOR.

CLASS 5—PHARMACEUTICALS

FOR DIETARY SUPPLEMENTS; NUTRITIONAL DRINK MIX FOR USE AS A MEAL REPLACEMENT; NUTRITIONAL SHAKES FOR USE AS A MEAL SUBSTITUTE; NUTRITIONAL SUPPLEMENT IN THE NATURE OF A NUTRIENT-DENSE, PROTEIN-BASED DRINK MIX; NUTRITIONAL SUPPLEMENTS; POWDERED NUTRITIONAL SUPPLEMENT DRINK MIX; PROTEIN SUPPLEMENTS (U.S. CLS. 6, 18, 44, 46, 51 AND 52).

CLASS 32—LIGHT BEVERAGES

FOR BOTTLED WATER; DRINKING WATER WITH VITAMINS; FLAVORED WATERS; ISOTONIC BEVERAGES; ISOTONIC DRINKS; NON-ALCOHOLIC BEER; NON-ALCOHOLIC BEVERAGES CONTAINING FRUIT JUICES; NON-ALCOHOLIC BEVERAGES WITH TEA FLAVOR; NON-ALCOHOLIC BEVERAGES, NAMELY, CARBONATED BEVERAGES; NON-ALCOHOLIC CIDER; NON-ALCOHOLIC FRUIT JUICE BEVERAGES; NON-ALCOHOLIC HONEY-BASED BEVERAGES; SPARKLING WATER; SPORTS DRINKS; SPORTS DRINKS, NAMELY, ENERGY DRINKS; SPRING WATER (U.S. CLS. 45, 46 AND 48).

JOHN E. MICHOS, EXAMINING ATTORNEY

fresh & pure

THE MARK CONSISTS OF "FRESH & PURE" IN A STYLIZED FONT.

CLASS 3—COSMETICS AND CLEANING PREPARATIONS

FOR NON-MEDICATED DOUCHE; NON-MEDICATED LIQUID CLEANSING SOLUTION FOR EXTERNAL FEMININE HYGIENE; NON-MEDICATED FOAMING CLEANSING BATH SOLUTION FOR EXTERNAL FEMININE HYGIENE AND CLEANSING; NON-MEDICATED BODY WASH (U.S. CLS. 1, 4, 6, 50, 51 AND 52).
FIRST USE 11-9-2009; IN COMMERCE 11-9-2009.

CLASS 5—PHARMACEUTICALS

FOR MEDICATED DOUCHE (U.S. CLS. 6, 18, 44, 46, 51 AND 52).
FIRST USE 11-9-2009; IN COMMERCE 11-9-2009.
ANN E. SAPPENFIELD, EXAMINING ATTORNEY

SN 77-929,312. PATHSTONE FAMILY OFFICE, LLC, ENGLEWOOD, NJ. FILED 2-5-2010.

PATHSTONE TRUST COMPANY

THE MARK CONSISTS OF STANDARD CHARACTERS WITHOUT CLAIM TO ANY PARTICULAR FONT, STYLE, SIZE, OR COLOR.

NO CLAIM IS MADE TO THE EXCLUSIVE RIGHT TO USE "TRUST COMPANY", APART FROM THE MARK AS SHOWN.

CLASS 35—ADVERTISING AND BUSINESS

FOR BUSINESS SUCCESSION PLANNING; TAX AND TAXATION PLANNING, ADVICE, INFORMATION AND CONSULTANCY SERVICES (U.S. CLS. 100, 101 AND 102).

CLASS 36—INSURANCE AND FINANCIAL

FOR BILL PAYMENT SERVICES; ESTATE PLANNING; FINANCIAL CONSULTING AND ADVISING IN THE FIELD OF MERGERS AND ACQUISITIONS; FINANCIAL PLANNING AND INVESTMENT ADVISORY SERVICES; FINANCIAL SERVICES, NAMELY, WEALTH MANAGEMENT SERVICES (U.S. CLS. 100, 101 AND 102).
JAMES GRIFFIN, EXAMINING ATTORNEY

SN 77-929,317. PATHSTONE FAMILY OFFICE, LLC, ENGLEWOOD, NJ. FILED 2-5-2010.

TO YOU, IT'S A JOURNEY -
TO US, IT'S A GUIDED PATH

THE MARK CONSISTS OF STANDARD CHARACTERS WITHOUT CLAIM TO ANY PARTICULAR FONT, STYLE, SIZE, OR COLOR.

CLASS 35—ADVERTISING AND BUSINESS

FOR BUSINESS SUCCESSION PLANNING; TAX AND TAXATION PLANNING, ADVICE, INFORMATION AND CONSULTANCY SERVICES (U.S. CLS. 100, 101 AND 102).

CLASS 36—INSURANCE AND FINANCIAL

FOR BILL PAYMENT SERVICES; ESTATE PLANNING; FINANCIAL CONSULTING AND ADVISING IN THE FIELD OF MERGERS AND ACQUISITIONS; FINANCIAL PLANNING AND INVESTMENT ADVISORY SERVICES; FINANCIAL SERVICES, NAMELY, WEALTH MANAGEMENT SERVICES (U.S. CLS. 100, 101 AND 102).
JAMES GRIFFIN, EXAMINING ATTORNEY

SN 77-929,353. DWELL LLC, SAN FRANCISCO, CA. FILED 2-5-2010.

DWELL MEDIA

THE MARK CONSISTS OF STANDARD CHARACTERS WITHOUT CLAIM TO ANY PARTICULAR FONT, STYLE, SIZE, OR COLOR.

OWNER OF U.S. REG. NOS. 2,452,089, 3,660,406 AND OTHERS.

NO CLAIM IS MADE TO THE EXCLUSIVE RIGHT TO USE "MEDIA", APART FROM THE MARK AS SHOWN.

CLASS 16—PAPER GOODS AND PRINTED MATTER

FOR MAGAZINES IN THE FIELD OF MODERN INTERIOR AND ARCHITECTURAL DESIGN AND SUSTAINABLE DESIGN (U.S. CLS. 2, 5, 22, 23, 29, 37, 38 AND 50).

CLASS 41—EDUCATION AND ENTERTAINMENT

FOR PROVIDING A WEBSITE FEATURING PODCASTS IN THE FIELD OF MODERN INTERIOR AND ARCHITECTURAL DESIGN AND SUSTAINABLE DESIGN; PROVIDING A WEBSITE FEATURING ONLINE JOURNALS, NAMELY, BLOGS IN THE FIELD OF MODERN INTERIOR AND ARCHITECTURAL DESIGN AND SUSTAINABLE DESIGN (U.S. CLS. 100, 101 AND 107).

CLASS 42—SCIENTIFIC AND COMPUTER SERVICES

FOR PROVIDING A WEBSITE FEATURING NON-DOWNLOADABLE VIDEOS, PHOTOGRAPHS, SLIDESHOWS, AND ARTICLES IN THE FIELD OF MODERN INTERIOR AND ARCHITECTURAL DESIGN AND SUSTAINABLE DESIGN (U.S. CLS. 100 AND 101).

JAMES MACFARLANE, EXAMINING ATTORNEY

SN 77-929,436. LIVE INTENT, INC., NEW YORK, NY. FILED 2-5-2010.

SPONSORED INTRODUCTIONS

THE MARK CONSISTS OF STANDARD CHARACTERS WITHOUT CLAIM TO ANY PARTICULAR FONT, STYLE, SIZE, OR COLOR.

NO CLAIM IS MADE TO THE EXCLUSIVE RIGHT TO USE "INTRODUCTIONS", APART FROM THE MARK AS SHOWN.

CLASS 35—ADVERTISING AND BUSINESS

FOR ADVERTISING, MARKETING AND PROMOTION SERVICES BY THE TRANSMISSION OF ADVERTISING MATERIAL AND THE DISSEMINATION OF ADVERTISING MESSAGES ON COMPUTER NETWORKS AND WIRELESS COMMUNICATIONS NETWORKS; ON-LINE BUSINESS NETWORKING SERVICES; AFFILIATE MARKETING SERVICES, NAMELY, PROMOTING THE GOODS AND SERVICES OF OTHERS BY PLACING PROMOTIONAL ADVERTISEMENTS VIA THE INTERNET AND WIRED AND WIRELESS COMMUNICATION DEVICES; ONLINE ADVERTISING AND MARKETING SERVICES, NAMELY, PROVIDING PAY FOR PERFORMANCE AND PAY-PER-CLICK ADVERTISING; ONLINE AUCTION SERVICES, NAMELY, AN ONLINE AUCTION EXCHANGE FOR BUYING AND SELLING DIGITAL ADVERTISING (U.S. CLS. 100, 101 AND 102).

CLASS 38—COMMUNICATION

FOR TELECOMMUNICATION SERVICES, NAMELY, PROVIDING ONLINE FACILITIES FOR REAL-TIME INTERACTION BETWEEN AND AMONG USERS OF COMPUTERS, MOBILE AND HANDHELD COMPUTERS, AND WIRED AND WIRELESS COMMUNICATION DEVICES IN THE FIELD OF GENERAL INTEREST (U.S. CLS. 100, 101 AND 104).

CLASS 41—EDUCATION AND ENTERTAINMENT

FOR ENTERTAINMENT SERVICES, NAMELY, PROVIDING ONLINE BLOGS FEATURING AUDIO CLIPS, VIDEO CLIPS, MULTI-MEDIA MATERIAL AND USER-DEFINED CONTENT IN THE FIELD OF SOCIAL NETWORKING (U.S. CLS. 100, 101 AND 107).

CLASS 45—PERSONAL AND LEGAL SERVICES

FOR ONLINE SOCIAL NETWORKING SERVICES (U.S. CLS. 100 AND 101).

LINDA E. BLOHM, EXAMINING ATTORNEY

SN 77-929,598. PIU HOLDINGS, LLC, DBA PUMP IT UP, TEMPE, AZ. FILED 2-5-2010.

SN 77-929,775. KATZ, BARRY, THOUSAND OAKS, CA. FILED 2-6-2010.

PumpStart

THE MARK CONSISTS OF STANDARD CHARACTERS WITHOUT CLAIM TO ANY PARTICULAR FONT, STYLE, SIZE, OR COLOR.

CLASS 25—CLOTHING

FOR (BASED ON USE IN COMMERCE) SHIRTS; T-SHIRTS (BASED ON INTENT TO USE) BASEBALL CAPS AND HATS; FLEECE PULLOVERS; HATS; HOODED SWEAT SHIRTS; POLO SHIRTS; SHORTS (U.S. CLS. 22 AND 39).

FIRST USE 3-1-2009; IN COMMERCE 3-1-2009.

CLASS 41—EDUCATION AND ENTERTAINMENT

FOR (BASED ON USE IN COMMERCE) ARRANGING, ORGANIZING, CONDUCTING AND HOSTING BIRTHDAY PARTIES; CHILDREN'S ENTERTAINMENT AND AMUSEMENT CENTERS, NAMELY, INTERACTIVE PLAY AREAS; DAY CAMP SERVICES; HOLIDAY CAMP SERVICES; RECREATIONAL CAMPS; SUMMER CAMPS (U.S. CLS. 100, 101 AND 107).

FIRST USE 3-1-2009; IN COMMERCE 3-1-2009.

FLORENTINA BLANDU, EXAMINING ATTORNEY

SN 77-929,604. COOPERATIVE FOR ASSISTANCE AND RELIEF EVERYWHERE, INC., ATLANTA, GA. FILED 2-5-2010.

A POWERFUL NOISE

THE MARK CONSISTS OF STANDARD CHARACTERS WITHOUT CLAIM TO ANY PARTICULAR FONT, STYLE, SIZE, OR COLOR.

CLASS 35—ADVERTISING AND BUSINESS

FOR PROMOTING PUBLIC AWARENESS OF THE NEED FOR PROVIDING AID TO PERSONS IN FOREIGN COUNTRIES (U.S. CLS. 100, 101 AND 102).

FIRST USE 3-4-2009; IN COMMERCE 3-4-2009.

CLASS 36—INSURANCE AND FINANCIAL

FOR CHARITABLE FUNDING RAISING SERVICES, NAMELY, RAISING MONEY FOR HUMANITARIAN, AGRICULTURAL, EDUCATIONAL, ENVIRONMENTAL AND HEALTHCARE PURPOSES, TO AID PEOPLE IN FOREIGN COUNTRIES (U.S. CLS. 100, 101 AND 102).

FIRST USE 3-4-2009; IN COMMERCE 3-4-2009.

SHAILA SETTLES, EXAMINING ATTORNEY

Tynormo

THE MARK CONSISTS OF STANDARD CHARACTERS WITHOUT CLAIM TO ANY PARTICULAR FONT, STYLE, SIZE, OR COLOR.

CLASS 9—ELECTRICAL AND SCIENTIFIC APPARATUS

FOR MOTION PICTURE FILMS ABOUT TYNORMO; MOTION PICTURE FILMS AND FILMS FOR TELEVISION FEATURING CHILDREN'S ENTERTAINMENT (U.S. CLS. 21, 23, 26, 36 AND 38).

CLASS 28—TOYS AND SPORTING GOODS

FOR FANTASY CHARACTER TOYS; PLUSH TOYS (U.S. CLS. 22, 23, 38 AND 50).

SANJEEV VOHRA, EXAMINING ATTORNEY

SN 77-929,783. EXPOSED POSTERS LLC, ARLINGTON, VA. FILED 2-6-2010.



THE COLOR(S) BLACK, WHITE, GRAY, ORANGE, AND YELLOW IS/ARE CLAIMED AS A FEATURE OF THE MARK.

THE MARK CONSISTS OF THE TWO WORDS "EXPOSED AND POSTERS". "EXPOSED" BEGINS WITH "E". "E" IN "EXPOSED" IS WHITE FADING INTO GRAY TOWARD THE TOP AND BOTTOM OF THE LETTER. "POSED" IS ALSO WHITE WITH A SLIGHT GRAY FADE TOWARD THE TOP AND BOTTOM OF THE LETTERS. THE "X" IN "EXPOSED" IS LARGER THAN THE OTHER LETTERS IN THE WORD WITH YELLOW IN THE CENTER, FADING TO ORANGE, AND THEN TO WHITE RADially. THERE IS ALSO A VERY SLIGHT THREE DIMENSIONAL ELEMENT TO THE "X". "POSTERS" IS A SLIGHT SMALLER FONT AND TO THE BOTTOM RIGHT OF "EXPOSED". "POSTERS" IS IN SOLID ORANGE.

CLASS 9—ELECTRICAL AND SCIENTIFIC APPARATUS

FOR DIGITAL ENTERTAINMENT SYSTEMS FOR WATCHING, STORING AND SHARING DIGITAL CONTENT ON A HOME COMPUTER NETWORK (U.S. CLS. 21, 23, 26, 36 AND 38).

CLASS 16—PAPER GOODS AND PRINTED MATTER

FOR MOUNTED POSTERS; POSTERS; POSTERS MADE OF PAPER (U.S. CLS. 2, 5, 22, 23, 29, 37, 38 AND 50).

JILL C. ALT, EXAMINING ATTORNEY

SN 77-929,804. LOWELL, JOHN T., SAN FRANCISCO, CA. FILED 2-6-2010.

Daydreaming.com

THE MARK CONSISTS OF STANDARD CHARACTERS WITHOUT CLAIM TO ANY PARTICULAR FONT, STYLE, SIZE, OR COLOR.

CLASS 35—ADVERTISING AND BUSINESS

FOR ADVERTISING AND BUSINESS SERVICES, NAMELY, PROVIDING AN ONLINE WEBSITE WHERE ADVERTISERS, MARKETERS, AND CONTENT PROVIDERS CAN INTERACT WITH USERS FOR ADVERTISING, BRANDING, AND PROMOTING KNOWLEDGE, PRODUCTS, AND SERVICES, AND TRADESHOWS, ON BEHALF OF THEMSELVES AND OTHERS, AND FOR EVALUATING AND RATING THE SAME, ALL THE FOREGOING RELEVANT TO HUMAN ACTIVITIES AFFECTING CLIMATE CHANGE AND RELATED FIELDS; ADVERTISING AND DIRECTORY SERVICES, NAMELY, PROMOTING THE SERVICES OF OTHERS BY PROVIDING A WEB PAGE FEATURING LINKS TO THE WEBSITES OF OTHERS; ON-LINE RETAIL STORE SERVICES FEATURING PHYSICAL AND VIRTUAL MERCHANDISE FOR USE BY MEMBERS OF AN ON-LINE COMMUNITY IN CONNECTION WITH A DESIGNATED WEBSITE FEATURING FICTIONAL CHARACTERS; PROMOTING THE GOODS AND SERVICES OF OTHERS BY PROVIDING A WEBSITE FEATURING COUPONS, REBATES, PRICE-COMPARISON INFORMATION, PRODUCT REVIEWS, LINKS TO THE RETAIL WEBSITES OF OTHERS, AND DISCOUNT INFORMATION; PROMOTION, ADVERTISING AND MARKETING OF ON-LINE WEBSITES; PROVIDING A SEARCHABLE ON-LINE ADVERTISING WEBSITE AND GUIDE FEATURING THE GOODS AND SERVICES OF OTHER VENDORS VIA THE INTERNET; PROVIDING A SEARCHABLE ONLINE ADVERTISING WEBSITE AND INFORMATIONAL GUIDE FEATURING THE GOODS AND SERVICES OF OTHER VENDORS VIA THE INTERNET IN THE FIELD OF TRAVEL AND CONSUMER PRODUCTS.; PROVIDING A SEARCHABLE WEBSITE FEATURING THE GOODS AND SERVICES OF OTHER VENDORS; PROVIDING A WEBSITE FOR CONNECTING SELLERS WITH BUYERS; PROVIDING A WEBSITE USED TO PLACE ON-LINE COMMERCIAL ORDERS IN THE FIELD OF TRAVEL AND CONSUMER PRODUCTS.; PROVIDING AN INTERACTIVE REAL ESTATE WEBSITE WHICH PROMOTES HOUSING AND APARTMENT PROPERTIES THROUGH OFFERING PROSPECTIVE TENANTS VIDEO WALK THROUGH, PROPERTY DESCRIPTIONS, TEXT, PRICE, LOCATION, MAPS AND OTHER INFORMATION THAT WOULD BE INFLUENTIAL TO A PROSPECTIVE TENANT IN MAKING A RENTAL DECISION; PROVIDING AN INTERNET WEBSITE PORTAL FEATURING LINKS TO MUSIC-RELATED MERCHANDISE FOR RETAIL PURPOSES (U.S. CLS. 100, 101 AND 102).

CLASS 45—PERSONAL AND LEGAL SERVICES

FOR INTERNET BASED SOCIAL NETWORKING, INTRODUCTION, AND DATING SERVICES; INTERNET-BASED SOCIAL NETWORKING SERVICES; ON-LINE SOCIAL NETWORKING SERVICES; ONLINE SOCIAL NETWORKING IN THE FIELD OF FOOD; ONLINE SOCIAL NETWORKING SERVICES PROVIDED THROUGH A FASHION COMMUNITY WEBSITE; ON-LINE SOCIAL NETWORKING SERVICES PROVIDED THROUGH A SPORTS COMMUNITY WEBSITE.; PROVIDING A SOCIAL NETWORKING WEBSITE FOR ENTERTAINMENT PURPOSES (U.S. CLS. 100 AND 101).

NORA BUCHANAN WILL, EXAMINING ATTORNEY

SN 77-929,811. SCONIK INTERNATIONAL, LLC, ALPHARETTA, GA. FILED 2-6-2010.

TACFIT

THE MARK CONSISTS OF STANDARD CHARACTERS WITHOUT CLAIM TO ANY PARTICULAR FONT, STYLE, SIZE, OR COLOR.

CLASS 9—ELECTRICAL AND SCIENTIFIC APPARATUS

FOR AUDIO AND VIDEO RECORDINGS FEATURING EXERCISE CLASSES AND INFORMATION ABOUT FITNESS AND HEALTH CLUB PROGRAMS; AUDIO-VISUAL RECORDINGS, NAMELY, PRE-RECORDED COMPACT DISCS, AUDIO AND VIDEO TAPES, DIGITAL VIDEO DISCS, AND CD-ROMS, ALL FEATURING EXERCISE CLASSES AND INFORMATION ABOUT FITNESS AND HEALTH CLUB PROGRAMS; PRE-RECORDED CDS AND DVDS FEATURING EXERCISE CLASSES AND INFORMATION ABOUT FITNESS AND HEALTH CLUB PROGRAMS; DOWNLOADABLE ELECTRONIC PUBLICATIONS IN THE NATURE OF TEACHING BOOKLETS AND TEACHING MANUALS IN THE FIELD OF HEALTH AND FITNESS, SUPPLIED ONLINE FROM DATABASES, FROM THE INTERNET, INTRANETS OR FROM EXTRANETS; DOWNLOADABLE MUSICAL SOUND RECORDINGS (U.S. CLS. 21, 23, 26, 36 AND 38).

FIRST USE 3-1-2007; IN COMMERCE 11-30-2008.

CLASS 16—PAPER GOODS AND PRINTED MATTER

FOR BOOKS IN THE FIELD OF FITNESS, PRINTED MATTER, NAMELY, BOOKS, BOOKLETS, NEWSLETTERS, MAGAZINES, MANUALS, POSTERS AND POSTCARDS, ALL FEATURING INFORMATION ABOUT FITNESS AND HEALTH CLUB PROGRAMS; INSTRUCTIONAL AND TEACHING MATERIALS, NAMELY, BOOKS, BOOKLETS, NEWSLETTERS, MAGAZINES, MANUALS, POSTERS AND POSTCARDS, ALL FEATURING INFORMATION ABOUT FITNESS AND HEALTH CLUB PROGRAMS; CALENDARS (U.S. CLS. 2, 5, 22, 23, 29, 37, 38 AND 50).

FIRST USE 3-1-2007; IN COMMERCE 11-30-2008.
TRACY FLETCHER, EXAMINING ATTORNEY

SN 77-929,821. TRIUMPHANT HEART INTERNATIONAL, INC., ORANGE, CA. FILED 2-6-2010.

SN 77-930,033. CHOCOLATE CUPCAKE, LLC, ATLANTA, GA. FILED 2-8-2010.

Triumphant Heart

THE MARK CONSISTS OF STANDARD CHARACTERS WITHOUT CLAIM TO ANY PARTICULAR FONT, STYLE, SIZE, OR COLOR.

OWNER OF U.S. REG. NOS. 3,594,543 AND 3,744,101.

CLASS 41—EDUCATION AND ENTERTAINMENT

FOR BUSINESS EDUCATION AND TRAINING SERVICES, NAMELY, DEVELOPING, AND FACILITATING CUSTOMIZED IN-COMPANY LEADERSHIP AND EXECUTIVE DEVELOPMENT PROGRAMS, PROVIDING EXECUTIVE COACHING SERVICES, AND PROVIDING PUBLIC AND IN-COMPANY KEYNOTE PRESENTATIONS TO BUSINESS LEADERS; LIFE COACHING SERVICES IN THE FIELD OF FUTURE OPTIONS AND CHOICES, LIFE PRACTICE, EXPLORATION OF CORE VALUES, PURPOSE AND VISION, AND PERSONAL ASSETS IN THE NATURE OF TALENTS AND SKILLS (U.S. CLS. 100, 101 AND 107).

FIRST USE 1-5-2010; IN COMMERCE 1-5-2010.

CLASS 42—SCIENTIFIC AND COMPUTER SERVICES

FOR BUILDING AND MAINTAINING WEBSITES (U.S. CLS. 100 AND 101).

FIRST USE 1-5-2010; IN COMMERCE 1-5-2010.

WILLIAM BRECKENFELD, EXAMINING ATTORNEY



THE COLOR(S) PINK, LIGHT PINK, BEIGE, DARKER BEIGE, MEDIUM PINK, MAGENTA, ORANGE, BROWN, BLACK AND GRAY IS/ARE CLAIMED AS A FEATURE OF THE MARK.

THE MARK CONSISTS OF "CUPCAKE" CONSISTING OF BEIGE CUP WITH GRAY VERTICAL LINES, PINK CAKE WITH BROWN TOPPING AND ANOTHER ORANGE TOPPING, PINK RIBBON THAT IS OUTLINED IN BLACK, WITH BROWN, PINK, MEDIUM PINK AND LIGHT PINK POLKA DOTS, "CHOCOLATE CUPCAKE" TEXT ON RIBBON IN BROWN, AND MAGENTA, BEIGE AND MAGENTA SPRINKLES ON CUPCAKE AND MAGENTA CHERRY ON TOP.

CLASS 18—LEATHER GOODS

FOR SCHOOLCHILDREN'S BACKPACKS (U.S. CLS. 1, 2, 3, 22 AND 41).

CLASS 25—CLOTHING

FOR T-SHIRTS (U.S. CLS. 22 AND 39).

CLASS 41—EDUCATION AND ENTERTAINMENT

FOR PUBLICATION OF BOOKS, OF MAGAZINES, OF JOURNALS, OF NEWSPAPERS, OF PERIODICALS, OF CATALOGS, OF BROCHURES (U.S. CLS. 100, 101 AND 107).

LAURIE MAYES, EXAMINING ATTORNEY

SN 77-929,911. DUFFY HOLDINGS LLC, WHITEHALL, PA. FILED 2-7-2010.

Nutri Gum

THE MARK CONSISTS OF STANDARD CHARACTERS WITHOUT CLAIM TO ANY PARTICULAR FONT, STYLE, SIZE, OR COLOR.

NO CLAIM IS MADE TO THE EXCLUSIVE RIGHT TO USE "GUM", APART FROM THE MARK AS SHOWN.

CLASS 5—PHARMACEUTICALS

FOR DIETARY AND NUTRITIONAL SUPPLEMENTS (U.S. CLS. 6, 18, 44, 46, 51 AND 52).

CLASS 30—STAPLE FOODS

FOR CHEWING GUM (U.S. CL. 46).

WILLIAM P. SHANAHAN, EXAMINING ATTORNEY

SN 77-930,107. DOREL JUVENILE GROUP, INC., FOXBORO, MA. FILED 2-8-2010.

PROGRADE

THE MARK CONSISTS OF STANDARD CHARACTERS WITHOUT CLAIM TO ANY PARTICULAR FONT, STYLE, SIZE, OR COLOR.

CLASS 9—ELECTRICAL AND SCIENTIFIC APPARATUS

FOR PROTECTIVE COVERS FOR ELECTRIC OUTLETS (U.S. CLS. 21, 23, 26, 36 AND 38).

CLASS 21—HOUSEWARES AND GLASS

FOR ORAL CARE DEVICES FOR CHILDREN AND INFANTS IN THE NATURE OF A TOOTHBRUSH (U.S. CLS. 2, 13, 23, 29, 30, 33, 40 AND 50).

SAMUEL E. SHARPER JR., EXAMINING ATTORNEY

CLASS 43—HOTEL AND RESTAURANT SERVICES

FOR CONSULTING SERVICES FOR OTHERS IN THE FIELD OF HOTEL SERVICES, RESORT LODGING SERVICES, EXTENDED STAY HOTEL SERVICES, RESTAURANT SERVICES, CATERING SERVICES, AND PROVIDING BANQUET FACILITIES FOR SPECIAL OCCASIONS (U.S. CLS. 100 AND 101).

JACQUELINE A. LAVINE, EXAMINING ATTORNEY

SN 77-930,197. LITTLE TREE PRODUCTIONS, PORT SAINT LUCIE, FL. FILED 2-8-2010.

SN 77-930,360. WILLOW HOTELS LLC, NEW YORK, NY. FILED 2-8-2010.

The Littlest Christmas Tree

THE MARK CONSISTS OF STANDARD CHARACTERS WITHOUT CLAIM TO ANY PARTICULAR FONT, STYLE, SIZE, OR COLOR.

CLASS 9—ELECTRICAL AND SCIENTIFIC APPARATUS

FOR PRE-RECORDED AUDIO TAPES, COMPACT DISKS AND PHONOGRAPH RECORDS FEATURING MUSIC (U.S. CLS. 21, 23, 26, 36 AND 38).

CLASS 41—EDUCATION AND ENTERTAINMENT

FOR ENTERTAINMENT SERVICES, NAMELY, AN ON-GOING TELEVISION HOLIDAY PROGRAM (U.S. CLS. 100, 101 AND 107).

ROBIN MITTLER, EXAMINING ATTORNEY

WILLOW LIFESTYLE CLUBS

THE MARK CONSISTS OF STANDARD CHARACTERS WITHOUT CLAIM TO ANY PARTICULAR FONT, STYLE, SIZE, OR COLOR.

OWNER OF U.S. REG. NO. 3,739,069.

NO CLAIM IS MADE TO THE EXCLUSIVE RIGHT TO USE "LIFESTYLE CLUBS", APART FROM THE MARK AS SHOWN.

CLASS 35—ADVERTISING AND BUSINESS

FOR OPERATING AND MANAGING HOTELS FOR OTHERS; MARKETING, STRATEGIC PLANNING AND BUSINESS MANAGEMENT CONSULTING SERVICES PROVIDED TO THE HOTEL, LODGING, RESORT, EXTENDED STAY FACILITIES, RESTAURANTS, CATERING AND BANQUET SERVICE INDUSTRIES; OPERATING AND MANAGING PROGRAMS IN THE NATURE OF DESTINATION CLUBS, VACATION CLUBS, AND EXTENDED STAY FACILITIES PROGRAMS (U.S. CLS. 100, 101 AND 102).

SN 77-930,356. WILLOW HOTELS LLC, NEW YORK, NY. FILED 2-8-2010.

CLASS 43—HOTEL AND RESTAURANT SERVICES

FOR CONSULTING SERVICES FOR OTHERS IN THE FIELD OF HOTEL SERVICES, RESORT LODGING SERVICES, EXTENDED STAY HOTEL SERVICES, RESTAURANT SERVICES, CATERING SERVICES, AND PROVIDING BANQUET FACILITIES FOR SPECIAL OCCASIONS (U.S. CLS. 100 AND 101).

JACQUELINE A. LAVINE, EXAMINING ATTORNEY

WILLOW CLUB

THE MARK CONSISTS OF STANDARD CHARACTERS WITHOUT CLAIM TO ANY PARTICULAR FONT, STYLE, SIZE, OR COLOR.

OWNER OF U.S. REG. NO. 3,739,069.

NO CLAIM IS MADE TO THE EXCLUSIVE RIGHT TO USE "CLUB", APART FROM THE MARK AS SHOWN.

SN 77-930,382. ARCHITECTURAL POLYMERS, INC., PALMERTON, PA. FILED 2-8-2010.

CLASS 35—ADVERTISING AND BUSINESS

FOR OPERATING AND MANAGING HOTELS FOR OTHERS; MARKETING, STRATEGIC PLANNING AND BUSINESS MANAGEMENT CONSULTING SERVICES PROVIDED TO THE HOTEL, LODGING, RESORT, EXTENDED STAY FACILITIES, RESTAURANTS, CATERING AND BANQUET SERVICE INDUSTRIES; OPERATING AND MANAGING PROGRAMS IN THE NATURE OF DESTINATION CLUBS, VACATION CLUBS, AND EXTENDED STAY FACILITIES PROGRAMS (U.S. CLS. 100, 101 AND 102).

ARCHITECTURAL POLYMERS

THE MARK CONSISTS OF STANDARD CHARACTERS WITHOUT CLAIM TO ANY PARTICULAR FONT, STYLE, SIZE, OR COLOR.

SEC. 2(F).

CLASS 19—NON-METALLIC BUILDING MATERIALS

FOR BRICKS; CONCRETE BUILDING MATERIALS, NAMELY, PANELS, SLABS, BLOCKS; CONSTRUCTION MATERIALS, NAMELY, NON-METAL EXTERIOR PANELS; NON-METAL CASTING FORMS FOR CONCRETE AND BRICK-LAYING (U.S. CLS. 1, 12, 33 AND 50).
FIRST USE 8-11-2000; IN COMMERCE 8-11-2000.

CLASS 40—MATERIAL TREATMENT

FOR CUSTOM MANUFACTURE OF NON-METAL EXTERIOR WALL PANELS TO THE ORDER AND SPECIFICATION OF OTHERS (U.S. CLS. 100, 103 AND 106).
FIRST USE 8-11-2000; IN COMMERCE 8-11-2000.
JENNIFER MARTIN, EXAMINING ATTORNEY

CLASS 9—ELECTRICAL AND SCIENTIFIC APPARATUS

FOR (BASED ON INTENT TO USE) APPARATUS FOR RECORDING, TRANSMISSION OR REPRODUCTION OF SOUND AND IMAGES; APPARATUS FOR TRANSMISSION OF COMMUNICATION; COMPUTERS; DATA PROCESSORS; INTEGRATED CIRCUITS AND INTEGRATED CIRCUIT CORES FOR USE IN WIRELESS COMMUNICATIONS AND WIRELESS COMMUNICATION EQUIPMENT AND APPARATI AND DIGITAL SIGNAL PROCESSORS (DSP); TELECOMMUNICATIONS AND DATA NETWORKING HARDWARE, NAMELY, DEVICES FOR TRANSPORTING AND AGGREGATING VOICE, DATA, AND VIDEO COMMUNICATIONS ACROSS MULTIPLE NETWORK INFRASTRUCTURES AND COMMUNICATIONS PROTOCOLS(BASED ON 44(E) APPARATUS FOR RECORDING, TRANSMISSION OR REPRODUCTION OF SOUND AND IMAGES; COMPUTERS; DATA PROCESSORS (U.S. CLS. 21, 23, 26, 36 AND 38).

SN 77-930,383. THE E.W. SCRIPPS COMPANY, CINCINNATI, OH. FILED 2-8-2010.

OURMOMS.COM

THE MARK CONSISTS OF STANDARD CHARACTERS WITHOUT CLAIM TO ANY PARTICULAR FONT, STYLE, SIZE, OR COLOR.

CLASS 42—SCIENTIFIC AND COMPUTER SERVICES

FOR COMPUTER SERVICES, NAMELY, HOSTING ON-LINE WEB FACILITIES FOR OTHERS FOR ORGANIZING AND CONDUCTING ONLINE MEETINGS, GATHERINGS, AND INTERACTIVE DISCUSSIONS (U.S. CLS. 100 AND 101).
FIRST USE 10-0-2008; IN COMMERCE 10-0-2008.

CLASS 42—SCIENTIFIC AND COMPUTER SERVICES

FOR (BASED ON INTENT TO USE) DESIGN AND DEVELOPMENT OF COMPUTER HARDWARE AND SOFTWARE; DESIGN FOR OTHERS OF INTEGRATED CIRCUITS AND INTEGRATED CIRCUIT CORES FOR USE IN WIRELESS COMMUNICATIONS AND WIRELESS COMMUNICATION EQUIPMENT AND APPARATI AND DIGITAL SIGNAL PROCESSORS (DSP); DESIGN OF COMPUTER HARDWARE, INTEGRATED CIRCUITS, COMMUNICATIONS HARDWARE AND SOFTWARE AND COMPUTER NETWORKS FOR OTHERS; SCIENTIFIC RESEARCH AND DEVELOPMENT(BASED ON 44(E) DESIGN AND DEVELOPMENT OF COMPUTER HARDWARE AND SOFTWARE; DESIGN FOR OTHERS OF INTEGRATED CIRCUITS AND INTEGRATED CIRCUIT CORES FOR USE IN WIRELESS COMMUNICATIONS AND WIRELESS COMMUNICATION EQUIPMENT AND APPARATI AND DIGITAL SIGNAL PROCESSORS (DSP); DESIGN OF COMPUTER HARDWARE, INTEGRATED CIRCUITS, COMMUNICATIONS HARDWARE AND SOFTWARE AND COMPUTER NETWORKS FOR OTHERS; SCIENTIFIC RESEARCH AND DEVELOPMENT (U.S. CLS. 100 AND 101).
MARK SHINER, EXAMINING ATTORNEY

CLASS 45—PERSONAL AND LEGAL SERVICES

FOR ON-LINE SOCIAL NETWORKING SERVICES (U.S. CLS. 100 AND 101).
FIRST USE 10-0-2008; IN COMMERCE 10-0-2008.
ASMAT KHAN, EXAMINING ATTORNEY

SN 77-930,471. FLIGHTPATH SERVICES, INC., TETERBORO, NJ. FILED 2-8-2010.

SN 77-930,452. MODESAT COMMUNICATIONS OU, TALLINN, ESTONIA, FILED 2-8-2010.

MODESAT

THE MARK CONSISTS OF STANDARD CHARACTERS WITHOUT CLAIM TO ANY PARTICULAR FONT, STYLE, SIZE, OR COLOR.
OWNER OF ERPN CMNTY TM OFC REG. NO. 5818281, DATED 6-2-2008, EXPIRES 4-6-2017.

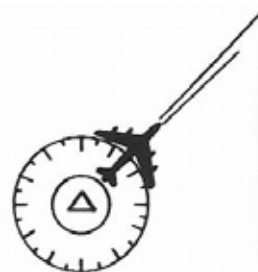

THE MARK CONSISTS OF A DESIGN ELEMENT COMPRISED OF AN AIRPLANE WITH TWO LINES EMANATING FROM THE NOSE, WHICH IS SUPERIMPOSED ON A FLIGHT GAUGE.

CLASS 35—ADVERTISING AND BUSINESS

FOR DISTRIBUTORSHIP SERVICES IN THE FIELD OF AIRCRAFT PARTS, AIRCRAFT EQUIPMENT AND AIRCRAFT PRODUCTS (U.S. CLS. 100, 101 AND 102).
FIRST USE 11-4-1976; IN COMMERCE 11-4-1976.

CLASS 37—CONSTRUCTION AND REPAIR

FOR REPAIR, SERVICING OR OVERHAULING OF AIRCRAFT WHEELS, AIRCRAFT BRAKES AND ASSEMBLIES, AIR CYLINDERS, AIRCRAFT BATTERIES AND BATTERY PACKS, AIRCRAFT LIFE VESTS, AIRCRAFT POWER SUPPLIES AND LIGHTING, AIRCRAFT FLOTATION DEVICES AND SURVIVAL EQUIPMENT; FEDERAL AVIATION ADMINISTRATION (FAA) CERTIFIED REPAIR STATIONS WHICH ENGAGE IN THE BUSINESS OF REPAIRING, SERVICING, OVERHAULING AND MAINTAINING AIRCRAFT PARTS AND EQUIPMENT (U.S. CLS. 100, 103 AND 106).

FIRST USE 11-4-1976; IN COMMERCE 11-4-1976.

CLASS 42—SCIENTIFIC AND COMPUTER SERVICES

FOR INSPECTION OF AIRCRAFT LIFE RAFTS, AIRCRAFT LIFE VESTS, AIRCRAFT WHEELS AND AIRCRAFT BRAKE ASSEMBLIES (U.S. CLS. 100 AND 101).

FIRST USE 11-4-1976; IN COMMERCE 11-4-1976.
JORDAN BAKER, EXAMINING ATTORNEY

SN 77-930,492. MLB ADVANCED MEDIA, L.P., NEW YORK, NY. FILED 2-8-2010.

BASEBALL EVERYWHERE

THE MARK CONSISTS OF STANDARD CHARACTERS WITHOUT CLAIM TO ANY PARTICULAR FONT, STYLE, SIZE, OR COLOR.

NO CLAIM IS MADE TO THE EXCLUSIVE RIGHT TO USE "BASEBALL", APART FROM THE MARK AS SHOWN.

CLASS 9—ELECTRICAL AND SCIENTIFIC APPARATUS

FOR COMPUTER SOFTWARE APPLICATIONS FOR MOBILE DEVICES; DOWNLOADABLE MULTIMEDIA FILES, VIDEO RECORDINGS, AUDIO RECORDINGS, VIDEO STREAMING AND AUDIO STREAMING, ALL IN THE FIELD OF BASEBALL; DOWNLOADABLE COMPUTER SOFTWARE FOR VIEWING DATABASES OF INFORMATION, STATISTICAL INFORMATION, AND MULTIMEDIA FILES IN THE FIELD OF BASEBALL; DOWNLOADABLE ELECTRONIC CONTENT, NAMELY, VIDEO CLIPS, SOUND CLIPS, TEXT AND MULTIMEDIA FILES, VISUALIZATIONS IN THE NATURE OF GRAPHICAL REPRESENTATION AND ANALYSIS OF BASEBALL GAMES, COMPETITIONS AND EXHIBITIONS; AND COMPUTER SOFTWARE FOR THE PERSONALIZATION OF MOBILE DEVICES (U.S. CLS. 21, 23, 26, 36 AND 38).

FIRST USE 7-10-2009; IN COMMERCE 7-10-2009.

CLASS 41—EDUCATION AND ENTERTAINMENT

FOR ENTERTAINMENT, EDUCATION AND INFORMATION SERVICES, NAMELY, BASEBALL GAMES, COMPETITIONS AND EXHIBITIONS RENDERED VIA A GLOBAL COMPUTER NETWORK; PROVIDING INFORMATION IN THE FIELD OF SPORTS, ENTERTAINMENT AND RELATED TOPICS AND PROVIDING FOR INFORMATIONAL MESSAGES RELATING THERETO, ALL VIA A GLOBAL COMPUTER NETWORK (U.S. CLS. 100, 101 AND 107).

FIRST USE 7-10-2009; IN COMMERCE 7-10-2009.
LAURIE KAUFMAN, EXAMINING ATTORNEY

SN 77-930,500. A. O. SMITH CORPORATION, MILWAUKEE, WI. FILED 2-8-2010.

INNOVATION HAS A NAME

THE MARK CONSISTS OF STANDARD CHARACTERS WITHOUT CLAIM TO ANY PARTICULAR FONT, STYLE, SIZE, OR COLOR.

OWNER OF U.S. REG. NO. 3,742,958.

CLASS 7—MACHINERY

FOR ELECTRIC MOTORS FOR MACHINES (U.S. CLS. 13, 19, 21, 23, 31, 34 AND 35).

CLASS 11—ENVIRONMENTAL CONTROL APPARATUS

FOR WATER HEATERS; ELECTRICAL BOILERS AND HEATING BOILERS (U.S. CLS. 13, 21, 23, 31 AND 34).

LAURIE KAUFMAN, EXAMINING ATTORNEY

SN 77-930,547. NETWORK CONTROLS & ELECTRIC, INC., GREENVILLE, SC. FILED 2-8-2010.

Network Controls and Electric

THE MARK CONSISTS OF STANDARD CHARACTERS WITHOUT CLAIM TO ANY PARTICULAR FONT, STYLE, SIZE, OR COLOR.

NO CLAIM IS MADE TO THE EXCLUSIVE RIGHT TO USE "ELECTRIC", APART FROM THE MARK AS SHOWN.
SEC. 2(F).

CLASS 37—CONSTRUCTION AND REPAIR

FOR ELECTRICAL REPAIRS, MAINTENANCE, AND INSTALLATION OF ELECTRICAL WIRING, OUTLETS, LIGHT FIXTURES, AND ELECTRICAL PANELS; TELECOMMUNICATION WIRING (U.S. CLS. 100, 103 AND 106).

FIRST USE 1-1-1992; IN COMMERCE 1-1-1992.

CLASS 42—SCIENTIFIC AND COMPUTER SERVICES

FOR PLANNING AND DEVELOPMENT OF ELECTRONIC COMMUNICATIONS NETWORKS (U.S. CLS. 100 AND 101).

FIRST USE 1-1-1992; IN COMMERCE 1-1-1992.
REBECCA POVARCHUK, EXAMINING ATTORNEY

SN 77-930,555. CANTOR, JOY L., WEST BLOOMFIELD, MI.
FILED 2-8-2010.

ANIMAL JOY

THE MARK CONSISTS OF STANDARD CHARACTERS WITHOUT CLAIM TO ANY PARTICULAR FONT, STYLE, SIZE, OR COLOR.

NO CLAIM IS MADE TO THE EXCLUSIVE RIGHT TO USE "ANIMAL", APART FROM THE MARK AS SHOWN.

CLASS 35—ADVERTISING AND BUSINESS

FOR PROMOTING PUBLIC AWARENESS OF THE NEED TO PREVENT ANIMAL CRUELTY AND MISTREATMENT OF ANIMALS; AND PROMOTING PUBLIC AWARENESS OF VEGETARIANISM AND VEGANISM (U.S. CLS. 100, 101 AND 102).

FIRST USE 6-0-2009; IN COMMERCE 6-0-2009.

CLASS 41—EDUCATION AND ENTERTAINMENT

FOR ONLINE PUBLICATIONS, NAMELY, COLUMNS FEATURING ARTICLES, STORIES AND ADVICE RELATED TO PETS, PET CARE, ANIMAL RESCUE, ANIMAL HEALTH, PUBLIC AWARENESS OF THE NEED TO PREVENT ANIMAL CRUELTY AND MISTREATMENT OF ANIMALS, PUBLIC AWARENESS OF VEGETARIANISM AND VEGANISM (U.S. CLS. 100, 101 AND 107).

FIRST USE 6-0-2009; IN COMMERCE 6-0-2009.

MARK T. MULLEN, EXAMINING ATTORNEY

SN 77-930,575. PAUKULIS, JOHN, CALABASAS, CA. FILED
2-8-2010.



THE COLOR(S) WHITE, RED, GRAY, AND KHAKI GREEN IS/ARE CLAIMED AS A FEATURE OF THE MARK.

THE MARK CONSISTS OF THE WORD "SHARE" IN THE COLOR WHITE ON A RED RECTANGLE NEXT TO THE WORD "VICTORY" IN THE COLOR WHITE ON A KHAKI GREEN RECTANGLE. BOTH RECTANGLES ARE FRAMED/OUTLINED WITH THE COLOR GRAY AND AN INNER FRAME/OUTLINE APPEARS IN WHITE.

CLASS 25—CLOTHING

FOR ATHLETIC APPAREL, NAMELY, SHIRTS, PANTS, JACKETS, FOOTWEAR, HATS AND CAPS, ATHLETIC UNIFORMS; HATS; SHIRTS (U.S. CLS. 22 AND 39).

CLASS 35—ADVERTISING AND BUSINESS

FOR ADVERTISEMENT FOR OTHERS ON THE INTERNET; ADVERTISING AND BUSINESS SERVICES, NAMELY, PROVIDING AN ONLINE WEBSITE WHERE ADVERTISERS, MARKETERS, AND CONTENT PROVIDERS CAN INTERACT WITH USERS FOR ADVERTISING, BRANDING, AND PROMOTING KNOWLEDGE, PRODUCTS, AND SERVICES, AND TRADE SHOWS, ON BEHALF OF THEMSELVES AND OTHERS, AND FOR EVALUATING AND RATING THE SAME, ALL THE FOREGOING RELEVANT TO HUMAN ACTIVITIES AFFECTING CLIMATE CHANGE AND RELATED FIELDS; ADVERTISING AND DIRECTORY SERVICES, NAMELY, PROMOTING THE SERVICES OF OTHERS BY PROVIDING A WEB PAGE FEATURING LINKS TO THE WEBSITES OF OTHERS; ADVERTISING AND MARKETING SERVICES, NAMELY, PROMOTING THE GOODS AND SERVICES OF OTHERS; ADVERTISING AND PROMOTIONAL SERVICES; ADVERTISING ON THE INTERNET FOR OTHERS; ADVERTISING PARTICULARLY SERVICES FOR THE PROMOTION OF GOODS; ADVERTISING, INCLUDING ON-LINE ADVERTISING ON A COMPUTER NETWORK; ADVERTISING, MARKETING AND PROMOTION SERVICES; ADVERTISING, MARKETING AND PROMOTIONAL SERVICES RELATED TO ALL INDUSTRIES FOR THE PURPOSE OF FACILITATING NETWORKING AND SOCIALIZING OPPORTUNITIES FOR BUSINESS PURPOSES; AN INTERACTIVE WEB SITE FOR USERS TO REVIEW AND RATE INTERNET CONTENT, PEOPLE, COMPANIES, PRODUCTS AND/OR SERVICES UTILIZING A SOFTWARE APPLICATION TO AWARD POINTS WHEREBY WEB SITE USERS ARE ELIGIBLE TO EXCHANGE POINTS EARNED FOR PROMOTIONAL ITEMS CONSISTING OF COUPONS, REBATES, DISCOUNTS OR SPECIAL OFFERINGS ON GOODS AND/OR SERVICE PROVIDED BY WEB SITE SPONSORS; CONTESTS AND INCENTIVE AWARD PROGRAMS TO PROMOTE THE SALE OF PRODUCTS AND SERVICES OF OTHERS; DESIGN OF INTERNET ADVERTISING; INTERNET ADVERTISING SERVICES; ON-LINE WHOLESALE AND RETAIL STORE SERVICES FEATURING BRANDED APPAREL; PLANNING, DESIGN, DEVELOPMENT, MAINTENANCE, TRACKING, REPORTING AND OPTIMIZATION OF ONLINE MARKETING ACTIVITIES FOR THIRD PARTIES; PROMOTING THE GOODS AND SERVICES OF OTHERS BY PROVIDING A COMMUNITY-DRIVEN WEB SITE FEATURING USER-SUBMITTED CONTENT IN THE NATURE OF COUPONS, REBATES, PRICE-COMPARISON INFORMATION, PRODUCT REVIEWS, LINKS TO THE RETAIL WEB SITES OF OTHERS, AND DISCOUNT INFORMATION; PROMOTING THE GOODS OF OTHERS, NAMELY, PROVIDING INFORMATION REGARDING DISCOUNTS, COUPONS, REBATES, VOUCHERS AND SPECIAL OFFERS FOR THE GOODS OF OTHERS; PROVIDING ADVERTISING SERVICE TO DISTRIBUTE ADVERTISEMENTS FOR DISPLAY ON INTERNET, NAMELY, IN WEBSITES, SOCIAL CONVERSATIONS OVER THE INTERNET, EMAILS, MICROBLOGS, BLOGS, ELECTRONIC MESSAGES, INSTANT MESSAGES, TEXT MESSAGES, MULTIMEDIA MESSAGES, SOCIAL NETWORKS, STATUS UPDATES, FORUMS, ELECTRONIC BULLETIN BOARDS; PROVIDING ADVERTISING, MARKETING AND PROMOTIONAL SERVICES, NAMELY, DEVELOPMENT OF ADVERTISING CAMPAIGNS FOR THE INTERNET; SOCIAL MEDIA STRATEGY AND MARKETING CONSULTANCY FOCUSING ON HELPING CLIENTS CREATE AND EXTEND THEIR PRODUCT AND BRAND STRATEGIES BY BUILDING VIRALLY ENGAGING MARKETING SOLUTIONS (U.S. CLS. 100, 101 AND 102).

CHRISIE B. KING, EXAMINING ATTORNEY

SN 77-930,742. INSPIRED BRANDS INC., THORNHILL, ONTARIO, CANADA, FILED 2-8-2010.

SN 77-930,864. MIKE VALLELY, LONG BEACH, CA. FILED 2-8-2010.

GRILL IT UP!

THE MARK CONSISTS OF STANDARD CHARACTERS WITHOUT CLAIM TO ANY PARTICULAR FONT, STYLE, SIZE, OR COLOR.

CLASS 30—STAPLE FOODS

FOR SPICES, SAUCES AND BARBEQUE SAUCES (U.S. CL. 46).

CLASS 43—HOTEL AND RESTAURANT SERVICES

FOR RESTAURANTS (U.S. CLS. 100 AND 101).
KATHY DE JONGE, EXAMINING ATTORNEY

SN 77-930,807. GRINDING GEAR GAMES LTD, AUCKLAND, NEW ZEALAND, FILED 2-8-2010.

Path of Exile

THE MARK CONSISTS OF STANDARD CHARACTERS WITHOUT CLAIM TO ANY PARTICULAR FONT, STYLE, SIZE, OR COLOR.

CLASS 9—ELECTRICAL AND SCIENTIFIC APPARATUS

FOR COMPUTER GAME SOFTWARE (U.S. CLS. 21, 23, 26, 36 AND 38).

CLASS 28—TOYS AND SPORTING GOODS

FOR PROMOTIONAL GAME MATERIALS (U.S. CLS. 22, 23, 38 AND 50).

CLASS 41—EDUCATION AND ENTERTAINMENT

FOR ENTERTAINMENT SERVICES, NAMELY, PROVIDING AN ON-LINE COMPUTER GAME (U.S. CLS. 100, 101 AND 107).
KATHRYN COWARD, EXAMINING ATTORNEY

MIKE V

THE MARK CONSISTS OF STANDARD CHARACTERS WITHOUT CLAIM TO ANY PARTICULAR FONT, STYLE, SIZE, OR COLOR.

THE NAME "MIKE V" IDENTIFIES A LIVING INDIVIDUAL WHOSE CONSENT IS OF RECORD.

CLASS 9—ELECTRICAL AND SCIENTIFIC APPARATUS

FOR COMPUTER GAME SOFTWARE; DOWNLOADABLE COMPUTER GAME SOFTWARE; COMPUTER PROGRAMS AND MANUALS SOLD AS A UNIT IN THE FIELDS OF COMPUTER GAMES; DIGITAL MEDIA, NAMELY, CDS, DVDS, AND DOWNLOADABLE MULTI-MEDIA, AUDIO, AND VIDEO FILES FEATURING MUSIC (U.S. CLS. 21, 23, 26, 36 AND 38).

CLASS 25—CLOTHING

FOR FOOTWEAR; CLOTHING, NAMELY, SHIRTS, TANK TOPS, SWEATSHIRTS, COATS, JACKETS, GLOVES, SCARVES, JEANS, PANTS, AND HATS (U.S. CLS. 22 AND 39).

CLASS 28—TOYS AND SPORTING GOODS

FOR SKATEBOARDS, SKATEBOARD ACCESSORIES, NAMELY, SKATEBOARD DECKS, SKATEBOARD TRUCKS, SKATEBOARD WHEEL ASSEMBLIES AND SKATEBOARD WHEELS; SAFETY PADDING AND SAFETY DEVICES FOR SKATEBOARDING, NAMELY, GLOVES, KNEE PADS, ELBOW PADS; SKATEBOARDING RAMPS AND JUMPS; TOYS, NAMELY, HANDHELD UNIT FOR PLAYING A VIDEO GAME OTHER THAN THOSE ADAPTED FOR USE WITH AN EXTERNAL DISPLAY SCREEN OR MONITOR, HAND HELD GAMES WITH LIQUID CRYSTAL DISPLAYS AND STAND ALONE VIDEO GAME MACHINES (U.S. CLS. 22, 23, 38 AND 50).

SUSAN STIGLITZ, EXAMINING ATTORNEY

SN 77-930,869. MIKE VALLELY, LONG BEACH, CA. FILED 2-8-2010.

BY THE SWORD

THE MARK CONSISTS OF STANDARD CHARACTERS WITHOUT CLAIM TO ANY PARTICULAR FONT, STYLE, SIZE, OR COLOR.

CLASS 9—ELECTRICAL AND SCIENTIFIC APPARATUS

FOR COMPUTER GAME SOFTWARE; DOWNLOADABLE COMPUTER GAME SOFTWARE; COMPUTER PROGRAMS AND MANUALS SOLD AS A UNIT IN THE FIELDS OF COMPUTER GAMES; DIGITAL MEDIA, NAMELY, CDS, DVDS, AND DOWNLOADABLE MULTI-MEDIA, AUDIO, AND VIDEO FILES FEATURING MUSIC (U.S. CLS. 21, 23, 26, 36 AND 38).

CLASS 25—CLOTHING

FOR FOOTWEAR; CLOTHING, NAMELY, SHIRTS, TANK TOPS, SWEATSHIRTS, COATS, JACKETS, GLOVES, SCARVES, JEANS, PANTS, AND HATS (U.S. CLS. 22 AND 39).

CLASS 28—TOYS AND SPORTING GOODS

FOR SKATEBOARDS, SKATEBOARD ACCESSORIES, NAMELY, SKATEBOARD DECKS, SKATEBOARD TRUCKS, SKATEBOARD WHEEL ASSEMBLIES AND SKATEBOARD WHEELS; SAFETY PADDING AND SAFETY DEVICES FOR SKATEBOARDING, NAMELY, GLOVES, KNEE PADS, ELBOW PADS; SKATEBOARDING RAMPS AND JUMPS; TOYS, NAMELY, HAND-HELD UNIT FOR PLAYING A VIDEO GAME OTHER THAN THOSE ADAPTED FOR USE WITH AN EXTERNAL DISPLAY SCREEN OR MONITOR, HAND HELD GAMES WITH LIQUID CRYSTAL DISPLAYS AND STAND ALONE VIDEO GAME MACHINES (U.S. CLS. 22, 23, 38 AND 50).

SUSAN STIGLITZ, EXAMINING ATTORNEY

SN 77-930,873. TRITON MEDIA GROUP, LLC, SHERMAN OAKS, CA. FILED 2-8-2010.

SPACIALNET

THE MARK CONSISTS OF STANDARD CHARACTERS WITHOUT CLAIM TO ANY PARTICULAR FONT, STYLE, SIZE, OR COLOR.

CLASS 38—COMMUNICATION

FOR STREAMING OF AUDIO, VISUAL, AND AUDIO-VISUAL MATERIAL VIA A GLOBAL COMPUTER NETWORK; TRANSMISSION AND DISTRIBUTION OF DATA OR AUDIO VISUAL IMAGES VIA A GLOBAL COMPUTER NETWORK OR THE INTERNET (U.S. CLS. 100, 101 AND 104).

FIRST USE 4-0-2006; IN COMMERCE 4-0-2006.

CLASS 42—SCIENTIFIC AND COMPUTER SERVICES

FOR COMPUTER SERVICES, NAMELY, HOSTING A SERVER ON A WEB SITE FOR THE PURPOSE OF FACILITATING AUDIO STREAMING BY RADIO BROADCASTERS (U.S. CLS. 100 AND 101).

FIRST USE 4-0-2006; IN COMMERCE 4-0-2006.
PATRICIA EVANKO, EXAMINING ATTORNEY

SN 77-930,874. MIKE VALLELY, LONG BEACH, CA. FILED 2-8-2010.

MIKE VALLELY

THE MARK CONSISTS OF STANDARD CHARACTERS WITHOUT CLAIM TO ANY PARTICULAR FONT, STYLE, SIZE, OR COLOR.

THE NAME "MIKE VALLELY" IDENTIFIES A LIVING INDIVIDUAL WHOSE CONSENT IS OF RECORD.

CLASS 9—ELECTRICAL AND SCIENTIFIC APPARATUS

FOR COMPUTER GAME SOFTWARE; DOWNLOADABLE COMPUTER GAME SOFTWARE; COMPUTER PROGRAMS AND MANUALS SOLD AS A UNIT IN THE FIELDS OF COMPUTER GAMES; DIGITAL MEDIA, NAMELY, CDS, DVDS, AND DOWNLOADABLE MULTI-MEDIA, AUDIO, AND VIDEO FILES FEATURING MUSIC (U.S. CLS. 21, 23, 26, 36 AND 38).

CLASS 25—CLOTHING

FOR FOOTWEAR; CLOTHING, NAMELY, SHIRTS, TANK TOPS, SWEATSHIRTS, COATS, JACKETS, GLOVES, SCARVES, JEANS, PANTS, AND HATS (U.S. CLS. 22 AND 39).

CLASS 28—TOYS AND SPORTING GOODS

FOR SKATEBOARDS, SKATEBOARD ACCESSORIES, NAMELY, SKATEBOARD DECKS, SKATEBOARD TRUCKS, SKATEBOARD WHEEL ASSEMBLIES AND SKATEBOARD WHEELS; SAFETY PADDING AND SAFETY DEVICES FOR SKATEBOARDING, NAMELY, GLOVES, KNEE PADS, ELBOW PADS; SKATEBOARDING RAMPS AND JUMPS; TOYS, NAMELY, HAND-HELD UNIT FOR PLAYING A VIDEO GAME OTHER THAN THOSE ADAPTED FOR USE WITH AN EXTERNAL DISPLAY SCREEN OR MONITOR, HAND HELD GAMES WITH LIQUID CRYSTAL DISPLAYS AND STAND ALONE VIDEO GAME MACHINES (U.S. CLS. 22, 23, 38 AND 50).

SUSAN STIGLITZ, EXAMINING ATTORNEY

SN 77-930,921. GEOEYE IMAGERY COLLECTION SYSTEMS INC., DULLES, VA. FILED 2-8-2010.



OWNER OF U.S. REG. NOS. 3,370,534 AND 3,529,980.
THE MARK CONSISTS OF A STYLIZED CIRCULAR DESIGN AND THE TERM "GEOEYE".

CLASS 9—ELECTRICAL AND SCIENTIFIC APPARATUS

FOR PRERECORDED ELECTRONIC MEDIA FEATURING IMAGES OF THE EARTH; AND COMPUTER SOFTWARE IN THE FIELD OF EARTH IMAGING FOR THE PURPOSE OF USING, VIEWING AND MANIPULATING IMAGES OF THE EARTH (U.S. CLS. 21, 23, 26, 36 AND 38).

FIRST USE 1-12-2006; IN COMMERCE 1-12-2006.

CLASS 16—PAPER GOODS AND PRINTED MATTER

FOR POSTERS; PHOTOGRAPHS; CALENDARS; MAPS FEATURING IMAGES OF THE EARTH (U.S. CLS. 2, 5, 22, 23, 29, 37, 38 AND 50).

FIRST USE 1-12-2006; IN COMMERCE 1-12-2006.

CLASS 41—EDUCATION AND ENTERTAINMENT

FOR DIGITAL IMAGING SERVICES; PHOTOGRAPHY SERVICES; AERIAL PHOTOGRAPHY SERVICES; SATELLITE PHOTOGRAPHY SERVICES (U.S. CLS. 100, 101 AND 107).

FIRST USE 1-12-2006; IN COMMERCE 1-12-2006.

CLASS 42—SCIENTIFIC AND COMPUTER SERVICES

FOR DESIGN, DEVELOPMENT, IMPLEMENTATION, UPDATING AND MAINTENANCE OF COMPUTER SOFTWARE AND DATABASES; CONSULTING SERVICES IN THE FIELD OF DESIGN, SELECTION, IMPLEMENTATION AND USE OF COMPUTER HARDWARE AND SOFTWARE SYSTEMS FOR OTHERS; INTERPRETATION OF DIGITAL AERIAL AND SATELLITE IMAGES OF THE EARTH; PHOTOGRAMMETRY SERVICES; GEOSPATIAL SERVICES, NAMELY, MAKING MAPS AND SCALE DRAWINGS FROM AERIAL AND SATELLITE PHOTOGRAPHS (U.S. CLS. 100 AND 101).

FIRST USE 1-12-2006; IN COMMERCE 1-12-2006.
JEFF DEFORD, EXAMINING ATTORNEY

SN 77-930,948. UNITEDHEALTH GROUP INCORPORATED, MINNETONKA, MN. FILED 2-8-2010.

PLANBIEN

THE MARK CONSISTS OF STANDARD CHARACTERS WITHOUT CLAIM TO ANY PARTICULAR FONT, STYLE, SIZE, OR COLOR.

THE ENGLISH TRANSLATION OF "PLANBIEN" IN THE MARK IS "GOOD PLAN".

CLASS 35—ADVERTISING AND BUSINESS

FOR HEALTH CARE COST MANAGEMENT SERVICES FOR HEALTH CARE BENEFIT PLANS AND HEALTH BENEFITS ACCOUNTS OF OTHERS; HEALTH CARE UTILIZATION MANAGEMENT SERVICES; HEALTH CARE UTILIZATION, REVIEW AND COST CONTAINMENT SERVICES (U.S. CLS. 100, 101 AND 102).

FIRST USE 5-28-2009; IN COMMERCE 5-28-2009.

CLASS 36—INSURANCE AND FINANCIAL

FOR ADMINISTRATION OF HEALTH CARE SERVICE PLANS AND HEALTH CARE BENEFIT PLANS; INSURANCE SERVICES, NAMELY, CLAIMS ADMINISTRATION OF HEALTH CARE SERVICE PLANS; INSURANCE UNDERWRITING IN THE FIELD OF HEALTH CARE; ADMINISTRATION OF PRE-PAID HEALTH CARE PLANS; ADMINISTRATION OF EMPLOYEE BENEFIT PLANS CONCERNING INSURANCE; ADMINISTRATION OF EMPLOYEE WELFARE BENEFIT PLANS; ADMINISTRATION OF PRE-PAID HEALTH CARE PLANS IN THE FIELDS OF COMPLEMENTARY AND ALTERNATIVE MEDICINES (U.S. CLS. 100, 101 AND 102).

FIRST USE 5-28-2009; IN COMMERCE 5-28-2009.

CLASS 44—MEDICAL, BEAUTY AND AGRICULTURAL SERVICES

FOR MANAGED HEALTH CARE SERVICES; PROVIDING HEALTH INFORMATION; HEALTH CARE IN THE NATURE OF HEALTH MAINTENANCE ORGANIZATIONS (HMOS), PREFERRED PROVIDER ORGANIZATIONS (PPOS) AND CONSUMER DIRECTED HEALTH PLANS; HEALTH CARE SERVICES, NAMELY, DISEASE MANAGEMENT PROGRAMS, AND HEALTH AND WELLNESS PROGRAMS; MANAGED COMPLEMENTARY AND ALTERNATIVE MEDICINE SERVICES PROVIDED THROUGH A NETWORK OF COMPLEMENTARY AND ALTERNATIVE MEDICINE PROVIDERS (U.S. CLS. 100 AND 101).

FIRST USE 5-28-2009; IN COMMERCE 5-28-2009.
JILL PRATER, EXAMINING ATTORNEY

SN 77-931,064. SERENE CARE INC., DBA SERENE CARE NATURAL MEDICINE & ACUPUNCTURE, PORTLAND, OR. FILED 2-9-2010.

SereneCare

THE MARK CONSISTS OF STANDARD CHARACTERS WITHOUT CLAIM TO ANY PARTICULAR FONT, STYLE, SIZE, OR COLOR.

CLASS 1—CHEMICALS

FOR ANTIOXIDANTS AND PROTEINS USED IN THE MANUFACTURE OF COSMETICS, BEVERAGES, FOOD PRODUCTS AND FOOD SUPPLEMENTS; BOTANICAL EXTRACTS FOR USE IN MAKING COSMETICS; COLLAGEN USED AS A RAW INGREDIENT IN THE MANUFACTURE OF COSMETICS; LIPIDS USED IN THE MANUFACTURE OF COSMETICS, BEVERAGES, FOOD PRODUCTS AND FOOD SUPPLEMENTS; PLANT AND HERB EXTRACTS FOR USE IN THE MANUFACTURE OF COSMETICS; PLANT EXTRACTS FOR USE IN THE MANUFACTURE OF CREAMS, LOTIONS AND COSMETIC PRODUCTS (U.S. CLS. 1, 5, 6, 10, 26 AND 46).

CLASS 3—COSMETICS AND CLEANING PREPARATIONS

FOR ALOE VERA GEL FOR COSMETIC PURPOSES; AROMATHERAPY BODY CARE PRODUCTS, NAMELY, BODY LOTION, SHOWER GEL, CUTICLE CREAM, SHAMPOO, CONDITIONER, NON-MEDICATED LIP BALM, SOAP, BODY POLISH, BODY AND FOOT SCRUB AND NON-MEDICATED FOOT CREAM; ASTRINGENTS FOR COSMETIC PURPOSES; BATH POWDER; BEAUTY CREAMS FOR BODY CARE; BODY AND BEAUTY CARE COSMETICS; COCOA BUTTER FOR COSMETIC PURPOSES; COSMETIC CREAMS; COSMETIC CREAMS FOR SKIN CARE; COSMETIC MASKS; COSMETIC PREPARATIONS FOR BODY CARE; COSMETIC PREPARATIONS FOR SKIN RENEWAL; COSMETIC PREPARATIONS FOR THE HAIR AND SCALP; COSMETIC PREPARATIONS, NAMELY, FIRING CREAMS; FACE CREAMS FOR COSMETIC USE; HAIR CARE CREAMS; HAIR CARE LOTIONS; LOTIONS FOR FACE AND BODY CARE; LOTIONS FOR SKIN; NATURAL COCOA BUTTER BASED PERSONAL CARE PRODUCTS, NAMELY, BODY LOTION, SHOWER GEL, SOAP, BODY POLISH, BODY AND FOOT SCRUB AND NON-MEDICATED SKIN CREAMS (U.S. CLS. 1, 4, 6, 50, 51 AND 52).

KIM MONINGHOFF, EXAMINING ATTORNEY

SN 77-931,381. SUN HARVEST FOODS, INC., SAN DIEGO, CA. FILED 2-9-2010.

GOT BROCCOLI?

THE MARK CONSISTS OF STANDARD CHARACTERS WITHOUT CLAIM TO ANY PARTICULAR FONT, STYLE, SIZE, OR COLOR.

NO CLAIM IS MADE TO THE EXCLUSIVE RIGHT TO USE "BROCCOLI", APART FROM THE MARK AS SHOWN.

CLASS 29—MEATS AND PROCESSED FOODS

FOR FROZEN VEGETABLES, NAMELY, BROCCOLI (U.S. CL. 46).

CLASS 31—NATURAL AGRICULTURAL PRODUCTS

FOR FRESH VEGETABLES, NAMELY, BROCCOLI (U.S. CLS. 1 AND 46).
ROBIN CHOSID, EXAMINING ATTORNEY

CLASS 25—CLOTHING

FOR SHORT-SLEEVED OR LONG-SLEEVED T-SHIRTS (U.S. CLS. 22 AND 39).
FIRST USE 1-1-1999; IN COMMERCE 1-1-1999.

CLASS 28—TOYS AND SPORTING GOODS

FOR HOBBY CRAFT KITS COMPRISING PAINTS, PENS, AND COLOR MARKERS FOR DECORATING SHIRTS PACKAGED THEREWITH (U.S. CLS. 22, 23, 38 AND 50).
FIRST USE 1-1-1999; IN COMMERCE 1-1-1999.
DAVID MILLER, EXAMINING ATTORNEY

SN 77-931,444. LOVE, BARBARA J., DESTIN, FL. FILED 2-9-2010.



THE MARK CONSISTS OF THE DESIGN OF AN ANIMATED YOUNG LATINA GIRL. THE LATINA GIRL IS A LITTLE WORLD CHEF WITH DARK HAIR AND MEDIUM-DARK TONED SKIN. SHE IS WEARING CULINARY CLOTHING, A CHEF'S HAT AND THONG SANDALS, AND HAS A FLOWER IN HER HAIR BEHIND ONE EAR.

CLASS 9—ELECTRICAL AND SCIENTIFIC APPARATUS

FOR AUDIO AND VIDEO RECORDINGS FEATURING MUSIC (U.S. CLS. 21, 23, 26, 36 AND 38).

CLASS 41—EDUCATION AND ENTERTAINMENT

FOR ENTERTAINMENT IN THE NATURE OF AN ONGOING SPECIAL VARIETY, NEWS, MUSIC OR COMEDY SHOW FEATURING CHILDREN'S PROGRAMMING BROADCAST OVER TELEVISION, SATELLITE, AUDIO, AND VIDEO MEDIA (U.S. CLS. 100, 101 AND 107).
MARK SHINER, EXAMINING ATTORNEY

SN 77-931,489. WILLIAMS, ALLEN PATRICK, DBA SIGNASHIRT SPECIALTIES, HENDERSON, NV. FILED 2-9-2010.

SIGnaShirt

THE MARK CONSISTS OF THE TERM "SIGNASHIRT" IN STYLIZED FONT.

SN 77-931,498. DOWN UNDER ANSWERS, L.L.C., BELLEVUE, WA. FILED 2-9-2010.

AFRICA ANSWERS

THE MARK CONSISTS OF STANDARD CHARACTERS WITHOUT CLAIM TO ANY PARTICULAR FONT, STYLE, SIZE, OR COLOR.
NO CLAIM IS MADE TO THE EXCLUSIVE RIGHT TO USE "AFRICA", APART FROM THE MARK AS SHOWN.

CLASS 39—TRANSPORTATION AND STORAGE

FOR ARRANGING AND COORDINATING TRAVEL ARRANGEMENTS FOR INDIVIDUALS AND GROUPS, NAMELY, DESTINATIONS STAYS, HONEYMOONS, FAMILY VACATIONS, AND DESTINATION WEDDINGS; ARRANGING TRAVEL TOURS; COORDINATING TRAVEL ARRANGEMENTS FOR INDIVIDUALS AND FOR GROUPS; ORGANIZATION OF EXCURSIONS, SIGHTSEEING TOURS, HOLIDAYS, TOURS AND TRAVEL; PROVIDING A WEBSITE FEATURING INFORMATION ON TRAVEL; PROVIDING INFORMATION, NEWS AND COMMENTARY IN THE FIELD OF TRAVEL; TRAVEL AGENCY SERVICES, NAMELY, MAKING RESERVATIONS AND BOOKINGS FOR TRANSPORTATION; TRAVEL AND TOUR INFORMATION SERVICE; TRAVEL GUIDE AND TRAVEL INFORMATION SERVICES (U.S. CLS. 100 AND 105).
FIRST USE 1-31-2010; IN COMMERCE 1-31-2010.

CLASS 43—HOTEL AND RESTAURANT SERVICES

FOR PROVIDING TRAVEL LODGING INFORMATION SERVICES AND TRAVEL LODGING BOOKING AGENCY SERVICES FOR TRAVELERS; TRAVEL AGENCY SERVICES, NAMELY, MAKING RESERVATIONS AND BOOKING FOR TEMPORARY LODGING (U.S. CLS. 100 AND 101).
FIRST USE 1-31-2010; IN COMMERCE 1-31-2010.
DANNEAN HETZEL, EXAMINING ATTORNEY

SN 77-931,620. DELUCA, DOMENICO, CONCORD, CA.
FILED 2-9-2010.



THE COLOR(S) GREEN AND BLACK IS/ARE CLAIMED AS A FEATURE OF THE MARK.

THE MARK CONSISTS OF GREEN PALM FRONDS OVERLAYED WITH THE LITERAL ELEMENT OF THE MARK "BIOFINA" AND AN ACCENT OVER THE LAST LETTER ALL IN THE COLOR BLACK.

CLASS 16—PAPER GOODS AND PRINTED MATTER

FOR PLASTIC BAGS FOR GENERAL PURPOSE; PLASTIC BAGS FOR UNDERGARMENT DISPOSAL; PLASTIC BUBBLE PACKS; PLASTIC FOOD STORAGE BAGS FOR HOUSEHOLD USE; PLASTIC BAGS FOR HOUSEHOLD USE; PLASTIC PAGES FOR HOLDING CARDS; PLASTIC SANDWICH BAGS; PLASTIC SHEETS AND LABELS FOR WRITING, PRINTING AND MARKING; AND PLASTIC GARBAGE BAGS (U.S. CLS. 2, 5, 22, 23, 29, 37, 38 AND 50).

CLASS 17—RUBBER GOODS

FOR PLASTIC IN THE FORM OF BARS, PELLETS, RODS, SHEETS AND TUBES FOR GENERAL INDUSTRIAL USE; PLASTIC IN EXTRUDED FORM FOR GENERAL INDUSTRIAL USE; PLASTIC IN THE FORM OF BARS, PELLETS, RODS, SHEETS AND TUBES FOR USE IN MANUFACTURING; PLASTIC PACKING FOR SHIPPING CONTAINERS; PLASTIC SHEETING FOR PREVENTING WEED GROWTH; PLASTIC SHEETING FOR USE AS DROP CLOTHS; PLASTIC TAPE FOR USE IN COMMERCIAL MANUFACTURING (U.S. CLS. 1, 5, 12, 13, 35 AND 50).

CLASS 21—HOUSEWARES AND GLASS

FOR PLASTIC GLOVES FOR HOUSEHOLD USE; PLASTIC CUPS (U.S. CLS. 2, 13, 23, 29, 30, 33, 40 AND 50).
WILLIAM ROSSMAN, EXAMINING ATTORNEY

SN 77-931,752. MUSE GAMES CORPORATION, NEW YORK, NY. FILED 2-9-2010.

GUNS OF ICARUS

THE MARK CONSISTS OF STANDARD CHARACTERS WITHOUT CLAIM TO ANY PARTICULAR FONT, STYLE, SIZE, OR COLOR.

CLASS 9—ELECTRICAL AND SCIENTIFIC APPARATUS

FOR COMPUTER GAME PROGRAMS; DOWNLOADABLE COMPUTER GAME PROGRAMS; INTERACTIVE MULTIMEDIA COMPUTER GAME PROGRAM (U.S. CLS. 21, 23, 26, 36 AND 38).

FIRST USE 7-9-2009; IN COMMERCE 7-9-2009.

CLASS 41—EDUCATION AND ENTERTAINMENT

FOR ENTERTAINMENT SERVICES, NAMELY, PROVIDING AN ON-LINE COMPUTER GAME (U.S. CLS. 100, 101 AND 107).

FIRST USE 7-9-2009; IN COMMERCE 7-9-2009.
ROBIN CHOSID, EXAMINING ATTORNEY

SN 77-931,864. STEARNS, GLENN, SANTA ANA, CA. AND STEARNS, MELINDA, SANTA ANA, CA. FILED 2-9-2010.

LIFE CHANGING LIVES

THE MARK CONSISTS OF STANDARD CHARACTERS WITHOUT CLAIM TO ANY PARTICULAR FONT, STYLE, SIZE, OR COLOR.

CLASS 35—ADVERTISING AND BUSINESS

FOR PROMOTING THE CHARITABLE SERVICES OF OTHERS, NAMELY, PROVIDING INDIVIDUALS WITH INFORMATION FOR THE PURPOSE OF MAKING DONATIONS TO CHARITIES (U.S. CLS. 100, 101 AND 102).

FIRST USE 11-30-2007; IN COMMERCE 11-30-2007.

CLASS 36—INSURANCE AND FINANCIAL

FOR ACCEPTING AND ADMINISTERING MONETARY CHARITABLE CONTRIBUTIONS; PROVIDING GRANTS TO OTHER NON-PROFIT ORGANIZATIONS; CHARITABLE SERVICES, NAMELY, ORGANIZING AND CONDUCTING SPECIAL EVENTS FOR CHARITABLE FUNDRAISING PURPOSES (U.S. CLS. 100, 101 AND 102).

FIRST USE 11-30-2007; IN COMMERCE 11-30-2007.
ELI HELLMAN, EXAMINING ATTORNEY

SN 77-931,878. THRIFTY BUNDLE LLC, ORLAND PARK, IL. FILED 2-9-2010.

THRIFTY BUNDLE SAVINGS BY THE BUNDLE

THE MARK CONSISTS OF STANDARD CHARACTERS WITHOUT CLAIM TO ANY PARTICULAR FONT, STYLE, SIZE, OR COLOR.

CLASS 16—PAPER GOODS AND PRINTED MATTER

FOR COUPON BOOKS; COUPONS (U.S. CLS. 2, 5, 22, 23, 29, 37, 38 AND 50).

CLASS 35—ADVERTISING AND BUSINESS

FOR ADVERTISING, MARKETING AND PROMOTION SERVICES (U.S. CLS. 100, 101 AND 102).
PAUL F. GAST, EXAMINING ATTORNEY

SN 77-931,893. MOM ENTERPRISES, INC., SAN RAFAEL, CA. FILED 2-9-2010.

SN 77-932,098. REACTIVETECH, PHILOMATH, OR. FILED 2-9-2010.

MOMMY'S BLISS

THE MARK CONSISTS OF STANDARD CHARACTERS WITHOUT CLAIM TO ANY PARTICULAR FONT, STYLE, SIZE, OR COLOR.

OWNER OF U.S. REG. NO. 3,304,341.

CLASS 3—COSMETICS AND CLEANING PREPARATIONS

FOR NON-MEDICATED SKIN CARE PREPARATIONS; NON-MEDICATED SKIN CARE PREPARATIONS FOR USE ON NIPPLES (U.S. CLS. 1, 4, 6, 50, 51 AND 52).

CLASS 5—PHARMACEUTICALS

FOR DIETARY AND NUTRITIONAL SUPPLEMENTS; MEDICATED DIAPER RASH OINTMENTS, CREAMS, AND LOTIONS; MEDICATED SKIN CARE PREPARATIONS; MEDICINAL PREPARATIONS FOR TREATMENT AND PREVENTION OF HEARTBURN AND NAUSEA (U.S. CLS. 6, 18, 44, 46, 51 AND 52).

INGRID C. EULIN, EXAMINING ATTORNEY

SN 77-931,936. SUNLEAF NATURALS, LLC., CHASKA, MN. FILED 2-9-2010.



THE MARK CONSISTS OF TWO STYLIZED LEAVES WHICH FORM A CIRCLE WITH RAYS AROUND THE CIRCLE.

CLASS 3—COSMETICS AND CLEANING PREPARATIONS

FOR BAR SOAP; BATH SOAPS; ESSENTIAL OILS; HAND SOAPS; LIP BALM; REED DIFFUSERS SOLD WITH SCENTED OILS; SHAVING SOAP; SKIN CARE PREPARATIONS, NAMELY, BODY BALM; SKIN SOAP; SOAPS AND DETERGENTS; SOAPS FOR BODY CARE; SOAPS FOR HOUSEHOLD USE; SOAPS FOR PERSONAL USE (U.S. CLS. 1, 4, 6, 50, 51 AND 52).

FIRST USE 8-0-2008; IN COMMERCE 9-0-2008.

CLASS 4—LUBRICANTS AND FUELS

FOR CANDLES (U.S. CLS. 1, 6 AND 15).
FIRST USE 8-0-2008; IN COMMERCE 9-0-2008.
TOBY BULLOFF, EXAMINING ATTORNEY



NO CLAIM IS MADE TO THE EXCLUSIVE RIGHT TO USE "HUNTING TARGETS" FOR INTERNATIONAL CLASS 28, APART FROM THE MARK AS SHOWN.

THE MARK CONSISTS OF A DUPLEX RIFLE SCOPE ON LEFT SIDE AND "HUNTING TARGETS" WRITTEN BELOW "REACTIVETECH", WITH "TECH" BEING SMALLER THAN "REACTIVE".

CLASS 25—CLOTHING

FOR BEANIES; HATS; JACKETS; SWEAT SHIRTS; T-SHIRTS (U.S. CLS. 22 AND 39).

FIRST USE 1-1-2010; IN COMMERCE 1-1-2010.

CLASS 28—TOYS AND SPORTING GOODS

FOR TARGETS (U.S. CLS. 22, 23, 38 AND 50).

FIRST USE 1-1-2010; IN COMMERCE 1-1-2010.

KATHLEEN M. VANSTON, EXAMINING ATTORNEY

SN 77-932,298. CARLINO, CRISTINA M., PHOENIX, AZ. FILED 2-10-2010.

NOZONE

THE MARK CONSISTS OF STANDARD CHARACTERS WITHOUT CLAIM TO ANY PARTICULAR FONT, STYLE, SIZE, OR COLOR.

CLASS 3—COSMETICS AND CLEANING PREPARATIONS

FOR NON-MEDICATED NASAL GEL AND OINTMENT FOR MOISTURIZING THE SKIN AROUND THE NOSE (U.S. CLS. 1, 4, 6, 50, 51 AND 52).

CLASS 5—PHARMACEUTICALS

FOR NASAL RINSE; NASAL SPRAY PREPARATIONS; PHARMACEUTICAL PREPARATIONS AND SUBSTANCES FOR USE IN THE NOSE, NAMELY, PHARMACEUTICAL PREPARATIONS AND SUBSTANCES FOR USE IN THE TREATMENT OF NASAL AND SINUS CONDITIONS; MEDICATED NASAL GEL AND OINTMENT, NAMELY, TOPICAL GEL AND OINTMENT FOR THE THERAPEUTIC TREATMENT OF NASAL AND SINUS CONDITIONS (U.S. CLS. 6, 18, 44, 46, 51 AND 52).

JULIE WATSON, EXAMINING ATTORNEY

SN 77-932,318. TERRY FOODS LTD, IDAHO FALLS, ID.
FILED 2-10-2010.

SN 77-932,658. RYLAND TANIGUCHI, SEATTLE, WA.
FILED 2-10-2010.

Yeoman

THE MARK CONSISTS OF STANDARD CHARACTERS WITHOUT CLAIM TO ANY PARTICULAR FONT, STYLE, SIZE, OR COLOR.

CLASS 29—MEATS AND PROCESSED FOODS

FOR PALM OIL; POTATO-BASED SNACK FOODS; SNACK FOOD DIPS; VEGETABLE-BASED SNACK FOODS (U.S. CL. 46).

CLASS 30—STAPLE FOODS

FOR FLOUR FOR FOOD; FOOD STARCH (U.S. CL. 46).

CLASS 35—ADVERTISING AND BUSINESS

FOR WHOLESALE FOOD DISTRIBUTORSHIP SERVICES (U.S. CLS. 100, 101 AND 102).
VIVIAN MICZNIK FIRST, EXAMINING ATTORNEY

SN 77-932,339. H. LEE MOFFITT CANCER CENTER AND RESEARCH INSTITUTE, INC., AKA MOFFITT CANCER CENTER, TAMPA, FL. FILED 2-10-2010.

LivWise

THE MARK CONSISTS OF STANDARD CHARACTERS WITHOUT CLAIM TO ANY PARTICULAR FONT, STYLE, SIZE, OR COLOR.

CLASS 16—PAPER GOODS AND PRINTED MATTER

FOR BOOKMARKS; COOKBOOK HOLDERS; DECALS; STICKERS (U.S. CLS. 2, 5, 22, 23, 29, 37, 38 AND 50).

CLASS 21—HOUSEWARES AND GLASS

FOR CUPS; INSULATING SLEEVE HOLDER FOR BEVERAGE CUPS; JAR OPENERS; MUGS (U.S. CLS. 2, 13, 23, 29, 30, 33, 40 AND 50).

CLASS 25—CLOTHING

FOR APRONS; T-SHIRTS (U.S. CLS. 22 AND 39).

CLASS 41—EDUCATION AND ENTERTAINMENT

FOR PROVIDING ON-LINE PUBLICATIONS IN THE NATURE OF ARTICLES AND RECIPES IN THE FIELD OF NUTRITION AND HEALTH (U.S. CLS. 100, 101 AND 107).

BERYL GARDNER, EXAMINING ATTORNEY

Ecosweet

THE MARK CONSISTS OF STANDARD CHARACTERS WITHOUT CLAIM TO ANY PARTICULAR FONT, STYLE, SIZE, OR COLOR.

CLASS 40—MATERIAL TREATMENT

FOR BACTERIAL REMOVAL TREATMENT OF BIOREMEDIATION; BATCH BIOLOGICAL TREATMENT SERVICES; BIOLOGICAL PETROLEUM TREATMENT SERVICES; BIOLOGICAL WASTE WATER TREATMENT SERVICES; CONTINUOUS BIOLOGICAL WATER TREATMENT SERVICES; CONVERSION OF TARGETED SUBSTRATES INTO TARGETED CHEMICAL PREPARATION BY TREATMENT WITH ENZYME SYSTEMS; ENVIRONMENTAL REMEDIATION SERVICES, NAMELY, SOIL TREATMENT SERVICES; ENVIRONMENTAL REMEDIATION SERVICES, NAMELY, SOIL, WASTE AND/OR WATER TREATMENT SERVICES; FUEL TREATMENT SERVICES; MATERIAL TREATMENT SERVICES IN CONNECTION WITH RECYCLING; METAL TREATMENT; NUCLEAR WASTE TREATMENT; OIL AND GAS WELL TREATMENT; OIL WELL PROSPECTING, NAMELY, PERFORATION AND SPILL TREATMENT; PROVIDING MATERIAL TREATMENT INFORMATION; SUSTAINABLE ON-SITE WATER RECYCLING AND WASTEWATER TREATMENT SERVICES; TREATMENT OF CRYSTALLINE MATERIALS USING A QUANTUM FIELD ACCELERATOR/GENERATOR; TREATMENT OF MATERIALS BY LASER BEAM; TREATMENT OF MATERIALS USING A QUANTUM FIELD ACCELERATOR/GENERATOR; TREATMENT OF MATERIALS, NAMELY, THE ADDITION OF POLYMER ADDITIVES, RADIO OPACIFIERS, AND ANTIMICROBIAL AGENTS TO MATERIALS TO RENDER THEM ECOGENIC, RADIOPAQUE, OR BACTERIOSTATIC; TREATMENT OF WASTE WATER; TREATMENT OF WATER USED IN NUCLEAR REACTORS; WASTE TREATMENT; WASTE WATER REPROCESSING; WASTE WATER TREATMENT SERVICES; WASTE WATER TREATMENT SERVICES FOR INDUSTRIAL PURPOSES; WATER DEMINERALIZATION; WATER FILTRATION AND CONDITIONING SERVICES; WATER RECYCLING AND DESALINATION SERVICES; WATER TREATING; WATER TREATMENT AND PURIFICATION; WATER TREATMENT SERVICES (U.S. CLS. 100, 103 AND 106).

CLASS 41—EDUCATION AND ENTERTAINMENT

FOR ENTERTAINMENT IN THE NATURE OF A WATER PARK AND AMUSEMENT CENTER; ENTERTAINMENT SERVICES, NAMELY, ARRANGING FOR TICKET RESERVATIONS FOR WATER PARKS AND AMUSEMENT CENTERS (U.S. CLS. 100, 101 AND 107).
TRACY WHITTAKER-BROWN, EXAMINING ATTORNEY

SN 77-932,748. MODULUS DESIGN, ALBUQUERQUE, NM.
FILED 2-10-2010.

DORITT L. CARROLL, EXAMINING ATTORNEY

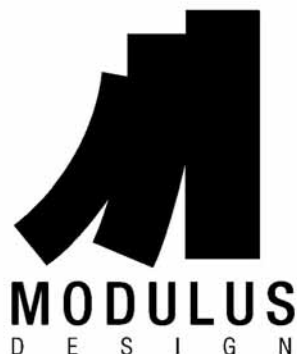

NO CLAIM IS MADE TO THE EXCLUSIVE RIGHT TO USE "DESIGN", APART FROM THE MARK AS SHOWN.

THE MARK CONSISTS OF THREE STICKS FALLING ON TOP OF EACH OTHER. BELOW THERE IS THE STYLIZED TEXT "MODULUS DESIGN".

CLASS 37—CONSTRUCTION AND REPAIR

FOR BUILDING CONSTRUCTION, REMODELING AND REPAIR; GENERAL CONSTRUCTION CONTRACTING (U.S. CLS. 100, 103 AND 106).

FIRST USE 8-0-2005; IN COMMERCE 1-0-2006.

CLASS 42—SCIENTIFIC AND COMPUTER SERVICES

FOR ARCHITECTURAL DESIGN (U.S. CLS. 100 AND 101).

FIRST USE 8-0-2005; IN COMMERCE 1-0-2006.

DORITT L. CARROLL, EXAMINING ATTORNEY

SN 77-932,781. CALLFINITY, INC., PITTSFORD, NY. FILED 2-10-2010.

vforce

THE MARK CONSISTS OF STANDARD CHARACTERS WITHOUT CLAIM TO ANY PARTICULAR FONT, STYLE, SIZE, OR COLOR.

CLASS 9—ELECTRICAL AND SCIENTIFIC APPARATUS

FOR COMPUTER SOFTWARE, NAMELY, AN APPLICATION ALLOWING SALES AND FIELD SERVICE EMPLOYEES TO UPDATE AND RECEIVE DATA STORED IN AN ENTERPRISE'S COMPUTER DATABASES IN REAL TIME, USING A MOBILE DEVICE, WITH FULL TELEPHONY INTEGRATION WITH THE TELEPHONE AND/OR SOFTWARE FEATURES OF THE MOBILE DEVICE; TELEPHONE CALL ROUTERS (U.S. CLS. 21, 23, 26, 36 AND 38).

CLASS 38—COMMUNICATION

FOR COMMUNICATIONS BY TELEPHONE; TELEPHONE COMMUNICATION SERVICES; TELEPHONY COMMUNICATION SERVICES (U.S. CLS. 100, 101 AND 104).

SN 77-932,869. NYSANTE INC., WINTER PARK, FL. FILED 2-10-2010.

LifeFX Global

THE MARK CONSISTS OF STANDARD CHARACTERS WITHOUT CLAIM TO ANY PARTICULAR FONT, STYLE, SIZE, OR COLOR.

CLASS 3—COSMETICS AND CLEANING PREPARATIONS

FOR BODY LOTIONS; COSMETIC CREAMS FOR SKIN CARE; FACE AND BODY LOTIONS; FACIAL LOTION; LOTIONS FOR FACE AND BODY CARE; MOISTURIZING CREAMS; SKIN MOISTURIZER (U.S. CLS. 1, 4, 6, 50, 51 AND 52).

CLASS 5—PHARMACEUTICALS

FOR DIETARY AND NUTRITIONAL SUPPLEMENTS; DIETARY SUPPLEMENTS; DIETARY SUPPLEMENTS FOR HUMAN CONSUMPTION; VITAMIN SUPPLEMENTS; VITAMINS (U.S. CLS. 6, 18, 44, 46, 51 AND 52).

ALICIA COLLINS, EXAMINING ATTORNEY

SN 77-932,908. CEDAR GROUP US, INC., BOSTON, MA. FILED 2-10-2010.



THE MARK CONSISTS OF A STYLIZED LETTER "V" TO THE LEFT OF THE WORDING "V1" IN STYLIZED TYPEFACE.

CLASS 9—ELECTRICAL AND SCIENTIFIC APPARATUS

FOR COMPUTER SOFTWARE FOR DOCUMENT MANAGEMENT AND DOCUMENT IMAGING (U.S. CLS. 21, 23, 26, 36 AND 38).

CLASS 16—PAPER GOODS AND PRINTED MATTER

FOR PRINTED MATTER IN THE NATURE OF INSTRUCTION MANUALS, SPECIFICATIONS AND TRAINING MANUALS IN THE FIELD OF COMPUTER SOFTWARE FOR DOCUMENT MANAGEMENT AND DOCUMENT IMAGING (U.S. CLS. 2, 5, 22, 23, 29, 37, 38 AND 50).

CLASS 42—SCIENTIFIC AND COMPUTER SERVICES

FOR DESIGN AND DEVELOPMENT OF COMPUTER SOFTWARE FOR DOCUMENT MANAGEMENT AND DOCUMENT IMAGING (U.S. CLS. 100 AND 101).

FIRST USE 7-15-2009; IN COMMERCE 7-15-2009.

PAUL F. GAST, EXAMINING ATTORNEY

CLASS 42—SCIENTIFIC AND COMPUTER SERVICES

FOR PROVIDING A WEB-BASED SYSTEM AND ONLINE PORTAL FOR CUSTOMERS TO REMOTELY MONITOR AND CONTROL INDUSTRIAL EQUIPMENT AND TO CONFIGURE AUTOMATED ALARMS AND NOTICES REGARDING REMOTELY MONITORED AND CONTROLLED INDUSTRIAL EQUIPMENT; PROVIDING A WEB-BASED SYSTEM AND ONLINE PORTAL FOR CUSTOMERS TO REMOTELY MONITOR VEHICLES AND MOBILE INDUSTRIAL ASSETS, AND TO CONFIGURE AUTOMATED ALARMS AND NOTICES REGARDING REMOTELY MONITORED VEHICLES AND MOBILE INDUSTRIAL ASSETS (U.S. CLS. 100 AND 101).

FIRST USE 11-28-2007; IN COMMERCE 3-24-2008.

DOMINIC J. FERRAIUOLO, EXAMINING ATTORNEY

SN 77-933,055. SCOTT, DARIN, SAN JOSE, CA. FILED 2-10-2010.

SN 77-932,954. AUTOCACHE, INC., AUSTIN, TX. FILED 2-10-2010.

LEARN, DEVELOP, COMPETE.
DOMINATE.

FleetZOOM

THE MARK CONSISTS OF STANDARD CHARACTERS WITHOUT CLAIM TO ANY PARTICULAR FONT, STYLE, SIZE, OR COLOR.

THE MARK CONSISTS OF STANDARD CHARACTERS WITHOUT CLAIM TO ANY PARTICULAR FONT, STYLE, SIZE, OR COLOR.

CLASS 28—TOYS AND SPORTING GOODS

FOR ATHLETIC SPORTING GOODS, NAMELY, ADHESIVE TAPE FOR HOCKEY STICK AND UNIFORM SUPPORT ; CHEST PROTECTORS ; HOCKEY GLOVES ; HOCKEY PUCKS ; HOCKEY STICK BLADES ; HOCKEY STICK SHAFTS ; HOCKEY STICKS ; ICE HOCKEY GOALIE PADS ; ICE HOCKEY STICKS (U.S. CLS. 22, 23, 38 AND 50).

CLASS 9—ELECTRICAL AND SCIENTIFIC APPARATUS

FOR TELECOMMUNICATIONS DEVICES FOR CAPTURING DATA AND INFORMATION FROM INDUSTRIAL EQUIPMENT, FOR TRANSMITTING THE DATA AND INFORMATION THROUGH A COMMUNICATIONS NETWORK, AND FOR RECEIVING REMOTE CONTROL COMMANDS THROUGH THE COMMUNICATIONS NETWORK; VEHICLE TRACKING DEVICES COMPRISED OF CELLULAR RADIO MODULES, COMPUTER SOFTWARE AND COMPUTER HARDWARE, SENSORS, TRANSMITTERS, RECEIVERS AND GLOBAL POSITIONING SATELLITE RECEIVERS, ALL FOR USE IN CONNECTION WITH VEHICLE TRACKING, VEHICLE MONITORING, AND ANTI-THEFT VEHICLE ALARMS (U.S. CLS. 21, 23, 26, 36 AND 38).

FIRST USE 3-24-2008; IN COMMERCE 3-24-2008.

CLASS 41—EDUCATION AND ENTERTAINMENT

FOR SPORT CAMPS; SPORTS CAMP SERVICES; PROFESSIONAL COACHING SERVICES IN THE FIELDS OF HOCKEY, FOOTBALL, BASKETBALL, BASEBALL, TENNIS AND GOLF; PROVIDING GROUP COACHING IN THE FIELDS OF HOCKEY, FOOTBALL, BASKETBALL, BASEBALL, TENNIS AND GOLF; ENTERTAINMENT IN THE NATURE OF HOCKEY, FOOTBALL, BASKETBALL, BASEBALL, TENNIS AND GOLF GAMES (U.S. CLS. 100, 101 AND 107).

FIRST USE 11-0-2008; IN COMMERCE 11-0-2008.

ESTHER A. BORSUK, EXAMINING ATTORNEY

CLASS 38—COMMUNICATION

FOR TRANSMISSION OF INFORMATION BY ELECTRONIC COMMUNICATIONS NETWORKS, NAMELY, TRANSMISSION OF INFORMATION TO AND FROM REMOTELY MONITORED INDUSTRIAL EQUIPMENT, AND TRANSMISSION OF ALARMS AND NOTICES RELATING TO REMOTELY MONITORED INDUSTRIAL EQUIPMENT; TRANSMISSION OF INFORMATION BY ELECTRONIC COMMUNICATIONS NETWORKS, NAMELY, TRANSMISSION OF INFORMATION TO AND FROM REMOTELY MONITORED VEHICLES AND MOBILE INDUSTRIAL ASSETS, AND TRANSMISSION OF ALARMS AND NOTICES RELATING TO REMOTELY MONITORED VEHICLES AND MOBILE INDUSTRIAL ASSETS (U.S. CLS. 100, 101 AND 104).

FIRST USE 11-28-2007; IN COMMERCE 3-24-2008.

SN 77-933,136. DAVID HOBBY, ELLICOTT CITY, MD. FILED 2-10-2010.

Strobist

THE MARK CONSISTS OF STANDARD CHARACTERS WITHOUT CLAIM TO ANY PARTICULAR FONT, STYLE, SIZE, OR COLOR.

CLASS 9—ELECTRICAL AND SCIENTIFIC APPARATUS

FOR CAMERA FILTERS; PHOTOGRAPHIC FILTERS (U.S. CLS. 21, 23, 26, 36 AND 38).
FIRST USE 8-28-2009; IN COMMERCE 8-28-2009.

SN 77-934,765. BLACK DAWG FRANCHISE GROUP, LLC, GOFSTOWN, NH. FILED 2-12-2010.

Black Dawg Property Services

THE MARK CONSISTS OF STANDARD CHARACTERS WITHOUT CLAIM TO ANY PARTICULAR FONT, STYLE, SIZE, OR COLOR.

OWNER OF U.S. REG. NO. 3,245,570.

NO CLAIM IS MADE TO THE EXCLUSIVE RIGHT TO USE "PROPERTY SERVICES", APART FROM THE MARK AS SHOWN.

CLASS 41—EDUCATION AND ENTERTAINMENT

FOR EDUCATION SERVICES, NAMELY, PROVIDING LIVE AND ON-LINE CLASSES, SEMINARS, AND WORKSHOPS IN THE FIELD OF LIGHTING OF PHOTOGRAPHY; ON-LINE JOURNALS, NAMELY, BLOGS FEATURING LIGHTING OF PHOTOGRAPHY (U.S. CLS. 100, 101 AND 107).

FIRST USE 2-28-2006; IN COMMERCE 2-28-2006.
KATHERINE CONNOLLY, EXAMINING ATTORNEY

CLASS 37—CONSTRUCTION AND REPAIR

FOR SNOW PLOWING, SNOW REMOVAL SERVICES, POWER STREET SWEEPING SERVICES, INSTALLATION AND MAINTENANCE OF SPRINKLER AND IRRIGATION SYSTEMS; ASPHALT REPAIR, SEALING AND MAINTENANCE, PARKING LOT STRIPING (U.S. CLS. 100, 103 AND 106).

FIRST USE 2-10-2010; IN COMMERCE 2-10-2010.

SN 77-934,728. WONDER LLC, DEERFIELD, IL. FILED 2-12-2010.

WONDER!

THE MARK CONSISTS OF STANDARD CHARACTERS WITHOUT CLAIM TO ANY PARTICULAR FONT, STYLE, SIZE, OR COLOR.

CLASS 44—MEDICAL, BEAUTY AND AGRICULTURAL SERVICES

FOR LAWN CARE SERVICES, LAWN MOWING SERVICES, LANDSCAPE GARDENING AND DESIGN SERVICES (U.S. CLS. 100 AND 101).

FIRST USE 2-10-2010; IN COMMERCE 2-10-2010.
AARON BRODSKY, EXAMINING ATTORNEY

CLASS 35—ADVERTISING AND BUSINESS

FOR ONLINE RETAIL STORE AND WHOLESALE DISTRIBUTORSHIP SERVICES OFFERED VIA A MEMBERSHIP CLUB IN THE FIELDS OF TOYS, GAMES, EDUCATIONAL AND DEVELOPMENTAL PRODUCTS, SPORTING GOODS, CHILDREN'S CLOTHING, FURNITURE, ELECTRONICS, GROCERIES AND PRIVATE LABEL GOODS (U.S. CLS. 100, 101 AND 102).

SN 77-935,295. TRUSTED FEDERAL SYSTEMS, INC., POTOMAC, MD. FILED 2-13-2010.

TFSI

THE MARK CONSISTS OF STANDARD CHARACTERS WITHOUT CLAIM TO ANY PARTICULAR FONT, STYLE, SIZE, OR COLOR.

CLASS 41—EDUCATION AND ENTERTAINMENT

FOR PROVIDING RECREATIONAL AREAS IN THE NATURE OF CHILDREN'S PLAY AREAS; EDUCATIONAL SERVICES, NAMELY, PROVIDING CLASSES AND INSTRUCTION IN CRAFTS, ART, MUSIC TUMBLING, JUMPING, THE USE OF TRAMPOLINES, SPORTING ACTIVITIES, AND ADVANCED COMPUTING AND COMPUTER GAMES USING INTERACTIVE COMPUTER STATIONS; PROVIDING FACILITIES FOR MOVIES, MUSIC, SHOWS AND SPECIAL EVENTS (U.S. CLS. 100, 101 AND 107).

CLASS 35—ADVERTISING AND BUSINESS

FOR BUSINESS MANAGEMENT CONSULTING AND ADVISORY SERVICES (U.S. CLS. 100, 101 AND 102).

CLASS 43—HOTEL AND RESTAURANT SERVICES

FOR RESTAURANT AND COFFEE SHOP SERVICES FEATURING ITALIAN FOOD, MEXICAN FOOD, AMERICAN FOOD, SALADS, SANDWICHES, AND ORGANIC FOODS (U.S. CLS. 100 AND 101).
AMY HELLA, EXAMINING ATTORNEY

CLASS 42—SCIENTIFIC AND COMPUTER SERVICES

FOR CONSULTING IN THE FIELD OF INFORMATION TECHNOLOGY (U.S. CLS. 100 AND 101).
TEJBIR SINGH, EXAMINING ATTORNEY

SN 77-935,299. TRUSTED FEDERAL SYSTEMS, INC., POTOMAC, MD. FILED 2-13-2010.

TFS

THE MARK CONSISTS OF STANDARD CHARACTERS WITHOUT CLAIM TO ANY PARTICULAR FONT, STYLE, SIZE, OR COLOR.

CLASS 35—ADVERTISING AND BUSINESS

FOR BUSINESS MANAGEMENT CONSULTANCY AND ADVISORY SERVICES (U.S. CLS. 100, 101 AND 102).

CLASS 42—SCIENTIFIC AND COMPUTER SERVICES

FOR CONSULTING IN THE FIELD OF INFORMATION TECHNOLOGY (U.S. CLS. 100 AND 101).
TEJBIR SINGH, EXAMINING ATTORNEY

SN 77-935,509. TRUSTED FEDERAL SYSTEMS, INC., POTOMAC, MD. FILED 2-14-2010.

TRUSTED STATE

THE MARK CONSISTS OF STANDARD CHARACTERS WITHOUT CLAIM TO ANY PARTICULAR FONT, STYLE, SIZE, OR COLOR.

CLASS 35—ADVERTISING AND BUSINESS

FOR BUSINESS MANAGEMENT CONSULTING AND ADVISORY SERVICES (U.S. CLS. 100, 101 AND 102).

CLASS 42—SCIENTIFIC AND COMPUTER SERVICES

FOR CONSULTING IN THE FIELD OF INFORMATION TECHNOLOGY (U.S. CLS. 100 AND 101).
TEJBIR SINGH, EXAMINING ATTORNEY

SN 77-936,314. MURAD, INC., EL SEGUNDO, CA. FILED 2-16-2010.



OWNER OF U.S. REG. NOS. 1,830,098 AND 2,062,211.
THE MARK CONSISTS OF "MURAD" AND DESIGN OF "M".

CLASS 3—COSMETICS AND CLEANING PREPARATIONS

FOR NON-MEDICATED SKIN CARE PREPARATIONS, NAMELY, CREAMS, LOTIONS, GELS, TONERS, CLEANSERS AND PEELS (U.S. CLS. 1, 4, 6, 50, 51 AND 52).
FIRST USE 8-0-2001; IN COMMERCE 8-0-2001.

CLASS 5—PHARMACEUTICALS

FOR DIETARY SUPPLEMENTS FOR HUMAN CONSUMPTION; VITAMINS (U.S. CLS. 6, 18, 44, 46, 51 AND 52).
FIRST USE 8-0-2001; IN COMMERCE 8-0-2001.
NICHOLAS ALTREE, EXAMINING ATTORNEY

SN 77-936,819. CARLINO, CRISTINA M., PHOENIX, AZ. FILED 2-16-2010.

END ZONE

THE MARK CONSISTS OF STANDARD CHARACTERS WITHOUT CLAIM TO ANY PARTICULAR FONT, STYLE, SIZE, OR COLOR.

CLASS 3—COSMETICS AND CLEANING PREPARATIONS

FOR NON-MEDICATED DIAPER RASH OINTMENTS AND LOTIONS (U.S. CLS. 1, 4, 6, 50, 51 AND 52).

CLASS 5—PHARMACEUTICALS

FOR HEMORRHOID TREATMENT PREPARATIONS; MEDICATED DIAPER RASH OINTMENTS AND LOTIONS (U.S. CLS. 6, 18, 44, 46, 51 AND 52).
JULIE WATSON, EXAMINING ATTORNEY

SN 77-937,930. COLT DEFENSE LLC, WEST HARTFORD, CT. FILED 2-17-2010.

COLTACTICAL

THE MARK CONSISTS OF STANDARD CHARACTERS WITHOUT CLAIM TO ANY PARTICULAR FONT, STYLE, SIZE, OR COLOR.

CLASS 13—FIREARMS

FOR AIR RIFLES; RIFLES AND PARTS THEREOF (U.S. CLS. 2 AND 9).

CLASS 25—CLOTHING

FOR FOOTWEAR; FOUL WEATHER GEAR; HATS; JACKETS; SHIRTS; SWEAT SHIRTS (U.S. CLS. 22 AND 39).

CLASS 28—TOYS AND SPORTING GOODS

FOR TOY GUNS (U.S. CLS. 22, 23, 38 AND 50).

CAROLYN CATALDO, EXAMINING ATTORNEY

SN 77-940,258. SCHERING CORPORATION, KENILWORTH, NJ. FILED 2-19-2010.

SN 77-938,037. DAZ PRODUCTIONS, INC., DRAPER, UT. FILED 2-17-2010.

DAZ

THE MARK CONSISTS OF STANDARD CHARACTERS WITHOUT CLAIM TO ANY PARTICULAR FONT, STYLE, SIZE, OR COLOR.

CLASS 9—ELECTRICAL AND SCIENTIFIC APPARATUS

FOR COMPUTER GRAPHICS SOFTWARE (U.S. CLS. 21, 23, 26, 36 AND 38).
FIRST USE 12-11-2000; IN COMMERCE 12-11-2000.

CLASS 42—SCIENTIFIC AND COMPUTER SERVICES

FOR COMPUTER GRAPHICS SERVICES (U.S. CLS. 100 AND 101).
FIRST USE 12-11-2000; IN COMMERCE 12-11-2000.
KAREN K. BUSH, EXAMINING ATTORNEY

SN 77-938,309. TRUSTED FEDERAL SYSTEMS, INC., POTOMAC, MD. FILED 2-17-2010.

Trusted Systems

THE MARK CONSISTS OF STANDARD CHARACTERS WITHOUT CLAIM TO ANY PARTICULAR FONT, STYLE, SIZE, OR COLOR.

NO CLAIM IS MADE TO THE EXCLUSIVE RIGHT TO USE "SYSTEMS", APART FROM THE MARK AS SHOWN.

CLASS 35—ADVERTISING AND BUSINESS

FOR BUSINESS MANAGEMENT CONSULTING (U.S. CLS. 100, 101 AND 102).

CLASS 42—SCIENTIFIC AND COMPUTER SERVICES

FOR CONSULTING IN THE FIELD OF INFORMATION TECHNOLOGY (U.S. CLS. 100 AND 101).
TEJBIR SINGH, EXAMINING ATTORNEY



THE MARK CONSISTS OF A STYLIZED DRAWING OF LUNGS.

CLASS 16—PAPER GOODS AND PRINTED MATTER

FOR PRINTED MATERIALS, NAMELY, SURVEYS IN THE FIELD OF MEDICAL AND HEALTH INFORMATION RELATING TO ASTHMA (U.S. CLS. 2, 5, 22, 23, 29, 37, 38 AND 50).
FIRST USE 11-3-2009; IN COMMERCE 11-3-2009.

CLASS 44—MEDICAL, BEAUTY AND AGRICULTURAL SERVICES

FOR PROVIDING A WEBSITE FEATURING MEDICAL AND HEALTH INFORMATION RELATING TO ASTHMA (U.S. CLS. 100 AND 101).
FIRST USE 11-3-2009; IN COMMERCE 11-3-2009.
ANNE MADDEN, EXAMINING ATTORNEY

SN 77-941,961. ROYAL TROPICS ASIA, LIMITED, TAIPEI, TAIWAN, FILED 2-22-2010.

OCULARA

THE MARK CONSISTS OF STANDARD CHARACTERS WITHOUT CLAIM TO ANY PARTICULAR FONT, STYLE, SIZE, OR COLOR.

CLASS 5—PHARMACEUTICALS

FOR NUTRITIONAL SUPPLEMENTS; VITAMIN AND MINERAL SUPPLEMENTS (U.S. CLS. 6, 18, 44, 46, 51 AND 52).

CLASS 32—LIGHT BEVERAGES

FOR FRUIT DRINKS AND JUICES; FRUIT JUICE CONCENTRATES; VEGETABLE DRINKS; VEGETABLE-FRUIT JUICES (U.S. CLS. 45, 46 AND 48).
SANJEEV VOHRA, EXAMINING ATTORNEY

SN 77-943,422. SCHERING CORPORATION, KENILWORTH, NJ. FILED 2-24-2010.



OWNER OF U.S. REG. NO. 2,409,024.
THE MARK CONSISTS OF THE WORDS "BE IN CHARGE" WITH ONE CURVED LINE OVER THE WORDS AND ONE CURVED LINE UNDER THE WORDS.

CLASS 16—PAPER GOODS AND PRINTED MATTER

FOR PRINTED MATERIALS, NAMELY, BROCHURES, WORKBOOKS, PAMPHLETS, BOOKLETS, NEWSLETTERS AND PROMOTIONAL MATERIALS IN THE FIELD OF HEPATITIS AND ITS TREATMENT (U.S. CLS. 2, 5, 22, 23, 29, 37, 38 AND 50).

CLASS 44—MEDICAL, BEAUTY AND AGRICULTURAL SERVICES

FOR PROVIDING A WEBSITE FEATURING MEDICAL AND HEALTH INFORMATION RELATING TO HEPATITIS AND ITS TREATMENT (U.S. CLS. 100 AND 101).
ANNE MADDEN, EXAMINING ATTORNEY

SN 77-943,423. SCHERING CORPORATION, KENILWORTH, NJ. FILED 2-24-2010.



OWNER OF U.S. REG. NO. 2,409,024.
THE COLOR(S) BLUE, GREEN AND RED IS/ARE CLAIMED AS A FEATURE OF THE MARK.
THE MARK CONSISTS OF THE WORDS "BE IN CHARGE" IN BLUE, WITH A RED DOT OVER THE "I", WITH A BLUE CURVED LINE OVER THE WORDS AND A GREEN CURVED LINE UNDER THE WORDS.

CLASS 16—PAPER GOODS AND PRINTED MATTER

FOR PRINTED MATERIALS, NAMELY, BROCHURES, WORKBOOKS, PAMPHLETS, BOOKLETS, NEWSLETTERS AND PROMOTIONAL MATERIALS IN THE FIELD OF HEPATITIS AND ITS TREATMENT (U.S. CLS. 2, 5, 22, 23, 29, 37, 38 AND 50).

CLASS 44—MEDICAL, BEAUTY AND AGRICULTURAL SERVICES

FOR PROVIDING A WEBSITE FEATURING MEDICAL AND HEALTH INFORMATION RELATING TO HEPATITIS AND ITS TREATMENT (U.S. CLS. 100 AND 101).
ANNE MADDEN, EXAMINING ATTORNEY

SN 77-944,077. PEPSICO, INC., PURCHASE, NY. FILED 2-24-2010.

HONOR THE CODE

THE MARK CONSISTS OF STANDARD CHARACTERS WITHOUT CLAIM TO ANY PARTICULAR FONT, STYLE, SIZE, OR COLOR.

CLASS 30—STAPLE FOODS

FOR TORTILLA CHIPS (U.S. CL. 46).

CLASS 32—LIGHT BEVERAGES

FOR SOFT DRINKS (U.S. CLS. 45, 46 AND 48).
KATHLEEN LORENZO, EXAMINING ATTORNEY

SN 77-944,087. DNF3, LLC, LAS VEGAS, NV. FILED 2-24-2010.

MURDER INK

THE MARK CONSISTS OF STANDARD CHARACTERS WITHOUT CLAIM TO ANY PARTICULAR FONT, STYLE, SIZE, OR COLOR.

NO CLAIM IS MADE TO THE EXCLUSIVE RIGHT TO USE "INK" FOR INTERNATIONAL CLASS 44, APART FROM THE MARK AS SHOWN.

CLASS 25—CLOTHING

FOR BELTS; BOTTOMS; JACKETS; JERSEYS; TOPS; WEARABLE GARMENTS AND CLOTHING, NAMELY, SHIRTS (U.S. CLS. 22 AND 39).

CLASS 44—MEDICAL, BEAUTY AND AGRICULTURAL SERVICES

FOR TATTOOING SERVICES (U.S. CLS. 100 AND 101).
MATTHEW PAPPAS, EXAMINING ATTORNEY

SN 77-944,383. ORO AGRI INC., AKA ORO AGRI, TROPHY CLUB, TX. FILED 2-25-2010.

OROWET

THE MARK CONSISTS OF STANDARD CHARACTERS WITHOUT CLAIM TO ANY PARTICULAR FONT, STYLE, SIZE, OR COLOR.

CLASS 1—CHEMICALS

FOR ADJUVANT FOR USE WITH AGRICULTURAL CHEMICALS; ADJUVANTS FOR USE IN THE MANUFACTURE OF HERBICIDES, INSECTICIDES, NEMATOCIDES; ADJUVANTS FOR USE WITH PESTICIDES (U.S. CLS. 1, 5, 6, 10, 26 AND 46).

FIRST USE 1-1-2007; IN COMMERCE 1-1-2007.

CLASS 5—PHARMACEUTICALS

FOR AGRICULTURAL PESTICIDES; BIOCIDES, GERMICIDES, BACTERICIDES, VIRUCIDES, FUNGICIDES, INSECTICIDES, PESTICIDES AND HERBICIDES; PESTICIDES FOR AGRICULTURAL USE (U.S. CLS. 6, 18, 44, 46, 51 AND 52).

KAREN SEVERSON, EXAMINING ATTORNEY

SN 77-944,730. NOVO NORDISK A/S, DK-2880 BAGSVAERD, DENMARK, FILED 2-25-2010.

DECKABETES

THE MARK CONSISTS OF STANDARD CHARACTERS WITHOUT CLAIM TO ANY PARTICULAR FONT, STYLE, SIZE, OR COLOR.

CLASS 16—PAPER GOODS AND PRINTED MATTER

FOR EDUCATIONAL PUBLICATIONS, NAMELY, EDUCATIONAL LEARNING CARDS IN THE FIELD OF DIABETES (U.S. CLS. 2, 5, 22, 23, 29, 37, 38 AND 50).

CLASS 28—TOYS AND SPORTING GOODS

FOR PLAYING CARDS (U.S. CLS. 22, 23, 38 AND 50).
HEATHER BIDDULPH, EXAMINING ATTORNEY

SN 77-945,520. COPLUS, INC., TAINAN HSIEN, TAIWAN, FILED 2-25-2010.

COPLUS

THE MARK CONSISTS OF STANDARD CHARACTERS WITHOUT CLAIM TO ANY PARTICULAR FONT, STYLE, SIZE, OR COLOR.

CLASS 11—ENVIRONMENTAL CONTROL APPARATUS

FOR RADIATOR CAPS AND AUTOMOTIVE LIGHTS, NAMELY, HEADLIGHTS, SIGNAL LIGHTS, BRAKE LIGHTS, TAILLIGHTS, CORNERING LIGHTS, AND SIDE MARKER VEHICLE REFLECTORS (U.S. CLS. 13, 21, 23, 31 AND 34).

CLASS 12—VEHICLES

FOR AUTOMOTIVE VEHICLE PARTS, NAMELY, REARVIEW MIRRORS, SIDE VIEW MIRRORS, GAS CAPS FOR VEHICLES, OIL TANK PLUGS AND CAPS, VEHICLE SIDE BARS, ENGINE HOODS, ORNAMENTAL GRILLE COVERS, AUTOMOBILE BUMPERS, AND MUD GUARDS (U.S. CLS. 19, 21, 23, 31, 35 AND 44).

ZACHARY BELLO, EXAMINING ATTORNEY

SN 77-948,091. CITIZENS FINANCIAL GROUP, INC., PROVIDENCE, RI. FILED 3-2-2010.

CITIZENS SECURE COMPLETE

THE MARK CONSISTS OF STANDARD CHARACTERS WITHOUT CLAIM TO ANY PARTICULAR FONT, STYLE, SIZE, OR COLOR.

OWNER OF U.S. REG. NOS. 2,482,203, 2,634,833 AND 2,668,486.

NO CLAIM IS MADE TO THE EXCLUSIVE RIGHT TO USE "SECURE COMPLETE", APART FROM THE MARK AS SHOWN.

CLASS 36—INSURANCE AND FINANCIAL

FOR FINANCIAL SERVICES, NAMELY, RETAIL AND COMMERCIAL ONLINE BANKING SERVICES OFFERED OVER PROTECTED COMPUTER NETWORKS (U.S. CLS. 100, 101 AND 102).

CLASS 45—PERSONAL AND LEGAL SERVICES

FOR FRAUD AND IDENTITY THEFT PROTECTION SERVICES (U.S. CLS. 100 AND 101).

ANGELA M. MICHELI, EXAMINING ATTORNEY

SN 77-948,118. CITIZENS FINANCIAL GROUP, INC., PROVIDENCE, RI. FILED 3-2-2010.

CITIZENS SECURE BASIC

THE MARK CONSISTS OF STANDARD CHARACTERS WITHOUT CLAIM TO ANY PARTICULAR FONT, STYLE, SIZE, OR COLOR.

OWNER OF U.S. REG. NOS. 2,482,203, 2,634,833 AND 2,668,486.

NO CLAIM IS MADE TO THE EXCLUSIVE RIGHT TO USE "SECURE BASIC", APART FROM THE MARK AS SHOWN.

CLASS 36—INSURANCE AND FINANCIAL

FOR FINANCIAL SERVICES, NAMELY, RETAIL AND COMMERCIAL ONLINE BANKING SERVICES OFFERED OVER PROTECTED COMPUTER NETWORKS (U.S. CLS. 100, 101 AND 102).

CLASS 45—PERSONAL AND LEGAL SERVICES

FOR FRAUD AND IDENTITY THEFT PROTECTION SERVICES (U.S. CLS. 100 AND 101).
ANGELA M. MICHELI, EXAMINING ATTORNEY

SN 77-948,332. CITIZENS FINANCIAL GROUP, INC., PROVIDENCE, RI. FILED 3-2-2010.

CHARTER ONE SECURE BASIC

SN 77-948,144. CITIZENS FINANCIAL GROUP, INC., PROVIDENCE, RI. FILED 3-2-2010.

CHARTER ONE SECURE COMPLETE

THE MARK CONSISTS OF STANDARD CHARACTERS WITHOUT CLAIM TO ANY PARTICULAR FONT, STYLE, SIZE, OR COLOR.

OWNER OF U.S. REG. NOS. 1,748,834, 2,450,402 AND OTHERS.

NO CLAIM IS MADE TO THE EXCLUSIVE RIGHT TO USE "SECURE COMPLETE", APART FROM THE MARK AS SHOWN.

THE MARK CONSISTS OF STANDARD CHARACTERS WITHOUT CLAIM TO ANY PARTICULAR FONT, STYLE, SIZE, OR COLOR.

OWNER OF U.S. REG. NOS. 1,748,834, 2,450,402 AND OTHERS.

NO CLAIM IS MADE TO THE EXCLUSIVE RIGHT TO USE "SECURE BASIC", APART FROM THE MARK AS SHOWN.

CLASS 36—INSURANCE AND FINANCIAL

FOR FINANCIAL SERVICES, NAMELY, RETAIL AND COMMERCIAL ONLINE BANKING SERVICES OFFERED OVER PROTECTED COMPUTER NETWORKS (U.S. CLS. 100, 101 AND 102).

CLASS 36—INSURANCE AND FINANCIAL

FOR FINANCIAL SERVICES, NAMELY, RETAIL AND COMMERCIAL ONLINE BANKING SERVICES OFFERED OVER PROTECTED COMPUTER NETWORKS (U.S. CLS. 100, 101 AND 102).

CLASS 45—PERSONAL AND LEGAL SERVICES

FOR FRAUD AND IDENTITY THEFT PROTECTION SERVICES (U.S. CLS. 100 AND 101).
ANGELA M. MICHELI, EXAMINING ATTORNEY

CLASS 45—PERSONAL AND LEGAL SERVICES

FOR FRAUD AND IDENTITY THEFT PROTECTION SERVICES (U.S. CLS. 100 AND 101).
ANGELA M. MICHELI, EXAMINING ATTORNEY

SN 77-948,211. DOLE FOOD COMPANY, INC., WESTLAKE VILLAGE, CA. FILED 3-2-2010.

SN 77-948,361. CITIZENS FINANCIAL GROUP, INC., PROVIDENCE, RI. FILED 3-2-2010.

CITIZENS SECURE**SQUISH'EMS!**

THE MARK CONSISTS OF STANDARD CHARACTERS WITHOUT CLAIM TO ANY PARTICULAR FONT, STYLE, SIZE, OR COLOR.

CLASS 29—MEATS AND PROCESSED FOODS

FOR FRUIT PUREES; PROCESSED FRUITS (U.S. CL. 46).

THE MARK CONSISTS OF STANDARD CHARACTERS WITHOUT CLAIM TO ANY PARTICULAR FONT, STYLE, SIZE, OR COLOR.

OWNER OF U.S. REG. NOS. 2,482,203, 2,668,486 AND OTHERS.

NO CLAIM IS MADE TO THE EXCLUSIVE RIGHT TO USE "SECURE", APART FROM THE MARK AS SHOWN.

CLASS 30—STAPLE FOODS

FOR FRUIT SAUCES EXCLUDING CRANBERRY SAUCE AND APPLSAUCE (U.S. CL. 46).
JUSTINE D. PARKER, EXAMINING ATTORNEY

CLASS 36—INSURANCE AND FINANCIAL

FOR FINANCIAL SERVICES, NAMELY, RETAIL AND COMMERCIAL ONLINE BANKING SERVICES OFFERED OVER PROTECTED COMPUTER NETWORKS (U.S. CLS. 100, 101 AND 102).

CLASS 45—PERSONAL AND LEGAL SERVICES

FOR FRAUD AND IDENTITY THEFT PROTECTION SERVICES (U.S. CLS. 100 AND 101).
ANGELA M. MICHELI, EXAMINING ATTORNEY

SN 77-948,380. THOMAS JEFFERSON UNIVERSITY, PHILADELPHIA, PA. FILED 3-2-2010.

SN 77-949,354. CITIZENS FINANCIAL GROUP, INC., PROVIDENCE, RI. FILED 3-3-2010.

SKILLS2CARE

CITIZENS FRAUD PROTECTOR

THE MARK CONSISTS OF STANDARD CHARACTERS WITHOUT CLAIM TO ANY PARTICULAR FONT, STYLE, SIZE, OR COLOR.

THE MARK CONSISTS OF STANDARD CHARACTERS WITHOUT CLAIM TO ANY PARTICULAR FONT, STYLE, SIZE, OR COLOR.

OWNER OF U.S. REG. NOS. 2,482,203, 2,668,486 AND OTHERS.

NO CLAIM IS MADE TO THE EXCLUSIVE RIGHT TO USE "FRAUD PROTECTOR", APART FROM THE MARK AS SHOWN.

CLASS 16—PAPER GOODS AND PRINTED MATTER

FOR PRINTED PERIODICALS AND PRINTED EDUCATIONAL MATERIALS, ALL IN THE FIELDS OF MEDICINE AND HEALTHCARE (U.S. CLS. 2, 5, 22, 23, 29, 37, 38 AND 50).

CLASS 41—EDUCATION AND ENTERTAINMENT

FOR EDUCATIONAL SERVICES, NAMELY, PROVIDING COURSES OF INSTRUCTION AT THE COLLEGE AND POSTGRADUATE LEVEL; PROVIDING CONTINUING EDUCATION SEMINARS, CLASSES, AND COURSES OF INSTRUCTION FOR HEALTH CARE PROFESSIONALS, AND PROVIDING SEMINARS, CLASSES, AND COURSES OF INSTRUCTION IN THE FIELD OF COMMUNITY HEALTH CARE EDUCATION (U.S. CLS. 100, 101 AND 107).

CLASS 36—INSURANCE AND FINANCIAL

FOR CREDIT AND DEBIT CARD SERVICES (U.S. CLS. 100, 101 AND 102).

CLASS 45—PERSONAL AND LEGAL SERVICES

FOR FRAUD AND IDENTITY THEFT PROTECTION SERVICES (U.S. CLS. 100 AND 101).
ANGELA M. MICHELI, EXAMINING ATTORNEY

CLASS 44—MEDICAL, BEAUTY AND AGRICULTURAL SERVICES

FOR HEALTH CARE SERVICES (U.S. CLS. 100 AND 101).
JUSTINE D. PARKER, EXAMINING ATTORNEY

SN 77-949,386. CITIZENS FINANCIAL GROUP, INC., PROVIDENCE, RI. FILED 3-3-2010.

SN 77-948,381. CITIZENS FINANCIAL GROUP, INC., PROVIDENCE, RI. FILED 3-2-2010.

CHARTER ONE SECURE

CHARTER ONE FRAUD PROTECTOR

THE MARK CONSISTS OF STANDARD CHARACTERS WITHOUT CLAIM TO ANY PARTICULAR FONT, STYLE, SIZE, OR COLOR.

OWNER OF U.S. REG. NOS. 1,748,834, 2,450,402 AND OTHERS.

NO CLAIM IS MADE TO THE EXCLUSIVE RIGHT TO USE "SECURE", APART FROM THE MARK AS SHOWN.

THE MARK CONSISTS OF STANDARD CHARACTERS WITHOUT CLAIM TO ANY PARTICULAR FONT, STYLE, SIZE, OR COLOR.

OWNER OF U.S. REG. NOS. 1,748,834, 2,450,402 AND OTHERS.

NO CLAIM IS MADE TO THE EXCLUSIVE RIGHT TO USE "FRAUD PROTECTOR", APART FROM THE MARK AS SHOWN.

CLASS 36—INSURANCE AND FINANCIAL

FOR FINANCIAL SERVICES, NAMELY, RETAIL AND COMMERCIAL ONLINE BANKING SERVICES OFFERED OVER PROTECTED COMPUTER NETWORKS (U.S. CLS. 100, 101 AND 102).

CLASS 36—INSURANCE AND FINANCIAL

FOR CREDIT AND DEBIT CARD SERVICES (U.S. CLS. 100, 101 AND 102).

CLASS 45—PERSONAL AND LEGAL SERVICES

FOR FRAUD AND IDENTITY THEFT PROTECTION SERVICES (U.S. CLS. 100 AND 101).
ANGELA M. MICHELI, EXAMINING ATTORNEY

CLASS 45—PERSONAL AND LEGAL SERVICES

FOR FRAUD AND IDENTITY THEFT PROTECTION SERVICES (U.S. CLS. 100 AND 101).
ANGELA M. MICHELI, EXAMINING ATTORNEY

SN 77-949,486. CW VENTURES LLC, DBA CENTER FOR AMERICAN RESPONSIBILITY, TIBURON, CA. FILED 3-3-2010.

SN 77-950,328. GREENWOOD EMERGENCY VEHICLES, INC., FORMERLY GREENWOOD FIRE APPARATUS, INC., NORTH ATTLEBORO, MA. FILED 3-4-2010.

Tough trucks. For tough
jobs.



NO CLAIM IS MADE TO THE EXCLUSIVE RIGHT TO USE "2012", APART FROM THE MARK AS SHOWN.

THE COLOR(S) RED, WHITE, GRAY IS/ARE CLAIMED AS A FEATURE OF THE MARK.

THE MARK CONSISTS OF A RED ROUND BUTTON WITH THE WORDS "RESET 2012" IN WHITE ENCASED IN TWO CONCENTRIC RINGS, THE FIRST HAVING A GRADIENT FROM GRAY TO WHITE, AND THE SECOND HAVING A GRADIENT FROM WHITE TO GRAY.

CLASS 16—PAPER GOODS AND PRINTED MATTER

FOR (BASED ON INTENT TO USE) BUMPER STICKERS; STICKERS (U.S. CLS. 2, 5, 22, 23, 29, 37, 38 AND 50).

CLASS 25—CLOTHING

FOR (BASED ON USE IN COMMERCE) HATS (BASED ON INTENT TO USE) TOPS (U.S. CLS. 22 AND 39).
FIRST USE 1-19-2010; IN COMMERCE 3-3-2010.

CLASS 35—ADVERTISING AND BUSINESS

FOR (BASED ON USE IN COMMERCE) ADVERTISING AND ADVERTISEMENT SERVICES; ADVERTISING AND MARKETING; ADVERTISING AND PROMOTIONAL SERVICES; ADVERTISING, MARKETING AND PROMOTION SERVICES; INFORMATION ABOUT POLITICAL ELECTIONS; PROVIDING INFORMATION REGARDING POLITICAL ISSUES, KNOWING HOW TO VOTE AND KNOWING HOW TO REGISTER TO VOTE (BASED ON INTENT TO USE) PROVIDING A WEBSITE FEATURING INFORMATION ABOUT POLITICAL ISSUES; PROVIDING AN INTERNET WEBSITE FEATURING NEWS AND INFORMATION IN THE FIELD OF NATIONAL AND INTERNATIONAL POLITICS; PROVIDING AN ON-LINE SEARCHABLE DATABASE FOR POLITICAL CAMPAIGNS WHICH ALLOW USERS TO COLLECT AND ANALYZE POLITICAL INFORMATION ELECTRONICALLY (U.S. CLS. 100, 101 AND 102).
FIRST USE 1-19-2010; IN COMMERCE 1-19-2010.

CLASS 38—COMMUNICATION

FOR (BASED ON INTENT TO USE) FACSIMILE COMMUNICATION (U.S. CLS. 100, 101 AND 104).
ARETHA SOMERVILLE, EXAMINING ATTORNEY

THE MARK CONSISTS OF STANDARD CHARACTERS WITHOUT CLAIM TO ANY PARTICULAR FONT, STYLE, SIZE, OR COLOR.

NO CLAIM IS MADE TO THE EXCLUSIVE RIGHT TO USE "TRUCKS", APART FROM THE MARK AS SHOWN.

CLASS 9—ELECTRICAL AND SCIENTIFIC APPARATUS

FOR FIRE TRUCKS (U.S. CLS. 21, 23, 26, 36 AND 38).

CLASS 12—VEHICLES

FOR LIGHT TRUCKS; MOTOR VEHICLES, NAMELY, AUTOMOBILES, TRUCKS, VANS, SPORT UTILITY VEHICLES AND STRUCTURAL PARTS THEREFOR; PICK-UP TRUCKS; TRUCKS (U.S. CLS. 19, 21, 23, 31, 35 AND 44).

COLLEEN KEARNEY, EXAMINING ATTORNEY

SN 77-950,546. VETOQUINOL U.S.A., INC., BUENA, NJ. FILED 3-4-2010.



NO CLAIM IS MADE TO THE EXCLUSIVE RIGHT TO USE "FOR PETS", APART FROM THE MARK AS SHOWN.

THE MARK CONSISTS OF A OVAL DESIGN IN THE BACKGROUND WITH THE WORDS "TOMLYN" IN LOWER CASE AND THE WORDS "FOR PETS. FOR LIFE." IN LOWER CASE IN A SMALLER FONT BELOW THE WORD "TOMLYN".

CLASS 3—COSMETICS AND CLEANING PREPARATIONS

FOR NON-MEDICATED GROOMING PREPARATIONS FOR PETS, NAMELY, SHAMPOO, HAIR RINSE, HAIR RELAXER, DEMATTING RINSE, HAND CREAM, DEODORANT, DEODORIZING SHAMPOO, MOISTURIZING SPRAYS FOR HAIR AND SKIN (U.S. CLS. 1, 4, 6, 50, 51 AND 52).

CLASS 5—PHARMACEUTICALS

FOR DIETARY SUPPLEMENTS FOR PETS; MEDICATED PREPARATIONS FOR PETS NAMELY, ANTI-SEPTIC PREPARATIONS, FUNGICIDE, FIRST AID LOTION, ANTIBACTERIAL STYPTIC POWDER, PREPARATIONS FOR TREATING CRACKING FEET, LAXATIVES, HAIRBALL LUBRICANTS, EYE WASH, EAR CLEANSER, SHAMPOO, PESTICIDE SHAMPOO (U.S. CLS. 6, 18, 44, 46, 51 AND 52).

MICHELLE DUBOIS, EXAMINING ATTORNEY

SN 77-951,377. MAUI BABE, INC., WAILUKU, HI. FILED 3-5-2010.

Maui Babe Purely Hawaiian

THE MARK CONSISTS OF STANDARD CHARACTERS WITHOUT CLAIM TO ANY PARTICULAR FONT, STYLE, SIZE, OR COLOR.

NO CLAIM IS MADE TO THE EXCLUSIVE RIGHT TO USE "HAWAIIAN", APART FROM THE MARK AS SHOWN.

CLASS 25—CLOTHING

FOR T-SHIRTS (U.S. CLS. 22 AND 39).

CLASS 30—STAPLE FOODS

FOR COFFEE (U.S. CL. 46).

CLASS 40—MATERIAL TREATMENT

FOR COFFEE ROASTING AND PROCESSING (U.S. CLS. 100, 103 AND 106).

MATTHEW MCDOWELL, EXAMINING ATTORNEY

SN 77-951,770. DNC PARKS & RESORTS AT YOSEMITE, INC., YOSEMITE, CA. FILED 3-5-2010.



OWNER OF U.S. REG. NOS. 2,741,174 AND 3,731,330.
THE MARK CONSISTS OF A REPRESENTATION OF A BADGER PAW PRINT.

CLASS 6—METAL GOODS

FOR METAL KEY CHAINS (U.S. CLS. 2, 12, 13, 14, 23, 25 AND 50).
FIRST USE 12-15-1990; IN COMMERCE 12-15-1990.

CLASS 9—ELECTRICAL AND SCIENTIFIC APPARATUS

FOR DECORATIVE MAGNETS (U.S. CLS. 21, 23, 26, 36 AND 38).
FIRST USE 12-15-1990; IN COMMERCE 12-15-1990.

CLASS 16—PAPER GOODS AND PRINTED MATTER

FOR STICKERS (U.S. CLS. 2, 5, 22, 23, 29, 37, 38 AND 50).
FIRST USE 12-15-1990; IN COMMERCE 12-15-1990.

CLASS 25—CLOTHING

FOR HATS; SOCKS; VISORS (U.S. CLS. 22 AND 39).
FIRST USE 12-15-1990; IN COMMERCE 12-15-1990.

CLASS 26—FANCY GOODS

FOR ORNAMENTAL NOVELTY PINS; ZIPPER PULLS (U.S. CLS. 37, 39, 40, 42 AND 50).
FIRST USE 12-15-1990; IN COMMERCE 12-15-1990.
ANDREA K. NADELMAN, EXAMINING ATTORNEY

SN 77-952,016. ELECTRIC BAT INTERACTIVE, LLC, AUSTIN, TX. FILED 3-5-2010.



NO CLAIM IS MADE TO THE EXCLUSIVE RIGHT TO USE "INTERACTIVE", APART FROM THE MARK AS SHOWN.

THE MARK CONSISTS OF THE WORDS "ELECTRIC BAT" WHERE IN THE WORD "BAT" IS IN FRONT OF A BAT IMAGE WITH EYES; AND THE WORD "INTERACTIVE" IS UNDERNEATH THE WORD "ELECTRIC".

CLASS 9—ELECTRICAL AND SCIENTIFIC APPARATUS

FOR DOWNLOADABLE COMPUTER GAME SOFTWARE (U.S. CLS. 21, 23, 26, 36 AND 38).

CLASS 38—COMMUNICATION

FOR PROVIDING ONLINE CHAT ROOMS FOR TRANSMISSION OF MESSAGES AMONG COMPUTER USERS CONCERNING TOPICS OF COMPUTER GAMING ENTERTAINMENT; PROVIDING ONLINE ELECTRONIC BULLETIN BOARDS FOR TRANSMISSION OF MESSAGES AMONG COMPUTER USERS CONCERNING TOPICS RELATED TO COMPUTER GAMES (U.S. CLS. 100, 101 AND 104).

CLASS 41—EDUCATION AND ENTERTAINMENT

FOR PROVIDING ONLINE NETWORKED AND INTERACTIVE COMPUTER GAMES VIA THE INTERNET (U.S. CLS. 100, 101 AND 107).
EDWARD FENNESSY, EXAMINING ATTORNEY

SN 77-955,431. KANEKA CORPORATION, OSAKA, JAPAN,
FILED 3-10-2010.

CellEffic

THE MARK CONSISTS OF STANDARD CHARACTERS WITHOUT CLAIM TO ANY PARTICULAR FONT, STYLE, SIZE, OR COLOR.

CLASS 9—ELECTRICAL AND SCIENTIFIC APPARATUS

FOR FILTERS FOR CELL SEPARATION FOR LABORATORY USE; LIQUID CIRCUITS USED WITH ABOVE FILTERS FOR LABORATORY USE (U.S. CLS. 21, 23, 26, 36 AND 38).

CLASS 10—MEDICAL APPARATUS

FOR FILTERS FOR CELL SEPARATION FOR MEDICAL AND PHARMACEUTICAL USE; LIQUID CIRCUITS USED WITH ABOVE FILTERS FOR PHARMACEUTICAL USE (U.S. CLS. 26, 39 AND 44).

KEVON CHISOLM, EXAMINING ATTORNEY

SN 77-955,905. KOHL'S ILLINOIS, INC., AURORA, IL. FILED
3-10-2010.

OWNER OF U.S. REG. NOS. 2,448,165 AND 3,351,623.
THE MARK CONSISTS OF THE WORDS "FIRST MOMENTS" WITH A DOT TRAIL LEADING TO A BEE IMAGE.

CLASS 16—PAPER GOODS AND PRINTED MATTER

FOR BABY BOOKS (U.S. CLS. 2, 5, 22, 23, 29, 37, 38 AND 50).

CLASS 20—FURNITURE AND ARTICLES NOT OTHERWISE CLASSIFIED

FOR PICTURE FRAMES (U.S. CLS. 2, 13, 22, 25, 32 AND 50).

CLASS 21—HOUSEWARES AND GLASS

FOR NON-METAL PIGGY BANKS (U.S. CLS. 2, 13, 23, 29, 30, 33, 40 AND 50).

CLASS 24—FABRICS

FOR BED BLANKETS; BURP CLOTHS; RECEIVING BLANKETS; TOWELS; WASH CLOTHS (U.S. CLS. 42 AND 50).

CLASS 25—CLOTHING

FOR BODY SUITS; BOOTIES; CLOTH BIBS; COVERALLS; CREEPERS; DRESSES; GOWNS; HEADWEAR; JACKETS; JUMPERS; PANTS; ROMPERS; SHIRTS; SHORTALLS; SHORTS; SKIRTS; SLEEPWEAR; SWEATERS (U.S. CLS. 22 AND 39).

CLASS 28—TOYS AND SPORTING GOODS

FOR PLUSH TOYS (U.S. CLS. 22, 23, 38 AND 50).
JESSICA A. POWERS, EXAMINING ATTORNEY

SN 77-955,907. KOHL'S ILLINOIS, INC., AURORA, IL. FILED
3-10-2010.



THE MARK CONSISTS OF A BEE IMAGE.

CLASS 16—PAPER GOODS AND PRINTED MATTER

FOR BABY BOOKS (U.S. CLS. 2, 5, 22, 23, 29, 37, 38 AND 50).

CLASS 20—FURNITURE AND ARTICLES NOT OTHERWISE CLASSIFIED

FOR PICTURE FRAMES (U.S. CLS. 2, 13, 22, 25, 32 AND 50).

CLASS 21—HOUSEWARES AND GLASS

FOR NON-METAL PIGGY BANKS (U.S. CLS. 2, 13, 23, 29, 30, 33, 40 AND 50).

CLASS 24—FABRICS

FOR BED BLANKETS; BURP CLOTHS; RECEIVING BLANKETS; TOWELS; WASH CLOTHS (U.S. CLS. 42 AND 50).

CLASS 25—CLOTHING

FOR BODY SUITS; BOOTIES; CLOTH BIBS; COVERALLS; CREEPERS; DRESSES; GOWNS; HEADWEAR; JACKETS; JUMPERS; PANTS; ROMPERS; SHIRTS; SHORTALLS; SHORTS; SKIRTS; SLEEPWEAR; SWEATERS (U.S. CLS. 22 AND 39).

CLASS 28—TOYS AND SPORTING GOODS

FOR PLUSH TOYS (U.S. CLS. 22, 23, 38 AND 50).
JESSICA A. POWERS, EXAMINING ATTORNEY

SN 77-957,008. SAMSUNG ELECTRONICS CO., LTD., SUWON-SI, GYEONGGI-DO, REPUBLIC OF KOREA, FILED 3-11-2010.

SN 77-957,489. ABBOTT LABORATORIES, ABBOTT PARK, IL. FILED 3-12-2010.

EYETOPIA

THE MARK CONSISTS OF STANDARD CHARACTERS WITHOUT CLAIM TO ANY PARTICULAR FONT, STYLE, SIZE, OR COLOR.

CLASS 35—ADVERTISING AND BUSINESS

FOR ON-LINE RETAIL STORE SERVICES FEATURING DOWNLOADABLE PRE-RECORDED MUSIC AND VIDEO, DOWNLOADABLE RINGTONES AND WALLPAPER, DOWNLOADABLE MOVIES, BOOKS, MAGAZINES, GAMES, AND APPLICATION SOFTWARE FOR MOBILE PHONES (U.S. CLS. 100, 101 AND 102).

CLASS 38—COMMUNICATION

FOR ELECTRONIC MAIL SERVICES; SERVICES OF PROVIDING ACCESS TO STREAMED SOUND AND AUDIO-VISUAL RECORDINGS OR MULTIMEDIA CONTENTS APPLICABLE FOR CELLULAR PHONES VIA THE INTERNET.; PROVIDING ON-LINE FORUMS FOR TRANSMISSION OF MESSAGES AMONG COMPUTER USERS CONCERNING MOBILE PHONES, MOBILE PHONE ACCESSORIES, AND MOBILE PHONE APPLICATIONS; TRANSMISSION OF SOUND, VIDEO AND INFORMATION FROM WEB CAMS, VIDEO CAMERAS OR MOBILE PHONES, ALL FEATURING LIVE OR RECORDED MATERIALS; VIDEO STREAMING SERVICES VIA THE INTERNET, FEATURING CONCERTS, SPORTING EVENTS AND FASHION SHOWS (U.S. CLS. 100, 101 AND 104).

CLASS 42—SCIENTIFIC AND COMPUTER SERVICES

FOR HOSTING OF DIGITAL CONTENTS APPLICABLE FOR MOBILE COMMUNICATION APPLIANCES VIA THE INTERNET OR GLOBAL COMPUTER NETWORKS; PROVIDING PERIODIC UPDATES REGARDING MOBILE PHONES AND MOBILE PHONE APPLICATIONS TO SUBSCRIBERS VIA ELECTRONIC MAIL; PROVIDING A WEBSITE THAT GIVES USERS THE ABILITY TO PURCHASE DOWNLOADABLE MOVIES, MUSIC, VIDEOS, BOOKS, MAGAZINES, DOWNLOADABLE RINGTONES, WALLPAPER, GRAPHICS, GAMES, AND APPLICATION SOFTWARE FOR MOBILE PHONES; COMPUTER SERVICES, NAMELY, PROVIDING A WEB-BASED SYSTEM AND ONLINE PORTAL THAT ALLOWS USERS TO COLLECT, STORE, MANAGE, DELIVER AND SHOWCASE ELECTRONIC CONTENT, NAMELY, MUSIC, VIDEOS, GAMES, MOVIES; COMPUTER SERVICES, NAMELY, PROVIDING SEARCH PLATFORMS TO ALLOW USERS TO REQUEST CONTENT FROM AND RECEIVE CONTENT TO A MOBILE DEVICE (U.S. CLS. 100 AND 101).
SEAN CROWLEY, EXAMINING ATTORNEY

DIRECTIONS FOR LIFE

THE MARK CONSISTS OF STANDARD CHARACTERS WITHOUT CLAIM TO ANY PARTICULAR FONT, STYLE, SIZE, OR COLOR.

CLASS 16—PAPER GOODS AND PRINTED MATTER

FOR PRINTED MATTER, NAMELY, BROCHURES, PAMPHLETS, FORMS AND MAGAZINE ARTICLE REPRINTS, ALL ON THE SUBJECT OF DIABETES (U.S. CLS. 2, 5, 22, 23, 29, 37, 38 AND 50).

CLASS 44—MEDICAL, BEAUTY AND AGRICULTURAL SERVICES

FOR PROVIDING MEDICAL INFORMATION TO HEALTHCARE PROFESSIONALS AND PATIENTS REGARDING DIABETES (U.S. CLS. 100 AND 101).
DANIEL CAPSHAW, EXAMINING ATTORNEY

SN 77-957,507. ABBOTT LABORATORIES, ABBOTT PARK, IL. FILED 3-12-2010.

REFINING GLUCOSE CONTROL...REDEFINING LIFE FOR PEOPLE WITH DIABETES

THE MARK CONSISTS OF STANDARD CHARACTERS WITHOUT CLAIM TO ANY PARTICULAR FONT, STYLE, SIZE, OR COLOR.

CLASS 16—PAPER GOODS AND PRINTED MATTER

FOR PRINTED MATTER, NAMELY, BROCHURES, PAMPHLETS, FORMS AND MAGAZINE ARTICLE REPRINTS ALL ON THE SUBJECT OF DIABETES (U.S. CLS. 2, 5, 22, 23, 29, 37, 38 AND 50).

CLASS 44—MEDICAL, BEAUTY AND AGRICULTURAL SERVICES

FOR PROVIDING MEDICAL INFORMATION TO HEALTHCARE PROFESSIONALS AND PATIENTS REGARDING DIABETES (U.S. CLS. 100 AND 101).
DANIEL CAPSHAW, EXAMINING ATTORNEY

SN 77-957,529. ABBOTT LABORATORIES, ABBOTT PARK, IL. FILED 3-12-2010.

REFLECT. CORRECT. PROJECT.

THE MARK CONSISTS OF STANDARD CHARACTERS WITHOUT CLAIM TO ANY PARTICULAR FONT, STYLE, SIZE, OR COLOR.

CLASS 16—PAPER GOODS AND PRINTED MATTER

FOR PRINTED MATTER, NAMELY, BROCHURES, PAMPHLETS, FORMS AND MAGAZINE ARTICLE REPRINTS ALL ON THE SUBJECT OF DIABETES (U.S. CLS. 2, 5, 22, 23, 29, 37, 38 AND 50).

CLASS 44—MEDICAL, BEAUTY AND AGRICULTURAL SERVICES

FOR PROVIDING MEDICAL INFORMATION TO HEALTHCARE PROFESSIONALS AND PATIENTS REGARDING DIABETES (U.S. CLS. 100 AND 101). DANIEL CAPSHAW, EXAMINING ATTORNEY

CLASS 25—CLOTHING

FOR CLOTHING, NAMELY, SHIRTS, T-SHIRTS, UNDER SHIRTS, NIGHT SHIRTS, RUGBY SHIRTS, POLO SHIRTS, CARDIGANS, JERSEYS, UNIFORMS, PANTS, TROUSERS, SUITS, BLAZERS, DRESS SHIRTS, SLACKS, JEANS, DENIM JEANS, CULOTTES, CARGO PANTS, OVERALLS, COVERALLS, JUMPERS, JUMP SUITS, SHORTS, BOXER SHORTS, TOPS, CROP TOPS, TANK TOPS, HALTER TOPS, SWEAT SHIRTS, SWEAT SHORTS, SWEAT PANTS, WRAPS, WARM-UP SUITS, JOGGING SUITS, TRACK SUITS, PLAY SUITS, BLOUSES, SKIRTS, DRESSES, GOWNS, SWEATERS, VESTS, FLEECE VESTS, PULLOVERS, SNOW SUITS, PARKAS, CAPES, ANORAKS, PONCHOS, JACKETS, SPORTS JACKETS, REVERSIBLE JACKETS, FLEECE JACKETS, COATS, TURTLENECKS, CLOTH SKI BIBS, BEACHWEAR, TENNIS WEAR, SURF WEAR, SKI WEAR, LAYETTES, INFANT WEAR, INFANTS SLEEPERS, BOOTIES, BABY BIBS NOT OF PAPER, CLOTH DIAPERS, CAPS, SWIM CAPS, BERETS, BEANIES, HATS, VISORS, HEADBANDS, WRIST BANDS, SWEAT BANDS, HEADWEAR, EAR MUFFS, APRONS, SCARVES, BANDANAS, BELTS, SUSPENDERS, NECKWEAR, NECKERCHIEFS, ASCOTS, UNDERWEAR, THERMAL UNDERWEAR, LONG UNDERWEAR, BRIEFS, SWIM AND BATHING TRUNKS, BRAS, SPORTS BRAS, BRASSIERES, BUSTIERS, CORSETS, PANTIES, THONGS, GARTERS AND GARTER BELTS, TEDDIES, GIRDLES, FOUNDATION GARMENTS, LOUNGEWEAR, ROBES, SMOCKS, UNDERCLOTHES, PAJAMAS, SLEEPWEAR, NIGHTWEAR, NIGHT GOWNS, LINGERIE, CAMISOLES, NEGLIGEEES, CHEMISES, CHEMISETTES, SLIPS, SARONGS, LEG WARMERS, PANTYHOSE, BODY STOCKINGS, KNEE HIGHS, LEGGINGS, TIGHTS, LEOTARDS, BODY SUITS, UNITARDS, BODY SHAPERS, GLOVES, MITTENS, RAINWEAR, SNEAKERS, BOOTS, GALOSHES, SANDALS, FLIP-FLOPS, AND SLIPPERS; FOOTWEAR, SHOES, HOSIERY, SOCKS, AND SWIMWEAR; MEN'S FORMALWEAR, NAMELY, SUITS, BLAZERS, JACKETS, TROUSERS, DRESS SHIRTS, TIES, COATS, RAIN COATS AND TRENCH COATS (U.S. CLS. 22 AND 39). APRIL ROACH, EXAMINING ATTORNEY

SN 77-958,508. LMT GLOBAL LLC, ONTARIO, CA. FILED 3-14-2010.

SN 77-959,765. OMP, INC., LONG BEACH, CA. FILED 3-16-2010.

Raw Kandi

THE MARK CONSISTS OF STANDARD CHARACTERS WITHOUT CLAIM TO ANY PARTICULAR FONT, STYLE, SIZE, OR COLOR.

CLASS 18—LEATHER GOODS

FOR TOTE AND TRAVEL BAGS, WAIST PACKS, BACKPACKS, KNAPSACKS, PURSES, GARMENT BAGS FOR TRAVEL, SATCHELS, LUGGAGE, TRUNKS, SUITCASES, BAGS FOR SPORTS, WALLETS, COSMETIC CASES AND BAGS SOLD EMPTY, TOILETRY AND VANITY CASES SOLD EMPTY, ATTACHE CASES, BRIEFCASES, BRIEFCASE-TYPE PORTFOLIOS (U.S. CLS. 1, 2, 3, 22 AND 41).

OBAGI FOR LIFE

THE MARK CONSISTS OF STANDARD CHARACTERS WITHOUT CLAIM TO ANY PARTICULAR FONT, STYLE, SIZE, OR COLOR.

OWNER OF U.S. REG. NOS. 2,786,594, 3,410,886 AND OTHERS.

CLASS 3—COSMETICS AND CLEANING PREPARATIONS

FOR NON-MEDICATED SKIN CARE PREPARATIONS (U.S. CLS. 1, 4, 6, 50, 51 AND 52).

CLASS 5—PHARMACEUTICALS

FOR MEDICATED SKIN CARE PREPARATIONS; PHARMACEUTICAL PREPARATIONS FOR SKIN CARE (U.S. CLS. 6, 18, 44, 46, 51 AND 52). KAPIL BHANOT, EXAMINING ATTORNEY

SN 77-959,931. CEDAR'S MEDITERRANEAN FOODS, INC.,
WARD HILL, MA. FILED 3-16-2010.

SN 77-960,581. DR. SEUSS ENTERPRISES, L.P., LA JOLLA,
CA. FILED 3-16-2010.

CEDAR'S MEDITERRANEAN FOODS

THE MARK CONSISTS OF STANDARD CHARACTERS WITHOUT CLAIM TO ANY PARTICULAR FONT, STYLE, SIZE, OR COLOR.

OWNER OF U.S. REG. NOS. 1,863,818 AND 3,289,317.

NO CLAIM IS MADE TO THE EXCLUSIVE RIGHT TO USE "MEDITERRANEAN FOODS", APART FROM THE MARK AS SHOWN.

CLASS 29—MEATS AND PROCESSED FOODS

FOR HUMMUS, TAHINI, BABA GHANNOUJ, PROCESSED LENTIL PILAF, CHICK PEA SALAD, BLACK BEAN SALAD, EDAMAME SALAD, FALAFEL, FETA CHEESE-BASED SPREADS, STUFFED GRAPE LEAVES, BRUSCHETTA TOPPINGS, TZATZIKI, NAMELY, A DIP COMPRISED OF YOGURT, CUCUMBER, MINT AND GARLIC, MUJADDARA, NAMELY, A PROCESSED SALAD COMPOSED OF A MIXTURE OF LENTILS, RICE, ONIONS AND SPICES (U.S. CL. 46).

FIRST USE 2-22-2010; IN COMMERCE 2-22-2010.

CLASS 30—STAPLE FOODS

FOR SALSA, TORTILLAS AND SANDWICH WRAPS, TORTILLA CHIPS; PITA BREAD, PITA CHIPS, BAKLAVA, HALVA, ORZO RICE SALAD, TABBOULEH (U.S. CL. 46).

FIRST USE 2-22-2010; IN COMMERCE 2-22-2010.

MICHELE SWAIN, EXAMINING ATTORNEY

SN 77-960,022. DOREL JUVENILE GROUP, INC., FOXBORO,
MA. FILED 3-16-2010.



THE MARK CONSISTS OF A DIAMOND OUTLINE WITHIN WHICH THE LETTER AND NUMBER "S1" APPEARS IN THE CENTER.

CLASS 12—VEHICLES

FOR STROLLERS; JUVENILE CAR SEATS; COMBINATION JUVENILE CAR SEATS AND STROLLERS (U.S. CLS. 19, 21, 23, 31, 35 AND 44).

CLASS 20—FURNITURE AND ARTICLES NOT OTHERWISE CLASSIFIED

FOR PLAY YARDS; HIGH CHAIRS (U.S. CLS. 2, 13, 22, 25, 32 AND 50).

SAMUEL E. SHARPER JR., EXAMINING ATTORNEY

DR. SEUSS

THE MARK CONSISTS OF STANDARD CHARACTERS WITHOUT CLAIM TO ANY PARTICULAR FONT, STYLE, SIZE, OR COLOR.

OWNER OF U.S. REG. NOS. 3,470,810, 3,701,165 AND OTHERS.

THE NAME "DR. SEUSS" DOES NOT IDENTIFY A LIVING INDIVIDUAL.

CLASS 16—PAPER GOODS AND PRINTED MATTER

FOR PAPER NAPKINS, PAPER TABLECLOTHS, PAPER WALL BANNERS, CARDBOARD CENTERPIECES, NOTEBOOKS, GREETING CARDS (U.S. CLS. 2, 5, 22, 23, 29, 37, 38 AND 50).

FIRST USE 3-1-2010; IN COMMERCE 3-1-2010.

CLASS 21—HOUSEWARES AND GLASS

FOR PAPER PLATES, PAPER CUPS (U.S. CLS. 2, 13, 23, 29, 30, 33, 40 AND 50).

FIRST USE 3-1-2010; IN COMMERCE 3-1-2010.

APRIL ROACH, EXAMINING ATTORNEY

SN 77-960,594. DR. SEUSS ENTERPRISES, L.P., LA JOLLA,
CA. FILED 3-16-2010.



OWNER OF U.S. REG. NOS. 3,470,810, 3,701,165 AND OTHERS.

THE NAME "DR. SEUSS" DOES NOT IDENTIFY A LIVING INDIVIDUAL.

THE MARK CONSISTS OF STYLIZED WORD "DR. SEUSS".

CLASS 16—PAPER GOODS AND PRINTED MATTER

FOR PAPER NAPKINS, PAPER TABLECLOTHS, PAPER WALL BANNERS, CARDBOARD CENTERPIECES, NOTEBOOKS, GREETING CARDS (U.S. CLS. 2, 5, 22, 23, 29, 37, 38 AND 50).

FIRST USE 3-1-2010; IN COMMERCE 3-1-2010.

CLASS 21—HOUSEWARES AND GLASS

FOR PAPER PLATES, PAPER CUPS (U.S. CLS. 2, 13, 23, 29, 30, 33, 40 AND 50).

FIRST USE 3-1-2010; IN COMMERCE 3-1-2010.

APRIL ROACH, EXAMINING ATTORNEY

SN 77-962,182. THE BINDING SITE GROUP, LTD., BIRMINGHAM, UNITED KINGDOM, FILED 3-18-2010.

COMBYLITE

THE MARK CONSISTS OF STANDARD CHARACTERS WITHOUT CLAIM TO ANY PARTICULAR FONT, STYLE, SIZE, OR COLOR.

CLASS 1—CHEMICALS

FOR REAGENTS, DIAGNOSTIC REAGENTS, BIOLOGICAL REAGENTS, HISTOLOGY REAGENTS, ENZYME IMMUNOASSAY REAGENTS, ANTIGEN SUBSTRATES, AND ANTIBODIES FOR SCIENTIFIC RESEARCH USE; AND TEST KITS COMPRISED OF REAGENTS, BUFFERS, CALIBRATORS, DILUENTS, ANTIBODIES, ANTIGEN SUBSTRATES, CONJUGATES, STOPPING SOLUTIONS, AND/OR ANTISERA FOR SCIENTIFIC AND RESEARCH USE USING BLOOD, BODY FLUIDS, BODY TISSUES OR EXTRACTS THEREOF (U.S. CLS. 1, 5, 6, 10, 26 AND 46).

CLASS 5—PHARMACEUTICALS

FOR CALIBRATING SOLUTIONS, DILUENTS, CONTROL SAMPLES, REAGENTS, ANTIBODIES, ANTIGEN SUBSTRATES, CONJUGATES, STOPPING SOLUTIONS, IMMUNOFLUORESCENCE REAGENTS, HISTOLOGY REAGENTS, ENZYME IMMUNOASSAY REAGENTS AND GENERAL PURPOSE REAGENTS FOR MEDICAL AND VETERINARY DIAGNOSTIC AND CLINICAL USE; AND DIAGNOSTIC AND IMMUNOLOGICAL TEST KITS CONSISTING OF REAGENTS, CONTROLS, BUFFERS, CALIBRATORS, DILUENTS, ANTIBODIES, ANTIGEN SUBSTRATES, CONJUGATES, STOPPING SOLUTIONS, AND/OR ANTISERA, ALL FOR USE IN MEASURING THE CONCENTRATION OF PROTEINS, ANTIBODIES, ANTIGENS AND OTHER SUBSTANCES IN BLOOD, OTHER BODY FLUIDS AND BODY TISSUES, OR EXTRACTS THEREOF, FOR USE IN THE DIAGNOSIS, TREATMENT, CURE, PREVENTION OR MITIGATION OF DISEASES AND OTHER CONDITIONS IN HUMANS AND ANIMALS (U.S. CLS. 6, 18, 44, 46, 51 AND 52).

PATRICIA EVANKO, EXAMINING ATTORNEY

SN 77-963,347. MUELLER SPORTS MEDICINE, INC., PRAIRIE DU SAC, WI. FILED 3-19-2010.

ATHLETIC CARE

THE MARK CONSISTS OF STANDARD CHARACTERS WITHOUT CLAIM TO ANY PARTICULAR FONT, STYLE, SIZE, OR COLOR.

NO CLAIM IS MADE TO THE EXCLUSIVE RIGHT TO USE "ATHLETIC", APART FROM THE MARK AS SHOWN.

CLASS 5—PHARMACEUTICALS

FOR TAPE AND TAPING SUPPLIES FOR MEDICAL PURPOSES, NAMELY, MEDICAL ADHESIVE TAPE, MEDICAL COHESIVE TAPE, MEDICAL PRETAPING FOAM UNDERWRAP, MEDICAL PRETAPING SPRAY ADHERENT; FIRST AID KITS; ATHLETIC TRAINERS' KITS COMPRISED PRIMARILY OF ADHESIVE BANDAGES, MEDICAL ADHESIVE TAPE, GAUZE PADS FOR DRESSINGS, MEDICAL COHESIVE TAPE, ANTI-BIOTIC OINTMENTS, ANTISEPTIC SPRAY, SPRAY-ON BANDAGES AND ICE BAGS FOR MEDICAL PURPOSES; ANALGESIC OINTMENTS AND BALMS; MEDICAL AND SURGICAL DRESSINGS, NAMELY, BLISTER PADS, WOUND DRESSINGS; NONMEDICATED TOPICAL GELS AND OINTMENTS FOR USE AS PERSONAL LUBRICANTS ON SKIN; ALL PURPOSE DISINFECTANTS AND ANTIBACTERIAL CLEANERS FOR SURFACES; SPRAY ON BANDAGES FOR SKIN WOUNDS; ANTISEPTIC SPRAYS AND OINTMENTS FOR MEDICAL USE; ADHESIVE BANDAGES (U.S. CLS. 6, 18, 44, 46, 51 AND 52).

CLASS 10—MEDICAL APPARATUS

FOR COHESIVE SUPPORT BANDAGES, COHESIVE COMPRESSION BANDAGES; COLD-HOT THERAPY PRODUCTS FOR MEDICAL PURPOSES, NAMELY, ICE BAGS, CHEMICALLY ACTIVATED COLD PACKS, CHEMICALLY ACTIVATED INSTANT COLD PACKS, COLD-HOT THERMAL PACKS FOR FIRST AID PURPOSES, SPRAY COOLANT FOR SKIN FOR MEDICAL PURPOSES, MEDICAL COLD-HOT WRAPS; ELASTIC BANDAGES, ELASTIC SUPPORT WRAPS FOR MEDICAL PURPOSES; MEDICAL AND ORTHOPEDIC PRODUCTS, NAMELY, ORTHOPEDIC BRACES, ANKLE BRACES, ANKLE SUPPORTS, ANKLE STABILIZERS, KNEE BRACES, KNEE SUPPORTS, KNEE STABILIZERS, KNEE SLEEVES, KNEE STRAPS, ELBOW SLEEVES, ELBOW SUPPORTS, WRIST BRACES, WRIST SUPPORTS, WRIST STABILIZERS, WRIST SLEEVES, COMPRESSION GLOVES, BACK BRACES, BACK SUPPORTS, BACK STABILIZERS, THUMB STABILIZERS, SHOULDER BRACES, THIGH SLEEVES, THIGH SUPPORTS, CALF/SHIN SUPPORTS, ARM SLINGS (U.S. CLS. 26, 39 AND 44).

CLASS 28—TOYS AND SPORTING GOODS

FOR TAPE AND TAPING SUPPLIES FOR ATHLETIC PURPOSES, NAMELY, ATHLETIC ADHESIVE TAPE, ATHLETIC COHESIVE TAPE AND BANDAGES, ATHLETIC PRETAPING FOAM UNDERWRAP, ATHLETIC PRETAPING SPRAY ADHERENT; GLARE REDUCING UNDER EYE STRIPS, EYE BLACK PASTE FOR REDUCING SUN GLARE FOR SPORTS ACTIVITIES; ATHLETIC SPORTING GOODS, NAMELY, ATHLETIC WRIST AND JOINT SUPPORTS, ANKLE BRACES, ANKLE SUPPORTS, ANKLE STABILIZERS, KNEE BRACES, KNEE SUPPORTS, KNEE STABILIZERS, KNEE PADS FOR ATHLETIC USE, KNEE SLEEVES, KNEE STRAPS, ELBOW SLEEVES, ELBOW SUPPORTS, ELBOW PADS FOR ATHLETIC USE, WRIST BRACES, WRIST SUPPORTS, WRIST STABILIZERS, WRIST SLEEVES, BACK BRACES, BACK SUPPORTS, BACK STABILIZERS, THUMB STABILIZERS, SHOULDER BRACES, THIGH SLEEVES, THIGH SUPPORTS, CALF/SHIN SUPPORTS, ARM SLINGS; COMPRESSION GLOVES FOR ATHLETIC USE; MOUTH GUARDS FOR ATHLETIC USE; NOSE GUARDS FOR ATHLETIC USE; ATHLETIC SUPPORTERS, JOCK STRAPS, PROTECTIVE ATHLETIC CUPS, ATHLETIC SUPPORT BRIEFS; PROTECTIVE COLLARS FOR FASTENING TO FOOTBALL SHOULDER PADS; NONMEDICATED LUBRICATING OINTMENTS AND GELS FOR REDUCING SKIN FRICTION IN SPORTS ACTIVITIES AND RUNNING; GRIP ENHANCERS FOR USE IN ATHLETIC ACTIVITIES, NAMELY, CHALK, CRUSHED AND POWDERED ROSIN, WATER REPELLING SPRAY FOR HANDS, ADHESIVE POWDER FOR HANDS, AEROSOL ADHESIVE NON-SLIP RESIN SPRAY FOR HANDS, AND PINE TAR FOR ATHLETIC EQUIPMENT (U.S. CLS. 22, 23, 38 AND 50).

LINDA POWELL, EXAMINING ATTORNEY

SN 77-965,294. FTEN, INC., NEW YORK, NY. FILED 3-22-2010.

SDL

THE MARK CONSISTS OF STANDARD CHARACTERS WITHOUT CLAIM TO ANY PARTICULAR FONT, STYLE, SIZE, OR COLOR.

CLASS 9—ELECTRICAL AND SCIENTIFIC APPARATUS

FOR SOFTWARE FOR USE IN HIGH SPEED, LOW LATENCY FINANCIAL SECURITIES TRADING (U.S. CLS. 21, 23, 26, 36 AND 38).

CLASS 35—ADVERTISING AND BUSINESS

FOR ANALYZING AND COMPILING DATA FOR MEASURING THE PERFORMANCE OF FINANCIAL MARKETS (U.S. CLS. 100, 101 AND 102).
DOMINIC FATHY, EXAMINING ATTORNEY

SN 77-967,574. CALLAWAY GOLF COMPANY, CARLSBAD, CA. FILED 3-24-2010.

Beyond Comfort

THE MARK CONSISTS OF STANDARD CHARACTERS WITHOUT CLAIM TO ANY PARTICULAR FONT, STYLE, SIZE, OR COLOR.

CLASS 25—CLOTHING

FOR FOOTWEAR; HEADWEAR; JACKETS; PANTS; SHIRTS; SOCKS (U.S. CLS. 22 AND 39).

CLASS 28—TOYS AND SPORTING GOODS

FOR GOLF GLOVES (U.S. CLS. 22, 23, 38 AND 50).
JOHN DWYER, EXAMINING ATTORNEY

SN 77-967,617. VALENT U.S.A. CORPORATION, WALNUT CREEK, CA. FILED 3-24-2010.

METLOCK

THE MARK CONSISTS OF STANDARD CHARACTERS WITHOUT CLAIM TO ANY PARTICULAR FONT, STYLE, SIZE, OR COLOR.

CLASS 1—CHEMICALS

FOR CHEMICAL PREPARATIONS FOR USE IN AGRICULTURE, HORTICULTURE AND FORESTRY, NAMELY, CHEMICAL PREPARATIONS FOR THE TREATMENT OF SEEDS (U.S. CLS. 1, 5, 6, 10, 26 AND 46).

CLASS 5—PHARMACEUTICALS

FOR FUNGICIDES (U.S. CLS. 6, 18, 44, 46, 51 AND 52).
JEAN IM, EXAMINING ATTORNEY

SN 77-968,144. PHOENIX INTANGIBLES HOLDING COMPANY, GREENVILLE, DE. FILED 3-25-2010.

**GetFleet Regional from
GetGo**

THE MARK CONSISTS OF STANDARD CHARACTERS WITHOUT CLAIM TO ANY PARTICULAR FONT, STYLE, SIZE, OR COLOR.

OWNER OF U.S. REG. NOS. 2,814,781 AND 2,927,501.
NO CLAIM IS MADE TO THE EXCLUSIVE RIGHT TO USE REGIONAL, APART FROM THE MARK AS SHOWN.

CLASS 9—ELECTRICAL AND SCIENTIFIC APPARATUS

FOR MAGNETICALLY ENCODED CREDIT CARD FOR FLEET PURCHASES OF GASOLINE AND RELATED PRODUCTS (U.S. CLS. 21, 23, 26, 36 AND 38).

CLASS 36—INSURANCE AND FINANCIAL

FOR CREDIT CARD SERVICES FOR FLEET PURCHASES OF GASOLINE AND RELATED PRODUCTS (U.S. CLS. 100, 101 AND 102).
JANICE L. MCMORROW, EXAMINING ATTORNEY

SN 77-968,147. PHOENIX INTANGIBLES HOLDING COMPANY, GREENVILLE, DE. FILED 3-25-2010.

GetFleet Regional

THE MARK CONSISTS OF STANDARD CHARACTERS WITHOUT CLAIM TO ANY PARTICULAR FONT, STYLE, SIZE, OR COLOR.

NO CLAIM IS MADE TO THE EXCLUSIVE RIGHT TO USE "REGIONAL", APART FROM THE MARK AS SHOWN.

CLASS 9—ELECTRICAL AND SCIENTIFIC APPARATUS

FOR MAGNETICALLY ENCODED CREDIT CARD FOR FLEET PURCHASES OF GASOLINE AND RELATED PRODUCTS (U.S. CLS. 21, 23, 26, 36 AND 38).

CLASS 36—INSURANCE AND FINANCIAL

FOR CREDIT CARD SERVICES FOR FLEET PURCHASES OF GASOLINE AND RELATED PRODUCTS (U.S. CLS. 100, 101 AND 102).

JANICE L. MCMORROW, EXAMINING ATTORNEY

SN 77-968,842. DOMENICO DELUCA, CONCORD, CA.
FILED 3-25-2010.

BIOFINA

THE MARK CONSISTS OF STANDARD CHARACTERS WITHOUT CLAIM TO ANY PARTICULAR FONT, STYLE, SIZE, OR COLOR.

CLASS 16—PAPER GOODS AND PRINTED MATTER

FOR PLASTIC BAGS FOR GENERAL PURPOSE; PLASTIC BAGS FOR UNDERGARMENT DISPOSAL; PLASTIC BUBBLE PACKS; PLASTIC FOOD STORAGE BAGS FOR HOUSEHOLD USE; PLASTIC BAGS FOR HOUSEHOLD USE; PLASTIC PAGES FOR HOLDING CARDS; PLASTIC SANDWICH BAGS; PLASTIC SHEETS AND LABELS FOR WRITING, PRINTING AND MARKING; AND PLASTIC GARBAGE BAGS (U.S. CLS. 2, 5, 22, 23, 29, 37, 38 AND 50).

CLASS 17—RUBBER GOODS

FOR PLASTIC IN THE FORM OF BARS, PELLETS, RODS, SHEETS AND TUBES FOR GENERAL INDUSTRIAL USE; PLASTIC IN EXTRUDED FORM FOR GENERAL INDUSTRIAL USE; PLASTIC IN THE FORM OF BARS, PELLETS, RODS, SHEETS AND TUBES FOR USE IN MANUFACTURING; PLASTIC PACKING FOR SHIPPING CONTAINERS; PLASTIC SHEETING FOR PREVENTING WEED GROWTH; PLASTIC SHEETING FOR USE AS DROP CLOTHS; PLASTIC TAPE FOR USE IN COMMERCIAL MANUFACTURING (U.S. CLS. 1, 5, 12, 13, 35 AND 50).

CLASS 21—HOUSEWARES AND GLASS

FOR PLASTIC GLOVES FOR HOUSEHOLD USE; PLASTIC CUPS (U.S. CLS. 2, 13, 23, 29, 30, 33, 40 AND 50).
WILLIAM ROSSMAN, EXAMINING ATTORNEY

SN 77-978,990. RANGER JOE'S COLUMBUS ARMY SURPLUS CO., DBA RANGER JOE'S INTERNATIONAL, COLUMBUS, GA. FILED 2-7-2009.



NO CLAIM IS MADE TO THE EXCLUSIVE RIGHT TO USE "GEAR", APART FROM THE MARK AS SHOWN. THE COLOR(S) RED AND BLACK IS/ARE CLAIMED AS A FEATURE OF THE MARK.

THE MARK CONSISTS OF THE STYLIZED WORDING "PHENIX GEAR" APPEARING IN THE COLOR BLACK BENEATH A STYLIZED IMAGE OF A PHOENIX IN THE COLOR RED WITH ITS WINGS RAISED, HEAD TURNED TO THE BIRDS LEFT, AND IMAGES OF FIRE EMANATING FROM ITS WINGS AND BODY.

CLASS 9—ELECTRICAL AND SCIENTIFIC APPARATUS

FOR TACTICAL GEAR AND EQUIPMENT, NAMELY, PROTECTIVE CLOTHING, PROTECTIVE VESTS, SAFETY HARNESES OTHER THAN FOR VEHICLES OR SPORTS PURPOSES, BELTS, RAPPPELLING BELTS, RIGGERS BELTS, TACTICAL VESTS, CHEST RIGS, MODULAR TACTICAL VESTS, ARMOR BEARING VESTS, MODULAR ARMOR BEARING VESTS, LOAD BEARING VESTS, MEDICAL AND PARAMEDIC VESTS, ALL FOR USE IN THE FIELDS OF MILITARY, LAW ENFORCEMENT, PARAMILITARY, RESCUE AND PUBLIC SAFETY APPLICATIONS (U.S. CLS. 21, 23, 26, 36 AND 38).

FIRST USE 9-1-2008; IN COMMERCE 9-21-2008.

CLASS 13—FIREARMS

FOR LAW ENFORCEMENT AND MILITARY TACTICAL OPERATIONS PRODUCTS AND ACCESSORIES, NAMELY, MAGAZINE POUCHES, GRENADE AND SMOKE CANISTER POUCHES, CARTRIDGE POUCHES, HOLSTERS, AMMUNITION, GUN, CARTRIDGE AND MAGAZINE BELTS FOR MILITARY EQUIPMENT, DRAG BAGS FOR AMMUNITION AND ARMS, AND MAGAZINES FOR WEAPONS, ALL FOR USE IN THE FIELDS OF MILITARY, LAW ENFORCEMENT, PARAMILITARY, RESCUE AND PUBLIC SAFETY APPLICATIONS (U.S. CLS. 2 AND 9).

FIRST USE 9-1-2008; IN COMMERCE 9-21-2008.

CLASS 24—FABRICS

FOR BLANKETS FOR OUTDOOR USE; BED BLANKETS; ALL FOR USE IN THE FIELDS OF MILITARY, LAW ENFORCEMENT, PARAMILITARY, RESCUE AND PUBLIC SAFETY APPLICATIONS (U.S. CLS. 42 AND 50).
FIRST USE 9-1-2008; IN COMMERCE 9-21-2008.

GEOFFREY FOSDICK, EXAMINING ATTORNEY

SN 77-979,227. BUYWITHME, INC., BOSTON, MA. FILED 4-27-2009.

BUYWITHME

THE MARK CONSISTS OF STANDARD CHARACTERS WITHOUT CLAIM TO ANY PARTICULAR FONT, STYLE, SIZE, OR COLOR.

CLASS 9—ELECTRICAL AND SCIENTIFIC APPARATUS

FOR CONSUMER COUPONS, GIFT CARDS, GIFT CERTIFICATES, VOUCHERS DOWNLOADED FROM A GLOBAL COMPUTER NETWORK (U.S. CLS. 21, 23, 26, 36 AND 38).

FIRST USE 5-0-2009; IN COMMERCE 5-0-2009.

CLASS 35—ADVERTISING AND BUSINESS

FOR PROMOTING THE GOODS AND SERVICES OF OTHERS; PROVIDING AN ON-LINE WEBSITE FOR PRICE COMPARISON INFORMATION; PROMOTING THE GOODS AND SERVICES OF OTHERS BY PROVIDING A WEB SITE FEATURING COUPONS, REBATES, PRICE-COMPARISON INFORMATION, PRODUCT REVIEWS, LINKS TO THE RETAIL WEB SITES OF OTHERS, AND DISCOUNT INFORMATION; MARKETING AND ADVERTISING CONSULTING SERVICES; BUYING CLUBS (U.S. CLS. 100, 101 AND 102).
 FIRST USE 5-0-2009; IN COMMERCE 5-0-2009.
 KHANH LE, EXAMINING ATTORNEY

CLASS 25—CLOTHING

FOR CLOTHING, NAMELY, SHIRTS, T-SHIRTS, UNDER SHIRTS, NIGHT SHIRTS, RUGBY SHIRTS, POLO SHIRTS, CARDIGANS, JERSEYS, UNIFORMS, DRESS SHIRTS, PANTS, TROUSERS, SLACKS, JEANS, CULOTTES, CARGO PANTS, DENIM JEANS, OVERALLS, COVERALLS, JUMPERS, JUMP SUITS, SHORTS, BOXER SHORTS, TOPS, CROP TOPS, TANK TOPS, HALTER TOPS, SWEAT SHIRTS, SWEAT SHORTS, SWEAT PANTS, WRAPS, WARM-UP SUITS, JOGGING SUITS, TRACK SUITS, PLAY SUITS, BLOUSES, SKIRTS, DRESSES, GOWNS, SWEATERS, VESTS, FLEECE VESTS, PULLOVERS, SNOW SUITS, PARKAS, ANORAKS, PONCHOS, JACKETS, REVERSIBLE JACKETS, COATS, BLAZERS, SUITS, TURTLENECKS, CLOTH SKI BIBS, SWIMWEAR, BEACHWEAR, TENNIS WEAR, SURF WEAR, SKI WEAR, LAYETTES, INFANTWEAR, INFANTS SLEEPERS, BOOTIES, BABY BIBS NOT OF PAPER, CLOTH DIAPERS, CAPS, SWIM CAPS, BERETS, BEANIES, HATS, VISORS, HEADBANDS, WRIST BANDS, SWEAT BANDS, HEADWEAR, EAR MUFFS, APRONS, SCARVES, BANDANAS, BELTS, SUSPENDERS, NECKWEAR, TIES, NECKERCHIEFS, ASCOTS, UNDERWEAR, THERMAL UNDERWEAR, LONG UNDERWEAR, BRIEFS, SWIM AND BATHING TRUNKS, BRAS, SPORTS BRAS, BRASSIERES, BUSTIERS, CORSETS, PANTIES, THONGS, GARTERS AND GARTER BELTS, TEDDIES, GIRDLES, FOUNDATION GARMENTS, SINGLET, SOCKS, LOUNGEWEAR, ROBES, SMOCKS, UNDERCLOTHES, PAJAMAS, SLEEPWEAR, NIGHT GOWNS, LINGERIE, CAMISOLES, NEGLIGEEES, CHEMISES, CHEMISETTES, SLIPS, SARONGS, LEG WARMERS, HOSIERY, PANTYHOSE, BODY STOCKINGS, KNEE HIGHS, LEGGINGS, TIGHTS, LEOTARDS, BODY SUITS, UNITARDS, BODY SHAPERS, GLOVES, MITTENS, FOOTWEAR, SHOES, SNEAKERS, BOOTS, GALOSHES, SANDALS, FLIP-FLOPS, SLIPPERS AND RAINWEAR (U.S. CLS. 22 AND 39).
 IRA J. GOODSaid, EXAMINING ATTORNEY

SN 77-979,590. ALTERNATIVE APPAREL, INC., NORCROSS, GA. FILED 12-11-2007.

SN 78-291,299. EMERGO (CYPRUS) LIMITED, NICOSIA, CYPRUS, FILED 8-22-2003.

ALTERNATIVE

EMERGO

THE MARK CONSISTS OF STANDARD CHARACTERS WITHOUT CLAIM TO ANY PARTICULAR FONT, STYLE, SIZE, OR COLOR.
 OWNER OF U.S. REG. NOS. 1,734,694, 3,054,396 AND 3,280,836.

THE MARK CONSISTS OF STANDARD CHARACTERS WITHOUT CLAIM TO ANY PARTICULAR FONT, STYLE, SIZE, OR COLOR.
 PRIORITY CLAIMED UNDER SEC. 44(D) ON ERPN CMNTY TM OFC APPLICATION NO. 3280344, FILED 8-13-2003, REG. NO. 003280344, DATED 5-14-2009, EXPIRES 8-13-2013.

CLASS 18—LEATHER GOODS

FOR ALL-PURPOSE SPORTS AND ATHLETIC BAGS; BEACH, BOOK, CARRY-ON, DUFFEL, DIAPER, GYM, LEATHER SHOPPING, SHOULDER, TOTE AND TRAVEL BAGS; MESSENGER-TYPE BAGS; FANNY PACKS AND WAIST PACKS; BACKPACKS; KNAPSACKS; PURSES; GARMENT BAGS FOR TRAVEL; SATCHELS; LUGGAGE; LUGGAGE TAGS; TRUNKS; SUITCASES; HAT BOXES FOR TRAVEL NOT OF PAPER OR CARDBOARD; COSMETIC CASES AND BAGS SOLD EMPTY; TOILETRY AND VANITY CASES SOLD EMPTY; TOOL BAGS SOLD EMPTY; ATTACHE CASES; BRIEFCASES; BRIEFCASE-TYPE PORTFOLIOS; DOCUMENT CASES; MEN'S CLUTCHES; BUSINESS CASES; BUSINESS CARD CASES; CALLING AND CREDIT CARD CASES; KEY CASES; LEATHER KEY CHAINS; WALLETS; BANK-NOTE HOLDERS; BILLFOLDS; UMBRELLAS; PARASOLS; WALKING STICKS (U.S. CLS. 1, 2, 3, 22 AND 41).

CLASS 35—ADVERTISING AND BUSINESS

FOR ADVERTISING SERVICES; MARKET RESEARCH AND ANALYSIS, RENDERING ADVICE TO ENTERPRISES REGARDING BUSINESS ORGANIZATION; BUSINESS-ECONOMIC CONSULTANCY; BUSINESS CONSULTANCY AND MEDIATION SERVICES IN THE FIELD OF MERGERS AND TAKEOVERS; INTERIM AND BUSINESS PROJECT MANAGEMENT, AS WELL AS CONDUCTING RESEARCH AND CONSULTANCY IN THESE FIELDS; BUSINESS CONSULTANCY AT DRAWING UP BUSINESS PLANS; THE CONTROL AND BUSINESS MANAGEMENT OF COMPANIES AND ORGANIZATIONS, EITHER OR NOT ON INTERIM PROJECT BASIS; PROFESSIONAL CONSULTATION IN THE BUSINESS FIELD; DRAWING UP BUSINESS EXPERTS' REPORTS (U.S. CLS. 100, 101 AND 102).

CLASS 36—INSURANCE AND FINANCIAL

FOR FINANCIAL SERVICES, NAMELY, FINANCIAL ANALYSIS, CONSULTATION AND MANAGEMENT; CAPITAL INVESTMENT CONSULTATION AND MANAGEMENT AND INVESTMENT CONSULTATION AND MANAGEMENT; RESEARCH AND CONSULTANCY IN THE FIELD OF FINANCINGS AND SHARE HOLDING; LEASE SECURITIZATION SERVICES; REAL ESTATE BROKERAGE, (U.S. CLS. 100, 101 AND 102).

PAUL F. GAST, EXAMINING ATTORNEY

SN 78-481,759. S.H. ROWAT ENTERPRISES LTD., PRE-SCOTT, CANADA, FILED 9-10-2004.

**SMART SIZE
SOLUTIONS**

SN 78-432,601. LIFE ZONE, INC., FRUIT HEIGHTS, UT. FILED 6-9-2004.

THE MARK CONSISTS OF STANDARD CHARACTERS WITHOUT CLAIM TO ANY PARTICULAR FONT, STYLE, SIZE, OR COLOR.

OWNER OF CANADA REG. NO. TMA759609, DATED 2-16-2010, EXPIRES 2-16-2020.

NO CLAIM IS MADE TO THE EXCLUSIVE RIGHT TO USE "SOLUTIONS", APART FROM THE MARK AS SHOWN.

LIFE ZONE

CLASS 9—ELECTRICAL AND SCIENTIFIC APPARATUS

FOR COMPUTER SOFTWARE FOR CLIENT RELATIONSHIP MANAGEMENT, MANAGING SALES FORCE DATA, LOAN MANAGEMENT AND ACCOUNTING (U.S. CLS. 21, 23, 26, 36 AND 38).

CLASS 42—SCIENTIFIC AND COMPUTER SERVICES

FOR TECHNICAL SUPPORT SERVICES, NAMELY, TROUBLESHOOTING OF COMPUTER SOFTWARE PROBLEMS; NON-PHYSICAL DATA CONVERSION OF COMPUTER PROGRAM DATA OR INFORMATION; COMPUTER SOFTWARE CONSULTATION IN THE FIELD OF COMPUTER SOFTWARE FOR CLIENT RELATIONSHIP MANAGEMENT, MANAGING SALES FORCE DATA, LOAN MANAGEMENT AND ACCOUNTING (U.S. CLS. 100 AND 101).

ALLISON SCHRODY, EXAMINING ATTORNEY

THE MARK CONSISTS OF STANDARD CHARACTERS WITHOUT CLAIM TO ANY PARTICULAR FONT, STYLE, SIZE, OR COLOR.

OWNER OF U.S. REG. NOS. 2,417,495, 2,417,496 AND 2,559,787.

CLASS 41—EDUCATION AND ENTERTAINMENT

FOR EDUCATIONAL SERVICES, NAMELY CONDUCTING SEMINARS IN THE FIELD OF NUTRITIONAL SUPPLEMENTS, SKIN CARE PRODUCTS, COSMETICS, AND HEALTH AND FITNESS (U.S. CLS. 100, 101 AND 107).

FIRST USE 2-13-1981; IN COMMERCE 4-1-1981.

CLASS 44—MEDICAL, BEAUTY AND AGRICULTURAL SERVICES

FOR FOOD NUTRITION CONSULTING IN THE FIELD OF NUTRITIONAL SUPPLEMENTS, BEAUTY CARE CONSULTATION AND INFORMATION SERVICES FEATURING INFORMATION ABOUT SKIN CARE PRODUCTS AND COSMETICS; PROVIDING HEALTH INFORMATION (U.S. CLS. 100 AND 101).

FIRST USE 2-13-1981; IN COMMERCE 4-1-1981.

DAVID MURRAY, EXAMINING ATTORNEY

SN 78-504,489. BILTMORE FARMS, LLC, ASHEVILLE, NC. FILED 10-22-2004.

**BILTMORE
COMMERCIAL**

THE MARK CONSISTS OF STANDARD CHARACTERS WITHOUT CLAIM TO ANY PARTICULAR FONT, STYLE, SIZE, OR COLOR.

OWNER OF U.S. REG. NOS. 2,041,899, 2,695,601 AND OTHERS.

NO CLAIM IS MADE TO THE EXCLUSIVE RIGHT TO USE "COMMERCIAL", APART FROM THE MARK AS SHOWN.

CLASS 35—ADVERTISING AND BUSINESS

FOR REAL ESTATE MARKETING SERVICES, NAMELY, ON-LINE SERVICES FEATURING TOURS OF RESIDENTIAL AND COMMERCIAL REAL ESTATE; BUSINESS ADMINISTRATION AND MANAGEMENT SERVICES IN THE FIELD OF COMMERCIAL REAL ESTATE (U.S. CLS. 100, 101 AND 102).

FIRST USE 7-9-2004; IN COMMERCE 7-9-2004.

CLASS 36—INSURANCE AND FINANCIAL

FOR REAL ESTATE BROKERAGE SERVICES (U.S. CLS. 100, 101 AND 102).

FIRST USE 7-9-2004; IN COMMERCE 7-9-2004.

CLASS 37—CONSTRUCTION AND REPAIR

FOR REAL ESTATE DEVELOPMENT, AND CUSTOM CONSTRUCTION OF HOMES (U.S. CLS. 100, 103 AND 106).

FIRST USE 7-9-2004; IN COMMERCE 7-9-2004.
ELLEN PERKINS, EXAMINING ATTORNEY

SN 78-521,711. BILTMORE FARMS, LLC, ASHEVILLE, NC.
FILED 11-23-2004.

BILTMORE FARMS

THE MARK CONSISTS OF STANDARD CHARACTERS WITHOUT CLAIM TO ANY PARTICULAR FONT, STYLE, SIZE, OR COLOR.

OWNER OF U.S. REG. NOS. 2,043,296, 2,043,297 AND OTHERS.

NO CLAIM IS MADE TO THE EXCLUSIVE RIGHT TO USE "FARMS", APART FROM THE MARK AS SHOWN.

CLASS 35—ADVERTISING AND BUSINESS

FOR REAL ESTATE MARKETING SERVICES, NAMELY, ON-LINE SERVICES FEATURING TOURS OF RESIDENTIAL AND COMMERCIAL REAL ESTATE (U.S. CLS. 100, 101 AND 102).

FIRST USE 8-8-1994; IN COMMERCE 8-8-1994.

CLASS 36—INSURANCE AND FINANCIAL

FOR REAL ESTATE BROKERAGE SERVICES (U.S. CLS. 100, 101 AND 102).

FIRST USE 8-8-1994; IN COMMERCE 8-8-1994.

CLASS 37—CONSTRUCTION AND REPAIR

FOR REAL ESTATE DEVELOPMENT, AND CUSTOM CONSTRUCTION OF HOMES (U.S. CLS. 100, 103 AND 106).

FIRST USE 8-8-1994; IN COMMERCE 8-8-1994.

CLASS 43—HOTEL AND RESTAURANT SERVICES

FOR HOTEL, BAR AND RESTAURANT SERVICES (U.S. CLS. 100 AND 101).

FIRST USE 8-8-1994; IN COMMERCE 8-8-1994.
ELLEN PERKINS, EXAMINING ATTORNEY

SN 78-536,184. SHANGRI-LA INTERNATIONAL HOTEL MANAGEMENT LIMITED, ROAD TOWN TORTOLA, BR. VIRGIN ISLANDS, FILED 12-21-2004.



OWNER OF HONG KONG REG. NO. 02239, DATED 10-10-1994, EXPIRES 10-10-2015.

OWNER OF ERPN CMNTY TM OFC REG. NO. 003446903, DATED 10-22-2003, EXPIRES 10-22-2013.

CLASS 35—ADVERTISING AND BUSINESS

FOR (BASED ON HONG KONG REGISTRATION 02239) BUSINESS MANAGEMENT OF HOTELS, MOTELS, APARTMENT AND CONDOMINIUM SERVICES, GUEST HOUSE/ACCOMMODATION, SPA, BEAUTY SERVICES, BAR, CAFE, CAFETERIA, COFFEE SHOP, CATERING, RESTAURANTS, CLUB, WINE CLUB, COCKTAIL LOUNGE SERVICES AND SNACK-BAR FOR OTHERS; BUSINESS CENTER SERVICES, NAMELY, PROVIDING OFFICE EQUIPMENT AND SERVICES TO OTHERS; PROVISION OF BUSINESS CONSULTANCY, ADVISORY, AND INFORMATION SERVICES IN THE FIELDS OF HOTELS, FRACTIONAL OWNERSHIP RESIDENCES, COMMERCIAL AND RETAIL PROPERTY, APARTMENTS, CONDOMINIUMS, GUEST HOUSE/ACCOMMODATION; MARKETING PROMOTION, ADVERTISING AND PUBLICITY SERVICES FOR OTHERS IN THE FIELDS OF HOTELS, RESORTS, FRACTIONAL OWNERSHIP OF RESIDENCES, APARTMENTS, CONDOMINIUMS, GUEST-HOUSE/ACCOMMODATION; ORGANIZATION OF EXHIBITS, CONVENTIONS, TRADE SHOWS AND TRADE FAIRS FOR OTHERS IN COMMERCIAL FIELDS; COMMERCIAL AND BUSINESS MANAGEMENT ASSISTANCE AND CONSULTANCY SERVICES FOR THE SALE OF GOODS; RETAIL HOTEL GIFT AND CONVENIENCE STORE SERVICES; AND FLOWER SHOP (U.S. CLS. 100, 101 AND 102).

CLASS 41—EDUCATION AND ENTERTAINMENT

FOR (BASED ON ERPN CMNTY TM REGISTRATION 003446903) HEALTH CLUB SERVICES, NAMELY, PROVIDING INSTRUCTION AND EQUIPMENT IN THE FIELD OF PHYSICAL EXERCISE; PROVISION OF SWIMMING POOL AND WORKOUT FACILITIES; EDUCATIONAL SERVICES, NAMELY, PROVIDING COURSES AND LECTURES IN THE FIELDS OF HEALTH, NUTRITION DIET, WELLNESS; PROVISION OF EXERCISE CLASSES (U.S. CLS. 100, 101 AND 107).

CLASS 43—HOTEL AND RESTAURANT SERVICES

FOR (BASED ON ERP N CMNTY TM REGISTRATION 003446903) RESORT HOTEL SERVICES AND GUEST HOUSE SERVICES; HOTEL, RESORT, TOURIST AND VACATION ACCOMMODATION RESERVATION SERVICES; RESTAURANT, CAFE, BAR, CAFETERIA, SNACK BAR, COFFEE-SHOP AND CATERING SERVICES; HOTEL LOUNGE SERVICES; PROVIDING INFORMATION RELATING TO HOTELS, RESORT LODGING, RESTAURANTS, BARS, PREPARATION OF FOODS AND BEVERAGES AND CATERING SERVICES ON-LINE FROM A COMPUTER DATABASE OR VIA THE INTERNET OR EXTRANETS (U.S. CLS. 100 AND 101).

CLASS 44—MEDICAL, BEAUTY AND AGRICULTURAL SERVICES

FOR (BASED ON ERP N CMNTY TM REGISTRATION 003446903) HEALTH AND BEAUTY SPA SERVICES FOR HEALTH AND WELLNESS OF THE BODY AND SPIRIT OFFERED AT A HEALTH OR BEAUTY SPA; FLOWER ARRANGING SERVICES; PROVISION OF SAUNA, SOLARIUM AND SUN DECK FACILITIES; BEAUTY SALON SERVICES, SKIN CARE BEAUTY TREATMENT SERVICES, HAIRDRESSING SERVICES, MASSAGE SERVICES, WEIGHT LOSS, GAIN AND CONTROL SERVICES, NAMELY, DIETARY, NUTRITIONAL AND WELLNESS SERVICES; PEDICURE AND MANICURE SERVICES, PROVISION OF INFORMATION AND ADVISORY RELATING TO THE USE OF SKIN, BEAUTY TREATMENT AND COSMETIC PRODUCTS, HEALTH CARE SERVICES; PROVIDING INFORMATION RELATING TO BEAUTY AND HAIR SALON SERVICES ON-LINE FROM A COMPUTER DATABASE OR VIA THE INTERNET OR EXTRANETS (U.S. CLS. 100 AND 101).
EUGENIA MARTIN, EXAMINING ATTORNEY

CLASS 9—ELECTRICAL AND SCIENTIFIC APPARATUS

FOR PUBLICATIONS DOWNLOADABLE FROM THE INTERNET IN THE NATURE OF MAGAZINES, CALENDARS, BOOKS, BOOKLETS, NEWSPAPERS, DIARIES, CATALOGS, PAMPHLETS, HANDBOOKS, NEWSLETTERS AND DIRECTORIES; DATABASES DOWNLOADABLE FROM THE INTERNET; ALL SAID PUBLICATIONS AND DATABASES IN THE FIELDS OF MARKETING, BUSINESS COMMUNICATIONS, FINANCIAL SERVICES, PACKAGING DESIGN, TECHNOLOGY, BUSINESS, SALES, BRANDS AND BRAND IDENTITY, PUBLIC RELATIONS, DIRECT MARKETING, MEDICAID, HEALTH CARE, HEALTH INSURANCE, MEDICAL CARE, PHARMACEUTICALS, MOTOR VEHICLES, CONSUMER PRODUCTS, FINANCIAL SERVICES, SHIPPING, TRAVEL, BEAUTY AND PERSONAL CARE, SOURCING, ENERGY, SPORTS, ENTERTAINMENT, TECHNOLOGY, BIOTECHNOLOGY, ADVERTISING, MEDIA, POLITICS, GOVERNMENT, PROMOTIONS, FORECASTING, CONSUMER BEHAVIOR AND OPINION POLLS; AND PRE-RECORDED MAGNETIC DATA CARRIERS, AUDIO DISCS, AND VIDEO DISCS FEATURING INFORMATION IN THE FIELDS OF, MARKETING, BUSINESS COMMUNICATIONS, FINANCIAL SERVICES, PACKAGING DESIGN, TECHNOLOGY, BUSINESS, SALES, BRANDS AND BRAND IDENTITY, PUBLIC RELATIONS, DIRECT MARKETING, MEDICAID, HEALTH CARE, HEALTH INSURANCE, MEDICAL CARE, PHARMACEUTICALS, MOTOR VEHICLES, CONSUMER PRODUCTS, FINANCIAL SERVICES, SHIPPING, TRAVEL, BEAUTY AND PERSONAL CARE, SOURCING, ENERGY, SPORTS, ENTERTAINMENT, TECHNOLOGY, BIOTECHNOLOGY, ADVERTISING, MEDIA, POLITICS, GOVERNMENT, PROMOTIONS, FORECASTING, CONSUMER BEHAVIOR AND OPINION POLLS; AND PRERECORDED DIGITAL STORAGE MEDIA, NAMELY, CDS AND DVDS, FEATURING INFORMATION IN THE HEALTH, MEDICAL AND PHARMACEUTICAL INDUSTRIES; DOWNLOADABLE FREWARE AND SHAREWARE FOR THE DISSEMINATION OF THE SOFTWARE OF OTHERS (U.S. CLS. 21, 23, 26, 36 AND 38).

CLASS 16—PAPER GOODS AND PRINTED MATTER

FOR PRINTED INSTRUCTIONAL AND TEACHING MATERIAL IN THE FIELDS OF HEALTH AND MEDICINE (U.S. CLS. 2, 5, 22, 23, 29, 37, 38 AND 50).

CLASS 35—ADVERTISING AND BUSINESS

FOR MARKET RESEARCH, MARKETING STUDIES; PROVISION OF BUSINESS MARKETING INFORMATION; PLANNING OF MARKETING STRATEGY; ANALYSIS AND TABULATION OF MARKET RESEARCH DATA AND STATISTICS; BUSINESS DATA COLLECTION AND THE PROVISION OF BUSINESS REPORTS RELATING THERETO; MARKETING RESEARCH, NAMELY, CONDUCTING INTERVIEWS FOR THE PURPOSE OF CONSULTING AND MARKETING; PROVISION OF STATISTICAL INFORMATION, PROVISION OF BUSINESS AND COMMERCIAL INFORMATION; BUSINESS RESEARCH AND INVESTIGATION; BUSINESS ENQUIRIES; BUSINESS APPRAISAL; ADVISORY SERVICES FOR BUSINESS MANAGEMENT; BUSINESS MANAGEMENT CONSULTATION; BUSINESS PLANNING AND BUSINESS ADMINISTRATION SERVICES; ADVERTISING, PUBLICITY, MARKETING AND SALES PROMOTION SERVICES AND THE ANALYSIS OF HE EFFECTIVENESS THEREOF, COMPILATION OF AND SYSTEMIZATION OF INFORMATION INTO COMPUTER DATABASES; DISTRIBUTION OF NEWS AND INFORMATION FOR OTHERS; RENTAL OF ADVERTISING SPACE AND SALES SPACE ON WEBSITES; ORGANIZING AND CONDUCTING SHOWS AND FAIRS, ALL FOR COMMERCIAL OR ADVERTISING PURPOSES; CONSULTATION, ANALYSIS, RESEARCH AND ADVICE IN THE FIELDS OF MARKETING, BUSINESS COMMUNICATION, SALES, BRANDS, BRAND IDENTITY, PUBLIC RELATIONS AND DIRECT MARKETING; NEWS CLIPPING SERVICES; THE MONITORING OF NEWS AND THE INTERNET AND PROVISION OF REPORTS ON THE RESULT OF SUCH MONITORING; PROVIDING INFORMATION TO FACILITATE

SN 78-575,429, UNITED BUSINESS MEDIA GROUP LIMITED, LONDON, ENGLAND, FILED 2-25-2005.



OWNER OF ERP N CMNTY TM OFC REG. NO. 004291911, DATED 4-17-2007, EXPIRES 2-10-2015.

NO CLAIM IS MADE TO THE EXCLUSIVE RIGHT TO USE "BUSINESS MEDIA", APART FROM THE MARK AS SHOWN.

THE LOCATION OF EXPERTS IN THE FIELDS OF EDUCATION, TECHNOLOGY AND RESEARCH; PROVISION OF BUSINESS INFORMATION RELATING TO OPERATING MEDICAL PRACTICES; ADVERTISING IN RELATION TO PHARMACEUTICAL OR MEDICAL PRODUCTS; DISTRIBUTION OF PROSPECTUSES, SAMPLES, PHARMACEUTICAL AND MEDICAL INFORMATION; SUBSCRIPTION SERVICES TO PHARMACEUTICAL AND MEDICAL PUBLICATIONS AND TO THE INTERNET AND THE WORLD TELECOMMUNICATIONS NETWORK FOR THIRD PARTIES; THE PRODUCTION OF ADVERTISING DOCUMENTS; MANAGEMENT OF COMPUTER FILES, DISTRIBUTION OF ADVERTISEMENTS AND COMMERCIAL ANNOUNCEMENTS TO THE PUBLIC RELATING TO PHARMACEUTICAL AND MEDICAL PRODUCTS AND INFORMATION; PROVISION OF BUSINESS INFORMATION IN THE FIELDS OF PHARMACEUTICAL PRODUCTS, AND THE AVAILABILITY OF HEALTH AND MEDICAL SERVICES; PROVIDING BUSINESS ANALYSIS OF INFORMATION IN THE FIELDS OF HEALTH, HEALTH CARE, MEDICAL CARE, PHARMACEUTICAL PRODUCTS, AND THE AVAILABILITY OF HEALTH AND MEDICAL SERVICES (U.S. CLS. 100, 101 AND 102).

CLASS 36—INSURANCE AND FINANCIAL

FOR CONSULTATION, RESEARCH AND ANALYSIS RELATING TO FINANCIAL SERVICES, THE ADMINISTRATION OF GOVERNMENT FUNDED HEALTH CARE, AND INSURANCE; PROVIDING FINANCIAL ANALYSIS OF INFORMATION IN THE FIELDS OF HEALTH, HEALTH CARE, MEDICAL CARE, PHARMACEUTICAL PRODUCTS, AND THE AVAILABILITY OF HEALTH AND MEDICAL SERVICES (U.S. CLS. 100, 101 AND 102).

CLASS 38—COMMUNICATION

FOR NEWS AGENCY SERVICES, NAMELY, THE TRANSMISSION OF CORPORATE FINANCIAL BUSINESS AND ENTERTAINMENT NEWS (U.S. CLS. 100, 101 AND 104).

CLASS 41—EDUCATION AND ENTERTAINMENT

FOR PUBLISHING OF MAGAZINES, NEWSPAPERS, BOOKS, AND JOURNALS ON THE INTERNET; ORGANIZING AND CONDUCTING SPECIAL EVENTS FOR EDUCATIONAL PURPOSES; CONDUCTING SPECIAL EVENTS, NAMELY, HOSTING AWARD PROGRAMS IN THE FIELDS OF BUSINESS AND HEALTH CARE; PRODUCTION OF MOTION PICTURE FILMS; PRODUCTION OF VIDEO COMPACT DISCS, DIGITAL VIDEO DISCS, VIDEO CASSETTES AND CD ROMS FEATURING CORPORATE TRAINING FOR EDUCATIONAL PURPOSES; EDUCATIONAL AND TRAINING SERVICES IN THE FIELD OF MEDICINE AND HEALTH CARE BY MEANS OF SEMINARS, CLASSES AND TUTORIALS PROVIDED IN PERSON AND ONLINE; PROVIDING TEMPORARY USE OF NON-DOWNLOADABLE ELECTRONIC PUBLICATIONS, NAMELY, MAGAZINES, CALENDARS, BOOKS, BOOKLETS, NEWSPAPERS, DIARIES, CATALOGS, PAMPHLETS, HANDBOOKS, NEWSLETTERS AND DIRECTORIES IN THE FIELDS OF MARKETING, BUSINESS COMMUNICATIONS, FINANCIAL SERVICES, PACKAGING DESIGN, TECHNOLOGY, BUSINESS, SALES, BRANDS AND BRAND IDENTITY, PUBLIC RELATIONS, DIRECT MARKETING, MEDICAID, HEALTH CARE, HEALTH INSURANCE, MEDICAL CARE, PHARMACEUTICALS, MOTOR VEHICLES, CONSUMER PRODUCTS, FINANCIAL SERVICES, SHIPPING, TRAVEL, BEAUTY AND PERSONAL CARE, SOURCING, ENERGY, SPORTS, ENTERTAINMENT, TECHNOLOGY, BIOTECHNOLOGY, ADVERTISING, MEDIA, POLITICS, GOVERNMENT, PROMOTIONS, FORECASTING, CONSUMER BEHAVIOR AND OPINION POLLS (U.S. CLS. 100, 101 AND 107).

CLASS 42—SCIENTIFIC AND COMPUTER SERVICES

FOR RENTAL, DESIGN, DEVELOPMENT AND LEASING OF COMPUTER SOFTWARE AND HARDWARE; PROVIDING MEDICAL AND SCIENTIFIC RESEARCH INFORMATION IN THE FIELD OF PHARMACEUTICALS AND CLINICAL TRIALS (U.S. CLS. 100 AND 101).

CLASS 44—MEDICAL, BEAUTY AND AGRICULTURAL SERVICES

FOR PROVISION OF MEDICAL NEWS AND MEDICAL INFORMATION IN THE FIELDS OF HEALTH, HEALTH CARE, MEDICAL CARE, PHARMACEUTICAL PRODUCTS, AND THE AVAILABILITY OF HEALTH AND MEDICAL SERVICES; PROVIDING MEDICAL ANALYSIS OF INFORMATION IN THE FIELDS OF HEALTH, HEALTH CARE, MEDICAL CARE, PHARMACEUTICAL PRODUCTS, AND THE AVAILABILITY OF HEALTH AND MEDICAL SERVICES (U.S. CLS. 100 AND 101).

ELI HELLMAN, EXAMINING ATTORNEY

SN 78-678,856. GEX TECHNOLOGIES, S.A., BARCELONA, SPAIN, FILED 7-26-2005.

FANTASTIC LEAGUE

THE MARK CONSISTS OF STANDARD CHARACTERS WITHOUT CLAIM TO ANY PARTICULAR FONT, STYLE, SIZE, OR COLOR.

OWNER OF ERP N CMNTY TM OFC REG. NO. 004511531, DATED 3-3-2010, EXPIRES 7-25-2015.

CLASS 9—ELECTRICAL AND SCIENTIFIC APPARATUS

FOR COMPUTER GAME PROGRAMS AND GAME SOFTWARE FOR THE BETTING, LOTTERY AND CASINO INDUSTRIES, GAMING EQUIPMENT, NAMELY, AMUSEMENT, BETTING, LOTTERY AND CASINO GAMING MACHINES; DOWNLOADABLE GAME PROGRAMS FOR USE IN MOBILE PHONES AND OVER THE INTERNET; 3D SPORTS ANIMATION PRODUCTS FOR USE IN INTERACTIVE TELEVISION, MOBILE PHONES AND OVER THE INTERNET, NAMELY, VIRTUAL SPORTS BETTING GAME PROGRAMS (U.S. CLS. 21, 23, 26, 36 AND 38).

CLASS 16—PAPER GOODS AND PRINTED MATTER

FOR PAPER AND GOODS MADE FROM THESE MATERIALS AND NOT INCLUDED IN OTHER CLASSES, NAMELY, PAPER, BOXES, PHOTOGRAPHS, STATIONERY, POSTERS, BANNERS, PRINTED CHARTS, MAGAZINE PAPER, CARDBOARD; PAMPHLETS, BOOKS, BROCHURES, NEWSLETTERS, JOURNALS AND MAGAZINES IN THE FIELDS OF COMPUTER SCIENCE AND GAMES (U.S. CLS. 2, 5, 22, 23, 29, 37, 38 AND 50).

CLASS 28—TOYS AND SPORTING GOODS

FOR GAME MACHINES, NAMELY, AMUSEMENT, BETTING, LOTTERY, SLOT AND CASINO GAMING MACHINES; PRINTED DISPOSABLE TICKET SETS, NAMELY, PRINTED LOTTERY TICKETS, SCRATCH CARDS AND BETTING SLIPS FOR PLAYING GAMES OF CHANCE (U.S. CLS. 22, 23, 38 AND 50).

CLASS 41—EDUCATION AND ENTERTAINMENT

FOR ONLINE COMPUTER GAMES OVER THE INTERNET; PROVISION OF EDUCATION AND TRAINING SERVICES RELATING TO PRODUCTS FOR THE LOTTERY, BETTING AND CASINO INDUSTRIES, NAMELY, PROVIDING TRAINING TO BETTING OPERATORS, LOTTERY OPERATORS, AND END USERS ON HOW TO OPERATE AND SUPPORT GAME PROGRAMS AND SOFTWARE FOR USE IN MOBILE PHONES, OVER THE INTERNET AND ON INTERACTIVE TELEVISION (U.S. CLS. 100, 101 AND 107).

GISELLE AGOSTO, EXAMINING ATTORNEY

SN 78-689,634. MONTAGE DEVELOPMENT, INC., ENCINO, CA. FILED 8-10-2005.

MONTAGE

THE MARK CONSISTS OF STANDARD CHARACTERS WITHOUT CLAIM TO ANY PARTICULAR FONT, STYLE, SIZE, OR COLOR.

CLASS 36—INSURANCE AND FINANCIAL

FOR LEASING OF APARTMENTS, REAL ESTATE AND REAL PROPERTY; RENTAL OF APARTMENTS; REAL ESTATE CONSULTANCY AND CONSULTATION; REAL ESTATE EQUITY SHARING, NAMELY, MANAGING AND ARRANGING FOR CO-OWNERSHIP OF REAL ESTATE; REAL ESTATE INVESTMENT, MANAGEMENT, MANAGEMENT CONSULTATION AND PROCUREMENT FOR OTHERS (U.S. CLS. 100, 101 AND 102).

CLASS 37—CONSTRUCTION AND REPAIR

FOR REAL ESTATE DEVELOPMENT AND SITE SELECTION (U.S. CLS. 100, 103 AND 106).

BRENDAN REGAN, EXAMINING ATTORNEY

SN 78-690,707. AVIARETO LIMITED, DUBLIN 2, IRELAND, FILED 8-11-2005.

AVIARETO

THE MARK CONSISTS OF STANDARD CHARACTERS WITHOUT CLAIM TO ANY PARTICULAR FONT, STYLE, SIZE, OR COLOR.

PRIORITY CLAIMED UNDER SEC. 44(D) ON UNITED KINGDOM APPLICATION NO. 2398059, FILED 7-29-2005.

THE WORDING "AVIARETO" HAS NO MEANING IN A FOREIGN LANGUAGE.

CLASS 35—ADVERTISING AND BUSINESS

FOR COMPILING AND ANALYZING DATA AND INFORMATION RELATING TO FINANCIAL SERVICES IN THE FIELD OF AIRCRAFT ASSET MANAGEMENT, ASSET BASED FINANCING AND LEASING OF AIRCRAFT AND AIRCRAFT EQUIPMENT AND AVIATION FINANCE; CREATING, COMPILING, PREPARING, PROCESSING AND PROVIDING INDEXES OF FINANCIAL INFORMATION RELATING TO AIRCRAFT ASSET MANAGEMENT, ASSET BASED FINANCING AND LEASING OF AIRCRAFT AND AIRCRAFT EQUIPMENT AND AVIATION FINANCE; ADVERTISING SERVICES; BUSINESS MARKETING SERVICES; COMPILING, STORING, ANALYZING AND RETRIEVING DATA AND INFORMATION FROM A COMPUTER DATABASE OR THE INTERNET, NAMELY, MANAGEMENT AND COMPILATION OF COMPUTERISED DATABASES; MAINTAINING, INDEXING AND ELECTRONICALLY DISTRIBUTING INFORMATION MATERIALS, NAMELY, PROVIDING AN ON-LINE COMPUTER DATABASE FEATURING TRADE INFORMATION IN THE FIELD OF INDUSTRIAL ASSET MANAGEMENT OF AIRCRAFT AND AIRCRAFT EQUIPMENT; CREATING INDEXES OF INFORMATION OR WEBSITES, NAMELY, COLLECTION, PREPARATION, COMPOSITION, STORAGE, PROCESSING, ACQUISITION AND PROVISION OF BUSINESS INFORMATION, DATA, STATISTICS AND INDICES RELATING TO AIRCRAFT AND AIRCRAFT EQUIPMENT; MANAGEMENT AND COMPILATION OF COMPUTERISED DATABASES AND MANAGEMENT AND COMPILATION OF A REGISTER FEATURING TITLE TRANSFER INFORMATION RELATING TO AIRCRAFT AND AIRCRAFT EQUIPMENT; SERVICES FOR THE ELECTRONIC AND MECHANICAL RECORDING OF INFORMATION AND RECORDS USED IN ELECTRONIC TRANSMISSIONS; MANAGEMENT AND COMPILATION OF COMPUTERISED DATABASES OF FINANCIAL INFORMATION RELATING TO AIRCRAFT ASSET MANAGEMENT, AIRCRAFT AND AIRCRAFT EQUIPMENT AND MANAGEMENT AND COMPILATION OF A REGISTER OF FINANCIAL INFORMATION RELATING TO AIRCRAFT ASSET MANAGEMENT, AIRCRAFT AND AIRCRAFT EQUIPMENT; INFORMATION, ADVISORY AND CONSULTANCY SERVICES IN RELATION TO ALL OF THE AFORESAID SERVICES PROVIDED IN PERSON, BY MAIL, TELEPHONE OR GLOBAL NETWORK ELECTRONIC MAIL (U.S. CLS. 100, 101 AND 102).

CLASS 36—INSURANCE AND FINANCIAL

FOR FINANCIAL SERVICES, NAMELY, FINANCING AND MONEY LENDING; FINANCIAL MANAGEMENT; FINANCIAL APPRAISALS AND FINANCIAL EVALUATION OF TITLE, CHARGES AND INTERESTS IN AIRCRAFT ASSET MANAGEMENT, AIRCRAFT AND AIRCRAFT EQUIPMENT; INVESTMENT SERVICES, NAMELY, ASSET MANAGEMENT SERVICES; PROVIDING FINANCIAL INFORMATION; MAINTAINING, INDEXING AND ELECTRONICALLY DISTRIBUTING INFORMATION MATERIALS, NAMELY, PROVIDING AN ON-LINE COMPUTER DATABASE FEATURING FINANCIAL INFORMATION IN THE FIELD OF AIRCRAFT ASSET MANAGEMENT, ASSET BASED FINANCING AND LEASING OF AIRCRAFT AND AIRCRAFT EQUIPMENT AND AVIATION FINANCE; INFORMATION, ADVISORY AND CONSULTANCY SERVICES IN RELATION TO ALL OF THE AFORESAID SERVICES PROVIDED IN PERSON, BY MAIL, TELEPHONE OR GLOBAL NETWORK ELECTRONIC MAIL (U.S. CLS. 100, 101 AND 102).

CLASS 42—SCIENTIFIC AND COMPUTER SERVICES

FOR COMPUTER SERVICES, NAMELY, PROVIDING SEARCH ENGINES FOR OBTAINING DATA ON A GLOBAL COMPUTER NETWORK; COMPUTER PROGRAMMING FOR OTHERS; PROVIDING TEMPORARY USE OF ONLINE, NON-DOWNLOADABLE SOFTWARE FOR SEARCHING AND RETRIEVING INFORMATION FROM DATABASES AND COMPUTER NETWORKS; PROVIDING SPECIFIC INFORMATION AS REQUESTED BY CUSTOMERS VIA THE INTERNET; WEB SITE DESIGN, CREATION, RESEARCH, ANALYSIS, TECHNICAL SUPPORT AND HOSTING SERVICES; DATABASE DEVELOPMENT SERVICES; PROVIDING TEMPORARY USE OF ONLINE, NON-DOWNLOADABLE SOFTWARE INTERFACES AVAILABLE OVER A NETWORK IN ORDER TO PROVIDE PERSONALISED ACCESS TO A GLOBAL COMPUTER INFORMATION NETWORK FOR THE TRANSFER AND DISSEMINATION OF INFORMATION; COMPUTER SERVICES, NAMELY, CREATING INDEXES OF INFORMATION, WEBSITES AND OTHER RESOURCES AVAILABLE ON COMPUTER NETWORKS; COMPUTER SERVICES, NAMELY, CREATING, HOSTING AND MAINTAINING AN ON-LINE WEBSITE FOR OTHERS FOR USE IN THE COLLECTION, PREPARATION, COMPOSITION, STORAGE, PROCESSING, ACQUISITION AND PROVISION OF FINANCIAL INFORMATION, DATA, STATISTICS AND INDICES RELATING TO AIRCRAFT ASSET MANAGEMENT, ASSET BASED FINANCING AND LEASING OF AIRCRAFT AND AIRCRAFT EQUIPMENT AND AVIATION FINANCE; INFORMATION, ADVISORY AND CONSULTANCY SERVICES IN RELATION TO ALL OF THE AFORESAID SERVICES PROVIDED IN PERSON, BY MAIL, TELEPHONE OR GLOBAL NETWORK ELECTRONIC MAIL (U.S. CLS. 100 AND 101).
 BARBARA RUTLAND, EXAMINING ATTORNEY

CLASS 7—MACHINERY

FOR AUTOMOTIVE ENGINE BLOCKS; AUTOMOTIVE PARTS, NAMELY, ENGINE SEALS; CAMSHAFTS FOR VEHICLE ENGINES; CATALYTIC CONVERTERS FOR MOTORS AND ENGINES; CONNECTING RODS FOR MACHINES, MOTORS AND ENGINES; DIESEL ENGINES FOR MACHINES; ENGINE BEARINGS; ENGINE CAMSHAFTS; ENGINE MUFFLERS; ENGINE OR MOTOR MUFFLERS; ENGINE PARTS, NAMELY, CONTACT POINTS; ENGINE RODS; ENGINE TIMING COMPONENTS, NAMELY, CAM SPROCKETS AND CHAINS; EXHAUST MANIFOLD FOR ENGINES; EXHAUST SILENCERS FOR ENGINES; FAN BELTS FOR MOTORS AND ENGINES; FUEL INJECTOR PARTS FOR LAND AND WATER VEHICLE ENGINES; GASKETS FOR INTERNAL COMBUSTION ENGINES; IGNITION PARTS FOR INTERNAL COMBUSTION ENGINES NAMELY, CONDENSERS; IGNITIONS PARTS FOR INTERNAL COMBUSTION ENGINES NAMELY, POINTS; INTAKE AND EXHAUST AIR FLOW VANE ASSEMBLY DEVICE FOR USE IN AN INTERNAL COMBUSTION ENGINE; INTERNAL COMBUSTION ENGINE PARTS NAMELY, PISTON RINGS; INTERNAL COMBUSTION ENGINE PARTS NAMELY, PISTONS; INTERNAL COMBUSTION ENGINES LAND VEHICLE PARTS, NAMELY, COILS; INTERNAL COMBUSTION ENGINES LAND VEHICLE PARTS, NAMELY, DISTRIBUTOR CAPS; INTERNAL COMBUSTION ENGINES LAND VEHICLE PARTS, NAMELY, DISTRIBUTOR ROTORS; INTERNAL COMBUSTION LAND VEHICLE ENGINE PARTS NAMELY, CONNECTING RODS; MECHANICAL ENGINE PARTS FOR LAND VEHICLES ; METAL ENGINE GASKETS FOR VEHICLES; MOTORCYCLE ENGINE PARTS, NAMELY, AIR CLEANERS; MUFFLERS FOR MOTORS AND ENGINES; NON-METAL ENGINE GASKET FOR VEHICLES; OIL FILTERS FOR MOTORS AND ENGINES; OIL PUMPS FOR USE IN MOTORS AND ENGINES; RADIATORS FOR MOTORS AND ENGINES; STARTERS FOR MOTORS AND ENGINES; TIMING BELTS FOR ENGINES FOR LAND VEHICLES; VEHICLE ENGINE PARTS, NAMELY, CRANKCASE BREATHERS; VEHICLE ENGINE PARTS, NAMELY, OIL COOLERS; VEHICLE ENGINE PARTS, NAMELY, OIL TANK PLUGS AND CAPS; VEHICLE ENGINE PARTS, NAMELY, OIL TANKS; VEHICLE ENGINE PARTS, NAMELY, PUSH RODS; VEHICLE ENGINE PARTS, NAMELY, ROCKER ARMS; VEHICLE PARTS, NAMELY, ENGINE CAM PROTECTORS; VEHICLE PARTS, NAMELY, ENGINE CASES; WATER PUMPS FOR USE IN MOTORS AND ENGINES (U.S. CLS. 13, 19, 21, 23, 31, 34 AND 35).

SN 78-747,967. VX UNLIMITED, INC., CHESTNUT HILL, MA. FILED 11-5-2005.

CLASS 12—VEHICLES

FOR AUTOMOBILE ENGINES; DIESEL ENGINES FOR LAND VEHICLES; ENGINES FOR LAND VEHICLES; HANDLEBARS; HUBS FOR VEHICLE WHEELS, NAMELY, HUBS FOR MOTORCYCLE WHEELS; INTERNAL COMBUSTION ENGINES FOR LAND VEHICLES; LAND VEHICLE CONSOLE PARTS, NAMELY, WIRING HARNESSES FOR CONTROL, MONITORING AND PROTECTION OF INDUSTRIAL GASOLINE AND DIESEL ENGINES; LAND VEHICLE ENGINE REBUILD KITS, SOLD AS A UNIT; LIGHT TRUCKS; MOTORCYCLE ENGINES; MOTORCYCLE KICKSTANDS; MOTORCYCLE SADDLEBAGS; MOTORCYCLE SIDECARS; MOTORCYCLES; MOTORCYCLES AND STRUCTURAL PARTS THEREFOR; PARTS OF MOTORCYCLES, NAMELY, BRAKE CABLES; PARTS OF MOTORCYCLES, NAMELY, BRAKE CALIPERS; PARTS OF MOTORCYCLES, NAMELY, BRAKE PEDALS; PARTS OF MOTORCYCLES, NAMELY, BRAKE ROTORS; PARTS OF MOTORCYCLES, NAMELY, CLUTCH CABLES; PARTS OF MOTORCYCLES, NAMELY, FORK BEARINGS AND RACES; PARTS OF MOTORCYCLES, NAMELY, FORK DUST BOOTS; PARTS OF MOTORCYCLES, NAMELY, FORK SEALS; PARTS OF MOTORCYCLES, NAMELY, FRONT DASH PANELS; PARTS OF MOTORCYCLES, NAMELY, FRONT SPACERS; PARTS OF MOTORCYCLES, NAMELY, HANDLE BAR CONTROL LEVERS; PARTS OF MOTORCYCLES, NAMELY, HANDLE BAR DAMPERS; PARTS OF MOTORCYCLES, NAMELY, HANDLE BAR GRIPS; PARTS OF MOTORCYCLES, NAMELY, HANDLE BARS; PARTS OF MOTORCYCLES, NAMELY, HEADLIGHT MOUNTS; PARTS

VX

THE MARK CONSISTS OF STANDARD CHARACTERS WITHOUT CLAIM TO ANY PARTICULAR FONT, STYLE, SIZE, OR COLOR.

OF MOTORCYCLES, NAMELY, SHIFT LEVERS; PICK-UP TRUCKS; PICKUP TRUCKS; PNEUMATIC TYRES AND INNER TUBES FOR MOTORCYCLES; STRUCTURAL PARTS FOR MOTORCYCLES; STRUCTURAL PARTS FOR TRUCKS; TIRES ; TWO-WHEELED MOTOR VEHICLES; TWO-WHEELED MOTORIZED VEHICLES; WHEEL BEARING KITS FOR USE WITH LAND VEHICLES; WHEEL DISKS FOR VEHICLES; WHEEL HUBS; WHEEL HUBS FOR THREE-WHEELED MOTOR VEHICLE; WHEEL RIMS; AUTOMOTIVE PARTS, NAMELY, TRANSMISSION SEALS (U.S. CLS. 19, 21, 23, 31, 35 AND 44).

CLASS 37—CONSTRUCTION AND REPAIR

FOR MOTORCYCLE CUSTOMIZATION SERVICES; REPAIR OR MAINTENANCE OF TWO-WHEELED MOTOR VEHICLES (U.S. CLS. 100, 103 AND 106).

ELLEN B. AWRICH, EXAMINING ATTORNEY

SN 78-791,762. MONTAGE DEVELOPMENT, INC., ENCINO, CA. FILED 1-13-2006.

montage

THE MARK CONSISTS OF THE WORD "MONTAGE" IN STYLIZED LOWERCASE LETTERS.

CLASS 36—INSURANCE AND FINANCIAL

FOR LEASING OF APARTMENTS; LEASING OF REAL ESTATE; LEASING OF REAL PROPERTY; LEASING OR RENTING OF BUILDINGS; REAL ESTATE CONSULTANCY; REAL ESTATE CONSULTATION; REAL ESTATE EQUITY SHARING, NAMELY, MANAGING AND ARRANGING FOR CO-OWNERSHIP OF REAL ESTATE; REAL ESTATE MANAGEMENT; REAL ESTATE MANAGEMENT CONSULTATION; REAL ESTATE PROCUREMENT FOR OTHERS; RENTAL OF APARTMENTS (U.S. CLS. 100, 101 AND 102).

CLASS 37—CONSTRUCTION AND REPAIR

FOR REAL ESTATE DEVELOPMENT; REAL ESTATE SITE SELECTION (U.S. CLS. 100, 103 AND 106).

BRENDAN REGAN, EXAMINING ATTORNEY

SN 78-791,660. MONTAGE DEVELOPMENT, INC., ENCINO, CA. FILED 1-13-2006.



montage

THE MARK CONSISTS OF AN OUTLINE OF A BUILDING WITH THE WORD "MONTAGE" (STYLIZED) BELOW THE OUTLINE.

CLASS 36—INSURANCE AND FINANCIAL

FOR LEASING OF APARTMENTS; LEASING OF REAL ESTATE; LEASING OF REAL PROPERTY; LEASING OR RENTING OF BUILDINGS; REAL ESTATE CONSULTANCY; REAL ESTATE CONSULTATION; REAL ESTATE EQUITY SHARING, NAMELY, MANAGING AND ARRANGING FOR CO-OWNERSHIP OF REAL ESTATE; REAL ESTATE MANAGEMENT; REAL ESTATE MANAGEMENT CONSULTATION; REAL ESTATE PROCUREMENT FOR OTHERS; RENTAL OF APARTMENTS (U.S. CLS. 100, 101 AND 102).

CLASS 37—CONSTRUCTION AND REPAIR

FOR REAL ESTATE DEVELOPMENT; REAL ESTATE SITE SELECTION (U.S. CLS. 100, 103 AND 106).

BRENDAN REGAN, EXAMINING ATTORNEY

SN 78-859,300. SP INDUSTRIES INC., WARMINSTER, PA. FILED 4-11-2006.

SP INDUSTRIES, INC.

THE MARK CONSISTS OF STANDARD CHARACTERS WITHOUT CLAIM TO ANY PARTICULAR FONT, STYLE, SIZE, OR COLOR.

NO CLAIM IS MADE TO THE EXCLUSIVE RIGHT TO USE "INDUSTRIES, INC.", APART FROM THE MARK AS SHOWN.

CLASS 9—ELECTRICAL AND SCIENTIFIC APPARATUS

FOR SPECIALIZED LABORATORY EQUIPMENT, NAMELY, GLASSWARE, DISTILLATION UNITS, LABORATORY FILTERS, PHOTOMETERS, INCUBATORS, FREEZE DRYERS, LYOPHILIZERS AND VACUUM DRYERS (U.S. CLS. 21, 23, 26, 36 AND 38).

FIRST USE 12-30-1988; IN COMMERCE 12-30-1988.

CLASS 37—CONSTRUCTION AND REPAIR

FOR REPAIR AND MAINTENANCE SERVICES IN CONNECTION WITH LABORATORY EQUIPMENT (U.S. CLS. 100, 103 AND 106).

FIRST USE 12-30-1988; IN COMMERCE 12-30-1988.

CLASS 40—MATERIAL TREATMENT

FOR CUSTOM MANUFACTURE OF LABORATORY GLASSWARE, DISTILLATION UNITS, FILTRATION APPARATUS, PHOTOMETERS, INCUBATORS, FREEZE DRYERS, LYOPHILIZERS AND VACUUM DRYERS (U.S. CLS. 100, 103 AND 106).

FIRST USE 12-30-1988; IN COMMERCE 12-30-1988.

REBECCA POVARCHUK, EXAMINING ATTORNEY

SN 78-882,183. RADISYS CANADA, INC., VANCOUVER, CANADA, FILED 5-12-2006.

eXtended Media Processing

THE MARK CONSISTS OF STANDARD CHARACTERS WITHOUT CLAIM TO ANY PARTICULAR FONT, STYLE, SIZE, OR COLOR.

PRIORITY CLAIMED UNDER SEC. 44(D) ON CANADA APPLICATION NO. 1297693, FILED 4-13-2006, REG. NO. TMA745,510, DATED 8-17-2009, EXPIRES 8-17-2024.

NO CLAIM IS MADE TO THE EXCLUSIVE RIGHT TO USE "MEDIA PROCESSING", APART FROM THE MARK AS SHOWN.

CLASS 9—ELECTRICAL AND SCIENTIFIC APPARATUS

FOR COMPUTER HARDWARE, FIRMWARE, AND SOFTWARE TO FACILITATE DEPLOYMENT AND PROCESSING OF AUDIO, VOICE, VIDEO, AND MULTIMEDIA CONTENT (U.S. CLS. 21, 23, 26, 36 AND 38).

CLASS 38—COMMUNICATION

FOR PROVIDING ACCESS TO OTHERS TO A GLOBAL COMPUTER NETWORK COMPRISED OF COMPUTER HARDWARE, FIRMWARE, AND SOFTWARE TO FACILITATE DEPLOYMENT AND PROCESSING OF AUDIO, VOICE, VIDEO, AND MULTIMEDIA CONTENT VIA AN INFORMATION NETWORK (U.S. CLS. 100, 101 AND 104).

MARK PILARO, EXAMINING ATTORNEY

SN 78-890,192. HARDY & GREYS LIMITED, ALNWICK, UNITED KINGDOM, FILED 5-23-2006.

Marksman

THE MARK CONSISTS OF STANDARD CHARACTERS WITHOUT CLAIM TO ANY PARTICULAR FONT, STYLE, SIZE, OR COLOR.

PRIORITY CLAIMED UNDER SEC. 44(D) ON ERP CMNTY TM OFC APPLICATION NO. 005043121, FILED 4-27-2006, REG. NO. 005043121, DATED 9-10-2009, EXPIRES 4-27-2016.

CLASS 8—HAND TOOLS

FOR FISHING KNIVES; FISHING LINE SNIPS; FISHING PLIERS; HAND-HELD FISHING HOOK SHARPENERS; HAND TOOLS FOR TYING KNOTS WHILE FISHING (U.S. CLS. 23, 28 AND 44).

CLASS 25—CLOTHING

FOR CLOTHING, SPECIFICALLY FOR ANGLERS, NAMELY, JACKETS, FISHING JACKETS, FLEECE JACKETS, GILETS, FLEECE GILETS, FISHING WAISTCOATS, FISHING VESTS, TROUSERS, FISHING TROUSERS, OVER-TROUSERS, FLEECE TROUSERS, TOPS AND TIGHTS FOR USE AS UNDERGARMENTS, SHIRTS, T-SHIRTS, GLOVES, SCARVES, SOCKS, MITTENS; WATERPROOF AND WEATHER RESISTANT CLOTHING SPECIFICALLY FOR ANGLERS, NAMELY, JACKETS, FISHING JACKETS, FLEECE JACKETS, GILETS, FLEECE GILETS, FISHING WAISTCOATS, FISHING VESTS, TROUSERS, FISHING TROUSERS, OVER-TROUSERS, FLEECE TROUSERS, TOPS AND TIGHTS FOR USE AS UNDERGARMENTS, SHIRTS, T-SHIRTS, GLOVES, SCARVES, SOCKS, MITTENS; HEADWEAR FOR FISHING, NAMELY, HATS, CAPS; FOOTWEAR FOR FISHING EXCLUDING BOOTS, NAMELY, WATERPROOF FOOTWEAR; FISHING WADERS (U.S. CLS. 22 AND 39).

CLASS 28—TOYS AND SPORTING GOODS

FOR SPORTSMAN FISHING BAGS; FISHING RODS; FISHING ROD EXTENSION HANDLES; FISHING FLIES; FISHING FLY WALLETS; ARTIFICIAL FISHING BAIT; PRE-PACKAGED FREEZE-DRIED FISHING BAIT; FISHING HOOKS; FISHING LURES; FISHING PRIESTS, NAMELY, WEIGHTED STICKS USED TO KILL FISH AFTER CATCH; FISHING FLOATS; FISHING LINE; FISHING LINE CASTS; HANDHELD FISHING NETS; LANDING NETS; FISHING PLUMBS; FISHING TACKLE; FISHING TACKLE FLOATS; FISHING TACKLE BOXES AND WALLETS; FISHING ROD CASES; FISHING ROD TUBES; FISHING ROD SUPPORTS; FISHING REELS; FISHING REEL CASES AND POUCHES; CASES AND POUCHES FOR HOLDING FISHING SPOOLS; FISHING GAFFS; FISHING WEIGHTS; BITE INDICATORS; BITE SENSORS; FISHING LEADERS; FISHING LINE TIPPETS; FISHING LINE SPOOLS; FISHING CREELS; AND FLY FISHING LINE BACKING (U.S. CLS. 22, 23, 38 AND 50).

LESLIE RICHARDS, EXAMINING ATTORNEY

SN 78-904,599. GUERRA INDUSTRIES, LLC, LOS ANGELES, CA. FILED 6-9-2006.

EL FLOW DE REGGAETON

THE MARK CONSISTS OF STANDARD CHARACTERS WITHOUT CLAIM TO ANY PARTICULAR FONT, STYLE, SIZE, OR COLOR.

OWNER OF U.S. REG. NOS. 3,011,807, 3,272,484 AND 3,420,781.

CLASS 9—ELECTRICAL AND SCIENTIFIC APPARATUS

FOR SUNGLASSES, CASES FOR SUNGLASSES, CARRYING CASES FOR DIGITAL MUSIC PLAYERS (U.S. CLS. 21, 23, 26, 36 AND 38).

CLASS 14—JEWELRY

FOR COSTUME JEWELRY, JEWELRY CHAINS, NECK CHAINS, BRACELETS, JEWELRY RINGS, AND WATCHES (U.S. CLS. 2, 27, 28 AND 50).

CLASS 18—LEATHER GOODS

FOR HANDBAGS, BACKPACKS AND WALLETS (U.S. CLS. 1, 2, 3, 22 AND 41).

CLASS 25—CLOTHING

FOR CLOTHING, NAMELY, SHIRTS, JERSEYS, POLOS, SHORTS, BLOUSES, BELTS, CAPS, DRESSES, HATS, HEADWEAR, JACKETS, JERSEYS, LINGERIE, LOUNGEWEAR, PANTS, SHORTS, SKIRTS, SLEEPWEAR, SOCKS, SWEAT PANTS, SWEAT SHIRTS, SWIMWEAR, T-SHIRTS, AND FOOTWEAR (U.S. CLS. 22 AND 39).

SHANNON TWOHIG, EXAMINING ATTORNEY

SN 78-956,587. SAO PAULO ALPARGATAS S.A., SAO PAULO, BRAZIL, FILED 8-21-2006.

HAVAIANAS

THE MARK CONSISTS OF STANDARD CHARACTERS WITHOUT CLAIM TO ANY PARTICULAR FONT, STYLE, SIZE, OR COLOR.

OWNER OF U.S. REG. NOS. 1,858,280, 1,906,924 AND 3,069,819.

THE FOREIGN WORDING IN THE MARK TRANSLATES INTO ENGLISH AS "HAWAIIAN".
SEC. 2(F).

CLASS 18—LEATHER GOODS

FOR BAGS, NAMELY, CARRY ALL BAGS (U.S. CLS. 1, 2, 3, 22 AND 41).

CLASS 24—FABRICS

FOR TOWELS (U.S. CLS. 42 AND 50).

CLASS 25—CLOTHING

FOR SPORTS CLOTHING, BEACH CLOTHING AND CAUSAL WEAR, NAMELY, SHIRTS, SHORTS, PANTS AND T-SHIRTS; HEADWEAR (U.S. CLS. 22 AND 39).

KAPIL BHANOT, EXAMINING ATTORNEY

SN 78-981,387. WAY-FM MEDIA GROUP, INC., COLORADO SPRINGS, CO. FILED 1-26-2006.

TOTAL AXXESS

THE MARK CONSISTS OF STANDARD CHARACTERS WITHOUT CLAIM TO ANY PARTICULAR FONT, STYLE, SIZE, OR COLOR.

CLASS 38—COMMUNICATION

FOR RADIO BROADCASTING SERVICES; RADIO BROADCASTING; RADIO PROGRAM BROADCASTING; RADIO BROADCASTING OF INFORMATION AND OTHER PROGRAMS; STREAMING OF AUDIO MATERIAL ON THE INTERNET; PROVIDING A WEBSITE OVER A GLOBAL COMPUTER INFORMATION NETWORK FEATURING INFORMATION ON RADIO BROADCASTING; AND PROVIDING ON-LINE FORUMS AND ELECTRONIC BULLETIN BOARDS FOR TRANSMISSION OF MESSAGES AMONG COMPUTER USERS CONCERNING MUSIC, ENTERTAINING, RADIO BROADCASTING, CONCERTS AND INSPIRATIONAL, CHRISTIAN AND RELIGIOUS TOPICS (U.S. CLS. 100, 101 AND 104).

FIRST USE 1-19-2004; IN COMMERCE 11-7-2005.

CLASS 41—EDUCATION AND ENTERTAINMENT

FOR PROVIDING A WEBSITE OVER A GLOBAL INFORMATION NETWORK FEATURING INFORMATION ON PERFORMING ARTISTS, AND MUSIC; ENTERTAINMENT IN THE NATURE OF ON-GOING RADIO PROGRAMS IN THE FIELD OF CHRISTIAN AND INSPIRATIONAL MUSIC, MUSICAL AND PERFORMING ARTISTS, LIVE INTERVIEWS AND CONCERTS; AND RADIO PROGRAMMING (U.S. CLS. 100, 101 AND 107).

FIRST USE 1-19-2004; IN COMMERCE 11-7-2005.

JOHN DWYER, EXAMINING ATTORNEY

SN 79-011,070. OVALE SA, SWITZERLAND, FILED 2-10-2005.

oyale

OWNER OF INTERNATIONAL REGISTRATION 0796451 DATED 1-23-2003, EXPIRES 1-23-2013.

THE ENGLISH TRANSLATION OF "OVALE" IS "OVAL".

CLASS 3—COSMETICS AND CLEANING PREPARATIONS

FOR SOAPS, NAMELY, CLEANSING PRODUCTS FOR NEWBORNS, LIQUID SOAP, PERFUMED SOAP; TALCUM POWDER; MOISTURIZING CREAM; PERFUMERY; ESSENTIAL OILS FOR PERSONAL USE; COSMETICS; HAIR LOTIONS (U.S. CLS. 1, 4, 6, 50, 51 AND 52).

CLASS 8—HAND TOOLS

FOR CUTLERY, NAMELY, KNIVES, FORKS, AND SPOONS (U.S. CLS. 23, 28 AND 44).

CLASS 11—ENVIRONMENTAL CONTROL APPARATUS

FOR LIGHTING APPARATUS, NAMELY, LAMPS FOR CHILDREN'S ROOMS AND CHILDREN'S NURSERIES (U.S. CLS. 13, 21, 23, 31 AND 34).

CLASS 14—JEWELRY

FOR JEWELRY, NAMELY, BRACELETS, NECKLACES, EARRINGS, BROOCHES, CUFFLINKS (U.S. CLS. 2, 27, 28 AND 50).

CLASS 18—LEATHER GOODS

FOR LEATHER GOODS, NAMELY, BAGS, SUITCASES, WALLETS, BRIEFCASES (U.S. CLS. 1, 2, 3, 22 AND 41).

CLASS 21—HOUSEWARES AND GLASS

FOR COMBS; SPONGES, NAMELY, BATH AND CLEANING SPONGES; BRUSHES, NAMELY, HAIR BRUSHES; BEVERAGE GLASSWARE; PORCELAIN AND EARTHENWARE, NAMELY, CUPS AND BOWLS (U.S. CLS. 2, 13, 23, 29, 30, 33, 40 AND 50).

CLASS 25—CLOTHING

FOR CLOTHING, NAMELY, BABY VESTS, BABY UNDERSHIRTS, BABY BODY SUITS, PAJAMAS, SHIRTS, SHORTS, PANTS, SOCKS; FOOTWEAR; HEADGEAR, NAMELY, BONNETS, CAPS, HATS (U.S. CLS. 22 AND 39).

CLASS 28—TOYS AND SPORTING GOODS

FOR TOYS, NAMELY, BABY MULTIPLE ACTIVITY TOYS, BABY RATTLES, BATH TOYS, CRIB TOYS, DOLLS AND ACCESSORIES THEREFOR, INFANT TOYS, INFANT'S RATTLES, PLUSH TOYS, AND STUFFED TOYS (U.S. CLS. 22, 23, 38 AND 50).
KELLY BOULTON, EXAMINING ATTORNEY

SN 79-020,142. TEN, SOCIÉTÉ PRIVÉE; À RESPONSABILITÉ LIMITÉE, B-1180 BRUXELLES, BELGIUM, FILED 12-14-2005.

TEN

THE MARK CONSISTS OF STANDARD CHARACTERS WITHOUT CLAIM TO ANY PARTICULAR FONT, STYLE, SIZE, OR COLOR.

PRIORITY DATE OF 9-1-2005 IS CLAIMED.
OWNER OF INTERNATIONAL REGISTRATION 0874816 DATED 12-14-2005, EXPIRES 12-14-2015.

THE ENGLISH TRANSLATION OF THE FOREIGN WORD IN THE MARK IS "TEN".

CLASS 24—FABRICS

FOR BED COVERS, NAMELY, BED SHEETS; TERRY TOWELS; TOWELS; BED BLANKETS, BED SPREADS; TABLE COVERS, NAMELY, TABLECLOTHS NOT MADE OF PAPER (U.S. CLS. 42 AND 50).

CLASS 25—CLOTHING

FOR CLOTHING, NAMELY, T-SHIRTS, SHIRTS, DRESS SHIRTS, BLOUSES, POLO AND SPORT SHIRTS, SWEATERS, PULLOVERS, THIN POLO-NECK TOPS, CARDIGANS, DRESSES, PULLOVER-DRESSES, TUNICS, POLAR FLEECE TOPS, BOLEROS, POLO-NECK PULLOVERS, JUMPERS, SKIRTS, TROUSERS, SHORTS, JOGGING SUITS, DUNGAREES, SLIPS, BERMUDA SHORTS, JEANS, CULOTTES, VESTS, BLAZERS, JACKETS, COATS, PARKAS, RAINCOATS, ANORAKS, FUR COATS, SUITS, UNDERPANTS, PANTIES AND KNICKERS, TOPS, BODYSUITS, PAJAMAS, DRESSING GOWNS, TIGHTS, PANTYHOSE, SOCKS, LINGERIE, UNDERSHIRTS, SCARVES, GLOVES, BELTS, TIES, CAPES, PAREOS, PONCHOS, SUSPENDERS, MULES, STOLE, FOOTWEAR, SWIMSUITS, BIKINIS, HEADGEAR, NAMELY, CAPS, HATS, AND HOODS (U.S. CLS. 22 AND 39).

CLASS 28—TOYS AND SPORTING GOODS

FOR TOYS, NAMELY, PLUSH AND FLUFFY DOLLS AND DOLLS (U.S. CLS. 22, 23, 38 AND 50).
NAKIA HENRY, EXAMINING ATTORNEY

SN 79-020,567. CONTINENTAL REIFEN DEUTSCHLAND GMBH, FED REP GERMANY, FILED 7-18-2005.



PRIORITY DATE OF 1-31-2005 IS CLAIMED.
OWNER OF INTERNATIONAL REGISTRATION 0876054 DATED 7-18-2005, EXPIRES 7-18-2015.
OWNER OF U.S. REG. NO. 622,300.

CLASS 7—MACHINERY

FOR ENGINES AND MOTORS FOR MACHINES AND NOT FOR LAND VEHICLES OR AEROSPACE VEHICLES; PARTS FOR ENGINES AND MOTORS NOT FOR AEROSPACE VEHICLES, NAMELY, ELECTRIC MOTOR PARTS NOT FOR LAND VEHICLES OR AEROSPACE VEHICLES; AIR FILTERS FOR ENGINES AND MOTORS; ENGINE AND MOTOR MOUNTS FOR MACHINE ENGINES AND MOTORS, HYDRAULIC AND PNEUMATIC CONTROLS FOR ENGINES AND MOTORS FOR MACHINES, ELECTRIC STARTERS FOR ENGINES AND MOTORS, AND MOTOR-DRIVEN GENERATORS, ALL OF THE AFOREMENTIONED GOODS NOT FOR AEROSPACE VEHICLES; MASTER CYLINDERS FOR MACHINES; ELECTRIC MOTORS NOT FOR LAND VEHICLES OR AEROSPACE VEHICLES; PUMPS AS PARTS OF MACHINES; MACHINE COUPLING AND TRANSMISSION COMPONENTS NOT FOR LAND VEHICLES OR AEROSPACE VEHICLES; CLUTCHES FOR MACHINES; GLOW PLUGS FOR DIESEL ENGINES; MACHINE PARTS, NAMELY, POWER TRANSMISSION BELTS, DRIVE BELTS, V-BELTS, V-RIBBED BELTS, VARIABLE SPEED GEAR BELTS, TIMING BELTS, SYNCHRONOUS DRIVE BELTS, STUDDED BELTS, TWIN-TOOTH SYNCHRONOUS DRIVE BELTS, FLAT BELTS, LIFTING BELTS, CONVEYOR BELTS, MATERIALS HANDLING BELTS, CONVEYOR TRACKS AND BELTS, PASSENGER CONVEYORS, SPRINGS, SHOCK-ABSORBER PISTONS, VIBRATION DAMPERS, SHOCK ABSORBERS FOR MACHINES, ALL OF THE AFOREMENTIONED GOODS NOT FOR AEROSPACE VEHICLE POWER PLANTS, AEROSPACE VEHICLE PISTON ENGINES, AEROSPACE VEHICLE TURBINE ENGINES, OR PARTS AND CONTROLS THEREFOR; VALVES BEING PARTS OF MACHINES (U.S. CLS. 13, 19, 21, 23, 31, 34 AND 35).

CLASS 9—ELECTRICAL AND SCIENTIFIC APPARATUS

FOR ALARM MONITORING SYSTEMS, BATTERIES AND THEIR COMPONENTS, ACCUMULATORS AND THEIR COMPONENTS, FUEL CELLS AND THEIR COMPONENTS, BATTERY CHARGERS, SPEED INDICATORS, WARNING LAMPS FOR VEHICLES, LEVEL GAUGES, PRESSURE GAUGES, SPEEDOMETERS, TACHOMETERS AND MEASURING INSTRUMENTS FOR MEASURING LENGTH, REV COUNTERS, ALL OF THE AFOREMENTIONED GOODS NOT FOR AEROSPACE VEHICLES; MEASURING, SIGNALING, CONTROLLING AND REGULATING DEVICES FOR LAND MOTOR VEHICLES, NAMELY, CRUISE CONTROLS, DATA PROCESSING UNITS, COMPUTER HARDWARE, FIRMWARE, AND SOFTWARE FOR CONTROLLING FUNCTIONS OF LAND MOTOR VEHICLES, ELECTRONIC AND ELECTRICAL MEASURING AND CONTROL DEVICES FOR CONTROLLING DRIVING STABILITY, ALL NOT FOR AEROSPACE VEHICLES; ELECTRONIC SENSORS AND ELECTRONIC CONTROL UNITS INCORPORATING DATA PROCESSORS FOR IMPROVING

LAND MOTOR VEHICLE DRIVING SAFETY AND DRIVING STABILITY BY SENSING STEERING WHEEL POSITION, VEHICLE ROTATION, VEHICLE ACCELERATION AND VEHICLE WHEEL SPEED, AND CONTROLLING SUSPENSION SYSTEMS AND VIBRATION DAMPERS, ALL NOT FOR AEROSPACE VEHICLES; VOLTAGE REGULATORS FOR VEHICLES, ELECTRIC AND ELECTRONIC MEASURING, CONTROL AND REGULATING DEVICES FOR INSTALLATION IN NON-AEROSPACE VEHICLES, FOR THE MONITORING AND CONTROL OF SPEED, TIRE PRESSURE AND VEHICLE DISTANCE; INFLATION-PRESSURE GAUGES AND REVOLUTION METERS; LIFE-SAVING EQUIPMENT, NAMELY, LIFE RAFTS, ESCAPE LADDERS, RESCUE NETS, RESCUE TARPULINS, LIFE BELTS, LIFE BUOYS, LIFE JACKETS, FIRE-EXTINGUISHING APPARATUS, APPARATUS AND INSTRUMENTS FOR CONDUCTING, SWITCHING, TRANSFORMING, ACCUMULATING, REGULATING OR CONTROLLING ELECTRICITY, ELECTRIC FUSES, ELECTRIC RELAYS, TRANSDUCERS, ELECTRONIC ACTUATORS INCLUDED IN THIS CLASS, ALL OF THE FOREMENTIONED GOODS EXCLUSIVE OF AEROSPACE VEHICLES; ELECTRICAL ACCESS AND SHUT-OFF DEVICES FOR VEHICLES EXCEPT FOR AEROSPACE VEHICLES, NAMELY, CONTROL DEVICES, OPERATING ELEMENTS AND ELECTRIC MOTORS; LASER REMOTE CONTROL STARTERS FOR VEHICLES, CAR NAVIGATION COMPUTERS, SOLAR BATTERIES; CONTACT LENSES, SPECTACLES, SPECTACLE CASES, BINOCULARS, OPTICAL MAGNIFIERS, SUNGLASSES, WARNING TRIANGLES FOR VEHICLE BREAKDOWNS, CIGARETTE LIGHTERS FOR AUTOMOBILES; COMPASSES, ACIDOMETERS, LEVEL GAUGES, SCALES, APPARATUS FOR RECORDING, TRANSMISSION OR REPRODUCTION OF SOUND OR IMAGES, NAMELY, ANTENNAS, RADIOS, TELEVISIONS, TELEPHONE EQUIPMENT, NAMELY, VIDEO PHONES, AND MAGNETIC, ELECTRONIC AND OPTICAL RECORDING MEDIA, NAMELY, RECORDING DISCS, MAGNETIC CARDS, CARDS WITH INTEGRATED CIRCUITS, SMART CARDS, PHONE CARDS, COMPUTERS, NAMELY, MONITORS, PERIPHERAL COMPUTER DEVICES, COMPUTER PROGRAMS AND SOFTWARE STORED IN CONTROLLERS FOR CONTROLLING VEHICLE FUNCTIONS; CONTROLLED ADJUSTING DEVICES FOR PARTS OF NON-AEROSPACE VEHICLES, NAMELY, VEHICLE SEATS, WINDOWS, MIRRORS, SLIDING ROOFS, THROTTLE VALVES (U.S. CLS. 21, 23, 26, 36 AND 38).

CLASS 12—VEHICLES

FOR ENGINES FOR LAND VEHICLES; TIRES, INNER TUBES FOR TIRES, WHEELS, WHEEL RIMS, TREAD FOR THE RETREADING OF TIRES, HUBCAPS, WHEEL RIM BANDS; BRAKES FOR VEHICLES AND THEIR COMPONENTS, NAMELY, PARKING BRAKES, ACTIVE PARKING BRAKES AND STEERING LOCKS, BRAKE PRESSURE DISTRIBUTORS, WHEEL BRAKES; BRAKE CYLINDERS, BRAKE PADS, BRAKE CALIPERS, BRAKE DRUMS, WHEEL BRAKES, BRAKE BLOCKS, BRAKE DISCS, BRAKE LININGS, BRAKE HOSES, BRAKE PRESSURE AMPLIFIERS, BRAKE PRESSURE REGULATORS, ADJUSTABLE BRAKE PEDALS, ALL OF THE FOREMENTIONED GOODS AS COMPONENTS OF BRAKE SYSTEMS; MECHANICAL AND HYDRAULIC CONTROL AND REGULATOR AND CUT-OUT RELAY CIRCUITS, INCLUDED IN THIS CLASS; STEERING UNITS FOR LAND VEHICLES AND PARTS THEREOF, CONTROLLED AND UNCONTROLLED CHASSIS AND SUSPENSIONS, SAFETY DEVICES FOR VEHICLES, INCLUDED IN THIS CLASS, NAMELY, AIRBAGS, BELT TIGHTENERS AND THEIR COMPONENTS AND ACCESSORIES, INCLUDED IN THIS CLASS; MACHINE COUPLING AND TRANSMISSION COMPONENTS, NAMELY, SHIFT CLUTCHES FOR LAND VEHICLES, ACTIVE AND PASSIVE, CONTROLLED AND UNCONTROLLED SHOCK ABSORBERS AND SPRINGS FOR VEHICLES, WHEELS AND THEIR COMPONENTS, NAMELY, PNEUMATIC SPRINGS AND GAS SPRINGS, AIR SUPPLY UNITS FOR PNEUMATIC SPRING SYSTEMS, SHOCK ABSORBERS AND STRUTS FOR VEHICLES, SHOCK ABSORBER SPRINGS FOR VEHICLES, SUPPORT SPRINGS FOR VEHICLES, VIBRATION DAMPERS AND TORSIONAL VIBRATION ABSORBERS EX-

CEPT COMPONENTS OF LAND VEHICLE ENGINES, VEHICLE ENGINES, VEHICLE CABINS AND DRIVERS' SEATS; HYDROMOUNTS, AS PARTS OF VEHICLES, INCLUDED IN THIS CLASS; AXLES AND AXLE MODULES, AXLE BELLOWS, DRIVE BELTS FOR LAND VEHICLES, INCLUDED IN THIS CLASS; VALVES FOR VEHICLE TIRES; AUTOMOTIVE INTERIOR TRIM AND LINING; AIRBAG COVERS; DASHBOARD LINING; UPHOLSTERY FOR VEHICLES; VEHICLE SEATS; PASSENGER BELLOWS IN RUBBER OR PLASTIC FOR TRAMS AND ARTICULATED BUSES (U.S. CLS. 19, 21, 23, 31, 35 AND 44).

CLASS 16—PAPER GOODS AND PRINTED MATTER

FOR PRINTERS' TYPE, PRINTING BLOCKS, NON-TEXTILE PRINTING BLANKETS; ATLASES, CALENDARS, GEOGRAPHIC MAPS, BALL PENS AND PENCILS, PENNANTS AND FLAGS OF PAPER, PAPER SERVIETTES, BOOKBINDING ARTICLES; PHOTOGRAPHS; STATIONERY WITH THE EXCEPTION OF WRITING PAPER; ADHESIVES FOR STATIONERY OR HOUSEHOLD PURPOSES; TEACHING MATERIALS, TEXTBOOKS, BROCHURES AND BOOKLETS IN THE FIELD OF AUTOMOBILES, AUTOMOTIVE REPAIR AND AUTOMOTIVE PARTS; PLASTIC MATERIALS FOR PACKAGING, INCLUDED IN THIS CLASS (U.S. CLS. 2, 5, 22, 23, 29, 37, 38 AND 50).

CLASS 17—RUBBER GOODS

FOR NON-METAL HOSES FOR AUTOMOTIVE AND INDUSTRIAL USE; NON-METAL HOSE FITTINGS; NON-METAL PIPE COUPLINGS AND JOINTS; RUBBER COMPENSATORS; PIPE SEALANTS; SEALING SLEEVES, SEALING RINGS, MEMBRANES, NAMELY, GASHOLDER DIAPHRAGMS AND ELASTOMER AND ELASTOMER COMPOSITE MEMBRANE MATERIALS FOR USE IN MAKING DIAPHRAGMS FOR COMMERCIAL, INDUSTRIAL, MEDICAL, OR HOUSEHOLD USE; BULKHEAD MATS OF RUBBER AND RUBBER SUBSTITUTES FOR VIBRATION AND SHOCK ABSORPTION IN TRACK LAYING; OIL ABSORPTION MATS OF RUBBER AND RUBBER SUBSTITUTES; VALVES OF RUBBER; SUNROOF, DOOR, WINDOW, ENGINE COMPARTMENT SEALANTS; UPHOLSTERY MATERIAL OF RUBBER OR PLASTIC; PLASTIC SHEET INSULATION; RUBBER FOR THE RETREADING OF TIRES (U.S. CLS. 1, 5, 12, 13, 35 AND 50).

CLASS 35—ADVERTISING AND BUSINESS

FOR ADVERTISING AND MARKETING, BUSINESS MANAGEMENT, BUSINESS ADMINISTRATION; OFFICE WORK, NAMELY, COMMERCIAL CONSULTANCY, PUBLIC RELATIONS WORK, RADIO AND TELEVISION ADVERTISING AND MARKETING, ORGANIZATION OF EXHIBITIONS AND FAIRS FOR COMMERCIAL AND ADVERTISING AND MARKETING PURPOSES, SALES RESEARCH, MARKET RESEARCH (U.S. CLS. 100, 101 AND 102).

CLASS 37—CONSTRUCTION AND REPAIR

FOR BUILDING CONSTRUCTION, REPAIR AND INSTALLATION SERVICES, NAMELY, MOTOR WORKSHOP SERVICES, CONVERSION, REPAIR, SERVICING, ASSEMBLY, DISMANTLING, MAINTENANCE, CARE, CLEANING AND PAINTING WORK ON VEHICLES, EXCEPT FOR AEROSPACE VEHICLES, ENGINES, EXCEPT FOR AEROSPACE ENGINES, TIRES AND THEIR COMPONENTS; REPAIR OF VEHICLES, EXCEPT FOR AEROSPACE VEHICLES, WITHIN THE SCOPE OF BREAKDOWN RECOVERY SERVICE, RETREADING OF TIRES (U.S. CLS. 100, 103 AND 106).

JANICE L. MCMORROW, EXAMINING ATTORNEY

SN 79-032,498. TLCG IP GMBH, CH-6304 ZUG, SWITZERLAND, FILED 11-8-2006.

SN 79-037,162. SHOP "N" DROP LLP, LONDON, UNITED KINGDOM, AND MS SHELLY FLAXMAN, LONDON, UNITED KINGDOM, FILED 1-16-2007.

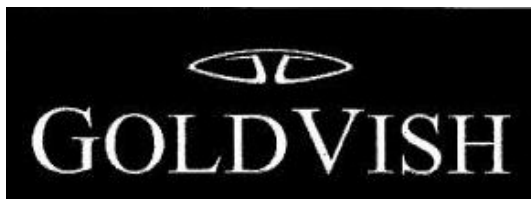

SHOP 'N' DROP

PRIORITY DATE OF 6-2-2006 IS CLAIMED.
OWNER OF INTERNATIONAL REGISTRATION 0907496
DATED 11-8-2006, EXPIRES 11-8-2016.

CLASS 9—ELECTRICAL AND SCIENTIFIC APPARATUS

FOR TELEPHONES, TELEPHONES MADE OF PRECIOUS METAL AND PRECIOUS STONES, CORDLESS, WIRELESS AND SATELLITE TELEPHONES; MOBILE COMMUNICATORS, NAMELY, MOBILE PHONES; SMART PHONES, ANTENNAS FOR TELEPHONES, MICROPHONES FOR TELEPHONES, AUDIO SPEAKERS FOR TELEPHONES, HEADSETS FOR TELEPHONES, HEADPHONES, EARPHONES, CARRYING CASES FOR MOBILE TELEPHONES; DIGITAL CAMERAS, VIDEO CAMERAS; PERSONAL AND CAR NAVIGATION DEVICES AND EQUIPMENT, NAMELY, COMPUTERS; GPS RECEIVERS; MEMORY CARDS AND ELECTRONIC CIRCUIT CARDS FOR MOBILE TELEPHONES; APPARATUS AND INSTRUMENTS FOR CONDUCTING, SWITCHING, TRANSFORMING, ACCUMULATING, REGULATING OR CONTROLLING ELECTRICITY, NAMELY, BATTERIES, BATTERY CHARGERS, POWER SUPPLIES, ELECTRICAL WIRES AND CABLES FOR MOBILE TELEPHONES; PERSONAL DIGITAL ASSISTANTS; BLANK MAGNETIC DATA CARRIERS, CALCULATING MACHINES, DATA PROCESSING AND COMPUTER EQUIPMENT, NAMELY, PERSONAL DIGITAL ASSISTANTS; ALL AFOREMENTIONED GOODS NOT FOR USE WITH CURRENCY AND CREDIT OPERATED SLOT MACHINES AND GAMING DEVICES, NAMELY, GAMING MACHINES FOR USE IN GAMING ESTABLISHMENTS (U.S. CLS. 21, 23, 26, 36 AND 38).

CLASS 14—JEWELRY

FOR PRECIOUS METALS AND THEIR ALLOYS; GOODS MADE OF PRECIOUS METAL AND THEIR ALLOYS, NAMELY, JEWELRY CHAINS, PENDANTS, CHARMS; JEWELRY, PRECIOUS STONES (U.S. CLS. 2, 27, 28 AND 50).

CLASS 16—PAPER GOODS AND PRINTED MATTER

FOR PAPER, CARDBOARD, POSTERS; POSTCARDS; PRINTED MATTER, NAMELY, BROCHURES, BOOKLETS, INSTRUCTIONAL AND TEACHING MATERIALS FEATURING INSTRUCTIONS ON HOW TO USE TELEPHONES, CORDLESS, WIRELESS OR SATELLITE TELEPHONES AND FACSIMILES MACHINES; PHOTOGRAPHS; STATIONERY; ADHESIVES FOR STATIONERY OR HOUSEHOLD PURPOSES; PRINTERS' TYPE; PRINTING BLOCKS (U.S. CLS. 2, 5, 22, 23, 29, 37, 38 AND 50).

CHRISTOPHER BUONGIORNO, EXAMINING ATTORNEY

PRIORITY DATE OF 10-26-2006 IS CLAIMED.
OWNER OF INTERNATIONAL REGISTRATION 0920619
DATED 1-16-2007, EXPIRES 1-16-2017.

CLASS 16—PAPER GOODS AND PRINTED MATTER

FOR PAPER, CARDBOARD AND GOODS MADE FROM THESE MATERIALS, NAMELY, PAPER BOXES, PAPER PACKAGING, CARDBOARD BOXES, CARDBOARD PACKAGING, CARDBOARD CONTAINERS, STATIONERY, BANNERS AND POSTERS; PRINTED MATTER, NAMELY, PRINTED STATIONERY, PARTIALLY PRINTED FORMS, PRINTED BANNERS, PRINTED POSTERS AND PRINTED FLYERS; BOOK-BINDING MATERIALS; PHOTOGRAPHS; ADHESIVES FOR STATIONERY OR HOUSEHOLD PURPOSES; ARTISTS' MATERIALS, NAMELY, PENCILS, PENS, DRAWING PADS AND DRAWING INSTRUMENTS; PAINT BRUSHES; TYPEWRITERS; OFFICE REQUISITES, NAMELY, FRANKING MACHINES, STAPLERS, PAPER FOLDING MACHINES AND EMBOSSERS; PRINTED INSTRUCTIONAL AND TEACHING MATERIAL IN THE FIELD OF ADVERTISING SERVICES AND RETAIL SERVICES; PLASTIC MATERIALS FOR PACKAGING, NAMELY, BAGS, BUBBLE PACKS; PRINTERS' TYPE; PRINTING BLOCKS; BUSINESS PAPERS, NAMELY, BUSINESS STATIONERY, FLYERS AND FORMS (U.S. CLS. 2, 5, 22, 23, 29, 37, 38 AND 50).

CLASS 35—ADVERTISING AND BUSINESS

FOR ADVERTISING; BUSINESS MANAGEMENT; BUSINESS ADMINISTRATION; PROVIDING OFFICE FUNCTIONS; BUSINESS SERVICES FOR RETAIL STORES, NAMELY, TRANSPORTATION, PACKAGING, STORAGE AND DISTRIBUTION OF GOODS SERVICES (U.S. CLS. 100, 101 AND 102).

CLASS 36—INSURANCE AND FINANCIAL

FOR INSURANCE, NAMELY, INSURANCE INFORMATION, INSURANCE BROKERAGE, INSURANCE CONSULTANCY AND ADVICE, INSURANCE UNDERWRITING; FINANCIAL AND MONETARY AFFAIRS, NAMELY, FINANCIAL ADVICE AND CONSULTANCY, CURRENCY EXCHANGE, FINANCIAL EVALUATION FOR INSURANCE PURPOSES, FINANCIAL INFORMATION, FINANCING SERVICES; REAL ESTATE AFFAIRS, NAMELY, REAL ESTATE INFORMATION, REAL ESTATE MANAGEMENT, REAL ESTATE LEASING, REAL ESTATE CONSULTANCY AND REAL ESTATE LISTING (U.S. CLS. 100, 101 AND 102).

CLASS 39—TRANSPORTATION AND STORAGE

FOR TRANSPORT OF GOODS; PACKAGING ARTICLES TO THE SPECIFICATIONS OF OTHERS; PACKAGING ARTICLES FOR TRANSPORT; STORAGE OF GOODS; TRAVEL ARRANGEMENTS; DELIVERY OF GOODS; SORTING OF GOODS FOR DELIVERY, NAMELY, RETAIL STORE GOODS; WAREHOUSING OF GOODS; DISTRIBUTION OF GOODS, NAMELY, DELIVERY OF GOODS IN ACCORDANCE WITH CONSUMER SPECIFICATIONS; PARKING AND DELIVERY SERVICES FOR CUSTOMERS, NAMELY, PROVISION OF PARKING FACILITIES TO ENABLE THE DROP-OFF AND DELIVERY OF MERCHANDISE IN ACCORDANCE WITH CONSUMER SPECIFICATIONS; SHOPPING DELIVERY SERVICES, NAMELY, DELIVERY OF MERCHANDISE IN ACCORDANCE WITH CONSUMER SPECIFICATIONS; MATERIALS HANDLING SERVICES, NAMELY, PACKING, DELIVERY AND TRANSPORT OF MERCHANDISE IN ACCORDANCE WITH CONSUMER SPECIFICATIONS; PROVISION OF CAR PARKING SPACES AND CAR PARKING FACILITIES (U.S. CLS. 100 AND 105).

SUZANNE BLANE, EXAMINING ATTORNEY

SN 79-042,131. ILLES, ANDREAS, BRANDENBURG, FED REP GERMANY, FILED 7-2-2007.

AnaAnAn

PRIORITY DATE OF 7-2-2007 IS CLAIMED.
OWNER OF INTERNATIONAL REGISTRATION 0933376
DATED 7-2-2007, EXPIRES 7-2-2017.

CLASS 15—MUSICAL INSTRUMENTS

FOR MUSICAL INSTRUMENTS; STANDS FOR MUSICAL INSTRUMENTS; CARRYING CASES FOR MUSICAL INSTRUMENTS, PADDED PROTECTIVE STORAGE BOXES FOR MUSICAL INSTRUMENTS, AND PROTECTIVE CARRYING SHEATHS FOR MUSICAL INSTRUMENTS (U.S. CLS. 2, 21 AND 36).

CLASS 16—PAPER GOODS AND PRINTED MATTER

FOR BOOKS IN ILLUSTRATED FORM, IN THE FIELD OF PHOTOGRAPHY, ART, DESIGN, MUSIC, LIFESTYLE; PICTURES; PICTURE BOOKS; FRAMED AND UNFRAMED PHOTOGRAPHS; EVENT ALBUMS; PAPER; CARDBOARD; GOODS MADE FROM PAPER AND CARDBOARD, NAMELY, POSTCARD DISPLAYS, PICTURE MOUNTS, DECORATIVE CENTERPIECES; PRINTED MATTER, NAMELY, CALENDARS, POSTCARDS, POSTERS, STICKERS; PACKING PAPER; STATIONERY; POSTERS; PORTRAITS; POSTCARDS; BROCHURES ABOUT PHOTOGRAPHY, ART, DESIGN, MUSIC, LIFESTYLE; PUBLICATION PAPER; BOOKMARKS; CALENDARS; CARDS, NAMELY, GREETING CARDS; ART PRINTS; ILLUSTRATIONS; BOOKLETS IN THE FIELD OF PHOTOGRAPHY, ART, MUSIC, DESIGN, LIFESTYLE (U.S. CLS. 2, 5, 22, 23, 29, 37, 38 AND 50).

CLASS 20—FURNITURE AND ARTICLES NOT OTHERWISE CLASSIFIED

FOR FURNITURE, MIRRORS, PICTURE FRAMES; OBJECTS MADE OF WOOD, CORK, REED, CANE, WICKER, HORN, BONE, IVORY, WHALEBONE, SHELL, AMBER, MOTHER-OF-PEARL, MEERSCHAUM AND SUBSTITUTES FOR ALL THESE MATERIALS, OR OF PLASTICS, NAMELY, SHELVES, TABLES, LAMP STANDS, BOXES (U.S. CLS. 2, 13, 22, 25, 32 AND 50).

CLASS 28—TOYS AND SPORTING GOODS

FOR GAMES, NAMELY, CARD GAMES, BOARD GAMES, EQUIPMENT SOLD AS A UNIT FOR PLAYING BOARD GAMES; PLAYTHINGS, NAMELY, PUPPETS, PUPPET THEATERS, CHESS PIECES; GYMNASTIC AND SPORTING ARTICLES NAMELY, SWINGS, EXERCISE WEIGHTS, JUMP ROPES, ARTIFICIAL CLIMBING WALLS (U.S. CLS. 22, 23, 38 AND 50).

CLASS 41—EDUCATION AND ENTERTAINMENT

FOR ENTERTAINMENT IN THE NATURE OF LIVE DANCE, MUSICAL AND THEATRICAL PERFORMANCES; SELECTION AND COMPILATION OF PRE-RECORDED MUSIC FOR BROADCASTING BY OTHERS; PROVISION OF PRERECORDED DIGITAL MUSIC ON-LINE; AUDIO AND VIDEO RECORDING AND PHOTOGRAPHY STUDIO SERVICES; MUSIC PUBLISHING SERVICES; MUSIC COMPOSITION FOR OTHERS; LIVE PERFORMANCES OF MUSIC AND SINGING; LIVE MUSIC CONCERTS; PRODUCTION AND PUBLISHING OF MUSIC RECORDINGS; PRODUCTION AND PUBLISHING OF VIDEO, MUSIC AND AUDIO RECORDINGS; PHOTOGRAPHY SERVICES (U.S. CLS. 100, 101 AND 107).

FRED CARL, EXAMINING ATTORNEY

SN 79-044,284. R. STAHL AKTIENGESELLSCHAFT, FED REP GERMANY, FILED 7-26-2007.



OWNER OF INTERNATIONAL REGISTRATION 0938679
DATED 7-26-2007, EXPIRES 7-26-2017.

THE MARK CONSISTS OF THE WORDING "STAHL" WITHIN A POLYGON ON A SQUARE.

THE ENGLISH TRANSLATION OF "STAHL" IS "STEEL".

CLASS 7—MACHINERY

FOR ELECTRIC CABLE HOISTS, CHAIN HOISTS AND CRANES FOR THE MECHANICAL ENGINEERING INDUSTRY; MACHINES FOR MECHANICAL CONVEYING AND HANDLING, NAMELY, ELECTRIC TROLLEYS, UNDERFLOOR CONVEYORS, CRANES, CRANE TRUCKS, SLEWING CRANES, COLUMN-MOUNTED SLEWING CRANES, WALL-MOUNTED SLEWING CRANES, FACTORY CRANES AND FACTORY CRANE TRUCKS, ELECTRIC CHAIN HOISTS, MANUAL CHAIN HOISTS, TACKLE BLOCKS IN THE NATURE OF ELECTRIC PULLEY BLOCKS; MOTORS NOT FOR LAND CRAFT FOR USE IN MECHANICAL CONVEYING AND HANDLING MACHINES FOR USE ON BOARD AIRCRAFT, SHIPS, AND FOR USE IN TROLLEYS, CRANES, CRANE TRUCKS, AND IN FIREDAMP ATMOSPHERES AND IN HAZARDOUS AREAS; HOUSINGS FOR MACHINES, MOTORS AND ELECTROTECHNICAL AND ELECTRONIC EQUIPMENT, NAMELY, HOUSINGS AS STRUCTURAL PARTS OF HOISTS, CRANES, CONVEYORS, TROLLEYS, AND CRANE TRUCKS FOR USE ON BOARD AIRCRAFT, SHIPS AND FOR USE IN FIREDAMP ATMOSPHERES AND IN HAZARDOUS AREAS (U.S. CLS. 13, 19, 21, 23, 31, 34 AND 35).

CLASS 9—ELECTRICAL AND SCIENTIFIC APPARATUS

FOR ELECTROTECHNICAL AND ELECTRONIC DEVICES IN THE ELECTRICAL POWER, FACTORY AUTOMATION OR PROCESS AUTOMATION FIELDS FOR CONTROLLING, REGULATING AND POWER DISTRIBUTION PURPOSES; REMOTE I/O DEVICES AND BUS HARDWARE AND SOFTWARE FOR THE AFOREMENTIONED GOODS; ELECTRICAL BUS MODULES AND ELECTRICAL BUSBARS; INTERFACING DEVICES AND INTERFACE UNITS IN THE NATURE OF USER INTERFACES FOR COMPUTERS, ELECTROTECHNICAL AND ELECTRONIC DEVICES; SAFETY BARRIERS AND ISOLATORS FOR USE IN ELECTRICAL INSTRUMENTATION CIRCUITS; POWER SUPPLIES, ELECTRICAL PLUGS AND SOCKETS, ELECTRICAL POWER DISTRIBUTION BOARDS AND DISTRIBUTION PANELS; ELECTRICAL INSTALLATION EQUIPMENT IN THE NATURE OF ELECTRICAL SWITCHES, JUNCTION BOXES, FUSES, AND CIRCUIT BREAKERS; ELECTRICAL TERMINAL BOXES, ELECTRICAL POWER DISTRIBUTION MONITORS AND ELECTRICAL CONTROLLERS; ELECTRICAL CONTROL PANELS, SWITCH-DISCONNECTORS IN THE NATURE OF CUT-OUT SWITCHES AND ELECTRONIC MOTOR CONTROLS; ALL FOR USE IN HAZARDOUS AREAS, IN VEHICLES, AIRCRAFT AND SHIPS AND IN FIREDAMP AREAS; MEASURING, CONTROL, SIGNALING, MONITORING, OPERATING AND TESTING EQUIPMENT AND SYSTEMS, NAMELY, COMPUTER TERMINALS, TOUCH SCREENS, COMPUTER DATA TRANSMITTERS, AND REMOTE CONTROLS FOR TELEMETERING MACHINES AND APPARATUS; SOFTWARE FOR REMOTELY MONITORING MEASURING SIGNALS, ENVIRONMENTAL CONDITIONS AND CONTROLLING DEVICES WITHIN A BUILDING, FACILITY, GROUNDS, OR DESIGNATED SPATIAL AREA; EMERGENCY WARNING LIGHTS (U.S. CLS. 21, 23, 26, 36 AND 38).

CLASS 11—ENVIRONMENTAL CONTROL APPARATUS

FOR LIGHTING DEVICES, NAMELY, LIGHTING FIXTURES FOR FLUORESCENT LAMPS, PENDANT LIGHTING FIXTURES, FLOODLIGHTS, TANK INSPECTION LAMPS, HAND LAMPS, PORTABLE LAMPS, AND REPAIR LIGHTING FIXTURES; GROUP AND CENTRAL BATTERY LIGHTING UNITS CONSISTING OF LIGHTING FIXTURES FEATURING LIGHT FAILURE DETECTION, AND ELECTRONIC CONTROLLERS, BATTERIES AND VOLTAGE CONVERTERS; LIGHTING POLES COMPRISED OF LIGHTING FIXTURES; INCANDESCENT LAMPS; LED CLUSTER LIGHTERS CONSISTING OF LED LIGHT BULBS AND FIXTURES; ALL THE AFORESAID LIGHTING DEVICES FOR USE IN HAZARDOUS AREAS, IN VEHICLES, AIRCRAFT AND SHIPS AND IN FIREDAMP AREAS (U.S. CLS. 13, 21, 23, 31 AND 34).

CLASS 42—SCIENTIFIC AND COMPUTER SERVICES

FOR DEVELOPMENT, DESIGN, PLANNING AND CONFIGURATION OF MACHINES, MOTORS, ELECTROTECHNICAL AND ELECTRONIC DEVICES AND SYSTEMS, FOR CONTROLLING, REGULATING, MEASURING, POWER DISTRIBUTION AND ENERGY PROTECTION PURPOSES; DEVELOPMENT, DESIGN, PLANNING AND CONFIGURATION OF MEASURING, CONTROL, SIGNALING, MONITORING, OPERATING AND TESTING EQUIPMENT AND SYSTEMS; DEVELOPMENT, DESIGN, PLANNING AND CONFIGURATION OF LOW-VOLTAGE SWITCHGEAR ASSEMBLIES, ELECTRIC AND ELECTRONIC CONTROLS AND MSR CABINETS AND OF LIGHTING DEVICES AND LIGHTING SYSTEMS; DRAFTING AND DEVELOPMENT OF COMPUTER HARDWARE AND COMPUTER SOFTWARE; RESEARCH IN THE TECHNICAL FIELDS OF MECHANICAL ENGINEERING AND ELECTRICAL ENGINEERING; PREPARATION OF ANALYSES AND EXPERT OPINIONS AND CONSULTANCY IN THE FIELDS OF MECHANICAL ENGINEERING, ENERGY PROTECTION AND EXPLOSION PROTECTION; PLANNING AND ENGINEERING OF ELECTROTECHNICAL AND ELECTRONIC SYSTEMS, FOR USE IN HAZARDOUS AREAS, IN VEHICLES, AIRCRAFT AND SHIPS, AND IN FIREDAMP AREAS (U.S. CLS. 100 AND 101).

JAMES MACFARLANE, EXAMINING ATTORNEY

SN 79-045,382. BOEHRINGER INGELHEIM INTERNATIONAL GMBH, FED REP GERMANY, FILED 9-19-2007.

PRISMA

THE MARK CONSISTS OF STANDARD CHARACTERS WITHOUT CLAIM TO ANY PARTICULAR FONT, STYLE, SIZE, OR COLOR.

OWNER OF INTERNATIONAL REGISTRATION 0941436 DATED 9-19-2007, EXPIRES 9-19-2017.

THE ENGLISH TRANSLATION OF THE WORD "PRISMA" IN THE MARK IS "PRISM".

CLASS 41—EDUCATION AND ENTERTAINMENT

FOR PUBLICATION OF BOOKS, PAMPHLETS, AND JOURNALS CONTAINING THE RESULTS OF CLINICAL TRIALS FOR PHARMACEUTICAL PREPARATIONS (U.S. CLS. 100, 101 AND 107).

CLASS 42—SCIENTIFIC AND COMPUTER SERVICES

FOR RESEARCH, NAMELY, CONDUCTING CLINICAL STUDIES FOR PHARMACEUTICAL PREPARATIONS (U.S. CLS. 100 AND 101).

CHRISTOPHER BUONGIORNO, EXAMINING ATTORNEY

SN 79-046,631. JERRY DAMMERS, UNITED KINGDOM, FILED 11-2-2007.

The Specials

OWNER OF INTERNATIONAL REGISTRATION 0944557 DATED 11-2-2007, EXPIRES 11-2-2017.

CLASS 9—ELECTRICAL AND SCIENTIFIC APPARATUS

FOR PRE-RECORDED MAGNETIC DATA CARRIERS FEATURING MUSIC, SONG AND SPOKEN WORDS, SOUND EFFECTS, AMBIENT SOUNDS AND TEXT IN THE NATURE OF POETRY AND LYRICS; RECORDING DISCS, NAMELY, PRE-RECORDED COMPACT DISCS FEATURING MUSIC, SONG AND SPOKEN WORDS, SOUND EFFECTS, AMBIENT SOUNDS AND TEXT IN THE NATURE OF POETRY AND LYRICS; SOUND AND VIDEO RECORDINGS, NAMELY, PRE-RECORDED VIDEO DISCS FEATURING MUSIC, SONG AND SPOKEN WORDS, SOUND EFFECTS, AMBIENT SOUNDS, VISUAL IMAGES AND TEXT IN THE NATURE OF POETRY AND LYRICS; PRE-RECORDED COMPACT DISCS, PHONOGRAPH RECORDS AND AUDIOTAPES FEATURING MUSIC, SONG AND SPOKEN WORDS, SOUND EFFECTS, AMBIENT SOUNDS, VISUAL IMAGES AND TEXT IN THE NATURE OF POETRY AND LYRICS; PRE-RECORDED DVDS FEATURING MUSIC, SONG AND SPOKEN WORDS, SOUND EFFECTS, AMBIENT SOUNDS, VISUAL IMAGES AND TEXT IN THE NATURE OF POETRY AND LYRICS (U.S. CLS. 21, 23, 26, 36 AND 38).

SN 79-047,211. ESTRELLA LIMITED, DOUGLAS, ISLE OF MAN IM11AE, UNITED KINGDOM, FILED 2-27-2007.

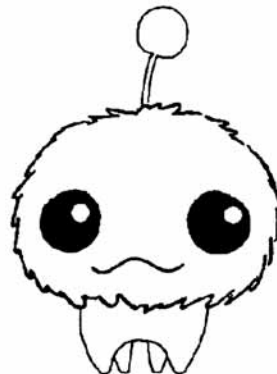
**CLASS 16—PAPER GOODS AND PRINTED MATTER**

FOR PACKAGING OF CD'S, AUDIOTAPES AND DVD'S, NAMELY, PACKAGING CONTAINERS OF PAPER AND CARDBOARD; PRINTED CD COVERS; PRINTED CD BOOKLETS; PRINTED MATTER, NAMELY, BOOKS AND MAGAZINES IN THE FIELD OF MUSIC; PRINTED DISPLAY ADVERTISING MATERIALS, NAMELY, ADVERTISING BOARDS OF PAPER OR CARDBOARD; ADVERTISING SIGNS OF PAPER OR CARDBOARD; SIGNBOARDS OF PAPER OR CARDBOARD; PHOTOGRAPHS; SONGBOOKS; POSTERS; POSTER BOARDS (U.S. CLS. 2, 5, 22, 23, 29, 37, 38 AND 50).

PRIORITY DATE OF 8-29-2006 IS CLAIMED.
OWNER OF INTERNATIONAL REGISTRATION 0946069
DATED 2-27-2007, EXPIRES 2-27-2017.

CLASS 9—ELECTRICAL AND SCIENTIFIC APPARATUS

FOR EYEGLASS FRAMES; SUNGLASSES; EYEGLASS CASES; CALCULATORS; DOWNLOADABLE WALLPAPER GRAPHICS FOR MOBILE PHONES; COMPUTER AND MOBILE PHONE SCREENSAVER SOFTWARE; DOWNLOADABLE VOICE TONES FOR MOBILE PHONES; DOWNLOADABLE RINGTONES FOR MOBILE PHONES; DOWNLOADABLE VIDEO RINGER FOR MOBILE PHONES; DOWNLOADABLE SOFTWARE FEATURING THEME FOR MOBILE PHONES IN THE NATURE OF A PRESET PACKAGE CONTAINING GRAPHICAL APPEARANCE DETAILS USED TO CUSTOMIZE THE LOOK AND FEEL OF THE OPERATING SYSTEM OF MOBILE PHONES; COMPUTER GAMES PROGRAMS; GUMBALL VENDING MACHINES; WIND-SOCKS; MAGNETS; MOBILE PHONES; THERMOMETERS NOT FOR MEDICAL PURPOSE; BAROMETERS; MOUSE PADS; KEYBOARDS FOR USE WITH COMPUTERS; COMPUTERS; COMPUTER PERIPHERAL DEVICES; TELEPHONES; PRE-RECORDED TAPE CASSETTES FEATURING COMPUTER GAMES, MOVIES, ANIMATED CARTOONS AND MUSIC; PRE-RECORDED DISCS FEATURING COMPUTER GAMES, MOVIES, ANIMATED CARTOONS AND MUSIC; VIDEO AND COMPUTER GAME CARTRIDGES; GOGGLES FOR SPORTS; NOSE CLIPS FOR SWIMMERS; COMPUTER SOFTWARE FOR APPLICATION ON MOBILE PHONES OR HANDHELD ELECTRONIC DEVICES, ELECTRONIC AND VIDEO GAMES, THE INTEGRATION OF TEXT, AUDIO, GRAPHICS, STILL IMAGES AND MOVING PICTURES INTO AN INTERACTIVE DELIVERY FOR MULTIMEDIA APPLICATIONS, PROCESSING DIGITAL MUSIC FILES AND ORGANIZING AND VIEWING DIGITAL IMAGES, PHOTOGRAPHS, ANIMATED CARTOONS AND MOVIES; COMPUTER GAME SOFTWARE; GAME SOFTWARE FOR USE WITH TELEVISIONS OR ELECTRONIC DEVICES; WEIGHING APPARATUS AND INSTRUMENTS; CAMERAS; APPARATUS AND INSTRUMENTS FOR ASTRONOMY NAMELY, TELESCOPES AND SUN DIALS; ELECTRIC DOOR BELLS; GALVANIC BATTERIES; VIDEO DISKS AND VIDEO TAPES WITH ANIMATED CARTOONS FOR SHOWING IN CINEMAS AND TELEVISION; ELECTRIC FLAT IRONS; DOWNLOADABLE ANIMATED CARTOONS; HANDHELD GAME CARTRIDGES; SCALES (U.S. CLS. 21, 23, 26, 36 AND 38).

CLASS 25—CLOTHING

FOR CLOTHING, NAMELY, SHIRTS, T-SHIRTS, JACKETS, TROUSERS, SUITS, SHORTS, DRESSES, SWEATERS, JUMPERS, JERSEYS, SWEATSHIRTS, TIES, SOCKS, UNDERWEAR; FOOTWEAR; HEADGEAR, NAMELY, HATS AND CAPS (U.S. CLS. 22 AND 39).

CLASS 41—EDUCATION AND ENTERTAINMENT

FOR EDUCATION SERVICES, NAMELY, CONDUCTING PROGRAMS IN THE FIELDS OF MUSIC, ART, LITERATURE AND POLITICS; TRAINING SERVICES IN THE FIELDS OF MUSIC, ART, LITERATURE AND POLITICS; ENTERTAINMENT IN THE NATURE OF LIVE MUSIC CONCERTS, DANCE PERFORMANCES AND THEATRICAL PRODUCTIONS; ORGANIZING COMMUNITY SPORTING AND CULTURAL ACTIVITIES (U.S. CLS. 100, 101 AND 107).

CIMMERIAN COLEMAN, EXAMINING ATTORNEY

CLASS 16—PAPER GOODS AND PRINTED MATTER

FOR TOWELS OF PAPER; PATTERNS FOR MAKING CLOTHES; BOOKMARKERS; BOOK COVERS; GIFT BAGS OF TEXTILE, PLASTIC AND/OR PAPER; ERASERS; LETTER OPENERS; PAPER GIFT WRAP; PLASTIC GIFT WRAP; GREETING CARDS; INVITATION CARDS; DRAWING BOARD; MEMO PADS; CALENDARS; POSTCARDS; RUBBER STAMPS; SCHOOL SUPPLIES, NAMELY, FOLDERS, PROTRACTORS, PAPER CLIPS, PENCIL SHARPENERS, AND BOOK MARKS; BANK CHECKS; NOTEBOOKS; GLOBES; CRAYONS AND MARKERS; ARTS AND CRAFT PAINT KITS; DECORATIVE PENCIL-TOP ORNAMENTS; FACIAL TISSUE; CHILDREN'S ACTIVITY BOOKS; ADDRESS BOOKS; BOOKS IN THE NATURE OF BABY BOOKS, COOK BOOKS, COMIC BOOKS, SONG BOOKS, RELIGIOUS BOOKS, AUTOGRAPH BOOKS, NOVELS, TRAVEL BOOKS, REFERENCE BOOKS IN THE FIELD OF TECHNOLOGY, ENTERTAINMENT, FINANCE, HEALTH, LEGAL, MEDICAL, EDUCATION, POLITICS, FASHION AND REAL ESTATES; DIARIES; CHILDREN'S EDUCATIONAL BOOKS; STORY BOOKS; POSTERS; MAGAZINES IN THE FIELD OF TECHNOLOGY, ENTERTAINMENT, FINANCE, LEGAL, MEDICAL, EDUCATION, POLITICS, FASHION, HEALTH, FOOD AND DRINKS, VACATION PLANNING, SHOPPING GUIDES, TRAVEL AND REAL ESTATES AND MAGAZINES FEATURING TOPICS OF INTEREST TO CHILDREN; COLORING BOOKS; STICKERS; STICKER ALBUMS; EMBROIDERY DESIGNS PATTERNS; MODELING CLAY; OFFICE REQUISITES, NAMELY, ADHESIVE TAPE DISPENSERS, CORRECTION FLUIDS, PAPER CUTTERS, FILE FOLDERS, MOISTENERS FOR GUMMED SURFACES, PENS, PUNCHES, DESK DIARIES, APPOINTMENT CALENDARS, ORGANIZER FILES, FINGER-STALLS, FRANKING MACHINES, ENVELOPE SEALING MACHINES, PAPER EMBOSSERS, PAPER FOLDING MACHINES, RUBBER BANDS, AND STAPLERS; WRITING INSTRUMENTS; PRINTED MATTERS IN THE NATURE OF BROCHURES ABOUT COMPUTER AND MOBILE PHONE SOFTWARE, ELECTRONIC GAMES, ONLINE GAMES, MAGAZINES, COMICS, MOVIES, BAGS, LUGGAGE, HOUSEHOLD UTENSILS, TEXTILES FOR HOUSEHOLD PURPOSES, CLOTHING, FOOTWEAR, HEADGEAR, GAMES, PLAYTHINGS, FOOD, DRINKS, SHOWS AND ENTERTAINMENT; GREETING CARDS, INVITATION CARDS, POST CARDS, ANNOUNCEMENT CARDS, GREETING BOOKLETS, PARTY GAME BOOKS, RULES BOOKS AND SCORE CARDS OR SCORE PADS FOR GAMES, XUAN PAPER FOR CHINESE PAINTING AND CALLIGRAPHY; PICTURES; STAPLING PRESSES; INK; ADHESIVES GLUES FOR STATIONERY OR HOUSEHOLD PURPOSES; DRAWING INSTRUMENTS; INKING RIBBONS FOR COMPUTER PRINTERS; PAPER TABLECLOTHS (U.S. CLS. 2, 5, 22, 23, 29, 37, 38 AND 50).

CLASS 18—LEATHER GOODS

FOR BACKPACKS; BELT BAGS; PURSES; WALLETS; LAUNDRY BAGS; BRIEFCASES; LUGGAGE; GYM BAGS; DAYPACKS; HANDBAGS; COLLARS FOR ANIMALS; LEATHER, UNWORKED AND SEMI-WORKED; UMBRELLAS (U.S. CLS. 1, 2, 3, 22 AND 41).

CLASS 21—HOUSEWARES AND GLASS

FOR MITTENS AND GLOVES FOR HOUSEHOLD PURPOSE; POT HOLDERS; PAPER PLATES, BOWLS, CUPS; LUNCH BOXES; CERAMIC MUGS; BASKETS OF WICKER, STRAW, WOOD OR CLOTH FOR DOMESTIC USE; ARTICLES MADE OF CERAMIC NAMELY, SCULPTURES, VASES, VESSELS, BOWLS, PLATES, POTS, FIGURINES; FIGURINES OF PORCELAIN, TERRA-COTTA, GLASS, CRYSTAL, BONA CHINA OR CERAMIC; PLAQUES OF PORCELAIN, TERRA-COTTA, GLASS, CRYSTAL, BONA CHINA OR CERAMIC; STAINED BEVERAGE GLASSWARE; COMBS; BRUSHES, NAMELY, HAIR BRUSHES, BATH BRUSHES, BILLIARD TABLE BRUSHES, SHOE BRUSHES, BRUSHES FOR PETS, BRUSHES FOR CLEANING PURPOSES, CAKE BRUSHES, CLOTHES BRUSHES, COSMETIC BRUSHES, SCRAPING BRUSHES, SCRUBBING BRUSHES, SHAVING BRUSHES AND WASHING BRUSHES; TOOTHBRUSHES; NON-ELECTRIC DOMES-

TIC APPLIANCES, NAMELY, NON-ELECTRIC COFFEE FILTERS, NON-ELECTRIC PORTABLE COLD BOXES, NON-ELECTRIC HEATERS FOR FEEDING BOTTLES, NON-ELECTRIC FRUIT PRESSES, NON-ELECTRIC KETTLES, NON-ELECTRIC KITCHEN MIXERS, NON-ELECTRIC WAFFLE IRONS; PLASTIC STORAGE CONTAINERS FOR DOMESTIC USE; ACRYLIC PLATES, BOWLS, CUPS, SAUCERS, CHOPSTICKS AND CHOPSTICK STANDS; CANISTER SETS; COOKIE JARS; CUPS NOT OF PRECIOUS METAL; DISHES NOT OF PRECIOUS METAL; SERVING BOWLS NOT OF PRECIOUS METAL; DINNERWARE; BEVERAGE GLASSWARE; KITCHEN UTENSIL NOT OF PRECIOUS METAL NAMELY SERVING TONGS, SPATULAS, LADLES, CASEROLE PANS, BRAISERS, ROASTERS, FRYING PANS, GRIDDLES, SAUCEPANS, SAUTE PANS, STOCKPOTS, WOKS, BAKING PANS, BASTING BRUSHES, BROWNING TRAYS, CAN OPENERS, COOKIE CUTTERS, CUTTING BOARDS, DOUBLE BOILERS, ROLLING PINS, SALAMANDERS, SALT AND PEPPER SHAKERS, SCOOPS, SCRAPERS, SKIMMERS, SPOONS AND WHISKS; LAMINATED PLACEMATS; BOTTLES, SOLD EMPTY; DRINKING VESSELS; TOOTHPICKS; COSMETIC UTENSILS, NAMELY, BRUSHES, DROPPERS SOLD EMPTY, FOAM APPLICATORS FOR APPLYING COSMETICS, MICRODERMABRASION SPONGES, EYELASH CURLERS AND CADDIES FOR ORGANIZING COSMETICS ITEMS; VACUUM BOTTLES; RUBBER HOUSEHOLD GLOVES; CAGES FOR HOUSEHOLD PETS; FLY SWATTERS (U.S. CLS. 2, 13, 23, 29, 30, 33, 40 AND 50).

CLASS 24—FABRICS

FOR BEDSPREADS; BLANKETS; CLOTH PLACEMATS; COMFORTERS; CURTAINS; FABRIC FOR TEXTILE USE; BATH TOWELS; BEACH TOWELS; KITCHEN TOWELS OF TEXTILE; GIFT WRAP OF TEXTILE; BED SHEETS; PILLOWCASES; WALL HANGINGS OF TEXTILE; GUMMED WATERPROOF CLOTH; FELT; UNFITTED FABRIC COVERS FOR FURNITURE; WASHING MITTS; MARABOU FABRIC; CLOTH FLAGS; SHROUDS (U.S. CLS. 42 AND 50).

CLASS 25—CLOTHING

FOR BEACHWEAR; BOXER SHORTS; UNDERWEAR; BRIEFS; UNDERSHIRTS; FLEECE PULLOVERS, JACKETS AND PANTS; JACKET; JEANS; SPORT JERSEYS; BLANKET SLIPPERS; OUTERWEAR; RAINWEAR; SHIRTS; SHORTS; PANTS; SLACKS; SLEEPWEAR; SWEATERS; SWEAT SHIRTS; SWEAT PANTS; T-SHIRTS; ROBES; WARM-UP SUITS; SHOES; BANDANNAS; BELTS; CAUSAL SHOES; HATS; BASEBALL CAPS; MITTENS AND GLOVES; SCARVES; SLIPPER SOCKS; SOCKS; HOSIERY; SUSPENDERS; TIES; PARTY CLOTHES IN THE NATURE OF MASQUERADE COSTUMES, HALLOWEEN COSTUMES, COSTUMES FOR USE IN CHILDREN'S DRESS-UP PLAY AND FORMAL PARTY WEAR IN THE NATURE OF TUXEDOS AND GOWNS; ARTICLES OF SWIMWEAR; LAYETTES CLOTHING; SKI BOOTS; CHASUBLES (U.S. CLS. 22 AND 39).

CLASS 28—TOYS AND SPORTING GOODS

FOR BALLOONS; PARTY NOVELTIES, NAMELY, SMALL TOYS, CRACKERS AND NOISEMAKERS, PAPER PARTY HATS, PARTY MASKS, AND PARTY GAMES; ACTIVITY SETS IN THE NATURE OF BOARD GAMES, RIDE-ON TOYS, BUILDING BLOCKS AND BALL GAMES; SPORTING ARTICLES, NAMELY, BASEBALLS, BASKETBALLS, BOWLING BALLS, CROQUET SETS, FOOTBALLS, GOLF CLUBS, HOCKEY STICKS, TENNIS RACQUETS, SOCCER BALLS, FISHING TACKLES AND FISHING RODS; TWIRLING AND RELAY BATONS; TOY BINOCULARS AND TELESCOPES; BLOCKS; SPINNING TOPS; TOY BOWLING GAMES; BUBBLE MAKING WAND AND SOLUTION SETS; TOY VEHICLE WITH FIGURE MODEL; TOY MODELING DOUGH; TOY TOOL CHESTS; ELECTRIC TOY ROAD RACING SETS; MAGIC TRICKS; EDUCATIONAL TOYS, NAMELY, BOARD GAMES, CARD GAMES, QUIZZES, PUZZLES AND STRATEGY GAMES; ELECTRONIC TOY TRAINS; TOY CRAFTS, NAMELY, HOBBY CRAFT SETS FOR MAKING TOY MODELS OR TOY FIGURINES; TOY GARDEN SETS; SKATEBOARDS;

TOY BICYCLES; TRADING CARDS GAMES; TOY MAKE-UP SETS; NON-FIGURAL PUSH AND PULL TOYS; CASES ADAPTED FOR CARRYING FIGURE TOYS; YO-YOS; CIRCUS TOYS; PRINTING TOYS, NAMELY, KITS CONTAINING SHAPES, PAINTS AND SPONGES FOR CHILDREN TO MAKE PRINTS; PUPPETS AND MARIONETTES; PUZZLES; WATER SQUIRTING TOYS; KALEIDOSCOPES; TOY KITCHEN SETS; MUSICAL TOYS; ORNAMENTS AND DECORATIONS FOR CHRISTMAS TREES; BATS BEING SPORTING ARTICLES; BASEBALL GLOVES; BEACH TOYS, NAMELY, SAND BUCKETS, SHOVELS, CASTLE MOULDS, SAND SCOOPS, INFLATABLE BEACH BALLS AND FLOATS; DART BOARDS; ICE SKATES; SPORTS BALLS; ROLLER SKATES; SNOWBOARDS; SLEDS; OUTDOOR PLAYGROUND APPARATUS, NAMELY, CLIMBING UNITS, SAND BOXES, SWING SETS, SLIDES AND SEESAWS; PLAY TENTS; ARTICLES FOR SWIMMING NAMELY, FLOATS, HAND PADDLES, FINS, FLIPPERS, GLOVES, KICKBOARDS AND SURF BOARDS; VINYL PLAY SWIMMING POOLS; WATER SLIDES PLAY APPARATUS; TOY WAGON; CHECKERS GAMES; STATIONARY EXERCISE BICYCLES; FISHING TACKLE; SWEAT ABSORBING GRIP STRIPES FOR BATS; GAMES, NAMELY, ACTION-TYPE TARGET GAMES, ARCADE GAMES, BOARD GAMES, CARD GAMES, CHESS GAMES, DART GAMES, DICE GAMES, HAND-HELD UNIT FOR PLAYING ELECTRONIC GAMES; ARCADE GAME MACHINES; MEMORY GAMES; PINBALL GAMES, STAND-ALONE VIDEO GAME MACHINES (U.S. CLS. 22, 23, 38 AND 50).

CLASS 30—STAPLE FOODS

FOR CANDIES; BREAKFAST CEREALS; COOKIES; PREPARED MEALS CONSISTING PRIMARILY OF NOODLES, PASTA, RICE; ICE CREAM; CHEWING GUM; CAKES; MICROWAVABLE MEALS CONSISTING PRIMARILY OF NOODLES, PASTA, RICE; EDIBLE ORNAMENTS FOR CHRISTMAS TREES; HONEY; FLOUR; POPCORN; SOYA FLOUR; TAPIOCA FLOUR FOR FOOD; COOKING SALT; SOYA SAUCE; SEASONINGS; LEAVEN; VANILLA FLAVORING; STARCH-BASED THICKENERS FOR WHIPPED CREAM; COFFEE; FUIT TEAS; TEA; CHOCOLATE BEVERAGES NOT BEING DAIRY-BASED OR VEGETABLE BASED (U.S. CL. 46).

CLASS 32—LIGHT BEVERAGES

FOR FRUIT JUICES; VEGETABLE JUICES; GINGER ALE; NON-ALCOHOLIC BEVERAGES, NAMELY, CARBONATED DRINKS, ENERGY DRINKS, FRUIT BASED SOFT DRINKS, NON-DAIRY SOY DRINKS, VEGETABLE-BASED DRINKS; PASTILLES FOR EFFERVESCING BEVERAGES; DRINKING WATER; ISOTONIC BEVERAGES (U.S. CLS. 45, 46 AND 48).

ANN E. SAPPENFIELD, EXAMINING ATTORNEY

SN 79-049,155. CA'DA MOSTO SPA SOCIETA' UNIPERSONALE, ITALY, FILED 11-6-2007.

VICTORVICTORIA

THE MARK CONSISTS OF STANDARD CHARACTERS WITHOUT CLAIM TO ANY PARTICULAR FONT, STYLE, SIZE, OR COLOR.

PRIORITY DATE OF 6-21-2007 IS CLAIMED.
OWNER OF INTERNATIONAL REGISTRATION 0951410 DATED 11-6-2007, EXPIRES 11-6-2017.

CLASS 3—COSMETICS AND CLEANING PREPARATIONS

FOR AFTER-SHAVE LOTIONS, EAU DE COLOGNE, ESSENTIAL OILS, AND PERFUMED FLORAL EXTRACTS FOR PERFUME; BASES FOR FLOWER PERFUMES, NAMELY, PERFUME OILS; ESSENTIAL OIL OF MINT FOR USE IN PERFUMERY; PERFUMERY MUSK, OILS FOR PERFUMES AND SCENTS, PERFUMERY, PERFUMES; SCENTED WATER, NAMELY, SCENTED LIME LINEN WATER (U.S. CLS. 1, 4, 6, 50, 51 AND 52).

CLASS 9—ELECTRICAL AND SCIENTIFIC APPARATUS

FOR CONTACT LENSES; CONTACT LENSES CASES; EYEGLOSS CASES; EYEGLOSS CHAINS; EYEGLOSS FRAMES; EYEGLOSS LENSES; EYEGASSES; SPECTACLES; SUNGLASSES (U.S. CLS. 21, 23, 26, 36 AND 38).

CLASS 14—JEWELRY

FOR ALARM CLOCKS, CHRONOGRAPHS FOR USE AS WATCHES AND TIMEPIECES, CHRONOMETERS, CLOCK, ELECTRIC CLOCKS AND WATCHES, PENDULUMS, NAMELY, PENDULUM CLOCKS, STOPWATCHES, STRAPS FOR WRISTWATCHES, WATCH BANDS, WATCH CHAINS, WATCH CRYSTALS FOR TIMEKEEPING, WATCH GLASSES, WATCHES, WRISTWATCHES; JEWELRY, NAMELY, BRACELETS; BROOCHES; JEWELRY CHAINS; JEWELRY CHARMS; DIAMONDS; EARRINGS; GOLD AND SILVER ITEMS, NAMELY, RINGS, NECKLACES AND BROOCHES; OBJECTS OF IMITATION GOLD, NAMELY, RINGS, NECKLACES, BROOCHES, BRACELETS AND EARRINGS; JEWEL CASES OF PRECIOUS METAL; JEWELRY; JEWELRY OF YELLOW AMBER; PASTE JEWELRY; COSTUME JEWELRY; KEY RINGS TRINKETS OR FOBS OF PRECIOUS METAL; NECKLACES; PEARL JEWELRY; JEWELRY PINS; PRECIOUS STONES; RINGS; SEMI-PRECIOUS STONES; THREADS OF PRECIOUS METAL AS JEWELRY; WORKS OF ART OF PRECIOUS METAL (U.S. CLS. 2, 27, 28 AND 50).

CLASS 18—LEATHER GOODS

FOR BAGS, NAMELY, GARMENT BAGS FOR TRAVEL; SHOPPING BAGS MADE OF LEATHER, TRAVEL BAGS, OVERNIGHT BAGS, OVERNIGHT CASES, SUITCASES, UMBRELLAS, WALKING STICKS; GOODS MADE OF LEATHER AND IMITATION LEATHER, NAMELY, SHOULDER BAGS, SHOPPING BAGS, SPORTS BAGS, ANIMAL GAME BAGS, HUNTER'S GAME BAGS, BEACH BAGS, SPORTS BAGS FOR USE WITH HOCKEY AND NOT BEING SPECIALLY ADAPTED FOR HOCKEY EQUIPMENT, HANDBAGS, ALL PURPOSE ATHLETIC BAGS, SCHOOL BAGS, BOOK BAGS, CLUTCH BAGS, BACKPACKS, KEY CASES, TOILETRY CASES SOLD EMPTY, PURSES; TRUNKS AND TRAVELLING BAGS, NAMELY, SHOULDER BAGS, SHOPPING BAGS MADE OF MESH, SKIN, AND TEXTILE, SPORTS BAGS, ANIMAL GAME BAGS, HUNTER'S GAME BAGS, BEACH BAGS, SPORTS BAGS FOR USE WITH HOCKEY AND NOT BEING SPECIALLY ADAPTED FOR HOCKEY EQUIPMENT, HANDBAGS, ALL PURPOSE ATHLETIC BAGS, SCHOOL BAGS, BOOK BAGS, CLUTCH BAGS, BACKPACKS, TOILETRY CASES SOLD EMPTY, PURSES (U.S. CLS. 1, 2, 3, 22 AND 41).

LAURA HAMMEL, EXAMINING ATTORNEY

SN 79-049,558. SPECTRACURE AB, SWEDEN, FILED 1-3-2008.



PRIORITY DATE OF 8-6-2007 IS CLAIMED.
OWNER OF INTERNATIONAL REGISTRATION 0952527 DATED 1-3-2008, EXPIRES 1-3-2018.

THE COLOR(S) BLUE, WHITE, RED AND CLARET IS/ARE CLAIMED AS A FEATURE OF THE MARK.

THE MARK CONSIST OF BLUE LETTER WITH BLUE INNER CIRCLE, RED MIDDLE HALF CIRCLE AND CLARET OUTER HALF CIRCLE ON A WHITE GROUND.

CLASS 9—ELECTRICAL AND SCIENTIFIC APPARATUS

FOR SCIENTIFIC, OPTICAL, MEASURING, AND TEACHING APPARATUS AND INSTRUMENTS, NAMELY, LASERS FOR INTERACTIVE DOSIMETRY MEASUREMENT AND SOFTWARE FOR USE IN THE OPERATION AND CONTROL OF LASERS USED IN INTERACTIVE DOSIMETRY MEASUREMENT (U.S. CLS. 21, 23, 26, 36 AND 38).

CLASS 10—MEDICAL APPARATUS

FOR SURGICAL, MEDICAL, DENTAL AND VETERINARY APPARATUS AND INSTRUMENTS, NAMELY, LASERS FOR PHOTODYNAMIC THERAPY (U.S. CLS. 26, 39 AND 44).

FRED CARL, EXAMINING ATTORNEY

SN 79-051,363. NEMIROFF; INTELLECTUAL PROPERTY ESTABLISHMENT, VADÚZ, LIECHTENSTEIN, FILED 12-19-2007.



PRIORITY DATE OF 8-8-2007 IS CLAIMED.
OWNER OF INTERNATIONAL REGISTRATION 0957318 DATED 12-19-2007, EXPIRES 12-19-2017.
OWNER OF U.S. REG. NOS. 2,630,585, 3,006,780 AND OTHERS.

THE MARK CONSISTS OF A GENERALLY RECTANGULAR BOTTLE IN THREE DIMENSIONAL FORM HAVING FOUR TAPERED SIDES, TWO SMALLER AND TWO LARGER, EACH SIDE BEING WIDER AT THE TOP AND NARROWING TO A TAPERED BASE, THE BASE BEING WIDER AT ITS BOTTOM, EACH SIDE DEFINING A FLAT RECESS EXTENDING OVER A SUBSTANTIAL PORTION OF EACH SIDE AND HAVING THE WORD "NEMIROFF" IN RAISED FORM EXTENDING VERTICALLY ALONG EACH OF THE TWO SMALLER SIDES WITHIN THE FLAT RECESSES. THE OPPOSITE SIDE VIEW OF THE BOTTLE HAS THE SAME CONFIGURATION AS THE VIEW SHOWN IN THE DRAWING. NEITHER THE BOTTLE CAP NOR THE BOTTLE BOTTOM IS CLAIMED AS A FEATURE OF THE MARK.

CLASS 33—WINES AND SPIRITS

FOR ALCOHOLIC BEVERAGES EXCEPT BEERS (U.S. CLS. 47 AND 49).

CLASS 35—ADVERTISING AND BUSINESS

FOR ADVERTISING SERVICES; BUSINESS MANAGEMENT; BUSINESS ADMINISTRATION; OFFICE FUNCTIONS; IMPORTATION AND EXPORTATION OF ALCOHOLIC BEVERAGES; RETAIL STORE AND WHOLESALE DISTRIBUTORSHIP SERVICES FEATURING ALCOHOLIC BEVERAGES (U.S. CLS. 100, 101 AND 102).

CHRISTINE MARTIN, EXAMINING ATTORNEY

SN 79-053,703. SMART HOLOGRAMS LIMITED, UNITED KINGDOM, FILED 1-17-2008.

SHOPS

PRIORITY DATE OF 7-18-2007 IS CLAIMED.
OWNER OF INTERNATIONAL REGISTRATION 0963973 DATED 1-17-2008, EXPIRES 1-17-2018.

CLASS 1—CHEMICALS

FOR CHEMICAL PREPARATIONS FOR DIAGNOSTIC PURPOSES, NAMELY, FOR USE IN RESEARCH, FOR SECURITY, THE VERIFICATION OF DOCUMENTS AND ARTICLES, THE PREVENTION AND DETECTION OF COUNTERFEITS, THE DETECTION OF NON-MEDICAL ANALYTES SUCH AS ENVIRONMENTAL CONTAMINANTS, FOR USE IN CONFIRMING THE ENVIRONMENTAL HISTORY OF PRODUCTS, TO DETERMINE EXPOSURE AND/OR CONTACT OF PRODUCTS WITH LIQUIDS, WATER, CHEMICALS, FOR IDENTIFYING THE DETERIORATION/DEGRADATION OF CONSUMABLES, FOOD STUFFS AND BEVERAGES, FOR TESTING THE LEVEL OF ALCOHOL IN BEVERAGES, THE COMBINATION IN PRODUCTS OF PROPRIETARY INGREDIENTS AND CHANGES IN THE COMPOSITION OF PRODUCTS; CHEMICALS FOR USE IN INDUSTRY, SCIENCE AND PHOTOGRAPHY; CHEMICAL PREPARATIONS FOR USE IN AGRICULTURE, HORTICULTURE AND FORESTRY, NAMELY, CHEMICAL PREPARATIONS FOR THE TREATMENT OF SEEDS; UNPROCESSED ARTIFICIAL RESINS AS RAW MATERIALS IN THE FORM OF POWDERS, LIQUIDS OR PASTES; UNPROCESSED PLASTICS; CHEMICAL SUBSTANCES FOR PRESERVING FOODSTUFFS; CHEMICAL PREPARATIONS FOR DIAGNOSTIC PURPOSES, NAMELY, FOR USE IN SCIENTIFIC RESEARCH; CHEMICAL REAGENTS FOR NON-MEDICAL PURPOSES; CHEMICAL DIAGNOSTIC REAGENTS FOR NON-MEDICAL PURPOSES; CHEMICAL DIAGNOSTIC PREPARATIONS, OTHER THAN FOR MEDICAL OR VETERINARY USE; DIAGNOSTIC REAGENTS FOR SCIENTIFIC OR RESEARCH USE; PROTEIN ARRAYS AND NUCLEOTIDE ARRAYS FOR SCIENTIFIC AND MEDICAL RESEARCH; ENZYME SUBSTRATES FOR USE IN SCIENCE OR INDUSTRY; REAGENTS FOR USE IN DIAGNOSTIC TESTS IN THE NATURE OF GENETIC IDENTITY TEST COMPRISED OF REAGENTS AND PATERNITY IDENTITY TESTS COMPRISED OF REAGENTS FOR USE IN SCIENCE AND INDUSTRY; CHEMICALS, NAMELY, BUFFER, STANDARD AND RINSING SOLUTIONS USED IN ANALYTICAL CHEMISTRY; POLYMER COMPOSITIONS USED IN THE MANUFACTURE OF COMMERCIAL AND INDUSTRIAL GOODS; DIAGNOSTIC TESTING KITS OTHER THAN FOR MEDICAL OR VETERINARY PURPOSES, NAMELY, TESTING KITS COMPRISING CHEMICALLY-TREATED NON-MEDICAL SWABS AND TEST STRIPS FOR SCIENTIFIC AND/OR RESEARCH IN THE NATURE OF TESTING REAGENTS, PURITY, THE COMPOSITION OF MATERIALS AND MIXTURES, COMBINATIONS OF INGREDIENTS, RADIATION, MAGNETIC FIELDS, PRESSURE, THE IDENTIFICATION OF MATERIALS AND MICROORGANISMS, CHEMICALS, VAPORS, GASES AND LIQUIDS, FOR SECURITY, FOR VERIFYING THE AUTHENTICITY OF DOCUMENTS AND ARTICLES, FOR PRODUCT SAFETY AND QUALITY CONTROL TESTING, FOR THE PREVENTION AND DETECTION OF COUNTERFEITS, FOR THE DETECTION OF CONTAMINANTS IN PRODUCTS AND IN THE ENVIRONMENT, FOR TESTING THE ENVIRONMENTAL HISTORY OF PRODUCTS, FOR DETERMINING EXPOSURE AND/OR CONTACT OF PRODUCTS WITH LIQUIDS, WATER, OR CHEMICAL, FOR IDENTIFYING THE DETERIORATION OR DEGRADATION OF CONSUMABLES, FOODSTUFFS AND BEVERAGES, FOR TESTING THE LEVEL OF ALCOHOL IN BEVERAGES, FOR TESTING PROPRIETARY INGREDIENTS IN BEVERAGES, FOR TESTING PROPRIETARY INGREDIENTS IN PRODUCTS, FOR TESTING FOR CHANGES IN THE COMPOSITION OF

PRODUCTS, FOR GENETIC TESTING, FOR BLOOD TESTING AND FOR GLUCOSE MONITORING, THE DETECTION OF NON-MEDICAL ANALYTES SUCH AS ENVIRONMENTAL CONTAMINANTS, FOR USE IN CONFIRMING THE ENVIRONMENTAL HISTORY OF PRODUCTS, TO DETERMINE THE EXPOSURE AND/OR CONTACT OF PRODUCTS WITH LIQUIDS, WATER, CHEMICALS, FOR TESTING THE LEVEL OF ALCOHOL IN BEVERAGES, THE COMBINATION IN PRODUCTS OF PROPRIETARY INGREDIENTS AND CHANGES IN THE COMPOSITION OF PRODUCTS, PERISHABLE RETAIL GOODS AND INDUSTRIAL GOODS AND MATERIALS; SENSITIZED SECURITY PAPERS, NAMELY, CHEMICAL TEST PAPER; POLYMER COATING AGENTS FOR ANTI-COUNTERFEITING AND PRODUCT VERIFICATION PAPERS AND LABELS (U.S. CLS. 1, 5, 6, 10, 26 AND 46).

CLASS 9—ELECTRICAL AND SCIENTIFIC APPARATUS

FOR SCIENTIFIC APPARATUS AND INSTRUMENTS FOR CREATING HOLOGRAMS AND INTERACTIVE HOLOGRAMS AND SENSOR HOLOGRAMS ENGINEERED TO MEASURE REFLECTED AND EMITTED LIGHT BY WAY OF CHANGING WAVELENGTH, IMAGE, BRIGHTNESS AND/OR POSITION IN RESPONSE TO BIOLOGICAL, CHEMICAL AND PHYSICAL STIMULI, FOR SCIENTIFIC USE AND/OR RESEARCH; SCIENTIFIC APPARATUS AND INSTRUMENTS FOR SCIENTIFIC USE AND/OR RESEARCH, NAMELY, HOLOGRAM APPARATUS FOR CREATING HOLOGRAMS THAT CONSIST OF A POLYMER MATRIX IN WHICH ARE RECORDED HOLOGRAPHIC GRATINGS AND WHICH HAVE RESPONSE MECHANISMS TO BIOLOGICAL, CHEMICAL AND PHYSICAL STIMULI; OPTICAL APPARATUS AND INSTRUMENTS, NAMELY, CAMERAS, MICROSCOPES, MAGNIFIERS IN THE NATURE OF MAGNIFYING LENSES, MAGNIFYING GLASSES, LENSES IN THE NATURE OF MAGNIFYING LENSES, MAGNIFYING GLASSES, LENSES IN THE NATURE OF MAGNIFYING GLASSES, POLARISERS, IN THE NATURE OF POLARIZING PLATES, PRISMS, LENSES AND MICROSCOPES, AND OPTICAL DEVICES USED FOR IDENTIFYING HOLOGRAMS AND HOLOGRAPHS FOR THE IDENTIFICATION AND VERIFICATION OF PRODUCTS AND DOCUMENTS AND TO PREVENT FORGERIES AND COUNTERFEITS, NAMELY, SCANNERS, OPTICAL FILTERS AND MAGNIFYING LENSES; DATA PROCESSING EQUIPMENT, NAMELY, CENTRAL PROCESSING UNITS FOR PROCESSING INFORMATION, DATA, SOUND OR IMAGES; COMPUTERS; COMPUTER SOFTWARE FOR USE IN ANALYZING AND TESTING BLOOD, ANALYTE, MICROORGANISMS, PATHOGENS, LEVELS OF MICROBIAL CONTAMINATION, GLUCOSE AND FOR USE IN CHEMICAL DETECTION AND IN THE FIELD OF GLUCOSE MONITORING; ELECTRONIC APPARATUS, NAMELY, ELECTRONIC APPARATUS FOR ELECTROPHYSIOLOGICAL MEASUREMENT AND TESTING OF CELLS; SPECTROMETERS; SENSORS, NAMELY, TEMPERATURE SENSORS AND ELECTRIC OR ELECTRONIC SENSORS FOR VERIFYING AND CHECKING FOR HOLOGRAMS AND HOLOGRAPHS WHICH ARE USED FOR THE CHECKING AND VERIFICATION OF DOCUMENTS AND ARTICLES; SENSORS AND ANALYSERS FOR DETECTING CHEMICAL, BIOLOGICAL AND PHYSICAL STIMULI NOT FOR MEDICAL PURPOSES AND TO TEST FOR THE ENVIRONMENTAL HISTORY OF PRODUCTS, TO DETERMINE EXPOSURE AND/OR CONTACT OF PRODUCTS WITH LIQUIDS, WATER, CHEMICALS, FOR IDENTIFYING THE DETERIORATION/DEGRADATION OF CONSUMABLES, FOOD STUFFS AND BEVERAGES, FOR TESTING THE LEVEL OF ALCOHOL IN BEVERAGES, THE COMBINATION IN PRODUCTS OF PROPRIETARY INGREDIENTS AND CHANGES IN THE COMPOSITION OF PRODUCTS; ASSAY MONITORING APPARATUS AND INSTRUMENTS, NAMELY, CLINICAL LABORATORY ANALYZERS FOR MEASURING AND TESTING FOR THE PRESENCE OR LEVEL OF ANTHRAX, BACTERIA, VIRUSES, GASES AND OTHER CONTAMINANTS IN THE ENVIRONMENT AND INFECTIOUS ORGANISMS AND FOR THE ENVIRONMENTAL HISTORY OF PRODUCTS, TO DETERMINE EXPOSURE AND/OR CONTACT OF PRODUCTS WITH LIQUIDS, WATER, CHEMICALS, FOR IDENTIFYING THE DETERIORATION/DEGRADATION OF CONSUMABLES, FOODSTUFFS AND BEVERAGES, FOR TEST-

ING THE LEVEL OF ALCOHOL AND BEVERAGES, THE COMBINATION OF PRODUCTS IN PROPRIETARY INGREDIENTS AND CHANGES IN THE COMPOSITION OF PRODUCTS AND NOT FOR MEDICAL USE; MICROBIAL MEASURING, DETECTION, TESTING AND IDENTIFICATION APPARATUS AND INSTRUMENTS; INSTRUMENTS FOR USE IN THE PROCESS OF SAMPLE ANALYSIS, NAMELY, CRUCIBLES, INCUBATORS AND STORAGE TUBES; SCIENTIFIC APPARATUS AND EQUIPMENT, NAMELY, SENSORS AND ANALYSERS FOR TESTING FOR THE PRESENCE OR LEVEL OF MICRO-ORGANISMS, GASES, AND ENVIRONMENTAL CONTAMINANTS, AND FOR THE ENVIRONMENTAL HISTORY OF PRODUCTS TO DETERMINE EXPOSURE AND/OR CONTACT OF PRODUCTS WITH LIQUIDS, WATER, CHEMICALS, FOR IDENTIFYING THE DETERIORATION/DEGRADATION OF CONSUMABLES, FOOD STUFFS AND BEVERAGES, FOR TESTING THE LEVEL OF ALCOHOL IN BEVERAGES, THE COMBINATION IN PRODUCTS OF PROPRIETARY INGREDIENTS AND CHANGES IN THE COMPOSITION OF PRODUCTS, ALL FOR TESTING REAGENTS, PURITY, THE COMPOSITION OF MATERIALS AND MIXTURES, COMBINATIONS OF INGREDIENTS, RADIATION, MAGNETIC FIELDS, PRESSURE, THE IDENTIFICATION OF MATERIALS AND MICROORGANISMS, CHEMICALS, VAPORS, GASES AND LIQUIDS, FOR SECURITY, FOR VERIFYING THE AUTHENTICITY OF DOCUMENTS AND ARTICLES, FOR PRODUCT SAFETY AND QUALITY CONTROL TESTING, FOR THE PREVENTION AND DETECTION OF COUNTERFEITS, FOR THE DETECTION OF CONTAMINANTS IN PRODUCTS AND IN THE ENVIRONMENT, FOR TESTING PROPRIETARY INGREDIENTS IN BEVERAGES, FOR TESTING PROPRIETARY INGREDIENTS IN PRODUCTS, FOR TESTING FOR CHANGES IN THE COMPOSITION OF PRODUCTS, FOR GENETIC TESTING, FOR BLOOD TESTING AND FOR GLUCOSE MONITORING; OPTICALLY VARIABLE LIGHT INTERFERENCE AND DIFFRACTION EFFECT EXHIBITING ARTICLES, NAMELY, OPTICAL HOLOGRAMS AND/OR HOLOGRAPHS, NAMELY, HOLOGRAM APPARATUS FOR DISPLAYING HOLOGRAMS AND HOLOGRAPHS WHICH FEATURE SURFACE RELIEF, EMBOSSED STRUCTURES, RULED GRATINGS AND PIXILATED STRUCTURES FOR SECURITY AND VERIFICATION WHICH CHANGE THEIR APPEARANCE AS THE ANGLE OF INCIDENCE OF LIGHT AND/OR VIEWING IS VARIED; ELECTRONIC MACHINES USED TO APPLY HOLOGRAPHIC OVERLAY AND TO SET UP AND CONTROL OF HOLOGRAMS AND VERIFICATIONS THEREOF; HOLOGRAM APPARATUS; ELECTRIC OR ELECTRONIC SENSORS FOR HOLOGRAPHS AND HOLOGRAMS; CONTACT LENSES WHICH INCORPORATE HOLOGRAMS AND HOLOGRAM SENSORS; SENSOR INSTRUMENTS FOR USE IN THE PROCESS OF SAMPLE ANALYSIS, NAMELY, ELECTRONIC SENSORS AND CARTRIDGES FOR TESTING FOR THE PRESENCE AND LEVEL OF ANTHRAX, BACTERIA, VIRUSES, GASES AND OTHER CONTAMINANTS AND INFECTIOUS ORGANISMS IN CONSUMER PRODUCTS, INDUSTRIAL PRODUCTS AND THE ENVIRONMENT; APPARATUS AND INSTRUMENTS ALL FOR DETECTING CODED, HIDDEN OR EMBEDDED MARKINGS AND SOFTWARE FOR USE WITH SUCH APPARATUS AND INSTRUMENTS, NAMELY, MONITORS, SCANNERS, TRANSDUCERS, READERS, BAR CODE READERS, ULTRAVIOLET SCANNERS AND HOLOGRAPHIC SENSORS FOR CHECKING AND VERIFYING DOCUMENTS AND ARTICLES AND TO PREVENT FORGERIES AND COUNTERFEITS AND TO TEST FOR THE ENVIRONMENTAL HISTORY OF PRODUCTS, TO DETERMINE EXPOSURE AND/OR CONTACT OF PRODUCTS WITH LIQUIDS, WATER, CHEMICALS, FOR IDENTIFYING THE DETERIORATION/DEGRADATION OF CONSUMABLES, FOOD STUFFS AND BEVERAGES, FOR TESTING THE LEVEL OF ALCOHOL IN BEVERAGES, THE COMBINATION IN PRODUCTS OF PROPRIETARY INGREDIENTS AND CHANGES IN THE COMPOSITION OF PRODUCTS; ELECTRONIC SCIENTIFIC APPARATUS AND EQUIPMENT FOR TESTING FOR THE PRESENCE AND LEVEL OF ANTHRAX, BACTERIA, VIRUSES, GASES AND OTHER CONTAMINANTS AND INFECTIOUS ORGANISMS, NAMELY, FOR USE IN CONSUMER PRODUCTS, INDUSTRIAL PRODUCTS AND IN THE ENVIRONMENT; OPTICALLY RECORDED HOLOGRAMS FEATURING MICRO TEXTS AND OTHER

COVERT SECURITY FEATURES, NAMELY, HOLOGRAM APPARATUS FOR DISPLAYING HOLOGRAMS AND HOLOGRAPHS (U.S. CLS. 21, 23, 26, 36 AND 38).

SN 79-054,866. WDF - WEB DESIGN FACTORY, SPOL S R.O., CZECH REPUBLIC, FILED 10-3-2007.

Glogster

CLASS 16—PAPER GOODS AND PRINTED MATTER

FOR PAPER, CARDBOARD GOODS, NAMELY, LABELS FEATURING HOLOGRAMS FOR THE PREVENTION OF COUNTERFEITS USED IN THE PACKAGING AND LABELING OF GOODS; PAPER CONTACT ADHESIVE LABELS AND PACKAGING IN THE NATURE OF PRESSURE SENSITIVE AND HEAT SENSITIVE LABELS AND PATCHES; HEAT AND PRESSURE SENSITIVE LABELS AND PACKAGING, NAMELY, CONTACT, HEAT AND PRESSURE SENSITIVE PAPER AND CARDBOARD LABEL AND BOXES; BOOK BINDINGS, PHOTOGRAPHS; STATIONERY; ADHESIVE FOR STATIONERY OR HOUSEHOLD PURPOSES; PRINTERS' TYPE; PRINTING BLOCKS; PAPER AND ADHESIVE SECURITY LABELS; PRINTED SECURITY DOCUMENTS AND MATERIALS FEATURING HOLOGRAMS AND HOLOGRAPHS, NAMELY, PRINTED CERTIFICATES, SECURITIES, PASSPORTS, IDENTIFICATION PAPER AND PAPERS, LICENSE DOCUMENTS, TICKETS AND VOUCHERS, CHEQUES, TRAVELERS' CHEQUES, FIDUCIARY STAMPS, TRAVEL DOCUMENTS, SHARE AND BOND CERTIFICATES, POSTAL ORDERS, MONEY ORDERS, COUPONS, TICKETS; PAPER AND SECURITY PAPER AND FILMS, NAMELY, PAPER, SECURITY PAPER AND PRINT SUBSTRATE IN THE NATURE OF TRANSPARENT, OPAQUE, AND TRANSLUCENT FILM UPON WHICH PRINTING CAN TAKE PLACE ALL FEATURING HOLOGRAMS AND HOLOGRAPHS FOR USE IN PRODUCING IDENTITY CARDS, OFFICIAL DOCUMENTS AND FIDUCIARY DOCUMENTS, NAMELY, PRINTED CERTIFICATES, SECURITIES, PASSPORTS, IDENTIFICATION PAPER AND PAPERS, LICENSE DOCUMENTS, TICKETS AND VOUCHERS, CHEQUES, TRAVELERS' CHEQUES, FIDUCIARY STAMPS, TRAVEL DOCUMENTS, SHARE AND BOND CERTIFICATES, POSTAL ORDERS, MONEY ORDERS, COUPONS, TICKETS; SECURITY FILM COMPRISING OF HOLOGRAMS AND HOLOGRAPHS WHICH IS AFFIXED TO PRINTED DOCUMENTS AND PACKAGING TO APPROVE AUTHENTICITY AND TO PROTECT FROM TAMPERING, NAMELY, PRINTED HOLOGRAM STICKERS FOR COMMERCIAL USE WHICH IS AFFIXED TO PRINTED DOCUMENTS AND PACKAGING TO PROVE AUTHENTICITY, TO PROTECT FROM ANTI-COUNTERFEITING, TO VERIFY ARTICLES AND TO PROTECT ARTICLES FROM TAMPERING FOR USE IN PRODUCING IDENTITY CARDS, OFFICIAL DOCUMENTS AND FIDUCIARY DOCUMENTS, NAMELY, PRINTED CERTIFICATES, SECURITIES, PASSPORTS, IDENTIFICATION PAPER AND PAPERS, LICENSE DOCUMENTS, TICKETS AND VOUCHERS, CHEQUES, TRAVELLERS' CHEQUES, FIDUCIARY STAMPS, TRAVEL DOCUMENTS, SHARE AND BOND CERTIFICATES, POSTAL ORDERS, MONEY ORDERS, COUPONS, TICKETS; SECURITY PRINTED MATTER, NAMELY, HOLOGRAMS AND HOLOGRAPHS; HOLOGRAPHIC AND HOLOGRAMATIC SECURITY TAPES AND HOLOGRAPHIC AND HOLOGRAMATIC TRANSFER TAPES, NAMELY, PRINTED HOLOGRAMS; HOLOGRAPHIC AND HOLOGRAMATIC PRINTED PAPER LABELS; HOLOGRAMS FEATURING MICRO TEXTS AND OTHER COVERT SECURITY FEATURES, NAMELY, PRINTED HOLOGRAMS FEATURING MICRO TEXTS AND OTHER COVERT SECURITY FEATURES (U.S. CLS. 2, 5, 22, 23, 29, 37, 38 AND 50).

APRIL ROACH, EXAMINING ATTORNEY

THE MARK CONSISTS OF STANDARD CHARACTERS WITHOUT CLAIM TO ANY PARTICULAR FONT, STYLE, SIZE, OR COLOR.

PRIORITY DATE OF 5-22-2007 IS CLAIMED.

OWNER OF INTERNATIONAL REGISTRATION 0967253 DATED 10-3-2007, EXPIRES 10-3-2017.

THE WORDING "GLOGSTER" HAS NO MEANING IN A FOREIGN LANGUAGE.

CLASS 9—ELECTRICAL AND SCIENTIFIC APPARATUS

FOR SOFTWARE TO ENABLE UPLOADING, POSTING, SHOWING, DISPLAYING, TAGGING, BLOGGING, SHARING OR OTHERWISE PROVIDING ELECTRONIC MEDIA OR INFORMATION OVER THE INTERNET OR OTHER COMMUNICATIONS NETWORKS (U.S. CLS. 21, 23, 26, 36 AND 38).

CLASS 35—ADVERTISING AND BUSINESS

FOR ADVERTISING AND PUBLICITY, PROMOTION AND MARKETING SERVICES FOR OTHERS IN THE FORM OF PROVIDING INFORMATION AND MULTIMEDIA CONTENT, NAMELY, PRERECORDED DVDS, CDS, PHOTOS, VIDEOS AND AUDIO CONTENT AND USER GENERATED MULTIMEDIA CONTENT OVER THE INTERNET AND OTHER COMMUNICATIONS NETWORKS (U.S. CLS. 100, 101 AND 102).

CLASS 38—COMMUNICATION

FOR BROADCASTING AND WEBCASTING SERVICES, NAMELY, UPLOADING, POSTING, SHOWING, DISPLAYING, TAGGING, BLOGGING, SHARING, AND OTHERWISE PROVIDING ACCESS TO AND TRANSMISSION OF ELECTRONIC MEDIA, MULTIMEDIA CONTENT AND INFORMATION OVER THE INTERNET AND OTHER COMMUNICATIONS NETWORKS; PROVIDING ACCESS TO AN ONLINE COMPUTER DATA BASE FEATURING VIDEO AND AUDIO CONTENT AND USER GENERATED MULTIMEDIA CONTENT; PROVIDING ONLINE FORUMS AND ONLINE CHAT ROOMS FOR TRANSMISSION OF MESSAGES AMONG USERS CONCERNING COLLEGIATE LIFE, GENERAL INTEREST, VIRTUAL COMMUNITY, PHOTO AND VIDEO SHARING; PROVIDING ACCESS TO A GLOBAL COMPUTER NETWORK, NAMELY, ACCESS TO BLOGS, BROADCASTING OF AUDIO AND VIDEO PROGRAMMES OVER A GLOBAL COMPUTER NETWORK (U.S. CLS. 100, 101 AND 104).

CLASS 41—EDUCATION AND ENTERTAINMENT

FOR EDUCATIONAL AND ENTERTAINMENT SERVICES PROVIDED VIA THE INTERNET AND OTHER COMPUTER AND COMMUNICATIONS NETWORKS, NAMELY, PROVIDING AN INTERNET WEBSITE FEATURING, USER-GENERATED PHOTOGRAPHIC, AUDIO, VIDEO AND PROSE PRESENTATIONS FEATURING INFORMATION ON ART, MUSIC, POP CULTURE, EDUCATION, ENTERTAINMENT, SPORTS, AND PERSONAL RELATIONSHIP ADVICE FOR ENTERTAINMENT PURPOSE ONLY; ON-LINE COMPUTER GAMES, MULTIMEDIA PUBLISHING OF ELECTRONIC PUBLICATIONS, NAMELY, ONLINE ELECTRONIC PUBLISHING OF TEXT AND GRAPHIC WORKS OF OTHERS FEATURING USER-GENERATED PHOTOGRAPHIC, AUDIO, VIDEO AND PROSE PRESENTATIONS FEATURING INFORMATION ON ART, MUSIC, POP CULTURE, EDUCATION, ENTERTAINMENT, SPORTS, AND PERSONAL RELATIONSHIP ADVICE FOR ENTERTAINMENT PURPOSE ONLY; ON-LINE JOURNALS, NAMELY, BLOGS FEATURING USER-GENERATED PHOTOGRAPHIC, AUDIO, VIDEO AND PROSE PRESENTATIONS FEATURING INFORMATION ON ART, MUSIC, POP CULTURE, EDUCATION, ENTERTAINMENT, SPORTS, AND PERSONAL RELATIONSHIP ADVICE FOR ENTERTAINMENT PURPOSE ONLY (U.S. CLS. 100, 101 AND 107).

CLASS 42—SCIENTIFIC AND COMPUTER SERVICES

FOR COMPUTER AND INTERNET-RELATED EXPERT TECHNICAL SERVICES, NAMELY, INTERACTIVE HOSTING SERVICES WHICH ALLOW THE USER TO PUBLISH AND SHARE THEIR OWN CONTENT AND IMAGES ON-LINE; APPLICATION SERVICE PROVIDER (ASP), NAMELY, HOSTING COMPUTER SOFTWARE APPLICATIONS OF OTHERS THAT PROVIDE ACCESS TO NON-DOWNLOADABLE SOFTWARE TO ENABLE SHARING OF MULTIMEDIA CONTENT AND COMMENTS AMONG USERS AND PROVIDE UPLOADING, DOWNLOADING, CAPTURING, SHOWING, EDITING, PLAYING, STREAMING, VIEWING, TAGGING, BLOGGING, SHARING, MANIPULATING, DISTRIBUTING, PUBLISHING AND REPRODUCING ELECTRONIC MEDIA, INFORMATION AND MULTIMEDIA CONTENT VIA THE INTERNET AND OTHER COMPUTER AND COMMUNICATIONS NETWORK, NAMELY, VIDEOS, PICTURES, TEXT, GAMES, USER-GENERATED CONTENT IN THE FORM OF SHARING OF MULTIMEDIA CONTENT VIA THE INTERNET AND OTHER COMPUTER AND COMMUNICATIONS NETWORKS; HOSTING OF DIGITAL CONTENT ON THE INTERNET, NAMELY, MULTIMEDIA DIGITAL CONTENT FOR OTHERS (U.S. CLS. 100 AND 101).

PAUL MORENO, EXAMINING ATTORNEY

CLASS 7—MACHINERY

FOR MACHINES AND INSTALLATIONS FOR MANUFACTURING INDUSTRIAL PRODUCTS, NAMELY, AUTOMATIC INDUSTRIAL LABELING MACHINES FOR APPLYING LABELS TO CONTAINERS AND BOTTLES, CANNING MACHINES, CAPPING MACHINES, CASTING MACHINES, ABRASIVE JET CUTTING MACHINES, CONTINUOUS CASTING MACHINES, CONTINUOUS METAL CASTING MACHINES, MACHINES FOR THE CUTTING AND FORMING OF MATERIALS, DIE-CUTTING MACHINES, DIE-STAMPING MACHINES, DRILLING MACHINES, GRINDING MACHINES FOR METALWORKING, GRINDING MACHINES FOR THE TREATMENT OF CERAMICS AND METAL, HORNING MACHINES FOR METALWORKING, INDUSTRIAL ROBOTS, ROBOTIC ARMS FOR INDUSTRIAL PURPOSES, INDUSTRIAL SEWING MACHINES, INDUSTRIAL TRASH COMPACTING MACHINES, LINEAR MOTIONS MACHINES FOR MOVING OBJECTS, LOADING AND UNLOADING MACHINES, MACHINE COUPLING AND BELTING EXCEPT FOR LAND VEHICLES, MACHINE COUPLINGS AND TRANSMISSION COMPONENTS EXCEPT FOR LAND VEHICLES, MACHINES AND LINES COMPOSED THEREOF FOR THE PRODUCTION OF AUTOMOBILE PARTS AND FOR THE PRODUCTION OF TECHNICAL TEXTILES, MACHINES FOR MANUFACTURING AND DISPENSING PACKING MATERIAL, MACHINES FOR SEPARATING TARGET MATERIALS FROM MIXTURES OF MATERIALS, MANIPULATORS FOR FORGING PRESSES AND FOR FORGING MACHINES, MATERIAL HANDLING MACHINES, NAMELY, PALLETIZERS, CASE ELEVATORS, AUTOMATIC PALLET DISPENSING MACHINES AND AUTOMATIC SLIP SHEET DISPENSING MACHINES, METAL WORKING MACHINES, PACKING MACHINES, PACKAGING MACHINES, STACKING MACHINES, MACHINES AND INSTALLATIONS FOR TOOL AND MATERIAL LOADING IN THE NATURE OF LOADING AND UNLOADING MACHINES, MACHINES FOR PRODUCTION, ASSEMBLY AND TESTING OF HIGH CAPACITY AUTOMOTIVE AND INDUSTRIAL BATTERIES, MACHINES FOR MANUFACTURING, ASSEMBLY AND TESTING NORMAL AND HIGH CAPACITY BATTERY CELLS; REPLACEMENT PARTS OF THE AFORESAID GOODS INCLUDED IN THIS CLASS; CONVEYOR AND TRANSPORT INSTALLATIONS, NAMELY, MECHANICAL CONVEYORS FOR GENERAL CARGO AND FOR SOLIDS, BELT CONVEYORS, LIFTING INSTALLATIONS FOR THE TRANSPORT OF PERSONS AND GOODS, PNEUMATIC TRANSPORTERS; PARTS OF THE AFORESAID GOODS INCLUDED IN THIS CLASS, NAMELY, CONVEYOR BELTS AND CONVEYOR LINES; CONTROL AND REGULATING APPARATUS FOR MACHINES, NAMELY, HYDRAULIC AND PNEUMATIC CONTROLS FOR MOTORS AND ENGINES, HYDRAULIC VALVE ACTUATORS, LINEAR ACTUATORS AND PNEUMATIC VALVE ACTUATORS, CONTROL UNITS IN THE NATURE OF HYDRAULIC AND PNEUMATIC CONTROLS FOR MACHINES, MOTORS AND ENGINES, VALVES BEING PARTS OF MACHINES AND REGULATORS BEING PARTS OF MACHINES (U.S. CLS. 13, 19, 21, 23, 31, 34 AND 35).

SN 79-056,734. ADS-TEC GMBH, FED REP GERMANY, FILED 6-26-2008.



OWNER OF INTERNATIONAL REGISTRATION 0971905 DATED 6-26-2008, EXPIRES 6-26-2018.

THE MARK CONSISTS OF THE WORDING "ADSTEC" IN STYLIZED FONT INSIDE OF A RECTANGLE WITH ROUNDED CORNERS WHERE THE RECTANGLE IS DIVIDED INTO TWO SECTIONS BETWEEN THE WORDING "ADS" AND "TEC".

CLASS 9—ELECTRICAL AND SCIENTIFIC APPARATUS

FOR INDUSTRIAL COMPUTERS FOR MACHINES AND TRANSPORT INSTALLATIONS FOR MACHINE CONSTRUCTION, NAMELY, FOR PRODUCTION INSTALLATIONS, TRANSPORT INSTALLATIONS, ROBOTS AND MATERIAL-HANDLING GRIPPERS; INDUSTRIAL COMPUTERS FOR VEHICLE ENGINEERING, NAMELY, FOR TRUCKS, BUSES, FORKLIFTS, INDUSTRIAL TRUCKS, TRAINS AND SHIPS; COMPUTERS FOR DIAGNOSTIC APPLICATIONS IN LAND VEHICLES, AIRCRAFT AND WATER VEHICLES, IN PARTICULAR, IN AUTOMOBILES, TRUCKS, LOCOMOTIVES, AIRPLANES AND SHIPS; COMPUTER HARDWARE AND COMPUTER PERIPHERAL DEVICES FOR THE AFORESAID COMPUTERS; COMPUTER SOFTWARE FOR THE AFORESAID COMPUTERS FOR RECEIVING, PROCESSING, TRANSMITTING AND DISPLAYING DATA AND FOR MONITORING AND CONTROLLING INDUSTRIAL PROCESSES; INTERFACES FOR THE AFORESAID COMPUTERS; ELECTRONIC NAVIGATIONAL INSTRUMENTS FOR VEHICLES, NAMELY, FOR TRUCKS, BUSES, FORKLIFTS, INDUSTRIAL TRUCKS, TRAINS AND SHIPS (U.S. CLS. 21, 23, 26, 36 AND 38).

CLASS 37—CONSTRUCTION AND REPAIR

FOR INSTALLATION, MAINTENANCE AND REPAIR OF INSTALLATIONS IN THE FIELD OF AUTOMATION AND CONTROL ENGINEERING (U.S. CLS. 100, 103 AND 106).

CLASS 42—SCIENTIFIC AND COMPUTER SERVICES

FOR COMPUTER SOFTWARE DESIGN FOR MACHINES FOR MANUFACTURING INDUSTRIAL PRODUCTS, CONVEYOR AND TRANSPORT INSTALLATIONS AND VEHICLES; INSTALLATION, MAINTENANCE AND REPAIR OF COMPUTER SOFTWARE FOR MACHINES FOR MANUFACTURING INDUSTRIAL PRODUCTS, CONVEYOR AND TRANSPORT INSTALLATIONS AND VEHICLES; DESIGNING OF NETWORKS FOR MACHINES FOR MANUFACTURING INDUSTRIAL PRODUCTS, CONVEYOR AND TRANSPORT INSTALLATIONS AND VEHICLES; TECHNICAL PROJECT STUDIES SERVICES, NAMELY, ENGINEERING SERVICES IN THE NATURE OF TECHNICAL PROJECT PLANNING AND DESIGN ENGINEERING AND CONDUCTING OF FEASIBILITY STUDIES FOR MACHINES FOR MANUFACTURING INDUSTRIAL PRODUCTS, CONVEYOR AND TRANSPORT INSTALLATIONS AND VEHICLES (U.S. CLS. 100 AND 101).

TINA BROWN, EXAMINING ATTORNEY

CLASS 1—CHEMICALS

FOR CHEMICALS USED IN INDUSTRY AND SCIENCE; CHEMICALS USED IN INDUSTRY AND SCIENCE, NAMELY, AROMATIC DICARBOXYLIC ACIDS; CHEMICAL USED IN INDUSTRY AND SCIENCE, NAMELY, CHEMICALS DERIVED FROM AROMATIC DICARBOXYLIC ACIDS (U.S. CLS. 1, 5, 6, 10, 26 AND 46).

CLASS 11—ENVIRONMENTAL CONTROL APPARATUS

FOR MACHINES USED IN THE CHEMICAL INDUSTRY, NAMELY, HEAT EXCHANGERS, HEAT PUMPS, SEPARATORS FOR THE CLEANING AND PURIFICATION OF LIQUIDS, NUCLEAR REACTORS, ALL OF THE AFOREMENTIONED GOODS FOR USE IN PRODUCING AROMATIC DICARBOXYLIC ACIDS FROM P-XYLENE IN A SUITABLE SOLVENT AND HEAT EXCHANGERS FOR PRODUCING AROMATIC DICARBOXYLIC ACIDS FROM P-XYLENE BY MEANS OF A SUITABLE CATALYST IN A REACTOR SYSTEM ON AN INDUSTRIAL SCALE (U.S. CLS. 13, 21, 23, 31 AND 34).

CLASS 37—CONSTRUCTION AND REPAIR

FOR BUILDING CONSTRUCTION, INCLUDING BUILDING OF INDUSTRIAL PLANTS, INSTALLATION, ASSEMBLY AND MAINTENANCE OF INDUSTRIAL PLANTS; START-UP OF PLANTS, APPARATUS AND PROCESSES FOR ANALYTICAL PURPOSES AND SYNTHESIS WITHIN THE SCOPE OF THE INSTALLATION, NAMELY, INSTALLATION OF REACTORS AND OTHER APPARATUS FOR THE PRODUCTION OF CHEMICAL SUBSTANCES (U.S. CLS. 100, 103 AND 106).

CLASS 40—MATERIAL TREATMENT

FOR CONVERSION OF TARGET SUBSTRATES INTO TARGETED CHEMICAL PREPARATION BY TREATMENT WITH ENZYME SYSTEMS, NAMELY, CHEMICAL PROCESSING OF P-XYLENE INTO AROMATIC DICARBOXYLIC ACIDS AND INTO PRODUCTS FROM AROMATIC DICARBOXYLIC ACIDS IN INDUSTRIAL PLANTS; CUSTOMER-SPECIFIC ASSEMBLING OF MECHANICAL APPARATUSES IN THE FIELD OF INDUSTRIAL MACHINES AND IN THE FIELD OF INDUSTRIAL MACHINE PLANTS (U.S. CLS. 100, 103 AND 106).

CLASS 42—SCIENTIFIC AND COMPUTER SERVICES

FOR RESEARCH AND DEVELOPMENT IN THE FIELD OF PROCESS ENGINEERING AND CHEMISTRY, IN PARTICULAR IN THE FIELD OF SYNTHESIS OF AROMATIC DICARBOXYLIC ACIDS AND THEIR DERIVATIVES; ENGINEERING SERVICES IN THE FIELD OF SYNTHESIS OF AROMATIC DICARBOXYLIC ACIDS AND THEIR DERIVATIVES; TECHNICAL DEVELOPMENT, TECHNICAL PROJECT PLANNING, CONSTRUCTION PLANNING IN THE NATURE OF RESEARCH ON BUILDING CONSTRUCTION AND TECHNICAL SYSTEM ENGINEERING OF PLANTS, MACHINES AND PROCESSES FOR ANALYTICAL PURPOSES AND SYNTHESIS, AS WELL AS TECHNICAL ADVISORY SERVICES, NAMELY, SCIENTIFIC CONSULTATION IN THE FIELD OF SYNTHESIS OF AROMATIC DICARBOXYLIC ACIDS AND THEIR PRODUCTS; CONDUCTING AND EVALUATION OF CHEMICAL ANALYSES; CHEMISTRY SERVICES, NAMELY, CONDUCTING AND EVALUATION OF CHEMICAL SYNTHESSES; PREPARATION OF EXPERT OPINIONS IN THE FIELD OF ENGINEERING AND PROCESSING OF CHEMICALS; ENGINEERING SERVICES REGARDING INDUSTRIAL PLANTS (U.S. CLS. 100 AND 101).

MELISSA VALLILLO, EXAMINING ATTORNEY

SN 79-058,457. LURGI GMBH, 60439 FRANKFURT AM MAIN, FED REP GERMANY, FILED 2-22-2008.

Mega PTA

THE MARK CONSISTS OF STANDARD CHARACTERS WITHOUT CLAIM TO ANY PARTICULAR FONT, STYLE, SIZE, OR COLOR.

PRIORITY DATE OF 8-24-2007 IS CLAIMED.
OWNER OF INTERNATIONAL REGISTRATION 0976227 DATED 2-22-2008, EXPIRES 2-22-2018.

NO CLAIM IS MADE TO THE EXCLUSIVE RIGHT TO USE "PTA", APART FROM THE MARK AS SHOWN.

SN 79-058,506. APOTHEKE DOCMORRIS HOLDING GMBH, FED REP GERMANY, FILED 10-16-2007.



PRIORITY DATE OF 4-20-2007 IS CLAIMED.
OWNER OF INTERNATIONAL REGISTRATION 0976370
DATED 10-16-2007, EXPIRES 10-16-2017.

THE COLOR(S) GREEN AND WHITE IS/ARE CLAIMED
AS A FEATURE OF THE MARK.

THE MARK CONSISTS OF THE COLORS GREEN AND
WHITE, WITH THE COLOR GREEN APPEARING IN THE
CROSS DESIGN ELEMENT, THE COLOR WHITE APPEAR-
ING AS A BORDER AROUND THE CROSS, AND THE
COLOR GREEN APPEARING AS AN OUTLINE AROUND
THIS BORDER.

CLASS 3—COSMETICS AND CLEANING PREPARATIONS

FOR BODY AND BEAUTY CARE PRODUCTS, NAMELY, LOTIONS AND CREAMS; COSMETIC PREPARATIONS FOR THE HAIR AND SCALP; COSMETICS AND COSMETIC PREPARATIONS; HAIR LOTIONS; COSMETIC GOODS, NAMELY, BATH AND SHOWER PREPARATIONS, NAMELY, BATH AND SHOWER GELS; SOAPS IN SOLID AND LIQUID FORM, NAMELY, MEDICATED SOAPS; PERFUMERY; PREPARATIONS FOR CLEANING TEETH (U.S. CLS. 1, 4, 6, 50, 51 AND 52).

CLASS 5—PHARMACEUTICALS

FOR PHARMACEUTICAL PRODUCTS, NAMELY, PREPARATIONS FOR HEALTH AND BODY CARE FOR MEDICAL PURPOSES AND PERSONAL HYGIENE NAMELY, ACNE MEDICATIONS, ANTIHISTAMINES, ANTISEPTICS AND GENERAL PURPOSE GERMICIDES, ANTACIDS, ANTIBIOTIC CREAM, COLD MEDICINE, COUGH DROPS, DANDRUFF SHAMPOO, DECONGESTANT TABLETS, DIARRHEA MEDICATION, EYE DROPS, HYDROCORTISONE CREAM, LAXATIVES, MEDICATED LIP BALM, NASAL SPRAY PREPARATIONS, PAIN RELIEVERS, NAMELY, ASPIRIN AND NON ASPIRIN; VITAMIN SUPPLEMENTS, PHARMACEUTICAL PREPARATIONS FOR SKIN CARE; BIOLOGICAL PREPARATIONS FOR MEDICAL PURPOSES; FOOD FOR BABIES; SWEETS FOR MEDICAL PURPOSES, NAMELY, CHEST AND COUGH DROPS; TEST STRIPS FOR DIABETES AND PREGNANCY TESTS KITS, STRIPS FOR CHOLESTEROL TESTS; MEDICAL PLASTERS AND MATERIALS FOR DRESSINGS, NAMELY, BANDAGES; HYGIENIC ARTICLES FOR WOMEN, NAMELY, SANITARY TOWELS, PANTY LINERS, TAMPONS, SANITARY PANTS; PASTILLES FOR PHARMACEUTICAL PURPOSES (U.S. CLS. 6, 18, 44, 46, 51 AND 52).

CLASS 8—HAND TOOLS

FOR NAIL SCISSORS AND MANICURE SETS (U.S. CLS. 23, 28 AND 44).

CLASS 9—ELECTRICAL AND SCIENTIFIC APPARATUS

FOR SCIENTIFIC, ELECTRICAL, ELECTRONIC, AND PHOTOGRAPHIC WEIGHING, MEASURING, SIGNALING, CHECKING, TEACHING, AND LIFE-SAVING APPARATUS AND INSTRUMENTS PARTICULARLY FOR USE IN LABORATORIES, PHARMACIES, AND DRUG STORES, NAMELY, EMERGENCY SIGNAL TRANSMITTERS; COMPUTER PERIPHERY DEVICES, COMPUTER PROGRAMS FOR CONTROLLING AND MANAGING PATIENT MEDICAL INFORMATION, PARTICULARLY FOR USE IN PHARMACIES, DRUG STORES, LABORATORIES AND PHYSICIAN PRACTICES; COMPUTER SOFTWARE, NAMELY, COMPUTER SOFTWARE FOR CONTROLLING AND MANAGING PATIENT MEDICAL INFORMATION, PARTICULARLY FOR USE IN PHARMACIES, DRUG STORES, LABORATORIES AND PHYSICIAN PRACTICES (U.S. CLS. 21, 23, 26, 36 AND 38).

CLASS 10—MEDICAL APPARATUS

FOR SURGICAL AND MEDICAL INSTRUMENTS AND APPARATUS, NAMELY, BLOOD PRESSURE GAUGES, BLOOD GLUCOSE METERS AND TESTING STRIPS, AND CHOLESTEROL METERS; ORTHOPEDIC ARTICLES, NAMELY, ORTHOPEDIC SUPPORT BANDAGES AND SURGICAL STOCKINGS; MEDICAL ANALYSIS EQUIPMENT, NAMELY, BLOOD PRESSURE MONITORS, BLOOD GLUCOSE MONITORS, AND HEART MONITORS (U.S. CLS. 26, 39 AND 44).

CLASS 11—ENVIRONMENTAL CONTROL APPARATUS

FOR LIGHTING FIXTURES, LIGHT BULBS, ELECTRIC MICROWAVE OVENS; ELECTRIC SPACE HEATERS AND WATER HEATERS; ELECTRIC FANS; ELECTRIC HAIR DRYERS, HUMIDIFIERS; HOT WATER BOTTLES, WATER FILTERS, AND WATER FILTERING APPARATUS; WATER TREATMENT DEVICES AND MACHINERY, NAMELY, CARTRIDGE FILTRATION UNITS, CHEMICAL STERILIZATION UNITS, REVERSE OSMOSIS FILTRATION UNITS, AND ULTRAVIOLET STERILIZATION UNITS; WATER-SOFTENING APPARATUS AND INSTILLATIONS, WATER DISTILLATION UNITS; DISTILLATION UNITS, AIR HUMIDIFIERS FOR CENTRAL HEATING RADIATORS (U.S. CLS. 13, 21, 23, 31 AND 34).

CLASS 16—PAPER GOODS AND PRINTED MATTER

FOR PRINTED MATTER, NAMELY, BOOKS, PRINTED PERIODICALS, JOURNALS, NEWSPAPERS, CATALOGUES, PROSPECTUSES, BROCHURES ALL IN THE FIELD OF MEDICINE, PHARMACEUTICALS, AND HEALTHCARE; BABIES' DIAPERS OF PAPER OR CELLULOSE, PAPER TISSUES FOR COSMETIC USE; OFFICE EQUIPMENT FOR PHARMACIES, NAMELY, CELLULOID COVERS, CELLULOID CARD SHEETS, CELLULOID PROTECTIVE SIGNS, PRINTED PRESCRIPTION LABELS, NON-MECHANICAL LABEL MOISTENERS (U.S. CLS. 2, 5, 22, 23, 29, 37, 38 AND 50).

CLASS 21—HOUSEWARES AND GLASS

FOR BRUSHES, NAMELY, HAIRBRUSHES, NAIL BRUSHES, TOILET BRUSHES, SHOE BRUSHES, DISHWASHING BRUSHES, FLOOR BRUSHES, CLOTHES BRUSHES, SHAVING BRUSHES; TOOTHBRUSHES, ELECTRIC TOOTHBRUSHES; COMBS; SPONGES FOR HOUSEHOLD PURPOSES (U.S. CLS. 2, 13, 23, 29, 30, 33, 40 AND 50).

CLASS 29—MEATS AND PROCESSED FOODS

FOR DIETETIC FOODSTUFFS FOR NON-MEDICAL PURPOSES BASED ON FATS, WITH ADDED FATTY ACIDS, VITAMINS, MINERALS, TRACE ELEMENTS, NAMELY, FRUIT-BASED SNACK FOODS, FRUIT-BASED SNACK BARS, FRUIT CONCENTRATES FOR USE AS AN INGREDIENT IN FOOD, AND VEGETABLE CONCENTRATES FOR USE AS AN INGREDIENT IN FOOD; PRESERVED, DRIED, AND COOKED FRUITS AND VEGETABLES (U.S. CL. 46).

CLASS 30—STAPLE FOODS

FOR DIETETIC FOODSTUFFS OR FOOD SUPPLEMENTS FOR NON-MEDICAL PURPOSES BASED ON CARBOHYDRATES, ROUGHAGE, WITH ADDED VITAMINS, MINERALS, TRACE ELEMENTS, NAMELY, SNACK FOODS AND SNACK BARS; COFFEE, TEA, BEVERAGES MADE FROM TEA; COCOA-BASED PRODUCTS, CHOCOLATE, MILK CHOCOLATE, CHOCOLATE BARS, FILLED CHOCOLATES; SUGAR, GLUCOSE FOR FOOD, CANDY STICKS; JELLIED FRUITS; FRUIT SAUCES EXCLUDING CRANBERRY SAUCE AND APPLESAUCE; FRUIT GUMS ALSO IN VARIOUS SHAPES AND FORMS, INCLUDING BEARS; LIQUORICE, STICK LIQUORICE; SWEETS, CARAMELS, PEPPERMINT CANDY SWEETS (U.S. CL. 46).

CLASS 32—LIGHT BEVERAGES

FOR ENERGY DRINKS; MINERAL AND AERATED WATERS; NON-ALCOHOLIC DRINKS, NAMELY, FRUIT DRINKS AND FRUIT JUICES, PARTICULARLY FRUIT NECTARS; VEGETABLE JUICES; SYRUPS AND NONALCOHOLIC PREPARATIONS, NAMELY, JUICE CONCENTRATES, SIMPLE SYRUPS, AND APERITIFS, FOR MAKING BEVERAGES (U.S. CLS. 45, 46 AND 48).

CLASS 35—ADVERTISING AND BUSINESS

FOR BUSINESS COMPANY CONSULTATION AND BUSINESS MANAGEMENT CONSULTATION, PARTICULARLY FOR PHARMACIES, DRUG STORES, PHYSICIAN PRACTICES, CLINICS AND DISPATCH CENTERS, AND PARTICULARLY FOR TURNOVER, COST, AND RESULTS MANAGEMENT; BUSINESS MANAGEMENT AND BUSINESS ADMINISTRATION FOR THIRD PARTIES, PARTICULARLY FOR PHARMACIES, DRUG STORES, PHYSICIANS' PRACTICES, CLINICS AND DISPATCH CENTERS; ADVERTISING SERVICES ON THE INTERNET; TELEVISION ADVERTISING AGENCY; RADIO ADVERTISING AGENCY; ADVERTISING BY MAIL ORDER; ADVERTISING AGENCY SERVICES; DISTRIBUTION OF ADVERTISEMENTS; ONLINE ADVERTISING ON A COMPUTER NETWORK; PRESENTATION OF GOODS FOR THIRD PARTIES FOR PRESENTATION AND SALES PURPOSES; SHOP WINDOW DECORATION; UPDATING, ENTRY, ORGANIZATION AND COLLECTION OF DATA IN COMPUTER DATABASES (U.S. CLS. 100, 101 AND 102).

CLASS 36—INSURANCE AND FINANCIAL

FOR REAL ESTATE CONSULTATION; FINANCIAL CONSULTATION; INSURANCE AGENCIES; REAL ESTATE BROKERAGE SERVICES FOR THIRD PARTIES; REAL ESTATE MANAGEMENT FOR THIRD PARTIES, PARTICULARLY FOR PHARMACIES, DRUG STORES, WAREHOUSES AND DISPATCH CENTERS; BROKERAGE, RENTAL AND LEASING OF REAL ESTATE, NAMELY, OF OFFICES, FOR PHARMACIES, DRUG STORES, WAREHOUSES AND DISPATCH CENTERS; FINANCIAL CONSULTANCY; FINANCIAL CONSULTANCY FOR FRANCHISING CONCEPTS; REAL ESTATE MANAGEMENT OF WAREHOUSE BUILDINGS FOR PHARMACEUTICAL WHOLESALERS (U.S. CLS. 100, 101 AND 102).

CLASS 37—CONSTRUCTION AND REPAIR

FOR CONSTRUCTION, NAMELY, CONSTRUCTION OF BUILDINGS FOR PHARMACIES, DRUG STORES, WAREHOUSES AND DISPATCH CENTERS; REPAIR WORK ON BUILDINGS, PARTICULARLY FOR PHARMACIES, DRUG STORES, WAREHOUSES AND DISPATCH CENTERS; AND UNDERGROUND BUILDING CONSTRUCTION WORK; INSTALLATION AND MAINTENANCE OF HARDWARE FOR THE OPERATION OF COMPUTER NETWORK SERVERS AND NETWORK SYSTEMS (U.S. CLS. 100, 103 AND 106).

CLASS 38—COMMUNICATION

FOR TELECOMMUNICATION ACCESS SERVICES; BROADCASTING TELEVISION PROGRAMS; BROADCASTING OF RADIO PROGRAMS; NEWS AGENCIES, NAMELY, THE TRANSMISSION OF NEWS ITEMS TO NEWS REPORTING ORGANIZATIONS; PROVISION OF TELECOMMUNICATIONS CONNECTIONS AND ACCESS TO A WORLDWIDE COMPUTER NETWORK; PROVISION OF ACCESS TO A COMPUTER NETWORK; ELECTRONIC MESSAGE TRANSMISSION; E-COMMERCE SERVICES, NAMELY, PROVIDING ACCESS TO INFORMATION ON THE INTERNET; FORWARDING MESSAGES OF ALL KINDS TO INTERNET ADDRESSES, NAMELY, WEB MESSAGING; PROVIDING ACCESS TO INFORMATION WITH REGARD TO CURRENT FINDINGS OF PHARMACEUTICAL RESEARCH ON THE INTERNET; PROVIDING ACCESS TO PHARMACEUTICAL INFORMATION ON THE INTERNET (U.S. CLS. 100, 101 AND 104).

CLASS 39—TRANSPORTATION AND STORAGE

FOR TRANSPORT BY AIR, CAR, TRAIN, AND SEA; PACKAGING AND STORAGE OF GOODS; DELIVERY OF GOODS, PARTICULARLY OF MEDICATIONS, BODY CARE AND BEAUTY PRODUCTS, DIETETIC FOODS AND DRINKS AND FOOD SUPPLEMENTS TO PHARMACIES, DRUG STORES, CLINICS, WHOLESALERS, PHYSICIANS' PRACTICES AND MEDICAL REPRESENTATIVES; DELIVERY OF GOODS TO PATIENTS AND END CONSUMERS; STORAGE OF GOODS, PARTICULARLY OF MEDICATIONS, BODY CARE AND BEAUTY PRODUCTS, DIETETIC FOODS AND DRINKS AND FOOD SUPPLEMENTS; GOODS WAREHOUSING; DELIVERY OF GOODS TO CUSTOMERS; COURIER SERVICES (U.S. CLS. 100 AND 105).

CLASS 40—MATERIAL TREATMENT

FOR CUSTOM ASSEMBLING OF MATERIALS, NAMELY, ASSEMBLY OF PRODUCTS FOR OTHERS (U.S. CLS. 100, 103 AND 106).

CLASS 41—EDUCATION AND ENTERTAINMENT

FOR PROVISION OF TRAINING AND FURTHER TRAINING IN THE FIELD OF MEDICINE, PHARMACY AND HEALTH CARE; TEACHING IN THE FIELD OF MEDICINE, PHARMACY AND HEALTHCARE; CONDUCTING OF SEMINARS, TEACHING, TRAINING AND FURTHER TRAINING MEASURES, PARTICULARLY IN THE FIELD OF HOW TO PROVIDE MEDICAL AND PHARMACEUTICAL PRODUCTS FOR INDUSTRIAL AND TEST PURPOSES, ARRANGEMENT AND CONDUCTING OF WORKSHOPS IN THE FIELD OF MEDICINE, PHARMACY AND HEALTHCARE; PRODUCTION OF INTERNET TELEVISION PROGRAMS IN THE FIELD OF MEDICINE, PHARMACY AND HEALTHCARE; EDITORIAL SUPERVISION OF INTERNET SITES, NAMELY EDITING OF TEXTS FOR PUBLICATION ON THE INTERNET, EXCEPT FOR ADVERTISING PURPOSES (U.S. CLS. 100, 101 AND 107).

CLASS 42—SCIENTIFIC AND COMPUTER SERVICES

FOR DEVELOPMENT OF COMPUTER PROGRAMS, PARTICULARLY IN THE HEALTH FIELD FOR DATA PROCESSING AND CONTROLLING AND MANAGING PATIENT MEDICAL INFORMATION; UPDATING COMPUTER SOFTWARE; COMPUTER CONSULTANCY SERVICES; DEVELOPMENT OF OPERATING SYSTEMS FOR COMPUTERS; SOFTWARE DESIGN FOR INTERNET PORTALS AND INTERNET PLATFORMS; DESIGN AND MAINTENANCE OF WEB SITES FOR THIRD PARTIES; CONSULTANCY ON THE DESIGN OF HOMEPAGES AND INTERNET SITES; DEVELOPMENT AND DESIGN OF HOMEPAGES AND INTERNET SITES, PARTICULARLY FOR PHARMACIES, DRUG STORES, PHYSICIANS' PRACTICES AND CLINICS; MEDICAL/PHARMACEUTICAL RESEARCH; FOLLOW-UP RESEARCH AND RESEARCH IN DATABASES AND ON THE INTERNET FOR SCIENTIFIC AND RESEARCH PURPOSES; SCIENTIFIC ANALYSIS OF PHARMACEUTICAL PRODUCTS; CIVIL ENGINEERING; SERVICES OF A MEDICAL LABORATORY (U.S. CLS. 100 AND 101).

CLASS 44—MEDICAL, BEAUTY AND AGRICULTURAL SERVICES

FOR CONSULTANCY RELATING TO PHARMACEUTICAL PRODUCTS, NAMELY, THROUGH A PHARMACIST OR DRUG STORE OPERATOR, PHARMACIST SERVICES, NAMELY, PREPARATION OF PHARMACEUTICAL PREPARATIONS AND MEDICINES FOR THIRD PARTIES ON THE BASIS OF MEDICAL PRESCRIPTIONS; PHARMACIST SERVICES, NAMELY, PREPARATION OF MEDICAL PRESCRIPTIONS FOR THIRD PARTIES; HEALTH AND NUTRITION CONSULTANCY, PARTICULARLY IN THE FIELD OF CARE AND HYGIENE OF THE SICK AND BABIES; HYGIENIC AND BEAUTY CARE FOR HUMAN BEINGS AND ANIMALS; PERFORMANCE OF MEDICAL TESTING; PSYCHOLOGICAL CONSULTATION OF PERSONNEL FOR MEDICAL PURPOSES; MEDICAL CONSULTATION ON THE APPROVAL OF MEDICATIONS FOR THIRD PARTIES (U.S. CLS. 100 AND 101).

TEJBIR SINGH, EXAMINING ATTORNEY

SN 79-059,071. ORYA ORGANIK YASAM GIDA; TEKSTIL TURIZM SANAYI VE TICARET ANONIM SIRKETI, TURKEY, FILED 7-24-2008.



OWNER OF INTERNATIONAL REGISTRATION 0939196 DATED 12-27-2006, EXPIRES 12-27-2016.

NO CLAIM IS MADE TO THE EXCLUSIVE RIGHT TO USE "CITY FARM", APART FROM THE MARK AS SHOWN.

THE COLOR(S) GOLD, YELLOW, RED, GREEN AND BLACK IS/ARE CLAIMED AS A FEATURE OF THE MARK.

THE MARK CONSISTS OF THE COLOR GOLD IN THE SUN AND ITS RAYS, THE COLOR YELLOW IN THE SUN, ITS RAYS AND THE BACKGROUND RECTANGLE, THE COLOR RED IN THE RECTANGULAR LINE BORDER, THE COLOR GREEN IN THE TWO TREE DESIGNS, THE COLOR BLACK IN THE WORDING "CITY FARM" AND THE DARK PARTS OF THE TREE DESIGNS AND THEIR SHADOWS.

CLASS 29—MEATS AND PROCESSED FOODS

FOR MEAT, FISH, POULTRY AND GAME, MEAT EXTRACTS, BOUILLON MEAT CONCENTRATES, BROTH, BOUILLONS; SEAFOOD, NAMELY, NON-LIVING FISH, MOLLUSK AND CRUSTACEANS; PRESERVED MEAT, FISH, AND VEGETABLES; DRIED AND COOKED VEGETABLES, READY MADE SOUPS; PREPARED MEALS MADE PRIMARILY OF MEAT, VEGETABLES AND FRUITS; PRESERVED OLIVES, PICKLES; MILK AND MILK PRODUCTS, EXCLUDING ICE CREAM, ICE MILK AND FROZEN YOGURT; MILK, WHITE CHEESE; KASAR, NAMELY, A MILD AND PALE YELLOW CHEESE MADE OF SHEEP'S MILK; YOGHURT; AYRAN, NAMELY, A DRINK MADE OF YOGHURT AND WATER; WHIPPED CREAM, CREAM; CHANTILLY CREAM, NAMELY, A SWEETENED WHIPPED CREAM; MILK POWDER, MILK BEVERAGES WITH HIGH MILK CONTENT; KEPHIR, NAMELY, A MILK BEVERAGE WITH HIGH MILK CONTENT; EDIBLE OILS AND FATS, BUTTER, MARGARINE; PEKMEZ, NAMELY, A THICK RENDERING OF GRAPE JUICE; FRUIT PULP, COMPOTE; EGGS, DRIED POWDERED EGGS; JELLIES FOR FOOD, UNFLAVORED GELATIN FOR FOOD; POTATO CHIPS, FRIED POTATOES, POLLEN PREPARED AS FOODSTUFF, TOMATO PASTES; PRESERVED PROCESSED LEGUMINOUS VEGETABLES, NAMELY, PEAS, BEANS, CHICKPEAS, LENTILS AND SOY BEANS (U.S. CL. 46).

CLASS 30—STAPLE FOODS

FOR COFFEE, COCOA, ARTIFICIAL COFFEE, MOCHA COFFEE, VEGETAL PREPARATIONS FOR USE AS COFFEE SUBSTITUTES, BEVERAGES BASED ON COFFEE OR COCOA, TAPIOCA, SAGO, SPAGHETTI, PASTA, RAVIOLI, PASTRIES, BISCUITS, WAFERS, CRACKERS, PIES, CAKES, WAFFLES, READY CAKES, PANCAKES, BREADS, PIZZAS, SANDWICHES, PUDDINGS, CHOCOLATE PUDDINGS, HONEY, ROYAL JELLY FOR FOOD PURPOSES, KETCHUP, MAYONNAISE, MUSTARD, SAUCES, SALAD DRESSINGS, VINEGAR, YEAST, BAKING POWDER, VANILLA, SPICES; ALL KINDS OF FLOUR NOT INCLUDING NUT FLOURS; SEMOLINA, FOOD STARCH; TEAS EXTRACTED FROM VEGETABLE LEAVES, ICE TEAS, SAGE TEA, LINDEN FLOWER TEA, THYME TEA; TURKISH DELIGHT, HALVAHS, FROZEN YOGURTS, CHOCOLATE PRODUCTS AS DECORATIONS FOR CHRISTMAS TREES, CHOCOLATE BASED BEVERAGES, CHEWING GUMS, ICE CREAMS, ICES, SALT, RICE, BOILED AND POUNDED WHEAT, GRAIN-BASED SNACK FOODS, CEREAL-BASED SNACK FOODS; CORN FLAKES, OATMEAL, BREAKFAST CEREALS, PROCESSED BREAKFAST GRAINS, GRANULATED SUGAR, LUMP SUGAR, POWDERED SUGAR (U.S. CL. 46).

CLASS 31—NATURAL AGRICULTURAL PRODUCTS

FOR AGRICULTURAL, HORTICULTURAL AND FORESTRY PRODUCTS AND GRAINS INCLUDED IN THIS CLASS, NAMELY, FLOWER BULBS, GRASS SEED, AND SEEDLINGS; CEREALS FOR ANIMAL CONSUMPTION, UNPROCESSED WHEAT, UNPROCESSED BARLEY, UNPROCESSED OATS, UNPROCESSED CORN, UNPROCESSED MAIZE, UNPROCESSED RYE; FRESH FRUITS AND VEGETABLES, FRESH MUSHROOMS, PLANT SEEDS, FLOWER BULBS, VEGETABLE SEEDS; LIVE ANIMALS, NATURAL PLANTS AND FLOWERS, EGGS FOR HATCHING, FOODSTUFFS FOR ANIMALS, MALT FOR BREWING, DRIED PLANTS AND HERBS FOR DECORATION, WREATHS OF NATURAL FLOWERS, SANDED PAPER FOR PETS, AROMATIC SAND FOR PETS, CUTTLE BONE FOR BIRDS (U.S. CLS. 1 AND 46).

CLASS 32—LIGHT BEVERAGES

FOR NON-ALCOHOLIC BEVERAGES, NAMELY, FRUIT BEVERAGES CONSISTING OF FRUIT JUICES WITH SPARKLING MINERAL WATER, ENERGY DRINKS, WHEY BEVERAGES AND ISOTONIC BEVERAGES FOR SPORTS NEEDS; BEERS, MINERAL AND AERATED WATERS; FRUIT DRINKS AND FRUIT JUICES; SYRUPS FOR MAKING BEVERAGES; ESSENCES AND OTHER PREPARATIONS FOR MAKING BEVERAGES, NAMELY, FRUIT SYRUPS AS WELL AS EFFERVESCENT TABLETS FOR MAKING NON-ALCOHOLIC BEVERAGES AND NON-ALCOHOLIC COCKTAILS (U.S. CLS. 45, 46 AND 48).

SN 79-060,022. PARSHIP GMBH, FED REP GERMANY, FILED 5-26-2008.

PARSHIP

CLASS 35—ADVERTISING AND BUSINESS

FOR ADVERTISING AGENCIES, PUBLICITY AGENCIES, TELEVISION ADVERTISING AGENCIES, RADIO ADVERTISING AGENCIES, PUBLIC RELATIONS SERVICES IN THE NATURE OF PREPARING PRESS RELEASES, DISSEMINATION OF ADVERTISING MATTER, ORGANIZATION OF EXHIBITIONS FOR COMMERCIAL OR ADVERTISING PURPOSES, ORGANIZATION OF TRADE FAIRS FOR COMMERCIAL OR ADVERTISING PURPOSES, MODELING FOR ADVERTISING OR SALES PROMOTION, MARKETING RESEARCH, MARKETING RESEARCH STUDIES, LAYOUT SERVICES FOR ADVERTISING PURPOSES, SHOP WINDOW DRESSING, OPINION POLLING SERVICES, PUBLIC RELATIONS; SECRETARIAL SERVICES, STENOGRAPHY SERVICES, PHOTOCOPYING, TYPING SERVICES, WORD PROCESSING, COMPUTERIZED FILE MANAGEMENT SERVICES, COMPILATION OF INFORMATION INTO COMPUTER DATABASES, SYSTEMIZATION OF INFORMATION INTO COMPUTER DATABASES; TELEPHONE ANSWERING FOR UNAVAILABLE SUBSCRIBERS, ARRANGING NEWSPAPER SUBSCRIPTIONS FOR OTHERS; RENTAL OF OFFICE MACHINES AND OFFICE EQUIPMENT, RENTAL OF VENDING MACHINES; BUSINESS MANAGEMENT AND ORGANIZATION CONSULTANCY, BUSINESS MANAGEMENT OF HOTELS, BUSINESS APPRAISALS, BUSINESS INQUIRIES, BUSINESS INVESTIGATION, PERSONNEL MANAGEMENT CONSULTANCY, EMPLOYMENT AGENCIES, PSYCHOLOGICAL TESTING FOR THE SELECTION OF PERSONNEL, PERSONNEL RECRUITMENT, BOOK-KEEPING, ACCOUNT AUDITING, ACCOUNTING, COST PRICE ANALYSIS, ECONOMIC FORECASTING, PAYROLL PREPARATION, TAX PREPARATION; IMPORT-EXPORT AGENCIES; BUSINESS MANAGEMENT OF PERFORMING ARTISTS; COMMERCIAL OR INDUSTRIAL MANAGEMENT ASSISTANCE; AUCTIONEERING; THE BRINGING TOGETHER, FOR THE BENEFIT OF OTHERS, OF A VARIETY OF GOODS, EXCLUDING THE TRANSPORT THEREOF, IN THE FIELD OF MEAT, SEAFOOD, DAIRY PRODUCTS, OILS AND BUTTER, PROCESSED FRUIT PRODUCTS AND JELLIES, EGG PRODUCTS, POTATOES, TOMATOES, VEGETABLES, BEANS, COFFEE AND COFFEE PRODUCTS, PASTAS, BREADS, PASTRIES, CAKES, PIZZAS, SANDWICHES, PUDDING, HONEY, CONDIMENTS, VINEGAR, YEAST, SPICES, FLOUR, FOOD STARCH, TEAS, CHOCOLATES AND SWEETS, SNACK FOODS, CEREALS, SUGAR, FLOWERS, WHEAT, BARLEY, OATS, CORN, RYE, FRUITS AND VEGETABLES, SEEDS, LIVE ANIMALS AND PLANTS, EGGS, FOODSTUFFS FOR ANIMALS, MALT, SANDED PAPER FOR PETS, NON-ALCOHOLIC BEVERAGES, ESSENCES AND FRUIT SYRUPS, AND EFFERVESCENT TABLETS FOR MAKING NON-ALCOHOLIC BEVERAGES AND NON-ALCOHOLIC COCKTAILS (U.S. CLS. 100, 101 AND 102).

FRED CARL, EXAMINING ATTORNEY

THE MARK CONSISTS OF STANDARD CHARACTERS WITHOUT CLAIM TO ANY PARTICULAR FONT, STYLE, SIZE, OR COLOR.

OWNER OF INTERNATIONAL REGISTRATION 0980002 DATED 5-26-2008, EXPIRES 5-26-2018.

CLASS 38—COMMUNICATION

FOR TELECOMMUNICATIONS, NAMELY, PROVIDING ACCESS TO THE INTERNET; ELECTRONIC TRANSMISSION OF MESSAGES AND INFORMATION VIA RADIO, TELEVISION AND TELEPHONE NETWORKS, INCLUDING CALL CENTRES, SMS SERVICES, AND ON DATA NETWORKS, IN PARTICULAR THE INTERNET; ELECTRONIC MAIL SERVICES, PROVIDING PORTALS ON THE INTERNET, NAMELY, PROVIDING INTERNET CHATROOMS; OPERATING CHATROOMS AND INTERNET FORUMS; ONLINE SERVICES, NAMELY, OPERATING CLIENT DATABASES AS INTERNET PLATFORMS FOR TRANSMISSION PURPOSES, NAMELY, ELECTRONIC EXCHANGE OF DATA STORED IN DATABASES ACCESSIBLE VIA TELECOMMUNICATION NETWORKS; RENTAL OF ACCESS TIME TO GLOBAL COMPUTER NETWORKS FOR ACCESSING COMPUTER DATABASE FOR OTHERS; PROVIDING ACCESS TO INTERNET FOR RETRIEVING CONTENT (U.S. CLS. 100, 101 AND 104).

CLASS 41—EDUCATION AND ENTERTAINMENT

FOR EDUCATION, NAMELY, PROVIDING CLASSES IN THE FIELD OF MATCHMAKING AND HUMAN RELATIONSHIPS, PROVIDING OF TRAINING, ENTERTAINMENT AND CULTURAL ACTIVITIES IN THE FIELD OF MATCHMAKING AND HUMAN RELATIONSHIPS, NAMELY, CONDUCTING PARTIES FOR THE PURPOSE OF DATING AND SOCIAL INTRODUCTION FOR ADULTS; SINGLES COACHING, NAMELY, TRAINING AND INSTRUCTION OF SINGLE PEOPLE IN MATTERS RELATING TO PARTNERSHIPS; PUBLISHING, NAMELY, PUBLICATION OF FILMS AND ELECTRONIC NEWSPAPERS IN COMPUTER NETWORKS, NAMELY, THE INTERNET; PRODUCTION, PUBLICATION, RENTAL AND OTHER PROCESSING OF MOTION PICTURES, VIDEO CASSETTES AND FILMS, CD-ROMS, DVDS AND MAGNETIC DATA CARRIERS FEATURING DOCUMENTARIES AND STORIES ABOUT MATCHMAKING AND HUMAN RELATIONSHIPS; PROVIDING CONTENT RETRIEVABLE VIA THE INTERNET, NAMELY, ONLINE NON-DOWNLOADABLE VIDEOS FEATURING DOCUMENTARIES AND STORIES ABOUT MATCHMAKING AND HUMAN RELATIONSHIPS; ORGANIZATION OF INTERNET GAMES (U.S. CLS. 100, 101 AND 107).

CLASS 42—SCIENTIFIC AND COMPUTER SERVICES

FOR SCIENTIFIC AND TECHNOLOGICAL SERVICES IN THE FIELD OF MATCHMAKING AND HUMAN RELATIONSHIPS FOR OTHERS, NAMELY, PROVIDING SCIENTIFIC RESEARCH; DESIGN AND DEVELOPMENT OF COMPUTER HARDWARE AND SOFTWARE; ONLINE SERVICES, NAMELY, OPERATING CLIENT DATABASES AS INTERNET PLATFORMS FOR DATA SEARCHES AND DATA COMPARISONS, NAMELY, PROVIDING SEARCH ENGINES; APPLICATION SERVICE PROVIDER SERVICES, NAMELY, INTEGRATION OF COMPUTER SYSTEMS AND NETWORKS IN THE NATURE OF CLIENT DATABASES AND INTERNET PLATFORMS AND THE INSTALLATION AND MAINTENANCE THEREOF IN RESPECT OF COMPUTER SOFTWARE; PROVIDING CONTENT RETRIEVABLE VIA THE INTERNET, NAMELY, PROVIDING AN INTERACTIVE WEB SITE THAT ALLOWS USERS TO COLLECT, STORE, MANAGE, DELIVER AND SHOW-CASE ELECTRONIC AND PAPER-BASED CONTENT; WEBSITE DESIGN, CREATION AND TECHNICAL SUPPORT IN THE NATURE OF TROUBLESHOOTING OF COMPUTER SOFTWARE PROGRAMS, INCLUDING FOR OTHERS (U.S. CLS. 100 AND 101).

CLASS 45—PERSONAL AND LEGAL SERVICES

FOR PERSONAL AND SOCIAL SERVICES RENDERED BY OTHERS TO MEET THE NEEDS OF INDIVIDUALS, NAMELY, PERSONAL FASHION CONSULTING SERVICES; DATING AGENCIES; COUPLE COUNSELING AND MARRIAGE BUREAUS; PERSONAL INTRODUCTION AGENCIES AND CONSULTANCY FOR DATING AND MATCHMAKING SERVICES; SINGLES COACHING, NAMELY, PERSONAL CONSULTANCY FOR SINGLE PEOPLE IN MATTERS RELATING TO PARTNERSHIPS; ARRANGING INTRODUCTIONS BETWEEN UNACQUAINTED PERSONS FOR RECREATIONAL PURPOSES PARTNERSHIP ANALYSIS FOR COUNSELING AND MATCHMAKING PURPOSES; ISSUING AND GRANTING OF USER RIGHTS TO INTELLECTUAL PROPERTY OR INDUSTRIAL PROPERTY RIGHTS, NAMELY, LICENSING OF INTELLECTUAL AND INDUSTRIAL PROPERTY (U.S. CLS. 100 AND 101).

DOMINIC FATHY, EXAMINING ATTORNEY

SN 79-060,054. ALFREDO SALVATORI S.R.L., QUERCETA (LU), ITALY, FILED 8-5-2008.



PRIORITY DATE OF 5-30-2008 IS CLAIMED.
OWNER OF INTERNATIONAL REGISTRATION 0980065 DATED 8-5-2008, EXPIRES 8-5-2018.
OWNER OF U.S. REG. NO. 2,907,547.
THE MARK CONSISTS OF A SQUARE WITH CURVED LINES THAT CURVE TOWARDS EACH OTHER AND GRADUALLY GET SMALLER AS THEY APPROACH THE ENDS OF THE SQUARE.

CLASS 11—ENVIRONMENTAL CONTROL APPARATUS

FOR APPARATUS FOR WATER SUPPLY AND FOR SANITARY PURPOSES, PLUMBING, TAPS AND FITTINGS, NAMELY, FAUCETS, SINKS, BIDETS, BATHTUBS AND HYDRO MASSAGE BATHTUBS, SHOWERS AND SHOWER CUBICLES, WATER CLOSETS (U.S. CLS. 13, 21, 23, 31 AND 34).

CLASS 19—NON-METALLIC BUILDING MATERIALS

FOR NON METALLIC BUILDING MATERIALS, NAMELY, MARBLE, STONE, CERAMIC TILES AND MARBLE TILES WHICH, THROUGH A SPECIFIC INDUSTRIAL PROCESS ARE MADE TO LOOK USED AND ANTIQUE; TILES MADE IN MARBLE; DRESS MARBLE TILES; NON-METAL MOSAIC TILES; NON-METAL TILES MADE WITH A SPECIFIC CONCAVE SHAPE; NON-METAL TILES MADE WITH THE SURFACE ENGRAVED WITH PARALLEL LINES, ALL FOR OUTDOOR AND INDOOR FLOORING AND FOR TILING BUILDING WALLS; NON-METALLIC BUILDING ORNAMENTS, NAMELY, COLUMNS, PILLARS, CAPITALS, DOORS, AND WINDOW JAMBS, MOULDINGS, GREEK FRETS, CEILING ROSES AND ROSE WINDOWS, LISTS, CORNICES, STAIRCASES AND STEPS, RISES, FLIGHTS, WINDOWSILLS, THRESHOLDS, PORTALS, SKIRTING BOARDS, CORNERSTONES, BRACKETS AND CONSOLES, ORNAMENTAL INLAYS, SWIMMING-POOL EDGES, AND CORBELS (U.S. CLS. 1, 12, 33 AND 50).

CLASS 21—HOUSEWARES AND GLASS

FOR BATHROOM FURNISHING ITEMS AND ACCESSORIES, NAMELY, SOAP BOXES AND TOILET PAPER HOLDERS; SPONGE HOLDERS; TOILET BRUSHES; SHAVING POTS, FLOWER POTS; AND VASES; WASH BASINS (U.S. CLS. 2, 13, 23, 29, 30, 33, 40 AND 50).

MATTHEW EINSTEIN, EXAMINING ATTORNEY

SN 79-061,649. KONECRANES PLC, FINLAND, FILED 8-21-2008.

LIFTING BUSINESSES

THE MARK CONSISTS OF STANDARD CHARACTERS WITHOUT CLAIM TO ANY PARTICULAR FONT, STYLE, SIZE, OR COLOR.

OWNER OF INTERNATIONAL REGISTRATION 0983898 DATED 8-21-2008, EXPIRES 8-21-2018.

CLASS 7—MACHINERY

FOR CRANES AND PARTS THEREFOR, HOISTS AND WINCHES, ELECTRIC MOTORS FOR CRANES, CRANE DRIVES, TRANSMISSION COMPONENTS, NAMELY, GEARS FOR CRANES AND GEARS FOR MACHINES, HOISTING EQUIPMENT, NAMELY, REACH STACKERS (U.S. CLS. 13, 19, 21, 23, 31, 34 AND 35).

CLASS 9—ELECTRICAL AND SCIENTIFIC APPARATUS

FOR ELECTRICAL AND ELECTRONIC INSTRUMENTS FOR MEASURING LOAD CAPACITY OF LIFTING MACHINERY FOR CRANES, LIFT TRUCKS AND REACH STACKERS; ELECTRICAL ELECTRONIC INSTRUMENTS FOR MEASURING THE SERVICE LIVES ON AN ELECTRIC DRIVE AND A LIFTING GEAR FOR CRANES, LIFT TRUCKS AND REACH STACKERS; TRANSMISSION LIMIT SWITCHES FOR CRANES, LIFT TRUCKS AND REACH STACKERS (U.S. CLS. 21, 23, 26, 36 AND 38).

CLASS 12—VEHICLES

FOR FORKLIFT TRUCKS (U.S. CLS. 19, 21, 23, 31, 35 AND 44).

CLASS 37—CONSTRUCTION AND REPAIR

FOR INDUSTRIAL MAINTENANCE SERVICES, NAMELY, INSTALLATION, MAINTENANCE, REPAIR AND REFURBISHMENT OF MECHANICAL AND ELECTRONIC EQUIPMENT (U.S. CLS. 100, 103 AND 106).
INGA ERVIN, EXAMINING ATTORNEY

CLASS 26—FANCY GOODS

FOR ORNAMENTAL NOVELTY BADGES FOR WEAR (U.S. CLS. 37, 39, 40, 42 AND 50).

CLASS 29—MEATS AND PROCESSED FOODS

FOR MEAT, FISH, POULTRY AND GAME; MEAT EXTRACTS; DRIED AND COOKED FRUITS AND VEGETABLES; JELLIES, JAMS; EGGS, MILK; EDIBLE OILS AND FATS; FRUIT FLAVORED YOGHURTS (U.S. CL. 46).

CLASS 30—STAPLE FOODS

FOR COFFEE, TEA, COCOA, SUGAR, RICE, FLOUR, BREAD, PASTRY, ICES; ICE CREAM; HONEY, TREATMENT; SALT, SAUCES; SPICES; ICE (U.S. CL. 46).

CLASS 31—NATURAL AGRICULTURAL PRODUCTS

FOR GRAINS, NAMELY, SEEDS FOR AGRICULTURAL PURPOSES, BULBS FOR AGRICULTURAL PURPOSES; FRESH FRUIT AND VEGETABLES (U.S. CLS. 1 AND 46).

CLASS 32—LIGHT BEVERAGES

FOR MINERAL AND AERATED WATERS; FRUIT DRINKS AND FRUIT JUICES (U.S. CLS. 45, 46 AND 48).

CLASS 41—EDUCATION AND ENTERTAINMENT

FOR EDUCATION SERVICES, NAMELY, CLASSES, SEMINARS, ON LINE CLASSES AND SEMINARS IN THE FIELD OF FOOD AND NUTRITION EDUCATION; PROVIDING TRAINING IN THE FIELD OF FOOD AND NUTRITION EDUCATION (U.S. CLS. 100, 101 AND 107).
LEIGH LOWRY, EXAMINING ATTORNEY

SN 79-061,672. BANGOR UNIVERSITY, UNITED KINGDOM, FILED 10-9-2008.

FOOD DUDES

THE MARK CONSISTS OF STANDARD CHARACTERS WITHOUT CLAIM TO ANY PARTICULAR FONT, STYLE, SIZE, OR COLOR.

PRIORITY DATE OF 4-16-2008 IS CLAIMED.
OWNER OF INTERNATIONAL REGISTRATION 0983949 DATED 10-9-2008, EXPIRES 10-9-2018.

NO CLAIM IS MADE TO THE EXCLUSIVE RIGHT TO USE "FOOD", APART FROM THE MARK AS SHOWN.

CLASS 9—ELECTRICAL AND SCIENTIFIC APPARATUS

FOR APPARATUS FOR RECORDING, TRANSMISSION OR REPRODUCTION OF SOUND OR IMAGES; BLANK MAGNETIC DATA CARRIERS AND BLANK RECORD DISCS; PRE-RECORDED MAGNETIC DATA CARRIERS AND RECORD DISKS FEATURING INFORMATION RELATING TO FOOD AND NUTRITION; AUDIO RECORDINGS, VISUAL RECORDINGS AND AUDIO VISUAL RECORDINGS FEATURING MUSIC, SHORT FILMS, INTERVIEWS, ANIMATED FILMS; COMPUTER GAMES PROGRAMS; EDUCATIONAL COMPUTER SOFTWARE FEATURING INSTRUCTION IN FOOD AND NUTRITION EDUCATION; Pedometers (U.S. CLS. 21, 23, 26, 36 AND 38).

CLASS 16—PAPER GOODS AND PRINTED MATTER

FOR PRINTED MATTER, NAMELY, BOOKS, MAGAZINES, BOOKLETS, LEAFLETS, POSTERS, PRINTED STICKERS IN THE FIELD OF FOOD AND NUTRITION EDUCATION; STATIONERY; PRINTED INSTRUCTIONAL AND TEACHING MATERIALS IN THE FIELD OF FOOD AND NUTRITION EDUCATION; RUBBER ERASERS; POSTERS; STICKERS, IRON-ON PLASTIC TRANSFERS; DECALCOMANIAS, COLORING PENCILS; PAPER; CARDBOARD AND GOODS MADE FROM THESE MATERIALS, NAMELY, CARDBOARD CONTAINERS; PAINT BOXES FOR CHILDREN; PENCIL CASES; DECORATIVE PENCIL-TOP ORNAMENTS (U.S. CLS. 2, 5, 22, 23, 29, 37, 38 AND 50).

CLASS 21—HOUSEWARES AND GLASS

FOR CONTAINERS FOR HOUSEHOLD USE; KITCHEN UTENSILS, NAMELY, SERVING SPOONS; DRINKING VESSELS; MUGS, BOTTLES SOLD EMPTY; LUNCH BOXES AND PLASTIC PLATES (U.S. CLS. 2, 13, 23, 29, 30, 33, 40 AND 50).

CLASS 25—CLOTHING

FOR CLOTHING, NAMELY, UNDERWEAR, SHIRTS, T-SHIRTS, SWEATSHIRTS, HOODED TOPS, TOPS, SHORTS, TROUSERS, SKIRTS, LEGGINGS, JOGGING PANTS, SOCKS, DRESSES; FOOTWEAR; HATS, CAPS, EAR MUFFS; TENNIS SWEAT BANDS (U.S. CLS. 22 AND 39).

SN 79-062,673. NADEO, FRANCE, FILED 11-7-2008.

QUESTMANIA

THE MARK CONSISTS OF STANDARD CHARACTERS WITHOUT CLAIM TO ANY PARTICULAR FONT, STYLE, SIZE, OR COLOR.

PRIORITY DATE OF 5-7-2008 IS CLAIMED.
OWNER OF INTERNATIONAL REGISTRATION 0986373 DATED 11-7-2008, EXPIRES 11-7-2018.

CLASS 9—ELECTRICAL AND SCIENTIFIC APPARATUS

FOR COMPUTER SOFTWARE, NAMELY, VIDEO-GAME SOFTWARE, INTERACTIVE GAME SOFTWARE, VIDEO GAME PROGRAMS; DOWNLOADABLE VIDEO GAME SOFTWARE VIA WIRELESS DEVICES; DOWNLOADABLE COMPUTER GAME SOFTWARE; INTERACTIVE GAME CARTRIDGES; INTERACTIVE VIDEO GAME PROGRAMS; VIDEO GAME CARTRIDGES (U.S. CLS. 21, 23, 26, 36 AND 38).

CLASS 25—CLOTHING

FOR HEADWEAR AND FOOTWEAR, ALL IN RELATION TO VIDEOGAME MERCHANDISING (U.S. CLS. 22 AND 39).

CLASS 28—TOYS AND SPORTING GOODS

FOR GAMES AND PLAYTHINGS, NAMELY, DOLLS, TOY ACTION FIGURES, PLUSH TOYS AND ACCESSORIES THEREFORE, PLAY SETS FOR DOLLS, PLAY SETS FOR TOY ACTION FIGURES, AND TOY VEHICLES; BILLIARD TABLES; BILLIARD CUES; BILLIARD BALLS; BALLS FOR GAMES; PLAY BALLOONS; CARD GAMES; BOARD GAMES; ICE SKATES; ROLLER SKATES; TOY SCOOTERS; SURF BOARDS; WINDSURFING BOARDS; SKIS (U.S. CLS. 22, 23, 38 AND 50).

CLASS 41—EDUCATION AND ENTERTAINMENT

FOR ENTERTAINMENT AND COMPUTER GAMING SERVICES, NAMELY, PROVIDING AN ON-LINE COMPUTER GAME; PROVIDING COMPUTER GAMES THAT MAY BE ACCESSED VIA A GLOBAL COMPUTER NETWORK; PROVIDING ON-LINE INFORMATION IN THE FIELD OF COMPUTER GAMING ENTERTAINMENT; ORGANIZATION OF COMPUTER GAMING COMPETITIONS (U.S. CLS. 100, 101 AND 107).

CLASS 42—SCIENTIFIC AND COMPUTER SERVICES

FOR DEVELOPMENT OF COMPUTER SOFTWARE, NAMELY, VIDEO GAME PROGRAMMING DEVELOPMENT SERVICES (U.S. CLS. 100 AND 101).

JAMES MACFARLANE, EXAMINING ATTORNEY

SN 79-062,801. DURABLE HUNKE & JOCHHEIM GMBH & CO. KG, FED REP GERMANY, FILED 6-18-2008.

DURAFRAME

THE MARK CONSISTS OF STANDARD CHARACTERS WITHOUT CLAIM TO ANY PARTICULAR FONT, STYLE, SIZE, OR COLOR.

PRIORITY DATE OF 1-18-2008 IS CLAIMED.

OWNER OF INTERNATIONAL REGISTRATION 0986776 DATED 6-18-2008, EXPIRES 6-18-2018.

CLASS 6—METAL GOODS

FOR STANDS OF METAL, NAMELY, FREE-STANDING METAL PANEL UNITS FOR EXHIBITIONS, DISPLAYS AND PARTITIONING; SIGN HOLDERS AND POSTER FRAMES OF METAL; METAL HOLDERS FOR SIGNS IN THE NATURE OF FRAMEWORKS OF METAL, FOR AFFIXING TO THE WALL, FOR ATTACHMENT TO A CARRYING FRAME, OR FOR PLACEMENT ON THE GROUND (U.S. CLS. 2, 12, 13, 14, 23, 25 AND 50).

CLASS 16—PAPER GOODS AND PRINTED MATTER

FOR HOLDERS FOR PRINTED INFORMATION CARRIERS, NAMELY, PAPER SIGN HOLDERS, POSTER BOARDS, DOCUMENT HOLDERS, DOCUMENT FILE RACKS, FOR ATTACHING TO DISPLAY FRAMES AND/OR FOR AFFIXING TO THE WALL; SLEEVES FOR HOLDING POSTERS, NAMELY, PLASTIC SLEEVES, PAPER SLEEVES; SLEEVES, NAMELY, PRESENTATION SLEEVES FOR DOCUMENTS, PROTECTIVE COVERS FOR PRINTED SHEETS AND OTHER PAPER DOCUMENTS (U.S. CLS. 2, 5, 22, 23, 29, 37, 38 AND 50).

CLASS 20—FURNITURE AND ARTICLES NOT OTHERWISE CLASSIFIED

FOR DISPLAY STANDS, PHOTO STANDS, AND NON-METAL HOLDERS FOR SIGNS; NON-METAL POSTER FRAMES FOR AFFIXING TO THE WALL AND/OR ATTACHING TO A CARRYING FRAME, NON-METAL POSTER FRAMES FOR PLACEMENT ON THE GROUND, NAMELY, DISPLAY RACKS; DISPLAY BOARDS; ERECTABLE PUBLICATIONS, NAMELY, ERECTABLE DISPLAYS, NAMELY, FREE-STANDING NON-METAL PANEL UNITS FOR EXHIBITIONS, DISPLAYS AND PARTITIONING; POINT OF PURCHASE DISPLAYS (U.S. CLS. 2, 13, 22, 25, 32 AND 50).

STEVEN PEREZ, EXAMINING ATTORNEY

SN 79-063,827. KABUSHIKI KAISHA KOMATSU SEISAKUSHO; (KOMATSU LTD.), JAPAN, FILED 7-1-2008.

Komatsu Utility

THE MARK CONSISTS OF STANDARD CHARACTERS WITHOUT CLAIM TO ANY PARTICULAR FONT, STYLE, SIZE, OR COLOR.

OWNER OF INTERNATIONAL REGISTRATION 0989301 DATED 7-1-2008, EXPIRES 7-1-2018.

OWNER OF U.S. REG. NOS. 1,071,304, 2,041,661 AND OTHERS.

NO CLAIM IS MADE TO THE EXCLUSIVE RIGHT TO USE "UTILITY", APART FROM THE MARK AS SHOWN.

THE ENGLISH TRANSLATION OF "KOMATSU" IN THE MARK IS "SMALL" OR "TINY PINE TREE".

SEC. 2(F).

CLASS 7—MACHINERY

FOR MINING AND CONSTRUCTION MACHINES AND APPARATUS, NAMELY, HYDRAULIC EXCAVATORS; WHEEL LOADERS; SNOW BLOWERS; SNOW PLOWS; SKID STEER LOADERS; COMPACT TRACK LOADERS; BACKHOE LOADERS (U.S. CLS. 13, 19, 21, 23, 31, 34 AND 35).

CLASS 12—VEHICLES

FOR AUTOMOBILES AND THEIR STRUCTURAL PARTS AND FITTINGS, NAMELY, FORK LIFT TRUCKS (U.S. CLS. 19, 21, 23, 31, 35 AND 44).

TINA L. SNAPP, EXAMINING ATTORNEY

SN 79-064,134. PIXVISIO, F-91800 BOUSSY-SAINT-ANTOINE, FRANCE, FILED 4-4-2008.



The logo for Kizola features the word "kizola" in a lowercase, sans-serif font. The letter "i" is black, "z" is black, "o" is a light green color, and "l" is black. The "a" is black. A horizontal line is positioned below the letters "z" and "o".

Partager l'image en toute simplicité

PRIORITY DATE OF 10-4-2007 IS CLAIMED.
OWNER OF INTERNATIONAL REGISTRATION 0990134 DATED 4-4-2008, EXPIRES 4-4-2018.

THE COLOR(S) BLACK (PANTONE 426 C), LIGHT GREEN (PANTONE 382 C), DARK RED (PANTONE 484 C), AND GRAY (PANTONE 447 C) IS/ARE CLAIMED AS A FEATURE OF THE MARK.

THE COLOR BLACK APPEARS ON THE LETTERS "K", "I", "Z", "A" IN THE WORD "KIZOA"; THE COLOR LIGHT GREEN APPEARS ON THE LETTER "O" IN THE WORD "KIZOA" AND ON THE CAMERA DESIGN; THE COLOR DARK RED APPEARS ON THE LINE BENEATH THE WORD "KIZOA"; AND THE COLOR GRAY APPEARS ON THE WORDING "PARTAGER L'IMAGE EN TOUTE SIMPLICITE".

THE ENGLISH TRANSLATION OF "PARTAGER L'IMAGE EN TOUTE SIMPLICITE" IN THE MARK IS "SHARING PICTURES MADE EASY". THE WORDING KIZOA HAS NO MEANING IN A FOREIGN LANGUAGE.

SN 79-064,307. AIR BERLIN PLC & CO.; LUFTVERKEHRS KG, BERLIN, FED REP GERMANY, FILED 8-8-2008.



CLASS 9—ELECTRICAL AND SCIENTIFIC APPARATUS

FOR APPARATUS FOR RECORDING, TRANSMITTING, REPRODUCING OR PROCESSING SOUND OR IMAGES; DATA PROCESSING AND COMPUTER EQUIPMENT; COMPUTER PERIPHERAL DEVICES, TELEPHONE APPARATUS; PERSONAL STEREO; DIGITAL PHOTO FRAMES; PROJECTIONS SCREENS FOR USE IN PHOTOGRAPHY; VIDEO SCREENS; FILTERS FOR PHOTOGRAPHY; PRINTERS FOR USE WITH COMPUTERS; DOWNLOADABLE COMPUTER PROGRAMS FOR EDITING PHOTOS, MAKING SLIDESHOWS AND MAKING DIGITAL SCRAPBOOKS FOR GENERAL USE, RECORDED COMPUTER PROGRAMS FOR EDITING PHOTOS, MAKING SLIDESHOWS AND MAKING DIGITAL SCRAPBOOKS FOR GENERAL USE, DOWNLOADABLE ELECTRONIC PUBLICATIONS, NAMELY, WEBSITES AND EMAILS FEATURING PHOTOGRAPHY, VIDEO TELEPHONES (U.S. CLS. 21, 23, 26, 36 AND 38).

CLASS 20—FURNITURE AND ARTICLES NOT OTHERWISE CLASSIFIED

FOR PICTURE FRAME BRACKETS; PICTURE FRAMES; MOULDINGS FOR PICTURE FRAMES (U.S. CLS. 2, 13, 22, 25, 32 AND 50).

CLASS 38—COMMUNICATION

FOR TELECOMMUNICATIONS SERVICES, NAMELY, PROVIDING ACCESS TO THE INTERNET FOR THE PURPOSES OF EDITING PHOTOS, MAKING SLIDESHOWS AND MAKING DIGITAL SCRAPBOOKS FOR GENERAL USE; COMMUNICATIONS VIA COMPUTER TERMINALS OR VIA FIBRE-OPTIC NETWORKS; PROVISION OF ACCESS TO A GLOBAL COMPUTER NETWORK; PROVIDING TELECOMMUNICATIONS CONNECTIONS TO A GLOBAL COMPUTER NETWORK FOR OTHERS; TELECONFERENCING SERVICES; ELECTRONIC MESSAGING SERVICES; RENTAL OF ACCESS TIME TO GLOBAL COMPUTER NETWORKS; PROVISION OF TELECOMMUNICATION CHANNELS ADAPTED TO HOME-SHOPPING SERVICES; PROVIDING DISCUSSION FORUMS ON THE INTERNET FOR TRANSMISSION OF MESSAGES AMONG COMPUTER USERS CONCERNING PHOTOGRAPHY, PROVIDING ACCESS TO DATABASES; RENTAL OF MESSAGE SENDING APPARATUS; ROUTING AND CONNECTING SERVICES FOR TELECOMMUNICATIONS; SENDING OF TELEGRAMS; MESSAGE SENDING; COMPUTER AIDED TRANSMISSION OF MESSAGES AND IMAGES (U.S. CLS. 100, 101 AND 104).

CLASS 40—MATERIAL TREATMENT

FOR PRINTING; PRINTING OF PHOTOGRAPHS, LITHOGRAPHIC PRINTING (U.S. CLS. 100, 103 AND 106).

DEBRA LEE, EXAMINING ATTORNEY

PRIORITY DATE OF 4-3-2008 IS CLAIMED. OWNER OF INTERNATIONAL REGISTRATION 0990574 DATED 8-8-2008, EXPIRES 8-8-2018.

THE COLOR(S) RED AND WHITE IS/ARE CLAIMED AS A FEATURE OF THE MARK.

THE MARK CONSISTS OF THE COLORS RED AND WHITE, WITH THE COLOR RED APPEARING IN THE RECTANGLE AND THE COLOR WHITE APPEARING IN THE BLOCK LETTERS "LTU" CENTRALLY LOCATED INSIDE THE RECTANGLE.

CLASS 12—VEHICLES

FOR APPARATUS FOR TRANSPORT BY LAND, AIR OR WATER, NAMELY, AIRCRAFT, BICYCLES, MOTORCYCLES, AUTOMOBILES, TRUCKS AND TRAILERS FOR HEAVY GOODS, BUSES, REFRIGERATED VEHICLES AND BOATS, VEHICULAR BALLOONS, AIRSHIPS, VEHICLE AND AIRCRAFT ACCESSORIES, NAMELY, SUN VISORS AND VEHICLE SEAT COVERS; PERAMBULATORS; CHILDREN'S BUGGIES IN THE NATURE OF BABY CARRIAGES; LAND VEHICLE ENGINES AND COMPONENTS, SOLD AS A UNIT (U.S. CLS. 19, 21, 23, 31, 35 AND 44).

CLASS 16—PAPER GOODS AND PRINTED MATTER

FOR OFFICE SUPPLIES, NAMELY, PAPER AND STATIONERY, PACKAGING PAPER, POSTCARDS AND GREETING CARDS, ADDRESS BOOKS AND PERSONAL DIARIES, NAMELY, APPOINTMENT CALENDARS, MEMO BOARDS AND MEMO PADS, ERASERS, BLOT- TING PADS, DESK TIDIES, NAMELY, DESKTOP ORGANIZERS AND PENCIL CUPS; DESK SETS MADE OF CARDBOARD OR PAPER, PLACARDS OF PAPER OR CARDBOARD; PAPER, CARDBOARD AND GOODS MADE FROM THESE MATERIALS, NAMELY, POSTERS, MAPS OF THE WORLD, AND BOOKBINDING MATERIALS, DESK BASKETS FOR DESK ACCESSORIES, DESK TRAYS, CORRECTING FLUIDS FOR TYPE; PHOTOGRAPHS; STATIONERY; ADHESIVES FOR STATIONERY OR HOUSEHOLD PURPOSES; TYPEWRITERS; PRINTED TEACHING MATERIALS IN THE FIELD OF TRAVEL AND TRAVEL ACCOMMODATIONS AND PRINTED TRAINING MANUALS IN THE FIELD OF TRAVEL AND TRAVEL ACCOMMODATIONS; PRINT LETTERS; PRINTED PRODUCTS, NAMELY, PRINTED AND EMBOSSED GREETING CARDS AND GIFT CARDS MADE OF CARDBOARD OR PLASTICS AND NOT MAGNETICALLY CODED; PRINTED PUBLICATIONS, NAMELY, MAGAZINES IN THE FIELD OF TRAVEL AND TRAVEL ACCOMMODATIONS; BOOKS AND MAGAZINES IN THE FIELD OF TRAVEL AND TRAVEL ACCOMMODATIONS; CAR STICKERS, CALENDARS AND DECORATIVE STICKERS AND TRANSFERS; PAPER TABLECLOTHS; SERVIETTES MADE OF PAPER; PAPER BAGS; INVITATION CARDS; GIFT WRAPPING PAPER; TABLE MATS MADE OF PAPER; PAPER AND PLASTIC TRASH CAN LINERS; PLASTIC FOOD STORAGE BAGS FOR HOUSEHOLD USE; COFFEE FILTERS MADE OF PAPER; PAPER LABELS; PAPER TOWELS; MOIST PAPER TOWELS; TOILET PAPER; PAPER FACE TOWELS; TISSUES, NAMELY, PAPER HANDKERCHIEFS; DISPOSABLE NAPPIES MADE OF PAPER; TYPEWRITER PAPER; COPY PAPER; ENVELOPES; THEMED NOTEPADS; NOTEPADS; NOTE PAPER; WRITING PAPER; SCRIBBLING PAPER; BINDING PAPER, NAMELY, BOND PAPER; FOLDERS AND RING BINDERS; BINDER COVERS; BOOK SLEEVES, NAMELY, BOOK COVERS; PADS OF PAINTING PAPER; PADS OF DRAWING PAPER; BOOKS OF PUZZLES AND

ROLE PLAYING GAME EQUIPMENT IN THE NATURE OF GAME BOOK MANUALS; PAPER, NAMELY, LUMINESCENT PAPER, ADHESIVE NOTELETS, CREPE PAPER AND SILK PAPER; PAPER CLIPS AND STAPLES; PAPER FLAGS; PAINT BOXES; CRAYONS AND PENCILS FOR DRAWING; CHALK; DECORATION FOR PENCILS AND CRAYONS, NAMELY, STICKERS; NEWSPAPERS; PRINTED TIMETABLES; PRINTED MATERIAL, NAMELY, PROGRAMMES FOR EVENTS; EVENT ALBUMS; PHOTO ALBUMS; AUTOGRAPH BOOKS; ADDRESS BOOKS; JOURNALS, NAMELY, DIARIES; TIME PLANNERS; ROAD MAPS; ENTRY TICKETS; SCRATCH CARDS; BANK CHECKS; INFORMATIONAL FLYERS FEATURING TRAVEL AND TRAVEL ACCOMMODATIONS; BROCHURES ABOUT TRAVEL AND TRAVEL ACCOMMODATIONS; COMIC STRIPS; STATIONERY ITEMS, NAMELY, STICKERS AND STICKER ALBUMS; ADVERTISING SIGNS OF PAPER, PAPER TRANSPARENCIES AND MATERIALS MADE OF PAPER; DECALS; STAPLERS; DRAWING TEMPLATES FOR PAPER GOODS AND STATIONERY; DOCUMENT HOLDERS; CLIPBOARDS; NOTEPAD HOLDERS; RUBBER STAMPS (U.S. CLS. 2, 5, 22, 23, 29, 37, 38 AND 50).

CLASS 28—TOYS AND SPORTING GOODS

FOR GAMES, NAMELY, BOARD GAMES AND PUZZLES; TOYS, NAMELY, SPORTS BALLS, RAG DOLLS AND SOFT SCULPTURE TOYS, TOY CARS, TOY BALLOONS, INFLATABLE TOYS, TOY PAPER AND PLASTIC PARTY HATS, TOY FOAM AND RUBBER HANDS; TABLES FOR TABLE FOOTBALL; EXERCISE AND SPORTS ARTICLES, NAMELY, FOOTBALLS; SPORTS GLOVES, NAMELY, BOXING GLOVES AND BASEBALL GLOVES, KNEE PADS FOR ATHLETIC USE, ELBOW PADS FOR ATHLETIC USE, SHOULDER PADS FOR ATHLETIC USE, SHIN PADS FOR ATHLETIC USE, APPROPRIATE SPORTS BAGS SPECIALLY ADAPTED FOR SPORTS EQUIPMENT AND CONTAINERS TO CARRY SPECIFIC SPORTS ARTICLES, NAMELY, FISHING TACKLE CONTAINERS; CHRISTMAS TREE DECORATIONS; HANDHELD CONSOLES, NAMELY, MANUALLY OPERATED ELECTRONIC GAMES OTHER THAN THOSE ADAPTED FOR USE WITH TELEVISION RECEIVERS ONLY; VIDEO GAME CONSOLES, NAMELY, STAND ALONE VIDEO GAME MACHINES; PLAYING CARDS (U.S. CLS. 22, 23, 38 AND 50).

CLASS 39—TRANSPORTATION AND STORAGE

FOR TRANSPORTATION, NAMELY, PACKAGING ARTICLES FOR TRANSPORTATION AND STORAGE OF GOODS; TRAVEL AGENCY SERVICES FOR THE ORGANIZATION OF TRAVEL, NAMELY, TOUR GUIDES, TRAVEL BOOKING AGENCIES, ORGANIZATION OF TOURS AND EXCURSIONS, RESERVATION AND BOOKING OF SEATS FOR TRAVEL; TRANSPORTATION OF PASSENGERS AND/OR GOODS BY AIRLINE, BUS, RAIL AND MOBILE HOMES; BOAT TRANSPORTATION; VEHICLE HIRE SERVICES, NAMELY, HIRED CAR TRANSPORT; CAR PARKING; TAXI SERVICES; FREIGHT FORWARDING SERVICES; CORRESPONDENCE DELIVERY BY POST, COURIER SERVICES FOR DELIVERY OF MESSAGES OR GOODS AND DELIVERY OF GOODS (U.S. CLS. 100 AND 105).

CLASS 43—HOTEL AND RESTAURANT SERVICES

FOR SERVICES ASSOCIATED WITH BOARD AND LODGING OF CUSTOMERS, NAMELY, THE PROVISION OF FOOD AND DRINK IN AIRCRAFT, CAFETERIAS AND RESTAURANTS; WAITING SERVICES, NAMELY, CATERING OF FOOD AND DRINKS TO CUSTOMERS; CATERING SERVICES; HOTEL SERVICES; PROVIDING HOTEL ACCOMMODATION AND CATERING SERVICES; RESERVATION OF HOTEL ROOMS AND TEMPORARY HOUSING ACCOMMODATIONS FOR OTHERS (U.S. CLS. 100 AND 101).
LEIGH LOWRY, EXAMINING ATTORNEY

SN 79-064,497. IXMATION AG, SWITZERLAND, FILED 1-5-2009.

TESTERO

THE MARK CONSISTS OF STANDARD CHARACTERS WITHOUT CLAIM TO ANY PARTICULAR FONT, STYLE, SIZE, OR COLOR.

PRIORITY DATE OF 7-25-2008 IS CLAIMED.
OWNER OF INTERNATIONAL REGISTRATION 0991045 DATED 1-5-2009, EXPIRES 1-5-2019.

CLASS 7—MACHINERY

FOR CUSTOM, MADE TO ORDER MACHINES AND MACHINE TOOLS FOR THE INSPECTION OF PRECISION PARTS SOLD AS AN INTEGRAL COMPONENT OF AUTOMATIC AND SEMI-AUTOMATIC ASSEMBLY AND MANUFACTURING MACHINES AND MACHINE TOOLS, AND REPLACEMENT PARTS THEREFOR, FOR USE IN INDUSTRIAL AND COMMERCIAL PRECISION PARTS QUALITY CONTROL APPLICATIONS IN A WIDE VARIETY OF SECTORS INCLUDING THE AUTOMOBILE, RENEWABLE ENERGIES, MEDICAL, HYDRAULICS, CONSUMER GOODS, HOUSEHOLD, JEWELRY AND WATCH INDUSTRIES (U.S. CLS. 13, 19, 21, 23, 31, 34 AND 35).

CLASS 42—SCIENTIFIC AND COMPUTER SERVICES

FOR QUALITY CONTROL FOR OTHERS; VISUAL INSPECTION OF PRECISION PARTS MECHANICALLY SHAPED OR FABRICATED; QUALITY CONTROL FOR OTHERS, NAMELY, CUSTOM QUALITY CONTROL OF PRECISION PARTS TO THE ORDER AND SPECIFICATION OF OTHERS IN THE MANUFACTURE OF A WIDE VARIETY OF GOODS NOT LIMITED BY TYPE AND WHICH USE AUTOMATED HANDLING AND INSPECTION TECHNOLOGY IN AN UNLIMITED NUMBER OF INDUSTRIES SUCH AS THE AUTOMOBILE, RENEWABLE ENERGIES, MEDICAL, HYDRAULICS, CONSUMER GOODS, HOUSEHOLD, JEWELRY AND WATCH INDUSTRIES (U.S. CLS. 100 AND 101).

LEIGH LOWRY, EXAMINING ATTORNEY

SN 79-064,972. VELLUTINI FRÉDÉRIC, FRANCE, FILED 7-24-2008.

INOVELI

THE MARK CONSISTS OF STANDARD CHARACTERS WITHOUT CLAIM TO ANY PARTICULAR FONT, STYLE, SIZE, OR COLOR.

PRIORITY DATE OF 2-4-2008 IS CLAIMED.
OWNER OF INTERNATIONAL REGISTRATION 0992326 DATED 7-24-2008, EXPIRES 7-24-2018.

THE WORDING "INOVELI" HAS NO MEANING IN A FOREIGN LANGUAGE.

CLASS 7—MACHINERY

FOR POWER TOOLS, NAMELY, ELECTRIC SCISSORS, LAWNMOWERS, ELECTRICAL WAX POLISHER MACHINES, MILLING MACHINES, ELECTRICAL SAWS, ELECTRICAL HAND-DRILLS, ELECTRICAL SCREW GUNS; TRANSMISSIONS FOR MACHINES; SPEED GOVERNORS FOR MACHINES, NAMELY, SPEED GOVERNORS FOR MOTORBIKES, MOTOR SCOOTERS, SNOW MOBILES, GO-KARTS, RECREATIONAL WATERCRAFT, CARS, AIRCRAFT, BOATS, HELICOPTERS, DRILLS, JACK HAMMERS, CROSSCUT SAWS, STRIMMERS, CRANES, TRACTORS, SAWS, LAWNMOWERS, GRINDERS, PLANES, HEDGE TRIMMERS, PRUNING SHEARS; HYDRAULIC AND PNEUMATIC CONTROLS FOR MACHINES; MACHINE PARTS, NAMELY, HANDLES FOR POWER TOOLS; BRAKES FOR MACHINES (U.S. CLS. 13, 19, 21, 23, 31, 34 AND 35).

CLASS 12—VEHICLES

FOR LAND VEHICLES; APPARATUS FOR LOCOMOTION BY LAND, AIR OR WATER, NAMELY, MOTOR SCOOTERS, SNOW MOBILES, GO-KARTS, BIKES, RECREATIONAL WATERCRAFT, CARS, AIRCRAFT, BOATS, HELICOPTERS, MOTORBIKES; ENGINES FOR LAND VEHICLES; GOODS HANDLING CARTS; ACCELERATING SYSTEMS FOR VEHICLES, NAMELY, ACCELERATORS; HANDLEBARS, STEERING WHEELS, GEAR SHIFTS, GEAR LEVEL KNOBS FOR LAND AND WATER VEHICLES; BRAKES FOR VEHICLES; CONTROLS FOR VEHICLES, NAMELY, STEERING WHEELS, HANDLES, HANDLEBARS, PEDALS (U.S. CLS. 19, 21, 23, 31, 35 AND 44).

TIMOTHY FINNEGAN, EXAMINING ATTORNEY

SN 79-065,060. TEN CATE THOLON B.V., NL-7443 RE NIJVERDAL, NETHERLANDS, FILED 9-1-2008.

Oasis

THE MARK CONSISTS OF STANDARD CHARACTERS WITHOUT CLAIM TO ANY PARTICULAR FONT, STYLE, SIZE, OR COLOR.

PRIORITY DATE OF 7-3-2008 IS CLAIMED.

OWNER OF INTERNATIONAL REGISTRATION 0992517 DATED 9-1-2008, EXPIRES 9-1-2018.

CLASS 17—RUBBER GOODS

FOR PLASTIC FIBERS, NOT FOR TEXTILE USE, FOR USE IN THE MANUFACTURE OF ARTIFICIAL TURF; SYNTHETIC YARNS FOR MAKING ARTIFICIAL TURF (U.S. CLS. 1, 5, 12, 13, 35 AND 50).

CLASS 23—YARNS AND THREADS

FOR YARNS; SPUN THREAD; ARTIFICIAL GRASS YARNS (U.S. CL. 43).

CLASS 27—FLOOR COVERINGS

FOR ARTIFICIAL TURF; BACKINGS FOR ARTIFICIAL TURF FLOOR MATS; ARTIFICIAL TURF FLOOR MATS (U.S. CLS. 19, 20, 37, 42 AND 50).

MARY CRAWFORD, EXAMINING ATTORNEY

SN 79-065,815. COMPAGNIE PLASTIC OMNIUM, FRANCE, FILED 11-27-2008.

INOPLAST

THE MARK CONSISTS OF STANDARD CHARACTERS WITHOUT CLAIM TO ANY PARTICULAR FONT, STYLE, SIZE, OR COLOR.

PRIORITY DATE OF 5-28-2008 IS CLAIMED.

OWNER OF INTERNATIONAL REGISTRATION 0994731 DATED 11-27-2008, EXPIRES 11-27-2018.

CLASS 1—CHEMICALS

FOR CHEMICAL PRODUCTS FOR USE IN INDUSTRY, NAMELY, THE CAR, TRUCKS AND CONSTRUCTION MACHINES INDUSTRIES; UNPROCESSED PLASTICS (U.S. CLS. 1, 5, 6, 10, 26 AND 46).

CLASS 2—PAINTS

FOR PAINTS, VARNISHES, LACQUERS, COLORANTS, PAINTS, MORDANTS FOR THE RETENTION OF COLORING SUBSTANCES, NAMELY, FOR USE IN THE CAR, TRUCKS AND CONSTRUCTION MACHINES INDUSTRIES (U.S. CLS. 6, 11 AND 16).

CLASS 7—MACHINERY

FOR MACHINERY AND MACHINE TOOLS FOR INDUSTRY, NAMELY, FOR THE CAR, TRUCKS AND CONSTRUCTION MACHINES INDUSTRIES AND FOR THE PRODUCTION OF PARTS FOR CARS, TRUCKS AND CONSTRUCTION MACHINES, NAMELY, CUTTING MACHINES, SANDING MACHINES AND ROBOT CELLS IN THE NATURE OF A SYSTEM CONSISTING PRIMARILY OF A ROBOT, CONTROLLERS, AND ROBOTIC ARMS FOR INDUSTRIAL PURPOSES FOR MACHINERY AND MACHINE TOOLS; PAINTING MACHINES; INDUSTRIAL PRESSES MACHINES, NAMELY, FOR THE PRODUCTION OF PARTS FOR CARS, TRUCKS AND CONSTRUCTION MACHINES; STAMPING MOLDS AS PARTS OF MACHINES FOR INDUSTRY, NAMELY, FOR THE CAR, TRUCKS AND CONSTRUCTION MACHINES INDUSTRIES AND THE PRODUCTION OF PARTS FOR CARS, TRUCKS AND CONSTRUCTION MACHINES (U.S. CLS. 13, 19, 21, 23, 31, 34 AND 35).

CLASS 9—ELECTRICAL AND SCIENTIFIC APPARATUS

FOR SCIENTIFIC, WEIGHING, MEASURING, MONITORING, INSPECTION AND TESTING APPARATUS AND INSTRUMENTS, NAMELY, CMM MACHINES, NAMELY, COORDINATE MEASURING MACHINES, GAUGES, NAMELY, AUTOMOTIVE MEASURING INSTRUMENTS, NAMELY, WATER TEMPERATURE GAUGES, AIR-FUEL/RATIO GAUGES, BOOST GAUGES, VACUUM GAUGES AND EXHAUST TEMPERATURE GAUGES, FORCE MEASUREMENT PRODUCTS, NAMELY, DIGITAL FORCE GAUGES, DIGITAL TORQUE GAUGES AND PHYSICAL MECHANICAL TESTING SUPPORTS USED THEREWITH SOLD AS A UNIT WITH THE GAUGES, LENGTH MEASURING GAUGES AND MICROMETER GAUGES; AND LABORATORY EQUIPMENT FOR TESTING PARTS AND MATERIALS, NAMELY, FOR TESTING PERFORMANCE, EFFICIENCY, QUALITY AND GAUGING OF PLANT EQUIPMENT FOR MANUFACTURING CARS, TRUCKS AND CONSTRUCTION MACHINES AND PARTS FOR CARS, TRUCKS AND CONSTRUCTION MACHINES; COMPUTER SOFTWARE FOR USE IN PRODUCING CARS, TRUCKS AND CONSTRUCTION MACHINES AND PARTS FOR CARS, TRUCKS AND CONSTRUCTION MACHINES (U.S. CLS. 21, 23, 26, 36 AND 38).

CLASS 37—CONSTRUCTION AND REPAIR

FOR SERVICING VEHICLES AND APPARATUS FOR LOCOMOTION BY LAND AND THEIR COMPONENTS; SERVICING VEHICLES AND APPARATUS FOR LOCOMOTION BY LAND AND THEIR COMPONENTS, NAMELY, DEGREASING AND CLEANING OF PLASTIC COMPONENTS OF VEHICLES AND APPARATUS FOR LOCOMOTION BY LAND (U.S. CLS. 100, 103 AND 106).

CLASS 40—MATERIAL TREATMENT

FOR TREATMENT OF MATERIALS, NAMELY, OF PLASTIC MATERIALS, NAMELY, COLORING, IONIZATION, MOLDING, ACTIVATION, NAMELY, PAINTING LAYERS AND PRIMARY COATINGS, DEOXIDATION, APPLICATION OF COATINGS IN THIN LAYERS, ABRASION BY MECHANICAL MEANS OR BY PLASMA OR BY CHEMICAL REACTION; SORTING AND RECYCLING OF WASTE, NAMELY, PLASTIC MATERIALS (U.S. CLS. 100, 103 AND 106).

CLASS 42—SCIENTIFIC AND COMPUTER SERVICES

FOR SCIENTIFIC, TECHNOLOGICAL AND INDUSTRIAL ANALYSIS AND RESEARCH SERVICES IN THE FIELD OF VEHICLES, NAMELY, OF CARS, TRUCKS AND CONSTRUCTION MACHINES; TECHNICAL PROJECT STUDIES IN THE NATURE OF FEA ANALYSIS, NAMELY, FINITE ELEMENT ANALYSIS, CAD MANUFACTURING STUDIES AND TECHNICAL PROJECT STUDIES IN THE NATURE OF PRODUCT RESEARCH AND DEVELOPMENT SERVICES; DRAWING UP EXPERT REPORTS BY ENGINEERS; MECHANICAL AND CHEMICAL RESEARCH; TECHNICAL RESEARCH INTO REPROCESSING AND RECYCLING MATERIALS; COMPUTER SOFTWARE DESIGN SERVICES, NAMELY, IN THE FIELDS OF DESIGN, TESTING AND PRODUCTION OF CARS, TRUCKS AND CONSTRUCTION MACHINES AND PARTS FOR CARS, TRUCKS AND CONSTRUCTION MACHINES, PROCESSING MATERIALS TO RECYCLE THEM, RECYCLING MATERIALS USED IN THE CAR, TRUCKS AND CONSTRUCTION MACHINES INDUSTRIES (U.S. CLS. 100 AND 101).
BERNICE MIDDLETON, EXAMINING ATTORNEY

SN 79-065,817. COMPAGNIE PLASTIC OMNIUM, FRANCE,
FILED 11-27-2008.



PRIORITY DATE OF 5-28-2008 IS CLAIMED.
OWNER OF INTERNATIONAL REGISTRATION 0994733
DATED 11-27-2008, EXPIRES 11-27-2018.
THE MARK CONSISTS OF AN OUTER CIRCLE CONTAINING A STYLIZED LETTER "N" NEAR A SMALL CIRCLE AND THE WORD "INOPLAST" BELOW THE OUTER CIRCLE.

CLASS 1—CHEMICALS

FOR CHEMICAL PRODUCTS FOR USE IN INDUSTRY, NAMELY, THE CAR, TRUCKS AND CONSTRUCTION MACHINES INDUSTRIES; UNPROCESSED PLASTICS (U.S. CLS. 1, 5, 6, 10, 26 AND 46).

CLASS 2—PAINTS

FOR PAINTS, VARNISHES, LACQUERS, COLORANTS, PAINTS, MORDANTS FOR THE RETENTION OF COLORING SUBSTANCES, NAMELY, FOR USE IN THE CAR, TRUCKS AND CONSTRUCTION MACHINES INDUSTRIES (U.S. CLS. 6, 11 AND 16).

CLASS 7—MACHINERY

FOR MACHINERY AND MACHINE TOOLS FOR INDUSTRY, NAMELY, FOR THE CAR, TRUCKS AND CONSTRUCTION MACHINES INDUSTRIES AND FOR THE PRODUCTION OF PARTS FOR CARS, TRUCKS AND CONSTRUCTION MACHINES, NAMELY, CUTTING MACHINES, SANDING MACHINES AND ROBOT CELLS IN THE NATURE OF A SYSTEM CONSISTING PRIMARILY OF A ROBOT, CONTROLLERS, AND ROBOTIC ARMS FOR INDUSTRIAL PURPOSES FOR MACHINERY AND MACHINE TOOLS; PAINTING MACHINES; INDUSTRIAL PRESSES MACHINES, NAMELY, FOR THE PRODUCTION OF PARTS FOR CARS, TRUCKS AND CONSTRUCTION MACHINES; STAMPING MOLDS AS PARTS OF MACHINES FOR INDUSTRY, NAMELY, FOR THE CAR, TRUCKS AND CONSTRUCTION MACHINES INDUSTRIES AND THE PRODUCTION OF PARTS FOR CARS, TRUCKS AND CONSTRUCTION MACHINES (U.S. CLS. 13, 19, 21, 23, 31, 34 AND 35).

CLASS 9—ELECTRICAL AND SCIENTIFIC APPARATUS

FOR SCIENTIFIC, WEIGHING, MEASURING, MONITORING, INSPECTION AND TESTING APPARATUS AND INSTRUMENTS, NAMELY, CMM MACHINES, NAMELY, COORDINATE MEASURING MACHINES, GAUGES, NAMELY, AUTOMOTIVE MEASURING INSTRUMENTS, NAMELY, WATER TEMPERATURE GAUGES, AIR-FUEL/RATIO GAUGES, BOOST GAUGES, VACUUM GAUGES AND EXHAUST TEMPERATURE GAUGES, FORCE MEASUREMENT PRODUCTS, NAMELY, DIGITAL FORCE GAUGES, DIGITAL TORQUE GAUGES AND PHYSICAL MECHANICAL TESTING SUPPORTS USED THEREWITH SOLD AS A UNIT WITH THE GAUGES, LENGTH MEASURING GAUGES AND MICROMETER GAUGES; AND LABORATORY EQUIPMENT FOR TESTING PARTS AND MATERIALS, NAMELY, FOR TESTING PERFORMANCE, EFFICIENCY, QUALITY AND GAUGING OF PLANT EQUIPMENT FOR MANUFACTURING CARS, TRUCKS AND CONSTRUCTION MACHINES AND PARTS FOR CARS, TRUCKS AND CONSTRUCTION MACHINES; COMPUTER SOFTWARE FOR USE IN PRODUCING CARS, TRUCKS AND CONSTRUCTION MACHINES AND PARTS FOR CARS, TRUCKS AND CONSTRUCTION MACHINES (U.S. CLS. 21, 23, 26, 36 AND 38).

CLASS 37—CONSTRUCTION AND REPAIR

FOR SERVICING VEHICLES AND APPARATUS FOR LOCOMOTION BY LAND AND THEIR COMPONENTS; SERVICING VEHICLES AND APPARATUS FOR LOCOMOTION BY LAND AND THEIR COMPONENTS, NAMELY, DEGREASING AND CLEANING OF PLASTIC COMPONENTS OF VEHICLES AND APPARATUS FOR LOCOMOTION BY LAND (U.S. CLS. 100, 103 AND 106).

CLASS 40—MATERIAL TREATMENT

FOR TREATMENT OF MATERIALS, NAMELY, OF PLASTIC MATERIALS, NAMELY, COLORING, IONIZATION, MOLDING, ACTIVATION, NAMELY, PAINTING LAYERS AND PRIMARY COATINGS, DEOXIDATION, APPLICATION OF COATINGS IN THIN LAYERS, ABRASION BY MECHANICAL MEANS OR BY PLASMA OR BY CHEMICAL REACTION; SORTING AND RECYCLING OF WASTE, NAMELY, PLASTIC MATERIALS (U.S. CLS. 100, 103 AND 106).

CLASS 42—SCIENTIFIC AND COMPUTER SERVICES

FOR SCIENTIFIC, TECHNOLOGICAL AND INDUSTRIAL ANALYSIS AND RESEARCH SERVICES IN THE FIELD OF VEHICLES, NAMELY, OF CARS, TRUCKS AND CONSTRUCTION MACHINES; TECHNICAL PROJECT STUDIES IN THE NATURE OF FEA ANALYSIS, NAMELY, FINITE ELEMENT ANALYSIS, CAD MANUFACTURING STUDIES AND TECHNICAL PROJECT STUDIES IN THE NATURE OF PRODUCT RESEARCH AND DEVELOPMENT SERVICES; DRAWING UP EXPERT REPORTS BY ENGINEERS; MECHANICAL AND CHEMICAL RESEARCH; TECHNICAL RESEARCH INTO REPROCESSING AND RECYCLING MATERIALS; COMPUTER SOFTWARE DESIGN SERVICES, NAMELY, IN THE FIELDS OF DESIGN, TESTING AND PRODUCTION OF CARS, TRUCKS AND CONSTRUCTION MACHINES AND PARTS FOR CARS, TRUCKS AND CONSTRUCTION MACHINES, PROCESSING MATERIALS TO RECYCLE THEM, RECYCLING MATERIALS USED IN THE CAR, TRUCKS AND CONSTRUCTION MACHINES INDUSTRIES (U.S. CLS. 100 AND 101).
BERNICE MIDDLETON, EXAMINING ATTORNEY

SN 79-065,963. WILD HIBISCUS FLOWER COMPANY PTY LTD, AUSTRALIA, FILED 12-10-2008.



PRIORITY DATE OF 6-17-2008 IS CLAIMED.
OWNER OF INTERNATIONAL REGISTRATION 0995110 DATED 12-10-2008, EXPIRES 12-10-2018.

NO CLAIM IS MADE TO THE EXCLUSIVE RIGHT TO USE "WILD HIBISCUS", APART FROM THE MARK AS SHOWN.

THE MARK CONSISTS OF A RECTANGLE CONTAINING THE WORDING "ANY EXCUSE! WILD HIBISCUS" AND A DESIGN WHICH CONSISTS OF A FLOWER ABOVE THE TERM "ANY EXCUSE!", WITH BUBBLES COMING OUT OF THE TOP OF THE FLOWER.

CLASS 29—MEATS AND PROCESSED FOODS

FOR PRESERVED FRUITS; DRIED FRUIT; COOKED FRUITS; JELLIES; JAMS; COMPOTES (U.S. CL. 46).

CLASS 32—LIGHT BEVERAGES

FOR FRUIT DRINKS; FRUIT JUICE CONCENTRATES; SYRUPS FOR BEVERAGES; PREPARATIONS, NAMELY, FRUIT JUICE NECTAR, FOR MAKING BEVERAGES, NAMELY, NON-ALCOHOLIC COCKTAILS; NON-ALCOHOLIC COCKTAILS; NON-ALCOHOLIC COCKTAIL BASES (U.S. CLS. 45, 46 AND 48).

CLASS 33—WINES AND SPIRITS

FOR ALCOHOLIC BEVERAGES EXCEPT BEER; ALCOHOLIC FRUIT EXTRACTS; PREPARED ALCOHOLIC COCKTAILS (U.S. CLS. 47 AND 49).
BILL DAWE, EXAMINING ATTORNEY

SN 79-066,439. CARBONE LORRAINE; APPLICATIONS ELECTRIQUES, FRANCE, FILED 12-12-2008.

WINDTRACKER

THE MARK CONSISTS OF STANDARD CHARACTERS WITHOUT CLAIM TO ANY PARTICULAR FONT, STYLE, SIZE, OR COLOR.
OWNER OF INTERNATIONAL REGISTRATION 0996526 DATED 12-12-2008, EXPIRES 12-12-2018.

CLASS 7—MACHINERY

FOR CARBON BRUSHES AND METAL BRUSHES BEING PARTS OF ROTATING ELECTRICAL MACHINES; BRUSH HOLDERS BEING ELECTRICAL MACHINE PARTS FOR USE IN ROTATING ELECTRICAL MACHINERY; RINGS, NAMELY, SYSTEMS COMPOSED OF METAL RINGS BEING PARTS OF MACHINES IN THE NATURE OF ELECTRIC GENERATORS THAT TRANSFER LIVE AND EARTH ELECTRIC CURRENT OF POWER IN ELECTRICAL EQUIPMENT BETWEEN A STATIONARY PART AND A ROTATING PART; SLIP RINGS, NAMELY, SYSTEMS OF METAL RINGS BEING MACHINE PARTS THAT TRANSFER LIVE AND EARTH CURRENT BETWEEN A FIXED COMPONENT AND A ROTATING COMPONENT; ELECTRICAL SLIP RINGS BEING PARTS OF ROTATING ELECTRICAL MACHINES; ELECTRICAL SLIP RINGS BEING PARTS OF ELECTRIC MOTORS FOR MACHINES; CARBON BRUSHES BEING PARTS OF MACHINERY IN THE NATURE OF ELECTRICAL GENERATORS FOR ELECTRICAL, TECHNICAL, ELECTROTECHNICAL AND MECHANICAL USE; GENERATORS OF ELECTRICITY AND OF ELECTRICITY DERIVED FROM WIND POWER (U.S. CLS. 13, 19, 21, 23, 31, 34 AND 35).

CLASS 9—ELECTRICAL AND SCIENTIFIC APPARATUS

FOR APPARATUS AND INSTRUMENTS FOR CONDUCTING, SWITCHING, TRANSFERRING, ACCUMULATING, REGULATING AND CONTROLLING ELECTRICITY, NAMELY, ELECTRIC SWITCHES, ELECTRICAL CONDUCTORS, WIND TURBINE CONTROLLERS, ELECTRIC ACCUMULATORS, VOLTMETERS, SIGNAL TRANSMISSION SYSTEMS COMPRISED OF ELECTRONIC SIGNAL RECEIVERS, SIGNAL TRANSMISSION SYSTEMS COMPRISING RADIO TRANSMITTERS, PROFILE METERS THAT MEASURE ROTARY SPEED, ENERGY, ELECTRICAL SIGNALS; VOLTAGE LIMITERS IN THE NATURE OF VOLTAGE REGULATORS AND LIGHTNING CONDUCTORS; LIGHTING ARRESTERS; CHECKING, SUPERVISION, MEASURING AND SIGNALLING APPARATUS, NAMELY, SIGNAL PROCESSORS, VOLTMETERS, ELECTRICAL DYNAMOMETERS, RING PROFILE METERS THAT MEASURE ENERGY AND ELECTRICAL CURRENT (U.S. CLS. 21, 23, 26, 36 AND 38).

CLASS 37—CONSTRUCTION AND REPAIR

FOR INSTALLATION, MAINTENANCE AND REPAIR OF WIND TURBINE CLUSTERS (U.S. CLS. 100, 103 AND 106).

SN 79-067,227. SPARKLING SPRING OY, FINLAND, FILED 10-7-2008.

CLASS 42—SCIENTIFIC AND COMPUTER SERVICES

FOR SCIENTIFIC RESEARCH STUDIES CONDUCTED BY ENGINEERS RELATING TO TECHNICAL PROJECTS TO GENERATE WIND POWER; DESIGN AND UPDATING OF SOFTWARE, CONVERSION OF DATA FROM A PHYSICAL MEDIUM TO AN ELECTRONIC MEDIUM, SCIENTIFIC AND TECHNOLOGICAL CONSULTANCY FOR ENERGY SAVING, RESEARCH ON ENERGY GENERATION (U.S. CLS. 100 AND 101).

MELISSA VALLILLO, EXAMINING ATTORNEY



SN 79-066,748. COTTON S.R.L., I-20022 CASTANO PRIMO (MI), ITALY, FILED 2-13-2009.



PRIORITY DATE OF 12-30-2008 IS CLAIMED. OWNER OF INTERNATIONAL REGISTRATION 0997335 DATED 2-13-2009, EXPIRES 2-13-2019.

THE NAME SHOWN IN THE MARK DOES NOT IDENTIFY A PARTICULAR LIVING INDIVIDUAL.

THE MARK CONSISTS OF THE WORDING "BB NENETTE" WITH "BB" IN A HIGHLY STYLIZED FORM AND "NENETTE" OVERLAID IN CURSIVE ON THE "BB".

OWNER OF INTERNATIONAL REGISTRATION 0998645 DATED 10-7-2008, EXPIRES 10-7-2018.

NO CLAIM IS MADE TO THE EXCLUSIVE RIGHT TO USE "SPARKLING SPRING", APART FROM THE MARK AS SHOWN.

THE MARK CONSISTS OF EIGHT DROPS IN AN OVERALL SEMI CIRCLE DESIGN PARTIALLY ENCOMPASSING THE STYLIZED WORDING "SPARKLING SPRING".

CLASS 11—ENVIRONMENTAL CONTROL APPARATUS

FOR BOTTLED WATER AND TAP WATER COOLERS AND WATER FILTERING APPARATUS (U.S. CLS. 13, 21, 23, 31 AND 34).

CLASS 32—LIGHT BEVERAGES

FOR BOTTLED WATER (U.S. CLS. 45, 46 AND 48).

CLASS 43—HOTEL AND RESTAURANT SERVICES

FOR RENTAL OF DRINKS DISPENSERS FOR DISPENSING CHILLED, HEATED AND CARBONATED WATER AND BEVERAGES (U.S. CLS. 100 AND 101).

ELI HELLMAN, EXAMINING ATTORNEY

CLASS 18—LEATHER GOODS

FOR LEATHER AND IMITATIONS OF LEATHER, NAMELY, SUITCASES, BRIEFCASES, HAND-BAGS, WALLETS, PURSES, COSMETIC CASES SOLD EMPTY, COSMETIC BAGS SOLD EMPTY; ANIMAL SKINS, HIDES; TRUNKS AND TRAVELLING BAGS; UMBRELLAS, PARASOLS AND WALKING STICKS; WHIPS, HARNESS AND SADDLERY (U.S. CLS. 1, 2, 3, 22 AND 41).

CLASS 25—CLOTHING

FOR DRESSING GOWNS, TIES, SHIRTS, SCARVES, SHAWLS, BATHROBES, SWEATERS, CARDIGANS, JACKETS, BATHING SUITS, BELTS AND UNDERGARMENTS, TROUSERS, COATS; FOOTWEAR; HATS, CAPS (U.S. CLS. 22 AND 39).

CLASS 35—ADVERTISING AND BUSINESS

FOR ADVERTISING; BUSINESS MANAGEMENT; BUSINESS ADMINISTRATION; OFFICE FUNCTIONS (U.S. CLS. 100, 101 AND 102).

SHAILA SETTLES, EXAMINING ATTORNEY

SN 79-067,350. LIDL STIFTUNG & CO. KG, 74167 NECKARSULM, FED REP GERMANY, FILED 1-7-2009.

Maxitrat

THE MARK CONSISTS OF STANDARD CHARACTERS WITHOUT CLAIM TO ANY PARTICULAR FONT, STYLE, SIZE, OR COLOR.

OWNER OF INTERNATIONAL REGISTRATION 0548744 DATED 10-17-1989, EXPIRES 10-17-2019.

CLASS 1—CHEMICALS

FOR WATER-SOFTENING PREPARATIONS FOR LAUNDRY USE (U.S. CLS. 1, 5, 6, 10, 26 AND 46).

CLASS 3—COSMETICS AND CLEANING PREPARATIONS

FOR BLEACHING PREPARATIONS AND OTHER SUBSTANCES FOR LAUNDRY USE, NAMELY, LAUNDRY DETERGENT AND LAUNDRY BLEACH; FABRIC SOFTENERS FOR LAUNDRY USE; PRODUCTS FOR FACILITATING IRONING, NAMELY, LAUNDRY STARCH; REINFORCED WASHING AIDS, NAMELY, ABRASIVE CLOTH; CLEANING, POLISHING, SCOURING AND ABRASIVE PREPARATIONS, STAIN REMOVERS, SALT FOR REMOVING STAINS, DISH WASHING AGENTS, CARPET CLEANING PREPARATIONS, TOILET CLEANING PREPARATIONS, SOAPS (U.S. CLS. 1, 4, 6, 50, 51 AND 52).

STEVEN PEREZ, EXAMINING ATTORNEY

SN 79-067,545. ROLANDOS ENTERPRISES PUBLIC LIMITED, CYPRUS, FILED 2-18-2009.

NEODERMA

THE MARK CONSISTS OF STANDARD CHARACTERS WITHOUT CLAIM TO ANY PARTICULAR FONT, STYLE, SIZE, OR COLOR.

PRIORITY DATE OF 12-17-2008 IS CLAIMED.

OWNER OF INTERNATIONAL REGISTRATION 0999567 DATED 2-18-2009, EXPIRES 2-18-2019.

CLASS 3—COSMETICS AND CLEANING PREPARATIONS

FOR SOAPS; PERFUMERY; ESSENTIAL OILS; COSMETICS; COSMETIC SKIN, BODY, AND HAIR CARE CREAMS; COSMETIC PREPARATIONS FOR SLIMMING PURPOSES; ASTRINGENTS FOR COSMETIC PURPOSES; COSMETIC PREPARATIONS FOR BATHS; LOTIONS FOR COSMETIC PURPOSES; POMADES FOR COSMETIC PURPOSES; COSMETIC PREPARATIONS FOR SKIN CARE; CLEANSING MILK FOR TOILET PURPOSES; HAIR LOTIONS; DENTIFRICES; SPRAYS FOR REFRESHING AND CLEANING THE SKIN; COSMETIC SUN-TANNING PREPARATIONS; MAKE-UP PREPARATIONS; MAKE-UP REMOVING PREPARATIONS; PERFUMERY, NAMELY, DEODORANTS FOR PERSONAL USE; TOILET WATERS; SCENTED LINEN WATERS; OILS FOR TOILETRY PURPOSES; PERFUMED OILS FOR SKIN CARE; PREPARATIONS FOR SHAVING; AFTERSHAVE LOTIONS; BEAUTY MASKS; ANTIPERSPIRANTS; BATH SALTS, NOT FOR MEDICAL PURPOSES; PREPARED WAX FOR DEPILATION; BODY CARE PRODUCTS, NAMELY, BODY LOTION; NON-MEDICATED MASSAGE PREPARATIONS, NAMELY, MASSAGE CREAMS AND OILS; COSMETIC LOTIONS FOR CARE OF SKIN (U.S. CLS. 1, 4, 6, 50, 51 AND 52).

CLASS 5—PHARMACEUTICALS

FOR SANITARY PREPARATIONS FOR MEDICAL PURPOSES; DIETETIC FOODS AND SUGARS ADAPTED FOR MEDICAL USE; DISINFECTANTS, NAMELY, DISINFECTANTS FOR SANITARY PURPOSES AND DISINFECTANTS FOR HYGIENE PURPOSES; MEDICATED BATH PREPARATIONS; CHEMICAL PREPARATIONS FOR MEDICAL OR PHARMACEUTICAL PURPOSES FOR THE TREATMENT OF SKIN ACNE, SKIN HYPER-PIGMENTATION AND SKIN COUPEROSE; HERBS FOR MEDICINAL PURPOSES; PHARMACEUTICAL PREPARATIONS FOR SKIN CARE (U.S. CLS. 6, 18, 44, 46, 51 AND 52).

CLASS 8—HAND TOOLS

FOR ELECTRIC AND NON-ELECTRIC DEPILATION APPLIANCES (U.S. CLS. 23, 28 AND 44).

CLASS 10—MEDICAL APPARATUS

FOR APPARATUS FOR MASSAGE; INSTRUMENTS FOR MASSAGE INCLUDING HOT STONE APPARATUS (U.S. CLS. 26, 39 AND 44).

CLASS 21—HOUSEWARES AND GLASS

FOR UTENSILS FOR USE IN BODY CARE, NAMELY, BODY SPONGES, BODY SCRUBBING PUFFS; APPLICATORS FOR COSMETICS, NAMELY, APPLICATOR SPONGES FOR APPLYING MAKE-UP; COSMETIC UTENSILS, NAMELY, COSMETIC BRUSHES FOR USE WITH COSMETIC SKIN AND BODY PRODUCTS AND MAKE-UP PRODUCTS AND COSMETIC SPATULAS FOR USE WITH COSMETIC SKIN AND BODY PRODUCTS (U.S. CLS. 2, 13, 23, 29, 30, 33, 40 AND 50).

CLASS 44—MEDICAL, BEAUTY AND AGRICULTURAL SERVICES

FOR HYGIENIC AND BEAUTY CARE FOR HUMAN BEINGS; AROMATHERAPY SERVICES; BEAUTY INSTITUTES, NAMELY, BEAUTY SPA SERVICES, NAMELY, COSMETIC BODY CARE; BEAUTY SALONS AND MASSAGE; FITNESS INSTITUTES, NAMELY, MEDICAL TESTING SERVICES, NAMELY, FITNESS EVALUATION; WELLNESS CENTERS, NAMELY, PROVIDING WELLNESS SERVICES, NAMELY, PERSONAL ASSESSMENTS, PERSONALIZED ROUTINES, MAINTENANCE SCHEDULES, AND COUNSELING; MANICURING; BEAUTICIAN SERVICES; HEALTHCARE RELATING TO THERAPEUTIC MASSAGE; MASSAGE; MASSAGE SERVICES; COSMETIC TREATMENT FOR THE FACE; COSMETIC TREATMENT FOR THE BODY; THERAPEUTIC TREATMENT FOR THE FACE AND BODY; SERVICES FOR THE CARE OF THE SKIN (U.S. CLS. 100 AND 101).

WARREN L. OLANDRIA, EXAMINING ATTORNEY

SN 79-068,034. STRUERS A/S, BALLERUP, DENMARK, FILED 12-22-2008.



PRIORITY DATE OF 6-26-2008 IS CLAIMED.

OWNER OF INTERNATIONAL REGISTRATION 1000736 DATED 12-22-2008, EXPIRES 12-22-2018.

THE MARK CONSISTS OF THREE DIAGONAL BARS TO THE LEFT OF THE WORDING "STRUERS".

CLASS 1—CHEMICALS

FOR UNPROCESSED PLASTICS, PHENOL FOR INDUSTRIAL PURPOSES, POLYESTER, ACRYLIC AND UNPROCESSED EPOXY RESINS, ALL AFOREMENTIONED GOODS FOR MOUNTING OR EMBEDDING OF SPECIMENS; MOUNTING OR EMBEDDING MATERIALS FOR USE IN THE MOLDING OF METALLURGICAL TEST SAMPLES FOR INDUSTRIAL PURPOSES, NAMELY, ARTIFICIAL AND SYNTHETIC RESINS; CHEMICAL PREPARATIONS FOR SCIENTIFIC PURPOSES AND CHEMICAL PREPARATIONS FOR INDUSTRIAL PURPOSES, NAMELY, REFRIGERANTS IN THE NATURE OF COOLANTS, EXCEPT FOR MEDICAL OR VETERINARY USE; GLUE FOR INDUSTRIAL PURPOSES (U.S. CLS. 1, 5, 6, 10, 26 AND 46).

CLASS 3—COSMETICS AND CLEANING PREPARATIONS

FOR ABRASIVES PREPARATIONS ALL IN POWDER OR GRANULE FORM OR IN THE FORM OF LIQUID SUSPENSIONS; ABRASIVE PAPER FOR GRINDING AND POLISHING OF MATERIALS; ABRASIVE CLOTH; AND DETERGENTS OTHER THAN FOR USE IN MANUFACTURING OPERATIONS AND FOR MEDICAL PURPOSES, NAMELY, CLEANING SOLUTIONS FOR USE IN THE GRINDING, POLISHING AND CLEANING OF METALLURGICAL TEST SAMPLES (U.S. CLS. 1, 4, 6, 50, 51 AND 52).

CLASS 4—LUBRICANTS AND FUELS

FOR INDUSTRIAL OILS AND GREASES; INDUSTRIAL LUBRICANTS, INDUSTRIAL METAL WORKING OILS (U.S. CLS. 1, 6 AND 15).

CLASS 7—MACHINERY

FOR MACHINES AND MACHINE APPARATUS AND PARTS FOR CUTTING, MIXING AND GRINDING; PARTS FOR CUTTING, MIXING AND GRINDING MACHINES, NAMELY, POWER OPERATED CUTTING WHEELS, MIXING WHEELS AND GRINDING WHEELS; MACHINES AND MACHINE APPARATUS AND PARTS FOR THE AFOREMENTIONED MACHINES FOR FILTERING, MOUNTING, EMBEDDING, PRESSING, POLISHING, DOSING, CLEANING, AND ETCHING OF METALLURGICAL SAMPLES; DRYING MACHINES FOR METALLURGICAL SAMPLES; VACUUM IMPREGNATING MACHINES FOR METALLURGICAL SAMPLES; STRUCTURAL PARTS AND FITTINGS FOR THE MENTIONED GOODS (U.S. CLS. 13, 19, 21, 23, 31, 34 AND 35).

CLASS 9—ELECTRICAL AND SCIENTIFIC APPARATUS

FOR ELECTRONIC APPARATUS FOR TESTING THE HARDNESS OF METALLIC AND NON-METALLIC INDUSTRIAL MATERIALS; INSTRUMENTS, NAMELY, OPTICAL INSPECTION APPARATUS FOR INDUSTRIAL USE, CAMERAS AND RECORDED COMPUTER SOFTWARE FOR OPTICAL INSPECTION, CONTROL, MEASURING, RECORDING AND ANALYSIS IN THE FIELD OF INSPECTION OF METALLURGICAL SAMPLES; X-RAY APPARATUS IN THE NATURE OF TESTING EQUIPMENT FOR DETERMINING INDUSTRIAL FLAWS, NOT FOR MEDICAL PURPOSES (U.S. CLS. 21, 23, 26, 36 AND 38).

CLASS 38—COMMUNICATION

FOR PROVIDING OF ACCESS TO KNOWLEDGE DATABASES (U.S. CLS. 100, 101 AND 104).

CLASS 41—EDUCATION AND ENTERTAINMENT

FOR EDUCATIONAL AND TRAINING ACTIVITIES, NAMELY, PROVIDING COURSES AND CLASSES IN THE FIELD OF MATERIALS TESTING; PROVIDING ONLINE COURSES AND TRAINING IN THE FIELD OF MATERIALS TESTING (U.S. CLS. 100, 101 AND 107).
DOMINIC FATHY, EXAMINING ATTORNEY

SN 79-068,162. YIWU LEIBONI BRAND PLANNING CO., LTD., CHINA, FILED 11-19-2008.



PRIORITY DATE OF 6-10-2008 IS CLAIMED.
OWNER OF INTERNATIONAL REGISTRATION 1000989 DATED 11-19-2008, EXPIRES 11-19-2018.

THE MARK CONSISTS OF THE WORD "WILD RABBIT" IN STYLIZED FONT, CHINESE CHARACTERS WHICH TRANSLITERATE AS "YE MAN TU" AND "WILD RABBIT" IN ENGLISH AND A DESIGN OF STYLIZED RABBIT WEARING A HAT, SHIRT, SHORTS AND SHOES.

THE NON-LATIN CHARACTERS IN THE MARK TRANSLITERATE TO "YE MAN TU" AND THIS MEANS "WILD RABBIT" IN ENGLISH.

CLASS 3—COSMETICS AND CLEANING PREPARATIONS

FOR COSMETICS; POLISHING PREPARATIONS; BODY LOTION; PERFUMERY; HAIR LOTIONS; DENTIFRICES; INCENSE; COSMETICS FOR ANIMALS; WASHING POWDER; DETERGENTS FOR WASHING DISHES (U.S. CLS. 1, 4, 6, 50, 51 AND 52).

CLASS 9—ELECTRICAL AND SCIENTIFIC APPARATUS

FOR EYEGLASS CASES; EYEGLASSES; SUNGLASSES; SOUND EQUIPMENT, NAMELY, SOUND AND VIDEO RECORDING AND PLAYBACK MACHINES; GALVANIC BATTERIES; ANTENNAS; COMPUTERS; POCKET CALCULATORS; TELESCOPES; VIDEO DISKS AND VIDEO TAPES WITH RECORDED ANIMATED CARTOONS; TELEPHONES; CAMERAS (U.S. CLS. 21, 23, 26, 36 AND 38).

CLASS 16—PAPER GOODS AND PRINTED MATTER

FOR PAPER; STATIONERY; WRITING INSTRUMENTS; PICTURES; PRINTED PUBLICATIONS, NAMELY, BOOKS IN THE FIELD OF ANIMATION; DRAWING INSTRUMENTS; DRAWING MATERIALS, NAMELY, CRAYONS; TYPEWRITERS; TEACHING MATERIALS, NAMELY, CHALKS; ARCHITECTURAL MODELS (U.S. CLS. 2, 5, 22, 23, 29, 37, 38 AND 50).

CLASS 18—LEATHER GOODS

FOR SCHOOL SATCHELS; PURSES; BACKPACKS; HANDBAGS; SHOPPING BAGS OF CANVAS, LEATHER AND TEXTILE; UNFITTED VANITY CASES; KEY CASES OF LEATHER; UMBRELLAS; POCKET WALLET; CARD CASES FOR BUSINESS CARDS AND CREDIT CARDS; CLOTHING FOR PETS (U.S. CLS. 1, 2, 3, 22 AND 41).

CLASS 25—CLOTHING

SN 79-068,388. ORAC NV, BELGIUM, FILED 3-13-2009.

FOR CLOTHING, NAMELY, JERSEYS, SHIRTS, UNDERWEAR, THOBES, AND TROUSERS; SHOES; HATS; HOSIERY; NECKTIES; STRAPS, NAMELY, LEATHER BELTS; GLOVES; LAYETTES; WEDDING DRESS; BATHING SUITS; RAINCOAT; DANCEWEAR, NAMELY, DANCE COSTUMES, DANCE SHOES; SHOWER CAPS (U.S. CLS. 22 AND 39).

CLASS 28—TOYS AND SPORTING GOODS

FOR TOYS, NAMELY, ELECTRONIC ACTION TOYS; GAMES, NAMELY, AMUSEMENT GAME MACHINES; BODY-TRAINING APPARATUS; BATTING GLOVES; BALLS FOR GAMES; FISHING TACKLE; ORNAMENTS FOR CHRISTMAS TREES; BALLOONS FOR PLAY; MACHINES FOR PHYSICAL EXERCISES; PLAYING CARDS; TOY WHISTLE; ROLLER SKATES; BOWS FOR ARCHERY; CHESS SETS; CONJURING APPARATUS IN THE NATURE OF MAGIC TRICKS (U.S. CLS. 22, 23, 38 AND 50).

JULIE VEPPUMTHARA, EXAMINING ATTORNEY

ORAC

SN 79-068,294. FLORIAN LENZ, DRESDEN, FED REP GERMANY, FILED 2-25-2009.



PRIORITY DATE OF 9-3-2008 IS CLAIMED.
OWNER OF INTERNATIONAL REGISTRATION 1001373 DATED 2-25-2009, EXPIRES 2-25-2019.

NO CLAIM IS MADE TO THE EXCLUSIVE RIGHT TO USE "CAMOUFLAGE SYSTEMS", APART FROM THE MARK AS SHOWN.

THE MARK CONSISTS OF THE WORDING "PHANTOMLEAF" AND "INTELLIGENT CAMOUFLAGE SYSTEMS" WRITTEN IN STYLIZED FONT AROUND THE PERIMETER OF A CIRCLE WITH A LARGE, STYLIZED LEAF WITH TWO EYES.

CLASS 22—CORDAGE AND FIBERS

FOR TARPULINS, NETTINGS AND CAMOUFLAGE NETS FOR VISUAL AND RADAR USES; AND UNFITTED CANVAS VEHICLE COVERS (U.S. CLS. 1, 2, 7, 19, 22, 42 AND 50).

CLASS 24—FABRICS

FOR TEXTILE FABRICS FOR MANUFACTURE OF CLOTHING, HELMETS AND PROTECTIVE PADS (U.S. CLS. 42 AND 50).

CLASS 25—CLOTHING

FOR CLOTHING, NAMELY, SHIRTS, JACKETS, COATS, PANTS AND OVERALL PANTS, GLOVES, PONCHOS; FOOTWEAR; AND HEADGEAR, NAMELY, HATS AND CAPS (U.S. CLS. 22 AND 39).

ELISSA GARBER KON, EXAMINING ATTORNEY

THE MARK CONSISTS OF STANDARD CHARACTERS WITHOUT CLAIM TO ANY PARTICULAR FONT, STYLE, SIZE, OR COLOR.

PRIORITY DATE OF 12-10-2008 IS CLAIMED.

OWNER OF INTERNATIONAL REGISTRATION 1001629 DATED 3-13-2009, EXPIRES 3-13-2019.

OWNER OF U.S. REG. NO. 1,587,835.

CLASS 11—ENVIRONMENTAL CONTROL APPARATUS

FOR LIGHTING APPARATUS, NAMELY, UPLIGHTERS, WALL LIGHTING; UNIVERSAL LAMP SHADE HOLDERS AND SOCKETS WITH REFLECTOR, NAMELY, FOR ENERGY-SAVING LAMPS, HALOGEN LAMPS AND INCANDESCENT LAMPS, MOUNTED ON A WALL ORNAMENT; INDIRECT LIGHTING SYSTEMS COMPRISED OF HALOGEN LIGHTS, HALOGEN STRIP LIGHTING, CORD, STRING AND LED STRIP IN COMBINATION WITH DECORATIVE WALL FRAMES AND FLUORESCENT LIGHTING SYSTEMS COMPRISED OF FLUORESCENT LAMPS, DIMMER, FIXTURE, CORD AND CONNECTION CABLE; LED INDICATION POINT LIGHTING FOR MOUNTING ON PLINTHS, NAMELY, LIGHTING FIXTURES FOR MOUNTING ON PLINTHS (U.S. CLS. 13, 21, 23, 31 AND 34).

CLASS 19—NON-METALLIC BUILDING MATERIALS

FOR NON-METAL DECORATIVE MOLDINGS AND DECORATIVE TRIM FOR USE IN BUILDING CONSTRUCTION FOR DECORATIVE PURPOSES IN THE NATURE OF WALL MOLDINGS, CEILING MOLDINGS, DECORATIVE COLUMNS, NAMELY, PLINTHS, ROSETTES, CORBELS, CORNICES, PILLARS, PILASTERS, CAPITALS, DOOR PANELS, WALL PANELS, DOOR FRAMES, WINDOW FRAMES, ARCHES (U.S. CLS. 1, 12, 33 AND 50).

CLASS 20—FURNITURE AND ARTICLES NOT OTHERWISE CLASSIFIED

FOR SOFT SCULPTURE WALL DECORATIONS MADE OF POLYURETHANE, POLYSTYRENE OR OTHER POLYMERS; SOFT SCULPTURE WALL DECORATIONS IN THE NATURE OF DOOR ORNAMENTS AND SURROUNDS MADE OF POLYURETHANE, POLYSTYRENE OR OTHER POLYMERS; FURNITURE FRAMES; MIRRORS; PEDESTALS NOT INCLUDED IN OTHER CLASSES (U.S. CLS. 2, 13, 22, 25, 32 AND 50).

WILLIAM ROSSMAN, EXAMINING ATTORNEY

SN 79-068,433. THE BEAUTYFULL CLUB, FRANCE, FILED 12-11-2008.



PRIORITY DATE OF 6-11-2008 IS CLAIMED.
OWNER OF INTERNATIONAL REGISTRATION 1001770 DATED 12-11-2008, EXPIRES 12-11-2018.

NO CLAIM IS MADE TO THE EXCLUSIVE RIGHT TO USE "THE BEAUTY INDUSTRY WORLDWIDE CLUB", APART FROM THE MARK AS SHOWN.

THE COLOR(S) RED, PINK AND BLACK IS/ARE CLAIMED AS A FEATURE OF THE MARK.

THE MARK CONSISTS OF THE WORDS "THE BEAUTYFULL CLUB THE BEAUTY INDUSTRY WORLDWIDE CLUB" FORMING THE PERIMETER OF A CIRCLE. ALL OF THE WORDING IS BLACK EXCEPT FOR THE LETTERS "FULL" IN "BEAUTYFULL", WHICH ARE RED. IN THE CENTER OF THE CIRCLE IS A FLOWER DESIGN. THE PETALS OF THE FLOWER ARE RED AND PINK. THE CENTER OF THE FLOWER IS BLACK.

CLASS 16—PAPER GOODS AND PRINTED MATTER

FOR PRINTED MATTER, NAMELY, BROCHURES, NEWSLETTERS, JOURNALS, MAGAZINES, LEAFLETS, IN THE FIELD OF BEAUTY CARE AND COSMETICS; BOOKBINDING MATERIAL; PHOTOGRAPHS; STATIONERY; ADHESIVES FOR STATIONERY AND HOUSEHOLD PURPOSES; ARTISTS' MATERIALS, NAMELY, CRAYONS, CHALK, PALETTES, CANVASSES, COLOR PENCILS, PAINTBRUSHES; TYPEWRITERS AND OFFICE REQUISITES EXCEPT FURNITURE, NAMELY, PENS, DESK BASKETS FOR DESK ACCESSORIES, DESK PADS AND WRITING PADS, PAPERCLIPS, TYPEWRITER RIBBONS, CACHETS, STAMP PADS, INKING PADS, CORRECTING FLUIDS, ERASERS, PENCIL SHARPENERS ELECTRIC AND NON-ELECTRIC; PRINTED INSTRUCTIONAL AND TEACHING MATERIAL EXCEPT APPARATUS, NAMELY, MANUALS, BOOKS, PAMPHLETS IN THE FIELD OF BEAUTY CARE AND COSMETICS; PRINTING TYPE; PRINTING BLOCKS; PAPER; CARDBOARD; CARDBOARD AND PAPER BOXES; POSTERS; PHOTO ALBUMS, STAMP ALBUMS; GREETING CARDS, NOTE CARDS; NEWSPAPERS; CALENDARS; WRITING INSTRUMENTS; LITHOGRAPHIC WORKS OF ART; PAINTINGS FRAMED AND NOT FRAMED; WATERCOLORS; SEWING PATTERNS; GRAPHIC PRINTS; DRAWING INSTRUMENTS; PAPER HANDKERCHIEFS; PAPER FACE TOWELS; PAPER TABLE LINEN; TOILET PAPER; DISPOSABLE BABIES' NAPKINS OF PAPER AND CELLULOSE; PAPER AND PLASTIC BAGS AND SMALL BAGS, NAMELY, WRAPPINGS, POUCHES, FOR PACKAGING PURPOSES; PAPER AND PLASTIC GARBAGE BAGS (U.S. CLS. 2, 5, 22, 23, 29, 37, 38 AND 50).

CLASS 35—ADVERTISING AND BUSINESS

FOR ADVERTISING; BUSINESS MANAGEMENT; BUSINESS ADMINISTRATION; PROVIDING OFFICE FUNCTIONS; DISSEMINATION OF ADVERTISING MATERIAL, NAMELY, LEAFLETS, PROSPECTUSES, PRINTED MATTER, SAMPLES; NEWSPAPER SUBSCRIPTION SERVICES FOR THIRD PARTIES; BUSINESS ORGANIZATION AND MANAGEMENT CONSULTING; BOOKKEEPING; DOCUMENT REPRODUCTION; EMPLOYMENT AGENCIES; COMPUTERIZED FILE MANAGEMENT; ORGANIZATION OF EXHIBITIONS FOR COMMERCIAL AND ADVERTISING PURPOSES; ONLINE ADVERTISING ON A COMPUTER NETWORK; RENTAL OF ADVERTISING SPACE ON THE INTERNET; PUBLISHING OF ADVERTISING TEXTS; RENTAL OF ADVERTISING SPACE; DISSEMINATION OF ADVERTISEMENTS; PUBLIC RELATIONS (U.S. CLS. 100, 101 AND 102).

CLASS 41—EDUCATION AND ENTERTAINMENT

FOR EDUCATION SERVICES, NAMELY, PROVIDING CLASSES, SEMINARS, WORKSHOPS, IN THE FIELD OF BEAUTY CARE AND COSMETICS; TRAINING IN THE FIELD OF BEAUTY CARE AND COSMETICS; ENTERTAINMENT SERVICES, NAMELY, LIVE DRAMATIC, COMEDIC AND MUSICAL PERFORMANCES; PROVIDING INFORMATION ON EDUCATIONAL AND ENTERTAINMENT EVENTS; BOOK PUBLISHING; BOOK LENDING; ANIMAL TRAINING; VIDEOTAPE FILM PRODUCTION; RENTAL OF CINEMATOGRAPHIC FILMS; RENTAL OF SOUND RECORDINGS; RENTAL OF VIDEO CASSETTE RECORDERS AND OF RADIO AND TELEVISION SETS; RENTAL OF SHOW STAGE SETS; VIDEOTAPE EDITING; PHOTOGRAPHY SERVICES; ARRANGING AND CONDUCTING EDUCATIONAL COLLOQUIUMS, CONFERENCES AND CONVENTIONS; ORGANIZATION OF EXHIBITIONS FOR CULTURAL AND EDUCATIONAL PURPOSES; BOOKING OF SEATS FOR SHOWS; PROVIDING GAMES ONLINE ON A COMPUTER NETWORK; GAMBLING SERVICES; ELECTRONIC PUBLISHING OF ONLINE BOOKS AND PERIODICALS; DESKTOP PUBLISHING FOR OTHERS (U.S. CLS. 100, 101 AND 107).

CLASS 42—SCIENTIFIC AND COMPUTER SERVICES

FOR EVALUATIONS, ASSESSMENTS AND RESEARCH IN THE FIELDS OF SCIENCE AND TECHNOLOGY PROVIDED BY ENGINEERS; DESIGN AND DEVELOPMENT OF COMPUTER HARDWARE AND SOFTWARE; RESEARCH AND DEVELOPMENT OF NEW PRODUCTS FOR THIRD PARTIES; INTERIOR DESIGN; DEVELOPMENT, DESIGN, INSTALLATION, MAINTENANCE, UPDATING AND RENTAL OF SOFTWARE; COMPUTER PROGRAMMING; COMPUTER CONSULTING; DATA CONVERSION OF COMPUTER PROGRAMS AND DATA, NOT PHYSICAL CONVERSION; CONVERSION OF DATA AND DOCUMENTS FROM PHYSICAL TO ELECTRONIC MEDIA; TECHNICAL INSPECTION OF MOTOR CARS; GRAPHIC ARTS DESIGN SERVICES; INDUSTRIAL DESIGN; AUTHENTICATING WORKS OF ART (U.S. CLS. 100 AND 101).

BARBARA GAYNOR, EXAMINING ATTORNEY

SN 79-069,886. KS TECHNIQUES SOCIÉTÉ ANONYME, BELGIUM, FILED 12-30-2008.



PRIORITY DATE OF 12-9-2008 IS CLAIMED.
OWNER OF INTERNATIONAL REGISTRATION 1005242 DATED 12-30-2008, EXPIRES 12-30-2018.

THE COLOR(S) VARIOUS SHADES OF BLUE AND WHITE IS/ARE CLAIMED AS A FEATURE OF THE MARK. THE MARK CONSISTS OF THE STYLIZED LETTERS "KST". THE LETTER "K" IS ROYAL BLUE IN COLOR. THE LETTER "S" IS WHITE WITH A LIGHT BLUE OUTLINE. THE LETTER "T" IS WHITE WITH A ROYAL BLUE OUTLINE.

CLASS 7—MACHINERY

FOR ELECTRIC CURRENT GENERATORS; ELECTRICAL LATHE TURNING MACHINES; ELECTRICAL MACHINES, NAMELY, STATIC AND DYNAMIC UNINTERRUPTIBLE POWER SUPPLY UNITS (UPS) THAT PROVIDE SHORT TERM UNINTERRUPTED POWER TO EQUIPMENT (U.S. CLS. 13, 19, 21, 23, 31, 34 AND 35).

CLASS 9—ELECTRICAL AND SCIENTIFIC APPARATUS

FOR ELECTRIC POWER SUPPLIES; APPARATUS DESIGNED FOR OPERATING, DISTRIBUTING, ACCUMULATING, REGULATING OR CONTROLLING ELECTRIC CURRENT, NAMELY, STATIC AND DYNAMIC POWER SUPPLIES (U.S. CLS. 21, 23, 26, 36 AND 38).

CLASS 42—SCIENTIFIC AND COMPUTER SERVICES

FOR DESIGN SERVICES FOR OTHERS IN THE FIELD OF ELECTRICAL SYSTEMS AND BUILDING, RESEARCH AND MAINTENANCE OF ELECTRICAL SYSTEMS, IN PARTICULAR, RELATING TO STATIC AND DYNAMIC UNINTERRUPTIBLE POWER SUPPLY (UPS) UNITS; TECHNOLOGICAL CONSULTATION IN THE FIELD OF ELECTRICAL SYSTEM DESIGN AND DEVELOPMENT, IN PARTICULAR, RELATING TO STATIC OR DYNAMIC UNINTERRUPTIBLE POWER SUPPLY (UPS) UNITS (U.S. CLS. 100 AND 101).

RUSS HERMAN, EXAMINING ATTORNEY

SN 79-070,243. FINMECCANICA SOCIETÀ PER AZIONI, ITALY, FILED 5-6-2009.



PRIORITY DATE OF 12-16-2008 IS CLAIMED.
OWNER OF INTERNATIONAL REGISTRATION 1006153 DATED 5-6-2009, EXPIRES 5-6-2019.

OWNER OF U.S. REG. NOS. 3,602,589 AND 3,602,590.
THE COLOR(S) GREY, RED, BLACK AND BROWN IS/ARE CLAIMED AS A FEATURE OF THE MARK.

THE MARK CONSISTS OF THE WORDING "MWANA SIMBA" WITH THE LETTERS "N", "S", AND BOTH "MS" APPEARING IN GREY, THE LETTERS "W" AND "B" APPEARING IN RED, AND THE LETTER "I" AND ALL THREE "A"S APPEARING IN BROWN. TO THE UPPER LEFT OF THE WORDING IS A PATTERN OF THREE RED AND FOUR GREY TRIANGULAR SEGMENTS, WHICH EXTEND RADIALLY OUTWARDS.

THE ENGLISH TRANSLATION OF "MWANA SIMBA" IN THE MARK IS "YOUNG LION."

CLASS 9—ELECTRICAL AND SCIENTIFIC APPARATUS

FOR APPARATUS AND INSTRUMENTS FOR CONDUCTING, SWITCHING, TRANSFORMING, ACCUMULATING, REGULATING OR CONTROLLING ELECTRICITY, NAMELY, POWER PLANTS CONTROL SYSTEMS COMPRISED OF ELECTRICAL PLUG DEVICE ENABLING CONNECTION AND DISCONNECTION OF POWER AND/OR CONTROL CABLES; APPARATUS AND INSTRUMENTS FOR CONDUCTING, SWITCHING, TRANSFORMING, ACCUMULATING, REGULATING OR CONTROLLING ELECTRICITY, NAMELY, SIMULATORS FOR POWER PLANT CONTROL EPC (ENGINEERING PROCUREMENT AND CONSTRUCTION) ON TURNKEY BASE OF POWER PLANTS, NAMELY, COMPUTER SIMULATORS; ELECTRICAL, ELECTRONIC, MEASURING, SIGNALING, SENSING AND CHECKING APPARATUS AND INSTRUMENTS FOR USE IN AIRCRAFT, ROTARY WING AIRCRAFT, HELICOPTERS, TILT ROTOR AIRCRAFT, NAMELY, ULTRASONIC EQUIPMENT USED TO TEST OR INSPECT DAMAGE TO AIRCRAFT, NAMELY, AIRCRAFT ALTITUDE INDICATORS, AIRCRAFT AIRSPEED SENSORS; DATA PROCESSING AND COMPUTER EQUIPMENT, NAMELY, COMPUTER SOFTWARE FOR FLIGHT SIMULATORS AIR TRAFFIC CONTROL SYSTEMS FOR CIVIL AND MILITARY PURPOSES; DATA PROCESSING AND COMPUTER EQUIPMENT IN THE NATURE OF COMMUNICATIONS APPARATUS AND INSTRUMENTS, NAMELY, AERONAUTICAL RADIO COMMUNICATION MACHINES AND APPARATUS, APPARATUS FOR TRANSMISSION OF COMMUNICATION, AERONAUTICAL RADIO COMMUNICATION MACHINES AND APPARATUS; APPARATUS AND INSTRUMENTS FOR CONDUCTING, SWITCHING, TRANSFORMING, ACCUMULATING, REGULATING OR CONTROLLING ELECTRICITY IN THE NATURE OF TESTING APPARATUS AND INSTRUMENTS, NAMELY, TELECOMMUNICATION LINE INTEGRITY TESTING APPARATUS; APPARATUS AND INSTRUMENTS FOR CONDUCTING, SWITCHING, TRANSFORMING, ACCUMULATING, REGULATING OR CONTROLLING ELECTRICITY IN THE NATURE OF ELECTRICAL AND ELECTRONIC COMPONENTS, SIGHTING AND TARGETING APPARATUS AND INSTRUMENTS, NAMELY, APPARATUS AND INSTRUMENTS FOR CONVEYING, DISTRIBUTING, TRANSFORMING, STORING, REGULATING OR CONTROLLING ELECTRIC CURRENT ELECTRONIC NAVIGATIONAL AND POSITIONING APPARATUS AND INSTRUMENTS, APPARATUS FOR CONTROLLING ELECTRIC CURRENT, NAMELY, ELECTRICAL CONTROLLERS FOR MAGNETIC BEARING CONTROL; LIFE SAVING AND TEACHING APPARATUS AND INSTRUMENTS IN THE NATURE OF PROTECTIVE SUITS AND HELMETS FOR AVIATORS AND PILOTS OF HELICOPTERS; DATA PROCESSING AND COMPUTER EQUIPMENT IN THE NATURE OF COMPUTER HARDWARE AND SOFTWARE FOR FLIGHT SIMULATORS; PRERECORDED MAGNETIC DATA CARRIERS FEATURING DATA ABOUT AFRICA, SOCIAL RESPONSIBILITY, NATURE, ENVIRONMENT, INDUSTRY, GEOGRAPHY, SUSTAINABILITY, RELIGION, CHARITABLE ACTIVITIES; COMPACT DISKS AND DIGITAL VIDEO DISKS REGARDING AFRICA, SOCIAL RESPONSIBILITY, NATURE, ENVIRONMENT, INDUSTRY, GEOGRAPHY, SUSTAINABILITY, RELIGION, CHARITABLE ACTIVITIES; APPARATUS FOR RECORDING, TRANSMISSION OR REPRODUCTION OF SOUND OR IMAGES ABOUT AFRICA, SOCIAL RESPONSIBILITY, NATURE, ENVIRONMENT, INDUSTRY, GEOGRAPHY, SUSTAINABILITY, RELIGION, CHARITABLE ACTIVITIES; APPARATUS FOR RECORDING, TRANSMITTING AND REPRODUCING SOUND OR IMAGES, NAMELY, AIR TRAFFIC CONTROL SYSTEMS FOR CIVIL AND MILITARY PURPOSES, NAMELY, SHORT,

MEDIUM AND LONG RANGE PRIMARY RADARS, APPARATUS FOR RECORDING, TRANSMITTING AND REPRODUCING SOUND OR IMAGES, NAMELY, SECONDARY RADARS, NAVIGATION COMPUTERS FOR AIRCRAFTS, HELICOPTERS, TRAINS, PASSENGER CARS, RADAR DATA EXTRACTORS DISPLAY DEVICES FOR EARTH OBSERVATION, LAUNCHING AND RETRIEVAL OF SATELLITES, TELECOMMUNICATIONS METEOROLOGY, ENVIRONMENTAL MANAGEMENT AND IMAGE TRANSMISSION, COMPUTERIZED MAPPING AND GRAPHIC APPARATUS FOR STORAGE OF GROUND COORDINATE VALUES, CONTROLLER WORKSTATIONS FOR CONTROL OF MILITARY, COMMERCIAL AND PRIVATE AVIATION TRAFFIC, CONTROL TOWER COMPUTER HARDWARE AND SOFTWARE FOR CONTROL OF MILITARY, COMMERCIAL AND PRIVATE AVIATION TRAFFIC, COMMUNICATION APPARATUS AND SOFTWARE FOR CONTROL OF MILITARY, COMMERCIAL AND PRIVATE AVIATION TRAFFIC; FLIGHT SIMULATORS FOR AIR TRAFFIC CONTROL; APPARATUS FOR RECORDING, TRANSMITTING AND REPRODUCING SOUND OR IMAGES IN THE NATURE OF RADIO COMMUNICATION APPARATUS FOR GROUND-AIR-GROUND RADIO COMMUNICATIONS; APPARATUS FOR RECORDING, TRANSMITTING AND REPRODUCING SOUND OR IMAGES, NAMELY, THREE-DIMENSIONAL RADARS FOR AIR SURVEILLANCE COMPRISED OF ANTENNA, TRANSMITTER AND RECEIVER DEVICES, DISPLAY DEVICES, CONTROLLER WORKSTATIONS AND COMPUTER PROCESSING SYSTEM; APPARATUS FOR RECORDING, TRANSMITTING AND REPRODUCING SOUND OR IMAGES, NAMELY, COAST AND LOW ALTITUDE SURVEILLANCE RADARS; AIRCRAFT ANTI-COLLISION SYSTEMS; APPARATUS FOR RECORDING, TRANSMITTING AND REPRODUCING SOUND OR IMAGES IN THE NATURE OF RADARS FOR AUTOMATIC FIRE CONTROL, NAMELY, FOR AUTOMATICALLY CONTROLLING GUNS AND MISSILES; TERRESTRIAL SURFACE-AIR MISSILE RADAR APPARATUS FOR POINT DEFENSE AND FOR BATTLE POINT FOR USE IN VEHICLES; APPARATUS FOR RECORDING, TRANSMITTING AND REPRODUCING SOUND OR IMAGES IN THE NATURE OF AIR-AIR MISSILE RADAR APPARATUS, AIR DEFENSE RADAR FOR INTERCEPTION, ANALYSIS AND JAMMING OF RADAR SIGNALS; APPARATUS FOR RECORDING, TRANSMITTING AND REPRODUCING SOUND OR IMAGES IN THE NATURE OF LASER AND RADAR SIGHTING AND TRACKING APPARATUS FOR MILITARY PURPOSES; LASER OBJECT DETECTORS FOR USE ON VEHICLES; SHIP BORNE RADARS FOR SEARCHING, IDENTIFYING, PRIORITIZING, TRACKING AND ENGAGING TARGETS, NAMELY, SHIP-BASED RADAR SYSTEMS COMPRISING ANTENNA, TRANSMITTER AND RECEIVER DEVICES, DISPLAY DEVICES IN THE NATURE OF SCREENS, SIGNAL AND DATA PROCESSING COMPUTERS, CONTROLLER WORKSTATIONS CONSISTING OF A SINGLE OR MULTIPLE PROGRAMMABLE CONTROLLERS (PLC) WITH INPUT AND OUTPUT FEATURES FOR DIGITAL DEVICES, WITH CAPABILITY OF BEING CONNECTED TO EXTERNAL SUPERVISORY COMPUTERS, CONTROL COMPUTER HARDWARE, COMMUNICATION APPARATUS AND SOFTWARE PROGRAMS FOR SEARCHING, IDENTIFYING, PRIORITIZING, TRACKING AND ENGAGING TARGETS; PASSIVE RADARS COMPRISED OF ANTENNA, RECEIVER DEVICE, DISPLAY DEVICES, CONTROLLER WORKSTATIONS AND COMPUTER PROCESSING SYSTEM; TEST EQUIPMENT CONSISTING OF ULTRASONIC EQUIPMENT USED TO TEST OR INSPECT DAMAGE TO AIRCRAFT FOR RADAR CHECK AND FUNCTIONAL PARAMETER DEFINITION AND SETTING; TELE-DIAGNOSTIC SYSTEM COMPRISED OF COMMUNICATIONS COMPUTERS FOR A CENTRALIZED MONITORING, CONTROL, DIAGNOSIS, CONFIGURATION MANAGEMENT AND MAINTENANCE ON GEOGRAPHICAL DISTRIBUTED SYSTEMS; SURFACE MOVEMENT GUIDANCE AND CONTROL SYSTEMS COMPRISED OF RADAR, RADIO TRANSMITTER AND RECEIVER, DISPLAY DEVICES, CONTROLLER WORKSTATIONS AND COMPUTER PROCESSING SYSTEM FOR USE IN THE AIRPORT AREA; NAVIGATION SYSTEMS FOR AIRCRAFT MANAGEMENT IN THE AIRPORT APPROACH PHASE; AVIATION WEATHER PROCESSING INFORMATION SYSTEMS, NAMELY, RADAR, COMPUTER HARDWARE AND SOFTWARE FOR WEATHER PROCESSING AND FORECASTING, SCREEN DISPLAYS AND WORK-

STATIONS FOR WEATHER PROCESSING AND FORECASTING; AIRCRAFT EN-ROUTE NAVIGATION AND LANDING AIDS COMPRISED OF INSTRUMENT LANDING SYSTEMS CONSISTING OF INSTRUMENT APPROACH APPARATUS PROVIDING PRECISE GUIDANCE TO AN AIRCRAFT APPROACHING A RUNWAY, MICROWAVE LANDING SYSTEM, AND SIGNAL TRANSMITTERS AND DETECTORS, DISTANCE MEASURING EQUIPMENT IN THE NATURE OF SENSORS, DATA LINK RECEIVER/TRANSMITTER SYSTEM AND VERY HIGH FREQUENCY VHF OMNI-DIRECTIONAL RANG SYSTEM SIGNALING WAYSIDE AND ONBOARD COMPONENTS AND SUBSYSTEMS COMPRISED OF OMNI DIRECTIONAL RADIOS (VOR), RADIO NAVIGATION SYSTEM FOR AIRCRAFT COMPRISING SATELLITES, TRANSMITTERS, RECEIVERS AND TRANSPONDERS, DISTANCE MEASURING EQUIPMENT (DME), COMPLETE SIGNALING SYSTEMS FOR RAILWAYS CONSISTING OF SIGNAL WHISTLES, SIGNAL BELLS, RAILWAY COMMUNICATION SYSTEM AND TERMINALS CONSISTING OF A TRAIN CONTROL SYSTEM USED IN THE RAILWAY INDUSTRY FOR DETECTING AND CONTROLLING TRAINS, GROUND FAULTS, BROKEN RAILS, POWER FAILURES, TRACK SWITCHES AND LIGHTS; TELECOMMUNICATION SYSTEMS, NAMELY, TELEPHONE NETWORKS COMPOSED OF RADIO TELEPHONES FOR GROUND-AIR-GROUND RADIO COMMUNICATIONS AND AUTOMATIC TELEPHONE EXCHANGES; TRANSMISSION APPARATUS, NAMELY, LARGE TELEPHONIC MULTIPLEX STATIONS CONSISTING OF LARGE TELEPHONIC MULTIPLEX APPARATUS FOR BROADCASTING SOUND AND IMAGES; SYSTEMS FOR RETAIL INFORMATION, NAMELY, GENERAL PURPOSE MINICOMPUTERS; RAILWAY AND UNDERGROUND SIGNALING, TURNKEY RAILWAY AND UNDERGROUND TRANSPORT SYSTEMS SIGNALING WAYSIDE AND ONBOARD COMPONENTS AND SUBSYSTEMS, COMPLETE SIGNALING SYSTEMS FOR RAILWAYS; TURNKEY RAILWAYS, LIGHT RAIL, TRAMWAY AND MASS TRANSIT TRANSPORTATION SYSTEMS, NAMELY, A TRAIN CONTROL SYSTEM USED IN THE RAILWAY INDUSTRY FOR DETECTING AND CONTROLLING TRAINS, GROUND FAULTS, BROKEN RAILS, POWER FAILURES, TRACK SWITCHES AND LIGHTS; POSTAL CHARGE METERS; SATELLITES, SPACE STATIONS COMPRISED OF SATELLITE CAPABLE OF ATTACHING TO GROUND STATIONS AND SPACE PLATFORMS USED FOR TELECOMMUNICATIONS, TELEVISION TRANSMISSIONS, DATA TRANSMISSION, METEOROLOGY PURPOSES; SATELLITE GROUND STATIONS CONSISTING OF COMPUTER SOFTWARE AND RADAR INSTRUMENTS FOR EARTH OBSERVATION, LAUNCHING AND RETRIEVAL OF SATELLITES, TELECOMMUNICATIONS METEOROLOGY, ENVIRONMENTAL MANAGEMENT AND SPACE PLATFORMS COMPRISED OF COMPUTER SOFTWARE USED FOR TELECOMMUNICATIONS, TELEVISION TRANSMISSIONS, DATA TRANSMISSION, METEOROLOGY PURPOSES, AND COMPUTER TERMINALS THEREFORE; NAVIGATION, IDENTIFICATION AND COMMUNICATIONS SYSTEMS, NAMELY, AVIONIC SENSOR SYSTEMS, NAVAL COMMUNICATION SYSTEMS COMPRISED OF AN OPTICAL METROLOGY INSPECTION SYSTEM COMPRISED OF A LIGHT SOURCE, ONE OR MORE CAMERAS AND SENSORS IN COMMUNICATION WITH COMPUTER SOFTWARE AND HARDWARE, SECURE COMMUNICATIONS SYSTEMS FOR MILITARY, CIVIL AND GOVERNMENT APPLICATIONS COMPRISED OF APPARATUS AND EQUIPMENTS FOR BROADCASTING BROADBAND RADIO VIA IP NETWORKS, COMPUTER NETWORKS AND COMPUTER TERMINALS FOR PROFESSIONAL COMMUNICATIONS, RADIO RELAYS, TELECOMMUNICATIONS MANAGEMENT SOFTWARE FOR MANAGING RAILWAY TRAFFIC; SURVEYING, WEIGHING AND MEASURING APPARATUS AND INSTRUMENTS, NAMELY, DIRECTIONAL COMPASSES, ALTIMETERS, AERO METERS, AMMETERS, BAROMETERS, CHRONOGRAPHS, CLINOMETERS, ODOMETERS, SPEEDOMETERS, PRESSURE GAUGES, THERMOMETERS NOT FOR MEDICAL USE, PYROMETERS, SCALES, METRIC CONVERTERS, METEOROLOGY RADIO-METERS, INTERFEROMETER PROBES FOR ATMOSPHERIC STUDIES AND ULTRAVIOLET SPECTROMETERS FOR ASTROPHYSICAL RESEARCH; ELECTRIC, SCIENTIFIC, TEACHING AND NAUTICAL APPARATUS AND INSTRUMENTS, NAMELY, BATTERIES, BATTERY CHARGERS, COMPUTER SOFT-

WARE FOR EARTH OBSERVATION, LAUNCHING AND RETRIEVAL OF SATELLITES, TELECOMMUNICATIONS METEOROLOGY, ENVIRONMENTAL MANAGEMENT AND IMAGE TRANSMISSION AND RADAR RECEIVERS WITH AMPLIFIERS FOR EARTH OBSERVATION, LAUNCHING AND RETRIEVAL OF SATELLITES, TELECOMMUNICATIONS METEOROLOGY, ENVIRONMENTAL MANAGEMENT AND IMAGE TRANSMISSION, RECEPTION AND PROCESSING MOBILE CELLULAR TELEPHONES WITH REPEATERS AND USER TERMINALS, ELECTRONIC CONVERTERS, ELECTRICAL TRANSFORMERS, PRESSURE VESSELS AND PRESSURIZED REACTORS IN THE NATURE OF ELECTRICAL CONTROLLERS FOR AUTOMATICALLY ACTUATING TURBINES, CHARGE REGULATORS FOR USE IN PHOTOVOLTAIC UNITS, NUCLEAR REACTORS, MAGNETS, SEMICONDUCTORS, COMPUTER OPERATING SYSTEMS AND ELECTROMECHANICAL CONTROLS FOR USE IN COMPUTER OPERATING SYSTEM USING MOTOR DRIVE AND CONTROL SYSTEM TECHNOLOGY FOR THE OPERATION OF EQUIPMENT IN PLANTS AND NAVAL SYSTEMS, ELECTROMECHANICAL CIRCUIT DEVICES, NAMELY, CIRCUIT BREAKERS AND ELECTRICAL CONTACTORS FOR CIRCUITS, ELECTRICAL AND COMPUTER CABLES, ELECTROMECHANICAL ACTUATORS USED FOR AUTOMATIC TRAIN CONTROL FOR THE AUTOMATIC OPERATION OF A BRAKE VALVE, ELECTRICAL CONTROLLERS AND ELECTRIC SWITCHERS, HIGH CAPACITY ELECTRICAL POWER SUPPLY, ELECTRIC RESISTORS FOR THERMAL DISSIPATION, ENVIRONMENTAL CONTROL APPARATUS, NAMELY, PHOTOVOLTAIC MODULES FOR ELECTRICITY GENERATION AND ELECTROCHEMICAL FUEL CELLS, LABORATORY ROBOTS FOR REMOTE MAINTENANCE OPERATIONS, HIGH DEXTERITY LABORATORY ROBOTS FOR APPLICATIONS IN THE NUCLEAR, AIRSPACE, CIVIL DEFENSE, MARINE AND REMOTE OR HAZARDOUS ENVIRONMENT SECTORS AND FOR USE IN THE TRANSFER AND INSPECTING OF REMOTE CONTROLLED MOBILE PLATFORMS, COMMAND CONTROL AND COMMUNICATION APPARATUS FOR OPERATION AT GROUP AND BATTERY LEVEL; CONTROL AND GUIDANCE ELECTRONICS FOR MISSILE WEAPON SYSTEMS, NAMELY, ELECTRIC SENSORS AND RADARS, SIMULATORS FOR AIR TRAFFIC CONTROL SIMULATORS FOR SYSTEM, APPARATUS FOR RECORDING, TRANSMITTING AND REPRODUCING SOUND OR IMAGES, NAMELY, RADIO COMMUNICATION APPARATUS FOR GROUND-AIR-GROUND RADIO COMMUNICATIONS, LASER OBJECT DETECTORS FOR USE ON VEHICLES, RADAR AND ULTRASONIC OBJECT DETECTORS FOR USE ON VEHICLES, TRANSMISSION APPARATUS, NAMELY, LARGE TELEPHONIC MULTIPLEX STATIONS CONSISTING OF LARGE TELEPHONIC MULTIPLEX APPARATUS FOR BROADCASTING SOUND AND IMAGES AND MICROWAVE LINKS IN THE NATURE OF RADIO WAVES, ELECTRO-OPTICAL SPACE INSTRUMENTS, NAMELY, RADIATION COUNTERS USED IN SATELLITES FOR MILITARY AND NAVAL ACTIONS AND COMMUNICATIONS, SATELLITE-BORNE ATMOSPHERIC X-RAY-RAY SENSORS, ELECTRO-OPTIC ATTITUDE SENSORS FOR SATELLITES, PRECISION APPROACH RADARS FOR LAND AND NAVAL APPLICATIONS, ELECTRONIC SENSORS FOR MONITORING AUTOMATIC NAVIGATION AND MAINTENANCE OPERATIONS IN SPACE, ALTITUDE SENSORS FOR USE ON SATELLITES AND SPACE EXPLORATION VEHICLES; DATA PROCESSING AND COMPUTER EQUIPMENT, NAMELY, COMPUTERIZED AND NON-COMPUTERIZED TEST EQUIPMENT FOR METEOROLOGY, NAMELY, MICRO HARDNESS TESTERS, EMBEDDING AND CUTTING TO PREPARE MATERIAL SAMPLES; APPARATUS AND INSTRUMENTS FOR CONDUCTING, SWITCHING, TRANSFORMING, ACCUMULATING, REGULATING OR CONTROLLING ELECTRICITY IN THE NATURE OF AUTOMATION SYSTEMS FOR FIELD ARTILLERY, CONSISTING OF ELECTRONIC COMMAND CONTROL AND COMMUNICATION APPARATUS IN THE NATURE OF COMPUTER INTRANET APPARATUS AND RADIO WAVE RECEIVER AND TRANSMISSION HARDWARE FOR OPERATION AT GROUP AND BATTERY LEVEL, AND PRINTERS AND BAR CODE SCANNERS FOR USE IN MONITORING AND PROCESSING REFRIGERANT STATUS OF SPECIFIC REFRIGERATION UNIT, ELECTRIC SUPPLY CABLES AND TEMPERATURE METERS FOR USE WITH CRYOGENIC PUMPS;

AIRBORNE SYSTEMS COMPRISED OF INFRA-RED SENSORS, OPTICAL HEADS WORKING IN THE RANGE OF VISIBLE RADIATION, INTERLOCKED SUPPORTS, COMPUTERS WITH SEARCHING ALGORITHMS, TRACKING, SWITCHBOARDS, ELECTRO-OPTIC MICRO SENSORS FOR AVIONICS USE IN AIDING NAVIGATION, OBSERVATION AND AIMING FOR AIRBORNE SURVEILLANCE, AIRBORNE ENVIRONMENTAL SENSING AND MONITORING, THERMAL IMAGERY SYSTEMS FOR REMOTE OBSERVATION AND AIMING FOR MISSILE TRACKING, NAVAL ELECTRO-OPTICAL LINE OF SIGHT, ALL-WEATHER SURVEILLANCE OF SECURITY-SENSITIVE AREAS AND LINE OF SIGHT OBSERVATION FOR VEHICULAR USE, AND LIGHT AND MEDIUM ANTI-AIRCRAFT GUNS FOR BARREL OR TURRET MOUNTING CONSISTING OF AIMING OPTICS, LASER RANGE FINDERS, DRIVE SERVERS FOR STORAGE AND, LASER RANGE FINDERS AND DIGITAL COMPUTERS, ARTILLERY FIRE CONTROL SYSTEMS COMPRISED OF SENSOR COMPUTERS FOR LOCAL CONTROL OF GUNS AND ANTI-AIRCRAFT, COMPRISED OF OPTICAL SIGHTS, DATA INTRODUCTION PANELS FOR MANAGING INFORMATION ON THE BATTLE FIELD, ON-BOARD COMPUTERS, AND RADAR STATIONS COMPRISED OF RADAR COMPUTER DATA RECEIVER AND SENDING APPARATUS, SIMULATED TRAINER AND FLIGHT SIMULATORS FOR TRAINING WITH ANTI-AIRCRAFT GUNS; COMPUTER TO COMPUTER MORTAR-FIRING DATA AND PRINTER-RECORDERS USED WITH COMPUTERS, ON-BOARD GYROSCOPES FOR SPIN CORRECTION, HYDRAULIC SERVO UNIT IN THE NATURE OF MOTOR CONTROLLERS TO ACTUATE FLIGHT DIRECTION UNITS, ON-BOARD MISSILE GUIDANCE AIDS FOR INFRA-RED SENSORS IN THE NATURE OF ELECTRONIC PROGRAMMED APPARATUS FOR ENVIRONMENTAL MONITORING AND MANAGEMENT SYSTEMS CONSISTING OF THERMAL ELECTROMAGNETIC RADIO AND OPTIC SENSORS AND PROBES WHICH SEND THE SENSED DATA TO COMPUTERS AND PROGRAMS FOR PROCESSING THIS INFORMATION FOR ENVIRONMENTAL AND CIVIL DEFENSE USE; PHOTOGRAPHIC, CINEMATOGRAPHIC AND OPTICAL APPARATUS AND INSTRUMENTS, NAMELY, PERISCOPES, THERMAL CAMERAS FOR GENERAL OBSERVATION AND BATTLEFIELD, AIRBORNE AND SHIPBOARD OBSERVATION AND AIMING, SURVEILLANCE DETECTION AND TARGET PURSUIT GUIDANCE SYSTEMS COMPRISING INFRA-RED SENSORS, COMPUTERS WITH SEARCHING ALGORITHMS, AUTOMATIC SWITCHBOARDS, ELECTRO-OPTIC MICRO SENSORS FOR AVIONICS USE IN AIDING NAVIGATION, OBSERVATION AND AIMING FOR AIRBORNE SURVEILLANCE, AIRBORNE ENVIRONMENTAL SENSING AND MONITORING, THERMAL IMAGERY SYSTEMS COMPRISED OF COMPUTERS FOR REMOTE OBSERVATION AND AIMING FOR MISSILE TRACKING, NAVAL ELECTRO-OPTICAL LINE OF SIGHT, ALL-WEATHER SURVEILLANCE OF SECURITY-SENSITIVE AREAS AND LINE OF SIGHT OBSERVATION FOR VEHICULAR USE, AND VIDEO HEAD MOUNTED DISPLAY AND ELECTRIC CABLE FOR USE IN CONNECTION WITH THESE DEVICES, PANORAMIC PERISCOPIC LASER SIGHTS FOR TANKS, BALLISTIC DIGITAL MICROPROCESSORS FOR FIRE CONTROLS, COMMANDER AND LOADER CONTROL PANELS FOR CONTROLLING TANK ATTITUDE, CROSS WIND PRESENCE, POWER AND TEMPERATURE-SENSITIVITY, TV CAMERAS FOR ARTIFICIAL VISION AND THERMAL ELECTROMAGNETIC SENSORS WITH REAL TIME IMAGE PROCESSING FOR ROBOTICS APPLICATIONS USED FOR SAFETY OPERATIONS AND HANDLING SUSPICIOUS OR DANGEROUS OBJECTS, OPTICAL MONITORS AND VIDEO CAMERA UNITS FOR OBSERVATION OF IN-SPACE CRYSTALLIZATION, ROBOTIC VIDEO CAMERA UNITS FOR SPACE-VEHICLE UTILIZATION, FEATURING RENDEZVOUS AND DOCKING, VISION, GUIDANCE, INSPECTION AND MONITORING, SPECTROMETERS FOR STUDY OF CELESTIAL BODIES, PHOTOGRAPHIC LENSES, CAMERAS, LENS MOUNTS, MICROSCOPES, TELESCOPES, SPY GLASSES AND BINOCULARS, OSCILLOGRAPHIC AND ELECTRONIC SCANNERS, INFRARED NIGHT VISION APPARATUS FOR OBSERVATION AT NIGHT OR IN LIMITED VISIBILITY CONDITIONS, NAMELY, INFRA-RED CAMERAS, NIGHT VISION GOGGLES; OPTICAL SYSTEMS COMPRISED OF OPTICAL MONITORS, OPTICAL TRANSCEIVERS, CABLES FOR ELECTRICAL OR OPTI-

CAL SIGNAL TRANSMISSION PERMITTING MICROSCOPIC ILLUMINATION AND FILMING OF FLUIDS UNDER EXAMINATION, SATELLITE-BORNE ALUMINUM PLANE MIRRORS AND BAFFLES, OPTICAL MONITORS FOR TESTING MATERIALS, DATA LOGGERS FOR TESTING MATERIALS COMPUTER PROGRAMS FOR GRAPHIC EDITING OF MAPS, COMPUTER GRAPHIC EDITORS, INFRARED ELECTRONIC CAMERAS FOR HEAT-SENSITIVE OBSERVATION PHOTOGRAPHY; ELECTRO-OPTIC IMAGE ANALYZERS FOR CONTACT LESS DIMENSIONAL MEASUREMENT AND TESTING; LIFE-SAVING APPARATUS AND INSTRUMENTS, NAMELY, EMERGENCY POWER FAILURE LIGHTS, BULLET-PROOF VESTS AND CLOTHING, SAFETY HELMETS, SAFETY GOGGLES, LIFE-SAVING RAFTS, LIFE JACKETS, LIFE-BUOYS, GAS MASKS, NAVIGATIONAL BUOYS, ELECTRO MECHANICAL AND ELECTRONIC SIGNAL LIGHTS AND MOVEABLE SCREEN SIGNALS FOR RAILWAY AND URBAN TRANSIT STATIONS AND LINES, SWITCH CONTROL BOXES, COLORED LIGHT SIGNALS AND MOVABLE SCREEN SIGNALS ALL FOR RAILWAY AND URBAN TRANSIT STATIONS, ILLUMINATED DIAGRAM AND INTERLOCK BOARD CHRONOLOGICAL EVENT DETECTORS FOR RECORDING CHANGES IN THE OPERATION OF RAILWAY EQUIPMENT, AC/DC SUBSTATIONS COMPRISED OF POWER-LINE TRANSMISSION MACHINES AND APPARATUS WHICH PROVIDE ELECTRICAL POWER TO RAILWAY NETWORKS AND URBAN TRANSIT AND TROLLEY-BUS NETWORKS, REGULATED AND REGENERATIVE SUBSTATIONS COMPRISED OF ELECTRICAL TRANSFORMERS, ELECTRIC CURRENT SWITCHES WHICH PROVIDE POWER TO RAILWAY NETWORKS, SILICON RECTIFIERS FOR SUBSTATIONS; SCIENTIFIC APPARATUS AND INSTRUMENTS, NAMELY, SPACE STATIONS SATELLITES, GROUND STATIONS COMPRISED OF COMPUTER SOFTWARE FOR EARTH OBSERVATION, LAUNCHING AND RETRIEVAL OF SATELLITES, TELECOMMUNICATIONS METEOROLOGY, ENVIRONMENTAL MANAGEMENT AND IMAGE TRANSMISSION, RECEPTION AND PROCESSING AND RADAR INSTRUMENTS FOR EARTH OBSERVATION, LAUNCHING AND RETRIEVAL OF SATELLITES, TELECOMMUNICATIONS METEOROLOGY, ENVIRONMENTAL MANAGEMENT AND IMAGE TRANSMISSION, AND RECEPTION AND PROCESSING, NAMELY, RADAR, SONAR AND MAGNETIC MINE DETECTORS AND DEGAUSSERS FOR DEMAGNETIZING; SCIENTIFIC APPARATUS AND INSTRUMENTS, NAMELY, MOBILE CELLULAR TELEPHONES WITH REPEATERS AND USER TERMINALS; SHIP BORNE OPTO-ELECTRONIC SYSTEMS COMPRISED OF INFRARED SENSORS FOR REMOTE OBSERVATION AND AIMING FOR MISSILE TRACKING, NAVAL ELECTRO-OPTICAL LINE OF SIGHT, ALL-WEATHER SURVEILLANCE OF SECURITY-SENSITIVE AREAS AND LINE OF SIGHT OBSERVATION FOR VEHICULAR USE, LASER SENSORS FOR REMOTE OBSERVATION AND AIMING FOR MISSILE TRACKING, NAVAL ELECTRO-OPTICAL LINE OF SIGHT, ALL-WEATHER SURVEILLANCE OF SECURITY-SENSITIVE AREAS AND LINE OF SIGHT OBSERVATION FOR VEHICULAR USE, COMPUTERS WITH SEARCHING AND TRACKING ALGORITHMS TO BE USED FOR SURVEILLANCE, TARGET DETECTION, RECOGNITION, IDENTIFICATION AND TRACKING, AND FIRE CONTROL OF NAVY ARTILLERY; RECONNAISSANCE, TARGET ACQUISITION, SURVEILLANCE, COMMAND AND CONTROL SYSTEMS FOR MILITARY, HOMELAND SECURITY, CRISIS MANAGEMENT, BORDER CONTROL AND LAW ENFORCEMENT APPLICATIONS ON LAND, AIR AND SEA, INCLUDING SENSORS, NAMELY, VISIBLE AND INFRARED LIGHT IMAGING SENSORS FOR OBSERVATION AT NIGHT OR IN LIMITED VISIBILITY CONDITIONS, SENSORS AND LASERS USED FOR RANGE FINDING AND COMBAT IDENTIFICATION AND TARGET DESIGNATION, RADAR, COMPUTER HARDWARE, SOFTWARE PROGRAMS FOR CHECKING THE INTEGRITY OF DATA GENERATED IN COMBAT MISSIONS OR COMBAT SIMULATIONS, AND SENSORS SOFTWARE FOR THE COORDINATION OF OPERATIONS, RECONNAISSANCE, SURVEILLANCE, TARGET ACQUISITION AND CONTROL OF THE FIRING OF ARMAMENTS (U.S. CLS. 21, 23, 26, 36 AND 38).

CLASS 14—JEWELRY

FOR PRECIOUS METALS AND THEIR ALLOYS; GOODS MADE OF PRECIOUS METAL OR PLATED THEREWITH, NAMELY, BOXES OF PRECIOUS METALS, FIGURINES OF PRECIOUS METALS, ORNAMENTAL PINS, TIE PINS AND TIE CLIPS; JEWELLERY; PRECIOUS STONES; HOROLOGICAL AND CHRONOMETRIC INSTRUMENTS (U.S. CLS. 2, 27, 28 AND 50).

CLASS 16—PAPER GOODS AND PRINTED MATTER

FOR PAPER, CARDBOARD AND GOODS MADE FROM THESE MATERIALS, NAMELY, ENVELOPES, POUCHES OF PAPER FOR PACKAGING, BOOKLETS IN THE FIELD OF AFRICA, SOCIAL RESPONSIBILITY, NATURE, ENVIRONMENT, GEOGRAPHY, SUSTAINABILITY, RELIGION, ETHNICITY, CHARITABLE ACTIVITIES, BOOKS IN THE FIELD OF AFRICA, SOCIAL RESPONSIBILITY, NATURE, ENVIRONMENT, GEOGRAPHY, SUSTAINABILITY, RELIGION, ETHNICITY, CHARITABLE ACTIVITIES, BOXES OF CARDBOARD OR PAPER, CALENDARS, CATALOGUES FEATURING CLOTHING, JEWELRY, BOOKS, CARDBOARD TUBES, CARDS, NAMELY, GREETING CARDS, TRIVIA CARDS, OCCASION CARDS, PICTURE CARDS, MOTIVATIONAL CARDS, BUSINESS CARDS, COVERS, NAMELY, BOOK COVERS, CHECKBOOK COVERS, PASSPORT COVERS, PAPER REPORT COVERS; PRINTED MATTER, NAMELY, ALBUMS FOR STICKERS, COINS, PHOTOGRAPH, SCRAPBOOK AND STAMPS; ALMANACS, GREETING CARDS, HANDBOOKS IN THE FIELD OF AFRICA, SOCIAL RESPONSIBILITY, NATURE, ENVIRONMENT, GEOGRAPHY, SUSTAINABILITY, RELIGION, ETHNICITY, CHARITABLE ACTIVITIES, NOTE BOOKS, PACKING PAPER, POSTERS, STICKERS; PUBLICATIONS, NAMELY, BOOKS, MAGAZINES, BROCHURES, BOOKLETS, HAND-OUTS, WORKBOOKS, JOURNALS, PLAYBOOKS, WORKSHEETS AND CARDS ABOUT AFRICA, SOCIAL RESPONSIBILITY, NATURE, ENVIRONMENT, GEOGRAPHY, SUSTAINABILITY, RELIGION, ETHNICITY, CHARITABLE ACTIVITIES; BOOKBINDING MATERIAL, NAMELY, BOOK COVERS, CRACK-AND-PEEL BINDING PAPER, REINFORCEMENT STRIPS, PEEL-AND-STICK LABELS, STAPLER AND STAPLES; PHOTOGRAPHS; STATIONERY; ADHESIVES FOR STATIONERY OR HOUSEHOLD PURPOSES; ARTISTS' MATERIALS, NAMELY, FOUNTAIN PENS, PAINT BOXES, PENCILS, PRINTING BLOCKS, DRAWING BOOKS, PAINT BRUSHES; TYPEWRITERS AND OFFICE REQUISITES, NAMELY, ENVELOPE SEALING MACHINES, ADHESIVE TAPE DISPENSERS, CORRECTING FLUID FOR TYPE, ELECTRIC PAPER HOLE PUNCHES, STAPLERS, RUBBER BANDS; INSTRUCTIONAL AND TEACHING MATERIAL IN THE FIELDS OF AFRICA, SOCIAL RESPONSIBILITY, NATURE, ENVIRONMENT, GEOGRAPHY, SUSTAINABILITY, RELIGION, CHARITABLE ACTIVITIES; PLASTIC MATERIALS FOR PACKAGING, NAMELY, PLASTIC POUCHES; PRINTERS' TYPE (U.S. CLS. 2, 5, 22, 23, 29, 37, 38 AND 50).

CLASS 18—LEATHER GOODS

FOR LEATHER AND IMITATION LEATHER; GOODS MADE OF LEATHER AND IMITATION LEATHER, NAMELY, LEATHER CASES, IMITATION LEATHER PURSES; ANIMAL SKINS AND HIDES; BAGS, NAMELY, SCHOOL BAGS, SPORT BAGS, HIKING BAGS, TEXTILE SHOPPING BAGS, TRAVELLING BAGS, TRAVELLING SETS, NAMELY, SUITCASES, WALLETS, HANDBAGS, BRIEFCASES; TRUNKS AND SUITCASES; UMBRELLAS, PARASOLS AND WALKING STICKS; WHIPS, HARNESS AND SADDLERY (U.S. CLS. 1, 2, 3, 22 AND 41).

CLASS 25—CLOTHING

FOR CLOTHING, NAMELY, TEE-SHIRTS, BATH ROBES, CAMISOLES, BELTS, CLOTHING FOR GYMNASTICS, NAMELY, UNITARDS, GYM SUITS, GYM PANTS, GYM SHORTS, SWEAT SUITS, SWEATSHIRTS, SWEAT PANTS, COATS, PARKAS, MOTORISTS' CLOTHING, NAMELY, CHAPS, LEATHER PANTS, VESTS, WIND VESTS, JACKETS, NECKTIES, OVERALLS, OVERCOATS, PANTS, SWEATERS, PULLOVERS, SHIRTS, SKIRTS, WRISTBANDS, TROUSERS; FOOTWEAR, NAMELY, FOOTBALL SHOES, GYMNASTIC SHOES; HEADGEAR, NAMELY, BANDANAS, BERETS, CAP PEAKS, CAPS, HATS (U.S. CLS. 22 AND 39).

CLASS 36—INSURANCE AND FINANCIAL

FOR INSURANCE SERVICES, NAMELY, INSURANCE AGENCY AND BROKERAGE; FINANCIAL, MONETARY AND BANKING AFFAIRS, NAMELY, BANKING SERVICES, FINANCIAL ADVICE, MONETARY EXCHANGE, FUNDRAISING AND FISCAL SPONSORSHIP, NAMELY, PROVIDING FUND RAISING ACTIVITIES, SUPPLEMENTAL FUNDING, CAPITAL IMPROVEMENT FUNDING, SCHOLARSHIPS AND FINANCIAL ASSISTANCE FOR PROGRAMS AND SERVICES OF OTHERS, FUND RAISING FOR OTHERS FOR THE PURPOSE OF PURCHASING COMPANIES; REAL ESTATE AFFAIRS, NAMELY, REAL ESTATE AGENCIES, REAL ESTATE BROKERAGE (U.S. CLS. 100, 101 AND 102).

CLASS 37—CONSTRUCTION AND REPAIR

FOR BUILDING CONSTRUCTION; REPAIR OF BUILDINGS, AUTOMOBILES, CAMERAS; INSTALLATION SERVICES, NAMELY, INSTALLATION OF SOLAR THERMAL INSTALLATIONS, DOORS AND WINDOWS, TELEPHONE LINES (U.S. CLS. 100, 103 AND 106).

CLASS 40—MATERIAL TREATMENT

FOR TREATMENT OF MATERIALS, NAMELY, METAL TREATMENT, PAPER TREATMENT (U.S. CLS. 100, 103 AND 106).

CLASS 41—EDUCATION AND ENTERTAINMENT

FOR EDUCATION SERVICES, NAMELY, OPERATING SCHOOLS, ORGANIZING EXHIBITIONS, PROVIDING INFORMATION ABOUT EDUCATION AND TEACHING IN THE FIELD OF RELIGION, EDUCATION, SUSTAINABILITY, NATURE, ETHNICITY, GEOGRAPHY, AFRICA, HISTORY, SOCIAL RESPONSIBILITY; PROVIDING OF TRAINING, NAMELY, ARRANGING AND CONDUCTING COLLOQUIUMS, CONCERTS, CONFERENCES, CONGRESSES, SEMINARS, SYMPOSIUMS AND WORKSHOPS IN THE FIELD OF SUSTAINABILITY, NATURE, ETHNICITY, GEOGRAPHY, AFRICA, HISTORY, SOCIAL RESPONSIBILITY; ENTERTAINMENT SERVICES, NAMELY, PROVIDING INFORMATION ABOUT RECREATION, SPORTING AND CULTURAL ACTIVITIES (U.S. CLS. 100, 101 AND 107).

CLASS 44—MEDICAL, BEAUTY AND AGRICULTURAL SERVICES

FOR MEDICAL SERVICES; VETERINARY SERVICES; HYGIENIC AND BEAUTY CARE FOR HUMAN BEINGS OR ANIMALS; AGRICULTURE AND FORESTRY SERVICES, NAMELY, ANIMAL GROOMING AND HORTICULTURE (U.S. CLS. 100 AND 101).

CLASS 45—PERSONAL AND LEGAL SERVICES

FOR LEGAL SERVICES; SECURITY SERVICES FOR THE PROTECTION OF PROPERTY AND INDIVIDUALS, NAMELY, SECURITY GUARD SERVICES, SECURITY INSPECTION SERVICES FOR OTHERS, MONITORING SECURITY SYSTEMS; PERSONAL AND SOCIAL SERVICES RENDERED BY OTHERS TO MEET THE NEEDS OF INDIVIDUALS, NAMELY, PERSONAL LETTER WRITING, PERSONAL SHOPPING FOR OTHERS, SOCIAL INTRODUCTION AGENCIES, ON-LINE SOCIAL NETWORKING SERVICES (U.S. CLS. 100 AND 101).
MATTHEW EINSTEIN, EXAMINING ATTORNEY

SN 79-070,505. THE FOOTBALL ASSOCIATION LIMITED, UNITED KINGDOM, FILED 5-8-2009.



PRIORITY DATE OF 11-11-2008 IS CLAIMED.
OWNER OF INTERNATIONAL REGISTRATION 1006723 DATED 5-8-2009, EXPIRES 5-8-2019.
THE MARK CONSISTS OF A CREST SHOWING THREE LIONS SURROUNDED BY FLOWERS.

CLASS 25—CLOTHING

FOR CLOTHING, NAMELY, TRACK SUITS, SHIRTS, SWEATSHIRTS, SWEATERS, T-SHIRTS, SHORTS, TOPS, SKIRTS, TROUSERS, DUNGAREES, SOCKS, GLOVES, TIES FOR WEAR, SCARVES, CLOTH BIBS, ROMPER SUITS, BABY SLEEP SUITS, ANORAKS, JACKETS, RAINWEAR, DRESSING GOWNS, PYJAMAS, BOXER SHORTS, BABY BOOTS, BELTS FOR WEAR, BRACES, WRIST BANDS, SWIMWEAR, SPORTS JERSEYS, POLO SHIRTS, CARDIGANS, SINGLETs, SUITS, VESTS, WARM-UP TOPS, WARM-UP SUITS, WARM-UP PANTS AND TROUSERS, SHORTS, SKIRTS, DRESSES, UNIFORMS, PARKAS, COATS, NIGHTSHIRTS, BATH ROBES, HOSIERY, MITTENS, SHAWLS, APRONS, BATHING SUITS, BIKINIS, SWIM TRUNKS, BOARD SHORTS, WET SUITS, BEACH COVER-UPS, BABY SLEEP SUITS; FOOTWEAR; HEADGEAR, NAMELY, HATS, CAPS, BEANIES, VISORS, EAR MUFFS, EAR WARMERS, BANDANAS, HEAD BANDS, SWIM CAPS, BATHING CAPS (U.S. CLS. 22 AND 39).

CLASS 38—COMMUNICATION

FOR TELECOMMUNICATION ACCESS SERVICES, NAMELY, PROVIDING USER ACCESS TO THE INTERNET IN THE NATURE OF INTERNET SERVICE PROVIDERS; TELECOMMUNICATION SERVICES, NAMELY, ELECTRONIC MAIL SERVICES, TRANSMISSION OF VOICE, AUDIO, DATA INFORMATION VIA TELECOMMUNICATIONS NETWORKS AND STREAMING OF AUDIO AND VISUAL MATERIAL ON THE INTERNET; COMMUNICATIONS SERVICES, NAMELY, SIGNAL TRANSMISSION FOR ELECTRONIC COMMERCE VIA TELECOMMUNICATION SYSTEMS AND DATA COMMUNICATIONS SYSTEMS; BROADCASTING SERVICES, NAMELY, BROADCASTING OF RADIO, TELEVISION AND SATELLITE PROGRAMMES VIA TELECOMMUNI-

CATIONS, CABLE, FIBRE OPTIC AND TELEVISION NETWORKS; RADIO AND TELEVISION BROADCASTING SERVICES; CELLULAR TELEPHONE COMMUNICATION SERVICES; COMMUNICATIONS BY FIBRE OPTIC NETWORKS; ELECTRONIC MAIL SERVICES; PROVISION OF COMMUNICATION SERVICES BY MEANS OF COMPUTER TERMINALS; TELEVISION BROADCASTING SERVICES VIA A TELEVISION CHANNEL BROADCASTING AND TRANSMISSION OF TELEVISION PROGRAMMES; DATA TRANSMISSION, NAMELY, TRANSMISSION OF DATA, VISUAL IMAGES, SOUND, GRAPHICS AND ELECTRONIC DATA BY MOBILE TELEPHONY AND CABLE PROGRAMME SERVICES, AND FIBRE OPTICS COMMUNICATIONS NETWORKS; TRANSMISSION OF TELEVISION PROGRAMMES, TEXT, MESSAGES, INFORMATION, SOUND AND IMAGES VIA COMMUNICATION AND COMPUTER NETWORKS; COMPUTER AIDED TRANSMISSION OF INFORMATION, MESSAGES, TEXT, SOUND, IMAGES, DATA AND TELEVISION PROGRAMMES; RECEIVING AND EXCHANGE OF INFORMATION, TEXT, MESSAGES, SOUND, IMAGES AND DATA, NAMELY, ELECTRONIC BULLETIN BOARD SERVICES, ELECTRONIC NEWS SERVICES, ELECTRONIC ENTERTAINMENT SERVICES, STREAMED AUDIO SERVICES, STREAMED VIDEO SERVICES, VIDEO-ON-DEMAND SERVICES, PAY-PER-VIEW SERVICES, AUDIO-ON-DEMAND SERVICES, TELETEXT SERVICES, VIDEO-TEXT SERVICES; INTERACTIVE VIDEO MESSAGING AND TEXT MESSAGING SERVICES; NEWS INFORMATION AND NEWS AGENCY SERVICES, NAMELY, THE TRANSMISSION OF NEWS ITEMS TO REPORTING ORGANIZATIONS, NEWS BULLETIN SERVICES; ELECTRONIC MESSAGE SENDING; COMMUNICATIONS BY AND/OR BETWEEN COMPUTERS AND COMPUTER TERMINALS; COMMUNICATIONS, NAMELY, PROVIDING ACCESS TO INFORMATION, TEXT, SOUND, IMAGES AND DATA VIA COMMUNICATION AND COMPUTER NETWORKS; PORTAL SERVICES, NAMELY, PROVIDING ACCESS TO A COMMUNICATIONS OR COMPUTER NETWORK; PROVIDING ACCESS TO DATABASES INCLUDING ONLINE COMPUTER DATABASES; ELECTRONIC DISPLAY, NAMELY, TRANSMISSION OF INFORMATION, MESSAGES, TEXT, IMAGES AND DATA; ON-LINE SERVICES, NAMELY, THE PROVISION OF CHAT ROOM FOR SOCIAL NETWORKING; TRANSMISSION OF INFORMATION ON-LINE, PROVIDING ACCESS TO ON-LINE INFORMATION SERVICES; CELLULAR TELEPHONE COMMUNICATION SERVICES; INFORMATION AND ADVISORY SERVICES, NAMELY, TELECOMMUNICATIONS CONSULTING IN THE NATURE OF TECHNICAL CONSULTING IN THE FIELD OF AUDIO, TEXT, AND VISUAL DATA TRANSMISSION AND COMMUNICATION RELATING TO ANY OF THE AFORESAID SERVICES (U.S. CLS. 100, 101 AND 104).

CLASS 41—EDUCATION AND ENTERTAINMENT

FOR EDUCATION, NAMELY, PROVIDING CLASSES, SEMINARS, WORKSHOPS AND LECTURES IN THE FIELD OF SPORT; PROVISION OF TRAINING IN THE FIELD OF SPORT; ENTERTAINMENT SERVICES, NAMELY, ENTERTAINMENT OF THE NATURE OF SPORTING EVENTS, PRODUCTION AND DISTRIBUTION OF RADIO AND TELEVISION BROADCASTS RELATING TO SPORT, STREAMING OF AUDIO AND VISUAL MATERIAL ON THE INTERNET, PROVIDING ONLINE SPORTS GAMES VIA THE INTERNET, NON-DOWNLOADABLE RINGTONES, PRE-RECORDED MUSIC, VIDEO AND GRAPHICS PRESENTED TO MOBILE COMMUNICATIONS DEVICES VIA A GLOBAL COMPUTER NETWORK AND WIRELESS NETWORKS; SPORTING AND CULTURAL ACTIVITIES IN THE NATURE OF FOOTBALL GAMES, EVENTS AND FAN CLUB SERVICES; PROVISION OF INFORMATION RELATING TO SPORTING EVENTS PROVIDED ON-LINE FROM A COMPUTER DATABASE OR THE INTERNET, ESCORTING AND DIRECTING SPECTATORS, VISITORS AND VEHICLES, ALL BEING PERFORMED BY STEWARDS IN RELATION TO SPORTS EVENTS, CONFERENCES, SEMINARS, CONCERTS AND EXHIBITIONS; RECREATIONAL INFORMATION SERVICES, NAMELY, PROVIDING INFORMATION ABOUT SPORTS AND FOOTBALL; RECREATIONAL INFORMATION SERVICES PROVIDED ON COMPUTER NETWORKS AND BY TELEPHONE, IN RELATION TO

SPORTS AND FOOTBALL; PROVISION OF SPORT, ENTERTAINMENT, CULTURAL AND MUSICAL EVENTS, NAMELY, SPORTS MATCHES AND TOURNAMENTS, MUSICAL, DANCE AND THEATRICAL PERFORMANCES AND SHOWS, STAGE EVENTS RENDERED LIVE OR RECORDED FOR THE PURPOSE OF DISTRIBUTION THROUGH BROADCAST MEDIA; RENTAL OF STADIUM FACILITIES; ARRANGING AND CONDUCTING EXHIBITIONS AND SEMINARS FOR ENTERTAINMENT AND EDUCATIONAL PURPOSES; EDUCATIONAL SERVICES, NAMELY, CLASSES, SEMINARS, WORKSHOPS AND LECTURES RELATING TO SPORTS, CULTURE AND MUSIC; PRODUCTION OF TELEVISION PROGRAMMES; TRAINING SERVICES IN THE FIELD OF SPORT, NAMELY, FOOTBALL; FOOTBALL ACADEMY SERVICES, NAMELY, THE PROVISION OF TRAINING SERVICES IN THE FIELD OF FOOTBALL; EDUCATIONAL ASSESSMENT AND QUALIFICATIONS SERVICES, NAMELY, OFFERING ASSESSMENTS AND SURVEYS IN THE FIELD OF EDUCATOR TRAINING AND PERFORMANCE FOR THE PURPOSE OF IMPROVING TEACHING PROCEDURES; COACHING IN THE FIELD OF SPORTS, NAMELY, FOOTBALL; ARRANGING AND ORGANIZATION OF COMPETITIONS AND SPORTING EVENTS; PROVISION OF COURSES OF INSTRUCTION IN COACHING, SPORTS MEDICINE, PLAYER DEVELOPMENT AND CHILD PROTECTION AND WELFARE; PHYSICAL FITNESS INSTRUCTION; PRACTICAL TRAINING DEMONSTRATIONS RELATING TO FOOTBALL; PROVIDING COURSES OF INSTRUCTION IN SELF-AWARENESS; ARRANGING AND CONDUCTING EDUCATIONAL SEMINARS, EDUCATIONAL CONFERENCES, EDUCATIONAL EXHIBITIONS, EDUCATIONAL SYMPOSIA, ALL ON THE SUBJECT OF SPORTS; PROVISION OF CLUB RECREATION FACILITIES; OFFICIATING AT SPORTS CONTESTS; SPORTS CAMP SERVICES; SPORTS CLUB SERVICES IN RELATION TO FOOTBALL; PROVISION OF FACILITIES FOR SPORTS EVENTS, SEMINARS AND CONCERTS; SPORTS REFEREEING AND OFFICIATING; TIMING OF SPORTS EVENTS; ORGANIZATION OF SPORTS TOURNAMENTS; PROVISION OF FACILITIES FOR SPORTS TOURNAMENTS; PUBLICATION OF PRINTED MATTER, NAMELY, ARTICLES, POSTERS, NEWSLETTERS, MAGAZINES, BROCHURES, LEAFLETS, CATALOGUES, GAME INFORMATION AND GAME SCHEDULES AND RESULTS RELATED TO SPORTS; PROVIDING RECOGNITION AND INCENTIVES BY THE WAY OF AWARDS AND CONTESTS TO DEMONSTRATE EXCELLENCE IN THE FIELD OF SPORTS, NAMELY, AWARDS CEREMONIES; BETTING SERVICES; PUBLICATION SERVICES, NAMELY, PUBLICATION OF ARTICLES, NEWSLETTERS, MAGAZINES, BROCHURES, CATALOGUES IN THE FIELD OF SPORTS, PUBLICATION OF ELECTRONIC BOOKS AND JOURNALS; PROVIDING INFORMATION RELATING TO ALL OF THE AFORESAID SERVICES IN RELATION TO SPORT AND SPORTS ENTERTAINMENT (U.S. CLS. 100, 101 AND 107).

LEIGH CAROLINE CASE, EXAMINING ATTORNEY

SN 79-070,848. EESTI ENERGIA AKTSIASELTS, ESTONIA,
FILED 2-27-2009.

ENEFIT

PRIORITY DATE OF 1-6-2009 IS CLAIMED.
OWNER OF INTERNATIONAL REGISTRATION 1007523
DATED 2-27-2009, EXPIRES 2-27-2019.

CLASS 1—CHEMICALS

FOR CHEMICALS USED IN INDUSTRY; PHOTOGRAPHIC CHEMICALS; CHEMICALS FOR USE IN AGRICULTURE, HORTICULTURE AND FORESTRY, EXCEPT FUNGICIDES, HERBICIDES, INSECTICIDES AND PARASITICIDES; UNPROCESSED ARTIFICIAL RESINS, UNPROCESSED PLASTICS; MANURES; FIRE EXTINGUISHING COMPOSITIONS; SOLDERING CHEMICALS AND TEMPERING SUBSTANCES; CHEMICAL SUBSTANCES FOR PRESERVING FOODSTUFFS; TANNING SUBSTANCES NAMELY TANNING AGENTS FOR USE IN THE MANUFACTURE OF LEATHER AND ENZYMES FOR USE IN THE TANNING OF LEATHER; ADHESIVES USED IN INDUSTRY; PHENOL FOR INDUSTRIAL PURPOSES; GLUES FOR INDUSTRIAL PURPOSES; CHEMICAL ADDITIVES FOR MOTOR FUEL; SOLVENTS, NAMELY, AROMATIC SOLVENTS FOR INDUSTRIAL AND COMMERCIAL USE (U.S. CLS. 1, 5, 6, 10, 26 AND 46).

CLASS 4—LUBRICANTS AND FUELS

FOR INDUSTRIAL OILS AND GREASES; ALL PURPOSE LUBRICANTS; FUELS; CANDLES AND WICKS FOR CANDLES FOR LIGHTING; OIL SHALE USED AS A FUEL IN INDUSTRY; OIL SHALE FOR USE IN THE MANUFACTURE OF OIL SHALE OIL; COKE, FUEL OIL; MAZUT, NAMELY RESIDUAL FUEL OIL; MOTOR FUEL; ELECTRICAL ENERGY; OIL SHALE OIL, NAMELY CRUDE OIL THAT IS OBTAINED FROM OIL SHALE BY HEATING AND DISTILLATION (U.S. CLS. 1, 6 AND 15).

CLASS 37—CONSTRUCTION AND REPAIR

FOR BUILDING CONSTRUCTION AND REPAIR; ASPHALTING; DISINFECTING; MINING EXTRACTION; MACHINERY INSTALLATION, MAINTENANCE AND REPAIR; CLEANING OF BUILDINGS; CLEANING OF RAILROAD TANK CARS; RENTAL OF CONSTRUCTION EQUIPMENT, BURNER MAINTENANCE AND REPAIR, MOTOR VEHICLE MAINTENANCE AND REPAIR; INSULATION WORKS, NAMELY, INSTALLATION OF BUILDING INSULATION; PIPELINE CONSTRUCTION AND MAINTENANCE; FURNACE INSTALLATION AND REPAIR (U.S. CLS. 100, 103 AND 106).

JANICE KIM, EXAMINING ATTORNEY

CLASS 3—COSMETICS AND CLEANING PREPARATIONS

FOR COSMETIC PRODUCTS, NAMELY, LOTIONS FOR COSMETIC PURPOSES, SKIN CREAMS, SKIN LOTIONS, ANTI-AGING CREAMS, ANTI-WRINKLE CREAMS, FACE CREAMS, NIGHT CREAMS, TISSUES IMPREGNATED WITH COSMETIC LOTIONS, HAND LOTIONS, BEAUTY MASKS, HAND CREAMS, SKIN WHITENING CREAMS, HAIR CARE CREAMS, HAIR LOTIONS, DEPILATORIES, DEPILATORY WAX, SHAVING SOAPS, SHAVING CREAMS, AFTER SHAVE LOTIONS, SUN CREAMS, SUN CARE LOTIONS, SUN TAN LOTIONS, SUN-BLOCK LOTIONS, SUN TANNING PREPARATIONS, SELF-TANNING PREPARATIONS, COSMETIC SOAPS, BATH BEADS, TALCUM POWDER FOR TOILET USE, CLEANSING MILK FOR TOILET PURPOSES, BABY OILS, BABY POWDERS, ESSENTIAL OILS FOR PERSONAL USE, NON-MEDICATED BATH SALTS, SKIN MOISTURIZER, HAND CREAMS, NAIL CARE PREPARATIONS, NON-MEDICATED LIP CARE PREPARATIONS, AND COSMETIC PREPARATIONS FOR SLIMMING PURPOSES, NAMELY, CREAMS FOR CELLULITE REDUCTION AND LOTIONS FOR CELLULITE REDUCTION; MAKE-UP PREPARATIONS, HAIR CARE PREPARATIONS, PERFUMES, PERFUMERY, ACCESSORIES FOR THE SKIN, NAMELY, ORNAMENTS, TRANSFERS AND STICKERS FOR FACE AND BODY, ALL FOR COSMETICS PURPOSES; FALSE EYEBROWS, MAKE-UP REMOVING PREPARATIONS; MAKE-UP AND NON-MEDICATED SKIN CARE PREPARATIONS FOR THE BODY, SKIN TONE, EYES, MOUTH, NAILS AND CHEEKS; TEMPORARY TATTOOS (U.S. CLS. 1, 4, 6, 50, 51 AND 52).

CLASS 21—HOUSEWARES AND GLASS

FOR MAKE-UP ACCESSORIES, NAMELY, MAKE-UP BRUSHES, COSMETIC BRUSHES, POWDER PUFFS; MAKE UP STENCILS (U.S. CLS. 2, 13, 23, 29, 30, 33, 40 AND 50).

CLASS 44—MEDICAL, BEAUTY AND AGRICULTURAL SERVICES

FOR BEAUTY SALONS; WELLNESS SALONS, NAMELY, SKIN CARE SALONS, HAIRDRESSING SALONS, AND MASSAGE SALONS; BEAUTY ADVICE; MAKE-UP ADVICE; NEW IMAGE ADVICE, NAMELY, PROVIDING INFORMATION IN THE FIELD OF PERSONAL BEAUTY; HYGIENIC AND BEAUTY CARE FOR HUMANS BEINGS AND ANIMALS (U.S. CLS. 100 AND 101).

LIEF MARTIN, EXAMINING ATTORNEY

SN 79-070,989. NEED SARL, FRANCE, FILED 11-10-2008.

FRED FARRUGIA

THE MARK CONSISTS OF STANDARD CHARACTERS WITHOUT CLAIM TO ANY PARTICULAR FONT, STYLE, SIZE, OR COLOR.

PRIORITY DATE OF 6-9-2008 IS CLAIMED.

OWNER OF INTERNATIONAL REGISTRATION 1007923 DATED 11-10-2008, EXPIRES 11-10-2018.

THE NAME(S), PORTRAIT(S), AND/OR SIGNATURE(S) SHOWN IN THE MARK IDENTIFIES "FRED FARRUGIA", WHOSE CONSENT(S) TO REGISTER IS MADE OF RECORD.

SN 79-071,123. TROVIT SEARCH, S.L., BARCELONA, SPAIN, FILED 4-30-2009.



OWNER OF INTERNATIONAL REGISTRATION 1008246 DATED 4-30-2009, EXPIRES 4-30-2019.

THE COLOR(S) LIGHT ORANGE, DARK ORANGE, LIGHT GREEN, DARK GREEN IS/ARE CLAIMED AS A FEATURE OF THE MARK.

THE MARK CONSISTS OF THE FOLLOWING: THE STYLIZED WORDING "TROVIT". THE LETTERS "TROW" AND "T" APPEAR IN LIGHT GREEN AND DARK GREEN. THE LETTER "I" APPEARS IN DARK ORANGE AND LIGHT ORANGE, AND THE CURVED BAND APPEARS IN LIGHT ORANGE.

THE WORDING "TROVIT" HAS NO MEANING IN A FOREIGN LANGUAGE.

CLASS 38—COMMUNICATION

FOR TELECOMMUNICATIONS SERVICES, NAMELY, TRANSMISSION OF GRAPHICS AND IMAGES BY MEANS OF TELECOMMUNICATIONS NETWORKS, WIRELESS COMMUNICATION NETWORKS, AND THE INTERNET (U.S. CLS. 100, 101 AND 104).

CLASS 41—EDUCATION AND ENTERTAINMENT

FOR EDUCATIONAL SERVICES, NAMELY, PROVIDING CLASSES, SEMINARS AND WORKSHOPS IN THE FIELD OF BUSINESS; PROVIDING TRAINING IN THE FIELD OF COMPUTER EDUCATION; AND ORGANIZING CULTURAL EVENTS (U.S. CLS. 100, 101 AND 107).
KRISTINA MORRIS, EXAMINING ATTORNEY

CLASS 42—SCIENTIFIC AND COMPUTER SERVICES

FOR DEVELOPMENT AND CALCULATION OF CONSTRUCTION ELEMENTS OF WOOD AND STACKING COMPONENTS OF WOOD; CALCULATION AND DETERMINATION OF STATISTICAL AND BUILDING PHYSICAL VALUES OF CONSTRUCTION ELEMENTS OF WOOD AND OF STACKING COMPONENTS OF WOOD. ALL AFOREMENTIONED SERVICES FOR ENGINEERING (U.S. CLS. 100 AND 101).
KRISTINA MORRIS, EXAMINING ATTORNEY

SN 79-071,657, CORBETT RESEARCH PTY LTD, AUSTRALIA, FILED 3-20-2009.

SN 79-071,503, KLH MASSIVHOLZ GESMBH, AUSTRIA, FILED 3-27-2009.

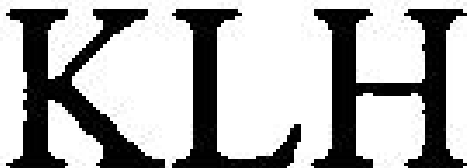

THE MARK CONSISTS OF STANDARD CHARACTERS WITHOUT CLAIM TO ANY PARTICULAR FONT, STYLE, SIZE, OR COLOR.

PRIORITY DATE OF 12-23-2008 IS CLAIMED.
OWNER OF INTERNATIONAL REGISTRATION 1009281 DATED 3-27-2009, EXPIRES 3-27-2019.

CLASS 19—NON-METALLIC BUILDING MATERIALS

FOR BUILDING MATERIALS MADE OF WOOD, NAMELY, FLOORING AND ROOFING UNDERLAYMENT, SHEATHING, PANELLING, SIDING, TILE-BOARDS, BEAMS, LUMBER, COMPOSITE WOOD PRODUCTS IN THE NATURE OF PANELS, ENGINEERED WOOD PRODUCTS IN THE NATURE OF PANELS, BOARDS, I-BEAMS, LAMINATED LUMBERS, JOISTS, POSTS, PLANKS, WALL-BOARDS, BOARDS OF WOOD, WOODEN WALL SLABS FOR BUILDINGS, WOODEN CEILING SLABS FOR BUILDINGS, WOODEN BEAMS; CONSTRUCTION ELEMENTS OF WOOD, NAMELY, PANELS, EXTERIOR AND INTERIOR MOLDINGS, DENTILS, DENTIL BLOCKS, EXTERIOR MOUNTING BLOCKS, WALL TILES, CEILING PANELS AND TILES, PREFABRICATED BUILDINGS MADE FROM WOOD, PREFABRICATED WOODEN AND LUMBER HOUSES; PRESSED, SIZED AND GLUED CONSTRUCTION ELEMENTS OF WOOD, NAMELY, LUMBER, PLYWOOD, BOARDS, DECKING, SPINDLES, POSTS, POST CAPS, SEMI-WORKED WOODS, WOOD BOARDS, SLABS MADE FROM BOUNDED OR GLUED WOOD STICKS OR WOOD BEAMS, CROSS-LAMINATED TIMBER, CROSS-LAMINATED TIMBER SLABS AND BEAMS, CROSS-LAMINATED TIMBER BOARDS, CROSS-LAMINATED TIMBER PRODUCED FROM SPRUCE-STRIPS WHICH ARE STACKED CROSS-WISE ON TOP OF EACH OTHER AND GLUED TO EACH OTHER, SLABS AND BARS MADE FROM CROSS-LAMINATED TIMBER AND STACKS OF WOOD POLES AND WOOD BOARDS (U.S. CLS. 1, 12, 33 AND 50).

QIExtractor

THE MARK CONSISTS OF STANDARD CHARACTERS WITHOUT CLAIM TO ANY PARTICULAR FONT, STYLE, SIZE, OR COLOR.

PRIORITY DATE OF 9-24-2008 IS CLAIMED.
OWNER OF INTERNATIONAL REGISTRATION 1009688 DATED 3-20-2009, EXPIRES 3-20-2019.

CLASS 1—CHEMICALS

FOR CHEMICAL, BIOCHEMICAL AND BIOTECHNOLOGICAL PRODUCTS FOR INDUSTRIAL AND SCIENTIFIC PURPOSES, IN PARTICULAR NUCLEIC ACIDS, ENZYMES, POLYMERASES, REAGENTS FOR STAINING AND MARKING, MOLECULAR PROBES, BUFFER, AQUEOUS AND NON-AQUEOUS SOLUTIONS OF ALCOHOLS AND SALTS, DISTILLED AND PURIFIED WATER, SILICA IN POWDERED, GRANULATE AND GEL FORM AND MAGNETIC PARTICLES IN FLUID FORM, NONE OF THE FOREGOING FOR MEDICAL OR VETERINARY PURPOSES; MATERIALS FOR COLUMNS AND REAGENTS AND SOLVENTS FOR SAMPLE PREPARATION, ALL OF THE FOREGOING FOR THE PURPOSE OF PURIFICATION, LYSIS, MODIFICATION AND MANIPULATION OF CELLS, AS WELL AS FOR THE PERFORMANCE OF MARKING, SEPARATION, ISOLATION, PURIFICATION, AMPLIFICATION AND ANALYTICAL METHODS FOR BIOPOLYMERS, IN PARTICULAR NUCLEIC ACIDS, ENZYMES, PROTEINS, MACRO MOLECULES AND BIOLOGICALLY ACTIVE SUBSTANCES FOR SEPARATION, ANALYSIS AND PURIFICATION OF BIOLOGICAL AND BIOCHEMICAL COMPOUNDS, NONE OF THE FOREGOING FOR MEDICAL OR VETERINARY PURPOSES; KITS COMPRISING CHEMICAL, BIOCHEMICAL AND BIOTECHNOLOGICAL PRODUCTS FOR SAMPLE PREPARATION, PURIFICATION, LYSIS, MODIFICATION AND MANIPULATION OF CELLS AS WELL AS FOR THE PERFORMANCE OF MARKING, SEPARATION, ISOLATION, PURIFICATION, AMPLIFICATION AND ANALYTICAL METHODS FOR BIOPOLYMERS, IN PARTICULAR NUCLEIC ACIDS, ENZYMES, PROTEINS, MACRO MOLECULES AND BIOLOGICALLY ACTIVE SUBSTANCES FOR SEPARATION, ANALYSIS AND PURIFICATION OF BIOLOGICAL AND BIOCHEMICAL COMPOUNDS, IN PARTICULAR NUCLEIC ACIDS MADE FROM BIOLOGICAL AND BIOCHEMICAL SAMPLE MATERIAL, NONE OF THE FOREGOING FOR MEDICAL OR VETERINARY PURPOSES (U.S. CLS. 1, 5, 6, 10, 26 AND 46).

CLASS 5—PHARMACEUTICALS

FOR PRODUCTS FOR MEDICAL AND VETERINARY MEDICAL PURPOSES, IN PARTICULAR DIAGNOSTIC PREPARATIONS, IN PARTICULAR NUCLEIC ACIDS, ENZYMES, POLYMERASES, REAGENTS FOR STAINING AND MARKING, MOLECULAR PROBES, BUFFER CHEMICALS AND AQUEOUS AND NON-AQUEOUS SOLUTIONS OF PRIMARY, SECONDARY AND TERTIARY ALCOHOLS AND SALTS, DISTILLED AND PURIFIED WATER, MAGNETIC PARTICLES IN FLUID FORM, AND MATERIALS FOR REACTION VESSELS FOR THE PURPOSE OF PURIFICATION, LYSIS, MODIFICATION AND MANIPULATION OF CELLS, AS WELL AS FOR THE PERFORMANCE OF MARKING, SEPARATION, ISOLATION, PURIFICATION, AMPLIFICATION AND ANALYTICAL METHODS FOR BIOPOLYMERS, IN PARTICULAR NUCLEIC ACIDS, ENZYMES, PROTEINS, MACRO MOLECULES AND BIOLOGICALLY ACTIVE SUBSTANCES FOR SEPARATION, ANALYSIS AND PURIFICATION OF BIOLOGICAL AND BIOCHEMICAL COMPOUNDS, ALL OF THE FOREGOING FOR MEDICAL AND VETERINARY PURPOSES; PRODUCTS FOR MEDICAL AND VETERINARY MEDICAL PURPOSES, NAMELY, CHEMICAL, BIOCHEMICAL AND BIOTECHNOLOGICAL PRODUCTS AS WELL AS KITS COMPRISING PRODUCTS FOR MEDICAL AND VETERINARY MEDICAL PURPOSES, IN PARTICULAR CHEMICAL, BIOCHEMICAL AND BIOTECHNOLOGICAL PRODUCTS FOR SAMPLE PREPARATION, PURIFICATION, LYSIS, MODIFICATION AND MANIPULATION OF CELLS, AS WELL AS FOR THE PERFORMANCE OF MARKING, SEPARATION, ISOLATION, PURIFICATION, AMPLIFICATION AND ANALYTICAL METHODS FOR BIOPOLYMERS, IN PARTICULAR NUCLEIC ACIDS FOR MEDICAL AND VETERINARY MEDICAL PURPOSES, ENZYMES, NATURAL AND ARTIFICIAL PROTEINS, MACRO MOLECULES, AND BIOLOGICALLY ACTIVE SUBSTANCES FOR DETECTING PATHOGENS, GENETIC INFORMATION AND CONDITIONS OF THE HUMAN BODY (U.S. CLS. 6, 18, 44, 46, 51 AND 52).

CLASS 9—ELECTRICAL AND SCIENTIFIC APPARATUS

FOR SCIENTIFIC APPARATUS, INSTRUMENTS AND EQUIPMENT FOR SCIENTIFIC RESEARCH, NON-MEDICAL DIAGNOSTIC ANALYSIS, CHEMICAL ANALYSIS, CLINICAL ANALYSIS AND INDUSTRIAL USE, NAMELY, NUCLEIC ACID PURIFIERS, SEQUENCERS, POLYMERASE CHAIN REACTION (PCR) CYCLERS, THERMOCYCLERS, ELECTROPORATORS, PIPETTING EQUIPMENT, INCUBATORS, LABORATORY CENTRIFUGES; LABORATORY EQUIPMENT AND AUTOMATED LABORATORY EQUIPMENT, NAMELY, APPARATUS FOR EXTRACTION, ANALYSIS AND HANDLING OF NUCLEIC ACIDS, NUCLEIC ACID EXTRACTORS AND AUTOMATED NUCLEIC ACID EXTRACTORS; PARTS AND ACCESSORIES FOR THE FOREGOING, NAMELY, ROBOTIC PARTS, PUMPS, CARBON-FILTER PURIFIERS, WASTE COLLECTION APPARATUS AND BOTTLES, FILTER CARTRIDGES, UV LIGHT STERILIZERS, REAGENT TUBS, SAMPLE CONTAINERS, HOLDERS FOR CONTAINERS, PIPETTE TIPS, PIPETTE TIP HOLDERS, PIPETTING AIDES, MICROPLATES; COMPUTER SOFTWARE FOR OPERATION AND MAINTENANCE OF SCIENTIFIC APPARATUS, INSTRUMENTS AND EQUIPMENT, NAMELY, AUTOMATED NUCLEIC ACID EXTRACTORS; COMPUTER SOFTWARE FOR CREATING EXPERIMENTAL PROFILES, PROVIDING EXPERIMENTAL REPORTS AND REPORTS OF APPARATUS PERFORMANCE VERIFICATION (U.S. CLS. 21, 23, 26, 36 AND 38).

PAUL MORENO, EXAMINING ATTORNEY

SN 79-071,723. DR. STEFAN BRANDT, FED REP GERMANY, FILED 7-15-2009.

Elbkind

THE MARK CONSISTS OF STANDARD CHARACTERS WITHOUT CLAIM TO ANY PARTICULAR FONT, STYLE, SIZE, OR COLOR.

OWNER OF INTERNATIONAL REGISTRATION 1009903 DATED 7-15-2009, EXPIRES 7-15-2019.

THE ENGLISH TRANSLATION OF "ELBKIND" IN THE MARK IS "CHILD OF THE ELF" OR "CHILD OF THE ELBE".

CLASS 18—LEATHER GOODS

FOR BAGS, NAMELY, SPORTS BAGS, SHOULDER BAGS, BUM BAGS, HIP BAGS, SCHOOL BAGS, CARRYALL BAGS, WHEELED BAGS, TRAVELLING BAGS, WASH BAGS FOR CARRYING TOILETRIES, HIKING BAGS, ALL-PURPOSE CARRYING BAGS, BELT BAGS, MESSENGER BAGS; RUCKSACKS; BELTS, NAMELY, LEATHER SHOULDER BELTS (U.S. CLS. 1, 2, 3, 22 AND 41).

CLASS 25—CLOTHING

FOR COATS, JACKETS, SWEAT SHIRTS, SWEATERS, T-SHIRTS, PULLOVERS, UNDERWEAR, TROUSERS, SHOES, SHIRTS, CAPS, BATHING SUITS (U.S. CLS. 22 AND 39).

VERNA BETH RIRIE, EXAMINING ATTORNEY

SN 79-071,906. KADIR TARIK EDIZ, TURKEY, FILED 3-24-2009.

Tarik Ediz

OWNER OF INTERNATIONAL REGISTRATION 1010374 DATED 3-24-2009, EXPIRES 3-24-2019.

THE NAME(S), PORTRAIT(S), AND/OR SIGNATURE(S) SHOWN IN THE MARK IDENTIFIES KADIR TARIK EDIZ, WHOSE CONSENT(S) TO REGISTER IS MADE OF RECORD.

THE WORDING "TARIK EDIZ" HAS NO MEANING IN A FOREIGN LANGUAGE.

CLASS 25—CLOTHING

FOR CLOTHING, NAMELY, PANTS, SHIRTS, AND DRESSES; FOOTWEAR; AND HEADGEAR, NAMELY, HATS AND CAPS (U.S. CLS. 22 AND 39).

CLASS 35—ADVERTISING AND BUSINESS

FOR ADVERTISING; BUSINESS MANAGEMENT; BUSINESS ADMINISTRATION; PROVIDING OFFICE FUNCTIONS; THE BRINGING TOGETHER, FOR THE BENEFIT OF OTHERS, OF A VARIETY OF GOODS, ENABLING CUSTOMERS TO CONVENIENTLY VIEW AND PURCHASE THOSE GOODS IN THE FIELDS OF CLOTHING, FOOTWEAR AND HEADGEAR (U.S. CLS. 100, 101 AND 102).

HAI-LY LAM, EXAMINING ATTORNEY

SN 79-071,984. HEUZÉ PHILIPPE, FRANCE, FILED 4-9-2009.

SIMPLY DIFFERENT !

THE MARK CONSISTS OF STANDARD CHARACTERS WITHOUT CLAIM TO ANY PARTICULAR FONT, STYLE, SIZE, OR COLOR.

PRIORITY DATE OF 10-17-2008 IS CLAIMED.

OWNER OF INTERNATIONAL REGISTRATION 1010656 DATED 4-9-2009, EXPIRES 4-9-2019.

CLASS 25—CLOTHING

FOR FOOTWEAR, CAPS, CAP VISORS, HATS, SUN HATS, SCARVES, BANDANAS, SHAWLS, HEADBANDS, BATHING CAPS, BELTS, BOAS, NECKTIES, SPORTS SHOES, GOLF SHOES, BEACH SHOES, CANVAS SANDALS, BATHING SANDALS, BEACH SANDALS, BATH SLIPPERS, SLIPPERS, LEGGINGS, BATHING TRUNKS, BATHING SUITS, BERMUDA SHORTS, SWIMSUITS, BATH ROBES, SARONGS, UNDERCLOTHING, UNDERWEAR, SHIRTS, SHORT-SLEEVED SHIRTS, TANK TOPS, SINGLETS, TEE-SHIRTS, POLO SHIRTS, PULL-OVERS, SWEATERS, SWEAT SHIRTS, BLOUSES, LEOTARDS, TAILOR-MADE SUITS, TROUSERS, SHORTS, SKIRTS, DRESSES, SARIS, OVERCOATS, PARKAS, JACKETS, WATERPROOF COATS, APRONS, PAJAMAS, HOUSECOATS, PEIGNOIRS, SOCKS, GLOVES, WET SUITS FOR WATER-SKIING (U.S. CLS. 22 AND 39).

CLASS 28—TOYS AND SPORTING GOODS

FOR PARLOR GAMES, AUTOMATIC COIN-OPERATED AMUSEMENT MACHINES, GOLF BALLS, GOLF CLUBS, GOLF CLUB HEADS, BAGS AND COVERS FOR GOLF CLUBS, GOLF BALL MARKERS, GOLF GLOVES, GOLF-BALL RECOVERY NETS, TRAINING NETS FOR TRAPPING GOLF BALLS, GOLF BALL CARRIERS, GOLF CLUB HOODS (U.S. CLS. 22, 23, 38 AND 50).

KRISTIN DAHLING, EXAMINING ATTORNEY

SN 79-071,987. RELENTLESS SOFTWARE LIMITED, BRIGHTON, UNITED KINGDOM, FILED 6-5-2009.



PRIORITY DATE OF 12-8-2008 IS CLAIMED.
OWNER OF INTERNATIONAL REGISTRATION 1010664 DATED 6-5-2009, EXPIRES 6-5-2019.

NO CLAIM IS MADE TO THE EXCLUSIVE RIGHT TO USE "SOFTWARE", APART FROM THE MARK AS SHOWN. THE MARK CONSISTS OF THE WORDING "RELENTLESS SOFTWARE" IN STYLISED LETTERING TO THE RIGHT OF THE DESIGN CONSISTING OF FIVE OBLONG SHAPES FORMING A STAR.

CLASS 9—ELECTRICAL AND SCIENTIFIC APPARATUS

FOR COMPUTER GAMES ENTERTAINMENT SOFTWARE, COMPUTER GAMES PROGRAMS, COMPUTER GAMES PROGRAMS, COMPUTER GAMES PROGRAMS DOWNLOADED VIA THE INTERNET, COMPUTER GAMES PROGRAMS RECORDED ON TAPES, COMPUTER GAMES SOFTWARE, COMPUTER GAMES APPARATUS ADAPTED FOR USE WITH CATHODE RAY TUBES, COMPUTER GAMES APPARATUS ADAPTED FOR USE WITH MONITORS, COMPUTER GAMES APPARATUS ADAPTED FOR USE WITH TELEVISION RECEIVERS, COMPUTER GAMES CARTRIDGES ADAPTED FOR USE WITH TELEVISION RECEIVERS, COMPUTER PROGRAMS FOR PLAYING GAMES, COMPUTER PROGRAMS FOR PLAYING GAMES, COMPUTER PROGRAMS FOR VIDEO GAMES, ELECTRIC COMPUTER GAMES ADAPTED FOR USE WITH TELEVISION RECEIVERS, ELECTRIC COMPUTER GAMES ADAPTED FOR USE WITH VISUAL DISPLAY UNITS, ELECTRONIC GAMES ADAPTED FOR USE WITH TELEVISION RECEIVERS, ELECTRONIC GAMES CONSOLES ADAPTED FOR USE WITH TELEVISION RECEIVERS, GAMES ADAPTED FOR USE WITH TELEVISION RECEIVERS, GAMES SOFTWARE FOR USE WITH COMPUTERS, GAMES SOFTWARE FOR USE WITH TELEVISION APPARATUS, INTERACTIVE EDUCATIONAL GAMES FOR USE WITH TELEVISION RECEIVERS, INTERACTIVE EDUCATIONAL GAMES FOR USE WITH VIDEO APPARATUS, INTERACTIVE ENTERTAINMENT GAMES SOFTWARE FOR USE WITH COMPUTERS, INTERACTIVE ENTERTAINMENT GAMES SOFTWARE FOR USE WITH PERSONAL COMPUTERS, INTERACTIVE VIDEO GAMES SOFTWARE, PROGRAM CARTRIDGES FOR COMPUTER GAMES, PROGRAM DISCS FOR VIDEO GAMES, PROGRAM MEMORY CARTRIDGES FOR TELEVISION GAME SETS, PROGRAMMED VIDEO GAMES, PROGRAMMED VIDEO GAMES CONTAINED ON CARTRIDGES AS SOFTWARE, VIDEO GAMES ON DISC AS SOFTWARE, VIDEO GAMES ON TAPE AS SOFTWARE, VIDEO GAMES PROGRAMS AS SOFTWARE, VIDEO GAME PROGRAMS, VIDEO GAME CARTRIDGES, VIDEO GAME COMPUTER PROGRAMS, VIDEO GAME PROGRAMS FOR USE IN COMPUTERS, VIDEO GAME PROGRAMS FOR USE WITH COMPUTERS (U.S. CLS. 21, 23, 26, 36 AND 38).

CLASS 42—SCIENTIFIC AND COMPUTER SERVICES

FOR COMPUTER SOFTWARE DESIGN, COMPUTER SOFTWARE DEVELOPMENT, COMPUTER SOFTWARE ENGINEERING, DESIGN OF SOFTWARE, DEVELOPMENT OF SOFTWARE, PROGRAMMING OF EDUCATIONAL SOFTWARE FOR OTHERS, SERVICES FOR THE DESIGN OF COMPUTER SOFTWARE, SERVICES FOR THE WRITING OF COMPUTER SOFTWARE, SOFTWARE CREATION, SOFTWARE DESIGN, SOFTWARE DEVELOPMENT, SOFTWARE ENGINEERING, UPDATING OF COMPUTER SOFTWARE, UPGRADING OF COMPUTER SOFTWARE, WRITING OF COMPUTER SOFTWARE (U.S. CLS. 100 AND 101).

TASNEEM HUSSAIN, EXAMINING ATTORNEY

SN 79-072,022. FORALWAYS B.V., NETHERLANDS, FILED 7-21-2009.



OWNER OF INTERNATIONAL REGISTRATION 0881786 DATED 10-12-2005, EXPIRES 10-12-2015.

THE MARK CONSISTS OF FOUR POLO PLAYERS HOLDING POLO MALLETS AND RIDING HORSES DEPICTED AS SHADOWS, WITH A SINGLE NUMBER IN THE ORDER "4" "3" "2" AND "1" ON THE BACK OF EACH PLAYER'S SHIRT.

CLASS 14—JEWELRY

FOR PRECIOUS METALS AND THEIR ALLOYS; GOODS MADE OF PRECIOUS METALS OR COATED THEREWITH, NAMELY, CUFF LINKS, KEY CHAINS, HAT ORNAMENTS, JEWEL CASES, JEWELLERY CASES, ORNAMENTS, TIE CLIPS, PINS BEING JEWELRY, TROPHIES AND WATCHES; JEWELLERY; PRECIOUS STONES; BRACELETS, CHARMS AND JEWELRY CHAINS; HOROLOGICAL AND CHRONOMETRIC INSTRUMENTS (U.S. CLS. 2, 27, 28 AND 50).

CLASS 18—LEATHER GOODS

FOR LEATHER AND IMITATION LEATHER BAGS, SPORT BAGS, SUITCASES, WALLETS, GENERAL PURPOSE TROLLEY BAGS, RUCKSACKS, HANDBAGS, PURSES, BELT BAGS, SCHOOL BAGS; ANIMAL SKINS, ANIMAL HIDES, TRAVELING BAGS MADE OF LEATHER, TRUNKS, LUGGAGE AND SUITCASES, UMBRELLAS, PARASOLS, WALKING STICKS, WHIPS, HARNESES AND SADDLERY (U.S. CLS. 1, 2, 3, 22 AND 41).

CLASS 25—CLOTHING

FOR CLOTHING, NAMELY, JUMPERS, PAJAMAS, COATS, JACKETS, SWEATERS, SHIRTS, T-SHIRTS, POLO SHIRTS, PANTS, TROUSERS, SUITS, SHORTS, SCARVES, TIES, SOCKS, SWIMWEAR, DRESSES, SKIRTS, PULLOVERS, BLOUSES; SPORTSWEAR, NAMELY, JOGGING SUITS; HEADWEAR, CAPS, GLOVES, SLIPPERS, FLIP-FLOPS, UNDERWEAR (U.S. CLS. 22 AND 39).

DOUGLAS LEE, EXAMINING ATTORNEY

SN 79-072,042. NORMAN ASA, NORWAY, FILED 2-16-2009.

NORMAN

THE MARK CONSISTS OF STANDARD CHARACTERS WITHOUT CLAIM TO ANY PARTICULAR FONT, STYLE, SIZE, OR COLOR.

PRIORITY DATE OF 11-6-2008 IS CLAIMED. OWNER OF INTERNATIONAL REGISTRATION 1010810 DATED 2-16-2009, EXPIRES 2-16-2019.

CLASS 9—ELECTRICAL AND SCIENTIFIC APPARATUS

FOR DATA PROCESSING EQUIPMENT AND COMPUTERS; ANTI VIRUS SOFTWARE FOR COMPUTERS; COMPUTER SOFTWARE FOR TRACING AND STOPPING DATA VIRUS; ANTI-SPY SOFTWARE FOR COMPUTERS; COMPUTER SOFTWARE FOR ANTI-SPAM FILTERS FOR COMPUTERS; PARENTAL CONTROL SOFTWARE FOR COMPUTERS; FIREWALL SOFTWARE FOR THE CREATION OF FIREWALLS FOR COMPUTERS (U.S. CLS. 21, 23, 26, 36 AND 38).

CLASS 42—SCIENTIFIC AND COMPUTER SERVICES

FOR INDUSTRIAL ANALYSIS AND RESEARCH SERVICES THE FIELD OF DATA SECURITY; DESIGN AND DEVELOPMENT OF COMPUTER HARDWARE AND SOFTWARE; TESTING AND MAINTENANCE OF COMPUTER SOFTWARE; COMPUTER PROGRAMMING; USER SUPPORT SERVICES RELATING TO COMPUTER SOFTWARE, NAMELY, TECHNOLOGY ADVICE PROVIDED TO INTERNET USERS BY MEANS OF A SUPPORT HOTLINE; DATA VIRUS ANALYSIS; DATA VIRUS CLEARANCE, NAMELY, ONLINE PROTECTION AGAINST DATA VIRUSES AND MALWARE CLEANING OF COMPUTERS; INFORMATION REGARDING DATA VIRUS PROTECTION SERVICES; RESTORATION AND RECOVERY OF DAMAGED DATA FILES; RENTAL OF COMPUTER SOFTWARE; RENTAL OF ACCESS TIME TO DATABASES; CONSULTANCY REGARDING DATA SAFETY; INSTALLATION AND UPDATING OF COMPUTER PROGRAMS (U.S. CLS. 100 AND 101).

ARETHA SOMERVILLE, EXAMINING ATTORNEY

SN 79-072,071. FASANGAS SRL, ITALY, FILED 5-15-2009.



PRIORITY DATE OF 1-26-2009 IS CLAIMED. OWNER OF INTERNATIONAL REGISTRATION 1010862 DATED 5-15-2009, EXPIRES 5-15-2019.

THE MARK CONSISTS OF THE WORD "FASANGAS" IN STYLIZED, UPPER CASE FONT, TO THE RIGHT OF A TRIANGLE CONTAINING TWO STYLIZED FORK WRENCHES, WITH ONE OF THE WRENCHES EXTENDING INTO A SEMI-ELLIPTICAL ARC CURVING ACROSS THE TRIANGLE.

THE WORDING "FASANGAS" HAS NO MEANING IN A FOREIGN LANGUAGE.

CLASS 7—MACHINERY

FOR SAW MACHINES, FILTERS FOR CLEANING COOLING AIR FOR ENGINES, AIR FILTERS FOR MECHANICAL PURPOSES, BEING PARTS OF MACHINES OR ENGINES, AIR FILTERS FOR VEHICLE MOTORS AND ENGINES; GAS-OPERATED WELDING MACHINES, GAS OPERATED SOLDERING IRONS, ELECTRIC WELDING MACHINES; AIR-POWERED TOOLS, NAMELY, SAWS; CHAIN SAWS, POWER-OPERATED SAWS; SAW BENCHES, BEING PARTS OF MACHINES; ELECTRIC HAND-HELD DRILLS, ELECTRIC CORDLESS DRILLS WITH RECHARGEABLE BATTERIES, ELECTRIC CORDLESS SCREWDRIVERS, CORDLESS IMPACT WRENCHES, COMPRESSED AIR IMPACT WRENCHES, AIR-OPERATED POWER TOOLS, NAMELY, RATCHET WRENCHES; ELECTRIC SCREWDRIVERS; POWER SAW BLADES, BEING PARTS OF MACHINES; BLADES, BEING PARTS OF MACHINES; POWER TOOLS, NAMELY, HAMMER DRIVERS; UNIVERSAL JOINTS, BEING MACHINE PARTS; FILTER REGULATORS WITH AIR INLET, BEING PARTS OF MACHINES OR ENGINES, FILTERS AND PURIFIERS WITH AIR INLETS FOR REMOVING CONTAMINANTS FROM AIR FOR USE WITH EQUIPMENT AND TOOLS; COMPRESSED AIR BLOW GUNS; POWER DRILL ACCESSORIES, NAMELY, NON-ELECTRICAL ADAPTERS FOR USE IN JOINING EXTENSIONS AND POWER DRILL BITS (U.S. CLS. 13, 19, 21, 23, 31, 34 AND 35).

CLASS 8—HAND TOOLS

FOR HAND TOOLS, NAMELY, WRENCHES, BOW SAWS, JIG-SAWS, CUTTERS, NAMELY, WIRE CUTTERS; BLADES FOR HAND SAWS; HAND TOOLS, NAMELY, SCISSORS, PLIERS, MILLING CUTTERS, HAMMERS, TAPS, GUNS, NAMELY, GREASE GUNS; EXTENSION PIECES FOR BRACES FOR SCREWTAPS, DIES, SCREWDRIVERS, CHISELS NOT FOR MEDICAL USE, TURNSCREWS, HAND DRILLS; PORTABLE GAS WELDERS; HAND TOOLS, NAMELY, COMBINATION WRENCHES, NON-SLIP COMBINATION WRENCHES, UNIVERSAL COMBINATION WRENCHES WITH NON-SLIP OPEN BOX, SPANNERS, SOCKETS, IMPACT SOCKETS, SOCKET SETS, GO-THRU SOCKETS, SOCKET WRENCHES, RATCHET WRENCHES, TORQUE WRENCHES, GEAR WRENCHES, FLARE NUT WRENCHES, TAP WRENCHES, KEY WRENCHES, TORX KEY WRENCHES, HEX KEY WRENCHES, T-WRENCHES; RATCHET HANDLES, EXTENSION BARS FOR HAND TOOLS, EXTENSION BARS FOR HAND TOOLS WITH QUICK AUTOMATIC RELEASE, PINNERS, CIRCLIP PLIERS, FLAT LONG PLIERS, WATER PUMP PLIERS, COMBINATION PLIERS, NOSE PLIERS, CUTTING PLIERS, CABLE CUTTING PLIERS, WHEEL BALANCING WEIGHT PLIERS, CRIMPING PLIERS, CUTTING NIPPERS, WIRE STRIPPERS, PIPE CUTTERS, ELECTRICIAN'S SCISSORS, HACKSAWS, HACKSAWS WITH DOUBLE BLADES, MINI-HACKSAWS WITH ERGONOMIC HAND GRIPS, MINI-HACKSAWS WITH ONE HAND GRIP, HACKSAW BLADES, MANUAL TAPS, REVERSIBLE RATCHET TAP HOLDERS, DIE HOLDERS, DRILLS, TWIST DRILLS, SAWS, SLITTING SAW BLADES, HOLLOW MILLS, HOLESAWS, ARBORS FOR HOLESAWS, ADAPTORS FOR ARBORS, FILES, CUT FILES; PARTS OF HAND TOOLS, NAMELY, BITS FOR HEAD SCREWS, BITS FOR HAND DRILLS, BIT HOLDERS WITH RETAINING RING FOR MANUALLY-OPERATED SCREWDRIVERS OR FOR HAND DRILLS, SOCKET BITS; HAND TOOLS, NAMELY, SQUARES, SQUARES WITH BLADES, FLEXIBLE MAGNETIC PICK UP TOOLS, DRIFT PUNCHES, CENTRE PUNCHES, PIN PUNCHES, BURINS, FLAT CHISELS, CAPE CHISELS, DRILL SOCKETS, STEEL HAMMERS, RUBBER HAMMERS, TORX SCREWDRIVERS, SLOTTED SCREWDRIVERS (U.S. CLS. 23, 28 AND 44).

CLASS 9—ELECTRICAL AND SCIENTIFIC APPARATUS

FOR LABORATORY EQUIPMENT AND SUPPLIES, NAMELY, CALIPERS; ELECTRIC BATTERIES; MEASURING TAPES; DIGITAL MULTIMETERS, DIGITAL CALIPERS; DIGITAL TORQUE WRENCHES, GAUGES, NAMELY, MICROMETER GAUGES, FEELER GAUGES; ELECTRIC BATTERIES FOR VEHICLES, ELECTRIC ACCUMULATORS; ELECTRIC ACCUMULATORS FOR VEHICLES, BATTERY CHARGERS (U.S. CLS. 21, 23, 26, 36 AND 38).

CLASS 12—VEHICLES

FOR SEAT COVERS FOR VEHICLES, COVERS FOR STEERING WHEELS AND GEAR LEVERS OF VEHICLES, COVERS FOR FENDERS OF VEHICLES; TOOL TROLLEYS; UNIVERSAL JOINTS FOR LAND VEHICLES (U.S. CLS. 19, 21, 23, 31, 35 AND 44).

CLASS 17—RUBBER GOODS

FOR FLEXIBLE PIPES, NOT OF METAL; AIR HOSES, POLYURETHANE NET REINFORCED AIR HOSES, EXTENSIBLE POLYURETHANE AIR HOSES, HOSES FOR PNEUMATIC TOOLS, RUBBER HOSE FOR USE IN CONNECTION WITH WELDING, JUNCTIONS NOT OF METAL FOR POLYURETHANE NET REINFORCED AIR HOSES AND EXTENSIBLE POLYURETHANE AIR HOSES, JOINT PACKINGS FOR POLYURETHANE NET REINFORCED AIR HOSES AND EXTENSIBLE POLYURETHANE AIR HOSES (U.S. CLS. 1, 5, 12, 13, 35 AND 50).

ESTHER BELENKER, EXAMINING ATTORNEY

SN 79-072,178. DELAWARE CONSULTING.; COÖPERATIEVE VENNOOTSCHAP MET BEPERKTE; AANSPRAKELIJKHEID, BELGIUM, FILED 4-14-2009.



OWNER OF INTERNATIONAL REGISTRATION 1011198 DATED 4-14-2009, EXPIRES 4-14-2019.

NO CLAIM IS MADE TO THE EXCLUSIVE RIGHT TO USE "CONSULTING", APART FROM THE MARK AS SHOWN.

THE COLOR(S) WHITE, BLACK, GREY AND RED IS/ARE CLAIMED AS A FEATURE OF THE MARK.

THE MARK CONSISTS OF THE BLACK WORDING "DELAWARE CONSULTING" WITH THE WORD "DELAWARE" APPEARING OVER THE WORD "CONSULTING"; A GREY OVAL WITH TWO BREAKS IN THE MIDDLE ENCIRCLES THE WORDING AND A RED CIRCLE APPEARS AT THE POINT OF THE BROKEN OVAL ABOVE THE LETTER "A" IN "DELAWARE"; THE INTERIOR PORTION OF THE OVAL IS WHITE.

CLASS 9—ELECTRICAL AND SCIENTIFIC APPARATUS

FOR COMPUTER SOFTWARE FOR USE IN DATABASE MANAGEMENT, FOR USE AS A SPREADSHEET, FOR THE COLLECTION, EDITING, ORGANIZING, MODIFYING, BOOK MARKING, TRANSMISSION, STORAGE AND SHARING OF DATA AND INFORMATION, FOR BUSINESS PROCESS OPTIMIZATION, FOR DOCUMENT MANAGEMENT, FOR INVOICE MANAGEMENT, FOR CUSTOMER DATABASES, FOR SUPPLY CHAIN PROCESSES; ELECTRONIC PUBLICATIONS IN THE NATURE OF BOOKS, MANUALS, MAGAZINES, BROCHURES, LEAFLETS IN THE FIELDS OF MANAGEMENT, FINANCES, LOGISTICS AND ECONOMICS THAT ARE DOWNLOADED FROM WEBSITES; DOWNLOADABLE ELECTRONIC PUBLICATIONS IN THE NATURE OF BOOKS, MANUALS, MAGAZINES, BROCHURES, LEAFLETS IN THE FIELDS OF MANAGEMENT, FINANCES, LOGISTICS AND ECONOMICS; ELECTRONIC PUBLICATIONS IN THE NATURE OF BOOKS, MANUALS, MAGAZINES, BROCHURES, LEAFLETS IN THE FIELDS OF MANAGEMENT, FINANCES, LOGISTICS AND ECONOMICS RECORDED ON COMPUTER MEDIA (U.S. CLS. 21, 23, 26, 36 AND 38).

CLASS 35—ADVERTISING AND BUSINESS

FOR PUBLICITY AND SALES PROMOTION; BUSINESS MANAGEMENT; BUSINESS ADMINISTRATION; ADMINISTRATIVE SERVICES, NAMELY, PROVIDING OFFICE FUNCTIONS; COMMERCIAL PROJECT MANAGEMENT AND COMMERCIAL PROJECT MANAGEMENT ASSISTANCE RELATED TO IT TECHNOLOGIES FOR OTHERS FOR BUSINESS PURPOSES; BUSINESS CONSULTATION, NAMELY, BUSINESS MANAGEMENT CONSULTATION, BUSINESS EXECUTIVE AND BUSINESS ECONOMICS CONSULTANCY; COMPILATION OF STATISTICS; MARKET CANVASSING, RESEARCH AND ANALYSIS; PUBLIC AND MARKET OPINION POLLING; BUSINESS MANAGEMENT CONSULTANCY; PERSONNEL MANAGEMENT, NAMELY, DISPOSAL, DEPLOYMENT AND DETACHMENT OF PERSONNEL, INCLUDING IT AND ICT SPECIALISTS; DATA COLLECTION AND SETTING UP SERVICES CONSISTING OF THE REGISTRATION, COLLECTION, TRANSCRIPTION, COMPILATION AND SYSTEMIZATION OF WRITTEN COMMUNICATIONS AND DATA; MANAGEMENT AND COMPILATION OF COMPUTERIZED DATABASES; RETAIL STORE SERVICES IN THE FIELD OF TELECOMMUNICATION APPARATUS, COMPUTERS, COMPUTER PERIPHERALS, COMPUTER HARDWARE AND COMPUTER SOFTWARE; MARKETING CONSULTANCY WITH THE AIM TO OPTIMIZE THE PURCHASE AND SELLING OF PRODUCTS ELECTRONICALLY; COMMERCIAL CONSULTANCY AND PROVIDING BUSINESS INFORMATION IN THE FIELD OF TRADE VIA ELECTRONIC COMMERCE; BUSINESS INFORMATION RELATED TO THE PRODUCTS WHICH CAN BE ORDERED ELECTRONICALLY; PUBLICITY AND SALES PROMOTION RELATED TO THE PRODUCTS WHICH CAN BE ORDERED ELECTRONICALLY; AFOREMENTIONED SERVICES ESPECIALLY RELATED TO TENDER AND IT/ICT ISSUES AND ON PROCESS ASSISTANCE BY PUTTING OUT TO TENDER OF PROJECTS, ALSO TO BE PROVIDED VIA INTERNET AND OTHER COMMUNICATION MEANS AND COMMUNICATION MEDIA (U.S. CLS. 100, 101 AND 102).

CLASS 38—COMMUNICATION

FOR PROVIDING ACCESS TO COMPUTER DATABASES, ELECTRONIC SITES AND THE INTERNET (U.S. CLS. 100, 101 AND 104).

CLASS 41—EDUCATION AND ENTERTAINMENT

FOR EDUCATION, NAMELY, CONDUCTING TRAINING, WORKSHOPS AND COURSES IN THE FIELDS OF IT/ICT AND INFORMATICS, TENDER AND IT/ICT ISSUES AND PROCESS ASSISTANCE BY PUTTING OUT TO TENDER OF PROJECTS; AFOREMENTIONED SERVICES ALSO TO BE PROVIDED VIA INTERNET AND OTHER COMMUNICATION MEANS AND COMMUNICATION MEDIA (U.S. CLS. 100, 101 AND 107).

CLASS 42—SCIENTIFIC AND COMPUTER SERVICES

FOR CONSULTANCY IN THE FIELD OF INSTALLATION, PREPARATION AND MAINTENANCE OF COMPUTER SOFTWARE; CONSULTANCY ON HOME AND WORKPLACE AUTOMATION HARDWARE AND SOFTWARE PROJECTS, AUTOMATION HARDWARE AND SOFTWARE CONCEPTS AND AUTOMATION HARDWARE AND SOFTWARE SOLUTIONS; CONSULTANCY IN THE FIELD OF DESIGN OF WEBSITES AND DESIGN OF INFORMATION TECHNOLOGY COMPUTER SYSTEMS AND GRAPHIC DESIGN; DESIGN OF INTERNET SITES AND COMPUTER NETWORKS FOR OTHERS FOR USE IN THE FIELDS OF PUBLICITY, PROMOTION AND PURCHASE AND SALE OF PRODUCTS; COMPUTER TECHNOLOGY SUPPORT SERVICES, NAMELY, TECHNICAL ADVICE VIA HELP DESKS IN THE FIELD OF IT AND ITC; COMPUTER PROGRAMMING; DEVELOPMENT, DESIGN, IMPLEMENTATION, PRODUCT TESTING AND MAINTENANCE OF SOFTWARE; DEVELOPMENT, DESIGN AND PRODUCT TESTING OF COMPUTERS AND COMPUTER HARDWARE; THE PROVIDING OF ON-LINE NON-DOWNLOADABLE SOFTWARE FOR THE PROCESSING, RECORDING AND RECALLING OF INFORMATION; MANAGING AND IMPLEMENTING OF AUTOMATION PROJECTS, NAMELY, DATA AUTOMATION AND COLLECTION SERVICE USING PROPRIETARY SOFTWARE TO EVALUATE, ANALYZE AND COLLECT SERVICE DATA; SERVICES OF ICT SPECIALISTS TO OPTIMIZE THE BUSINESS PROCESSES AND INFORMATION STREAMS, NAMELY, INFORMATION AND COMMUNICATIONS TECHNOLOGY INTEGRATION SERVICES; SERVICES OF PROJECT OFFICES, NAMELY, CONSULTANCY CONCERNING IT AND ITC WITHIN THE SCOPE OF PROJECTS; SERVICES OF IT AND ITC SPECIALISTS, NAMELY, REMOTE AND ON-SITE MANAGEMENT OF THE INFORMATION AND COMMUNICATIONS TECHNOLOGY SYSTEMS OF OTHERS; CONCEPTION AND DEVELOPMENT OF STRATEGIES, CONCEPTS AND SOLUTIONS IN THE FIELD OF IT AND ITC, NAMELY, INFORMATION AND COMMUNICATIONS TECHNOLOGY CONSULTATION; TECHNICAL CONSULTANCY AND ASSISTANCE WITH COMPUTER-BASED INFORMATION SYSTEMS AND COMPONENTS BY ICT SPECIALISTS AT THE IMPLEMENTATION OF IT AND ITC SOLUTION (U.S. CLS. 100 AND 101).

MARIAM MAHMOUDI, EXAMINING ATTORNEY

SN 79-072,286. EUROMOBIL - S.P.A., FRAZ.FALZE' DI PIAVE (TREVISO), ITALY, FILED 11-7-2008.



PRIORITY DATE OF 7-25-2008 IS CLAIMED. OWNER OF INTERNATIONAL REGISTRATION 1011524 DATED 11-7-2008, EXPIRES 11-7-2018.

NO CLAIM IS MADE TO THE EXCLUSIVE RIGHT TO USE "GRUPPO", APART FROM THE MARK AS SHOWN.

THE MARK CONSISTS OF A SIGN DEPICTING THE WORDING "GRUPPO EUROMOBIL" IN FANCY CHARACTERS, IN WHICH THE WORDING "GRUPPO", IN A SMALLER SIZE, IS PLACED ABOVE THE WORDING "EUROMOBIL" AND UNDER A STYLIZED SERIES OF FIVE STARS POSITIONED ONE AFTER THE OTHER IN A SLIGHTLY CURVED MANNER AND ASCENDING FROM LEFT TOWARDS RIGHT, ALL ENCLOSED IN A STYLIZED RECTANGULAR LABEL.

THE ENGLISH TRANSLATION OF THE WORD "GRUPPO" IN THE MARK IS "GROUP".

CLASS 7—MACHINERY

FOR DISHWASHERS; WASHING MACHINES FOR HOUSEHOLD PURPOSES; DRY-CLEANING MACHINES; ELECTRIC KNIVES; VEGETABLE GRATING MACHINES; ELECTRIC MEAT MINCERS; ELECTRIC CAN OPENERS; ELECTRIC COFFEE GRINDERS; ELECTRIC GRINDING MILLS FOR HOUSEHOLD PURPOSES; ELECTRIC WHISKS FOR HOUSEHOLD PURPOSES; ELECTRIC FOOD BLENDERS FOR HOUSEHOLD PURPOSES; ELECTRIC FOOD PRESSES FOR HOUSEHOLD PURPOSES; ELECTRIC FOOD PROCESSORS; MEAT CHOPPERS, BEING MACHINES; BREAD CUTTING MACHINES; KNITTING MACHINES; DYEING MACHINES; SAUSAGE MACHINES; AERATED BEVERAGES MAKING MACHINES; MINERAL WATER MAKING MACHINES; BOTTLE CAPPING MACHINES; SEWING MACHINES; COIN-OPERATED CLOTHES WASHING MACHINES; ELECTRIC KITCHEN MACHINES, NAMELY, ELECTRIC BEATERS; COMPRESSORS FOR REFRIGERATORS; INDUSTRIAL ROBOTS, BEING MACHINES; ELECTRIC SCISSORS; ELECTRIC WAX-POLISHING MACHINES FOR HOUSEHOLD PURPOSES; ELECTRICAL FLOOR POLISHING MACHINES FOR HOUSEHOLD PURPOSES; FOOD WASTE DISPOSERS, BEING MACHINES; WASTE DISPOSERS, BEING MACHINES; CARPET CLEANING MACHINES; VACUUM CLEANERS; VACUUM CLEANER HOSES; VACUUM CLEANER BAGS; ELECTRIC SHOE POLISHERS; CHEMICAL FIBER SPINNING MACHINES; MIXERS, BEING MACHINES; ELECTRICAL CHOPPING, CRUSHING, SHAKING AND GRINDING MACHINES FOR HOUSEHOLD PURPOSES; KNEADING MACHINES (U.S. CLS. 13, 19, 21, 23, 31, 34 AND 35).

CLASS 11—ENVIRONMENTAL CONTROL APPARATUS

FOR OVENS OTHER THAN FOR EXPERIMENTAL PURPOSES, NAMELY, ELECTRIC AND GAS COOKING OVENS; ELECTRIC STOVES, GAS STOVES; ELECTRIC AND GAS STOVES, BEING HEATING APPLIANCES; ELECTRIC AND GAS KITCHEN RANGES; GAS AND ELECTRIC GRILLS, BEING COOKING APPLIANCES; GAS COOKERS; ELECTRIC COOKERS; COOKING RANGES; COOKING RINGS IN THE NATURE OF ELECTRIC COOKTOPS; MICROWAVE OVENS, BEING COOKING APPARATUS; EXTRACTOR HOODS FOR KITCHENS; VENTILATION HOODS; REFRIGERATORS, ICE BOXES IN THE NATURE OF FREEZERS, ICE CHESTS, FREEZERS, REFRIGERATING CABINETS AND CONTAINERS, ALL BEING REFRIGERATING MACHINES; ICE MAKING MACHINES; WASH-HAND BASINS AND BOWLS, BEING PARTS OF SANITARY INSTALLATIONS; SINKS; KITCHEN SINKS; LIGHTERS PRIMARILY FOR LIGHTING GAS GRILLS AND FIREPLACES; ROTISSERIES; BARBECUES; ELECTRIC DEEP FRYERS; ELECTRIC COFFEE MACHINES; ELECTRIC KETTLES; ELECTRIC PRESSURE COOKING SAUCEPANS; ELECTRIC COFFEE PERCOLATORS; ELECTRIC WATER HEATERS FOR HOUSEHOLD PURPOSES, BEING HEATING APPARATUS; COFFEE FILTERS NOT OF PAPER BEING PART OF ELECTRIC COFFEE MAKERS; COFFEE ROASTERS; ELECTRIC TOASTERS; ELECTRIC ROASTERS; LAMP BULBS, ELECTRIC LAMPS, LAMP REFLECTORS, LIGHT DIFFUSERS, LAMP SHADES, LIGHT BULBS, CHANDELIERS, CEILING LIGHTS, FLARES, SOLDERING LAMPS, GAS LAMPS, LANTERNS; BEVERAGES COOLING APPARATUS; ELECTRIC FANS FOR HOUSEHOLD PURPOSES; FANS FOR AIR CONDITIONING; AIR FILTERING INSTALLATIONS; AIR FILTERS FOR AIR CONDITIONING UNITS; AIR CONDITIONING INSTALLATIONS; AIR CONDITIONING APPARATUS; AIR COOLING APPARATUS; HAIR DRYERS; HEATING BOILERS, OTHER THAN PARTS OF MACHINES; KILNS; ANTI-SPLASH TAP NOZZLES; FAUCETS FOR PIPES; WATER CLOSETS; TOILET BOWLS; SHOWERS AND SHOWER CUBICLES; BATH CUBICLES; SAUNA BATH INSTALLATIONS; BIDETS; BATH TUBS; WATER HEATERS FOR BATHS; BATHTUB ENCLOSURES; BED WARMERS; WATER AND AIR PURIFYING APPARATUS AND INSTALLATIONS; FILTERS FOR DRINKING WATER; ELECTRICALLY HEATED CARPETS; ELECTRIC RADIATORS; FRICTION LIGHTERS FOR LIGHTING GRILLS AND FIREPLACES; LIGHTERS PRIMARILY FOR LIGHTING GAS HEATING AND COOKING APPLIANCES; TAPS IN THE NATURE OF

FAUCETS FOR WATER INSTALLATIONS; ELECTRIC HAND DRYING APPARATUS FOR WASHROOMS; TUMBLE CLOTHES DRYERS; AIR AND WATER FILTERS FOR HOUSEHOLD PURPOSES; RADIATORS AND BOILERS AS PARTS OF HEATING INSTALLATIONS; GAS BURNERS; PIPES, BEING PARTS OF SANITARY INSTALLATIONS; ELECTRICAL BLANKETS, NOT FOR MEDICAL PURPOSES; HEATING CUSHIONS, NOT FOR MEDICAL PURPOSES; ELECTRIC FOOT WARMERS; CHEMICALLY-ACTIVATED HEATING PACKS FOR PROVIDING WARMTH TO THE FEET NOT FOR MEDICAL PURPOSES; STERILIZERS; ELECTRIC CLOTHES DRYING MACHINES FOR HOUSEHOLD PURPOSES (U.S. CLS. 13, 21, 23, 31 AND 34).

CLASS 20—FURNITURE AND ARTICLES NOT OTHERWISE CLASSIFIED

FOR FURNITURE, OFFICE FURNITURE, METALLIC FURNITURE; BEDS, NOT FOR MEDICAL PURPOSES; WARDROBES, CHESTS OF DRAWERS, DRAWERS, DRESSING TABLES, DIVANS, ARMCHAIRS; CHAIRS, BEING SEATS; DECK CHAIRS; SEATS, NOT FOR VEHICLES; STOOLS, CHAISE LOUNGES; DESKS, BEING FURNITURE; DRAWING DESKS, DRESSERS, METALLIC TABLES, TABLE TOPS, SMALL TABLES FOR COMPUTERS, MODULAR FURNITURE FOR KITCHENS; BEDROOM FURNITURE, GARDEN AND OUTDOOR FURNITURE, UPHOLSTERED FURNITURE, KITCHEN FURNITURE, ADJUSTABLE KITCHEN FURNITURE, LIVING ROOM FURNITURE, SCHOOL FURNITURE, BATHROOM FURNITURE, DINING CHAIRS, LOUNGE CHAIRS, EASY CHAIRS, FOLDING CHAIRS, CHAIR PADS, POUFS, SETTEES, SOFAS, SOFA BEDS, FOOTSTOOLS, BEDSIDE TABLES, WRITING DESKS, TABLES, SIDE TABLES, DINING TABLES, COFFEE TABLES; SCREENS, BEING FURNITURE; DRAWER UNITS BEING CHESTS OF DRAWERS, CHIFFONIERS, BASSINETTES, LOCKERS, COMMODES BEING CHESTS OF DRAWERS, CUPBOARDS, FILING CABINETS, INDEX CABINETS, KITCHEN CABINETS; SHOWCASES, BEING FURNITURE; SIDEBOARDS, GARMENT COVERS BEING WARDROBES, WALK-IN CLOSETS BEING WARDROBES; BOOK RESTS, BEING FURNITURE; BOOKCASES, LIBRARY SHELVES, FURNITURE SHELVES, BENCHES, BOTTLE RACKS, BOTTLE CASINGS OF WOOD, KEY BOARDS IN THE NATURE OF STORAGE RACKS FOR HANGING KEYS, MAGAZINE RACKS, CLOTHES HANGERS; CLOTHES HOOKS, NOT OF METAL; HAT STANDS, UMBRELLA STANDS, STORAGE RACKS FOR UMBRELLAS; SERVING TROLLEYS, BEING FURNITURE; TROLLEYS FOR COMPUTERS BEING COMPACT ROLLING DESKS; DINNER WAGONS, BEING FURNITURE; MIRRORS, BEING NON-PORABLE LOOKING GLASSES; HAND-HELD MIRRORS; MIRRORS, BEING PART OF A DRESSER; SHELVES FOR STORAGE; DISPLAY STANDS; INDEX CABINETS BEING FURNITURE; HIGH CHAIRS FOR BABIES; CRADLES; NON-METAL, NON-REFRIGERATED CHESTS FOR STORING MEAT; COAT HANGERS; MATTRESSES; SPRING MATTRESSES; CHESTS FOR TOYS; CHESTS, NOT OF METAL; NARROW CHESTS, NOT OF METAL; BOXES OF WOOD OR PLASTIC; BOXES OF WOOD OR PLASTIC FOR TRANSPORTATION AND FOR PACKAGING; DISPLAY CASES OF WOOD OR PLASTIC; BAKERS' BREAD BASKETS; TRAYS, NOT OF METAL, FOR COMPUTER KEYBOARDS; NON-METALLIC BOTTLE STOPPERS AND CAPS, REMOVABLE MATS OR COVERS FOR SINKS; LADDERS OF WOOD OR PLASTICS; BROOM HANDLES, NOT OF METAL; TOOL HANDLES NOT OF METAL; NON-METAL TENT PEGS; PICTURE FRAMES; BAMBOO CURTAINS; NON-ELECTRIC FANS FOR PERSONAL USE; STATUES OF WOOD, WAX, PLASTER OR PLASTIC; FIGURINES, BEING STATUETTES, OF WOOD, WAX, PLASTER OR PLASTIC; WORKS OF ART OF WOOD, WAX, PLASTER OR PLASTIC; BUSTS OF WOOD, WAX, PLASTER OR PLASTIC; DISPLAY BOARDS; SIGNBOARDS OF WOOD OR PLASTICS; DRINKING STRAWS; DECORATIONS OF PLASTIC FOR FOODSTUFFS; PET CUSHIONS; FURNITURE PARTITIONS OF WOOD; DOORS FOR FURNITURE; FURNITURE FITTINGS, NOT OF METAL; FURNITURE CASTERS, NOT OF METAL; BED CASTERS, NOT OF METAL; BED FITTINGS, NOT OF METAL, NAMELY, BED FRAMES, RAILS AND HEADBOARDS; FIXED TOWEL DISPENSERS, NOT OF METAL; HOOKS, NOT OF METAL, FOR CLOTHES RAILS; PILLOWS, CUSH-

IONS; BOLSTERS; SLATTED INDOOR BLINDS; CURTAIN ROLLERS; CURTAIN RAILS; CURTAIN HOOKS; CURTAIN RINGS; CURTAIN RODS; WOVEN TIMBER BLINDS, BEING FURNITURE; WINDOW FITTINGS, NOT OF METAL; NON-METAL COTTER PINS; HINGES, NOT OF METAL; BOLTS, NOT OF METAL; RIVETS, NOT OF METAL; SCREWS NOT OF METAL; DOOR FITTINGS, NOT OF METAL; CURTAIN HOLDERS, NOT OF TEXTILE MATERIAL; PULLEYS OF PLASTICS FOR BLINDS; BASKETS, NOT OF METAL, NAMELY, BAKER'S BREAD BASKETS; LOCKS, OTHER THAN ELECTRIC, NOT OF METAL; DRAWER RAILS; BEAD CURTAINS FOR DECORATION (U.S. CLS. 2, 13, 22, 25, 32 AND 50).

STEVEN PEREZ, EXAMINING ATTORNEY

CLASS 37—CONSTRUCTION AND REPAIR

FOR BUILDING CONSTRUCTION AND REPAIR; ASPHALTING; DISINFECTING; MINING EXTRACTION; MACHINERY INSTALLATION, MAINTENANCE AND REPAIR; CLEANING OF BUILDINGS; CLEANING OF RAILROAD TANK CARS; RENTAL OF CONSTRUCTION EQUIPMENT, BURNER MAINTENANCE AND REPAIR, MOTOR VEHICLE MAINTENANCE AND REPAIR; INSULATION WORKS, NAMELY, INSTALLATION OF BUILDING INSULATION; PIPELINE CONSTRUCTION AND MAINTENANCE; FURNACE INSTALLATION AND REPAIR (U.S. CLS. 100, 103 AND 106).

CHERYL CLAYTON, EXAMINING ATTORNEY

SN 79-072,316. EESTI ENERGIA AKTSIASELTS, ESTONIA, FILED 2-27-2009.



PRIORITY DATE OF 1-6-2009 IS CLAIMED.
OWNER OF INTERNATIONAL REGISTRATION 1011613 DATED 2-27-2009, EXPIRES 2-27-2019.

THE COLOR(S) GREY, GREEN AND YELLOW IS/ARE CLAIMED AS A FEATURE OF THE MARK.

THE MARK CONSISTS OF A STYLIZED CURVED GREEN LINE WITH YELLOW EDGES ABOVE THE TERM "ENEFIT" IN GRAY.

CLASS 1—CHEMICALS

FOR CHEMICALS USED IN INDUSTRY; PHOTOGRAPHIC CHEMICALS; CHEMICALS FOR USE IN AGRICULTURE, HORTICULTURE AND FORESTRY, EXCEPT FUNGICIDES, HERBICIDES, INSECTICIDES AND PARASITICIDES; UNPROCESSED ARTIFICIAL RESINS, UNPROCESSED PLASTICS; MANURES; FIRE EXTINGUISHING COMPOSITIONS; SOLDERING CHEMICALS AND TEMPERING SUBSTANCES; CHEMICAL SUBSTANCES FOR PRESERVING FOODSTUFFS; TANNING SUBSTANCES, NAMELY, TANNING AGENTS FOR USE IN THE MANUFACTURE OF LEATHER AND ENZYMES FOR USE IN THE TANNING OF LEATHER; ADHESIVES USED IN INDUSTRY; PHENOL FOR INDUSTRIAL PURPOSES; GLUES FOR INDUSTRIAL PURPOSES; CHEMICAL ADDITIVES FOR MOTOR FUEL; SOLVENTS, NAMELY, AROMATIC SOLVENTS FOR INDUSTRIAL AND COMMERCIAL USE (U.S. CLS. 1, 5, 6, 10, 26 AND 46).

CLASS 4—LUBRICANTS AND FUELS

FOR INDUSTRIAL OILS AND GREASES; ALL PURPOSE LUBRICANTS; FUELS; CANDLES AND WICKS FOR LIGHTING; OIL SHALE, USED AS A FUEL IN INDUSTRY AND AS A SOURCE OF OIL; COKE, FUEL OIL; MAZUT, NAMELY, RESIDUAL FUEL OIL; MOTOR FUEL; ELECTRICAL ENERGY; OIL SHALE OIL, NAMELY, CRUDE OIL THAT IS OBTAINED FROM OIL SHALE BY HEATING AND DISTILLATION (U.S. CLS. 1, 6 AND 15).

SN 79-072,390. WIEDERKEHR RECYCLING AG, WALTENSCHWIL, SWITZERLAND, FILED 4-29-2009.



PRIORITY DATE OF 11-21-2008 IS CLAIMED.
OWNER OF INTERNATIONAL REGISTRATION 1011791 DATED 4-29-2009, EXPIRES 4-29-2019.

NO CLAIM IS MADE TO THE EXCLUSIVE RIGHT TO USE "RECYCLING", APART FROM THE MARK AS SHOWN.

THE MARK CONSISTS OF THE STYLIZED PICTURE OF A DREDGER BUCKET IN A HUTCH WHEREAS THE HUTCH IS AT THE SAME TIME A STYLIZED LETTER "W"; THE AFOREMENTIONED PICTURE APPEARS UPON A SQUARE BACKGROUND; THE MARK FURTHER CONSISTS OF THE WORDING "WIEDERKEHR RECYCLING" APPEARING NEAR THE BOTTOM-LEFT CORNER OF A RECTANGULAR BACKGROUND, WITH THE LOWER-LEFT CORNER OF THE RECTANGULAR BACKGROUND POSITIONED AT THE UPPER-RIGHT CORNER OF THE AFOREMENTIONED SQUARE BACKGROUND.

CLASS 4—LUBRICANTS AND FUELS

FOR FUELS; SUBSTITUTE FUELS, NAMELY, LIQUID FUELS, METHANOL FUEL, GASEOUS FUELS; FUELS DERIVED FROM THE RECYCLING OF RECYCLABLE MATERIALS, NAMELY, LIQUID FUELS, BIOFUELS; INDUSTRIAL OILS AND GREASES; LUBRICANTS, NAMELY, INDUSTRIAL LUBRICANTS, MARINE LUBRICANTS, ALL PURPOSE LUBRICANTS (U.S. CLS. 1, 6 AND 15).

CLASS 6—METAL GOODS

FOR COMMON METALS AND THEIR ALLOYS; SCRAP METAL, NAMELY, COMMON METALS AND THEIR ALLOYS (U.S. CLS. 2, 12, 13, 14, 23, 25 AND 50).

CLASS 7—MACHINERY

FOR MACHINES AND MACHINE INSTALLATIONS FOR SEPARATING, SORTING AND RECYCLING RECYCLABLE MATERIALS AND WASTE; MACHINES FOR THE TREATMENT OF MATERIALS, NAMELY, MILLING MACHINES AND GRINDING MACHINES; MACHINES FOR THE TREATMENT OF COMMON METALS, NAMELY, METAL WELDING MACHINES, METAL WORKING MACHINES, METAL EXTRUSION PRESSES, METAL SAWING AND CUTTING MACHINES, METAL GRINDING MACHINES; ROBOTS, NAMELY, INDUSTRIAL ROBBOTS; PARTS AND COMPONENTS OF THE AFOREMENTIONED GOODS NOT INCLUDED IN OTHER CLASSES (U.S. CLS. 13, 19, 21, 23, 31, 34 AND 35).

CLASS 17—RUBBER GOODS

FOR SEMI-PROCESSED PLASTICS; GOODS MADE OF SEMI-PROCESSED PLASTICS, NAMELY, FILMS AND SHEETS MADE FROM SEMI-PROCESSED PLASTIC; RUBBER; GUTTA-PERCHA; MICA; PACKING AND INSULATING MATERIALS; FLEXIBLE PIPES, NOT OF METAL (U.S. CLS. 1, 5, 12, 13, 35 AND 50).

CLASS 39—TRANSPORTATION AND STORAGE

FOR TRANSPORT LOGISTICS, NAMELY, SUPPLY CHAIN LOGISTICS AND REVERSE LOGISTICS SERVICES IN THE NATURE OF STORAGE, TRANSPORTATION AND DELIVERY OF GOODS FOR OTHERS BY AIR, RAIL, SHIP OR TRUCK; DISTRIBUTION OF ENERGY; PACKAGING OF GOODS, NAMELY, PACKAGING ARTICLES FOR TRANSPORTATION AND PACKAGING ARTICLES TO THE ORDER AND SPECIFICATION OF OTHERS; STORAGE OF GOODS; RENTAL OF WAREHOUSES; RENTAL OF CONTAINERS FOR STORING AND TRANSPORTING GOODS, NAMELY, RENTAL OF STORAGE CONTAINERS; INFORMATION AND CONSULTANCY IN CONNECTION WITH THE AFOREMENTIONED SERVICES (U.S. CLS. 100 AND 105).

CLASS 40—MATERIAL TREATMENT

FOR RECYCLING OF WASTE AND TRASH; RECYCLING OF RECYCLABLE MATERIALS; SORTING AND SEPARATING WASTE AND RECYCLABLE MATERIALS; WASTE TREATMENT; RECYCLING OF VEHICLES; MATERIAL TREATMENT SERVICES IN CONNECTION WITH RECYCLING; TREATMENT OF METALS; TREATMENT OF PLASTIC SUBSTANCES, NAMELY, RECYCLING; CUSTOM ASSEMBLING OF PRODUCTS FOR OTHERS; PRODUCTION OF ENERGY FROM RECYCLABLE MATERIALS; PRODUCTION OF ENERGY IN THE CONTEXT OF RECYCLING; INFORMATION AND CONSULTANCY IN CONNECTION WITH THE AFOREMENTIONED SERVICES (U.S. CLS. 100, 103 AND 106).

KEVIN CORWIN, EXAMINING ATTORNEY

SN 79-072,464. JOANNE ELLIS, MIDDLE ASTON; OXFORDSHIRE OX25 5QL, UNITED KINGDOM, FILED 6-4-2009.



OWNER OF INTERNATIONAL REGISTRATION 1012002 DATED 6-4-2009, EXPIRES 6-4-2019.

NO CLAIM IS MADE TO THE EXCLUSIVE RIGHT TO USE "BUGGY", APART FROM THE MARK AS SHOWN.

CLASS 12—VEHICLES

FOR CUSTOMISED COVERS FOR PUSHCHAIRS AND PRAMS (U.S. CLS. 19, 21, 23, 31, 35 AND 44).

CLASS 24—FABRICS

FOR BLANKETS, NAMELY, BLANKET THROWS, CHILDRENS BLANKETS (U.S. CLS. 42 AND 50).
KRISTINA MORRIS, EXAMINING ATTORNEY

SN 79-072,549. JULIA DONALDSON, LONDON, UNITED KINGDOM, AND AXEL SCHEFFLER, LONDON, UNITED KINGDOM, FILED 5-26-2009.

GRUFFALO

THE MARK CONSISTS OF STANDARD CHARACTERS WITHOUT CLAIM TO ANY PARTICULAR FONT, STYLE, SIZE, OR COLOR.

PRIORITY DATE OF 11-26-2008 IS CLAIMED.
OWNER OF INTERNATIONAL REGISTRATION 1012287 DATED 5-26-2009, EXPIRES 5-26-2019.

CLASS 3—COSMETICS AND CLEANING PREPARATIONS

FOR NON-MEDICATED TOILETRIES; COSMETICS; NON-MEDICATED BATH PREPARATIONS; SHOWER PREPARATIONS, NAMELY, SHOWER GEL, SHOWER CREAMS; SHOWER SOAP; SHOWER FOAMS; BATH FOAM; BATH OIL; BATH SALTS; BUBBLE BATHS; SHAMPOO; HAIR GEL; HAIR CARE PREPARATIONS; COTTON WOOL FOR COSMETIC PURPOSES; DEODORANTS FOR PERSONAL USE; MAKE-UP REMOVING PREPARATIONS; MOUTH WASHES; NAIL CARE PREPARATIONS; NAIL VARNISH AND POLISHES; PREPARATIONS FOR CLEANING THE TEETH; NON-MEDICATED SKIN CARE PREPARATIONS; TALCUM POWDER (U.S. CLS. 1, 4, 6, 50, 51 AND 52).

CLASS 9—ELECTRICAL AND SCIENTIFIC APPARATUS

FOR DIGITAL MEDIA, NAMELY, PRE-RECORDED VIDEO CASSETTES, DIGITAL VIDEO DISCS, DIGITAL VERSATILE DISCS, DOWNLOADABLE AUDIO AND VIDEO RECORDINGS, DVDS AND HIGH DEFINITION DIGITAL DISCS FEATURING ANIMATED CARTOONS; AUDIOVISUAL RECORDINGS FEATURING MUSIC, CHILDREN'S STORIES AND ANIMATION; CAMERAS; CINEMATOGRAPHIC FILMS; COMPUTER GAMES SOFTWARE FOR CHILDREN'S EDUCATION AND ENTERTAINMENT; ELECTRONIC COMPUTER GAME PROGRAMS ADAPTED FOR USE WITH VIDEO APPARATUS OR TELEVISION RECEIVERS; ELECTRONIC PUBLICATIONS, NAMELY, BOOKS, COMICS AND MAGAZINES FEATURING ANIMATED CARTOONS, CHILDREN'S STORIES AND EDUCATIONAL GAMES, COMPETITIONS AND QUIZZES RECORDED ON COMPUTER MEDIA; ELECTRONIC PUBLICATIONS, NAMELY, COLOURING BOOKS AND POSTERS RECORDED ON COMPUTER MEDIA; COMPUTER SOFTWARE FOR CREATING AND SENDING ELECTRONIC GREETING CARDS; MOTION PICTURE FILMS AND FILMS FOR TELEVISION FEATURING CHILDREN'S ENTERTAINMENT INCLUDING ANIMATED CARTOONS; COMPUTER GAMES SOFTWARE; INTERACTIVE EDUCATIONAL GAME PROGRAMS FOR USE WITH VIDEO APPARATUS OR TELEVISION RECEIVERS; INTERACTIVE ENTERTAINMENT GAME SOFTWARE FOR USE WITH COMPUTERS; INTERACTIVE VIDEO GAME SOFTWARE; MOUSE PADS; PRE-RECORDED MEDIA, NAMELY, VIDEO TAPES AND CASSETTES, COMPACT DISCS (CDS), AUDIO CASSETTE TAPES, DIGITAL VERSATILE DISCS (DVDS), VIDEO GAME CARTRIDGES AND COMPUTER DISCS ALL FEATURING CHILDREN'S ENTERTAINMENT, ANIMATED CARTOONS, CHILDREN'S STORIES AND EDUCATIONAL GAMES, COMPETITIONS AND QUIZZES; PRE-RECORDED COMPACT INTERACTIVE DISCS FEATURING ANIMATED CARTOONS, CHILDREN'S STORIES AND EDUCATIONAL GAMES, COMPETITIONS AND QUIZZES; PROTECTIVE HELMETS FOR SPORTS; SUNGLASSES AND SPECTACLE FRAMES; WATER WINGS, NAMELY, SWIM FLOATS FOR SAFETY PURPOSES (U.S. CLS. 21, 23, 26, 36 AND 38).

CLASS 14—JEWELRY

FOR JEWELRY; JEWELRY CASES OF PRECIOUS METAL OR COATED THEREWITH; CUFF LINKS, BROOCHES, BRACELETS, BANGLES, EARRINGS, PENDANTS, MEDALLIONS, TRINKETS IN THE NATURE OF KEY CHAINS AND KEY RINGS OF PRECIOUS METAL, CHARMS, RINGS, WATCH STRAPS, TIE PINS, ORNAMENTAL PINS, JEWELRY PINS, TIE CLIPS, COLLECTABLE COINS; HOROLOGICAL AND CHRONOMETRIC INSTRUMENTS; PRECIOUS STONES; BADGES OF PRECIOUS METAL, JEWELRY BOXES, KEY FOBS OF PRECIOUS METAL, KEY RINGS OF PRECIOUS METAL OR COATED WITH PRECIOUS METAL; ORNAMENTS OF PRECIOUS METAL, STATUETTES AND FIGURINES OF PRECIOUS METAL, OR COATED THEREWITH; WATCHES AND CLOCKS (U.S. CLS. 2, 27, 28 AND 50).

CLASS 16—PAPER GOODS AND PRINTED MATTER

FOR BOOKS IN THE FIELD OF ANIMATED CARTOONS, CHILDREN'S STORIES AND EDUCATIONAL GAMES, COMPETITIONS AND QUIZZES; COMICS; MAGAZINES FEATURING ANIMATED CARTOONS, CHILDREN'S STORIES AND EDUCATIONAL GAMES, COMPETITIONS AND QUIZZES; CHILDREN'S ACTIVITY BOOKS; ADDRESS BOOKS; ALBUMS FOR PHOTOGRAPHS, STICKERS, STAMPS, CARDS AND COINS; AUTOGRAPH BOOKS; BINDERS; BOOK MARKERS; CALENDARS; CARTOON STRIPS; CASES, HOLDERS AND STANDS FOR PENS, PENCILS, PASTELS AND CRAYONS; COLOURING BOOKS; DECALCOMANIAS; DIARIES; DOCUMENT FILES AND BOXES FOR STATIONERY AND PAPERS; DRAWING BOOKS, PADS, PENS AND PEN SETS COMPRISED OF PENS, COLOUR PENS, FELT-TIP PENS, FOUNTAIN PENS, INK PENS, BALLPOINT PENS, ROLLER BALL PENS, CORRECTING PENS, PEN CASES, BOXES FOR PENS AND PEN HOLDERS; EASELS; EMBROIDERY, SEWING AND KNITTING PATTERNS; FOLDERS FOR STATIONERY AND PAPERS; GLUE FOR STATIONERY OR HOUSEHOLD PURPOSES; GREETING CARDS; INK FOR WRITING INSTRUMENTS; MODELLING CLAY; NEWSLETTERS IN THE FIELD OF ANIMATED CARTOONS, CHILDREN'S STORIES AND EDUCATIONAL GAMES, COMPETITIONS AND QUIZZES; NOTE BOOKS AND NOTE PADS; PRINTED PARTY INVITATIONS; PENCIL SHARPENERS; PENS, PAINT BOXES, PAINT BRUSHES, PASTELS, CRAYONS, PENCILS; POST CARDS; PRINTED MATTER, NAMELY, HEIGHT CHARTS; PICTURES AND POSTERS; PRINTED PUBLICATIONS, NAMELY, BOOKS, COMICS AND MAGAZINES IN THE FIELD OF ANIMATED CARTOONS, CHILDREN'S STORIES AND EDUCATIONAL GAMES, COMPETITIONS AND QUIZZES; RUBBER ERASERS; DRAWING RULERS; SCRAP BOOKS; STATIONERY; STENCILS; STICKERS AND TRANSFERS; PAPER TABLECLOTHS, PAPER MATS, NAPKINS OF PAPER; PRINTED TEACHING MATERIALS IN THE FIELD OF PRE-SCHOOL CHILDREN'S EDUCATION; TRADING CARDS; WRAPPING PAPER; WRITING PADS AND PAPER; MODELLING COMPOUND AND APPARATUS IN THE NATURE OF MOULDS TO WORK WITH SAID MODELLING COMPOUND SOLD AS A UNIT; BLACKBOARDS; BOOK ENDS; PADS OF PRINTED PARTY INVITATIONS; PAPER PARTY BAGS; PARTY GAME BOOKS, PARTY STATIONERY; PRINTED SIGNS OF PAPER; MONEY CLIPS OF PRECIOUS METAL OR COATED WITH PRECIOUS METAL (U.S. CLS. 2, 5, 22, 23, 29, 37, 38 AND 50).

CLASS 18—LEATHER GOODS

FOR ALL PURPOSE CARRYING BAGS; UMBRELLAS; ATHLETIC BAGS; BACK PACKS; BEACH BAGS; BUM BAGS; COIN PURSES; DIAPER BAGS; DUFFLE BAGS; HANDBAGS; KEY CASES; LEATHER KEY CHAINS; LUGGAGE; SCHOOL BAGS; SUITCASES; SYNTHETIC FABRIC LUNCH BAGS; TOTE BAGS; UNFITTED VANITY CASES; WALLETTS (U.S. CLS. 1, 2, 3, 22 AND 41).

CLASS 20—FURNITURE AND ARTICLES NOT OTHERWISE CLASSIFIED

FOR FURNITURE, MIRRORS, PICTURE FRAMES; ARTICLES MADE OF WOOD, CORK, REED, CANE, WICKER OR PLASTIC WHICH ARE NOT INCLUDED IN OTHER CLASSES, NAMELY, BULLETIN BOARDS, WOOD BEDSTEADS, BED CASTERS NOT OF METAL, BINS OF WOOD OR PLASTIC, WOOD BOXES, INDOOR BLINDS OF WOOD OR REED, WOODEN OR PLASTIC DOORKNOBS, PACKAGING CONTAINERS OF PLASTIC, FIGURINES OF WOOD, WAX, PLASTER OR PLASTIC; GARDEN FURNITURE; PILLOWS AND CUSHIONS; CAKE DECORATING KITS CONSISTING OF PLASTIC CAKE DECORATIONS; DRINKING STRAWS; PILLOWS; SLEEPING BAGS; TOY BOXES (U.S. CLS. 2, 13, 22, 25, 32 AND 50).

CLASS 21—HOUSEWARES AND GLASS

FOR HOUSEHOLD AND KITCHEN UTENSILS AND CONTAINERS NOT OF PRECIOUS METAL OR COATED THEREWITH, NAMELY, SERVINGWARE FOR SERVING FOOD, NON-ELECTRIC EGG BEATERS, NON-ELECTRIC FOOD BLENDERS, CHOPSTICKS, MIXING SPOONS; FUNNELS, ICE CUBE MOULDS, SALT AND PEPPER CELLARS, PIE SERVERS, ROLLING PINS, ICE-CREAM SCOOPS, AND CONTAINERS, FOR HOUSEHOLD USE, NOT OF PRECIOUS METAL OR COATED THEREWITH; BATHROOM ACCESSORIES, NAMELY, SOAP BOXES, SOAP HOLDERS, SOAP DISPENSERS, TOILET PAPER HOLDERS, TOOTHBRUSHES, TOILET BRUSHES, TOILET UTENSILS, NAMELY, BATHROOM WASH BASINS, PORTABLE BATH TUBS FOR BABIES, BATH BRUSHES, BATHROOM SPONGES, BATHROOM GARBAGE BINS, TOOTHBRUSH HOLDERS, TOWEL HOLDERS IN THE NATURE OF TOWEL BARS AND RINGS, TOILET PAPER HOLDERS AND ALL PURPOSE PORTABLE HOUSEHOLD CONTAINERS FOR CLEANING PRODUCTS AND COSMETICS, NOT OF PRECIOUS METAL, BABY BATH TUBS, BATH SPONGES, BOTTLES SOLD EMPTY, DRINKING GLASSES, LUNCH BOXES, THERMAL INSULATED CONTAINERS FOR FOOD OR BEVERAGE; BOWLS, GLASSWARE, NAMELY, VASES, CUPS, MUGS, SAUCERS AND PLATES; PORCELAIN, NAMELY, VASES, CUPS, MUGS, SAUCERS AND PLATES; EARTHENWARE, NAMELY, VASES, CUPS, MUGS, SAUCERS AND PLATES; HAIR BRUSHES AND COMBS; INFANT CUPS; METAL CAKE PANS, COOKIE CUTTERS; MUGS; NON-METAL PIGGY BANKS; PLATES; PORTABLE BABY BATH TUBS; POTTIES FOR CHILDREN AND TOILET TRAINER SEATS THEREOF SOLD AS A UNIT; CERAMICS, NAMELY, VASES, CUPS, MUGS, SAUCERS AND PLATES; COASTERS NOT OF PAPER AND NOT BEING TABLE LINEN, GOBLETS, PLATES OF PRECIOUS METAL OR COATED WITH PRECIOUS METAL; SERVING TRAYS OF PRECIOUS METAL OR COATED WITH PRECIOUS METAL (U.S. CLS. 2, 13, 23, 29, 30, 33, 40 AND 50).

CLASS 24—FABRICS

FOR CLOTH BANNERS; BED COVERS AND PLASTIC TABLE COVERS; BED LINEN; BED SPREADS; BLINDS OF TEXTILE IN THE NATURE OF WINDOW CURTAINS; FABRIC BUNTING FLAGS; COASTERS OF TABLE LINEN OR OF TEXTILE; CURTAINS; CUSHION COVERS; FACE TOWELS; HANDKERCHIEFS; HOUSEHOLD LINEN; LOOSE FURNITURE COVERINGS, NAMELY, UNFITTED FURNITURE COVERS NOT OF PAPER; BED SHEETS, PILLOW CASES, DUVET COVERS; TABLE LINEN; TABLE MATS NOT OF PAPER; TABLE NAPKINS OF TEXTILE; TEXTILE GOODS, NAMELY, BED CANOPIES AND BEAN BAG COVERS IN THE NATURE OF UNFITTED FABRIC FURNITURE COVERS FOR BEAN BAG CHAIRS; TEXTILE FABRICS FOR USE IN MAKING CUSHIONS AND CUSHION COVERS; THROWS BEING FURNITURE COVERINGS; TOWELS; TRACED CLOTH FOR EMBROIDERY; WALL HANGINGS OF TEXTILE; FLANNEL (U.S. CLS. 42 AND 50).

CLASS 25—CLOTHING

FOR CLOTHING, NAMELY, APRONS, BANDANAS, BATH ROBES, BATHING SUITS, BATHING TRUNKS, BELTS, BIBS, NAMELY, CLOTH BIBS, CHILDREN'S AND INFANT'S CLOTH EATING BIBS, COATS, ADULT AND CHILDREN'S CLOTHING, NAMELY, FANCY DRESS COSTUMES AND MASQUERADE COSTUMES, NAMELY, CHARACTER COSTUMES, DRESSING GOWNS, DRESSES, GLOVES, JACKETS, JERSEYS, JUMPERS, LEGGINGS, MONEY BELTS, NECKTIES, PANTS, PYJAMAS, OVERCOATS, SCARVES, SHAWLS, SHIRTS, SOCKS, TEE SHIRTS, SHORTS, SWEATERS, SKIRTS, TIGHTS, TROUSERS, UNDERWEAR, PAINTING SMOCKS AND CLOTH PAINTING BIBS; FOOTWEAR; HEADGEAR, NAMELY, EAR MUFFS, VISORS, CAPS AND HATS (U.S. CLS. 22 AND 39).

CLASS 28—TOYS AND SPORTING GOODS

FOR TOYS, GAMES AND PLAYTHINGS, NAMELY, CROQUET SETS; ACTION FIGURES; ACTION FIGURE ACCESSORIES; BUBBLE-MAKING WAND AND SOLUTION SETS; BALLOONS; BALLS FOR GAMES; BATTERY-OPERATED ACTION TOYS; BOARD GAMES; TOY BUILDING BLOCKS; BUILDING GAMES; CARD GAMES; CHRISTMAS TREE ORNAMENTS AND DECORATION; CLOTHES FOR DOLLS OR SOFT TOYS; DOLL ACCESSORIES; DOLLS; DOLL ACCESSORIES, NAMELY, DOLL'S PRAMS; GAMES, NAMELY, ACTION SKILL GAMES, ARCADE GAMES, ELECTRONIC EDUCATIONAL GAME MACHINES FOR CHILDREN, LCD GAME MACHINES; GYMNASIAC AND SPORTING ARTICLES, NAMELY, BALANCE BEAMS, EXERCISE BENCHES, BALLS AND RINGS FOR GYMNASIACS, RACKETS FOR RACKET GAMES; HAND PUPPETS; INFANT RATTLES; INFANT ACTION CRIB TOYS; JIGSAW PUZZLES; KITES; MANIPULATIVE PUZZLES; FACE MASKS; TOY MOBILES; SCALE MODEL VEHICLES; HOBBY CRAFT SETS FOR MAKING TOYS; NOVELTIES FOR PARTIES, NAMELY, PARTY FAVOURS IN THE NATURE OF SMALL TOYS; PLAYING CARDS; PLUSH TOYS; PUPPETS; PUZZLES; RIDE-ON TOYS; PLAYGROUND EQUIPMENT, NAMELY, SANDBOXES AND SLIDES; INFLATABLE SWIMMING POOLS, BATH TOYS, POOL WATER TOYS, WATER SQUIRTING TOYS; SKATEBOARDS, ICE SKATES, SNOW SKIS, FLYING DISCS, HOCKEY STICKS, SNOW SLEDS FOR RECREATIONAL USE; SOAP BUBBLES, NAMELY, BUBBLE MAKING WAND AND SOLUTION SETS; SOFT SCULPTED TOY FIGURES; TOY BAKE WARE; TOY BANKS; TOY COOKWARE; TOY FIGURES; TOY TOOLS, CHILDREN'S DRESS UP ACCESSORIES, NAMELY, TOY TOOL BELTS AND TOY HARD HATS; TOY VEHICLES; CHILDREN'S TOY TRICYCLES OTHER THAN FOR TRANSPORT; COSTUMES BEING CHILDREN'S PLAYTHINGS, NAMELY, DOLL'S COSTUMES AND COSTUME MASKS FOR CHILDREN; HAND HELD UNITS FOR PLAYING ELECTRONIC GAMES OTHER THAN THOSE ADAPTED FOR USE WITH AN EXTERNAL DISPLAY SCREEN OR MONITOR; WATER TOYS, NAMELY, POOL DIVING RINGS; PAPER PARTY HATS; BATH PLAY SETS COMPRISED OF BATH TOYS (U.S. CLS. 22, 23, 38 AND 50).

CLASS 29—MEATS AND PROCESSED FOODS

FOR FRESH, COOKED, CHILLED AND FROZEN PREPARED MEALS CONSISTING PRIMARILY OF MEAT, FISH, POULTRY OR VEGETABLES; MEAT, FISH, POULTRY AND GAME; MEAT EXTRACTS; PRESERVED, DRIED AND COOKED FRUITS AND VEGETABLES; JELLIES, JAMS; EGGS, MILK AND MILK PRODUCTS EXCLUDING ICE CREAM, ICE MILK AND FROZEN YOGHURT; YOGHURT, CHEESE; EDIBLE OILS AND FATS; SOUPS; POTATO CRISPS; PROCESSED BEANS; CANDIED FRUIT, SNACKS, NAMELY, FRUIT BASED SNACK FOOD AND MEAT BASED SNACK FOOD; FRUIT TOPPING; PROCESSED NUTS; PEANUT BUTTER; PICKLES; RAISINS; FRUIT AND VEGETABLE SALADS (U.S. CL. 46).

CLASS 30—STAPLE FOODS

FOR FRESH, COOKED, CHILLED AND FROZEN PREPARED MEALS CONSISTING PRIMARILY OF PASTA OR RICE; PIZZAS, PIES AND PASTA DISHES CONSISTING OF PASTA; BREAD; BREAKFAST CEREALS, CEREAL BASED ENERGY BARS, MUESLI, CORNFLAKES, PROCESSED CEREALS; CHOCOLATE SYRUPS AND CHOCOLATE TOPPING; FLOUR AND PREPARATIONS MADE FROM CEREALS, NAMELY, CEREAL-BASED FOOD TO BE USED AS A BREAKFAST FOOD, SNACK FOOD OR INGREDIENT IN MAKING OTHER FOODS; GINGER BREAD; GOLDEN SYRUP; HONEY; ICE CREAM AND FROZEN CONFECTIONS, FROZEN YOGHURT; KETCHUP; MARSHMALLOWS; MAYONNAISE; MUSTARD; PANCAKES; PASTA; PASTRIES AND CONFECTIONERY MADE OF SUGAR; CHOCOLATE; CANDIES, CANDY BARS; BISCUITS, COOKIES; CAKES; CRACKERS; RUSKS; PIES; RAVIOLI; SALT; SANDWICHES; SAUCES; SNACK MIX CONSISTING PRIMARILY OF CRACKERS, PRETZELS, CANDIED NUTS AND/OR POPPED POPCORN; SPICES; SUGAR, RICE, TAPIOCA, SAGO, ARTIFICIAL COFFEE; TEA, COFFEE, COCOA, BEVERAGES WITH COCOA AND CHOCOLATE BASE; CHOCOLATE FOOD BEVERAGES NOT BEING DAIRY-BASED OR VEGETABLE BASED; TREAACLE; VINEGAR; SALAD DRESSINGS; FRUIT SAUCES EXCLUDING CRANBERRY SAUCE OR APPLESAUCE (U.S. CL. 46).

CLASS 32—LIGHT BEVERAGES

FOR BEERS; MINERAL AND AERATED WATERS; NON-ALCOHOLIC DRINKS, NAMELY, CARBONATED BEVERAGES AND BEVERAGES CONTAINING FRUIT JUICES; FRUIT DRINKS AND FRUIT JUICES; SYRUPS FOR MAKING BEVERAGES; SHANDY, NON-ALCOHOLIC BEERS AND WINES; FROZEN FRUIT DRINK CONCENTRATES USED IN THE PREPARATION OF FROZEN FRUIT BASED BEVERAGES; SWEETENED POWDERED DRINK MIXES USED IN THE PREPARATION OF SOFT DRINKS (U.S. CLS. 45, 46 AND 48).

CLASS 41—EDUCATION AND ENTERTAINMENT

FOR ENTERTAINMENT, NAMELY, AMUSEMENT ARCADE SERVICES, AMUSEMENT PARKS AND PRESENTATION OF LIVE SHOW PERFORMANCES; ENTERTAINMENT IN THE NATURE OF FILMS AND ONGOING TELEVISION PROGRAMS IN THE FIELD OF ANIMATED CARTOONS, CHILDREN'S STORIES AND EDUCATIONAL GAMES, COMPETITIONS AND QUIZZES; ENTERTAINMENT SERVICES, NAMELY, ON-LINE INTERACTIVE CHILDREN'S STORIES, PROVIDING ON-LINE COMPUTER GAMES, COMPETITIONS AND QUIZZES IN THE FIELD OF ENTERTAINMENT, EDUCATION, CULTURE, SPORTS, AND OTHER NON-BUSINESS AND NON-COMMERCIAL FIELDS; EDUCATION SERVICES, NAMELY, PROVIDING BOTH ON-LINE AND HANDS-ON CHILDREN'S EDUCATION BY MEANS OF A SERIES OF TELEVISION PROGRAMS AND ONLINE NON-DOWNLOADABLE ANIMATED CARTOONS, CHILDREN'S STORIES AND EDUCATIONAL GAMES, COMPETITIONS AND QUIZZES ALL IN THE FIELD OF EDUCATION; ORGANIZING COMMUNITY SPORTING AND CULTURAL ACTIVITIES; ENTERTAINMENT SERVICES, NAMELY, PROVIDING ON-LINE ELECTRONIC GAMES; THE PROVISION OF ON-LINE ELECTRONIC PUBLICATIONS IN THE NATURE OF BOOKS, COMICS AND MAGAZINES FEATURING ANIMATED CARTOONS, CHILDREN'S STORIES AND EDUCATIONAL GAMES, COMPETITIONS AND QUIZZES; BOOK PUBLISHING; CHILDREN'S ENTERTAINMENT AND EDUCATION SERVICES, NAMELY, PRESENTATION OF LIVE SHOW PERFORMANCES AND ONGOING TELEVISION ANIMATED CARTOON SHOWS; ELECTRONIC GAMES PROVIDED VIA THE INTERNET; PUBLISHING OF ELECTRONIC PUBLICATIONS, NAMELY, PUBLICATION OF ELECTRONIC TEXT AND GRAPHIC PUBLICATIONS OF OTHERS FEATURING ANIMATED CARTOONS, CHILDREN'S STORIES AND EDUCATIONAL GAMES, COMPETITIONS AND QUIZZES; FAN CLUBS; FILM PRODUCTION; LIVE PERFORMANCES AND PERSONAL APPEARANCES BY A COSTUMED CHARACTER; ORGANIZATION OF

COMPETITIONS, NAMELY, COMPETITIONS FEATURING PUZZLES AND QUIZZES; PROVISION OF ON-LINE INFORMATION RELATING TO ENTERTAINMENT AND/OR EDUCATION; RADIO PROGRAM PRODUCTION; ENTERTAINMENT IN THE NATURE PRESENTATION OF LIVE STAGE SHOW PERFORMANCES; TELEVISION PROGRAM PRODUCTION (U.S. CLS. 100, 101 AND 107).

KATHERINE E. HALMEN, EXAMINING ATTORNEY

SN 79-072,814. BALLSKATE SYSTEMS AG, SWITZERLAND, FILED 8-4-2009.

BALLSKATE

THE MARK CONSISTS OF STANDARD CHARACTERS WITHOUT CLAIM TO ANY PARTICULAR FONT, STYLE, SIZE, OR COLOR.

OWNER OF INTERNATIONAL REGISTRATION 1013063 DATED 8-4-2009, EXPIRES 8-4-2019.

CLASS 9—ELECTRICAL AND SCIENTIFIC APPARATUS

FOR PROTECTIVE HELMETS FOR SPORTS (U.S. CLS. 21, 23, 26, 36 AND 38).

CLASS 25—CLOTHING

FOR SPORTS CLOTHING, NAMELY, T-SHIRTS, SHORTS, PANTS, SOCKS, SHIRTS, JACKETS, SWEATERS, SWEAT SUITS, UNDERWEAR, SCARVES AND HATS; SPORTS FOOTWEAR (U.S. CLS. 22 AND 39).

CLASS 28—TOYS AND SPORTING GOODS

FOR PROTECTIVE CLOTHING, NAMELY, KNEE GUARDS, WRIST GUARDS AND SHIN GUARDS; PROTECTION FOR HANDS AGAINST SPORTS INJURIES, NAMELY, HAND PADS FOR ATHLETIC USE; GLOVES, NAMELY, ROLLER SKATING GLOVES (U.S. CLS. 22, 23, 38 AND 50).

ALLISON HOLTZ, EXAMINING ATTORNEY

SN 79-072,853. KM IMPRESS CO., LTD., JAPAN, FILED 6-10-2009.



OWNER OF INTERNATIONAL REGISTRATION 1013160 DATED 6-10-2009, EXPIRES 6-10-2019.

THE MARK CONSISTS OF THE STYLIZED TEXT "KM" WITH A THREE LINE DESIGN THROUGH THE MIDDLE OF THE TEXT.

CLASS 7—MACHINERY

FOR MACHINES FOR THE TEXTILE INDUSTRY, NAMELY, FABRIC PRESS MACHINES, SEWING MACHINES, HEAT TRANSFER PRESS MACHINES AND QUILTING MACHINES; CLOTH CUTTING MACHINES FOR TEXTILE USE; CLOTH SPREADING MACHINES FOR SPREADING OUT FABRIC AND CLOTH FOR LAYING AND CUTTING OF TEXTILES (U.S. CLS. 13, 19, 21, 23, 31, 34 AND 35).

CLASS 9—ELECTRICAL AND SCIENTIFIC APPARATUS

FOR NEEDLE DETECTING MACHINES USED FOR DETECTING SEWING NEEDLES ON OR IN FABRIC (U.S. CLS. 21, 23, 26, 36 AND 38).

MARK SPARACINO, EXAMINING ATTORNEY

SN 79-072,854. KM IMPRESS CO., LTD., JAPAN, FILED 6-10-2009.



OWNER OF INTERNATIONAL REGISTRATION 1013161 DATED 6-10-2009, EXPIRES 6-10-2019.

CLASS 7—MACHINERY

FOR MACHINES FOR THE TEXTILE INDUSTRY, NAMELY, FABRIC PRESS MACHINES, SEWING MACHINES, HEAT TRANSFER PRESS MACHINES AND QUILTING MACHINES; CLOTH CUTTING MACHINES FOR TEXTILE USE; CLOTH SPREADING MACHINES FOR SPREADING OUT FABRIC AND CLOTH FOR LAYING AND CUTTING OF TEXTILES (U.S. CLS. 13, 19, 21, 23, 31, 34 AND 35).

CLASS 9—ELECTRICAL AND SCIENTIFIC APPARATUS

FOR NEEDLE DETECTING MACHINES USED FOR DETECTING SEWING NEEDLES ON OR IN FABRIC (U.S. CLS. 21, 23, 26, 36 AND 38).

MARK SPARACINO, EXAMINING ATTORNEY

SN 79-072,960. YOO, TAE HOON, REPUBLIC OF KOREA, FILED 5-27-2009.



OWNER OF INTERNATIONAL REGISTRATION 1013432 DATED 5-27-2009, EXPIRES 5-27-2019.

THE COLOR(S) DARK GREEN, LIGHT GREEN, PINK, BLUE, PURPLE, BROWN, WHITE, BLACK AND GRAY IS/ARE CLAIMED AS A FEATURE OF THE MARK.

THE MARK CONSISTS OF A STYLIZED CREATURE AND THE LITERAL ELEMENT "DUPAMO" APPEARING BENEATH THE CHARACTER. THE CREATURE IS PRI-

MARILY LIGHT GREEN BUT HAS TUFTS OF FUR IN DARK GREEN ON ITS SIDE AND THE TOP OF ITS HEAD; THE TIPS OF THE CREATURE'S PAWS ARE DARK GREEN AS ARE THE SOLES OF ITS FEET. THERE ARE LONG MANE-LIKE EARS THAT ARE LIGHT AND DARK GREEN WITH PINK SHADING INSIDE AND WHITE WING-LIKE TOPS WITH GRAY SHADING. THE EYES ARE BLUE AND BLACK WITH DARK GREEN EYEBROWS; THERE IS A WHITE HEART IN THE MIDDLE OF ITS FOREHEAD AND A SMALL PINK HEART FORMS ITS NOSE. ITS MOUTH IS OPEN AND IS PINK INSIDE. THERE IS A WHITE PEARL NECKLACE WITH GRAY SHADING AROUND ITS NECK AND A SACHEL SLUNG ACROSS ITS BODY WITH A STRAP VISIBLE IN PURPLE AND BROWN STRIPES, ENDING IN A PARTIAL VIEW OF THE PURPLE SACHEL. THE TERM "DUPAMO" APPEARS IN WHITE BLOCK LETTERS OUTLINED IN BOLD GREEN LINES.

THE WORDING "DUPAMO" HAS NO MEANING IN A FOREIGN LANGUAGE.

CLASS 9—ELECTRICAL AND SCIENTIFIC APPARATUS

FOR PRERECORDED VIDEO DISKS AND VIDEO TAPES FEATURING ANIMATED CARTOONS; RECORDED VIDEOTAPES NOT FEATURING MUSIC, BUT FEATURING ANIMATED CARTOONS; DOWNLOADABLE MOTION PICTURE FILMS FEATURING ANIMATED CARTOONS; PRE-RECORDED COMPACT DISC OF MUSIC; PRE-RECORDED AUDIOTAPES OF MUSIC; PROTECTIVE MASKS, NAMELY, DUST MASKS; PROTECTIVE HELMETS; MOUSE PADS; PORTABLE COMMUNICATIONS APPARATUS, NAMELY, WIRELESS PHONES; DRY CELL BATTERIES; LUMINOUS SIGNS; LIFE JACKETS; SUNGLASSES; COMPUTER GAME PROGRAMS; PERSONAL DIGITAL ASSISTANTS; COMPUTER PROGRAMS FOR ANIMATED CARTOONS; DOWNLOADABLE SOFTWARE FOR ANIMATED CARTOONS; COMPUTER SOFTWARE FOR ANIMATED CARTOONS; DOWNLOADABLE ELECTRONIC MUSIC VIA THE INTERNET AND WIRELESS DEVICES; PRE-RECORDED ELECTRONIC MEDIA OF MUSIC; PRE-RECORDED ELECTRONIC MEDIA NOT FEATURING MUSIC OR COMPUTER SOFTWARE, BUT FEATURING ANIMATED CARTOONS; VIRTUAL REALITY GAME SOFTWARE; COMPUTER PROGRAMS FOR PRE-RECORDED GAMES; MICROPHONES; ELECTRONIC PENS FOR VISUAL DISPLAY UNITS; TELEPHONE SETS; PORTABLE TELEPHONES; ELECTRONIC AGENDAS; PERSONAL COMPUTERS; GLASSES, NAMELY, EYE GLASSES; BINOCULARS; TELEVISION MONITORS; TELEVISION RECEIVERS; TELECAMERAS; MP3 PLAYERS; BLANK INTEGRATED CIRCUIT CARDS; BLANK SMART CARDS; CALCULATORS; NOTEBOOK COMPUTERS; TAPE RECORDERS; DIGITAL CAMERAS; DIGITAL INPUT AND OUTPUT SCANNERS; DIGITAL COLOUR COPIERS; DIGITAL COLOUR PRINTERS; MOUSE DATA PROCESSING EQUIPMENT, NAMELY, TOUCHPADS; EARPHONES; FIRE EXTINGUISHERS; PRINTERS FOR USE WITH COMPUTERS; COMPUTER KEYBOARDS; HEADPHONES; HOLOGRAM APPARATUS (U.S. CLS. 21, 23, 26, 36 AND 38).

CLASS 16—PAPER GOODS AND PRINTED MATTER

FOR NAPKIN PAPER; COPY PAPER; CARDBOARD MADE FROM PAPER MULBERRY; CELLOPHANE PAPER; NEWSPRINT PAPER; WAXED PAPER; OILED PAPER FOR PAPER UMBRELLAS; PRINTING PAPER; OILED PAPER FOR FLOOR; TRANSFER PAPER; WET TOWELS OF PAPER; HANDKERCHIEFS OF PAPER; TOWELS OF PAPER; FACE TOWELS OF PAPER; POSTCARD PAPER; PACKING PAPER; MILLBOARD PAPERBOARD; WRITING AND DRAWING PAPER; XUAN PAPER FOR CHINESE PAINTING AND CALLIGRAPHY; PAPER MACHE; TOILET PAPER; NAPKINS OF PAPER FOR REMOVING MAKE-UP; TAGS FOR INDEX CARDS; PRINTED ARITHMETICAL TABLES; NOTE BOOKS; CONTROL TOKENS; RULED PAPER; LEDGER BOOKS; LOOSE-LEAF PAPER; MEMO PAPER; BUSINESS CARD PAPER; INDEX CARDS FOR STATIONERY; PLOTTING PAPERS; ENVELOPES; PAPER PAD FOR OFFICE USE; PAPER FILE JACKETS; POCKET NOTEBOOKS; SKETCHBOOKS; SCRAPBOOKS; ALBUMS, NAMELY, PHOTOGRAPH ALBUMS; PARCEL TAGS FOR MEMO, NAMELY, SHIPPING LABELS; ACCOUNT BOOKS;

BOOKMARKERS; ACCOUNT SLIP PADS; CARBON PAPER; TRACING PATTERNS; TRACING PAPER; WRITING PADS; FOUNTAIN PENS; BALL POINT PENS; WRITING BRUSHES; FELT MARKING PENS; MECHANICAL PENCILS; PENCILS; STEEL PENS; PENS; PENCIL HOLDERS; CLIPBOARDS; PAPER KNIVES; PAPER CLIPS; STANDS FOR PENS AND PENCILS; BOXES FOR PENS; PEN CASES; PEN CLIPS; LETTER PAPER; LETTERHEAD PAPER; PAPER KNIVES LETTER OPENERS; CORRESPONDENCE RACKS; WRITING-BRUSH RACK; WRITING CASES SETS; WRISTBANDS FOR THE RETENTION OF WRITING INSTRUMENTS; PENCIL OR PEN BOXES; WRITING BOARDS; WRITING BOARDS ERASERS; STAPLERS; WRAPS FOR PACKAGING FOOD PRODUCTS; INSECT COLLECTORS' BOXES; CARTONS MADE FROM CORRUGATED FIBRE BOARD; BOXES MADE OF PAPER; PAPER SACKS FOR WRAPPING; BAGS ENVELOPES, POUCHES OF PLASTICS FOR PACKAGING; MATS FOR BEER GLASSES, NAMELY, PAPER COASTERS; BLINDS OF PAPER; PLACE MATS OF PAPER; TABLEMATS OF PAPER; TABLE LINEN OF PAPER; BRUSHES FOR DECORATORS; DRAWING INSTRUMENTS; DRAWING BOARDS; DISPOSABLE BABIES' DIAPERS OF PAPER AND CELLULOSE; DISPOSABLE BABIES' NAPKIN-PANTS AND DIAPER-PANTS OF PAPER AND CELLULOSE; DISPOSABLE DIAPERS OF CELLULOSE; PICTURE POSTCARDS; SONG BOOKS; PICTURE BOOKS; CALENDARS; COMIC BOOKS; MUSICAL GREETING CARDS; SUBWAY TICKETS OTHER THAN MAGNETIC; TELEPHONE CARDS OTHER THAN MAGNETIC; BOOKS IN THE FIELD OF ANIMATED CARTOONS; CREDIT CARDS OTHER THAN MAGNETIC; GUMS ADHESIVES FOR HOUSEHOLD PURPOSES; GLUE FOR HOUSEHOLD PURPOSES; SILVER PAPER; PLASTIC FOILS FOR KITCHEN USE; PAPER LABELS; STICKERS; SIGNBOARDS OF PAPER OR CARDBOARD; FLAGS OF PAPER; PLACARDS OF PAPER OR CARDBOARD; ADVERTISEMENT BOARDS OF PAPER OR CARDBOARD; NATIONAL FLAGS OF PAPER; PAPER PENNANTS; COVERS OF PAPER FOR FLOWER POTS; CORRUGATED BOARD; PAINT BOXES FOR USE IN SCHOOL; ALBUMS FOR STICKERS; CHARCOAL PENCILS; ARTISTS' WATERCOLOR SAUCERS; ENGRAVING PLATES; ETCHING NEEDLES; CANVAS FOR PAINTING; CRAYONS; PASTEL CRAYONS; PAINT-BRUSHES; PAINTERS' EASELS; PALETTES FOR PAINTERS; RUBBER ERASERS; LOOSE-LEAF BINDERS; INK STICKS; INDIAN INKS; PRINTED INSTRUCTIONAL FOR WORD MEMORIZATION; GUM ADHESIVES FOR STATIONERY PURPOSES; STARCH ADHESIVE FOR STATIONERY PURPOSES; DOCUMENT FILES FOR STATIONERY PURPOSES; GLUE FOR STATIONERY PURPOSES; GUMMED TAPE FOR STATIONERY USE; ADHESIVE TAPES FOR STATIONERY PURPOSES; INK STONES; BOOKENDS; PAPERWEIGHTS; ELASTIC BANDS FOR OFFICES; STAPLES FOR OFFICES; CLIPS FOR OFFICES, NAMELY, PAPER CLIPS; PUNCHES; PHOTOGRAPH STANDS; FOLDERS FOR PAPERS; LITHOGRAPHIC STONES; CORRECTING FLUIDS; STAMP STANDS; STAMP PADS; CASES FOR RUBBER STAMPS OR SEALING STAMPS; BLOTTERS; THUMB-TACKS; CONNECTED SCALES STATIONERY; PENCIL SHARPENERS, ELECTRIC OR NON-ELECTRIC; PENCIL LEADS; PENCIL LEAD HOLDERS; PENCIL HOLDERS; FRENCH CURVES; SEALS; STAMPS, NAMELY, INK STAMPS; STAMPING INKS; DATE STAMPS; INK, NAMELY, INK FOR WRITING INSTRUMENTS; INKWELLS; INKSTANDS; INK ERASERS; INKING PADS; IMPRESSION STAMPS AND SEALS AND ASSOCIATED BASES ALL WITH A MAGNETIC FEATURE FOR INTERCHANGING THE STAMPS AND SEALS; MAGNETIC BOARDS; THUMB-TACKS FOR DRAWING; DRAWING SQUARES; COMPASSES FOR DRAWING; TRACING NEEDLES FOR DRAWING PURPOSES; DRAWING PINS, NAMELY, THUMB-TACKS; DRAWING PADS; DRAWING T-SQUARES; DRAFTING PAPER; PAPER BOWS FOR GIFT WRAPPING; CLASPS FOR ATTACHING PAPERS FOR STATIONARY PURPOSES; DRAWER LINERS OF PAPER, PERFUMED OR NOT; FITTED TOILET LID COVERS OF PAPER; SQUARE RULERS; SHEETS OF PLASTICS PLACED UNDER A SHEET OF PAPER WHEN WRITING; BLACKBOARDS; BLACKBOARD ERASERS; CHALK ERASERS; PUSH PINS; BOOKLETS IN THE FIELD OF ANIMATED CARTOONS; GREETING CARDS; POSTCARDS; POSTAGE STAMPS; BOOKS FOR USE IN THE TEACHING OF MUSIC; PRINTED FORMS; PRINTED TIMETABLES; DIARIES; MAGAZINES IN THE FIELD OF ANIMATED

CARTOONS; TELEPHONE DIRECTORIES; PRINTED PERIODICALS IN THE FIELD OF ANIMATED CARTOONS; GEOGRAPHICAL MAPS; CATALOGUES IN THE FIELD OF ANIMATED CARTOONS; TICKETS; PAMPHLETS IN THE FIELD OF ANIMATED CARTOONS; POSTERS; PRINTED EDUCATIONAL MATERIALS, NAMELY, STUDY BOOKS OR INSTRUCTIONAL PAPERS IN THE FIELD OF ANIMATED CARTOONS; PRINTED HANDBOOKS IN THE FIELD OF ANIMATED CARTOONS; NEWSLETTERS IN THE FIELD OF ANIMATED CARTOONS; PHOTOGRAPHS; BLUEPRINTS; ARCHITECTS' MODELS; ARCHITECTURAL MODELS; THREE-DIMENSIONAL MODELS OF ANIMALS AND PLANTS FOR EDUCATIONAL AND ARTISTIC PURPOSES; MODELLING CLAY; MODELS FOR EDUCATIONAL PURPOSES, NAMELY, THREE-DIMENSIONAL MODELS; MODELLING PASTE FOR HANDICRAFT OR STATIONARY PURPOSES; MODELLING MATERIALS, NAMELY, MODELING MATERIALS AND COMPOUNDS FOR USE BY CHILDREN (U.S. CLS. 2, 5, 22, 23, 29, 37, 38 AND 50).

CLASS 28—TOYS AND SPORTING GOODS

FOR TOYS FOR DOMESTIC PETS; CANDLE HOLDERS FOR CHRISTMAS TREES; ORNAMENTS FOR CHRISTMAS TREES; FLIPPERS FOR SWIMMING; TOY MASKS; INFLATABLE SWIMMING POOLS; RUBBER TOYS, NAMELY, RUBBER CHARACTER TOYS; METAL TOYS, NAMELY, CONSTRUCTION TOYS; TOY XYLOPHONES; TOY PIANOS; TOY DOLLS; TOY FURNITURE; TOY CLOCKS AND WATCHES; PRACTICAL JOKES NOVELTIES, NAMELY, FACE MASKS; MARIONETTES; TOYS OF RATTAN, NAMELY, DOLLS; REMOTE CONTROLLED APPARATUS FOR GAMES OTHER THAN THOSE ADAPTED FOR USE WITH TELEVISION RECEIVERS; MANNEQUIN PLAY DOLLS; MASCOT DOLLS; TOY MOBILES; INFLATABLE TOYS; WOODEN TOYS, NAMELY, BUILDING BLOCKS; TOY SETS, NAMELY, TOY CONSTRUCTION SETS; PUPPETS; MODEL VEHICLES FOR CHILDREN; TRICYCLES FOR CHILDREN; ROCKING HORSES; TOY MUSICAL INSTRUMENTS; SPORT BALLS; PLAY BALLS; TOY BLOCKS, NAMELY, TOY BUILDING BLOCKS; SCOOTERS TOYS; FLYING DISCS TOYS; DOLLS' ROOMS; DOLLS' FEEDING BOTTLES; CLOTHES FOR DOLLS; DOLLS' HOUSES; DOLLS' BEDS; FURNITURE FOR DOLLS' HOUSES; TEDDY BEARS; PAPER TOYS, NAMELY, PAPER DOLLS; PLUSH TOYS; PLASTIC TOYS, NAMELY, PLASTIC CHARACTER TOYS; RING GAMES; KOREAN TRADITIONAL DOMINO GAMES (GOLPAE); MARBLES FOR GAMES; GAME EQUIPMENTS FOR DIAMOND GAMES, NAMELY, BATS AND GLOVES FOR BASEBALL; DARTS; QUILTS; DOMINOES; ROULETTE WHEELS; CONJURING APPARATUS, NAMELY, MAGIC TRICKS; KALEIDOSCOPIES; BOARD GAMES; BINGO CARDS; CONFETTI; BACKGAMMON GAMES; KITES; SPINNING TOPS; PUZZLES; JIGSAW PUZZLES; HORSESHOE GAMES; PLAY BALLOONS; GOLF BAGS, WITH OR WITHOUT WHEELS; GOLF BALLS; GOLF GLOVES; GOLF CLUBS; SWINGS; BASKETBALLS; RACKETS; TENNIS GLOVES; ROLLER SKATES; WOODEN HORSES FOR ATHLETIC USE, NAMELY, GYMNASTIC VAULTING HORSES; KNEE GUARDS FOR ATHLETIC USE; PLAYGROUND EQUIPMENT, NAMELY, SLIDES; BODY BOARDS; VOLLEYBALLS; CYCLING GLOVES; SURF BOARDS; BAGS FOR SURFING BOARDS; SNOW GLOBES; SNOW SHOES; SKATEBOARDS; SKIS; SKI BAGS; SOLE COVERINGS FOR SKIS; SPRING BOARDS; ICE SKATES; BASEBALLS; BASEBALL GLOVES; BASEBALL BAT CASES; BASEBALL BATTING GLOVES; BASEBALL MASKS; BASEBALL MITTS; BASEBALL BATS; X-SHAPED STRETCH BAND FOR USE IN SPORTS TRAINING; SKIPPING ROPES; TENNIS BALLS; FOOTBALLS; CADDIE BAGS FOR GOLF CLUBS; BAGS SPECIALLY DESIGNED FOR HOLDING CRICKET EQUIPMENT; PUNCH BALLS; CASES FOR FISHING TACKLES; TOYS, NAMELY, ARCADE GAMES (U.S. CLS. 22, 23, 38 AND 50).

ELLEN BURNS, EXAMINING ATTORNEY

SN 79-072,963. TEC TRADING GMBH, 40724 HILDEN, FED REP GERMANY, FILED 7-6-2009.



OWNER OF INTERNATIONAL REGISTRATION 1013445 DATED 7-6-2009, EXPIRES 7-6-2019.

THE COLOR(S) BLACK, WHITE AND BLUE IS/ARE CLAIMED AS A FEATURE OF THE MARK.

THE MARK CONSISTS OF THE WORDING "FIBERTEC" IN WHITE OUTLINED IN BLACK WITH A WATER DROPLET IN BLUE WITH WHITE SHADING. THE WHITE BACKGROUND DOES NOT FORM PART OF THE MARK.

CLASS 1—CHEMICALS

FOR CHEMICALS FOR USE IN THE MANUFACTURE OF TEXTILES AND CARPETS IN THE NATURE OF DRESSING AND FINISHING PREPARATIONS; STAIN PREVENTING CHEMICALS FOR USE ON FABRICS AND CARPETS; CHEMICALS FOR USE IN THE MANUFACTURE OF TEXTILES AND CARPETS IN THE NATURE OF IMPREGNATING CHEMICALS; CHEMICAL LEATHER FRESHENING PREPARATIONS, NAMELY, AQUEOUS AROMATIC ADDITIVES FOR USE IN THE MANUFACTURE OF LEATHER; CHEMICALS FOR USE IN THE MANUFACTURE OF LEATHER IN THE NATURE OF IMPREGNATING CHEMICALS; LEATHER WATERPROOFING CHEMICALS; WATERPROOFING CHEMICALS FOR TEXTILES AND CARPETS (U.S. CLS. 1, 5, 6, 10, 26 AND 46).

CLASS 3—COSMETICS AND CLEANING PREPARATIONS

FOR SHOEMAKERS' WAX FOR RETAIL SALE (U.S. CLS. 1, 4, 6, 50, 51 AND 52).

CLASS 4—LUBRICANTS AND FUELS

FOR LEATHER PRESERVING OIL AND GREASE; LEATHER PRESERVING GREASE FOR SHOES (U.S. CLS. 1, 6 AND 15).

TRACY FLETCHER, EXAMINING ATTORNEY

SN 79-073,031. PARADOX LONDON LIMITED, UNITED KINGDOM, FILED 7-16-2009.



OWNER OF INTERNATIONAL REGISTRATION 1013557 DATED 7-16-2009, EXPIRES 7-16-2019.

THE NAME(S), PORTRAIT(S), AND/OR SIGNATURE(S) SHOWN IN THE MARK DOES NOT IDENTIFY A PARTICULAR LIVING INDIVIDUAL.

THE MARK CONSISTS OF THE STYLIZED WORDING "SIENA XZANE" WHERE THE LETTER "X" IS EXTENDED AND IN A DIFFERENT FONT FROM THE REST OF THE WORDING.

CLASS 18—LEATHER GOODS

FOR ARTICLES MADE OF LEATHER OR OF IMITATION LEATHER, NAMELY, LEATHER PURSES; WHIPS; HARNESES; CARRY-ON BAGS, TRAVELLING BAGS, ATHLETIC BAGS, COSMETIC BAGS SOLD EMPTY, SCHOOLBAGS, HANDBAGS; BACKPACKS; SATCHELS; HOLDALLS; HAVERSACKS; KNAPSACKS; RUCKSACKS; VALISES; CASES, SUITCASES, BRIEFCASES, BUSINESS CARD CASES, DOCUMENT CASES, ARTICLES OF LUGGAGE; PURSES; WALLETS; LEATHER POUCHES; UMBRELLAS (U.S. CLS. 1, 2, 3, 22 AND 41).

CLASS 25—CLOTHING

FOR ARTICLES OF CLOTHING, NAMELY, SHIRTS, PANTS, JACKETS, DRESSES, SKIRTS, BLOUSES, LINGERIE, STOCKINGS, AND FOOTWEAR (U.S. CLS. 22 AND 39).

TASNEEM HUSSAIN, EXAMINING ATTORNEY

CLASS 30—STAPLE FOODS

FOR ICE CREAMS, PRODUCTS FOR ICE CREAM PREPARATION, NAMELY, ICE CREAM MIXES, ICE CREAM POWDER, STARCH-BASED BINDING AGENTS FOR ICE CREAM (U.S. CL. 46).

CLASS 43—HOTEL AND RESTAURANT SERVICES

FOR SERVICES FOR PROVIDING FOOD AND DRINK, BAR SERVICES, ICE CREAM SHOP SERVICES IN THE NATURE OF RESTAURANT, CATERING (U.S. CLS. 100 AND 101).

KATHERINE M. DUBRAY, EXAMINING ATTORNEY

SN 79-073,149. ONE.COM FZ-LLC, UNITED ARAB EMIR., FILED 7-17-2009.



THE MARK CONSISTS OF STANDARD CHARACTERS WITHOUT CLAIM TO ANY PARTICULAR FONT, STYLE, SIZE, OR COLOR.

PRIORITY DATE OF 6-23-2009 IS CLAIMED.

OWNER OF INTERNATIONAL REGISTRATION 1014001 DATED 7-17-2009, EXPIRES 7-17-2019.

CLASS 35—ADVERTISING AND BUSINESS

FOR BUSINESS CONSULTATION SERVICES IN THE FIELD OF DOMAIN NAMES (U.S. CLS. 100, 101 AND 102).

CLASS 42—SCIENTIFIC AND COMPUTER SERVICES

FOR WEB SITE HOSTING SERVICES (U.S. CLS. 100 AND 101).

KATHERINE M. DUBRAY, EXAMINING ATTORNEY

SN 79-073,291. INTERFOOD S.R.L., I-42100 REGGIO EMILIA, ITALY, FILED 7-17-2009.



PRIORITY DATE OF 6-12-2009 IS CLAIMED.

OWNER OF INTERNATIONAL REGISTRATION 1014435 DATED 7-17-2009, EXPIRES 7-17-2019.

THE MARK CONSISTS OF THE WORDING "BELLAMIA" DONE IN FANTASY BLOCK LETTERS; ABOVE THE WORDING IS A STYLISED REPRESENTATION OF A LADYBIRD; BOTH THE WORDING AND THE LADYBIRD ARE SURROUNDED BY A FANTASY BORDER.

THE ENGLISH TRANSLATION OF "BELLA MIA" IN THE MARK IS "MY BEAUTIFUL ONE".

SN 79-073,339. AUTOGRILL S.P.A., ITALY, FILED 8-7-2009.



PRIORITY DATE OF 8-4-2009 IS CLAIMED.

OWNER OF INTERNATIONAL REGISTRATION 1014530 DATED 8-7-2009, EXPIRES 8-7-2019.

THE COLOR(S) RED AND WHITE IS/ARE CLAIMED AS A FEATURE OF THE MARK.

THE MARK CONSISTS OF RED SPEECH BALLOON CONTAINING "FEEL GOOD?" IN WHITE LETTERS. THE STIPPLING IN THE MARK IS FOR SHADING PURPOSES ONLY.

CLASS 35—ADVERTISING AND BUSINESS

FOR STATISTICAL ANALYSIS AND REPORTING SERVICES FOR BUSINESS PURPOSES; COMPILATION OF STATISTICS FOR BUSINESS OR COMMERCIAL PURPOSES AND COLLECTED VIA QUESTIONNAIRES; COMPILATION OF STATISTICS FOR BUSINESS OR COMMERCIAL PURPOSES; PROVIDING AN INTERACTIVE WEB SITE FOR PERSONS TO REGISTER COMPLAINTS AGAINST COMPANIES AND/OR SERVICES OF ALL TYPES; PROVIDING AND COLLECTING QUESTIONNAIRES TO REGISTER CONSUMER SUGGESTIONS AND COMPLAINTS (U.S. CLS. 100, 101 AND 102).

CLASS 41—EDUCATION AND ENTERTAINMENT

FOR ARRANGING OF PRIZE CONTESTS (U.S. CLS. 100, 101 AND 107).

MARCIE MILONE, EXAMINING ATTORNEY

SN 79-073,463, KRISTOF DHONT, B-2000 ANTWERPEN, BELGIUM, FILED 3-2-2009.

DATETUBE

THE MARK CONSISTS OF STANDARD CHARACTERS WITHOUT CLAIM TO ANY PARTICULAR FONT, STYLE, SIZE, OR COLOR.

PRIORITY DATE OF 9-2-2008 IS CLAIMED.
OWNER OF INTERNATIONAL REGISTRATION 1014850 DATED 3-2-2009, EXPIRES 3-2-2019.

CLASS 38—COMMUNICATION

FOR TELECOMMUNICATION SERVICES IN THE NATURE OF ELECTRONIC VOICE AND IMAGING SERVICES, NAMELY, TRANSMISSION OF SOUND, IMAGES, MESSAGES, DOCUMENTS AND OTHER DATA VIA ELECTRONIC CHANNELS; PROVIDING INTERNET ACCESS TO CHAT AND DISCUSSION GROUPS CONCERNING DATING SERVICES AND MATCHMAKING SERVICES (U.S. CLS. 100, 101 AND 104).

CLASS 45—PERSONAL AND LEGAL SERVICES

FOR DATING SERVICES; MARRIAGE PARTNER INTRODUCTION; MATCHMAKING SERVICES; ALL THE AFORESAID SERVICES WHETHER OR NOT PROVIDED VIA ELECTRONIC CHANNELS, INCLUDING THE INTERNET (U.S. CLS. 100 AND 101).

ELI HELLMAN, EXAMINING ATTORNEY

SN 79-073,471, NORITSU KOKI CO., LTD., WAKAYAMA, JAPAN, FILED 6-1-2009.

refocus^[+]

OWNER OF INTERNATIONAL REGISTRATION 1014872 DATED 6-1-2009, EXPIRES 6-1-2019.

THE COLOR(S) GREY AND RED IS/ARE CLAIMED AS A FEATURE OF THE MARK.

THE MARK CONSISTS OF THE WORDING "REFOCUS" IN THE COLOR GRAY, AND GRAY APPEARS AS THE SHADING IN THE BRACKETS ENCOMPASSING THE PLUS SYMBOL. THE COLOR RED APPEARS AS THE SHADING IN THE PLUS SYMBOL.

CLASS 9—ELECTRICAL AND SCIENTIFIC APPARATUS

FOR PHOTO DEVELOPING MACHINES AND APPARATUS; PHOTO FILM DEVELOPING MACHINES AND APPARATUS; PRINTERS USED IN PHOTOGRAPHIC PRINTING; DIGITAL PHOTO PRINTERS; SILVER HALIDE PHOTO PRINTERS; INK-JET PHOTO PRINTERS; DYE SUBLIMATION PHOTO PRINTERS; FILM EXTRACTING MACHINES, NAMELY, MACHINE FOR REMOVAL OF FILM FROM CARTRIDGE FOR USE IN PHOTOGRAPHIC DEVELOPMENT; FILM ENVELOPING MACHINES, NAMELY, MACHINE FOR PLACING PROTECTIVE PLASTIC SLEEVES ON DEVELOPED NEGATIVE FILM FOR USE IN PHOTOGRAPHIC DEVELOPMENT; FILM DETACHERS FOR USE IN PRE-PROCESSING APS FILMS; FILM REATTACHERS FOR USE IN POST-PROCESSING APS FILMS; COMPUTERS; SERVERS FOR WEB HOSTING; NETWORK SERVERS; COMPUTER PERIPHERALS; IMAGE SCANNERS; ELECTRONIC COMPUTER TERMINALS FOR ON-LINE PHOTO PRINT ORDERS; COMPUTER SYSTEMS COMPRISED OF COMPUTERS, MONITORS, ELECTRONIC CARD READERS, THE AFOREMENTIONED SYSTEMS FOR RECEPTION OF ON-LINE PHOTO PRINT ORDERS, STATUS CHECK, TRANSMITTING, RECEIVING, MANAGEMENT OF DATA, FEE CALCULATION THEREFOR AND/OR MAKING APPROPRIATE ARRANGEMENTS OF THESE PROCEDURES; COMPUTER SOFTWARE FOR OPERATION OF PRINTERS USED IN PHOTOGRAPHIC PRINTING; COMPUTER SOFTWARE FOR MANAGEMENT OF PHOTO PRINT ORDERS; COMPUTER SOFTWARE FOR PROCESSING OF IMAGE DATA; COMPUTER SOFTWARE FOR RECEPTION OF ON-LINE PHOTO PRINT ORDERS, STATUS CHECK, TRANSMITTING, RECEIVING, MANAGEMENT OF DATA, FEE CALCULATION THEREFOR AND/OR MAKING APPROPRIATE ARRANGEMENTS OF THESE PROCEDURES; DOWNLOADABLE ELECTRONIC PUBLICATIONS IN THE NATURE OF MAGAZINES OR BOOKS IN THE FIELD OF PHOTOGRAPHY; PRE-RECORDED MEDIA FEATURING DIGITALLY CODED IMAGE DATA; REPLACEMENT PARTS FOR THE AFORESAID GOODS (U.S. CLS. 21, 23, 26, 36 AND 38).

CLASS 16—PAPER GOODS AND PRINTED MATTER

FOR STATIONERY; MATERIALS FOR ORGANIZING PHOTOGRAPHS, NAMELY, PHOTOGRAPH BINDING CODES, FOLDERS, PHOTOGRAPH MOUNTS, PHOTOGRAPH FASTENERS AND BINDING STRIPS; STICKERS; POSTERS; CATALOGUES IN THE FIELD OF PHOTOGRAPHY; PRINTED HANDBOOKS AND MANUALS IN THE FIELD OF PHOTOGRAPHY; PAMPHLETS IN THE FIELD OF PHOTOGRAPHY; PHOTOGRAPHS; PHOTOGRAPH MOUNTS OF PAPER OR CARDBOARD; PHOTOGRAPH STANDS; PHOTO ALBUMS; CALENDARS; BOOKS IN THE FIELD OF PHOTOGRAPHY; PRINTED PUBLICATIONS, NAMELY, BOOKS AND MAGAZINES IN THE FIELD OF PHOTOGRAPHY; PRINTED PERIODICALS IN THE FIELD OF PHOTOGRAPHY; BOOKLETS IN THE FIELD OF PHOTOGRAPHY (U.S. CLS. 2, 5, 22, 23, 29, 37, 38 AND 50).

CLASS 40—MATERIAL TREATMENT

FOR PHOTOGRAPHIC DEVELOPMENT; PHOTOGRAPHIC PRINTING; PHOTOGRAPHIC ENLARGING; PHOTOGRAPHIC PROCESSING; DIGITAL PROCESSING OF PHOTOGRAPHS; PHOTOGRAPHIC AGENCIES, NAMELY, PHOTOGRAPHIC DEVELOPMENT, PHOTOGRAPHIC PRINTING AND PHOTOGRAPHIC ENLARGING SERVICES; PROVIDING INFORMATION, ADVICE AND CONSULTING RELATING TO PHOTOGRAPHIC DEVELOPMENT, PHOTOGRAPHIC PRINTING AND PHOTOGRAPHIC ENLARGING; PROCESSING OF CINEMATOGRAPHIC FILMS; PHOTOGRAPHIC PROCESSING, RETOUCHING, EDITING AND DUPLICATION; PHOTOGRAPHIC PROCESSING, RETOUCHING, EDITING AND DUPLICATION BY MEANS OF COMPUTERS; PROVIDING INFORMATION, ADVICE AND CONSULTING RELATING TO PROCESSING, RETOUCHING, EDITING AND DUPLICATION OF PHOTOGRAPHS, DIGITAL PHOTOGRAPHS, AND IMAGE DATA; PRINTING OF DIGITAL IMAGES, DIGITAL PHOTOGRAPHS, AND IMAGE DATA ONTO

PHOTOGRAPHIC PAPERS; PRINTING OF DIGITAL IMAGES, DIGITAL PHOTOGRAPHS, AND IMAGE DATA ONTO PHOTOGRAPHIC PAPERS; PROVIDING INFORMATION, ADVICE AND CONSULTING SERVICES RELATING TO PRINTING OF DIGITAL IMAGES, DIGITAL PHOTOGRAPHS, AND IMAGE DATA ONTO PHOTOGRAPHIC PAPERS; PRINTING OF PHOTOGRAPHIC IMAGE DATA FOR COMPUTERS; PROVIDING INFORMATION, ADVICE AND CONSULTING SERVICES RELATING TO PRINTING OF PHOTOGRAPHIC IMAGE DATA FOR COMPUTERS; PRINTING OF PHOTOGRAPHIC IMAGE DATA FROM COMPUTERS, THE AFOREMENTIONED PRINTING SERVICES FEATURING CONSUMER NOTIFICATION OF ORDER RECEIPTS, FINISHES AND CHARGES BY MEANS OF DATA TRANSMISSION APPARATUS AND MOBILE PHONES; DEVELOPMENT OF SLIDE FILMS; PHOTOGRAPHIC SLIDE FILM PROCESSING; RENTAL OF MACHINES AND APPARATUS FOR PHOTOGRAPHIC DEVELOPING, PHOTOGRAPHIC PRINTING, PHOTOGRAPHIC ENLARGING OR PHOTOGRAPHIC FINISHING; PHOTOGRAPHIC PROCESSING, NAMELY, RECORDING DIGITALLY CODED IMAGE DATA ONTO BLANK RECORDING MEDIA; PHOTOGRAPHIC PROCESSING, NAMELY, RECORDING PHOTOGRAPHIC IMAGE DATA ONTO ALL KINDS OF DATA MEDIA; RENTAL OF MACHINES AND APPARATUS FOR RECORDING PHOTOGRAPHIC IMAGE DATA ONTO ALL KINDS OF DATA MEDIA, NAMELY, PRINTERS USED IN PHOTOGRAPHIC PRINTING, DIGITAL PHOTO PRINTERS, SILVER HALIDE PHOTO PRINTERS, INK-JET PHOTO PRINTERS, DYE SUBLIMATION PHOTO PRINTERS (U.S. CLS. 100, 103 AND 106).

ELI HELLMAN, EXAMINING ATTORNEY

SN 79-073,472. MARTIN EHRENBERGER, SCHWARZENBACH A.D. SAALE, FED REP GERMANY, FILED 6-2-2008.



OWNER OF INTERNATIONAL REGISTRATION 1014886 DATED 6-2-2008, EXPIRES 6-2-2018.

THE MARK CONSISTS OF TWO EQUAL SIDED CROSSES APPEARING ON EITHER SIDE OF THE WORDING "BLACKRIVER".

CLASS 25—CLOTHING

FOR CLOTHING, NAMELY, SHIRTS, SHORTS, FOOTWEAR, PANTS, JACKETS AND HEADWEAR (U.S. CLS. 22 AND 39).

CLASS 28—TOYS AND SPORTING GOODS

FOR SKATEBOARDING GOODS AND EQUIPMENT MANUFACTURED FROM WOOD AND PLASTIC, NAMELY, FINGER SKATEBOARDS, HAND SKATEBOARDS, STRUCTURAL PARTS FOR SKATEBOARDS, AND SKATEBOARD RAILS; SKATEBOARDING, FINGER SKATEBOARDING AND HAND SKATEBOARDING RAMP AND JUMPS, NAMELY, OLLIEBOXES, FUNBOXES, QUARTERPIPES AND HALFPPIPES (U.S. CLS. 22, 23, 38 AND 50).

ELI HELLMAN, EXAMINING ATTORNEY

SN 79-073,501. WEAP, F-94420 LE PLESSIS TREVISE, FRANCE, FILED 3-12-2009.

FESMAN

THE MARK CONSISTS OF STANDARD CHARACTERS WITHOUT CLAIM TO ANY PARTICULAR FONT, STYLE, SIZE, OR COLOR.

PRIORITY DATE OF 10-21-2008 IS CLAIMED.

OWNER OF INTERNATIONAL REGISTRATION 1014952 DATED 3-12-2009, EXPIRES 3-12-2019.

CLASS 9—ELECTRICAL AND SCIENTIFIC APPARATUS

FOR APPARATUS FOR RECORDING, TRANSMISSION OR REPRODUCTION OF SOUND AND IMAGES; BLANK MAGNETIC RECORDING MEDIA, BLANK SOUND RECORDING DISCS; BLANK SOUND RECORDING MEDIA; OPTICAL DISCS AND OPTICAL COMPACT DISCS FEATURING PRE-RECORDED MOTION PICTURES, TELEVISION SERIES, MOTION PICTURE SOUNDTRACKS AND MUSIC; BLANK OPTICAL DATA MEDIA CARRIERS; BLANK MAGNETIC DATA MEDIA CARRIERS; AUDIO-VIDEO COMPACT DISCS FEATURING PRE-RECORDED MOTION PICTURES, TELEVISION SERIES, MOTION PICTURE SOUNDTRACKS AND MUSIC; VIDEO AND AUDIO CASSETTES FEATURING PRE-RECORDED MOTION PICTURES, TELEVISION SERIES, MOTION PICTURE SOUNDTRACKS AND MUSIC; DOWNLOADABLE COMPUTER PROGRAMS FOR ELECTRONIC MAIL, CALENDAR AND SCHEDULING, SOUND RECORDING, IMAGE EDITING, PROJECT MANAGEMENT AND CUSTOMER MANAGEMENT; RECORDED COMPUTER PROGRAMS FOR ELECTRONIC MAIL, CALENDAR AND SCHEDULING, SOUND RECORDING, IMAGE EDITING, PROJECT MANAGEMENT AND CUSTOMER MANAGEMENT; COMPUTER GAMES SOFTWARE; EDUCATIONAL SOFTWARE FEATURING INSTRUCTIONS IN THE FIELDS OF ART, MUSIC, HISTORY, FOLK CULTURE, TRADITIONAL KNOWLEDGE AND INDIGENOUS PEOPLES; COMPUTER VIDEO GAMES PROGRAMS ADAPTED FOR USE WITH AN EXTERNAL DISPLAY SCREEN OR MONITOR; PERSONAL STEREOS; HEADSETS FOR CELLULAR TELEPHONES AND MP3 PLAYERS; CHRONOGRAPHS FOR USE AS WATCHES; CINEMATOGRAPHIC APPARATUS; VIDEO DISKS AND VIDEO TAPES WITH RECORDED ANIMATED CARTOONS; PHOTOGRAPHIC TRANSPARENCIES; DIGITAL PHOTOS FRAMES FOR PHOTOGRAPHIC TRANSPARENCIES; OPTICAL GOODS, NAMELY, SPECTACLES, CONTACT LENSES, OPTICAL LENSES; SUNGLASSES ; SPORT GOGGLES FOR USE IN SKIING, SNOWBOARDING, SCUBA, BASE JUMP AND SKY DIVING; SPECTACLE CASES; MAGNETIC CARDS; DATA PROCESSING APPARATUS; DOWNLOADABLE ELECTRONIC PUBLICATIONS IN THE NATURE OF ELECTRONIC BOOKS, MAGAZINES, NEWSLETTERS, PHOTO BOOKS AND NEWSPAPERS IN THE FIELD OF ART, MUSIC, HISTORY, FOLK CULTURE, TRADITIONAL KNOWLEDGE AND INDIGENOUS PEOPLES; MOBILE TELEPHONES (U.S. CLS. 21, 23, 26, 36 AND 38).

CLASS 16—PAPER GOODS AND PRINTED MATTER

FOR PAPER, CARDBOARD; PRINTED MATTER, NAMELY, BROCHURES, LEAFLETS, GUIDES, BOOKS, MANUALS, PRESS RELEASE, IN THE FIELD OF ART, MUSIC, HISTORY, FOLK CULTURE, TRADITIONAL KNOWLEDGE AND INDIGENOUS PEOPLES; BOOK-BINDING MATERIAL; PHOTOGRAPHS; STATIONERY; PRINTING BLOCKS; POSTERS, GRAPHIC PRINTS; PICTURES; STICKERS; WATERCOLOURS; COMIC BOOKS; PRINTED PUBLICATIONS, NAMELY, BROCHURES, LEAFLETS, GUIDES, BOOKS, MANUALS, PRESS RELEASE, IN THE FIELD OF ART, MUSIC, HISTORY, FOLK CULTURE, TRADITIONAL KNOWLEDGE AND INDIGENOUS PEOPLES; COIN, PHOTO, EVENT AND STAMP ALBUMS; ATLASES; CATALOGUES IN THE FIELD OF ART, MUSIC, HISTORY, FOLK CULTURE,

TRADITIONAL KNOWLEDGE AND INDIGENOUS PEOPLES; GEOGRAPHICAL MAPS; ALMANACS; CALENDARS; BOOKMARKERS; SCHOOL SUPPLIES, NAMELY, STATIONERY, MARKERS, PENS, PENCILS, ERASERS, PAPER, WRITING PADS, NOTEBOOKS; WRITING INSTRUMENTS, PENCILS; SLATE PENCILS; WRITING SLATES; PENCIL HOLDERS; PENHOLDERS; ELECTRIC AND NON-ELECTRIC PENCIL SHARPENERS; DRAWING PADS; SCHOOL WRITING AND DRAWING ART BOOKS; PAPERWEIGHTS; DRAWING SUPPLIES AND INSTRUMENTS, NAMELY, RULERS, CHALKS, PAPER, COLOUR PENCILS AND BRUSH; FOLDERS FOR PAPERS; INKWELLS; TELEPHONE INDEXES; BOOKBINDINGS; ENTRY TICKETS; CARDBOARD OR PAPER BOXES; ADDRESS STAMPS, GREETING CARDS; SEALING STAMPS; ENVELOPES; POSTAGE STAMPS; ANNOUNCEMENT CARDS; CARDS, NAMELY, BUSINESS CARDS AND GREETING CARDS; MUSICAL GREETING CARDS; PHOTO-ENGRAVINGS; ENGRAVED WORKS OF ART MADE FROM CUSTOM MANUFACTURED PAPER; LITHOGRAPHIC WORKS OF ART; LITHOGRAPHS, ENGRAVINGS; GRAPHIC ART REPRODUCTIONS; OLEOGRAPHS; COASTERS OF PAPER; PAPER COASTER MATS OF PAPER FOR BEER GLASSES; TABLECLOTHS OF PAPER; WRITING PADS; HAND TOWELS OF PAPER; FLAGS OF PAPER; PENNANTS OF PAPER; PAPER LABELS, NOT OF TEXTILES; FIGURINES OF PAPIER MÂCHÉ; COFFEE FILTERS OF PAPER (U.S. CLS. 2, 5, 22, 23, 29, 37, 38 AND 50).

CLASS 25—CLOTHING

FOR FOOTWEAR; HEADGEAR, NAMELY, HATS, CAPS; SOCKS; TIGHTS; STOCKINGS; BEDROOM SLIPPERS; HOUSE SLIPPERS; BEACH SHOES; SPORTS SHOES; ESPADRILLES; WOODEN SHOES; SANDALS; BOOTS, HALF-BOOTS; BRIEFS; PANTS; UNDERWEAR; LADIES' PANTS; BRASSIERES; STOCKING SUSPENDERS; GARTERS; BABIES' PANTS; BRACES; BELTS FOR CLOTHING; TROUSERS; SKIRTS, PETTICOATS; DRESSES; BODY SUITS; SHIRTS, SHORT-SLEEVED SHIRTS; SINGLETTS; TEE-SHIRTS; PULLOVERS; WAISTCOATS; WATERPROOF COATS; COATS; TOPCOATS; OVERCOATS; PARKAS; PELERINES; JACKETS; STUFF JACKETS; UNIFORMS; NECKTIES; SUITS; MASQUERADE COSTUMES; GABARDINE RAINCOATS, DRESSES, SUIT, OVERCOAT, TROUSERS AND PARKAS; FUR, NAMELY, HATS, CAPS, COATS AND JACKETS; OVERALLS; SCARVES; GLOVES; FINGERLESS GLOVES; BERTS; BANDANAS; HOSE, KNITTED CAPS; CAPS; HATS; VEILS; HALF VEILS; SWEATERS; HEAD-SCARVES; KNITTED CAPS, SUITS, DRESSING GOWNS, BATH SHOES; BIBS, NOT OF PAPER; HOUSECOATS; CLOTHING OF LEATHER, NAMELY, TROUSERS, JACKETS, SKIRTS, DRESSES, COATS, RAINCOATS AND OVERCOATS; CLOTHING OF IMITATION LEATHER, NAMELY, TROUSERS, JACKETS, SKIRTS, DRESSES, COATS, RAINCOATS AND OVERCOATS; PYJAMAS; SARIS; APRONS; TOGAS; TURBANS; PAPER CLOTHING, NAMELY, PAPER HATS (U.S. CLS. 22 AND 39).

CLASS 35—ADVERTISING AND BUSINESS

FOR ADVERTISING SERVICES; BUSINESS MANAGEMENT; BUSINESS ADMINISTRATION; PROVIDING OFFICE FUNCTIONS; BILLING, NAMELY, BILL-POSTING; ADVERTISING AGENCIES; COMMERCIAL INFORMATION AGENCIES; DISSEMINATION OF ADVERTISING MATTER; PRESENTATION OF GOODS ON ANY COMMUNICATION MEDIA, FOR RETAIL PURPOSES; DIRECT ADVERTISING MAILING; DEMONSTRATION OF GOODS BY ELECTRONIC MEANS, ALSO FOR THE BENEFIT OF THE SO-CALLED TEleshopping AND HOMESHOPPING SERVICES; DISSEMINATION AND DISTRIBUTION OF ADVERTISING MATERIAL, NAMELY, LEAFLETS, PROSPECTUSES, PRINTED MATTER AND SAMPLES; ORGANISATION OF EXHIBITIONS FOR COMMERCIAL OR ADVERTISING PURPOSES; ADVERTISING MATERIAL RENTAL; RENTAL OF ADVERTISING SPACE; RENTAL OF ADVERTISING TIME ON ANY COMMUNICATION MEDIA; PAGE LAYOUT FOR ADVERTISING PURPOSES, NAMELY, PROVIDING SPACE AT A WEB SITE FOR THE ADVERTISEMENT OF THE GOODS AND SERVICES OF OTHERS; SALES PROMOTION FOR OTHERS; PUBLICATION OF ADVERTISING TEXTS SERVICES;

UPDATING OF ADVERTISING TEXT MATERIAL; DISSEMINATION OF ADVERTISEMENTS; ONLINE ADVERTISING ON A COMPUTER NETWORK; ADVERTISING BY MAIL ORDER; RADIO ADVERTISING; TELEVISION ADVERTISING; SEARCH FOR SPONSORS, NAMELY, PROMOTING THE GOODS AND SERVICES OF OTHERS BY ARRANGING FOR SPONSORS TO AFFILIATE THEIR GOODS AND SERVICES WITH A CULTURAL EVENT; PUBLIC RELATIONS; COMMERCIAL ADMINISTRATION OF THE LICENSING OF THE GOODS AND SERVICES OF OTHERS; BUSINESS ORGANIZATION AND MANAGEMENT CONSULTANCY; BUSINESS MANAGEMENT CONSULTANCY; PROFESSIONAL BUSINESS CONSULTING; BUSINESS INFORMATION; BUSINESS MANAGEMENT ASSISTANCE; COMMERCIAL INFORMATION AGENCIES; MARKETING RESEARCH; DATA SEARCH IN COMPUTER FILES FOR OTHERS RELATING TO BUSINESS MANAGEMENT; RESEARCH FOR BUSINESS PURPOSES; OUTSOURCING SERVICES IN THE FIELD OF CULTURAL EVENTS ORGANIZATION; ARRANGING SUBSCRIPTIONS TO TELECOMMUNICATIONS SERVICES FOR OTHERS; DOCUMENT REPRODUCTION; COMPILATION OF INFORMATION INTO COMPUTER DATABASES; COMPUTERIZED BUSINESS FILE MANAGEMENT; PHOTOCOPYING; ARRANGING NEWSPAPER SUBSCRIPTIONS FOR OTHERS; IMPORT-EXPORT AGENCIES; BUSINESS MANAGEMENT OF PERFORMING ARTISTS; SHOP-WINDOW DRESSING (U.S. CLS. 100, 101 AND 102).

CLASS 38—COMMUNICATION

FOR TELECOMMUNICATIONS SERVICES, NAMELY, TRANSMITTING STREAMED SOUND AND AUDIO-VISUAL RECORDINGS VIA THE INTERNET AND VIA CELLULAR TELEPHONES, PROVIDING INSTANT MESSAGE SERVICES IN THE FORM OF TEXT, IMAGES, AUDIO OR VIDEO OR A COMBINATION OF THESE FORMATS, PROVIDING ACCESS TO DIGITAL AUDIO, VIDEO AND DATA WEBSITES FROM A DATABASE OR INTERNET; TELEVISION PROGRAMME BROADCASTING; RADIO PROGRAMME BROADCASTING; RADIO BROADCASTS; TELEVISION BROADCASTS; RADIO BROADCASTING; TELECONFERENCING SERVICES; ELECTRONIC BULLETIN BOARD SERVICES; PRESS AGENCIES, NAMELY, THE TRANSMISSION OF NEWS ITEMS TO NEWS REPORTING ORGANIZATIONS; NEWS AGENCIES, NAMELY, THE TRANSMISSION OF NEWS ITEMS TO NEWS REPORTING ORGANIZATIONS; COMMUNICATIONS BY COMPUTER TERMINALS; RADIO COMMUNICATIONS; PROVIDING ONLINE DISCUSSION FORUMS ON THE INTERNET FOR TRANSMISSION OF MESSAGES AMONG COMPUTER USERS; PROVIDING ACCESS TO DATABASES; CELLULAR TELEPHONE COMMUNICATION; TELEPHONE SERVICES; COMMUNICATIONS BY TELEPHONE; CABLE TELEVISION BROADCASTING (U.S. CLS. 100, 101 AND 104).

CLASS 41—EDUCATION AND ENTERTAINMENT

FOR EDUCATION SERVICES, NAMELY, PROVIDING CLASSES, SEMINARS, CONFERENCES AND WORKSHOPS IN THE FIELD OF ART, MUSIC, HISTORY, FOLK CULTURE, TRADITIONAL KNOWLEDGE AND INDIGENOUS PEOPLES; PROVIDING OF ART, MUSIC, HISTORY, FOLK CULTURE, TRADITIONAL KNOWLEDGE AND INDIGENOUS PEOPLES TRAINING SERVICES; ENTERTAINMENT, IN THE NATURE OF LIVE PERFORMANCES IN THE FIELDS OF MUSIC AND ART; ORGANIZATION OF SPORTING AND CULTURAL EVENTS; ARRANGING AND CONDUCTING OF CULTURAL EVENTS, COLLOQUIUMS, CONCERTS, CONFERENCES, CONGRESSES, SEMINARS AND SYMPOSIUMS IN THE FIELDS OF EDUCATION, CULTURE, SPORTS AND ENTERTAINMENT FOR NON-BUSINESS AND NON COMMERCIAL PURPOSES; ORGANIZATION OF EXHIBITIONS FOR CULTURAL OR EDUCATIONAL PURPOSES; PROVIDING MUSEUM FACILITIES FOR THE PRESENTATION OF EXHIBITIONS; ORGANIZATION OF SPORTS AND EDUCATIONAL COMPETITIONS; EDUCATIONAL SERVICES, NAMELY, ARRANGING AND CONDUCTING OF TRAINING WORKSHOPS IN THE FIELD OF ART, MUSIC, HISTORY, FOLK CULTURE, TRADITIONAL KNOWLEDGE

AND INDIGENOUS PEOPLES; OPERATING LOTTERIES; ORGANIZATION OF EVENTS FOR COMMERCIAL AND ADVERTISING PURPOSES; PLANNING OF PARTIES IN NIGHT CLUBS AND DISCOTHEQUE; ORGANIZATION OF FORMAL DANCE BALLS; PARTY PLANNING; ENTERTAINER SERVICES, NAMELY, LIVE, TELEVISED AND MOVIE APPEARANCES BY PROFESSIONAL ENTERTAINERS; PRODUCTION OF TELEVISION SHOWS; ENTERTAINMENT TICKET AGENCY SERVICES; BOOKING OF SEATS FOR SHOWS; ENTERTAINMENT IN THE NATURE OF THEATRE PRODUCTIONS; ORCHESTRA SERVICES; PRESENTATION OF LIVE SHOW PERFORMANCES; ENTERTAINMENT, NAMELY, A CONTINUING VARIETY SHOW BROADCAST OVER TELEVISION AND RADIO; FILM PRODUCTION; VIDEOTAPE TAPE FILM PRODUCTION; VIDEO TAPE EDITING; VIDEO TAPE RECORDING FOR OTHERS; INFORMATION ON EDUCATION AND EDUCATION TUITION; TEACHING IN THE FIELD OF ART, MUSIC, HISTORY, FOLK CULTURE, TRADITIONAL KNOWLEDGE AND INDIGENOUS PEOPLES; PRACTICAL TRAINING IN THE FIELD OF ART, MUSIC, HISTORY, FOLK CULTURE, TRADITIONAL KNOWLEDGE AND INDIGENOUS PEOPLES; PROVIDING INFORMATION IN THE FIELD OF RECREATION ACTIVITIES; ENTERTAINMENT INFORMATION; PUBLICATION OF BOOKS; PUBLICATION OF TEXTS, OTHER THAN PUBLICITY TEXTS; ELECTRONIC PUBLICATION OF BOOKS AND PERIODICALS ONLINE; MOBILE LIBRARY SERVICES; PROVISION OF NON-DOWNLOADABLE ONLINE ELECTRONIC PUBLICATIONS; ELECTRONIC DESKTOP PUBLISHING FOR OTHERS; LENDING LIBRARIES; DRAFT WRITING AND PUBLICATION OF TEXTS OTHER THAN ADVERTISING TEXTS; RENTAL OF SOUND RECORDINGS; DIGITAL IMAGING SERVICES; ENTERTAINMENT SERVICES, NAMELY, PROVIDING GAMES ONLINE ON A COMPUTER NETWORK; RENTAL OF CINEMATOGRAPHIC FILMS; PHOTOGRAPHY; PHOTOGRAPHIC REPORTING; NEWS REPORTERS SERVICES; TRANSLATION (U.S. CLS. 100, 101 AND 107).

MAYUR VAGHANI, EXAMINING ATTORNEY

SN 79-073,505. SECERNO LIMITED, WEST WAY, OXFORD OX2 0JJ, UNITED KINGDOM, FILED 4-29-2009.

SECERNO INTENT-BASED MODELING

THE MARK CONSISTS OF STANDARD CHARACTERS WITHOUT CLAIM TO ANY PARTICULAR FONT, STYLE, SIZE, OR COLOR.

PRIORITY DATE OF 10-29-2008 IS CLAIMED.
OWNER OF INTERNATIONAL REGISTRATION 1014960 DATED 4-29-2009, EXPIRES 4-29-2019.

OWNER OF U.S. REG. NO. 3,427,071.
NO CLAIM IS MADE TO THE EXCLUSIVE RIGHT TO USE "MODELING", APART FROM THE MARK AS SHOWN.

CLASS 9—ELECTRICAL AND SCIENTIFIC APPARATUS

FOR COMPUTER SOFTWARE AND HARDWARE FOR SECURITY AND PROTECTION OF OTHER COMPUTER SOFTWARE, HARDWARE AND COMMUNICATIONS DEVICES (U.S. CLS. 21, 23, 26, 36 AND 38).

CLASS 42—SCIENTIFIC AND COMPUTER SERVICES

FOR COMPUTER AND SOFTWARE SECURITY SERVICES, NAMELY, RESTRICTING ACCESS TO AND BY COMPUTER NETWORKS TO AND OF DATABASES, UNDESIRE WEBSITES, MEDIA AND INDIVIDUALS AND FACILITIES; PROFESSIONAL CONSULTANCY RELATING TO COMPUTER SECURITY; COMPUTER CONSULTATION, DESIGN, TESTING, AND RESEARCH; ADVISORY SERVICES IN THE FIELD OF COMPUTER SECURITY; RESEARCH AND DEVELOPMENT OF COMPUTER HARDWARE AND SOFTWARE; COMPUTER SYSTEMS ANALYSIS; COMPUTER PROGRAMMING SERVICES; INFORMATION RELATING TO ALL THE AFORESAID (U.S. CLS. 100 AND 101).

MAYUR VAGHANI, EXAMINING ATTORNEY

SN 79-073,549. REGIE PUBLICITAIRE DES TRANSPORTS; PARISIENS METROBUS PUBLICITE; SOCIETE ANONYME, FRANCE, FILED 5-25-2009.

NUMERIFLASH

PRIORITY DATE OF 11-25-2008 IS CLAIMED.
OWNER OF INTERNATIONAL REGISTRATION 1015084 DATED 5-25-2009, EXPIRES 5-25-2019.

CLASS 9—ELECTRICAL AND SCIENTIFIC APPARATUS

FOR LUMINOUS ELECTRONIC NOTICE BOARDS AND MECHANICAL ELECTRONIC NOTICE BOARDS FOR THE DISSEMINATION OF IMAGES, SOUNDS AND ADVERTISING SPOTS; VIDEO DISPLAYS FOR THE DISSEMINATION OF ADVERTISEMENT SPOTS; LUMINOUS ELECTRONIC AND DIGITAL DISPLAY BOARDS FOR THE DISSEMINATION OF COMMERCIAL SPOTS; ELECTRONIC NOTICE BOARDS FOR THE DISSEMINATION OF COMMERCIAL SPOTS (U.S. CLS. 21, 23, 26, 36 AND 38).

CLASS 35—ADVERTISING AND BUSINESS

FOR ADVERTISING, RENTAL OF ADVERTISING TIME ON ALL MEANS OF COMMUNICATION, RENTAL OF ADVERTISING SPACE, RENTAL OF ADVERTISING MATERIAL, ONLINE ADVERTISING ON A COMPUTER NETWORK (U.S. CLS. 100, 101 AND 102).

CLASS 38—COMMUNICATION

FOR TELECOMMUNICATION SERVICES, NAMELY, TRANSMISSION OF ADVERTISING PROGRAMS AND MEDIA ADVERTISING COMMUNICATIONS VIA DIGITAL COMMUNICATIONS NETWORKS; TRANSMISSION OF IMAGES, SOUNDS, MESSAGES AND COMPUTER-ASSISTED ADVERTISING IMAGES AND INFORMATION, DISPATCH VIA COMPUTER TERMINALS OF ADVERTISING AND INFORMATION MESSAGES (U.S. CLS. 100, 101 AND 104).

FRANK LATTUCA, EXAMINING ATTORNEY

SN 79-073,720. FREDERIQUE CRESTIN BILLET, FRANCE, FILED 6-19-2009.



PRIORITY DATE OF 4-22-2009 IS CLAIMED.
OWNER OF INTERNATIONAL REGISTRATION 1015525 DATED 6-19-2009, EXPIRES 6-19-2019.

OWNER OF U.S. REG. NO. 3,623,085.
THE COLOR(S) BLUE IS/ARE CLAIMED AS A FEATURE OF THE MARK.

THE MARK CONSISTS OF THE WORDING "SAJOU" AND THE ENTIRE MARK IS IN BLUE.

CLASS 8—HAND TOOLS

FOR HAND TOOLS, NAMELY, NEEDLE-THREADERS, BUTTON FASTENERS, TRACING WHEELS FOR REPRODUCING PATTERNS, DRESS MAKING SCISSORS, UNPICKING SCISSORS; POCKET KNIVES (U.S. CLS. 23, 28 AND 44).

CLASS 9—ELECTRICAL AND SCIENTIFIC APPARATUS

FOR TAPE MEASURES, DRESSMAKERS' MEASURES; MAGNETS (U.S. CLS. 21, 23, 26, 36 AND 38).

CLASS 26—FANCY GOODS

FOR NEEDLES FOR HAND SEWING, SEWING MACHINE NEEDLES, KNITTING NEEDLES, BAGGER'S NEEDLES, LACE-MAKING NEEDLES, DARNING NEEDLES, STITCH HOLDERS, NEEDLE CASES, NOT OF PRECIOUS METAL, NEEDLE CUSHIONS, SEWING THIMBLES; FASTENERS, BUCKLES, HOOKS AND EYES FOR SEWING; FASTENINGS FOR GARTERS, ZIPPERS AND ZIP FASTENERS, EMBROIDERING CROCHET HOOKS, BUTTONS, SNAP FASTENERS, LINGERIE BUTTONS, FASTENINGS FOR SUSPENDERS, PINS FOR SEWING, HAIR PINS, SAFETY PINS; SPRING FASTENINGS FOR CLOTHING, RIVETS FOR CLOTHING, CHAINS FOR CLOTHING, CLASPS FOR BELTS, CLOTHING, SKIRTS, FASTENINGS FOR CLOTHING, PINS FOR PLEATING; LACE TRIMMING, EMBROIDERY, SHOULDER PADS FOR CLOTHING, HEAT-BONDED LACE TRIMMING AND EMBROIDERY, HEAT-BONDED RIBBONS FOR CLOTHING AND CURTAINS, CORSET BUSKS, RIBBONS, LACES (U.S. CLS. 37, 39, 40, 42 AND 50).

HOWARD SMIGA, EXAMINING ATTORNEY

SN 79-073,799. ACOUSTICON HÖRSYSTEME GMBH, FED REP GERMANY, FILED 7-15-2009.



THE MARK CONSISTS OF STANDARD CHARACTERS WITHOUT CLAIM TO ANY PARTICULAR FONT, STYLE, SIZE, OR COLOR.

OWNER OF INTERNATIONAL REGISTRATION 1015723 DATED 7-15-2009, EXPIRES 7-15-2019.

CLASS 9—ELECTRICAL AND SCIENTIFIC APPARATUS

FOR AUDIOLOGICAL MEASURING APPARATUS AND MEASURING SYSTEMS CONSISTING OF COMPUTER HARDWARE, NAMELY, AUDIOMETERS AND COMPUTERIZED CONTROL SYSTEMS, CONTROL APPARATUS AND OUTPUT DEVICES; SOFTWARE FOR AUDIO LOGICAL PURPOSES, NAMELY, SOFTWARE FOR OPERATING SPEAKERS AND MICROPHONES AND SOFTWARE FOR AUTOMATIC EVALUATION AND DISPLAY OF HEARING TEST RESULTS; ACOUSTIC METERS AND SOFTWARE FOR CUSTOMIZING HEARING AIDS FOR THE DEAF (U.S. CLS. 21, 23, 26, 36 AND 38).

CLASS 10—MEDICAL APPARATUS

FOR HEARING AIDS FOR THE DEAF (U.S. CLS. 26, 39 AND 44).

KRISTIN DAHLING, EXAMINING ATTORNEY

SN 79-073,952. MARCUS SOMMER SOMSO MODELLE GMBH, FED REP GERMANY, FILED 8-18-2009.



THE MARK CONSISTS OF STANDARD CHARACTERS WITHOUT CLAIM TO ANY PARTICULAR FONT, STYLE, SIZE, OR COLOR.

PRIORITY DATE OF 3-11-2009 IS CLAIMED.

OWNER OF INTERNATIONAL REGISTRATION 1016128 DATED 8-18-2009, EXPIRES 8-18-2019.

OWNER OF U.S. REG. NO. 3,225,270.

CLASS 9—ELECTRICAL AND SCIENTIFIC APPARATUS

FOR SCIENTIFIC TEACHING APPARATUS AND INSTRUMENTS, NAMELY, MEDICAL TEACHING MANNEQUINS; APPARATUS AND INSTRUMENTS FOR SCIENTIFIC RESEARCH IN LABORATORIES, NAMELY, MEDICAL TEACHING MANNEQUINS; SCIENTIFIC TEACHING APPARATUS AND INSTRUMENTS, NAMELY, PRERECORDED MAGNETIC DATA CARRIERS FEATURING INSTRUCTIONAL, EDUCATIONAL, AND TEACHING MATERIALS IN THE FIELDS OF HUMAN AND ANIMAL ANATOMY, BOTANY AND ZOOLOGY; APPARATUS AND INSTRUMENTS FOR SCIENTIFIC RESEARCH IN LABORATORIES, NAMELY, PRERECORDED MAGNETIC DATA CARRIERS FEATURING INSTRUCTIONAL, EDUCATIONAL, AND TEACHING MATERIALS IN THE FIELDS OF HUMAN AND ANIMAL ANATOMY, BOTANY AND ZOOLOGY (U.S. CLS. 21, 23, 26, 36 AND 38).

CLASS 16—PAPER GOODS AND PRINTED MATTER

FOR INSTRUCTIONAL AND TEACHING MATERIAL, IN PARTICULAR ANATOMIC MODELS OF HUMAN BODIES, ANIMAL BODIES AND BOTANICAL MODELS FOR SCIENTIFIC TEACHING PURPOSES; ARTIFICIAL EXTREMITIES, ARTIFICIAL BONES AND SKELETONS FOR TEACHING PURPOSES (U.S. CLS. 2, 5, 22, 23, 29, 37, 38 AND 50).

CLASS 17—RUBBER GOODS

FOR PLASTICS IN EXTRUDED FORM FOR USE IN MANUFACTURE (U.S. CLS. 1, 5, 12, 13, 35 AND 50).

RON FAIRBANKS, EXAMINING ATTORNEY

SN 79-073,999. COACH CLUB, F-92310 SEVRES, FRANCE, FILED 6-8-2009.



THE MARK CONSISTS OF STANDARD CHARACTERS WITHOUT CLAIM TO ANY PARTICULAR FONT, STYLE, SIZE, OR COLOR.

OWNER OF INTERNATIONAL REGISTRATION 1016284 DATED 6-8-2009, EXPIRES 6-8-2019.

CLASS 25—CLOTHING

FOR CLOTHING, NAMELY, SHIRTS, UNDERWEAR, BELTS, GLOVES, NECKTIES, HOSIERY, SOCKS; FOOTWEAR; BEACH, SKI OR SPORTS FOOTWEAR; HEADGEAR, NAMELY, HEADSCARVES; LEATHER OR IMITATION LEATHER CLOTHING, NAMELY, SHIRTS, PANTS, SKIRTS; BABIES' DIAPERS OF TEXTILE (U.S. CLS. 22 AND 39).

CLASS 35—ADVERTISING AND BUSINESS

FOR ADVERTISING; BUSINESS MANAGEMENT; BUSINESS ADMINISTRATION; OFFICE FUNCTIONS; DISSEMINATION OF ADVERTISING MATERIAL, NAMELY, LEAFLETS, PROSPECTUSES, PRINTED MATTER, SAMPLES; ARRANGING NEWSPAPER SUBSCRIPTIONS FOR OTHERS; BUSINESS ORGANIZATION AND MANAGEMENT CONSULTANCY; ACCOUNTING; DOCUMENTS REPRODUCTION; EMPLOYMENT AGENCIES; COMPUTERIZED FILE MANAGEMENT; ORGANIZATION OF EXHIBITIONS FOR COMMERCIAL OR ADVERTISING PURPOSES; ONLINE ADVERTISING ON A COMPUTER NETWORK; RENTAL OF ADVERTISING TIME ON ANY COMMUNICATION MEDIA; PUBLICATION OF ADVERTISING TEXTS; RENTAL OF ADVERTISING SPACE; DISSEMINATION OF ADVERTISING MATTER; PUBLIC RELATIONS (U.S. CLS. 100, 101 AND 102).

CLASS 38—COMMUNICATION

FOR TELECOMMUNICATIONS ACCESS SERVICES; TELECOMMUNICATIONS INFORMATION; COMMUNICATIONS VIA COMPUTER TERMINALS OR VIA FIBRE-OPTIC NETWORKS; RADIO OR TELEPHONE COMMUNICATION; MOBILE PHONE COMMUNICATIONS; PROVISION OF ACCESS TO A GLOBAL COMPUTER NETWORK; TELECOMMUNICATIONS CONNECTIONS TO A GLOBAL COMPUTER NETWORK; NEWS AGENCY SERVICES FOR ELECTRONIC TRANSMISSION; RENTAL OF TELECOMMUNICATION APPARATUS; BROADCASTS OF RADIO AND TELEVISION PROGRAMS; TELECONFERENCING SERVICES; E-MAIL SERVICES; RENTAL OF ACCESS TIME TO GLOBAL COMPUTER NETWORKS (U.S. CLS. 100, 101 AND 104).

CLASS 41—EDUCATION AND ENTERTAINMENT

FOR EDUCATION SERVICES, NAMELY, PROVIDING PHYSICAL FITNESS INSTRUCTION; TRAINING IN THE FIELD OF SPORTS, NAMELY, AEROBICS, BODY SCULPT, ABS AND GLUTS, YOGA, PILATES, RELAXATION, FITNESS FIGHT, SKI INSTRUCTION, SALSA SOLO, SALSA COUPLES, STRETCHING, SENIORS GYM, EXERCISES AT THE OFFICE; ENTERTAINMENT IN THE NATURE OF PROVIDING SPORT ACTIVITIES; ORGANIZING SPORTING AND CULTURAL ACTIVITIES; INFORMATION ON EDUCATION OR ENTERTAINMENT; PROVIDING INFORMATION, NEWS AND COMMENTARY IN THE FIELD OF LEISURE ACTIVITIES; BOOK PUBLISHING; VIDEO TAPE FILM PRODUCTION; RENTAL OF MOTION PICTURES; VIDEOTAPE EDITING; ORGANIZATION OF EDUCATIONAL AND ENTERTAINMENT COMPETITIONS; ARRANGING AND HOLDING OF EDUCATIONAL COLLOQUIUMS, CONFERENCES OR CONGRESSES; ORGANIZATION OF EXHIBITIONS FOR CULTURAL OR EDUCATIONAL PURPOSES; PROVIDING GAMES ONLINE ON A COMPUTER NETWORK; GAMBLING SERVICES; DESKTOP PUBLISHING (U.S. CLS. 100, 101 AND 107).

KATHLEEN LORENZO, EXAMINING ATTORNEY

SN 79-074,051. PREGLEM SA, SWITZERLAND, FILED 6-19-2009.

ESMYA

THE MARK CONSISTS OF STANDARD CHARACTERS WITHOUT CLAIM TO ANY PARTICULAR FONT, STYLE, SIZE, OR COLOR.

PRIORITY DATE OF 12-23-2008 IS CLAIMED.
OWNER OF INTERNATIONAL REGISTRATION 1016455
DATED 6-19-2009, EXPIRES 6-19-2019.

CLASS 5—PHARMACEUTICALS

FOR MEDICINAL PREPARATIONS FOR THE PREVENTION AND TREATMENT OF REPRODUCTIVE DISEASES AND DISORDERS; PHARMACEUTICAL PREPARATIONS FOR THE PREVENTION AND TREATMENT OF REPRODUCTIVE DISEASES AND DISORDERS; BIOLOGICAL PREPARATIONS FOR DIAGNOSTIC PURPOSES, TREATMENT AND PREVENTION OF CONDITIONS, NAMELY, FOR THE PREVENTION AND TREATMENT OF REPRODUCTIVE DISEASES AND DISORDERS (U.S. CLS. 6, 18, 44, 46, 51 AND 52).

CLASS 35—ADVERTISING AND BUSINESS

FOR ADVERTISING AND PROMOTION SERVICES; RETAIL STORE SERVICES FEATURING PHARMACEUTICAL, MEDICINAL AND BIOLOGICAL PREPARATIONS FOR DIAGNOSTIC PURPOSES, TREATMENT AND PREVENTION OF CONDITIONS; THE GROUPING TOGETHER, FOR THE BENEFIT OF OTHERS, OF PHARMACEUTICAL, BIOLOGICAL OR MEDICINAL PREPARATIONS (EXCLUDING THEIR TRANSPORT) ENABLING CUSTOMERS TO CONVENIENTLY VIEW AND PURCHASE THOSE GOODS (U.S. CLS. 100, 101 AND 102).

CLASS 44—MEDICAL, BEAUTY AND AGRICULTURAL SERVICES

FOR MEDICAL SERVICES (U.S. CLS. 100 AND 101).
GINA HAYES, EXAMINING ATTORNEY

SN 79-074,348. FIAT GROUP AUTOMOBILES S.P.A., I-10135 TORINO, ITALY, FILED 7-17-2009.



PRIORITY DATE OF 7-10-2009 IS CLAIMED.
OWNER OF INTERNATIONAL REGISTRATION 1017212
DATED 7-17-2009, EXPIRES 7-17-2019.
THE MARK CONSISTS OF A CAR DESIGN.

CLASS 16—PAPER GOODS AND PRINTED MATTER

FOR PAPER, CARDBOARD, PAPER CUTTERS, PENS, FOUNTAIN PENS, FELT PENS, BALLPOINT PENS, PEN HOLDERS, WRITING IMPLEMENTS, FOLDERS, DOCUMENT HOLDERS, PHOTOGRAPHS, STATIONERY, ADHESIVES FOR STATIONERY OR HOUSEHOLD PURPOSES; SCRAPBOOK ALBUMS, CARDBOARD HAT BOXES; PHOTO ALBUMS; PRINTING PAPER, PAPERWEIGHTS; PAINTBRUSHES; TYPEWRITERS; WRAPPING PAPER, PLASTIC FILMS NOT FOR COMMERCIAL OR INDUSTRIAL PURPOSES; PLASTIC SHEETS FOR WRITING, PRINTING AND MARKING; PLASTIC BAGS FOR PACKAGING; PRINTING TYPE; PRINTING BLOCKS (U.S. CLS. 2, 5, 22, 23, 29, 37, 38 AND 50).

CLASS 24—FABRICS

FOR FABRICS AND TEXTILE GOODS NOT INCLUDED IN OTHER CLASSES, NAMELY, FABRICS FOR THE MANUFACTURE OF CLOTHING; BED COVERS, NAMELY, COMFORTERS; TABLE COVERS, NAMELY, TABLE CLOTHS NOT OF PAPER (U.S. CLS. 42 AND 50).

CLASS 25—CLOTHING

FOR T-SHIRTS, SWEAT SHIRTS, POLO-SHIRTS, TIES, CAPS, OVERALLS, WIND RESISTANT JACKETS, WATERPROOF JACKETS, BLAZERS, PULLOVERS, COATS, ROBES, SCARVES, SWEATERS, SHIRTS, TROUSERS, BELTS, RAINCOATS, TRACK SUITS, SHORTS, GLOVES, PAJAMAS, SLIPPERS, SWIM-WEAR, OVERALL COATS, FOULARDS; FOOTWEAR (U.S. CLS. 22 AND 39).

LINDA ORNDORFF, EXAMINING ATTORNEY

SN 79-074,591. KAZAGO ONLINE, FRANCE, FILED 5-11-2009.



PRIORITY DATE OF 3-17-2009 IS CLAIMED.
OWNER OF INTERNATIONAL REGISTRATION 1017947
DATED 5-11-2009, EXPIRES 5-11-2019.

THE MARK CONSISTS OF THE HEAD OF THREE CHARACTERS: THE FIRST ONE IS WINKING AND HAS HIS HAIR RAISED ON HIS HEAD, THE SECOND ONE IS SMILING AND HAS OPENED-EYES AND CURLY HAIRS, THE THIRD ONE IS BALD AND HAS CLOSED-EYES, ABOVE THE STYLIZED WORDING "NOOJA".

CLASS 9—ELECTRICAL AND SCIENTIFIC APPARATUS

FOR PRE-RECORDED SOUND AND/OR VISUAL AND/OR TEXT RECORDING CARRIERS, NAMELY, COMPACT DISCS, AUDIO CASSETTES, VIDEO CASSETTES, DIGITAL VERSATILE DISC, COMPACT DISCS - READ ONLY MEMORY, CARTRIDGES AND CHIPS FEATURING GAMES FOR USE WITH A VIRTUAL UNIVERSE OR A MULTIPLAYER ONLINE GAME; LEISURE SOFTWARE, NAMELY, COMPUTER SOFTWARE USED FOR PROVIDING MULTI-USER ACCESS TO ONLINE GAMING ENVIRONMENTS; COMPUTER-GAMING SOFTWARE; VIDEO GAME SOFTWARE; SOFTWARE FOR VIRTUAL REALITY GAMES; INTERACTIVE VIDEO GAMES OF VIRTUAL REALITY COMPRISED OF COMPUTER HARDWARE FOR USE WITH AN EXTERNAL MONITOR AND SOFTWARE; HAND-HELD UNITS WITH INTEGRATED SOFTWARE FOR PLAYING ELECTRONIC GAMES FOR USE WITH EXTERNAL DISPLAY SCREEN OR MONITOR; COMPUTER GRAPHICS SOFTWARE; DOWNLOADABLE VIDEO GAME PROGRAMMES; DOWNLOADABLE ELECTRONIC PUBLICATIONS IN THE NATURE OF ELECTRONIC BOOKS AND NEWSLETTERS IN THE FIELD OF A VIRTUAL UNIVERSE OR A MULTIPLAYER ONLINE GAME; VIDEO DISKS AND VIDEO TAPES WITH RECORDED ANIMATED CARTOONS (U.S. CLS. 21, 23, 26, 36 AND 38).

CLASS 16—PAPER GOODS AND PRINTED MATTER

FOR PRINTED MATTER, NAMELY, NEWSPAPERS, COMICS, PHOTOGRAPHS, MAGAZINES, BOOKS, STORYBOOKS, ART BOOKS, PRINTED PERIODICALS, NEWSLETTERS AND BROCHURES ALL IN THE FIELD OF A VIRTUAL UNIVERSE OR A MULTIPLAYER ONLINE GAME; PUBLICATIONS AND PRINTED MATTER, NAMELY, NEWSPAPERS, COMICS, PHOTOGRAPHS, MAGAZINES, BOOKS, STORYBOOKS, ART BOOKS, PRINTED PERIODICALS, NEWSLETTERS AND BROCHURES ALL IN THE FIELD OF COMPUTER GAMES AND ENTERTAINMENT; COMPUTER GAME INSTRUCTION MANUALS; STATIONERY; PAPER; CARDBOARD; POSTERS; ALBUMS FOR COINS, PHOTOGRAPHS, STAMPS, CARDS, TRADING CARD GAMES; NOTE CARDS, GIFT CARDS, SCORE CARDS, POST CARDS, TRADING CARD GAMES; CARDS FOR COLLECTING; BOOKS IN THE FIELD OF A VIRTUAL UNIVERSE OR A MULTIPLAYER ONLINE GAME; NEWSPAPERS; PROSPECTUSES AND BROCHURES IN THE FIELD OF A VIRTUAL UNIVERSE OR MULTIPLAYER ONLINE GAME; CALENDARS; GRAPHIC PRINTS; COMICS (U.S. CLS. 2, 5, 22, 23, 29, 37, 38 AND 50).

CLASS 28—TOYS AND SPORTING GOODS

FOR GAMES AND PLAYTHINGS, NAMELY, PUPPET THEATRES, MARIONETTES, DOLLS, PLUSH TOYS, TEDDY BEARS, MODELED PLASTIC TOY FIGURINES, CHESS GAMES, BACKGAMMON GAMES, ELECTRONIC DART GAMES, TRADING CARD GAMES, PUZZLES, DICE GAMES, MUSICAL INSTRUMENTS TOYS, MUSICAL GAMES IN THE NATURE OF MUSICAL BOARD GAMES, BICYCLES, ROLLER SKATES, SKATE-BOARD, SURF BOARDS, AMUSEMENT MACHINES, AUTOMATIC AND COIN-OPERATED, KITE, SKITTLES, BALLS, BALLOONS; PORTABLE VIDEO GAMES IN THE NATURE OF HAND-HELD GAMES WITH OR WITHOUT INTEGRATED SCREENS; BOARD GAMES; PLAYING CARDS (U.S. CLS. 22, 23, 38 AND 50).

CLASS 38—COMMUNICATION

FOR TELECOMMUNICATIONS SERVICES, NAMELY, TELECOMMUNICATIONS CONSULTATION, TELECOMMUNICATIONS BY EMAIL, TELECOMMUNICATION GATEWAY SERVICES; PROVIDING MULTI-USER ACCESS TO A GLOBAL COMPUTER INFORMATION NETWORK WHERE EDUCATIONAL ENTERTAINMENT, GAMES AND APPLICATIONS MAY BE PLAYED; PROVIDING ONLINE CHAT ROOMS AND ELECTRONIC BULLETIN BOARDS FOR TRANSMISSION OF MESSAGES AMONG USERS IN THE FIELD OF GENERAL INTEREST; TRANSMISSION AND DIFFUSION OF DATA VIA THE INTERNET, RADIO, TELEVISION AND MOBILE NETWORKS; BROADCASTING OF AUDIOVISUAL PROGRAMMES VIA THE INTERNET, TELEVISION AND MOBILE NETWORKS; DELIVERY OF DIGITAL MUSIC AND VIDEO BY ELECTRONIC TRANSMISSION; ELECTRONIC MAIL SERVICES; COMMUNICATION SERVICES IN THE FORM OF TEXT MESSAGES AND ELECTRONIC MESSAGES USED TO PARTICIPATE IN ONLINE COMPUTER GAMES; RENTAL OF ACCESS TIME TO DATABASES AND INTERNET WEBSITES; PROVIDING MULTI-USER ACCESS TO A GLOBAL COMPUTER INFORMATION NETWORK FEATURING APPLICATIONS FOR ELECTRONIC DISCUSSION FORUMS AND CHAT ROOMS; PROVIDING ADVICE, CONSULTANCY AND INFORMATION ON ALL THE AFOREMENTIONED SERVICES (U.S. CLS. 100, 101 AND 104).

CLASS 41—EDUCATION AND ENTERTAINMENT

FOR ENTERTAINMENT SERVICES, NAMELY, THE ONLINE PROVISION OF COMPUTER GAMES AND MUSICAL PRODUCTIONS VIA COMMUNICATION NETWORKS; ONLINE INTERACTIVE GAME SERVICES, NAMELY, PROVIDING ONLINE VIDEO GAMES, ONLINE MULTI-PLAYER GAME SERVICES, INTERACTIVE COMPETITION AND INTERACTIVE ENTERTAINMENT SERVICES IN THE NATURE OF A VIRTUAL UNIVERSE PROVIDED VIA COMMUNICATION NETWORKS; PUBLICATION OF BOOKS AND MAGAZINES; MULTIMEDIA ENTERTAINMENT SOFTWARE PRODUCTION SERVICES; PRODUCTION OF RADIO AND TELEVISION PROGRAMMES; PRODUCTION OF AUDIOVISUAL PROGRAMMES IN THE FIELD OF MUSIC AND ENTERTAINMENT; PRODUCTION OF ANIMATED PROGRAMMES AND FEATURE FILMS; PRODUCTION OF SOUND AND MUSIC RECORDINGS; MUSIC PRODUCTION AND PUBLISHING; PROVIDING ADVICE, CONSULTANCY AND INFORMATION ON ALL THE AFOREMENTIONED SERVICES (U.S. CLS. 100, 101 AND 107).

DARRYL SPRUILL, EXAMINING ATTORNEY

SN 79-074,665. KARL STORZ GMBH & CO. KG, FED REP GERMANY, FILED 10-2-2009.

S-PORTAL

THE MARK CONSISTS OF STANDARD CHARACTERS WITHOUT CLAIM TO ANY PARTICULAR FONT, STYLE, SIZE, OR COLOR.

PRIORITY DATE OF 4-20-2009 IS CLAIMED.

OWNER OF INTERNATIONAL REGISTRATION 1018082 DATED 10-2-2009, EXPIRES 10-2-2019.

OWNER OF U.S. REG. NO. 3,099,885.

CLASS 10—MEDICAL APPARATUS

FOR SURGICAL AND MEDICAL APPARATUS AND INSTRUMENTS FOR USE IN GENERAL AND ENDOSCOPIC SURGERY (U.S. CLS. 26, 39 AND 44).

CLASS 16—PAPER GOODS AND PRINTED MATTER

FOR PRINTED MATERIAL, NAMELY, CATALOGUES, MAGAZINES, JOURNALS, BROCHURES AND INFORMATIONAL FLYERS, LETTERS AND SHEETS IN THE FIELD OF MEDICAL TECHNOLOGY; BINDERS; PRINTED TEACHING AND INSTRUCTIONAL MANUALS IN THE FIELD OF MEDICAL TECHNOLOGY; PHOTOGRAPHS (U.S. CLS. 2, 5, 22, 23, 29, 37, 38 AND 50).

TASNEEM HUSSAIN, EXAMINING ATTORNEY

SN 79-074,666. KARL STORZ GMBH & CO. KG, FED REP GERMANY, FILED 10-2-2009.

FLIPCONE

THE MARK CONSISTS OF STANDARD CHARACTERS WITHOUT CLAIM TO ANY PARTICULAR FONT, STYLE, SIZE, OR COLOR.

PRIORITY DATE OF 4-20-2009 IS CLAIMED.

OWNER OF INTERNATIONAL REGISTRATION 1018083 DATED 10-2-2009, EXPIRES 10-2-2019.

OWNER OF U.S. REG. NO. 3,674,986.

CLASS 10—MEDICAL APPARATUS

FOR SURGICAL AND MEDICAL APPARATUS FOR USE IN GENERAL AND ENDOSCOPIC SURGERY (U.S. CLS. 26, 39 AND 44).

CLASS 16—PAPER GOODS AND PRINTED MATTER

FOR PRINTED MATERIAL, NAMELY, CATALOGUES, MAGAZINES, JOURNALS, BROCHURES AND INFORMATIONAL FLYERS, LETTERS AND SHEETS IN THE FIELD OF MEDICAL TECHNOLOGY; BINDERS; PRINTED TEACHING AND INSTRUCTIONAL MANUALS IN THE FIELD OF MEDICAL TECHNOLOGY; PHOTOGRAPHS (U.S. CLS. 2, 5, 22, 23, 29, 37, 38 AND 50).

TASNEEM HUSSAIN, EXAMINING ATTORNEY

SN 79-074,687. BELVEST S.P.A., ITALY, FILED 7-13-2009.

BELVEST

THE MARK CONSISTS OF STANDARD CHARACTERS WITHOUT CLAIM TO ANY PARTICULAR FONT, STYLE, SIZE, OR COLOR.

PRIORITY DATE OF 5-15-2009 IS CLAIMED.

OWNER OF INTERNATIONAL REGISTRATION 1018142 DATED 7-13-2009, EXPIRES 7-13-2019.

OWNER OF U.S. REG. NOS. 1,495,878 AND 2,980,745.

CLASS 18—LEATHER GOODS

FOR KEY-CASES, BAGS, SUITCASES AND WALLETS, BRIEFCASES, CASES, HANDBAGS, POUCHES, PURSES, SHOULDER BELTS, TRAVELLING CASES, ALL THESE ARTICLES ARE MADE OF LEATHER, SKINS AND IMITATION LEATHER (U.S. CLS. 1, 2, 3, 22 AND 41).

CLASS 25—CLOTHING

FOR CLOTHING FOR MEN, WOMEN AND CHILDREN, NAMELY, BELTS, COATS, RAINCOATS, WAISTCOATS, BLOUSES AND PULLOVERS, JACKETS, TROUSERS, DRESSES, SUITS, SWIMSUITS, SHIRTS AND CHEMISES, T-SHIRTS, SWEATERS, UNDERWEAR, SOCKS AND STOCKINGS, GLOVES, TIES, SCARVES, FOOTWEAR FOR MEN, WOMEN AND CHILDREN, HEADGEAR FOR MEN, WOMEN AND CHILDREN, NAMELY, HATS AND CAPS (U.S. CLS. 22 AND 39).

DOMINIC FATHY, EXAMINING ATTORNEY

SN 79-074,734. KARL STORZ GMBH & CO. KG, FED REP GERMANY, FILED 9-9-2009.

ALTOVIS

THE MARK CONSISTS OF STANDARD CHARACTERS WITHOUT CLAIM TO ANY PARTICULAR FONT, STYLE, SIZE, OR COLOR.

PRIORITY DATE OF 3-13-2009 IS CLAIMED.

OWNER OF INTERNATIONAL REGISTRATION 1018265 DATED 9-9-2009, EXPIRES 9-9-2019.

CLASS 9—ELECTRICAL AND SCIENTIFIC APPARATUS

FOR ENDOSCOPES FOR NON-MEDICAL PURPOSES, NAMELY, ENDOSCOPES FOR TECHNICAL AND SCIENTIFIC PURPOSES AND PARTS THEREOF; CAMERAS, NAMELY, CDD-CAMERAS, NAMELY, FOR TECHNICAL ENDOSCOPY; MICROSCOPES; ADAPTERS AND CABLES FOR CONNECTING CAMERAS TO ENDOSCOPES; APPARATUS FOR RECORDING AND REPRODUCING IMAGES, NAMELY, ENDOSCOPY (U.S. CLS. 21, 23, 26, 36 AND 38).

CLASS 10—MEDICAL APPARATUS

FOR SURGICAL AND MEDICAL APPARATUS AND INSTRUMENTS FOR USE IN GENERAL SURGERY AND FOR ENDOSCOPIC SURGERY (U.S. CLS. 26, 39 AND 44).

CLASS 16—PAPER GOODS AND PRINTED MATTER

FOR PRINTED MATTER, TEACHING AND INSTRUCTION MATERIALS EXCEPT APPARATUS, NAMELY, CATALOGUES, MAGAZINES, JOURNALS, BROCHURES, PRINTED TEACHING AND INSTRUCTIONAL MANUALS, AND INFORMATIONAL FLYERS, LETTERS AND SHEETS IN THE FIELD OF MEDICAL TECHNOLOGY; PHOTOGRAPHS (U.S. CLS. 2, 5, 22, 23, 29, 37, 38 AND 50).

TASNEEM HUSSAIN, EXAMINING ATTORNEY

SN 79-074,951. XINES S.R.L., I-00198 ROMA, ITALY, FILED 5-6-2009.

GALITZINE

OWNER OF INTERNATIONAL REGISTRATION 0558736 DATED 8-6-1990, EXPIRES 8-6-2010.
OWNER OF U.S. REG. NOS. 2,723,387 AND 3,619,627.

CLASS 9—ELECTRICAL AND SCIENTIFIC APPARATUS

FOR EYE GLASSES (U.S. CLS. 21, 23, 26, 36 AND 38).

CLASS 14—JEWELRY

FOR JEWELS, IMITATION JEWELLERY, CLOCKS, WATCHES (U.S. CLS. 2, 27, 28 AND 50).

CLASS 18—LEATHER GOODS

FOR BAGS, NAMELY, HANDBAGS, SHOULDER BAGS, GENTLEMEN'S HANDBAGS, MEN'S SHOULDER BAGS, BEACH BAGS, GYM BAGS, SCHOOL BAGS, TEXTILE AND LEATHER SHOPPING BAGS, SHOPPING BAGS WITH WHEELS ATTACHED, TRAVELING BAGS, TRUNKS, SUITCASES, PURSES AND WALLETS; LEATHER CASES FOR KEYS; UMBRELLAS, PARASOLS, WALKING STICKS (U.S. CLS. 1, 2, 3, 22 AND 41).

CLASS 24—FABRICS

FOR FABRICS, NAMELY, COTTON, LINEN, HEMP CLOTH, WOOLEN FABRIC, SILK FABRIC, COTTON BASE MIXED FABRICS, MIXED WOOLEN FABRIC, MIXED SILK FABRICS, SYNTHETIC FIBER FABRICS; TOWELS, BED COVERS, BED SHEETS, BED BLANKETS; TABLE CLOTHS NOT OF PAPER, TEXTILE NAPKINS, TABLE LINEN; CURTAINS (U.S. CLS. 42 AND 50).

CLASS 25—CLOTHING

FOR HATS, CAPS, SCARVES, NECKERCHIEFS AND BANDANAS, NECKTIES, SHIRTS, POLO SHIRTS, T-SHIRTS, JACKETS, WAISTCOATS, SWEATERS, CARDIGANS, ANORAKS, OVERCOATS, RAINCOATS, SUITS AND DRESSES, SKIRTS, TROUSERS, SHORTS, PANTS, SWIMSUITS, PAJAMAS, NIGHTGOWNS, TRACKSUITS, SOCKS, STOCKINGS, BOOTS, SHOES, SLIPPERS, GLOVES, BELTS (U.S. CLS. 22 AND 39).

CAROL SPILS, EXAMINING ATTORNEY

SN 79-074,972. VALVITALIA S.P.A., ITALY, FILED 10-27-2009.

TECNOFORGE

THE MARK CONSISTS OF STANDARD CHARACTERS WITHOUT CLAIM TO ANY PARTICULAR FONT, STYLE, SIZE, OR COLOR.

OWNER OF INTERNATIONAL REGISTRATION 0971502 DATED 6-19-2008, EXPIRES 6-19-2018.

CLASS 6—METAL GOODS

FOR JUNCTIONS AND FLANGES OF METAL FOR PIPES (U.S. CLS. 2, 12, 13, 14, 23, 25 AND 50).

CLASS 7—MACHINERY

FOR MACHINES FOR THE REDUCTION AND REGULATION OF PRESSURE AND PARTS THEREFOR, NAMELY, BALL VALVES, SEALANT BALL VALVES OF METAL, AND BUTTERFLY VALVES (U.S. CLS. 13, 19, 21, 23, 31, 34 AND 35).

CLASS 9—ELECTRICAL AND SCIENTIFIC APPARATUS

FOR SCIENTIFIC, CHECKING AND MEASURING APPARATUS AND INSTRUMENTS FOR GASES AND VAPORS, NAMELY, GAS SENSORS FOR MEASURING GAS CONCENTRATION (U.S. CLS. 21, 23, 26, 36 AND 38).

DAVID MILLER, EXAMINING ATTORNEY

SN 79-074,996. CESPA SRL, ITALY, FILED 6-26-2009.

C e s a r e p .

PRIORITY DATE OF 5-15-2009 IS CLAIMED.

OWNER OF INTERNATIONAL REGISTRATION 1018924 DATED 6-26-2009, EXPIRES 6-26-2019.

OWNER OF U.S. REG. NOS. 1,904,514, 2,787,369 AND OTHERS.

THE NAME(S), PORTRAIT(S), AND/OR SIGNATURE(S) SHOWN IN THE MARK IDENTIFIES CESARE PACIOTTI, WHOSE CONSENT(S) TO REGISTER IS MADE OF RECORD.

CLASS 18—LEATHER GOODS

FOR LEATHER AND IMITATIONS OF LEATHER, TRUNKS AND SUITCASES, UMBRELLAS, BEACH UMBRELLAS, WALKING STICKS, HAVERSACK, BAGS, NAMELY, BARREL BAGS, BOSTON BAGS, REUSABLE SHOPPING BAGS, CABIN BAGS OF LEATHER OR IMITATION LEATHER, SACKS IN THE NATURE OF A SOFT HANDBAG, TROLLEY BAGS IN THE NATURE OF A WHEELED SUITCASE, COIN POUCHES, SUITCASES, BACKPACKS, CLUTCH BAGS, TRUNKS, SPORT AND TRAVELLING BAGS, GARMENT BAGS FOR TRAVEL, BEACH BAGS, SEA TRAVELLING BAGS, BRIEFCASES, PURSES, WALLETS, KEY CASES, SHOULDER BAGS, CARRY-ON BAGS, TOTE BAGS, HANDBAGS, LEATHER ANIMAL LEASHES, SACHEL BAGS, COSMETIC VANITY CASES SOLD EMPTY, WAIST BAGS (U.S. CLS. 1, 2, 3, 22 AND 41).

CLASS 25—CLOTHING

FOR CLOTHING ITEMS, NAMELY, SWEATERS, CARDIGANS, SLIPS, SUITS, TROUSERS, SHORTS, JUMPERS, RAINCOATS, SUITS AND DRESSES MADE OF LEATHER, STOCKINGS AND SOCKS, GARTER BELTS, WIND-RESISTANT JACKETS, SKI TROUSERS, FUR COATS, OVERCOATS, JACKETS, SKIRTS, DRESSES, UNDERSHIRTS, T-SHIRTS, SPORT T-SHIRTS, BLOUSES, SHIRT COLLARS, SHIRTS, FOULARDS, BEACHWEAR, SWIMSUITS, BIKINI, TRACKSUITS, UNDERWEAR, BRAS, BRASSIERE, CORSETS, FOUNDATION SLIPS, BRIEFS AND BIKINI BRIEFS, VESTS, NIGHTGOWNS, NEGLIGEEES, PYJAMAS, GLOVES, SHAWLS, SCARVES, NECKTIES, BOW TIES, BELTS, SUSPENDERS, HATS AND CAPS, SHOES, BOOTS, LACED BOOTS, LEATHER SHOES, RUBBER SHOES, RAIN SHOES, SPORT SHOES, SANDALS, SLIPPERS, SHOE SOLES, SHOES HEELS, MOULDED SOLES FOR SHOES (U.S. CLS. 22 AND 39).

DEBRA LEE, EXAMINING ATTORNEY

SN 79-075,027. PAFE OY, FINLAND, FILED 10-7-2009.

PAFE

THE MARK CONSISTS OF STANDARD CHARACTERS WITHOUT CLAIM TO ANY PARTICULAR FONT, STYLE, SIZE, OR COLOR.

PRIORITY DATE OF 4-8-2009 IS CLAIMED.

OWNER OF INTERNATIONAL REGISTRATION 1019001 DATED 10-7-2009, EXPIRES 10-7-2019.

THE WORDING "PAFE" HAS NO MEANING IN A FOREIGN LANGUAGE.

CLASS 6—METAL GOODS

FOR REFUSE CONTAINERS AND DUSTBINS OF METAL FOR STORAGE OR TRANSPORT (U.S. CLS. 2, 12, 13, 14, 23, 25 AND 50).

CLASS 12—VEHICLES

FOR APPARATUS FOR LOCOMOTION BY LAND, NAMELY, CARGO TRAILERS (U.S. CLS. 19, 21, 23, 31, 35 AND 44).

CLASS 21—HOUSEWARES AND GLASS

FOR REFUSE CONTAINERS AND DUSTBINS AND THEIR PARTS, FOR HOUSEHOLD USE, REAL ESTATES, RESIDENTIAL AREAS, PUBLIC PLACES, ROAD AND STREET AREAS, PARK AREAS, RECREATIONAL AREAS AND HOLIDAY RESORTS (U.S. CLS. 2, 13, 23, 29, 30, 33, 40 AND 50).

CLASS 39—TRANSPORTATION AND STORAGE

FOR TRANSPORT AND STORAGE OF WASTE, GARBAGE WASTE COLLECTION AND DISPOSAL SERVICES, GARBAGE COLLECTION, NAMELY, EMPTYING OF REFUSE CONTAINERS AND DUSTBINS; RENTAL OF CONTAINERS FOR RECEIVING, TRANSPORTING AND DUMPING GARBAGE AND DUMPSTERS FOR TRASH; RENTAL OF VEHICLES AND CARGO TRAILERS (U.S. CLS. 100 AND 105).

CLASS 42—SCIENTIFIC AND COMPUTER SERVICES

FOR INDUSTRIAL DESIGN IN RELATION TO ENVIRONMENT AND PROPERTY MAINTENANCE; NEW PRODUCT DESIGN AND DEVELOPMENT SERVICES OF PRODUCTS RELATING TO ENVIRONMENTAL AND PROPERTY MAINTENANCE (U.S. CLS. 100 AND 101).

LAURA HAMMEL, EXAMINING ATTORNEY

SN 79-075,092. PCP 2000 PTY LTD, ADELAIDE SA, AUSTRALIA, FILED 7-24-2009.

NUBUILDER

THE MARK CONSISTS OF STANDARD CHARACTERS WITHOUT CLAIM TO ANY PARTICULAR FONT, STYLE, SIZE, OR COLOR.

PRIORITY DATE OF 6-19-2009 IS CLAIMED.

OWNER OF INTERNATIONAL REGISTRATION 1019188 DATED 7-24-2009, EXPIRES 7-24-2019.

CLASS 9—ELECTRICAL AND SCIENTIFIC APPARATUS

FOR COMPUTER SOFTWARE, NAMELY, DATABASE MANAGEMENT SOFTWARE FOR BUSINESS PURPOSES; COMPUTER SOFTWARE THAT PROVIDES WEB-BASED ACCESS TO APPLICATIONS AND SERVICES THROUGH A WEB OPERATING SYSTEM OR PORTAL INTERFACE (U.S. CLS. 21, 23, 26, 36 AND 38).

CLASS 42—SCIENTIFIC AND COMPUTER SERVICES

FOR COMPUTER SERVICES, NAMELY, COMPUTER SOFTWARE PROGRAMMING AND DESIGN; COMPUTER SERVICES, NAMELY, PROVIDING A WEB-BASED SYSTEM AND ONLINE PORTAL FOR CUSTOMERS TO REMOTELY MANAGE, ADMINISTER, MODIFY AND CONTROL THEIR END USER COMPUTER DEVICES, DATA AND SOFTWARE APPLICATIONS; APPLICATION SERVICE PROVIDER (ASP), NAMELY, HOSTING COMPUTER SOFTWARE APPLICATIONS OF OTHERS (U.S. CLS. 100 AND 101).

ALEX KEAM, EXAMINING ATTORNEY

SN 79-075,491. JETTE BETEILIGUNGS GMBH & CO. KG, FED REP GERMANY, FILED 9-28-2009.

JETTE

THE MARK CONSISTS OF STANDARD CHARACTERS WITHOUT CLAIM TO ANY PARTICULAR FONT, STYLE, SIZE, OR COLOR.

PRIORITY DATE OF 4-15-2009 IS CLAIMED.
OWNER OF INTERNATIONAL REGISTRATION 1019860
DATED 9-28-2009, EXPIRES 9-28-2019.
OWNER OF U.S. REG. NO. 3,245,121.

CLASS 8—HAND TOOLS

FOR TABLE CUTLERY, NAMELY, KNIVES, FORKS AND SPOONS; SILVER PLATED KNIVES, FORKS AND SPOONS (U.S. CLS. 23, 28 AND 44).

CLASS 17—RUBBER GOODS

FOR RUBBER, GUTTA-PERCHA, GUM, ASBESTOS, MICA AND GOODS MADE FROM THESE MATERIALS AND NOT INCLUDED IN OTHER CLASSES, NAMELY, ACRYLIC RUBBER, ACOUSTICAL TILES, DUCT TAPE, FLUORO RUBBER; PLASTICS IN EXTRUDED FORM IN THE NATURE OF BARS, BLOCKS, PELLETS, RODS, SHEETS, AND TUBES FOR USE IN MANUFACTURE; PACKING, STOPPING AND INSULATING MATERIALS (U.S. CLS. 1, 5, 12, 13, 35 AND 50).

CLASS 26—FANCY GOODS

FOR LACE AND EMBROIDERY, RIBBONS AND BRAIDS; BUTTONS, HOOKS AND EYES, SEWING PINS AND NEEDLES; ARTIFICIAL FLOWERS (U.S. CLS. 37, 39, 40, 42 AND 50).

TINA L. SNAPP, EXAMINING ATTORNEY

SN 79-075,611. MESSIER-BUGATTI, VELIZY VILLACOU-BLAY, FRANCE, FILED 5-20-2009.



PRIORITY DATE OF 11-21-2008 IS CLAIMED.
OWNER OF INTERNATIONAL REGISTRATION 1020165
DATED 5-20-2009, EXPIRES 5-20-2019.

NO CLAIM IS MADE TO THE EXCLUSIVE RIGHT TO USE "GLOBAL", APART FROM THE MARK AS SHOWN.

THE COLOR(S) GREEN, BLUE AND YELLOW IS/ARE CLAIMED AS A FEATURE OF THE MARK.

THE MARK CONSISTS OF THE FOLLOWING: THE WORDING "GLOBAL" IN GREEN, THE WORDING "CARE BY MESSIER-BUGATTI" IN BLUE, AND A YELLOW CURVED BAND IN YELLOW AT THE TOP OF THE MARK.

CLASS 37—CONSTRUCTION AND REPAIR

FOR MAINTENANCE SERVICES, NAMELY, MAINTENANCE AND UPKEEP SERVICES FOR AIR VEHICLES AND AIR VEHICLE COMPONENTS; AIRCRAFT REPAIR SERVICES, NAMELY, ASSISTANCE IN HANDLING AIR VEHICLE BREAKDOWNS OR BREAKS OR FAILURE OF A COMPONENT OR SETS OF COMPONENTS FOR SUCH VEHICLES; AIRCRAFT REPAIR SERVICES FOR AIR VEHICLES AND AIR VEHICLE COMPONENTS; AIRCRAFT REPAIR SERVICES, NAMELY, ASSISTANCE IN HANDLING AIR VEHICLE BREAKDOWNS OR BREAKS OR FAILURE OF A COMPONENT OR SETS OF COMPONENTS FOR SUCH VEHICLES, CONSISTING OF REPLACEMENT AND INSTALLATION OF EITHER TEMPORARY OR PERMANENT COMPONENTS OR SETS OF COMPONENTS OF AIR VEHICLES; AIRCRAFT REPAIR SERVICES FOR THE REPLACEMENT OF AIR VEHICLE COMPONENTS WITH HIGHER PERFORMANCE COMPONENTS WITHIN THE FRAMEWORK OF A CONTRACT FOR THE MAINTENANCE OF SUCH COMPONENTS; INFORMATION AND CONSULTING IN THE FIELD OF THE MAINTENANCE, UPKEEP, REPAIR AND REPLACEMENT OF AIR VEHICLES AND AIR VEHICLE COMPONENTS; INFORMATION AND ADVICE IN THE FIELD OF THE MAINTENANCE, UPKEEP, REPAIR AND REPLACEMENT OF AIR VEHICLES AND AIR VEHICLE COMPONENTS WITH A VIEW TO OPTIMIZING THE AVAILABILITY OF AIR VEHICLES AND REDUCING THE DOWN TIME THEREOF (U.S. CLS. 100, 103 AND 106).

CLASS 39—TRANSPORTATION AND STORAGE

FOR SERVICES FOR THE TRANSPORT OF AIR VEHICLE PARTS OR COMPONENTS BY AIR, RAIL, TRUCK, TRAIN AND BOAT; AIR VEHICLE WAREHOUSING SERVICES; SERVICES FOR THE PACKAGING AND WAREHOUSING OF AIR VEHICLE COMPONENTS; AIR TRANSPORT INFORMATION AND CONSULTING; AIR TRANSPORTATION INFORMATION AND CONSULTING WITH A VIEW TO OPTIMIZING THE AVAILABILITY OF AIR VEHICLES AND REDUCING THE DOWN TIME THEREOF; RENTAL OF VEHICLES OR OF COMPONENTS, SETS OF COMPONENTS OF VEHICLES FOR AIR TRANSPORT (U.S. CLS. 100 AND 105).

CLASS 41—EDUCATION AND ENTERTAINMENT

FOR PERSONNEL TRAINING RELATING TO THE MAINTENANCE, REPAIR, UPKEEP, CONTROLS, CHECKS OR REPLACEMENT OF AIR VEHICLES OR AIR VEHICLE COMPONENTS; INFORMATION AND CONSULTING FOR PERSONNEL TRAINING RELATING TO THE MAINTENANCE, REPAIR, UPKEEP, CONTROLS, CHECKS OR REPLACEMENT OF AIR VEHICLES OR AIR VEHICLE COMPONENTS; ARRANGING AND CONDUCTING OF EDUCATIONAL COLLOQUIUMS, EDUCATIONAL CONFERENCES AND EDUCATIONAL CONVENTIONS FOR PERSONNEL TRAINING RELATING TO THE MAINTENANCE, REPAIR, UPKEEP, CONTROLS, CHECKS OR REPLACEMENT OF AIR VEHICLES OR AIR VEHICLE COMPONENTS (U.S. CLS. 100, 101 AND 107).

JUSTINE D. PARKER, EXAMINING ATTORNEY

SN 79-076,037. ELSEVIER PROPERTIES S.A., SWITZERLAND, FILED 9-10-2009.

SCIVERSE

THE MARK CONSISTS OF STANDARD CHARACTERS WITHOUT CLAIM TO ANY PARTICULAR FONT, STYLE, SIZE, OR COLOR.

PRIORITY DATE OF 3-27-2009 IS CLAIMED.

OWNER OF INTERNATIONAL REGISTRATION 1021383
DATED 9-10-2009, EXPIRES 9-10-2019.

SN 79-076.427. ELSEVIER PROPERTIES S.A., CH-2000 NEU-
CHÂTEL, SWITZERLAND, FILED 9-10-2009.

CLASS 9—ELECTRICAL AND SCIENTIFIC APPARATUS

FOR COMPUTER PROGRAMS AND SOFTWARE USED FOR SEARCHING DATA IN THE FIELD OF SCIENTIFIC RESEARCH; SOFTWARE DOWNLOADABLE FROM THE INTERNET USED FOR SEARCHING DATA IN THE FIELD OF SCIENTIFIC RESEARCH (U.S. CLS. 21, 23, 26, 36 AND 38).

SCIVAL

THE MARK CONSISTS OF STANDARD CHARACTERS WITHOUT CLAIM TO ANY PARTICULAR FONT, STYLE, SIZE, OR COLOR.

PRIORITY DATE OF 3-27-2009 IS CLAIMED.
OWNER OF INTERNATIONAL REGISTRATION 1022374
DATED 9-10-2009, EXPIRES 9-10-2019.

CLASS 38—COMMUNICATION

FOR PROVISION OF ACCESS AND RENTAL OF ACCESS TIME TO COMPUTER DATABASES (U.S. CLS. 100, 101 AND 104).

CLASS 9—ELECTRICAL AND SCIENTIFIC APPARATUS

FOR COMPUTER PROGRAMS AND SOFTWARE USED FOR SEARCHING DATA IN THE FIELD OF SCIENTIFIC RESEARCH; SOFTWARE DOWNLOADABLE FROM THE INTERNET USED FOR SEARCHING DATA IN THE FIELD OF SCIENTIFIC RESEARCH (U.S. CLS. 21, 23, 26, 36 AND 38).

CLASS 41—EDUCATION AND ENTERTAINMENT

FOR INFORMATION ON EDUCATION SUPPLIED ONLINE FROM COMPUTER DATABASES OR THE INTERNET; PUBLISHING DOWNLOADABLE ELECTRONIC PUBLICATIONS ONLINE; PUBLICATION, IN ELECTRONIC OR NON-ELECTRONIC FORMAT, OF TEXTS, BOOKS, REVIEWS AND MAGAZINES; PROVIDING PUBLICATIONS ON THE INTERNET WITH BROWSING FUNCTION, NAMELY, PUBLISHING OF ELECTRONIC PUBLICATIONS; ARRANGING AND CONDUCTING OF TRAINING WORKSHOPS IN THE FIELD OF SCIENTIFIC RESEARCH; ORGANIZING AND CONDUCTING EXHIBITIONS, DEMONSTRATIONS, READINGS, CONVENTIONS, SEMINARS, AND WORKSHOPS FOR EDUCATIONAL PURPOSES IN THE FIELD OF SCIENTIFIC RESEARCH; EDUCATIONAL AND TRAINING SERVICES, NAMELY, CONDUCTING CLASSES, CONVENTIONS, SEMINARS, CONFERENCES AND WORKSHOPS IN THE FIELD OF SCIENTIFIC RESEARCH AND DISTRIBUTING EDUCATIONAL MATERIALS IN CONNECTION THEREWITH; PROVIDING INFORMATION, ASSISTANCE AND ADVICE TO PARTICIPANTS, VISITORS AND EXHIBITORS OF EDUCATIONAL EXHIBITIONS AND CONFERENCES, NAMELY, PROVIDING INFORMATION IN THE FIELD OF EDUCATIONAL CONFERENCES ON THE TOPIC OF SCIENTIFIC RESEARCH INCLUDING ALL THE ABOVE INFORMATION AND ADVICE SUPPLIED ELECTRONICALLY, INCLUDING ON A WEBSITE; PUBLISHING SERVICES, INCLUDING COMPUTER-ASSISTED PUBLISHING, NAMELY, PUBLISHING BOOKLETS AND BROCHURES RELATING TO PRESENTATIONS AND EXHIBITIONS, CONFERENCES, CONVENTIONS, SEMINARS, AND WORKSHOPS OF AN EDUCATIONAL NATURE; CONSULTANCY AND PROVISION OF INFORMATION IN THE FIELD OF EDUCATIONAL EXHIBITIONS ON THE TOPIC OF SCIENTIFIC RESEARCH (U.S. CLS. 100, 101 AND 107).

CLASS 38—COMMUNICATION

FOR PROVISION OF ACCESS AND RENTAL OF ACCESS TIME TO COMPUTER DATABASES (U.S. CLS. 100, 101 AND 104).

CLASS 41—EDUCATION AND ENTERTAINMENT

FOR INFORMATION ON EDUCATION SUPPLIED ONLINE FROM COMPUTER DATABASES OR THE INTERNET; PUBLISHING DOWNLOADABLE ELECTRONIC PUBLICATIONS ONLINE; PUBLICATION, IN ELECTRONIC OR NON-ELECTRONIC FORMAT, OF TEXTS, BOOKS, REVIEWS AND MAGAZINES; PROVIDING PUBLICATIONS ON THE INTERNET WITH BROWSING FUNCTION, NAMELY, PUBLISHING OF ELECTRONIC PUBLICATIONS; ARRANGING AND CONDUCTING OF TRAINING WORKSHOPS IN THE FIELD OF SCIENTIFIC RESEARCH; ORGANIZING AND MANAGING EXHIBITIONS, DEMONSTRATIONS, READINGS, CONVENTIONS, SEMINARS, AND WORKSHOPS FOR EDUCATIONAL PURPOSES IN THE FIELD OF SCIENTIFIC RESEARCH; EDUCATIONAL AND TRAINING SERVICES, NAMELY, CONDUCTING CLASSES, CONVENTIONS, SEMINARS, CONFERENCES AND WORKSHOPS IN THE FIELD OF SCIENTIFIC RESEARCH AND DISTRIBUTING EDUCATIONAL MATERIALS IN CONNECTION THEREWITH; PROVIDING INFORMATION, ASSISTANCE AND ADVICE TO PARTICIPANTS, VISITORS AND EXHIBITORS OF EDUCATIONAL EXHIBITIONS AND CONFERENCES, NAMELY, PROVIDING INFORMATION IN THE FIELD OF SCIENTIFIC RESEARCH; PUBLISHING SERVICES, NAMELY, PUBLISHING AND COMPUTER-ASSISTED PUBLISHING OF BOOKS, BOOKLETS AND BROCHURES RELATING TO PRESENTATIONS AND EXHIBITIONS, CONFERENCES, CONVENTIONS, SEMINARS, AND WORKSHOPS OF AN EDUCATIONAL NATURE; CONSULTING SERVICES IN THE FIELDS OF SCIENTIFIC RESEARCH AND EDUCATIONAL EXHIBITIONS (U.S. CLS. 100, 101 AND 107).

CLASS 42—SCIENTIFIC AND COMPUTER SERVICES

FOR PROVIDING DATABASES IN THE FIELD OF SCIENTIFIC RESEARCH; COMPUTING SERVICES, NAMELY, PROVIDING INFORMATION IN THE FORM OF BIBLIOGRAPHIC CITATIONS AND EXTRACTS FROM NEWSPAPER ARTICLES, REPORTS AND RESEARCH MATERIAL, ALL IN THE SCIENTIFIC FIELD, FROM A COMPUTER DATABASE VIA A GLOBAL COMPUTER NETWORK; SCIENTIFIC AND INDUSTRIAL RESEARCH (U.S. CLS. 100 AND 101).

VIVIAN MICZNIK FIRST, EXAMINING ATTORNEY

CLASS 42—SCIENTIFIC AND COMPUTER SERVICES

FOR PROVIDING DATABASES IN THE FIELD OF SCIENTIFIC RESEARCH; COMPUTING SERVICES, NAMELY, PROVIDING INFORMATION IN THE FORM OF BIBLIOGRAPHIC CITATIONS AND EXTRACTS FROM NEWSPAPER ARTICLES, REPORTS AND RESEARCH MATERIAL, ALL IN THE SCIENTIFIC FIELD, FROM A COMPUTER DATABASE VIA A GLOBAL COMPUTER NETWORK; SCIENTIFIC RESEARCH (U.S. CLS. 100 AND 101).

SEAN CROWLEY, EXAMINING ATTORNEY

SN 79-076,479. IMAGEY LIGHTING CO., LTD., JINSHAN DISTRICT, SHANGHAI CITY, CHINA, FILED 9-25-2009.



PRIORITY DATE OF 8-7-2009 IS CLAIMED.
 OWNER OF INTERNATIONAL REGISTRATION 1022496 DATED 9-25-2009, EXPIRES 9-25-2019.
 THE MARK CONSISTS OF THE TERM "IMIGY" TO THE RIGHT OF A STYLIZED LETTER "I" IN A CIRCLE.
 THE WORDING "IMIGY" HAS NO MEANING IN A FOREIGN LANGUAGE.

CLASS 9—ELECTRICAL AND SCIENTIFIC APPARATUS

FOR NEON SIGNS, SEMICONDUCTOR CHIPS, MECHANICAL SIGNS, CHARGERS FOR BATTERIES, CHARGERS FOR ELECTRIC BATTERIES; ELECTRIC CONTROL PANELS; FLUORESCENT SCREENS, FLASHLIGHTS WITH LIGHT EMITTING DIODES FOR USE IN PHOTOGRAPHY; COMPUTER OPERATING PROGRAMS, RECORDED (U.S. CLS. 21, 23, 26, 36 AND 38).

CLASS 11—ENVIRONMENTAL CONTROL APPARATUS

FOR LAMPS, LIGHT BULBS, CEILING LIGHTS, SAFETY LAMPS FOR UNDERGROUND USE; LIGHTS FOR VEHICLES; GAS LAMPS; SOLDERING LAMPS; AIR-CONDITIONING, AIR COOLING AND VENTILATION APPARATUS AND INSTRUMENTS (U.S. CLS. 13, 21, 23, 31 AND 34).
 LIEF MARTIN, EXAMINING ATTORNEY

SN 79-077,395. KABUSHIKI KAISHA PFU (PFU LIMITED), JAPAN, FILED 9-18-2009.



OWNER OF INTERNATIONAL REGISTRATION 1025121 DATED 9-18-2009, EXPIRES 9-18-2019.
 OWNER OF U.S. REG. NO. 2,568,757.

CLASS 9—ELECTRICAL AND SCIENTIFIC APPARATUS

FOR ELECTRICAL BATTERIES AND CELLS; ELECTRIC WIRES AND CABLES; CINEMATOGRAPHIC SOUND RECORDING INSTRUMENTS AND APPARATUS; TELECOMMUNICATION DEVICES AND APPARATUS, NAMELY, TELEPHONES, FACSIMILE MACHINES, MODEMS AND RADIO AND TELEVISION TRANSMITTERS AND RECEIVERS; COMPUTERS AND COMPUTERS PROGRAMS FOR COMPUTER OPERATING SYSTEMS, MIDDLEWARE SOFTWARE FOR COMMON USE IN DEVELOPING OR RUNNING APPLICATION PROGRAMS, AND APPLICATION PROGRAMS FOR USE IN CONSTRUCTING AND MANAGING DATABASES, OR EDITING, STORING, AND RETRIEVING TEXTUAL, AUDIO, IMAGE OR VIDEO FILES; COMPUTER MONITORS, KEYBOARDS, PRINTERS; SCANNERS, OPTICAL CHARACTER READERS, MAGNETIC TAPE DRIVES, DIGITAL DISK DRIVES, ALL FOR COMPUTERS; PERIPHERAL AND TERMINAL APPARATUS AND INSTRUMENTS FOR DATA PROCESSING, NAMELY, FREE-STANDING MULTIMEDIA INFORMATION KIOSKS COMPRISING OF COMPUTERS, COMPUTER HARDWARE, COMPUTER PERIPHERALS, AND COMPUTER OPERATING SOFTWARE FOR CUSTOMER ASSISTANCE, INFORMATION SERVICES, DIGITAL SIGNAGE, MONETARY TRANSACTIONS AND GENERAL PURPOSE FOR USE IN A WIDE VARIETY OF LOCATIONS, SUCH AS STATIONS, AIRPORTS, HOSPITALS, SCHOOLS AND UNIVERSITIES, SHOPPING CENTERS, RESTAURANTS AND OTHER PUBLIC FACILITIES; ENCODED MAGNETIC CARDS, BLANK MAGNETIC DISKS; COMPUTER MEMORIES AND PRINTED CIRCUITS; FIRE ALARMS; ANTI-THEFT ALARMS; VENDING MACHINES; COIN-OPERATED GATES FOR CAR PARKING FACILITIES; CASH REGISTERS; COIN COUNTING OR SORTING MACHINES; ELECTRIC SIGNS FOR DISPLAYING TARGET FIGURES, CURRENT OUTPUTS OR THE LIKE; PHOTOCOPYING MACHINES; TIME AND DATE STAMPING MACHINES; TIME CLOCKS; VOTING MACHINES; ELECTRIC DOOR OPENERS (U.S. CLS. 21, 23, 26, 36 AND 38).

CLASS 37—CONSTRUCTION AND REPAIR

FOR MACHINERY INSTALLATION; REPAIR AND MAINTENANCE OF OFFICE MACHINES AND APPARATUS; REPAIR AND MAINTENANCE OF COMPUTERS INCLUDING CENTRAL PROCESSING UNITS, PROGRAMMED DATA CARRYING ELECTRIC CIRCUITS, MAGNETIC DISKS, COMPUTERS PERIPHERALS AND SCANNERS; TELEPHONE REPAIR; REPAIR OF RADIO OR TELEVISION SETS; PROVIDING INFORMATION RELATING TO MAINTENANCE OF COMPUTERS, COMPUTER PERIPHERALS, AND SCANNERS, VIA ON-LINE TELECOMMUNICATION NETWORK (U.S. CLS. 100, 103 AND 106).

CLASS 42—SCIENTIFIC AND COMPUTER SERVICES

FOR INDUSTRIAL DESIGN; COMPUTER SOFTWARE DESIGN, COMPUTER PROGRAMMING, OR MAINTENANCE OF COMPUTER SOFTWARE; TESTING OR RESEARCH ON ELECTRICITY; RENTAL OF COMPUTERS, COMPUTER CENTRAL PROCESSING UNITS, AND COMPUTER PROGRAMS RECORDED IN PRINTED CIRCUIT; RENTAL OF COMPUTER HARDWARE, SOFTWARE AND SCANNERS; DESIGNING OF COMPUTER HARDWARE; DESIGN OF PRINTED CIRCUIT BOARDS FOR OTHERS; DESIGN OF ELECTRIC MACHINES AND APPARATUS FOR OTHERS; DESIGN OF POWER SUPPLIES FOR OTHERS; INSPECTIONS OF ELECTRONIC APPARATUS AND INSTRUMENTS, INCLUDING COMPUTERS AND COMPUTER PERIPHERAL OR TERMINAL APPARATUS AND

INSTRUMENTS, ACCORDING TO OVERSEAS SAFETY STANDARDS; TESTING OR RESEARCH ON ELECTRICITY WITH RESPECT TO ELECTROMAGNETIC IMPEDIMENT; PROVIDING INFORMATION RELATING TO COMPUTER SOFTWARE DESIGN, COMPUTER PROGRAMMING, OR MAINTENANCE OF COMPUTER SOFTWARE; CONSULTANCY FOR DESIGNING OF COMPUTER PROGRAMS; INSTALLING COMPUTER PROGRAMS; CONSULTANCY FOR INSTALLATION OF COMPUTER SYSTEMS; TECHNICAL WRITING FOR OTHERS IN THE FIELD OF COMPUTERS AND COMPUTER PERIPHERALS (U.S. CLS. 100 AND 101).

GEOFFREY FOSDICK, EXAMINING ATTORNEY

SN 85-003,001. CLINTON GRAHAM, MILTON, MA. FILED 3-31-2010.

Design Your Body

THE MARK CONSISTS OF STANDARD CHARACTERS WITHOUT CLAIM TO ANY PARTICULAR FONT, STYLE, SIZE, OR COLOR.

CLASS 25—CLOTHING

FOR ATHLETIC APPAREL, NAMELY, SHIRTS, PANTS, JACKETS, FOOTWEAR, HATS AND CAPS, ATHLETIC UNIFORMS; SHORT-SLEEVED OR LONG-SLEEVED T-SHIRTS; T-SHIRTS (U.S. CLS. 22 AND 39).

CLASS 42—SCIENTIFIC AND COMPUTER SERVICES

FOR HOSTING AN ONLINE WEBSITE FEATURING A WEB-BASED HEALTH AND FITNESS MANAGEMENT SYSTEM; PROVIDING A WEB SITE FEATURING TECHNOLOGY THAT ENABLES INTERNET USERS TO CREATE, BOOKMARK, ANNOTATE, AND PUBLICLY SHARE FITNESS-RELATED DATA, AS WELL AS PROVIDING HEALTH AND FITNESS PROFESSIONALS WITH A SUBSCRIPTION-BASED CLIENT MANAGEMENT SYSTEM; PROVIDING A WEBSITE THAT GIVES USERS THE ABILITY TO CREATE CUSTOMIZED WEB PAGES FEATURING USER-DEFINED PROFILES; PROVIDING AN ONLINE WEBSITE FOR CREATING AND HOSTING MICRO WEBSITES FOR BUSINESSES (U.S. CLS. 100 AND 101).

FIRST USE 2-26-2007; IN COMMERCE 3-21-2007.
GRETCHEN ULRICH, EXAMINING ATTORNEY

SN 85-004,170. VERMILLION, INC., FREEMONT, CA. FILED 4-1-2010.



THE COLOR(S) TEAL, WHITE AND ORANGE IS/ARE CLAIMED AS A FEATURE OF THE MARK.

THE MARK CONSISTS OF THE TERM "OVA" WRITTEN IN A STYLIZED SCRIPT IN TEAL FOLLOWED BY THE NUMBER "1" IN SUPERScript IN WHITE INSIDE AN ORANGE CIRCLE.

CLASS 1—CHEMICALS

FOR REAGENTS FOR SCIENTIFIC OR MEDICAL RESEARCH USE (U.S. CLS. 1, 5, 6, 10, 26 AND 46).

CLASS 5—PHARMACEUTICALS

FOR REAGENTS, DIAGNOSTIC PREPARATIONS FOR MEDICAL PURPOSES; DIAGNOSTIC KITS CONSISTING PRIMARILY OF MONOCLONAL ANTIBODIES, BUFFERS AND REAGENTS FOR USE IN DISEASE TESTING (U.S. CLS. 6, 18, 44, 46, 51 AND 52).

CLASS 9—ELECTRICAL AND SCIENTIFIC APPARATUS

FOR SOFTWARE UTILIZED TO ANALYZE BIOMARKERS IN THE FIELD OF CANCER RESEARCH, DIAGNOSIS AND TREATMENT (U.S. CLS. 21, 23, 26, 36 AND 38).

CLASS 42—SCIENTIFIC AND COMPUTER SERVICES

FOR PROVIDING MEDICAL AND SCIENTIFIC RESEARCH IN THE FIELD OF PHARMACEUTICAL AND CLINICAL TRIALS; MEDICAL AND SCIENTIFIC RESEARCH SERVICES IN THE FIELD OF CANCER TREATMENT AND DIAGNOSIS; PROVIDING REAGENT SAMPLE TESTING AND DIAGNOSTIC SERVICES FOR OTHERS IN THE FIELDS OF SCIENCE AND RESEARCH RELATED THERETO; PRODUCT DEVELOPMENT SERVICES FOR OTHERS IN THE BIOMEDICAL, GENOMICS, PHARMACOGENOMICS, DIAGNOSTIC, CLINICAL TRIAL DESIGN AND BIOTECHNOLOGY FIELDS (U.S. CLS. 100 AND 101).

CLASS 44—MEDICAL, BEAUTY AND AGRICULTURAL SERVICES

FOR PROVIDING MEDICAL INFORMATION; MEDICAL CONSULTING IN THE FIELD OF BIOLOGICAL INFECTION DISEASE CONTROL (U.S. CLS. 100 AND 101).

BENJAMIN OKEKE, EXAMINING ATTORNEY

SN 85-004,911. ZHUHAI SEINE TECHNOLOGY CO. LTD., ZHUHAI, GUANGDONG, CHINA, FILED 4-2-2010.

LEMERO

THE MARK CONSISTS OF STANDARD CHARACTERS WITHOUT CLAIM TO ANY PARTICULAR FONT, STYLE, SIZE, OR COLOR.

THE WORDING "LEMERO" HAS NO MEANING IN A FOREIGN LANGUAGE.

CLASS 2—PAINTS

FOR FILLED INK CARTRIDGE FOR PRINTERS, PHOTOCOPIERS AND WORD PROCESSORS; FILLED TONER CARTRIDGE FOR PRINTERS, PHOTOCOPIERS AND WORD PROCESSORS; INK FOR PRINTERS, PHOTOCOPIERS AND WORD PROCESSORS; TONER FOR PRINTERS, PHOTOCOPIERS AND WORD PROCESSORS (U.S. CLS. 6, 11 AND 16).

CLASS 9—ELECTRICAL AND SCIENTIFIC APPARATUS

FOR COMPUTER PERIPHERAL DEVICES; PRINTERS FOR USE WITH COMPUTERS; COMPUTER CHIPS; ELECTRONIC CHIPS FOR THE MANUFACTURE OF INTEGRATED CIRCUITS; INTEGRATED CIRCUITS; PHOTOCOPY MACHINES; ELECTROSTATIC COPYING MACHINES; BLANK MAGNETIC DISKS; BLANK OPTICAL DISCS; WORD PROCESSORS; AUDIO VISUAL RECEIVERS; DIGITAL MEDIA RECEIVERS (U.S. CLS. 21, 23, 26, 36 AND 38).

CLASS 16—PAPER GOODS AND PRINTED MATTER

FOR INKING RIBBONS FOR COMPUTER PRINTERS; INKING SHEETS FOR DOCUMENT REPRODUCING MACHINES; COPYING PAPER; WRITING PAPER; PUNCHES; PRINTING PAPER; PAPER RIBBONS; OFFICE PAPER STATIONERY; COMPUTER PAPER; DUPLICATING INK; WRITING INK; PAPER FOR RECORDING MACHINES; INKING RIBBONS; PAPER SHEETS FOR NOTE TAKING (U.S. CLS. 2, 5, 22, 23, 29, 37, 38 AND 50).

SHANNON TWOHIG, EXAMINING ATTORNEY

SN 85-004,929. DREAMWELL, LTD., LAS VEGAS, NV. FILED 4-2-2010.

BETTER SLEEP THROUGH SCIENCE

THE MARK CONSISTS OF STANDARD CHARACTERS WITHOUT CLAIM TO ANY PARTICULAR FONT, STYLE, SIZE, OR COLOR.

CLASS 20—FURNITURE AND ARTICLES NOT OTHERWISE CLASSIFIED

FOR MATTRESSES AND BOX SPRINGS (U.S. CLS. 2, 13, 22, 25, 32 AND 50).

CLASS 35—ADVERTISING AND BUSINESS

FOR RETAIL STORE SERVICES AND ON-LINE RETAIL STORE SERVICES FEATURING MATTRESSES AND BOX SPRINGS (U.S. CLS. 100, 101 AND 102).

ANDREA SAUNDERS, EXAMINING ATTORNEY

SN 85-004,938. ZHUHAI SEINE TECHNOLOGY CO. LTD., ZHUHAI, GUANGDONG, CHINA, FILED 4-2-2010.

SAILNER

THE MARK CONSISTS OF STANDARD CHARACTERS WITHOUT CLAIM TO ANY PARTICULAR FONT, STYLE, SIZE, OR COLOR.

THE WORDING "SAILNER" HAS NO MEANING IN A FOREIGN LANGUAGE.

CLASS 2—PAINTS

FOR FILLED INK CARTRIDGE FOR PRINTERS, PHOTOCOPIERS AND WORD PROCESSORS; FILLED TONER CARTRIDGE FOR PRINTERS, PHOTOCOPIERS AND WORD PROCESSORS; INK FOR PRINTERS, PHOTOCOPIERS AND WORD PROCESSORS; TONER FOR PRINTERS, PHOTOCOPIERS AND WORD PROCESSORS (U.S. CLS. 6, 11 AND 16).

CLASS 9—ELECTRICAL AND SCIENTIFIC APPARATUS

FOR COMPUTER PERIPHERAL DEVICES; PRINTERS FOR USE WITH COMPUTERS; COMPUTER CHIPS; ELECTRONIC CHIPS FOR THE MANUFACTURE OF INTEGRATED CIRCUITS; INTEGRATED CIRCUITS; PHOTOCOPY MACHINES; ELECTROSTATIC COPYING MACHINES; BLANK MAGNETIC DISKS; BLANK OPTICAL DISCS; WORD PROCESSORS; AUDIO VISUAL RECEIVERS; DIGITAL MEDIA RECEIVERS (U.S. CLS. 21, 23, 26, 36 AND 38).

CLASS 16—PAPER GOODS AND PRINTED MATTER

FOR INKING RIBBONS FOR COMPUTER PRINTERS; INKING SHEETS FOR DOCUMENT REPRODUCING MACHINES; COPYING PAPER; WRITING PAPER; PUNCHES; PRINTING PAPER; PAPER RIBBONS; OFFICE PAPER STATIONERY; COMPUTER PAPER; DUPLICATING INK; WRITING INK; PAPER FOR RECORDING MACHINES; INKING RIBBONS; PAPER SHEETS FOR NOTE TAKING (U.S. CLS. 2, 5, 22, 23, 29, 37, 38 AND 50).

SHANNON TWOHIG, EXAMINING ATTORNEY

SN 85-005,157. ZUFFA, LLC, LAS VEGAS, NV. FILED 4-2-2010.

OCTAGON COLLECTION

THE MARK CONSISTS OF STANDARD CHARACTERS WITHOUT CLAIM TO ANY PARTICULAR FONT, STYLE, SIZE, OR COLOR.

NO CLAIM IS MADE TO THE EXCLUSIVE RIGHT TO USE "COLLECTION", APART FROM THE MARK AS SHOWN.

CLASS 9—ELECTRICAL AND SCIENTIFIC APPARATUS

FOR SUNGLASSES, EYE GLASSES (U.S. CLS. 21, 23, 26, 36 AND 38).

CLASS 14—JEWELRY

FOR WATCHES, JEWELRY (U.S. CLS. 2, 27, 28 AND 50).

JOHN E. MICHOS, EXAMINING ATTORNEY

SN 85-009,236. TREX COMPANY, INC., WINCHESTER, VA.
FILED 4-8-2010.

TREX

THE MARK CONSISTS OF STANDARD CHARACTERS WITHOUT CLAIM TO ANY PARTICULAR FONT, STYLE, SIZE, OR COLOR.

OWNER OF U.S. REG. NOS. 1,881,449, 1,938,516 AND 2,937,507.

CLASS 6—METAL GOODS

FOR METAL BUILDING MATERIALS, NAMELY, FENCING AND GATES, PILLAR POSTS, ARBORS, PERGOLAS, GAZEBOS, COLONNADES, LAMP POSTS, MAIL BOX POSTS, SHUTTERS, LATTICE PANELS, TRELLISES AND CUPOLAS; METAL STORAGE SHEDS (U.S. CLS. 2, 12, 13, 14, 23, 25 AND 50).

CLASS 11—ENVIRONMENTAL CONTROL APPARATUS

FOR OUTDOOR LIGHTING, NAMELY, LIGHTS FOR DECKS, WALKWAYS, PATIOS, LANDSCAPES, UMBRELLAS, AND DECORATIVE TORCHES AND LANTERNS; SOLAR LIGHT FIXTURES, NAMELY, OUTDOOR SOLAR POWERED LIGHTING UNITS AND FIXTURES; OUTDOOR GAS LIGHTS; OUTDOOR FIREPLACES AND FIRE PITS; GAS PATIO HEATERS; ELECTRIC PATIO HEATERS (U.S. CLS. 13, 21, 23, 31 AND 34).

CLASS 18—LEATHER GOODS

FOR UMBRELLA FRAMES; UMBRELLA BASES; TABLE UMBRELLAS; UMBRELLA COVERS; PATIO UMBRELLAS (U.S. CLS. 1, 2, 3, 22 AND 41).

CLASS 19—NON-METALLIC BUILDING MATERIALS

FOR NON-METAL BUILDING MATERIALS, NAMELY, FENCING AND GATES, PILLAR POSTS, ARBORS, PERGOLAS, GAZEBOS, COLONNADES, LAMP POSTS, MAIL BOX POSTS, SHUTTERS, SIDING, LATTICE PANELS, TRELLISES AND CUPOLAS; NON-METAL STORAGE SHEDS; PAVER TILES (U.S. CLS. 1, 12, 33 AND 50).

CLASS 20—FURNITURE AND ARTICLES NOT OTHERWISE CLASSIFIED

FOR OUTDOOR FURNITURE; WOOD STORAGE BOXES; CUSHIONED WOOD BOXES FOR STORAGE; NON-METAL AND NON-PAPER CONTAINERS FOR STORAGE OR TRANSPORT (U.S. CLS. 2, 13, 22, 25, 32 AND 50).

CLASS 21—HOUSEWARES AND GLASS

FOR PLANTERS FOR FLOWERS AND PLANTS (U.S. CLS. 2, 13, 23, 29, 30, 33, 40 AND 50).

CLASS 22—CORDAGE AND FIBERS

FOR OUTSIDE STRUCTURES FOR SHADING, SHELTERING AND PROTECTION, NAMELY, TEMPORARY AND PORTABLE TENTS; AWNINGS; CANVAS CANOPIES (U.S. CLS. 1, 2, 7, 19, 22, 42 AND 50).

CLASS 28—TOYS AND SPORTING GOODS

FOR PLAYGROUND EQUIPMENT, NAMELY, CLIMBING UNITS, SAND BOXES, AND SWING SETS; KITS FOR BUILDING OUTDOOR PLAY EQUIPMENT (U.S. CLS. 22, 23, 38 AND 50).

KIMBERLY PERRY, EXAMINING ATTORNEY

SN 85-010,993. QUALCOMM INCORPORATED, SAN DIEGO, CA. FILED 4-9-2010.



THE MARK CONSISTS OF A STYLIZED MAN DESIGN.

CLASS 35—ADVERTISING AND BUSINESS

FOR PROVIDING AN ONLINE RETAIL STORE FEATURING A WIDE VARIETY OF CONSUMER GOODS AND SERVICES OF OTHERS; ADVERTISING AND MARKETING, NAMELY, PROMOTING THE GOODS AND SERVICES OF OTHERS; DISSEMINATION OF ADVERTISING FOR OTHERS VIA AN ON-LINE COMMUNICATIONS NETWORK ON THE INTERNET; MARKETING OR ADVERTISING OR PROMOTING THE RETAIL GOODS AND SERVICES OF OTHERS TO WIRELESS OR NON-WIRELESS COMMUNICATION DEVICES; BUSINESS SERVICES FOR CONSUMERS OR OTHERS CONSISTING OF BUSINESS DATA COLLECTION OR REPORTING (U.S. CLS. 100, 101 AND 102).

CLASS 38—COMMUNICATION

FOR TELECOMMUNICATION CONSULTATION SERVICES RELATING TO TELECOMMUNICATIONS COMPUTER SOFTWARE USED TO FACILITATE INTERFACES BETWEEN COMPUTER SOFTWARE OR COMPUTER HARDWARE USED IN WIRELESS COMMUNICATION DEVICES OR COMPUTERS OR USED WITHIN MIXED NETWORKS EMPLOYING WIRELESS OR NON-WIRELESS COMMUNICATION DEVICES OR COMPUTERS (U.S. CLS. 100, 101 AND 104).

CLASS 39—TRANSPORTATION AND STORAGE

FOR SERVICES FOR CONSUMERS OR OTHERS CONSISTING OF ELECTRONIC STORAGE OF DATA (U.S. CLS. 100 AND 105).

CLASS 42—SCIENTIFIC AND COMPUTER SERVICES

FOR CONSULTATION, EVALUATION AND RESEARCH IN THE FIELDS OF COMPUTER SOFTWARE DEVELOPMENT OR THE USE OF COMPUTER SOFTWARE APPLICATIONS OR DATA, HOSTING COMPUTER SOFTWARE APPLICATIONS FOR OTHERS AND SOCIAL NETWORKING; TELECOMMUNICATION COMPUTER SOFTWARE TECHNOLOGY CONSULTATION SERVICES RELATING TO COMPUTER SOFTWARE USED TO FACILITATE INTERFACES BETWEEN COMPUTER SOFTWARE OR COMPUTER HARDWARE USED IN WIRELESS COMMUNICATION DEVICES OR COMPUTERS, OR WITHIN MIXED NETWORKS EMPLOYING WIRELESS OR NON-WIRELESS COMMUNICATION DEVICES OR COMPUTERS (U.S. CLS. 100 AND 101).

CLASS 45—PERSONAL AND LEGAL SERVICES

FOR SERVICES FOR CONSUMERS OR OTHERS CONSISTING OF DIGITAL RIGHTS MANAGEMENT, NAMELY, AUTHENTICATION, ISSUANCE OR VALIDATION OF DIGITAL CERTIFICATES (U.S. CLS. 100 AND 101).

BRIDGETT SMITH, EXAMINING ATTORNEY

SN 85-013,393. UNITED STATES POSTAL SERVICE, WASHINGTON, DC. FILED 4-14-2010.

POSTMARK AMERICA

THE MARK CONSISTS OF STANDARD CHARACTERS WITHOUT CLAIM TO ANY PARTICULAR FONT, STYLE, SIZE, OR COLOR.

OWNER OF U.S. REG. NOS. 2,391,365, 2,416,568 AND OTHERS.

NO CLAIM IS MADE TO THE EXCLUSIVE RIGHT TO USE "AMERICA", APART FROM THE MARK AS SHOWN.

CLASS 16—PAPER GOODS AND PRINTED MATTER

FOR BOOKS REGARDING STAMPS, HISTORY, AND AMERICA; PENCILS, BINDERS; AND OTHER PAPER PRODUCTS, NAMELY, STATIONERY, NOTE PADS AND POSTCARDS; NOVELTY IDENTIFICATION DOCUMENTS IN THE NATURE OF IMITATION PASSPORTS; RUBBER STAMPS (U.S. CLS. 2, 5, 22, 23, 29, 37, 38 AND 50).

CLASS 35—ADVERTISING AND BUSINESS

FOR RETAIL STORE SERVICES IN THE FIELD OF MAIL AND DELIVERY ITEMS, PASSPORT ITEMS, PRINTED MATTERS, CLOTHING, BAGS, COLLECTIBLES, AND GENERAL MERCHANDISE; PROMOTING RECREATION AND TOURISM ALONG NATIONAL HISTORIC AND SCENIC TRAILS IN PART BY USE OF TOURIST TRAVEL IMITATION PASSPORT POSTMARKS AND CANCELLATIONS WITHIN THE UNITED STATES (U.S. CLS. 100, 101 AND 102).

JEFFERY COWARD, EXAMINING ATTORNEY

SN 85-020,800. JOHN B. SANFILIPPO & SON, INC., ELGIN, IL. FILED 4-22-2010.



NO CLAIM IS MADE TO THE EXCLUSIVE RIGHT TO USE "SABOR", APART FROM THE MARK AS SHOWN.

THE MARK CONSISTS OF AN IMAGE OF A SUN EMBODYING HUMAN FACIAL FEATURES WITH RAYS RADIATING OUTWARDLY FROM ITS PERIMETER AND CENTERED ABOVE THE WORDS "SABOR Y TRADICIÓN".

THE ENGLISH TRANSLATION OF "SABOR Y TRADICIÓN" IN THE MARK IS "FLAVOR AND TRADITION".

CLASS 29—MEATS AND PROCESSED FOODS

FOR SHELLED AND ROASTED NUTS; PROCESSED NUTS; PROCESSED FLAVORED NUTS; CANDIED NUTS; SNACK MIX CONSISTING PRIMARILY OF PROCESSED FRUITS AND PROCESSED NUTS (U.S. CL. 46).

CLASS 30—STAPLE FOODS

FOR CHOCOLATE COVERED NUTS; SNACK MIXES CONSISTING PRIMARILY OF WHEAT-BASED OR RICE-BASED SNACK FOODS AND ALSO CONTAINING PROCESSED NUTS (U.S. CL. 46).

CLASS 31—NATURAL AGRICULTURAL PRODUCTS

FOR NUTS THAT ARE RAW AND UNPROCESSED (U.S. CLS. 1 AND 46).

JOHN E. MICHOS, EXAMINING ATTORNEY

SN 85-026,613. THE MCGRAW-HILL COMPANIES, INC., NEW YORK, NY. FILED 4-29-2010.

A SMARTER, BETTER WORLD

THE MARK CONSISTS OF STANDARD CHARACTERS WITHOUT CLAIM TO ANY PARTICULAR FONT, STYLE, SIZE, OR COLOR.

CLASS 9—ELECTRICAL AND SCIENTIFIC APPARATUS

FOR PRE-RECORDED CD-ROMS, COMPUTER DISCS, DVDS, AND AUDIO TAPES ALL FEATURING GENERAL NEWS, BUSINESS AND FINANCIAL INFORMATION, INFORMATION IN THE CONSTRUCTION INDUSTRY, AND EDUCATIONAL CONTENT (U.S. CLS. 21, 23, 26, 36 AND 38).

CLASS 16—PAPER GOODS AND PRINTED MATTER

FOR EDUCATIONAL AND INSTRUCTIONAL MATERIALS IN THE NATURE OF BOOKS, TEXTBOOKS, PRINTED TEACHING MATERIALS, MANUALS, STUDY GUIDES, PAMPHLETS, WORKBOOKS, BROCHURES, TESTS, TESTING SHEETS, AND USER MANUALS FOR PRESCHOOL, KINDERGARTEN, PRIMARY EDUCATION, SECONDARY EDUCATION, HIGHER EDUCATION, AND ADULT EDUCATION AND PROFESSIONAL EDUCATION; TRADE PUBLICATIONS IN THE FIELDS OF CONSTRUCTION, ENGINEERING, CONTRACTING, ARCHITECTURE, ENVIRONMENTALLY-CONSCIOUS BUILDING, COMMODITIES AND THE ENERGY, METALS, AND SHIPPING INDUSTRIES; PAMPHLETS, BROCHURES, AND NEWSLETTERS RELATING TO ON MARKET RESEARCH RELATING TO AUTOMOBILES, BOATS, ELECTRONICS, FINANCE, HEALTHCARE, HOMES, INSURANCE, TELECOM, TRAVEL, AND CONSUMER PRODUCTS; PAMPHLETS, BROCHURES, AND NEWSLETTERS RELATING TO SOCIAL MEDIA; MAGAZINES AND NEWSLETTERS RELATING TO AVIATION, AEROSPACE, AND AERONAUTICS, AND SPACE TECHNOLOGY AND INDUSTRY DEVELOPMENTS; PAMPHLETS, BROCHURES, AND NEWSLETTERS RELATING TO FINANCIAL INFORMATION, FINANCIAL MARKETS RESEARCH, FINANCE, INVESTING, COMPANY AND STOCK RESEARCH AND RATINGS, STOCK PRICES, CREDIT RATINGS, EQUITY RESEARCH, FUNDS, FINANCIAL INDICES, RISK SOLUTIONS, AND INVESTMENT DATA (U.S. CLS. 2, 5, 22, 23, 29, 37, 38 AND 50).

CLASS 35—ADVERTISING AND BUSINESS

FOR ONLINE RETAIL STORE SERVICES IN THE FIELD OF CONSTRUCTION EQUIPMENT AND SUPPLIES; BUSINESS CONSULTATION; CONDUCTING TRADE SHOWS IN THE FIELDS OF FINANCE, BUSINESS, EDUCATION, ENERGY, AVIATION AND THE AEROSPACE INDUSTRIES, BROADCASTING, HEALTHCARE, AND CONSTRUCTION; PROVIDING BUSINESS INFORMATION ONLINE; PROVIDING NEWS AND INFORMATION IN THE FIELDS OF CONSUMER GOODS AND SERVICES; MARKET RESEARCH SERVICES; BUSINESS INFORMATION IN THE FIELDS OF MARKET RESEARCH AND PRODUCT AND SERVICES RATINGS; PROVIDING A WEBSITE FEATURING PRODUCT RATINGS; PROVIDING A WEBSITE FEATURING MARKET RESEARCH; CONDUCTING BUSINESS AND MARKET RESEARCH SURVEYS; PROVIDING RECOGNITION IN THE FORM OF AN AWARD FOR RECEIPT OF THE BEST CUSTOMER PRODUCT SATISFACTION RANKING BASED ON MARKET RESEARCH STUDIES; PROVIDING A WEBSITE FEATURING INFORMATION IN THE FIELDS OF COMMERCIAL INFORMATION, BUSINESS INFORMATION, AND MARKETING OR DEMOGRAPHIC DATA; CONSULTING SERVICES IN THE NATURE OF MARKET RESEARCH; PROVIDING AN ONLINE DATABASE THAT ALLOWS USERS TO ACCESS NEWS AND INFORMATION REGARDING BIDS AND ANALYSIS IN THE DESIGN AND CONSTRUCTION INDUSTRY; PROVIDING AN ONLINE DATABASE GIVING INFORMATION CONCERNING NEWS AND INFORMATION, PROJECT LEADS CONTENT, PRODUCT CONTENT, FUNCTIONAL DESIGN AND CONSTRUCTION RELATED APPLICATIONS ALL FOR THE DESIGN AND CONSTRUCTION INDUSTRY; PROVIDING NEWS AND INFORMATION IN THE FIELDS OF THE CONSTRUCTION INDUSTRY AND THE CONTRACTING INDUSTRY; PROVIDING GENERAL NEWS AND INFORMATION IN THE FIELDS OF THE SHIPPING INDUSTRY; NEWS REPORTING SERVICES, NAMELY, PROVIDING REAL-TIME INFORMATION RELATING TO ENERGY EFFICIENCY; PREPARING CUSTOM REPORTS FOR CLIENTS REGARDING MARKETING INFORMATION COLLECTED FROM SOCIAL NETWORKING MEDIA; PROVIDING MARKETING INFORMATION COLLECTED FROM SOCIAL NETWORKING MEDIA (U.S. CLS. 100, 101 AND 102).

CLASS 36—INSURANCE AND FINANCIAL

FOR FINANCIAL CONSULTATION; FINANCIAL RESEARCH; RATING OF SECURITIES AND MUTUAL FUNDS; AND SECURITY BROKERAGE SERVICES; PROVIDING ON-LINE COMPUTER DATABASES FEATURING FINANCIAL AND INVESTMENT INFORMATION, PROVIDING REAL-TIME INFORMATION RELATING TO THE FINANCIAL MARKETS; NEWS REPORTING SERVICES, NAMELY, PROVIDING REAL-TIME INFORMATION RELATING TO THE COMMODITIES INDUSTRY, PROVIDING NEWS AND INFORMATION IN THE FIELDS OF FINANCIAL MARKETS (U.S. CLS. 100, 101 AND 102).

CLASS 37—CONSTRUCTION AND REPAIR

FOR PROVIDING INFORMATION ONLINE TO THE CONSTRUCTION INDUSTRY IN THE FIELD OF CONSTRUCTION; PROVIDING GENERAL NEWS AND INFORMATION ABOUT METAL DRILLING; PROVIDING NEWS AND INFORMATION IN THE FIELD OF ENVIRONMENTALLY-CONSCIOUS BUILDING (U.S. CLS. 100, 103 AND 106).

CLASS 39—TRANSPORTATION AND STORAGE

FOR PROVIDING NEWS AND INFORMATION ONLINE IN THE FIELD OF AVIATION TRAVEL (U.S. CLS. 100 AND 105).

CLASS 40—MATERIAL TREATMENT

FOR PROVIDING INFORMATION ONLINE TO THE ENERGY INDUSTRY IN THE FIELD OF ENERGY GENERATION AND PRODUCTION; PROVIDING GENERAL NEWS AND INFORMATION ABOUT METAL TREATMENT (U.S. CLS. 100, 103 AND 106).

CLASS 41—EDUCATION AND ENTERTAINMENT

FOR PUBLISHING SERVICES, NAMELY, PUBLICATION OF BOOKS, PAMPHLETS, BROCHURES, TESTS AND TESTING SHEETS PROVIDED IN PRINT, AND ELECTRONIC MEDIA; EDUCATIONAL SERVICES, NAMELY, PROVIDING CUSTOMIZED ON-LINE LEARNING AND ASSESSMENT PLATFORMS; PROVIDING ON-LINE HOMEWORK ASSIGNMENTS, TESTS, TEACHING AIDS, AND EDUCATIONAL MATERIALS NETWORK FOR THE EDUCATION OF STUDENTS; EDUCATIONAL SERVICES, NAMELY, PROVIDING INTERACTIVE ONLINE CUSTOMIZED HOMEWORK ASSIGNMENTS, TESTS AND TEACHING AIDS AND MATERIALS ACCESSED THROUGH A GLOBAL COMPUTER NETWORK FOR STUDENTS AND INSTRUCTORS FOR USE IN HIGHER EDUCATION; ARRANGING AND CONDUCTING EDUCATIONAL CONFERENCES, WORKSHOPS, AND EXHIBITIONS RELATING TO ADVERTISING, MARKETING, BUSINESS, ECONOMICS, TESTING SKILLS AND TEACHING SKILLS; STANDARDIZED TESTING AND SCORING; SCORING OF STANDARDIZED TESTS SERVICES; CONDUCTING AWARDS PROGRAMS PROVIDING INCENTIVES TO PEOPLE, BUSINESS ENTITIES AND ORGANIZATIONS TO DEMONSTRATE EXCELLENCE IN A VARIETY OF FIELDS THROUGH THE ISSUANCE OF AWARDS; PROVIDING A WEB SITE CONTAINING NON-DOWNLOADABLE EDUCATIONAL MATERIALS IN THE SUBJECTS OF BUSINESS, TECHNOLOGY, ART, DRAFTING AND DESIGN, CARPENTRY AND CONSTRUCTION, MANUFACTURING, AUTOMOTIVE AND ELECTRONIC TECHNOLOGIES, HEALTH CARE OCCUPATIONS, PROTECTIVE SERVICES, CAREER EDUCATION, AND DRIVER EDUCATION; TELEVISION AND RADIO PROGRAMMING SERVICES; CONDUCTING AWARDS PROGRAMS PROVIDING INCENTIVES TO PEOPLE, BUSINESS ENTITIES AND ORGANIZATIONS TO DEMONSTRATE EXCELLENCE IN A VARIETY OF FIELDS THROUGH THE ISSUANCE OF AWARDS (U.S. CLS. 100, 101 AND 107).

JUNE 22, 2010

U.S. PATENT AND TRADEMARK OFFICE

TM 377

CLASS 42—SCIENTIFIC AND COMPUTER SERVICES

PAUL F. GAST, EXAMINING ATTORNEY

FOR PROVIDING NEWS AND INFORMATION IN THE FIELDS OF ARCHITECTURE AND ENGINEERING (U.S. CLS. 100 AND 101).

* * * * *

SECTION 2.— INTERNATIONAL CLASSIFICATION

The short titles associated below with the international class numbers are terms designed merely for quick identification and are not an official part of the international classification. The full names of international classes are given in section 6.1 of the trademark rules of practice.

The designation "U.S. Cl." appearing in this section refers to the U.S. class in effect prior to Sep. 1, 1973 rather than the international class which applies to applications filed on or after that date. For adoption of international classification see notice in the OFFICIAL GAZETTE of Jun. 26, 1973 (911 O.G. TM 210).

Application in one class

CLASS 1—CHEMICALS

SN 77-441,205. COSMOCEL S.A., S NICOLÁS DE LOS GARZA, MEXICO, FILED 4-7-2008.

ROOT RX 2

THE MARK CONSISTS OF STANDARD CHARACTERS WITHOUT CLAIM TO ANY PARTICULAR FONT, STYLE, SIZE, OR COLOR.

NO CLAIM IS MADE TO THE EXCLUSIVE RIGHT TO USE "ROOT", APART FROM THE MARK AS SHOWN.

FOR FERTILIZERS FOR PROFESSIONAL AGRICULTURAL USE SOLD EXCLUSIVELY AND DIRECTLY TO FARMERS BY APPLICANT AND NOT TO THE GENERAL CONSUMING PUBLIC BY WAY OF THIRD PARTY RETAILERS, WHOLESALERS OR OTHERWISE (U.S. CLS. 1, 5, 6, 10, 26 AND 46).

FIRST USE 12-1-2007; IN COMMERCE 12-1-2007.
WILLIAM BRECKENFELD, EXAMINING ATTORNEY

SN 77-586,198. KOA GLASS CO., LTD., TOKYO, JAPAN, FILED 10-6-2008.

MILLIONGUARD

THE MARK CONSISTS OF STANDARD CHARACTERS WITHOUT CLAIM TO ANY PARTICULAR FONT, STYLE, SIZE, OR COLOR.

PRIORITY CLAIMED UNDER SEC. 44(D) ON JAPAN APPLICATION NO. 2008-58968, FILED 7-18-2008, REG. NO. 5210905, DATED 3-6-2009, EXPIRES 3-6-2019.

FOR RAW PLASTIC MATERIAL, NAMELY, INORGANIC ANTIMICROBIAL AGENT FOR INDUSTRIAL USE, NAMELY, ANTIMICROBIAL CHEMICAL AGENTS FOR USE IN THE MANUFACTURE OF PLASTICS AND THE MANUFACTURE OF HOUSEHOLD PRODUCTS (U.S. CLS. 1, 5, 6, 10, 26 AND 46).

JAMES STEIN, EXAMINING ATTORNEY

CLASS 1—(Continued).

SN 77-631,816. LG CHEM. LTD., SEOUL, REPUBLIC OF KOREA, FILED 12-12-2008.

LUMIPLAS

THE MARK CONSISTS OF STANDARD CHARACTERS WITHOUT CLAIM TO ANY PARTICULAR FONT, STYLE, SIZE, OR COLOR.

OWNER OF REPUBLIC OF KOREA REG. NO. 0814041, DATED 2-11-2010, EXPIRES 2-11-2020.

FOR UNPROCESSED PLASTIC RESINS (U.S. CLS. 1, 5, 6, 10, 26 AND 46).

SUSAN RICHARDS, EXAMINING ATTORNEY

SN 77-645,673. ACTIVE ORGANICS, LP, LEWISVILLE, TX, FILED 1-8-2009.

ACTIVE ORGANICS

THE MARK CONSISTS OF STANDARD CHARACTERS WITHOUT CLAIM TO ANY PARTICULAR FONT, STYLE, SIZE, OR COLOR.

NO CLAIM IS MADE TO THE EXCLUSIVE RIGHT TO USE "ORGANICS", APART FROM THE MARK AS SHOWN. SEC. 2(F).

FOR ORGANIC BIOLOGICAL EXTRACTS FOR USE IN THE MANUFACTURE OF COSMETICS, SKIN CARE AND HAIR CARE PRODUCTS (U.S. CLS. 1, 5, 6, 10, 26 AND 46).

FIRST USE 12-10-1981; IN COMMERCE 12-10-1981.
LAURIE KAUFMAN, EXAMINING ATTORNEY

CLASS 1—(Continued).

SN 77-730,619. TIGER-SUL PRODUCTS (CANADA) CO., CALGARY, CANADA, FILED 5-6-2009.



OWNER OF CANADA REG. NO. TMA761,862, DATED 3-17-2010, EXPIRES 3-17-2025.

THE MARK CONSISTS OF THE WORD "TIGER" NEXT TO A PICTURE OF A TIGER, BOTH ABOVE A SPLIT PARALLELOGRAM.

FOR FERTILIZER (U.S. CLS. 1, 5, 6, 10, 26 AND 46).

FIRST USE 7-0-1998; IN COMMERCE 7-0-1998.

SHAILA SETTLES, EXAMINING ATTORNEY

CLASS 1—(Continued).

SN 77-780,985. NIPPON SHOKUBAI CO., LTD., OSAKA-SHI, OSAKA, JAPAN, FILED 7-14-2009.

LAGEN

THE MARK CONSISTS OF STANDARD CHARACTERS WITHOUT CLAIM TO ANY PARTICULAR FONT, STYLE, SIZE, OR COLOR.

PRIORITY CLAIMED UNDER SEC. 44(D) ON JAPAN APPLICATION NO. T2009-046150, FILED 6-19-2009, REG. NO. 5303115, DATED 2-19-2010, EXPIRES 2-19-2020.

THE WORDING "LAGEN" HAS NO MEANING IN A FOREIGN LANGUAGE.

FOR CHEMICALS FOR USE IN THE MANUFACTURE OF POLYMERS USED AS CONCRETE ADMIXTURES; CHEMICALS FOR USE IN THE MANUFACTURE OF POLYMERS USED AS CONCRETE ADMIXTURES (U.S. CLS. 1, 5, 6, 10, 26 AND 46).

STEPHANIE ALI, EXAMINING ATTORNEY

SN 77-782,156. BIAGRO WESTERN SALES, INC., VISALIA, CA. FILED 7-15-2009.

TAKE OFF

THE MARK CONSISTS OF STANDARD CHARACTERS WITHOUT CLAIM TO ANY PARTICULAR FONT, STYLE, SIZE, OR COLOR.

FOR METABOLIC PLANT FERTILIZERS AND GROWTH REGULATORS FOR AGRICULTURAL USE (U.S. CLS. 1, 5, 6, 10, 26 AND 46).

LAURIE MAYES, EXAMINING ATTORNEY

SN 77-749,489. AMOREPACIFIC CORPORATION, SEOUL, REPUBLIC OF KOREA, FILED 6-1-2009.

DERMO NETWORK PROTECTION

THE MARK CONSISTS OF STANDARD CHARACTERS WITHOUT CLAIM TO ANY PARTICULAR FONT, STYLE, SIZE, OR COLOR.

PRIORITY CLAIMED UNDER SEC. 44(D) ON REPUBLIC OF KOREA APPLICATION NO. 402009000083, FILED 1-8-2009, REG. NO. 40-0821228, DATED 4-27-2010, EXPIRES 4-27-2020.

FOR CHEMICAL ADDITIVES FOR USE IN THE MANUFACTURE OF COSMETICS; CHEMICAL ADDITIVES FOR USE IN THE MANUFACTURE OF FOOD SUPPLEMENTS FOR DIETARY PURPOSES; ENZYMES FOR USE IN THE MANUFACTURE OF COSMETICS; CHEMICAL REAGENTS FOR NON-MEDICAL USE; ANTIOXIDANT USED IN THE MANUFACTURE OF COSMETICS; ORGANIC ACID SALTS FOR USE IN THE MANUFACTURE OF COSMETICS; MIXED FERTILIZERS; ARTIFICIAL SWEETENERS; MINERAL ACID FOR USE IN THE MANUFACTURE OF COSMETICS; EMULSIFIERS FOR USE IN THE MANUFACTURE OF COSMETICS (U.S. CLS. 1, 5, 6, 10, 26 AND 46).

KATHERINE CONNOLLY, EXAMINING ATTORNEY

SN 77-796,770. PHOENIX PLASTICS COMPANY, INC., CONROE, TX. FILED 8-4-2009.

GAIA

THE MARK CONSISTS OF STANDARD CHARACTERS WITHOUT CLAIM TO ANY PARTICULAR FONT, STYLE, SIZE, OR COLOR.

FOR NATURAL AND SYNTHETIC CHEMICAL ADDITIVES FOR USE IN THE MANUFACTURING OF PLASTIC COMPOSITIONS AND PRODUCTS (U.S. CLS. 1, 5, 6, 10, 26 AND 46).

WILLIAM BRECKENFELD, EXAMINING ATTORNEY

CLASS 1—(Continued).

SN 77-804,242. MERCK KGAA, DARMSTADT, FED REP GERMANY, FILED 8-13-2009.

ESHMUNO

THE MARK CONSISTS OF STANDARD CHARACTERS WITHOUT CLAIM TO ANY PARTICULAR FONT, STYLE, SIZE, OR COLOR.

OWNER OF FED REP GERMANY REG. NO. 302009006964, DATED 3-12-2009, EXPIRES 2-28-2019.

THE WORDING "ESHMUNO" HAS NO MEANING IN A FOREIGN LANGUAGE.

FOR CHEMICALS USED IN INDUSTRY AND SCIENCE (U.S. CLS. 1, 5, 6, 10, 26 AND 46).

MARIAM MAHMOUDI, EXAMINING ATTORNEY

SN 77-813,249. MOTUL, 93300 AUBERVILLIERS, FRANCE, FILED 8-26-2009.

MOTOCOOL

THE MARK CONSISTS OF STANDARD CHARACTERS WITHOUT CLAIM TO ANY PARTICULAR FONT, STYLE, SIZE, OR COLOR.

OWNER OF ERPN CMNTY TM OFC REG. NO. 002706752, DATED 6-5-2003, EXPIRES 5-21-2012.

FOR CHEMICAL ENGINE TREATMENTS, NAMELY, LIQUIDS FOR THE COOLING CIRCUITS OF MOTOR VEHICLES; ANTI-FREEZE; ANTI-FREEZE FOR THE COOLING CIRCUITS OF MOTOR VEHICLES (U.S. CLS. 1, 5, 6, 10, 26 AND 46).

FIRST USE 1-0-2003; IN COMMERCE 1-0-2003.
CURTIS FRENCH, EXAMINING ATTORNEY

SN 77-869,548. CHEMTECH, INC., ADEL, IA. FILED 11-10-2009.



THE COLOR(S) WHITE, BLACK, GREEN AND YELLOW IS/ARE CLAIMED AS A FEATURE OF THE MARK.

THE MARK CONSISTS OF A ROUND GLASS BEAKER, LARGE AT THE BASE THAT GETS SMALLER TOWARD THE ROUND TOP, WITH YELLOW LIQUID IN IT OUTLINED IN BLACK. THE YELLOW LIQUID HAS FOUR GROUPS OF WHITE BUBBLES OUTLINED IN BLACK WITH THE TOP BUBBLE BEING A BIT LARGER THAN THE BOTTOM TWO. LEANING AGAINST THE TOP OF

CLASS 1—(Continued).

THE GLASS BEAKER IS A GREEN LIZARD OUTLINED IN BLACK WITH A WHITE LAB COAT. THE LAB COAT HAS THREE BUTTONS DOWN THE MIDDLE OUTLINED IN BLACK AND A POCKET ON THE LEFT SIDE OF THE LIZARD'S JACKET OUTLINED IN BLACK. THE LIZARD HAS HIS RIGHT HAND ON HIS HIP, AND THE LEFT ARM IS STRAIGHT AND HE IS LEANING ON THE TOP SMALLER ROUND PORTION OF THE BEAKER. HIS GREEN TAIL WRAPS AROUND HIS BODY AND SLIGHTLY COVERS THE BOTTOM LEFT CORNER OF THE BEAKER. THE LIZARD ALSO HAS LARGE WHITE EYES OUTLINED IN BLACK WITH BLACK PUPILS WITH WHITE DOTS IN THE CENTER, AND THE PUPILS ARE LOOKING AT THE BEAKER.

FOR CHEMICALS FOR USE IN INDUSTRY AND SCIENCE (U.S. CLS. 1, 5, 6, 10, 26 AND 46).

FIRST USE 6-1-2006; IN COMMERCE 6-1-2006.

MATTHEW MCDOWELL, EXAMINING ATTORNEY

SN 77-879,936. AMERICAN AGRITECH, L.L.C., CHANDLER, AZ. FILED 11-24-2009.

ZHO

THE MARK CONSISTS OF STANDARD CHARACTERS WITHOUT CLAIM TO ANY PARTICULAR FONT, STYLE, SIZE, OR COLOR.

FOR AUXILIARY PLANT AND SOIL SUBSTANCES IN THE NATURE OF SOIL IMPROVING PREPARATIONS (U.S. CLS. 1, 5, 6, 10, 26 AND 46).

FIRST USE 4-1-2010; IN COMMERCE 4-1-2010.

GISELLE AGOSTO, EXAMINING ATTORNEY

SN 77-881,872. NOVOZYMES A/S, BAGSVAERD, DENMARK, FILED 11-30-2009.

MSHzyme

THE MARK CONSISTS OF STANDARD CHARACTERS WITHOUT CLAIM TO ANY PARTICULAR FONT, STYLE, SIZE, OR COLOR.

FOR ENZYMES FOR THE BREWING INDUSTRY (U.S. CLS. 1, 5, 6, 10, 26 AND 46).

FIRST USE 2-0-2007; IN COMMERCE 2-0-2007.

INGRID C. EULIN, EXAMINING ATTORNEY

CLASS 1—(Continued).

SN 77-886,520. EISAI R&D MANAGEMENT CO., LTD., TOKYO, JAPAN, FILED 12-4-2009.

PIVKA-II EISAI

THE MARK CONSISTS OF STANDARD CHARACTERS WITHOUT CLAIM TO ANY PARTICULAR FONT, STYLE, SIZE, OR COLOR.

OWNER OF U.S. REG. NOS. 1,503,641, 2,172,577 AND 2,212,335.

FOR DIAGNOSTIC PREPARATIONS AND REAGENTS FOR SCIENTIFIC OR RESEARCH USE; AND DIAGNOSTIC MEDIA; NAMELY, REAGENTS AND PREPARATIONS FOR BACTERIAL CULTURES FOR SCIENTIFIC OR RESEARCH USE; DIAGNOSTIC PREPARATIONS AND REAGENTS FOR CLINICAL OR MEDICAL LABORATORY USE AND DIAGNOSTIC MEDIA, NAMELY, REAGENTS AND PREPARATIONS FOR BACTERIAL CULTURES FOR CLINICAL OR MEDICAL LABORATORY USE (U.S. CLS. 1, 5, 6, 10, 26 AND 46).

ANNE FARRELL, EXAMINING ATTORNEY

SN 77-916,110. CEMENTAID INTERNATIONAL MARKETING LTD., HONG KONG, HONG KONG, FILED 1-20-2010.

CALTITE

THE MARK CONSISTS OF STANDARD CHARACTERS WITHOUT CLAIM TO ANY PARTICULAR FONT, STYLE, SIZE, OR COLOR.

FOR CONCRETE CONTROL COMPOUNDS, NAMELY, WATERPROOFING AN CORROSION INHIBITING CHEMICAL ADDITIVES FOR CONCRETE (U.S. CLS. 1, 5, 6, 10, 26 AND 46).

FIRST USE 2-1-1996; IN COMMERCE 2-1-1996.

FRED CARL, EXAMINING ATTORNEY

SN 77-916,138. CEMENTAID INTERNATIONAL MARKETING LTD., HONG KONG, HONG KONG, FILED 1-20-2010.

SUPERPLASTET

THE MARK CONSISTS OF STANDARD CHARACTERS WITHOUT CLAIM TO ANY PARTICULAR FONT, STYLE, SIZE, OR COLOR.

FOR CONCRETE CONTROL COMPOUNDS, NAMELY, WATERPROOFING AND CORROSION INHIBITING CHEMICAL ADDITIVES FOR CONCRETE (U.S. CLS. 1, 5, 6, 10, 26 AND 46).

FIRST USE 2-1-1996; IN COMMERCE 2-1-1996.

FRED CARL, EXAMINING ATTORNEY

CLASS 1—(Continued).

SN 77-919,292. ADJUVANTS UNLIMITED, INC., TULSA, OK. FILED 1-25-2010.

GFORCE

THE MARK CONSISTS OF STANDARD CHARACTERS WITHOUT CLAIM TO ANY PARTICULAR FONT, STYLE, SIZE, OR COLOR.

FOR SURFACTANTS AND CHEMICAL ADDITIVES USED WITH PESTICIDES AND PLANT NUTRITION PRODUCTS (U.S. CLS. 1, 5, 6, 10, 26 AND 46).

LEIGH LOWRY, EXAMINING ATTORNEY

SN 77-919,299. ADJUVANTS UNLIMITED, INC., TULSA, OK. FILED 1-25-2010.

PROZORB

THE MARK CONSISTS OF STANDARD CHARACTERS WITHOUT CLAIM TO ANY PARTICULAR FONT, STYLE, SIZE, OR COLOR.

FOR SURFACTANTS AND CHEMICAL ADDITIVES USED WITH PESTICIDES AND PLANT NUTRITION PRODUCTS (U.S. CLS. 1, 5, 6, 10, 26 AND 46).

LEIGH LOWRY, EXAMINING ATTORNEY

SN 77-919,422. AMERICAN AGRITECH, L.L.C., CHANDLER, AZ. FILED 1-25-2010.

HYDROPLEX

THE MARK CONSISTS OF STANDARD CHARACTERS WITHOUT CLAIM TO ANY PARTICULAR FONT, STYLE, SIZE, OR COLOR.

FOR PLANT NUTRIENTS AND SUPPLEMENTS IN THE NATURE OF PLANT FOOD (U.S. CLS. 1, 5, 6, 10, 26 AND 46).

FIRST USE 1-31-2000; IN COMMERCE 1-31-2000.

GISELLE AGOSTO, EXAMINING ATTORNEY

CLASS 1—(Continued).

SN 77-920,046. ISP INVESTMENTS INC., WILMINGTON, DE. FILED 1-26-2010.

RAPIFLOC

THE MARK CONSISTS OF STANDARD CHARACTERS WITHOUT CLAIM TO ANY PARTICULAR FONT, STYLE, SIZE, OR COLOR.

FOR ACRYLATES POLYMER COMPOSITIONS FOR USE IN THE MANUFACTURE OF HOUSEHOLD AND INDUSTRIAL CLEANERS; ACRYLATES POLYMER CHEMICAL SLURRIES FOR POTABLE WATER TREATMENT; ACRYLATES POLYMER CHEMICALS FOR USE IN OILFIELD EXPLORATION (U.S. CLS. 1, 5, 6, 10, 26 AND 46).

KHANH LE, EXAMINING ATTORNEY

SN 77-921,595. SOUZA, GLAUCO R., DBA NANO3D BIOSCIENCES, INC., HOUSTON, TX. FILED 1-27-2010.

Nano3D Biosciences

THE MARK CONSISTS OF STANDARD CHARACTERS WITHOUT CLAIM TO ANY PARTICULAR FONT, STYLE, SIZE, OR COLOR.

NO CLAIM IS MADE TO THE EXCLUSIVE RIGHT TO USE "BIOSCIENCES", APART FROM THE MARK AS SHOWN.

FOR ACTIVE CHEMICAL INGREDIENTS FOR USE IN THE MANUFACTURE OF ANTI-CANCER DRUGS; ARTIFICIAL PLANT-CULTIVATION SOIL; BIOLOGICAL TISSUE, NAMELY, A SET OF MATCHED FROZEN AND FIXED HUMAN BIOLOGICAL SPECIMENS DERIVED FROM THE DIVISION OF ONE ORIGINAL SPECIMEN FOR USE IN SCIENTIFIC AND MEDICAL RESEARCH; BIOLOGICAL TISSUE, NAMELY, BLOOD, STEM CELLS, UMBILICAL CORDS AND PLACENTAS FOR SCIENTIFIC AND MEDICAL RESEARCH USE; BIOLOGICAL TISSUE, NAMELY, SHED STEM CELLS (STEM CELLS FROM HUMAN EXFOLIATED DECIDUOUS TEETH), DENTAL PULP AND HUMAN MAXIOFACIAL BONE ELEMENTS FOR SCIENTIFIC USE AND RESEARCH IN CELLULAR HEALING THERAPIES; BIOMEDICAL COMPOUNDS, NAMELY, PEPTIDE SUBSTRATES USED IN ANALYZING AND DETECTING CERTAIN TOXINS FOR CLINICAL OR MEDICAL LABORATORY USE; BIOTECHNOLOGY FORMED GENES, MICROBES AND ENZYMES FOR USE IN THE PRODUCTION OF AGRICULTURAL SEEDS TO ENHANCE PLANTS' GROWTH THEREFROM; CARBON NANO PARTICLES, NAMELY, CARBON NANO PARTICLES THAT PHOTOLUMINESCE; CELLS FOR SCIENTIFIC, LABORATORY OR MEDICAL RESEARCH; CHEMICAL ADDITIVES FOR USE AS CLEANSING, DEODORIZING AND REFRESHING INGREDIENTS IN THE MANUFACTURE OF MOUTH SPRAYS, DENTAL CEMENTS AND MEDICINES FOR DENTAL PURPOSES; CHEMICAL GEL FOR USE AS AN ICE SUBSTITUTE; CHEMICAL REAGENTS FOR NON-MEDICAL PURPOSES; CHEMICALLY ACTIVATED ADHESIVE LABEL FOR SENSING THE PRESENCE OF OXYGEN IN INTRAVENOUS MEDICAL AND PHARMACEUTICAL CONTAINERS; CHEMICALLY TREATED NON-MEDICAL TEST STRIPS FOR CALIBRATION OF LABORATORY TEST EQUIPMENT; CHEMICALS FOR USE IN BIOTECHNOLOGICAL MANUFACTURING PROCESSES; CHEMICALS FOR USE IN BIOTECHNOLOGICAL PRODUCT DEVELOPMENT;

CLASS 1—(Continued).

CULTURES OF MICROORGANISMS OTHER THAN FOR MEDICAL AND VETERINARY USE; DIAGNOSTIC PREPARATIONS FOR CLINICAL OR MEDICAL LABORATORY USE; DIAGNOSTIC PREPARATIONS OTHER THAN FOR MEDICAL OR VETERINARY PURPOSES; DIAGNOSTIC REAGENTS AND PREPARATIONS, EXCEPT FOR MEDICAL OR VETERINARY USE; DIAGNOSTIC REAGENTS FOR CLINICAL OR MEDICAL LABORATORY USE; ELECTROPHORESIS GELS OTHER THAN FOR MEDICAL OR VETERINARY PURPOSES; ENZYMES DERIVED FROM BIOTECHNOLOGICAL PROCESSES FOR USE IN INDUSTRY; FOOD SUPPLEMENTS FOR AGRICULTURAL PRODUCTS AND OTHER PLANTS; GROWING MEDIA FOR PLANTS; IMMUNOHISTOCHEMISTRY DETECTION KITS CONSISTING OF MOUSE SECONDARY REAGENTS, DAB CHROMOGENS, DAB BUFFERS, PEROXIDASE BLOCKING REAGENT, AND HEMATOXYLIN, FOR ANATOMIC PATHOLOGY PURPOSES IN THE MEDICAL DIAGNOSTICS INDUSTRY; LABORATORY CHEMICALS, NAMELY, AN ANTIBODY REAGENT USED FOR THE DETECTION OF ANTIGENS IN CELL AND TISSUE ANALYSIS FOR IN VITRO DIAGNOSTIC USE; MAGNETIC FLUID FOR INDUSTRIAL PURPOSES; MEDICAL GRADE POLYURETHANES FOR USE IN THE MANUFACTURE OF MEDICAL TUBING, FILMS, SPRAYS, AND MEMBRANES; NUCLEIC ACID ISOLATION AND PURIFICATION KIT CONSISTING PRIMARILY OF REAGENTS AND MAGNETIC BEADS FOR SCIENTIFIC RESEARCH PURPOSES; NUCLEIC ACID SEQUENCES AND CHEMICAL REAGENTS FOR OTHER THAN MEDICAL AND VETERINARY PURPOSES; NUTRITIVE ADDITIVE TO ENHANCE THE BIOLOGICAL ACTIVITY OF WATER, SOIL, SEEDS AND PLANTS FOR PURPOSES OF FERTILIZATION AND BIOREMEDIATION OF POLLUTANTS; PLANT AND HERB EXTRACTS FOR USE IN THE MANUFACTURE OF COSMETICS; PLANT EXTRACTS FOR USE IN THE MANUFACTURE OF CREAMS, LOTIONS AND COSMETIC PRODUCTS; PLANT EXTRACTS, NAMELY PHYTOCHEMICALS, USED IN THE MANUFACTURE OF MEDICAL PRODUCTS; PLANT FOOD; PLANT GROWTH REGULATING PREPARATIONS; PLANT GROWTH REGULATORS FOR AGRICULTURAL USE; PLANT HORMONES (PHYTOHORMONES); PLANT NUTRITION PREPARATIONS; POLYMERS AND POLYMERIC ADDITIVES FOR USE IN THE MANUFACTURE OF PHARMACEUTICAL PREPARATIONS, MEDICAL DEVICES, PLASTICS, COSMETICS, PERSONAL CARE PRODUCTS, COATINGS, ADHESIVES, AND LUBRICANTS; PREPARATIONS FOR FORTIFYING PLANTS; PROTEIN ARRAYS AND NUCLEOTIDE ARRAYS FOR SCIENTIFIC AND MEDICAL RESEARCH; REAGENT KITS COMPRISING GENERIC DNA CIRCLE, DNA PRIMERS, POLYMERASE AND BUFFERS FOR USE IN BIOTECHNOLOGY FIELDS; REAGENTS AND SUBSTRATES, NAMELY, CHEMICAL COMPOUNDS FOR USE IN PATTERNING AT NANO SCALE OR NEAR NANO SCALE; REAGENTS FOR SCIENTIFIC OR MEDICAL RESEARCH USE; REAGENTS FOR TESTING THE STERILITY OF MEDICAL EQUIPMENT; SILICA GEL; STEM CELLS FOR RESEARCH OR SCIENTIFIC PURPOSES; STEM CELLS FOR RESEARCH PURPOSES; SUBSTANCES FOR REGULATING PLANT GROWTH; SYNTHETIC AMORPHOUS SILICA GEL FOR FURTHER PROCESSING IN CONNECTION WITH THE MANUFACTURE OF FINISHED GOODS; TESTING KITS CONTAINING PEPTIDE SUBSTRATES USED IN ANALYZING AND DETECTING CERTAIN TOXINS FOR CLINICAL OR MEDICAL LABORATORY USE (U.S. CLS. 1, 5, 6, 10, 26 AND 46).

LAKEISHA LEWIS, EXAMINING ATTORNEY

CLASS 1—(Continued).

SN 77-922,614. SOUZA, GLAUCO R., DBA NANO3D BIOSCIENCES, INC., HOUSTON, TX. FILED 1-28-2010.

Bio-Assembler

THE MARK CONSISTS OF STANDARD CHARACTERS WITHOUT CLAIM TO ANY PARTICULAR FONT, STYLE, SIZE, OR COLOR.

FOR ACTIVE CHEMICAL INGREDIENTS FOR USE IN THE MANUFACTURE OF ANTI-CANCER DRUGS; ANTIOXIDANTS AND PROTEINS USED IN THE MANUFACTURE OF COSMETICS, BEVERAGES, FOOD PRODUCTS AND FOOD SUPPLEMENTS; ARTIFICIAL PLANT-CULTIVATION SOIL; BIOCHEMICAL REAGENTS COMMONLY KNOWN AS PROBES, FOR DETECTING AND ANALYZING MOLECULES IN PROTEIN OR NUCLEOTIDE ARRAYS; BIOLOGICAL TISSUE, NAMELY, A SET OF MATCHED FROZEN AND FIXED HUMAN BIOLOGICAL SPECIMENS DERIVED FROM THE DIVISION OF ONE ORIGINAL SPECIMEN FOR USE IN SCIENTIFIC AND MEDICAL RESEARCH; BIOLOGICAL TISSUE, NAMELY, BLOOD, STEM CELLS, UMBILICAL CORDS AND PLACENTAS FOR SCIENTIFIC AND MEDICAL RESEARCH USE; BIOLOGICAL TISSUE, NAMELY, SHED STEM CELLS (STEM CELLS FROM HUMAN EXFOLIATED DECIDUOUS TEETH), DENTAL PULP AND HUMAN MAXIOFACIAL BONE ELEMENTS FOR SCIENTIFIC USE AND RESEARCH IN CELLULAR HEALING THERAPIES; BIOMEDICAL COMPOUNDS, NAMELY, PEPTIDE SUBSTRATES USED IN ANALYZING AND DETECTING CERTAIN TOXINS FOR CLINICAL OR MEDICAL LABORATORY USE; BIOMEDICAL COMPOUNDS, NAMELY, PEPTIDE SUBSTRATES USED IN ANALYZING AND DETECTING CERTAIN TOXINS FOR LABORATORY OR RESEARCH USE; BIOTECHNOLOGY FORMED GENES, MICROBES AND ENZYMES FOR USE IN THE PRODUCTION OF AGRICULTURAL SEEDS TO ENHANCE PLANTS' GROWTH THEREFROM; CARBON NANO PARTICLES, NAMELY, CARBON NANO PARTICLES THAT PHOTOLUMINESCE; CELLS FOR SCIENTIFIC, LABORATORY OR MEDICAL RESEARCH; CHEMICAL ADDITIVES FOR USE AS CLEANSING, DEODORIZING AND REFRESHING INGREDIENTS IN THE MANUFACTURE OF MOUTH SPRAYS, DENTAL CEMENTS AND MEDICINES FOR DENTAL PURPOSES; CHEMICAL ADDITIVES FOR USE IN THE MANUFACTURE OF PHARMACEUTICALS, COSMETICS; CHEMICAL GEL FOR USE AS AN ICE SUBSTITUTE; CHEMICAL REAGENTS FOR NON-MEDICAL PURPOSES; CHEMICALLY ACTIVATED ADHESIVE LABEL FOR SENSING THE PRESENCE OF OXYGEN IN INTRAVENOUS MEDICAL AND PHARMACEUTICAL CONTAINERS; CHEMICALLY TREATED NON-MEDICAL TEST STRIPS FOR CALIBRATION OF LABORATORY TEST EQUIPMENT; CHEMICALS FOR USE IN BIOTECHNOLOGICAL MANUFACTURING PROCESSES; CHEMICALS FOR USE IN BIOTECHNOLOGICAL PRODUCT DEVELOPMENT; CHEMICALS FOR USE IN THE PURIFICATION OF PROTEINS FOR IN VITRO USE; CULTURES OF MICROORGANISMS OTHER THAN FOR MEDICAL AND VETERINARY USE; DIAGNOSTIC KITS CONSISTING PRIMARILY OF MONOCLONAL ANTIBODIES, BUFFERS, AND REAGENTS TO MONITOR TOXICITY OF DRUGS; DIAGNOSTIC PREPARATIONS FOR SCIENTIFIC OR RESEARCH USE; DIAGNOSTIC PREPARATIONS FOR CLINICAL OR MEDICAL LABORATORY USE; DIAGNOSTIC PREPARATIONS FOR SCIENTIFIC USE; DIAGNOSTIC PREPARATIONS OTHER THAN FOR MEDICAL OR VETERINARY PURPOSES; DIAGNOSTIC PREPARATIONS USED IN SCIENCE; DIAGNOSTIC REAGENTS AND PREPARATIONS, EXCEPT FOR MEDICAL OR VETERINARY USE; DIAGNOSTIC REAGENTS FOR CLINICAL OR MEDICAL LABORATORY USE; DIAGNOSTIC REAGENTS FOR IN VITRO USE IN BIOCHEMISTRY, CLINICAL CHEMISTRY AND MICROBIOLOGY; ELECTROPHORESIS GELS OTHER THAN FOR MEDICAL OR VETERINARY PURPOSES; ENZYME SUBSTRATES; ENZYMES DERIVED FROM

CLASS 1—(Continued).

BIOTECHNOLOGICAL PROCESSES FOR USE IN INDUSTRY; ENZYMES FOR USE IN PROTEIN HYDROLYSIS; FOOD SUPPLEMENTS FOR AGRICULTURAL PRODUCTS AND OTHER PLANTS; GROWING MEDIA FOR PLANTS; IMMUNOHISTOCHEMISTRY DETECTION KITS CONSISTING OF MOUSE SECONDARY REAGENTS, DAB CHROMOGENS, DAB BUFFERS, PEROXIDASE BLOCKING REAGENT, AND HEMATOXYLIN, FOR ANATOMIC PATHOLOGY PURPOSES IN THE MEDICAL DIAGNOSTICS INDUSTRY; KIT CONTAINING PRE-PACKED COLUMNS, CHEMICALS, PREMADE BUFFER CONCENTRATES, SYRINGES AND INSTRUCTIONAL MANUAL FOR THE PURIFICATION OF PROTEINS FOR IN VITRO USE; LABORATORY CHEMICALS, NAMELY, AN ANTIBODY REAGENT USED FOR THE DETECTION OF ANTIGENS IN CELL AND TISSUE ANALYSIS FOR IN VITRO DIAGNOSTIC USE; MAGNETIC FLUID FOR INDUSTRIAL PURPOSES; MEDICAL GRADE POLYURETHANES FOR USE IN THE MANUFACTURE OF MEDICAL TUBING, FILMS, SPRAYS, AND MEMBRANES; NUCLEIC ACID ISOLATION AND PURIFICATION KIT CONSISTING PRIMARILY OF REAGENTS AND MAGNETIC BEADS FOR SCIENTIFIC RESEARCH PURPOSES; NUCLEIC ACID SEQUENCES AND CHEMICAL REAGENTS FOR OTHER THAN MEDICAL AND VETERINARY PURPOSES; NUTRITIVE ADDITIVE TO ENHANCE THE BIOLOGICAL ACTIVITY OF WATER, SOIL, SEEDS AND PLANTS FOR PURPOSES OF FERTILIZATION AND BIOREMEDIATION OF POLLUTANTS; PLANT AND HERB EXTRACTS FOR USE IN THE MANUFACTURE OF COSMETICS; PLANT EXTRACTS FOR USE IN THE MANUFACTURE OF CREAMS, LOTIONS AND COSMETIC PRODUCTS; PLANT EXTRACTS, NAMELY PHYTOCHEMICALS, USED IN THE MANUFACTURE OF MEDICAL PRODUCTS, CREAMS, LOTIONS, AND COSMETIC PRODUCTS; PLANT FOOD; PLANT GROWTH REGULATING PREPARATIONS; PLANT GROWTH REGULATORS FOR AGRICULTURAL USE; PLANT HORMONES (PHYTOHORMONES); PLANT NUTRITION PREPARATIONS; POLYMER BASE COMPOSITIONS USED IN THE MANUFACTURE OF COMMERCIAL, INDUSTRIAL AND DOMESTIC GOODS; POLYMER BEADS FOR USE IN MANUFACTURING; POLYMERS AND POLYMERIC ADDITIVES FOR USE IN THE MANUFACTURE OF INDUSTRIAL PRODUCTS, CONSUMER AND HOUSEHOLD PRODUCTS, SEALANTS, AND AUTOMOTIVE FLUIDS; POLYMERS AND POLYMERIC ADDITIVES FOR USE IN THE MANUFACTURE OF PHARMACEUTICAL PREPARATIONS, MEDICAL DEVICES, PLASTICS, COSMETICS, PERSONAL CARE PRODUCTS, COATINGS, ADHESIVES, AND LUBRICANTS; POLYMERS AND POLYMERIC ADDITIVES FOR USE IN THE MANUFACTURE OF PHARMACEUTICAL PREPARATIONS, PLASTICS, COSMETICS, PERSONAL CARE PRODUCTS, COATINGS, ADHESIVES, AND LUBRICANTS; PREPARATIONS FOR FORTIFYING PLANTS; PROTEIN ARRAYS AND NUCLEOTIDE ARRAYS FOR SCIENTIFIC AND MEDICAL RESEARCH; REAGENT FOR CHEMICAL ANALYSES; REAGENT KITS COMPRISING GENERIC DNA CIRCLE, DNA PRIMERS, POLYMERASE AND BUFFERS FOR USE IN BIOTECHNOLOGY FIELDS; REAGENTS AND SUBSTRATES, NAMELY, CHEMICAL COMPOUNDS FOR USE IN PATTERNING AT NANO SCALE OR NEAR NANO SCALE; REAGENTS FOR RESEARCH PURPOSES; REAGENTS FOR SCIENTIFIC OR MEDICAL RESEARCH USE; REAGENTS FOR TESTING THE STERILITY OF MEDICAL EQUIPMENT; REAGENTS FOR TESTING THE STERILITY OF PHARMACEUTICALS AND INJECTABLE SOLUTIONS; REAGENTS FOR USE IN SCIENTIFIC APPARATUS FOR CHEMICAL OR BIOLOGICAL ANALYSIS; REAGENTS USED FOR ANALYTICAL MOISTURE DETERMINATIONS; RESEARCH REAGENTS FOR INDUSTRIAL USE, NAMELY, FOR FOOD TESTING; SILICA GEL; STEM CELLS FOR

CLASS 1—(Continued).

RESEARCH OR SCIENTIFIC PURPOSES; STEM CELLS FOR RESEARCH PURPOSES; SUBSTANCES FOR REGULATING PLANT GROWTH; SYNTHETIC AMORPHOUS SILICA GEL FOR FURTHER PROCESSING IN CONNECTION WITH THE MANUFACTURE OF FINISHED GOODS; TESTING KITS CONTAINING PEPTIDE SUBSTRATES USED IN ANALYZING AND DETECTING CERTAIN TOXINS FOR CLINICAL OR MEDICAL LABORATORY USE; TESTING KITS CONTAINING PEPTIDE SUBSTRATES USED IN ANALYZING AND DETECTING CERTAIN TOXINS FOR LABORATORY OR RESEARCH USE (U.S. CLS. 1, 5, 6, 10, 26 AND 46).
LAKEISHA LEWIS, EXAMINING ATTORNEY

SN 77-922,786. SOUZA, GLAUCO R., DBA NANO3D BIOSCIENCES, INC., HOUSTON, TX. FILED 1-28-2010.



NO CLAIM IS MADE TO THE EXCLUSIVE RIGHT TO USE "BIOSCIENCES" AND "INC.", APART FROM THE MARK AS SHOWN.

THE COLOR(S) BLACK, GREEN, BLUE IS/ARE CLAIMED AS A FEATURE OF THE MARK.

THE MARK CONSISTS OF A STYLIZED LETTER "N" IN BLACK WHERE ABOVE THE LETTER APPEAR THREE GREEN SPHERES EACH CONTAINING A BLUE DOT, ALSO A BLUE NUMBER "3" AND LETTER "D" FOLLOWED BELOW BY THE WORDS "BIOSCIENCES, INC." IN BLACK.

FOR ACTIVE CHEMICAL INGREDIENTS FOR USE IN THE MANUFACTURE OF ANTI-CANCER DRUGS; ANTIOXIDANTS AND PROTEINS USED IN THE MANUFACTURE OF COSMETICS, BEVERAGES, FOOD PRODUCTS AND FOOD SUPPLEMENTS; ARTIFICIAL PLANT-CULTIVATION SOIL; BIOCHEMICAL REAGENTS COMMONLY KNOWN AS PROBES, FOR DETECTING AND ANALYZING MOLECULES IN PROTEIN OR NUCLEOTIDE ARRAYS; BIOLOGICAL TISSUE, NAMELY, A SET OF MATCHED FROZEN AND FIXED HUMAN BIOLOGICAL SPECIMENS DERIVED FROM THE DIVISION OF ONE ORIGINAL SPECIMEN FOR USE IN SCIENTIFIC AND MEDICAL RESEARCH; BIOLOGICAL TISSUE, NAMELY, BLOOD, STEM CELLS, UMBILICAL CORDS AND PLACENTAS FOR SCIENTIFIC AND MEDICAL RESEARCH USE; BIOLOGICAL TISSUE, NAMELY, SHED STEM CELLS (STEM CELLS FROM HUMAN EXFOLIATED DECIDUOUS TEETH), DENTAL PULP AND HUMAN MAXIOFACIAL BONE ELEMENTS FOR SCIENTIFIC USE AND RESEARCH IN CELLULAR HEALING THERAPIES; BIOMEDICAL COMPOUNDS, NAMELY, PEPTIDE SUBSTRATES USED IN ANALYZING AND DETECTING CERTAIN TOXINS FOR CLINICAL OR MEDICAL LABORATORY USE; BIOMEDICAL COMPOUNDS, NAMELY, PEPTIDE SUBSTRATES USED IN ANALYZING AND DETECTING CERTAIN TOXINS FOR LABORATORY OR RESEARCH USE; BIOTECHNOLOGY FORMED GENES, MICROBES AND ENZYMES FOR USE IN THE PRODUCTION OF AGRICULTURAL SEEDS TO ENHANCE PLANTS' GROWTH THEREFROM; CARBON NANO PARTICLES, NAMELY, CARBON NANO PARTICLES THAT PHOTOLUMINESCE; CELLS FOR SCIENTIFIC, LABORATORY OR MEDICAL RESEARCH; CHEMICAL ADDITIVES FOR USE AS CLEANSING, DEODORIZING AND REFRESHING INGREDIENTS IN THE MANUFACTURE OF MOUTH SPRAYS, DENTAL CEMENTS AND MEDICINES FOR DENTAL PURPOSES; CHEMICAL ADDITIVES FOR USE IN THE MANUFACTURE OF PHARMACEUTICALS, COSMETICS; CHEMICAL GEL FOR USE AS AN ICE SUBSTITUTE; CHEMICAL PRE-

CLASS 1—(Continued).

PARATIONS AND SUBSTANCES USED TO DENATURE OTHER CHEMICAL SUBSTANCES BY RENDERING THEM UNSUITABLE FOR HUMAN AND ANIMAL CONSUMPTION; CHEMICAL REAGENTS FOR NON-MEDICAL PURPOSES; CHEMICALLY ACTIVATED ADHESIVE LABEL FOR SENSING THE PRESENCE OF OXYGEN IN INTRAVENOUS MEDICAL AND PHARMACEUTICAL CONTAINERS; CHEMICALLY TREATED NON-MEDICAL TEST STRIPS FOR CALIBRATION OF LABORATORY TEST EQUIPMENT; CHEMICALS FOR USE IN BIOTECHNOLOGICAL MANUFACTURING PROCESSES; CHEMICALS FOR USE IN BIOTECHNOLOGICAL PRODUCT DEVELOPMENT; CHEMICALS FOR USE IN THE PURIFICATION OF PROTEINS FOR IN VITRO USE; COLORIMETRIC SURFACE SWAB TO INDICATE PRESENCE OF CHEMICAL OR BIOLOGICAL SUBSTANCE; CULTURES OF MICROORGANISMS OTHER THAN FOR MEDICAL AND VETERINARY USE; DIAGNOSTIC KITS CONSISTING PRIMARILY OF MONOCLONAL ANTIBODIES, BUFFERS, AND REAGENTS TO MONITOR TOXICITY OF DRUGS; DIAGNOSTIC PREPARATIONS FOR SCIENTIFIC OR RESEARCH USE; DIAGNOSTIC PREPARATIONS FOR CLINICAL OR MEDICAL LABORATORY USE; DIAGNOSTIC PREPARATIONS FOR SCIENTIFIC USE; DIAGNOSTIC PREPARATIONS OTHER THAN FOR MEDICAL OR VETERINARY PURPOSES; DIAGNOSTIC PREPARATIONS USED IN SCIENCE; DIAGNOSTIC REAGENTS AND PREPARATIONS, EXCEPT FOR MEDICAL OR VETERINARY USE; DIAGNOSTIC REAGENTS FOR CLINICAL OR MEDICAL LABORATORY USE; DIAGNOSTIC REAGENTS FOR IN VITRO USE IN BIOCHEMISTRY, CLINICAL CHEMISTRY AND MICROBIOLOGY; ELECTROPHORESIS GELS OTHER THAN FOR MEDICAL OR VETERINARY PURPOSES; ENZYME SUBSTRATES; ENZYMES DERIVED FROM BIOTECHNOLOGICAL PROCESSES FOR USE IN INDUSTRY; ENZYMES FOR USE IN PROTEIN HYDROLYSIS; FOOD SUPPLEMENTS FOR AGRICULTURAL PRODUCTS AND OTHER PLANTS; GROWING MEDIA FOR PLANTS; IMMUNOHISTOCHEMISTRY DETECTION KITS CONSISTING OF MOUSE SECONDARY REAGENTS, DAB CHROMOGENS, DAB BUFFERS, PEROXIDASE BLOCKING REAGENT, AND HEMATOXYLIN, FOR ANATOMIC PATHOLOGY PURPOSES IN THE MEDICAL DIAGNOSTICS INDUSTRY; KIT CONTAINING PRE-PACKED COLUMNS, CHEMICALS, PRE-MADE BUFFER CONCENTRATES, SYRINGES AND INSTRUCTIONAL MANUAL FOR THE PURIFICATION OF PROTEINS FOR IN VITRO USE; LABORATORY CHEMICALS, NAMELY, AN ANTIBODY REAGENT USED FOR THE DETECTION OF ANTIGENS IN CELL AND TISSUE ANALYSIS FOR IN VITRO DIAGNOSTIC USE; MAGNETIC FLUID FOR INDUSTRIAL PURPOSES; MEDICAL GRADE POLYURETHANES FOR USE IN THE MANUFACTURE OF MEDICAL TUBING, FILMS, SPRAYS, AND MEMBRANES; NUCLEIC ACID ISOLATION AND PURIFICATION KIT CONSISTING PRIMARILY OF REAGENTS AND MAGNETIC BEADS FOR SCIENTIFIC RESEARCH PURPOSES; NUCLEIC ACID SEQUENCES AND CHEMICAL REAGENTS FOR OTHER THAN MEDICAL AND VETERINARY PURPOSES; NUTRITIVE ADDITIVE TO ENHANCE THE BIOLOGICAL ACTIVITY OF WATER, SOIL, SEEDS AND PLANTS FOR PURPOSES OF FERTILIZATION AND BIOMEDIATION OF POLLUTANTS; PLANT AND HERB EXTRACTS FOR USE IN THE MANUFACTURE OF COSMETICS; PLANT EXTRACTS FOR USE IN THE MANUFACTURE OF CREAMS, LOTIONS AND COSMETIC PRODUCTS; PLANT EXTRACTS, NAMELY, PHYTOCHEMICALS, USED IN THE MANUFACTURE OF MEDICAL PRODUCTS, CREAMS, LOTIONS, AND COSMETIC PRODUCTS; PLANT FOOD; PLANT GROWTH REGULATING PREPARATIONS; PLANT GROWTH REGULATORS FOR AGRICULTURAL USE; PLANT HORMONES (PHYTOHORMONES); PLANT NUTRITION PREPARATIONS; POLYMER BASE COMPOSITIONS USED IN THE MANUFACTURE OF COMMERCIAL, INDUSTRIAL AND DOMESTIC GOODS; POLYMER BEADS FOR USE IN MANUFACTURING; POLYMERS AND POLYMERIC ADDITIVES FOR USE IN THE MANUFACTURE OF INDUSTRIAL PRODUCTS, CONSUMER AND HOUSEHOLD PRODUCTS, SEALANTS, AND AUTOMOTIVE FLUIDS; POLYMERS AND POLYMERIC ADDITIVES FOR USE IN THE MANUFACTURE OF PHARMACEUTICAL PREPARATIONS, MEDICAL DEVICES, PLASTICS, COSMETICS, PERSONAL CARE

CLASS 1—(Continued).

PRODUCTS, COATINGS, ADHESIVES, AND LUBRICANTS; POLYMERS AND POLYMERIC ADDITIVES FOR USE IN THE MANUFACTURE OF PHARMACEUTICAL PREPARATIONS, PLASTICS, COSMETICS, PERSONAL CARE PRODUCTS, COATINGS, ADHESIVES, AND LUBRICANTS; PREPARATIONS FOR FORTIFYING PLANTS; PROTEIN ARRAYS AND NUCLEOTIDE ARRAYS FOR SCIENTIFIC AND MEDICAL RESEARCH; REAGENT FOR CHEMICAL ANALYSES; REAGENT KITS COMPRISING GENERIC DNA CIRCLE, DNA PRIMERS, POLYMERASE AND BUFFERS FOR USE IN BIOTECHNOLOGY FIELDS; REAGENTS AND SUBSTRATES, NAMELY, CHEMICAL COMPOUNDS FOR USE IN PATTERNING AT NANO SCALE OR NEAR NANO SCALE; REAGENTS FOR RESEARCH PURPOSES; REAGENTS FOR SCIENTIFIC OR MEDICAL RESEARCH USE; REAGENTS FOR TESTING THE STERILITY OF MEDICAL EQUIPMENT; REAGENTS FOR TESTING THE STERILITY OF PHARMACEUTICALS AND INJECTABLE SOLUTIONS; REAGENTS FOR USE IN SCIENTIFIC APPARATUS FOR CHEMICAL OR BIOLOGICAL ANALYSIS; REAGENTS USED FOR ANALYTICAL MOISTURE DETERMINATIONS; RESEARCH REAGENTS FOR INDUSTRIAL USE, NAMELY, FOR FOOD TESTING; SILICA GEL; STEM CELLS FOR RESEARCH OR SCIENTIFIC PURPOSES; STEM CELLS FOR RESEARCH PURPOSES; SUBSTANCES FOR REGULATING PLANT GROWTH; SYNTHETIC AMORPHOUS SILICA GEL FOR FURTHER PROCESSING IN CONNECTION WITH THE MANUFACTURE OF FINISHED GOODS; SYNTHETIC RESIN COMPOUNDS IN THE FORM OF MICROSPHERES USED TO INCORPORATE VARIOUS OTHER SUBSTANCES; TEST PARTICLES FOR BIODETECTION SYSTEMS, BIOLOGICAL ANALOGUES AND MICROSCOPIC CARRIER BEADS WITH CHEMICALLY ATTACHED DNA FRAGMENTS FOR USE IN TESTING THE OPERATION OF EQUIPMENT USED FOR ANALYZING AIR FOR THE PRESENCE OF HARMFUL BIOLOGICAL SUBSTANCES; TESTING KITS CONTAINING PEPTIDE SUBSTRATES USED IN ANALYZING AND DETECTING CERTAIN TOXINS FOR CLINICAL OR MEDICAL LABORATORY USE; TESTING KITS CONTAINING PEPTIDE SUBSTRATES USED IN ANALYZING AND DETECTING CERTAIN TOXINS FOR LABORATORY OR RESEARCH USE (U.S. CLS. 1, 5, 6, 10, 26 AND 46).

FIRST USE 7-14-2008; IN COMMERCE 0-0-2010.
LAKEISHA LEWIS, EXAMINING ATTORNEY

SN 77-924,959. TNE MEC COMPANY, INC., KANSAS CITY, MO. FILED 2-1-2010.

HYDROLINK

THE MARK CONSISTS OF STANDARD CHARACTERS WITHOUT CLAIM TO ANY PARTICULAR FONT, STYLE, SIZE, OR COLOR.

OWNER OF U.S. REG. NO. 2,972,259.
FOR CHEMICAL COMPOUNDS USED AS AN INGREDIENT OF PAINT FOR CURING PAINT (U.S. CLS. 1, 5, 6, 10, 26 AND 46).

MICHAEL WIENER, EXAMINING ATTORNEY

CLASS 1—(Continued).

SN 77-925,300. LANKA DUPONT, DBA UBER HOUSE LLC, SAG HARBOR, NY. FILED 2-1-2010.



THE MARK CONSISTS OF THE STYLIZED WORDING "HIIPUSS V" INSIDE THE DESIGN OF A RECTANGULAR SHAPE, HAVING EIGHT HEXAGON-SHAPED BOLTS AROUND THE PERIMETER OF THE RECTANGLE.

FOR PHEROMONES FOR USE IN THE MANUFACTURE OF COLOGNES, PERFUMES, COSMETICS, ROOM FRAGRANCES AND AROMATHERAPY OILS (U.S. CLS. 1, 5, 6, 10, 26 AND 46).

FIRST USE 11-25-2008; IN COMMERCE 11-25-2008.
JAY BESCH, EXAMINING ATTORNEY

SN 77-925,528. IMERYS, PARIS, FRANCE, FILED 2-2-2010.

SPHERYS

THE MARK CONSISTS OF STANDARD CHARACTERS WITHOUT CLAIM TO ANY PARTICULAR FONT, STYLE, SIZE, OR COLOR.

FOR CHEMICALS FOR USE IN MICROENCAPSULATION TECHNOLOGY (U.S. CLS. 1, 5, 6, 10, 26 AND 46).
MARGERY A. TIERNEY, EXAMINING ATTORNEY

SN 77-925,539. WILLIS, LARRELL I., LAKELAND, FL. FILED 2-2-2010.

SS SOLID START

THE MARK CONSISTS OF STANDARD CHARACTERS WITHOUT CLAIM TO ANY PARTICULAR FONT, STYLE, SIZE, OR COLOR.

FOR CHEMICAL ENGINE TREATMENTS AND ADDITIVES FOR ENGINE OILS, GASOLINE AND DIESEL FUELS, TRANSMISSION FLUIDS AND COOLING SYSTEMS (U.S. CLS. 1, 5, 6, 10, 26 AND 46).

FIRST USE 1-10-2010; IN COMMERCE 1-10-2010.
MELISSA VALLILLO, EXAMINING ATTORNEY

CLASS 1—(Continued).

SN 77-926,022. W.M. BARR & COMPANY, INC., MEMPHIS, TN. FILED 2-2-2010.

Prep-All

THE MARK CONSISTS OF STANDARD CHARACTERS WITHOUT CLAIM TO ANY PARTICULAR FONT, STYLE, SIZE, OR COLOR.

FOR CHEMICAL PREPARATIONS FOR REMOVING WAX, GREASE, SILICONE, ROAD FILM AND SANDING RESIDUE FROM AUTOMOTIVE SURFACES SUCH AS METAL, PLASTIC AND FIBERGLASS (U.S. CLS. 1, 5, 6, 10, 26 AND 46).

FIRST USE 5-1-1992; IN COMMERCE 5-1-1992.
TARAH HARDY, EXAMINING ATTORNEY

CLASS 1—(Continued).

SN 77-926,627. JSH INTERNATIONAL, LLC, RIVERSIDE, NJ. FILED 2-3-2010.

BAE

THE MARK CONSISTS OF STANDARD CHARACTERS WITHOUT CLAIM TO ANY PARTICULAR FONT, STYLE, SIZE, OR COLOR.

FOR INDUSTRIAL PRODUCTS, NAMELY, ORGANIC PEAT HUMIC EXTRACTS FOR THE STIMULATION OF MICROORGANISMS THAT ARE USED IN GREASE TRAPS, WASTEWATER TREATMENT, PUMPING STATIONS AND SEWAGE PLANTS, AND LANDFILLS, RESULTING IN THE ELIMINATION OF GREASE AND IN THE REDUCTION OF SOLIDS FOR DISPOSAL, MODERATION OR ELIMINATION OF ODORS, SLUDGE COMPACTION, INCREASE ANAEROBIC METHANE GENERATION, AND REDUCTION OF THE NEGATIVE EFFECTS OF POLYMERS AND OTHER TOXINS (U.S. CLS. 1, 5, 6, 10, 26 AND 46).

PATRICIA EVANKO, EXAMINING ATTORNEY

SN 77-926,428. VARIDIAN LLC, RICHMOND, VA. FILED 2-2-2010.

Selectex

THE MARK CONSISTS OF STANDARD CHARACTERS WITHOUT CLAIM TO ANY PARTICULAR FONT, STYLE, SIZE, OR COLOR.

FOR CHEMICAL AGENTS FOR IMPREGNATING, BINDING OR COATING OF TEXTILES, FURS AND LEATHER, NON-WOVENS AND FABRICS; CHEMICALS USED IN THE MANUFACTURE OF FABRIC OR TEXTILES; FABRIC PROTECTANT FOR CLOTHING, TEXTILES, BED SHEETS, LINENS; SPECIALTY CHEMICALS, NAMELY, CHEMICAL ADDITIVES FOR USE IN THE MANUFACTURE OF FABRICS AND OF SURFACES OF A WIDE VARIETY OF MANUFACTURED PRODUCTS, FOR HEALTH AND SAFETY RELATED PURPOSES; WATERPROOFING CHEMICAL COMPOSITIONS FOR ARTICLES OF FABRIC (U.S. CLS. 1, 5, 6, 10, 26 AND 46).

MORGAN WYNNE, EXAMINING ATTORNEY

SN 77-927,269. ABSORBENT MATERIALS COMPANY, INC., DBA ABS MATERIALS, WOOSTER, OH. FILED 2-3-2010.

Osorb

THE MARK CONSISTS OF STANDARD CHARACTERS WITHOUT CLAIM TO ANY PARTICULAR FONT, STYLE, SIZE, OR COLOR.

FOR CHEMICAL ADSORBENTS FOR REMOVING IMPURITIES FROM FUEL; CHEMICAL AGENTS FOR CHELATING AND SEQUESTERING; CHEMICAL AGENTS FOR REMOVING ACID IN INDUSTRIAL MANUFACTURING APPLICATIONS; CHEMICAL COMPOSITION FOR SOLIDIFICATION OF FLUIDS AND FOR ABSORBING SPILLS; CHEMICALS FOR USE IN DECONTAMINATION OF POLLUTED SITES; CHEMICALS FOR USE IN INDUSTRY AND SCIENCE; CHEMICALS FOR USE IN THE BIOCHEMICAL AND CHEMICAL INDUSTRY; CHEMICALS FOR USE IN THE FIELD OF OIL EXPLORATION AND PRODUCTION; WASTE WATER TREATMENT CHEMICALS FOR INDUSTRIAL USE (U.S. CLS. 1, 5, 6, 10, 26 AND 46).

FIRST USE 1-1-2009; IN COMMERCE 1-1-2009.

ELIZABETH HUGHITT, EXAMINING ATTORNEY

CLASS 1—(Continued).

SN 77-927,731. SANTIAGO, JASON, PALM BEACH GARDENS, FL. FILED 2-4-2010.

WallFlowers

THE MARK CONSISTS OF STANDARD CHARACTERS WITHOUT CLAIM TO ANY PARTICULAR FONT, STYLE, SIZE, OR COLOR.
 FOR GROWING MEDIA FOR PLANTS (U.S. CLS. 1, 5, 6, 10, 26 AND 46).
 JOHN DALIER, EXAMINING ATTORNEY

CLASS 1—(Continued).

SN 77-928,933. SEA LANE BIOTECHNOLOGIES, LLC, ATHERTON, CA. FILED 2-5-2010.

SURROBODY

THE MARK CONSISTS OF STANDARD CHARACTERS WITHOUT CLAIM TO ANY PARTICULAR FONT, STYLE, SIZE, OR COLOR.
 FOR DIAGNOSTIC OR REAGENT PROTEIN AND PEPTIDE PREPARATIONS FOR SCIENTIFIC, FORENSIC, OR RESEARCH USE (U.S. CLS. 1, 5, 6, 10, 26 AND 46).
 AMY C. KEAN, EXAMINING ATTORNEY

SN 77-928,132. FERRO CORPORATION, CLEVELAND, OH. FILED 2-4-2010.

SURESTOP

THE MARK CONSISTS OF STANDARD CHARACTERS WITHOUT CLAIM TO ANY PARTICULAR FONT, STYLE, SIZE, OR COLOR.
 OWNER OF U.S. REG. NO. 3,655,259.
 FOR CHEMICAL COMPOUNDS USED IN INDUSTRIAL FRICTION APPLICATIONS (U.S. CLS. 1, 5, 6, 10, 26 AND 46).
 FIRST USE 1-1-2010; IN COMMERCE 1-1-2010.
 JAMES LOVELACE, EXAMINING ATTORNEY

SN 77-929,788. JENKINS, JOE C., III, DBA STITCHCRETE, NEWBERRY, FL. FILED 2-6-2010.

STITCHCRETE

THE MARK CONSISTS OF STANDARD CHARACTERS WITHOUT CLAIM TO ANY PARTICULAR FONT, STYLE, SIZE, OR COLOR.
 FOR SYNTHETIC RESINS THAT ARE USED TO REPAIR AND FILL HOLES AND CRACKS, ADHERE TO SURROUNDING MATERIALS AND SEAL SURFACES FOR USE IN HARSH ENVIRONMENTS (U.S. CLS. 1, 5, 6, 10, 26 AND 46).
 NORA BUCHANAN WILL, EXAMINING ATTORNEY

SN 77-928,190. THILMANY LLC, KAUKAUNA, WI. FILED 2-4-2010.

GREENPRENE

THE MARK CONSISTS OF STANDARD CHARACTERS WITHOUT CLAIM TO ANY PARTICULAR FONT, STYLE, SIZE, OR COLOR.
 FOR CHEMICALS, NAMELY, ISOPRENE (U.S. CLS. 1, 5, 6, 10, 26 AND 46).
 DAVID COLLIER, EXAMINING ATTORNEY

SN 77-930,095. HEARTLAND SOLUTIONS, INC., GRAIN VALLEY, MO. FILED 2-8-2010.

NANOBURST

THE MARK CONSISTS OF STANDARD CHARACTERS WITHOUT CLAIM TO ANY PARTICULAR FONT, STYLE, SIZE, OR COLOR.
 FOR ADJUVANT FOR USE WITH AGRICULTURAL CHEMICALS (U.S. CLS. 1, 5, 6, 10, 26 AND 46).
 FIRST USE 12-28-2009; IN COMMERCE 12-28-2009.
 WILLIAM BRECKENFELD, EXAMINING ATTORNEY

CLASS 1—(Continued).

SN 77-930,800. SNI SOLUTIONS, INC., GENESEO, IL. FILED 2-8-2010.

ICE AX

THE MARK CONSISTS OF STANDARD CHARACTERS WITHOUT CLAIM TO ANY PARTICULAR FONT, STYLE, SIZE, OR COLOR.

FOR CHEMICAL PREPARATIONS FOR MELTING SNOW AND ICE (U.S. CLS. 1, 5, 6, 10, 26 AND 46).
DAVID C. REIHNER, EXAMINING ATTORNEY

SN 77-931,130. MARSHALL INNOVATIVE TECHNOLOGIES LLC, SOUTHFIELD, MI. FILED 2-9-2010.

Maxfil

THE MARK CONSISTS OF STANDARD CHARACTERS WITHOUT CLAIM TO ANY PARTICULAR FONT, STYLE, SIZE, OR COLOR.

FOR INORGANIC FILLER PARTICULATES FOR USE IN CASTING OR COMPRESSION MOLDING OPERATIONS IN THE COMPOSITE AND RUBBER INDUSTRIES (U.S. CLS. 1, 5, 6, 10, 26 AND 46).
PAUL F. GAST, EXAMINING ATTORNEY

SN 77-931,159. VERIDIAN MEDICAL, L.L.C., LAKE CHARLES, LA. FILED 2-9-2010.



NO CLAIM IS MADE TO THE EXCLUSIVE RIGHT TO USE "MEDICAL", APART FROM THE MARK AS SHOWN.
THE COLOR(S) BLUE IS/ARE CLAIMED AS A FEATURE OF THE MARK.

THE MARK CONSISTS OF THE WORDS "VERIDIAN MEDICAL" WITH A CROSS BETWEEN THE TWO WORDS CONSISTING OF SHORTER HORIZONTAL LINES FORMING THE TOP AND BOTTOM PARTS OF THE CROSS AND LONGER HORIZONTAL LINES FORMING THE MIDDLE OF THE CROSS, ALL IN BLUE.

FOR DIAGNOSTIC PREPARATIONS FOR CLINICAL OR MEDICAL LABORATORY USE (U.S. CLS. 1, 5, 6, 10, 26 AND 46).

FIRST USE 8-1-2009; IN COMMERCE 8-1-2009.
VIVIAN MICZNIK FIRST, EXAMINING ATTORNEY

CLASS 1—(Continued).

SN 77-931,892. PREMARK RWP HOLDINGS, INC., WILMINGTON, DE. FILED 2-9-2010.

PEG

THE MARK CONSISTS OF STANDARD CHARACTERS WITHOUT CLAIM TO ANY PARTICULAR FONT, STYLE, SIZE, OR COLOR.

THE NAME IN THE MARK DOES NOT REFER TO A PARTICULAR LIVING INDIVIDUAL.
FOR ADHESIVES FOR GENERAL INDUSTRIAL AND CONSTRUCTION USE (U.S. CLS. 1, 5, 6, 10, 26 AND 46).
PAUL F. GAST, EXAMINING ATTORNEY

SN 77-932,906. KEYSTONE STARCHES, LLC, NORTH CHARLESTON, SC. FILED 2-10-2010.

KEYLOCK

THE MARK CONSISTS OF STANDARD CHARACTERS WITHOUT CLAIM TO ANY PARTICULAR FONT, STYLE, SIZE, OR COLOR.

FOR STARCH-BASED ADDITIVES FOR THE PAPER PRODUCTION PROCESS (U.S. CLS. 1, 5, 6, 10, 26 AND 46).

ANDREA K. NADELMAN, EXAMINING ATTORNEY

SN 77-936,175. REICHHOLD, INC., DURHAM, NC. FILED 2-16-2010.

ENVIROLITE

THE MARK CONSISTS OF STANDARD CHARACTERS WITHOUT CLAIM TO ANY PARTICULAR FONT, STYLE, SIZE, OR COLOR.

FOR POLYESTER RESIN COMPOUNDS BASED ON RENEWABLE OR RECYCLABLE MATERIALS FOR USE IN THE MANUFACTURE OF FIBERGLASS AND NON-FIBERGLASS REINFORCED COMPOSITE PARTS FOR TRANSPORTATION, MARINE, CORROSION, CONSUMER, CONSTRUCTION AND OTHER END USE MARKETS (U.S. CLS. 1, 5, 6, 10, 26 AND 46).

TRACY CROSS, EXAMINING ATTORNEY

CLASS 1—(Continued).

SN 79-075,576. CLAIRE EMANUEL, INNALOO WA 6018, AUSTRALIA, FILED 10-19-2009.



PRIORITY DATE OF 10-7-2009 IS CLAIMED.
OWNER OF INTERNATIONAL REGISTRATION 1020058 DATED 10-19-2009, EXPIRES 10-19-2019.

THE MARK CONSISTS OF THE STYLIZED WORDING "SO2GO" WITH A DESIGN OF A BRANCH WITH LEAVES AND A CONE AT THE END EXTENDING FROM THE BOTTOM OF THE NUMBER "2".

FOR CHEMICAL PREPARATIONS FOR USE AS INGREDIENTS FOR BEVERAGES; CHEMICALS FOR REMOVING PRESERVATIVES IN BEVERAGES (U.S. CLS. 1, 5, 6, 10, 26 AND 46).

VERNA BETH RIRIE, EXAMINING ATTORNEY

CLASS 2—(Continued).

SN 77-886,405. ROSSI LICENSING, LLC, BALTIMORE, MD. FILED 12-4-2009.

GAME POINT

THE MARK CONSISTS OF STANDARD CHARACTERS WITHOUT CLAIM TO ANY PARTICULAR FONT, STYLE, SIZE, OR COLOR.

FOR SEALER COATINGS FOR USE ON ATHLETIC SURFACES AND OTHER RECREATIONAL SURFACES (U.S. CLS. 6, 11 AND 16).

WARREN L. OLANDRIA, EXAMINING ATTORNEY

SN 77-886,417. ROSSI LICENSING, LLC, BALTIMORE, MD. FILED 12-4-2009.

CLASS 2—PAINTS

SN 77-783,282. E. I. DU PONT DE NEMOURS AND COMPANY, WILMINGTON, DE. FILED 7-17-2009.

STANDOBLUE

THE MARK CONSISTS OF STANDARD CHARACTERS WITHOUT CLAIM TO ANY PARTICULAR FONT, STYLE, SIZE, OR COLOR.

OWNER OF U.S. REG. NO. 1,458,900.

FOR PAINTS, VARNISHES, LACQUERS AND PRIMERS FOR USE IN AUTOMOTIVE INDUSTRIAL COATING AND REFINISHING APPLICATIONS (U.S. CLS. 6, 11 AND 16).

GISELLE AGOSTO, EXAMINING ATTORNEY

TOP SPIN

THE MARK CONSISTS OF STANDARD CHARACTERS WITHOUT CLAIM TO ANY PARTICULAR FONT, STYLE, SIZE, OR COLOR.

FOR SEALER COATINGS FOR USE ON ATHLETIC SURFACES AND OTHER RECREATIONAL SURFACES (U.S. CLS. 6, 11 AND 16).

WARREN L. OLANDRIA, EXAMINING ATTORNEY

SN 77-900,319. SPECTRUM PRODUCTS, LLC, MISSOULA, MT. FILED 12-23-2009.

SN 77-822,479. AKZO NOBEL COATINGS INTERNATIONAL B.V., ARNHEM, NETHERLANDS, FILED 9-9-2009.

PRO AQUAAMBER

THE MARK CONSISTS OF STANDARD CHARACTERS WITHOUT CLAIM TO ANY PARTICULAR FONT, STYLE, SIZE, OR COLOR.

FOR WOOD COATINGS, NAMELY, VARNISHES, LACQUERS, PAINTS, FLOOR COATINGS AND PRESERVATIVE WAX COATINGS FOR WOOD SURFACES (U.S. CLS. 6, 11 AND 16).

JAMES LOVELACE, EXAMINING ATTORNEY

SPECTRA SHIELD

THE MARK CONSISTS OF STANDARD CHARACTERS WITHOUT CLAIM TO ANY PARTICULAR FONT, STYLE, SIZE, OR COLOR.

NO CLAIM IS MADE TO THE EXCLUSIVE RIGHT TO USE "SHIELD", APART FROM THE MARK AS SHOWN.

FOR CORROSION INHIBITANTS IN THE NATURE OF A COATING FOR USE ON STAINLESS STEEL IN OR NEAR A POOL ENVIRONMENT (U.S. CLS. 6, 11 AND 16).

CHRISTINE COOPER, EXAMINING ATTORNEY

CLASS 2—(Continued).

SN 77-925,101. TNE MEC COMPANY, INC., KANSAS CITY, MO. FILED 2-1-2010.

EPOXOBLOCK WB

THE MARK CONSISTS OF STANDARD CHARACTERS WITHOUT CLAIM TO ANY PARTICULAR FONT, STYLE, SIZE, OR COLOR.

OWNER OF U.S. REG. NO. 1,742,609.

NO CLAIM IS MADE TO THE EXCLUSIVE RIGHT TO USE "WB", APART FROM THE MARK AS SHOWN.

FOR EPOXY PAINT-TYPE COATING FOR USE ON CONCRETE, MASONRY AND BLOCK WALLS (U.S. CLS. 6, 11 AND 16).

MICHAEL WIENER, EXAMINING ATTORNEY

CLASS 3—COSMETICS AND CLEANING PREPARATIONS

SN 77-540,952. SOAR TRADING INC., HOUSTON, TX. FILED 8-6-2008.

SN 77-930,096. KONICA MINOLTA BUSINESS SOLUTIONS U.S.A., INC., RAMSEY, NJ. FILED 2-8-2010.

SIMITRI

THE MARK CONSISTS OF STANDARD CHARACTERS WITHOUT CLAIM TO ANY PARTICULAR FONT, STYLE, SIZE, OR COLOR.

FOR TONER (U.S. CLS. 6, 11 AND 16).

ELISSA GARBER KON, EXAMINING ATTORNEY

ANN'DOR

SN 77-931,654. THE NORMAN ROCKWELL FAMILY AGENCY, INC., LAGRANGEVILLE, NY. FILED 2-9-2010.



OWNER OF U.S. REG. NOS. 1,666,322, 3,172,850 AND 3,458,489.

THE NAME(S), PORTRAIT(S), AND/OR SIGNATURE(S) SHOWN IN THE MARK DOES NOT IDENTIFY A PARTICULAR LIVING INDIVIDUAL.

THE MARK CONSISTS OF A FIVE POINT STAR IN A SQUARE WITH THE WORDING "NORMAN ROCKWELL" APPEARING IN A BANNER TO THE RIGHT.

FOR EXTERIOR PAINTS, FABRIC PAINTS, FINGER PAINTS, FLOOR PAINTS, GLAZES, HOUSE PAINT; ENAMELS IN THE NATURE OF HOUSE PAINT; PAINTS AND VARNISHES FOR HOUSES AND ARTISTS; OIL COLORS, OIL PAINTS, PAINT FOR MODEL AIRPLANES, MODEL CARS AND LIKE; PAINTS FOR ARTS AND CRAFTS (U.S. CLS. 6, 11 AND 16).

JAY FLOWERS, EXAMINING ATTORNEY

THE MARK CONSISTS OF STANDARD CHARACTERS WITHOUT CLAIM TO ANY PARTICULAR FONT, STYLE, SIZE, OR COLOR.

FOR FALSE NAILS; NAIL TIPS (U.S. CLS. 1, 4, 6, 50, 51 AND 52).

JULIE WATSON, EXAMINING ATTORNEY

CLASS 3—(Continued).

SN 77-543,522. BY KILIAN, PARIS, FRANCE, FILED 8-11-2008.

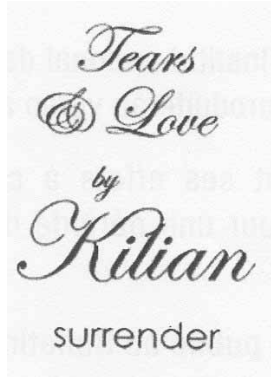

PRIORITY CLAIMED UNDER SEC. 44(D) ON FRANCE APPLICATION NO. 083555203, FILED 2-12-2008, REG. NO. 083555203, DATED 2-12-2008, EXPIRES 2-12-2018.

OWNER OF U.S. REG. NOS. 3,436,358, 3,458,323 AND OTHERS.

THE NAME(S), PORTRAIT(S), AND/OR SIGNATURE(S) SHOWN IN THE MARK DOES NOT IDENTIFY A PARTICULAR LIVING INDIVIDUAL.

THE MARK CONSISTS OF THE STYLIZED WORDING "TEARS & LOVE BY KILIAN SURRENDER".

FOR PERFUMES, EAU DE PARFUM, EAU DE TOILETTE, EAU DE COLOGNE, ESSENTIAL OILS, COSMETIC CREAMS, BATH AND SHOWER COSMETIC PREPARATIONS, SKIN MOISTURIZING CREAMS, ANTI-WRINKLE CREAMS, SKIN CLEANSING GELS, NON-MEDICATED SKIN EXFOLIATING CREAMS AND GELS, BEAUTY MASKS, COSMETIC PREPARATIONS FOR SKIN RENEWAL, SKIN TANNING COSMETIC PREPARATIONS, NON-MEDICATED HAIR TREATMENT PREPARATIONS, NAMELY, CAPILLARY LOTIONS, HAIRSPRAYS, HAIR LOTIONS, EYE MAKE-UP, MASCARA, LIPSTICKS, MAKE-UP, FOUNDATION, EYE-LINER, NAIL VARNISH, POWDER MAKE-UP, COSMETIC PREPARATIONS FOR SLIMMING PURPOSES, NAMELY, SCULPTING GELS, CREAMS, LOTIONS FOR CELLULITE REDUCTION, MAKE-UP REMOVING PREPARATIONS, DEODORANTS FOR PERSONAL USE, ANTIPERSPIRANTS, SOAPS, OILS FOR COSMETIC USE, BODY LOTION, BATH AND SHOWER MILK, BATH AND SHOWER GEL, BODY CREAM, BODY MOISTURIZING LOTION, BATH OIL, TALCUM POWDER, AFTER-SHAVE LOTION, AFTER SHAVE BALM, ALUM STONE FOR PERSONAL USE, SHAVING FOAM, SHAVING PRODUCTS, NAMELY, SHAVING CREAM, SHAVING GEL, POTPOURRIS, NON-MEDICATED BATH SALTS, TISSUES IMPREGNATED WITH COSMETIC LOTIONS, COSMETIC PREPARATIONS FOR THE CARE OF MOUTH AND TEETH, DENTIFRICES (U.S. CLS. 1, 4, 6, 50, 51 AND 52).

APRIL HESIK, EXAMINING ATTORNEY

CLASS 3—(Continued).

SN 77-543,589. BY KILIAN, PARIS, FRANCE, FILED 8-11-2008.

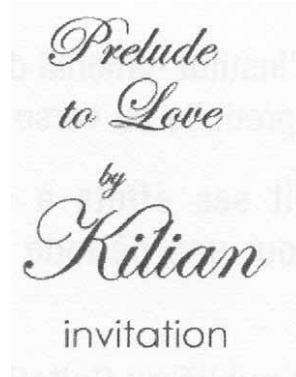

PRIORITY CLAIMED UNDER SEC. 44(D) ON FRANCE APPLICATION NO. 083555204, FILED 2-12-2008, REG. NO. 083555204, DATED 2-12-2008, EXPIRES 2-12-2018.

OWNER OF U.S. REG. NOS. 3,436,358, 3,458,323 AND OTHERS.

THE NAME(S), PORTRAIT(S), AND/OR SIGNATURE(S) SHOWN IN THE MARK DOES NOT IDENTIFY A PARTICULAR LIVING INDIVIDUAL.

THE MARK CONSISTS OF THE STYLIZED WORDING "PRELUDE TO LOVE BY KILIAN INVITATION".

FOR PERFUMES, EAU DE PARFUM, EAU DE TOILETTE, EAU DE COLOGNE, ESSENTIAL OILS, COSMETIC CREAMS, BATH AND SHOWER COSMETIC PREPARATIONS, SKIN MOISTURIZING CREAMS, ANTI-WRINKLE CREAMS, SKIN CLEANSING GELS, NON-MEDICATED SKIN EXFOLIATING CREAMS AND GELS, BEAUTY MASKS, COSMETIC PREPARATIONS FOR SKIN RENEWAL, SKIN TANNING COSMETIC PREPARATIONS, NON-MEDICATED HAIR TREATMENT PREPARATIONS, NAMELY, CAPILLARY LOTIONS, HAIRSPRAYS, HAIR LOTIONS, EYE MAKE-UP, MASCARA, LIPSTICKS, MAKE-UP, FOUNDATION, EYE-LINER, NAIL VARNISH, POWDER MAKE-UP, COSMETIC PREPARATIONS FOR SLIMMING PURPOSES, NAMELY, SCULPTING GELS, CREAMS, LOTIONS FOR CELLULITE REDUCTION, MAKE-UP REMOVING PREPARATIONS, DEODORANTS FOR PERSONAL USE, ANTIPERSPIRANTS, SOAPS, OILS FOR COSMETIC USE, BODY LOTION, BATH AND SHOWER MILK, BATH AND SHOWER GEL, BODY CREAM, BODY MOISTURIZING LOTION, BATH OIL, TALCUM POWDER, AFTER-SHAVE LOTION, AFTER SHAVE BALM, ALUM STONE FOR PERSONAL USE, SHAVING FOAM, SHAVING PRODUCTS, NAMELY, SHAVING CREAM, SHAVING GEL, POTPOURRIS, NON-MEDICATED BATH SALTS, TISSUES IMPREGNATED WITH COSMETIC LOTIONS, COSMETIC PREPARATIONS FOR THE CARE OF MOUTH AND TEETH, DENTIFRICES (U.S. CLS. 1, 4, 6, 50, 51 AND 52).

APRIL HESIK, EXAMINING ATTORNEY

CLASS 3—(Continued).

SN 77-631,835. SKIN RESEARCH LABORATORIES, INC.,
MARIETTA, GA. FILED 12-12-2008.

DERMA BLOK

THE MARK CONSISTS OF STANDARD CHARACTERS
WITHOUT CLAIM TO ANY PARTICULAR FONT, STYLE,
SIZE, OR COLOR.

NO CLAIM IS MADE TO THE EXCLUSIVE RIGHT TO
USE "DERMA", APART FROM THE MARK AS SHOWN.
FOR SKIN CREAMS (U.S. CLS. 1, 4, 6, 50, 51 AND 52).
FIRST USE 5-1-2007; IN COMMERCE 5-1-2007.
EUGENIA MARTIN, EXAMINING ATTORNEY

CLASS 3—(Continued).

SN 77-645,690. ACTIVE ORGANICS, LP, LEWISVILLE, TX.
FILED 1-8-2009.

ACTIVE ORGANICS

THE MARK CONSISTS OF STANDARD CHARACTERS
WITHOUT CLAIM TO ANY PARTICULAR FONT, STYLE,
SIZE, OR COLOR.

NO CLAIM IS MADE TO THE EXCLUSIVE RIGHT TO
USE "ORGANICS", APART FROM THE MARK AS SHOWN.
SEC. 2(F).

FOR EXFOLIANTS, SCRUBS, PEELS, MOISTURIZERS
AND CLEANSERS, ALL FOR TOPICAL APPLICATION
TO THE SKIN; LOTIONS, GELS, CREAMS AND SER-
UMS FOR USE ON THE SKIN; FACIAL MASKS; SUN
SCREEN PREPARATIONS; HAIR CARE PREPARA-
TIONS; ALL OF THE AFOREMENTIONED GOODS
ARE IN WHOLE OR IN PART COMPRISED OF OR-
GANIC MATERIALS (U.S. CLS. 1, 4, 6, 50, 51 AND 52).
FIRST USE 12-10-1981; IN COMMERCE 12-10-1981.
LAURIE KAUFMAN, EXAMINING ATTORNEY

SN 77-647,351. WIZCOZ CO., LTD., GANGNAM-GU, SEOUL,
REPUBLIC OF KOREA, FILED 1-12-2009.

SN 77-641,041. NEW EARTH LABS, INC., MALIBU, CA.
FILED 12-30-2008.



NO CLAIM IS MADE TO THE EXCLUSIVE RIGHT TO
USE "THINNING HAIR", APART FROM THE MARK AS
SHOWN.

THE MARK CONSISTS OF THE STYLIZED WORDING
"CROWN. REAL HELP FOR THINNING HAIR" WITH
FLOWING HAIR WITH A DESIGN OF FLOWING HAIR
COMING OUT OF THE TOP OF THE "C" IN CROWN AND A
SOLID RECTANGLE AS A PERIOD TO THE RIGHT OF
CROWN.

FOR HAIR CARE PREPARATIONS (U.S. CLS. 1, 4, 6,
50, 51 AND 52).

FIRST USE 11-0-2008; IN COMMERCE 11-0-2008.
TIMOTHY FINNEGAN, EXAMINING ATTORNEY



PRIORITY CLAIMED UNDER SEC. 44(D) ON REPUBLIC
OF KOREA APPLICATION NO. 40-2008-0055, FILED 12-2-
2008, REG. NO. 0810276, DATED 12-31-2009, EXPIRES 12-31-
2019.

THE MARK CONSISTS OF THE WORD "SKIN79" ABOVE
A CROSS IN THE MIDDLE OF A LINE.

FOR COSMETICS; NON-MEDICATED SKIN CARE
AND TREATMENT PRODUCTS, NAMELY, CLEANS-
ERS, TONERS, MOISTURIZERS, FACIAL AND EYE
CREAMS, MASKS, REJUVENATING CREAMS, LO-
TIONS, BODY BALM, GELS, OILS, TONERS, CLEA-
NERS, PEELS, SUNSCREENS, SUNBLOCKS, ANTI-
AGING FLUIDS, ANTI-AGING GELS, ANTI-WRINKLE
CREAMS, SKIN LIGHTENERS, SKIN WHITENING
CREAMS, SKIN WHITENING SERUMS, SKIN WHITEN-
ING FLUIDS, CLEANSING MILK AND COSMETIC
PREPARATIONS FOR SKIN RENEWAL; COSMETICS,
NAMELY, LIQUID MAKE-UP, CONCEALERS, MAKE-
UP BASE, CORRECTIVE MAKE-UP AND BEAUTY EN-
HANCING CREAMS, LOTIONS AND GELS; BEAUTY
SERUMS FOR SKIN; ANTI-AGING CREAMS (U.S. CLS.
1, 4, 6, 50, 51 AND 52).

KATHY DE JONGE, EXAMINING ATTORNEY

CLASS 3—(Continued).

SN 77-647,369. WIZCOZ CO., LTD., GANGNAM-GU, SEOUL, REPUBLIC OF KOREA, FILED 1-12-2009.

Jessie & Rosie

PRIORITY CLAIMED UNDER SEC. 44(D) ON REPUBLIC OF KOREA APPLICATION NO. 40-2008-0056, FILED 12-8-2008, REG. NO. 0816266, DATED 3-8-2010, EXPIRES 3-8-2020. THE MARK CONSISTS OF THE WORDS "JESSIE & ROSIE" IN STYLIZED LETTERING.

FOR COSMETICS; NON-MEDICATED SKIN CARE AND TREATMENT PRODUCTS, NAMELY, CLEANSERS, TONERS, MOISTURIZERS, FACIAL AND EYE CREAMS, MASKS, REJUVENATING CREAMS, LOTIONS, BODY BALM, GELS, OILS, TONERS, CLEANSERS, PEELS, SUNSCREENS, SUNBLOCKS, ANTI-AGING FLUIDS, ANTI-AGING GELS, ANTI-WRINKLE CREAMS, SKIN LIGHTENERS, WHITENING CREAMS, WHITENING SERUMS, WHITENING FLUIDS, CLEANSING MILK AND COSMETIC SOLUTIONS FOR SKIN RENEWAL; COSMETICS, NAMELY, LIQUID MAKE-UP, CONCEALERS, MAKE-UP BASE, CORRECTIVE MAKE-UP AND BEAUTY ENHANCING CREAMS, LOTIONS AND GELS; BEAUTY SERUMS FOR SKIN; ANTI-AGING CREAMS (U.S. CLS. 1, 4, 6, 50, 51 AND 52).

KATHY DE JONGE, EXAMINING ATTORNEY

SN 77-668,610. AMERICAN GLOBAL HEALTH GROUP, LLC, BELLEVUE, WA. FILED 2-11-2009.



NO CLAIM IS MADE TO THE EXCLUSIVE RIGHT TO USE "BABY" AND "CARE", APART FROM THE MARK AS SHOWN.

THE COLOR(S) PINK, BEIGE AND BLACK IS/ARE CLAIMED AS A FEATURE OF THE MARK.

THE MARK CONSISTS OF A BABY IN BEIGE SKIN COLOR AND BLACK OUTLINES LOOKING TO ITS RIGHT AND ITS RIGHT HAND IN ITS MOUTH AND THE LEFT HAND DOWN. BELOW THE BABY IS WRITTEN "BABY BARE CARE" IN PINK.

FOR BEAUTY CREAMS FOR BODY CARE; BODY AND BEAUTY CARE COSMETICS; COSMETIC CREAMS FOR SKIN CARE; COSMETIC PREPARATIONS FOR BODY CARE; LOTIONS FOR FACE AND BODY CARE; NON-MEDICATED SKIN CARE PREPARATIONS; NON-MEDICATED SKIN CARE PREPARATIONS, NAMELY, CREAMS, LOTIONS, GELS, TONERS, CLEANSERS AND PEELS; NON-MEDICATED SKIN CREAMS; NON-MEDICATED STIMULATING LOTIONS FOR THE SKIN; SKIN CREAMS; SKIN CREAMS IN LIQUID AND IN SOLID FORM; SKIN LOTIONS; SKIN MOISTURIZER; SKIN TONERS (U.S. CLS. 1, 4, 6, 50, 51 AND 52).

WILLIAM VERHOSEK, EXAMINING ATTORNEY

CLASS 3—(Continued).

SN 77-698,653. CERRUTI 1881 S.A.S., PARIS, FRANCE, FILED 3-25-2009.

L'ESSENCE DE
CERRUTI

PRIORITY CLAIMED UNDER SEC. 44(D) ON ERPNTY TM OFC APPLICATION NO. 008174518, FILED 3-24-2009, REG. NO. 008174518, DATED 10-7-2009, EXPIRES 3-24-2019.

OWNER OF U.S. REG. NOS. 1,704,471, 2,363,844 AND OTHERS.

THE MARK CONSISTS OF THE TERMS "L'ESSENCE DE" IN STYLIZED FORM ABOVE THE TERM "CERRUTI" IN STYLIZED FORM.

THE ENGLISH TRANSLATION OF "L'ESSENCE DE" IN THE MARK IS "THE ESSENCE OF".

FOR TOILET AND BATH PREPARATIONS NOT FOR MEDICAL USE, NAMELY, PERFUMES, EAU DE PERFUME, EAU DE TOILETTE, SOAPS, SHOWER GELS, CLEANING EMULSIONS FOR THE BODY, BATH CRYSTALS, EXFOLIANTS FOR THE HAIR AND SKIN; SHAMPOOS AND HAIR CARE PREPARATIONS NOT FOR MEDICAL USE; DEODORANTS FOR PERSONAL USE; ESSENTIAL OILS, MASSAGE OILS, BATH OILS; HAND AND BODY LOTIONS AND CREAMS; BODY TALC; SHAVING CREAM, AFTER-SHAVE LOTIONS AND BALMS; SUNSCREEN PREPARATIONS; POTPOURRI, SCENTED SACHETS AND ROOM FRAGRANCES (U.S. CLS. 1, 4, 6, 50, 51 AND 52).

ANNE FARRELL, EXAMINING ATTORNEY

SN 77-709,157. DETAIL DEVILS LLC, NEW YORK, NY. FILED 4-7-2009.

GRANNY'S GREEN APPLE
ORGANIC SOLUTIONS

THE MARK CONSISTS OF STANDARD CHARACTERS WITHOUT CLAIM TO ANY PARTICULAR FONT, STYLE, SIZE, OR COLOR.

NO CLAIM IS MADE TO THE EXCLUSIVE RIGHT TO USE "ORGANIC SOLUTIONS", APART FROM THE MARK AS SHOWN.

FOR ORGANIC CLEANING, ODOR REMOVING AND STAIN REMOVING PRODUCTS, NAMELY, CARPET CLEANERS; CLEANER FOR USE ON GREASE TRAPS AND KITCHEN AND BATHROOM SURFACES; CLEANING AGENTS AND PREPARATIONS; CLEANING PREPARATIONS CONTAINING MICROBIAL ENZYMES, USED TO PRESERVE DRAIN SYSTEMS AND WATERWAYS; CLEANING PREPARATIONS FOR CLEANING SURFACES; CLEANING PREPARATIONS FOR CLEANSING DRAINS; CLEANING PREPARATIONS FOR HOUSEHOLD PURPOSES; CLEANING PREPARATIONS FOR INDOOR AND OUTDOOR SURFACES; DEGREASING PREPARATIONS FOR INDOOR AND OUTDOOR SURFACES; GLASS CLEANING PREPARATIONS; PET ODOR REMOVERS; PET STAIN REMOVERS; STAIN REMOVING PREPARATIONS (U.S. CLS. 1, 4, 6, 50, 51 AND 52).

FIRST USE 3-24-2009; IN COMMERCE 3-24-2009.
SUSAN RICHARDS, EXAMINING ATTORNEY

CLASS 3—(Continued).

SN 77-713,099. AUSTRALIAN GOLD, LLC, INDIANAPOLIS, IN. FILED 4-14-2009.

SIENNA SUNSET

THE MARK CONSISTS OF STANDARD CHARACTERS WITHOUT CLAIM TO ANY PARTICULAR FONT, STYLE, SIZE, OR COLOR.

FOR SKIN CARE PREPARATIONS, NAMELY, NON-MEDICATED INDOOR AND OUTDOOR SKIN TANNING PREPARATIONS (U.S. CLS. 1, 4, 6, 50, 51 AND 52).
COLLEEN DOMBROW, EXAMINING ATTORNEY

SN 77-751,292. BGK TRADEMARK HOLDINGS, LLC, BEVERLY HILLS, CA. FILED 6-3-2009.

BEYONCÉ HEAT

THE MARK CONSISTS OF STANDARD CHARACTERS WITHOUT CLAIM TO ANY PARTICULAR FONT, STYLE, SIZE, OR COLOR.

THE NAME(S), PORTRAIT(S), AND/OR SIGNATURE(S) SHOWN IN THE MARK IDENTIFIES BEYONCÉ KNOWLES, WHOSE CONSENT(S) TO REGISTER IS MADE OF RECORD.

FOR PERFUMERY, ESSENTIAL OILS, SOAPS, COSMETICS, AND HAIR LOTIONS (U.S. CLS. 1, 4, 6, 50, 51 AND 52).

LINDSEY RUBIN, EXAMINING ATTORNEY

CLASS 3—(Continued).

SN 77-758,204. WALTON ISAACSON, LLC, SHERMAN OAKS, CA. FILED 6-12-2009.

JUST CAUSE

THE MARK CONSISTS OF STANDARD CHARACTERS WITHOUT CLAIM TO ANY PARTICULAR FONT, STYLE, SIZE, OR COLOR.

FOR AFTER SHAVE LOTIONS; AFTERSHAVE; AFTER SUN CREAMS AND LOTIONS; AGE SPOT REDUCING CREAMS; ANTIPERSPIRANTS AND DEODORANTS FOR PERSONAL USE; AROMATHERAPY BODY CARE PRODUCTS, NAMELY, BODY LOTION, SHOWER GEL, CUTICLE CREAM, SHAMPOO, CONDITIONER, NON-MEDICATED LIP BALM, SOAP, BODY POLISH, BODY AND FOOT SCRUB AND NON-MEDICATED FOOT CREAM; ASTRINGENTS FOR COSMETIC PURPOSES; BABY LOTION, OIL AND POWDER; BATH BEADS AND CRYSTALS; BATH FOAM, GEL, LOTION AND OIL; BATH SALTS BEAUTY CREAMS FOR BODY CARE; BEAUTY GELS; BEAUTY LOTIONS; BEAUTY MASKS; BODY BUTTER; BODY CREAMS; BODY LOTION; BODY MIST; BODY POWDER; BODY SCRUB; BODY SPLASH; BODY SPRAYS; BODY WASH BUBBLE BATH; COLD CREAMS; COLOGNE; ESSENTIAL OILS; EXFOLIANT CREAM; EYE CREAM; FACE AND BODY CREAMS; FACE AND BODY LOTIONS; FACIAL CLEANSERS; FACIAL SCRUBS; FACIAL MASKS; FRAGRANCES; HAIR BLEACHING PREPARATIONS; HAIR CARE PREPARATIONS; HAIR COLOR; HAIR GEL AND HAIR MOUSSE; HAIR RELAXERS HAIR CONDITIONER; HAIR SHAMPOO; HAIR SPRAYS AND HAIR GELS; HAIR STRAIGHTENING PREPARATIONS; HAIR STYLING PREPARATIONS; HAIR STYLING SPRAYS; HAND CREAM; HAND LOTIONS; MOUTH WASHES; NAIL CARE PREPARATIONS; PERFUME; SHAVING CREAMS; SHAVING PREPARATIONS; SHOWER GEL, BODY POLISH, BODY AND FOOT SCRUB AND NON-MEDICATED SKIN CREAMS; SKIN CLEANSERS; SKIN MOISTURIZERS; SKIN TONERS; SOAPS FOR PERSONAL USE; COSMETICS (U.S. CLS. 1, 4, 6, 50, 51 AND 52).
JOHN DALIER, EXAMINING ATTORNEY

SN 77-776,235. EQUI-SPA, L.L.C., ANKENY, IA. FILED 7-8-2009.

EQUI-SPA

THE MARK CONSISTS OF STANDARD CHARACTERS WITHOUT CLAIM TO ANY PARTICULAR FONT, STYLE, SIZE, OR COLOR.

FOR NON-MEDICATED GROOMING PREPARATIONS FOR HORSES, NAMELY, LEAVE IN CONDITIONER, MUSCLE WASH, COAT REFRESH SPRAY, SHEATH CLEANER, HOOF MOISTURIZER, CLEANSING SPRAY, PROTECTIVE BALM FOR COAT AND HOOF, MANE AND TAIL MOISTURIZING SPRAY AND GEL, BODY WASH, MASSAGE OILS, AND SUMMER DEODORANT SPRAY (U.S. CLS. 1, 4, 6, 50, 51 AND 52).

FIRST USE 12-31-2005; IN COMMERCE 12-31-2005.
MARK PILARO, EXAMINING ATTORNEY

CLASS 3—(Continued).

SN 77-777,024. KIMBERLY FOWLER INC., VENICE, CA. FILED 7-8-2009.



NO CLAIM IS MADE TO THE EXCLUSIVE RIGHT TO USE "ANTI-AGING SYSTEM", APART FROM THE MARK AS SHOWN.

THE MARK CONSISTS OF THE STYLIZED WORDS "YAS YOUR ANTI-AGING SYSTEM". "YAS" APPEARS VERTICALLY IN THE MARK; "YOUR ANTI-AGING SYSTEM" APPEARS TO THE LEFT OF "YAS". A DOT DESIGN APPEARS ABOVE THE LETTER "Y" IN "YAS" AND TO THE UPPER RIGHT OF THE LETTER "S" IN "YAS".

FOR NON-MEDICATED SKIN CARE PREPARATIONS (U.S. CLS. 1, 4, 6, 50, 51 AND 52).
KAELE KUNG, EXAMINING ATTORNEY

SN 77-794,441. MAIRA JUNG COMÉRCIO DE ARTIGOS DE USO PESSOAL LTDA., RIO DE JANEIRO, RJ, BRAZIL, FILED 7-31-2009.

MAIRA JUNG PITANGA

THE MARK CONSISTS OF STANDARD CHARACTERS WITHOUT CLAIM TO ANY PARTICULAR FONT, STYLE, SIZE, OR COLOR.

NO CLAIM IS MADE TO THE EXCLUSIVE RIGHT TO USE "PITANGA", APART FROM THE MARK AS SHOWN.

THE NAME "MAIRA JUNG" IDENTIFIES A LIVING INDIVIDUAL WHOSE CONSENT IS OF RECORD.

FOR PERFUME AND COLOGNE MADE IN WHOLE OR IN PART CONTAINING PITANGA EXTRACT (U.S. CLS. 1, 4, 6, 50, 51 AND 52).

LOURDES AYALA, EXAMINING ATTORNEY

CLASS 3—(Continued).

SN 77-796,681. LANG DENTAL MANUFACTURING CO., INC., WHEELING, IL. FILED 8-4-2009.

EL COR

THE MARK CONSISTS OF STANDARD CHARACTERS WITHOUT CLAIM TO ANY PARTICULAR FONT, STYLE, SIZE, OR COLOR.

THE ENGLISH TRANSLATION OF THE WORD "EL COR" IS THE HEART.

FOR DENTAL MATERIALS, NAMELY, CLEANING SOLVENT MADE FROM ORANGE TERPENES USED FOR REMOVING ZINC OXIDE AND EUGENOL DENTAL CEMENTS FROM INSTRUMENTS AND OTHER SURFACES (U.S. CLS. 1, 4, 6, 50, 51 AND 52).

FIRST USE 1-0-1976; IN COMMERCE 1-0-1976.

KATHLEEN LORENZO, EXAMINING ATTORNEY

SN 77-796,700. LANG DENTAL MANUFACTURING CO., INC., WHEELING, IL. FILED 8-4-2009.

ALGINOUT

THE MARK CONSISTS OF STANDARD CHARACTERS WITHOUT CLAIM TO ANY PARTICULAR FONT, STYLE, SIZE, OR COLOR.

FOR DENTAL MATERIALS, NAMELY, CLEANING SOLUTIONS FOR REMOVAL OF ALGINATE FROM IMPRESSION TRAYS AND DENTAL INSTRUMENTS (U.S. CLS. 1, 4, 6, 50, 51 AND 52).

FIRST USE 0-0-1965; IN COMMERCE 1-0-1965.

KATHLEEN LORENZO, EXAMINING ATTORNEY

SN 77-797,582. KERN, JAMIE, STUDIO CITY, CA. FILED 8-5-2009.

Bye Bye Cosmetics

THE MARK CONSISTS OF STANDARD CHARACTERS WITHOUT CLAIM TO ANY PARTICULAR FONT, STYLE, SIZE, OR COLOR.

NO CLAIM IS MADE TO THE EXCLUSIVE RIGHT TO USE "COSMETICS", APART FROM THE MARK AS SHOWN.

FOR BEAUTY CREAMS FOR BODY CARE; BODY CREAMS; BODY LOTIONS; COSMETICS; FRAGRANCES FOR PERSONAL USE; HAIR CARE PREPARATIONS; MAKE-UP; NON-MEDICATED SKIN CARE PREPARATIONS (U.S. CLS. 1, 4, 6, 50, 51 AND 52).

FIRST USE 8-1-2009; IN COMMERCE 8-1-2009.

WILLIAM ROSSMAN, EXAMINING ATTORNEY

CLASS 3—(Continued).

SN 77-798,810. FLOOD, PETER T., NAPLES, FL. FILED 8-6-2009.

BAHAMA BLUE

THE MARK CONSISTS OF STANDARD CHARACTERS WITHOUT CLAIM TO ANY PARTICULAR FONT, STYLE, SIZE, OR COLOR.

FOR SUN TAN LOTIONS, SUN TAN OILS, SUN BLOCK PREPARATIONS, LIP BALMS, SUN SCREENS, AFTER SUN SKIN GELS (U.S. CLS. 1, 4, 6, 50, 51 AND 52).

ALYSSA STEEL, EXAMINING ATTORNEY

CLASS 3—(Continued).

SN 77-804,104. COTY US LLC, NEW YORK, NY. FILED 8-13-2009.

**THE WORLD'S FIRST CONSUMER
GENERATED FRAGRANCE**

THE MARK CONSISTS OF STANDARD CHARACTERS WITHOUT CLAIM TO ANY PARTICULAR FONT, STYLE, SIZE, OR COLOR.

NO CLAIM IS MADE TO THE EXCLUSIVE RIGHT TO USE "FRAGRANCE", APART FROM THE MARK AS SHOWN.

FOR PERFUMERY (U.S. CLS. 1, 4, 6, 50, 51 AND 52).
JILL PRATER, EXAMINING ATTORNEY

SN 77-800,822. ABSOLUTE COATINGS, INC., NEW ROCHELLE, NY. FILED 8-10-2009.



OWNER OF U.S. REG. NOS. 2,692,133 AND 2,787,914.
NO CLAIM IS MADE TO THE EXCLUSIVE RIGHT TO USE "NON-TOXIC", "LOW ODOR", "PREMIUM GREEN", "PAINT & FINISH REMOVER", OR "REMOVES MULTIPLE COATS IN 90 MINUTES", APART FROM THE MARK AS SHOWN.

THE COLOR(S) BLACK, WHITE, YELLOW AND GREEN IS/ARE CLAIMED AS A FEATURE OF THE MARK.

THE MARK CONSISTS OF THE WORDING "ZIP-STRIP" IN WHITE LETTER ON A BLACK BACKGROUND, OVERLAPPING A HORIZONTAL BLACK LINE, WITH A WHITE BAND ABOVE THE LINE AND A YELLOW BAND BELOW THE LINE. THE YELLOW BAND CONTAINS THE WORDS "NON-TOXIC" AND "LOW ODOR" IN YELLOW LETTERS ON A BLACK RING SURROUNDING A GREEN LEAF, ABOVE AND TO THE RIGHT OF THE WORDS "PREMIUM GREEN" IN GREEN LETTERS OUTLINED IN WHITE, WHICH, IN TURN, ARE ABOVE THE WORDS "PAINT & FINISH REMOVER" IN BLACK LETTERS OUTLINED IN WHITE, ALL ABOVE THE WORDS "REMOVES MULTIPLE COATS IN 90 MINUTES*" IN BLACK LETTERS. ALL OF THE FOREGOING ARE ABOVE A BLACK LINE, WHICH IS ABOVE A GREEN BAND, WHICH, IN TURN, IS ABOVE A WHITE BAND.

FOR WATER-BASED PAINT REMOVER (U.S. CLS. 1, 4, 6, 50, 51 AND 52).

BARBARA GAYNOR, EXAMINING ATTORNEY

SN 77-804,684. L'OREAL, PARIS, FRANCE, FILED 8-14-2009.

PROPERFECT SALON AIRBRUSH

THE MARK CONSISTS OF STANDARD CHARACTERS WITHOUT CLAIM TO ANY PARTICULAR FONT, STYLE, SIZE, OR COLOR.

NO CLAIM IS MADE TO THE EXCLUSIVE RIGHT TO USE "SALON AIRBRUSH", APART FROM THE MARK AS SHOWN.

FOR SUNLESS TANNING PREPARATIONS (U.S. CLS. 1, 4, 6, 50, 51 AND 52).

JENNIFER DIXON, EXAMINING ATTORNEY

SN 77-811,777. JAHNER, RICHARD JOHN, KULA, HI. FILED 8-25-2009.

HERPEX

THE MARK CONSISTS OF STANDARD CHARACTERS WITHOUT CLAIM TO ANY PARTICULAR FONT, STYLE, SIZE, OR COLOR.

FOR ESSENTIAL OILS FOR PERSONAL USE (U.S. CLS. 1, 4, 6, 50, 51 AND 52).

TRICIA SONNEBORN, EXAMINING ATTORNEY

CLASS 3—(Continued).

SN 77-812,122. ORLY INTERNATIONAL, INC., VAN NUYS, CA. FILED 8-25-2009.



OWNER OF U.S. REG. NOS. 1,144,642 AND 1,527,646.
 THE MARK CONSISTS OF THE LETTER "L", A STAR, THE LETTER "A", A STAR, ABOVE THE WORDS "BY ORLY".
 FOR COSMETICS, NAIL CARE PREPARATIONS, AND COSMETIC PREPARATIONS FOR BODY CARE (U.S. CLS. 1, 4, 6, 50, 51 AND 52).
 GINA FINK, EXAMINING ATTORNEY

SN 77-815,441. ELISEA LORRENZI COSMETICS, NEW YORK, NY. FILED 8-28-2009.



NO CLAIM IS MADE TO THE EXCLUSIVE RIGHT TO USE "AVENUE DES CHAMPS ELYSEES", APART FROM THE MARK AS SHOWN.

THE NAME(S), PORTRAIT(S), AND/OR SIGNATURE(S) SHOWN IN THE MARK DOES NOT IDENTIFY A PARTICULAR LIVING INDIVIDUAL.

THE MARK CONSISTS OF TWO SINGLE LINE OUTER CIRCLES WITH THE STYLIZED TEXT "AVENUE DES CHAMPS ELYSEES" INSIDE THE AREA BETWEEN THE TWO CIRCLES AND ARCHED AT THE TOP CENTER OF THE MARK. AT THE 3 AND 9 POSITION OF THE CIRCLE ARE STYLIZED DESIGNS TO RESEMBLE THE TOP OF A SCREW HEAD. IN THE CENTER OF THE MARK ARE THE LETTERS "EL" WITH THE "E" FACING LEFT AND THE "L" FACING RIGHT. CENTERED BELOW THE "EL" LETTERS IS THE NAME "ELISEA LORRENZI".

THE ENGLISH TRANSLATION OF "DES CHAMPS ELYSEES" IN THE MARK IS "OF FIELDS ELYSEES".

FOR BODY AND BEAUTY CARE COSMETICS; COSMETICS; MAKE-UP; NON-MEDICATED SKIN CARE PREPARATIONS; PERFUME (U.S. CLS. 1, 4, 6, 50, 51 AND 52).
 PAULA MAHONEY, EXAMINING ATTORNEY

CLASS 3—(Continued).

SN 77-817,150. SANTE SEMPRINI CESARI, UNION CITY, NJ. FILED 9-1-2009.

MAXIMA HAIR & BODY
 TECHNOLOGY

THE MARK CONSISTS OF STANDARD CHARACTERS WITHOUT CLAIM TO ANY PARTICULAR FONT, STYLE, SIZE, OR COLOR.

NO CLAIM IS MADE TO THE EXCLUSIVE RIGHT TO USE "HAIR & BODY TECHNOLOGY", APART FROM THE MARK AS SHOWN.

FOR HAIR BLEACHING PREPARATIONS; HAIR CARE CREAMS; HAIR CARE LOTIONS; HAIR GEL AND HAIR MOUSSE; HAIR LACQUERS; HAIR SHAMPOOS AND CONDITIONERS; HAIR SPRAY; HAIR WAVING LOTION; HAIR WAX; NON-MEDICATED HAIR SERUMS (U.S. CLS. 1, 4, 6, 50, 51 AND 52).

FIRST USE 11-1-2007; IN COMMERCE 11-1-2007.
 CHERYL CLAYTON, EXAMINING ATTORNEY

SN 77-824,444. L'OREAL, PARIS, FRANCE, FILED 9-11-2009.

SUPER-BLENDABLE

THE MARK CONSISTS OF STANDARD CHARACTERS WITHOUT CLAIM TO ANY PARTICULAR FONT, STYLE, SIZE, OR COLOR.

SEC. 2(F).
 FOR COSMETICS (U.S. CLS. 1, 4, 6, 50, 51 AND 52).
 FIRST USE 1-0-2004; IN COMMERCE 1-0-2004.
 INGA ERVIN, EXAMINING ATTORNEY

CLASS 3—(Continued).

SN 77-825,095. WONDEUX INTERNATIONAL LIMITED,
WANCHAI, HONG KONG, FILED 9-11-2009.



THE MARK CONSISTS OF A SCRIPT "W" WITH THE WORD "WONDEUX" CENTERED BELOW IT, ALL SURROUNDED BY A CLOVERLEAF DESIGN, ALL FURTHER SURROUNDED BY A CIRCLE DESIGN.

THE WORDING "WONDEUX" HAS NO MEANING IN A FOREIGN LANGUAGE.

FOR SOAPS; ANTIPERSPIRANT SOAP; DEODORANT SOAP; DISINFECTANT SOAP; MEDICATED SOAP; LOTIONS FOR COSMETIC PURPOSES; MAKE-UP REMOVING PREPARATIONS; PERFUMERY; ESSENTIAL OILS; COSMETICS; HAIR LOTIONS; AFTER SHAVE LOTIONS; COSMETIC PREPARATIONS FOR BATHS; BEAUTY MASKS (U.S. CLS. 1, 4, 6, 50, 51 AND 52).

ANNE MADDEN, EXAMINING ATTORNEY

CLASS 3—(Continued).

SN 77-840,999. CLAYMONT BOND PTY LTD, MELBOURNE,
AUSTRALIA, FILED 10-5-2009.

MIRENESSE

THE MARK CONSISTS OF STANDARD CHARACTERS WITHOUT CLAIM TO ANY PARTICULAR FONT, STYLE, SIZE, OR COLOR.

THE WORDING "MIRENESSE" HAS NO MEANING IN A FOREIGN LANGUAGE.

FOR ADHESIVES FOR COSMETIC USE; AFTER-SUN GELS; AFTER-SUN MILKS; AFTER-SUN OILS; ALOE VERA GEL FOR COSMETIC PURPOSES; ASTRINGENTS FOR COSMETIC PURPOSES; BATH OILS FOR COSMETIC PURPOSES; BATH POWDER; BLEACHING PREPARATIONS FOR COSMETIC PURPOSES; BODY AND BEAUTY CARE COSMETICS; CHALK FOR COSMETIC USE; CLEANER FOR COSMETIC BRUSHES; CLEANSING CREAMS; COCOA BUTTER FOR COSMETIC PURPOSES; COLOGNES, PERFUMES AND COSMETICS; COLORING PREPARATIONS FOR COSMETIC PURPOSES; CONCEALERS; COSMETIC BALLS; COSMETIC CREAMS; COSMETIC CREAMS FOR SKIN CARE; COSMETIC FACIAL BLOTTING PAPERS; COSMETIC HAIR DRESSING PREPARATIONS; COSMETIC HAIR REGROWTH INHIBITING PREPARATIONS; COSMETIC MASKS; COSMETIC MILKS; COSMETIC OILS; COSMETIC OILS FOR THE EPIDERMIS; COSMETIC OLIVE OIL FOR THE FACE AND BODY; COSMETIC PADS; COSMETIC PENCILS; COSMETIC PREPARATIONS; COSMETIC PREPARATIONS AGAINST SUNBURN; COSMETIC PREPARATIONS FOR BODY CARE; COSMETIC PREPARATIONS FOR EYE LASHES; COSMETIC PREPARATIONS FOR SKIN RENEWAL; COSMETIC PREPARATIONS FOR SLIMMING PURPOSES; COSMETIC PREPARATIONS FOR THE CARE OF MOUTH AND TEETH; COSMETIC PREPARATIONS FOR THE HAIR AND SCALP; COSMETIC PREPARATIONS, NAMELY, FIRMSING CREAMS; COSMETIC PREPARATIONS, NAMELY, FIRMSING LOTIONS; COSMETIC PREPARATIONS, NAMELY, SKIN BALSAMS; COSMETIC PRODUCTS IN THE FORM OF AEROSOLS FOR SKIN CARE; COSMETIC PRODUCTS IN THE FORM OF AEROSOLS FOR SKINCARE; COSMETIC PRODUCTS TAKEN ORALLY, NAMELY, PILLS THAT INDUCE BRONZING OF THE SKIN; COSMETIC ROUGES; COSMETIC SOAPS; COSMETIC SUN-PROTECTING PREPARATIONS; COSMETIC SUN-TANNING PREPARATIONS; COSMETIC SUNTAN LOTIONS; COSMETIC SUNTAN PREPARATIONS; COSMETICS; COSMETICS AND COSMETIC PREPARATIONS; COSMETICS AND MAKE-UP; COSMETICS FOR ANIMALS; COSMETICS IN GENERAL, INCLUDING PERFUMES; COSMETICS IN THE FORM OF MILKS, LOTIONS AND EMULSIONS; COSMETICS, NAMELY, COMPACTS; COSMETICS, NAMELY, LIP PRIMER; COSMETICS, NAMELY, LIP REPAIRERS; COTTON BALLS FOR COSMETIC PURPOSES; COTTON BUDS FOR COSMETIC PURPOSES; COTTON FOR COSMETIC PURPOSES; COTTON PUFFS FOR COSMETIC PURPOSES; COTTON STICKS FOR COSMETIC PURPOSES; COTTON SWABS FOR COSMETIC PURPOSES; COTTON WOOL AND COTTON STICKS FOR COSMETIC PURPOSES; COTTON WOOL FOR COSMETIC PURPOSES; DECORATIVE TRANSFERS AND SKIN JEWELS FOR COSMETIC PURPOSES; EYE COMPRESSES FOR COSMETIC PURPOSES; EYEBROW COSMETICS; FACE CREAMS AND CLEANSERS CONTAINING BENZOYL PEROXIDE FOR COSMETIC PURPOSES; FACE CREAMS FOR COSMETIC USE; FOAMS CONTAINING COSMETICS AND SUNSCREENS; GAUZE FOR COSMETIC PURPOSES; GIFT BASKETS CONTAINING NON-MEDICATED BATH PREPARATIONS AND COSMETIC PREPARATIONS; GLITTER FOR COSMETIC PURPOSES; GRAPE SEED OIL FOR COSMETIC USE; GREASES FOR COSMETIC PURPOSES; HENNA FOR COSMETIC PURPOSES; IMPREGNATED CLEANING PADS IMPREGNATED WITH COSMETICS; LOTIONS FOR COSMETIC PURPOSES; MILK FOR COSMETIC PURPOSES; MINERAL POWDER FOR USE IN COSMETIC BODY

SN 77-825,269. SHIPMAN, MARISSA J, SAN FRANCISCO,
CA. FILED 9-11-2009.

Mad Lash

THE MARK CONSISTS OF STANDARD CHARACTERS WITHOUT CLAIM TO ANY PARTICULAR FONT, STYLE, SIZE, OR COLOR.

NO CLAIM IS MADE TO THE EXCLUSIVE RIGHT TO USE "LASH", APART FROM THE MARK AS SHOWN.

FOR COSMETICS; MASCARA (U.S. CLS. 1, 4, 6, 50, 51 AND 52).

CIMMERIAN COLEMAN, EXAMINING ATTORNEY

CLASS 3—(Continued).

WRAP APPLICATIONS; NAIL VARNISH FOR COSMETIC PURPOSES; NON-MEDICATED COSMETIC SKIN CARE PREPARATIONS CONSISTING OF ORGANIC COCONUT VIRGIN OIL AND COCONUT VIRGIN OIL; NON-MEDICATED HAIR TREATMENT PREPARATIONS FOR COSMETIC PURPOSES; NUTRITIONAL OILS FOR COSMETIC PURPOSES; OILS FOR COSMETIC PURPOSES; PARAFFIN WAX FOR COSMETIC PURPOSES; PENCILS FOR COSMETIC PURPOSES; PERFUME OILS FOR THE MANUFACTURE OF COSMETIC PREPARATIONS; PETROLEUM JELLY FOR COSMETIC PURPOSES; PLANT AND HERB EXTRACTS SOLD AS COMPONENTS OF COSMETICS; PRE-MOISTENED COSMETIC TISSUES; PRE-MOISTENED COSMETIC TOWELLETTES; PRE-MOISTENED COSMETIC WIPES; PRIVATE LABEL COSMETICS; RETINOL CREAM FOR COSMETIC PURPOSES; ROSE OIL FOR COSMETIC PURPOSES; SELF-TANNING PREPARATIONS; SHEA BUTTER FOR COSMETIC PURPOSES; SKIN AND BODY TOPICAL LOTIONS, CREAMS AND OILS FOR COSMETIC USE; SKIN CONDITIONING CREAMS FOR COSMETIC PURPOSES; SKIN FRESHENERS; SOAPS; SOLID POWDER FOR COMPACTS; SUNTAN OILS FOR COSMETIC PURPOSES; TANNING AND AFTER-SUN MILKS, GELS AND OILS; TANNING GELS; TANNING MILKS; TANNING OILS; TEETH WHITENING STRIPS IMPREGNATED WITH TEETH WHITENING PREPARATIONS; TISSUES IMPREGNATED WITH COSMETIC LOTIONS; TONERS; TOOTH WHITENERS FOR COSMETIC PURPOSES COMPRISED OF NEUTRAL SODIUM FLUORIDE SUSTAINED RELEASE GEL; TOPICAL SKIN SPRAYS FOR COSMETIC PURPOSES; WRINKLE-MINIMIZING COSMETIC PREPARATIONS FOR TOPICAL FACIAL USE (U.S. CLS. 1, 4, 6, 50, 51 AND 52).

FIRST USE 11-17-1999; IN COMMERCE 11-17-1999.
MICHAEL GAFFAR, EXAMINING ATTORNEY

CLASS 3—(Continued).

SN 77-858,822. MEYER DISTRIBUTION, INC. DBA PARFUMS VIVANT, LOS ANGELES, CA. FILED 10-27-2009.

NEW BLUE FOR MEN

THE MARK CONSISTS OF STANDARD CHARACTERS WITHOUT CLAIM TO ANY PARTICULAR FONT, STYLE, SIZE, OR COLOR.

NO CLAIM IS MADE TO THE EXCLUSIVE RIGHT TO USE "FOR MEN", APART FROM THE MARK AS SHOWN.

FOR PERFUME; PERFUME OILS; PERFUME OILS FOR THE MANUFACTURE OF COSMETIC PREPARATIONS; PERFUMED CREAMS; PERFUMED SOAP; PERFUMES AND COLOGNES; PERFUMES, AFTERSHAVES AND COLOGNES; PERFUMES, EAU DE COLOGNES AND AFTERSHAVES (U.S. CLS. 1, 4, 6, 50, 51 AND 52).

FIRST USE 3-1-2009; IN COMMERCE 3-1-2009.
NAPOLEON SHARMA, EXAMINING ATTORNEY

SN 77-848,940. PURE & NATURAL COMPANY, SCOTTSDALE, AZ. FILED 10-14-2009.

SN 77-862,897. KANEKA CORPORATION, KITA-KU, OSAKA, JAPAN, FILED 11-2-2009.

SKINTRITION

THE MARK CONSISTS OF STANDARD CHARACTERS WITHOUT CLAIM TO ANY PARTICULAR FONT, STYLE, SIZE, OR COLOR.

FOR BAR SOAP; BATH LOTION; BATH SOAPS; BODY WASHES; FACE AND BODY LOTIONS; HAND CLEANING PREPARATIONS; HAND LOTIONS; HAND SOAPS; LIQUID SOAPS; SKIN LOTIONS; WATERLESS SOAP (U.S. CLS. 1, 4, 6, 50, 51 AND 52).

RAUL CORDOVA, EXAMINING ATTORNEY

KANEKA QH

THE MARK CONSISTS OF STANDARD CHARACTERS WITHOUT CLAIM TO ANY PARTICULAR FONT, STYLE, SIZE, OR COLOR.

OWNER OF JAPAN REG. NO. 4840897, DATED 2-25-2005, EXPIRES 2-25-2015.

OWNER OF U.S. REG. NO. 3,534,420.

NO CLAIM IS MADE TO THE EXCLUSIVE RIGHT TO USE "QH", APART FROM THE MARK AS SHOWN.

FOR COSMETICS; TOILETRIES, NAMELY, ESSENTIAL OILS, CONDITIONER, HAIR RINSE, BATH OIL, BATH GEL, BODY POWDER, BODY LOTION, BODY CREAM, BODY MOISTURIZERS, PERSONAL DEODORANTS AND ANTIPERSPIRANTS (U.S. CLS. 1, 4, 6, 50, 51 AND 52).

KELLEY WELLS, EXAMINING ATTORNEY

CLASS 3—(Continued).

SN 77-864,041. PRAI BEAUTY GROUP, INC., NEW CA-
NAAN, CT. FILED 11-3-2009.

PURE PRAI...PURE GENIUS!
Cathy Kangas

OWNER OF U.S. REG. NOS. 2,165,451, 2,176,335 AND
3,258,233.

THE NAME(S), PORTRAIT(S), AND/OR SIGNATURE(S)
SHOWN IN THE MARK IDENTIFIES "CATHY KANGAS",
WHOSE CONSENT(S) TO REGISTER IS MADE OF RE-
CORD.

THE MARK CONSISTS OF THE PHRASE "PURE PRAI...
PURE GENIUS!" AND THE SIGNATURE "CATHY KAN-
GAS".

FOR FACE CREAMS; EYE CREAM; BEAUTY LO-
TIONS; LOTIONS FOR COSMETIC PURPOSES; FACIAL
LOTIONS; EYE LOTIONS; BEAUTY SERUMS; NON-
MEDICATED ANTI-AGING SERUM; NON-MEDICATED
LOTIONS AND SERUMS FOR USE ON THE SKIN (U.S.
CLS. 1, 4, 6, 50, 51 AND 52).

JAMES GRIFFIN, EXAMINING ATTORNEY

CLASS 3—(Continued).

SN 77-878,873. SANTE' DE JEUNESSE, INC., MANHATTAN
BEACH, CA. FILED 11-23-2009.

BOTNE'

THE MARK CONSISTS OF STANDARD CHARACTERS
WITHOUT CLAIM TO ANY PARTICULAR FONT, STYLE,
SIZE, OR COLOR.

THE WORDING "BOTNE" HAS NO MEANING IN A
FOREIGN LANGUAGE.

FOR COSMETICS AND SKIN CARE PREPARATIONS
CONTAINING NATURAL INGREDIENTS AND BOTA-
NICALS, NAMELY, BEAUTY OILS, BEAUTY CREAMS,
BEAUTY SERUMS, BEAUTY MILKS, BEAUTY LOTIONS
AND MOISTURIZERS, TONING LOTIONS, BEAUTY
MASKS, BEAUTY GELS, MAKE-UP REMOVING MILKS,
COSMETIC SCRUBBING AND EXFOLIATING SKIN
PREPARATIONS; ESSENTIAL OILS AND NUTRI-
TIONAL OILS FOR COSMETIC PURPOSES; MASSAGE
OILS, BATH OILS AND BATH SALTS; ANTI-AGING
CLEANSER, ANTI-AGING CREAMS, ANTI-AGING
MOISTURIZERS, ANTI-AGING TONERS, ANTI-AGING
SERUMS; SOAPS (U.S. CLS. 1, 4, 6, 50, 51 AND 52).

FIRST USE 11-1-2009; IN COMMERCE 11-1-2009.

STEPHANIE ALI, EXAMINING ATTORNEY

SN 77-867,401. ADVANCED BEAUTY COSMETICS, INC.,
MIAMI, FL. FILED 11-6-2009.

CAROTONE

THE MARK CONSISTS OF STANDARD CHARACTERS
WITHOUT CLAIM TO ANY PARTICULAR FONT, STYLE,
SIZE, OR COLOR.

FOR BODY AND BEAUTY CARE COSMETICS,
NAMELY, BODY CREAMS; BODY LOTIONS; BODY
SPRAYS; BODY GELS, NAMELY, BATH, EYE, AND
BEAUTY GELS; BODY OILS; BODY MILKS; BODY
SOAPS; BODY MOISTURIZERS, NAMELY, SKIN
MOISTURIZERS; BODY POWDERS; SKIN MASKS;
BODY PERFUMES; BODY COLOGNES (U.S. CLS. 1, 4,
6, 50, 51 AND 52).

FIRST USE 10-22-2009; IN COMMERCE 10-22-2009.

ODESSA BIBBINS, EXAMINING ATTORNEY

SN 77-881,944. MARKET AMERICA, INC., GREENSBORO,
NC. FILED 11-30-2009.

YOURS

THE MARK CONSISTS OF STANDARD CHARACTERS
WITHOUT CLAIM TO ANY PARTICULAR FONT, STYLE,
SIZE, OR COLOR.

FOR EAU DE TOILETTE; FRAGRANCES FOR PER-
SONAL USE; PERFUME (U.S. CLS. 1, 4, 6, 50, 51 AND 52).

ANDREA BUTLER, EXAMINING ATTORNEY

CLASS 3—(Continued).

SN 77-882,546. GIFTS OF THE EARTH ENTERPRISES, DBA MEDICINE FLOWER, CARSON CITY, NV. FILED 11-30-2009.

Medicine Flower

THE MARK CONSISTS OF STANDARD CHARACTERS WITHOUT CLAIM TO ANY PARTICULAR FONT, STYLE, SIZE, OR COLOR.

NO CLAIM IS MADE TO THE EXCLUSIVE RIGHT TO USE "FLOWER", APART FROM THE MARK AS SHOWN.

FOR (BASED ON USE IN COMMERCE) AFTER-SUN OILS; AROMATHERAPY BODY CARE PRODUCTS, NAMELY, BODY LOTION, SHOWER GEL, CUTICLE CREAM, SHAMPOO, CONDITIONER, NON-MEDICATED LIP BALM, SOAP, BODY POLISH, BODY AND FOOT SCRUB AND NON-MEDICATED FOOT CREAM; AROMATHERAPY INHALER SOLD FILLED WITH AROMATHERAPY ESSENTIAL OILS; AROMATHERAPY LOTIONS; AROMATHERAPY OILS; BATH OILS AND BATH SALTS; BATH SOAPS IN LIQUID, SOLID OR GEL FORM; BODY AND BEAUTY CARE COSMETICS; BODY BUTTER; BODY LOTIONS; BODY OILS; BODY SCRUB; COLOGNES, PERFUMES AND COSMETICS; COSMETIC OILS; COSMETICS IN THE FORM OF MILKS, LOTIONS AND EMULSIONS; EAU DE PERFUME; ESSENTIAL OILS; ESSENTIAL OILS AS PERFUME FOR LAUNDRY PURPOSES; ESSENTIAL OILS FOR FLAVORING BEVERAGES; ESSENTIAL OILS FOR FOOD FLAVORINGS; ESSENTIAL OILS FOR INDUSTRIAL USE FOR CLEANING AND DISINFECTING PRODUCTS; ESSENTIAL OILS FOR PERSONAL USE; ESSENTIAL OILS FOR USE IN THE MANUFACTURE OF SCENTED PRODUCTS; ETHEREAL OILS; FACIAL SCRUBS; FOOD FLAVORING, BEING ESSENTIAL OILS; FOOD FLAVORINGS PREPARED FROM ESSENTIAL OILS; FOOT SCRUBS; HAND SCRUBS; HAND SOAPS; MASSAGE OILS; NUTRITIONAL OILS FOR COSMETIC PURPOSES; OILS FOR CLEANING PURPOSES; OILS FOR COSMETIC PURPOSES; OILS FOR PERFUMES AND SCENTS; OILS FOR TOILETRY PURPOSES; PERFUME OILS; PERFUME OILS FOR THE MANUFACTURE OF COSMETIC PREPARATIONS; PERFUMED POWDERS; PERFUMED SOAPS; PERFUMES; PERFUMES, EAU DE COLOGNES AND AFTERSHAVES (BASED ON INTENT TO USE) BABY LOTION; BABY OILS; BODY GLITTER; SUN-TANNING OILS AND LOTIONS (U.S. CLS. 1, 4, 6, 50, 51 AND 52).

FIRST USE 8-1-1985; IN COMMERCE 8-1-1986.
FRED MANDIR, EXAMINING ATTORNEY

CLASS 3—(Continued).

SN 77-885,205. SAFIYA, INC., CARSON CITY, NV. FILED 12-3-2009.



SAFIYA

THE MARK CONSISTS OF A SQUARE CONTAINING THE STYLIZED TEXT "S" AND ROWS OF ABSTRACT DESIGNS IN THE BACKGROUND, AND "SAFIYA" BELOW.

THE ENGLISH TRANSLATION OF THE WORD "SAFIYA" IN THE MARK IS "PURE AND CLEAR MINDED."

FOR BEAUTY PRODUCTS AND BATH AND BODY PRODUCTS, NAMELY, BODY LOTIONS, SOAPS, SHOWER SCRUBS, LIP BALMS, SHOWER GELS, BATH BOMBS, BATH FIZZES, MASSAGE OILS, FACE CLEANSER, FACE MOISTURIZER, SHAMPOO, CONDITIONER, MAKE-UP, LIPSTICK, LIP GLOSSES, BLUSH, EYE SHADOW AND NAIL POLISH (U.S. CLS. 1, 4, 6, 50, 51 AND 52).

FIRST USE 3-24-2008; IN COMMERCE 3-24-2008.
APRIL HESIK, EXAMINING ATTORNEY

SN 77-886,718. ADVANCED BEAUTY COSMETICS, INC., MIAMI, FL. FILED 12-4-2009.

GLOW & WHITE

THE MARK CONSISTS OF STANDARD CHARACTERS WITHOUT CLAIM TO ANY PARTICULAR FONT, STYLE, SIZE, OR COLOR.

FOR BODY AND BEAUTY CARE COSMETICS, NAMELY, BODY CREAMS; BODY LOTIONS; BODY SPRAYS; BODY GELS, NAMELY, BATH, EYE, AND BEAUTY GELS; BODY OILS; BODY MILKS; BODY SOAPS; BODY MOISTURIZERS, NAMELY, SKIN MOISTURIZERS; BODY POWDERS; SKIN MASKS; BODY PERFUMES; BODY COLOGNES (U.S. CLS. 1, 4, 6, 50, 51 AND 52).

FIRST USE 10-22-2009; IN COMMERCE 10-22-2009.
ODESSA BIBBINS, EXAMINING ATTORNEY

CLASS 3—(Continued).

SN 77-893,409. COTY US, LLC, NEW YORK, NY. FILED 12-15-2009.

THICKEN UP

THE MARK CONSISTS OF STANDARD CHARACTERS WITHOUT CLAIM TO ANY PARTICULAR FONT, STYLE, SIZE, OR COLOR.

FOR NAIL CARE PREPARATIONS (U.S. CLS. 1, 4, 6, 50, 51 AND 52).

FIRST USE 2-0-1998; IN COMMERCE 2-0-1998.

SAMUEL E. SHARPER JR., EXAMINING ATTORNEY

SN 77-898,456. FLETCHER, JAMEY G., FALMOUTH, MA. FILED 12-21-2009.

FUMARGERIE

THE MARK CONSISTS OF STANDARD CHARACTERS WITHOUT CLAIM TO ANY PARTICULAR FONT, STYLE, SIZE, OR COLOR.

FOR BATH AND SHOWER GELS AND SALTS NOT FOR MEDICAL PURPOSES; BATH SOAPS IN LIQUID, SOLID OR GEL FORM; INCENSE; REEDS AND SCENTED OILS, SOLD AS A UNIT, FOR USE IN ROOM SCENT DIFFUSERS (U.S. CLS. 1, 4, 6, 50, 51 AND 52).

FIRST USE 11-12-2009; IN COMMERCE 11-12-2009.

WENDY GOODMAN, EXAMINING ATTORNEY

SN 77-898,755. CRYSTALLINE HEALTH & BEAUTY FROM THE DEAD SEA LTD, AKA R.M REPRESENTATION SERVICES AND OPERATION, TEL AVIV, ISRAEL, FILED 12-22-2009.

DEEP
BEAUTY IS SEA DEEP

FOR AGE RETARDANT GEL; ALOE VERA GEL FOR COSMETIC PURPOSES; ANTI-AGING CREAM; ANTI-AGING CREAMS; ANTI-FRECKLE CREAMS; ANTI-WRINKLE CREAM; ANTI-WRINKLE CREAMS; AROMATHERAPY BODY CARE PRODUCTS, NAMELY, BODY LOTION, SHOWER GEL, CUTICLE CREAM, SHAMPOO, CONDITIONER, NON-MEDICATED LIP BALM, SOAP, BODY POLISH, BODY AND FOOT SCRUB AND NON-MEDICATED FOOT CREAM; AROMATHERAPY CREAMS; AROMATHERAPY LOTIONS; AROMATHERAPY OIL; AROMATHERAPY OILS; BABY LOTION; BABY OIL; BABY OILS; BAR SOAP; BATH AND SHOWER GELS AND SALTS NOT FOR MEDICAL PURPOSES; BATH CREAM; BATH CRYSTALS; BATH FOAM; BATH FOAMS; BATH GEL; BATH GELS; BATH LOTION; BATH MILKS; BATH OIL; BATH OILS; BATH OILS AND BATH SALTS; BATH OILS FOR COSMETIC PURPOSES; BATH SALTS; BATH SOAPS; BATH SOAPS IN LIQUID, SOLID OR GEL FORM; BATHING LO-

CLASS 3—(Continued).

TIONS; BEAUTY CREAMS; BEAUTY CREAMS FOR BODY CARE; BEAUTY GELS; BEAUTY LOTIONS; BODY BUTTER; BODY CREAM; BODY CREAM SOAP; BODY CREAMS; BODY LOTION; BODY LOTIONS; BODY MASK CREAM; BODY MASK LOTION; BODY OIL; BODY OILS; BODY SCRUB; BOOT CREAM; BUBBLE BATH; CLEANSING CREAMS; COCOA BUTTER FOR COSMETIC PURPOSES; COSMETIC CREAMS; COSMETIC CREAMS FOR SKIN CARE; COSMETIC OILS; COSMETIC PREPARATIONS, NAMELY, FIRMLING CREAMS; COSMETIC PREPARATIONS, NAMELY, FIRMLING LOTIONS; COSMETIC SOAPS; COSMETICS IN THE FORM OF MILKS, LOTIONS AND EMULSIONS; CREAM SOAPS; CUTICLE CREAM; ESSENTIAL OILS; ESSENTIAL OILS FOR PERSONAL USE; EXFOLIANT CREAMS; EYE CREAM; EYE GELS; EYE LOTIONS; FACE AND BODY BEAUTY CREAMS; FACE AND BODY CREAMS; FACE AND BODY LOTIONS; FACE CREAMS; FACE CREAMS AND CLEANSERS CONTAINING BENZOYL PEROXIDE FOR COSMETIC PURPOSES; FACE CREAMS FOR COSMETIC USE; FACE MILK AND LOTIONS; FACIAL CREAM; FACIAL CREAMS; FACIAL LOTION; FACIAL SCRUBS; FOAM BATH; FOAM CLEANSERS FOR PERSONAL USE; FOAMS CONTAINING COSMETICS AND SUNSCREENS; FOOT SCRUBS; GEL EYE MASKS; GIFT BASKETS CONTAINING NON-MEDICATED BATH PREPARATIONS AND COSMETIC PREPARATIONS; HAIR CARE CREAMS; HAIR CARE LOTIONS; HAIR CREAMS; HAIR LOTION; HAIR LOTIONS; HAND CREAM; HAND CREAMS; HAND LOTIONS; HAND SCRUBS; HAND SOAPS; LAVENDER OIL; LIP CREAM; LIQUID BATH SOAPS; LIQUID SOAP; LIQUID SOAP USED IN FOOT BATH; LIQUID SOAPS; LIQUID SOAPS FOR HANDS AND FACE; LIQUID SOAPS FOR HANDS, FACE AND BODY; LOTIONS FOR COSMETIC PURPOSES; LOTIONS FOR FACE AND BODY CARE; MAKE-UP REMOVING LOTIONS; MAKE-UP REMOVING MILK, GEL, LOTIONS AND CREAMS; MASSAGE CREAMS; MASSAGE LOTIONS; MASSAGE OIL; MASSAGE OILS; MINERAL SALT IN THE NATURE OF BATH SALTS NOT FOR MEDICAL PURPOSES; MOISTURIZING CREAMS; NAIL CREAM; NATURAL COCOA BUTTER BASED PERSONAL CARE PRODUCTS, NAMELY, BODY LOTION, SHOWER GEL, SOAP, BODY POLISH, BODY AND FOOT SCRUB AND NON-MEDICATED SKIN CREAMS; NIGHT CREAM; NON-MEDICATED BATH PREPARATIONS; NON-MEDICATED BATH SALTS; NON-MEDICATED BODY SOAKS; NON-MEDICATED BUBBLE BATH PREPARATIONS; NON-MEDICATED FOOT CREAM; NON-MEDICATED FOOT LOTIONS; NON-MEDICATED FOOT SOAKS; NON-MEDICATED HAIR RESTORATION LOTIONS; NON-MEDICATED SKIN CARE PREPARATIONS, NAMELY, CREAMS, LOTIONS, GELS, TONERS, CLEANSERS AND PEELS; OIL BATHS FOR HAIR CARE; OILS FOR COSMETIC PURPOSES; PERFUMED CREAMS; PERFUMED SOAP; PERFUMED SOAPS; SALT SCRUB FOR THE BODY AND FACE; SCENTED BODY LOTIONS AND CREAMS; SCENTED OILS; SHEA BUTTER FOR COSMETIC PURPOSES; SHOWER AND BATH FOAM; SHOWER AND BATH GEL; SHOWER CREAMS; SHOWER GEL; SHOWER GELS; SKIN AND BODY TOPICAL LOTIONS, CREAMS AND OILS FOR COSMETIC USE; SKIN CLEANSING CREAM; SKIN CLEANSING LOTION; SKIN CONDITIONING CREAMS FOR COSMETIC PURPOSES; SKIN CREAM; SKIN CREAMS; SKIN CREAMS IN LIQUID AND IN SOLID FORM; SKIN CREAMS IN LIQUID AND SOLID; SKIN CREAMS IN LIQUID AND SOLID FORM; SKIN LOTION; SKIN LOTIONS; SKIN SOAP; SOAPS FOR BODY CARE; SOAPS FOR PERSONAL USE; TONING LOTION, FOR THE FACE, BODY AND HANDS; WRINKLE RESISTANT CREAM (U.S. CLS. 1, 4, 6, 50, 51 AND 52).

BRENDAN MCCAULEY, EXAMINING ATTORNEY

CLASS 3—(Continued).

SN 77-899,372. INK\$AVER, LLC, CANTON, CT. FILED 12-22-2009.



THE COLOR(S) BLACK, GREEN AND BLUE IS/ARE CLAIMED AS A FEATURE OF THE MARK.

THE MARK CONSISTS OF THE WORDING "INKSAVER" IN BLACK, EXCEPT FOR THE LETTER "S" WHICH APPEARS AS A GREEN DOLLAR SIGN. THE WORDING IS PARTIALLY OVERLAID ON A GLOBE DESIGN IN GREEN AND BLUE.

FOR WET AND DRY DISPOSABLE WIPES IMPREGNATED WITH ORGANIC AND EARTH FRIENDLY CLEANING COMPOUNDS FOR INDUSTRIAL AND COMMERCIAL USE; WET AND DRY DISPOSABLE WIPES IMPREGNATED WITH ORGANIC AND EARTH FRIENDLY CLEANING COMPOUNDS FOR CLEANING PRINTER CARTRIDGES (U.S. CLS. 1, 4, 6, 50, 51 AND 52).

CHRISTINE COOPER, EXAMINING ATTORNEY

CLASS 3—(Continued).

SN 77-916,649. SWIPES, INC., POMPANO BEACH, FL. FILED 1-21-2010.



NO CLAIM IS MADE TO THE EXCLUSIVE RIGHT TO USE "WIPES", APART FROM THE MARK AS SHOWN.

THE MARK CONSISTS OF A LEAF NEXT TO THE WORD "SWIPES" AND THE WORDS "LOVIN WIPES" BENEATH THE TERM "SWIPES".

FOR NON-MEDICATED PRE-MOISTENED TOWEL-ETTES FOR PERSONAL SANITARY USE (U.S. CLS. 1, 4, 6, 50, 51 AND 52).

ANDREW LEASER, EXAMINING ATTORNEY

SN 77-921,040. CAPUCILLI, ALYSSA S., NEW YORK, NY. AND SCHORIES, PAT, NEW YORK, NY. FILED 1-27-2010.



THE MARK CONSISTS OF THE LITERAL ELEMENTS "BISCUIT" AND "THE LITTLE YELLOW PUPPY" IN STYLIZED LETTERING, A CIRCULAR RING, AND A FANCIFUL REPRESENTATION OF A PUPPY. THE WORD "BISCUIT" APPEARS IN THE TOP OF THE RING AND THE WORDS "THE LITTLE YELLOW PUPPY" APPEAR ALONG THE BOTTOM OF THE RING. AT THE CENTER OF THE RING IS A FANCIFUL REPRESENTATION OF A PUPPY.

FOR BABY HAIR CONDITIONER; BABY LOTION; BABY OILS; BABY POWDERS; BABY SHAMPOO; SOAPS; LIQUID SOAP; SHOWER AND BATH GEL, OILS, SALTS, AND CREAMS; COSMETICS, PERFUMES, COLOGNES, TOILET WATER; ESSENTIAL OILS; TALCUM POWDER; FACIAL CLEANSERS AND SCRUBS; PREPARATIONS FOR THE CARE OF THE SKIN, NAMELY, FACIAL CREAMS, FACIAL MOISTURIZERS, FACE WASH, BEAUTY MILKS, SKIN MOISTURIZERS AND SKIN MOISTURIZER MASKS, SKIN CLEANSERS, SKIN CONDITIONERS, HAND CREAMS AND HAND LOTIONS, MASSAGE OILS, ESSENTIAL OILS FOR PERSONAL USE, BATH BEADS, BATH CRYSTALS, BATH FOAM, BATH POWDERS, BODY SCRUBS, BODY AND HAND LOTIONS, BODY OILS, BODY POWDERS, BODY MASK CREAMS AND LOTIONS; NON-MEDICATED TOILET PREPARATIONS, NAMELY, NON-MEDICATED TOILETRIES, BODY SOAKS, BATH SALTS, FOOT POWDER AND CREAMS, NON-MEDICATED SKIN CARE PREPARATIONS, NON-MEDICATED SKIN SERUM, AND STIMULATING LOTIONS FOR THE SKIN; NON-MEDICATED MASSAGE PREPARATIONS IN THE NATURE OF MASSAGE OILS, GELS, CREAMS, LOTIONS, POWDERS, SPRAYS, AND OINTMENTS; COTTON STICKS FOR COSMETIC PURPOSES; SUN-TANNING AND AFTER-SUN PREPARATIONS, NAMELY, SUNSC-

SN 77-909,411. ADVANCED BEAUTY COSMETICS, INC., MIAMI, FL. FILED 1-11-2010.

CITROCLEAR

THE MARK CONSISTS OF STANDARD CHARACTERS WITHOUT CLAIM TO ANY PARTICULAR FONT, STYLE, SIZE, OR COLOR.

FOR BODY AND BEAUTY CARE COSMETICS, NAMELY, BODY CREAMS; BODY LOTIONS; BODY SPRAYS; BODY GELS, NAMELY, BATH, EYE, AND BEAUTY GELS; BODY OILS; BODY MILKS; BODY SOAPS; BODY MOISTURIZERS, NAMELY, SKIN MOISTURIZERS; BODY POWDERS; SKIN MASKS; BODY PERFUMES; BODY COLOGNES (U.S. CLS. 1, 4, 6, 50, 51 AND 52).

FIRST USE 9-24-2009; IN COMMERCE 9-24-2009.

ODESSA BIBBINS, EXAMINING ATTORNEY

CLASS 3—(Continued).

REEN PREPARATIONS, SUNTANNING PREPARATIONS, AFTER-SUN LOTIONS, COSMETIC SUN-PROTECTING PREPARATIONS, SUN TAN OILS, HAIRCARE PREPARATIONS, NAMELY, SHAMPOOS, CONDITIONERS, HAIR COLOR, HAIR WAVING LOTION, PERMANENT WAVE PREPARATIONS, HAIR EMOLLIENTS, HAIR MASCARA, HAIR POMADES, HAIR RELAXING PREPARATIONS, HAIR STYLING PREPARATIONS, AND HAIR CARE PREPARATIONS; NON-MEDICATED SCALP TREATMENT CREAM; NAIL POLISH, NAIL VARNISH FOR COSMETIC PURPOSES; SCENTED ARTICLES ALL FOR PERFUMERY PURPOSES, NAMELY, INCENSE, ROOM FRAGRANCES, FRAGRANCE EMITTING WICKS FOR ROOM FRAGRANCES, SACHETS, SCENTED CERAMIC STONES, SCENTED LINEN SPRAYS AND SCENTED ROOM SPRAYS, SCENTED OILS USED TO PRODUCE AROMAS WHEN HEATED, SCENTED PINE CONES, POTPOURRI, AND AROMATIC PILLOWS COMPRISING POTPOURRI IN FABRIC CONTAINERS (U.S. CLS. 1, 4, 6, 50, 51 AND 52).

JOHN SCHUYLER YARD, EXAMINING ATTORNEY

CLASS 3—(Continued).

SN 77-923,625. LITTLE BUSY BODIES, INC., BEAVERTON, OR. FILED 1-29-2010.



THE MARK CONSISTS OF A TEAR DROP SHAPE INCLUDING A NOSE AND NOSTRIL PROFILE.

FOR DISPOSABLE NASAL WIPES IMPREGNATED WITH SALINE; DISPOSABLE WIPES IMPREGNATED WITH SALINE FOR PERSONAL HYGIENE; PRE-MOISTENED COSMETIC WIPES; SCENT-INFUSED PRE-MOISTENED COSMETIC WIPES; MOISTURIZING DISPOSABLE WIPES IMPREGNATED WITH CLEANSING CHEMICALS OR COMPOUNDS FOR PERSONAL HYGIENE (U.S. CLS. 1, 4, 6, 50, 51 AND 52).

MARK PILARO, EXAMINING ATTORNEY

SN 77-922,296. RIVER VEDA LTD., MANUKAU, AUCKLAND, NEW ZEALAND, FILED 1-28-2010.



THE MARK CONSISTS OF THE WORD "RIVERVEDA" IN A STYLIZED MANNER AND A STYLIZED DRAWING OF AN INCOMPLETE CIRCLE ENCIRCLING THE LETTERS "EDA".

FOR COSMETICS (U.S. CLS. 1, 4, 6, 50, 51 AND 52).
AMEEN IMAM, EXAMINING ATTORNEY

SN 77-924,314. FINGERMATES, INC., BELMAR, NJ. FILED 1-30-2010.

HURRY UP!

THE MARK CONSISTS OF STANDARD CHARACTERS WITHOUT CLAIM TO ANY PARTICULAR FONT, STYLE, SIZE, OR COLOR.

FOR NAIL CARE PREPARATIONS; LIQUID AEROSOL NAIL GLUE DRYER; LIQUID NAIL POLISH DRYER; NAIL POLISH TOP COATS (U.S. CLS. 1, 4, 6, 50, 51 AND 52).

FIRST USE 3-22-1995; IN COMMERCE 3-22-1995.
ANTHONY RINKER, EXAMINING ATTORNEY

CLASS 3—(Continued).

SN 77-924,573. TOPCO ASSOCIATES, LLC, SKOKIE, IL. FILED 2-1-2010.

SUPREME CLEAN

THE MARK CONSISTS OF STANDARD CHARACTERS WITHOUT CLAIM TO ANY PARTICULAR FONT, STYLE, SIZE, OR COLOR.

OWNER OF U.S. REG. NO. 3,578,048.
NO CLAIM IS MADE TO THE EXCLUSIVE RIGHT TO USE "CLEAN", APART FROM THE MARK AS SHOWN.
FOR LIQUID LAUNDRY DETERGENT (U.S. CLS. 1, 4, 6, 50, 51 AND 52).
FIRST USE 9-0-2009; IN COMMERCE 9-0-2009.
EDWARD FENNESSY, EXAMINING ATTORNEY

CLASS 3—(Continued).

SN 77-925,703. TOMASI, VERONIQUE HUNKIN, LOS ANGELES, CA. FILED 2-2-2010.



SN 77-924,786. FOR THE EARTH CORP., PHOENIX, AZ. FILED 2-1-2010.

What Stain?

THE MARK CONSISTS OF STANDARD CHARACTERS WITHOUT CLAIM TO ANY PARTICULAR FONT, STYLE, SIZE, OR COLOR.

NO CLAIM IS MADE TO THE EXCLUSIVE RIGHT TO USE "STAIN", APART FROM THE MARK AS SHOWN.
FOR ALL-PURPOSE CLEANERS (U.S. CLS. 1, 4, 6, 50, 51 AND 52).
DOMINIC J. FERRAIUOLO, EXAMINING ATTORNEY

NO CLAIM IS MADE TO THE EXCLUSIVE RIGHT TO USE "TAHITI", APART FROM THE MARK AS SHOWN.

THE MARK CONSISTS OF THE WORDING "KIA'ORA TAHITI" BELOW A STYLIZED TURTLE WITH A DESIGN ON ITS BACK IN THE NATURE OF A MASK.

THE ENGLISH TRANSLATION OF THE MAORI WORD "KIA'ORA" IN THE MARK IS "HELLO!", "CHEERS!", "GOOD LUCK!", "BEST WISHES!", OR "BE WELL!".
FOR BODY OILS; COSMETIC OILS; HAIR OILS; SCENTED OILS (U.S. CLS. 1, 4, 6, 50, 51 AND 52).
CHRISTINE COOPER, EXAMINING ATTORNEY

SN 77-925,606. MANA PRODUCTS, INC., LONG ISLAND CITY, NY. FILED 2-2-2010.

EVOLUCIÓN

THE MARK CONSISTS OF STANDARD CHARACTERS WITHOUT CLAIM TO ANY PARTICULAR FONT, STYLE, SIZE, OR COLOR.

THE ENGLISH TRANSLATION OF "EVOLUCIÓN" IN THE MARK IS "EVOLUTION".
FOR NON-MEDICATED SKIN CARE PREPARATIONS (U.S. CLS. 1, 4, 6, 50, 51 AND 52).
ALICE BENMAMAN, EXAMINING ATTORNEY

SN 77-926,222. THE DIAL CORPORATION, SCOTTSDALE, AZ. FILED 2-2-2010.

NEVER GET CAUGHT OFF GUARD

THE MARK CONSISTS OF STANDARD CHARACTERS WITHOUT CLAIM TO ANY PARTICULAR FONT, STYLE, SIZE, OR COLOR.

FOR DEODORANTS AND ANTIPERSPIRANTS (U.S. CLS. 1, 4, 6, 50, 51 AND 52).
FIRST USE 1-15-2010; IN COMMERCE 1-15-2010.
REBECCA EISINGER, EXAMINING ATTORNEY

CLASS 3—(Continued).

SN 77-926,390. AMERICAN INTERNATIONAL INDUSTRIES, COMMERCE, CA. FILED 2-2-2010.

JUST ONE

THE MARK CONSISTS OF STANDARD CHARACTERS WITHOUT CLAIM TO ANY PARTICULAR FONT, STYLE, SIZE, OR COLOR.

FOR COSMETIC HAIR DRESSING PREPARATIONS; COSMETIC PREPARATIONS FOR THE HAIR AND SCALP; HAIR CARE CREAMS; HAIR CARE LOTIONS; HAIR CARE PREPARATIONS; HAIR CLEANING PREPARATIONS; HAIR CREAMS; HAIR DRESSINGS FOR MEN; HAIR DRESSINGS FOR WOMEN; NON-MEDICATED HAIR SERUMS; NON-MEDICATED HAIR TREATMENT PREPARATIONS FOR COSMETIC PURPOSES (U.S. CLS. 1, 4, 6, 50, 51 AND 52).
MARTHA FROMM, EXAMINING ATTORNEY

CLASS 3—(Continued).

SN 77-927,374. KLENZ, LLC, TEA, SD. FILED 2-3-2010.

SHOWER IN A TOWEL

THE MARK CONSISTS OF STANDARD CHARACTERS WITHOUT CLAIM TO ANY PARTICULAR FONT, STYLE, SIZE, OR COLOR.

OWNER OF U.S. REG. NO. 3,342,763.
FOR DISPOSABLE WIPES AND TOWELS IMPREGNATED WITH CHEMICALS OR COMPOUNDS FOR PERSONAL HYGIENE (U.S. CLS. 1, 4, 6, 50, 51 AND 52).
B. PARADEWELAI, EXAMINING ATTORNEY

SN 77-926,745. ESTEE LAUDER COSMETICS LTD., AGINCOURT, ONTARIO, CANADA, FILED 2-3-2010.

MAC HAUTE & NAUGHTY LASH

THE MARK CONSISTS OF STANDARD CHARACTERS WITHOUT CLAIM TO ANY PARTICULAR FONT, STYLE, SIZE, OR COLOR.

OWNER OF U.S. REG. NOS. 1,642,532, 2,716,306 AND OTHERS.

NO CLAIM IS MADE TO THE EXCLUSIVE RIGHT TO USE "LASH", APART FROM THE MARK AS SHOWN.

FOR COSMETICS (U.S. CLS. 1, 4, 6, 50, 51 AND 52).
SIMON TENG, EXAMINING ATTORNEY

SN 77-927,733. GOLD RUSH BRANDS, LLC, SCARSDALE, NY. FILED 2-4-2010.

FIRST BRANDS

THE MARK CONSISTS OF STANDARD CHARACTERS WITHOUT CLAIM TO ANY PARTICULAR FONT, STYLE, SIZE, OR COLOR.

NO CLAIM IS MADE TO THE EXCLUSIVE RIGHT TO USE "BRANDS", APART FROM THE MARK AS SHOWN.

FOR HOUSEHOLD CLEANERS, NAMELY, SOAP, OIL BASED SOAP AND FLOOR POLISH, AND ALL-PURPOSE CLEANING PREPARATIONS FOR WOOD, HOUSEHOLD SURFACES AND FLOORS; GENERAL PURPOSE CLEANING LIQUIDS; FABRIC SOFTENER, LAUNDRY DETERGENT AND LAUNDRY BLEACH; HEALTH AND BEAUTY PRODUCTS, NAMELY, AFTER-SHAVE LOTIONS, BABY OIL, BATH GEL, BATH OIL, BATH POWDER, BODY CREAM, BODY OIL, BUBBLE BATH, COSMETICS COMPACTS, DEODORANT SOAP, EAU DE TOILETTE, EYE MAKEUP, FACE POWDER, FACIAL CREAMS, HAIR CARE PREPARATIONS, HAIR CONDITIONERS, HAIR GEL, HAIR MOUSSE, HAIR SHAMPOO, HAIR STYLING PREPARATIONS, LIP GLOSS, LIPSTICK, SKIN LOTIONS, HAIR LOTIONS, FACIAL LOTIONS, BODY LOTIONS, HAIR WAVING LOTIONS, MAKEUP, MASCARA, NAIL GLITTER, NAIL POLISH, PERFUME, PERSONAL DEODORANTS, ROOM FRAGRANCES, SACHETS, SHAVING CREAM, SHAVING GEL, SHAVING LOTION, SHAVING PREPARATIONS, SHOWER GEL, SKIN CONDITIONERS, SKIN CREAM, SKIN LOTION; SOAPS FOR HANDS, FACE AND BODY; SUN SCREEN PREPARATIONS, AND TOOTHPASTE (U.S. CLS. 1, 4, 6, 50, 51 AND 52).
JAY BESCH, EXAMINING ATTORNEY

SN 77-926,870. SKINMEDICA, INC., CARLSBAD, CA. FILED 2-3-2010.

UV PROPLEX

THE MARK CONSISTS OF STANDARD CHARACTERS WITHOUT CLAIM TO ANY PARTICULAR FONT, STYLE, SIZE, OR COLOR.

NO CLAIM IS MADE TO THE EXCLUSIVE RIGHT TO USE "UV", APART FROM THE MARK AS SHOWN.

FOR SUNSCREEN LOTION (U.S. CLS. 1, 4, 6, 50, 51 AND 52).
JESSICA A. POWERS, EXAMINING ATTORNEY

CLASS 3—(Continued).

SN 77-927,790. INDUSTRIAL FARMACEUTICA CANTABRIA, S.A., MADRID, SPAIN, FILED 2-4-2010.

ENDOCARE

THE MARK CONSISTS OF STANDARD CHARACTERS WITHOUT CLAIM TO ANY PARTICULAR FONT, STYLE, SIZE, OR COLOR.

OWNER OF SPAIN REG. NO. 1970827, DATED 1-5-1996, RENEWED AS REG. NO. 1970827, DATED 8-18-2005, EXPIRES 6-13-2015.

OWNER OF U.S. REG. NO. 2,337,518. FOR MOISTURIZING COSMETIC PRODUCTS, NAMELY, SKIN LOTIONS (U.S. CLS. 1, 4, 6, 50, 51 AND 52).

WILLIAM P. SHANAHAN, EXAMINING ATTORNEY

CLASS 3—(Continued).

SN 77-927,922. INTEGRATED SPORTS SPECIALTIES, LLC, MENDHAM, NJ. FILED 2-4-2010.

PLAY-OFF

THE MARK CONSISTS OF STANDARD CHARACTERS WITHOUT CLAIM TO ANY PARTICULAR FONT, STYLE, SIZE, OR COLOR.

FOR LAUNDRY DETERGENT; STAIN REMOVERS (U.S. CLS. 1, 4, 6, 50, 51 AND 52).

DEZMONA MIZELLE, EXAMINING ATTORNEY

SN 77-927,958. COUNTRY LIFE, LLC, HAUPPAUGE, NY. FILED 2-4-2010.

SN 77-927,833. MURAD, INC., EL SEGUNDO, CA. FILED 2-4-2010.

CLEAN SCENE

THE MARK CONSISTS OF STANDARD CHARACTERS WITHOUT CLAIM TO ANY PARTICULAR FONT, STYLE, SIZE, OR COLOR.

FOR NON-MEDICATED SKIN CARE PREPARATIONS, NAMELY, CREAMS, LOTIONS, GELS, TONERS, CLEANSERS AND PEELS (U.S. CLS. 1, 4, 6, 50, 51 AND 52).

NICHOLAS ALTREE, EXAMINING ATTORNEY

THOROUGHLY CLEAN

THE MARK CONSISTS OF STANDARD CHARACTERS WITHOUT CLAIM TO ANY PARTICULAR FONT, STYLE, SIZE, OR COLOR.

NO CLAIM IS MADE TO THE EXCLUSIVE RIGHT TO USE "CLEAN", APART FROM THE MARK AS SHOWN.

FOR FACIAL CLEANSERS; SKIN CLEANSERS (U.S. CLS. 1, 4, 6, 50, 51 AND 52).

FIRST USE 10-16-1997; IN COMMERCE 10-16-1997.

ELLEN PERKINS, EXAMINING ATTORNEY

SN 77-928,114. BORGHESE TRADEMARKS, INC., WILMINGTON, DE. FILED 2-4-2010.

FANGO DELICATO

THE MARK CONSISTS OF STANDARD CHARACTERS WITHOUT CLAIM TO ANY PARTICULAR FONT, STYLE, SIZE, OR COLOR.

NO CLAIM IS MADE TO THE EXCLUSIVE RIGHT TO USE "FANGO", APART FROM THE MARK AS SHOWN.

THE ENGLISH TRANSLATION OF "FANGO DELICATO" IN THE MARK IS "DELICATE MUD".

FOR ANTI-AGING CREAMS; ANTI-WRINKLE CREAMS; BEAUTY CREAMS FOR BODY CARE; BEAUTY LOTIONS; COSMETIC CREAMS FOR SKIN CARE; COSMETIC PREPARATIONS FOR BODY CARE; EXFOLIANT CREAMS; FACE AND BODY LOTIONS; LOTIONS FOR FACE AND BODY CARE; MOISTURIZING CREAMS; NON-MEDICATED SKIN CARE PREPARATIONS; SKIN CLEANSERS; SKIN CONDITIONERS; SKIN CREAMS; SKIN LOTIONS; SKIN MASKS; SKIN MOISTURIZER; SKIN TEXTURIZERS; SKIN TONERS (U.S. CLS. 1, 4, 6, 50, 51 AND 52).

FIRST USE 0-0-1985; IN COMMERCE 0-0-1985.

CHARLES L. JENKINS, EXAMINING ATTORNEY

SN 77-927,841. MURAD, INC., EL SEGUNDO, CA. FILED 2-4-2010.

EYE LUSCIOUS

THE MARK CONSISTS OF STANDARD CHARACTERS WITHOUT CLAIM TO ANY PARTICULAR FONT, STYLE, SIZE, OR COLOR.

NO CLAIM IS MADE TO THE EXCLUSIVE RIGHT TO USE "EYE", APART FROM THE MARK AS SHOWN.

FOR NON-MEDICATED SKIN CARE PREPARATIONS, NAMELY, CREAMS, LOTIONS, GELS, TONERS, CLEANSERS AND PEELS (U.S. CLS. 1, 4, 6, 50, 51 AND 52).

NICHOLAS ALTREE, EXAMINING ATTORNEY

CLASS 3—(Continued).

SN 77-928,243. RUPA VICKERS RUSSE, DBA WWW.MA-HATMAMA.COM, ENGLEWOOD, FL. FILED 2-4-2010.



NO CLAIM IS MADE TO THE EXCLUSIVE RIGHT TO USE "PH SKIN CARE", APART FROM THE MARK AS SHOWN.

THE MARK CONSISTS OF THE LETTERING "PH" IN A SLANTED FONT WITH THE LETTERING SKIN CARE LOCATED UNDERNEATH IN A SMALLER UPRIGHT FONT WITH ALL LETTERING SURROUNDED BY ONE WREATH OF FLORA IMAGES.

FOR BODY AND BEAUTY CARE COSMETICS (U.S. CLS. 1, 4, 6, 50, 51 AND 52).

CYNTHIA SLOAN, EXAMINING ATTORNEY

SN 77-928,378. INTERNATIONAL DESIGN ASSOCIATES LTD, NEW YORK, NY. FILED 2-4-2010.

KWANZAA

THE MARK CONSISTS OF STANDARD CHARACTERS WITHOUT CLAIM TO ANY PARTICULAR FONT, STYLE, SIZE, OR COLOR.

THE ENGLISH TRANSLATION OF "KWANZAA" IN THE MARK IS "FIRST FRUIT OF THE HARVEST".

FOR BATH SOAPS IN LIQUID, SOLID OR GEL FORM; FRAGRANCES FOR PERSONAL USE; HOUSEHOLD CLEANING PREPARATIONS; NON-MEDICATED SKIN CARE PREPARATIONS (U.S. CLS. 1, 4, 6, 50, 51 AND 52).

FIRST USE 2-4-2010; IN COMMERCE 2-4-2010.

WARREN L. OLANDRIA, EXAMINING ATTORNEY

CLASS 3—(Continued).

SN 77-928,411. COBALT BALLOON LLC, NEW YORK, NY. FILED 2-4-2010.

LASHTOPIA

THE MARK CONSISTS OF STANDARD CHARACTERS WITHOUT CLAIM TO ANY PARTICULAR FONT, STYLE, SIZE, OR COLOR.

FOR EYELINER; MASCARA (U.S. CLS. 1, 4, 6, 50, 51 AND 52).

JASON BLAIR, EXAMINING ATTORNEY

SN 77-928,484. DUCHESS COSMETICS, TACOMA, WA. FILED 2-4-2010.



NO CLAIM IS MADE TO THE EXCLUSIVE RIGHT TO USE "COSMETICS", APART FROM THE MARK AS SHOWN.

THE MARK CONSISTS OF A CROWN ABOVE THE INTERLOCKING LETTERS "DC"; THE WORD "DUCHESS" APPEARS UNDERNEATH THE LETTERS "DC", AND THE WORD "COSMETICS" APPEARS UNDERNEATH THE WORD "DUCHESS".

FOR COSMETICS (U.S. CLS. 1, 4, 6, 50, 51 AND 52).

COLLEEN DOMBROW, EXAMINING ATTORNEY

SN 77-928,766. MONTAY, INC., NEW YORK, NY. FILED 2-5-2010.

AMBRA DI VENEZIA

THE MARK CONSISTS OF STANDARD CHARACTERS WITHOUT CLAIM TO ANY PARTICULAR FONT, STYLE, SIZE, OR COLOR.

THE ENGLISH TRANSLATION OF "AMBRA DI VENEZIA" IN THE MARK IS "AMBER OF VENICE".

FOR PARFUM AND EAU DE PARFUM, BODY CREAM (U.S. CLS. 1, 4, 6, 50, 51 AND 52).

FIRST USE 4-7-1998; IN COMMERCE 4-7-1998.

HAI-LY LAM, EXAMINING ATTORNEY

CLASS 3—(Continued).

SN 77-929,022. COBALT BALLOON LLC, NEW YORK, NY. FILED 2-5-2010.

CARE & CONCEAL

THE MARK CONSISTS OF STANDARD CHARACTERS WITHOUT CLAIM TO ANY PARTICULAR FONT, STYLE, SIZE, OR COLOR.

FOR CONCEALERS FOR EYES; EYE MAKE-UP; MAKE-UP (U.S. CLS. 1, 4, 6, 50, 51 AND 52).
JASON BLAIR, EXAMINING ATTORNEY

SN 77-929,033. YOUNGBLOOD SKIN CARE PRODUCTS, LLC, DBA YOUNGBLOOD MINERAL COSMETICS, SIMI VALLEY, CA. FILED 2-5-2010.

BREATHE NEW LIFE INTO YOUR SKIN

THE MARK CONSISTS OF STANDARD CHARACTERS WITHOUT CLAIM TO ANY PARTICULAR FONT, STYLE, SIZE, OR COLOR.

FOR COSMETICS; NON-MEDICATED SKIN CARE PREPARATIONS (U.S. CLS. 1, 4, 6, 50, 51 AND 52).
FIRST USE 4-0-2009; IN COMMERCE 4-0-2009.
SUE LAWRENCE, EXAMINING ATTORNEY

SN 77-929,046. UNILEVER SUPPLY CHAIN, INC., CLINTON, CT. FILED 2-5-2010.

WAKE UP AND STAY ALERT

THE MARK CONSISTS OF STANDARD CHARACTERS WITHOUT CLAIM TO ANY PARTICULAR FONT, STYLE, SIZE, OR COLOR.

FOR SHOWER GEL, BODY CLEANING WASH, SOAPS, BODY SPRAYS, ANTI-PERSPIRANTS AND DEODORANTS ALL FOR PERSONAL USE (U.S. CLS. 1, 4, 6, 50, 51 AND 52).
MELISSA VALLILLO, EXAMINING ATTORNEY

CLASS 3—(Continued).

SN 77-929,211. PAYLESS SHOESOURCE WORLDWIDE, INC., TOPEKA, KS. FILED 2-5-2010.



THE COLOR(S) BROWN IS/ARE CLAIMED AS A FEATURE OF THE MARK.

THE MARK CONSISTS OF WORDS "ZOE & ZAC" IN A STYLIZED FONT, ALL IN THE COLOR BROWN. THE WORD "ZOE" IS IN A THIN LINE FONT. THE AMPERSAND IS IN A THIN LINE FONT, AND THE WORD "ZAC" IS IN A BOLD, THICKER FONT.

FOR BATH CRYSTALS; BATH GELS; BATH OILS; BATH SALTS; BATH SOAPS; BEAUTY GELS; BODY BUTTER; BODY CREAMS; BODY LOTION; BODY SCRUB; BUBBLE BATH; COLOGNE; COSMETICS; EAU DE TOILETTE; FACIAL LOTION; FRAGRANCES FOR PERSONAL USE; HAIR CONDITIONERS; HAIR SHAMPOO; LIP GLOSS; LIPSTICK; MASSAGE OILS; MOISTURIZING CREAMS; NAIL ENAMEL; PERFUMES; SHOWER AND BATH GEL (U.S. CLS. 1, 4, 6, 50, 51 AND 52).

DOMINICK J. SALEMI, EXAMINING ATTORNEY

SN 77-929,286. EVA GABOR INTERNATIONAL, INC., KANSAS CITY, MO. FILED 2-5-2010.

INTERPLEX

THE MARK CONSISTS OF STANDARD CHARACTERS WITHOUT CLAIM TO ANY PARTICULAR FONT, STYLE, SIZE, OR COLOR.

FOR ADHESIVES FOR AFFIXING FALSE HAIR (U.S. CLS. 1, 4, 6, 50, 51 AND 52).
SHAUNIA CARLYLE, EXAMINING ATTORNEY

SN 77-929,309. POLSTON ENTERPRISES, LLC, PINE GROVE, PA. FILED 2-5-2010.

Polished Mama

THE MARK CONSISTS OF STANDARD CHARACTERS WITHOUT CLAIM TO ANY PARTICULAR FONT, STYLE, SIZE, OR COLOR.

FOR BODY AND BEAUTY CARE COSMETICS; NAIL POLISH; NAIL POLISH REMOVER (U.S. CLS. 1, 4, 6, 50, 51 AND 52).
FIRST USE 1-1-2007; IN COMMERCE 3-1-2007.
HOWARD B. LEVINE, EXAMINING ATTORNEY

CLASS 3—(Continued).

SN 77-930,012. GHODOUSSI, VAHID, MEMPHIS, TN. FILED 2-7-2010.

OPTIMUM OPTI

THE MARK CONSISTS OF STANDARD CHARACTERS WITHOUT CLAIM TO ANY PARTICULAR FONT, STYLE, SIZE, OR COLOR.
FOR AUTOMOTIVE CLEANING PREPARATIONS (U.S. CLS. 1, 4, 6, 50, 51 AND 52).
FIRST USE 1-21-2010; IN COMMERCE 1-21-2010.
SUNG IN, EXAMINING ATTORNEY

SN 77-930,064. ECO-LOGICAL INDUSTRIES, CHESTER, VT. FILED 2-8-2010.

SKEETER SKATTER

THE MARK CONSISTS OF STANDARD CHARACTERS WITHOUT CLAIM TO ANY PARTICULAR FONT, STYLE, SIZE, OR COLOR.
FOR COSMETICS AND CLEANING PRODUCTS, NAMELY, ESSENTIAL OILS, COSMETICS, SENSUAL BODY OIL AND SPRAY MADE WITH MOSQUITO REPELLING ESSENTIAL OILS (U.S. CLS. 1, 4, 6, 50, 51 AND 52).
DORITT L. CARROLL, EXAMINING ATTORNEY

SN 77-930,070. BIENIASZ, JOSEPH, EMMETT, ID. FILED 2-8-2010.

AMAROMA, LLC

THE MARK CONSISTS OF STANDARD CHARACTERS WITHOUT CLAIM TO ANY PARTICULAR FONT, STYLE, SIZE, OR COLOR.
NO CLAIM IS MADE TO THE EXCLUSIVE RIGHT TO USE "LLC", APART FROM THE MARK AS SHOWN.
FOR COSMETICS AND CLEANING PRODUCTS, NAMELY, PERFUMES, ESSENTIAL OILS, DENTIFRICES FOR CONSUMERS (U.S. CLS. 1, 4, 6, 50, 51 AND 52).
RENEE MCCRAY, EXAMINING ATTORNEY

CLASS 3—(Continued).

SN 77-930,402. NETWORK BUILDING CONCEPTS, LLC, DELAWARE CITY, DE. FILED 2-8-2010.

DE51

THE MARK CONSISTS OF STANDARD CHARACTERS WITHOUT CLAIM TO ANY PARTICULAR FONT, STYLE, SIZE, OR COLOR.
FOR ALL-PURPOSE CLEANERS (U.S. CLS. 1, 4, 6, 50, 51 AND 52).
FIRST USE 1-5-2010; IN COMMERCE 1-30-2010.
H. M. FISHER, EXAMINING ATTORNEY

SN 77-931,667. ENCHANTÉ ACCESSORIES, INC., NEW YORK, NY. FILED 2-9-2010.

BE MINE

THE MARK CONSISTS OF STANDARD CHARACTERS WITHOUT CLAIM TO ANY PARTICULAR FONT, STYLE, SIZE, OR COLOR.
FOR BODY LOTION, SHOWER GEL, BUBBLE BATH, BATH SALT AND HAND SOAP (U.S. CLS. 1, 4, 6, 50, 51 AND 52).
MIDGE BUTLER, EXAMINING ATTORNEY

SN 77-931,720. NU VISION GROUP LLC, NEW YORK, NY. FILED 2-9-2010.

HOT IS BLACK

THE MARK CONSISTS OF STANDARD CHARACTERS WITHOUT CLAIM TO ANY PARTICULAR FONT, STYLE, SIZE, OR COLOR.
FOR BODY SPRAYS; COLOGNE; FRAGRANCES FOR PERSONAL USE; PERFUME; TOILET WATER (U.S. CLS. 1, 4, 6, 50, 51 AND 52).
JUSTINE D. PARKER, EXAMINING ATTORNEY

CLASS 3—(Continued).

SN 77-931,734. NU VISION GROUP LLC, NEW YORK, NY. FILED 2-9-2010.

ROCK & FREEDOM

THE MARK CONSISTS OF STANDARD CHARACTERS WITHOUT CLAIM TO ANY PARTICULAR FONT, STYLE, SIZE, OR COLOR.
FOR BODY SPRAYS; COLOGNE; FRAGRANCES FOR PERSONAL USE; PERFUME; TOILET WATER (U.S. CLS. 1, 4, 6, 50, 51 AND 52).
JUSTINE D. PARKER, EXAMINING ATTORNEY

SN 77-931,748. SMITH, LESLIE, CONVERSE, TX. FILED 2-9-2010.

FN11

THE MARK CONSISTS OF STANDARD CHARACTERS WITHOUT CLAIM TO ANY PARTICULAR FONT, STYLE, SIZE, OR COLOR.
FOR HAIR CARE PREPARATIONS (U.S. CLS. 1, 4, 6, 50, 51 AND 52).
KATHY DE JONGE, EXAMINING ATTORNEY

SN 77-931,799. NU VISION GROUP LLC, NEW YORK, NY. FILED 2-9-2010.

SENSATION ECSTASY NOIR

THE MARK CONSISTS OF STANDARD CHARACTERS WITHOUT CLAIM TO ANY PARTICULAR FONT, STYLE, SIZE, OR COLOR.
OWNER OF U.S. REG. NOS. 3,292,270, 3,540,208 AND 3,664,808.
THE ENGLISH TRANSLATION OF "NOIR" IN THE MARK IS "BLACK".
FOR BODY SPRAYS; COLOGNE; FRAGRANCES FOR PERSONAL USE; PERFUME; TOILET WATER (U.S. CLS. 1, 4, 6, 50, 51 AND 52).
JUSTINE D. PARKER, EXAMINING ATTORNEY

CLASS 3—(Continued).

SN 77-931,955. AMAL FELAYA LLC, LAS VEGAS, NV. FILED 2-9-2010.

SINIORA

THE MARK CONSISTS OF STANDARD CHARACTERS WITHOUT CLAIM TO ANY PARTICULAR FONT, STYLE, SIZE, OR COLOR.
THE WORDING "SINIORA" HAS NO MEANING IN A FOREIGN LANGUAGE.
FOR FRAGRANCES FOR PERSONAL USE; PERFUME (U.S. CLS. 1, 4, 6, 50, 51 AND 52).
JANICE KIM, EXAMINING ATTORNEY

SN 77-931,973. GENETIC DENIM LLC, NEW YORK, NY. FILED 2-9-2010.

Genetic

THE MARK CONSISTS OF STANDARD CHARACTERS WITHOUT CLAIM TO ANY PARTICULAR FONT, STYLE, SIZE, OR COLOR.
FOR COLOGNE; EAU DE TOILETTE AND EAU DE COLOGNE; FRAGRANCES; PERFUMES (U.S. CLS. 1, 4, 6, 50, 51 AND 52).
ALEX KEAM, EXAMINING ATTORNEY

SN 77-932,125. DISNEY ENTERPRISES, INC., BURBANK, CA. FILED 2-9-2010.

WHAT KIND OF WORLD DO YOU WANT TO CREATE?

THE MARK CONSISTS OF STANDARD CHARACTERS WITHOUT CLAIM TO ANY PARTICULAR FONT, STYLE, SIZE, OR COLOR.
FOR COSMETICS; DENTIFRICES; NON-MEDICATED TOILETRIES; HOME FRAGRANCES; FRAGRANCES; PERFUMES (U.S. CLS. 1, 4, 6, 50, 51 AND 52).
WILLIAM BRECKENFELD, EXAMINING ATTORNEY

CLASS 3—(Continued).

SN 77-932,630. COMMERCIAL MAINTENANCE CHEMICAL CORP., DBA COMMERCIAL MAINTENANCE CHEMICAL CORP., FARMINGDALE, NY. FILED 2-10-2010.

GREEN GOBBLER

THE MARK CONSISTS OF STANDARD CHARACTERS WITHOUT CLAIM TO ANY PARTICULAR FONT, STYLE, SIZE, OR COLOR.

NO CLAIM IS MADE TO THE EXCLUSIVE RIGHT TO USE "GREEN", APART FROM THE MARK AS SHOWN.

FOR LOW ENVIRONMENTAL IMPACT DRAIN OPENERS (U.S. CLS. 1, 4, 6, 50, 51 AND 52).

DAVID H. STINE, EXAMINING ATTORNEY

SN 77-932,718. FABIOLA GUTIERREZ, DBA XPLICIT COSMETICS, LONG BEACH, CA. FILED 2-10-2010.

Xplicit Cosmetics

THE MARK CONSISTS OF STANDARD CHARACTERS WITHOUT CLAIM TO ANY PARTICULAR FONT, STYLE, SIZE, OR COLOR.

NO CLAIM IS MADE TO THE EXCLUSIVE RIGHT TO USE "COSMETICS", APART FROM THE MARK AS SHOWN.

FOR BLUSH; BODY POWDER; COSMETICS AND MAKE-UP; EYE LINER; EYE SHADOWS; FACE AND BODY LOTIONS; FACE POWDER; FACIAL WASHES; FOUNDATIONS; LIP GLOSS; LIP LINER; LIPSTICKS; MAKE-UP FOR THE FACE AND BODY; MASCARAS; NON-MEDICATED SKIN CARE PREPARATIONS; SKIN TONERS (U.S. CLS. 1, 4, 6, 50, 51 AND 52).

FIRST USE 1-1-2010; IN COMMERCE 1-1-2010.

LEIGH CAROLINE CASE, EXAMINING ATTORNEY

SN 77-932,868. HEALTHY HAIR JOURNEY ENTERPRISES, LLC, LAWRENCEVILLE, GA. FILED 2-10-2010.

HTN NATURALS

THE MARK CONSISTS OF STANDARD CHARACTERS WITHOUT CLAIM TO ANY PARTICULAR FONT, STYLE, SIZE, OR COLOR.

NO CLAIM IS MADE TO THE EXCLUSIVE RIGHT TO USE "NATURALS", APART FROM THE MARK AS SHOWN.

FOR HAIR CARE KITS COMPRISING NON-MEDICATED HAIR CARE PREPARATIONS, NAMELY, SHAMPOO, CONDITIONERS, HAIR LOTION, HAIR OIL AND SCALP SPRAY; HAIR CARE PREPARATIONS; HAIR CONDITIONERS; HAIR LOTIONS; HAIR OILS; HAIR SHAMPOO; HAIR SPRAYS (U.S. CLS. 1, 4, 6, 50, 51 AND 52).

DAVID C. REIHNER, EXAMINING ATTORNEY

CLASS 3—(Continued).

SN 77-932,886. ROBERT STUFANO, BRISTOL, CT. FILED 2-10-2010.

WONDER-KLEEN

THE MARK CONSISTS OF STANDARD CHARACTERS WITHOUT CLAIM TO ANY PARTICULAR FONT, STYLE, SIZE, OR COLOR.

FOR MULTI-SURFACE CLEANING PREPARATIONS; MULTI-PURPOSE LIQUID CLEANER AND DEGREASER; ALL PURPOSE CLEANERS AND CLEANING PREPARATIONS; AUTOMOTIVE, TIRE, GLASS AND WHEEL CLEANING PREPARATIONS; CLEANING PREPARATIONS FOR HOUSEHOLD PURPOSES; CLEANING, WASHING AND POLISHING PREPARATIONS; CLEANING PREPARATION FOR CLEANING SURFACES (U.S. CLS. 1, 4, 6, 50, 51 AND 52).

FIRST USE 7-1-1999; IN COMMERCE 7-1-1999.

DOMINIC J. FERRAIUOLO, EXAMINING ATTORNEY

SN 77-932,964. ROBERT STUFANO, BRISTOL, CT. FILED 2-10-2010.

BOBBY BUBBLES

THE MARK CONSISTS OF STANDARD CHARACTERS WITHOUT CLAIM TO ANY PARTICULAR FONT, STYLE, SIZE, OR COLOR.

FOR MULTI-SURFACE CLEANING PREPARATIONS; MULTI-PURPOSE LIQUID CLEANER AND DEGREASER; ALL PURPOSE CLEANERS AND CLEANING PREPARATIONS; AUTOMOTIVE, TIRE, GLASS AND WHEEL CLEANING PREPARATIONS; CLEANING PREPARATIONS FOR HOUSEHOLD PURPOSES; CLEANING, WASHING AND POLISHING PREPARATIONS; CLEANING PREPARATION FOR CLEANING SURFACES (U.S. CLS. 1, 4, 6, 50, 51 AND 52).

FIRST USE 2-9-2010; IN COMMERCE 2-9-2010.

DOMINIC J. FERRAIUOLO, EXAMINING ATTORNEY

SN 77-932,991. BEAUTY PLUS, INC., DUARTE, CA. FILED 2-10-2010.

ROCK STAR PRINCESS

THE MARK CONSISTS OF STANDARD CHARACTERS WITHOUT CLAIM TO ANY PARTICULAR FONT, STYLE, SIZE, OR COLOR.

FOR COSMETICS (U.S. CLS. 1, 4, 6, 50, 51 AND 52).

INGA ERVIN, EXAMINING ATTORNEY

CLASS 3—(Continued).

SN 77-934,385. L'OREAL, PARIS, FRANCE, FILED 2-12-2010.

FORTIGEN

THE MARK CONSISTS OF STANDARD CHARACTERS WITHOUT CLAIM TO ANY PARTICULAR FONT, STYLE, SIZE, OR COLOR.

FOR COMBINATION OF INGREDIENTS USED AS AN INTEGRAL COMPONENT OF HAIR COLORING PREPARATIONS (U.S. CLS. 1, 4, 6, 50, 51 AND 52).

GINA HAYES, EXAMINING ATTORNEY

CLASS 3—(Continued).

SN 77-936,637. MURAD, INC., EL SEGUNDO, CA. FILED 2-16-2010.

CRAZY FOR CLEAR

THE MARK CONSISTS OF STANDARD CHARACTERS WITHOUT CLAIM TO ANY PARTICULAR FONT, STYLE, SIZE, OR COLOR.

FOR NON-MEDICATED SKIN CARE PREPARATIONS, NAMELY, CREAMS, LOTIONS, GELS, TONERS, CLEANSERS AND PEELS (U.S. CLS. 1, 4, 6, 50, 51 AND 52).

NICHOLAS ALTREE, EXAMINING ATTORNEY

SN 77-934,659. THE PROCTER & GAMBLE COMPANY, CINCINNATI, OH. FILED 2-12-2010.

VITANIACIN

THE MARK CONSISTS OF STANDARD CHARACTERS WITHOUT CLAIM TO ANY PARTICULAR FONT, STYLE, SIZE, OR COLOR.

OWNER OF U.S. REG. NOS. 2,460,415 AND 3,298,997.

FOR INGREDIENT COMPRISED OF VITAMINS SOLD AS A COMPONENT OF BODY WASH (U.S. CLS. 1, 4, 6, 50, 51 AND 52).

LINDA E. BLOHM, EXAMINING ATTORNEY

SN 77-936,646. MURAD, INC., EL SEGUNDO, CA. FILED 2-16-2010.

DOWN FOR DEFENSE

THE MARK CONSISTS OF STANDARD CHARACTERS WITHOUT CLAIM TO ANY PARTICULAR FONT, STYLE, SIZE, OR COLOR.

FOR NON-MEDICATED SKIN CARE PREPARATIONS, NAMELY, CREAMS, LOTIONS, GELS, TONERS, CLEANSERS AND PEELS (U.S. CLS. 1, 4, 6, 50, 51 AND 52).

NICHOLAS ALTREE, EXAMINING ATTORNEY

SN 77-936,287. L'OREAL, PARIS, FRANCE, FILED 2-16-2010.

EVERSLEEK

THE MARK CONSISTS OF STANDARD CHARACTERS WITHOUT CLAIM TO ANY PARTICULAR FONT, STYLE, SIZE, OR COLOR.

FOR HAIR CARE PREPARATIONS (U.S. CLS. 1, 4, 6, 50, 51 AND 52).

GINA HAYES, EXAMINING ATTORNEY

SN 77-936,658. MURAD, INC., EL SEGUNDO, CA. FILED 2-16-2010.

JUMPING FOR JUICY

THE MARK CONSISTS OF STANDARD CHARACTERS WITHOUT CLAIM TO ANY PARTICULAR FONT, STYLE, SIZE, OR COLOR.

FOR NON-MEDICATED SKIN CARE PREPARATIONS, NAMELY, CREAMS, LOTIONS, GELS, TONERS, CLEANSERS AND PEELS (U.S. CLS. 1, 4, 6, 50, 51 AND 52).

NICHOLAS ALTREE, EXAMINING ATTORNEY

CLASS 3—(Continued).

SN 77-937,015. LITTLE BUSY BODIES, INC., BEAVERTON, OR. FILED 2-16-2010.

**THE NEXT GENERATION IN
TISSUE**

THE MARK CONSISTS OF STANDARD CHARACTERS WITHOUT CLAIM TO ANY PARTICULAR FONT, STYLE, SIZE, OR COLOR.

NO CLAIM IS MADE TO THE EXCLUSIVE RIGHT TO USE "TISSUE", APART FROM THE MARK AS SHOWN.

FOR DISPOSABLE NASAL WIPES IMPREGNATED WITH SALINE; DISPOSABLE WIPES IMPREGNATED WITH SALINE FOR PERSONAL HYGIENE; PRE-MOISTENED COSMETIC WIPES; SCENT-INFUSED PRE-MOISTENED COSMETIC WIPES; MOISTURIZING DISPOSABLE WIPES IMPREGNATED WITH CLEANSING CHEMICALS OR COMPOUNDS FOR PERSONAL HYGIENE (U.S. CLS. 1, 4, 6, 50, 51 AND 52).

MARK PILARO, EXAMINING ATTORNEY

CLASS 3—(Continued).

SN 77-937,755. JOHNSON & JOHNSON, NEW BRUNSWICK, NJ. FILED 2-17-2010.

**OUR KIDS WILL INHERIT OUR
PLANET**

THE MARK CONSISTS OF STANDARD CHARACTERS WITHOUT CLAIM TO ANY PARTICULAR FONT, STYLE, SIZE, OR COLOR.

FOR TOILETRIES, NAMELY, BODY WASH AND SKIN CLEANSERS; HAIR SHAMPOO; SKIN CARE PREPARATIONS, NAMELY, BODY LOTION (U.S. CLS. 1, 4, 6, 50, 51 AND 52).

TIMOTHY FINNEGAN, EXAMINING ATTORNEY

SN 77-937,020. HENKEL AG & CO. KGAA, DUESSELDORF, FED REP GERMANY, FILED 2-16-2010.

SMOOTH 'N SHINE THERAPY

THE MARK CONSISTS OF STANDARD CHARACTERS WITHOUT CLAIM TO ANY PARTICULAR FONT, STYLE, SIZE, OR COLOR.

OWNER OF U.S. REG. NOS. 1,782,349, 2,445,644 AND OTHERS.

NO CLAIM IS MADE TO THE EXCLUSIVE RIGHT TO USE "THERAPY", APART FROM THE MARK AS SHOWN.

FOR HAIR CARE PREPARATIONS (U.S. CLS. 1, 4, 6, 50, 51 AND 52).

FIRST USE 10-31-2003; IN COMMERCE 10-31-2003.

TASNEEM HUSSAIN, EXAMINING ATTORNEY

SN 77-938,554. L'OREAL, PARIS, FRANCE, FILED 2-18-2010.

RESPECT AQUATIQUE

THE MARK CONSISTS OF STANDARD CHARACTERS WITHOUT CLAIM TO ANY PARTICULAR FONT, STYLE, SIZE, OR COLOR.

OWNER OF U.S. REG. NO. 3,578,799.
FOR SHAMPOO, CONDITIONER (U.S. CLS. 1, 4, 6, 50, 51 AND 52).

GINA HAYES, EXAMINING ATTORNEY

SN 77-937,023. LITTLE BUSY BODIES, INC., BEAVERTON, OR. FILED 2-16-2010.

DOES YOUR NOSE KNOW?

THE MARK CONSISTS OF STANDARD CHARACTERS WITHOUT CLAIM TO ANY PARTICULAR FONT, STYLE, SIZE, OR COLOR.

FOR DISPOSABLE NASAL WIPES IMPREGNATED WITH SALINE; DISPOSABLE WIPES IMPREGNATED WITH SALINE FOR PERSONAL HYGIENE; PRE-MOISTENED COSMETIC WIPES; SCENT-INFUSED PRE-MOISTENED COSMETIC WIPES; MOISTURIZING DISPOSABLE WIPES IMPREGNATED WITH CLEANSING CHEMICALS OR COMPOUNDS FOR PERSONAL HYGIENE (U.S. CLS. 1, 4, 6, 50, 51 AND 52).

MARK PILARO, EXAMINING ATTORNEY

SN 77-939,056. MANA PRODUCTS, INC., LONG ISLAND CITY, NY. FILED 2-18-2010.

72 HOUR

THE MARK CONSISTS OF STANDARD CHARACTERS WITHOUT CLAIM TO ANY PARTICULAR FONT, STYLE, SIZE, OR COLOR.

FOR COSMETICS (U.S. CLS. 1, 4, 6, 50, 51 AND 52).

ALICE BENMAMAN, EXAMINING ATTORNEY

CLASS 3—(Continued).

SN 77-945,790. UNILEVER SUPPLY CHAIN, INC., CLINTON, CT. FILED 2-26-2010.

Caress
Sheer Twilight

THE MARK CONSISTS OF THE WORDS "CARESS SHEER TWILIGHT" IN STYLIZED FORM.
FOR SHOWER GEL, PERSONAL BODY CLEANING WASH AND SOAP (U.S. CLS. 1, 4, 6, 50, 51 AND 52).
MELISSA VALLILLO, EXAMINING ATTORNEY

SN 77-945,795. UNILEVER SUPPLY CHAIN, INC., CLINTON, CT. FILED 2-26-2010.

Caress
Scarlet Blossom

THE MARK CONSISTS OF THE WORDS "CARESS SCARLET BLOSSOM" IN STYLIZED FORM.
FOR SHOWER GEL, PERSONAL BODY CLEANING WASH AND SOAP (U.S. CLS. 1, 4, 6, 50, 51 AND 52).
MELISSA VALLILLO, EXAMINING ATTORNEY

SN 77-951,787. COSMETIC DERMATOLOGY, INC., MIAMI, FL. FILED 3-5-2010.

DR. BRANDT NECKLIFT

THE MARK CONSISTS OF STANDARD CHARACTERS WITHOUT CLAIM TO ANY PARTICULAR FONT, STYLE, SIZE, OR COLOR.
OWNER OF U.S. REG. NOS. 2,285,902, 2,959,414 AND OTHERS.
NO CLAIM IS MADE TO THE EXCLUSIVE RIGHT TO USE "NECKLIFT", APART FROM THE MARK AS SHOWN.
THE NAME "DR. BRANDT" IDENTIFIES A LIVING INDIVIDUAL WHOSE CONSENT IS OF RECORD.
FOR SKIN CREAMS, SKIN MOISTURIZERS, AND SKIN EMOLLIENTS (U.S. CLS. 1, 4, 6, 50, 51 AND 52).
KAELIE KUNG, EXAMINING ATTORNEY

CLASS 3—(Continued).

SN 77-954,588. LITTLE BUSY BODIES, INC., BEAVERTON, OR. FILED 3-9-2010.

SALINE SOOTHERS

THE MARK CONSISTS OF STANDARD CHARACTERS WITHOUT CLAIM TO ANY PARTICULAR FONT, STYLE, SIZE, OR COLOR.
NO CLAIM IS MADE TO THE EXCLUSIVE RIGHT TO USE "SALINE", APART FROM THE MARK AS SHOWN.
FOR DISPOSABLE NASAL WIPES IMPREGNATED WITH SALINE; DISPOSABLE WIPES IMPREGNATED WITH SALINE FOR PERSONAL HYGIENE; PRE-MOISTENED COSMETIC WIPES; SCENT-INFUSED PRE-MOISTENED COSMETIC WIPES; MOISTURIZING DISPOSABLE WIPES IMPREGNATED WITH CLEANSING CHEMICALS OR COMPOUNDS FOR PERSONAL HYGIENE (U.S. CLS. 1, 4, 6, 50, 51 AND 52).
MARK PILARO, EXAMINING ATTORNEY

SN 77-954,636. LITTLE BUSY BODIES, INC., BEAVERTON, OR. FILED 3-9-2010.

THE NEXT GENERATION OF TISSUES

THE MARK CONSISTS OF STANDARD CHARACTERS WITHOUT CLAIM TO ANY PARTICULAR FONT, STYLE, SIZE, OR COLOR.
NO CLAIM IS MADE TO THE EXCLUSIVE RIGHT TO USE "TISSUES", APART FROM THE MARK AS SHOWN.
FOR DISPOSABLE NASAL WIPES IMPREGNATED WITH SALINE; DISPOSABLE WIPES IMPREGNATED WITH SALINE FOR PERSONAL HYGIENE; PRE-MOISTENED COSMETIC WIPES; SCENT-INFUSED PRE-MOISTENED COSMETIC WIPES; MOISTURIZING DISPOSABLE WIPES IMPREGNATED WITH CLEANSING CHEMICALS OR COMPOUNDS FOR PERSONAL HYGIENE (U.S. CLS. 1, 4, 6, 50, 51 AND 52).
MARK PILARO, EXAMINING ATTORNEY

SN 77-956,870. MANA PRODUCTS, INC., LONG ISLAND CITY, NY. FILED 3-11-2010.

CHROMACEUTICAL

THE MARK CONSISTS OF STANDARD CHARACTERS WITHOUT CLAIM TO ANY PARTICULAR FONT, STYLE, SIZE, OR COLOR.
FOR COSMETICS (U.S. CLS. 1, 4, 6, 50, 51 AND 52).
ALICE BENMAMAN, EXAMINING ATTORNEY

CLASS 3—(Continued).

SN 77-957,015. INTERNATIONAL DESIGN ASSOCIATES LTD, NEW YORK, NY. FILED 3-11-2010.

FLOWER MARKET

THE MARK CONSISTS OF STANDARD CHARACTERS WITHOUT CLAIM TO ANY PARTICULAR FONT, STYLE, SIZE, OR COLOR.

FOR BATH SOAPS IN LIQUID, SOLID OR GEL FORM; FRAGRANCES FOR PERSONAL USE; HOUSEHOLD CLEANING PREPARATIONS; NON-MEDICATED SKIN CARE PREPARATIONS; ROOM FRAGRANCES (U.S. CLS. 1, 4, 6, 50, 51 AND 52).

FIRST USE 3-11-2010; IN COMMERCE 3-11-2010.

WARREN L. OLANDRIA, EXAMINING ATTORNEY

SN 77-961,517. THE SUN PRODUCTS CORPORATION, WILTON, CT. FILED 3-17-2010.

FRESH MORNING BREEZE

THE MARK CONSISTS OF STANDARD CHARACTERS WITHOUT CLAIM TO ANY PARTICULAR FONT, STYLE, SIZE, OR COLOR.

OWNER OF U.S. REG. NO. 2,919,356.

FOR FABRIC SOFTENER; LAUNDRY BLEACH (U.S. CLS. 1, 4, 6, 50, 51 AND 52).

KAREN SEVERSON, EXAMINING ATTORNEY

SN 77-961,949. MANA PRODUCTS, INC., LONG ISLAND CITY, NY. FILED 3-18-2010.

THE BEAUTY TRUST

THE MARK CONSISTS OF STANDARD CHARACTERS WITHOUT CLAIM TO ANY PARTICULAR FONT, STYLE, SIZE, OR COLOR.

FOR COSMETICS (U.S. CLS. 1, 4, 6, 50, 51 AND 52).

ALICE BENMAMAN, EXAMINING ATTORNEY

CLASS 3—(Continued).

SN 77-962,022. L'OREAL, PARIS, FRANCE, FILED 3-18-2010.

THE ONE SWEEP

THE MARK CONSISTS OF STANDARD CHARACTERS WITHOUT CLAIM TO ANY PARTICULAR FONT, STYLE, SIZE, OR COLOR.

FOR EYE SHADOW (U.S. CLS. 1, 4, 6, 50, 51 AND 52).

GINA HAYES, EXAMINING ATTORNEY

SN 77-962,236. ESTEE LAUDER COSMETICS LTD., AGINCOURT, ONTARIO, CANADA, FILED 3-18-2010.

MAC SUPERSLICK

THE MARK CONSISTS OF STANDARD CHARACTERS WITHOUT CLAIM TO ANY PARTICULAR FONT, STYLE, SIZE, OR COLOR.

OWNER OF U.S. REG. NOS. 3,023,827, 3,603,684 AND OTHERS.

FOR COSMETICS (U.S. CLS. 1, 4, 6, 50, 51 AND 52).

SIMON TENG, EXAMINING ATTORNEY

SN 77-963,703. THE SUN PRODUCTS CORPORATION, WILTON, CT. FILED 3-19-2010.

BRISA FRESCA DE LA MANANA

THE MARK CONSISTS OF STANDARD CHARACTERS WITHOUT CLAIM TO ANY PARTICULAR FONT, STYLE, SIZE, OR COLOR.

OWNER OF U.S. REG. NO. 2,919,356.

THE ENGLISH TRANSLATION OF "BRISA FRESCA DE LA MANANA" IS "FRESH MORNING BREEZE".

FOR FABRIC SOFTENER; LAUNDRY BLEACH (U.S. CLS. 1, 4, 6, 50, 51 AND 52).

KAREN SEVERSON, EXAMINING ATTORNEY

CLASS 3—(Continued).

SN 77-968,603. THE SUN PRODUCTS CORPORATION, WILTON, CT. FILED 3-25-2010.

FRESH MORNING BREEZE

THE MARK CONSISTS OF STANDARD CHARACTERS WITHOUT CLAIM TO ANY PARTICULAR FONT, STYLE, SIZE, OR COLOR.
OWNER OF U.S. REG. NO. 2,919,356.
FOR DISH DETERGENT (U.S. CLS. 1, 4, 6, 50, 51 AND 52).
KAREN SEVERSON, EXAMINING ATTORNEY

SN 77-968,610. THE SUN PRODUCTS CORPORATION, WILTON, CT. FILED 3-25-2010.

BRISA FRESCA DE LA MANANA

THE MARK CONSISTS OF STANDARD CHARACTERS WITHOUT CLAIM TO ANY PARTICULAR FONT, STYLE, SIZE, OR COLOR.
OWNER OF U.S. REG. NO. 2,919,356.
THE ENGLISH TRANSLATION OF "BRISA FRESCA DE LA MANANA" IS "FRESH MORNING BREEZE".
FOR DISH DETERGENT (U.S. CLS. 1, 4, 6, 50, 51 AND 52).
KAREN SEVERSON, EXAMINING ATTORNEY

SN 79-058,189. LAUNCH PAD ENTERPRISES PTY LTD, TENNYSON POINT NSW 2111, AUSTRALIA, FILED 7-31-2008.



OWNER OF INTERNATIONAL REGISTRATION 0975639 DATED 7-31-2008, EXPIRES 7-31-2018.
THE NAME(S), PORTRAIT(S), AND/OR SIGNATURE(S) SHOWN IN THE MARK DOES NOT IDENTIFY A PARTICULAR LIVING INDIVIDUAL.
FOR SOAPS, COSMETICS, NON-MEDICATED SKIN CARE AND BODY CARE PREPARATIONS, HAIR CARE PREPARATIONS (U.S. CLS. 1, 4, 6, 50, 51 AND 52).
KATHERINE STOIDES, EXAMINING ATTORNEY

CLASS 3—(Continued).

SN 79-063,347. ARGANIS COSMETICS SARL, CASABLANCA, MOROCCO, FILED 11-7-2008.



OWNER OF INTERNATIONAL REGISTRATION 0988125 DATED 11-7-2008, EXPIRES 11-7-2018.
THE COLOR(S) GREEN AND GRAY IS/ARE CLAIMED AS A FEATURE OF THE MARK.
THE MARK CONSISTS OF THE WORDING "ARGANIS" IN GREEN, APPEARING ON A STYLIZED DEPICTION OF A TREE IN GRAY. THE TREE AND WORDING ARE SURROUNDED BY A SINGLE-LINE GRAY SQUARE. THE COLOR WHITE REPRESENTS BACKGROUND, OUTLINING, SHADING AND/OR TRANSPARENT AREAS, AND IS NOT PART OF THE MARK.
THE WORDING "ARGANIS" HAS NO MEANING IN A FOREIGN LANGUAGE.
FOR SOAPS FOR PERSONAL USE; ESSENTIALS OILS; COSMETICS; HAIR LOTIONS (U.S. CLS. 1, 4, 6, 50, 51 AND 52).
JAMES MACFARLANE, EXAMINING ATTORNEY

SN 79-063,957. COTY DEUTSCHLAND GMBH, 55116 MAINZ, FED REP GERMANY, FILED 12-3-2008.

RIMMEL MOISTURE RENEW

THE MARK CONSISTS OF STANDARD CHARACTERS WITHOUT CLAIM TO ANY PARTICULAR FONT, STYLE, SIZE, OR COLOR.
PRIORITY DATE OF 6-4-2008 IS CLAIMED.
OWNER OF INTERNATIONAL REGISTRATION 0989712 DATED 12-3-2008, EXPIRES 12-3-2018.
OWNER OF U.S. REG. NOS. 2,976,346, 3,516,588 AND OTHERS.
NO CLAIM IS MADE TO THE EXCLUSIVE RIGHT TO USE "MOISTURE", APART FROM THE MARK AS SHOWN.
FOR COSMETICS, NAMELY, LIPSTICK, MASCARA AND EYE SHADOW (U.S. CLS. 1, 4, 6, 50, 51 AND 52).
JULIE GUTTADAURO, EXAMINING ATTORNEY

CLASS 3—(Continued).

SN 79-065,177. DALLI-WERKE GMBH & CO. KG, STOLBERG, FED REP GERMANY, FILED 2-4-2009.

Sun Med

THE MARK CONSISTS OF STANDARD CHARACTERS WITHOUT CLAIM TO ANY PARTICULAR FONT, STYLE, SIZE, OR COLOR.

PRIORITY DATE OF 8-6-2008 IS CLAIMED.

OWNER OF INTERNATIONAL REGISTRATION 0992926 DATED 2-4-2009, EXPIRES 2-4-2019.

NO CLAIM IS MADE TO THE EXCLUSIVE RIGHT TO USE "SUN", APART FROM THE MARK AS SHOWN.

FOR BLEACHING PREPARATIONS FOR HOUSEHOLD USE; SUBSTANCES FOR LAUNDRY USE, NAMELY, LAUNDRY BLEACH, LAUNDRY DETERGENT, LAUNDRY PRE-SOAK, BLUEING FOR LAUNDRY; CLEANING, POLISHING AND SCOURING PREPARATIONS; GENERAL PURPOSE ABRASIVE LIQUIDS AND POWDERS; SOAPS; ESSENTIAL OILS, COSMETICS, SKIN SOAPS, HAIR LOTION, CLEANING, WASHING, AND POLISHING PREPARATIONS, NAMELY, PREPARATIONS FOR REMOVING GREASE; DENTIFRICES (U.S. CLS. 1, 4, 6, 50, 51 AND 52).

KATHERINE E. HALMEN, EXAMINING ATTORNEY

SN 79-070,050. AMETIS COSMETIC, LYON, FRANCE, FILED 3-4-2009.



A M E T I S

OWNER OF INTERNATIONAL REGISTRATION 1005588 DATED 3-4-2009, EXPIRES 3-4-2019.

THE MARK CONSISTS OF THE WORDING "AMETIS" APPEARING BELOW A DESIGN OF A CIRCLE THAT IS TOTALLY SHADED.

THE WORDING "AMETIS" HAS NO MEANING IN A FOREIGN LANGUAGE.

FOR BLEACHING PREPARATIONS FOR COSMETIC PURPOSES AND HOUSEHOLD USE; SOAPS; PERFUMERY; ESSENTIAL OILS; HAIR LOTIONS; DENTIFRICES; COSMETIC PREPARATIONS FOR SLIMMING PURPOSES; COSMETIC KITS COMPRISING FOUNDATION CREAM, LIPSTICK, LIP GLOSS, MASCARA; COSMETICS; COSMETIC CREAMS; LOTIONS FOR COSMETIC USE; COSMETIC PREPARATIONS FOR SKIN CARE; POMADES FOR COSMETIC USE (U.S. CLS. 1, 4, 6, 50, 51 AND 52).

MARIAM MAHMOUDI, EXAMINING ATTORNEY

CLASS 3—(Continued).

SN 85-002,905. MANA PRODUCTS, INC., LONG ISLAND CITY, NY. FILED 3-31-2010.

BEAUTY AS NATURE INTENDED

THE MARK CONSISTS OF STANDARD CHARACTERS WITHOUT CLAIM TO ANY PARTICULAR FONT, STYLE, SIZE, OR COLOR.

FOR COSMETIC PREPARATIONS FOR BODY CARE; COSMETICS; HAIR CARE PREPARATIONS; NON-MEDICATED SKIN CARE PREPARATIONS (U.S. CLS. 1, 4, 6, 50, 51 AND 52).

ALICE BENMAMAN, EXAMINING ATTORNEY

SN 85-004,689. AMERICAN INTERNATIONAL INDUSTRIES, COMMERCE, CA. FILED 4-1-2010.

FRUTIQUE

THE MARK CONSISTS OF STANDARD CHARACTERS WITHOUT CLAIM TO ANY PARTICULAR FONT, STYLE, SIZE, OR COLOR.

FOR ANTI-AGING CREAMS; BEAUTY CREAMS; COSMETIC PREPARATIONS, NAMELY, FIRING CREAMS; EXFOLIANT CREAMS; EXFOLIANTS FOR SKIN; EYE CREAM; EYE GELS; FACIAL CLEANSERS; FACIAL CREAMS; FACIAL MASKS; MOISTURIZING CREAMS; NIGHT CREAM; SKIN CLEANSERS (U.S. CLS. 1, 4, 6, 50, 51 AND 52).

MARTHA FROMM, EXAMINING ATTORNEY

SN 85-019,105. L'OREAL USA CREATIVE, INC., NEW YORK, NY. FILED 4-21-2010.

24 SMOOTH REPAIR TECHNOLOGY

THE MARK CONSISTS OF STANDARD CHARACTERS WITHOUT CLAIM TO ANY PARTICULAR FONT, STYLE, SIZE, OR COLOR.

OWNER OF U.S. REG. NO. 3,532,030.

NO CLAIM IS MADE TO THE EXCLUSIVE RIGHT TO USE "REPAIR TECHNOLOGY", APART FROM THE MARK AS SHOWN.

FOR A COMBINATION OF INGREDIENTS SOLD AS A COMPONENT PART OF HAIR CARE PREPARATIONS AND HAIR STYLING PREPARATIONS; HAIR CARE PREPARATIONS; AND HAIR STYLING PREPARATIONS (U.S. CLS. 1, 4, 6, 50, 51 AND 52).

JOHN HWANG, EXAMINING ATTORNEY

CLASS 3—(Continued).

SN 85-021,381. PACIFIC WORLD CORPORATION, LAKE FOREST, CA. FILED 4-23-2010.

GEO GIRL

THE MARK CONSISTS OF STANDARD CHARACTERS WITHOUT CLAIM TO ANY PARTICULAR FONT, STYLE, SIZE, OR COLOR.

FOR LIP GLOSSES AND LIP BALMS; EYE SHADOWS, EYE LINERS, MASCARAS; CHEEK BLUSH; ARTIFICIAL FINGERNAILS; NAIL ART, NAMELY, STICKERS AND RHINESTONES; NAIL ART PENS; FINGERNAIL POLISHES; BATH GEL, FIZZING BALLS, AND BUBBLES; BODY CLEANSERS, BODY SCRUBS, BODY LOTIONS; FACIAL CLEANSERS, FACIAL SCRUBS AND FACIAL LOTIONS; BODY SPRAYS CONTAINING FRAGRANCE AND BODY SPRAYS CONTAINING GLITTER; HAIR SHAMPOO AND CONDITIONER (U.S. CLS. 1, 4, 6, 50, 51 AND 52).

JOHN HWANG, EXAMINING ATTORNEY



SN 85-026,378. CHEN, CANDACE, LOS ANGELES, CA. FILED 4-29-2010.

Time To Put Your Face on a Maintenance Schedule

THE MARK CONSISTS OF STANDARD CHARACTERS WITHOUT CLAIM TO ANY PARTICULAR FONT, STYLE, SIZE, OR COLOR.

FOR AFTER SHAVE LOTIONS; ANTI-AGING MOISTURIZER; FACIAL CLEANSERS; NON-MEDICATED FACIAL AND EYE SERUM CONTAINING ANTIOXIDANTS; SHAVING CREAM; SKIN CARE PRODUCTS, NAMELY, NON-MEDICATED SKIN SERUM; SUN SCREEN (U.S. CLS. 1, 4, 6, 50, 51 AND 52).

FIRST USE 4-5-2010; IN COMMERCE 4-5-2010.
LINDA M. KING, EXAMINING ATTORNEY



SN 85-027,019. L'OREAL USA CREATIVE, INC., NEW YORK, NY. FILED 4-30-2010.

COLORTATTOO

THE MARK CONSISTS OF STANDARD CHARACTERS WITHOUT CLAIM TO ANY PARTICULAR FONT, STYLE, SIZE, OR COLOR.

FOR COSMETICS (U.S. CLS. 1, 4, 6, 50, 51 AND 52).
JOHN HWANG, EXAMINING ATTORNEY

CLASS 3—(Continued).

SN 85-029,054. GLOBAL SWEET POLYOLS, LLC, REHOBOTH, MA. FILED 5-3-2010.

FRAGMINTS

THE MARK CONSISTS OF STANDARD CHARACTERS WITHOUT CLAIM TO ANY PARTICULAR FONT, STYLE, SIZE, OR COLOR.

FOR BREATH FRESHENING CONFECTIONARY, NAMELY, DISSOLVABLE BREATH STRIPS, BREATH MINTS, CANDY AND GUM; BREATH MINTS FOR USE AS A BREATH FRESHENER (U.S. CLS. 1, 4, 6, 50, 51 AND 52).

FIRST USE 1-15-2010; IN COMMERCE 1-15-2010.
ALYSSA STEEL, EXAMINING ATTORNEY



CLASS 4—LUBRICANTS AND FUELS

SN 77-520,207. CANDLE LAMP COMPANY, LLC, RIVERSIDE, CA. FILED 7-11-2008.

GREENHEAT

THE MARK CONSISTS OF STANDARD CHARACTERS WITHOUT CLAIM TO ANY PARTICULAR FONT, STYLE, SIZE, OR COLOR.

FOR CHAFING DISH FUEL (U.S. CLS. 1, 6 AND 15).
FIRST USE 6-0-2003; IN COMMERCE 6-0-2003.

TASNEEM HUSSAIN, EXAMINING ATTORNEY



SN 77-880,498. THE ALPHA GROUP OF DELAWARE, INC., DELAWARE, OH. FILED 11-25-2009.

Charcoal Buddy

THE MARK CONSISTS OF STANDARD CHARACTERS WITHOUT CLAIM TO ANY PARTICULAR FONT, STYLE, SIZE, OR COLOR.

NO CLAIM IS MADE TO THE EXCLUSIVE RIGHT TO USE "CHARCOAL", APART FROM THE MARK AS SHOWN.

FOR SOLID FIRE STARTERS (U.S. CLS. 1, 6 AND 15).
FIRST USE 5-22-2009; IN COMMERCE 5-22-2009.
CARYN GLASSER, EXAMINING ATTORNEY

CLASS 4—(Continued).

SN 77-890,750. SMITH MOUNTAIN INDUSTRIES, INC.,
FOREST, VA. FILED 12-10-2009.

MIKA

THE MARK CONSISTS OF STANDARD CHARACTERS
WITHOUT CLAIM TO ANY PARTICULAR FONT, STYLE,
SIZE, OR COLOR.
FOR CANDLES; WICKS FOR CANDLES (U.S. CLS. 1, 6
AND 15).
IRA J. GOODSaid, EXAMINING ATTORNEY

SN 77-891,476. SMITH MOUNTAIN INDUSTRIES, INC.,
FOREST, VA. FILED 12-11-2009.

AMERICAN TREASURES

THE MARK CONSISTS OF STANDARD CHARACTERS
WITHOUT CLAIM TO ANY PARTICULAR FONT, STYLE,
SIZE, OR COLOR.
NO CLAIM IS MADE TO THE EXCLUSIVE RIGHT TO
USE "AMERICAN", APART FROM THE MARK AS SHOWN.
FOR CANDLES; WICKS FOR CANDLES (U.S. CLS. 1, 6
AND 15).
IRA J. GOODSaid, EXAMINING ATTORNEY

SN 77-899,814. SMITH MOUNTAIN INDUSTRIES, INC.,
FOREST, VA. FILED 12-23-2009.

WOOD LITE

THE MARK CONSISTS OF STANDARD CHARACTERS
WITHOUT CLAIM TO ANY PARTICULAR FONT, STYLE,
SIZE, OR COLOR.
FOR CANDLES; WICKS FOR CANDLES (U.S. CLS. 1, 6
AND 15).
IRA J. GOODSaid, EXAMINING ATTORNEY

CLASS 4—(Continued).

SN 77-899,819. SMITH MOUNTAIN INDUSTRIES, INC.,
FOREST, VA. FILED 12-23-2009.

ARBOR GLOW

THE MARK CONSISTS OF STANDARD CHARACTERS
WITHOUT CLAIM TO ANY PARTICULAR FONT, STYLE,
SIZE, OR COLOR.
FOR CANDLES; WICKS FOR CANDLES (U.S. CLS. 1, 6
AND 15).
IRA J. GOODSaid, EXAMINING ATTORNEY

SN 77-926,770. SZEIDER, PETER J., WEST SENECA, NY.
FILED 2-3-2010.



THE MARK CONSISTS OF THE STYLIZED TEXT "BARN
& BUGGY" WITH A BARN.
FOR CANDLES (U.S. CLS. 1, 6 AND 15).
GEORGE LORENZO, EXAMINING ATTORNEY

SN 77-926,858. FOR YOUR PLEASURE INC., PETERBOR-
OUGH, NH. FILED 2-3-2010.

Caress Me Candle

THE MARK CONSISTS OF STANDARD CHARACTERS
WITHOUT CLAIM TO ANY PARTICULAR FONT, STYLE,
SIZE, OR COLOR.
NO CLAIM IS MADE TO THE EXCLUSIVE RIGHT TO
USE "CANDLE", APART FROM THE MARK AS SHOWN.
FOR CANDLES (U.S. CLS. 1, 6 AND 15).
FIRST USE 10-19-2005; IN COMMERCE 10-19-2005.
PATRICIA EVANKO, EXAMINING ATTORNEY

CLASS 4—(Continued).

SN 77-927,105. MAN CAVE, LLC, MINNEAPOLIS, MN. FILED 2-3-2010.

THE KINGS STOCK

THE MARK CONSISTS OF STANDARD CHARACTERS WITHOUT CLAIM TO ANY PARTICULAR FONT, STYLE, SIZE, OR COLOR.
 FOR WOOD CHIPS FOR SMOKING AND GRILLING (U.S. CLS. 1, 6 AND 15).
 FIRST USE 12-7-2008; IN COMMERCE 12-7-2008.
 MAYUR VAGHANI, EXAMINING ATTORNEY

CLASS 4—(Continued).

SN 77-930,764. SNI SOLUTIONS, INC., GENESEO, IL. FILED 2-8-2010.

BIOCOTE

THE MARK CONSISTS OF STANDARD CHARACTERS WITHOUT CLAIM TO ANY PARTICULAR FONT, STYLE, SIZE, OR COLOR.
 FOR DUST LAYING AND ABSORBING COMPOSITION FOR USE ON UNPAVED ROADS; DUST-BINDING COMPOSITIONS (U.S. CLS. 1, 6 AND 15).
 DAVID C. REIHNER, EXAMINING ATTORNEY

SN 77-930,126. CARLINO, CRISTINA M., PHOENIX, AZ. FILED 2-8-2010.

ARCHETYPE

THE MARK CONSISTS OF STANDARD CHARACTERS WITHOUT CLAIM TO ANY PARTICULAR FONT, STYLE, SIZE, OR COLOR.
 FOR CANDLE-MAKING KITS; CANDLES; FIRE LIGHTERS; PATIO TORCHES (U.S. CLS. 1, 6 AND 15).
 APRIL HESIK, EXAMINING ATTORNEY

SN 77-931,012. SUPERIOR GENERAL PARTNER INC., CALGARY, ALBERTA, CANADA, FILED 2-8-2010.

SUPERIOR

THE MARK CONSISTS OF STANDARD CHARACTERS WITHOUT CLAIM TO ANY PARTICULAR FONT, STYLE, SIZE, OR COLOR.
 OWNER OF U.S. REG. NOS. 3,263,583 AND 3,411,223. SEC. 2(F).
 FOR LIQUEFIED PETROLEUM GAS (U.S. CLS. 1, 6 AND 15).
 FIRST USE 2-0-2005; IN COMMERCE 2-0-2005.
 KIM MONINGHOFF, EXAMINING ATTORNEY

SN 77-930,747. SNI SOLUTIONS, INC., GENESEO, IL. FILED 2-8-2010.

BIO

THE MARK CONSISTS OF STANDARD CHARACTERS WITHOUT CLAIM TO ANY PARTICULAR FONT, STYLE, SIZE, OR COLOR.
 FOR DUST LAYING AND ABSORBING COMPOSITION FOR USE ON UNPAVED ROADS; DUST-BINDING COMPOSITIONS (U.S. CLS. 1, 6 AND 15).
 DAVID C. REIHNER, EXAMINING ATTORNEY

SN 77-931,426. SHOP COLETTE LTD., DBA SHOP COLETTE LTD., CHICAGO, IL. FILED 2-9-2010.

Shop Colette

THE MARK CONSISTS OF STANDARD CHARACTERS WITHOUT CLAIM TO ANY PARTICULAR FONT, STYLE, SIZE, OR COLOR.
 NO CLAIM IS MADE TO THE EXCLUSIVE RIGHT TO USE "SHOP", APART FROM THE MARK AS SHOWN.
 FOR CANDLES (U.S. CLS. 1, 6 AND 15).
 CURTIS FRENCH, EXAMINING ATTORNEY

CLASS 4—(Continued).

SN 77-957,691. INTERNATIONAL DESIGN ASSOCIATES LTD, NEW YORK, NY. FILED 3-12-2010.

FLOWER MARKET

THE MARK CONSISTS OF STANDARD CHARACTERS WITHOUT CLAIM TO ANY PARTICULAR FONT, STYLE, SIZE, OR COLOR.

FOR FRAGRANT WAX FOR USE IN POTPOURRI BURNERS; SCENTED CANDLES; TAPERS (U.S. CLS. 1, 6 AND 15).

FIRST USE 3-11-2010; IN COMMERCE 3-11-2010.

WARREN L. OLANDRIA, EXAMINING ATTORNEY

SN 77-979,255. SALT CITY CANDLE COMPANY, INC., WEST JORDAN, UT. FILED 11-6-2008.

MELTER TOWER

THE MARK CONSISTS OF STANDARD CHARACTERS WITHOUT CLAIM TO ANY PARTICULAR FONT, STYLE, SIZE, OR COLOR.

NO CLAIM IS MADE TO THE EXCLUSIVE RIGHT TO USE "MELTER", APART FROM THE MARK AS SHOWN.

FOR WICKLESS CANDLES AND FRAGRANT WAX (U.S. CLS. 1, 6 AND 15).

FIRST USE 7-1-2008; IN COMMERCE 7-1-2008.

DAVID I, EXAMINING ATTORNEY

CLASS 5—PHARMACEUTICALS

SN 77-076,153. GLAXOSMITHKLINE BIOLOGICALS, S.A., RIXENSART, BELGIUM, FILED 1-4-2007.

PANDEMVAL

THE MARK CONSISTS OF STANDARD CHARACTERS WITHOUT CLAIM TO ANY PARTICULAR FONT, STYLE, SIZE, OR COLOR.

PRIORITY CLAIMED UNDER SEC. 44(D) ON UNITED KINGDOM APPLICATION NO. 2440752, FILED 12-6-2006, REG. NO. 2440752, DATED 12-6-2006, EXPIRES 12-6-2016.

FOR VACCINES FOR HUMAN USE (U.S. CLS. 6, 18, 44, 46, 51 AND 52).

MORGAN WYNNE, EXAMINING ATTORNEY

CLASS 5—(Continued).

SN 77-134,467. GLAXOSMITHKLINE BIOLOGICALS, S.A., RIXENSART, BELGIUM, FILED 3-19-2007.

RESMURIX

THE MARK CONSISTS OF STANDARD CHARACTERS WITHOUT CLAIM TO ANY PARTICULAR FONT, STYLE, SIZE, OR COLOR.

PRIORITY CLAIMED UNDER SEC. 44(D) ON UNITED KINGDOM APPLICATION NO. 2445561, FILED 2-2-2007, REG. NO. 2445561, DATED 2-2-2007, EXPIRES 2-2-2017.

FOR VACCINES FOR HUMAN USE (U.S. CLS. 6, 18, 44, 46, 51 AND 52).

MORGAN WYNNE, EXAMINING ATTORNEY

SN 77-134,485. GLAXOSMITHKLINE BIOLOGICALS, S.A., RIXENSART, BELGIUM, FILED 3-19-2007.

BEKORIX

THE MARK CONSISTS OF STANDARD CHARACTERS WITHOUT CLAIM TO ANY PARTICULAR FONT, STYLE, SIZE, OR COLOR.

PRIORITY CLAIMED UNDER SEC. 44(D) ON UNITED KINGDOM APPLICATION NO. 2448433, FILED 3-5-2007, REG. NO. 2448433, DATED 3-5-2007, EXPIRES 3-5-2017.

FOR VACCINES FOR HUMAN USE (U.S. CLS. 6, 18, 44, 46, 51 AND 52).

MORGAN WYNNE, EXAMINING ATTORNEY

SN 77-414,459. KOA GLASS CO., LTD., TOKYO, JAPAN, FILED 3-6-2008.

MILLIONGUARD

THE MARK CONSISTS OF STANDARD CHARACTERS WITHOUT CLAIM TO ANY PARTICULAR FONT, STYLE, SIZE, OR COLOR.

PRIORITY CLAIMED UNDER SEC. 44(D) ON JAPAN APPLICATION NO. 2008-15593, FILED 3-3-2008.

OWNER OF JAPAN REG. NO. 5154336, DATED 7-25-2008, EXPIRES 7-25-2018.

FOR INORGANIC ANTIMICROBIAL PREPARATIONS TO PREVENT, WEAKEN AND/OR KILL BACTERIA, FUNGI, CYANOBACTERIA, DIATOM AND VIRUSES FOR INDUSTRIAL USE (U.S. CLS. 6, 18, 44, 46, 51 AND 52).

WANDA KAY PRICE, EXAMINING ATTORNEY

CLASS 5—(Continued).

SN 77-480,957. CRITICAL BIOLOGICS CORPORATION, LEBANON, NJ. FILED 5-22-2008.

CLASS 5—(Continued).

SN 77-580,428. HISAMITSU PHARMACEUTICAL CO., INC., TOSU-SHI, SAGA, JAPAN, FILED 9-27-2008.

SOLINEX

THE MARK CONSISTS OF STANDARD CHARACTERS WITHOUT CLAIM TO ANY PARTICULAR FONT, STYLE, SIZE, OR COLOR.

FOR PHARMACEUTICAL OR MEDICAL PREPARATIONS FOR USE IN THE TREATMENT, DIAGNOSIS, MONITORING AND PREVENTION OF MEDICAL CONDITIONS, NAMELY, RESPIRATORY DISORDERS, PULMONARY DISEASES, KIDNEY DISEASES, DIABETES, BLOOD DISORDERS, CARDIAC DISEASES, TRAUMATIC INJURY, METABOLIC DISEASES, NEUROLOGICAL DISORDERS, INFLAMMATORY DISEASES AND INFECTIONS (U.S. CLS. 6, 18, 44, 46, 51 AND 52).

ALICIA COLLINS, EXAMINING ATTORNEY



SN 77-486,925. ASTRAZENECA AB, SÖDERTÄLJE, SWEDEN, FILED 5-30-2008.

ICIRCRI

THE MARK CONSISTS OF STANDARD CHARACTERS WITHOUT CLAIM TO ANY PARTICULAR FONT, STYLE, SIZE, OR COLOR.

PRIORITY CLAIMED UNDER SEC. 44(D) ON ERPNCMNTY TM OFC APPLICATION NO. 6531495, FILED 12-20-2007, REG. NO. 6531495, DATED 11-21-2008, EXPIRES 12-20-2017.

FOR PHARMACEUTICAL PREPARATIONS FOR THE TREATMENT OF DISEASES AND DISORDERS OF THE CARDIOVASCULAR, GASTROINTESTINAL, RESPIRATORY AND NERVOUS SYSTEMS; PHARMACEUTICAL PREPARATIONS FOR THE TREATMENT OF PAIN, INFLAMMATION AND INFECTION; PHARMACEUTICAL PREPARATIONS FOR THE TREATMENT OF CANCER AND DIABETES (U.S. CLS. 6, 18, 44, 46, 51 AND 52).

JASON TURNER, EXAMINING ATTORNEY

OWNER OF UNITED KINGDOM REG. NO. 2520381, DATED 7-6-2009, EXPIRES 7-6-2019.

OWNER OF U.S. REG. NOS. 2,963,568, 3,102,070 AND OTHERS.

THE COLOR(S) BLUE, WHITE AND YELLOW IS/ARE CLAIMED AS A FEATURE OF THE MARK.

THIS IS A MOTION MARK CONSISTING OF THE STYLIZED WORDING "HISAMITSU" IN THE UPPER-LEFT CORNER OF THE MARK, THE WORD "SALONPAS" IN THE MIDDLE OF THE MARK, BOTH COLORED WHITE, AND THE PHRASE "BE MORE ACTIVE" DIRECTLY UNDERNEATH AND COLORED IN YELLOW, ALL AGAINST A DARK BLUE BACKGROUND. THE MOTION MARK FURTHER CONSISTS OF AN ANIMATED SEQUENCE OF IMAGES IN WHICH THE LETTERS OF THE WORD "SALONPAS" APPEAR SEQUENTIALLY FROM LEFT TO RIGHT AND GROW IN SIZE UNTIL THEY COMPLETELY SPELL OUT THE WORD "SALONPAS". AFTER "SALONPAS" IS SPELLED OUT, THE PHRASE "BE MORE ACTIVE" APPEARS QUICKLY INTO VIEW BELOW THE WORD "SALONPAS".

FOR EXTERNAL ANALGESIC PHARMACEUTICALS FOR THE RELIEF OF ACHEs AND PAINS OF MUSCLES AND JOINTS ASSOCIATED WITH ARTHRITIS, SIMPLE BACKACHES, STRAINS, BRUISES AND SPRAINS (U.S. CLS. 6, 18, 44, 46, 51 AND 52).

NICHOLAS ALTREE, EXAMINING ATTORNEY

CLASS 5—(Continued).

SN 77-645,699. ACTIVE ORGANICS, LP, LEWISVILLE, TX. FILED 1-8-2009.

ACTIVE ORGANICS

THE MARK CONSISTS OF STANDARD CHARACTERS WITHOUT CLAIM TO ANY PARTICULAR FONT, STYLE, SIZE, OR COLOR.

NO CLAIM IS MADE TO THE EXCLUSIVE RIGHT TO USE "ORGANICS", APART FROM THE MARK AS SHOWN. SEC. 2(F).

FOR MEDICATED SKIN CARE PREPARATIONS INCLUDING, EXFOLIANTS, SCRUBS, PEELS, MOISTURIZERS AND CLEANSERS, ALL FOR TOPICAL APPLICATION TO THE SKIN; MEDICATED LOTIONS, GELS, CREAMS AND SERUMS FOR USE ON THE SKIN; MEDICATED FACIAL MASKS; MEDICATED SUN SCREEN PREPARATIONS; MEDICATED HAIR CARE PREPARATIONS; ALL OF THE AFOREMENTIONED GOODS ARE IN WHOLE OR IN PART COMPRISED OF ORGANIC MATERIALS (U.S. CLS. 6, 18, 44, 46, 51 AND 52).

FIRST USE 12-10-1981; IN COMMERCE 12-10-1981. LAURIE KAUFMAN, EXAMINING ATTORNEY

CLASS 5—(Continued).

SN 77-696,985. SCHERING CORPORATION, KENILWORTH, NJ. FILED 3-23-2009.



THE COLOR(S) PURPLE AND GREEN IS/ARE CLAIMED AS A FEATURE OF THE MARK.

THE MARK CONSISTS OF A STYLIZED DRAWING OF A LEAF DESIGN WITH A SHADOW UNDERNEATH IT. THE TOP TO MIDDLE PORTION OF THE LEAF IS PURPLE (PANTONE 5205) AND THE END PORTION OF THE LEAF IS LIGHT PURPLE. THE STYLIZED DRAWING OF THE SHADOW UNDERNEATH THE LEAF IS GREEN (PANTONE 5797). THE COLOR WHITE REPRESENTS BACKGROUND, OUTLINING, SHADING OR TRANSPARENT AREAS AND IS NOT PART OF THE MARK.

FOR PHARMACEUTICAL PREPARATIONS RELATING TO WOMEN'S HEALTH FOR THE TREATMENT OF GYNECOLOGICAL DISORDERS (U.S. CLS. 6, 18, 44, 46, 51 AND 52). AMEEN IMAM, EXAMINING ATTORNEY

SN 77-700,661. URL PHARMA, INC., PHILADELPHIA, PA. FILED 3-27-2009.



NO CLAIM IS MADE TO THE EXCLUSIVE RIGHT TO USE "PHARMA" AND "MEDICINES", APART FROM THE MARK AS SHOWN.

THE MARK CONSISTS OF TWO CIRCLES, ONE SUPERIMPOSED ON THE OTHER. THE FIRST CIRCLE HAS THE TERM "URL" WRITTEN INSIDE OF IT. THE WORDS "PHARMA" AND "SMARTER SCIENCE." AND "SAFER MEDICINES." ARE WRITTEN TO THE RIGHT OF THE CIRCLES.

FOR MEDICINES AND MEDICAMENTS FOR THE TREATMENT AND PREVENTION OF MALARIA, BLOOD DISORDERS, NAMELY, DYSLIPIDEMIAS, RHEUMATIC DISORDERS, INFLAMMATORY DISORDERS, METABOLIC DISORDERS, NAMELY, GOUT AND FAMILIAL MEDITERRANEAN FEVER; A FULL LINE OF PRESCRIPTION AND NON-PRESCRIPTION PHARMACEUTICALS, MEDICINES AND MEDICAMENTS (U.S. CLS. 6, 18, 44, 46, 51 AND 52). INGA ERVIN, EXAMINING ATTORNEY

SN 77-664,344. AMDL, INC., TUSTIN, CA. FILED 2-5-2009.

DR-70

THE MARK CONSISTS OF STANDARD CHARACTERS WITHOUT CLAIM TO ANY PARTICULAR FONT, STYLE, SIZE, OR COLOR.

FOR REAGENTS FOR CLINICAL MEDICAL LABORATORY USE SOLD AS A COMPONENT OF A DIAGNOSTIC KIT FOR DISEASE TESTING (U.S. CLS. 6, 18, 44, 46, 51 AND 52).

FIRST USE 5-1-1996; IN COMMERCE 5-1-1997. MICHELLE DUBOIS, EXAMINING ATTORNEY

CLASS 5—(Continued).

SN 77-735,793. WOODBOLT DISTRIBUTION LLC, BRYAN, TX. FILED 5-13-2009.

D4 Thermal Shock

THE MARK CONSISTS OF STANDARD CHARACTERS WITHOUT CLAIM TO ANY PARTICULAR FONT, STYLE, SIZE, OR COLOR.

OWNER OF U.S. REG. NO. 2,838,850.
FOR DIETARY AND NUTRITIONAL SUPPLEMENTS; DIETARY SUPPLEMENTS; DIETARY SUPPLEMENTS FOR HUMAN CONSUMPTION; NUTRITIONAL SUPPLEMENTS (U.S. CLS. 6, 18, 44, 46, 51 AND 52).
FIRST USE 7-15-2006; IN COMMERCE 1-18-2007.
RUSS HERMAN, EXAMINING ATTORNEY

SN 77-770,511. NEW CHAPTER, INC., BRATTLEBORO, VT. FILED 6-29-2009.

BOTANICAL ANTIOXIDANT STABILITY SYSTEM

THE MARK CONSISTS OF STANDARD CHARACTERS WITHOUT CLAIM TO ANY PARTICULAR FONT, STYLE, SIZE, OR COLOR.

NO CLAIM IS MADE TO THE EXCLUSIVE RIGHT TO USE "BOTANICAL ANTIOXIDANT", APART FROM THE MARK AS SHOWN.

FOR ANTIOXIDANT VITAMINS, NUTRITIONAL AND DIETARY SUPPLEMENTS (U.S. CLS. 6, 18, 44, 46, 51 AND 52).
KELLY TRUSILO, EXAMINING ATTORNEY

SN 77-775,278. FRESENIUS KABI AG, FRANKFURT, FED REP GERMANY, FILED 7-7-2009.



OWNER OF U.S. REG. NOS. 1,756,408, 1,861,731 AND 2,699,208.

THE STIPPLING IS FOR SHADING PURPOSES ONLY.
THE MARK CONSISTS OF THREE VERTICAL WAVY STRIPES COMPRISING A WAVY BAND TO THE LEFT OF THE WORDING "FRESENIUS KABI".

FOR PHARMACEUTICAL PREPARATIONS, NAMELY, PREPARATIONS FOR BLOOD VOLUME REPLACEMENT (U.S. CLS. 6, 18, 44, 46, 51 AND 52).
SUZANNE BLANE, EXAMINING ATTORNEY

CLASS 5—(Continued).

SN 77-783,621. U.S. NUTRACEUTICALS, L.L.C., DBA VA-LENSA INTERNATIONAL, EUSTIS, FL. FILED 7-17-2009.

OMEGA VISION

THE MARK CONSISTS OF STANDARD CHARACTERS WITHOUT CLAIM TO ANY PARTICULAR FONT, STYLE, SIZE, OR COLOR.

NO CLAIM IS MADE TO THE EXCLUSIVE RIGHT TO USE "OMEGA", APART FROM THE MARK AS SHOWN.

FOR VITAMINS AND NUTRITIONAL SUPPLEMENTS, ALL CONTAINING OMEGA-3 FATTY ACIDS (U.S. CLS. 6, 18, 44, 46, 51 AND 52).

KATHERINE CONNOLLY, EXAMINING ATTORNEY

SN 77-788,959. CSL BEHRING GMBH, MARBURG, FED REP GERMANY, FILED 7-24-2009.

INHIBLO

THE MARK CONSISTS OF STANDARD CHARACTERS WITHOUT CLAIM TO ANY PARTICULAR FONT, STYLE, SIZE, OR COLOR.

OWNER OF UNITED KINGDOM REG. NO. 2496615, DATED 12-19-2008, EXPIRES 9-3-2018.

OWNER OF ERP N CMNTY TM OFC REG. NO. 007533086, DATED 8-10-2009, EXPIRES 1-19-2019.

FOR PHARMACEUTICAL PREPARATIONS AND SUBSTANCES FOR THE TREATMENT OF BLOOD OR BLEEDING DISORDERS; PHARMACEUTICAL PREPARATIONS FOR THE TREATMENT OF DEFICIENCIES OF BLOOD COAGULATION; BLOOD FACTOR XIII FOR THE TREATMENT OF BLOOD OR BLEEDING DISORDERS (U.S. CLS. 6, 18, 44, 46, 51 AND 52).

EVELYN BRADLEY, EXAMINING ATTORNEY

CLASS 5—(Continued).

SN 77-790,302. YUNG SHIN PHARM. IND. CO., LTD., TACHIA TAICHUNG, TAIWAN, FILED 7-27-2009.

漢鼎

THE MARK CONSISTS OF CHINESE CHARACTERS. THE NON-LATIN CHARACTERS IN THE MARK TRANSLITERATE TO HAN DEAN AND "HAN" MEANS "CHINESE PEOPLE OR LANGUAGE" IN ENGLISH AND "DEAN" MEANS "A THREE-LEGGED ANCIENT CHINESE COOKING VESSEL" IN ENGLISH.

FOR MEDICINAL HERBS; FOUR SUBSTANCE DECOCTION PILLS FOR MEDICINAL PURPOSES; LOQUAT SYRUP FOR MEDICINAL PURPOSES; TRANSDERMAL PATCHES FOR PAIN RELIEF; MOXA STICKS FOR MEDICINAL PURPOSES, NAMELY, MOXIBUSTION; MEDICINAL ALCOHOLIC BEVERAGES FOR PAIN RELIEF; PHARMACEUTICAL PREPARATIONS IN THE FORM OF KNEAD FOR PAIN RELIEF; GINSENG FOR MEDICINAL USE; FEVER RELIEF TABLET AND PILLS; MENSTRUAL SYMPTOM TREATMENT PREPARATIONS; PHARMACEUTICAL PREPARATIONS FOR THE PREVENTION AND TREATMENT OF KIDNEY DISEASES; PHARMACEUTICAL PREPARATIONS FOR FACILITATING BLOOD GENERATION; PHARMACEUTICAL PREPARATIONS FOR WEIGHT GAIN; DIET PILLS; PHARMACEUTICAL PREPARATIONS FOR THE TREATMENT OF ECZEMA; PHARMACEUTICAL PREPARATIONS FOR THE TREATMENT OF GOUT; PHARMACEUTICAL PREPARATIONS FOR THE TREATMENT OF ARTHRITIS; PHARMACEUTICAL PREPARATIONS FOR BOOSTING ENERGY; PHARMACEUTICAL PREPARATIONS FOR THE TREATMENT OF BURNS; ACNE TREATMENT PREPARATIONS; PHARMACEUTICAL ANTI-ALLERGIC PREPARATIONS AND SUBSTANCES; ANTIDEPRESSANTS; PHARMACEUTICAL PREPARATIONS FOR THE PREVENTION AND TREATMENT OF DISORDERS OF THE IMMUNE SYSTEM; PHARMACEUTICAL PREPARATIONS FOR TREATING DIABETES; CHOLESTEROL REDUCERS; HYPNOTICS; GASTRO-INTESTINAL TREATMENT PREPARATIONS; NUTRITIONAL SUPPLEMENTS FOR ELIMINATING TOXINS FROM THE LIVER; VITAMINS; VITAMIN PREPARATIONS; CALCIUM SUPPLEMENTS, NAMELY, CALCIUM POWDER; MULTIVITAMIN PREPARATIONS; HEPATOPROTECTIVE AGENTS FOR MEDICINAL PURPOSES, NAMELY, LIVER FUNCTION PROTECTIVE AGENT; TRANSDERMAL ANTI-INFLAMMATORY ANALGESIC ADHESIVE PATCHES FOR MEDICINAL PURPOSES; PHARMACEUTICAL PREPARATIONS IN THE FORM OF SOAK FOR PAIN RELIEF; VITAMIN SUPPLEMENT IN TABLET FORM FOR USE IN MAKING AN EFFERVESCENT BEVERAGE WHEN ADDED TO WATER; MINERAL NUTRITIONAL SUPPLEMENTS; MINERAL FOOD SUPPLEMENTS; PROTEIN SUPPLEMENTS; NUTRITIONAL SUPPLEMENTS; PLANT FIBER NUTRITIONAL SUPPLEMENTS; FOOD SUPPLEMENTS, NAMELY, ANTI-OXIDANTS; DIETARY SUPPLEMENTS FOR MEDICAL USE CONTAINING LACTIC ACID BACTERIA; VITAMIN AND MINERAL SUPPLEMENTS; MEDICINAL DRINKS FOR MEDICAL USE, FOR USE IN BODY MAINTENANCE AND WEIGHT CONTROL; DIETETIC FOOD PRODUCTS FOR MEDICAL USE, FOR USE IN BODY MAINTENANCE AND WEIGHT CONTROL; TEAS FOR MEDICAL USE, FOR USE IN BODY MAINTENANCE AND WEIGHT CONTROL; LECITHIN FOR USE AS A DIETARY SUPPLEMENT; DIETARY AND NUTRITIONALLY FORTIFIED FOOD PRODUCTS ADAPTED FOR MEDICAL USE; DIETARY FIBER POWDER AS AN ADDITIVE FOR FOOD PRODUCTS FOR RESTRICTED DIET; FOOD FOR BABIES (U.S. CLS. 6, 18, 44, 46, 51 AND 52).

MICHELE SWAIN, EXAMINING ATTORNEY

CLASS 5—(Continued).

SN 77-792,224. GULF COAST NUTRITIONALS, INC., NAPLES, FL. FILED 7-29-2009.

SEA MOBILITY JOINT RESCUE

THE MARK CONSISTS OF STANDARD CHARACTERS WITHOUT CLAIM TO ANY PARTICULAR FONT, STYLE, SIZE, OR COLOR.

OWNER OF U.S. REG. NOS. 2,316,662 AND 2,620,077.

NO CLAIM IS MADE TO THE EXCLUSIVE RIGHT TO USE "JOINT", APART FROM THE MARK AS SHOWN.

FOR PET FOOD SUPPLEMENT (U.S. CLS. 6, 18, 44, 46, 51 AND 52).

JENNY PARK, EXAMINING ATTORNEY

SN 77-792,233. YUNG SHIN PHARM. IND. CO., LTD., TACHIA TAICHUNG, TAIWAN, FILED 7-29-2009.

HanDean

THE MARK CONSISTS OF STANDARD CHARACTERS WITHOUT CLAIM TO ANY PARTICULAR FONT, STYLE, SIZE, OR COLOR.

THE WORDING "HANDEAN" HAS NO MEANING IN A FOREIGN LANGUAGE.

FOR MEDICINAL HERBS; FOUR SUBSTANCE DECOCTION PILLS FOR MEDICINAL PURPOSES; LOQUAT SYRUP FOR MEDICINAL PURPOSES; TRANSDERMAL PATCHES FOR PAIN RELIEF; MOXA STICKS FOR MEDICINAL PURPOSES, NAMELY, MOXIBUSTION; MEDICINAL ALCOHOLIC BEVERAGES FOR PAIN RELIEF; PHARMACEUTICAL PREPARATIONS IN THE FORM OF KNEAD FOR PAIN RELIEF; GINSENG FOR MEDICINAL USE; FEVER RELIEF TABLET AND PILLS; MENSTRUAL SYMPTOM TREATMENT PREPARATIONS; PHARMACEUTICAL PREPARATIONS FOR THE PREVENTION AND TREATMENT OF KIDNEY DISEASES; PHARMACEUTICAL PREPARATIONS FOR FACILITATING BLOOD GENERATION; PHARMACEUTICAL PREPARATIONS FOR WEIGHT GAIN; DIET PILLS; PHARMACEUTICAL PREPARATIONS FOR THE TREATMENT OF ECZEMA; PHARMACEUTICAL PREPARATIONS FOR THE TREATMENT OF GOUT; PHARMACEUTICAL PREPARATIONS FOR THE TREATMENT OF ARTHRITIS; PHARMACEUTICAL PREPARATIONS FOR BOOSTING ENERGY; PREPARATIONS FOR THE TREATMENT OF BURNS; ACNE TREATMENT PREPARATIONS; PHARMACEUTICAL ANTI-ALLERGIC PREPARATIONS AND SUBSTANCES; ANTIDEPRESSANTS; PHARMACEUTICAL PREPARATIONS FOR THE PREVENTION AND TREATMENT OF DISORDERS OF THE IMMUNE SYSTEM; PHARMACEUTICAL PREPARATIONS FOR TREATING DIABETES; CHOLESTEROL REDUCERS; HYPNOTICS; GASTRO-INTESTINAL TREATMENT PREPARATIONS; NUTRITIONAL SUPPLEMENTS FOR ELIMINATING TOXINS FROM THE LIVER; VITAMINS; VITAMIN PREPARATIONS; CALCIUM SUPPLEMENTS, NAMELY, CALCIUM POWDER; MULTI-VITAMIN PREPARATIONS; HEPATOPROTECTIVE AGENTS FOR MEDICINAL PURPOSES, NAMELY, LIVER FUNCTION PROTECTIVE AGENT; TRANSDERMAL ANTI-INFLAMMATORY ANALGESIC ADHESIVE PATCHES FOR MEDICINAL PURPOSES; PHARMACEUTICAL PREPARATIONS IN THE FORM OF SOAK FOR PAIN RELIEF; VITAMIN SUPPLEMENT IN TABLET

CLASS 5—(Continued).

FORM FOR USE IN MAKING AN EFFERVESCENT BEVERAGE WHEN ADDED TO WATER; MINERAL NUTRITIONAL SUPPLEMENTS; MINERAL FOOD SUPPLEMENTS; PROTEIN SUPPLEMENTS; NUTRITIONAL SUPPLEMENTS; PLANT FIBER NUTRITIONAL SUPPLEMENTS; FOOD SUPPLEMENTS, NAMELY, ANTI-OXIDANTS; DIETARY SUPPLEMENTS FOR MEDICAL USE CONTAINING LACTIC ACID BACTERIA; VITAMIN AND MINERAL SUPPLEMENTS; MEDICINAL DRINKS FOR MEDICAL USE, FOR USE IN BODY MAINTENANCE AND WEIGHT CONTROL; DIETETIC FOOD PRODUCTS FOR MEDICAL USE, FOR USE IN BODY MAINTENANCE AND WEIGHT CONTROL; TEAS FOR MEDICAL USE, FOR USE IN BODY MAINTENANCE AND WEIGHT CONTROL; LECITHIN FOR USE AS A DIETARY SUPPLEMENT; DIETARY AND NUTRITIONALLY FORTIFIED FOOD PRODUCTS ADAPTED FOR MEDICAL USE; DIETARY FIBER POWDER AS AN ADDITIVE FOR FOOD PRODUCTS FOR RESTRICTED DIET; FOOD FOR BABIES (U.S. CLS. 6, 18, 44, 46, 51 AND 52).

MICHELE SWAIN, EXAMINING ATTORNEY

SN 77-795,849. BIOSYNC, LLC, GREEN LAKE, WI. FILED 8-3-2009.

BIO-LONGEVITY

THE MARK CONSISTS OF STANDARD CHARACTERS WITHOUT CLAIM TO ANY PARTICULAR FONT, STYLE, SIZE, OR COLOR.

FOR DIETARY AND NUTRITIONAL SUPPLEMENTS (U.S. CLS. 6, 18, 44, 46, 51 AND 52).

FIRST USE 2-1-2005; IN COMMERCE 2-1-2005.

MARK SPARACINO, EXAMINING ATTORNEY

SN 77-796,187. BIOSYNC, LLC, GREEN LAKE, WI. FILED 8-4-2009.

BIO-JOINT EASE

THE MARK CONSISTS OF STANDARD CHARACTERS WITHOUT CLAIM TO ANY PARTICULAR FONT, STYLE, SIZE, OR COLOR.

FOR DIETARY AND NUTRITIONAL SUPPLEMENTS (U.S. CLS. 6, 18, 44, 46, 51 AND 52).

FIRST USE 3-10-2004; IN COMMERCE 3-10-2004.

MARK SPARACINO, EXAMINING ATTORNEY

CLASS 5—(Continued).

SN 77-796,188. BIOSYNC, LLC, GREEN LAKE, WI. FILED 8-4-2009.

BIO-DAILY ESSENTIALS

THE MARK CONSISTS OF STANDARD CHARACTERS WITHOUT CLAIM TO ANY PARTICULAR FONT, STYLE, SIZE, OR COLOR.

NO CLAIM IS MADE TO THE EXCLUSIVE RIGHT TO USE "ESSENTIALS", APART FROM THE MARK AS SHOWN.

FOR DIETARY AND NUTRITIONAL SUPPLEMENTS (U.S. CLS. 6, 18, 44, 46, 51 AND 52).

FIRST USE 3-10-2004; IN COMMERCE 3-10-2004.

MARK SPARACINO, EXAMINING ATTORNEY

SN 77-796,557. TAOS HERB COMPANY, INC., TAOS, NM. FILED 8-4-2009.

TAOS HERB CO.

THE MARK CONSISTS OF STANDARD CHARACTERS WITHOUT CLAIM TO ANY PARTICULAR FONT, STYLE, SIZE, OR COLOR.

NO CLAIM IS MADE TO THE EXCLUSIVE RIGHT TO USE "HERB CO.", APART FROM THE MARK AS SHOWN. SEC. 2(F).

FOR ANTI-ITCH OINTMENT; BEE POLLEN FOR USE AS A DIETARY FOOD SUPPLEMENT; COUGH TREATMENT PREPARATIONS; DIETARY AND NUTRITIONAL SUPPLEMENTS; DIETARY SUPPLEMENTS; DIETARY SUPPLEMENTS FOR HUMAN CONSUMPTION; GROUND FLAXSEED FIBER FOR USE AS A DIETARY SUPPLEMENT; HEMORRHOIDAL OINTMENTS; HERB TEAS FOR MEDICINAL PURPOSES; HERBAL SUPPLEMENTS; HERBAL TEAS FOR MEDICINAL PURPOSES; HERBS FOR MEDICINAL PURPOSES; INSECT REPELLENTS; LECITHIN FOR USE AS A DIETARY SUPPLEMENT; MEDICINAL HERB EXTRACTS; MEDICINAL HERBAL EXTRACTS FOR MEDICAL PURPOSES; MEDICINAL HERBS; MEDICINAL HERBS IN DRIED OR PRESERVED FORM; MEDICINAL TEA; MINERAL NUTRITIONAL SUPPLEMENTS; NATURAL HERBAL SUPPLEMENTS; NUTRACEUTICALS FOR USE AS A DIETARY SUPPLEMENT; NUTRITIONAL SUPPLEMENTS; VITAMIN AND MINERAL SUPPLEMENTS; VITAMIN SUPPLEMENTS (U.S. CLS. 6, 18, 44, 46, 51 AND 52).

FIRST USE 1-9-1981; IN COMMERCE 2-1-1981.

AARON BRODSKY, EXAMINING ATTORNEY

CLASS 5—(Continued).

SN 77-796,699. LANG DENTAL MANUFACTURING CO., INC., WHEELING, IL. FILED 8-4-2009.

FLEXACRYL

THE MARK CONSISTS OF STANDARD CHARACTERS WITHOUT CLAIM TO ANY PARTICULAR FONT, STYLE, SIZE, OR COLOR.

FOR DENTAL MATERIALS, NAMELY, ETHYL METHACRYLATE ACRYLIC RESINS FOR RELINING PROSTHETIC DENTURES (U.S. CLS. 6, 18, 44, 46, 51 AND 52).

FIRST USE 0-0-1965; IN COMMERCE 1-0-1965.

KATHLEEN LORENZO, EXAMINING ATTORNEY

CLASS 5—(Continued).

SN 77-797,778. JPI COMMERCIAL, LLC, PALO ALTO, CA. FILED 8-5-2009.

REKINLA

THE MARK CONSISTS OF STANDARD CHARACTERS WITHOUT CLAIM TO ANY PARTICULAR FONT, STYLE, SIZE, OR COLOR.

FOR PHARMACEUTICAL PREPARATIONS ACTING ON THE CENTRAL NERVOUS SYSTEM; PHARMACEUTICAL PREPARATIONS ACTING ON THE MUSCULOSKELETAL SYSTEM; PHARMACEUTICAL PREPARATIONS FOR USE IN MANAGING FIBROMYALGIA (U.S. CLS. 6, 18, 44, 46, 51 AND 52).

GISELLE AGOSTO, EXAMINING ATTORNEY

SN 77-796,710. LANG DENTAL MANUFACTURING CO., INC., WHEELING, IL. FILED 8-4-2009.

SPLINTLINE

THE MARK CONSISTS OF STANDARD CHARACTERS WITHOUT CLAIM TO ANY PARTICULAR FONT, STYLE, SIZE, OR COLOR.

FOR DENTAL MATERIALS, NAMELY, COPOLYMER RESIN FORMULATIONS FOR MAKING TEMPORARY CROWN AND BRIDGE RESTORATIONS (U.S. CLS. 6, 18, 44, 46, 51 AND 52).

FIRST USE 0-0-1968; IN COMMERCE 0-0-1968.

KATHLEEN LORENZO, EXAMINING ATTORNEY

SN 77-797,803. JPI COMMERCIAL, LLC, PALO ALTO, CA. FILED 8-5-2009.

MYARIVE

THE MARK CONSISTS OF STANDARD CHARACTERS WITHOUT CLAIM TO ANY PARTICULAR FONT, STYLE, SIZE, OR COLOR.

FOR PHARMACEUTICAL PREPARATIONS ACTING ON THE CENTRAL NERVOUS SYSTEM; PHARMACEUTICAL PREPARATIONS ACTING ON THE MUSCULOSKELETAL SYSTEM; PHARMACEUTICAL PREPARATIONS FOR USE IN MANAGING FIBROMYALGIA (U.S. CLS. 6, 18, 44, 46, 51 AND 52).

GISELLE AGOSTO, EXAMINING ATTORNEY

SN 77-796,711. LANG DENTAL MANUFACTURING CO., INC., WHEELING, IL. FILED 8-4-2009.

TEMPO

THE MARK CONSISTS OF STANDARD CHARACTERS WITHOUT CLAIM TO ANY PARTICULAR FONT, STYLE, SIZE, OR COLOR.

FOR DENTAL MATERIALS, NAMELY, ACRYLIC RESINS FOR DENTAL RELINING PROSTHETIC DENTURES (U.S. CLS. 6, 18, 44, 46, 51 AND 52).

FIRST USE 0-0-1965; IN COMMERCE 0-0-1965.

KATHLEEN LORENZO, EXAMINING ATTORNEY

SN 77-797,806. JPI COMMERCIAL, LLC, PALO ALTO, CA. FILED 8-5-2009.

BELMORO

THE MARK CONSISTS OF STANDARD CHARACTERS WITHOUT CLAIM TO ANY PARTICULAR FONT, STYLE, SIZE, OR COLOR.

FOR PHARMACEUTICAL PREPARATIONS ACTING ON THE CENTRAL NERVOUS SYSTEM; PHARMACEUTICAL PREPARATIONS ACTING ON THE MUSCULOSKELETAL SYSTEM; PHARMACEUTICAL PREPARATIONS FOR USE IN MANAGING FIBROMYALGIA (U.S. CLS. 6, 18, 44, 46, 51 AND 52).

GISELLE AGOSTO, EXAMINING ATTORNEY

CLASS 5—(Continued).

SN 77-798,330. WOODBOLT DISTRIBUTION LLC, BRYAN, TX. FILED 8-6-2009.

M5 Extreme

THE MARK CONSISTS OF STANDARD CHARACTERS WITHOUT CLAIM TO ANY PARTICULAR FONT, STYLE, SIZE, OR COLOR.

OWNER OF U.S. REG. NO. 2,904,878.
FOR DIETARY AND NUTRITIONAL SUPPLEMENTS; DIETARY SUPPLEMENTS; DIETARY SUPPLEMENTS FOR HUMAN CONSUMPTION; NUTRACEUTICALS FOR USE AS A DIETARY SUPPLEMENT; NUTRITIONAL SUPPLEMENTS; POWDERED FRUIT-FLAVORED DIETARY SUPPLEMENT DRINK MIX; POWDERED NUTRITIONAL SUPPLEMENT DRINK MIX (U.S. CLS. 6, 18, 44, 46, 51 AND 52).
FIRST USE 12-10-2001; IN COMMERCE 4-23-2002.
JAMES STEIN, EXAMINING ATTORNEY

CLASS 5—(Continued).

SN 77-798,655. PTC THERAPEUTICS, INC., SOUTH PLAINFIELD, NJ. FILED 8-6-2009.

ILUMERNA

THE MARK CONSISTS OF STANDARD CHARACTERS WITHOUT CLAIM TO ANY PARTICULAR FONT, STYLE, SIZE, OR COLOR.

FOR PHARMACEUTICAL PREPARATIONS FOR THE TREATMENT OF GENETIC DISORDERS (U.S. CLS. 6, 18, 44, 46, 51 AND 52).
GEOFFREY FOSDICK, EXAMINING ATTORNEY

SN 77-798,646. PTC THERAPEUTICS, INC., SOUTH PLAINFIELD, NJ. FILED 8-6-2009.

TRANSLARNA

THE MARK CONSISTS OF STANDARD CHARACTERS WITHOUT CLAIM TO ANY PARTICULAR FONT, STYLE, SIZE, OR COLOR.

FOR PHARMACEUTICAL PREPARATIONS FOR THE TREATMENT OF GENETIC DISORDERS (U.S. CLS. 6, 18, 44, 46, 51 AND 52).
GEOFFREY FOSDICK, EXAMINING ATTORNEY

SN 77-799,000. NORTHSTAR RX LLC, MEMPHIS, TN. FILED 8-6-2009.

NORTHSTARX

THE MARK CONSISTS OF STANDARD CHARACTERS WITHOUT CLAIM TO ANY PARTICULAR FONT, STYLE, SIZE, OR COLOR.

FOR GENERIC PHARMACEUTICAL PREPARATIONS, NAMELY, NEUROMUSCULAR AGENTS, ANTI-MICROBIAL DRUGS, ANTI-PARASITIC DRUGS, ANTIVIRAL DRUGS, ANTIBIOTIC DRUGS, ANTI-DIABETIC DRUGS, ANTIHISTAMINES, VACCINES, NARCOTICS, PARASYMPATHOMIMETIC DRUGS, PARASYMPATHOLYTIC DRUGS, SYMPATHOMIMETIC DRUGS, SYMPATHOLYTIC DRUGS, DIURETICS, ANTI-EMETIC DRUGS, ANALGESICS, PSYCHOTROPIC DRUGS, LIPID REGULATORS, ANTI-DEPRESSANTS, ANTI-INFLAMMATORY DRUGS, ONCOLOGY DRUGS AND AGENTS FOR THE MANAGEMENT OF CANCER, HORMONES, OPHTHALMIC DRUGS, DERMATOLOGICAL DRUGS, LOCAL AND GENERAL ANAESTHETICS, VETERINARY DOSAGE FORMS; GENERIC PHARMACEUTICAL PREPARATIONS FOR THE TREATMENT OF CARDIOVASCULAR DISORDERS, RENAL DISORDERS, METABOLIC DISORDERS, DISORDERS OF THE BLOOD OR CIRCULATION SYSTEM, DISORDERS OF THE PULMONARY SYSTEM, ALLERGIC DISORDERS, AUTO IMMUNE DISORDERS, RESPIRATORY ILLNESSES, GASTROINTESTINAL DISORDERS OR AILMENTS, EPILEPSY, DISEASES AND DISORDERS OF THE ENDOCRINE SYSTEM (U.S. CLS. 6, 18, 44, 46, 51 AND 52).
FIRST USE 9-4-2007; IN COMMERCE 9-4-2007.
ALEX KEAM, EXAMINING ATTORNEY

SN 77-798,649. PTC THERAPEUTICS, INC., SOUTH PLAINFIELD, NJ. FILED 8-6-2009.

APERLURI

THE MARK CONSISTS OF STANDARD CHARACTERS WITHOUT CLAIM TO ANY PARTICULAR FONT, STYLE, SIZE, OR COLOR.

FOR PHARMACEUTICAL PREPARATIONS FOR THE TREATMENT OF GENETIC DISORDERS (U.S. CLS. 6, 18, 44, 46, 51 AND 52).
GEOFFREY FOSDICK, EXAMINING ATTORNEY

CLASS 5—(Continued).

SN 77-799,307. LANNETT HOLDINGS, INC., WILMINGTON, DE. FILED 8-7-2009.

DIGOX

THE MARK CONSISTS OF STANDARD CHARACTERS WITHOUT CLAIM TO ANY PARTICULAR FONT, STYLE, SIZE, OR COLOR.

FOR PHARMACEUTICAL PREPARATIONS, NAMELY, DIGOXIN FOR USE IN THE TREATMENT OF HEART CONDITIONS (U.S. CLS. 6, 18, 44, 46, 51 AND 52).

ALICIA COLLINS, EXAMINING ATTORNEY

SN 77-799,316. LANNETT HOLDINGS, INC., WILMINGTON, DE. FILED 8-7-2009.

DIGISTAT

THE MARK CONSISTS OF STANDARD CHARACTERS WITHOUT CLAIM TO ANY PARTICULAR FONT, STYLE, SIZE, OR COLOR.

FOR PHARMACEUTICAL PREPARATIONS, NAMELY, DIGOXIN FOR USE IN THE TREATMENT OF HEART CONDITIONS (U.S. CLS. 6, 18, 44, 46, 51 AND 52).

ALICIA COLLINS, EXAMINING ATTORNEY

SN 77-804,424. FEIN INNOVATIONS LLC, TAMPA, FL. FILED 8-13-2009.

FEIN

THE MARK CONSISTS OF STANDARD CHARACTERS WITHOUT CLAIM TO ANY PARTICULAR FONT, STYLE, SIZE, OR COLOR.

THE ENGLISH TRANSLATION OF FEIN IS FINE FOR DIETARY BEVERAGE SUPPLEMENTS FOR HUMAN CONSUMPTION IN LIQUID AND DRY MIX FORM FOR THERAPEUTIC PURPOSES; DIETARY SUPPLEMENTAL DRINKS; POWDERED NUTRITIONAL SUPPLEMENT DRINK MIX (U.S. CLS. 6, 18, 44, 46, 51 AND 52).

FIRST USE 12-1-2008; IN COMMERCE 4-1-2009.
KYLE PEETE, EXAMINING ATTORNEY

CLASS 5—(Continued).

SN 77-805,762. BRISTOL-MYERS SQUIBB COMPANY, NEW YORK, NY. FILED 8-17-2009.

RENZOPA

THE MARK CONSISTS OF STANDARD CHARACTERS WITHOUT CLAIM TO ANY PARTICULAR FONT, STYLE, SIZE, OR COLOR.

FOR PHARMACEUTICAL PREPARATIONS FOR HUMAN USE FOR THE TREATMENT AND PREVENTION OF OBESITY, DIABETES, INCONTINENCE, CARDIOVASCULAR DISEASES, CENTRAL NERVOUS SYSTEM DISEASES AND DISORDERS, METABOLIC DISORDERS, STROKE, CANCER, INFLAMMATION AND INFLAMMATORY DISEASES, RESPIRATORY AND INFECTIOUS DISEASES, AUTO-IMMUNE DISEASES, SOLID ORGAN TRANSPLANT REJECTION; PHARMACEUTICAL PREPARATIONS FOR HUMAN USE, NAMELY, ANTIBIOTICS, ANTI-FUNGALS, ANTI-VIRALS, IMMUNOSUPPRESSANTS AND PHARMACEUTICAL ANTIBODIES (U.S. CLS. 6, 18, 44, 46, 51 AND 52).

KARANENDRA S. CHHINA, EXAMINING ATTORNEY

SN 77-805,800. BRISTOL-MYERS SQUIBB COMPANY, NEW YORK, NY. FILED 8-17-2009.

BRELCAPA

THE MARK CONSISTS OF STANDARD CHARACTERS WITHOUT CLAIM TO ANY PARTICULAR FONT, STYLE, SIZE, OR COLOR.

FOR PHARMACEUTICAL PREPARATIONS FOR HUMAN USE FOR THE TREATMENT AND PREVENTION OF OBESITY, DIABETES, INCONTINENCE, CARDIOVASCULAR DISEASES, CENTRAL NERVOUS SYSTEM DISEASES AND DISORDERS, METABOLIC DISORDERS, STROKE, CANCER, INFLAMMATION AND INFLAMMATORY DISEASES, RESPIRATORY AND INFECTIOUS DISEASES, AUTO-IMMUNE DISEASES, SOLID ORGAN TRANSPLANT REJECTION; PHARMACEUTICAL PREPARATIONS FOR HUMAN USE, NAMELY, ANTIBIOTICS, ANTI-FUNGALS, ANTI-VIRALS, IMMUNOSUPPRESSANTS AND PHARMACEUTICAL ANTIBODIES (U.S. CLS. 6, 18, 44, 46, 51 AND 52).

KARANENDRA S. CHHINA, EXAMINING ATTORNEY

CLASS 5—(Continued).

SN 77-805,826. BRISTOL-MYERS SQUIBB COMPANY, NEW YORK, NY. FILED 8-17-2009.

ARPIQUA

THE MARK CONSISTS OF STANDARD CHARACTERS WITHOUT CLAIM TO ANY PARTICULAR FONT, STYLE, SIZE, OR COLOR.

FOR PHARMACEUTICAL PREPARATIONS FOR HUMAN USE FOR THE TREATMENT AND PREVENTION OF OBESITY, DIABETES, INCONTINENCE, CARDIOVASCULAR DISEASES, CENTRAL NERVOUS SYSTEM DISEASES AND DISORDERS, METABOLIC DISORDERS, STROKE, CANCER, INFLAMMATION AND INFLAMMATORY DISEASES, RESPIRATORY AND INFECTIOUS DISEASES, AUTO-IMMUNE DISEASES, SOLID ORGAN TRANSPLANT REJECTION; PHARMACEUTICAL PREPARATIONS FOR HUMAN USE, NAMELY, ANTIBIOTICS, ANTI-FUNGALS, ANTI-VIRALS, IMMUNOSUPPRESSANTS AND PHARMACEUTICAL ANTIBODIES (U.S. CLS. 6, 18, 44, 46, 51 AND 52).
KARANENDRA S. CHHINA, EXAMINING ATTORNEY

CLASS 5—(Continued).

SN 77-809,972. NOVARTIS AG, BASEL, SWITZERLAND, FILED 8-21-2009.



THE COLOR(S) BLACK, WHITE, BROWN AND YELLOW IS/ARE CLAIMED AS A FEATURE OF THE MARK.

THE MARK CONSISTS OF AN IMAGE OF AN OWL WITH BROWN FEATHERS AND YELLOW EYES WEARING A BLACK AND WHITE SHIRT.

FOR PHARMACEUTICAL PREPARATION FOR THE RELIEF OF DROWSINESS (U.S. CLS. 6, 18, 44, 46, 51 AND 52).
ANNE MADDEN, EXAMINING ATTORNEY

SN 77-805,831. BRISTOL-MYERS SQUIBB COMPANY, NEW YORK, NY. FILED 8-17-2009.

BELTAPTA

THE MARK CONSISTS OF STANDARD CHARACTERS WITHOUT CLAIM TO ANY PARTICULAR FONT, STYLE, SIZE, OR COLOR.

FOR PHARMACEUTICAL PREPARATIONS FOR HUMAN USE FOR THE TREATMENT AND PREVENTION OF OBESITY, DIABETES, INCONTINENCE, CARDIOVASCULAR DISEASES, CENTRAL NERVOUS SYSTEM DISEASES AND DISORDERS, METABOLIC DISORDERS, STROKE, CANCER, INFLAMMATION AND INFLAMMATORY DISEASES, RESPIRATORY AND INFECTIOUS DISEASES, AUTO-IMMUNE DISEASES, SOLID ORGAN TRANSPLANT REJECTION; PHARMACEUTICAL PREPARATIONS FOR HUMAN USE, NAMELY, ANTIBIOTICS, ANTI-FUNGALS, ANTI-VIRALS, IMMUNOSUPPRESSANTS AND PHARMACEUTICAL ANTIBODIES (U.S. CLS. 6, 18, 44, 46, 51 AND 52).
KARANENDRA S. CHHINA, EXAMINING ATTORNEY

SN 77-816,666. PLEXUS WORLDWIDE, INC., DBA PLEXUS PINK, SCOTTSDALE, AZ. FILED 8-31-2009.



NO CLAIM IS MADE TO THE EXCLUSIVE RIGHT TO USE "SLIM", APART FROM THE MARK AS SHOWN.

THE COLOR(S) DARK PURPLE, DARK PINK, LIGHT PINK IS/ARE CLAIMED AS A FEATURE OF THE MARK.

THE MARK CONSISTS OF THE WORD "PLEXUS" APPEARING IN DARK PURPLE, THE WORD "SLIM" APPEARING IN DARK PINK AND THE MIRROR IMAGE OF AN "S" APPEARING IN LIGHT PINK.

FOR POWDERED FRUIT-FLAVORED DIETARY SUPPLEMENT DRINK MIX (U.S. CLS. 6, 18, 44, 46, 51 AND 52).

FIRST USE 7-29-2009; IN COMMERCE 8-20-2009.
SAIMA MAKHDOOM, EXAMINING ATTORNEY

CLASS 5—(Continued).

SN 77-817,607. AGROLABS, INC., HILLSIDE, NJ. FILED 9-1-2009.



NO CLAIM IS MADE TO THE EXCLUSIVE RIGHT TO USE "AÇAÍ", APART FROM THE MARK AS SHOWN.

THE MARK CONSISTS OF THE WORD "AÇAÍ" IN A HIGHLY STYLIZED LARGE FONT, AND THE WORD "XTRA" IN A SMALLER STYLIZED FONT APPEARING WITHIN A RECTANGULAR FRAME ANGLING VERY SLIGHTLY UPWARDS FROM LEFT TO RIGHT AND POSITIONED BELOW AND AT THE RIGHT EDGE OF THE WORD "AÇAÍ".

FOR LIQUID NUTRITIONAL SUPPLEMENT (U.S. CLS. 6, 18, 44, 46, 51 AND 52).

FIRST USE 2-28-2009; IN COMMERCE 2-28-2009.
CHRIS WELLS, EXAMINING ATTORNEY

SN 77-828,435. AMBAYA GOLD, LLC, SEDONA, AZ. FILED 9-17-2009.

ORME OXYGEN +

THE MARK CONSISTS OF STANDARD CHARACTERS WITHOUT CLAIM TO ANY PARTICULAR FONT, STYLE, SIZE, OR COLOR.

NO CLAIM IS MADE TO THE EXCLUSIVE RIGHT TO USE "OXYGEN", APART FROM THE MARK AS SHOWN.

THE ENGLISH TRANSLATION OF "ORME" IN THE MARK IS ELM.

FOR LIQUID NUTRITIONAL SUPPLEMENT; MINERAL NUTRITIONAL SUPPLEMENTS; MINERAL SUPPLEMENTS (U.S. CLS. 6, 18, 44, 46, 51 AND 52).

FIRST USE 5-1-2007; IN COMMERCE 5-1-2007.
KEVIN CORWIN, EXAMINING ATTORNEY

CLASS 5—(Continued).

SN 77-832,054. BRISTOL-MYERS SQUIBB COMPANY, NEW YORK, NY. FILED 9-22-2009.

PLORATRO

THE MARK CONSISTS OF STANDARD CHARACTERS WITHOUT CLAIM TO ANY PARTICULAR FONT, STYLE, SIZE, OR COLOR.

FOR PHARMACEUTICAL PREPARATIONS FOR HUMAN USE FOR THE TREATMENT AND PREVENTION OF CANCER; PHARMACEUTICAL PREPARATIONS FOR HUMAN USE, NAMELY, ANTIBIOTICS (U.S. CLS. 6, 18, 44, 46, 51 AND 52).

KARANENDRA S. CHHINA, EXAMINING ATTORNEY

SN 77-832,109. BRISTOL-MYERS SQUIBB COMPANY, NEW YORK, NY. FILED 9-22-2009.

MASISARC

THE MARK CONSISTS OF STANDARD CHARACTERS WITHOUT CLAIM TO ANY PARTICULAR FONT, STYLE, SIZE, OR COLOR.

FOR PHARMACEUTICAL PREPARATIONS FOR HUMAN USE FOR THE TREATMENT AND PREVENTION OF OBESITY, DIABETES, INCONTINENCE, CARDIOVASCULAR DISEASES, CENTRAL NERVOUS SYSTEM DISEASES AND DISORDERS, METABOLIC DISORDERS, STROKE, CANCER, INFLAMMATION AND INFLAMMATORY DISEASES, RESPIRATORY AND INFECTIOUS DISEASES, AUTO-IMMUNE DISEASES, SOLID ORGAN TRANSPLANT REJECTION; PHARMACEUTICAL PREPARATIONS FOR HUMAN USE, NAMELY, ANTIBIOTICS, ANTI-FUNGALS, ANTI-VIRALS, IMMUNOSUPPRESSANTS AND PHARMACEUTICAL ANTIBODIES (U.S. CLS. 6, 18, 44, 46, 51 AND 52).

KARANENDRA S. CHHINA, EXAMINING ATTORNEY

SN 77-832,792. AVID RADIOPHARMACEUTICALS, INC., PHILADELPHIA, PA. FILED 9-23-2009.

ALZVID

THE MARK CONSISTS OF STANDARD CHARACTERS WITHOUT CLAIM TO ANY PARTICULAR FONT, STYLE, SIZE, OR COLOR.

FOR DIAGNOSTIC AGENTS, PREPARATIONS AND SUBSTANCES FOR MEDICAL PURPOSES; DIAGNOSTIC SCANNING AGENTS FOR MEDICAL USE, NAMELY, DIAGNOSTIC SCANNING AGENTS FOR IN VIVO USE; RADIOPHARMACEUTICAL DIAGNOSTIC PREPARATIONS FOR MEDICAL USE; RADIOPHARMACEUTICAL DIAGNOSTIC PREPARATIONS FOR USE IN THE DIAGNOSIS OF NEURODEGENERATIVE AMYLOID DISEASES (U.S. CLS. 6, 18, 44, 46, 51 AND 52).

ROBERT LAVACHE, EXAMINING ATTORNEY

CLASS 5—(Continued).

SN 77-832,803. AVID RADIOPHARMACEUTICALS, INC., PHILADELPHIA, PA. FILED 9-23-2009.

ALZIMAGE

THE MARK CONSISTS OF STANDARD CHARACTERS WITHOUT CLAIM TO ANY PARTICULAR FONT, STYLE, SIZE, OR COLOR.

FOR DIAGNOSTIC AGENTS, PREPARATIONS AND SUBSTANCES FOR MEDICAL PURPOSES; DIAGNOSTIC SCANNING AGENTS FOR MEDICAL USE, NAMELY, DIAGNOSTIC SCANNING AGENTS FOR IN VIVO USE; RADIOPHARMACEUTICAL DIAGNOSTIC PREPARATIONS FOR MEDICAL USE; RADIOPHARMACEUTICAL DIAGNOSTIC PREPARATIONS FOR USE IN THE DIAGNOSIS OF NEURODEGENERATIVE AMYLOID DISEASES (U.S. CLS. 6, 18, 44, 46, 51 AND 52).
ROBERT LAVACHE, EXAMINING ATTORNEY

CLASS 5—(Continued).

SN 77-832,848. AVID RADIOPHARMACEUTICALS, INC., PHILADELPHIA, PA. FILED 9-23-2009.

ALZTEST

THE MARK CONSISTS OF STANDARD CHARACTERS WITHOUT CLAIM TO ANY PARTICULAR FONT, STYLE, SIZE, OR COLOR.

FOR DIAGNOSTIC AGENTS, PREPARATIONS AND SUBSTANCES FOR MEDICAL PURPOSES; DIAGNOSTIC SCANNING AGENTS FOR MEDICAL USE, NAMELY, DIAGNOSTIC SCANNING AGENTS FOR IN VIVO USE; RADIOPHARMACEUTICAL DIAGNOSTIC PREPARATIONS FOR MEDICAL USE; RADIOPHARMACEUTICAL DIAGNOSTIC PREPARATIONS FOR USE IN THE DIAGNOSIS OF NEURODEGENERATIVE AMYLOID DISEASES (U.S. CLS. 6, 18, 44, 46, 51 AND 52).
ROBERT LAVACHE, EXAMINING ATTORNEY

SN 77-832,812. AVID RADIOPHARMACEUTICALS, INC., PHILADELPHIA, PA. FILED 9-23-2009.

ALZPET

THE MARK CONSISTS OF STANDARD CHARACTERS WITHOUT CLAIM TO ANY PARTICULAR FONT, STYLE, SIZE, OR COLOR.

FOR DIAGNOSTIC AGENTS, PREPARATIONS AND SUBSTANCES FOR MEDICAL PURPOSES; DIAGNOSTIC SCANNING AGENTS FOR MEDICAL USE, NAMELY, DIAGNOSTIC SCANNING AGENTS FOR IN VIVO USE; RADIOPHARMACEUTICAL DIAGNOSTIC PREPARATIONS FOR MEDICAL USE; RADIOPHARMACEUTICAL DIAGNOSTIC PREPARATIONS FOR USE IN THE DIAGNOSIS OF NEURODEGENERATIVE AMYLOID DISEASES (U.S. CLS. 6, 18, 44, 46, 51 AND 52).
ROBERT LAVACHE, EXAMINING ATTORNEY

SN 77-832,860. AVID RADIOPHARMACEUTICALS, INC., PHILADELPHIA, PA. FILED 9-23-2009.

AMYIMAGE

THE MARK CONSISTS OF STANDARD CHARACTERS WITHOUT CLAIM TO ANY PARTICULAR FONT, STYLE, SIZE, OR COLOR.

FOR DIAGNOSTIC AGENTS, PREPARATIONS AND SUBSTANCES FOR MEDICAL PURPOSES; DIAGNOSTIC SCANNING AGENTS FOR MEDICAL USE, NAMELY, DIAGNOSTIC SCANNING AGENTS FOR IN VIVO USE; RADIOPHARMACEUTICAL DIAGNOSTIC PREPARATIONS FOR MEDICAL USE; RADIOPHARMACEUTICAL DIAGNOSTIC PREPARATIONS FOR USE IN THE DIAGNOSIS OF NEURODEGENERATIVE AMYLOID DISEASES (U.S. CLS. 6, 18, 44, 46, 51 AND 52).
ROBERT LAVACHE, EXAMINING ATTORNEY

SN 77-832,844. AVID RADIOPHARMACEUTICALS, INC., PHILADELPHIA, PA. FILED 9-23-2009.

ALZSCAN

THE MARK CONSISTS OF STANDARD CHARACTERS WITHOUT CLAIM TO ANY PARTICULAR FONT, STYLE, SIZE, OR COLOR.

FOR DIAGNOSTIC AGENTS, PREPARATIONS AND SUBSTANCES FOR MEDICAL PURPOSES; DIAGNOSTIC SCANNING AGENTS FOR MEDICAL USE, NAMELY, DIAGNOSTIC SCANNING AGENTS FOR IN VIVO USE; RADIOPHARMACEUTICAL DIAGNOSTIC PREPARATIONS FOR MEDICAL USE; RADIOPHARMACEUTICAL DIAGNOSTIC PREPARATIONS FOR USE IN THE DIAGNOSIS OF NEURODEGENERATIVE AMYLOID DISEASES (U.S. CLS. 6, 18, 44, 46, 51 AND 52).
ROBERT LAVACHE, EXAMINING ATTORNEY

SN 77-832,876. AVID RADIOPHARMACEUTICALS, INC., PHILADELPHIA, PA. FILED 9-23-2009.

AMYLYTE

THE MARK CONSISTS OF STANDARD CHARACTERS WITHOUT CLAIM TO ANY PARTICULAR FONT, STYLE, SIZE, OR COLOR.

FOR DIAGNOSTIC AGENTS, PREPARATIONS AND SUBSTANCES FOR MEDICAL PURPOSES; DIAGNOSTIC SCANNING AGENTS FOR MEDICAL USE, NAMELY, DIAGNOSTIC SCANNING AGENTS FOR IN VIVO USE; RADIOPHARMACEUTICAL DIAGNOSTIC PREPARATIONS FOR MEDICAL USE; RADIOPHARMACEUTICAL DIAGNOSTIC PREPARATIONS FOR USE IN THE DIAGNOSIS OF NEURODEGENERATIVE AMYLOID DISEASES (U.S. CLS. 6, 18, 44, 46, 51 AND 52).
ROBERT LAVACHE, EXAMINING ATTORNEY

CLASS 5—(Continued).

SN 77-832,894. AVID RADIOPHARMACEUTICALS, INC., PHILADELPHIA, PA. FILED 9-23-2009.

AMYPET

THE MARK CONSISTS OF STANDARD CHARACTERS WITHOUT CLAIM TO ANY PARTICULAR FONT, STYLE, SIZE, OR COLOR.

FOR DIAGNOSTIC AGENTS, PREPARATIONS AND SUBSTANCES FOR MEDICAL PURPOSES; DIAGNOSTIC SCANNING AGENTS FOR MEDICAL USE, NAMELY, DIAGNOSTIC SCANNING AGENTS FOR IN VIVO USE; RADIOPHARMACEUTICAL DIAGNOSTIC PREPARATIONS FOR MEDICAL USE; RADIOPHARMACEUTICAL DIAGNOSTIC PREPARATIONS FOR USE IN THE DIAGNOSIS OF NEURODEGENERATIVE AMYLOID DISEASES (U.S. CLS. 6, 18, 44, 46, 51 AND 52).
ROBERT LAVACHE, EXAMINING ATTORNEY

SN 77-832,919. AVID RADIOPHARMACEUTICALS, INC., PHILADELPHIA, PA. FILED 9-23-2009.

AMYVID

THE MARK CONSISTS OF STANDARD CHARACTERS WITHOUT CLAIM TO ANY PARTICULAR FONT, STYLE, SIZE, OR COLOR.

FOR DIAGNOSTIC AGENTS, PREPARATIONS AND SUBSTANCES FOR MEDICAL PURPOSES; DIAGNOSTIC SCANNING AGENTS FOR MEDICAL USE, NAMELY, DIAGNOSTIC SCANNING AGENTS FOR IN VIVO USE; RADIOPHARMACEUTICAL DIAGNOSTIC PREPARATIONS FOR MEDICAL USE; RADIOPHARMACEUTICAL DIAGNOSTIC PREPARATIONS FOR USE IN THE DIAGNOSIS OF NEURODEGENERATIVE AMYLOID DISEASES (U.S. CLS. 6, 18, 44, 46, 51 AND 52).
MARK PILARO, EXAMINING ATTORNEY

SN 77-832,935. AVID RADIOPHARMACEUTICALS, INC., PHILADELPHIA, PA. FILED 9-23-2009.

AMYTEST

THE MARK CONSISTS OF STANDARD CHARACTERS WITHOUT CLAIM TO ANY PARTICULAR FONT, STYLE, SIZE, OR COLOR.

FOR DIAGNOSTIC AGENTS, PREPARATIONS AND SUBSTANCES FOR MEDICAL PURPOSES; DIAGNOSTIC SCANNING AGENTS FOR MEDICAL USE, NAMELY, DIAGNOSTIC SCANNING AGENTS FOR IN VIVO USE; RADIOPHARMACEUTICAL DIAGNOSTIC PREPARATIONS FOR MEDICAL USE; RADIOPHARMACEUTICAL DIAGNOSTIC PREPARATIONS FOR USE IN THE DIAGNOSIS OF NEURODEGENERATIVE AMYLOID DISEASES (U.S. CLS. 6, 18, 44, 46, 51 AND 52).
MARK PILARO, EXAMINING ATTORNEY

CLASS 5—(Continued).

SN 77-832,949. AVID RADIOPHARMACEUTICALS, INC., PHILADELPHIA, PA. FILED 9-23-2009.

PLAQUELYTE

THE MARK CONSISTS OF STANDARD CHARACTERS WITHOUT CLAIM TO ANY PARTICULAR FONT, STYLE, SIZE, OR COLOR.

FOR DIAGNOSTIC AGENTS, PREPARATIONS AND SUBSTANCES FOR MEDICAL PURPOSES; DIAGNOSTIC SCANNING AGENTS FOR MEDICAL USE, NAMELY, DIAGNOSTIC SCANNING AGENTS FOR IN VIVO USE; RADIOPHARMACEUTICAL DIAGNOSTIC PREPARATIONS FOR MEDICAL USE; RADIOPHARMACEUTICAL DIAGNOSTIC PREPARATIONS FOR USE IN THE DIAGNOSIS OF NEURODEGENERATIVE AMYLOID DISEASES (U.S. CLS. 6, 18, 44, 46, 51 AND 52).
MARK PILARO, EXAMINING ATTORNEY

SN 77-832,981. AVID RADIOPHARMACEUTICALS, INC., PHILADELPHIA, PA. FILED 9-23-2009.

PLAQUEVID

THE MARK CONSISTS OF STANDARD CHARACTERS WITHOUT CLAIM TO ANY PARTICULAR FONT, STYLE, SIZE, OR COLOR.

FOR DIAGNOSTIC AGENTS, PREPARATIONS AND SUBSTANCES FOR MEDICAL PURPOSES; DIAGNOSTIC SCANNING AGENTS FOR MEDICAL USE, NAMELY, DIAGNOSTIC SCANNING AGENTS FOR IN VIVO USE; RADIOPHARMACEUTICAL DIAGNOSTIC PREPARATIONS FOR MEDICAL USE; RADIOPHARMACEUTICAL DIAGNOSTIC PREPARATIONS FOR USE IN THE DIAGNOSIS OF NEURODEGENERATIVE AMYLOID DISEASES (U.S. CLS. 6, 18, 44, 46, 51 AND 52).
ROBERT LAVACHE, EXAMINING ATTORNEY

SN 77-833,809. AVID RADIOPHARMACEUTICALS, INC., PHILADELPHIA, PA. FILED 9-24-2009.

AMYSCAN

THE MARK CONSISTS OF STANDARD CHARACTERS WITHOUT CLAIM TO ANY PARTICULAR FONT, STYLE, SIZE, OR COLOR.

FOR DIAGNOSTIC AGENTS, PREPARATIONS AND SUBSTANCES FOR MEDICAL PURPOSES; DIAGNOSTIC SCANNING AGENTS FOR MEDICAL USE, NAMELY, DIAGNOSTIC SCANNING AGENTS FOR IN VIVO USE; RADIOPHARMACEUTICAL DIAGNOSTIC PREPARATIONS FOR MEDICAL USE; RADIOPHARMACEUTICAL DIAGNOSTIC PREPARATIONS FOR USE IN THE DIAGNOSIS OF NEURODEGENERATIVE AMYLOID DISEASES (U.S. CLS. 6, 18, 44, 46, 51 AND 52).
MARK PILARO, EXAMINING ATTORNEY

CLASS 5—(Continued).

SN 77-844,658. THAI, PETER, ALHAMBRA, CA. FILED 10-8-2009.

Herbaroma

THE MARK CONSISTS OF STANDARD CHARACTERS WITHOUT CLAIM TO ANY PARTICULAR FONT, STYLE, SIZE, OR COLOR.

FOR HERBAL PRODUCTS, NAMELY, GINSENG PRODUCTS, NAMELY, GINSENG FOR MEDICINAL USE, DIETARY SUPPLEMENTS, NAMELY, GINSENG TABLETS, HERBAL SUPPLEMENTS CONTAINING GINSENG (U.S. CLS. 6, 18, 44, 46, 51 AND 52).

FIRST USE 3-28-2007; IN COMMERCE 3-28-2007.
SETH A. RAPPAPORT, EXAMINING ATTORNEY

SN 77-844,683. AMPANAX, INC., ALHAMBRA, CA. FILED 10-8-2009.

Ampanax

THE MARK CONSISTS OF STANDARD CHARACTERS WITHOUT CLAIM TO ANY PARTICULAR FONT, STYLE, SIZE, OR COLOR.

THE WORDING "AMPANAX" HAS NO MEANING IN A FOREIGN LANGUAGE.

FOR HERBAL SUPPLEMENTS (U.S. CLS. 6, 18, 44, 46, 51 AND 52).

FIRST USE 6-30-2009; IN COMMERCE 6-30-2009.
KATHY DE JONGE, EXAMINING ATTORNEY

SN 77-849,431. WYETH LLC, MADISON, NJ. FILED 10-15-2009.

THERE'S A ROBITUSSIN THAT'S RIGHT FOR YOU

THE MARK CONSISTS OF STANDARD CHARACTERS WITHOUT CLAIM TO ANY PARTICULAR FONT, STYLE, SIZE, OR COLOR.

OWNER OF U.S. REG. NOS. 3,178,113, 3,469,360 AND OTHERS.

FOR PHARMACEUTICAL PREPARATIONS, NAMELY, COUGH, COLD, ALLERGY AND FLU PREPARATIONS (U.S. CLS. 6, 18, 44, 46, 51 AND 52).

GENE MACIOL, EXAMINING ATTORNEY

CLASS 5—(Continued).

SN 77-860,178. ELI LILLY AND COMPANY, INDIANAPOLIS, IN. FILED 10-29-2009.



OWNER OF U.S. REG. NO. 3,677,077.

THE MARK CONSISTS OF TWO LEAF-LIKE DESIGNS OVERLAPPING EACH OTHER WITH THE TERM "ADCIRCA" BELOW.

THE WORDING "ADCIRCA" HAS NO MEANING IN A FOREIGN LANGUAGE.

FOR PHARMACEUTICAL PREPARATIONS FOR THE TREATMENT OF DISEASES AND DISORDERS OF THE CARDIOVASCULAR SYSTEM, HYPERTENSION AND PULMONARY ARTERIAL HYPERTENSION (U.S. CLS. 6, 18, 44, 46, 51 AND 52).

FIRST USE 7-13-2009; IN COMMERCE 7-13-2009.
BRENDAN MCCAULEY, EXAMINING ATTORNEY

SN 77-863,124. BIOYOUNG, LLC, DIAMOND BAR, CA. FILED 11-2-2009.



THE MARK CONSISTS OF PROFILE OF WOMEN FACING RIGHT FORMING A CIRCLE WITH THE WORD "BIO" ON THE LEFT HAND SIDE OF PROFILE AND THE WORD "YOUNG" IN SCRIPT UNDER THE PROFILE.

FOR DIETARY FOOD SUPPLEMENTS (U.S. CLS. 6, 18, 44, 46, 51 AND 52).

FIRST USE 4-4-2000; IN COMMERCE 4-4-2000.
LESLEY LAMOTHE, EXAMINING ATTORNEY

SN 77-869,175. BOEHRINGER INGELHEIM VETMEDICA, INC., ST. JOSEPH, MO. FILED 11-10-2009.

OXY-TET

THE MARK CONSISTS OF STANDARD CHARACTERS WITHOUT CLAIM TO ANY PARTICULAR FONT, STYLE, SIZE, OR COLOR.

FOR VETERINARY ANTIBIOTIC (U.S. CLS. 6, 18, 44, 46, 51 AND 52).

FIRST USE 3-0-1973; IN COMMERCE 3-0-1973.
ALLISON SCHRODY, EXAMINING ATTORNEY

CLASS 5—(Continued).

SN 77-870,112. SHOFU, INC., KYOTO, JAPAN, FILED 11-11-2009.



NO CLAIM IS MADE TO THE EXCLUSIVE RIGHT TO USE "MINIMALLY INVASIVE COSMETIC DENTISTRY", APART FROM THE MARK AS SHOWN.

THE MARK CONSISTS OF DRAWING OF TOOTH WITH THE LETTERS "M" "I" "C" AND "D" THROUGH THE DESIGN WITH THE WORDS "MINIMALLY INVASIVE COSMETIC DENTISTRY" UNDER THE DRAWING.

FOR PRODUCTS FOR USE IN COSMETIC DENTISTRY, IN THE NATURE OF DENTAL PREVENTATIVES AND RESTORATIVES, NAMELY, DENTAL POLISH, DENTAL SEALANTS, DENTAL RESTORATION COMPOUNDS, DENTAL VENEERS, DENTAL PORCELAIN MATERIALS, AND DENTAL CEMENTS (U.S. CLS. 6, 18, 44, 46, 51 AND 52).

PRISCILLA MILTON, EXAMINING ATTORNEY

SN 77-871,179. QN LABS, LLC, ROUND ROCK, TX. FILED 11-12-2009.

QN CENTER

THE MARK CONSISTS OF STANDARD CHARACTERS WITHOUT CLAIM TO ANY PARTICULAR FONT, STYLE, SIZE, OR COLOR.

FOR DIETARY AND NUTRITIONAL SUPPLEMENTS (U.S. CLS. 6, 18, 44, 46, 51 AND 52).

FIRST USE 6-30-2009; IN COMMERCE 6-30-2009.
LAURIE KAUFMAN, EXAMINING ATTORNEY

CLASS 5—(Continued).

SN 77-879,509. MARTEK BIOSCIENCES CORPORATION, COLUMBIA, MD. FILED 11-24-2009.

BRAIN ARMOR

THE MARK CONSISTS OF STANDARD CHARACTERS WITHOUT CLAIM TO ANY PARTICULAR FONT, STYLE, SIZE, OR COLOR.

NO CLAIM IS MADE TO THE EXCLUSIVE RIGHT TO USE "BRAIN", APART FROM THE MARK AS SHOWN.

FOR NUTRITIONAL SUPPLEMENTS; DIETARY SUPPLEMENTS (U.S. CLS. 6, 18, 44, 46, 51 AND 52).

SARA THOMAS, EXAMINING ATTORNEY

SN 77-880,455. PROTHERA, INC., RENO, NV. FILED 11-25-2009.



OWNER OF U.S. REG. NO. 2,426,507.

NO CLAIM IS MADE TO THE EXCLUSIVE RIGHT TO USE "LABS", APART FROM THE MARK AS SHOWN.

THE COLOR(S) BLUE IS/ARE CLAIMED AS A FEATURE OF THE MARK.

THE MARK CONSISTS OF THE BLUE WORDING "KLAIRE LABS" BENEATH WHICH IS THE BLUE LETTER "K" CONTAINED WITHIN A BLUE STAR-SHAPED DESIGN.

FOR NUTRITIONAL SUPPLEMENTS; DIETARY FOOD SUPPLEMENTS; DIETARY SUPPLEMENTS; FOOD SUPPLEMENTS; ENZYMES, NAMELY, ENZYME FOOD SUPPLEMENTS; LIQUID DIETARY SUPPLEMENTS AND DIETARY SUPPLEMENT DRINK MIXES; VITAMINS; MINERALS, NAMELY, MINERAL SUPPLEMENTS; AMINO ACIDS FOR NUTRITIONAL PURPOSES (U.S. CLS. 6, 18, 44, 46, 51 AND 52).

FIRST USE 0-0-2004; IN COMMERCE 0-0-2004.

MEGHAN REINHART, EXAMINING ATTORNEY

CLASS 5—(Continued).

SN 77-884,866. SHAHRIGIAN, DAVID, NORTHVILLE, MI. FILED 12-2-2009.



THE MARK CONSISTS OF THE WORD "KLIMB" WITH TWO DIFFERENT SIZED MOUNTAIN LOCATED ON TOP OF THE WORD IN-BETWEEN THE "K" AND "B". THE "K" AND "B" ARE LARGER SO THAT THE MOUNTAINS FIT WITHIN THE WORD BUT STICK UP OVER THE TOP OF THE LETTERS.

FOR NUTRITIONAL FOOD BARS FOR USE AS A MEAL REPLACEMENT; NUTRITIONAL DRINKS FOR USE AS A MEAL REPLACEMENT (U.S. CLS. 6, 18, 44, 46, 51 AND 52).

LAKEISHA LEWIS, EXAMINING ATTORNEY

CLASS 5—(Continued).

SN 77-887,988. MALABAR PRODUCTOS NATURALES, LLC, SAN ANTONIO, TX. FILED 12-7-2009.



NO CLAIM IS MADE TO THE EXCLUSIVE RIGHT TO USE "AMERICA", APART FROM THE MARK AS SHOWN.

THE MARK CONSISTS OF THE STYLIZED WORDING "XANARAMERICA", WITH A BIGGER FONT SIZE FOR THE FIRST PART OF THE WORD "XANAR" AND A SMALLER FONT SIZE FOR THE LAST PART OF THE WORD "AMERICA". THE FIRST PART OF THE LITERAL ELEMENT, "XANAR", IS PARTIALLY INSIDE OF A STYLIZED OVAL.

FOR DIETARY AND NUTRITIONAL SUPPLEMENTS; DIETARY BEVERAGE SUPPLEMENTS FOR HUMAN CONSUMPTION IN LIQUID AND DRY MIX FORM FOR THERAPEUTIC PURPOSES; DIETARY FOOD SUPPLEMENTS; DIETARY SUPPLEMENT FOR ELIMINATING TOXINS FROM THE INTESTINAL TRACT; DIETARY SUPPLEMENTS; DIETARY SUPPLEMENTS FOR HUMAN CONSUMPTION; HERBAL SUPPLEMENTS; HERBAL TEAS FOR MEDICINAL PURPOSES; MEDICINAL HERBAL EXTRACTS FOR MEDICAL PURPOSES; NATURAL HERBAL SUPPLEMENTS (U.S. CLS. 6, 18, 44, 46, 51 AND 52).

FIRST USE 3-1-2008; IN COMMERCE 3-1-2008.

NAKWAMA ANKRAH, EXAMINING ATTORNEY

SN 77-886,303. PROFESSIONAL SUPPLEMENTS, LLC, DALLAS, TX. FILED 12-4-2009.



NO CLAIM IS MADE TO THE EXCLUSIVE RIGHT TO USE "WHEY", APART FROM THE MARK AS SHOWN.

THE MARK CONSISTS OF THE TEXT "DIAMOND" ABOVE AND "WHEY" BELOW WITH A SHADOW REFLECTION BELOW IT, AND THE "I" IN "DIAMOND" STYLIZED WITH A DIAMOND ABOVE IT.

FOR DIETARY SUPPLEMENTS CONTAINING WHEY (U.S. CLS. 6, 18, 44, 46, 51 AND 52).

CHRIS DONINGER, EXAMINING ATTORNEY

SN 77-891,298. FOREST LABORATORIES, INC., NEW YORK, NY. FILED 12-11-2009.



THE MARK CONSISTS OF STANDARD CHARACTERS WITHOUT CLAIM TO ANY PARTICULAR FONT, STYLE, SIZE, OR COLOR.

FOR PHARMACEUTICAL PREPARATIONS FOR THE TREATMENT OF BACTERIAL INFECTIONS, PAIN, CARDIOVASCULAR SYSTEM DISEASES AND DISORDERS, RESPIRATORY SYSTEM DISEASES AND DISORDERS, NEUROPATHIC PAIN, DIABETIC NEUROPATHY, NEUROLOGICAL DISORDERS, NEURODEGENERATIVE DISORDERS, DEPRESSION, DIABETES AND CENTRAL NERVOUS SYSTEM AND GASTROINTESTINAL DISEASES AND DISORDERS (U.S. CLS. 6, 18, 44, 46, 51 AND 52).

NANCY CLARKE, EXAMINING ATTORNEY

CLASS 5—(Continued).

SN 77-891,617. LAMBI, S.A. DE C.V., ESCOBEDO, NUEVO LEON, MEXICO, FILED 12-11-2009.



OWNER OF ERPN CMNTY TM OFC REG. NO. 004377446, DATED 12-4-2006, EXPIRES 5-4-2015.

NO CLAIM IS MADE TO THE EXCLUSIVE RIGHT TO USE "SENIOR", "PROTECTOR PARA ADULTO", "ADULT BRIEF", AND "MADURA", APART FROM THE MARK AS SHOWN.

THE COLOR(S) BLUE,WHITE. IS/ARE CLAIMED AS A FEATURE OF THE MARK.

THE MARK CONSISTS OF BLUE BACKGROUND THE WORDING "SENIOR" IN LARGE WHITE FONTS UNDERLINED BY A WHITE STRIPE THE WORDS "PROTECTOR PARA ADULTO ADULT BRIEF" IN SMALLER WHITE LETTERS UNDER THE WHITE STRIPE AND UNDER THESE WORDS THE WORDS "UNA SOLUCION MADURA" IN LARGER WHITE FONTS.

THE ENGLISH TRANSLATION OF "PROTECTOR PARA ADULTO" IN THE MARK IS ADULT PROTECTION. THE ENGLISH TRANSLATION OF "UNA SOLUCION MADURA" IN THE MARK IS A MATURE SOLUTION.

FOR DISPOSABLE ADULT DIAPERS; INCONTINENCE DIAPERS; SANITARY NAPKINS; SANITARY PADS; SANITARY TOWELS (U.S. CLS. 6, 18, 44, 46, 51 AND 52).

H. M. FISHER, EXAMINING ATTORNEY

SN 77-892,244. FARKAS GLENN R., CARROLLTON, TX. FILED 12-13-2009.

HYDRAVITE

THE MARK CONSISTS OF STANDARD CHARACTERS WITHOUT CLAIM TO ANY PARTICULAR FONT, STYLE, SIZE, OR COLOR.

FOR VITAMIN SUPPLEMENT IN TABLET FORM FOR USE IN MAKING AN EFFERVESCENT BEVERAGE WHEN ADDED TO WATER (U.S. CLS. 6, 18, 44, 46, 51 AND 52).

HOWARD B. LEVINE, EXAMINING ATTORNEY

CLASS 5—(Continued).

SN 77-896,675. REGEN SYNERGISTICS, LLC, BETHLEHEM, PA. FILED 12-18-2009.

Regen Synergistics

THE MARK CONSISTS OF STANDARD CHARACTERS WITHOUT CLAIM TO ANY PARTICULAR FONT, STYLE, SIZE, OR COLOR.

NO CLAIM IS MADE TO THE EXCLUSIVE RIGHT TO USE "SYNERGISTICS", APART FROM THE MARK AS SHOWN.

FOR MEDICINAL DRINKS, NAMELY, JOINT AND CELL SUPPORT FRUIT FLAVORED DRINKS, TOPICAL WOUND CARE DRESSINGS AND BANDAGES, NAMELY, FOR DENTAL, PHARMACEUTICAL, AND VETERINARY PURPOSES (U.S. CLS. 6, 18, 44, 46, 51 AND 52).

BENJAMIN OKEKE, EXAMINING ATTORNEY

SN 77-899,851. TOPCO ASSOCIATES, LLC, SKOKIE, IL. FILED 12-23-2009.

DEFENSIVE CARE

THE MARK CONSISTS OF STANDARD CHARACTERS WITHOUT CLAIM TO ANY PARTICULAR FONT, STYLE, SIZE, OR COLOR.

NO CLAIM IS MADE TO THE EXCLUSIVE RIGHT TO USE "CARE", APART FROM THE MARK AS SHOWN.

FOR PROBIOTIC, IMMUNITY-BOOSTING DIETARY SUPPLEMENTS (U.S. CLS. 6, 18, 44, 46, 51 AND 52).

EDWARD FENNESSY, EXAMINING ATTORNEY

CLASS 5—(Continued).

SN 77-900,735. ON THE BALL, INC., PLANTATION, FL. FILED 12-24-2009.



NO CLAIM IS MADE TO THE EXCLUSIVE RIGHT TO USE "CILEA EYELASH GROWTH STIMULATOR", APART FROM THE MARK AS SHOWN.

THE COLOR(S) PINK AND BLACK IS/ARE CLAIMED AS A FEATURE OF THE MARK.

THE MARK CONSISTS OF THE WORDING "CILEA EYELASH GROWTH STIMULATOR BY PURESUAASION" IN THE COLOR BLACK. TO THE RIGHT OF THE WORDING IS A DESIGN CONTAINING INTERMINGLING, SCROLLING LINES THAT APPEAR IN THE COLOR PINK.

FOR EYELASH GROWTH STIMULANT (U.S. CLS. 6, 18, 44, 46, 51 AND 52).

FIRST USE 11-23-2009; IN COMMERCE 11-23-2009.
H. M. FISHER, EXAMINING ATTORNEY

CLASS 5—(Continued).

SN 77-906,205. PFIZER INC., NEW YORK, NY. FILED 1-6-2010.

UPLYSO

THE MARK CONSISTS OF STANDARD CHARACTERS WITHOUT CLAIM TO ANY PARTICULAR FONT, STYLE, SIZE, OR COLOR.

FOR PHARMACEUTICALS FOR USE IN THE TREATMENT OF LYSOSOMAL STORAGE DISEASES (U.S. CLS. 6, 18, 44, 46, 51 AND 52).

FIRST USE 11-2-2009; IN COMMERCE 11-2-1009.
ERNEST SHOSHO, EXAMINING ATTORNEY

SN 77-911,380. CYANOTECH CORPORATION, KAILUA-KONA, HI. FILED 1-13-2010.

SN 77-905,096. CRISTINA CIURO AESCHMANN, KEY BISCAYNE, FL. FILED 1-5-2010.



THE COLOR(S) BLACK AND RED IS/ARE CLAIMED AS A FEATURE OF THE MARK.

THE MARK CONSISTS OF THE LETTERS "LINATURAL" IN BLACK STYLIZED FONT PARTIALLY OVERLAPPING A RED OBLONG SHAPE BELOW. THE COLOR WHITE IN THE MARK REPRESENTS BACKGROUND AND/OR TRANSPARENT AREAS, AND IS NOT PART OF THE MARK.

THE WORDING "LINATURAL" HAS NO MEANING IN A FOREIGN LANGUAGE.

FOR DIETARY AND NUTRITIONAL SUPPLEMENTS (U.S. CLS. 6, 18, 44, 46, 51 AND 52).

FIRST USE 11-1-2009; IN COMMERCE 12-15-2009.
STEVEN PEREZ, EXAMINING ATTORNEY

KING OF THE CAROTENOIDS

THE MARK CONSISTS OF STANDARD CHARACTERS WITHOUT CLAIM TO ANY PARTICULAR FONT, STYLE, SIZE, OR COLOR.

FOR NUTRITIONAL SUPPLEMENTS FOR HUMAN CONSUMPTION; NUTRACEUTICALS FOR THE TREATMENT OF OXIDATIVE STRESS, DECREASED IMMUNITY, AND INFLAMMATORY CONDITIONS; NUTRACEUTICALS FOR USE AS A DIETARY SUPPLEMENT; DIETARY SUPPLEMENTS; NUTRITIONAL SUPPLEMENTS; NUTRITIONAL ADDITIVES FOR MEDICAL PURPOSES FOR USE IN FOODS AND DIETARY SUPPLEMENTS FOR HUMAN CONSUMPTION; NUTRITIONAL ADDITIVES FOR USE IN FEED FOR ANIMALS FOR MEDICAL PURPOSES; DIETARY SUPPLEMENTS FOR ANIMAL CONSUMPTION; FOOD SUPPLEMENTS; FOOD SUPPLEMENTS, NAMELY, ANTI-OXIDANTS; HOMEOPATHIC SUPPLEMENTS, NAMELY, DILUTED DOSES FROM THE PLANT, MINERAL AND ANIMAL KINGDOMS FOR HUMAN CONSUMPTION; DRINK MIXES, NAMELY, DIETARY DRINK MIX FOR USE AS A MEAL REPLACEMENT, POWDERED FRUIT-FLAVORED DIETARY SUPPLEMENT DRINK MIX, NUTRITIONAL SUPPLEMENT IN THE NATURE OF A NUTRIENT-DENSE, PROTEIN-BASED DRINK MIX; ALL OF THE FOREGOING CONTAINING CAROTENOIDS (U.S. CLS. 6, 18, 44, 46, 51 AND 52).

BRENDAN REGAN, EXAMINING ATTORNEY

CLASS 5—(Continued).

SN 77-912,501. MERCK KGAA, D 64293 DARMSTADT, FED REP GERMANY, FILED 1-15-2010.

EUTHYROX

THE MARK CONSISTS OF STANDARD CHARACTERS WITHOUT CLAIM TO ANY PARTICULAR FONT, STYLE, SIZE, OR COLOR.

OWNER OF FED REP GERMANY REG. NO. 896184, DATED 8-4-1972, EXPIRES 6-30-2012.

THE WORDING "EUTHYROX" HAS NO MEANING IN A FOREIGN LANGUAGE.

FOR PHARMACEUTICAL PREPARATIONS FOR THE PREVENTION AND TREATMENT OF DISEASES AND DISORDERS OF THE THYROID GLAND (U.S. CLS. 6, 18, 44, 46, 51 AND 52).

NAKIA HENRY, EXAMINING ATTORNEY

SN 77-912,509. MERCK KGAA, D 64293 DARMSTADT, FED REP GERMANY, FILED 1-15-2010.

NOVOTHYROX

THE MARK CONSISTS OF STANDARD CHARACTERS WITHOUT CLAIM TO ANY PARTICULAR FONT, STYLE, SIZE, OR COLOR.

OWNER OF FED REP GERMANY REG. NO. 30155987, DATED 12-18-2001, EXPIRES 9-30-2011.

OWNER OF U.S. REG. NO. 2,824,448.

THE WORDING "NOVOTHYROX" HAS NO MEANING IN A FOREIGN LANGUAGE.

FOR PHARMACEUTICAL PREPARATIONS FOR THE PREVENTION AND TREATMENT OF DISEASES AND DISORDERS OF THE THYROID GLAND (U.S. CLS. 6, 18, 44, 46, 51 AND 52).

NAKIA HENRY, EXAMINING ATTORNEY

SN 77-913,243. KLRM, LLC, LONG BEACH, CA. FILED 1-15-2010.

Urologist's RetainRegain

THE MARK CONSISTS OF STANDARD CHARACTERS WITHOUT CLAIM TO ANY PARTICULAR FONT, STYLE, SIZE, OR COLOR.

NO CLAIM IS MADE TO THE EXCLUSIVE RIGHT TO USE "UROLOGIST'S", APART FROM THE MARK AS SHOWN.

FOR NUTRACEUTICALS FOR THE TREATMENT OF NATURALLY OCCURRING AGE RELATED ERECTILE DYSFUNCTION (U.S. CLS. 6, 18, 44, 46, 51 AND 52).

MARGERY A. TIERNEY, EXAMINING ATTORNEY

CLASS 5—(Continued).

SN 77-913,737. SUNWAY BIOTECH LLC, DBA SUNWAY BIOTECH, OAK HILLS, CA. FILED 1-18-2010.

**Sunway Biotech
International, LLC**

THE MARK CONSISTS OF STANDARD CHARACTERS WITHOUT CLAIM TO ANY PARTICULAR FONT, STYLE, SIZE, OR COLOR.

NO CLAIM IS MADE TO THE EXCLUSIVE RIGHT TO USE "BIOTECH INTERNATIONAL, LLC", APART FROM THE MARK AS SHOWN.

FOR HOMEOPATHIC SUPPLEMENTS (U.S. CLS. 6, 18, 44, 46, 51 AND 52).

FIRST USE 9-30-2005; IN COMMERCE 9-18-2006.

KELLY BOULTON, EXAMINING ATTORNEY

SN 77-916,878. NOVARTIS AG, BASEL, SWITZERLAND, FILED 1-21-2010.

THERAFLU MAX-D

THE MARK CONSISTS OF STANDARD CHARACTERS WITHOUT CLAIM TO ANY PARTICULAR FONT, STYLE, SIZE, OR COLOR.

OWNER OF U.S. REG. NOS. 1,452,879, 3,550,152 AND OTHERS.

FOR COUGH, COLD, FLU AND ALLERGY TREATMENT PREPARATIONS (U.S. CLS. 6, 18, 44, 46, 51 AND 52).

EVELYN BRADLEY, EXAMINING ATTORNEY

CLASS 5—(Continued).

SN 77-918,617. UNIVERSAL LIFE FORCE, INC., SHERMAN OAKS, CA. FILED 1-23-2010.

DR. BO'S TOTAL TRIM

THE MARK CONSISTS OF STANDARD CHARACTERS WITHOUT CLAIM TO ANY PARTICULAR FONT, STYLE, SIZE, OR COLOR.

OWNER OF U.S. REG. NOS. 3,120,492 AND 3,126,376. THE NAME(S), PORTRAIT(S), AND/OR SIGNATURE(S) SHOWN IN THE MARK IDENTIFIES "DR. BOWEN WAGNER", WHOSE CONSENT(S) TO REGISTER IS MADE OF RECORD.

FOR DIETARY AND NUTRITIONAL SUPPLEMENTS; DIETARY FOOD SUPPLEMENTS; NUTRACEUTICALS FOR USE AS A DIETARY SUPPLEMENT; NUTRITIONAL SUPPLEMENT IN THE NATURE OF A NUTRIENT-DENSE, PROTEIN-BASED DRINK MIX; PROTEIN POWDER, NAMELY, WEIGHT MANAGEMENT POWDERS FOR USE AS A FOOD FILLERS; PROTEIN PRODUCTS, NAMELY, WEIGHT GAIN AND WEIGHT LOSS DIETARY SUPPLEMENTS; FAT LOSS DIETARY SUPPLEMENTS; VITAMIN SUPPLEMENTS; MINERAL SUPPLEMENTS; THERMOGENIC PRODUCTS, NAMELY, THERMOGENIC DIETARY SUPPLEMENTS AND MEDICINAL HERBS FOR PROMOTING THERMOGENIC EFFECT IN THE HUMAN BODY; MEAL REPLACEMENT PRODUCTS, NAMELY, POWDERS AND SHAKES; VITAMIN SUPPLEMENTS, MINERAL SUPPLEMENTS, AND HERBAL SUPPLEMENTS, ALL FOR USE IN WEIGHT LOSS IN POWDER, CAPSULE, TABLET, AND LIQUID FORM (U.S. CLS. 6, 18, 44, 46, 51 AND 52).

FIRST USE 9-19-1997; IN COMMERCE 9-19-1997.
LINDA ESTRADA, EXAMINING ATTORNEY

SN 77-919,629. SEVEN CONSULTING, LLC, ARLINGTON, VA. FILED 1-25-2010.

Neurolix

THE MARK CONSISTS OF STANDARD CHARACTERS WITHOUT CLAIM TO ANY PARTICULAR FONT, STYLE, SIZE, OR COLOR.

THE WORDING "NEUROLIX" HAS NO MEANING IN A FOREIGN LANGUAGE.

FOR HEALTH FOOD SUPPLEMENTS; NUTRACEUTICALS FOR THE TREATMENT OF DIABETIC NEUROPATHY; NUTRACEUTICALS FOR USE AS A DIETARY SUPPLEMENT (U.S. CLS. 6, 18, 44, 46, 51 AND 52).

MYRIAH HABEEB, EXAMINING ATTORNEY

CLASS 5—(Continued).

SN 77-920,054. OHP, INC., MAINLAND, PA. FILED 1-26-2010.

SIROCCO

THE MARK CONSISTS OF STANDARD CHARACTERS WITHOUT CLAIM TO ANY PARTICULAR FONT, STYLE, SIZE, OR COLOR.

THE ENGLISH TRANSLATION OF THE WORD "SIROCCO" IN THE MARK IS "HOT DESERT WIND".

FOR INSECTICIDES AND MITICIDES FOR HORTICULTURAL PURPOSES (U.S. CLS. 6, 18, 44, 46, 51 AND 52).

LOURDES AYALA, EXAMINING ATTORNEY

SN 77-921,825. MARZ, KEITH, VAN NUYS, CA. FILED 1-27-2010.

SLIM SPRAYS

THE MARK CONSISTS OF STANDARD CHARACTERS WITHOUT CLAIM TO ANY PARTICULAR FONT, STYLE, SIZE, OR COLOR.

NO CLAIM IS MADE TO THE EXCLUSIVE RIGHT TO USE "SPRAYS", APART FROM THE MARK AS SHOWN.

FOR APPETITE SUPPRESSANTS; ORAL SPRAY FOR BOOSTING ENERGY (U.S. CLS. 6, 18, 44, 46, 51 AND 52).

FIRST USE 12-1-2008; IN COMMERCE 12-1-2008.
INGA ERVIN, EXAMINING ATTORNEY

SN 77-922,955. NOOTS NUTRITION, SACRAMENTO, CA. FILED 1-28-2010.



NO CLAIM IS MADE TO THE EXCLUSIVE RIGHT TO USE "COMBAT NUTRITION", APART FROM THE MARK AS SHOWN.

THE MARK CONSISTS OF THE STYLIZED TEXT "RUCKPACK COMBAT NUTRITION. GET SOME!" WITH A TARGET RETICLE.

FOR MULTIVITAMIN PREPARATIONS (U.S. CLS. 6, 18, 44, 46, 51 AND 52).

FIRST USE 9-4-2008; IN COMMERCE 9-15-2008.
ADA HAN, EXAMINING ATTORNEY

CLASS 5—(Continued).

SN 77-923,285. AVID RADIOPHARMACEUTICALS, INC., PHILADELPHIA, PA. FILED 1-29-2010.

AMYVUE

THE MARK CONSISTS OF STANDARD CHARACTERS WITHOUT CLAIM TO ANY PARTICULAR FONT, STYLE, SIZE, OR COLOR.

FOR DIAGNOSTIC AGENTS, PREPARATIONS AND SUBSTANCES FOR MEDICAL PURPOSES; DIAGNOSTIC SCANNING AGENTS FOR MEDICAL USE, NAMELY, DIAGNOSTIC SCANNING AGENTS FOR IN VIVO USE; RADIOPHARMACEUTICAL DIAGNOSTIC PREPARATIONS FOR MEDICAL USE; RADIOPHARMACEUTICAL DIAGNOSTIC PREPARATIONS FOR USE IN THE DIAGNOSIS OF NEURODEGENERATIVE AMYLOID DISEASES (U.S. CLS. 6, 18, 44, 46, 51 AND 52).
EMILY CARLSEN, EXAMINING ATTORNEY

SN 77-923,503. CARLOS EDUARDO BACA DELGADO, MEXICO D.F., MEXICO, FILED 1-29-2010.



THE MARK CONSISTS OF A STYLIZED DRAWING OF A FLOWER WITH A CIRCLE DIVIDED IN THE MIDDLE BY A HORIZONTAL LINE IN THE CENTER OF THE FLOWER; THE STYLIZED WORDING "ALECOS" APPEARS BELOW THE DESIGN ELEMENT; THE DESIGN ELEMENT AND STYLIZED WORDING "ALECOS" ARE ENCLOSED IN A SQUARE.

THE WORDING "ALECOS" HAS NO MEANING IN A FOREIGN LANGUAGE.

FOR DIETARY AND NUTRITIONAL SUPPLEMENTS; HERBAL SUPPLEMENTS (U.S. CLS. 6, 18, 44, 46, 51 AND 52).

AMEEN IMAM, EXAMINING ATTORNEY

CLASS 5—(Continued).

SN 77-923,577. CETRA NUTRACEUTICALS INC., SILVER SPRINGS, NV. FILED 1-29-2010.

Zehntose

THE MARK CONSISTS OF STANDARD CHARACTERS WITHOUT CLAIM TO ANY PARTICULAR FONT, STYLE, SIZE, OR COLOR.

FOR DIETARY SUPPLEMENTS (U.S. CLS. 6, 18, 44, 46, 51 AND 52).

FIRST USE 5-7-2009; IN COMMERCE 7-27-2009.

HAI-LY LAM, EXAMINING ATTORNEY

SN 77-923,713. NATURESMART, RONKONKOMA, NY. FILED 1-29-2010.

AminoLogic

THE MARK CONSISTS OF STANDARD CHARACTERS WITHOUT CLAIM TO ANY PARTICULAR FONT, STYLE, SIZE, OR COLOR.

FOR VITAMINS, MINERAL SUPPLEMENTS, NUTRITIONAL SUPPLEMENTS AND DIETARY SUPPLEMENTS (U.S. CLS. 6, 18, 44, 46, 51 AND 52).

FIRST USE 1-1-2005; IN COMMERCE 1-1-2005.

CIMMERIAN COLEMAN, EXAMINING ATTORNEY

SN 77-924,530. HEALING EARTH TEAS, STARKSBORO, VT. FILED 2-1-2010.

HEALING EARTH

THE MARK CONSISTS OF STANDARD CHARACTERS WITHOUT CLAIM TO ANY PARTICULAR FONT, STYLE, SIZE, OR COLOR.

FOR HERB TEAS FOR MEDICINAL PURPOSES; HERBAL SUPPLEMENTS (U.S. CLS. 6, 18, 44, 46, 51 AND 52).

FIRST USE 12-5-2009; IN COMMERCE 12-5-2009.

ALEX KEAM, EXAMINING ATTORNEY

CLASS 5—(Continued).

SN 77-924,664. SIMPLICI-D HEALTH PRODUCTS, INC., APTOS, CA. FILED 2-1-2010.

All that C promised...and
more

THE MARK CONSISTS OF STANDARD CHARACTERS WITHOUT CLAIM TO ANY PARTICULAR FONT, STYLE, SIZE, OR COLOR.

FOR MULTI-VITAMIN PREPARATIONS; VITAMIN D PREPARATIONS; VITAMIN SUPPLEMENTS (U.S. CLS. 6, 18, 44, 46, 51 AND 52).

AMY C. KEAN, EXAMINING ATTORNEY

SN 77-925,122. SCHERING CORPORATION, KENILWORTH, NJ. FILED 2-1-2010.



THE MARK CONSISTS OF A SOLID SPHERE WITH 12 OUTWARD-FACING HALF-MOONS ON THE PERIMETER, SURROUNDED ON 4 SIDES BY A SOLID BENT LINE.

FOR PHARMACEUTICAL PREPARATIONS FOR THE TREATMENT OR PREVENTION OF VIRAL DISEASES AND IMMUNOSUPPRESSIVE DISORDERS (U.S. CLS. 6, 18, 44, 46, 51 AND 52).

ANNE MADDEN, EXAMINING ATTORNEY

SN 77-925,241. HA NORTH AMERICAN SALES AB, SCOTTSDALE, AZ. FILED 2-1-2010.

THE LITTLE BLACK DRESS OF
FILLERS

THE MARK CONSISTS OF STANDARD CHARACTERS WITHOUT CLAIM TO ANY PARTICULAR FONT, STYLE, SIZE, OR COLOR.

FOR PHARMACEUTICAL PREPARATIONS FOR USE IN AUGMENTATION OF SOFT TISSUE, SMOOTHING OUT WRINKLES AND FINE LINES, AND CONTOURING THE FACE (U.S. CLS. 6, 18, 44, 46, 51 AND 52).

JOSETTE BEVERLY, EXAMINING ATTORNEY

CLASS 5—(Continued).

SN 77-925,247. WINSTON LABORATORIES, INC., VERNON HILLS, IL. FILED 2-1-2010.

Neuroderm

THE MARK CONSISTS OF STANDARD CHARACTERS WITHOUT CLAIM TO ANY PARTICULAR FONT, STYLE, SIZE, OR COLOR.

FOR A PATCH CONTAINING A TOPICAL ANALGESIC FOR RELIEF OF PAIN (U.S. CLS. 6, 18, 44, 46, 51 AND 52).

JOSETTE BEVERLY, EXAMINING ATTORNEY

SN 77-925,250. YANG, LI CHEN, BEVERLY HILLS, CA. FILED 2-1-2010.

PRENOREX

THE MARK CONSISTS OF STANDARD CHARACTERS WITHOUT CLAIM TO ANY PARTICULAR FONT, STYLE, SIZE, OR COLOR.

FOR DIETARY SUPPLEMENT, NAMELY, NITRIC OXIDE PROMOTER (U.S. CLS. 6, 18, 44, 46, 51 AND 52). FIRST USE 12-20-2001; IN COMMERCE 12-20-2001.

WON TEAK OH, EXAMINING ATTORNEY

SN 77-925,253. ECONUGENICS, INC., SANTA ROSA, CA. FILED 2-1-2010.

HONOKIOLFORTE

THE MARK CONSISTS OF STANDARD CHARACTERS WITHOUT CLAIM TO ANY PARTICULAR FONT, STYLE, SIZE, OR COLOR.

FOR DIETARY SUPPLEMENTS (U.S. CLS. 6, 18, 44, 46, 51 AND 52).

LAURA HAMMEL, EXAMINING ATTORNEY

CLASS 5—(Continued).

SN 77-925,462. HOFFMAN, JANIE, DBA MAMMA CHIA, LLC, BONSALE, CA. FILED 2-1-2010.

Seed Your Soul

THE MARK CONSISTS OF STANDARD CHARACTERS WITHOUT CLAIM TO ANY PARTICULAR FONT, STYLE, SIZE, OR COLOR.

FOR NUTRITIONALLY FORTIFIED BEVERAGES (U.S. CLS. 6, 18, 44, 46, 51 AND 52).

FIRST USE 12-7-2009; IN COMMERCE 12-7-2009.

JOHN E. MICHOS, EXAMINING ATTORNEY

CLASS 5—(Continued).

SN 77-925,634. HIGH NOON FEEDS, LLC, BIRD CITY, KS. FILED 2-2-2010.



SN 77-925,559. FORTRESS SYSTEMS, LLC, AKA FSI NUTRITION, OMAHA, NE. FILED 2-2-2010.

GRAPPLERS NUTRITION

THE MARK CONSISTS OF STANDARD CHARACTERS WITHOUT CLAIM TO ANY PARTICULAR FONT, STYLE, SIZE, OR COLOR.

NO CLAIM IS MADE TO THE EXCLUSIVE RIGHT TO USE "NUTRITION", APART FROM THE MARK AS SHOWN.

FOR DIETARY AND NUTRITIONAL SUPPLEMENTS (U.S. CLS. 6, 18, 44, 46, 51 AND 52).

INGA ERVIN, EXAMINING ATTORNEY

THE MARK CONSISTS OF THE LETTERS "H" AND "N" APPEARING IN A CIRCLE WHERE THE RIGHT LEG OF THE "H" AND THE LEFT LEG OF THE "N" ARE JOINED INTO A SINGLE LEG. DIAMONDS APPEAR AT THE 3 O'CLOCK, 6 O'CLOCK, 9 O'CLOCK, AND 12 O'CLOCK POSITIONS. THE NUMBER "12" APPEARS AT THE 12 O'CLOCK POSITION. A CLOCK HAND POINTS DIRECTLY TO THE 12 O'CLOCK POSITION. AN OUTER CIRCLE FRAMES THE REST OF THE MARK.

FOR ANIMAL FEED SUPPLEMENTS (U.S. CLS. 6, 18, 44, 46, 51 AND 52).

FIRST USE 11-30-2002; IN COMMERCE 11-30-2002.

STEVEN R. FINE, EXAMINING ATTORNEY

SN 77-925,645. BRAINCEUTICALS, LLC, DALLAS, TX. FILED 2-2-2010.

Brain Aid

SN 77-925,609. VITACOST.COM INC., BOCA RATON, FL. FILED 2-2-2010.

FLEX360

THE MARK CONSISTS OF STANDARD CHARACTERS WITHOUT CLAIM TO ANY PARTICULAR FONT, STYLE, SIZE, OR COLOR.

FOR DIETARY AND NUTRITIONAL SUPPLEMENTS (U.S. CLS. 6, 18, 44, 46, 51 AND 52).

STEVEN JACKSON, EXAMINING ATTORNEY

THE MARK CONSISTS OF STANDARD CHARACTERS WITHOUT CLAIM TO ANY PARTICULAR FONT, STYLE, SIZE, OR COLOR.

NO CLAIM IS MADE TO THE EXCLUSIVE RIGHT TO USE "BRAIN", APART FROM THE MARK AS SHOWN.

FOR DIETARY SUPPLEMENTAL DRINKS; NUTRACEUTICALS FOR USE AS A DIETARY SUPPLEMENT; VITAMIN SUPPLEMENTS (U.S. CLS. 6, 18, 44, 46, 51 AND 52).

CAROLINE WOOD, EXAMINING ATTORNEY

CLASS 5—(Continued).

SN 77-925,679. ANABOLIC ADDICTION, HUNTERTOWN, IN. FILED 2-2-2010.



NO CLAIM IS MADE TO THE EXCLUSIVE RIGHT TO USE "ANABOLIC", APART FROM THE MARK AS SHOWN. THE COLOR(S) RED, WHITE AND BLACK IS/ARE CLAIMED AS A FEATURE OF THE MARK. THE MARK CONSISTS OF TWO HORN-LIKE DESIGNS APPEARING IN RED WITH THE WORDING "ANABOLIC ADDICTION" APPEARING ACROSS THE HORNS IN WHITE WITH BLACK OUTLINING. THE MARK APPEARS ON A TRANSPARENT BACKGROUND. FOR NUTRITIONAL SUPPLEMENTS (U.S. CLS. 6, 18, 44, 46, 51 AND 52). AMY KERTGATE, EXAMINING ATTORNEY

SN 77-926,023. EBNM, LLC, SCOTTSDALE, AZ. FILED 2-2-2010.

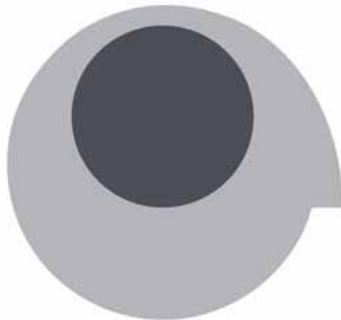

THE MARK CONSISTS OF A STYLIZED SHADED-IN DEPICTION OF A HUMAN HEAD PROFILE CONTAINING A DARKER SHADED-IN CIRCLE DEPICTING THE BRAIN INSIDE THE HEAD. FOR NUTRITIONAL SUPPLEMENTS (U.S. CLS. 6, 18, 44, 46, 51 AND 52). FIRST USE 7-24-2009; IN COMMERCE 7-24-2009. TARAH HARDY, EXAMINING ATTORNEY

CLASS 5—(Continued).

SN 77-926,096. WALCO INTERNATIONAL, INC., WES-
TLAKE, TX. FILED 2-2-2010.

AGRI-LUBE

THE MARK CONSISTS OF STANDARD CHARACTERS WITHOUT CLAIM TO ANY PARTICULAR FONT, STYLE, SIZE, OR COLOR. FOR VETERINARY PREPARATIONS, NAMELY, HAND LUBRICANT CONCENTRATE FOR USE BY VETERINARIANS (U.S. CLS. 6, 18, 44, 46, 51 AND 52). LAURA KOVALSKY, EXAMINING ATTORNEY

SN 77-926,248. DAVID E. NEAL, MILL VALLEY, CA. AND SUSAN P. MARTIN, MILL VALLEY, CA. FILED 2-2-2010.

ESSENTIAL DEFENSE

THE MARK CONSISTS OF STANDARD CHARACTERS WITHOUT CLAIM TO ANY PARTICULAR FONT, STYLE, SIZE, OR COLOR. FOR FUNGICIDES; INSECTICIDES (U.S. CLS. 6, 18, 44, 46, 51 AND 52). DAVID HOFFMAN, EXAMINING ATTORNEY

SN 77-926,341. THE BINDING SITE GROUP, LTD., BIR-
MINGHAM, UNITED KINGDOM, FILED 2-2-2010.

HEVYLITE

THE MARK CONSISTS OF STANDARD CHARACTERS WITHOUT CLAIM TO ANY PARTICULAR FONT, STYLE, SIZE, OR COLOR. OWNER OF U.S. REG. NO. 3,776,368. FOR CLINICAL MEDICAL REAGENTS; DIAGNOSTIC AGENTS, PREPARATIONS AND SUBSTANCES FOR MEDICAL PURPOSES; DIAGNOSTIC KITS CONSISTING PRIMARILY OF MONOCLONAL ANTIBODIES, BUFFERS, AND REAGENTS FOR USE IN DISEASE TESTING; DIAGNOSTIC PREPARATIONS FOR MEDICAL OR VETERINARY PURPOSES; DIAGNOSTIC PREPARATIONS FOR MEDICAL PURPOSES; DIAGNOSTIC REAGENTS FOR MEDICINAL USE; MEDICAL DIAGNOSTIC REAGENTS; MEDICAL DIAGNOSTIC REAGENTS AND ASSAYS FOR TESTING OF BODY FLUIDS; REAGENTS AND MEDIA FOR MEDICAL AND VETERINARY DIAGNOSTIC PURPOSES; REAGENTS FOR MEDICAL USE (U.S. CLS. 6, 18, 44, 46, 51 AND 52). PATRICIA EVANKO, EXAMINING ATTORNEY

CLASS 5—(Continued).

SN 77-926,371. 3-V BIOSCIENCES, INC., MENLO PARK, CA. FILED 2-2-2010.

3-V BIOSCIENCES

THE MARK CONSISTS OF STANDARD CHARACTERS WITHOUT CLAIM TO ANY PARTICULAR FONT, STYLE, SIZE, OR COLOR.

NO CLAIM IS MADE TO THE EXCLUSIVE RIGHT TO USE "BIOSCIENCES", APART FROM THE MARK AS SHOWN.

FOR ANTIVIRAL AND ANTI-MICROBIAL PHARMACEUTICALS FOR THE TREATMENT OF INFECTIOUS DISEASE FOR USE IN HUMAN AND VETERINARY MEDICINE (U.S. CLS. 6, 18, 44, 46, 51 AND 52).

DAWN FELDMAN, EXAMINING ATTORNEY

SN 77-926,443. PONIARD PHARMACEUTICALS, INC., SEATTLE, WA. FILED 2-2-2010.

PONIARD

THE MARK CONSISTS OF STANDARD CHARACTERS WITHOUT CLAIM TO ANY PARTICULAR FONT, STYLE, SIZE, OR COLOR.

OWNER OF U.S. REG. NO. 3,247,488.

FOR PHARMACEUTICAL PREPARATIONS FOR THE TREATMENT OF CANCER (U.S. CLS. 6, 18, 44, 46, 51 AND 52).

PRISCILLA MILTON, EXAMINING ATTORNEY

SN 77-926,490. CALIFORNIA NATURAL BRANDS, INC., LOS ANGELES, CA. FILED 2-2-2010.

KISS MY OUCH

THE MARK CONSISTS OF STANDARD CHARACTERS WITHOUT CLAIM TO ANY PARTICULAR FONT, STYLE, SIZE, OR COLOR.

FOR ADHESIVE FOR BANDAGES FOR SKIN WOUNDS (U.S. CLS. 6, 18, 44, 46, 51 AND 52).

FIRST USE 3-1-2010; IN COMMERCE 3-1-2010.

JULIE VEPPUMTHARA, EXAMINING ATTORNEY

CLASS 5—(Continued).

SN 77-926,505. HUA NA INTERNATIONAL INVESTMENT DEVELOPMENT COMPANY LIMITED, COUNTY OF NEW CASTLE, DE. FILED 2-3-2010.

HUANA

THE WORDING "HUANA" HAS NO MEANING IN A FOREIGN LANGUAGE.

FOR COD LIVER OIL; DIETARY AND NUTRITIONAL SUPPLEMENTS; DIETARY AND NUTRITIONALLY FORTIFIED FOOD PRODUCTS ADAPTED FOR MEDICAL USE; DIETARY FOOD SUPPLEMENTS; DIETARY SUPPLEMENTS; HERBAL SUPPLEMENTS; MEAL REPLACEMENT BARS; MINERAL SUPPLEMENTS; MULTI-VITAMIN PREPARATIONS; POWDERED NUTRITIONAL SUPPLEMENT DRINK MIX (U.S. CLS. 6, 18, 44, 46, 51 AND 52).

FIRST USE 11-11-2009; IN COMMERCE 11-11-2009.

KEVIN DINALLO, EXAMINING ATTORNEY

SN 77-926,514. RICK ANSON, BOISE, ID. FILED 2-3-2010.

Add's Function to Water

THE MARK CONSISTS OF STANDARD CHARACTERS WITHOUT CLAIM TO ANY PARTICULAR FONT, STYLE, SIZE, OR COLOR.

FOR DIETARY AND NUTRITIONAL SUPPLEMENTS (U.S. CLS. 6, 18, 44, 46, 51 AND 52).

KEVON CHISOLM, EXAMINING ATTORNEY

SN 77-926,854. DEZAN GROUP, RALEIGH, NC. FILED 2-3-2010.

PREVRX

THE MARK CONSISTS OF STANDARD CHARACTERS WITHOUT CLAIM TO ANY PARTICULAR FONT, STYLE, SIZE, OR COLOR.

FOR NUTRITIONAL SUPPLEMENTS; VITAMINS (U.S. CLS. 6, 18, 44, 46, 51 AND 52).

GRETCHEN ULRICH, EXAMINING ATTORNEY

CLASS 5—(Continued).

SN 77-927,334. NATURAL APPROACH USA, INC., NEW YORK, NY. FILED 2-3-2010.

VITA STRUCTURE

THE MARK CONSISTS OF STANDARD CHARACTERS WITHOUT CLAIM TO ANY PARTICULAR FONT, STYLE, SIZE, OR COLOR.

FOR DIETARY AND NUTRITIONAL SUPPLEMENTS (U.S. CLS. 6, 18, 44, 46, 51 AND 52).

JAY BESCH, EXAMINING ATTORNEY

CLASS 5—(Continued).

SN 77-927,571. TROY BUSINESS DEVELOPMENT GROUP INTERNATIONAL LLC, WEST COVINA, CA. FILED 2-3-2010.



THE MARK CONSISTS OF THE WORD "JOYEUX" IN CURSIVE LETTERING AND AN ABSTRACT BUTTERFLY ON TOP OF THE WORD.

THE ENGLISH TRANSLATION OF "JOYEUX" IN THE MARK IS "JOYFUL".

FOR NUTRITIONAL SUPPLEMENTS (U.S. CLS. 6, 18, 44, 46, 51 AND 52).

LINDA ORNDORFF, EXAMINING ATTORNEY

SN 77-927,499. JASON DESHAW, PLENTYWOOD, MT. FILED 2-3-2010.

MOUSE-OUT

THE MARK CONSISTS OF STANDARD CHARACTERS WITHOUT CLAIM TO ANY PARTICULAR FONT, STYLE, SIZE, OR COLOR.

FOR RODENT REPELLANT (U.S. CLS. 6, 18, 44, 46, 51 AND 52).

TRACY WHITTAKER-BROWN, EXAMINING ATTORNEY



THE MARK CONSISTS OF FLOWER. FOR AIR FRESHENERS (U.S. CLS. 6, 18, 44, 46, 51 AND 52).

DEIRDRE ROBERTSON, EXAMINING ATTORNEY

SN 77-927,560. AZUR PHARMA INTERNATIONAL II LIMITED, HAMILTON, BERMUDA. FILED 2-3-2010.

AVC

THE MARK CONSISTS OF STANDARD CHARACTERS WITHOUT CLAIM TO ANY PARTICULAR FONT, STYLE, SIZE, OR COLOR.

FOR VAGINAL PREPARATIONS, NAMELY, ANTI-FUNGALS (U.S. CLS. 6, 18, 44, 46, 51 AND 52).

FIRST USE 12-31-1948; IN COMMERCE 12-31-1948.

MARGARET POWER, EXAMINING ATTORNEY

SN 77-927,864. DOCTORS RX, LLC, INDIANAPOLIS, IN. FILED 2-4-2010.

RIP, DIP, SHAKE & SIP

THE MARK CONSISTS OF STANDARD CHARACTERS WITHOUT CLAIM TO ANY PARTICULAR FONT, STYLE, SIZE, OR COLOR.

FOR NUTRITIONAL SUPPLEMENTS (U.S. CLS. 6, 18, 44, 46, 51 AND 52).

ADA HAN, EXAMINING ATTORNEY

CLASS 5—(Continued).

SN 77-927,996. NUTRABOLICS, INC., RICHMOND, BC, CANADA, FILED 2-4-2010.

BLACK MAGIC

THE MARK CONSISTS OF STANDARD CHARACTERS WITHOUT CLAIM TO ANY PARTICULAR FONT, STYLE, SIZE, OR COLOR.

FOR HERBAL MALE ENHANCEMENT CAPSULES (U.S. CLS. 6, 18, 44, 46, 51 AND 52).
RENEE SERVANCE, EXAMINING ATTORNEY

SN 77-928,162. W.F. YOUNG, INCORPORATED, EAST LONGMEADOW, MA. FILED 2-4-2010.

POWER GEL

THE MARK CONSISTS OF STANDARD CHARACTERS WITHOUT CLAIM TO ANY PARTICULAR FONT, STYLE, SIZE, OR COLOR.

OWNER OF U.S. REG. NOS. 1,765,208 AND 3,479,803.
NO CLAIM IS MADE TO THE EXCLUSIVE RIGHT TO USE "GEL", APART FROM THE MARK AS SHOWN.
FOR EXTERNAL ANALGESIC FOR VETERINARY USE (U.S. CLS. 6, 18, 44, 46, 51 AND 52).
SARA THOMAS, EXAMINING ATTORNEY

SN 77-928,254. U.S. NUTRACEUTICALS, L.L.C., DBA VALENSA INTERNATIONAL, EUSTIS, FL. FILED 2-4-2010.

MICROCOSANOL

THE MARK CONSISTS OF STANDARD CHARACTERS WITHOUT CLAIM TO ANY PARTICULAR FONT, STYLE, SIZE, OR COLOR.

OWNER OF U.S. REG. NO. 3,314,303.
FOR VITAMINS AND NUTRITIONAL SUPPLEMENTS (U.S. CLS. 6, 18, 44, 46, 51 AND 52).
NICHOLAS COLEMAN, EXAMINING ATTORNEY

CLASS 5—(Continued).

SN 77-928,302. MCDANIEL WATER, CANYON, TX. FILED 2-4-2010.

Mac-Life

THE MARK CONSISTS OF STANDARD CHARACTERS WITHOUT CLAIM TO ANY PARTICULAR FONT, STYLE, SIZE, OR COLOR.

FOR CATALYTIC WATER USED AS A DIETARY SUPPLEMENT THAT IS ADDED TO HUMAN DRINKING WATER (U.S. CLS. 6, 18, 44, 46, 51 AND 52).

FIRST USE 1-1-2009; IN COMMERCE 6-1-2009.
BRIAN NEVILLE, EXAMINING ATTORNEY

SN 77-928,542. OMS INVESTMENTS, INC., LOS ANGELES, CA. FILED 2-4-2010.

ORTHO ELEMENTALS

THE MARK CONSISTS OF STANDARD CHARACTERS WITHOUT CLAIM TO ANY PARTICULAR FONT, STYLE, SIZE, OR COLOR.

OWNER OF U.S. REG. NOS. 423,264, 3,649,812 AND OTHERS.

FOR PESTICIDES, INSECTICIDES, HERBICIDES, AND FUNGICIDES (U.S. CLS. 6, 18, 44, 46, 51 AND 52).
ANDREA K. NADELMAN, EXAMINING ATTORNEY

SN 77-928,801. THE TERMINIX INTERNATIONAL COMPANY LIMITED PARTNERSHIP, MEMPHIS, TN. FILED 2-5-2010.



OWNER OF U.S. REG. NOS. 3,519,494, 3,519,495 AND 3,523,618.

THE STIPPLING IS FOR SHADING PURPOSES ONLY.
THE MARK CONSISTS OF A 2-DIMENSIONAL SHIELD OUTLINED BY A SOLID BORDER, WITH SHADING INSIDE THE SHIELD AND AN OVOID LEAF SHAPE SUPERIMPOSED ON THE SHADED PART OF THE SHIELD.

FOR INSECT SPRAYS (U.S. CLS. 6, 18, 44, 46, 51 AND 52).

FIRST USE 11-0-2009; IN COMMERCE 11-0-2009.
JOHN WILKE, EXAMINING ATTORNEY

CLASS 5—(Continued).

SN 77-928,900. MOSBAUGH, JAMES D, TAMPA, FL. FILED 2-5-2010.

Prolaurin

THE MARK CONSISTS OF STANDARD CHARACTERS WITHOUT CLAIM TO ANY PARTICULAR FONT, STYLE, SIZE, OR COLOR.

FOR DIETARY AND NUTRITIONAL SUPPLEMENTS; DIETARY FOOD SUPPLEMENTS; NUTRITIONAL SUPPLEMENT FOR ELIMINATING TOXINS FROM THE INTESTINAL TRACT; NUTRITIONAL SUPPLEMENTS; PHARMACEUTICAL PREPARATIONS AND SUBSTANCES FOR THE TREATMENT OF GASTRO-INTESTINAL DISEASES; PHARMACEUTICAL PREPARATIONS FOR THE PREVENTION OF INFECTION FROM PATHOGENIC ENTERIC BACTERIA; PHARMACEUTICAL PREPARATIONS FOR THE TREATMENT OF INFECTION FROM PATHOGENIC ENTERIC BACTERIA; THERAPEUTIC PHARMACEUTICAL FOR THE TREATMENT OF INTESTINAL DISORDERS (U.S. CLS. 6, 18, 44, 46, 51 AND 52).

BRIDGETT SMITH, EXAMINING ATTORNEY

CLASS 5—(Continued).

SN 77-928,954. IPSEN BIOPHARM LIMITED, WREXHAM, UNITED KINGDOM, FILED 2-5-2010.



OWNER OF U.S. REG. NOS. 1,624,403, 3,759,924 AND OTHERS.

THE COLOR(S) BLACK AND BLUE IS/ARE CLAIMED AS A FEATURE OF THE MARK.

THE MARK CONSISTS OF THE FOLLOWING: THE WORDING "DYSPORT" IN BLACK SUPERIMPOSED ON A FOUR LINE BLUE WAVE DESIGN.

FOR PHARMACEUTICAL PREPARATIONS CONTAINING BOTULINUM TOXIN, BOTULINUM TOXIN-HAEMAGGLUTININ COMPLEX, BOTULINUM TOXIN FRAGMENTS AND OTHER BOTULINUM TOXIN DERIVATIVES FOR THE TREATMENT OF NEUROLOGICAL DISORDERS; PHARMACEUTICAL PREPARATIONS CONTAINING BOTULINUM TOXIN WITH SPECIFIED COMPONENT(S) OF THE TOXIN HAEMAGGLUTININ COMPLEX FOR THE TREATMENT OF NEUROLOGICAL DISORDERS; PHARMACEUTICAL PREPARATIONS FOR THE TREATMENT AND PREVENTION OF NEUROMUSCULAR DISORDERS; PHARMACEUTICAL PREPARATIONS FOR THE TREATMENT AND PREVENTION OF CERVICAL DYSTONIA, CEREBRAL PALSY, AND SPASTICITY (U.S. CLS. 6, 18, 44, 46, 51 AND 52).

COLLEEN KEARNEY, EXAMINING ATTORNEY

SN 77-929,018. LUNTE, ROBERT, KIRKLAND, WA. FILED 2-5-2010.

Vishudda

THE MARK CONSISTS OF STANDARD CHARACTERS WITHOUT CLAIM TO ANY PARTICULAR FONT, STYLE, SIZE, OR COLOR.

FOR HERBAL TEAS FOR MEDICINAL PURPOSES (U.S. CLS. 6, 18, 44, 46, 51 AND 52).

FIRST USE 6-29-2009; IN COMMERCE 6-29-2009.

JORDAN BAKER, EXAMINING ATTORNEY

SN 77-928,928. SEA LANE BIOTECHNOLOGIES, LLC, ATHERTON, CA. FILED 2-5-2010.

SURROBODY

THE MARK CONSISTS OF STANDARD CHARACTERS WITHOUT CLAIM TO ANY PARTICULAR FONT, STYLE, SIZE, OR COLOR.

FOR PHARMACEUTICAL PROTEIN AND PEPTIDE PREPARATIONS FOR IN-VIVO DIAGNOSTIC, PROPHYLACTIC OR THERAPEUTIC USE (U.S. CLS. 6, 18, 44, 46, 51 AND 52).

AMY C. KEAN, EXAMINING ATTORNEY

SN 77-929,295. L. PERRIGO COMPANY, ALLEGAN, MI. FILED 2-5-2010.

MUCUS-TEC

THE MARK CONSISTS OF STANDARD CHARACTERS WITHOUT CLAIM TO ANY PARTICULAR FONT, STYLE, SIZE, OR COLOR.

FOR EXPECTORANTS (U.S. CLS. 6, 18, 44, 46, 51 AND 52).

IRA J. GOODSaid, EXAMINING ATTORNEY

CLASS 5—(Continued).

SN 77-929,596. MARGALIT, JON, SAN DIEGO, CA. FILED 2-5-2010.

GYMGERM

THE MARK CONSISTS OF STANDARD CHARACTERS WITHOUT CLAIM TO ANY PARTICULAR FONT, STYLE, SIZE, OR COLOR.
FOR ANTISEPTIC PREPARATIONS (U.S. CLS. 6, 18, 44, 46, 51 AND 52).
RAMONA ORTIGA, EXAMINING ATTORNEY

SN 77-929,664. INNUTRA, LLC, YORBA LINDA, CA. FILED 2-5-2010.

KonjaLean

THE MARK CONSISTS OF STANDARD CHARACTERS WITHOUT CLAIM TO ANY PARTICULAR FONT, STYLE, SIZE, OR COLOR.
FOR DIETARY AND NUTRITIONAL SUPPLEMENTS (U.S. CLS. 6, 18, 44, 46, 51 AND 52).
DAVID TAYLOR, EXAMINING ATTORNEY

SN 77-929,711. THREE LOLLIES, WEST HILLS, CA. FILED 2-5-2010.

Hangover Sucks

THE MARK CONSISTS OF STANDARD CHARACTERS WITHOUT CLAIM TO ANY PARTICULAR FONT, STYLE, SIZE, OR COLOR.
NO CLAIM IS MADE TO THE EXCLUSIVE RIGHT TO USE "HANGOVER", APART FROM THE MARK AS SHOWN.
FOR DIETARY AND NUTRITIONAL SUPPLEMENTS (U.S. CLS. 6, 18, 44, 46, 51 AND 52).
WILLIAM BRECKENFELD, EXAMINING ATTORNEY

CLASS 5—(Continued).

SN 77-930,234. PURDUE PRODUCTS L.P., STAMFORD, CT. FILED 2-8-2010.

FULL CARE

THE MARK CONSISTS OF STANDARD CHARACTERS WITHOUT CLAIM TO ANY PARTICULAR FONT, STYLE, SIZE, OR COLOR.
FOR DIETARY SUPPLEMENTS (U.S. CLS. 6, 18, 44, 46, 51 AND 52).
DAVID MURRAY, EXAMINING ATTORNEY

SN 77-930,271. FIT NEW MOMMY, O' FALLON, MO. FILED 2-8-2010.

fit new mommy

NO CLAIM IS MADE TO THE EXCLUSIVE RIGHT TO USE "NEW MOMMY", APART FROM THE MARK AS SHOWN.
THE MARK CONSISTS OF A LADY WITH A STROLLER AND THE STYLIZED TEXT "FIT NEW MOMMY". THE "O" IS IN THE SHAPE OF A HEART.
FOR NUTRITIONAL SUPPLEMENTS; PHARMACEUTICAL PRODUCTS AND PREPARATIONS TO PREVENT STRETCH MARKS; VITAMINS (U.S. CLS. 6, 18, 44, 46, 51 AND 52).
ELLEN BURNS, EXAMINING ATTORNEY

SN 77-930,312. SOCIETE DES PRODUITS NESTLE S.A., 1800 VEVEY, SWITZERLAND, FILED 2-8-2010.

CALCILOCK

THE MARK CONSISTS OF STANDARD CHARACTERS WITHOUT CLAIM TO ANY PARTICULAR FONT, STYLE, SIZE, OR COLOR.
FOR DIETETIC FOODS ADAPTED FOR MEDICAL PURPOSES, NAMELY, NUTRITIONALLY FORTIFIED BEVERAGES, BARS AND POWDERS, AND MEAL REPLACEMENT BEVERAGES, BARS AND POWDERS; NUTRITIONAL SUPPLEMENTS (U.S. CLS. 6, 18, 44, 46, 51 AND 52).
BENJAMIN OKEKE, EXAMINING ATTORNEY

CLASS 5—(Continued).

SN 77-930,344. GASPARI NUTRITION, INC., LAKEWOOD, NJ. FILED 2-8-2010.

AROMASTANE

THE MARK CONSISTS OF STANDARD CHARACTERS WITHOUT CLAIM TO ANY PARTICULAR FONT, STYLE, SIZE, OR COLOR.

FOR DIETARY AND NUTRITIONAL SUPPLEMENTS; DIETARY FOOD SUPPLEMENTS; DIETARY SUPPLEMENTS; DIETARY SUPPLEMENTS FOR ANIMALS; DIETARY SUPPLEMENTS FOR HUMAN CONSUMPTION; FOOD SUPPLEMENTS; HERBAL SUPPLEMENTS; NATURAL HERBAL SUPPLEMENTS; NUTRITIONAL SUPPLEMENTS; VITAMIN AND MINERAL SUPPLEMENTS; VITAMIN SUPPLEMENTS (U.S. CLS. 6, 18, 44, 46, 51 AND 52).

KIMBERLY FRYE, EXAMINING ATTORNEY

CLASS 5—(Continued).

SN 77-930,617. 3-V BIOSCIENCES, INC., MENLO PARK, CA. FILED 2-8-2010.



THE MARK CONSISTS OF A SHADED IN TRIANGLE WITH A LARGE CIRCLE INSIDE IT. INSIDE THE LARGE CIRCLE ARE THREE SMALLER CIRCLES ATTACHED TO THE EDGES OF THE CIRCLE.

FOR ANTIVIRAL AND ANTI-MICROBIAL PHARMACEUTICALS FOR THE TREATMENT OF INFECTIOUS DISEASE FOR USE IN HUMAN AND VETERINARY MEDICINE (U.S. CLS. 6, 18, 44, 46, 51 AND 52).

DAWN FELDMAN, EXAMINING ATTORNEY

SN 77-930,390. AXXIOM,LLC, SALISBURY, MD. FILED 2-8-2010.

BOVAX

THE MARK CONSISTS OF STANDARD CHARACTERS WITHOUT CLAIM TO ANY PARTICULAR FONT, STYLE, SIZE, OR COLOR.

FOR VACCINES FOR CATTLE (U.S. CLS. 6, 18, 44, 46, 51 AND 52).

FRANK LATTUCA, EXAMINING ATTORNEY

SN 77-930,692. ERNST MUHLBAUER GMBH & CO. KG, NORDERFRIEDRICHSKOOG, FED REP GERMANY, FILED 2-8-2010.

LUXATEMP ULTRA

SN 77-930,528. JOHNSON & JOHNSON, NEW BRUNSWICK, NJ. FILED 2-8-2010.

VYLASTA

THE MARK CONSISTS OF STANDARD CHARACTERS WITHOUT CLAIM TO ANY PARTICULAR FONT, STYLE, SIZE, OR COLOR.

FOR HUMAN OPHTHALMIC PHARMACEUTICALS (U.S. CLS. 6, 18, 44, 46, 51 AND 52).

TIMOTHY FINNEGAN, EXAMINING ATTORNEY

THE MARK CONSISTS OF STANDARD CHARACTERS WITHOUT CLAIM TO ANY PARTICULAR FONT, STYLE, SIZE, OR COLOR.

OWNER OF U.S. REG. NO. 1,911,030.
FOR TEMPORARY DENTAL CROWN AND BRIDGE MATERIAL; MATERIAL FOR STOPPING TEETH (U.S. CLS. 6, 18, 44, 46, 51 AND 52).

TEJBIR SINGH, EXAMINING ATTORNEY

CLASS 5—(Continued).

SN 77-930,761. ACTAVIS GROUP HF, IS-220 HAFNARFJORDUR, ICELAND, FILED 2-8-2010.



OWNER OF U.S. REG. NOS. 3,188,469, 3,402,190 AND OTHERS.

THE MARK CONSISTS OF THE WORD "ACTAVIS" WITH AN ARC DESIGN AND LINE BENEATH THE ARC APPEARING TO THE UPPER LEFT SIDE OF THE "A" IN THE WORD.

FOR GENERIC PHARMACEUTICALS, NAMELY, PREPARATIONS AND SUBSTANCES FOR THE PREVENTION AND TREATMENT OF ALIMENTARY TRACT AND METABOLIC DISEASES AND DISORDERS, DERMATOLOGICAL DISEASES AND DISORDERS, GENITOURINARY AND SEXUAL DISEASES AND DISORDERS, MUSCULO-SKELETAL SYSTEM DISEASES AND DISORDERS, NERVOUS SYSTEM DISEASES AND DISORDERS, RESPIRATORY SYSTEM DISEASES AND DISORDERS, SENSORY ORGAN DISEASES AND DISORDERS; SYSTEMIC HORMONAL PHARMACEUTICAL PREPARATIONS AND SUBSTANCES; PHARMACEUTICALS, NAMELY, ANTI-INFECTIVES; PHARMACEUTICAL PREPARATIONS, NAMELY, ANTINEOPLASTIC AND IMMUNOMODULATING AGENTS; ANTIPARASITIC PREPARATIONS AND SUBSTANCES (U.S. CLS. 6, 18, 44, 46, 51 AND 52).

FIRST USE 4-0-2006; IN COMMERCE 4-0-2006.
DEIRDRE ROBERTSON, EXAMINING ATTORNEY

SN 77-930,879. ABBOTT LABORATORIES, ABBOTT PARK, IL. FILED 2-8-2010.

LIPENTRA

THE MARK CONSISTS OF STANDARD CHARACTERS WITHOUT CLAIM TO ANY PARTICULAR FONT, STYLE, SIZE, OR COLOR.

FOR PHARMACEUTICAL PREPARATIONS FOR THE TREATMENT OF ARTERIOSCLEROTIC DISEASES, AUTOIMMUNE DISEASES, CANCER, CARDIOVASCULAR DISEASES, CENTRAL NERVOUS SYSTEM DISEASES, DIABETES AND OTHER METABOLIC DISORDERS, INFLAMMATION AND INFLAMMATORY DISEASES, RESPIRATORY AND INFECTIOUS DISEASES, PERIPHERAL AND CENTRAL VASCULAR DISEASES, SEIZURE DISORDERS, SHOCK AND CENTRAL NERVOUS SYSTEM TRAUMA, STROKE, AND VIRAL DISEASES (U.S. CLS. 6, 18, 44, 46, 51 AND 52).

DANIEL CAPSHAW, EXAMINING ATTORNEY

CLASS 5—(Continued).

SN 77-931,712. GASPARI NUTRITION, INC., LAKEWOOD, NJ. FILED 2-9-2010.

NOVAPLEX

THE MARK CONSISTS OF STANDARD CHARACTERS WITHOUT CLAIM TO ANY PARTICULAR FONT, STYLE, SIZE, OR COLOR.

FOR DIETARY AND NUTRITIONAL SUPPLEMENTS; DIETARY FOOD SUPPLEMENTS; DIETARY SUPPLEMENTS; DIETARY SUPPLEMENTS FOR ANIMALS; DIETARY SUPPLEMENTS FOR HUMAN CONSUMPTION; FOOD SUPPLEMENTS; HERBAL SUPPLEMENTS; NATURAL HERBAL SUPPLEMENTS; NATURAL SUPPLEMENTS FOR TREATING ERECTILE DYSFUNCTION; NUTRACEUTICALS FOR USE AS A DIETARY SUPPLEMENT (U.S. CLS. 6, 18, 44, 46, 51 AND 52).

KIMBERLY FRYE, EXAMINING ATTORNEY

SN 77-931,737. GASPARI NUTRITION, INC., LAKEWOOD, NJ. FILED 2-9-2010.

NOVEPLEX

THE MARK CONSISTS OF STANDARD CHARACTERS WITHOUT CLAIM TO ANY PARTICULAR FONT, STYLE, SIZE, OR COLOR.

FOR DIETARY AND NUTRITIONAL SUPPLEMENTS; DIETARY FOOD SUPPLEMENTS; DIETARY SUPPLEMENTS; DIETARY SUPPLEMENTS FOR ANIMALS; DIETARY SUPPLEMENTS FOR HUMAN CONSUMPTION; FOOD SUPPLEMENTS; HERBAL SUPPLEMENTS; NATURAL HERBAL SUPPLEMENTS; NATURAL SUPPLEMENTS FOR TREATING ERECTILE DYSFUNCTION; NUTRACEUTICALS FOR USE AS A DIETARY SUPPLEMENT (U.S. CLS. 6, 18, 44, 46, 51 AND 52).

KIMBERLY FRYE, EXAMINING ATTORNEY

SN 77-931,896. UNISAL WELLNESS TECHNOLOGIES, DBA ACCTRIX, SEATTLE, WA. FILED 2-9-2010.

Acctrix

THE MARK CONSISTS OF STANDARD CHARACTERS WITHOUT CLAIM TO ANY PARTICULAR FONT, STYLE, SIZE, OR COLOR.

FOR DIETARY AND NUTRITIONAL SUPPLEMENTS (U.S. CLS. 6, 18, 44, 46, 51 AND 52).

FIRST USE 10-10-2008; IN COMMERCE 6-6-2009.

INGRID C. EULIN, EXAMINING ATTORNEY

CLASS 5—(Continued).

SN 77-931,937. ENTERAL HEALTH AND NUTRITION, LLC, DES PERES, MO. FILED 2-9-2010.



NO CLAIM IS MADE TO THE EXCLUSIVE RIGHT TO USE "ENTERAL HEALTH & NUTRITION", APART FROM THE MARK AS SHOWN.

THE MARK CONSISTS OF A SPHERE CONTAINING THE LETTERS "EHN", ALL OF WHICH IS ABOVE THE WORDS "ENTERAL HEALTH & NUTRITION".

FOR DIETARY SUPPLEMENTS (U.S. CLS. 6, 18, 44, 46, 51 AND 52).
ALEX KEAM, EXAMINING ATTORNEY

SN 77-932,090. EO MEDSOLUTIONS, ALICE, TX. FILED 2-9-2010.



NO CLAIM IS MADE TO THE EXCLUSIVE RIGHT TO USE "VITAMIN D3 CHOLECALCIFEROL", APART FROM THE MARK AS SHOWN.

THE MARK CONSISTS OF THE NAME "TRISUVA" CENTERED ABOVE "VITAMIN D3 CHOLECALCIFEROL". THE "D3" IS PRINTED ON A REFLECTIVE CIRCLE AND THE NUMBER "3" OF THE "D3" MARK IS TYPESET LOWER TO THE "D".

FOR VITAMIN D PREPARATIONS; VITAMIN D SUPPLEMENTS (U.S. CLS. 6, 18, 44, 46, 51 AND 52).
JAMES A. RAUEN, EXAMINING ATTORNEY

CLASS 5—(Continued).

SN 77-932,173. AMES, PHILIP, NORTH HOLLYWOOD, CA. FILED 2-9-2010.

It's That Much Better

THE MARK CONSISTS OF STANDARD CHARACTERS WITHOUT CLAIM TO ANY PARTICULAR FONT, STYLE, SIZE, OR COLOR.

FOR ANTIBACTERIAL HAND-SANITIZING PREPARATIONS AS FOAMS, GELS OR LOTIONS (U.S. CLS. 6, 18, 44, 46, 51 AND 52).

IRA J. GOODSaid, EXAMINING ATTORNEY

SN 77-932,352. L. PERRIGO COMPANY, ALLEGAN, MI. FILED 2-10-2010.

ALLER-FEX

THE MARK CONSISTS OF STANDARD CHARACTERS WITHOUT CLAIM TO ANY PARTICULAR FONT, STYLE, SIZE, OR COLOR.

FOR ANTIHISTAMINES (U.S. CLS. 6, 18, 44, 46, 51 AND 52).

IRA J. GOODSaid, EXAMINING ATTORNEY

SN 77-932,608. B.R.A.T. DIET LLC, ARROYO GRANDE, CA. FILED 2-10-2010.

In Sickness and in Health

THE MARK CONSISTS OF STANDARD CHARACTERS WITHOUT CLAIM TO ANY PARTICULAR FONT, STYLE, SIZE, OR COLOR.

FOR DIETARY BEVERAGE SUPPLEMENTS FOR HUMAN CONSUMPTION IN LIQUID AND DRY MIX FORM FOR THERAPEUTIC PURPOSES; NUTRITIONALLY FORTIFIED BEVERAGES; VITAMIN FORTIFIED BEVERAGES (U.S. CLS. 6, 18, 44, 46, 51 AND 52).

MICHAEL KEATING, EXAMINING ATTORNEY

CLASS 5—(Continued).

SN 77-933,403. GASPARI NUTRITION, INC., LAKEWOOD, NJ. FILED 2-11-2010.

MYOFUSION

THE MARK CONSISTS OF STANDARD CHARACTERS WITHOUT CLAIM TO ANY PARTICULAR FONT, STYLE, SIZE, OR COLOR.

FOR DIETARY AND NUTRITIONAL SUPPLEMENTS; DIETARY FOOD SUPPLEMENTS; DIETARY SUPPLEMENTS; DIETARY SUPPLEMENTS FOR ANIMALS; DIETARY SUPPLEMENTS FOR HUMAN CONSUMPTION; FOOD SUPPLEMENTS; HERBAL SUPPLEMENTS; NATURAL HERBAL SUPPLEMENTS; NUTRITIONAL SUPPLEMENTS; VITAMIN AND MINERAL SUPPLEMENTS; VITAMIN SUPPLEMENTS (U.S. CLS. 6, 18, 44, 46, 51 AND 52).

FIRST USE 12-1-2009; IN COMMERCE 12-1-2009.
KIMBERLY FRYE, EXAMINING ATTORNEY

CLASS 5—(Continued).

SN 77-936,259. SCHERING CORPORATION, KENILWORTH, NJ. FILED 2-16-2010.



THE COLOR(S) BLUE AND GREEN IS/ARE CLAIMED AS A FEATURE OF THE MARK.

THE MARK CONSISTS OF A SOLID BLUE SPHERE WITH 12 BLUE OUTWARD-FACING HALF-MOONS ON THE PERIMETER, SURROUNDED ON 4 SIDES BY A SOLID GREEN BENT LINE.

FOR PHARMACEUTICAL PREPARATIONS FOR THE TREATMENT OR PREVENTION OF VIRAL DISEASES AND IMMUNOSUPPRESSIVE DISORDERS (U.S. CLS. 6, 18, 44, 46, 51 AND 52).

ANNE MADDEN, EXAMINING ATTORNEY

SN 77-936,812. CARLINO, CRISTINA M., PHOENIX, AZ. FILED 2-16-2010.

ZONE DEFENSE

THE MARK CONSISTS OF STANDARD CHARACTERS WITHOUT CLAIM TO ANY PARTICULAR FONT, STYLE, SIZE, OR COLOR.

FOR ANTIBIOTIC CREAMS; ANTIBIOTIC HAND-WASH; ANTIBIOTIC OINTMENTS; ANTIBIOTIC PREPARATIONS; ANTISEPTIC PREPARATIONS (U.S. CLS. 6, 18, 44, 46, 51 AND 52).

JULIE WATSON, EXAMINING ATTORNEY

SN 77-935,601. DENTSPLY INTERNATIONAL INC., YORK, PA. FILED 2-15-2010.

PERIODERM

THE MARK CONSISTS OF STANDARD CHARACTERS WITHOUT CLAIM TO ANY PARTICULAR FONT, STYLE, SIZE, OR COLOR.

FOR PROCESSED HUMAN DONOR SKIN FOR THE REPLACEMENT OF SOFT TISSUE (U.S. CLS. 6, 18, 44, 46, 51 AND 52).

FIRST USE 12-22-2009; IN COMMERCE 12-22-2009.
NICHOLAS COLEMAN, EXAMINING ATTORNEY

SN 77-938,683. BRISTOL-MYERS SQUIBB COMPANY, NEW YORK, NY. FILED 2-18-2010.

PLORADRO

THE MARK CONSISTS OF STANDARD CHARACTERS WITHOUT CLAIM TO ANY PARTICULAR FONT, STYLE, SIZE, OR COLOR.

FOR ANTI-VIRAL, ANTI-CANCER AND ANTIBIOTIC PHARMACEUTICAL PREPARATIONS FOR HUMAN USE (U.S. CLS. 6, 18, 44, 46, 51 AND 52).

SUSAN STIGLITZ, EXAMINING ATTORNEY

CLASS 5—(Continued).

SN 77-940,013. HA NORTH AMERICAN SALES AB, SCOTTSDALE, AZ. FILED 2-19-2010.

PERLANE-L

THE MARK CONSISTS OF STANDARD CHARACTERS WITHOUT CLAIM TO ANY PARTICULAR FONT, STYLE, SIZE, OR COLOR.

OWNER OF U.S. REG. NOS. 3,030,752, 3,249,918 AND 3,441,344.

FOR PHARMACEUTICAL PREPARATIONS FOR USE IN AUGMENTATION OF SOFT TISSUE, SMOOTHING OUT WRINKLES AND FINE LINES, AND CONTOURING THE LIPS AND FACE; KITS CONSISTING OF SYRINGES PRE FILLED WITH PHARMACEUTICAL PREPARATIONS FOR SOFT TISSUE AUGMENTATION, SMOOTHING OUT WRINKLES AND LINES, AND CONTOURING THE LIPS AND FACE (U.S. CLS. 6, 18, 44, 46, 51 AND 52).

FIRST USE 2-11-2010; IN COMMERCE 2-11-2010.
JOSETTE BEVERLY, EXAMINING ATTORNEY

SN 77-940,065. ALBAUGH, INC., ANKENY, IA. FILED 2-19-2010.

GLYSTAR GOLD

THE MARK CONSISTS OF STANDARD CHARACTERS WITHOUT CLAIM TO ANY PARTICULAR FONT, STYLE, SIZE, OR COLOR.

OWNER OF U.S. REG. NOS. 2,750,792 AND 2,889,470.

FOR PESTICIDES (U.S. CLS. 6, 18, 44, 46, 51 AND 52).
ALYSSA STEEL, EXAMINING ATTORNEY

SN 77-940,127. HA NORTH AMERICAN SALES AB, SCOTTSDALE, AZ. FILED 2-19-2010.

RESTYLANE-L

THE MARK CONSISTS OF STANDARD CHARACTERS WITHOUT CLAIM TO ANY PARTICULAR FONT, STYLE, SIZE, OR COLOR.

OWNER OF U.S. REG. NOS. 2,390,731, 3,293,479 AND 3,358,109.

FOR PHARMACEUTICAL PREPARATIONS FOR USE IN AUGMENTATION OF SOFT TISSUE, SMOOTHING OUT WRINKLES AND FINE LINES, AND CONTOURING THE LIPS AND FACE; KITS CONSISTING OF SYRINGES PREFILLED WITH PHARMACEUTICAL PREPARATIONS FOR SOFT TISSUE AUGMENTATION, SMOOTHING OUT WRINKLES AND LINES, AND CONTOURING THE LIPS AND FACE (U.S. CLS. 6, 18, 44, 46, 51 AND 52).

FIRST USE 2-11-2010; IN COMMERCE 2-11-2010.
JOSETTE BEVERLY, EXAMINING ATTORNEY

CLASS 5—(Continued).

SN 77-940,227. ABBOTT LABORATORIES, ABBOTT PARK, IL. FILED 2-19-2010.

SIMILAC ON-THE-GO

THE MARK CONSISTS OF STANDARD CHARACTERS WITHOUT CLAIM TO ANY PARTICULAR FONT, STYLE, SIZE, OR COLOR.

OWNER OF U.S. REG. NOS. 227,046 AND 2,465,112.

FOR POWDER PACKS OF POWDERED INFANT FORMULA AND PRE-FILLED BOTTLES OF PREPARED READY TO FEED INFANT FORMULA (U.S. CLS. 6, 18, 44, 46, 51 AND 52).

DANIEL CAPSHAW, EXAMINING ATTORNEY

SN 77-940,564. GOLD RUSH BRANDS, LLC, SCARSDALE, NY. FILED 2-19-2010.

SENIORITY

THE MARK CONSISTS OF STANDARD CHARACTERS WITHOUT CLAIM TO ANY PARTICULAR FONT, STYLE, SIZE, OR COLOR.

FOR MULTI-VITAMIN PREPARATIONS; VITAMIN AND MINERAL SUPPLEMENTS; VITAMINS (U.S. CLS. 6, 18, 44, 46, 51 AND 52).

JAY BESCH, EXAMINING ATTORNEY

SN 77-946,969. DEERE & COMPANY, MOLINE, IL. FILED 3-1-2010.

REDZONE

THE MARK CONSISTS OF STANDARD CHARACTERS WITHOUT CLAIM TO ANY PARTICULAR FONT, STYLE, SIZE, OR COLOR.

FOR HERBICIDES (U.S. CLS. 6, 18, 44, 46, 51 AND 52).

FIRST USE 10-6-2006; IN COMMERCE 10-6-2006.

DAVID I, EXAMINING ATTORNEY

CLASS 5—(Continued).

SN 77-947,521. FIT NEW MOMMY, O' FALLON, MO. FILED 3-1-2010.

MOMMY GET YOUR BODY BACK

THE MARK CONSISTS OF STANDARD CHARACTERS WITHOUT CLAIM TO ANY PARTICULAR FONT, STYLE, SIZE, OR COLOR.

NO CLAIM IS MADE TO THE EXCLUSIVE RIGHT TO USE "MOMMY", APART FROM THE MARK AS SHOWN.

FOR VITAMIN SUPPLEMENTS (U.S. CLS. 6, 18, 44, 46, 51 AND 52).

FIRST USE 12-1-2009; IN COMMERCE 2-26-2010.
ELLEN BURNS, EXAMINING ATTORNEY

CLASS 5—(Continued).

SN 77-948,450. SANOFI-AVENTIS, PARIS 75013, FRANCE, FILED 3-2-2010.

PEPVELI

THE MARK CONSISTS OF STANDARD CHARACTERS WITHOUT CLAIM TO ANY PARTICULAR FONT, STYLE, SIZE, OR COLOR.

THE WORDING "PEPVELI" HAS NO MEANING IN A FOREIGN LANGUAGE.

FOR PHARMACEUTICAL PREPARATIONS FOR THE PREVENTION AND TREATMENT OF DIABETES (U.S. CLS. 6, 18, 44, 46, 51 AND 52).

WARREN L. OLANDRIA, EXAMINING ATTORNEY

SN 77-948,120. SANOFI-AVENTIS, PARIS, FRANCE, FILED 3-2-2010.

LYXUMIA

THE MARK CONSISTS OF STANDARD CHARACTERS WITHOUT CLAIM TO ANY PARTICULAR FONT, STYLE, SIZE, OR COLOR.

THE WORDING "LYXUMIA" HAS NO MEANING IN A FOREIGN LANGUAGE.

FOR PHARMACEUTICAL PREPARATIONS FOR THE PREVENTION AND TREATMENT OF DIABETES (U.S. CLS. 6, 18, 44, 46, 51 AND 52).

WARREN L. OLANDRIA, EXAMINING ATTORNEY

SN 77-948,453. SANOFI-AVENTIS, PARIS 75013, FRANCE, FILED 3-2-2010.

PEPVELIA

THE MARK CONSISTS OF STANDARD CHARACTERS WITHOUT CLAIM TO ANY PARTICULAR FONT, STYLE, SIZE, OR COLOR.

THE WORDING "PEPVELIA" HAS NO MEANING IN A FOREIGN LANGUAGE.

FOR PHARMACEUTICAL PREPARATIONS FOR THE PREVENTION AND TREATMENT OF DIABETES (U.S. CLS. 6, 18, 44, 46, 51 AND 52).

WARREN L. OLANDRIA, EXAMINING ATTORNEY

SN 77-948,442. SANOFI-AVENTIS, PARIS 75013, FRANCE, FILED 3-2-2010.

PEPLIZA

THE MARK CONSISTS OF STANDARD CHARACTERS WITHOUT CLAIM TO ANY PARTICULAR FONT, STYLE, SIZE, OR COLOR.

THE WORDING "PEPLIZA" HAS NO MEANING IN A FOREIGN LANGUAGE.

FOR PHARMACEUTICAL PREPARATIONS FOR THE PREVENTION AND TREATMENT OF DIABETES (U.S. CLS. 6, 18, 44, 46, 51 AND 52).

WARREN L. OLANDRIA, EXAMINING ATTORNEY

SN 77-948,457. SANOFI-AVENTIS, PARIS 75013, FRANCE, FILED 3-2-2010.

POPVELI

THE MARK CONSISTS OF STANDARD CHARACTERS WITHOUT CLAIM TO ANY PARTICULAR FONT, STYLE, SIZE, OR COLOR.

THE WORDING "POPVELI" HAS NO MEANING IN A FOREIGN LANGUAGE.

FOR PHARMACEUTICAL PREPARATIONS FOR THE PREVENTION AND TREATMENT OF DIABETES (U.S. CLS. 6, 18, 44, 46, 51 AND 52).

WARREN L. OLANDRIA, EXAMINING ATTORNEY

CLASS 5—(Continued).

SN 77-948,500. SANOFI-AVENTIS, PARIS 75013, FRANCE,
FILED 3-2-2010.

MEZIPOP

THE MARK CONSISTS OF STANDARD CHARACTERS
WITHOUT CLAIM TO ANY PARTICULAR FONT, STYLE,
SIZE, OR COLOR.

THE WORDING "MEZIPOP" HAS NO MEANING IN A
FOREIGN LANGUAGE.

FOR PHARMACEUTICAL PREPARATIONS FOR THE
PREVENTION AND TREATMENT OF DIABETES (U.S.
CLS. 6, 18, 44, 46, 51 AND 52).

WARREN L. OLANDRIA, EXAMINING ATTORNEY

SN 77-948,579. SANOFI-AVENTIS, PARIS 75013, FRANCE,
FILED 3-2-2010.

MYPOPRA

THE MARK CONSISTS OF STANDARD CHARACTERS
WITHOUT CLAIM TO ANY PARTICULAR FONT, STYLE,
SIZE, OR COLOR.

THE WORDING "MYPOPRA" HAS NO MEANING IN A
FOREIGN LANGUAGE.

FOR PHARMACEUTICAL PREPARATIONS FOR THE
PREVENTION AND TREATMENT OF DIABETES (U.S.
CLS. 6, 18, 44, 46, 51 AND 52).

WARREN L. OLANDRIA, EXAMINING ATTORNEY

SN 77-949,043. SUAREZ CORPORATION INDUSTRIES, N.
CANTON, OH. FILED 3-3-2010.

PRETTY FIT

THE MARK CONSISTS OF STANDARD CHARACTERS
WITHOUT CLAIM TO ANY PARTICULAR FONT, STYLE,
SIZE, OR COLOR.

FOR DIETARY SUPPLEMENTS; MINERAL SUPPLE-
MENTS; NUTRITIONAL SUPPLEMENTS; VITAMIN
SUPPLEMENTS (U.S. CLS. 6, 18, 44, 46, 51 AND 52).

CHARLES L. JENKINS, EXAMINING ATTORNEY

CLASS 5—(Continued).

SN 77-949,589. ARES TRADING S.A., AUBONNE CH1170,
SWITZERLAND, FILED 3-3-2010.

REBIDOSE

THE MARK CONSISTS OF STANDARD CHARACTERS
WITHOUT CLAIM TO ANY PARTICULAR FONT, STYLE,
SIZE, OR COLOR.

OWNER OF U.S. REG. NO. 3,678,530.

FOR PHARMACEUTICAL PREPARATIONS FOR HU-
MAN USE, NAMELY, PREPARATIONS FOR THE
TREATMENT OF IMMUNOLOGICAL DISEASES AND
DISORDERS, INFLAMMATORY DISEASES AND DIS-
ORDERS, NEUROLOGICAL DISEASES AND DISOR-
DERS (U.S. CLS. 6, 18, 44, 46, 51 AND 52).

ALICE BENMAMAN, EXAMINING ATTORNEY

SN 77-949,627. GLAXO GROUP LIMITED, GREENFORD,
MIDDLESEX, UNITED KINGDOM, FILED 3-3-2010.

RISPRIT

THE MARK CONSISTS OF STANDARD CHARACTERS
WITHOUT CLAIM TO ANY PARTICULAR FONT, STYLE,
SIZE, OR COLOR.

FOR PHARMACEUTICAL PREPARATIONS AND SUB-
STANCES FOR THE TREATMENT OF INFECTIOUS
DISEASES, BLOOD DISORDERS, PAIN, INFLAMMA-
TION, SEPSIS, ALOPECIA, OBESITY AND COGNITIVE
DISORDERS; PHARMACEUTICAL PREPARATIONS
AND SUBSTANCES FOR THE TREATMENT OF VIRAL,
METABOLIC, ENDOCRINE, MUSCULOSKELETAL,
CARDIOVASCULAR, CARDIOPULMONARY, GENI-
TOURINARY, SEXUAL DYSFUNCTION, ONCOLOGI-
CAL, HEPATOLOGICAL, OPHTHALMIC,
RESPIRATORY, NEUROLOGICAL, GASTROINTESTI-
NAL, HORMONAL, DERMATOLOGICAL, PSYCHIA-
TRIC AND IMMUNE SYSTEM RELATED DISEASES
AND DISORDERS; PHARMACEUTICAL PREPARA-
TIONS AND SUBSTANCES FOR THE TREATMENT OF
DAMAGED SKIN AND TISSUE; AND FOR VACCINES
(U.S. CLS. 6, 18, 44, 46, 51 AND 52).

PAUL CROWLEY, EXAMINING ATTORNEY

CLASS 5—(Continued).

SN 77-951,135. FIT NEW MOMMY, O'FALLON, MO. FILED 3-4-2010.

mommy feel fabulous

THE MARK CONSISTS OF STANDARD CHARACTERS WITHOUT CLAIM TO ANY PARTICULAR FONT, STYLE, SIZE, OR COLOR.

NO CLAIM IS MADE TO THE EXCLUSIVE RIGHT TO USE "MOMMY", APART FROM THE MARK AS SHOWN.

FOR VITAMIN SUPPLEMENTS (U.S. CLS. 6, 18, 44, 46, 51 AND 52).

FIRST USE 12-1-2009; IN COMMERCE 2-26-2010.
ELLEN BURNS, EXAMINING ATTORNEY

SN 77-952,020. ABBOTT LABORATORIES, ABBOTT PARK, IL. FILED 3-5-2010.

PRECISION XTRA

THE MARK CONSISTS OF STANDARD CHARACTERS WITHOUT CLAIM TO ANY PARTICULAR FONT, STYLE, SIZE, OR COLOR.

OWNER OF U.S. REG. NOS. 2,753,332, 3,293,222 AND OTHERS.

FOR TEST STRIPS FOR MEASURING BLOOD GLUCOSE LEVELS (U.S. CLS. 6, 18, 44, 46, 51 AND 52).

DANIEL CAPSHAW, EXAMINING ATTORNEY

SN 77-952,570. PURDUE PRODUCTS L.P., STAMFORD, CT. FILED 3-7-2010.

BODY SURE

THE MARK CONSISTS OF STANDARD CHARACTERS WITHOUT CLAIM TO ANY PARTICULAR FONT, STYLE, SIZE, OR COLOR.

FOR DIETARY SUPPLEMENTS (U.S. CLS. 6, 18, 44, 46, 51 AND 52).

DAVID MURRAY, EXAMINING ATTORNEY

CLASS 5—(Continued).

SN 77-952,572. PURDUE PRODUCTS L.P., STAMFORD, CT. FILED 3-7-2010.

SELF ASSURE

THE MARK CONSISTS OF STANDARD CHARACTERS WITHOUT CLAIM TO ANY PARTICULAR FONT, STYLE, SIZE, OR COLOR.

FOR DIETARY SUPPLEMENTS (U.S. CLS. 6, 18, 44, 46, 51 AND 52).

DAVID MURRAY, EXAMINING ATTORNEY

SN 77-954,132. HOFFMAN, JANIE, DBA MAMMA CHIA, LLC, BONSALL, CA. FILED 3-9-2010.

Mamma Chia

THE MARK CONSISTS OF STANDARD CHARACTERS WITHOUT CLAIM TO ANY PARTICULAR FONT, STYLE, SIZE, OR COLOR.

NO CLAIM IS MADE TO THE EXCLUSIVE RIGHT TO USE "CHIA", APART FROM THE MARK AS SHOWN.

FOR AROMATIZED BEVERAGES BASED ON FRUIT, PROTEIN, CORDIAL, SUGAR AND OTHER FLUID NUTRIENTS, NAMELY, MEAL REPLACEMENT DRINKS FOR USE AS A FOOD FILLERS (U.S. CLS. 6, 18, 44, 46, 51 AND 52).

FIRST USE 4-6-2009; IN COMMERCE 4-6-2009.
JOHN E. MICHOS, EXAMINING ATTORNEY

CLASS 5—(Continued).

SN 77-954,164. HOFFMAN, JANIE, DBA MAMMA CHIA, LLC, BONSALE, CA. FILED 3-9-2010.



NO CLAIM IS MADE TO THE EXCLUSIVE RIGHT TO USE "CHIA", APART FROM THE MARK AS SHOWN. THE COLOR(S) PURPLE AND RED IS/ARE CLAIMED AS A FEATURE OF THE MARK.

THE MARK CONSISTS OF A PURPLE GODDESS HOLDING PLANT STALKS WITH PURPLE GRADIENT RAYS SURROUNDING HER. THE WORDING "MAMMA CHIA" IS IN RED AND "SEED YOUR SOUL" IS IN PURPLE.

FOR AROMATIZED BEVERAGES BASED ON FRUIT, PROTEIN, CORDIAL, SUGAR AND OTHER FLUID NUTRIENTS, NAMELY, MEAL REPLACEMENT DRINKS FOR USE AS A FOOD FILLERS (U.S. CLS. 6, 18, 44, 46, 51 AND 52).

FIRST USE 4-6-2009; IN COMMERCE 4-6-2009. JOHN E. MICHO, EXAMINING ATTORNEY

SN 77-955,263. BOEHRINGER INGELHEIM INTERNATIONAL GMBH, INGELHEIM AM RHEIN, FED REP GERMANY, FILED 3-10-2010.

DULCOGAS

THE MARK CONSISTS OF STANDARD CHARACTERS WITHOUT CLAIM TO ANY PARTICULAR FONT, STYLE, SIZE, OR COLOR.

OWNER OF U.S. REG. NOS. 3,527,795, 3,667,064 AND 3,763,452.

FOR PHARMACEUTICAL PREPARATIONS FOR THE ALIMENTARY TRACT AND METABOLISM (U.S. CLS. 6, 18, 44, 46, 51 AND 52).

CARYN GLASSER, EXAMINING ATTORNEY

CLASS 5—(Continued).

SN 77-956,557. RECKITT BENCKISER, INC., PARSIPPANY, NJ. FILED 3-11-2010.

FULL FORCE

THE MARK CONSISTS OF STANDARD CHARACTERS WITHOUT CLAIM TO ANY PARTICULAR FONT, STYLE, SIZE, OR COLOR.

OWNER OF U.S. REG. NO. 3,392,532.

FOR PHARMACEUTICAL PREPARATIONS FOR USE AS A NASAL MOISTURIZER, NASAL DECONGESTANT AND DECONGESTANT PREPARATION (U.S. CLS. 6, 18, 44, 46, 51 AND 52).

FIRST USE 11-11-2007; IN COMMERCE 11-11-2007. ESTHER BELENKER, EXAMINING ATTORNEY

SN 77-960,175. GASPARI NUTRITION, INC., LAKEWOOD, NJ. FILED 3-16-2010.

DETONATE

THE MARK CONSISTS OF STANDARD CHARACTERS WITHOUT CLAIM TO ANY PARTICULAR FONT, STYLE, SIZE, OR COLOR.

FOR DIETARY AND NUTRITIONAL SUPPLEMENTS (U.S. CLS. 6, 18, 44, 46, 51 AND 52).

KIMBERLY FRYE, EXAMINING ATTORNEY

SN 77-961,667. INNOCENZI, MARK, FRANKLIN LAKES, NJ. FILED 3-17-2010.

NutraBoost

THE MARK CONSISTS OF STANDARD CHARACTERS WITHOUT CLAIM TO ANY PARTICULAR FONT, STYLE, SIZE, OR COLOR.

FOR NUTRITIONAL SUPPLEMENTS; NUTRITIONAL ADDITIVES FOR MEDICAL PURPOSES USED IN FOODS AND DIETARY SUPPLEMENTS FOR HUMAN CONSUMPTION (U.S. CLS. 6, 18, 44, 46, 51 AND 52).

TEJBIR SINGH, EXAMINING ATTORNEY

CLASS 5—(Continued).

SN 77-962,393. GLAXO GROUP LIMITED, GREENFORD, MIDDLESEX, UNITED KINGDOM, FILED 3-18-2010.

TAFINALAR

THE MARK CONSISTS OF STANDARD CHARACTERS WITHOUT CLAIM TO ANY PARTICULAR FONT, STYLE, SIZE, OR COLOR.

FOR PHARMACEUTICAL PREPARATIONS AND SUBSTANCES FOR THE TREATMENT OF INFECTIOUS DISEASES, BLOOD DISORDERS, PAIN, INFLAMMATION, SEPSIS, ALOPECIA, OBESITY AND COGNITIVE DISORDERS; PHARMACEUTICAL PREPARATIONS AND SUBSTANCES FOR THE TREATMENT OF VIRAL, METABOLIC, ENDOCRINE, MUSCULOSKELETAL, CARDIOVASCULAR, CARDIOPULMONARY, GENITOURINARY, SEXUAL DYSFUNCTION, ONCOLOGICAL, HEPATOLOGICAL, OPHTHALMIC, RESPIRATORY, NEUROLOGICAL, GASTROINTESTINAL, HORMONAL, DERMATOLOGICAL, PSYCHIATRIC AND IMMUNE SYSTEM RELATED DISEASES AND DISORDERS; PHARMACEUTICAL PREPARATIONS AND SUBSTANCES FOR THE TREATMENT OF DAMAGED SKIN AND TISSUE; AND FOR VACCINES (U.S. CLS. 6, 18, 44, 46, 51 AND 52).

PAUL CROWLEY, EXAMINING ATTORNEY

CLASS 5—(Continued).

SN 77-962,398. GLAXO GROUP LIMITED, GREENFORD, MIDDLESEX, UNITED KINGDOM, FILED 3-18-2010.

IPTORZA

THE MARK CONSISTS OF STANDARD CHARACTERS WITHOUT CLAIM TO ANY PARTICULAR FONT, STYLE, SIZE, OR COLOR.

FOR PHARMACEUTICAL PREPARATIONS AND SUBSTANCES FOR THE TREATMENT OF INFECTIOUS DISEASES, BLOOD DISORDERS, PAIN, INFLAMMATION, SEPSIS, ALOPECIA, OBESITY AND COGNITIVE DISORDERS; PHARMACEUTICAL PREPARATIONS AND SUBSTANCES FOR THE TREATMENT OF VIRAL, METABOLIC, ENDOCRINE, MUSCULOSKELETAL, CARDIOVASCULAR, CARDIOPULMONARY, GENITOURINARY, SEXUAL DYSFUNCTION, ONCOLOGICAL, HEPATOLOGICAL, OPHTHALMIC, RESPIRATORY, NEUROLOGICAL, GASTROINTESTINAL, HORMONAL, DERMATOLOGICAL, PSYCHIATRIC AND IMMUNE SYSTEM RELATED DISEASES AND DISORDERS; PHARMACEUTICAL PREPARATIONS AND SUBSTANCES FOR THE TREATMENT OF DAMAGED SKIN AND TISSUE; AND FOR VACCINES (U.S. CLS. 6, 18, 44, 46, 51 AND 52).

PAUL CROWLEY, EXAMINING ATTORNEY

SN 77-962,397. GLAXO GROUP LIMITED, GREENFORD, MIDDLESEX, UNITED KINGDOM, FILED 3-18-2010.

IVARNA

THE MARK CONSISTS OF STANDARD CHARACTERS WITHOUT CLAIM TO ANY PARTICULAR FONT, STYLE, SIZE, OR COLOR.

FOR PHARMACEUTICAL PREPARATIONS AND SUBSTANCES FOR THE TREATMENT OF INFECTIOUS DISEASES, BLOOD DISORDERS, PAIN, INFLAMMATION, SEPSIS, ALOPECIA, OBESITY AND COGNITIVE DISORDERS; PHARMACEUTICAL PREPARATIONS AND SUBSTANCES FOR THE TREATMENT OF VIRAL, METABOLIC, ENDOCRINE, MUSCULOSKELETAL, CARDIOVASCULAR, CARDIOPULMONARY, GENITOURINARY, SEXUAL DYSFUNCTION, ONCOLOGICAL, HEPATOLOGICAL, OPHTHALMIC, RESPIRATORY, NEUROLOGICAL, GASTROINTESTINAL, HORMONAL, DERMATOLOGICAL, PSYCHIATRIC AND IMMUNE SYSTEM RELATED DISEASES AND DISORDERS; PHARMACEUTICAL PREPARATIONS AND SUBSTANCES FOR THE TREATMENT OF DAMAGED SKIN AND TISSUE; AND FOR VACCINES (U.S. CLS. 6, 18, 44, 46, 51 AND 52).

PAUL CROWLEY, EXAMINING ATTORNEY

SN 77-962,401. GLAXO GROUP LIMITED, GREENFORD, MIDDLESEX, UNITED KINGDOM, FILED 3-18-2010.

EVARNO

THE MARK CONSISTS OF STANDARD CHARACTERS WITHOUT CLAIM TO ANY PARTICULAR FONT, STYLE, SIZE, OR COLOR.

FOR PHARMACEUTICAL PREPARATIONS AND SUBSTANCES FOR THE TREATMENT OF INFECTIOUS DISEASES, BLOOD DISORDERS, PAIN, INFLAMMATION, SEPSIS, ALOPECIA, OBESITY AND COGNITIVE DISORDERS; PHARMACEUTICAL PREPARATIONS AND SUBSTANCES FOR THE TREATMENT OF VIRAL, METABOLIC, ENDOCRINE, MUSCULOSKELETAL, CARDIOVASCULAR, CARDIOPULMONARY, GENITOURINARY, SEXUAL DYSFUNCTION, ONCOLOGICAL, HEPATOLOGICAL, OPHTHALMIC, RESPIRATORY, NEUROLOGICAL, GASTROINTESTINAL, HORMONAL, DERMATOLOGICAL, PSYCHIATRIC AND IMMUNE SYSTEM RELATED DISEASES AND DISORDERS; PHARMACEUTICAL PREPARATIONS AND SUBSTANCES FOR THE TREATMENT OF DAMAGED SKIN AND TISSUE; AND FOR VACCINES (U.S. CLS. 6, 18, 44, 46, 51 AND 52).

PAUL CROWLEY, EXAMINING ATTORNEY

CLASS 5—(Continued).

SN 77-963,565. VITACOST.COM INC., BOCA RATON, FL.
FILED 3-19-2010.

CLASS 5—(Continued).

SN 78-434,470. MAJEED, MUHAMMED, PISCATAWAY, NJ.
FILED 6-14-2004.

ARTHROPOWER ULTRA

THE MARK CONSISTS OF STANDARD CHARACTERS
WITHOUT CLAIM TO ANY PARTICULAR FONT, STYLE,
SIZE, OR COLOR.
FOR DIETARY AND NUTRITIONAL SUPPLEMENTS
(U.S. CLS. 6, 18, 44, 46, 51 AND 52).
STEVEN JACKSON, EXAMINING ATTORNEY

NIA SLOW SR

THE MARK CONSISTS OF STANDARD CHARACTERS
WITHOUT CLAIM TO ANY PARTICULAR FONT, STYLE,
SIZE, OR COLOR.
NO CLAIM IS MADE TO THE EXCLUSIVE RIGHT TO
USE "SLOW SR", APART FROM THE MARK AS SHOWN.
FOR NUTRITIONAL SUPPLEMENT (U.S. CLS. 6, 18,
44, 46, 51 AND 52).
BILL DAWE, EXAMINING ATTORNEY

SN 77-967,423. GASPARI NUTRITION, INC., LAKEWOOD,
NJ. FILED 3-24-2010.

SN 78-486,525. INOVIOBIOLOGIC INC., CALGARY, ALBER-
TA, FILED 9-20-2004.

WHITELINE

THE MARK CONSISTS OF STANDARD CHARACTERS
WITHOUT CLAIM TO ANY PARTICULAR FONT, STYLE,
SIZE, OR COLOR.
FOR DIETARY AND NUTRITIONAL SUPPLEMENTS
FOR HUMANS (U.S. CLS. 6, 18, 44, 46, 51 AND 52).
KIMBERLY FRYE, EXAMINING ATTORNEY

INOVOBIOLOGIC

THE MARK CONSISTS OF STANDARD CHARACTERS
WITHOUT CLAIM TO ANY PARTICULAR FONT, STYLE,
SIZE, OR COLOR.
PRIORITY CLAIMED UNDER SEC. 44(D) ON CANADA
APPLICATION NO. 1230933, FILED 9-20-2004, REG. NO.
TMA742930, DATED 7-2-2009, EXPIRES 7-2-2024.
FOR NUTRITIONAL SUPPLEMENTS, DIETARY SUP-
PLEMENTS AND NUTRITIONAL INGREDIENTS IN
THE NATURE OF VITAMINS AND MEDICINAL HER-
BAL EXTRACTS (U.S. CLS. 6, 18, 44, 46, 51 AND 52).
WILLIAM VERHOSEK, EXAMINING ATTORNEY

SN 77-967,609. VALENT U.S.A. CORPORATION, WALNUT
CREEK, CA. FILED 3-24-2010.

SN 78-675,405. GND INTERNATIONAL CORPORATION,
LAS VEGAS, NV. FILED 7-21-2005.

FIERCE

THE MARK CONSISTS OF STANDARD CHARACTERS
WITHOUT CLAIM TO ANY PARTICULAR FONT, STYLE,
SIZE, OR COLOR.
FOR HERBICIDE (U.S. CLS. 6, 18, 44, 46, 51 AND 52).
JEAN IM, EXAMINING ATTORNEY

KERAGENEX

THE MARK CONSISTS OF STANDARD CHARACTERS
WITHOUT CLAIM TO ANY PARTICULAR FONT, STYLE,
SIZE, OR COLOR.
FOR MINERAL SUPPLEMENTS (U.S. CLS. 6, 18, 44, 46,
51 AND 52).
STEVEN JACKSON, EXAMINING ATTORNEY

CLASS 5—(Continued).

SN 78-695,585. HDM TRADEMARKS LTD., OAKVILLE, ONTARIO, CANADA, FILED 8-18-2005.

HYDROXYCUT HARDCORE

THE MARK CONSISTS OF STANDARD CHARACTERS WITHOUT CLAIM TO ANY PARTICULAR FONT, STYLE, SIZE, OR COLOR.

FOR DIETARY SUPPLEMENT FOR WEIGHT LOSS FOR ATHLETES AND BODYBUILDERS AS CAPLETS, CAPSULES AND TABLETS (U.S. CLS. 6, 18, 44, 46, 51 AND 52).

ANDREA SAUNDERS, EXAMINING ATTORNEY

SN 79-073,413. MEDAC GESELLSCHAFT FÜR KLINISCHE; SPEZIALPRÄPARATE MBH, FED REP GERMANY, FILED 8-14-2009.

Medaspar

THE MARK CONSISTS OF STANDARD CHARACTERS WITHOUT CLAIM TO ANY PARTICULAR FONT, STYLE, SIZE, OR COLOR.

OWNER OF INTERNATIONAL REGISTRATION 1014697 DATED 8-14-2009, EXPIRES 8-14-2019.

THE WORDING "MEDASPAR" HAS NO MEANING IN A FOREIGN LANGUAGE.

FOR PHARMACEUTICAL PREPARATIONS FOR TREATING CANCER AND AUTOIMMUNE DISEASES (U.S. CLS. 6, 18, 44, 46, 51 AND 52).

JERI J. FICKES, EXAMINING ATTORNEY

CLASS 5—(Continued).

SN 79-074,135. NOVARTIS AG, SWITZERLAND, FILED 5-20-2009.

OLERIVE

THE MARK CONSISTS OF STANDARD CHARACTERS WITHOUT CLAIM TO ANY PARTICULAR FONT, STYLE, SIZE, OR COLOR.

OWNER OF INTERNATIONAL REGISTRATION 1016671 DATED 5-20-2009, EXPIRES 5-20-2019.

OWNER OF U.S. REG. NO. 2,995,314.

FOR PHARMACEUTICAL PREPARATIONS FOR THE PREVENTION AND TREATMENT OF DISORDERS OF THE NERVOUS SYSTEM, THE IMMUNE SYSTEM, THE CARDIO-VASCULAR SYSTEM, THE METABOLIC SYSTEM, THE RESPIRATORY SYSTEM, THE MUSCULO-SKELETAL SYSTEM, THE GENITOURINARY SYSTEM; FOR THE TREATMENT OF INFLAMMATORY DISORDERS; FOR USE IN DERMATOLOGY, ONCOLOGY, HEMATOLOGY AND IN TISSUE AND ORGAN TRANSPLANTATION, IN OPHTHALMOLOGY AND FOR GASTROENTEROLOGICAL DISORDERS; PHARMACEUTICAL PREPARATIONS FOR THE PREVENTION AND TREATMENT OF OCULAR DISORDERS OR DISEASES, BACTERIA-BASED DISEASES OR DISORDERS, AUTOIMMUNE DISEASES OR DISORDERS, KIDNEY DISEASES OR DISORDERS, AND DIABETES; ANTIFUNGAL PREPARATIONS; ANTI-INFECTIVES; ANTIVIRAL; ANTIBIOTICS; VACCINES, DIAGNOSTIC PREPARATIONS FOR MEDICAL USE (U.S. CLS. 6, 18, 44, 46, 51 AND 52).

GINA HAYES, EXAMINING ATTORNEY

SN 79-077,787. THOMAS WEBER, SWITZERLAND, FILED 10-6-2009.

PRIMAVEST

THE MARK CONSISTS OF STANDARD CHARACTERS WITHOUT CLAIM TO ANY PARTICULAR FONT, STYLE, SIZE, OR COLOR.

PRIORITY DATE OF 4-8-2009 IS CLAIMED.

OWNER OF INTERNATIONAL REGISTRATION 1026118 DATED 10-6-2009, EXPIRES 10-6-2019.

FOR CHEMICAL PREPARATIONS FOR DENTAL USE, NAMELY, COATING MASSES, QUARTZ POWDERS, BINDING AGENTS, PRESSED CERAMIC, MODELLING COMPOUNDS, SEPARATOR AGENTS, CONTACT AGENTS, WETTING AGENTS (U.S. CLS. 6, 18, 44, 46, 51 AND 52).

PAUL MORENO, EXAMINING ATTORNEY

CLASS 5—(Continued).

SN 85-002,987. GLAXO GROUP LIMITED, GREENFORD, MIDDLESEX, UNITED KINGDOM, FILED 3-31-2010.

DEFENOR

THE MARK CONSISTS OF STANDARD CHARACTERS WITHOUT CLAIM TO ANY PARTICULAR FONT, STYLE, SIZE, OR COLOR.

FOR PHARMACEUTICAL PREPARATIONS AND SUBSTANCES FOR THE TREATMENT OF CARDIOVASCULAR RELATED DISEASES AND DISORDERS, EXCLUDING VACCINES (U.S. CLS. 6, 18, 44, 46, 51 AND 52).

PAUL CROWLEY, EXAMINING ATTORNEY

CLASS 6—METAL GOODS

SN 77-664,847. CASATA TECHNOLOGIES INC., SAULT STE MARIE, ONTARIO, CANADA, FILED 2-6-2009.

EVOLUTION DECK

THE MARK CONSISTS OF STANDARD CHARACTERS WITHOUT CLAIM TO ANY PARTICULAR FONT, STYLE, SIZE, OR COLOR.

PRIORITY CLAIMED UNDER SEC. 44(D) ON CANADA APPLICATION NO. 1,426,772, FILED 2-4-2009, REG. NO. TMA761,333, DATED 3-10-2010, EXPIRES 3-10-2025.

NO CLAIM IS MADE TO THE EXCLUSIVE RIGHT TO USE "DECK", APART FROM THE MARK AS SHOWN.

FOR DECKING SYSTEMS, NAMELY, METAL COMPONENTS FOR USE IN THE CONSTRUCTION OF DECKS, NAMELY, METAL POSTS, BEAMS, INTEGRATED PLATFORM JOISTS, DECKING, BRACKETS, SHORES, AND SUPPORTS (U.S. CLS. 2, 12, 13, 14, 23, 25 AND 50).

HELENE LIWINSKI, EXAMINING ATTORNEY

SN 85-008,485. BODYWELL NUTRITION LLC, SUNRISE, FL. FILED 4-7-2010.

BODYHOT

THE MARK CONSISTS OF STANDARD CHARACTERS WITHOUT CLAIM TO ANY PARTICULAR FONT, STYLE, SIZE, OR COLOR.

FOR VITAMINS AND NUTRITIONAL SUPPLEMENTS FOR HUMAN CONSUMPTION (U.S. CLS. 6, 18, 44, 46, 51 AND 52).

RENEE MCCRAY, EXAMINING ATTORNEY

SN 77-716,709. THE EARTHLY WAY, INC., BELLEVUE, WA. FILED 4-17-2009.

Y-STAKES

THE MARK CONSISTS OF STANDARD CHARACTERS WITHOUT CLAIM TO ANY PARTICULAR FONT, STYLE, SIZE, OR COLOR.

NO CLAIM IS MADE TO THE EXCLUSIVE RIGHT TO USE "STAKES", APART FROM THE MARK AS SHOWN.

FOR ONE, TWO AND THREE FOOT SIZED STAKES MADE FROM BROWN COATED ALUMINUM TUBING WITH BENDABLE, GREEN WIRE ARMS, USED TO SUPPORT BOTH OUTDOOR AND INDOOR PLANTS (U.S. CLS. 2, 12, 13, 14, 23, 25 AND 50).

FIRST USE 3-1-1993; IN COMMERCE 10-22-1993. MICHAEL ENGEL, EXAMINING ATTORNEY

SN 85-010,755. GASPARI NUTRITION, INC., LAKEWOOD, NJ. FILED 4-9-2010.

QUALITINE

THE MARK CONSISTS OF STANDARD CHARACTERS WITHOUT CLAIM TO ANY PARTICULAR FONT, STYLE, SIZE, OR COLOR.

FOR DIETARY AND NUTRITIONAL SUPPLEMENTS (U.S. CLS. 6, 18, 44, 46, 51 AND 52).

KIMBERLY FRYE, EXAMINING ATTORNEY

SN 77-749,864. STAM, ROBERT, TACOMA, WA. FILED 6-2-2009.

EZ BAR

THE MARK CONSISTS OF STANDARD CHARACTERS WITHOUT CLAIM TO ANY PARTICULAR FONT, STYLE, SIZE, OR COLOR.

NO CLAIM IS MADE TO THE EXCLUSIVE RIGHT TO USE "BAR", APART FROM THE MARK AS SHOWN.

FOR METAL SHOWER GRAB BARS (U.S. CLS. 2, 12, 13, 14, 23, 25 AND 50).

Laurie Mayes, Examining Attorney

CLASS 6—(Continued).

SN 77-756,090. DAECHANG CO., LTD, GYEONGGI-DO, REPUBLIC OF KOREA, FILED 6-10-2009.



The logo for BRASS ONE features the word "BRASS" in a bold, sans-serif font, followed by a large, stylized number "1" that overlaps the letter "S". Below the "1" is the word "ONE" in a similar bold, sans-serif font.

NO CLAIM IS MADE TO THE EXCLUSIVE RIGHT TO USE "BRASS", APART FROM THE MARK AS SHOWN.

THE MARK CONSISTS OF THE WORD "BRASSONE" WITH THE NUMBER "1" SUPERIMPOSED OVER THE LETTER "O".

FOR BRASS RODS FOR USE IN VALVES, TIRE PARTS, ELECTRIC CORDS, BOLTS, NUTS, ZIPPERS, RIVETS, SYNCHRONIZER RINGS, PARTS FOR WATCHES AND CAMERAS, PROPELLER AXLES, PUMP AXLES, FOOD-CONNECTED PARTS, MACHINERY AND ELECTRICAL PARTS, CONSTRUCTION MATERIALS AND CHEMICAL INDUSTRIAL MATERIALS; BRASS PIPES FOR USE IN PIPE PARTS FOR CONSTRUCTION, HOT AND COLD WATER PIPE PARTS, FOOD-CONNECTED PARTS, TAPS, BEVERAGE PIPE PARTS, ELECTRIC AND ELECTRONIC PARTS, CONSTRUCTION MATERIALS, CHEMICAL INDUSTRIAL MATERIALS AND MACHINERY PARTS; BRASS PLATES FOR USE IN SWITCHES, LEAD FRAMES, CONNECTORS, RELAYS, ELECTRIC AND ELECTRONIC PARTS, CONSTRUCTION MATERIALS, CHEMICAL INDUSTRIAL MATERIALS, MACHINERY PARTS, SHIP MATERIALS; BRASS WIRES FOR USE IN ELECTRIC WIRES, EDM WIRES, SMALL SCREWS, WIRE NETS, BOLTS, NUTS, CAMERA PARTS, ELECTRIC AND ELECTRONIC PARTS AND MACHINERY PARTS; BRASS INGOTS FOR USE IN DECORATIONS, ARTS AND CRAFT MATERIALS, CONSTRUCTION MATERIALS, VALVES, PIPE PARTS, RIVETS, TAPS AND MACHINERY PARTS; BRASS CASTINGS FOR USE IN VALVES, SUPPORTERS, PROPELLERS FOR SHIPS, BEARINGS, GEARS, BOLTS, NUTS, MACHINERY PARTS, CONSTRUCTION PARTS, CHEMICAL INDUSTRIAL MATERIALS, SHIP MATERIALS, ARTS AND CRAFT MATERIALS, CASTING PARTS MADE BY SAND CASTING, MOLD CASTING, CENTRIFUGAL CASTING AND PRECISION CASTING PROCESSES; SEMI-FINISHED ARTICLES OF BRASS IN THE FORM OF BILLETS, BARS, PIPES, WIRES, SLABS, PLATES, SHEETS, TUBES, INGOTS (U.S. CLS. 2, 12, 13, 14, 23, 25 AND 50).

LINDA ESTRADA, EXAMINING ATTORNEY

SN 77-765,063. GOIN, HUGH L., CRESTON, WA. AND GOIN, CLAY J., SPOKANE, WA. FILED 6-22-2009.



The logo for CURB-EZ consists of the words "CURB-EZ" in a bold, sans-serif font.

THE MARK CONSISTS OF STANDARD CHARACTERS WITHOUT CLAIM TO ANY PARTICULAR FONT, STYLE, SIZE, OR COLOR.

FOR METAL LOADING RAMPS FOR USE WITH VEHICLES, AND COMPONENT PARTS THEREOF; METAL ACCESS RAMPS FOR USE WITH VEHICLES AND COMPONENT PARTS THEREOF; PORTABLE METAL STRUCTURES FOR STORING RAMPS FOR AGRICULTURAL, COMMERCIAL OR INDUSTRIAL PURPOSES; METAL CONTAINERS FOR THE STORAGE AND TRANSPORTATION OF RAMPS (U.S. CLS. 2, 12, 13, 14, 23, 25 AND 50).

WENDY GOODMAN, EXAMINING ATTORNEY

CLASS 6—(Continued).

SN 77-779,620. INGENUITY INDUSTRIES, INC., DBA TELECOM LIFTERS, BROWNSVILLE, CA. FILED 7-13-2009.



The logo for BW USA features the stylized letters "BW" above a horizontal line with a small vertical tick mark in the center, and the word "USA" below it.

NO CLAIM IS MADE TO THE EXCLUSIVE RIGHT TO USE "USA", APART FROM THE MARK AS SHOWN.

THE MARK CONSISTS OF THE STYLIZED LETTERS "BW" APPEARING ABOVE A DESIGN RESEMBLING ELECTRICAL GROUNDING, ALL APPEARING ABOVE THE STYLIZED LETTERS "USA".

FOR WASHERS OF METAL, NAMELY, TWO HOLE LUG WASHERS FOR USE WITH GROUND BARS FOR ELECTRICAL AND ELECTRONIC EQUIPMENT ON CELL TOWERS (U.S. CLS. 2, 12, 13, 14, 23, 25 AND 50).

FIRST USE 2-19-2008; IN COMMERCE 5-1-2009.

KAELIE KUNG, EXAMINING ATTORNEY

SN 77-797,167. MOTIVATION LLC, BOSSIER CITY, LA. FILED 8-5-2009.



The logo for MOTIVATION features a stylized graphic of three wavy, flame-like elements above the word "MOTIVATION" in a bold, sans-serif font, with the tagline "WE CAN DO IT" below it.

THE MARK CONSISTS OF A BOX HAVING THREE WAVE-LIKE ELEMENTS THEREIN, WHICH IS POSITIONED ABOVE THE WORD "MOTIVATION", WHICH IS POSITIONED ABOVE THE WORDS "WE CAN DO IT".

FOR EQUIPMENT FOR USE IN COMMERCIAL MARINE DOCKS, NAMELY, METAL SHACKLES AND HOOKS FOR LIFTING AND RIGGING (U.S. CLS. 2, 12, 13, 14, 23, 25 AND 50).

FIRST USE 7-0-2009; IN COMMERCE 7-0-2009.

MICHAEL LITZAU, EXAMINING ATTORNEY

CLASS 6—(Continued).

SN 77-801,290. WIDEAWAKE-DEATHROW ENTERTAINMENT LLC, CALABASAS, CA. FILED 8-10-2009.



THE MARK CONSISTS OF THE WORDS "DEATH ROW RECORDS" IN FANCIFUL LETTERING SURROUNDING A DESIGN OF A HOODED PERSON STRAPPED TO AN ELECTRIC CHAIR.

FOR KEYRINGS OF COMMON METAL (U.S. CLS. 2, 12, 13, 14, 23, 25 AND 50).

DAVID TOOLEY, EXAMINING ATTORNEY

SN 77-802,623. VICINAY CADENAS, S.A., BILBAO, VIZCAYA, SPAIN, FILED 8-12-2009.

QWELD

THE MARK CONSISTS OF STANDARD CHARACTERS WITHOUT CLAIM TO ANY PARTICULAR FONT, STYLE, SIZE, OR COLOR.

OWNER OF SPAIN REG. NO. 2.516.316, DATED 5-6-2003, EXPIRES 12-5-2012.

OWNER OF U.S. REG. NO. 2,817,213.

FOR METALLIC CHAINS FOR SHIP AND OIL INDUSTRY (U.S. CLS. 2, 12, 13, 14, 23, 25 AND 50).

LYDIA BELZER, EXAMINING ATTORNEY

CLASS 6—(Continued).

SN 77-843,748. BAL SEAL ENGINEERING, FOOTHILL RANCH, CA. FILED 10-7-2009.

Bal Seal Canted Coil Spring

THE MARK CONSISTS OF STANDARD CHARACTERS WITHOUT CLAIM TO ANY PARTICULAR FONT, STYLE, SIZE, OR COLOR.

OWNER OF U.S. REG. NO. 2,924,860.

NO CLAIM IS MADE TO THE EXCLUSIVE RIGHT TO USE "SEAL" AND "CANTED COIL SPRING", APART FROM THE MARK AS SHOWN.

FOR METAL HARDWARE, NAMELY, CANTED COIL SPRINGS FOR USE IN CONNECTORS, NAMELY, ELECTRICAL, MEDICAL, AND MECHANICAL CONNECTORS (U.S. CLS. 2, 12, 13, 14, 23, 25 AND 50).

ERIN FALK, EXAMINING ATTORNEY

SN 77-843,788. BAL SEAL ENGINEERING, FOOTHILL RANCH, CA. FILED 10-7-2009.

Bal Seal Canted Coil

THE MARK CONSISTS OF STANDARD CHARACTERS WITHOUT CLAIM TO ANY PARTICULAR FONT, STYLE, SIZE, OR COLOR.

OWNER OF U.S. REG. NO. 2,924,860.

NO CLAIM IS MADE TO THE EXCLUSIVE RIGHT TO USE "SEAL" AND "CANTED COIL", APART FROM THE MARK AS SHOWN.

FOR METAL HARDWARE, NAMELY, CANTED COIL SPRINGS FOR USE IN CONNECTORS, NAMELY, ELECTRICAL, MEDICAL, AND MECHANICAL CONNECTORS (U.S. CLS. 2, 12, 13, 14, 23, 25 AND 50).

ERIN FALK, EXAMINING ATTORNEY

SN 77-852,735. VINTECH SYSEM INC., CHICAGO, IL. FILED 10-20-2009.

FOISON

THE MARK CONSISTS OF THE TERM "FOISON" WITH A KEY LOCK DESIGN WITHIN THE FIRST "O" AND A KEY DESIGN WITHIN THE SECOND "O".

FOR DOOR HARDWARE, NAMELY, KEYS AND KEY CYLINDERS; METAL CHAIN DOOR GUARDS; METAL CLASPS FOR DOOR; METAL DOOR BOLTS; METAL DOOR LATCHES; METAL HANDLES FOR DOOR; METAL KEYS FOR LOCKS; METAL LOCKING MECHANISMS; METAL LOCKS; METAL LOCKS AND KEYS THEREFOR; METAL MULTI-POINT LOCKING SYSTEM IN A WOOD DOOR; METAL SASH LOCKS; METAL SECURITY LOCK CYLINDERS; SMALL ITEMS OF METAL HARDWARE, NAMELY, HIGH SECURITY LOCKS AND SHEET METAL PLATES PRIMARILY FOR THE CASINO AND GAMING INDUSTRY (U.S. CLS. 2, 12, 13, 14, 23, 25 AND 50).

TEJBIR SINGH, EXAMINING ATTORNEY

CLASS 6—(Continued).

SN 77-862,027. EMMETT,TROY DEE, CARMICHAEL, CA.
FILED 10-31-2009.

Z Post

THE MARK CONSISTS OF STANDARD CHARACTERS WITHOUT CLAIM TO ANY PARTICULAR FONT, STYLE, SIZE, OR COLOR.

NO CLAIM IS MADE TO THE EXCLUSIVE RIGHT TO USE "POST", APART FROM THE MARK AS SHOWN.

FOR METAL FENCE POSTS; METAL POSTS (U.S. CLS. 2, 12, 13, 14, 23, 25 AND 50).

FIRST USE 4-1-2009; IN COMMERCE 5-25-2009.

JULIE GUTTADAURO, EXAMINING ATTORNEY

SN 77-883,903. VENKO TROPHIES & AWARDS, INC.,
MIAMI, FL. FILED 12-2-2009.



NO CLAIM IS MADE TO THE EXCLUSIVE RIGHT TO USE "TROPHIES", APART FROM THE MARK AS SHOWN.

THE MARK CONSISTS OF THE WORDS "VENKO TROPHIES" WITH THE "V" IN "VENKO" IN STYLIZED FORM HAVING A "V" DISPOSED PARTIALLY WITHIN THE OPEN SPACE BETWEEN THE LEFT AND RIGHT SIDES OF ANOTHER "V".

THE ENGLISH TRANSLATION OF THE ESPERANTO WORD "VENKO" IN THE MARK IS "VICTORY".

FOR TROPHIES, STATUES, AND FIGURES OF COMMON METAL; AWARDS, NAMELY, WALL PLAQUES OF COMMON METAL; AWARDS, NAMELY, COMMEMORATIVE CUPS OF COMMON METAL (U.S. CLS. 2, 12, 13, 14, 23, 25 AND 50).

ELLEN BURNS, EXAMINING ATTORNEY

SN 77-902,666. VOGELSANG CORPORATION, LAKEWOOD,
NJ. FILED 12-30-2009.

ERP-Series

THE MARK CONSISTS OF STANDARD CHARACTERS WITHOUT CLAIM TO ANY PARTICULAR FONT, STYLE, SIZE, OR COLOR.

NO CLAIM IS MADE TO THE EXCLUSIVE RIGHT TO USE "SERIES", APART FROM THE MARK AS SHOWN.

FOR FASTENERS, NAMELY, METAL CYLINDRICAL SELF-LOCKING NON-THREADED FASTENERS (U.S. CLS. 2, 12, 13, 14, 23, 25 AND 50).

DAVID TOOLEY, EXAMINING ATTORNEY

CLASS 6—(Continued).

SN 77-923,847. WOOF WOOF CASTLE, LLC., MECHANICS-
BURG, PA. FILED 1-29-2010.

PEEK A BOO

THE MARK CONSISTS OF STANDARD CHARACTERS WITHOUT CLAIM TO ANY PARTICULAR FONT, STYLE, SIZE, OR COLOR.

FOR LATCH SYSTEMS COMPOSED PRIMARILY OF METAL FOR INTERIOR DOORS TO LIMIT THE MAXIMUM OPENING OF THE DOOR MARKETED TO PET OWNERS, NAMELY, A FIRST MOUNTING MEMBER TO ATTACH TO THE DOOR, A SECOND MOUNTING MEMBER TO ATTACH TO A WALL, AND HOOK AND EYE MEMBERS CARRIED BY THE MOUNTING MEMBERS (U.S. CLS. 2, 12, 13, 14, 23, 25 AND 50).

DANIEL CAPSHAW, EXAMINING ATTORNEY

SN 77-924,501. ZHENSHI HOLDING GROUP CO., LIMITED,
TONGXIANG, ZHEJIANG, CHINA, FILED 2-1-2010.



THE MARK CONSISTS OF A DESIGN FORMED BY THE LETTERS "S" AND "Z" TO THE LEFT OF CHINESE CHARACTERS AND THE WORD "ZHENSHI".

THE NON-LATIN CHARACTERS IN THE MARK TRANSLITERATE TO "ZHENSHI" AND THIS HAS NO MEANING IN A FOREIGN LANGUAGE.

FOR BUILDING MATERIALS, NAMELY, COMPOSITE PANELS COMPOSED PRIMARILY OF METAL; BUILDING MATERIALS, NAMELY, METAL COUNTERTOPS FOR FURTHER INSTALLATION; CHROME IRON ORES; COBALT ORES; COMMON METALS, UNWROUGHT AND SEMI-WORKED, FOR FURTHER MANUFACTURE; COPPER ORES; DOOR FITTINGS OF METAL; DOORS OF METAL; IRON ORES; LEAD ORES; MANGANESE ORES; METAL ALLOYS FOR FURTHER MANUFACTURING; METAL BUILDING MATERIAL, NAMELY, FASCIA; METAL BUILDING MATERIALS, NAMELY, SOFFITS; METAL HARDWARE, NAMELY, CARBINERS OF METAL; METAL HARDWARE, NAMELY, NUTS; METAL HARDWARE, NAMELY, PULLEYS; METAL HARDWARE, NAMELY, SPRINGS; METAL HARDWARE, NAMELY, WASHERS; METAL HOSE FITTINGS; METAL JOINERY FITTINGS; METAL LOCKS; METAL PIPES AND FITTINGS THEREFOR; METAL REINFORCEMENT MATERIALS FOR BUILDING; MOLYBDENUM ORES; NICKEL ORES; NON-ELECTRICAL CABLES AND WIRES OF COMMON METAL; PIPEWORK OF METAL INCLUDING THOSE FROM ALLOY STEEL AND TITANIUM; TIN ORES; TUNGSTEN ORES; ZINC ORES (U.S. CLS. 2, 12, 13, 14, 23, 25 AND 50).

FIRST USE 6-16-1992; IN COMMERCE 2-15-2007.

SHANNON TWOHIG, EXAMINING ATTORNEY

CLASS 6—(Continued).

SN 77-925,091. DMFCWBS, LLC, WEST CHESTER, OH.
FILED 2-1-2010.

PROSTUD

THE MARK CONSISTS OF STANDARD CHARACTERS WITHOUT CLAIM TO ANY PARTICULAR FONT, STYLE, SIZE, OR COLOR.

FOR METAL DRYWALL FRAMING (U.S. CLS. 2, 12, 13, 14, 23, 25 AND 50).

FIRST USE 11-2-2009; IN COMMERCE 11-2-2009.
NANCY CLARKE, EXAMINING ATTORNEY

CLASS 6—(Continued).

SN 77-926,386. NIKIANI, INC., DBA BUGGYGUARD, PALM BEACH GARDENS, FL. FILED 2-2-2010.

If you love it, lock it

THE MARK CONSISTS OF STANDARD CHARACTERS WITHOUT CLAIM TO ANY PARTICULAR FONT, STYLE, SIZE, OR COLOR.

FOR METAL LOCKS (U.S. CLS. 2, 12, 13, 14, 23, 25 AND 50).

JULIE VEPPUMTHARA, EXAMINING ATTORNEY

SN 77-925,615. KUO, HSI-TAI, PINGTUNG COUNTY 920, TAIWAN, FILED 2-2-2010.



THE MARK CONSISTS OF A GRAPHIC REPRESENTATION OF A MAPLE LEAF.

FOR METAL LOCKS; METAL PADLOCKS; METAL LOCKS FOR DOORS; LOCK CYLINDERS OF METAL; METAL KEYPAD LOCKS; METAL KEYS FOR LOCKS (U.S. CLS. 2, 12, 13, 14, 23, 25 AND 50).

FIRST USE 11-15-2009; IN COMMERCE 11-15-2009.
CORY BOONE, EXAMINING ATTORNEY

SN 77-926,396. NIKIANI, INC., DBA BUGGYGUARD, PALM BEACH GARDENS, FL. FILED 2-2-2010.

B-hook

THE MARK CONSISTS OF STANDARD CHARACTERS WITHOUT CLAIM TO ANY PARTICULAR FONT, STYLE, SIZE, OR COLOR.

FOR METAL LOCKS (U.S. CLS. 2, 12, 13, 14, 23, 25 AND 50).

JULIE VEPPUMTHARA, EXAMINING ATTORNEY

SN 77-925,739. BULLOCK, SCOTT E., ST. GEORGE, UT. FILED 2-2-2010.

SHORELOCK

THE MARK CONSISTS OF STANDARD CHARACTERS WITHOUT CLAIM TO ANY PARTICULAR FONT, STYLE, SIZE, OR COLOR.

FOR BOAT ANCHOR, NAMELY, AN ANCHOR SHAFT FOR DRILLING INTO SHORE AND ATTACHING A LINE THAT CONNECTS TO A BOAT (U.S. CLS. 2, 12, 13, 14, 23, 25 AND 50).

FIRST USE 10-17-2009; IN COMMERCE 10-17-2009.
NATALIE POLZER, EXAMINING ATTORNEY

SN 77-926,932. DNC PARKS & RESORTS AT YOSEMITE, INC., YOSEMITE, CA. FILED 2-3-2010.



OWNER OF U.S. REG. NOS. 1,403,190, 1,408,511 AND OTHERS.

THE MARK CONSISTS OF THE DESIGN OF A MOUNTAIN INSIDE A CIRCLE BORDER.

FOR METAL KEY CHAINS (U.S. CLS. 2, 12, 13, 14, 23, 25 AND 50).

FIRST USE 6-30-2002; IN COMMERCE 6-30-2002.
ANDREA K. NADELMAN, EXAMINING ATTORNEY

CLASS 6—(Continued).

SN 77-928,561. NUSSBAUM, SALLY, COCONUT CREEK, FL. FILED 2-4-2010.

MERCY SCREW

THE MARK CONSISTS OF STANDARD CHARACTERS WITHOUT CLAIM TO ANY PARTICULAR FONT, STYLE, SIZE, OR COLOR.

OWNER OF U.S. REG. NO. 3,690,443.
FOR HUMOROUS NOVELTY ITEM, NAMELY, METAL SCREWS (U.S. CLS. 2, 12, 13, 14, 23, 25 AND 50).
FIRST USE 10-1-2009; IN COMMERCE 10-1-2009.
AMEEN IMAM, EXAMINING ATTORNEY

SN 77-930,244. BERRIMAN, PETER, BAYFIELD, CO. FILED 2-8-2010.

twoguysfourhands.com

THE MARK CONSISTS OF STANDARD CHARACTERS WITHOUT CLAIM TO ANY PARTICULAR FONT, STYLE, SIZE, OR COLOR.

FOR ORNAMENTS MADE OF STEEL (U.S. CLS. 2, 12, 13, 14, 23, 25 AND 50).
FIRST USE 9-13-2009; IN COMMERCE 9-13-2009.
CHRISTOPHER BUONGIORNO, EXAMINING ATTORNEY

SN 77-931,113. MANUFACTURAS ESPECIALIZADAS, S.A., SANTA CATARINA, NL, MEXICO, FILED 2-9-2010.



THE MARK CONSISTS OF A CIRCLE WITH 3 EQUIDISTANTLY SPACED TUBES EXTENDING FROM ITS INTERIOR.

FOR COPPER AND COPPER ALLOY PIPES AND TUBES (U.S. CLS. 2, 12, 13, 14, 23, 25 AND 50).
PAUL F. GAST, EXAMINING ATTORNEY

CLASS 6—(Continued).

SN 77-931,123. MANUFACTURAS ESPECIALIZADAS, S.A., SANTA CATARINA, NL, MEXICO, FILED 2-9-2010.

EZO

THE MARK CONSISTS OF STANDARD CHARACTERS WITHOUT CLAIM TO ANY PARTICULAR FONT, STYLE, SIZE, OR COLOR.

FOR COPPER AND COPPER ALLOY PIPES AND TUBES (U.S. CLS. 2, 12, 13, 14, 23, 25 AND 50).
PAUL F. GAST, EXAMINING ATTORNEY

SN 77-931,711. CERADYNE, INC., COSTA MESA, CA. FILED 2-9-2010.

BORALUMINUM

THE MARK CONSISTS OF STANDARD CHARACTERS WITHOUT CLAIM TO ANY PARTICULAR FONT, STYLE, SIZE, OR COLOR.

OWNER OF U.S. REG. NO. 3,052,484.
FOR ALUMINUM ALLOY (U.S. CLS. 2, 12, 13, 14, 23, 25 AND 50).
FIRST USE 2-1-2009; IN COMMERCE 2-1-2009.
JEAN IM, EXAMINING ATTORNEY

SN 77-931,828. GALPIN AUTO SPORTS LLC, VAN NUYS, CA. FILED 2-9-2010.



THE MARK CONSISTS OF AN ABSTRACT RENDERING OF A FACE.

FOR METAL KEY CHAINS (U.S. CLS. 2, 12, 13, 14, 23, 25 AND 50).
KAREN BRACEY, EXAMINING ATTORNEY

CLASS 6—(Continued).

SN 77-931,977. NEUMANN, DONALD J., PLYMOUTH, MN. FILED 2-9-2010.

FurFinders

THE MARK CONSISTS OF STANDARD CHARACTERS WITHOUT CLAIM TO ANY PARTICULAR FONT, STYLE, SIZE, OR COLOR.
FOR METAL PET TAGS (U.S. CLS. 2, 12, 13, 14, 23, 25 AND 50).
ALEX KEAM, EXAMINING ATTORNEY

CLASS 6—(Continued).

SN 79-073,183. BAOYI GROUP CO., LTD., CHINA, FILED 9-8-2009.



OWNER OF INTERNATIONAL REGISTRATION 1014114 DATED 9-8-2009, EXPIRES 9-8-2019.
THE MARK CONSISTS OF A DIAMOND SHAPE CONTAINING FOUR ADDITIONAL DIAMONDS ABOVE TWO CHINESE CHARACTERS ABOVE THE WORD "BAOYI".
THE ENGLISH TRANSLATION OF THE FOREIGN WORD(S) IN THE MARK IS: THE FIRST CHINESE CHARACTER MEANS "PROTECT", "DEFEND"; THE SECOND CHINESE CHARACTER MEANS "ONE".
THE TRANSLITERATION OF THE NON-LATIN CHARACTERS IN THE MARK IS: "BAOYI".
FOR VALVES OF METAL OTHER THAN PARTS OF MACHINES, PIPE WORK OF METAL, ADVERTISEMENT COLUMNS OF METAL, SCREWS OF METAL, HINGES OF METAL, LOCKS OTHER THAN ELECTRIC OF METAL, IRONMONGERY, NAMELY, PULLEYS, METAL PIPE, METAL FLANGES, METAL CHESTS (U.S. CLS. 2, 12, 13, 14, 23, 25 AND 50).
DAVID TOOLEY, EXAMINING ATTORNEY

SN 77-954,385. ALLSTAR MARKETING GROUP, LLC, HAWTHORNE, NY. FILED 3-9-2010.

EASY REACH

THE MARK CONSISTS OF STANDARD CHARACTERS WITHOUT CLAIM TO ANY PARTICULAR FONT, STYLE, SIZE, OR COLOR.
FOR RETRACTABLE PLANT HANGERS COMPRISED PRIMARILY OF METAL WITH PLASTIC CASING (U.S. CLS. 2, 12, 13, 14, 23, 25 AND 50).
RAMONA ORTIGA, EXAMINING ATTORNEY

SN 79-074,571. VALVOSANITARIA BUGATTI S.P.A., ITALY, FILED 7-23-2009.



PRIORITY DATE OF 5-28-2009 IS CLAIMED.
OWNER OF INTERNATIONAL REGISTRATION 1017897 DATED 7-23-2009, EXPIRES 7-23-2019.
OWNER OF U.S. REG. NOS. 2,839,377 AND 3,298,259.
THE COLOR(S) GREEN AND WHITE IS/ARE CLAIMED AS A FEATURE OF THE MARK.
THE COLOR GREEN APPEARS IN THE TEXT OF THE WORDING "BUGATTI", IN THE OUTLINE OF THE TEXT OF THE WORDING "VALVOSANITARIA", THE SHADING OF OUTLINE OF THE DIAMOND DESIGN, AND IN THE TEXT OF THE LETTER "V" APPEARING WITHIN THE DIAMOND DESIGN. THE COLOR WHITE APPEARS IN THE TEXT OF THE WORDING "VALVOSANITARIA", AND AS THE INTERIOR SHADING OF THE DIAMOND DESIGN.
THE TERM "VALVOSANITARIA" HAS NO MEANING IN A FOREIGN LANGUAGE
FOR METAL VALVES AND COUPLINGS FOR TUBES OF METAL, THE AFOREMENTIONED GOODS NOT BEING PARTS OF MACHINES (U.S. CLS. 2, 12, 13, 14, 23, 25 AND 50).
ELI HELLMAN, EXAMINING ATTORNEY

CLASS 7—MACHINERY

SN 77-291,356. URBAN MANUFACTURING, INC., PEWAU-
KEE, WI. FILED 9-28-2007.



NO CLAIM IS MADE TO THE EXCLUSIVE RIGHT TO USE "TOOL WORKS" AND "MADE IN USA", APART FROM THE MARK AS SHOWN.

THE MARK CONSISTS OF TWO CONCENTRIC CIRCLES CONTAINING FIVE SMALL CIRCLES AND THE WORDING "BOSS TOOL WORKS MADE IN USA" AND "BTW".

FOR MACHINE TOOLS FOR USE IN CLAMPING AND SECURING VISES, JAWS, AND CHUCKS, NAMELY CLAMPS, VISES, VISE MOUNTS, JAWS, CHUCKS, COLLETS, TABLE STOPS, COLLET NUTS AND LOCK NUTS; POWER-DRIVEN WRENCHES FOR USE IN THE PRECISION CLAMPING AND SECURING OF WORK PIECES AND MACHINE TOOL HOLDERS AND FOR USE IN INSTALLING AND REMOVING COLLETS, VISES, JAWS, AND CHUCKS (U.S. CLS. 13, 19, 21, 23, 31, 34 AND 35).

FIRST USE 3-0-2004; IN COMMERCE 3-0-2004.
YAT SYE, LEE, EXAMINING ATTORNEY

CLASS 7—(Continued).

SN 77-601,243. LINDE, LLC, MURRAY HILL, NJ. FILED 10-
27-2008.



OWNER OF U.S. REG. NO. 2,199,131.
NO CLAIM IS MADE TO THE EXCLUSIVE RIGHT TO USE "CRYO", APART FROM THE MARK AS SHOWN.

THE MARK CONSISTS OF THE STYLIZED TERM "CRYO" ABOVE THE TERM "STAR" WHEREIN A STAR DESIGN IS INTEGRATED INTO THE LETTER "A", ALL WITHIN AN INCOMPLETE SQUARE.

FOR PUMPS FOR CRYOGENIC LIQUIDS, NAMELY, CENTRIFUGAL AND RECIPROCATING PUMPS WITH ELECTRIC, HYDRAULIC OR MECHANICAL DRIVE; TURBINES NOT FOR LAND VEHICLES; TURBOEXPANDERS NOT FOR LAND VEHICLES; COMPRESSORS FOR MACHINES, NAMELY, CENTRIFUGAL AND RECIPROCATING COMPRESSORS HAVING ELECTRIC, HYDRAULIC OR MECHANICAL DRIVE; GENERATORS OF ELECTRICITY; FILLING MACHINES, NAMELY, MACHINES FOR FILLING PRESSURE VESSELS WITH INDUSTRIAL GASES COMPRISING RECIPROCATING AND CENTRIFUGAL PUMPS WITH ASSOCIATED VAPORIZERS; AND PARTS AND FITTINGS FOR THE AFORESAID GOODS (U.S. CLS. 13, 19, 21, 23, 31, 34 AND 35).

FIRST USE 9-0-1972; IN COMMERCE 9-0-1972.
HELENE LIWINSKI, EXAMINING ATTORNEY

SN 77-669,573. CLAYTON CORPORATION, FENTON, MO.
FILED 2-12-2009.

CPDS

THE MARK CONSISTS OF STANDARD CHARACTERS WITHOUT CLAIM TO ANY PARTICULAR FONT, STYLE, SIZE, OR COLOR.

FOR MACHINES FOR DISPENSING SPRAY POLYURETHANE INSULATING FOAM (U.S. CLS. 13, 19, 21, 23, 31, 34 AND 35).

DOUGLAS LEE, EXAMINING ATTORNEY

CLASS 7—(Continued).

SN 77-669,644. CLAYTON CORPORATION, FENTON, MO. FILED 2-12-2009.



THE MARK CONSISTS OF AN OVAL WITH THE LETTERS "CPDS".
 FOR MACHINES FOR DISPENSING SPRAY POLYURETHANE INSULATING FOAM (U.S. CLS. 13, 19, 21, 23, 31, 34 AND 35).
 DOUGLAS LEE, EXAMINING ATTORNEY

CLASS 7—(Continued).

SN 77-685,708. RANDOLPH TOOL COMPANY, INC., HARTVILLE, OH. FILED 3-6-2009.

FIELD RECOVERY OCEAN GEAR

THE MARK CONSISTS OF STANDARD CHARACTERS WITHOUT CLAIM TO ANY PARTICULAR FONT, STYLE, SIZE, OR COLOR.
 NO CLAIM IS MADE TO THE EXCLUSIVE RIGHT TO USE "OCEAN GEAR", APART FROM THE MARK AS SHOWN.
 FOR HYDRAULICALLY-POWERED INDUSTRIAL CUTTING TOOL THAT CLAMPS ITSELF AROUND A PIPE OR A COLUMN AND HAVING A HYDRAULICALLY-DRIVEN CUTTING BLADE ADAPTED TO CUT THE PIPE OR COLUMN INCLUDING UNDERWATER PIPES AND COLUMNS (U.S. CLS. 13, 19, 21, 23, 31, 34 AND 35).
 FIRST USE 8-31-2009; IN COMMERCE 8-31-2009.
 BARBARA GAYNOR, EXAMINING ATTORNEY

SN 77-719,188. GREAT STUFF, INC., AUSTIN, TX. FILED 4-21-2009.

LIFE JUST GOT A LITTLE EASIER

THE MARK CONSISTS OF STANDARD CHARACTERS WITHOUT CLAIM TO ANY PARTICULAR FONT, STYLE, SIZE, OR COLOR.
 FOR POWER OPERATED GARDEN HOSE REELS, POWER OPERATED ELECTRICAL CORD REELS, AND PARTS AND FITTINGS THEREFOR; POWER OPERATED GARDEN HOSE REELS, POWER OPERATED ELECTRICAL CORD REELS AND REPLACEMENT HOSES AND REPLACEMENT ELECTRICAL CORDS SOLD AS A UNIT (U.S. CLS. 13, 19, 21, 23, 31, 34 AND 35).
 JENNY PARK, EXAMINING ATTORNEY

SN 77-729,290. SHOP VAC CORPORATION, WILLIAMSPORT, PA. FILED 5-5-2009.

SHOP VAC SUPER

SN 77-674,425. LAUREN AGRISYSTEMS, LTD., NEW PHILADELPHIA, OH. FILED 2-20-2009.



THE COLOR(S) GREEN IS/ARE CLAIMED AS A FEATURE OF THE MARK.
 THE MARK CONSISTS OF THE COLOR GREEN AS APPLIED TO A MILKING LINER IN ITS ENTIRETY. THE GOODS COMPRISE MILKING LINERS THAT ARE USED WITH AUTOMATED DAIRY MILKING EQUIPMENT. THE DOTTED OUTLINE OF THE GOODS IS INTENDED TO SHOW THE POSITION OF THE MARK ON A MILKING LINER AND IS NOT PART OF THE MARK.
 SEC. 2(F).
 FOR FITTED ELASTOMERIC MILKING LINERS FOR DAIRY MILKING MACHINES (U.S. CLS. 13, 19, 21, 23, 31, 34 AND 35).
 FIRST USE 12-31-2004; IN COMMERCE 12-31-2004.
 LINDA ESTRADA, EXAMINING ATTORNEY

THE MARK CONSISTS OF STANDARD CHARACTERS WITHOUT CLAIM TO ANY PARTICULAR FONT, STYLE, SIZE, OR COLOR.
 OWNER OF U.S. REG. NOS. 647,763, 2,027,359 AND OTHERS.
 NO CLAIM IS MADE TO THE EXCLUSIVE RIGHT TO USE "SUPER", APART FROM THE MARK AS SHOWN.
 SEC. 2(F) AS TO "SHOP VAC".
 FOR VACUUM CLEANERS (U.S. CLS. 13, 19, 21, 23, 31, 34 AND 35).
 CORY BOONE, EXAMINING ATTORNEY

CLASS 7—(Continued).

SN 77-767,881. SEARS BRANDS, LLC, HOFFMAN ESTATES, IL. FILED 6-25-2009.



THE COLOR(S) WHITE AND BLUE IS/ARE CLAIMED AS A FEATURE OF THE MARK.
 THE MARK CONSISTS OF A STYLIZED BLUE AND WHITE HAND OUTLINED IN BLACK WITH A WHITE DROP OF WATER CENTERED IN THE PALM. THE COLOR BLACK IN THE DRAWING ONLY REPRESENTS OUTLINING AND IS NOT PART OF THE MARK.
 FOR LCD PANELS SOLD AS COMPONENT PARTS OF CLOTHES WASHING MACHINES FEATURING WASHING CYCLE OPTIONS TO ENSURE A GENTLE WASH CYCLE FOR DELICATE LOADS (U.S. CLS. 13, 19, 21, 23, 31, 34 AND 35).
 MORGAN WYNNE, EXAMINING ATTORNEY

CLASS 7—(Continued).

SN 77-767,896. SEARS BRANDS, LLC, HOFFMAN ESTATES, IL. FILED 6-25-2009.



THE COLOR(S) WHITE AND BLUE IS/ARE CLAIMED AS A FEATURE OF THE MARK.
 THE MARK CONSISTS OF A WHITE AND BLUE SQUARE OUTLINED IN BLACK, WITH A WHITE CIRCLE AND THREE WAVY WHITE LINES INSIDE THE SQUARE. THE COLOR BLACK IN THE DRAWING ONLY REPRESENTS OUTLINING AND IS NOT PART OF THE MARK.
 FOR LCD PANELS SOLD AS COMPONENT PARTS OF CLOTHES WASHING MACHINES FEATURING WASHING CYCLE OPTIONS TO CLEAN AND SANITIZE THE INSIDE DRUM OF THE WASHER (U.S. CLS. 13, 19, 21, 23, 31, 34 AND 35).
 MORGAN WYNNE, EXAMINING ATTORNEY

SN 77-767,882. SEARS BRANDS, LLC, HOFFMAN ESTATES, IL. FILED 6-25-2009.

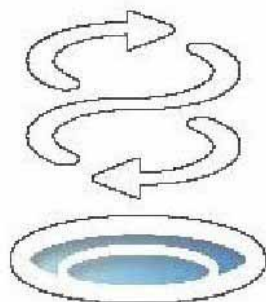

THE COLOR(S) WHITE AND BLUE IS/ARE CLAIMED AS A FEATURE OF THE MARK.
 THE MARK CONSISTS OF THREE WHITE CURVED LINES OUTLINED IN BLACK, TWO WITH ARROWS, OVER A STYLIZED, CIRCULAR-SHAPED WHITE AND BLUE DRAIN OUTLINED IN BLACK. THE COLOR BLACK IN THE DRAWING ONLY REPRESENTS OUTLINING AND IS NOT PART OF THE MARK.
 FOR LCD PANELS SOLD AS COMPONENT PARTS OF CLOTHES WASHING MACHINES FEATURING WASHING CYCLE OPTIONS TO SPINS LOADS OF CLOTHING AND DRAIN WATER FROM THE WASH DRUM (U.S. CLS. 13, 19, 21, 23, 31, 34 AND 35).
 MORGAN WYNNE, EXAMINING ATTORNEY

SN 77-767,915. SEARS BRANDS, LLC, HOFFMAN ESTATES, IL. FILED 6-25-2009.



THE COLOR(S) WHITE AND RED IS/ARE CLAIMED AS A FEATURE OF THE MARK.
 THE MARK CONSISTS OF A RED AND WHITE STYLIZED HEART OUTLINED IN BLACK. THE COLOR BLACK IN THE DRAWING ONLY REPRESENTS OUTLINING AND IS NOT PART OF THE MARK.
 FOR LCD PANELS SOLD AS COMPONENT PARTS OF CLOTHES WASHING MACHINES FEATURING WASHING CYCLE OPTIONS THAT ALLOWS USERS TO STORE AND SELECT THEIR FAVORITE WASH CYCLES (U.S. CLS. 13, 19, 21, 23, 31, 34 AND 35).
 MORGAN WYNNE, EXAMINING ATTORNEY

CLASS 7—(Continued).

SN 77-769,364. STEWART ENGINEERS, INC., WAKE FOREST, NC. FILED 6-26-2009.



OWNER OF U.S. REG. NO. 3,096,363.
THE MARK CONSISTS OF THE TERM "ACURACOAT" WITH A CIRCLE BEHIND THE LEFT "A" AND THREE PARALLEL BARS ON THE UPPER RIGHT SIDE OF THE CIRCLE.

FOR CHEMICAL VAPOR DEPOSITION SYSTEM FOR FLAT GLASS COATING CONSISTING PRIMARILY OF COATING HEADS, METERS AND DISPENSERS FOR GLASS COATINGS, CONTAINMENT FACILITIES IN THE NATURE OF TANKS FOR CHEMICALS, AND EXHAUST SYSTEMS CONSISTING PRIMARILY OF EXTRACTION FANS SOLD AS A UNIT (U.S. CLS. 13, 19, 21, 23, 31, 34 AND 35).

FIRST USE 1-0-2008; IN COMMERCE 1-0-2008.
CHRISTINA SOBRAL, EXAMINING ATTORNEY

SN 77-780,687. SATA GMBH & CO. KG, KORNWESTHEIM, FED REP GERMANY, FILED 7-14-2009.

100 B P

THE MARK CONSISTS OF STANDARD CHARACTERS WITHOUT CLAIM TO ANY PARTICULAR FONT, STYLE, SIZE, OR COLOR.

OWNER OF ERP N CMNTY TM OFC REG. NO. 008374969, DATED 1-12-2010, EXPIRES 6-19-2019.

FOR PAINT SPRAY GUNS (U.S. CLS. 13, 19, 21, 23, 31, 34 AND 35).

KATINA MISTER, EXAMINING ATTORNEY

SN 77-787,160. J.H. FENNER & CO. LIMITED, EAST YORKSHIRE, ENGLAND, FILED 7-22-2009.

EAGLE FREESTYLE

THE MARK CONSISTS OF STANDARD CHARACTERS WITHOUT CLAIM TO ANY PARTICULAR FONT, STYLE, SIZE, OR COLOR.

FOR PORTABLE WELDING MACHINES USED IN THE JOINING/SPLICING OF THERMOPLASTIC BELTING (U.S. CLS. 13, 19, 21, 23, 31, 34 AND 35).

FIRST USE 7-2-2009; IN COMMERCE 7-2-2009.
MARIAM MAHMOUDI, EXAMINING ATTORNEY

CLASS 7—(Continued).

SN 77-802,151. TNT RESCUE SYSTEMS, INC., ASHIPUN, WI. FILED 8-11-2009.

TNT RESCUE

THE MARK CONSISTS OF STANDARD CHARACTERS WITHOUT CLAIM TO ANY PARTICULAR FONT, STYLE, SIZE, OR COLOR.

NO CLAIM IS MADE TO THE EXCLUSIVE RIGHT TO USE "RESCUE", APART FROM THE MARK AS SHOWN.

FOR EXTRICATION EQUIPMENT, NAMELY, POWER TOOLS FOR SPREADING, CUTTING AND DISPLACING STRUCTURES AND AIR COMPRESSORS FOR OPERATING EXTRICATION EQUIPMENT (U.S. CLS. 13, 19, 21, 23, 31, 34 AND 35).

BRIAN NEVILLE, EXAMINING ATTORNEY

SN 77-802,695. WOODLAND POWER PRODUCTS, INC., WEST HAVEN, CT. FILED 8-12-2009.

CYCLONE MATE

THE MARK CONSISTS OF STANDARD CHARACTERS WITHOUT CLAIM TO ANY PARTICULAR FONT, STYLE, SIZE, OR COLOR.

OWNER OF U.S. REG. NO. 2,269,657.

FOR POWER-OPERATED LIFT USED FOR LIFTING AND LOWERING A DUMP TRAILER TO UNLOAD LAWN DEBRIS AND OTHER TRAILER CONTENTS FOR EXCLUSIVE USE WITH A POWER-OPERATED VACUUM RAKE DESIGNED TO COLLECT LEAVES AND OTHER DEBRIS (U.S. CLS. 13, 19, 21, 23, 31, 34 AND 35).

ALYSSA STEEL, EXAMINING ATTORNEY

CLASS 7—(Continued).

SN 77-804,133. ATD-ABBAUSYSTEME GMBH, DORTMUND, FED REP GERMANY, FILED 8-13-2009.

CLASS 7—(Continued).

SN 77-804,184. ATD-ABBAUSYSTEME GMBH, DORTMUND, FED REP GERMANY, FILED 8-13-2009.



NO CLAIM IS MADE TO THE EXCLUSIVE RIGHT TO USE "PRESSURE GAS SYSTEM" AND THE DESIGN OF THE GAS TUBE, APART FROM THE MARK AS SHOWN.

THE COLOR(S) RED, WHITE, GREY, BLACK, BLUE IS/ ARE CLAIMED AS A FEATURE OF THE MARK.

THE MARK CONSISTS OF THE WORDING "ATD-SYSTEM PRESSURE GAS SYSTEM CARDOX" IN A STYLIZED FONT AND A DESIGN CONSISTING OF A GAS TUBE, SIX CURVED VERTICAL LINES THAT REPRESENT AIR EMANATING FROM THE GAS TUBE, A CURVED RECTANGULAR SHAPE AND A CIRCLE ENCLOSING ALL OF THE AFOREMENTIONED ELEMENTS. THE WORDING "ATD-SYSTEM" IS IN THE COLOR WHITE AND SET AGAINST A RECTANGULAR-SHAPED BACKGROUND IN THE COLOR RED, THE WORDING "PRESSURE GAS SYSTEM CARDOX" IS IN THE COLOR BLUE, THE GAS TUBE IS IN THE COLORS BLACK, WHITE AND GREY, AND THE VERTICAL LINES AND CIRCLE ARE IN THE COLOR RED.

FOR EQUIPMENT FOR THE REMOVAL OF BUILD-UP AND CHOKE, NAMELY, CLEANING MACHINES CONSISTING OF GAS-OPERATED POWER GENERATORS, CU-RINGS AND SHEAR DISCS FOR OIL AND GAS INDUSTRIAL MACHINES; GAS TUBE PRIMING INSTRUMENTS FOR THE REMOVAL OF BUILD-UP AND CHOKE, NAMELY, GAS TUBE PRIMING MACHINES; DRILLING INSTRUMENTS FOR THE REMOVAL OF BUILD-UP AND CHOKE, NAMELY, DRILLING RODS, DRILLING BITS AND SMALL DRILLING RIGS; FILLING MACHINES FOR THE REMOVAL OF BUILD-UP AND CHOKE, NAMELY, FILLING PUMPS AND FILLING COMPRESSORS (U.S. CLS. 13, 19, 21, 23, 31, 34 AND 35).

RENEE MCCRAY, EXAMINING ATTORNEY

NO CLAIM IS MADE TO THE EXCLUSIVE RIGHT TO USE "CERTIFIED", "GAS SYSTEM" AND THE DESIGN OF THE GAS TUBE, APART FROM THE MARK AS SHOWN.

THE COLOR(S) RED, WHITE, GREY, BLACK, BLUE IS/ ARE CLAIMED AS A FEATURE OF THE MARK.

THE MARK CONSISTS OF THE WORDING "CERTIFIED ATD-PRESSURE GAS SYSTEM" IN A STYLIZED FONT AND A DESIGN CONSISTING OF A GAS TUBE, SIX CURVED VERTICAL LINES THAT REPRESENT AIR EMANATING FROM THE GAS TUBE, A CURVED RECTANGULAR SHAPE AND A CIRCLE ENCLOSING ALL OF THE AFOREMENTIONED ELEMENTS. THE WORDING "CERTIFIED" IS IN THE COLOR WHITE AND SET AGAINST A RECTANGULAR-SHAPED BACKGROUND IN THE COLOR RED, THE WORDING "ATD-PRESSURE GAS SYSTEM" IS IN THE COLOR BLUE, THE GAS TUBE IS IN THE COLORS BLACK, WHITE AND GREY, AND THE VERTICAL LINES AND CIRCLE ARE IN THE COLOR RED.

FOR EQUIPMENT FOR THE REMOVAL OF BUILD-UP AND CHOKE, NAMELY, CLEANING MACHINES CONSISTING OF GAS-OPERATED POWER GENERATORS, CU-RINGS AND SHEAR DISCS FOR OIL AND GAS INDUSTRIAL MACHINES; GAS TUBE PRIMING INSTRUMENTS FOR THE REMOVAL OF BUILD-UP AND CHOKE, NAMELY, GAS TUBE PRIMING MACHINES; DRILLING INSTRUMENTS FOR THE REMOVAL OF BUILD-UP AND CHOKE, NAMELY, DRILLING RODS, DRILLING BITS AND SMALL DRILLING RIGS; FILLING MACHINES FOR THE REMOVAL OF BUILD-UP AND CHOKE, NAMELY, FILLING PUMPS AND FILLING COMPRESSORS (U.S. CLS. 13, 19, 21, 23, 31, 34 AND 35).

RENEE MCCRAY, EXAMINING ATTORNEY

CLASS 7—(Continued).

SN 77-805,055. KARDEX AG, ZURICH, SWITZERLAND, FILED 8-14-2009.

KARDEX

THE MARK CONSISTS OF STANDARD CHARACTERS WITHOUT CLAIM TO ANY PARTICULAR FONT, STYLE, SIZE, OR COLOR.

OWNER OF ERPN CMNTY TM OFC REG. NO. 000048264, DATED 10-20-1999, EXPIRES 4-1-2016.

OWNER OF U.S. REG. NO. 2,031,925.

FOR MACHINES AND APPARATUS USED FOR STORAGE, RETRIEVAL, CONVEYING, STOCK CONTROL, LIFTING AND MECHANICAL HANDLING, NAMELY, VERTICAL LIFT MODULES, VERTICAL CAROUSELS AND HORIZONTAL CAROUSELS; MACHINES AND APPARATUS USED FOR AUTOMATICALLY DEPOSITING ARTICLES IN OR RETRIEVING ARTICLES FROM A STORE, NAMELY, VERTICAL LIFT MODULES, VERTICAL CAROUSELS AND HORIZONTAL CAROUSELS; MACHINES AND APPARATUS USED FOR CONVEYING, LIFTING, HOISTING AND HANDLING, NAMELY, VERTICAL LIFT MODULES, VERTICAL CAROUSELS AND HORIZONTAL CAROUSELS AND INDUSTRIAL ROBOTS; INDUSTRIAL ROBOTIC APPARATUS, NAMELY, VERTICAL LIFT MODULES, VERTICAL CAROUSELS AND HORIZONTAL CAROUSELS AND BELT AND ROLLERS TO BE USED THEREWITH; PAPER SHREDDING MACHINES; CONVEYOR BELTS AND MACHINE PARTS THEREFOR, NAMELY, ROLLER BEARINGS; PAPER SHREDDING MACHINES FOR INDUSTRIAL USE; PRINTING PRESS MACHINES; LABELING AND BAR CODE APPLICATION MACHINE; INDUSTRIAL LABELING MACHINES; STRUCTURAL AND REPLACEMENT PARTS THEREFOR FOR ALL THE AFORESAID GOODS (U.S. CLS. 13, 19, 21, 23, 31, 34 AND 35).

FIRST USE 0-0-1964; IN COMMERCE 0-0-1964.
TASNEEM HUSSAIN, EXAMINING ATTORNEY

SN 77-815,310. ATD-ABBAUSYSTEME GMBH, DORTMUND, FED REP GERMANY, FILED 8-28-2009.



NO CLAIM IS MADE TO THE EXCLUSIVE RIGHT TO USE "CERTIFIED," "GAS SYSTEM" AND THE DESIGN OF THE GAS TUBE, APART FROM THE MARK AS SHOWN.

THE COLOR(S) RED, WHITE, GREY, BLACK, BLUE IS/ARE CLAIMED AS A FEATURE OF THE MARK.

THE MARK CONSISTS OF THE WORDING "CERTIFIED ATD-PRESSURE GAS SYSTEM CARDOX" IN A STYLIZED FONT AND A DESIGN CONSISTING OF A GAS TUBE, SIX

CLASS 7—(Continued).

CURVED VERTICAL LINES THAT REPRESENT AIR EMANATING FROM THE GAS TUBE, A CURVED RECTANGULAR SHAPE AND A CIRCLE ENCLOSING ALL OF THE AFOREMENTIONED ELEMENTS. THE WORDING "CERTIFIED" IS IN THE COLOR WHITE AND SET AGAINST A RECTANGULAR-SHAPED BACKGROUND IN THE COLOR RED, THE WORDING "ATD-PRESSURE GAS SYSTEM CARDOX" IS IN THE COLOR BLUE, THE GAS TUBE IS IN THE COLORS BLACK, WHITE AND GREY, AND THE VERTICAL LINES AND CIRCLE ARE IN THE COLOR RED.

FOR EQUIPMENT FOR THE REMOVAL OF BUILD-UP AND CHOKE, NAMELY, CLEANING MACHINES CONSISTING OF GAS-OPERATED POWER GENERATORS, CU-RINGS AND SHEAR DISCS FOR OIL AND GAS INDUSTRIAL MACHINES; GAS TUBE PRIMING INSTRUMENTS FOR THE REMOVAL OF BUILD-UP AND CHOKE, NAMELY, GAS TUBE PRIMING MACHINES; DRILLING INSTRUMENTS FOR THE REMOVAL OF BUILD-UP AND CHOKE, NAMELY, DRILLING RODS, DRILLING BITS AND SMALL DRILLING RIGS; FILLING MACHINES FOR THE REMOVAL OF BUILD-UP AND CHOKE, NAMELY, FILLING PUMPS AND FILLING COMPRESSORS (U.S. CLS. 13, 19, 21, 23, 31, 34 AND 35).

RENEE MCCRAY, EXAMINING ATTORNEY

SN 77-869,658. COMCO USA, INC., SCHAUMBURG, IL, FILED 11-10-2009.

KEINS

THE MARK CONSISTS OF STANDARD CHARACTERS WITHOUT CLAIM TO ANY PARTICULAR FONT, STYLE, SIZE, OR COLOR.

FOR PIPE AND TUBE FORMING MACHINES AND MACHINE TOOLS FOR THE CUTTING, FORMING AND BENDING OF PIPES, TUBES AND WIRE (U.S. CLS. 13, 19, 21, 23, 31, 34 AND 35).

FIRST USE 11-7-1996; IN COMMERCE 11-7-1996.
SHANNON TWOHIG, EXAMINING ATTORNEY

SN 77-881,962. EMLER, DON, RANCHO DOMINGUEZ, CA, FILED 11-30-2009.

FMF RESONANCE CHAMBER TECHNOLOGY

THE MARK CONSISTS OF STANDARD CHARACTERS WITHOUT CLAIM TO ANY PARTICULAR FONT, STYLE, SIZE, OR COLOR.

OWNER OF U.S. REG. NOS. 1,449,555, 2,975,274 AND OTHERS.

NO CLAIM IS MADE TO THE EXCLUSIVE RIGHT TO USE "RESONANCE CHAMBER TECHNOLOGY", APART FROM THE MARK AS SHOWN.

FOR VEHICLE AND AUTOMOTIVE ENGINE PARTS, NAMELY, HEADERS, INTAKE MANIFOLDS, EXHAUST PIPES, EXHAUST MANIFOLDS, SILENCERS, MUFFLERS, SPARK ARRESTORS (U.S. CLS. 13, 19, 21, 23, 31, 34 AND 35).

FIRST USE 6-15-2009; IN COMMERCE 6-15-2009.
ELIZABETH HUGHITT, EXAMINING ATTORNEY

CLASS 7—(Continued).

SN 77-884,298. DEROSA, JOHN L., UPPER MARLBORO, MD.
FILED 12-2-2009.

MUSCLECHUCK

THE MARK CONSISTS OF STANDARD CHARACTERS WITHOUT CLAIM TO ANY PARTICULAR FONT, STYLE, SIZE, OR COLOR.

FOR CHUCKS FOR POWER TOOLS, NAMELY, ROUTERS, MILLING MACHINES, AND DRIVEN LATHE TOOLS (U.S. CLS. 13, 19, 21, 23, 31, 34 AND 35).
EDWARD FENNESSY, EXAMINING ATTORNEY

SN 77-901,016. ROAD ART STUDIOS, LLC, MEDFORD, OR.
FILED 12-25-2009.



NO CLAIM IS MADE TO THE EXCLUSIVE RIGHT TO USE "AUTO", APART FROM THE MARK AS SHOWN.

THE MARK CONSISTS OF BOX CONTAINING THE LETTERS "AV" AND THE WORDS "AUTO VALET" BETWEEN TWO HORIZONTAL LINES.

FOR CONVEYORS; POWER-OPERATED LIFTS FOR MOVING, PARKING AND STORING LAND VEHICLES (U.S. CLS. 13, 19, 21, 23, 31, 34 AND 35).

FIRST USE 5-1-2009; IN COMMERCE 8-1-2009.
MICHAEL KEATING, EXAMINING ATTORNEY

SN 77-914,680. WINDENSITY, INC., FOLSOM, CA. FILED 1-19-2010.

TurboStak

THE MARK CONSISTS OF STANDARD CHARACTERS WITHOUT CLAIM TO ANY PARTICULAR FONT, STYLE, SIZE, OR COLOR.

FOR AERODYNAMIC DEVICE FOR AUTOMOTIVE EXHAUST PIPES TO REDUCE EXHAUST BACK PRESSURE AND IMPROVE FUEL ECONOMY (U.S. CLS. 13, 19, 21, 23, 31, 34 AND 35).

FIRST USE 2-20-2010; IN COMMERCE 2-20-2010.
VIVIAN MICZNIK FIRST, EXAMINING ATTORNEY

CLASS 7—(Continued).

SN 77-914,976. KOIKE ARONSON, INC., ARCADE, NY.
FILED 1-19-2010.

3D-LT

THE MARK CONSISTS OF STANDARD CHARACTERS WITHOUT CLAIM TO ANY PARTICULAR FONT, STYLE, SIZE, OR COLOR.

FOR MECHANICAL ARM THAT HOLDS A PLASMA CUTTING TORCH TO MAKE BEVEL CUTS (U.S. CLS. 13, 19, 21, 23, 31, 34 AND 35).

KIM MONINGHOFF, EXAMINING ATTORNEY

SN 77-917,375. WHEEL JOCKEY, LLC, WAXHAW, NC.
FILED 1-21-2010.



OWNER OF U.S. REG. NO. 3,741,097.

THE MARK CONSISTS OF THE WORDS "WHEELJOCKEY" ACCOMPANIED BY THREE DESIGN ELEMENTS TO THE LEFT OF THE WORDS. INSIDE AND OUTSIDE DESIGN ELEMENTS ARE MOST LIKE A 1/4 CIRCLE AND MIDDLE ELEMENT IS REPRESENTATIVE OF MOTORCYCLE CHAIN.

FOR MECHANICAL DEVICE THAT SUPPORTS AND ELEVATES THE WHEEL(S) OF A MOTORCYCLE SUCH THAT THE WHEEL CAN BE ROTATED TO FACILITATE WHEEL CLEANING AND DRIVE CHAIN MAINTENANCE (U.S. CLS. 13, 19, 21, 23, 31, 34 AND 35).

FIRST USE 1-29-2009; IN COMMERCE 10-15-2009.
LESLIE RICHARDS, EXAMINING ATTORNEY

SN 77-919,332. WINTER EQUIPMENT COMPANY, INC., WILLOUGHBY, OH. FILED 1-25-2010.

BLOCKBUSTER

THE MARK CONSISTS OF STANDARD CHARACTERS WITHOUT CLAIM TO ANY PARTICULAR FONT, STYLE, SIZE, OR COLOR.

FOR SPECIALLY ADAPTED PARTS FOR SNOW PLOWS, COMMERCIAL PLOWS, HIGHWAY PLOWS AND AGRICULTURAL PLOWS IN THE NATURE OF EDGE GUARDS, BLADE WEAR GUARDS, AND MOLDBOARD SHOES (U.S. CLS. 13, 19, 21, 23, 31, 34 AND 35).

FIRST USE 12-7-2009; IN COMMERCE 12-7-2009.
TRACY FLETCHER, EXAMINING ATTORNEY

CLASS 7—(Continued).

SN 77-923,478. TIGERCAT INTERNATIONAL INC., CAMBRIDGE, ONTARIO, CANADA, FILED 1-29-2010.



THE MARK CONSISTS OF THE CAPITAL LETTERS "ER" FOLLOWED BY A GRADUATED SERIES OF HORIZONTAL LINES.

FOR MACHINES, NAMELY, EXCAVATOR-STYLE BOOMS FOR USE IN TIMBER HARVESTING AND OPERATOR HYDRAULIC CONTROLS AND CONTROL TECHNOLOGY COMPRISED OF HYDRAULIC AND MECHANICAL LINKAGES FOR EXCAVATOR-STYLE BOOMS FOR USE IN TIMBER HARVESTING (U.S. CLS. 13, 19, 21, 23, 31, 34 AND 35).
STEVEN JACKSON, EXAMINING ATTORNEY

CLASS 7—(Continued).

SN 77-926,935. PC TURNKEY, INC., SPRINGDALE, AR. FILED 2-3-2010.

Pyro-Flow

THE MARK CONSISTS OF STANDARD CHARACTERS WITHOUT CLAIM TO ANY PARTICULAR FONT, STYLE, SIZE, OR COLOR.

FOR GASIFIERS (U.S. CLS. 13, 19, 21, 23, 31, 34 AND 35).
MICHAEL GAFFAR, EXAMINING ATTORNEY

SN 77-926,031. O'DRILL / MCM, INC., HOUSTON, TX. FILED 2-2-2010.

O'DRILL

THE MARK CONSISTS OF STANDARD CHARACTERS WITHOUT CLAIM TO ANY PARTICULAR FONT, STYLE, SIZE, OR COLOR.

FOR DESANDER MACHINES; DESILTER MACHINES; HIGH PRESSURE PUMPS FOR WASHING APPLIANCES AND INSTALLATIONS; LINEAR MOTION SHALE SHAKER MACHINES; STANDARD SHAKER MACHINES; MUD AGITATOR MACHINES; MUD HOPPER MACHINES; MUD GUN MACHINES; MUD BUCKET MACHINES; PARTS AND FITTINGS FOR OIL AND GAS WELL MACHINES, NAMELY, GATE VALVES, SHEAR RELIEF VALVES, RESET RELIEF VALVES, FLOAT VALVES, PLUG VALVES, PRESSURE GAUGES, BUTTERFLY VALVES, HYDROCYCLONES, CHOKE NIPPLES, HAMMER UNIONS, FLUID END MODULES, AND LINERS, PISTONS AND PISTON RODS; SOLIDS SEPARATION SHAKER MACHINES (U.S. CLS. 13, 19, 21, 23, 31, 34 AND 35).

FIRST USE 12-31-1982; IN COMMERCE 12-31-1982.
PAUL F. GAST, EXAMINING ATTORNEY

SN 77-927,151. GRACO MINNESOTA INC., MINNEAPOLIS, MN. FILED 2-3-2010.

LubriSystem

THE MARK CONSISTS OF STANDARD CHARACTERS WITHOUT CLAIM TO ANY PARTICULAR FONT, STYLE, SIZE, OR COLOR.

FOR POWER-OPERATED LUBRICANT DISPENSERS FOR MACHINES (U.S. CLS. 13, 19, 21, 23, 31, 34 AND 35).
FIRST USE 12-31-2001; IN COMMERCE 12-31-2001.
KRISTIN CARLSON, EXAMINING ATTORNEY

SN 77-926,675. TRANSFORM SYSTEM, INC., ARLINGTON, TX. FILED 2-3-2010.

PIN-N-GO

THE MARK CONSISTS OF STANDARD CHARACTERS WITHOUT CLAIM TO ANY PARTICULAR FONT, STYLE, SIZE, OR COLOR.

FOR CONVEYOR BELTS (U.S. CLS. 13, 19, 21, 23, 31, 34 AND 35).
ANNE MADDEN, EXAMINING ATTORNEY

SN 77-927,612. ADVANCED INDUSTRIES, INC., CHELSEA, MI. FILED 2-3-2010.

KOOLBLAST

THE MARK CONSISTS OF STANDARD CHARACTERS WITHOUT CLAIM TO ANY PARTICULAR FONT, STYLE, SIZE, OR COLOR.

FOR COOLANT DIRECTING DEVICES, NAMELY, END MILL HOLDERS AND MACHINE CUTTING TOOL HOLDERS, BOTH OF WHICH INCLUDE PASSAGES FOR DIRECTING COOLANT AT A WORKPIECE TOOL INTERFACE (U.S. CLS. 13, 19, 21, 23, 31, 34 AND 35).
FIRST USE 10-17-2002; IN COMMERCE 7-28-2003.
KATHERINE CHANG, EXAMINING ATTORNEY

CLASS 7—(Continued).

SN 77-928,799. WOHLGEMUTH, JASON, LOUISVILLE, KY.
FILED 2-5-2010.

MOWBARROW

THE MARK CONSISTS OF STANDARD CHARACTERS WITHOUT CLAIM TO ANY PARTICULAR FONT, STYLE, SIZE, OR COLOR.

FOR ELECTRIC LAWNMOWERS; GASOLINE LAWN MOWERS; LAWN MOWERS; LAWNMOWERS; MECHANICAL LAWN MOWERS (U.S. CLS. 13, 19, 21, 23, 31, 34 AND 35).

RENEE SERVANCE, EXAMINING ATTORNEY

CLASS 7—(Continued).

SN 77-929,385. ZODIAC POOL CARE, INC., MOORPARK, CA. FILED 2-5-2010.

T5 DUO

THE MARK CONSISTS OF STANDARD CHARACTERS WITHOUT CLAIM TO ANY PARTICULAR FONT, STYLE, SIZE, OR COLOR.

FOR SWIMMING POOL SPA AND CLEANING EQUIPMENT, NAMELY, SWEEPERS AND VACUUMS, AND PARTS THEREFOR (U.S. CLS. 13, 19, 21, 23, 31, 34 AND 35).

CARRIE GENOVESE, EXAMINING ATTORNEY

SN 77-929,902. CLARKE INTERNATIONAL INC., EPPING, ESSEX, UNITED KINGDOM, FILED 2-7-2010.

EDISON

THE MARK CONSISTS OF STANDARD CHARACTERS WITHOUT CLAIM TO ANY PARTICULAR FONT, STYLE, SIZE, OR COLOR.

FOR PORTABLE ELECTRIC POWER GENERATORS (U.S. CLS. 13, 19, 21, 23, 31, 34 AND 35).

KATHLEEN M. VANSTON, EXAMINING ATTORNEY

SN 77-928,938. ARI RENEWABLE ENERGY COMPANY, MANASSAS, VA. FILED 2-5-2010.



NO CLAIM IS MADE TO THE EXCLUSIVE RIGHT TO USE "RENEWABLE ENERGY COMPANY", APART FROM THE MARK AS SHOWN.

THE COLOR(S) BLUE, GREEN, ORANGE, WHITE AND SILVER IS/ARE CLAIMED AS A FEATURE OF THE MARK.

THE MARK CONSISTS OF THE LETTERS "ARI" COMPOSED OF THE COLOR GREEN STARTING WITH A DARK SHADE AT THE BOTTOM THEN GETTING LIGHTER AT THE TOP PORTION OF THE LETTERS. TO THE LEFT OF LETTERS "ARI" IS A SPHERICAL DESIGN WITH THREE WHITE WAVY BANDS THAT INTERSECT IN THE SPHERE'S MIDDLE AND SPLITS THE SPHERE OPEN TO EXPOSE ITS SILVER INTERIOR. THE SPHERE IS COMPOSED OF THE COLOR BLUE WITH LIGHTER SHADING THROUGH THE CENTER. THE WORDS "RENEWABLE ENERGY COMPANY" IN THE COLOR GREEN ARE SIGNIFICANTLY SMALLER AND BELOW THE SPHERE AND "ARI". AN ELLIPTICAL FORM, COMPOSED OF THE COLOR ORANGE, STARTS AT THE TOP OF THE "I" IN "ARI", ENCIRCLES THE WORDS "RENEWABLE ENERGY COMPANY" AND STOPS AT THE BOTTOM OF THE "R" IN THE WORD "RENEWABLE".

FOR WIND TURBINES; WIND-POWERED ELECTRICITY GENERATORS; WINDMILLS (U.S. CLS. 13, 19, 21, 23, 31, 34 AND 35).

FIRST USE 5-27-2008; IN COMMERCE 5-27-2008.

ADA HAN, EXAMINING ATTORNEY

SN 77-930,040. JARVIS, TERRY D., FORT COLLINS, CO. FILED 2-8-2010.

NaturCut

THE MARK CONSISTS OF STANDARD CHARACTERS WITHOUT CLAIM TO ANY PARTICULAR FONT, STYLE, SIZE, OR COLOR.

FOR NON-MOTORIZED WALK-BEHIND REEL-TYPE LAWN MOWER (U.S. CLS. 13, 19, 21, 23, 31, 34 AND 35).

FIRST USE 1-1-2010; IN COMMERCE 2-1-2010.

KIM MONINGHOFF, EXAMINING ATTORNEY

CLASS 7—(Continued).

SN 77-930,171. GOOD IDEAS INC., LAKE CITY, PA. FILED 2-8-2010.

Compost Wizard

THE MARK CONSISTS OF STANDARD CHARACTERS WITHOUT CLAIM TO ANY PARTICULAR FONT, STYLE, SIZE, OR COLOR.

NO CLAIM IS MADE TO THE EXCLUSIVE RIGHT TO USE "COMPOST", APART FROM THE MARK AS SHOWN. FOR MACHINES, NAMELY, COMPOSTERS (U.S. CLS. 13, 19, 21, 23, 31, 34 AND 35).

FIRST USE 12-10-2009; IN COMMERCE 12-10-2009.
ANDREA SAUNDERS, EXAMINING ATTORNEY

SN 77-930,496. GARTNER, MATTHEW C, STRATHMORE, ALBERTA, CANADA, FILED 2-8-2010.

ENERWAV

THE MARK CONSISTS OF STANDARD CHARACTERS WITHOUT CLAIM TO ANY PARTICULAR FONT, STYLE, SIZE, OR COLOR.

FOR WIND-POWERED ELECTRICITY GENERATORS (U.S. CLS. 13, 19, 21, 23, 31, 34 AND 35).

MICHAEL SOUDERS, EXAMINING ATTORNEY

SN 77-930,703. ISUZU COMMERCIAL TRUCK OF AMERICA, INC., ANAHEIM, CA. FILED 2-8-2010.

ECO-MAX

THE MARK CONSISTS OF STANDARD CHARACTERS WITHOUT CLAIM TO ANY PARTICULAR FONT, STYLE, SIZE, OR COLOR.

FOR AIR FILTERS FOR VEHICLE MOTORS AND ENGINES; ANTI-POLLUTION DEVICES FOR MOTORS AND ENGINES; BELTS FOR ENGINES; CAMSHAFTS FOR VEHICLE ENGINES; CATALYTIC CONVERTERS FOR MOTORS AND ENGINES; COMBUSTION ENGINE FUEL NOZZLES; CYLINDER HEADS FOR ENGINES; CYLINDERS FOR MOTORS AND ENGINES; ENGINE BEARINGS; ENGINE EXHAUST TIPS; ENGINE PARTS, NAMELY, CONTACT POINTS; ENGINE PARTS, NAMELY, OIL DIPSTICKS; ENGINE RODS; ENGINE TIMING COMPONENTS, NAMELY, CAM SPROCKETS AND CHAINS; FAN BELTS FOR MOTORS AND ENGINES; FANS FOR MOTORS AND ENGINES; FUEL FILTERS; FUEL PUMPS FOR LAND VEHICLES; GAS-KETS FOR INTERNAL COMBUSTION ENGINES; IGNITION PARTS FOR INTERNAL COMBUSTION ENGINES, NAMELY, CONDENSERS; INTERNAL COMBUSTION

CLASS 7—(Continued).

ENGINES LAND VEHICLE PARTS, NAMELY, COILS; INTERNAL COMBUSTION ENGINES LAND VEHICLE PARTS, NAMELY, DISTRIBUTOR CAPS; INTERNAL COMBUSTION ENGINES LAND VEHICLE PARTS, NAMELY, DISTRIBUTOR ROTORS; OIL FILTERS; OIL FILTERS FOR MOTORS AND ENGINES; RADIATORS FOR VEHICLES; STARTERS FOR MOTORS AND ENGINES; VEHICLE ENGINE PARTS, NAMELY, CHARGE AIR COOLERS AND THEIR COMPONENT PARTS; VEHICLE ENGINE PARTS, NAMELY, CRANKCASE BREATHERS; VEHICLE ENGINE PARTS, NAMELY, INTERCOOLERS; VEHICLE ENGINE PARTS, NAMELY, OIL COOLERS; VEHICLE ENGINE PARTS, NAMELY, OIL TANK PLUGS AND CAPS; VEHICLE ENGINE PARTS, NAMELY, OIL TANKS; VEHICLE ENGINE PARTS, NAMELY, PUSH RODS; VEHICLE ENGINE PARTS, NAMELY, ROCKER ARMS; VEHICLE PARTS, NAMELY, ENGINE CAM PROTECTORS; VEHICLE PARTS, NAMELY, ENGINE CASES; WATER PUMPS FOR USE IN MOTORS AND ENGINES (U.S. CLS. 13, 19, 21, 23, 31, 34 AND 35).

KIMBERLY FRYE, EXAMINING ATTORNEY

SN 77-931,167. VASTEX INTERNATIONAL, INC., ALLENTOWN, PA. FILED 2-9-2010.

VASTEX

THE MARK CONSISTS OF STANDARD CHARACTERS WITHOUT CLAIM TO ANY PARTICULAR FONT, STYLE, SIZE, OR COLOR.

FOR PRINTING MACHINES (U.S. CLS. 13, 19, 21, 23, 31, 34 AND 35).

FIRST USE 2-6-1968; IN COMMERCE 2-6-1968.
B. PARADEWELAI, EXAMINING ATTORNEY

SN 77-931,220. VASTEX INTERNATIONAL, INC., ALLENTOWN, PA. FILED 2-9-2010.

VRS

THE MARK CONSISTS OF STANDARD CHARACTERS WITHOUT CLAIM TO ANY PARTICULAR FONT, STYLE, SIZE, OR COLOR.

FOR PRINTING MACHINES (U.S. CLS. 13, 19, 21, 23, 31, 34 AND 35).

FIRST USE 1-1-2010; IN COMMERCE 1-1-2010.
B. PARADEWELAI, EXAMINING ATTORNEY

CLASS 7—(Continued).

SN 77-931,516. MATRICAL, INC., DBA MATRICAL BIOSCIENCE, SPOKANE, WA. FILED 2-9-2010.

Label X 2D

THE MARK CONSISTS OF STANDARD CHARACTERS WITHOUT CLAIM TO ANY PARTICULAR FONT, STYLE, SIZE, OR COLOR.

NO CLAIM IS MADE TO THE EXCLUSIVE RIGHT TO USE "LABEL" AND "2D", APART FROM THE MARK AS SHOWN.

FOR AUTOMATIC INDUSTRIAL LABELING MACHINES FOR APPLYING LABELS TO CONTAINERS AND BOTTLES (U.S. CLS. 13, 19, 21, 23, 31, 34 AND 35).

FIRST USE 9-15-2008; IN COMMERCE 9-15-2008.
MAYUR VAGHANI, EXAMINING ATTORNEY

SN 77-931,823. ADVANCED FLOW ENGINEERING, INC., CORONA, CA. FILED S.R. 2-9-2010; AM. P.R. 5-11-2010.

DYNAMIC AIR SCOOP D.A.S.

THE MARK CONSISTS OF STANDARD CHARACTERS WITHOUT CLAIM TO ANY PARTICULAR FONT, STYLE, SIZE, OR COLOR.

NO CLAIM IS MADE TO THE EXCLUSIVE RIGHT TO USE "DYNAMIC AIR SCOOP", APART FROM THE MARK AS SHOWN.

FOR AIR INTAKE SYSTEMS COMPRISING AIR FILTERS AND INTAKE TUBING CONNECTING THE AIR FILTER TO THE ENGINE OF LAND VEHICLES (U.S. CLS. 13, 19, 21, 23, 31, 34 AND 35).

FIRST USE 10-9-2008; IN COMMERCE 10-9-2008.
KATHRYN COWARD, EXAMINING ATTORNEY

CLASS 7—(Continued).

SN 77-932,774. ACTIVATED DECOR INC., HAMILTON, CANADA, FILED 2-10-2010.

INTELLALIFTS

THE MARK CONSISTS OF STANDARD CHARACTERS WITHOUT CLAIM TO ANY PARTICULAR FONT, STYLE, SIZE, OR COLOR.

FOR MOTORIZED CEILING CONSOLES FOR THE MOUNTING AND AUTOMATIC SWIVELLING OF FLAT SCREENS IN THE NATURE OF LIFT SYSTEMS TO HIDE OR INTEGRATE AUDIO OR VIDEO EQUIPMENT INTO FURNITURE, CABINETS, PARTITION WALLS OR SUSPENDED CEILINGS COMPRISING POWER- OPERATED LIFTS, ELECTRIC AND PNEUMATIC HOISTS AS WELL AS LIFTING COLUMNS; MOTORIZED WALL AND TABLE CONSOLES FOR THE MOUNTING AND AUTOMATIC SWIVELLING OF FLAT SCREENS IN THE NATURE OF TV LIFT SYSTEMS TO HIDE OR INTEGRATE AUDIO OR VIDEO EQUIPMENT INTO FURNITURE, CABINETS, PARTITION WALLS OR SUSPENDED CEILING COMPRISING OF POWER- OPERATED LIFTS; MOUNTING FRAMES AND CROSSES FOR THE INSTALLATION OF FLAT SCREENS BEING PARTS OF POWER- OPERATED LIFTS; MOTORIZED EQUIPMENT AND PARTS THEREOF, NAMELY, CONTROL MECHANISMS IN THE NATURE OF HYDRAULIC, MECHANICAL OR ELECTRICAL CONTROLS FOR MACHINES, MOTORS AND ENGINES FOR LIFTING AND LOWERING OF FLAT SCREENS (U.S. CLS. 13, 19, 21, 23, 31, 34 AND 35).

FIRST USE 12-31-2007; IN COMMERCE 12-31-2007.
JOHN WILKE, EXAMINING ATTORNEY

SN 77-934,465. PROVISUR TECHNOLOGIES, INC., CHICAGO, IL. FILED 2-12-2010.

BEEMAX

THE MARK CONSISTS OF STANDARD CHARACTERS WITHOUT CLAIM TO ANY PARTICULAR FONT, STYLE, SIZE, OR COLOR.

FOR FOOD PROCESSING EQUIPMENT, NAMELY, COMMERCIAL GRADE ELECTRIC FOOD PROCESSORS (U.S. CLS. 13, 19, 21, 23, 31, 34 AND 35).

FIRST USE 4-30-2008; IN COMMERCE 4-30-2008.
KIMBERLY FRYE, EXAMINING ATTORNEY

CLASS 7—(Continued).

SN 77-935,843. GRACO MINNESOTA INC., MINNEAPOLIS, MN. FILED 2-15-2010.

D-GUN

THE MARK CONSISTS OF STANDARD CHARACTERS WITHOUT CLAIM TO ANY PARTICULAR FONT, STYLE, SIZE, OR COLOR.

FOR SPRAY GUNS FOR PLURAL COMPONENT MATERIALS, NAMELY, POLYUREAS, POLYUR-ETHANES, FOAMS AND OTHER FAST-SET MATERI-ALS (U.S. CLS. 13, 19, 21, 23, 31, 34 AND 35).

FIRST USE 1-1-1985; IN COMMERCE 1-1-1985.
KRISTIN CARLSON, EXAMINING ATTORNEY

SN 77-935,906. GRACO MINNESOTA INC., MINNEAPOLIS, MN. FILED 2-15-2010.

GX-7

THE MARK CONSISTS OF STANDARD CHARACTERS WITHOUT CLAIM TO ANY PARTICULAR FONT, STYLE, SIZE, OR COLOR.

FOR SPRAY GUNS FOR PLURAL COMPONENT MATERIALS, NAMELY, POLYUREAS, POLYUR-ETHANES, FOAMS AND OTHER FAST-SET MATERI-ALS (U.S. CLS. 13, 19, 21, 23, 31, 34 AND 35).

FIRST USE 1-1-1990; IN COMMERCE 1-1-1990.
KRISTIN CARLSON, EXAMINING ATTORNEY

SN 77-937,605. GRACO MINNESOTA INC., MINNEAPOLIS, MN. FILED 2-17-2010.

MERKUR

THE MARK CONSISTS OF STANDARD CHARACTERS WITHOUT CLAIM TO ANY PARTICULAR FONT, STYLE, SIZE, OR COLOR.

THE ENGLISH TRANSLATION OF "MERKUR" IN THE MARK IS "MERCURY".

FOR POSITIVE DISPLACEMENT PUMPS (U.S. CLS. 13, 19, 21, 23, 31, 34 AND 35).

FIRST USE 12-29-2000; IN COMMERCE 12-29-2000.
KRISTIN CARLSON, EXAMINING ATTORNEY

CLASS 7—(Continued).

SN 77-940,232. ADVANCED INDUSTRIES, INC., CHELSEA, MI. FILED 2-19-2010.

THERMALFIT

THE MARK CONSISTS OF STANDARD CHARACTERS WITHOUT CLAIM TO ANY PARTICULAR FONT, STYLE, SIZE, OR COLOR.

FOR MACHINE TOOL HOLDERS, NAMELY, END MILL HOLDERS FOR MOUNTING A CUTTING TOOL AND CUTTING TOOL HOLDERS FOR MOUNTING A CUTTING TOOL (U.S. CLS. 13, 19, 21, 23, 31, 34 AND 35).

KATHERINE CHANG, EXAMINING ATTORNEY

SN 77-967,085. ZODIAC POOL CARE, INC., MOORPARK, CA. FILED 3-24-2010.

BARACUDA MX

THE MARK CONSISTS OF STANDARD CHARACTERS WITHOUT CLAIM TO ANY PARTICULAR FONT, STYLE, SIZE, OR COLOR.

OWNER OF U.S. REG. NO. 1,505,584.

FOR SWIMMING POOL AND SPA CLEANING EQUIP-MENT, NAMELY, SWEEPERS AND VACUUMS, AND PARTS THEREFOR (U.S. CLS. 13, 19, 21, 23, 31, 34 AND 35).

CARRIE GENOVESE, EXAMINING ATTORNEY

SN 79-045,918. Q-TRANSPORT MATERIEL A/S, DENMARK, FILED 10-24-2007.



OWNER OF INTERNATIONAL REGISTRATION 0664654 DATED 11-6-1996, EXPIRES 11-6-2016.

THE MARK CONSISTS OF THE LETTER "Q" INSIDE A SQUARE.

FOR MACHINES, NAMELY, CONVEYORS USED FOR MATERIAL AND PRODUCT TRANSPORT (U.S. CLS. 13, 19, 21, 23, 31, 34 AND 35).

YAT SYE, LEE, EXAMINING ATTORNEY

CLASS 7—(Continued).

SN 79-071,729. VIFAMA, S.L., SPAIN, FILED 10-31-2008.



PRIORITY DATE OF 10-23-2008 IS CLAIMED.
OWNER OF INTERNATIONAL REGISTRATION 1009930
DATED 10-31-2008, EXPIRES 10-31-2018.
THE COLOR(S) WHITE AND RED IS/ARE CLAIMED AS
A FEATURE OF THE MARK.
THE TERM "VIFAMA" AND LOGO IN RED; BACK-
GROUND IN WHITE.

THE MARK CONSISTS OF THE TERM "VIFAMA" AND A
CIRCULAR LOGO WITH TWO DISSECTING LINES IN
RED, ALL ON A BACKGROUND OF WHITE.

FOR MACHINES AND MACHINE TOOLS, NAMELY,
FOOTWEAR MANUFACTURING MACHINES AND MACHINERY
FOR MOULDING FOOTWEAR BACKPARTS (U.S. CLS. 13, 19, 21, 23, 31, 34 AND 35).

TRACY CROSS, EXAMINING ATTORNEY

CLASS 7—(Continued).

SN 79-078,916. AMAZONEN-WERKE H. DREYER GMBH & CO KG, FED REP GERMANY, FILED 9-23-2009.

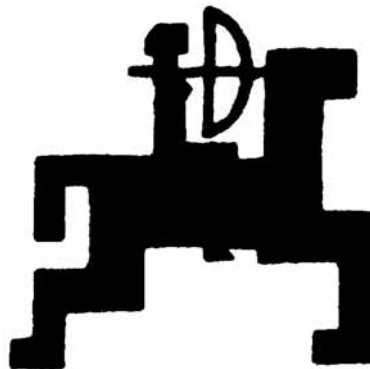

OWNER OF INTERNATIONAL REGISTRATION 0223905
DATED 9-21-1959, EXPIRES 9-21-2019.

THE MARK CONSISTS OF A STYLIZED HORSE AND A
FEMALE RIDER WITH A BOW AND ARROW.

FOR FERTILIZER DISTRIBUTORS; SPREADERS FOR
MANURE; SOWERS; LAND CULTIVATION IMPLE-
MENTS, NAMELY, HAY MAKING MACHINES; POWER
OPERATED TOOLS, NAMELY, POTATO DIGGERS,
POTATO SORTERS-CALIBRATORS, POTATO AND
SEED CLEANERS, SEED SEPARATORS, FIELD
SPRAYERS, SOIL TILLAGE IMPLEMENTS, AND SEED
DRILLS; CONVEYERS (U.S. CLS. 13, 19, 21, 23, 31, 34
AND 35).

JOHN DALIER, EXAMINING ATTORNEY

SN 79-073,206. VIEGA GMBH & CO. KG, FED REP GER-
MANY, FILED 7-30-2009.

Viega Pressgun

THE MARK CONSISTS OF STANDARD CHARACTERS
WITHOUT CLAIM TO ANY PARTICULAR FONT, STYLE,
SIZE, OR COLOR.

OWNER OF INTERNATIONAL REGISTRATION 1014189
DATED 7-30-2009, EXPIRES 7-30-2019.

OWNER OF U.S. REG. NOS. 2,820,583, 2,850,021 AND
OTHERS.

NO CLAIM IS MADE TO THE EXCLUSIVE RIGHT TO
USE "PRESSGUN", APART FROM THE MARK AS SHOWN.
SEC. 2(F) AS TO "VIEGA".

FOR ELECTRIC AND BATTERY OPERATED PRESS-
ING TOOLS FOR COMPRESSING PIPELINE CONNec-
TORS (U.S. CLS. 13, 19, 21, 23, 31, 34 AND 35).

KELLY TRUSILO, EXAMINING ATTORNEY

SN 85-003,214. GRACO MINNESOTA INC., MINNEAPOLIS,
MN. FILED 3-31-2010.

GRINDLAZER

THE MARK CONSISTS OF STANDARD CHARACTERS
WITHOUT CLAIM TO ANY PARTICULAR FONT, STYLE,
SIZE, OR COLOR.

FOR MACHINE FOR GROOVING, INLAYING, RE-
MOVING LINES AND SMOOTHING BUMPS ON AS-
PHALT AND CONCRETE SURFACES (U.S. CLS. 13, 19,
21, 23, 31, 34 AND 35).

FIRST USE 1-31-2010; IN COMMERCE 1-31-2010.

KRISTIN CARLSON, EXAMINING ATTORNEY

CLASS 8—HAND TOOLS

SN 77-628,337. C.A.S. IBERIA, INC., SALE CREEK, TN.
FILED 12-8-2008.



NO CLAIM IS MADE TO THE EXCLUSIVE RIGHT TO USE "KNIVES", APART FROM THE MARK AS SHOWN.

THE COLOR(S) YELLOW AND BLACK IS/ARE CLAIMED AS A FEATURE OF THE MARK.

THE MARK CONSISTS OF A YELLOW OVAL WITH A BLACK BORDER AND THE WORDS "ROCK CREEK" HIGHLIGHTED IN YELLOW ALONG THE TOP OF THE BORDER AND THE WORD "KNIVES" HIGHLIGHTED IN YELLOW ALONG THE BOTTOM OF THE BORDER AND THE DEPICTION OF AN EXPOSED BLACK ROCK OUTCROPPING CONTAINED IN A BLACK CREEK FLOWING THROUGH THE CENTER OF THE OVAL.

FOR KNIVES, NAMELY, FIXED-BLADE HUNTING AND TACTICAL KNIVES (U.S. CLS. 23, 28 AND 44).

FIRST USE 7-23-2008; IN COMMERCE 7-23-2008.

BRENDAN REGAN, EXAMINING ATTORNEY

CLASS 8—(Continued).

SN 77-821,274. WILLIAMS, ERNEST, PERRY HALL, MD.
FILED 9-7-2009.



THE COLOR(S) BLACK AND WHITE IS/ARE CLAIMED AS A FEATURE OF THE MARK.

THE MARK CONSISTS OF THE LETTERS "EZ" IN BLACK, THE LETTERS "CUT" IN WHITE AGAINST A BLACK BACKGROUND, WITH THE WORD "EVERYTHING" IN BLACK.

FOR HANDHELD CUTTING TOOLS FOR PRECISION CUTTING OF TILE, GLASS, PLASTIC AND LAMINATE (U.S. CLS. 23, 28 AND 44).

LINDA ORNDORFF, EXAMINING ATTORNEY

SN 77-825,650. GARDENA CANADA LTD., BRAMPTON,
ONTARIO, CANADA. FILED 9-14-2009.

NORTHERN HORIZONS

SN 77-786,156. NCH CORPORATION, IRVING, TX. FILED 7-21-2009.

CRYOTAP

THE MARK CONSISTS OF STANDARD CHARACTERS WITHOUT CLAIM TO ANY PARTICULAR FONT, STYLE, SIZE, OR COLOR.

OWNER OF U.S. REG. NO. 2,480,540.

FOR HAND TOOLS, NAMELY, TAPS FOR MANUALLY OPERATED HAND TOOLS (U.S. CLS. 23, 28 AND 44).

FIRST USE 6-23-1999; IN COMMERCE 6-23-1999.

SETH A. RAPPAPORT, EXAMINING ATTORNEY

THE MARK CONSISTS OF STANDARD CHARACTERS WITHOUT CLAIM TO ANY PARTICULAR FONT, STYLE, SIZE, OR COLOR.

FOR SNOW PUSHERS, AND SNOW SHOVELS OF VARIOUS SIZES WITH METAL AND WOOD HANDLES AND SHAFTS AND A PLASTIC D GRIP; SNOW SCRAPERS SNOW SHOVELS OF VARIOUS SIZES WITH METAL AND WOOD HANDLES AND SHAFTS; SNOW SHOVELS WITH A BACK SAVER METAL HANDLE AND SHAFT WITH A PLASTIC D GRIP; CHILDRENS' SNOW SHOVELS WITH WOOD HANDLES AND PLASTIC D GRIPS; CAR SNOW SHOVELS WITH WOOD HANDLES AND WITH TELESCOPIC METAL HANDLES AND A D GRIP; GRAIN SHOVELS WITH WOOD HANDLES AND WITH PLASTIC D GRIPS; GENERAL SHOVELS FOR MULTI-PURPOSE SHOVELING WITH WOOD HANDLES AND WITH PLASTIC D GRIPS; ICE CHOPPERS, SCRAPERS AND EDGERS WITH BOTH METAL AND WOOD HANDLES; METAL AND PLASTIC SCOOPS WITH METAL HANDLES FOR SNOW SHOVELING OF LARGE AND SMALL AREAS; ROOF RAKES FOR REMOVING SNOW FROM ROOFS HAVING A PLASTIC BLADE WITH ALUMINUM EXTENDABLE TUBING ATTACHED; ICE SCRAPERS WITH A BRUSH ATTACHED, FOR REMOVING SNOW FROM CARS, MADE FROM PLASTIC WITH HANDLES FROM WOOD, METAL AND ALUMINUM (U.S. CLS. 23, 28 AND 44).

LINDA E. BLOHM, EXAMINING ATTORNEY

CLASS 8—(Continued).

SN 77-825,797. GARDENA CANADA LTD., BRAMPTON, ONTARIO, CANADA, FILED 9-14-2009.

NORTHERN PASSAGES

THE MARK CONSISTS OF STANDARD CHARACTERS WITHOUT CLAIM TO ANY PARTICULAR FONT, STYLE, SIZE, OR COLOR.

FOR SNOW PUSHERS, AND SNOW SHOVELS OF VARIOUS SIZES WITH METAL AND WOOD HANDLES AND SHAFTS AND A PLASTIC D GRIP; SNOW SCRAPERS SNOW SHOVELS OF VARIOUS SIZES WITH METAL AND WOOD HANDLES AND SHAFTS; SNOW SHOVELS WITH A BACK SAVER METAL HANDLE AND SHAFT WITH A PLASTIC D GRIP; CHILDRENS' SNOW SHOVELS WITH WOOD HANDLES AND PLASTIC D GRIPS; CAR SNOW SHOVELS WITH WOOD HANDLES AND WITH TELESCOPIC METAL HANDLES AND A D GRIP; GRAIN SHOVELS WITH WOOD HANDLES AND WITH PLASTIC D GRIPS; GENERAL SHOVELS FOR MULTI-PURPOSE SHOVELING WITH WOOD HANDLES AND WITH PLASTIC D GRIPS; ICE CHOPPERS, SCRAPERS AND EDGERS WITH BOTH METAL AND WOOD HANDLES; METAL AND PLASTIC SCOOPS WITH METAL HANDLES FOR SNOW SHOVELING OF LARGE AND SMALL AREAS; ROOF RAKES FOR REMOVING SNOW FROM ROOFS HAVING A PLASTIC BLADE WITH ALUMINUM EXTENDABLE TUBING ATTACHED; ICE SCRAPERS WITH A BRUSH ATTACHED, FOR REMOVING SNOW FROM CARS, MADE FROM PLASTIC WITH HANDLES FROM WOOD, METAL AND ALUMINUM (U.S. CLS. 23, 28 AND 44).

LINDA E. BLOHM, EXAMINING ATTORNEY

SN 77-825,807. GARDENA CANADA LTD., BRAMPTON, ONTARIO, CANADA, FILED 9-14-2009.

NORTHERN WILDERNESS

THE MARK CONSISTS OF STANDARD CHARACTERS WITHOUT CLAIM TO ANY PARTICULAR FONT, STYLE, SIZE, OR COLOR.

FOR SNOW PUSHERS, AND SNOW SHOVELS OF VARIOUS SIZES WITH METAL AND WOOD HANDLES AND SHAFTS AND A PLASTIC D GRIP; SNOW SCRAPERS SNOW SHOVELS OF VARIOUS SIZES WITH METAL AND WOOD HANDLES AND SHAFTS; SNOW SHOVELS WITH A BACK SAVER METAL HANDLE AND SHAFT WITH A PLASTIC D GRIP; CHILDRENS' SNOW SHOVELS WITH WOOD HANDLES AND PLASTIC D GRIPS; CAR SNOW SHOVELS WITH WOOD HANDLES AND WITH TELESCOPIC METAL HANDLES AND A D GRIP; GRAIN SHOVELS WITH WOOD HANDLES AND WITH PLASTIC D GRIPS; GENERAL SHOVELS FOR MULTI-PURPOSE SHOVELING WITH WOOD HANDLES AND WITH PLASTIC D GRIPS; ICE CHOPPERS, SCRAPERS AND EDGERS WITH BOTH METAL AND WOOD HANDLES; METAL AND PLASTIC SCOOPS WITH METAL HANDLES FOR SNOW SHOVELING OF LARGE AND SMALL AREAS; ROOF RAKES FOR REMOVING SNOW FROM ROOFS HAVING A PLASTIC BLADE WITH ALUMINUM EXTENDABLE TUBING ATTACHED; ICE SCRAPERS WITH A BRUSH ATTACHED, FOR REMOVING SNOW FROM CARS, MADE FROM PLASTIC WITH HANDLES FROM WOOD, METAL AND ALUMINUM (U.S. CLS. 23, 28 AND 44).

LINDA E. BLOHM, EXAMINING ATTORNEY

CLASS 8—(Continued).

SN 77-887,613. FLOK LLC, NEW YORK, NY. FILED 12-7-2009.

POPPIN

THE MARK CONSISTS OF STANDARD CHARACTERS WITHOUT CLAIM TO ANY PARTICULAR FONT, STYLE, SIZE, OR COLOR.

FOR SCISSORS; KNIVES, FORKS AND SPOONS (U.S. CLS. 23, 28 AND 44).

TRACY CROSS, EXAMINING ATTORNEY

SN 77-899,088. HIP INNOVATIONS, LLC, WILLISTON, VT. FILED 12-22-2009.

WHACK A TACK

THE MARK CONSISTS OF STANDARD CHARACTERS WITHOUT CLAIM TO ANY PARTICULAR FONT, STYLE, SIZE, OR COLOR.

FOR HAND OPERATED DEVICE FOR DRIVING AN ANGLED TACK INTO A WALL WITH A SINGLE MOTION (U.S. CLS. 23, 28 AND 44).

NELSON SNYDER, EXAMINING ATTORNEY

SN 77-913,704. RENKERT, MICHAEL F., DENVER, CO. FILED 1-17-2010.

CONCEPTUAL MATTERS

THE MARK CONSISTS OF STANDARD CHARACTERS WITHOUT CLAIM TO ANY PARTICULAR FONT, STYLE, SIZE, OR COLOR.

FOR MANUALLY OPERATED HAND TOOLS FOR FORMING A SUBSTANTIALLY UNIFORM AND SMOOTH CAULK BEAD PROFILE FROM CAULKING MATERIAL, NAMELY, A SPECIALIZED TAPE DISPENSER FOR APPLYING REMOVABLE CAULKING TAPE TO A SURFACE TO DEFINE A CAULK BEAD BORDER AND A CAULKING MATERIAL FORMING TOOL TO PROFILE THE CAULK BEAD ADJACENT TO THE TAPE (U.S. CLS. 23, 28 AND 44).

SALLY SHIH, EXAMINING ATTORNEY

CLASS 8—(Continued).

SN 77-926,599. HI-FIVE PRODUCTS DEVELOPING CO., LTD., TAICHUNG COUNTY, TAIWAN, FILED 2-3-2010.

Grab Wrench

THE MARK CONSISTS OF STANDARD CHARACTERS WITHOUT CLAIM TO ANY PARTICULAR FONT, STYLE, SIZE, OR COLOR.

NO CLAIM IS MADE TO THE EXCLUSIVE RIGHT TO USE "WRENCH", APART FROM THE MARK AS SHOWN. FOR HAND TOOLS, NAMELY, WRENCHES (U.S. CLS. 23, 28 AND 44).

FIRST USE 1-29-2010; IN COMMERCE 1-29-2010. ODESSA BIBBINS, EXAMINING ATTORNEY

CLASS 8—(Continued).

SN 77-930,137. CARLINO, CRISTINA M., PHOENIX, AZ. FILED 2-8-2010.

ARCHETYPE

THE MARK CONSISTS OF STANDARD CHARACTERS WITHOUT CLAIM TO ANY PARTICULAR FONT, STYLE, SIZE, OR COLOR.

FOR DISPOSABLE RAZORS; DISPOSABLE TABLEWARE, NAMELY, KNIVES, FORKS AND SPOONS; EYELASH CURLERS; FIREPLACE TOOL SETS SOLD AS A UNIT; GARDENING TOOLS, NAMELY, TROWELS, SHEARS, AND MANUALLY OPERATED PRUNERS; MANICURE SETS; SCISSORS; TABLEWARE, NAMELY, KNIVES, FORKS AND SPOONS (U.S. CLS. 23, 28 AND 44).

APRIL HESIK, EXAMINING ATTORNEY

SN 77-929,568. THE GREAT AMERICAN TOOL COMPANY, INC., BUFFALO, NY. FILED 2-5-2010.

AIR FORCE ONE

THE MARK CONSISTS OF STANDARD CHARACTERS WITHOUT CLAIM TO ANY PARTICULAR FONT, STYLE, SIZE, OR COLOR.

FOR FIXED BLADE KNIVES AND FOLDING KNIVES (U.S. CLS. 23, 28 AND 44).

GILBERT SWIFT, EXAMINING ATTORNEY

SN 77-930,585. L.P.I. CONSUMER PRODUCTS, INC., POMPANO BEACH, FL. FILED 2-8-2010.

OBSESSION

THE MARK CONSISTS OF STANDARD CHARACTERS WITHOUT CLAIM TO ANY PARTICULAR FONT, STYLE, SIZE, OR COLOR.

FOR RAZORS (U.S. CLS. 23, 28 AND 44).

SHARON MEIER, EXAMINING ATTORNEY

SN 77-929,581. THE GREAT AMERICAN TOOL COMPANY, INC., BUFFALO, NY. FILED 2-5-2010.

MARINE ONE

THE MARK CONSISTS OF STANDARD CHARACTERS WITHOUT CLAIM TO ANY PARTICULAR FONT, STYLE, SIZE, OR COLOR.

FOR FIXED BLADE KNIVES AND FOLDING KNIVES (U.S. CLS. 23, 28 AND 44).

GILBERT SWIFT, EXAMINING ATTORNEY

SN 77-931,739. EARTHKARE PACKAGING INNOVATIONS COMPANY, LOS ANGELES, CA. FILED 2-9-2010.

EARTHKARE KUTLERY

THE MARK CONSISTS OF STANDARD CHARACTERS WITHOUT CLAIM TO ANY PARTICULAR FONT, STYLE, SIZE, OR COLOR.

NO CLAIM IS MADE TO THE EXCLUSIVE RIGHT TO USE "CUTLERY", APART FROM THE MARK AS SHOWN.

FOR BIODEGRADABLE CUTLERY, NAMELY, KNIVES, FORKS, SPOONS AND SPORKS (U.S. CLS. 23, 28 AND 44).

DAVID I, EXAMINING ATTORNEY

CLASS 8—(Continued).

SN 77-932,012. GB II CORPORATION, DBA COLUMBIA RIVER KNIFE & TOOL COMPANY, TUALATIN, OR. FILED 2-9-2010.

WHEN SECONDS MATTER

THE MARK CONSISTS OF STANDARD CHARACTERS WITHOUT CLAIM TO ANY PARTICULAR FONT, STYLE, SIZE, OR COLOR.

OWNER OF U.S. REG. NO. 3,225,975.

FOR RESCUE APPARATUS, NAMELY, MULTI-FUNCTION HAND TOOL COMPRISED OF A BLADE FOR CUTTING SEAT BELTS AND METAL POINT FOR BREAKING VEHICLE WINDOWS (U.S. CLS. 23, 28 AND 44).

NATALIE POLZER, EXAMINING ATTORNEY

SN 77-932,058. GB II CORPORATION, DBA COLUMBIA RIVER KNIFE & TOOL COMPANY, TUALATIN, OR. FILED 2-9-2010.

JUST IN TIME

THE MARK CONSISTS OF STANDARD CHARACTERS WITHOUT CLAIM TO ANY PARTICULAR FONT, STYLE, SIZE, OR COLOR.

FOR RESCUE APPARATUS, NAMELY, MULTI-FUNCTION HAND TOOL COMPRISED OF A BLADE FOR CUTTING SEAT BELTS AND METAL POINT FOR BREAKING VEHICLE WINDOWS (U.S. CLS. 23, 28 AND 44).

NATALIE POLZER, EXAMINING ATTORNEY

SN 77-932,170. LUWISCH, EVAN, SOUTH AMBOY, NJ. FILED 2-9-2010.

FLEXIPEEL

THE MARK CONSISTS OF STANDARD CHARACTERS WITHOUT CLAIM TO ANY PARTICULAR FONT, STYLE, SIZE, OR COLOR.

FOR NON-ELECTRIC VEGETABLE PEELERS (U.S. CLS. 23, 28 AND 44).

JANICE L. MCMORROW, EXAMINING ATTORNEY

CLASS 8—(Continued).

SN 77-958,489. EVRIHOLDER PRODUCTS LLC, ANAHEIM, CA. FILED 3-14-2010.

EVRI SCISS

THE MARK CONSISTS OF STANDARD CHARACTERS WITHOUT CLAIM TO ANY PARTICULAR FONT, STYLE, SIZE, OR COLOR.

FOR NAIL SCISSORS (U.S. CLS. 23, 28 AND 44).
CAROLYN CATALDO, EXAMINING ATTORNEY

SN 85-004,517. WORLD TRIATHLON CORPORATION, TAMPA, FL. FILED 4-1-2010.

IRONMAN

THE MARK CONSISTS OF STANDARD CHARACTERS WITHOUT CLAIM TO ANY PARTICULAR FONT, STYLE, SIZE, OR COLOR.

OWNER OF U.S. REG. NOS. 1,258,881, 3,328,979 AND OTHERS.

FOR HAND-OPERATED BICYCLE TOOLS FOR REPAIR AND MAINTENANCE PURPOSES, MULTI-FUNCTION HAND TOOLS FOR REPAIR AND MAINTENANCE OF BICYCLES, AND ALL OF THE FOREGOING MARKETED IN ASSOCIATION WITH CONTESTS CONSISTING OF SWIMMING, BIKING AND RUNNING (U.S. CLS. 23, 28 AND 44).

JUDITH HELFMAN, EXAMINING ATTORNEY

SN 85-021,383. PACIFIC WORLD CORPORATION, LAKE FOREST, CA. FILED 4-23-2010.

GEO GIRL

THE MARK CONSISTS OF STANDARD CHARACTERS WITHOUT CLAIM TO ANY PARTICULAR FONT, STYLE, SIZE, OR COLOR.

FOR MANICURE IMPLEMENTS, NAMELY, NAIL FILES; PEDICURE IMPLEMENTS, NAMELY, NAIL FILES (U.S. CLS. 23, 28 AND 44).

JOHN HWANG, EXAMINING ATTORNEY

CLASS 9—ELECTRICAL AND SCIENTIFIC APPARATUS

SN 76-689,791. SAFE GLOW CORPORATION, YORBA LINDA, CA. FILED 5-19-2008.

SAFE GLOW

THE MARK CONSISTS OF STANDARD CHARACTERS WITHOUT CLAIM TO ANY PARTICULAR FONT, STYLE, SIZE, OR COLOR.

NO CLAIM IS MADE TO THE EXCLUSIVE RIGHT TO USE "GLOW", APART FROM THE MARK AS SHOWN.

FOR NON-ELECTRICAL, PHOTOLUMINESCENT EXIT SIGNS, EMERGENCY PHOTOLUMINESCENT LIGHTS AND SAFETY MARKERS FOR INSTALLATION IN AND AROUND BUILDINGS TO MARK MEANS OF EGRESS (U.S. CLS. 21, 23, 26, 36 AND 38).

FIRST USE 2-2-2002; IN COMMERCE 2-2-2002.
STEVEN PEREZ, EXAMINING ATTORNEY

CLASS 9—(Continued).

SN 76-698,522. HAVIS, INC., WARMINSTER, PA. FILED 7-20-2009.

CHARGE GUARD

THE MARK CONSISTS OF STANDARD CHARACTERS WITHOUT CLAIM TO ANY PARTICULAR FONT, STYLE, SIZE, OR COLOR.

OWNER OF U.S. REG. NO. 1,659,573.

FOR ELECTRONIC AUTO SHUT-OFF TIMER SWITCH THAT PROVIDES CIRCUIT PROTECTION FOR VEHICLES POWER SYSTEM (U.S. CLS. 21, 23, 26, 36 AND 38).

FIRST USE 2-8-2006; IN COMMERCE 2-8-2006.
GEOFFREY FOSDICK, EXAMINING ATTORNEY

SN 76-699,086. CANADA PIPELINE ACCESSORIES CO. LTD., CALGARY, ALBERTA, CANADA, FILED 8-21-2009.

TBR CHANGER

THE MARK CONSISTS OF STANDARD CHARACTERS WITHOUT CLAIM TO ANY PARTICULAR FONT, STYLE, SIZE, OR COLOR.

NO CLAIM IS MADE TO THE EXCLUSIVE RIGHT TO USE "TBR", APART FROM THE MARK AS SHOWN.

FOR FLOW CONDITIONERS, NAMELY, DEVICES FOR REGULATING FLUID FLOW IN PRESSURIZED PIPELINES (U.S. CLS. 21, 23, 26, 36 AND 38).

STEPHANIE ALI, EXAMINING ATTORNEY

SN 76-698,390. ENOVIZE INC., SKOKIE, IL. FILED 7-13-2009.



THE COLOR(S) GREEN, LIGHT GRAY AND DARK GRAY IS/ARE CLAIMED AS A FEATURE OF THE MARK.

THE LITERAL ELEMENT OF THE MARK CONSISTS OF "LITEFUZE". THE MARK CONSISTS OF THE WORDING "LITEFUZE" IN STYLIZED LETTERING. A DROP SHADOW APPEARS IN THE WORDING "LITEFUZE". A CORD CONNECTED TO THE LETTER "L" APPEARS RUNNING ACROSS HORIZONTALLY. A PLUG APPEARS AT THE RIGHT END OF THE CORD. THE WORDING "LITEFUZE" APPEARS SLIGHTLY OVERLAPPING THE CORD. THE COLOR GREEN APPEARS IN THE WORD "LITE". THE COLOR LIGHT GRAY APPEARS IN THE CORD AND PLUG. THE COLOR DARK GRAY APPEARS IN THE WORD "FUZE" AND DROP SHADOW.

FOR VOLTAGE CONVERTERS, VOLTAGE ADAPTERS, VOLTAGE REGULATORS, ELECTRIC POWER CONVERSION DEVICES, AND ELECTRIC VOLTAGE TRANSFORMERS FOR CONVERTING ELECTRIC VOLTAGE FROM 110/115/220/240 VOLTS TO 110/115/220/240 VOLTS (U.S. CLS. 21, 23, 26, 36 AND 38).

JORDAN BAKER, EXAMINING ATTORNEY

SN 76-700,630. OPIN SYSTEMS, INC., BLOOMINGTON, MN. FILED 12-2-2009.



NO CLAIM IS MADE TO THE EXCLUSIVE RIGHT TO USE "SYSTEMS", APART FROM THE MARK AS SHOWN.

THE COLOR(S) RED AND GRAY IS/ARE CLAIMED AS A FEATURE OF THE MARK.

THE MARK CONSISTS OF THE COLOR GREY APPEARS IN THE LETTERS OF THE WORDS "OPIN" AND "SYSTEMS" AND IN THE LOWER LEFT AND UPPER RIGHT QUADRANTS OF THE SINGLE LETTER "O". THE COLOR RED APPEARS IN THE TOP LEFT AND THE LOWER RIGHT QUADRANTS OF THE SINGLE LETTER "O".

FOR COMPUTER SOFTWARE FOR ELECTRONIC DOCUMENT MANAGEMENT, DOCUMENT ARCHIVING, DOCUMENT DISTRIBUTION, REPORT MANAGEMENT, REPORT DISTRIBUTION, REPORT ARCHIVING, BILL PRESENTMENT AND BILL PAYMENT (U.S. CLS. 21, 23, 26, 36 AND 38).

FIRST USE 6-30-2005; IN COMMERCE 6-30-2005.
SEAN CROWLEY, EXAMINING ATTORNEY

CLASS 9—(Continued).

SN 76-701,466. FOWLER, DEWAINÉ, LA CRESCENTA, CA. FILED 2-3-2010.

Z & R

FOR COMPUTER HARDWARE FOR RECORDING AND ANALYZING PURCHASER INFORMATION ASSOCIATED WITH PURCHASE OF AN AUTOMOBILE (U.S. CLS. 21, 23, 26, 36 AND 38).

ZHALEH DELANEY, EXAMINING ATTORNEY

SN 77-130,997. HILL-ROM SERVICES, INC., BATESVILLE, IN. FILED 3-14-2007.

REMINDME

THE MARK CONSISTS OF STANDARD CHARACTERS WITHOUT CLAIM TO ANY PARTICULAR FONT, STYLE, SIZE, OR COLOR.

FOR COMPUTER HARDWARE AND SOFTWARE FOR HEALTHCARE FACILITY DATA COLLECTION, COMMUNICATIONS AND ALERT SYSTEMS COMPRISING ELECTRONIC TIMERS, NOTIFICATION AND REMINDER SYSTEMS (U.S. CLS. 21, 23, 26, 36 AND 38).

BENJAMIN OKEKE, EXAMINING ATTORNEY

SN 77-221,471. LSI CORPORATION, MILPITAS, CA. FILED 7-3-2007.

LSI

THE MARK CONSISTS OF STANDARD CHARACTERS WITHOUT CLAIM TO ANY PARTICULAR FONT, STYLE, SIZE, OR COLOR.

OWNER OF U.S. REG. NOS. 1,482,179, 2,783,758 AND 2,896,580.

SEC. 2(F).

FOR INTEGRATED CIRCUITS; SEMICONDUCTORS; COMMUNICATION AND COMPUTER HARDWARE, NAMELY, NETWORK AND SIGNAL PROCESSORS, ELECTRONIC SWITCHES, DATA BUSES, PROCESSOR BUSES, TRANSMITTERS; COMPUTER HARDWARE, NAMELY, SWITCH FABRIC CONSISTING OF ASYNCHRONOUS TRANSFER MODE/ATM, ETHERNET, FRAME RELAY, AND SYNCHRONOUS OPTICAL NETWORK/SONET SWITCHES; COMPUTER HARDWARE FOR INFORMATION STORAGE, NAMELY, DISK DRIVE CONTROLLERS, DIGITAL SIGNAL PROCESSORS, READ CHANNELS, PREAMPLIFIERS, MOTOR CONTROLLERS; COMPUTER SOFTWARE DEVELOPMENT TOOLS; PC CARD RADIOS; COMPUTER NETWORK ADAPTERS; COMPUTER HARDWARE IN THE NATURE OF ELECTRONIC COMMUNICATIONS NETWORKING COMPONENTS, NAMELY, MAPPERS, FRAMERS, COMPUTER SWITCHES; COMPUTER HARDWARE, NAMELY, NETWORK COMMUNICA-

CLASS 9—(Continued).

TION DRIVERS AND NETWORK PROCESSORS; COMPUTER HARDWARE, NAMELY, LINE DRIVERS; CLOCK CIRCUITS, NAMELY, INTEGRATED CIRCUITS FOR SYSTEM SYNCHRONIZATION AND TIMING; COMPUTER SOFTWARE FOR USE IN THE MANAGEMENT OF WIRELESS COMMUNICATION SYSTEMS; MULTIPLEXERS; COMMUNICATIONS EQUIPMENT, NAMELY, MODEMS, SIGNAL CONVERTERS, COMPUTER HARDWARE IN THE NATURE OF MAPPERS, PCI ADAPTERS AND DIGITAL SIGNAL PROCESSORS; ELECTRONIC VOICE SYNTHESIZING APPARATUS, NAMELY, VOICE CODERS; WIRELESS ACCESS TRANSMITTERS; AMPLIFIERS; TRANSCEIVERS; LAN (LOCAL AREA NETWORK) HARDWARE; COMPUTER SOFTWARE DRIVERS, NAMELY, COMPUTER PROGRAMS FOR CONTROLLING NETWORK COMMUNICATION DEVICES AND COMPUTER PROGRAMS FOR CONTROLLING COMPUTER DEVICES, PROTOCOL STACK SOFTWARE; COMPUTER HARDWARE DRIVERS; COMPUTER PROGRAMS FOR CONTROLLING COMPUTER PERIPHERALS; SATELLITE DIGITAL RADIO TRANSCEIVERS AND SATELLITE DIGITAL RADIO RECEIVERS; MOBILE PHONE BASE BAND INTEGRATED CIRCUITS; COMPUTER HARDWARE, NAMELY, NETWORKING BASE BAND CHIPS AND MEDIA ACCESS CONTROLLERS; PHYSICAL LAYER DEVICES, NAMELY, INTEGRATED CIRCUIT CHIPS FOR THE TRANSMISSION AND PROCESSING OF DATA IN DATA AND TELECOMMUNICATION NETWORKS; STORAGE ATTACHED NETWORKING DEVICES, NAMELY, BLANK HARD DRIVES AND SEMICONDUCTOR MEMORIES FOR USE IN TELECOMMUNICATION NETWORKS, POWER MANAGEMENT DEVICES, NAMELY, INTEGRATED CIRCUITS FOR POWER SEQUENCING AND FAULT MONITORING IN CONSUMER ELECTRONICS AND COMPUTERS; COMPUTER HARDWARE, NAMELY, MICROPROCESSORS AND DIGITAL SIGNAL PROCESSORS FOR CODING AND DECODING VIDEO INFORMATION; COMPUTER SOFTWARE FOR CODING AND DECODING VIDEO INFORMATION; COMPUTER HARDWARE AND SOFTWARE FOR CONFIGURING, MANAGING AND MAINTAINING DATA STORAGE SYSTEMS AND REDUNDANT ARRAYS OF DISKS; COMPUTER SOFTWARE FOR INTEGRATING COMPUTING RESOURCES INTO A UNIFIED NETWORK; COMPUTER SOFTWARE FOR ANALYZING THE PERFORMANCE OF DATA STORAGE SYSTEMS; AND COMPUTER HARDWARE, NAMELY, DATA COMMUNICATION PROTOCOL CONTROLLERS, DATA BUS EXPANDERS, AND HOST BUS ADAPTERS (U.S. CLS. 21, 23, 26, 36 AND 38).

KELLEY WELLS, EXAMINING ATTORNEY

CLASS 9—(Continued).

SN 77-246,557. DATALOGIC MOBILE, INC., EUGENE, OR. FILED 8-3-2007.

PEGASO

THE MARK CONSISTS OF STANDARD CHARACTERS WITHOUT CLAIM TO ANY PARTICULAR FONT, STYLE, SIZE, OR COLOR.

THE ENGLISH TRANSLATION OF "PEGASO" IS "PEGASUS".

FOR MICROPROCESSOR CONTROLLED PORTABLE HAND-HELD DATA TERMINAL, RF AND SCANNING AND IMAGING DEVICES FOR THE CAPTURE, COLLECTION, AND MANAGEMENT OF DATA, COMPRISED OF OPTICAL CODE READERS, BAR CODE SCANNERS, PORTABLE DATA TERMINALS, AND ACCESSORIES THEREFOR, NAMELY, DOCKING STATIONS, HANDLES, STANDS, HOLDERS, HOLSTERS, BATTERY CHARGER, AND COVERS SOLD AS A COMPONENT OF DATA READER DEVICES, AND REPLACEMENT PARTS THEREFOR; COMPUTER SOFTWARE FOR USE IN DECODING THE COLLECTED DATA; COMPUTER SOFTWARE FOR USE IN DECODING READERS AND PROCESSORS OF DATA FROM OPTICAL CODES, ELECTRONIC TAGS, AND MAGNETIC CARDS; COMPUTER SOFTWARE FOR USE IN TRAINING USERS OF DATA CAPTURE SYSTEMS AND DATA READERS; COMPUTER SOFTWARE FOR PROVIDING FEEDBACK ON AND ANALYZING OPERATION AND EFFICIENCY OF DATA CAPTURE SYSTEMS AND DATA READERS; AND DOWNLOADABLE USER MANUALS FOR DATA CAPTURE SYSTEMS, NAMELY, OPTICAL CODE READERS, BAR CODE SCANNERS, AND PORTABLE DATA TERMINALS (U.S. CLS. 21, 23, 26, 36 AND 38).

FIRST USE 6-22-2007; IN COMMERCE 6-22-2007.
ELLEN B. AWRICH, EXAMINING ATTORNEY

SN 77-312,740. VESTALIFE, LLC, IRVINE, CA. FILED 10-24-2007.

Butterfly

THE MARK CONSISTS OF STANDARD CHARACTERS WITHOUT CLAIM TO ANY PARTICULAR FONT, STYLE, SIZE, OR COLOR.

FOR MP3 DOCKING STATIONS HAVING SPEAKERS (U.S. CLS. 21, 23, 26, 36 AND 38).

TIMOTHY FINNEGAN, EXAMINING ATTORNEY

CLASS 9—(Continued).

SN 77-328,207. WESTLOCK CONTROLS CORPORATION, SADDLEBROOK, NJ. FILED 11-13-2007.

QUANTUM

THE MARK CONSISTS OF STANDARD CHARACTERS WITHOUT CLAIM TO ANY PARTICULAR FONT, STYLE, SIZE, OR COLOR.

FOR ELECTRONIC CONTROLLERS FOR USE IN OPENING AND CLOSING ROTARY VALVES FOR USE IN THE OIL, GAS, CHEMICAL AND PHARMACEUTICAL INDUSTRIES (U.S. CLS. 21, 23, 26, 36 AND 38).

FIRST USE 3-1-1995; IN COMMERCE 3-1-1995.
EMILY CARLSEN, EXAMINING ATTORNEY

SN 77-347,322. CONTEXTREAM LTD., PETACH TIKVAH, ISRAEL, FILED 12-7-2007.

CONTEXTREAM

OWNER OF ISRAEL REG. NO. 200084, DATED 1-22-2009, EXPIRES 5-8-2017.

THE MARK CONSISTS OF THE WORD "CONTEXTREAM" WITH THE "X" OVERSIZED AND STYLIZED.

FOR COMPUTER HARDWARE AND SOFTWARE FOR TRANSMISSION OF VIDEO, AUDIO AND DATA OVER NETWORKS (U.S. CLS. 21, 23, 26, 36 AND 38).

HENRY S. ZAK, EXAMINING ATTORNEY

SN 77-356,597. X-RAY OPTICAL SYSTEMS, INC., EAST GREENBUSH, NY. FILED S.R. 12-20-2007; AM. P.R. 4-22-2010.

HDXRF

NO CLAIM IS MADE TO THE EXCLUSIVE RIGHT TO USE "HDXRF", APART FROM THE MARK AS SHOWN.

THE MARK CONSISTS OF THE LETTERS "HDXRF" WITH A DESIGN OF LINES FORMING RAYS STREAMING THROUGH THE LETTERS "X" "R" AND "F"

FOR ELECTRONIC INSTRUMENTS, NAMELY, ANALYZERS CONSISTING OF AN X-RAY SOURCE AND FLUORESCENCE DETECTOR COMPONENTS FOR DETECTING AND MEASURING THE CONCENTRATIONS OF ONE OR MORE ANALYTERS IN A SAMPLE FOR ANALYSIS OF THE CHEMICAL COMPOSITION OF THE SAMPLE (U.S. CLS. 21, 23, 26, 36 AND 38).

FIRST USE 11-25-2008; IN COMMERCE 11-25-2008.
LINDA ESTRADA, EXAMINING ATTORNEY

CLASS 9—(Continued).

SN 77-365,959. SARMIENTO, PEDRO ARNULFO, SAN DIEGO, CA. FILED 1-7-2008.

SENSOSPHERE

THE MARK CONSISTS OF STANDARD CHARACTERS WITHOUT CLAIM TO ANY PARTICULAR FONT, STYLE, SIZE, OR COLOR.

FOR GAS SENSORS FOR MEASURING GAS CONCENTRATION (U.S. CLS. 21, 23, 26, 36 AND 38).

MATTHEW MCDOWELL, EXAMINING ATTORNEY

SN 77-493,180. POWER DISTRIBUTION, INC., RICHMOND, VA. FILED 6-6-2008.

PDIQ

THE MARK CONSISTS OF STANDARD CHARACTERS WITHOUT CLAIM TO ANY PARTICULAR FONT, STYLE, SIZE, OR COLOR.

FOR ELECTRONIC MONITORS FOR ELECTRIC POWER DISTRIBUTION EQUIPMENT, NAMELY, INTELLIGENT ELECTRONIC MONITORS AND MONITOR MODULES FOR MONITORING ELECTRIC CURRENT AND ELECTRICAL SIGNALS; ELECTRIC POWER DISTRIBUTION EQUIPMENT, NAMELY, POWER DISTRIBUTION UNITS FEATURING ELECTRONIC INTELLIGENT MONITORING CAPABILITIES (U.S. CLS. 21, 23, 26, 36 AND 38).

FIRST USE 8-0-2008; IN COMMERCE 8-0-2008.

MICHAEL GAAFAR, EXAMINING ATTORNEY

CLASS 9—(Continued).

SN 77-509,364. BEYONDRRELATIONS, LLC, ROCKFORD, IL. FILED 6-26-2008.



NO CLAIM IS MADE TO THE EXCLUSIVE RIGHT TO USE "SPECIAL PROCESSING SUITE", "INDUSTRY RULES", "CUSTOMER REQUIREMENTS", "CLIENT", AND "MATERIAL & CONDITION", APART FROM THE MARK AS SHOWN.

THE MARK CONSISTS OF THE WORD "RISE" ON THE FIRST LINE WITH THE WORDS "SPECIAL PROCESSING SUITE" DIRECTLY BELOW ON THE SECOND LINE; WITH THE WORDS "INDUSTRY RULES", "CUSTOMER REQUIREMENTS", "RISE CLIENT", "MATERIAL & CONDITION" ALL APPEARING IN FOUR RECTANGULAR SHAPED DESIGNS DIRECTLY TO THE RIGHT OF THE WORDS "RISE SPECIAL PROCESSING SUITE" IN A STACKED STYLE FORM.

FOR ENTERPRISE RESOURCE PLANNING (ERP) SOFTWARE FOR MANAGING MANUFACTURING SPECIFICATIONS, MATERIAL SPECIFICATIONS, JOB QUOTES, ORDER TRACKING, VENDOR TRACKING, ACCOUNTS RECEIVABLES, CUSTOMER REQUIREMENTS, CONTRACTOR REQUIREMENTS AND MANUFACTURING PROCESSES USED IN CONNECTION WITH ENGINEERING IN THE DEFENSE, AEROSPACE, AUTOMOTIVE AND COMMERCIAL INDUSTRIES (U.S. CLS. 21, 23, 26, 36 AND 38).

TRACY CROSS, EXAMINING ATTORNEY

SN 77-522,618. TRADEBYTES DATA CORP., VANCOUVER, CANADA, FILED 7-15-2008.

eSeaClear

THE MARK CONSISTS OF STANDARD CHARACTERS WITHOUT CLAIM TO ANY PARTICULAR FONT, STYLE, SIZE, OR COLOR.

OWNER OF CANADA REG. NO. TMA757517, DATED 1-21-2010, EXPIRES 1-21-2025.

FOR COMPUTER SOFTWARE, NAMELY, SOFTWARE THAT RECORDS PRE-ARRIVAL INFORMATION FROM SMALL SEA-GOING VESSELS (U.S. CLS. 21, 23, 26, 36 AND 38).

FIRST USE 5-30-2008; IN COMMERCE 5-30-2008.

KHANH LE, EXAMINING ATTORNEY

CLASS 9—(Continued).

SN 77-542,322. CELLCO PARTNERSHIP, DBA VERIZON WIRELESS, BASKING RIDGE, NJ. FILED 8-8-2008.

CLASS 9—(Continued).

SN 77-586,203. CARDO SYSTEMS, INC., PITTSBURGH, PA. FILED 10-6-2008.

COMMUNICATION IN MOTION

RAVEN

THE MARK CONSISTS OF STANDARD CHARACTERS WITHOUT CLAIM TO ANY PARTICULAR FONT, STYLE, SIZE, OR COLOR.

FOR WIRELESS COMMUNICATION DEVICE FEATURING VOICE, DATA AND IMAGE TRANSMISSION INCLUDING VOICE, TEXT AND PICTURE MESSAGING, A VIDEO AND STILL IMAGE CAMERA, ALSO FUNCTIONAL TO PURCHASE MUSIC, GAMES, VIDEO AND SOFTWARE APPLICATIONS OVER THE AIR FOR DOWNLOADING TO THE DEVICE (U.S. CLS. 21, 23, 26, 36 AND 38).

RENEE MCCRAY, EXAMINING ATTORNEY

THE MARK CONSISTS OF STANDARD CHARACTERS WITHOUT CLAIM TO ANY PARTICULAR FONT, STYLE, SIZE, OR COLOR.

FOR WIRELESS NON-STATIONARY COMMUNICATION DEVICES, NAMELY, WIRELESS HEADSETS FOR HELMETS USED FOR COMMUNICATING VIA MOBILE PHONES AND INTERCOMS, AND LISTENING TO MUSIC VIA MP3 PLAYERS, AND LISTENING TO INFORMATION PROVIDED BY GPS DEVICES; WIRELESS NON-STATIONARY COMMUNICATION DEVICES, NAMELY, WIRELESS HEADSETS FOR MOTORCYCLE HELMETS USED FOR COMMUNICATING VIA MOBILE PHONES AND INTERCOMS, AND LISTENING TO MUSIC VIA MP3 PLAYERS, AND LISTENING TO INFORMATION PROVIDED BY GPS DEVICES (U.S. CLS. 21, 23, 26, 36 AND 38).

SANI KHOURI, EXAMINING ATTORNEY

SN 77-599,150. LG ELECTRONICS INC., SEOUL, REPUBLIC OF KOREA, FILED 10-23-2008.

SN 77-569,192. DRUIDE INFORMATIQUE INC., MONTREAL, CANADA, FILED 9-12-2008.

Pro:Centric

ANTI-OOPS!

THE MARK CONSISTS OF STANDARD CHARACTERS WITHOUT CLAIM TO ANY PARTICULAR FONT, STYLE, SIZE, OR COLOR.

PRIORITY CLAIMED UNDER SEC. 44(D) ON CANADA APPLICATION NO. 1406614, FILED 8-8-2008, REG. NO. TMA762,824, DATED 3-29-2010, EXPIRES 3-29-2025.

FOR COMPUTER SOFTWARE, NAMELY, A TOOL WHICH CHECKS IF AN ATTACHMENT MENTIONED IN AN EMAIL CORRESPONDENCE HAS IN FACT BEEN ATTACHED AND ADVISES THE SENDER ACCORDINGLY (U.S. CLS. 21, 23, 26, 36 AND 38).

ROSELLE HERRERA, EXAMINING ATTORNEY

THE MARK CONSISTS OF STANDARD CHARACTERS WITHOUT CLAIM TO ANY PARTICULAR FONT, STYLE, SIZE, OR COLOR.

PRIORITY CLAIMED UNDER SEC. 44(D) ON REPUBLIC OF KOREA APPLICATION NO. 40-2008-0049, FILED 10-20-2008, REG. NO. 0811225, DATED 1-11-2010, EXPIRES 1-11-2020.

FOR PLASMA DISPLAY PANEL TELEVISIONS; LIQUID CRYSTAL DISPLAY TELEVISIONS; DIGITAL LIGHT PROCESSING PROJECTION TELEVISIONS; SUPER SLIM TELEVISIONS; FLAT CATHODE-RAY TUBE TELEVISIONS; SET-TOP BOXES FOR RECEIVING GROUND WAVE BROADCAST; SET-TOP BOXES FOR RECEIVING SATELLITE BROADCAST; DIGITAL VERSATILE DISC RECORDERS; BLANK DIGITAL VIDEO TAPES; BLANK MAGNETIC VIDEO TAPES; BLANK DIGITAL AUDIO TAPES; BLANK MAGNETIC AUDIO TAPES; VIDEO PROJECTORS; REMOTE CONTROLLERS FOR TELEVISION; RECORDED COMPUTER PROGRAMS FOR ENABLING THE TELEVISION TO ACCEPT AUDIO AND VIDEO INPUTS FROM COMPUTERS; DOWNLOADABLE COMPUTER PROGRAMS FOR ENABLING THE TELEVISION TO ACCEPT AUDIO AND VIDEO INPUTS FROM COMPUTERS (U.S. CLS. 21, 23, 26, 36 AND 38).

MICHAEL LITZAU, EXAMINING ATTORNEY

CLASS 9—(Continued).

SN 77-619,789. AIRBIQUITY INC., SEATTLE, WA. FILED 11-21-2008.



The logo for 'aqLink' features the word 'aqLink' in a lowercase, sans-serif font. The 'a' and 'q' are in a dark grey color, while the 'L' is significantly larger and bolder, also in dark grey. The 'i' and 'n' are in a lighter grey color. The 'k' is in a dark grey color. Three small dots are positioned below the 'i' and 'n'.

THE MARK CONSISTS OF THE WORD "AQLINK" WITH THREE DOTS IN A HORIZONTAL ROW FOLLOWING THE TAIL OF THE LETTER "Q".

FOR WIRELESS TELECOMMUNICATIONS SOFTWARE WHICH ATTACH TO WIRELESS TELEPHONES, PERSONAL DIGITAL ASSISTANTS (PDAS), AND TELEMATICS UNITS, AND TRANSMIT LOCATION INFORMATION CONCERNING THE WIRELESS TELEPHONE, PDA OR TELEMATICS UNITS TO WHICH IT IS ATTACHED, USING THE GLOBAL POSITIONING SYSTEM (GPS) (U.S. CLS. 21, 23, 26, 36 AND 38).

FIRST USE 11-30-2000; IN COMMERCE 11-30-2000.
TRACY FLETCHER, EXAMINING ATTORNEY

CLASS 9—(Continued).

SN 77-629,612. LG ELECTRONICS INC., SEOUL, REPUBLIC OF KOREA, FILED 12-9-2008.

TruMotion 240Hz Performance

THE MARK CONSISTS OF STANDARD CHARACTERS WITHOUT CLAIM TO ANY PARTICULAR FONT, STYLE, SIZE, OR COLOR.

PRIORITY CLAIMED UNDER SEC. 44(D) ON REPUBLIC OF KOREA APPLICATION NO. 2008-0056043, FILED 12-2-2008, REG. NO. 0811931, DATED 1-18-2010, EXPIRES 1-18-2020.

NO CLAIM IS MADE TO THE EXCLUSIVE RIGHT TO USE "240HZ PERFORMANCE", APART FROM THE MARK AS SHOWN.

FOR PLASMA DISPLAY PANEL TELEVISIONS; LIQUID CRYSTAL DISPLAY TELEVISIONS; DIGITAL LIGHT PROCESSING PROJECTION TELEVISIONS; SUPER SLIM TELEVISIONS; FLAT CATHODE-RAY TUBE TELEVISIONS (U.S. CLS. 21, 23, 26, 36 AND 38).

ANNE E. GUSTASON, EXAMINING ATTORNEY

SN 77-629,608. LG ELECTRONICS INC., SEOUL, REPUBLIC OF KOREA, FILED 12-9-2008.

TruMotion 200Hz Performance

THE MARK CONSISTS OF STANDARD CHARACTERS WITHOUT CLAIM TO ANY PARTICULAR FONT, STYLE, SIZE, OR COLOR.

PRIORITY CLAIMED UNDER SEC. 44(D) ON REPUBLIC OF KOREA APPLICATION NO. 2008-0056042, FILED 12-2-2008, REG. NO. 0811930, DATED 1-18-2010, EXPIRES 1-18-2020.

NO CLAIM IS MADE TO THE EXCLUSIVE RIGHT TO USE "200HZ PERFORMANCE", APART FROM THE MARK AS SHOWN.

FOR PLASMA DISPLAY PANEL TELEVISIONS; LIQUID CRYSTAL DISPLAY TELEVISIONS; DIGITAL LIGHT PROCESSING PROJECTION TELEVISIONS; SUPER SLIM TELEVISIONS; FLAT CATHODE-RAY TUBE TELEVISIONS (U.S. CLS. 21, 23, 26, 36 AND 38).

ANNE E. GUSTASON, EXAMINING ATTORNEY

SN 77-629,623. LG ELECTRONICS INC., SEOUL, REPUBLIC OF KOREA, FILED 12-9-2008.

TruMotion 400Hz Performance

THE MARK CONSISTS OF STANDARD CHARACTERS WITHOUT CLAIM TO ANY PARTICULAR FONT, STYLE, SIZE, OR COLOR.

PRIORITY CLAIMED UNDER SEC. 44(D) ON REPUBLIC OF KOREA APPLICATION NO. 2008-0056044, FILED 12-2-2008, REG. NO. 0811932, DATED 1-18-2010, EXPIRES 1-18-2020.

NO CLAIM IS MADE TO THE EXCLUSIVE RIGHT TO USE "400HZ PERFORMANCE", APART FROM THE MARK AS SHOWN.

FOR PLASMA DISPLAY PANEL TELEVISIONS; LIQUID CRYSTAL DISPLAY TELEVISIONS; DIGITAL LIGHT PROCESSING PROJECTION TELEVISIONS; SUPER SLIM TELEVISIONS; FLAT CATHODE-RAY TUBE TELEVISIONS (U.S. CLS. 21, 23, 26, 36 AND 38).

ANNE E. GUSTASON, EXAMINING ATTORNEY

CLASS 9—(Continued).

SN 77-629,645. LG ELECTRONICS INC., SEOUL, REPUBLIC OF KOREA, FILED 12-9-2008.

TruMotion 480Hz Performance

THE MARK CONSISTS OF STANDARD CHARACTERS WITHOUT CLAIM TO ANY PARTICULAR FONT, STYLE, SIZE, OR COLOR.

PRIORITY CLAIMED UNDER SEC. 44(D) ON REPUBLIC OF KOREA APPLICATION NO. 2008-0056045, FILED 12-2-2008, REG. NO. 0811933, DATED 1-18-2010, EXPIRES 1-18-2020.

NO CLAIM IS MADE TO THE EXCLUSIVE RIGHT TO USE "480HZ PERFORMANCE", APART FROM THE MARK AS SHOWN.

FOR PLASMA DISPLAY PANEL TELEVISIONS; LIQUID CRYSTAL DISPLAY TELEVISIONS; DIGITAL LIGHT PROCESSING PROJECTION TELEVISIONS; SUPER SLIM TELEVISIONS; FLAT CATHODE-RAY TUBE TELEVISIONS (U.S. CLS. 21, 23, 26, 36 AND 38).

ANNE E. GUSTASON, EXAMINING ATTORNEY

SN 77-629,646. LG ELECTRONICS INC., SEOUL, REPUBLIC OF KOREA, FILED 12-9-2008.

TruMotion 120Hz Performance

THE MARK CONSISTS OF STANDARD CHARACTERS WITHOUT CLAIM TO ANY PARTICULAR FONT, STYLE, SIZE, OR COLOR.

PRIORITY CLAIMED UNDER SEC. 44(D) ON REPUBLIC OF KOREA APPLICATION NO. 2008-0056041, FILED 12-2-2008, REG. NO. 0811929, DATED 1-18-2010, EXPIRES 1-18-2020.

NO CLAIM IS MADE TO THE EXCLUSIVE RIGHT TO USE "120HZ PERFORMANCE", APART FROM THE MARK AS SHOWN.

FOR PLASMA DISPLAY PANEL TELEVISIONS; LIQUID CRYSTAL DISPLAY TELEVISIONS; DIGITAL LIGHT PROCESSING PROJECTION TELEVISIONS; SUPER SLIM TELEVISIONS; FLAT CATHODE-RAY TUBE TELEVISIONS (U.S. CLS. 21, 23, 26, 36 AND 38).

ANNE E. GUSTASON, EXAMINING ATTORNEY

CLASS 9—(Continued).

SN 77-635,390. APPLE INC., CUPERTINO, CA. FILED 12-17-2008.

Motion

THE MARK CONSISTS OF STANDARD CHARACTERS WITHOUT CLAIM TO ANY PARTICULAR FONT, STYLE, SIZE, OR COLOR.

PRIORITY CLAIMED UNDER SEC. 44(D) ON TRINIDAD/TOBAGO APPLICATION NO. 39972, FILED 6-24-2008. SEC. 2(F).

FOR COMPUTER GRAPHICS SOFTWARE; COMPUTER SOFTWARE FOR USE IN VIDEO AND MOTION PICTURE PRODUCTION; COMPUTER SOFTWARE FOR THE CREATION AND EDITING OF GRAPHICS AND SPECIAL EFFECTS (U.S. CLS. 21, 23, 26, 36 AND 38).

FIRST USE 4-18-2004; IN COMMERCE 8-10-2004.

JERI J. FICKES, EXAMINING ATTORNEY

SN 77-637,453. SANDS, DAWN M., ELEVA, WI. FILED 12-20-2008.

PLANTSTIK

THE MARK CONSISTS OF STANDARD CHARACTERS WITHOUT CLAIM TO ANY PARTICULAR FONT, STYLE, SIZE, OR COLOR.

FOR MULTI-PURPOSE GARDEN TOOL IN THE NATURE OF A GRADUATED RULER USED TO MEASURE PLANTING DEPTHS, TO SPACE SEEDS, SEEDLINGS, AND ROWS, TO MARK FURROWS AND MAKE STRAIGHT ROWS AND THAT MAY ALSO BE USED TO MOVE SOIL TO COVER SEEDS (U.S. CLS. 21, 23, 26, 36 AND 38).

FIRST USE 4-1-1997; IN COMMERCE 4-1-1999.

WENDY GOODMAN, EXAMINING ATTORNEY

SN 77-637,525. SANDS, DAWN M., ELEVA, WI. FILED 12-21-2008.

SMARTSTIK

THE MARK CONSISTS OF STANDARD CHARACTERS WITHOUT CLAIM TO ANY PARTICULAR FONT, STYLE, SIZE, OR COLOR.

FOR MULTI-PURPOSE GARDEN TOOL IN THE NATURE OF A GRADUATED RULER USED TO MEASURE PLANTING DEPTHS, TO SPACE SEEDS, SEEDLINGS, AND ROWS, TO MARK FURROWS AND MAKE STRAIGHT ROWS AND THAT MAY ALSO BE USED TO MOVE SOIL TO COVER SEEDS (U.S. CLS. 21, 23, 26, 36 AND 38).

FIRST USE 10-1-2008; IN COMMERCE 12-0-2008.

WENDY GOODMAN, EXAMINING ATTORNEY

CLASS 9—(Continued).

SN 77-645,463. FELLOWSHIP TECHNOLOGIES, LP, IRVING, TX. FILED 1-8-2009.



THE MARK CONSISTS OF THE TERM "RETURN ON MINISTRY" BETWEEN LINES, EACH LINE HAVING A CIRCULAR ARROW EXTENDING FROM SAID LINE.

FOR COMPUTER SOFTWARE USED IN INFORMATION MANAGEMENT, NAMELY, COMPUTER SOFTWARE USED IN THE OPERATION AND MANAGEMENT OF CHURCHES (U.S. CLS. 21, 23, 26, 36 AND 38).

FIRST USE 9-18-2008; IN COMMERCE 9-18-2008.
AMY KERTGATE, EXAMINING ATTORNEY

CLASS 9—(Continued).

SN 77-651,476. GRANT GEISSMAN, DBA GENERAL CONFUSION MUSIC/FUTURISM RECORDS, SHERMAN OAKS, CA. FILED 1-16-2009.



NO CLAIM IS MADE TO THE EXCLUSIVE RIGHT TO USE "RECORDS", APART FROM THE MARK AS SHOWN.

THE MARK CONSISTS OF THE WORDING "FUTURISM RECORDS" DIRECTLY BELOW A STYLIZED MOLECULAR MODEL.

FOR AUDIO DISCS FEATURING MUSIC (U.S. CLS. 21, 23, 26, 36 AND 38).

FIRST USE 1-1-2006; IN COMMERCE 1-1-2006.
NICHOLAS ALTREE, EXAMINING ATTORNEY

SN 77-654,875. SICARIO GROUP LLC, MALDEN, MA. FILED 1-22-2009.

SN 77-647,827. V-MODA, LLC, DBA V-MODA, LLC, LOS ANGELES, CA. FILED 1-12-2009.

VEGA

THE MARK CONSISTS OF STANDARD CHARACTERS WITHOUT CLAIM TO ANY PARTICULAR FONT, STYLE, SIZE, OR COLOR.

FOR HEADPHONES, PERSONAL HEADPHONES FOR USE WITH SOUND TRANSMITTING SYSTEMS; COMMUNICATIONS HEADSETS; HEADSETS FOR TELEPHONES; TELEPHONE HEADSETS, EARPHONES; EARPHONES (U.S. CLS. 21, 23, 26, 36 AND 38).

ERIN FALK, EXAMINING ATTORNEY

Ultimate Breaks & Beats

THE MARK CONSISTS OF STANDARD CHARACTERS WITHOUT CLAIM TO ANY PARTICULAR FONT, STYLE, SIZE, OR COLOR.

NO CLAIM IS MADE TO THE EXCLUSIVE RIGHT TO USE "BREAKS AND BEATS", APART FROM THE MARK AS SHOWN.

SEC. 2(F).

FOR COMPACT DISCS FEATURING MUSIC; DIGITAL MEDIA, NAMELY, PRE-RECORDED VIDEO CASSETTES, DIGITAL VIDEO DISCS, DIGITAL VERSATILE DISCS, DOWNLOADABLE AUDIO AND VIDEO RECORDINGS, DVDS, AND HIGH DEFINITION DIGITAL DISKS FEATURING MUSICAL PERFORMANCES; DIGITAL MEDIA, NAMELY, USB (UNIVERSAL SERIAL BUS) HARDWARE FEATURING VIDEO PERFORMANCES AND MUSICAL PERFORMANCES; DIGITAL MUSIC DOWNLOADABLE FROM THE INTERNET; DOWNLOADABLE MUSICAL SOUND RECORDINGS; DOWNLOADABLE RING TONES, GRAPHICS AND MUSIC VIA A GLOBAL COMPUTER NETWORK AND WIRELESS DEVICES; PHONOGRAPH RECORDS FEATURING MUSIC (U.S. CLS. 21, 23, 26, 36 AND 38).

FIRST USE 1-1-1985; IN COMMERCE 8-31-2008.
TINA BROWN, EXAMINING ATTORNEY

CLASS 9—(Continued).

SN 77-658,941. POWER DISTRIBUTION, INC., RICHMOND, VA. FILED 1-29-2009.

CLASS 9—(Continued).

SN 77-666,280. GLORY LTD., HIMEJI-SHI, HYOGO-KEN, JAPAN, FILED 2-9-2009.

J-Comm

THE MARK CONSISTS OF STANDARD CHARACTERS WITHOUT CLAIM TO ANY PARTICULAR FONT, STYLE, SIZE, OR COLOR.

FOR BRANCH CIRCUIT MONITOR SYSTEMS THAT MONITOR CURRENT, VOLTAGE, AND POWER RELATED MEASURES FOR BRANCH AND SUB FEED BREAKERS ON SELECTED CIRCUITS ON DISTRIBUTION EQUIPMENT, WHICH SYSTEMS MAY BE ENCLOSED IN AN UNDERFLOOR BOX, ENCLOSED IN A WALL MOUNTED ENCLOSURE, OR MOUNTED IN A CUSTOM ENCLOSURE ON EXISTING DISTRIBUTION, AND WHICH ARE TYPICALLY INSTALLED IN A DATA CENTER (U.S. CLS. 21, 23, 26, 36 AND 38).

KIMBERLY FRYE, EXAMINING ATTORNEY

CASHINFINITY

SN 77-664,854. BENCHWORKZZ, AUSTIN, TX. FILED 2-6-2009.

CLIK3

THE MARK CONSISTS OF STANDARD CHARACTERS WITHOUT CLAIM TO ANY PARTICULAR FONT, STYLE, SIZE, OR COLOR.

FOR COMPUTER PROGRAMS FOR COMPUTER PROGRAM DEVELOPMENT, PERFORMANCE ANALYSIS, DEBUGGING, ERROR CORRECTION, COLLECTION, EDITING, ORGANIZING, MODIFYING, BOOK MARKING, TRANSMISSION, STORAGE AND SHARING OF DATA AND INFORMATION (U.S. CLS. 21, 23, 26, 36 AND 38).

JULIE WATSON, EXAMINING ATTORNEY

THE MARK CONSISTS OF STANDARD CHARACTERS WITHOUT CLAIM TO ANY PARTICULAR FONT, STYLE, SIZE, OR COLOR.

FOR CASH REGISTERS; CASH REGISTERS EQUIPPED WITH SAFETY CASHBOXES; MONEY COUNTING AND SORTING MACHINES; MONEY COUNTING AND SORTING MACHINES EQUIPPED WITH SAFETY CASHBOXES; CASH DEPOSITOR MACHINES; CASH DISPENSERS; CASH MANAGEMENT SYSTEM COMPRISED OF COMPUTER HARDWARE, COMPUTER PROGRAMS USED FOR CASH MANAGEMENT, AND CASH REGISTER; CASH MANAGEMENT SYSTEM COMPRISED OF COMPUTER HARDWARE, COMPUTER PROGRAMS USED FOR CASH MANAGEMENT, AND MONEY COUNTING AND SORTING MACHINES; MONEY EXCHANGERS; CASH SETTLEMENT SYSTEM COMPRISING OF COMPUTER HARDWARE, COMPUTER PROGRAMS USED FOR CASH ACCOUNTING AND SETTLEMENT, AND CASH REGISTERS; CASH SETTLEMENT SYSTEM COMPRISING OF COMPUTER HARDWARE, COMPUTER PROGRAMS USED FOR CASH ACCOUNTING AND SETTLEMENT, AND CASH RECEIVING/DISPENSING APPARATUS; BANKNOTE COUNTING MACHINES; BANKNOTE CHECKERS IN THE NATURE OF BANKNOTE RECOGNITION MACHINES FOR DETECTING COUNTERFEIT NOTES; CASH DISPENSING MACHINES; CASH DEPOSIT AND/OR DISPENSING MACHINES; COIN COUNTING MACHINES; COMPUTER SOFTWARE FOR CASH MANAGEMENT (U.S. CLS. 21, 23, 26, 36 AND 38).

AMEEN IMAM, EXAMINING ATTORNEY

CLASS 9—(Continued).

SN 77-666,294. GLORY LTD., HIMEJI-SHI, HYOGO-KEN, JAPAN, FILED 2-9-2009.



THE MARK CONSISTS OF A LIGHT "C" NEXT TO A DARK INFINITY SIGN AND "CASHINFINITY" APPEARING BELOW WITH "CASH" IN BOLD LETTERS.

FOR CASH REGISTERS; CASH REGISTERS EQUIPPED WITH SAFETY CASHBOXES; MONEY COUNTING AND SORTING MACHINES; MONEY COUNTING AND SORTING MACHINES EQUIPPED WITH SAFETY CASHBOXES; CASH DEPOSITOR MACHINES; CASH DISPENSERS; CASH MANAGEMENT SYSTEM COMPRISED OF COMPUTER HARDWARE, COMPUTER PROGRAMS USED FOR CASH MANAGEMENT, AND CASH REGISTER; CASH MANAGEMENT SYSTEM COMPRISED OF COMPUTER HARDWARE, COMPUTER PROGRAMS USED FOR CASH MANAGEMENT, AND MONEY COUNTING AND SORTING MACHINES; MONEY EXCHANGERS; CASH SETTLEMENT SYSTEM COMPRISING OF COMPUTER HARDWARE, COMPUTER PROGRAMS USED FOR CASH ACCOUNTING AND SETTLEMENT, AND CASH REGISTERS; CASH SETTLEMENT SYSTEM COMPRISING OF COMPUTER HARDWARE, COMPUTER PROGRAMS USED FOR CASH ACCOUNTING AND SETTLEMENT, AND CASH RECEIVING/DISPENSING APPARATUS; BANKNOTE COUNTING MACHINES; BANKNOTE CHECKERS IN THE NATURE OF BANKNOTE RECOGNITION MACHINES FOR DETECTING COUNTERFEIT NOTES; CASH DISPENSING MACHINES; CASH DEPOSIT AND/OR DISPENSING MACHINES; COIN COUNTING MACHINES; COMPUTER SOFTWARE FOR CASH MANAGEMENT (U.S. CLS. 21, 23, 26, 36 AND 38).
AMEEN IMAM, EXAMINING ATTORNEY

SN 77-668,545. LAVRY ENGINEERING, INC., POULSBO, WA. FILED 2-11-2009.

>PIC< **PLAYBACK IMAGE CONTROL**

THE MARK CONSISTS OF STANDARD CHARACTERS WITHOUT CLAIM TO ANY PARTICULAR FONT, STYLE, SIZE, OR COLOR.

NO CLAIM IS MADE TO THE EXCLUSIVE RIGHT TO USE "PLAYBACK IMAGE CONTROL", APART FROM THE MARK AS SHOWN.

FOR DIGITAL-TO-ANALOG (D/A) CONVERTERS WITH STEREO IMAGE CONTROL (U.S. CLS. 21, 23, 26, 36 AND 38).

FIRST USE 2-5-2009; IN COMMERCE 2-5-2009.
AMY HELLA, EXAMINING ATTORNEY

CLASS 9—(Continued).

SN 77-675,725. U.S. BUREAU OF THE CENSUS, WASHINGTON, DC. FILED 2-23-2009.

OnTheMap

THE MARK CONSISTS OF STANDARD CHARACTERS WITHOUT CLAIM TO ANY PARTICULAR FONT, STYLE, SIZE, OR COLOR.

FOR COMPUTER SOFTWARE THAT PROVIDES WEB-BASED ACCESS TO DATA TABLES AND DOCUMENTS IN VARIOUS STANDARDIZED FORMATS AS WELL AS MAPS AND CHARTS OF THE DATA ABOUT JOBS AND WORKERS IN THE UNITED STATES THROUGH A WEB OPERATING SYSTEM OF PORTAL INTERFACE (U.S. CLS. 21, 23, 26, 36 AND 38).

FIRST USE 6-22-2005; IN COMMERCE 6-22-2005.
INGRID C. EULIN, EXAMINING ATTORNEY

SN 77-681,752. QUALITY VISION INTERNATIONAL, INC., ROCHESTER, NY. FILED 3-2-2009.

SMARTPROBE

THE MARK CONSISTS OF STANDARD CHARACTERS WITHOUT CLAIM TO ANY PARTICULAR FONT, STYLE, SIZE, OR COLOR.

OWNER OF U.S. REG. NOS. 1,833,196, 3,576,601 AND OTHERS.

SEC. 2(F).

FOR MEASURING APPARATUS, NAMELY, OPTOMECHANICAL SENSORS AND COMPUTER SOFTWARE FOR DIMENSIONAL INSPECTION OF MANUFACTURED COMPONENTS (U.S. CLS. 21, 23, 26, 36 AND 38).

FIRST USE 11-30-1996; IN COMMERCE 11-30-1996.
MICHAEL ENGEL, EXAMINING ATTORNEY

CLASS 9—(Continued).

SN 77-708,166. MULTIMEDIA GAMES, INC., AUSTIN, TX. FILED 4-7-2009.



OWNER OF U.S. REG. NO. 2,397,566.
 NO CLAIM IS MADE TO THE EXCLUSIVE RIGHT TO USE "MULTIMEDIA GAMES", APART FROM THE MARK AS SHOWN.
 THE COLOR(S) RED, GREEN AND GRAY IS/ARE CLAIMED AS A FEATURE OF THE MARK.
 THE MARK CONSISTS OF FROM LEFT TO RIGHT, TWO RED CHERRIES THAT ARE JOINED TOGETHER BY GREEN STEMS, ONE STEM HAVING A GREEN LEAF, FOLLOWED BY THE UPPERCASE WORDS "MULTIMEDIA GAMES" IN GRAY.
 FOR GAMING MACHINES INCLUDING SLOT MACHINES OR VIDEO LOTTERY TERMINALS; GAMING MACHINES THAT GENERATE OR DISPLAY WAGER OUTCOMES; GAMING MACHINES, NAMELY, ELECTRONIC SLOT AND BINGO MACHINES (U.S. CLS. 21, 23, 26, 36 AND 38).
 FIRST USE 4-7-2009; IN COMMERCE 4-7-2009.
 KIM SAITO, EXAMINING ATTORNEY

CLASS 9—(Continued).

SN 77-715,314. SAVANTIS GROUP, SAN FRANCISCO, CA. FILED 4-16-2009.



THE MARK CONSISTS OF STANDARD CHARACTERS WITHOUT CLAIM TO ANY PARTICULAR FONT, STYLE, SIZE, OR COLOR.
 FOR COMPUTER SOFTWARE FOR USE IN THE RETAIL INDUSTRY FOR MANAGING INVENTORY AND PRICING AND PROMOTIONAL ACTIVITIES, TRACKING SUPPLIES FROM DISTRIBUTION CENTERS TO DELIVERY, ANALYZING SALES INFORMATION AND STORE PERFORMANCES AND FINANCIALS, INTEGRATING PHONE AND INTERNET SALES WITH TRADITIONAL RETAIL, AND MONITORING BUSINESS OPERATIONS AND GENERAL OFFICE FUNCTIONS (U.S. CLS. 21, 23, 26, 36 AND 38).
 FIRST USE 5-5-2008; IN COMMERCE 5-5-2008.
 ANDREW LEASER, EXAMINING ATTORNEY

SN 77-712,053. HYSOM, DENNIS J., SEBASTOPOL, CA. AND WALKER, CHRISTINE M., SEBASTOPOL, CA. FILED 4-11-2009.



THE MARK CONSISTS OF STANDARD CHARACTERS WITHOUT CLAIM TO ANY PARTICULAR FONT, STYLE, SIZE, OR COLOR.
 FOR CHILDREN'S EDUCATIONAL MUSIC CDS AND DVDS; DIGITAL MATERIALS, NAMELY, AUDIO CDS, DVDS FEATURING SONGS AND STORIES; DIGITAL MEDIA, NAMELY, AUDIO CDS, DVDS FEATURING SONGS AND STORIES; PRE-RECORDED CDS FEATURING SONGS AND STORIES; PRE-RECORDED CDS, VIDEO TAPES, LASER DISKS AND DVDS FEATURING SONGS AND STORIES (U.S. CLS. 21, 23, 26, 36 AND 38).
 FIRST USE 7-15-1986; IN COMMERCE 7-15-1986.
 ROSELLE HERRERA, EXAMINING ATTORNEY

SN 77-717,172. ONTARIO SYSTEMS, LLC, MUNCIE, IN. FILED 4-20-2009.



THE COLOR(S) BLACK AND BLUE IS/ARE CLAIMED AS A FEATURE OF THE MARK.
 THE MARK CONSISTS OF THE WORD "ADAPT" IN BLACK CAPITAL LETTERS FOLLOWED BY AN INCOMPLETE BRACKET IN BLUE FOLLOWED BY THE WORD "SAVVY" IN BOLD BLACK CAPITAL LETTERS FOLLOWED BY AN INCOMPLETE BRACKET IN BLUE.
 FOR COMPUTER SOFTWARE FOR USE IN DEBT AND REVENUE MANAGEMENT FOR MEDICAL BUSINESSES (U.S. CLS. 21, 23, 26, 36 AND 38).
 MICHAEL LITZAU, EXAMINING ATTORNEY

CLASS 9—(Continued).

SN 77-717,180. ONTARIO SYSTEMS, LLC, MUNCIE, IN.
FILED 4-20-2009.



NO CLAIM IS MADE TO THE EXCLUSIVE RIGHT TO USE "COLLECT", APART FROM THE MARK AS SHOWN.
THE COLOR(S) BLACK AND BLUE IS/ARE CLAIMED AS A FEATURE OF THE MARK.
THE MARK CONSISTS OF THE WORD "COLLECT" IN BLACK CAPITAL LETTERS FOLLOWED BY AN INCOMPLETE BRACKET IN BLUE FOLLOWED BY THE WORD "SAVVY" IN BOLD BLACK CAPITAL LETTERS FOLLOWED BY AN INCOMPLETE BRACKET IN BLUE.
FOR COMPUTER SOFTWARE FOR USE IN DEBT AND REVENUE MANAGEMENT FOR MEDICAL BUSINESSES (U.S. CLS. 21, 23, 26, 36 AND 38).
MICHAEL LITZAU, EXAMINING ATTORNEY

CLASS 9—(Continued).

SN 77-717,205. ONTARIO SYSTEMS, LLC, MUNCIE, IN.
FILED 4-20-2009.



NO CLAIM IS MADE TO THE EXCLUSIVE RIGHT TO USE "LEND", APART FROM THE MARK AS SHOWN.
THE COLOR(S) BLACK AND BLUE IS/ARE CLAIMED AS A FEATURE OF THE MARK.
THE MARK CONSISTS OF THE WORD "LEND" IN BLACK CAPITAL LETTERS FOLLOWED BY AN INCOMPLETE BRACKET IN BLUE FOLLOWED BY THE WORD "SAVVY" IN BOLD BLACK CAPITAL LETTERS FOLLOWED BY AN INCOMPLETE BRACKET IN BLUE.
FOR COMPUTER SOFTWARE FOR USE IN DEBT AND REVENUE MANAGEMENT FOR MEDICAL BUSINESSES (U.S. CLS. 21, 23, 26, 36 AND 38).
MICHAEL LITZAU, EXAMINING ATTORNEY

SN 77-717,194. ONTARIO SYSTEMS, LLC, MUNCIE, IN.
FILED 4-20-2009.



THE COLOR(S) BLACK AND BLUE IS/ARE CLAIMED AS A FEATURE OF THE MARK.
THE MARK CONSISTS OF THE WORD "CULTURE" IN BLACK CAPITAL LETTERS FOLLOWED BY AN INCOMPLETE BRACKET IN BLUE FOLLOWED BY THE WORD "SAVVY" IN BOLD BLACK CAPITAL LETTERS FOLLOWED BY AN INCOMPLETE BRACKET IN BLUE.
FOR COMPUTER SOFTWARE FOR USE IN DEBT AND REVENUE MANAGEMENT FOR MEDICAL BUSINESSES (U.S. CLS. 21, 23, 26, 36 AND 38).
MICHAEL LITZAU, EXAMINING ATTORNEY

SN 77-717,213. ONTARIO SYSTEMS, LLC, MUNCIE, IN.
FILED 4-20-2009.



THE COLOR(S) BLACK AND BLUE IS/ARE CLAIMED AS A FEATURE OF THE MARK.
THE MARK CONSISTS OF THE WORD "SERVI" IN BLACK CAPITAL LETTERS FOLLOWED BY AN INCOMPLETE BRACKET IN BLUE FOLLOWED BY THE WORD "SAVVY" IN BOLD BLACK CAPITAL LETTERS FOLLOWED BY AN INCOMPLETE BRACKET IN BLUE.
FOR COMPUTER SOFTWARE FOR USE IN DEBT AND REVENUE MANAGEMENT FOR MEDICAL BUSINESSES (U.S. CLS. 21, 23, 26, 36 AND 38).
MICHAEL LITZAU, EXAMINING ATTORNEY

CLASS 9—(Continued).

SN 77-718,795. NIPPON GENETICS CO., LTD., TOKYO, JAPAN, FILED 4-21-2009.

FastGene

THE MARK CONSISTS OF STANDARD CHARACTERS WITHOUT CLAIM TO ANY PARTICULAR FONT, STYLE, SIZE, OR COLOR.

OWNER OF JAPAN REG. NO. 4786781, DATED 7-16-2004, EXPIRES 7-16-2016.

FOR LABORATORY APPARATUS AND INSTRUMENTS FOR GENETIC SCREENING, NAMELY, PCR PLATES, NAMELY, POLYMERASE CHAIN REACTION (PCR) PLATES, PCR TUBES, NAMELY, POLYMERASE CHAIN REACTION (PCR) TUBES (U.S. CLS. 21, 23, 26, 36 AND 38).

ELIZABETH KAJUBI, EXAMINING ATTORNEY

CLASS 9—(Continued).

SN 77-734,792. SAVANTIS GROUP, SAN FRANCISCO, CA, FILED 5-12-2009.



The logo for "Retail ON" features the word "Retail" in a sans-serif font, with "ON" in a blue circle to its right. The entire logo is set against a light orange background.

NO CLAIM IS MADE TO THE EXCLUSIVE RIGHT TO USE "RETAIL", APART FROM THE MARK AS SHOWN.

THE COLOR(S) ORANGE AND BLUE IS/ARE CLAIMED AS A FEATURE OF THE MARK.

THE MARK CONSISTS OF THE WORD "RETAIL" IN ORANGE FOLLOWED BY THE WORD "ON" IN BLUE. THE WORD "ON" IS SURROUNDED BY AN ORANGE CIRCLE.

FOR COMPUTER SOFTWARE FOR USE IN THE RETAIL INDUSTRY FOR MANAGING INVENTORY AND PRICING AND PROMOTIONAL ACTIVITIES, TRACKING SUPPLIES FROM DISTRIBUTION CENTERS TO DELIVERY, ANALYZING SALES INFORMATION AND STORE PERFORMANCES AND FINANCIALS, INTEGRATING PHONE AND INTERNET SALES WITH TRADITIONAL RETAIL, AND MONITORING BUSINESS OPERATIONS AND GENERAL OFFICE FUNCTIONS (U.S. CLS. 21, 23, 26, 36 AND 38).

FIRST USE 5-8-2008; IN COMMERCE 5-8-2008.

ANDREW LEASER, EXAMINING ATTORNEY

SN 77-730,053. HTC CORPORATION, TAOYUAN CITY, TAIWAN, FILED 5-6-2009.



The logo for "htc HERO" features the lowercase letters "htc" in a bold, sans-serif font, followed by the word "HERO" in a larger, all-caps, sans-serif font.

OWNER OF U.S. REG. NO. 3,532,002.
THE MARK CONSISTS OF THE TERMS "HTC HERO" IN A STYLIZED FONT.

FOR MOBILE PHONES; SMART PHONES; PERSONAL DIGITAL ASSISTANTS; CONNECTION CABLES, BATTERIES, POWER ADAPTORS, BATTERY CHARGERS, KEYBOARDS, MICROPHONES, LOUDSPEAKERS, CARRYING CASES FOR MOBILE PHONES, IN-CAR CHARGERS FOR MOBILE PHONES; ACCESSORIES FOR MOBILE PHONES AND PERSONAL DIGITAL ASSISTANTS, NAMELY, HEADSETS, HEADSETS WITH WIRELESS TRANSMISSION FUNCTION, CRADLES, REMOTE CONTROLS AND LEATHER CASES (U.S. CLS. 21, 23, 26, 36 AND 38).

LAKEISHA LEWIS, EXAMINING ATTORNEY

SN 77-737,171. EVOLUTIONARY PRODUCTS, INC., CULVER CITY, CA, FILED 5-14-2009.

SUPER STYLER

THE MARK CONSISTS OF STANDARD CHARACTERS WITHOUT CLAIM TO ANY PARTICULAR FONT, STYLE, SIZE, OR COLOR.

NO CLAIM IS MADE TO THE EXCLUSIVE RIGHT TO USE "STYLER", APART FROM THE MARK AS SHOWN.

SEC. 2(F).

FOR ELECTRONICALLY-DRIVEN ELECTRIC ROTARY HAIR BRUSH FOR STYLING A USER'S HAIR (U.S. CLS. 21, 23, 26, 36 AND 38).

FIRST USE 10-17-2002; IN COMMERCE 10-17-2002.

SETH A. RAPPAPORT, EXAMINING ATTORNEY

CLASS 9—(Continued).

SN 77-741,526. V FACTORY, SANTA FE SPRINGS, CA.
FILED 5-20-2009.

XSCORPION

THE MARK CONSISTS OF STANDARD CHARACTERS WITHOUT CLAIM TO ANY PARTICULAR FONT, STYLE, SIZE, OR COLOR.

FOR AUTOMOTIVE ELECTRONICS AND ELECTRONIC GOODS IN THE NATURE OF CAR AND HOME AUDIO ACCESSORIES, NAMELY, SPEAKER CABLES, POWER CABLES, ELECTRICAL CONNECTORS, FUSES, FUSE HOLDERS, BATTERY TERMINALS, CAR STEREO ADAPTERS, ANTENNA CONNECTORS, POWER DISTRIBUTION BLOCKS, CIRCUIT BREAKERS, NOISE FILTERS, CAPACITORS, RESISTORS, SWITCHES, ELECTRIC RELAYS, BATTERY TERMINAL CONNECTOR CLAMPS, COAXIAL CABLES, ELECTRICAL WIRING HARNESES, INSTALLATION KITS COMPRISED PRIMARILY OF ELECTRICAL CONNECTORS, STEREO NOISE REDUCERS, AND ENCLOSURES FOR SPEAKERS (U.S. CLS. 21, 23, 26, 36 AND 38).

FIRST USE 1-1-1996; IN COMMERCE 1-1-1996.
DAVID MILLER, EXAMINING ATTORNEY

CLASS 9—(Continued).

SN 77-742,454. S&L MARKETING GROUP, CLERMONT, FL.
FILED 5-21-2009.



THE COLOR(S) YELLOW AND GREEN IS/ARE CLAIMED AS A FEATURE OF THE MARK.

THE MARK CONSISTS OF A YELLOW CIRCLE ON THE BACKGROUND WITH THE GREEN WORDS "TU TAMBIÉN PUEDES" ON TOP OF IT. THE WORD "PUEDES" HAS THE LETTERS A LITTLE OFFSET BETWEEN THEM. ON TOP OF EVERYTHING THERE ARE TWO YELLOW EXCLAMATION MARKS. THE LEFT EXCLAMATION MARK IS ON TOP OF THE LETTER "P" AND THE RIGHT EXCLAMATION MARK ON TOP OF THE LETTER "S".

THE ENGLISH TRANSLATION OF "TU TAMBIÉN PUEDES" IN THE MARK IS YOU CAN TOO.

FOR DVDS AND CDS ON SELF-AID AND SELF-IMPROVEMENT TOPICS (U.S. CLS. 21, 23, 26, 36 AND 38).

FIRST USE 12-21-2008; IN COMMERCE 12-21-2008.
KAREN BRACEY, EXAMINING ATTORNEY

SN 77-746,417. COMMERCIAL AND INDUSTRIAL DESIGN CO., INC., IRVINE, CA. FILED 5-28-2009.

ISTORAGEPRO

THE MARK CONSISTS OF STANDARD CHARACTERS WITHOUT CLAIM TO ANY PARTICULAR FONT, STYLE, SIZE, OR COLOR.

FOR COMPUTER SOFTWARE FOR INPUT AND OUTPUT COMPUTER OPTIMIZATION, PROCESSING, BRIDGING AND SWITCHING; COMPUTER SOFTWARE FOR STORING, SHARING, EDITING AND STREAMING AUDIO, VIDEO AND DATA; COMPUTER HARDWARE; CASINGS AND CASING PARTS FOR ELECTRICAL EQUIPMENT, NAMELY, HOUSINGS FOR COMPUTER PARTS AND HARD DRIVE; COMPUTER INTERFACE CARDS FOR DATA PROCESSING EQUIPMENT IN THE FORM OF PRINTED CIRCUITS; MEMORY FLASH CARDS; RAM DEVICES, NAMELY, RAM MODULES, COMPACT FLASH DRIVES AND SOLID STATE DRIVES (SSDS); CASH REGISTERS; MEMORY CARDS, NAMELY, OPTICAL CODING DATA MEMORY APPARATUS; EXTERNAL COMPUTER HARD DRIVES; SOLID STATE DRIVES (SSDs); DATA STORAGE INPUT AND OUTPUT DEVICES, NAMELY, HOST-BUS ADAPTERS, RAID CONTROLLERS, VIDEO CAPTURE CARDS, COMPUTER SWITCHES, ROUTERS, AND PCIE RAID CARDS; RANDOM MEMORY STORAGE DEVICES, NAMELY, EXTERNAL COMPUTER HARDWARE INSTALLED WITH HARD DRIVES, TAPE DRIVES, COMPACT FLASH DRIVES OR SOLID STATE DRIVES (SSDs); COMPUTER CABLES; CIRCULATORS; PRINTERS; CO-AXIAL CABLES; POWER SUPPLIES; COMPUTER HEAT SINKS; CIRCUIT BOARDS AND MOTHERBOARDS; ELECTRONIC DATA INPUT AND OUTPUT RECORDERS; COMPUTER PERIPHERAL DEVICES (U.S. CLS. 21, 23, 26, 36 AND 38).

SKYE YOUNG, EXAMINING ATTORNEY

SN 77-741,694. BURKE FRANKLIN, CHICO, CA. FILED 5-20-2009.

BIZ PLAN BUILDER

THE MARK CONSISTS OF STANDARD CHARACTERS WITHOUT CLAIM TO ANY PARTICULAR FONT, STYLE, SIZE, OR COLOR.

SEC. 2(F).
FOR COMPUTER SOFTWARE, NAMELY, APPLICATION PROGRAMS FOR CREATING BUSINESS AND MARKETING PLANS FEATURING PLAN TEMPLATES AND ACCOMPANYING USER MANUALS SOLD AS A UNIT (U.S. CLS. 21, 23, 26, 36 AND 38).

FIRST USE 4-1-1988; IN COMMERCE 4-1-1988.
REBECCA GILBERT, EXAMINING ATTORNEY

CLASS 9—(Continued).

SN 77-749,663. NEW RIVER KINEMATICS, INC., WILLIAMSBURG, VA. FILED 6-2-2009.

ROBOTASSIST

THE MARK CONSISTS OF STANDARD CHARACTERS WITHOUT CLAIM TO ANY PARTICULAR FONT, STYLE, SIZE, OR COLOR.

FOR COMPUTER SOFTWARE FOR ROBOT SIMULATION AND CONTROL CUSTOMIZED FOR USE IN SPATIAL TRANSFORMATIONS, INDUSTRIAL AUTOMATION, ROBOTIC DEVICES AND OTHER INDUSTRIAL HARDWARE (U.S. CLS. 21, 23, 26, 36 AND 38).

FIRST USE 3-12-1996; IN COMMERCE 3-12-1996.
TIMOTHY FINNEGAN, EXAMINING ATTORNEY

SN 77-753,552. DIMENSION TECHNOLOGY SOLUTIONS, INC., ENGLEWOOD, CO. FILED 6-5-2009.

eMESA Live

THE MARK CONSISTS OF STANDARD CHARACTERS WITHOUT CLAIM TO ANY PARTICULAR FONT, STYLE, SIZE, OR COLOR.

NO CLAIM IS MADE TO THE EXCLUSIVE RIGHT TO USE "LIVE", APART FROM THE MARK AS SHOWN.

FOR COMPUTER SOFTWARE FOR APPLICATION AND DATABASE INTEGRATION; COMPUTER SOFTWARE THAT PROVIDES REAL-TIME, INTEGRATED BUSINESS MANAGEMENT INTELLIGENCE BY COMBINING INFORMATION FROM VARIOUS DATABASES AND PRESENTING IT IN AN EASY-TO-UNDERSTAND USER INTERFACE (U.S. CLS. 21, 23, 26, 36 AND 38).

FIRST USE 5-1-2007; IN COMMERCE 12-1-2007.
FLORENTINA BLANDU, EXAMINING ATTORNEY

SN 77-765,565. PARAMOUNT PICTURES CORPORATION, HOLLYWOOD, CA. FILED 6-22-2009.

OMG! HIGH SCHOOL

THE MARK CONSISTS OF STANDARD CHARACTERS WITHOUT CLAIM TO ANY PARTICULAR FONT, STYLE, SIZE, OR COLOR.

FOR VIDEO GAME DISCS FEATURING INTERACTIVE VIDEO GAMES (U.S. CLS. 21, 23, 26, 36 AND 38).

FIRST USE 5-1-2009; IN COMMERCE 5-1-2009.
JOHN DWYER, EXAMINING ATTORNEY

CLASS 9—(Continued).

SN 77-766,643. INQUISITIVE MINDS, INC., PALO ALTO, CA. FILED 6-23-2009.

ZOODLES

THE MARK CONSISTS OF STANDARD CHARACTERS WITHOUT CLAIM TO ANY PARTICULAR FONT, STYLE, SIZE, OR COLOR.

FOR COMPUTER HARDWARE, AND PERIPHERALS, AND MANUALS SUPPLIED THEREWITH; COMPUTER SOFTWARE FOR SEARCHING, LOCATING AND TRANSFERRING INFORMATION ACROSS GLOBAL COMPUTER COMMUNICATIONS NETWORKS; EDUCATIONAL SOFTWARE FOR CHILDREN; COMPUTER SOFTWARE IN THE NATURE OF A WEB BROWSER FOR BROWSING GLOBAL COMPUTER NETWORKS AND SECURE PRIVATE NETWORKS, AND SOFTWARE PROGRAMS TO CONNECT COMPUTERS TO THE GLOBAL COMPUTER NETWORK AND TO SECURE PRIVATE NETWORKS; COMPUTER SOFTWARE IN THE NATURE OF A WEB BROWSER FOR USE BY CHILDREN, PARENTS, FAMILIES, EDUCATORS AND INDIVIDUALS CARING FOR CHILDREN IN BROWSING GLOBAL COMPUTER NETWORKS AND SECURE PRIVATE NETWORKS AND LOCATING AGE-APPROPRIATE CONTENT FOR CHILDREN; COMPUTER SOFTWARE IN THE NATURE OF A WEB BROWSER THAT ENABLES PARENTS, FAMILIES, EDUCATORS AND INDIVIDUALS CARING FOR CHILDREN TO MONITOR AND CONTROL THE ONLINE CONTENT CHILDREN HAVE ACCESS TO, CUSTOMIZE THE TYPES OF CONTENT CHILDREN CAN ACCESS IN ORDER TO PROMOTE SPECIFIC EDUCATIONAL OR ENTERTAINMENT GOALS, AND EVALUATE THE EDUCATIONAL VALUE OF THE ONLINE CONTENT CHILDREN ARE INTERACTING WITH; COMPUTER GAME SOFTWARE FOR CHILDREN AND CHILDREN'S EDUCATIONAL SOFTWARE FEATURING GAMES, PUZZLES, EDUCATIONAL CHALLENGES AND ACTIVITIES, DOWNLOADABLE VIA A GLOBAL COMPUTER NETWORK AND WIRELESS DEVICES, NAMELY, MOBILE COMPUTERS AND COMMUNICATION DEVICES, ELECTRONIC HAND-HELD AND STATIONARY GAME UNITS; VIDEO RECORDINGS, AUDIO RECORDINGS, VIDEO DISCS, CD-ROMS, DVDS, ALL FEATURING EDUCATIONAL AND ENTERTAINMENT CONTENT FOR CHILDREN AND EDUCATIONAL SOFTWARE FEATURING INSTRUCTION IN MATH, READING, SCIENCE, SOCIAL STUDIES, AND COGNITIVE, PHYSICAL, AND CREATIVE DEVELOPMENT FOR CHILDREN, PARENTS, FAMILIES, EDUCATORS AND INDIVIDUALS CARING FOR CHILDREN; COMPUTER GAME PROGRAMS AND CARTRIDGES, COMPUTER PERIPHERALS, COMPUTER MOUSE PADS, PHOTOGRAPHIC CAMERAS, VIDEO CAMERAS, CALCULATORS, COMPACT DISC PLAYERS, RADIOS, PHONOGRAPHS, DIGITAL AUDIO TAPE PLAYERS, AUDIO TAPE RECORDERS, VIDEO TAPE RECORDERS, WALKIE-TALKIES, DECORATIVE REFRIGERATOR MAGNETS, BABY MONITORS, BICYCLE HELMETS, AND HAND-HELD UNITS FOR PLAYING ELECTRONIC GAMES FOR USE WITH EXTERNAL DISPLAY SCREEN OR MONITOR (U.S. CLS. 21, 23, 26, 36 AND 38).

MARIA-VICTORIA SUAREZ, EXAMINING ATTORNEY

CLASS 9—(Continued).

SN 77-769,288. CVE GROUP, INC., RIVERDALE, NJ. FILED 6-26-2009.



THE MARK CONSISTS OF A CUBE SHOWING THE LETTERS "C", "E", AND "V" ON EACH VISIBLE SIDE WITH THE WORDING "CVE" UNDERNEATH IT.

FOR MULTIMEDIA DIGITAL PLAYERS, NAMELY, DIGITAL AUDIO PLAYERS, DVD PLAYERS AND OPTICAL DISC PLAYERS; PERIPHERALS, NAMELY, AUDIO SPEAKERS, RADIO SIGNAL TUNERS, NAMELY, AM/FM TUNER, DIGITAL MEDIA RECEIVERS AND DIGITAL MEDIA AMPLIFIERS; REMOTE CONTROL UNITS FOR RADIOS, TELEVISIONS, STEREO, AUDIO SPEAKERS DIGITAL AUDIO PLAYERS, AND DIGITAL VERSATILE PLAYERS; ELECTRIC AND COAXIAL CABLES AND ADAPTORS, NAMELY, AUDIO AND VIDEO CABLES, POWER CABLES, NAMELY, AC CABLES, POWER SUPPLY ADAPTORS FOR USE WITH ELECTRONIC DEVICES, NAMELY, AC ADAPTORS AND DC ADAPTORS; MULTIMEDIA SYSTEMS COMPRISED OF DIGITAL TELEVISIONS, NAMELY, LCD, PLASMA, LED AND OLED TV, DIGITAL AUDIO PLAYERS, DIGITAL VERSATILE PLAYERS, STEREO RECEIVERS, AUDIO SPEAKERS, DIGITAL MEDIA AMPLIFIERS AND DIGITAL MEDIA RECEIVERS; WIRELESS DEVICES FOR NAVIGATION AND COMMUNICATION, NAMELY, TRACKING UNITS THAT COMBINE GPS AND CELLULAR TECHNOLOGIES FOR DETERMINING LOCATION INFORMATION AND COMMUNICATING THE LOCATION INFORMATION FOR TRACKING VEHICLES AND PERSONS (U.S. CLS. 21, 23, 26, 36 AND 38).

CHRISTINA SOBRAL, EXAMINING ATTORNEY

CLASS 9—(Continued).

SN 77-772,733. VIDEONEXT NETWORK SOLUTIONS, INC., CHANTILLY, VA. FILED 7-1-2009.

cavu

THE MARK CONSISTS OF STANDARD CHARACTERS WITHOUT CLAIM TO ANY PARTICULAR FONT, STYLE, SIZE, OR COLOR.

FOR BUILDING SECURITY SYSTEMS COMPRISING SOFTWARE AND HARDWARE FOR PROVIDING PICTURE, VIDEO, ALARM STATUS, BUILDING PLANS, AND OTHER INFORMATION TO A REMOTE STATION; COMPUTER APPLICATION SOFTWARE FOR MOBILE PHONES, NAMELY, SOFTWARE FOR TRANSMITTING, RECEIVING, VIEWING, ANNOTATING AND RECORDING VIDEO AND ALARM SIGNALS TO AND FROM SECURITY SYSTEMS; COMPUTER HARDWARE AND SOFTWARE SYSTEM FOR TRACKING PEOPLE, OBJECTS AND PETS USING GPS DATA ON A DEVICE ON THE TRACKED PEOPLE, OBJECTS AND PETS; COMPUTER SOFTWARE FOR USE IN THE SAFEGUARDING OF DIGITAL FILES, INCLUDING AUDIO, VIDEO, TEXT, BINARY, STILL IMAGES, GRAPHICS AND MULTIMEDIA FILES; COMPUTER SOFTWARE FOR WIRELESS CONTENT DELIVERY; ELECTRONIC VIDEO SURVEILLANCE PRODUCTS, NAMELY, ELECTRONIC COMPONENTS OF SECURITY SYSTEMS; VIDEO PHONES (U.S. CLS. 21, 23, 26, 36 AND 38).

FIRST USE 4-20-2009; IN COMMERCE 5-20-2009.
LANA PHAM, EXAMINING ATTORNEY

SN 77-775,554. INTELLIDEN, INC., COLORADO SPRINGS, CO. FILED 7-7-2009.

SmartModels

THE MARK CONSISTS OF STANDARD CHARACTERS WITHOUT CLAIM TO ANY PARTICULAR FONT, STYLE, SIZE, OR COLOR.

FOR COMPUTER NETWORKING SOFTWARE THAT ACTS AS A COMPUTER NETWORK ABSTRACTION LAYER BY TRANSLATING THE COMPUTER NETWORK DEVICE CONFIGURATION INFORMATION INTO STANDARDIZED DEVICE MODELS (U.S. CLS. 21, 23, 26, 36 AND 38).

FIRST USE 3-1-2009; IN COMMERCE 3-1-2009.
THOMAS MANOR, EXAMINING ATTORNEY

CLASS 9—(Continued).

SN 77-779,562. SONICS, INC., MILPITAS, CA. FILED 7-13-2009.

SONICSGN

THE MARK CONSISTS OF STANDARD CHARACTERS WITHOUT CLAIM TO ANY PARTICULAR FONT, STYLE, SIZE, OR COLOR.

OWNER OF U.S. REG. NOS. 2,888,224, 3,047,031 AND OTHERS.

FOR COMPUTER SOFTWARE USED AS A DEVELOPMENT TOOL FOR USE IN THE DESIGN OF INTEGRATED CIRCUITS; MICRONETWORKS FOR USE IN THE DESIGN OF INTEGRATED CIRCUITS; SYSTEM-LEVEL PROTOCOL CORES AND DEVICE DRIVERS FOR USE IN AUTOMOTIVE ELECTRONICS, CONSUMER ELECTRONICS, COMMUNICATIONS AND COMPUTERS; SOFTWARE APPLICATION DESIGN TOOLS FOR USE IN DESIGN OF INTEGRATED CIRCUITS (U.S. CLS. 21, 23, 26, 36 AND 38).

TARA PATE, EXAMINING ATTORNEY

CLASS 9—(Continued).

SN 77-779,778. CODE 3, INC., ST. LOUIS, MO. FILED 7-13-2009.

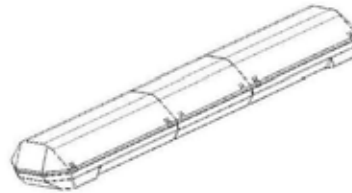

THE MARK CONSISTS OF AN ORNAMENTAL THREE-DIMENSIONAL PRODUCT CONFIGURATION TRADE DRESS FOR A LIGHT BAR HAVING FACETED SURFACES WITH MULTIPLE, SUBSTANTIALLY FLAT SIDES, AND WITH AN OVERALL RELATIVELY HIGH PROFILE.

SEC. 2(F).

FOR EMERGENCY VEHICLE LIGHT BARS AND WARNING LIGHT BARS FOR USE ON VEHICLES (U.S. CLS. 21, 23, 26, 36 AND 38).

FIRST USE 10-31-1989; IN COMMERCE 10-31-1989.

WILLIAM P. SHANAHAN, EXAMINING ATTORNEY

SN 77-779,768. CODE 3, INC., ST. LOUIS, MO. FILED 7-13-2009.

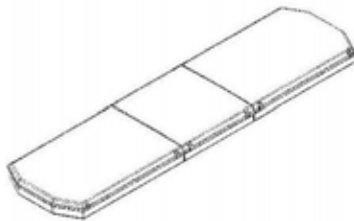

THE MARK CONSISTS OF AN ORNAMENTAL THREE-DIMENSIONAL PRODUCT CONFIGURATION TRADE DRESS FOR A LIGHT BAR HAVING FACETED SURFACES WITH MULTIPLE, SUBSTANTIALLY FLAT SIDES, AND WITH AN OVERALL SLIM PROFILE.

SEC. 2(F).

FOR EMERGENCY VEHICLE LIGHT BARS AND WARNING LIGHT BARS FOR USE ON VEHICLES (U.S. CLS. 21, 23, 26, 36 AND 38).

FIRST USE 2-6-2002; IN COMMERCE 2-6-2002.

WILLIAM P. SHANAHAN, EXAMINING ATTORNEY

SN 77-779,788. CODE 3, INC., ST. LOUIS, MO. FILED 7-13-2009.

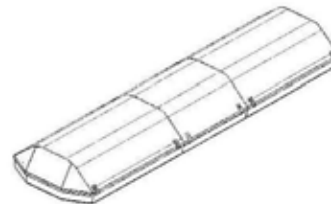

THE MARK CONSISTS OF AN ORNAMENTAL THREE-DIMENSIONAL PRODUCT CONFIGURATION TRADE DRESS FOR A LIGHT BAR HAVING FACETED SURFACES WITH MULTIPLE, SUBSTANTIALLY FLAT SIDES, AND WITH AN OVERALL LOW-PROFILED, SQUAT SHAPE.

SEC. 2(F).

FOR EMERGENCY VEHICLE LIGHT BARS AND WARNING LIGHT BARS FOR USE ON VEHICLES (U.S. CLS. 21, 23, 26, 36 AND 38).

FIRST USE 4-1-1998; IN COMMERCE 4-1-1998.

WILLIAM P. SHANAHAN, EXAMINING ATTORNEY

CLASS 9—(Continued).

SN 77-781,237. PROMISE TECHNOLOGY, INC., MILPITAS, CA. FILED 7-15-2009.

VESSRAID

THE MARK CONSISTS OF STANDARD CHARACTERS WITHOUT CLAIM TO ANY PARTICULAR FONT, STYLE, SIZE, OR COLOR.

FOR COMPUTER HARDWARE FOR USE IN DATA MANAGEMENT AND DATA PROTECTION; COMPUTER HARDWARE FOR USE IN ENERGY MANAGEMENT ON COMPUTER STORAGE DEVICES, NAMELY, HARD DRIVES (U.S. CLS. 21, 23, 26, 36 AND 38).

B. PARADEWELAI, EXAMINING ATTORNEY

SN 77-781,383. EPPENDORF AG, HAMBURG, FED REP GERMANY, FILED 7-15-2009.

Eppendorf BioSpectrometer

THE MARK CONSISTS OF STANDARD CHARACTERS WITHOUT CLAIM TO ANY PARTICULAR FONT, STYLE, SIZE, OR COLOR.

OWNER OF U.S. REG. NOS. 1,404,655, 2,452,949 AND 3,187,659.

NO CLAIM IS MADE TO THE EXCLUSIVE RIGHT TO USE "BIOSPECTROMETER", APART FROM THE MARK AS SHOWN.

FOR SCIENTIFIC APPARATUS, NAMELY, SPECTROMETERS AND PARTS AND FITTINGS THEREFOR (U.S. CLS. 21, 23, 26, 36 AND 38).

LINDA M. KING, EXAMINING ATTORNEY

SN 77-782,051. LEMKO CORPORATION, SCHAMBERG, IL. FILED 7-15-2009.

Node1

THE MARK CONSISTS OF STANDARD CHARACTERS WITHOUT CLAIM TO ANY PARTICULAR FONT, STYLE, SIZE, OR COLOR.

FOR COMPUTER SOFTWARE FOR A SERVER AT A CELL SITE TO FACILITATE CELLULAR COMMUNICATIONS BY PROVIDING SWITCHING, AUTHENTICATION, AND CALL DETAIL REPORTING (U.S. CLS. 21, 23, 26, 36 AND 38).

FIRST USE 12-31-2008; IN COMMERCE 2-3-2009.
FRED CARL, EXAMINING ATTORNEY

CLASS 9—(Continued).

SN 77-782,056. FRONTLYNAZ INC., NEWARK, DE. FILED 7-15-2009.

Frontlynaz

THE MARK CONSISTS OF STANDARD CHARACTERS WITHOUT CLAIM TO ANY PARTICULAR FONT, STYLE, SIZE, OR COLOR.

FOR DIGITAL MATERIALS, NAMELY, CDS, DVDS, VIDEO FILES, AND DOWNLOADABLE AUDIO FILES FEATURING FRONTLYNAZ INC. MUSIC, SONGS AND IMAGES; DIGITAL MEDIA, NAMELY, CDS, DVDS, VIDEO FILES, AND DOWNLOADABLE AUDIO FILES, FEATURING FRONTLYNAZ INC. MUSIC, AND SONGS; DIGITAL MUSIC DOWNLOADABLE FROM THE INTERNET; DOWNLOADABLE MP3 FILES, MP3 RECORDINGS, ON-LINE DISCUSSION BOARDS, WEBCASTS AND PODCASTS FEATURING MUSIC, AUDIO BOOKS AND NEWS BROADCASTS; DOWNLOADABLE MUSICAL SOUND RECORDINGS; DOWNLOADABLE RING TONES, GRAPHICS AND MUSIC VIA A GLOBAL COMPUTER NETWORK AND WIRELESS DEVICES; PRE-RECORDED CDS FEATURING MUSIC WRITTEN AND PRODUCED THROUGH FRONTLYNAZ INC (U.S. CLS. 21, 23, 26, 36 AND 38).

FIRST USE 4-1-2001; IN COMMERCE 1-1-2003.
FRED CARL, EXAMINING ATTORNEY

SN 77-786,273. FLUID OPERATIONS GMBH, WALLDORF, FED REP GERMANY, FILED 7-21-2009.

fluid Operations

THE MARK CONSISTS OF STANDARD CHARACTERS WITHOUT CLAIM TO ANY PARTICULAR FONT, STYLE, SIZE, OR COLOR.

NO CLAIM IS MADE TO THE EXCLUSIVE RIGHT TO USE "OPERATIONS", APART FROM THE MARK AS SHOWN.

FOR COMPUTER SOFTWARE FOR APPLICATION AND DATABASE INTEGRATION; COMPUTER SOFTWARE FOR COMPUTER SYSTEM AND APPLICATION DEVELOPMENT, DEPLOYMENT AND MANAGEMENT; COMPUTER SOFTWARE FOR CONTROLLING AND MANAGING ACCESS SERVER APPLICATIONS; COMPUTER SOFTWARE THAT ASSISTS COMPUTERS IN DEPLOYING PARALLEL APPLICATIONS AND PERFORMING PARALLEL COMPUTATIONS; COMPUTER SOFTWARE THAT PROVIDES REAL-TIME, INTEGRATED BUSINESS MANAGEMENT INTELLIGENCE BY COMBINING INFORMATION FROM VARIOUS DATABASES AND PRESENTING IT IN AN EASY-TO-UNDERSTAND USER INTERFACE; COMPUTER SOFTWARE THAT PROVIDES WEB-BASED ACCESS TO APPLICATIONS AND SERVICES THROUGH A WEB OPERATING SYSTEM OR PORTAL INTERFACE; GRAPHICAL USER INTERFACE SOFTWARE (U.S. CLS. 21, 23, 26, 36 AND 38).

FIRST USE 3-1-2008; IN COMMERCE 5-11-2009.
MICHELE SWAIN, EXAMINING ATTORNEY

CLASS 9—(Continued).

SN 77-786,390. FLUID OPERATIONS GMBH, WALLDORF, FED REP GERMANY, FILED 7-21-2009.

Virtual Landscape Manager
(VL Manager)

THE MARK CONSISTS OF STANDARD CHARACTERS WITHOUT CLAIM TO ANY PARTICULAR FONT, STYLE, SIZE, OR COLOR.

NO CLAIM IS MADE TO THE EXCLUSIVE RIGHT TO USE "VIRTUAL LANDSCAPE MANAGER" AND "MANAGER", APART FROM THE MARK AS SHOWN.

FOR COMPUTER SOFTWARE FOR ADMINISTRATION OF COMPUTER NETWORKS; COMPUTER SOFTWARE FOR APPLICATION AND DATABASE INTEGRATION; COMPUTER SOFTWARE FOR COMPUTER SYSTEM AND APPLICATION DEVELOPMENT, DEPLOYMENT AND MANAGEMENT; COMPUTER SOFTWARE FOR CONTROLLING AND MANAGING ACCESS SERVER APPLICATIONS; COMPUTER SOFTWARE THAT ASSISTS COMPUTERS IN DEPLOYING PARALLEL APPLICATIONS AND PERFORMING PARALLEL COMPUTATIONS; COMPUTER SOFTWARE THAT PROVIDES REAL-TIME, INTEGRATED BUSINESS MANAGEMENT INTELLIGENCE BY COMBINING INFORMATION FROM VARIOUS DATABASES AND PRESENTING IT IN AN EASY-TO-UNDERSTAND USER INTERFACE; COMPUTER SOFTWARE THAT PROVIDES WEB-BASED ACCESS TO APPLICATIONS AND SERVICES THROUGH A WEB OPERATING SYSTEM OR PORTAL INTERFACE; GRAPHICAL USER INTERFACE SOFTWARE (U.S. CLS. 21, 23, 26, 36 AND 38).

MICHELE SWAIN, EXAMINING ATTORNEY

CLASS 9—(Continued).

SN 77-788,763. FOREIGN-TRADE ZONE CORPORATION, MOBILE, AL. FILED 7-24-2009.



OWNER OF U.S. REG. NO. 3,079,627.

NO CLAIM IS MADE TO THE EXCLUSIVE RIGHT TO USE "PREMIER", APART FROM THE MARK AS SHOWN.

THE COLOR(S) GOLD AND GREEN IS/ARE CLAIMED AS A FEATURE OF THE MARK.

THE MARK CONSISTS OF THE LETTERS "S" AND "Z" IN AN INTERCONNECTED STYLIZED FONT ARE DISPOSED WITHIN A CIRCLE. THE TOP PART OF THE CIRCLE IS GREEN AND THE BOTTOM PART OF THE CIRCLE IS GOLD. THE TERM "SMARTZONE" IS DISPOSED TO THE RIGHT OF THE CIRCLE. THE WORD "SMART" IN GREEN AND THE WORD "ZONE" IN GOLD. THE WORD "PREMIER" IS BENEATH THE TERM "SMARTZONE" IN A SMALLER GREEN FONT. THE COLOR WHITE REPRESENTS BACKGROUND AREA AND IS NOT PART OF THE MARK.

FOR SOFTWARE IN THE FIELD OF FOREIGN TRADE ZONE INVENTORY CONTROL, RECORD KEEPING, MATERIALS MANAGEMENT, FINANCIAL MANAGEMENT, SHIPPING MANAGEMENT, AND COMPLIANCE WITH CUSTOMS REGULATIONS (U.S. CLS. 21, 23, 26, 36 AND 38).

FIRST USE 11-16-2007; IN COMMERCE 11-16-2007.

MARIA-VICTORIA SUAREZ, EXAMINING ATTORNEY

SN 77-788,756. BOLTSWITCH, INC., CRYSTAL LAKE, IL. FILED 7-24-2009.

BOLTSWITCH

THE MARK CONSISTS OF STANDARD CHARACTERS WITHOUT CLAIM TO ANY PARTICULAR FONT, STYLE, SIZE, OR COLOR.

SEC. 2(F).

FOR PRESSURE CONTACT SWITCHES, FUSED POWER CIRCUIT DEVICES, FUSED POWER CIRCUIT DEVICE ENCLOSURES, BLOWN FUSE DETECTORS, CAPACITOR UNITS, NAMELY, CAPACITOR TRIP UNITS, PHASE FAILURE RELAYS, DUMMY FUSES, GROUND FAULT RELAYS, GROUND FAULT SENSORS, FUSE BLOCKS, PULLOUT SWITCHES, ENCLOSED PULLOUT SWITCHES, ENCLOSED SWITCHES, MILL SWITCHES, DOUBLE-THROW SWITCHES, NAMELY, GENEVA SWITCHES AND MANUAL TRANSFER SWITCHES, AND NO-FUSE TIE SWITCHES (U.S. CLS. 21, 23, 26, 36 AND 38).

FIRST USE 12-19-1967; IN COMMERCE 12-19-1967.

CHRIS WELLS, EXAMINING ATTORNEY

SN 77-789,412. GL DYNAMICS, INC., DBA GL DYNAMICS SOFTWARE, INC., SAN FRANCISCO, CA. FILED 7-24-2009.

TeamPlaybook

THE MARK CONSISTS OF STANDARD CHARACTERS WITHOUT CLAIM TO ANY PARTICULAR FONT, STYLE, SIZE, OR COLOR.

FOR SOFTWARE FOR RECORDING AND ANALYZING ATHLETIC GAMES INFORMATION, TO CREATE GAME PLANS, AND FOR ANIMATING GAME PLANS AND RELATED DECISION MAKING (U.S. CLS. 21, 23, 26, 36 AND 38).

FIRST USE 1-15-2009; IN COMMERCE 1-15-2009.

MARK PILARO, EXAMINING ATTORNEY

CLASS 9—(Continued).

SN 77-790,472. LEMKO CORPORATION, SCHAUMBERG, IL. FILED 7-27-2009.

Node2

THE MARK CONSISTS OF STANDARD CHARACTERS WITHOUT CLAIM TO ANY PARTICULAR FONT, STYLE, SIZE, OR COLOR.

FOR COMPUTER SOFTWARE FOR A SERVER TO PROVIDE A GATEWAY BETWEEN AN INTERNET PROTOCOL BASED, COMMUNICATION SYSTEM AND LEGACY CIRCUIT-SWITCHED NETWORKS (U.S. CLS. 21, 23, 26, 36 AND 38).

FIRST USE 12-31-2008; IN COMMERCE 2-3-2009.
FRED CARL, EXAMINING ATTORNEY

SN 77-791,919. NEWCOMB COMPANY, INCORPORATED, DBA NCI, HUNTSVILLE, AL. FILED 7-29-2009.

GoLogic

THE MARK CONSISTS OF STANDARD CHARACTERS WITHOUT CLAIM TO ANY PARTICULAR FONT, STYLE, SIZE, OR COLOR.

FOR ELECTRONIC INSTRUMENTS, NAMELY, LOGIC ANALYZERS (U.S. CLS. 21, 23, 26, 36 AND 38).

FIRST USE 2-1-2000; IN COMMERCE 2-1-2000.
BRIAN NEVILLE, EXAMINING ATTORNEY

SN 77-792,585. CLEANAPP, LLC, PLYMOUTH, MN. FILED 7-30-2009.

APPITIZE

THE MARK CONSISTS OF STANDARD CHARACTERS WITHOUT CLAIM TO ANY PARTICULAR FONT, STYLE, SIZE, OR COLOR.

FOR COMPUTER APPLICATION SOFTWARE FOR MOBILE PHONES (U.S. CLS. 21, 23, 26, 36 AND 38).

MIDGE BUTLER, EXAMINING ATTORNEY

CLASS 9—(Continued).

SN 77-792,948. POWERWEB ENERGY INC., PHILADELPHIA, PA. FILED 7-30-2009.

GSMART

THE MARK CONSISTS OF STANDARD CHARACTERS WITHOUT CLAIM TO ANY PARTICULAR FONT, STYLE, SIZE, OR COLOR.

FOR LIGHTING CONTROL SYSTEMS COMPRISING A COMBINATION OF THERMOSTATS, SENSORS, LIGHTING CONTROLS AND LIGHTING CONTROL SOFTWARE FOR USE IN COMMERCIAL AND INDUSTRIAL FACILITIES (U.S. CLS. 21, 23, 26, 36 AND 38).

PATRICIA EVANKO, EXAMINING ATTORNEY

SN 77-794,047. PMOSOFT, LLC, COPPELL, TX. FILED 7-31-2009.

PMIQ

THE MARK CONSISTS OF STANDARD CHARACTERS WITHOUT CLAIM TO ANY PARTICULAR FONT, STYLE, SIZE, OR COLOR.

FOR COMPUTER SOFTWARE FOR INTEGRATED PROJECT MANAGEMENT OFFICE INFORMATION AND QUALITY SYSTEMS MANAGEMENT (U.S. CLS. 21, 23, 26, 36 AND 38).

ANDREA HACK, EXAMINING ATTORNEY

CLASS 9—(Continued).

SN 77-795,288. KABUSHIKI KAISHA HUDSON, MINATO-KU, TOKYO, JAPAN, FILED 8-3-2009.



THE COLOR(S) BLUE, WHITE, GRAY, AND BLACK IS/ ARE CLAIMED AS A FEATURE OF THE MARK.

THE MARK CONSISTS OF THE STYLIZED WORD "CALLING" CONTAINING THE COLORS WHITE AND BLUE ON A BLACK BACKGROUND WITH STREAKS OF GRAY BEHIND THE LETTERING.

FOR COMPUTER VIDEO GAME PROGRAMS; COMPUTER VIDEO GAME PROGRAMS FOR MOBILE PHONES; COMPUTER VIDEO GAME SOFTWARE; COMPUTER VIDEO GAME PROGRAMS DOWNLOADABLE VIA A TELECOMMUNICATIONS NETWORK; IMAGE AND SOUND FILES OF VIDEO GAMES DOWNLOADABLE VIA A TELECOMMUNICATIONS NETWORK; CARTRIDGES, CASSETTES, CARDS, AND DISCS CONTAINING PRE-RECORDED COMPUTER VIDEO GAME PROGRAMS (U.S. CLS. 21, 23, 26, 36 AND 38).
ZACHARY BELLO, EXAMINING ATTORNEY

SN 77-795,958. PIXAR, EMERYVILLE, CA. FILED 8-3-2009.

TRACTOR

THE MARK CONSISTS OF STANDARD CHARACTERS WITHOUT CLAIM TO ANY PARTICULAR FONT, STYLE, SIZE, OR COLOR.

FOR COMPUTER SOFTWARE FOR CONTROLLING RENDER PROCESSES ON RENDER FARMS AND OTHER LARGE SCALE COMPUTER NETWORKS (U.S. CLS. 21, 23, 26, 36 AND 38).
HANNO RITTNER, EXAMINING ATTORNEY

CLASS 9—(Continued).

SN 77-797,184. TOPCON MEDICAL SYSTEMS, INC., PARAMUS, NJ. FILED 8-5-2009.

SYNERGY

THE MARK CONSISTS OF STANDARD CHARACTERS WITHOUT CLAIM TO ANY PARTICULAR FONT, STYLE, SIZE, OR COLOR.

FOR COMPUTER SOFTWARE USED TO ACQUIRE, IMPORT, PROCESS, MEASURE, ANALYZE, AND STORE CLINICAL IMAGES AND VIDEOS OF THE EYE, AND TO MANAGE PATIENT DATA, DIAGNOSTIC DATA, CLINICAL INFORMATION, AND REPORTS FROM OPHTHALMIC DIAGNOSTIC INSTRUMENTS THROUGH EITHER A DIRECT CONNECTION WITH INSTRUMENTS OR THROUGH COMPUTERIZED NETWORKS (U.S. CLS. 21, 23, 26, 36 AND 38).
SETH A. RAPPAPORT, EXAMINING ATTORNEY

SN 77-797,185. TOPCON MEDICAL SYSTEMS, INC., PARAMUS, NJ. FILED 8-5-2009.

TOPCON SYNERGY

THE MARK CONSISTS OF STANDARD CHARACTERS WITHOUT CLAIM TO ANY PARTICULAR FONT, STYLE, SIZE, OR COLOR.

FOR COMPUTER SOFTWARE USED TO ACQUIRE, IMPORT, PROCESS, MEASURE, ANALYZE, AND STORE CLINICAL IMAGES AND VIDEOS OF THE EYE, AND TO MANAGE PATIENT DATA, DIAGNOSTIC DATA, CLINICAL INFORMATION, AND REPORTS FROM OPHTHALMIC DIAGNOSTIC INSTRUMENTS THROUGH EITHER A DIRECT CONNECTION WITH INSTRUMENTS OR THROUGH COMPUTERIZED NETWORKS (U.S. CLS. 21, 23, 26, 36 AND 38).
SETH A. RAPPAPORT, EXAMINING ATTORNEY

CLASS 9—(Continued).

SN 77-798,213. NATIONZ TECHNOLOGIES INC., SHENZHEN, CHINA, FILED 8-6-2009.

nationz

THE MARK CONSISTS OF THE WORD "NATIONZ" IN STYLIZED LETTERS.

FOR APPARATUS FOR TRANSMISSION OF COMMUNICATION; BLANK INTEGRATED CIRCUIT CARDS; COMPUTER CHIPS; COMPUTER HARDWARE FOR COMMUNICATING AUDIO, VIDEO AND DATA BETWEEN COMPUTERS VIA A GLOBAL COMPUTER NETWORK, WIDE-AREA COMPUTER NETWORKS, AND PEER-TO-PEER COMPUTER NETWORKS; COMPUTER NETWORK HUBS, SWITCHES AND ROUTERS; COMPUTER NETWORKING HARDWARE; COMPUTER PERIPHERAL DEVICES; DATA PROCESSORS; ELECTRONIC CHIPS FOR THE MANUFACTURER OF INTEGRATED CIRCUITS; INTEGRATED CIRCUITS; NOTEBOOK COMPUTERS; SEMI-CONDUCTORS; TELECOMMUNICATIONS AND DATA NETWORKING HARDWARE, NAMELY, DEVICES FOR TRANSPORTING AND AGGREGATING VOICE, DATA, AND VIDEO COMMUNICATIONS ACROSS MULTIPLE NETWORK INFRASTRUCTURES AND COMMUNICATIONS PROTOCOLS; INTERCOMMUNICATION APPARATUS FOR TRANSMISSION OF COMMUNICATIONS; NETWORK COMMUNICATION APPARATUS FOR TRANSMISSION OF COMMUNICATIONS; RECORDED COMPUTER SOFTWARE FOR ENSURING THE SECURITY OF ELECTRONIC MAIL, ELECTRONIC COMMUNICATIONS, USER NAMES, PASSWORDS AND OTHER INFORMATION STORED IN COMPUTERS AND SERVERS (U.S. CLS. 21, 23, 26, 36 AND 38).

FRED MANDIR, EXAMINING ATTORNEY

CLASS 9—(Continued).

SN 77-798,215. NATIONZ TECHNOLOGIES INC., SHENZHEN, CHINA, FILED 8-6-2009.



THE MARK CONSISTS OF SEVEN IRREGULAR TRIANGLES POSITIONED IN A MANNER SO AS TO FORM AN ABSTRACT SEVEN SIDED FIGURE.

FOR APPARATUS FOR TRANSMISSION OF COMMUNICATION; BLANK INTEGRATED CIRCUIT CARDS; COMPUTER CHIPS; COMPUTER HARDWARE FOR COMMUNICATING AUDIO, VIDEO AND DATA BETWEEN COMPUTERS VIA A GLOBAL COMPUTER NETWORK, WIDE-AREA COMPUTER NETWORKS, AND PEER-TO-PEER COMPUTER NETWORKS; COMPUTER NETWORK HUBS, SWITCHES AND ROUTERS; COMPUTER NETWORKING HARDWARE; COMPUTER PERIPHERAL DEVICES; DATA PROCESSORS; ELECTRONIC CHIPS FOR THE MANUFACTURER OF INTEGRATED CIRCUITS; INTEGRATED CIRCUITS; NOTEBOOK COMPUTERS; SEMI-CONDUCTORS; TELECOMMUNICATIONS AND DATA NETWORKING HARDWARE, NAMELY, DEVICES FOR TRANSPORTING AND AGGREGATING VOICE, DATA, AND VIDEO COMMUNICATIONS ACROSS MULTIPLE NETWORK INFRASTRUCTURES AND COMMUNICATIONS PROTOCOLS; INTERCOMMUNICATION APPARATUS FOR TRANSMISSION OF COMMUNICATIONS; NETWORK COMMUNICATION APPARATUS FOR TRANSMISSION OF COMMUNICATIONS; RECORDED COMPUTER SOFTWARE FOR ENSURING THE SECURITY OF ELECTRONIC MAIL, ELECTRONIC COMMUNICATIONS, USER NAMES, PASSWORDS AND OTHER INFORMATION STORED IN COMPUTERS AND SERVERS (U.S. CLS. 21, 23, 26, 36 AND 38).

FRED MANDIR, EXAMINING ATTORNEY

CLASS 9—(Continued).

SN 77-798,573. NASH STUDIO INC., KITA-KU, OSAKA, JAPAN, FILED 8-6-2009.



OWNER OF U.S. REG. NO. 2,330,416.
THE MARK CONSISTS OF THE STYLIZED WORDING "NASH".

SEC. 2(F).
FOR RECORDED AUDIO DISCS FEATURING MUSIC AND SOUND EFFECTS; RECORDED AUDIO COMPACT DISCS FEATURING MUSIC AND SOUND EFFECTS; RECORDED AUDIO CD-ROMS FEATURING MUSIC AND SOUND EFFECTS; RECORDED DVD-AUDIO DISCS FEATURING MUSIC AND SOUND EFFECTS; RECORDED DVD-VIDEO DISCS FEATURING MUSIC AND SOUND EFFECTS; RECORDED DVD-ROM DISCS FEATURING MUSIC AND SOUND EFFECTS; RECORDED ANALOGUE AUDIO RECORDS FEATURING MUSIC AND SOUND EFFECTS; RECORDED AUDIO TAPES FEATURING MUSIC AND SOUND EFFECTS; RECORDED AUDIO INTEGRATED CIRCUIT TIPS FEATURING MUSIC AND SOUND EFFECTS; RECORDED AUDIO MINI DISCS AND RECORDED AUDIO MAGNETO OPTICAL DISCS FEATURING MUSIC AND SOUND EFFECTS; DIGITAL MUSIC DOWNLOADABLE FROM THE INTERNET; DIGITAL MATERIALS, NAMELY, DOWNLOADABLE IMAGE FILES FEATURING MUSIC AND SOUND EFFECTS; AND DIGITAL MATERIALS, NAMELY, DOWNLOADABLE VIDEO FILES FEATURING MUSIC AND SOUND EFFECTS (U.S. CLS. 21, 23, 26, 36 AND 38).

FIRST USE 8-1-1978; IN COMMERCE 9-26-1997.
BRENDAN MCCAULEY, EXAMINING ATTORNEY

SN 77-798,729. HUMANA INC., LOUISVILLE, KY. FILED 8-6-2009.

RACE AGAINST TIME

THE MARK CONSISTS OF STANDARD CHARACTERS WITHOUT CLAIM TO ANY PARTICULAR FONT, STYLE, SIZE, OR COLOR.

FOR COMPUTER GAME SOFTWARE; ELECTRONIC GAME PROGRAMS, ELECTRONIC GAME SOFTWARE, INTERACTIVE VIDEO GAME PROGRAMS, COMPUTER GAME PROGRAMS, INTERACTIVE MULTIMEDIA COMPUTER GAME PROGRAMS, CHILDREN'S EDUCATIONAL SOFTWARE (U.S. CLS. 21, 23, 26, 36 AND 38).
HELENE LIWINSKI, EXAMINING ATTORNEY

CLASS 9—(Continued).

SN 77-798,800. HUMANA INC., LOUISVILLE, KY. FILED 8-6-2009.



THE MARK CONSISTS OF STANDARD CHARACTERS WITHOUT CLAIM TO ANY PARTICULAR FONT, STYLE, SIZE, OR COLOR.

FOR VIDEO GAMES IN THE NATURE OF VIDEO GAME PROGRAMS; VIDEO GAME SOFTWARE; COMPUTER GAME SOFTWARE; ELECTRONIC GAME PROGRAMS; ELECTRONIC GAME SOFTWARE; INTERACTIVE ELECTRONIC GAME SOFTWARE; INTERACTIVE VIDEO GAME PROGRAMS; INTERACTIVE VIDEO GAME SOFTWARE; COMPUTER GAME PROGRAMS; INTERACTIVE MULTIMEDIA COMPUTER GAME PROGRAMS; EDUCATIONAL COMPUTER GAME PROGRAMS; VIDEO GAMES IN THE NATURE OF VIDEO GAME PROGRAMS FEATURING EDUCATIONAL, INFORMATIONAL, AND ENTERTAINMENT CONTENT, NAMELY, STORIES, MUSIC, GAMES, PUZZLES, AND EDUCATIONAL INSTRUCTION, INFORMATIONAL INSTRUCTION, AND ENTERTAINMENT INSTRUCTION ALL ON GAMES, PUZZLES, WEIGHT LOSS, DIETING, HEALTH, WELLNESS, NUTRITION, SPORTS, EXERCISE, AND PHYSICAL FITNESS (U.S. CLS. 21, 23, 26, 36 AND 38).

KATHERINE CONNOLLY, EXAMINING ATTORNEY

SN 77-799,139. SAMSUNG ELECTRONICS CO., LTD., SUWON-SI, GYEONGGI-DO, REPUBLIC OF KOREA, FILED 8-6-2009.

SAMSUNG QUAKE

THE MARK CONSISTS OF STANDARD CHARACTERS WITHOUT CLAIM TO ANY PARTICULAR FONT, STYLE, SIZE, OR COLOR.

OWNER OF U.S. REG. NOS. 3,410,845, 3,632,944 AND OTHERS.
THE ENGLISH TRANSLATION OF THE WORD "SAMSUNG" IN THE MARK IS THREE STARS.
FOR MOBILE PHONES; SMARTPHONES (U.S. CLS. 21, 23, 26, 36 AND 38).
BRIDGETT SMITH, EXAMINING ATTORNEY

CLASS 9—(Continued).

SN 77-799,987. APRISO CORPORATION, LONG BEACH, CA.
FILED 8-7-2009.

FLEXNET

THE MARK CONSISTS OF STANDARD CHARACTERS WITHOUT CLAIM TO ANY PARTICULAR FONT, STYLE, SIZE, OR COLOR.

OWNER OF U.S. REG. NO. 3,018,933.

FOR COMPUTER SOFTWARE FOR BUSINESS PROCESS MANAGEMENT IN THE FIELDS OF MANUFACTURING, SUPPLY CHAIN, WAREHOUSING AND DISTRIBUTION, NAMELY, FOR CONTROLLING AND INTEGRATING MANUFACTURING PROCESSES AND OPERATIONS, INVENTORY TRACKING AND MANAGEMENT, SUPPLY CHAIN MANAGEMENT, WAREHOUSE MANAGEMENT AND LOGISTICS, QUALITY CONTROL, ESTABLISHING AND MAINTAINING QUALITY INSPECTION PLANS, INTEGRATING COMPLEX ANALYTICS CALCULATIONS INTO PRODUCTION, ENGINEERING AND QUALITY PROCESSES, TRACKING DEFECTIVE PRODUCTS, PLANNING AND TRACKING EQUIPMENT MAINTENANCE, COLLECTING AND TRACKING TIME AND LABOR, CREATING, VIEWING AND DISTRIBUTING REPORTS ABOUT FACTORY PROCESSES AND LABOR, GENERATING AND PRINTING BAR CODE LABELS, AND MANAGING OPERATIONS ACROSS MULTIPLE MANUFACTURING PLANTS; COMPUTER COMMUNICATIONS SOFTWARE FOR USE IN THE FIELDS OF MANUFACTURING, SUPPLY CHAIN, WAREHOUSING AND DISTRIBUTION THAT ALLOWS WORKERS, SUPPLIERS, MANUFACTURERS, PRODUCT DESIGNERS, PROCESS ENGINEERS, MANAGEMENT AND OTHER EMPLOYEES TO COLLABORATE AND COMMUNICATE WITH EACH OTHER VIA THE INTERNET (U.S. CLS. 21, 23, 26, 36 AND 38).

FIRST USE 12-0-2002; IN COMMERCE 12-0-2002.
CAROLINE WOOD, EXAMINING ATTORNEY

CLASS 9—(Continued).

SN 77-800,655. ARUZE GAMING AMERICA, INC., LAS VEGAS, NV. FILED 8-10-2009.

DRAGON'S FORTUNE

THE MARK CONSISTS OF STANDARD CHARACTERS WITHOUT CLAIM TO ANY PARTICULAR FONT, STYLE, SIZE, OR COLOR.

FOR COMPONENTS FOR GAMING MACHINES THAT GENERATE OR DISPLAY WAGER OUTCOMES, NAMELY, CONTROLLERS, DISPLAYS, BUTTON PANELS, BOLSTERS, ELECTRICAL WIRING, AND COMPUTER HARDWARE AND SOFTWARE ASSOCIATED THEREWITH; COMPUTER GAME SOFTWARE FOR GAMING MACHINES INCLUDING SLOT MACHINES OR VIDEO LOTTERY TERMINALS; COMPUTER SOFTWARE AND FIRMWARE FOR GAMES OF CHANCE ON ANY COMPUTERIZED PLATFORM, INCLUDING DEDICATED GAMING CONSOLES, VIDEO BASED SLOT MACHINES, REEL BASED SLOT MACHINES, AND VIDEO LOTTERY TERMINALS; ELECTRONIC AND ELECTRO-MECHANICAL GAMING TABLES WITH VIDEO OUTPUT; ELECTRONIC COMPONENTS FOR SLOT MACHINES; GAMING EQUIPMENT, NAMELY, SLOT MACHINES WITH OR WITHOUT VIDEO OUTPUT; GAMING MACHINES; GAMING MACHINES INCLUDING SLOT MACHINES OR VIDEO LOTTERY TERMINALS; GAMING MACHINES THAT GENERATE OR DISPLAY WAGER OUTCOMES; GAMING MACHINES, NAMELY, DEVICES WHICH ACCEPT A WAGER; GAMING SOFTWARE THAT GENERATES OR DISPLAYS WAGER OUTCOMES OF GAMING MACHINES; MACHINES FOR PLAYING GAMES OF CHANCE; SLOT MACHINES (U.S. CLS. 21, 23, 26, 36 AND 38).

FIRST USE 8-10-2009; IN COMMERCE 11-17-2009.
JAY BESCH, EXAMINING ATTORNEY

SN 77-803,451. NEW LINE PRODUCTIONS, INC., LOS ANGELES, CA. FILED 8-12-2009.

WATERTOWER MUSIC

THE MARK CONSISTS OF STANDARD CHARACTERS WITHOUT CLAIM TO ANY PARTICULAR FONT, STYLE, SIZE, OR COLOR.

NO CLAIM IS MADE TO THE EXCLUSIVE RIGHT TO USE "MUSIC", APART FROM THE MARK AS SHOWN.

FOR MOTION PICTURE FILMS FEATURING COMEDY, DRAMA, ACTION, ADVENTURE AND/OR ANIMATION, AND MOTION PICTURE FILMS FOR BROADCAST ON TELEVISION FEATURING COMEDY, DRAMA, ACTION, ADVENTURE AND/OR ANIMATION; AUDIO TAPES, AUDIO-VIDEO TAPES, AUDIO VIDEO CASSETTES, AUDIO VIDEO DISCS, AND DIGITAL VERSATILE DISCS FEATURING MUSIC, COMEDY, DRAMA, ACTION, ADVENTURE, AND/OR ANIMATION; STEREO HEADPHONES; CORDLESS TELEPHONES; AUDIO CASSETTE AND CD PLAYERS; CD ROM COMPUTER GAME DISCS; TELEPHONE AND/OR RADIO PAGERS; SHORT MOTION PICTURE FILM CASSETTES FEATURING COMEDY, DRAMA, ACTION, ADVENTURE AND/OR ANIMATION TO BE USED WITH HAND-HELD VIEWERS OR PROJECTORS; VIDEO CASSETTE RECORDERS AND PLAYERS, COMPACT DISC PLAYERS, DIGITAL AUDIO TAPE RECORDERS

SN 77-800,034. LAVRY ENGINEERING, INC., ROLLING BAY, WA. FILED 8-7-2009.

LAVRY

THE MARK CONSISTS OF STYLIZED LETTERS "LAVRY".

SEC. 2(F) AS TO "LAVRY".

FOR ELECTRONIC AUDIO EQUIPMENT, NAMELY, ANALOG-TO-DIGITAL (A/D) CONVERTERS, DIGITAL-TO-ANALOG (D/A) CONVERTERS, DIGITAL OPTIMIZERS AND PRE-AMPLIFIERS (U.S. CLS. 21, 23, 26, 36 AND 38).

KATHERINE CONNOLLY, EXAMINING ATTORNEY

CLASS 9—(Continued).

AND PLAYERS; RADIOS; MOUSE PADS; EYEGLASSES, SUNGLASSES AND CASES THEREFOR; GAME EQUIPMENT SOLD AS A UNIT FOR PLAYING A PARLOR-TYPE COMPUTER GAME; VIDEO AND COMPUTER GAME PROGRAMS; VIDEO GAME CARTRIDGES AND CASSETTES; COMPUTER AND VIDEO GAMES WHICH ARE DESIGNED FOR HARDWARE PLATFORMS, NAMELY, GAME CONSOLES AND PERSONAL COMPUTERS; CD-ROM COMPUTER GAME DISCS AND COMPUTER PROGRAMS, NAMELY, SOFTWARE LINKING DIGITIZED VIDEO AND AUDIO MEDIA TO A GLOBAL COMPUTER INFORMATION NETWORK, CELLULAR TELEPHONE ACCESSORIES, NAMELY, HANDS-FREE ACCESSORIES, CELLULAR TELEPHONE COVERS AND CELLULAR TELEPHONE FACE COVERS; ENCODED MAGNETIC CARDS, NAMELY, PHONE CARDS, CREDIT CARDS, CASH CARDS, DEBIT CARDS AND MAGNETIC KEY CARDS; AND DECORATIVE MAGNETS; DOWNLOADABLE COMPUTER AND VIDEO GAME PROGRAMS VIA THE INTERNET (U.S. CLS. 21, 23, 26, 36 AND 38).

APRIL HESIK, EXAMINING ATTORNEY

SN 77-803,471. ASHRAF, SALMAN, KARACHI, PAKISTAN, FILED 8-12-2009.



NO CLAIM IS MADE TO THE EXCLUSIVE RIGHT TO USE "FOLDER PROTECT", APART FROM THE MARK AS SHOWN.

THE MARK CONSISTS OF THE STYLIZED REPRESENTATION OF THE WORD "FOLDER" ABOVE AND TO THE LEFT OF THE WORD "PROTECT"; THE "F" IN THE WORD "FOLDER" IS DEPICTED AS A STYLIZED KEY.

FOR COMPUTER SECURITY SOFTWARE FOR SETTING ACCESS RIGHTS TO DATA STORED ON COMPUTERS (U.S. CLS. 21, 23, 26, 36 AND 38).

PAUL MORENO, EXAMINING ATTORNEY

SN 77-806,006. GRANOVETTER, RANDY, LA JOLLA, CA. FILED 8-17-2009.

EarPuff

THE MARK CONSISTS OF STANDARD CHARACTERS WITHOUT CLAIM TO ANY PARTICULAR FONT, STYLE, SIZE, OR COLOR.

FOR EARPHONE ACCESSORIES, NAMELY, EARPHONE CUSHIONS IN THE FORM OF BIODEGRADABLE MEMORY FOAM THAT ENCAPSULATES ANY EAR BUD AND FORMS A COMFORTABLE TEMPORARY EAR MOLD UNTIL THE EAR BUD IS REMOVED FROM THE EAR (U.S. CLS. 21, 23, 26, 36 AND 38).

ADA HAN, EXAMINING ATTORNEY

CLASS 9—(Continued).

SN 77-806,287. PACIFIC PARTNERS INNOVATIONS, INC., OCEANSIDE, CA. FILED 8-17-2009.

ELEVATE TO VENTILATE

THE MARK CONSISTS OF STANDARD CHARACTERS WITHOUT CLAIM TO ANY PARTICULAR FONT, STYLE, SIZE, OR COLOR.

FOR ELECTRONIC DEVICE IN THE NATURE OF A SENSING DEVICE TO BE COUPLED TO OR PLACED ADJACENT TO A BED FOR MONITORING THE INCLINATION ANGLE OF AN ADJUSTABLE BED (U.S. CLS. 21, 23, 26, 36 AND 38).

SUE LAWRENCE, EXAMINING ATTORNEY

SN 77-807,415. PLATZ ENTERPRISES, INC., DBA THERMOCARE, PASO ROBLES, CA. AND PLATZ, D. FRANK, DBA PLATZ ENTERPRISES, INC., PASO ROBLES, CA. FILED 8-18-2009.

NO CLAIM IS MADE TO THE EXCLUSIVE RIGHT TO USE "PORTABLE ANIMAL INTENSIVE CARE UNITS", APART FROM THE MARK AS SHOWN.

THE COLOR(S) DARK RED AND BLACK IS/ARE CLAIMED AS A FEATURE OF THE MARK.

THE MARK CONSISTS OF THE WORDS "THERMOCARE PORTABLE ANIMAL INTENSIVE CARE UNITS". THE MARK CONSISTS OF THE MAIN WORD "THERMOCARE", WRITTEN IN ALL BLACK LETTERS WITH THE EXCEPTION OF A RED LETTER "O". THE "C" IN "CARE" IS CAPITALIZED SO THAT THE MARK READS AS TWO CAPITALIZED WORDS WITH NO SPACE BETWEEN THEM. THERE ARE THREE SOLID RED DOTS BELOW THE WORD "THERMOCARE", AND ALIGNED ON THE LEFT SIDE. THE DOTS ARE IMMEDIATELY FOLLOWED BY THE TAGLINE "PORTABLE ANIMAL INTENSIVE CARE UNITS" WRITTEN IN A BLACK FONT.

FOR LABORATORY CAGES FOR SMALL ANIMALS; LABORATORY EQUIPMENT AND SUPPLIES, NAMELY, INCUBATORS (U.S. CLS. 21, 23, 26, 36 AND 38).

FIRST USE 11-24-2008; IN COMMERCE 11-24-2008.

ARETHA SOMERVILLE, EXAMINING ATTORNEY

CLASS 9—(Continued).

SN 77-814,502. BIRD LOVERS ONLY RESCUE SERVICE INCORPORATED, SCHERERVILLE, IN. FILED 8-27-2009.

**SNOWBALL THE DANCING
COCKATOO**

THE MARK CONSISTS OF STANDARD CHARACTERS WITHOUT CLAIM TO ANY PARTICULAR FONT, STYLE, SIZE, OR COLOR.

NO CLAIM IS MADE TO THE EXCLUSIVE RIGHT TO USE "DANCING COCKATOO", APART FROM THE MARK AS SHOWN.

FOR DVDS FEATURING DOMESTIC ANIMALS; MOBILE PHONE STRAPS; FLASH MEMORY CARDS (U.S. CLS. 21, 23, 26, 36 AND 38).

DAVID TAYLOR, EXAMINING ATTORNEY

SN 77-815,224. EDSA MICRO CORPORATION, SAN DIEGO, CA. FILED 8-28-2009.

PALADIN SMARTGRID

THE MARK CONSISTS OF STANDARD CHARACTERS WITHOUT CLAIM TO ANY PARTICULAR FONT, STYLE, SIZE, OR COLOR.

OWNER OF U.S. REG. NO. 2,096,997.

NO CLAIM IS MADE TO THE EXCLUSIVE RIGHT TO USE "SMARTGRID", APART FROM THE MARK AS SHOWN.

FOR COMPUTER SOFTWARE FOR THE DESIGN, MONITORING, ANALYSIS, MODELING AND PREDICTIVE CONTROL OF ELECTRICAL POWER DISTRIBUTION SYSTEM INFRASTRUCTURE EXTENDING TO ON-PREMISE AND/OR PUBLIC POWER GRIDS (U.S. CLS. 21, 23, 26, 36 AND 38).

JILL PRATER, EXAMINING ATTORNEY

CLASS 9—(Continued).

SN 77-815,248. GABRIEL GONZALEZ, SAN ANTONIO, TX. FILED 8-28-2009.



THE COLOR(S) THE COLOR(S) PURPLE, TURQUOISE, ORANGE, GRAY, BLACK IS/ARE CLAIMED AS A FEATURE OF THE MARK.

THE MARK CONSISTS OF AN ORDERED ARRAY OF SQUARES IN PURPLE, TURQUOISE, ORANGE GRAY AND BLACK, DEPICTING A PIXELED RUNNING MAN IN THE SHAPE OF A CAPITAL "U" WITH A DIE SHOWING ITS NUMBER SIX IN BLACK DOTS. THE WORD "URIZEN" IN BLACK APPEARS IN THE BOTTOM PART.

FOR AMUSEMENT APPARATUS AND GAMES ADAPTED FOR USE WITH TELEVISION RECEIVERS OR WITH VIDEO OR COMPUTER MONITORS; BACKUP DRIVES FOR COMPUTERS; CARRYING CASES FOR MOBILE COMPUTERS; CHILDREN'S EDUCATIONAL SOFTWARE; COMPILER SOFTWARE; COMPONENTS FOR GAMING MACHINES THAT GENERATE OR DISPLAY WAGER OUTCOMES, NAMELY, CONTROLLERS, DISPLAYS, BUTTON PANELS, BOLSTERS, ELECTRICAL WIRING, AND COMPUTER HARDWARE AND SOFTWARE ASSOCIATED THEREWITH; COMPONENTS FOR GAMING MACHINES, NAMELY, CONTROLLERS, DISPLAYS, BUTTON PANELS, BOLSTERS, ELECTRICAL WIRING, AND COMPUTER HARDWARE AND SOFTWARE ASSOCIATED THEREWITH; COMPUTER APPLICATION SOFTWARE FOR MOBILE PHONES; COMPUTER CABLES; COMPUTER CAMERAS; COMPUTER CARD ADAPTER; COMPUTER CARRYING CASES; COMPUTER CHASSIS; COMPUTER CURSOR CONTROL DEVICES, NAMELY, COMPUTER MOUSE; COMPUTER CURSOR CONTROL DEVICES, NAMELY, DIGITIZER TABLETS; COMPUTER CURSOR CONTROL DEVICES, NAMELY, LIGHT PENS; COMPUTER CURSOR CONTROL DEVICES, NAMELY, TOUCH PADS; COMPUTER CURSOR CONTROL DEVICES, NAMELY, TRACKBALLS; COMPUTER DOCKING STATION; COMPUTER GAME CARTRIDGES; COMPUTER GAME CARTRIDGES AND DISCS; COMPUTER GAME CASSETTES; COMPUTER GAME CONSOLES FOR USE WITH AN EXTERNAL DISPLAY SCREEN OR MONITOR; COMPUTER GAME DISCS; COMPUTER GAME EQUIPMENT, NAMELY, DISCS; COMPUTER GAME JOYSTICKS; COMPUTER GAME PROGRAMS; COMPUTER GAME PROGRAMS, CARTRIDGES, AND CASSETTES; COMPUTER GAME SOFTWARE; COMPUTER GAME SOFTWARE DOWNLOADABLE FROM A GLOBAL COMPUTER NETWORK; COMPUTER GAME SOFTWARE FOR GAMING MACHINES INCLUDING SLOT MACHINES OR VIDEO LOTTERY TERMINALS; COMPUTER GAME SOFTWARE FOR GAMING MACHINES, NAMELY, SLOT MACHINES AND VIDEO LOTTERY TERMINALS; COMPUTER GAME SOFTWARE FOR PERSONAL COMPUTERS AND HOME VIDEO GAME CONSOLES; COMPUTER GAME SOFTWARE FOR USE WITH PERSONAL COMPUTERS, HOME VIDEO GAME CONSOLES USED WITH TELEVISIONS, AND FOR ARCADE-BASED VIDEO GAME CONSOLES; COMPUTER GAME SOFTWARE, NAMELY, A COMPUTER CRAPS GAME; COMPUTER GAME TAPES; COMPUTER HARDWARE AND COMPUTER PERIPHERAL DEVICES; COMPUTER HARDWARE AND PERIPHERAL DEVICES; COMPUTER HARDWARE AND PERIPHERAL DEVICES; COMPUTER HARDWARE AND PERIPHERAL DEVICES;

CLASS 9—(Continued).

ERALS; COMPUTER HARDWARE AND PERIPHERALS THEREFOR; COMPUTER HARDWARE AND SOFTWARE SYSTEM FOR TRACKING PEOPLE, OBJECTS AND PETS USING GPS DATA ON A DEVICE ON THE TRACKED PEOPLE, OBJECTS AND PETS; COMPUTER HARDWARE FOR COMMUNICATING AUDIO, VIDEO AND DATA BETWEEN COMPUTERS VIA A GLOBAL COMPUTER NETWORK, WIDE-AREA COMPUTER NETWORKS, AND PEER-TO-PEER COMPUTER NETWORKS; COMPUTER HARDWARE FOR TELECOMMUNICATIONS; COMPUTER JOYSTICKS; COMPUTER KEYBOARDS; COMPUTER KEYPADS; COMPUTER MEMORIES; COMPUTER MEMORY HARDWARE; COMPUTER MICE; COMPUTER MONITOR FRAMES; COMPUTER MONITORS; COMPUTER MOUSE; COMPUTER MOUSE, NAMELY, TOUCHPADS; COMPUTER MOUSE, NAMELY, TRACKBALLS; COMPUTER PROGRAMS FOR SEARCHING THE CONTENTS OF COMPUTERS AND COMPUTER NETWORKS BY REMOTE CONTROL; COMPUTER PROGRAMS FOR THE ENABLING OF ACCESS OR ENTRANCE CONTROL; COMPUTER PROGRAMS FOR USING THE INTERNET AND THE WORLD WIDE WEB; COMPUTER PROGRAMS FOR VIDEO AND COMPUTER GAMES; COMPUTER SCREEN FILTERS; COMPUTER SCREEN SAVER SOFTWARE; COMPUTER SCREENS; COMPUTER SEARCH ENGINE SOFTWARE; COMPUTER SOFTWARE AND FIRMWARE FOR GAMES OF CHANCE ON ANY COMPUTERIZED PLATFORM, INCLUDING DEDICATED GAMING CONSOLES, VIDEO BASED SLOT MACHINES, REEL BASED SLOT MACHINES, AND VIDEO LOTTERY TERMINALS; COMPUTER SOFTWARE AND FIRMWARE FOR OPERATING SYSTEM PROGRAMS; COMPUTER SOFTWARE DEVELOPMENT TOOLS; COMPUTER SOFTWARE FOR ORGANIZING AND VIEWING DIGITAL IMAGES AND PHOTOGRAPHS; COMPUTER SOFTWARE FOR PROCESSING DIGITAL MUSIC FILES; COMPUTER SOFTWARE TO ENABLE THE TRANSMISSION OF PHOTOGRAPHS TO MOBILE TELEPHONES; COMPUTER SOFTWARE TO ENHANCE THE AUDIO-VISUAL CAPABILITIES OF MULTIMEDIA APPLICATIONS, NAMELY, FOR THE INTEGRATION OF TEXT, AUDIO, GRAPHICS, STILL IMAGES AND MOVING PICTURES; COMPUTER SOFTWARE, NAMELY, GAME ENGINE SOFTWARE FOR VIDEO GAME DEVELOPMENT AND OPERATION; COMPUTER SOFTWARE, NAMELY, SOFTWARE DEVELOPMENT TOOLS FOR THE CREATION OF MOBILE INTERNET APPLICATIONS AND CLIENT INTERFACES; COMPUTER STANDS SPECIALLY DESIGNED FOR HOLDING A COMPUTER, PRINTER AND ACCESSORIES; COMPUTER STORAGE DEVICES, NAMELY, FLASH DRIVES; COMPUTER STYLUS; COMPUTER SWITCHES; COMPUTER TERMINALS, KEYBOARDS AND PRINTERS; COMPUTER TOUCHSCREENS; COMPUTER-GAMING SOFTWARE; COMPUTERS; COMPUTERS, NAMELY, NETBOOKS; CONSUMER COUPONS DOWNLOADED FROM A GLOBAL COMPUTER NETWORK; DESKTOP COMPUTERS; DIGITAL ENTERTAINMENT SYSTEMS FOR WATCHING, STORING AND SHARING DIGITAL CONTENT ON A HOME COMPUTER NETWORK; DOWNLOADABLE COMPUTER GAME PROGRAMS; DOWNLOADABLE COMPUTER GRAPHICS; DOWNLOADABLE COMPUTER PROGRAMS FEATURING POSITIONABLE GAME PIECE FIGURES FOR USE IN THE FIELD OF COMPUTER GAMES; DOWNLOADABLE COMPUTER SOFTWARE IN THE FIELD OF MEMORY TRAINING ACTIVITIES SOLD AS A UNIT WITH POSITIONABLE FIGURES; DOWNLOADABLE RING TONES, GRAPHICS AND MUSIC VIA A GLOBAL COMPUTER NETWORK AND WIRELESS DEVICES; DUST COVERS FOR COMPUTERS; ELECTRONIC COMPUTERS; ELECTRONIC GAME SOFTWARE; ELECTRONIC GAME SOFTWARE FOR CELLULAR TELEPHONES; ELECTRONIC GAME SOFTWARE FOR HANDHELD ELECTRONIC DEVICES; ELECTRONIC GAME SOFTWARE FOR WIRELESS DEVICES; ELECTRONIC GAME SOFTWARE, NAMELY, AN ELECTRONIC CRAPS GAME; ELECTRONIC GAME SOFTWARE, NAMELY, AN ELECTRONIC VIDEO CRAPS GAME; ELECTRONIC PUBLICATIONS, NAMELY, E-ZINES FEATURING GAME SOFTWARE RECORDED ON COMPUTER MEDIA; GAME CONTROLLERS FOR COMPUTER GAMES; GAME SOFTWARE; GAMING SOFTWARE THAT GENERATES OR DISPLAYS WAGER OUTCOMES OF GAMING MACHINES; HANDHELD COMPUTERS; HANDHELD PERSONAL COMPUTERS; HARD DISCS FOR COMPUTERS;

CLASS 9—(Continued).

INTERACTIVE GAME SOFTWARE; INTERACTIVE MULTIMEDIA COMPUTER GAME PROGRAM; INTERACTIVE VIDEO GAMES OF VIRTUAL REALITY COMPRISED OF COMPUTER HARDWARE AND SOFTWARE; INTERFACES AND PERIPHERAL DEVICES FOR COMPUTERS; INTERFACES FOR COMPUTERS; JACKETS FOR COMPUTER DISKS; LAPTOP COMPUTERS; MICRO-COMPUTERS; MOBILE COMPUTERS; MOUSE PADS; NOTEBOOK AND LAPTOP COMPUTERS; NOTEBOOK COMPUTER CARRYING CASES; NOTEBOOK COMPUTERS; PERSONAL COMPUTERS; POWER ADAPTERS FOR COMPUTERS; PRINTERS FOR COMPUTERS; TRADING CARDS RECORDED ON COMPUTER DISCS; UPI (UNIVERSAL PERIPHERAL INTERFACE) SOFTWARE; VIDEO AND COMPUTER GAME PROGRAMS; VIDEO GAME SOFTWARE; VIDEO GAME SOFTWARE, NAMELY, A VIDEO CRAPS GAME; VINYL COVERS SPECIALLY ADAPTED FOR CELL PHONES, MP3 PLAYERS, LAPTOPS, COMPUTERS, PORTABLE SATELLITE RADIOS, PERSONAL DIGITAL ASSISTANTS, REMOTE CONTROLS, AND TELEVISION SATELLITE RECORDERS; VIRTUAL REALITY GAME SOFTWARE; WIRELESS COMPUTER MICE; WIRELESS COMPUTER PERIPHERALS; WRIST RESTS FOR COMPUTER MOUSE USERS; WRIST RESTS FOR USE WITH COMPUTERS; WRIST SUPPORTS FOR COMPUTER MOUSE USERS (U.S. CLS. 21, 23, 26, 36 AND 38).
 FLORENTINA BLANDU, EXAMINING ATTORNEY

SN 77-817,929. LEIGHT, GARRETT, VENICE, CA. FILED 9-1-2009.

Garrett Leight Optical

THE MARK CONSISTS OF STANDARD CHARACTERS WITHOUT CLAIM TO ANY PARTICULAR FONT, STYLE, SIZE, OR COLOR.
 NO CLAIM IS MADE TO THE EXCLUSIVE RIGHT TO USE "OPTICAL", APART FROM THE MARK AS SHOWN.
 THE NAME "GARRETT LEIGHT" IDENTIFIES A LIVING INDIVIDUAL WHOSE CONSENT IS OF RECORD.
 FOR EYEWEAR (U.S. CLS. 21, 23, 26, 36 AND 38).
 WILLIAM ROSSMAN, EXAMINING ATTORNEY

CLASS 9—(Continued).

SN 77-817,984. INSPIRATION IS THE SECRET, INC., WOODSTOCK, GA. FILED 9-1-2009.

CAPABLES

THE MARK CONSISTS OF STANDARD CHARACTERS WITHOUT CLAIM TO ANY PARTICULAR FONT, STYLE, SIZE, OR COLOR.

FOR AUDIO RECORDINGS FEATURING ADVICE IN THE FIELDS OF PARENTING AND RELATIONSHIPS, INSPIRATIONAL MESSAGES AND EMOTIONAL INTELLIGENCE; VIDEO RECORDINGS FEATURING ADVICE IN THE FIELDS OF PARENTING AND RELATIONSHIPS, INSPIRATIONAL MESSAGES AND EMOTIONAL INTELLIGENCE; DIGITAL MEDIA, NAMELY, CDS FEATURING ADVICE IN THE FIELDS OF PARENTING AND RELATIONSHIPS, INSPIRATIONAL MESSAGES AND EMOTIONAL INTELLIGENCE; DOWNLOADABLE ELECTRONIC PUBLICATIONS IN THE NATURE OF BOOKS AND NEWSLETTERS FEATURING ADVICE IN THE FIELDS OF PARENTING AND RELATIONSHIPS, INSPIRATIONAL MESSAGES AND EMOTIONAL INTELLIGENCE RECORDED ON COMPUTER MEDIA (U.S. CLS. 21, 23, 26, 36 AND 38).

MAYUR VAGHANI, EXAMINING ATTORNEY

SN 77-821,705. ATHMA, VINAY, SUNNYVALE, CA. FILED 9-8-2009.

Ambient Raag

THE MARK CONSISTS OF STANDARD CHARACTERS WITHOUT CLAIM TO ANY PARTICULAR FONT, STYLE, SIZE, OR COLOR.

FOR COMPACT DISCS FEATURING MUSIC; COMPUTER SOFTWARE FEATURING MUSICAL SOUND RECORDINGS AND MUSICAL VIDEO RECORDINGS; DIGITAL MUSIC DOWNLOADABLE FROM THE INTERNET; DOWNLOADABLE MP3 FILES, MP3 RECORDINGS, ON-LINE DISCUSSION BOARDS, WEBCASTS AND PODCASTS FEATURING MUSIC, AUDIO BOOKS AND NEWS BROADCASTS; DOWNLOADABLE MUSICAL SOUND RECORDINGS; DOWNLOADABLE RING TONES, GRAPHICS AND MUSIC VIA A GLOBAL COMPUTER NETWORK AND WIRELESS DEVICES; DOWNLOADABLE MUSIC AND RINGTONES VIA THE INTERNET AND WIRELESS DEVICES (U.S. CLS. 21, 23, 26, 36 AND 38).

FIRST USE 8-15-2009; IN COMMERCE 8-15-2009.
CHRISTINA SOBRAL, EXAMINING ATTORNEY

CLASS 9—(Continued).

SN 77-822,167. UBER ENTERTAINMENT INC., KIRKLAND, WA. FILED 9-8-2009.

MONDAY NIGHT COMBAT

THE MARK CONSISTS OF STANDARD CHARACTERS WITHOUT CLAIM TO ANY PARTICULAR FONT, STYLE, SIZE, OR COLOR.

FOR VIDEO GAME SOFTWARE AND PROGRAMS AND ELECTRONIC AND MOBILE APPLICATIONS FOR THIRD-PERSON SHOOTER GAMES FOR PERSONAL COMPUTERS, HANDHELD COMPUTERS AND MOBILE DEVICES, HOME VIDEO GAME CONSOLES, PORTABLE GAMING SYSTEMS, AND ARCADE-BASED VIDEO GAME CONSOLES (U.S. CLS. 21, 23, 26, 36 AND 38).

MARC LEIPZIG, EXAMINING ATTORNEY

SN 77-823,859. GARMIN LTD., CAMANA BAY, CAYMAN ISLANDS, FILED 9-10-2009.

ECOROUTE

THE MARK CONSISTS OF STANDARD CHARACTERS WITHOUT CLAIM TO ANY PARTICULAR FONT, STYLE, SIZE, OR COLOR.

FOR COMPUTER SOFTWARE FOR PROCESSING AND TRANSMITTING TRAVEL DIRECTIONS (U.S. CLS. 21, 23, 26, 36 AND 38).

FIRST USE 1-0-2009; IN COMMERCE 1-0-2009.
LINDA E. BLOHM, EXAMINING ATTORNEY

SN 77-823,861. AZUL SYSTEMS, INC., MOUNTAIN VIEW, CA. FILED 9-10-2009.

AZUL BARE METAL

THE MARK CONSISTS OF STANDARD CHARACTERS WITHOUT CLAIM TO ANY PARTICULAR FONT, STYLE, SIZE, OR COLOR.

NO CLAIM IS MADE TO THE EXCLUSIVE RIGHT TO USE "BARE METAL", APART FROM THE MARK AS SHOWN.

THE ENGLISH TRANSLATION OF THE TERM "AZUL" IN THE MARK IS "BLUE."

FOR COMPUTER SOFTWARE AND OPERATING PROGRAM FOR OPERATING SYSTEM PROGRAMS, PROVIDING THEM WITH POLICY BASED RESOURCE CONTROLS, RESOURCE MONITORING, AND COOPERATIVE MANAGEMENT OF SHARED RESOURCES (U.S. CLS. 21, 23, 26, 36 AND 38).

BRIAN NEVILLE, EXAMINING ATTORNEY

CLASS 9—(Continued).

SN 77-824,001. GARMIN LTD., CAMANA BAY, CAYMAN ISLANDS, FILED 9-10-2009.



THE MARK CONSISTS OF A STYLIZED LEAF DESIGN AND THE STYLIZED WORD "ECOROUTE".
FOR COMPUTER SOFTWARE FOR PROCESSING AND TRANSMITTING TRAVEL DIRECTIONS (U.S. CLS. 21, 23, 26, 36 AND 38).
FIRST USE 1-0-2009; IN COMMERCE 1-0-2009.
LINDA E. BLOHM, EXAMINING ATTORNEY

SN 77-827,754. TITAN ENTERPRISES LIMITED, DORSET, UNITED KINGDOM, FILED 9-16-2009.

ATRATO

THE MARK CONSISTS OF STANDARD CHARACTERS WITHOUT CLAIM TO ANY PARTICULAR FONT, STYLE, SIZE, OR COLOR.

PRIORITY CLAIMED UNDER SEC. 44(D) ON ERP NCNTY TM OFC APPLICATION NO. 008292039, FILED 5-11-2009, REG. NO. 008292039, DATED 12-1-2009, EXPIRES 5-11-2019.

FOR FLOW MEASURING APPARATUS AND INSTRUMENTS, NAMELY, FLOW METERS, FLOW INDICATORS, AND FLOW SENSORS; INSTRUMENTS AND INSTRUMENTATION FOR USE WITH FLOW METERS, NAMELY, ANALOG CONVERTERS, BATCH CONTROLLERS, DIGITAL FLOW-RATE GAUGES, FLOW RATE COUNTERS, FLOW SWITCHES AND FLOW TOTALIZERS; PARTS AND FITTINGS FOR ALL THE AFORESAID GOODS (U.S. CLS. 21, 23, 26, 36 AND 38).

ANNE E. GUSTASON, EXAMINING ATTORNEY

SN 77-828,768. KELLY RESEARCH CORP., WAUKESHA, WI, FILED 9-17-2009.

SUPERFENCE

THE MARK CONSISTS OF STANDARD CHARACTERS WITHOUT CLAIM TO ANY PARTICULAR FONT, STYLE, SIZE, OR COLOR.

FOR PERIMETER SECURITY SYSTEMS COMPRISED PRIMARILY OF ANTI-INTRUSION DETECTORS, ALARMS AND MODULES FOR MOUNTING TO A BARRIER, AND CONTROLS AND MONITORS THAT INTERFACE WITH THE ANTI-INTRUSION DETECTORS, ALARMS AND MODULES FOR MAINTAINING SECURITY OF BUILDINGS, GROUNDS AND FACILITIES (U.S. CLS. 21, 23, 26, 36 AND 38).

MORGAN WYNNE, EXAMINING ATTORNEY

CLASS 9—(Continued).

SN 77-829,443. UNITED STATES DEPARTMENT OF HOMELAND SECURITY, WASHINGTON, DC. FILED 9-18-2009.

HAZUS

THE MARK CONSISTS OF STANDARD CHARACTERS WITHOUT CLAIM TO ANY PARTICULAR FONT, STYLE, SIZE, OR COLOR.

FOR COMPUTER SOFTWARE, NAMELY, EARTHQUAKE LOSS ESTIMATION SOFTWARE CONSISTING OF INVENTORY DATA COLLECTION SOFTWARE, GEOGRAPHICAL INFORMATION COLLECTION SOFTWARE, RISK ASSESSMENT SOFTWARE, FINANCIAL PLANNING SOFTWARE EMPLOYING A STANDARDIZED METHODOLOGY ON A REGIONAL AND NATIONAL LEVEL FOR USE IN PLANNING AND STIMULATING MITIGATION EFFORTS TO REDUCE LOSS FROM EARTHQUAKES AND PREPARING FOR EMERGENCY RESPONSE AND RECOVERY FOLLOWING A NATURAL DISASTER; TO PREPARE RAPID LOSS ESTIMATES FOLLOWING A NATURAL DISASTER; AND TO PROVIDE AN ASSESSMENT OF REGIONAL AND NATIONWIDE RISK OF LOSS AND ALLOCATION OF RESOURCES FOR FUTURE EVENTS AND EMERGENCY FUNDS AND TECHNICAL MANUALS DISTRIBUTED THEREWITH FOR USE WITH THE SOFTWARE (U.S. CLS. 21, 23, 26, 36 AND 38).

FIRST USE 3-28-1996; IN COMMERCE 3-28-1996.
CHRIS WELLS, EXAMINING ATTORNEY

SN 77-829,638. YALE SECURITY INC., MONROE, NC. FILED 9-18-2009.

SAFE ZONE

THE MARK CONSISTS OF STANDARD CHARACTERS WITHOUT CLAIM TO ANY PARTICULAR FONT, STYLE, SIZE, OR COLOR.

FOR ELECTROMECHANICAL DOOR OPERATORS NOT FOR USE IN CONNECTION WITH ELEVATORS; ELECTROMECHANICAL DOOR CLOSERS-HOLDERS NOT FOR USE IN CONNECTION WITH ELEVATORS (U.S. CLS. 21, 23, 26, 36 AND 38).

TAMARA FRAZIER, EXAMINING ATTORNEY

CLASS 9—(Continued).

SN 77-829,845. CURRENT COMMUNICATIONS SERVICES, LLC, GERMANTOWN, MD. FILED 9-18-2009.

CURRENT OPENGRID

THE MARK CONSISTS OF STANDARD CHARACTERS WITHOUT CLAIM TO ANY PARTICULAR FONT, STYLE, SIZE, OR COLOR.

OWNER OF U.S. REG. NOS. 3,060,968, 3,537,960 AND OTHERS.

NO CLAIM IS MADE TO THE EXCLUSIVE RIGHT TO USE "OPEN GRID", APART FROM THE MARK AS SHOWN.

FOR COMPUTER SOFTWARE FOR NETWORK MANAGEMENT, MANAGEMENT OF DATA, PROVIDING STATISTICAL ANALYSIS, PRODUCING NOTIFICATIONS AND REPORTS, AND ENSURING SECURITY OF DATA AND DISTRIBUTION OF NATURAL GAS AND ELECTRICITY; COMPUTER SOFTWARE PLATFORM FOR INTEGRATING ANY DEVICE INCLUDING INTELLIGENT SENSORS, CAPACITOR BANKS, TAP CHANGERS, RECLOSERS, SWITCHES, SUBSTATION DEVICES AND METERS WITH COMMUNICATION SYSTEMS, NAMELY, FIBER, 3G, WIRELESS, DSL CABLE, WIMAX AND BPL; COMPUTER SOFTWARE, NAMELY, AN APPLICATION THAT COMBINES REAL-TIME DATA TO ENABLE A DEVICE OR A PERSON TO TAKE SPECIFIC ACTION AT A SPECIFIC TIME AND PLACE TO IMPROVE EFFICIENCY AND RELIABILITY OF DISTRIBUTION AND TO FACILITATE THE INTEGRATION OF DISTRIBUTED NATURAL GAS AND ELECTRICITY (U.S. CLS. 21, 23, 26, 36 AND 38).

FIRST USE 2-0-2009; IN COMMERCE 2-0-2009.

TASNEEM HUSSAIN, EXAMINING ATTORNEY

SN 77-830,656. PROMISE TECHNOLOGY, INC., MILPITAS, CA. FILED 9-21-2009.

VESS

THE MARK CONSISTS OF STANDARD CHARACTERS WITHOUT CLAIM TO ANY PARTICULAR FONT, STYLE, SIZE, OR COLOR.

FOR COMPUTER HARDWARE FOR USE IN DATA MANAGEMENT AND DATA PROTECTION; COMPUTER HARDWARE FOR USE IN ENERGY MANAGEMENT ON COMPUTER STORAGE DEVICES, NAMELY, HARD DRIVES (U.S. CLS. 21, 23, 26, 36 AND 38).

B. PARADEWELAI, EXAMINING ATTORNEY

CLASS 9—(Continued).

SN 77-831,258. CLOUDLARK, LLC, SAN JUAN, PUERTO RICO, FILED 9-21-2009.



THE COLOR(S) BLACK, RED, YELLOW AND WHITE IS/ ARE CLAIMED AS A FEATURE OF THE MARK.

THE MARK CONSISTS OF THE WORDING "BE GOOD" WITH THE LETTERS "O" BEING REPRESENTED BY AN ANGEL AND DEVIL DESIGN. THE COLOR BLACK APPEARS IN THE LETTERS "BEG" AND "D!" AND IN THE EYES, MOUTHS, AND EYEBROWS OF FACIAL DESIGNS AND IN THE GOATEE AND HORNS IN THE DEVIL DESIGN; THE COLOR RED APPEARS IN THE BODY OF THE DEVIL DESIGN; THE COLOR YELLOW APPEARS IN THE BODY OF THE ANGEL DESIGN, IN THE HALO AND AS BACKGROUND IN THE EYES OF THE DEVIL; THE COLOR WHITE APPEARS IN THE DEVIL'S FANGS AND IN THE BACKGROUND OF THE ANGEL'S EYES.

FOR COMPUTER SOFTWARE FOR USE IN MANAGING AND TRACKING POINTS EARNED AND LOST BASED ON BEHAVIOR EXHIBITED BY CHILDREN AND IN WHICH THE POINTS MAY BE EXCHANGED FOR AWARDS (U.S. CLS. 21, 23, 26, 36 AND 38).

KAREN BRACEY, EXAMINING ATTORNEY

SN 77-831,816. STUDIOPLUS SOFTWARE LLC, CAMBRIDGE, MN. FILED 9-22-2009.



THE MARK CONSISTS OF THE WORDING "STUDIOPLUS" IN STYLIZED FORM, FOLLOWED BY A STYLIZED PLUS SYMBOL, I.E. "+".

FOR COMPUTER PROGRAMS FOR EDITING IMAGES, SOUND AND VIDEO; COMPUTER SOFTWARE FOR ORGANIZING AND VIEWING DIGITAL IMAGES AND PHOTOGRAPHS; COMPUTER SOFTWARE FOR THE COLLECTION, EDITING, ORGANIZING, MODIFYING, BOOK MARKING, TRANSMISSION, STORAGE AND SHARING OF DATA AND INFORMATION (U.S. CLS. 21, 23, 26, 36 AND 38).

FIRST USE 9-12-2000; IN COMMERCE 1-1-2003.

NANCY CLARKE, EXAMINING ATTORNEY

CLASS 9—(Continued).

SN 77-833,458. ZHANG, YANCHEN, SAN CLEMENTE, CA. FILED 9-23-2009.

AngleCube

THE MARK CONSISTS OF STANDARD CHARACTERS WITHOUT CLAIM TO ANY PARTICULAR FONT, STYLE, SIZE, OR COLOR.

FOR MEASUREMENT STANDARD DEVICES FOR NANOMETROLOGY, NAMELY, MEASURING TOOLS HAVING A PATTERN IN THE MICROMETER OR NANOMETER RANGES; TESTING EQUIPMENT FOR MEASURING THE TEMPERATURE, PRESSURE, POSITION OR FORM OF WORKPIECES IN A MACHINE TOOL; TOOL MEASURING INSTRUMENTS (U.S. CLS. 21, 23, 26, 36 AND 38).

FIRST USE 5-10-2008; IN COMMERCE 5-10-2008.
GEORGIA CARTY, EXAMINING ATTORNEY

CLASS 9—(Continued).

SN 77-833,820. MOBILE INSIGHT, LLC, MIAMI, FL. FILED 9-24-2009.

MOBILE INSIGHT

THE MARK CONSISTS OF STANDARD CHARACTERS WITHOUT CLAIM TO ANY PARTICULAR FONT, STYLE, SIZE, OR COLOR.

NO CLAIM IS MADE TO THE EXCLUSIVE RIGHT TO USE "MOBILE", APART FROM THE MARK AS SHOWN.

FOR DOWNLOADABLE SOFTWARE IN THE NATURE OF A MOBILE APPLICATION FOR GATHERING RELEVANT BUSINESS FIELD INFORMATION FOR SUBMISSION TO A DEDICATED WEB PORTAL, INCLUDING MONITORING EMPLOYEE FIELD WORK COMPLIANCE IN THE GATHERING OF SAID RELEVANT FIELD INFORMATION (U.S. CLS. 21, 23, 26, 36 AND 38).

FIRST USE 10-0-2007; IN COMMERCE 10-0-2007.
LINDA ORNDORFF, EXAMINING ATTORNEY

SN 77-833,661. BITSPower INTERNATIONAL CO., LTD., CHANGHUA COUNTY, TAIWAN, FILED 9-23-2009.



BitSpower

THE MARK CONSISTS OF A DRAGON IN A CIRCLE ON THE LEFT HAND SIDE OF THE MARK ALONG WITH THE WORD OF "BITSPower".

THE WORDING "BITSPower" HAS NO MEANING IN A FOREIGN LANGUAGE.

FOR TEMPERATURE CONTROLLER FOR COMPUTER HARDWARE AND PERIPHERALS, ELECTRIC CONTROL PANELS, CENTRAL PROCESSING UNIT (CPU) COOLERS, COMPUTER CARRYING CASES, RAM (RANDOM ACCESS MEMORY) CARD, COMPUTER HARDWARE, COMPUTER MOTHERBOARDS, COMPUTER GRAPHICS BOARDS, DISC STORAGE CONTAINERS, RADIO FREQUENCY IDENTIFICATION (RFID) TAGS, LAPTOP CARRYING CASES, BAGS AND CASES SPECIALLY ADAPTED FOR HOLDING OR CARRYING PORTABLE TELEPHONES AND TELEPHONE EQUIPMENT AND ACCESSORIES, COMPUTER GAME SOFTWARE DOWNLOADABLE FROM A GLOBAL COMPUTER NETWORK (U.S. CLS. 21, 23, 26, 36 AND 38).

FIRST USE 7-15-2003; IN COMMERCE 4-16-2004.
DAVID I, EXAMINING ATTORNEY

SN 77-833,845. MOBILE INSIGHT, LLC, MIAMI, FL. FILED 9-24-2009.

REAL-TIME INFORMATION. CUTTING-EDGE DELIVERY.

THE MARK CONSISTS OF STANDARD CHARACTERS WITHOUT CLAIM TO ANY PARTICULAR FONT, STYLE, SIZE, OR COLOR.

NO CLAIM IS MADE TO THE EXCLUSIVE RIGHT TO USE "REAL-TIME INFORMATION" AND "DELIVERY", APART FROM THE MARK AS SHOWN.

FOR DOWNLOADABLE SOFTWARE IN THE NATURE OF A MOBILE APPLICATION FOR GATHERING RELEVANT BUSINESS FIELD INFORMATION FOR SUBMISSION TO A DEDICATED WEB PORTAL, INCLUDING MONITORING EMPLOYEE FIELD WORK COMPLIANCE IN THE GATHERING OF SAID RELEVANT FIELD INFORMATION (U.S. CLS. 21, 23, 26, 36 AND 38).

FIRST USE 3-0-2008; IN COMMERCE 3-0-2008.
LINDA ORNDORFF, EXAMINING ATTORNEY

CLASS 9—(Continued).

SN 77-833,864. MOBILE INSIGHT, LLC, MIAMI, FL. FILED 9-24-2009.

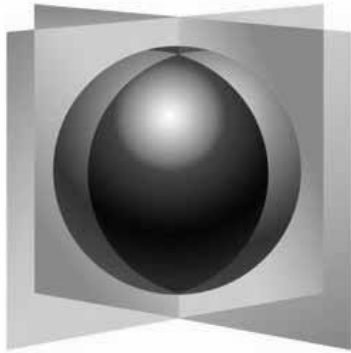

THE MARK CONSISTS OF A SPHERE CENTERED WITHIN A PLURALITY OF INTERSECTING WINDOW PANES.

FOR DOWNLOADABLE SOFTWARE IN THE NATURE OF A MOBILE APPLICATION FOR GATHERING RELEVANT BUSINESS FIELD INFORMATION FOR SUBMISSION TO A DEDICATED WEB PORTAL, INCLUDING MONITORING EMPLOYEE FIELD WORK COMPLIANCE IN THE GATHERING OF SAID RELEVANT FIELD INFORMATION (U.S. CLS. 21, 23, 26, 36 AND 38).

FIRST USE 10-0-2007; IN COMMERCE 10-0-2007.
LINDA ORNDORFF, EXAMINING ATTORNEY

CLASS 9—(Continued).

SN 77-835,326. PRO FORM SOLUTIONS, DBA PRO FORM SOLUTIONS, LA MESA, CA. FILED 9-25-2009.

pro form solutions

THE MARK CONSISTS OF STANDARD CHARACTERS WITHOUT CLAIM TO ANY PARTICULAR FONT, STYLE, SIZE, OR COLOR.

NO CLAIM IS MADE TO THE EXCLUSIVE RIGHT TO USE "FORM SOLUTIONS", APART FROM THE MARK AS SHOWN.

FOR DOWNLOADABLE ELECTRONIC DATA FILES AND DATABASES, NAMELY, BUSINESS AND TAX FORMS, FOR USE WITH COMPUTER SOFTWARE (U.S. CLS. 21, 23, 26, 36 AND 38).

PAM WILLIS, EXAMINING ATTORNEY

SN 77-837,072. KABUSHIKI KAISHA HUDSON, MINATOKU, TOKYO, JAPAN, FILED 9-29-2009.

High Stakes
Texas Hold'em

SN 77-834,737. JONES INVESTMENT CO. INC., WILMINGTON, DE. FILED 9-25-2009.

GLO JEANS

THE MARK CONSISTS OF STANDARD CHARACTERS WITHOUT CLAIM TO ANY PARTICULAR FONT, STYLE, SIZE, OR COLOR.

OWNER OF U.S. REG. NOS. 2,529,980 AND 2,810,991.
FOR EYEWEAR (U.S. CLS. 21, 23, 26, 36 AND 38).
LINDA ORNDORFF, EXAMINING ATTORNEY

NO CLAIM IS MADE TO THE EXCLUSIVE RIGHT TO USE "TEXAS HOLD'EM" AND THE CONFIGURATION OF POKER CHIPS AND PLAYING CARDS, APART FROM THE MARK AS SHOWN.

THE MARK CONSISTS OF THE WORDING "HIGH STAKES" WITH THE WORDING "TEXAS HOLD'EM" DIRECTLY UNDER THE WORDING "HIGH STAKES". THERE ARE THREE POKER CHIPS AND TWO PLAYING CARDS TO THE RIGHT OF THE WORDING "HIGH STAKES". THE POKER CHIPS HAVE DASHES AROUND THE EDGES AND A "S" IN THE CENTER. THE PLAYING CARD ON THE LEFT IS AN ACE OF HEARTS. THE PLAYING CARD ON THE RIGHT IS AN ACE OF SPADES WITH THE WORD "HUDSON" AND A HONEYBEE DESIGN IN THE CENTER.

FOR COMPUTER VIDEO GAME PROGRAMS; COMPUTER VIDEO GAME PROGRAMS FOR MOBILE PHONES; COMPUTER VIDEO GAME SOFTWARE; COMPUTER VIDEO GAME PROGRAMS DOWNLOADABLE VIA A TELECOMMUNICATIONS NETWORK; IMAGE AND SOUND FILES OF VIDEO GAMES DOWNLOADABLE VIA A TELECOMMUNICATIONS NETWORK; CARTRIDGES, CASSETTES, CARDS AND DISCS CONTAINING PRE-RECORDED COMPUTER VIDEO GAME PROGRAMS (U.S. CLS. 21, 23, 26, 36 AND 38).

ZACHARY BELLO, EXAMINING ATTORNEY

CLASS 9—(Continued).

SN 77-837,112. IN TOUCH MINISTRIES, INC., ATLANTA, GA. FILED 9-29-2009.

IN TOUCH

THE MARK CONSISTS OF STANDARD CHARACTERS WITHOUT CLAIM TO ANY PARTICULAR FONT, STYLE, SIZE, OR COLOR.

OWNER OF U.S. REG. NOS. 1,211,426 AND 1,332,925.
FOR HOUSE MARK FOR A FULL LINE OF AUDIO AND VIDEO RECORDINGS, DOWNLOADABLE AUDIO AND VIDEO RECORDINGS, ELECTRONIC PUBLICATIONS RECORDED ON ELECTRONIC MEDIA, DOWNLOADABLE PUBLICATIONS IN THE NATURE OF ARTICLES, DEVOTIONALS, AND MAGAZINES, NEWSLETTERS AND BOOKS THAT ARE DOWNLOADABLE OR RECORDED ON ELECTRONIC MEDIA, PRE-RECORDED COMPACT DISCS AND DVDS, ALL IN THE FIELDS OF SPIRITUALITY, RELIGION, ETHICS, SOCIAL ISSUES, CULTURAL ISSUES, RELATIONSHIPS, AND LIFESTYLE (U.S. CLS. 21, 23, 26, 36 AND 38).
FIRST USE 1-0-1977; IN COMMERCE 1-0-1977.
SOPHIA S. KIM, EXAMINING ATTORNEY

CLASS 9—(Continued).

SN 77-839,710. HUISH SCUBA, LLC, DBA HUISH DIVERS, LLC, SALT LAKE CITY, UT. FILED 10-1-2009.



NO CLAIM IS MADE TO THE EXCLUSIVE RIGHT TO USE "DIVERS", APART FROM THE MARK AS SHOWN.

THE MARK CONSISTS OF THE WORDS "HUISH DIVERS" IN STYLIZED FONT BELOW A LOGO. THE LOGO CONSISTS OF THE LETTERS "HD" WHICH ARE DRAWN TO GENERALLY RESEMBLE A SHARK.

FOR SNORKEL VESTS; FIRST AND SECOND STAGE REGULATORS FOR USE IN SCUBA DIVING; BUOYANCY COMPENSATOR DEVICES FOR DIVERS; INFLATORS FOR USE WITH BUOYANCY COMPENSATOR DEVICES; DIVE COMPUTERS AND CONSOLES FOR UNDERWATER USE; DIVING COMPASSES; DIVING GAUGES AND INSTRUMENTATION, NAMELY, PRESSURE GAUGES, DEPTH GAUGES, TEMPERATURE GAUGES, DIVING COMPUTERS, AND PRESSURE TRANSMITTERS USED FOR SCUBA DIVING; SCUBA MASKS, DIVE FLAGS, SNORKELS, AND UNDERWATER CAMERAS (U.S. CLS. 21, 23, 26, 36 AND 38).
REGINA DRUMMOND, EXAMINING ATTORNEY

SN 77-837,119. IN TOUCH MINISTRIES, INC., ATLANTA, GA. FILED 9-29-2009.

IN TOUCH MINISTRIES

THE MARK CONSISTS OF STANDARD CHARACTERS WITHOUT CLAIM TO ANY PARTICULAR FONT, STYLE, SIZE, OR COLOR.

OWNER OF U.S. REG. NOS. 1,211,426 AND 1,332,925.
NO CLAIM IS MADE TO THE EXCLUSIVE RIGHT TO USE "MINISTRIES", APART FROM THE MARK AS SHOWN.
FOR HOUSE MARK FOR A FULL LINE OF AUDIO AND VIDEO RECORDINGS, DOWNLOADABLE AUDIO AND VIDEO RECORDINGS, ELECTRONIC PUBLICATIONS RECORDED ON ELECTRONIC MEDIA, DOWNLOADABLE PUBLICATIONS IN THE NATURE OF ARTICLES, DEVOTIONALS, AND MAGAZINES, NEWSLETTERS AND BOOKS THAT ARE DOWNLOADABLE OR RECORDED ON ELECTRONIC MEDIA, PRE-RECORDED COMPACT DISCS AND DVDS, ALL IN THE FIELDS OF SPIRITUALITY, RELIGION, ETHICS, SOCIAL ISSUES, CULTURAL ISSUES, RELATIONSHIPS, AND LIFESTYLE (U.S. CLS. 21, 23, 26, 36 AND 38).
FIRST USE 5-0-1979; IN COMMERCE 5-0-1979.
SOPHIA S. KIM, EXAMINING ATTORNEY

SN 77-840,818. GATLING, CLARA INGRAM, MAUMELLE, AR. AND GATLING, JERRY B., MAUMELLE, AR. FILED 10-3-2009.

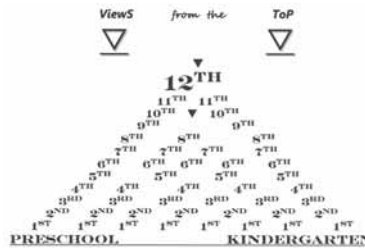

NO CLAIM IS MADE TO THE EXCLUSIVE RIGHT TO USE "PRESCHOOL", "KINDERGARTEN", "1ST", "2ND", "3RD", "4TH", "5TH", "6TH", "7TH", "8TH", "9TH", "10TH", "11TH" AND "12TH", APART FROM THE MARK AS SHOWN.

THE MARK CONSISTS OF THE PHRASE "VIEWS FROM THE TOP" WITH A TRIANGLE POINTED DOWN OVER A LINE BELOW EACH OF THE WORDS "VIEWS" AND "TOP"; ALL ABOVE A PYRAMID FORMED FROM THE NUMBERS "1ST" THROUGH "12TH" WITH "12TH" AT THE TOP OF THE PYRAMID UNDER A TRIANGLE POINTED DOWN, AND WITH THE WORDS "PRESCHOOL" AND "KINDERGARTEN" UNDERLINED AT THE BOTTOM.
FOR COMPUTER SOFTWARE FOR EVALUATING TEACHER PERFORMANCE BASED ON STUDENT ACHIEVEMENT (U.S. CLS. 21, 23, 26, 36 AND 38).
JASON TURNER, EXAMINING ATTORNEY

CLASS 9—(Continued).

SN 77-846,656. FRESenius MEDICAL CARE HOLDINGS, INC., WALTHAM, MA. FILED 10-12-2009.

CHAIRSIDE

THE MARK CONSISTS OF STANDARD CHARACTERS WITHOUT CLAIM TO ANY PARTICULAR FONT, STYLE, SIZE, OR COLOR.

FOR COMPUTER SOFTWARE FOR USE IN DIALYSIS CLINICS, NAMELY, SOFTWARE USED TO RECORD DIALYSIS MACHINE TREATMENT PARAMETERS, PERFORM DIALYSIS MACHINE SAFETY CHECKS, RECORD AND MONITOR PATIENT VITAL SIGNS, RECORD LABORATORY TEST REQUESTS AND RECORD POST-TREATMENT EVALUATION DATA (U.S. CLS. 21, 23, 26, 36 AND 38).

FIRST USE 11-30-2005; IN COMMERCE 11-30-2005.
BARBARA A. GOLD, EXAMINING ATTORNEY

CLASS 9—(Continued).

SN 77-848,793. IMATION CORP., OAKDALE, MN. FILED 10-14-2009.



THE MARK CONSISTS OF A STYLIZED HUMAN FIGURE IN THE FORM OF AN "X" IN REVERSE TONES WITHIN A SOLID SQUARE WITH ROUNDED CORNERS.

FOR CONSUMER ELECTRONICS, NAMELY, PORTABLE MULTIMEDIA PLAYERS, DIGITAL AUDIO PLAYERS AND RECORDERS, MP3 PLAYERS, PERSONAL DIGITAL ASSISTANTS (PDAS), DVD PLAYERS AND RECORDERS, COMPUTER GAME CONSOLES FOR USE WITH AN EXTERNAL DISPLAY SCREEN OR MONITOR, DIGITAL CAMERAS, AND MOBILE PHONES, LAPTOP COMPUTERS, TELEVISIONS, SATELLITE DISH RECEIVERS, HOME AND AUTOMOBILE STEREO SYSTEMS COMPRISING STEREO SPEAKERS AND STEREO RECEIVERS, AND HARD DISK DRIVES; ACCESSORIES FOR HAND HELD DIGITAL ELECTRONIC DEVICES, NAMELY, ELECTRONIC DOCKING CONNECTORS, DOCKING STANDS AND CRADLES, AND DOCKING STATIONS; BATTERIES AND BATTERY PACKS; BATTERY CHARGERS; TRAVEL CHARGING KITS COMPRISING ELECTRIC CHARGING CABLES AND ADAPTERS; ELECTRICAL CONNECTORS, WIRES, CABLES, ADAPTERS, AND USB (UNIVERSAL SERIAL BUS) HARDWARE IN THE NATURE OF COMPUTER PERIPHERALS; HIGH DENSITY MULTIMEDIA INTERFACE (HDMI) APPARATUS, NAMELY, PORTS, CABLES AND SWITCHES; WIRED AND WIRELESS REMOTE CONTROLS FOR AUTOMOBILE AND HOME AUDIO DEVICES; REMOTE CONTROL TRANSMITTER FOR RADIO-CONTROLLED DEVICES; STEREO AMPLIFIERS AND SPEAKER BASE STATIONS IN THE NATURE OF SPEAKER ENCLOSURES; AUDIO SYSTEMS COMPRISING AUDIO SPEAKERS AND AUDIO-VIDEO RECEIVERS; AUDIO RECORDERS; IMAGE SCANNERS, VIDEO SCREENS AND MEDIA READERS IN THE NATURE OF FLASH CARD READERS; PROTECTIVE SLEEVES, SCREEN PROTECTORS, STORAGE CASES, BAGS AND CARRYING CASES, ALL SPECIFICALLY ADAPTED FOR HAND-HELD DIGITAL ELECTRONIC DEVICES, PORTABLE MULTIMEDIA PLAYERS, DIGITAL AUDIO PLAYERS, AND MOBILE PHONES; ATTACHMENT DEVICES, NAMELY, HOLDERS, STRAPS, ARMBANDS, LANYARDS, AND BELT CLIPS SPECIALLY ADAPTED FOR HANDHELD DIGITAL ELECTRONIC DEVICES, PORTABLE MULTIMEDIA PLAYERS, DIGITAL AUDIO PLAYERS, AND MOBILE PHONES (U.S. CLS. 21, 23, 26, 36 AND 38).

STEVEN PEREZ, EXAMINING ATTORNEY

SN 77-847,908. KABBALAH CENTRE INTERNATIONAL, INC., LOS ANGELES, CA. FILED 10-13-2009.



OWNER OF U.S. REG. NOS. 2,709,764, 2,885,664 AND OTHERS.

THE COLOR(S) GRAY, AQUA BLUE AND MAROON IS/ARE CLAIMED AS A FEATURE OF THE MARK.

THE MARK CONSISTS OF A SERIES OF DOTS CONNECTED BY LINES FORMING AN AQUA BLUE GEOMETRIC DESIGN, WITH A SMALL STYLIZED GRAY LION DESIGN TO ITS LEFT, AND TO ITS RIGHT THE WORDS "THE KABBALAH CENTRE" IN MAROON ABOVE THE WORDS "LEARN TRANSFORM CONNECT" IN GRAY.

SEC. 2(F) AS TO "THE KABBALAH CENTRE".

FOR AUDIO AND VIDEO RECORDINGS FEATURING RELIGION AND SPIRITUALITY (U.S. CLS. 21, 23, 26, 36 AND 38).

COLLEEN KEARNEY, EXAMINING ATTORNEY

CLASS 9—(Continued).

SN 77-853,137. SHARK EYES, INC., LOS ANGELES, CA. FILED 5-12-2010.



THE MARK CONSISTS OF A BACKWARD CAPITAL "G" WITH A CONNECTING FORWARD "C".
FOR SUNGLASSES AND SPECTACLES (U.S. CLS. 21, 23, 26, 36 AND 38).
FIRST USE 5-22-2008; IN COMMERCE 5-22-2008.
FLORENTINA BLANDU, EXAMINING ATTORNEY

SN 77-854,220. HEWLETT-PACKARD DEVELOPMENT COMPANY, L.P., HOUSTON, TX. FILED 10-21-2009.

INGENIUM

THE MARK CONSISTS OF STANDARD CHARACTERS WITHOUT CLAIM TO ANY PARTICULAR FONT, STYLE, SIZE, OR COLOR.
FOR COMPUTER SOFTWARE FOR THE ADMINISTRATION OF INSURANCE POLICIES (U.S. CLS. 21, 23, 26, 36 AND 38).
FIRST USE 10-0-1995; IN COMMERCE 10-0-1995.
JOHN KELLY, EXAMINING ATTORNEY

SN 77-855,166. THORLABS, INC., NEWTON, NJ. FILED 10-22-2009.

POLARIS

THE MARK CONSISTS OF STANDARD CHARACTERS WITHOUT CLAIM TO ANY PARTICULAR FONT, STYLE, SIZE, OR COLOR.
FOR MOUNTS FOR SCIENTIFIC AND TECHNICAL APPARATUS, NAMELY, OPTICAL MIRRORS (U.S. CLS. 21, 23, 26, 36 AND 38).
FIRST USE 9-30-2009; IN COMMERCE 10-9-2009.
STEVEN R. FINE, EXAMINING ATTORNEY

CLASS 9—(Continued).

SN 77-855,693. CRESTRON ELECTRONICS, INC., ROCKLEIGH, NJ. FILED 10-23-2009.

Prodagio

THE MARK CONSISTS OF STANDARD CHARACTERS WITHOUT CLAIM TO ANY PARTICULAR FONT, STYLE, SIZE, OR COLOR.

THE WORDING "PRODAGIO" HAS NO MEANING IN A FOREIGN LANGUAGE.

FOR MULTIMEDIA DISTRIBUTION ACCESSORIES, NAMELY, SIGNAL ROUTERS FOR COMPUTER NETWORKS AND AMPLIFIERS, COMPUTER HARDWARE IN THE NATURE OF AUDIO AND VIDEO INTERFACE MODULES AND PANELS, AUDIO AND VIDEO INTERFACE CABLES, SIGNAL POWER WIRE, SIGNAL PROCESSORS, AND SIGNAL CONVERTERS; AUDIO AND VIDEO ELECTRICAL WIRES, AMPLIFIERS, RADIO TUNERS AND SURROUND SOUND EQUIPMENT, NAMELY, AUDIO PROCESSORS AND AMPLIFIERS, ELECTRICAL CABLES AND ELECTRIC CONTROL PANELS (U.S. CLS. 21, 23, 26, 36 AND 38).

MELISSA VALLILLO, EXAMINING ATTORNEY

SN 77-855,811. VIZUALL, INC., AKA SCHEDUALL, HOLLYWOOD, FL. FILED 10-23-2009.

SCHEDULINK

THE MARK CONSISTS OF STANDARD CHARACTERS WITHOUT CLAIM TO ANY PARTICULAR FONT, STYLE, SIZE, OR COLOR.

FOR COMPUTER SOFTWARE FOR MANAGING AND SCHEDULING BROADCAST TRANSMISSIONS FOR SATELLITE AND TERRESTRIAL NETWORKS, INCLUDING SCHEDULING, CONFLICT MANAGEMENT, BANDWIDTH CAPACITY MANAGEMENT, BUSINESS ANALYSIS, REPORTING AND INVOICING (U.S. CLS. 21, 23, 26, 36 AND 38).

FIRST USE 7-31-2001; IN COMMERCE 7-31-2001.

LINDSEY RUBIN, EXAMINING ATTORNEY

CLASS 9—(Continued).

SN 77-857,405. CHUANG, MICHAEL, EL CERRITO, CA. FILED 10-26-2009.



NO CLAIM IS MADE TO THE EXCLUSIVE RIGHT TO USE "5 IN A ROW", APART FROM THE MARK AS SHOWN. THE MARK CONSISTS OF "5 IN A ROW" CHALLENGE. FOR CELL PHONE GAMES, NAMELY, DOWNLOADABLE ELECTRONIC GAME PROGRAMS (U.S. CLS. 21, 23, 26, 36 AND 38).

FIRST USE 10-26-2009; IN COMMERCE 10-26-2009. FLORENTINA BLANDU, EXAMINING ATTORNEY

SN 77-863,785. HALE PRODUCTS, INC., CONSHOHOCKEN, PA. FILED 11-3-2009.

VDR View

THE MARK CONSISTS OF STANDARD CHARACTERS WITHOUT CLAIM TO ANY PARTICULAR FONT, STYLE, SIZE, OR COLOR.

NO CLAIM IS MADE TO THE EXCLUSIVE RIGHT TO USE "VDR", APART FROM THE MARK AS SHOWN.

FOR COMPUTER SOFTWARE FOR DOWNLOADING VEHICLE INFORMATION TO A SPREADSHEET FORM (U.S. CLS. 21, 23, 26, 36 AND 38).

FIRST USE 8-4-2009; IN COMMERCE 8-4-2009. LINDA M. KING, EXAMINING ATTORNEY

SN 77-864,345. BIZWORLD FOUNDATION, SAN FRANCISCO, CA. FILED 11-3-2009.

BIZWORLD

THE MARK CONSISTS OF STANDARD CHARACTERS WITHOUT CLAIM TO ANY PARTICULAR FONT, STYLE, SIZE, OR COLOR.

OWNER OF U.S. REG. NO. 2,385,392.

FOR DOWNLOADABLE ELECTRONIC PUBLICATIONS, NAMELY, COURSE CURRICULUM IN THE FIELDS OF ENTREPRENEURSHIP, BUSINESS, MANAGEMENT, MARKETING, AND FINANCE VIA THE INTERNET (U.S. CLS. 21, 23, 26, 36 AND 38).

STEPHANIE ALI, EXAMINING ATTORNEY

CLASS 9—(Continued).

SN 77-864,353. INBORNE TECHNOLOGY CORPORATION, MESA, AZ. FILED 11-3-2009.

LUMIAMD

THE MARK CONSISTS OF STANDARD CHARACTERS WITHOUT CLAIM TO ANY PARTICULAR FONT, STYLE, SIZE, OR COLOR.

FOR COMPUTER SOFTWARE FOR MANAGING FRONT OFFICE FUNCTIONS AND BACK OFFICE FUNCTIONS IN THE MEDICAL FIELD, NAMELY, DATABASE MANAGEMENT SOFTWARE USED TO SCHEDULE APPOINTMENTS, CREATE INVOICES, TRACK PAYMENTS, AND UPDATE PATIENT INFORMATION (U.S. CLS. 21, 23, 26, 36 AND 38).

STEPHANIE ALI, EXAMINING ATTORNEY

SN 77-865,442. THE HOUSE ON F STREET, LLC, CLEVELAND, OH. FILED 11-4-2009.

SPY IN THE CITY

THE MARK CONSISTS OF STANDARD CHARACTERS WITHOUT CLAIM TO ANY PARTICULAR FONT, STYLE, SIZE, OR COLOR.

FOR COMPUTER OPERATING SOFTWARE FOR SMART PHONES WITH EMBEDDED GPS AND MAPPING SOFTWARE APPLICATIONS; COMPUTER GAME SOFTWARE FOR SMART PHONES, AND INSTRUCTIONAL MANUALS SOLD TOGETHER THEREWITH AS A UNIT (U.S. CLS. 21, 23, 26, 36 AND 38).

SUSAN STIGLITZ, EXAMINING ATTORNEY

SN 77-868,946. BEIJING FUGUANG RUIFENG TECHNOLOGY CO., LTD., HAIDIAN DIST., BEIJING, CHINA, FILED 11-10-2009.



THE NON-LATIN CHARACTERS IN THE MARK TRANSLITERATE TO "SENWAY", AND THIS MEANS "ASCENDANT" AND "POWERFUL" IN ENGLISH.

FOR APPARATUS FOR RECORDING, TRANSMISSION OR REPRODUCTION OF SOUND AND IMAGES (U.S. CLS. 21, 23, 26, 36 AND 38).

FIRST USE 1-1-2007; IN COMMERCE 1-1-2007.

MARIA-VICTORIA SUAREZ, EXAMINING ATTORNEY

CLASS 9—(Continued).

SN 77-870,606. ROSE RADIOLOGY, LLC, BELLAIRE, TX. FILED 11-11-2009.

MOUSER

THE MARK CONSISTS OF STANDARD CHARACTERS WITHOUT CLAIM TO ANY PARTICULAR FONT, STYLE, SIZE, OR COLOR.

FOR COMPUTER SOFTWARE FOR MANAGING OTHER SOFTWARE APPLICATIONS SUCH AS WORD PROCESSING, DATABASE, IMAGING, AND OTHER SOFTWARE APPLICATIONS FOUND ON A COMPUTER; COMPUTER SOFTWARE FOR MANAGEMENT OF MULTIPLE SOFTWARE APPLICATIONS; COMPUTER SOFTWARE FOR AUTOMATED VIEWING, ARRANGING, AND EXECUTING OF MULTIPLE SOFTWARE APPLICATIONS (U.S. CLS. 21, 23, 26, 36 AND 38).
COLLEEN DOMBROW, EXAMINING ATTORNEY

CLASS 9—(Continued).

SN 77-872,114. DUCK CREEK TECHNOLOGIES, INC., BOLIVAR, MO. FILED 11-13-2009.



OWNER OF U.S. REG. NOS. 2,610,474 AND 2,885,657.
NO CLAIM IS MADE TO THE EXCLUSIVE RIGHT TO USE "TECHNOLOGIES", APART FROM THE MARK AS SHOWN.

THE MARK CONSISTS OF AN IMAGE OF A DUCK WITH ITS WATER REFLECTION AND THE WORDS "DUCK CREEK" ABOVE THE WORD "TECHNOLOGIES".

FOR SOFTWARE FOR USE IN DEVELOPING AND MANAGING INSURANCE PRODUCTS RELATED TO INSURANCE-RELATED UNDERWRITING, RATING, QUOTE MANAGEMENT, PROPOSALS, APPLICATIONS, BROKERAGE, ENROLLMENT AND POLICY SERVICES IN THE FIELDS OF COMMERCIAL, AUTO, HOMEOWNERS, FIRE, SPECIALTY, LIFE, HEALTH, PROPERTY, CASUALTY, ACCIDENT AND ANNUITY INSURANCE (U.S. CLS. 21, 23, 26, 36 AND 38).
FIRST USE 12-1-2005; IN COMMERCE 12-1-2005.
MARC LEIPZIG, EXAMINING ATTORNEY

SN 77-872,088. DUCK CREEK TECHNOLOGIES, INC., BOLIVAR, MO. FILED 11-13-2009.

DUCK CREEK

THE MARK CONSISTS OF STANDARD CHARACTERS WITHOUT CLAIM TO ANY PARTICULAR FONT, STYLE, SIZE, OR COLOR.

OWNER OF U.S. REG. NOS. 2,610,474 AND 2,885,657.
FOR SOFTWARE FOR USE IN DEVELOPING AND MANAGING INSURANCE PRODUCTS RELATED TO INSURANCE-RELATED UNDERWRITING, RATING, QUOTE MANAGEMENT, PROPOSALS, APPLICATIONS, BROKERAGE, ENROLLMENT AND POLICY SERVICES IN THE FIELDS OF COMMERCIAL, AUTO, HOMEOWNERS, FIRE, SPECIALTY, LIFE, HEALTH, PROPERTY, CASUALTY, ACCIDENT AND ANNUITY INSURANCE (U.S. CLS. 21, 23, 26, 36 AND 38).
FIRST USE 12-1-2005; IN COMMERCE 12-1-2005.
MARC LEIPZIG, EXAMINING ATTORNEY

SN 77-872,871. ANOBIT TECHNOLOGIES LTD., HERZLIYA, ISRAEL, FILED 11-15-2009.

ADD ANOTHER BIT

THE MARK CONSISTS OF STANDARD CHARACTERS WITHOUT CLAIM TO ANY PARTICULAR FONT, STYLE, SIZE, OR COLOR.

FOR INTEGRATED CIRCUIT DEVICES, NAMELY, COMPUTER MEMORY CHIPS AND MEMORY CONTROLLER CHIPS, AND ELECTRONIC APPARATUS CONTAINING SUCH INTEGRATED CIRCUIT DEVICES, NAMELY, COMPUTERS, DATA STORAGE DEVICES, NAMELY, FIXED AND REMOVABLE COMPUTER STORAGE DRIVES IN THE NATURE OF HARD DISK DRIVES AND FLASH DRIVES, DIGITAL CAMERAS, DIGITAL VIDEO AND AUDIO RECORDERS AND PLAYERS, AND PORTABLE COMMUNICATION AND COMPUTING DEVICES, NAMELY, CELLULAR TELEPHONES, PERSONAL DIGITAL ASSISTANTS, AND WIRELESS COMMUNICATION DEVICES, NAMELY, TRANSMITTERS AND RECEIVERS OF VIDEO, AUDIO AND TEXT DATA (U.S. CLS. 21, 23, 26, 36 AND 38).
NATALIE POLZER, EXAMINING ATTORNEY

CLASS 9—(Continued).

SN 77-873,525. DUCK CREEK TECHNOLOGIES, INC., BOLIVAR, MO. FILED 11-16-2009.



THE MARK CONSISTS OF AN IMAGE OF A DUCK WITH ITS WATER REFLECTION.

FOR SOFTWARE FOR USE IN DEVELOPING AND MANAGING INSURANCE PRODUCTS RELATED TO INSURANCE-RELATED UNDERWRITING, RATING, QUOTE MANAGEMENT, PROPOSALS, APPLICATIONS, BROKERAGE, ENROLLMENT AND POLICY SERVICES IN THE FIELDS OF COMMERCIAL, AUTO, HOMEOWNERS, FIRE, SPECIALTY, LIFE, HEALTH, PROPERTY, CASUALTY, ACCIDENT AND ANNUITY INSURANCE (U.S. CLS. 21, 23, 26, 36 AND 38).

FIRST USE 1-1-2006; IN COMMERCE 1-1-2006.
MARC LEIPZIG, EXAMINING ATTORNEY

SN 77-873,567. DUCK CREEK TECHNOLOGIES, INC., BOLIVAR, MO. FILED 11-16-2009.



OWNER OF U.S. REG. NOS. 2,610,474 AND 2,885,657.
NO CLAIM IS MADE TO THE EXCLUSIVE RIGHT TO USE "TECHNOLOGIES", APART FROM THE MARK AS SHOWN.

THE MARK CONSISTS OF AN IMAGE OF A DUCK WITH ITS WATER REFLECTION AND THE WORDS "DUCK CREEK" ABOVE THE WORD "TECHNOLOGIES".

FOR SOFTWARE FOR USE IN DEVELOPING AND MANAGING INSURANCE PRODUCTS RELATED TO INSURANCE-RELATED UNDERWRITING, RATING, QUOTE MANAGEMENT, PROPOSALS, APPLICATIONS, BROKERAGE, ENROLLMENT AND POLICY SERVICES IN THE FIELDS OF COMMERCIAL, AUTO, HOMEOWNERS, FIRE, SPECIALTY, LIFE, HEALTH, PROPERTY, CASUALTY, ACCIDENT AND ANNUITY INSURANCE (U.S. CLS. 21, 23, 26, 36 AND 38).

FIRST USE 1-1-2006; IN COMMERCE 1-1-2006.
MARC LEIPZIG, EXAMINING ATTORNEY

CLASS 9—(Continued).

SN 77-876,008. WATERFALL SECURITY SOLUTIONS LTD., ROSH HAAYIN, ISRAEL, FILED 11-19-2009.

ONE WAY TO CONNECT

THE MARK CONSISTS OF STANDARD CHARACTERS WITHOUT CLAIM TO ANY PARTICULAR FONT, STYLE, SIZE, OR COLOR.

FOR COMPUTER HARDWARE AND SOFTWARE FOR ELECTRONIC DATA SECURITY (U.S. CLS. 21, 23, 26, 36 AND 38).

FIRST USE 3-1-2008; IN COMMERCE 9-1-2009.
WARREN L. OLANDRIA, EXAMINING ATTORNEY

SN 77-877,445. COBY ELECTRONICS CORPORATION, LAKE SUCCESS, NY. FILED 11-20-2009.

JAMMERZ XTRA

THE MARK CONSISTS OF STANDARD CHARACTERS WITHOUT CLAIM TO ANY PARTICULAR FONT, STYLE, SIZE, OR COLOR.

OWNER OF U.S. REG. NO. 3,636,192.

NO CLAIM IS MADE TO THE EXCLUSIVE RIGHT TO USE "EXTRA", APART FROM THE MARK AS SHOWN.

FOR AUDIO HEADPHONES; EAR PHONES; EARPHONE ACCESSORIES, NAMELY, EARPHONE CUSHIONS, EARPHONE PADS, CORD MANAGEMENT SYSTEMS, EARPHONE CASES, AND EARPHONE EXTENSION CORDS; EARPHONES; EARPHONES AND HEADPHONES; HANDS FREE DEVICES FOR MOBILEPHONES; HEADPHONES; HEADPHONES INCLUDING ATTACHED LANYARD; PERSONAL HEADPHONES FOR SOUND TRANSMITTING APPARATUSES; PERSONAL HEADPHONES FOR USE WITH SOUND TRANSMITTING SYSTEMS; STEREO HEADPHONES (U.S. CLS. 21, 23, 26, 36 AND 38).

FIRST USE 10-21-2009; IN COMMERCE 10-21-2009.
ERIN FALK, EXAMINING ATTORNEY

SN 77-878,025. SPINTOUCH, INC., SANTA ANA, CA. FILED 11-20-2009.

IBAR

THE MARK CONSISTS OF STANDARD CHARACTERS WITHOUT CLAIM TO ANY PARTICULAR FONT, STYLE, SIZE, OR COLOR.

FOR COMPUTER DISPLAY AND INPUT SYSTEM COMPRISED OF A MULTIMEDIA PROJECTOR, CAMERA AND COMPUTER SOFTWARE FOR DISPLAYING IMAGES AND DETECTING OBJECTS, USER GESTURES AND COMMANDS (U.S. CLS. 21, 23, 26, 36 AND 38).

KATHLEEN LORENZO, EXAMINING ATTORNEY

CLASS 9—(Continued).

SN 77-878,345. GAVRILOVIC, MILAN, DBA MIGA, CUMMING, GA. FILED 11-22-2009.



THE MARK CONSISTS OF A HEART-SHAPED HORNED SKULL RESEMBLING AN ALIEN, FEATURING TWO ELLIPTICAL EYE SOCKETS, RESPECTIVELY, TO THE LEFT AND RIGHT OF THE CENTER OF THE SKULL, WITH A TRIANGULAR NOSE FEATURING TWO NOSTRILS. ADJACENT TO THE SKULL THE LETTERS "MIGA" APPEAR ITALICIZED IN UPPER CASE LETTERS.

THE ENGLISH TRANSLATION OF "MIGA" IN THE MARK IS CRUMB.

FOR ARTICLES OF PROTECTIVE CLOTHING FOR WEAR BY MOTORCYCLISTS FOR PROTECTION AGAINST ACCIDENT OR INJURY; CLOTHING FOR PROTECTION AGAINST ACCIDENTS, IRRADIATION AND FIRE; INSULATING CLOTHING FOR PROTECTION AGAINST ACCIDENT OR INJURY; MOTORCYCLE GOGGLES; MOTORCYCLE HELMETS; PROTECTIVE CLOTHING; PROTECTIVE CLOTHING AND HEADGEAR; REFLECTIVE AND ILLUMINATED CLOTHING FOR SAFETY PURPOSES; SAFETY PRODUCTS, NAMELY, EMBROIDERED REFLECTIVE PATCHES TO BE WORN ON CLOTHING (U.S. CLS. 21, 23, 26, 36 AND 38).

FIRST USE 10-5-2009; IN COMMERCE 10-19-2009.
ESTHER BELENKER, EXAMINING ATTORNEY

CLASS 9—(Continued).

SN 77-879,721. SOURCE MEDICAL SOLUTIONS, INC., BIRMINGHAM, AL. FILED 11-24-2009.

SOURCEMEDICAL

THE MARK CONSISTS OF STANDARD CHARACTERS WITHOUT CLAIM TO ANY PARTICULAR FONT, STYLE, SIZE, OR COLOR.

OWNER OF U.S. REG. NOS. 2,786,950, 2,967,454 AND OTHERS.

FOR (BASED ON USE IN COMMERCE) SOFTWARE FOR USE IN SURGICAL HOSPITALS, AMBULATORY SURGERY CENTERS, PHYSICIAN PRACTICES AND PHYSICAL THERAPY PRACTICES FOR MANAGING PATIENT INFORMATION, SCHEDULING, PATIENT REGISTRATION, CLINICAL DOCUMENTATION, INVENTORY MANAGEMENT, MEDICAL BILLING, ACCOUNTS RECEIVABLE COLLECTIONS, AND REPORTING REGARDING THE FOREGOING; (BASED ON INTENT TO USE) SOFTWARE FOR USE IN PHYSICIAN PRACTICES FOR MANAGING PATIENT INFORMATION, SCHEDULING, PATIENT REGISTRATION, CLINICAL DOCUMENTATION, INVENTORY MANAGEMENT, MEDICAL BILLING, ACCOUNTS RECEIVABLE COLLECTIONS, AND REPORTING REGARDING THE FOREGOING (U.S. CLS. 21, 23, 26, 36 AND 38).

FIRST USE 12-31-2006; IN COMMERCE 12-31-2006.
KIM SAITO, EXAMINING ATTORNEY

SN 77-881,012. ALLOY SOFTWARE, INC., AKA ALLOY SOFTWARE, EAST HANOVER, NJ. FILED 11-25-2009.

Alloy Universe

THE MARK CONSISTS OF STANDARD CHARACTERS WITHOUT CLAIM TO ANY PARTICULAR FONT, STYLE, SIZE, OR COLOR.

OWNER OF U.S. REG. NOS. 2,832,129, 3,649,955 AND 3,653,669.

FOR COMPUTER SOFTWARE, NAMELY, SOFTWARE FOR HELP DESK SERVICE MANAGEMENT, CUSTOMER RELATIONSHIP MANAGEMENT, CHANGE MANAGEMENT, BUSINESS ASSET MANAGEMENT AND NETWORK MANAGEMENT (U.S. CLS. 21, 23, 26, 36 AND 38).

WILLIAM ROSSMAN, EXAMINING ATTORNEY

CLASS 9—(Continued).

SN 77-881,261. ALLIED TELESIS HOLDINGS K.K., SHINAGAWA-KU, TOKYO, JAPAN, FILED 11-25-2009.

AlliedView

THE MARK CONSISTS OF STANDARD CHARACTERS WITHOUT CLAIM TO ANY PARTICULAR FONT, STYLE, SIZE, OR COLOR.

PRIORITY CLAIMED UNDER SEC. 44(D) ON JAPAN APPLICATION NO. 2009-060831, FILED 8-10-2009.

FOR COMPUTER SOFTWARE FOR NETWORK MANAGEMENT (U.S. CLS. 21, 23, 26, 36 AND 38).

FIRST USE 9-19-2007; IN COMMERCE 9-19-2007.
JUSTINE D. PARKER, EXAMINING ATTORNEY

SN 77-883,445. MCKAIN, NANCY, PLEASANTON, CA. FILED 12-1-2009.

MAGNETIC MANTRAS

THE MARK CONSISTS OF STANDARD CHARACTERS WITHOUT CLAIM TO ANY PARTICULAR FONT, STYLE, SIZE, OR COLOR.

FOR DECORATIVE MAGNETS, NAMELY, CUSTOM DESIGNED MAGNETIC MAGNETS THAT HAVE A POSITIVE MESSAGE (U.S. CLS. 21, 23, 26, 36 AND 38).

KATHERINE CHANG, EXAMINING ATTORNEY

SN 77-883,885. TODOROO INC., FORMERLY GRACEFUL TOOLS, INC., PALO ALTO, CA. FILED 12-2-2009.

Astrid

THE MARK CONSISTS OF STANDARD CHARACTERS WITHOUT CLAIM TO ANY PARTICULAR FONT, STYLE, SIZE, OR COLOR.

THE NAME "ASTRID" DOES NOT IDENTIFY A LIVING INDIVIDUAL.

FOR COMPUTER SOFTWARE FOR USE IN TASK MANAGEMENT, PROVIDING REMINDERS, AND PERSONAL ORGANIZATION BY UTILIZING DATA FROM THE INTERNET AND SENDING DATA TO THE INTERNET, FOR USE ON COMPUTERS, LAPTOPS, MOBILE PHONES, AND OTHER MOBILE ELECTRONIC DEVICES (U.S. CLS. 21, 23, 26, 36 AND 38).

FIRST USE 12-26-2008; IN COMMERCE 12-26-2008.
JAY BESCH, EXAMINING ATTORNEY

CLASS 9—(Continued).

SN 77-883,955. U-REACH INC., TAIPEI 115, TAIWAN, FILED 12-2-2009.



THE MARK CONSISTS OF THE TERM "UREACH" UNDERNEATH A SQUARE CONTAINING THE STYLIZED LETTER "R".

FOR COMPUTER PROCESSORS; COMPUTER PROGRAMS FOR USE AS A SPREADSHEET, WORD PROCESSING; COMPUTER MONITORS; COMPUTERS; COMPUTER MOUSE; DATA PROCESSING EQUIPMENT, NAMELY, DATA PROCESSOR AND COMPUTERS; COMPUTER MEMORIES; COMPUTER KEYBOARDS; COMPUTER SOFTWARE FOR USE AS A SPREADSHEET, WORD PROCESSING; BLANK MAGNETIC DATA CARRIERS MEDIA; INTERFACE CARDS FOR USE IN COMPUTERS IN THE FORM OF PRINTED CIRCUITS; NOTEBOOK COMPUTERS; BLANK OPTICAL DISCS; SCANNERS; PORTABLE ELECTRONIC TRANSLATORS; MOTHERBOARDS FOR COMPUTERS, PRINTERS, COMPUTER HARDWARE; NAVIGATION APPARATUS FOR VEHICLES AND ON-BOARD COMPUTERS; DISK DRIVES FOR COMPUTERS; BLANK COMPUTER DISKS (U.S. CLS. 21, 23, 26, 36 AND 38).

SAIMA MAKHDOOM, EXAMINING ATTORNEY

SN 77-885,406. NEW LINE PRODUCTIONS, INC., LOS ANGELES, CA. FILED 12-3-2009.

WATERTOWER MUSIC

THE MARK CONSISTS OF STANDARD CHARACTERS WITHOUT CLAIM TO ANY PARTICULAR FONT, STYLE, SIZE, OR COLOR.

NO CLAIM IS MADE TO THE EXCLUSIVE RIGHT TO USE "MUSIC", APART FROM THE MARK AS SHOWN.

FOR DIGITAL MUSIC AND VIDEO MUSIC RECORDINGS DOWNLOADABLE FROM THE INTERNET; DOWNLOADABLE RING TONES, MUSIC, GRAPHICS AND ELECTRONIC GAMES VIA THE INTERNET; DOWNLOADABLE MP3 FILES, MP3 RECORDINGS, ON-LINE DISCUSSION BOARDS, WEBCASTS, WEBINARS AND PODCASTS FEATURING MUSIC, AUDIO BOOKS AND ENTERTAINMENT NEWS BROADCASTS (U.S. CLS. 21, 23, 26, 36 AND 38).

JAY FLOWERS, EXAMINING ATTORNEY

CLASS 9—(Continued).

SN 77-887,508. DELOACHE DATA SYSTEMS, INC., TULSA, OK. FILED 12-7-2009.

DeLoache Financials

THE MARK CONSISTS OF STANDARD CHARACTERS WITHOUT CLAIM TO ANY PARTICULAR FONT, STYLE, SIZE, OR COLOR.

NO CLAIM IS MADE TO THE EXCLUSIVE RIGHT TO USE "FINANCIALS", APART FROM THE MARK AS SHOWN.

SEC. 2(F).

FOR DATABASE MANAGEMENT SOFTWARE FOR ACCOUNTING (U.S. CLS. 21, 23, 26, 36 AND 38).

FIRST USE 8-3-1999; IN COMMERCE 8-3-1999.

HENRY S. ZAK, EXAMINING ATTORNEY

SN 77-889,605. CORTEX, USA, LTD., WOODSTOCK, GA. FILED 12-9-2009.

FAHRENHEIT[°]

THE MARK CONSISTS OF STANDARD CHARACTERS WITHOUT CLAIM TO ANY PARTICULAR FONT, STYLE, SIZE, OR COLOR.

FOR ELECTRIC HAIR STRAIGHTENING IRONS (U.S. CLS. 21, 23, 26, 36 AND 38).

FIRST USE 10-28-2009; IN COMMERCE 10-28-2009.

HAI-LY LAM, EXAMINING ATTORNEY

SN 77-891,992. BALLY GAMING, INC., DBA BALLY TECHNOLOGIES, LAS VEGAS, NV. FILED 12-11-2009.

TIME ZONE BONUS

THE MARK CONSISTS OF STANDARD CHARACTERS WITHOUT CLAIM TO ANY PARTICULAR FONT, STYLE, SIZE, OR COLOR.

NO CLAIM IS MADE TO THE EXCLUSIVE RIGHT TO USE "BONUS", APART FROM THE MARK AS SHOWN.

FOR GAMING DEVICES, NAMELY, SLOT MACHINES WITH OR WITHOUT VIDEO OUTPUT (U.S. CLS. 21, 23, 26, 36 AND 38).

DOUGLAS LEE, EXAMINING ATTORNEY

CLASS 9—(Continued).

SN 77-892,350. STAX DEVELOPMENT, LLC., VANCOUVER, WA. FILED 12-14-2009.



NO CLAIM IS MADE TO THE EXCLUSIVE RIGHT TO USE "MEDIA", APART FROM THE MARK AS SHOWN.

THE MARK CONSISTS OF THE STYLIZED WORDING "MEDIA STIX" ON A SHADED BACKGROUND.

FOR CD STORAGE RACKS (U.S. CLS. 21, 23, 26, 36 AND 38).

FIRST USE 1-1-2007; IN COMMERCE 11-1-2009.

KATHERINE CONNOLLY, EXAMINING ATTORNEY

SN 77-892,972. TIME PLAZA INC., ALHAMBRA, CA. FILED 12-14-2009.



Francise Lewis

"FRANCISE LEWIS" DOES NOT IDENTIFY A LIVING INDIVIDUAL.

THE MARK CONSISTS OF A STYLIZED LETTER "FL"; "F" FALLEN DOWN TO LEFT SIDE; "L" REFLECTED VERTICALLY 90 DEGREE FALLEN DOWN TO LEFT SIDE WITH "FRANCISE LEWIS" ON BOTTOM.

FOR CASES FOR EYEGLASSES AND SUNGLASSES; CASES FOR SPECTACLES AND SUNGLASSES; CHAINS FOR SPECTACLES AND FOR SUNGLASSES; EYEWEAR; EYEWEAR ACCESSORIES, NAMELY, STRAPS, NECK CORDS AND HEAD STRAPS WHICH RESTRAIN EYEWEAR FROM MOVEMENT ON A WEARER; EYEWEAR CASES; EYEWEAR RETAINERS; FRAMES FOR SPECTACLES AND SUNGLASSES; LENSES FOR SUNGLASSES; NOSE GUARDS WHICH CAN BE WORN BY ATTACHMENT TO EYEWEAR SUCH AS SUNGLASSES AND SKI GOGGLES; PROTECTIVE EYEWEAR; PROTECTIVE EYEWEAR AND COMPONENT PARTS THEREOF; SAFETY EYEWEAR; SPECTACLES AND SUNGLASSES; SPORTS EYEWEAR; SUNGLASS CHAINS AND CORDS; SUNGLASS LENSES; SUNGLASSES; SUNGLASSES AND SPECTACLES (U.S. CLS. 21, 23, 26, 36 AND 38).

FIRST USE 1-10-2005; IN COMMERCE 6-11-2005.

ELIZABETH KAJUBI, EXAMINING ATTORNEY

CLASS 9—(Continued).

SN 77-895,397. COBY ELECTRONICS CORPORATION, LAKE SUCCESS, NY. FILED 12-17-2009.

JAMMERZ TALK

THE MARK CONSISTS OF STANDARD CHARACTERS WITHOUT CLAIM TO ANY PARTICULAR FONT, STYLE, SIZE, OR COLOR.

OWNER OF U.S. REG. NO. 3,636,192.

NO CLAIM IS MADE TO THE EXCLUSIVE RIGHT TO USE "TALK", APART FROM THE MARK AS SHOWN.

FOR AUDIO HEADPHONES; EAR PHONES; EARPHONE ACCESSORIES, NAMELY, EARPHONE CUSHIONS, EARPHONE PADS, CORD MANAGEMENT SYSTEMS, EARPHONE CASES, AND EARPHONE EXTENSION CORDS; EARPHONES; EARPHONES AND HEADPHONES; HEADPHONES; HEADPHONES INCLUDING ATTACHED LANYARD; PERSONAL HEADPHONES FOR SOUND TRANSMITTING APPARATUSES; PERSONAL HEADPHONES FOR USE WITH SOUND TRANSMITTING SYSTEMS; STEREO HEADPHONES (U.S. CLS. 21, 23, 26, 36 AND 38).

ERIN FALK, EXAMINING ATTORNEY

SN 77-896,219. INLAND PRODUCTS, INC., FULLERTON, CA. FILED 12-17-2009.

NuGiant

THE MARK CONSISTS OF THE WORDING "NUGIANT" IN STYLIZED FORM WITH CAPITAL LETTERS "N" AND "G".

FOR VOLTAGE SURGE PROTECTORS (U.S. CLS. 21, 23, 26, 36 AND 38).

FIRST USE 12-12-2009; IN COMMERCE 12-12-2009.

SHARON MEIER, EXAMINING ATTORNEY

SN 77-896,663. HIGHER BALANCE, LLC, AKA HIGHER BALANCE INSTITUTE, PORTLAND, OR. FILED 12-18-2009.

Higher Balance Meditation

THE MARK CONSISTS OF STANDARD CHARACTERS WITHOUT CLAIM TO ANY PARTICULAR FONT, STYLE, SIZE, OR COLOR.

OWNER OF U.S. REG. NO. 3,166,709.

NO CLAIM IS MADE TO THE EXCLUSIVE RIGHT TO USE "MEDITATION", APART FROM THE MARK AS SHOWN.

FOR AUDIO AND VIDEO RECORDINGS FEATURING INFORMATION ABOUT SPIRITUAL DEVELOPMENT, PERSONAL GROWTH AND MEDITATION (U.S. CLS. 21, 23, 26, 36 AND 38).

FIRST USE 1-1-2003; IN COMMERCE 6-1-2003.

WENDY GOODMAN, EXAMINING ATTORNEY

CLASS 9—(Continued).

SN 77-896,668. SHOPPERTRAK RCT CORPORATION, CHICAGO, IL. FILED 12-18-2009.

INSIDETRAK

THE MARK CONSISTS OF STANDARD CHARACTERS WITHOUT CLAIM TO ANY PARTICULAR FONT, STYLE, SIZE, OR COLOR.

FOR ELECTRONIC COMPUTER BASED SYSTEM FOR COUNTING PEOPLE AND FOR CORRELATING THAT INFORMATION TO POINT-OF-SALE TRANSACTIONS AND SERVICES, COMPOSED OF COMPUTER HARDWARE, COMPUTER SOFTWARE FOR COUNTING AND CORRELATION, ELECTRONIC AND OPTICAL COMMUNICATIONS INSTRUMENTS AND COMPONENTS IN THE NATURE OF OPTICAL TRANSMITTERS, RECEIVERS, AND IMAGE CAPTURING DEVICES, AND RADIO FREQUENCY IDENTIFICATION (RFID) TAGS, CARDS, AND READERS (U.S. CLS. 21, 23, 26, 36 AND 38).

ROBIN MITTLER, EXAMINING ATTORNEY

SN 77-899,480. INDUSTRIAL TECHNOLOGY RESEARCH INSTITUTE, CHUTUNG, HSIN-CHU, TAIWAN, FILED 12-22-2009.



OWNER OF TAIWAN REG. NO. 01341586, DATED 12-16-2008, EXPIRES 12-15-2018.

THE MARK CONSISTS OF A RECTANGLE WITH STYLIZED WORD "FLEXPEAKER".

FOR AMPLIFIERS (U.S. CLS. 21, 23, 26, 36 AND 38).

GISELLE AGOSTO, EXAMINING ATTORNEY

CLASS 9—(Continued).

SN 77-899,736. GUANGZHOU TAI FENG YUAN ENTERPRISE CO., LTD., GUANGDONG, 510730, CHINA, FILED 12-23-2009.



THE MARK CONSISTS OF A DESIGN FEATURING THREE HORIZONTAL BARS WITH ROUNDED CORNERS, STACKED HORIZONTALLY WITH TWO LINES OF SPACE IN BETWEEN THEM. AN INVERTED INCOMPLETE TRIANGLE MADE UP OF SPINES IS INSIDE THE THREE BARS TO GIVE A PUZZLE-LIKE APPEARANCE TO THE BARS. THE DESIGN IS PRESENTED TO THE LEFT OF THE WORD "TIFY".

FOR DIGITAL PHOTO FRAMES FOR DISPLAYING DIGITAL PICTURES, VIDEO CLIPS AND MUSIC; DVD PLAYERS; ELECTRIC DOOR BELLS; MP4 PLAYERS; RECORD PLAYERS; SCALES; TELEVISIONS (U.S. CLS. 21, 23, 26, 36 AND 38).

TRACY WHITTAKER-BROWN, EXAMINING ATTORNEY

CLASS 9—(Continued).

SN 77-902,410. CHRISTIANSTEVEN SOFTWARE LTD., AKA CHRISTIANSTEVENS, CHARLOTTE, NC. FILED 12-29-2009.



THE COLOR(S) BLUE, BLACK, AND GREY IS/ARE CLAIMED AS A FEATURE OF THE MARK.

THE MARK CONSISTS OF THE LETTERS "SQL-RD" WITH THE TOP HALF OF EACH LETTER IN GREY AND THE BOTTOM HALF OF EACH LETTER IN BLACK WITH A NODE TO THE RIGHT OF THE LETTERS. THE NODE IS A BLUE SPHERE WITH SIX GREY CYLINDERS POINTING OUT FROM THE SPHERE.

FOR COMPUTER SOFTWARE FOR APPLICATION AND DATABASE INTEGRATION; COMPUTER SOFTWARE FOR PROVIDING AN ON-LINE DATABASE TO UPLOAD BUSINESS DATA, PROVIDE STATISTICAL ANALYSIS, AND PRODUCE NOTIFICATIONS AND DISTRIBUTION OF REPORTS; COMPUTER SOFTWARE FOR DISTRIBUTION OF AUTOMATED REPORTS THAT MAY BE DOWNLOADED FROM A GLOBAL COMPUTER NETWORK; COMPUTER SOFTWARE FOR AUTOMATED REPORT DISTRIBUTION FOR USE ONLY IN CONNECTION WITH SQL SERVER REPORTING SERVICES, IN CLASS 009 (U.S. CLS. 21, 23, 26, 36 AND 38).

FIRST USE 9-6-2002; IN COMMERCE 9-26-2005.
DAVID ELTON, EXAMINING ATTORNEY

SN 77-901,909. NEW CONCEPTS DEVELOPMENT CORPORATION, WOODSTOCK, IL. FILED 12-29-2009.

MAXMEM

THE MARK CONSISTS OF STANDARD CHARACTERS WITHOUT CLAIM TO ANY PARTICULAR FONT, STYLE, SIZE, OR COLOR.

OWNER OF U.S. REG. NO. 2,331,974.
FOR COMPUTER MEMORY UPGRADE KIT COMPRISING ONE OR MORE COMPUTER MEMORY MODULES, HAND TOOL FOR INSTALLING COMPUTER MEMORY MODULE, AND INSTRUCTION MANUAL (U.S. CLS. 21, 23, 26, 36 AND 38).

MICHAEL LITZAU, EXAMINING ATTORNEY

SN 77-906,697. ATRONIC INTERNATIONAL GMBH, LÜBBECKE, FED REP GERMANY, FILED 1-7-2010.

JOIN'N PLAY

SN 77-901,939. NEW CONCEPTS DEVELOPMENT CORPORATION, WOODSTOCK, IL. FILED 12-29-2009.

MAXRAM

THE MARK CONSISTS OF STANDARD CHARACTERS WITHOUT CLAIM TO ANY PARTICULAR FONT, STYLE, SIZE, OR COLOR.

OWNER OF U.S. REG. NO. 2,331,974.
FOR COMPUTER MEMORY UPGRADE KIT COMPRISING ONE OR MORE COMPUTER MEMORY MODULES, HAND TOOL FOR INSTALLING COMPUTER MEMORY MODULE, AND INSTRUCTION MANUAL (U.S. CLS. 21, 23, 26, 36 AND 38).

MICHAEL LITZAU, EXAMINING ATTORNEY

THE MARK CONSISTS OF STANDARD CHARACTERS WITHOUT CLAIM TO ANY PARTICULAR FONT, STYLE, SIZE, OR COLOR.

OWNER OF ERPN CMNTY TM OFC REG. NO. 007300262, DATED 5-27-2009, EXPIRES 10-9-2018.

FOR RECONFIGURABLE CASINO AND LOTTERY GAMING EQUIPMENT, NAMELY, GAMING MACHINES (U.S. CLS. 21, 23, 26, 36 AND 38).

LEIGH LOWRY, EXAMINING ATTORNEY

CLASS 9—(Continued).

SN 77-907,130. SUSTAINABLE INTELLIGENCE, LLC, ROCHESTER, NY. FILED 1-7-2010.

Values Mosaic

THE MARK CONSISTS OF STANDARD CHARACTERS WITHOUT CLAIM TO ANY PARTICULAR FONT, STYLE, SIZE, OR COLOR.

NO CLAIM IS MADE TO THE EXCLUSIVE RIGHT TO USE "VALUES", APART FROM THE MARK AS SHOWN.

FOR INFORMATION MANAGEMENT COMPUTER SOFTWARE FOR USE BY INDIVIDUALS AND ORGANIZATIONS TO MANAGE AND SORT INFORMATION IN ORDER TO MAKE DECISIONS BASED ON THEIR OWN VALUES AND THOSE OF THEIR STAKEHOLDERS (U.S. CLS. 21, 23, 26, 36 AND 38).

JENNIFER MARTIN, EXAMINING ATTORNEY

CLASS 9—(Continued).

SN 77-907,933. TIME PLAZA INC., ALHAMBRA, CA. FILED 1-8-2010.



THE MARK CONSISTS OF HUNGRY COYOTE WITH GREEDY EYES, TONGUE SPROUTED, ERECTED EARS, AND STYLISH HAIR COMES WITH IDENTIFIER "SUN-V" INSIDE TWO SQUARE CURVE BRACKETS.

FOR CASES FOR EYEGLASSES AND SUNGLASSES; CASES FOR SPECTACLES AND SUNGLASSES; CHAINS FOR SPECTACLES AND FOR SUNGLASSES; FRAMES FOR SPECTACLES AND SUNGLASSES; LENSES FOR SUNGLASSES; NOSE GUARDS WHICH CAN BE WORN BY ATTACHMENT TO EYEWEAR SUCH AS SUNGLASSES AND SKI GOGGLES; SPECTACLES AND SUNGLASSES; SUNGLASS CHAINS AND CORDS; SUNGLASS LENSES; SUNGLASSES; SUNGLASSES AND SPECTACLES (U.S. CLS. 21, 23, 26, 36 AND 38).

FIRST USE 1-11-2005; IN COMMERCE 6-15-2005.
ELIZABETH KAJUBI, EXAMINING ATTORNEY

SN 77-907,813. INEQQUEST TECHNOLOGIES, INC., MANSFIELD, MA. FILED 1-8-2010.

Cricket

THE MARK CONSISTS OF STANDARD CHARACTERS WITHOUT CLAIM TO ANY PARTICULAR FONT, STYLE, SIZE, OR COLOR.

FOR VIDEO QUALITY MANAGEMENT AND SERVICE ASSURANCE ELECTRONIC MEASURING DEVICE FOR USE IN AUDITING, MONITORING, ANALYZING AND TROUBLESHOOTING DIGITAL VIDEO DISTRIBUTION NETWORKS (U.S. CLS. 21, 23, 26, 36 AND 38).

FIRST USE 10-30-2006; IN COMMERCE 10-30-2006.
HOWARD SMIGA, EXAMINING ATTORNEY

SN 77-909,316. TESLAVISION CORPORATION, KIRKLAND, WA. FILED 1-11-2010.

TeslaVision

SN 77-907,817. INEQQUEST TECHNOLOGIES, INC., MANSFIELD, MA. FILED 1-8-2010.

IQCricket

THE MARK CONSISTS OF STANDARD CHARACTERS WITHOUT CLAIM TO ANY PARTICULAR FONT, STYLE, SIZE, OR COLOR.

FOR VIDEO QUALITY MANAGEMENT AND SERVICE ASSURANCE ELECTRONIC MEASURING DEVICE FOR USE IN AUDITING, MONITORING, ANALYZING AND TROUBLESHOOTING DIGITAL VIDEO DISTRIBUTION NETWORKS (U.S. CLS. 21, 23, 26, 36 AND 38).

HOWARD SMIGA, EXAMINING ATTORNEY

THE MARK CONSISTS OF STANDARD CHARACTERS WITHOUT CLAIM TO ANY PARTICULAR FONT, STYLE, SIZE, OR COLOR.

FOR LUMINOUS SIGNS (U.S. CLS. 21, 23, 26, 36 AND 38).

FIRST USE 1-1-2009; IN COMMERCE 4-1-2009.
TOBY BULLOFF, EXAMINING ATTORNEY

CLASS 9—(Continued).

SN 77-909,337. NEW POTATO TECHNOLOGIES, INC., WILMINGTON, NC. FILED 1-11-2010.

APCESSORY

THE MARK CONSISTS OF STANDARD CHARACTERS WITHOUT CLAIM TO ANY PARTICULAR FONT, STYLE, SIZE, OR COLOR.

FOR CONSUMER ELECTRONICS ACCESSORIES FOR PORTABLE DIGITAL VIDEO AND DIGITAL AUDIO PLAYERS INTENDED FOR AUTOMOTIVE, HOME AND MARINE USE, NAMELY, PERIPHERAL HARDWARE IN THE NATURE OF ELECTRONIC DOCKING STATIONS AND RADIO FREQUENCY COMMUNICATION TRANSMITTERS AND RECEIVERS USED IN SHORT-RANGE TRANSMISSION OF DATA, AND INTEGRATED SOFTWARE IN THE NATURE OF GAME SOFTWARE AND UTILITY PROGRAMS; ACCESSORY KITS FOR PORTABLE DIGITAL VIDEO AND DIGITAL AUDIO PLAYERS COMPRISING DOCKING STATIONS AND RADIO FREQUENCY COMMUNICATION TRANSMITTERS AND RECEIVERS USED IN SHORT-RANGE TRANSMISSION OF DATA; WIRED AND WIRELESS LINKS BETWEEN SOFTWARE INTERFACES AND PERIPHERAL HARDWARE FOR PORTABLE DIGITAL VIDEO AND DIGITAL AUDIO PLAYERS, NAMELY, USB (UNIVERSAL SERIAL BUS) HARDWARE AND OPERATING SOFTWARE, WIRED ASYNCHRONOUS SERIAL INTERFACE HARDWARE AND OPERATING SOFTWARE, AND WIRELESS RADIO FREQUENCY COMMUNICATION LINKS (U.S. CLS. 21, 23, 26, 36 AND 38).

NICHOLAS ALTREE, EXAMINING ATTORNEY

SN 77-909,843. PROSOFT ENGINEERING, INC., PLEASANTON, CA. FILED 1-12-2010.

DRIVEPULSE

THE MARK CONSISTS OF STANDARD CHARACTERS WITHOUT CLAIM TO ANY PARTICULAR FONT, STYLE, SIZE, OR COLOR.

FOR SOFTWARE FOR MONITORING A HARD DRIVE IN A COMPUTER (U.S. CLS. 21, 23, 26, 36 AND 38).

TIMOTHY FINNEGAN, EXAMINING ATTORNEY

CLASS 9—(Continued).

SN 77-910,107. HALLMARK LICENSING, INC., KANSAS CITY, MO. FILED 1-12-2010.



OWNER OF U.S. REG. NOS. 525,798, 2,964,163 AND OTHERS.

NO CLAIM IS MADE TO THE EXCLUSIVE RIGHT TO USE "BUSINESS", APART FROM THE MARK AS SHOWN.

THE MARK CONSISTS OF A FIVE-POINTED, OPEN CROWN DESIGN OVER THE WORD "HALLMARK" IN SCRIPT, OVER THE WORDS "BUSINESS CONNECTIONS" IN BLOCK LETTERS.

FOR DECORATIVE MAGNETS; MAGNETICALLY ENCODED DEBIT CARDS (U.S. CLS. 21, 23, 26, 36 AND 38).

EMILY CARLSEN, EXAMINING ATTORNEY

SN 77-912,694. SYNAPSENSE CORPORATION, FOLSOM, CA. FILED 1-15-2010.

SYNAPSOFT

THE MARK CONSISTS OF STANDARD CHARACTERS WITHOUT CLAIM TO ANY PARTICULAR FONT, STYLE, SIZE, OR COLOR.

FOR COMPUTER SOFTWARE, NAMELY, OPERATING SYSTEM SOFTWARE, APPLICATION SOFTWARE AND ANALYSIS AND DIAGNOSTIC SOFTWARE FOR USE IN SENSING, MONITORING, COMPUTING AND COMMUNICATING DATA TO INFORMATION TECHNOLOGY INFRASTRUCTURES (U.S. CLS. 21, 23, 26, 36 AND 38).

FIRST USE 12-0-2006; IN COMMERCE 12-0-2006.
ROBERT C. CLARK JR., EXAMINING ATTORNEY

CLASS 9—(Continued).

SN 77-912,789. DIVERSIFIED DIAMOND PRODUCTS, INC., PHOENIX, AZ. FILED 1-15-2010.



The logo for Accu-traq features the word "Accu-traq" in a sans-serif font. A thick, black, curved line arches over the letters "traq", starting from the top of the "t" and ending at the top of the "q".

THE MARK CONSISTS OF THE WORDS "ACCU" AND "TRAQ" SEPARATED BY A "HYPHEN", WITH A SEMI-CIRCULAR DESIGN ELEMENT EXTENDING ABOVE THE WORDS.

FOR SYSTEMS AND KITS COMPRISING CABINETS SPECIALLY ADAPTED FOR ELECTRICAL EQUIPMENT, SCANNERS, ELECTRIC SENSORS, RADIO FREQUENCY IDENTIFICATION TAGS AND ELECTRONIC BAR CODE TAGS, BAR CODE READERS, ELECTRONIC TRANSMITTERS, ELECTRONIC RECEIVERS, SOFTWARE, AND ANTENNA, ALL FOR MONITORING THE STATUS AND LOCATION OF MATERIALS AND PERSONNEL (U.S. CLS. 21, 23, 26, 36 AND 38).

FIRST USE 4-20-2009; IN COMMERCE 4-20-2009.
MICHELE SWAIN, EXAMINING ATTORNEY

SN 77-913,086. IDONDEMAND, INC., FREMONT, CA. FILED 1-15-2010.

TouchSecure

THE MARK CONSISTS OF STANDARD CHARACTERS WITHOUT CLAIM TO ANY PARTICULAR FONT, STYLE, SIZE, OR COLOR.

FOR COMPUTER HARDWARE AND SOFTWARE FOR USE IN NETWORK MANAGEMENT IN THE FIELD OF CONTROLLING NETWORK FUNCTIONS AND ACCESS IN THE FIELD OF NETWORK SECURITY AND SERVER SECURITY (U.S. CLS. 21, 23, 26, 36 AND 38).

GILBERT SWIFT, EXAMINING ATTORNEY

CLASS 9—(Continued).

SN 77-914,803. PROMIRROR, INC., GLOUCESTER, MA. FILED 1-19-2010.

PROMIRROR

THE MARK CONSISTS OF STANDARD CHARACTERS WITHOUT CLAIM TO ANY PARTICULAR FONT, STYLE, SIZE, OR COLOR.

FOR VIDEO TRAINING SYSTEM COMPRISING A VIDEO RECORDER, VIDEO PLAYBACK SCREEN, SOFTWARE FOR MANAGING, OPERATING, MANIPULATING, AND ANALYZING VIDEO FOR SPORTS AND RECREATIONAL TRAINING (U.S. CLS. 21, 23, 26, 36 AND 38).

FIRST USE 1-0-2006; IN COMMERCE 1-0-2006.
ELLEN B. AWRICH, EXAMINING ATTORNEY

SN 77-914,854. WILLIE SHROPSHIRE, BATON ROUGE, LA. FILED 1-19-2010.

Mad Monsta Entertainment

THE MARK CONSISTS OF STANDARD CHARACTERS WITHOUT CLAIM TO ANY PARTICULAR FONT, STYLE, SIZE, OR COLOR.

NO CLAIM IS MADE TO THE EXCLUSIVE RIGHT TO USE "ENTERTAINMENT", APART FROM THE MARK AS SHOWN.

FOR DIGITAL MEDIA, NAMELY, PRE-RECORDED VIDEO CASSETTES, DIGITAL VIDEO DISCS, DIGITAL VERSATILE DISCS, DOWNLOADABLE AUDIO AND VIDEO RECORDINGS, DVDS, AND HIGH DEFINITION DIGITAL DISCS FEATURING MUSIC; DOWNLOADABLE MUSICAL SOUND RECORDINGS; MUSICAL SOUND RECORDINGS (U.S. CLS. 21, 23, 26, 36 AND 38).

FRED CARL, EXAMINING ATTORNEY

SN 77-915,397. SAVANH, BOBBY B, PORTLAND, OR. FILED 1-19-2010.



The logo for EZ-GROW features the text "EZ-GROW" in a bold, sans-serif font. The letter "O" is replaced by a stylized sun icon consisting of a central circle with six rays extending outwards.

THE MARK CONSISTS OF THE TERM "EZ-GROW" WITH THE LETTER "O" DISPLAYED AS A SHINING SUN WITH SIX RAY BANDS.

FOR FLUORESCENT LAMP BALLAST FOR ELECTRIC LIGHTS; LIGHTING BALLASTS (U.S. CLS. 21, 23, 26, 36 AND 38).

TARA PATE, EXAMINING ATTORNEY

CLASS 9—(Continued).

SN 77-915,404. SAVANH, BOBBY B, PORTLAND, OR. FILED 1-19-2010.



NO CLAIM IS MADE TO THE EXCLUSIVE RIGHT TO USE "GROW", APART FROM THE MARK AS SHOWN. THE MARK CONSISTS OF TWO WORDS "GROW" AND "KING" WITH THE "O" IN "GROW" SHADED IN AND A THREE PRONGED CROWN POSITIONED ABOVE THE LETTERS "ING" IN "KING".

FOR FLUORESCENT LAMP BALLAST FOR ELECTRIC LIGHTS; LIGHTING BALLASTS (U.S. CLS. 21, 23, 26, 36 AND 38).

TARA PATE, EXAMINING ATTORNEY

SN 77-916,428. ASTEC CO., LTD., FUKUOKA, JAPAN, FILED 1-21-2010.

Penguin
Incubator



NO CLAIM IS MADE TO THE EXCLUSIVE RIGHT TO USE "INCUBATOR", APART FROM THE MARK AS SHOWN.

THE COLOR(S) BLUE, WHITE AND YELLOW IS/ARE CLAIMED AS A FEATURE OF THE MARK.

THE MARK CONSISTS OF THE WORDS "PENGUIN INCUBATOR" IN THE COLOR BLUE. THE WORD "PENGUIN" IS IN THE TOP POSITION SEPARATED BY A BLUE HORIZONTAL LINE WITH THE WORD "INCUBATOR" AT THE BOTTOM. THE UPPER PORTION OF THE LETTER "P" SYMBOLIZES A SIDE VIEW OF THE HEAD OF A PENGUIN WITH A BLUE DOT AS ITS EYE AND TWO SMALL TRIANGLES AS THE PENGUIN'S BEAK. THE DESIGN FEATURES THE DRAWING OF A FRONT VIEW OF A PENGUIN WITH HEAD DOWN AND BODY IN THE COLORS BLUE AND WHITE FEATURING A YELLOW NECK. THE DRAWING ALSO SHOWS A YELLOW AND WHITE EGG PLACED IN BETWEEN THE PENGUIN FEET IN COLOR BLUE. NO CLAIM IS MADE TO THE BACKGROUND COLOR OF THE MARK.

FOR LABORATORY EQUIPMENT AND SUPPLIES, NAMELY, INCUBATORS (U.S. CLS. 21, 23, 26, 36 AND 38).

FIRST USE 10-17-2009; IN COMMERCE 10-17-2009.
NAKIA HENRY, EXAMINING ATTORNEY

CLASS 9—(Continued).

SN 77-918,425. IGN ENTERTAINMENT, INC., BRISBANE, CA. FILED 1-22-2010.



THE MARK CONSISTS OF THE LETTERS "IGN" TO THE RIGHT OF A DESIGN WHICH CONSISTS OF A FOUR-POINTED STAR OVER A CIRCLE.

FOR DOWNLOADABLE COMPUTER GAME AND VIDEO GAME SOFTWARE; DOWNLOADABLE VIDEOS IN THE FIELD OF COMPUTER GAMES AND VIDEO GAMES, MOTION PICTURE FILMS ABOUT ACTION, ADVENTURE, DRAMA, COMEDY, SPORTS, MUSIC AND CHILDREN'S ENTERTAINMENT, AND TELEVISION SHOWS ABOUT ACTION, ADVENTURE, DRAMA, COMEDY, SPORTS, MUSIC AND CHILDREN'S ENTERTAINMENT (U.S. CLS. 21, 23, 26, 36 AND 38).

FIRST USE 12-8-2009; IN COMMERCE 12-8-2009.
LEIGH LOWRY, EXAMINING ATTORNEY

SN 77-918,461. LOPEZ, JUAN, PERRIS, CA. FILED 1-22-2010.

SERVO DIGITAL MEDIA GROUP

THE MARK CONSISTS OF STANDARD CHARACTERS WITHOUT CLAIM TO ANY PARTICULAR FONT, STYLE, SIZE, OR COLOR.

NO CLAIM IS MADE TO THE EXCLUSIVE RIGHT TO USE "DIGITAL MEDIA GROUP", APART FROM THE MARK AS SHOWN.

FOR PRE-RECORDED CDS, DVDS, DOWNLOADABLE MP3 FILES AND MP3 RECORDINGS, AUDIO DOWNLOADS IN THE NATURE OF DOWNLOADABLE MP3 FILES AND MP3 RECORDINGS AND VINYL PHONOGRAPH RECORDS FEATURING MUSIC AND ENTERTAINMENT IN THE NATURE OF MUSIC VIDEOS (U.S. CLS. 21, 23, 26, 36 AND 38).

FIRST USE 1-1-2010; IN COMMERCE 1-1-2010.
AMEEN IMAM, EXAMINING ATTORNEY

CLASS 9—(Continued).

SN 77-919,305. SUMOPTI, PALO ALTO, CA. FILED 1-25-2010.

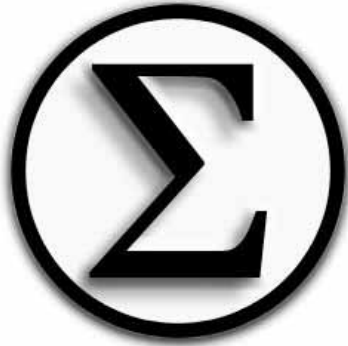

THE MARK CONSISTS OF A CAPITAL LETTER "SIGMA" FROM THE GREEK ALPHABET, ENCLOSED IN A CIRCLE. FOR COMPUTER HARDWARE; COMPUTER SOFTWARE FOR DATA PROCESSING (U.S. CLS. 21, 23, 26, 36 AND 38).

AMEEN IMAM, EXAMINING ATTORNEY

CLASS 9—(Continued).

SN 77-919,387. PLANTSENSE, INC., SAN FRANCISCO, CA. FILED 1-25-2010.



THE MARK CONSISTS OF THE WORD "EASYBLOOM" WITH A CIRCULAR DESIGN ELEMENT THAT HAS SIX PETALS FORMING A FLOWER DESIGN.

FOR ELECTRONIC PLANT MOISTURE SENSOR (U.S. CLS. 21, 23, 26, 36 AND 38).

FIRST USE 8-30-2008; IN COMMERCE 10-22-2008.
RAMONA ORTIGA, EXAMINING ATTORNEY

SN 77-919,367. PLANTSENSE, INC., SAN FRANCISCO, CA. FILED 1-25-2010.



NO CLAIM IS MADE TO THE EXCLUSIVE RIGHT TO USE "PLANTSENSE", APART FROM THE MARK AS SHOWN.

THE MARK CONSISTS OF TWO LEAVES IN THE FORM OF A HALF CLOVER NEXT TO THE WORDING "PLANT-SENSE".

FOR ELECTRONIC PLANT MOISTURE SENSOR (U.S. CLS. 21, 23, 26, 36 AND 38).

FIRST USE 1-1-2007; IN COMMERCE 10-22-2008.
RAMONA ORTIGA, EXAMINING ATTORNEY

SN 77-920,039. PICTURETHIS ???, SOUTH KENT, CT. FILED 1-26-2010.

A PICTURETHIS DVD ???

THE MARK CONSISTS OF STANDARD CHARACTERS WITHOUT CLAIM TO ANY PARTICULAR FONT, STYLE, SIZE, OR COLOR.

NO CLAIM IS MADE TO THE EXCLUSIVE RIGHT TO USE "DVD", APART FROM THE MARK AS SHOWN.

FOR DIGITAL MEDIA, NAMELY, PRE-RECORDED DVDS AND HIGH DEFINITION DIGITAL DISCS FEATURING PICTURE BOOKS (U.S. CLS. 21, 23, 26, 36 AND 38).

MARY CRAWFORD, EXAMINING ATTORNEY

SN 77-920,120. MOTION GRID INC., PLANO, TX. FILED 1-26-2010.

Contactpoints

THE MARK CONSISTS OF STANDARD CHARACTERS WITHOUT CLAIM TO ANY PARTICULAR FONT, STYLE, SIZE, OR COLOR.

FOR COMPUTER SOFTWARE FOR USE IN CUSTOMER RELATIONSHIP MANAGEMENT (CRM) (U.S. CLS. 21, 23, 26, 36 AND 38).

JASON BLAIR, EXAMINING ATTORNEY

CLASS 9—(Continued).

SN 77-922,613. MICROSOFT CORPORATION, REDMOND, WA. FILED 1-28-2010.

LIFECAM STUDIO

THE MARK CONSISTS OF STANDARD CHARACTERS WITHOUT CLAIM TO ANY PARTICULAR FONT, STYLE, SIZE, OR COLOR.

OWNER OF U.S. REG. NO. 3,620,523.
FOR COMPUTER SOFTWARE FOR USE AS AN INTERFACE BETWEEN WEBCAMS AND COMPUTERS; WEBCAMS (U.S. CLS. 21, 23, 26, 36 AND 38).
DAVID TAYLOR, EXAMINING ATTORNEY

SN 77-922,687. DDM & ASSOCIATES, INC., FULLERTON, CA. FILED 1-28-2010.

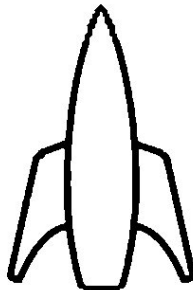

THE MARK CONSISTS OF A ROCKET SHIP.
FOR MUSICAL INSTRUMENT AMPLIFIERS; ELECTRONIC PRODUCTS FOR THE MANIPULATION OF THE FREQUENCY, TIME, AND AMPLITUDE CHARACTERISTICS OF AUDIO SIGNALS, NAMELY, AUDIO PROCESSORS; ELECTRONIC EFFECT PEDALS FOR USE WITH SOUND AMPLIFIERS; FOOT SWITCH ASSEMBLIES THAT CONNECTS TO A MUSICAL AMPLIFIER, USED AS A CONTROLLING DEVICE THAT ENABLES THE USER TO SWITCH FROM TWO DIFFERENT SOUNDS FROM THE AMPLIFIER; SIGNAL PROCESSORS (U.S. CLS. 21, 23, 26, 36 AND 38).
FIRST USE 7-1-1994; IN COMMERCE 6-26-1995.
REGINA DRUMMOND, EXAMINING ATTORNEY

CLASS 9—(Continued).

SN 77-922,689. LUIDIA, INC., SAN CARLOS, CA. FILED 1-28-2010.

EBEAM EDGE

THE MARK CONSISTS OF STANDARD CHARACTERS WITHOUT CLAIM TO ANY PARTICULAR FONT, STYLE, SIZE, OR COLOR.

OWNER OF U.S. REG. NO. 2,491,855.
SEC. 2(F).
FOR COMPUTER HARDWARE AND SOFTWARE FOR USE WITH ELECTRONIC MEETING BOARDS, NAMELY, MARKING PEN SLEEVES FITTED WITH SIGNAL TRANSMITTERS, SIGNAL CAPTURE BARS FOR ATTACHMENT TO MEETING BOARDS, AND SOFTWARE THAT CONVEYS DATA TRANSMITTED FROM THE PEN SLEEVES AND CAPTURE BAR TO A PC VIA THE INTERNET (U.S. CLS. 21, 23, 26, 36 AND 38).
FIRST USE 6-15-2009; IN COMMERCE 6-15-2009.
REGINA DRUMMOND, EXAMINING ATTORNEY

SN 77-923,077. DIVERSE BRANDS, INC., SANTA MONICA, CA. FILED 1-28-2010.

KARBON

THE MARK CONSISTS OF STANDARD CHARACTERS WITHOUT CLAIM TO ANY PARTICULAR FONT, STYLE, SIZE, OR COLOR.

FOR ELECTRIC IRONS FOR STYLING HAIR (U.S. CLS. 21, 23, 26, 36 AND 38).
JENNY PARK, EXAMINING ATTORNEY

SN 77-923,250. NEWTECH ELECTRONICS INDUSTRIES, INC., MIAMI GARDENS, FL. FILED 1-29-2010.

NEWTECH

THE MARK CONSISTS OF STANDARD CHARACTERS WITHOUT CLAIM TO ANY PARTICULAR FONT, STYLE, SIZE, OR COLOR.

FOR CONSUMER ELECTRONICS, NAMELY, PHONE CHARGERS, PHONE DOCKING STATIONS; RADIOS INCORPORATING CLOCKS, MP3 PLAYERS, MP4 PLAYERS, TELEVISIONS, DVD PLAYERS, RADIOS, PORTABLE DVD PLAYERS (U.S. CLS. 21, 23, 26, 36 AND 38).
FIRST USE 12-31-1991; IN COMMERCE 12-31-1991.
HEATHER THOMPSON, EXAMINING ATTORNEY

CLASS 9—(Continued).

SN 77-923,320. TIMES MICROWAVE SYSTEMS, INC., WALLINGFORD, CT. FILED 1-29-2010.

TIMES-PROTECT

THE MARK CONSISTS OF STANDARD CHARACTERS WITHOUT CLAIM TO ANY PARTICULAR FONT, STYLE, SIZE, OR COLOR.

FOR RADIO FREQUENCY COAXIAL VOLTAGE SURGE PROTECTORS, ELECTRICAL AND COAXIAL CABLES, AND ELECTRIC CONNECTORS (U.S. CLS. 21, 23, 26, 36 AND 38).

MARY CRAWFORD, EXAMINING ATTORNEY

SN 77-923,621. OWENS, DAVID R, DBA ENDLESS GRIND ENTERTAINMENT, MILWAUKEE, WI. FILED 1-29-2010.

Endless Grind Entertainment

THE MARK CONSISTS OF STANDARD CHARACTERS WITHOUT CLAIM TO ANY PARTICULAR FONT, STYLE, SIZE, OR COLOR.

NO CLAIM IS MADE TO THE EXCLUSIVE RIGHT TO USE "ENTERTAINMENT", APART FROM THE MARK AS SHOWN.

FOR ABDOMINAL BELTS CONTAINING BUILT-IN SPEAKERS FOR PURPOSES OF TRANSMITTING MUSIC/SOUNDS/EDUCATIONAL MATERIAL TO A FETUS AND BUILT-IN POCKETS IN WHICH TO CARRY AUDIO TRANSMITTERS; AUDIO RECORDINGS FEATURING MUSIC; AUDIO SPEAKERS THAT MAY BE ATTACHED WITH ADHESIVE TO THE ABDOMINAL AREA OF PREGNANT WOMEN FOR THE PURPOSE OF TRANSMITTING MUSIC/SOUNDS TO THE FETUS, NOT FOR MEDICAL PURPOSES; AUDIO TAPES FEATURING MUSIC; CHILDREN'S EDUCATIONAL MUSIC CDS AND DVDS; COMPACT DISC PLAYERS; COMPACT DISCS FEATURING MUSIC; COMPUTER HARDWARE AND SOFTWARE FOR PROCESSING DIGITAL MUSIC FILES; COMPUTER SOFTWARE FEATURING MUSICAL SOUND RECORDINGS AND MUSICAL VIDEO RECORDINGS; COMPUTER SOFTWARE FOR PROCESSING DIGITAL MUSIC FILES; DIGITAL MUSIC DOWNLOADABLE FROM THE INTERNET; DIGITAL MUSIC SYSTEM THAT SYNCHRONIZES DIGITAL MUSIC FILES STORED ON A HOME UNIT AND A CAR UNIT; DIGITAL MUSIC SYSTEMS THAT SYNCHRONIZES DIGITAL RADIO FILES STORED ON A HOME UNIT, A CAR UNIT, OR PORTABLE UNIT AND THAT MAY BE BACKED UP TO AN INTERNET DEPOSITORY; DIGITAL PHOTO FRAMES FOR DISPLAYING DIGITAL PICTURES, VIDEO CLIPS AND MUSIC; DOWNLOADABLE MP3 FILES, MP3 RECORDINGS, ON-LINE DISCUSSION BOARDS, WEBCASTS, WEBINARS AND PODCASTS FEATURING MUSIC, AUDIO BOOKS AND NEWS BROADCASTS; DOWNLOADABLE MUSICAL SOUND RECORDINGS; DOWNLOADABLE RING TONES, GRAPHICS AND MUSIC VIA A GLOBAL COMPUTER NETWORK AND WIRELESS DEVICES; DOWNLOADABLE VIDEO RECORDINGS FEATURING MUSIC (U.S. CLS. 21, 23, 26, 36 AND 38).

MARTHA FROMM, EXAMINING ATTORNEY

CLASS 9—(Continued).

SN 77-923,638. BLUEPRINT SOLUTIONS, LLC, EDEN PRAIRIE, MN. FILED 1-29-2010.



THE COLOR(S) ROYAL BLUE AND WHITE IS/ARE CLAIMED AS A FEATURE OF THE MARK.

THE MARK CONSISTS OF A ROYAL BLUE CIRCLE WITH A WHITE DIAGONAL POSITIONED "B" WHICH HAS A NOTCH EXTENDING FROM THE BACKSIDE OF THE "B". THE CIRCLE IS POSITIONED TO THE LEFT OF THE WORD "BLUEPRINT" IN ROYAL BLUE.

FOR COMPUTER SOFTWARE TO ASSIST IN HEALTH CARE CLINIC MANAGEMENT AND PATIENT TRACKING, SPECIFICALLY FOR USE WITH CLINICS THAT OPERATE AUDIOMETERS (U.S. CLS. 21, 23, 26, 36 AND 38).

DOMINIC FATHY, EXAMINING ATTORNEY

SN 77-923,684. BLUEPRINT SOLUTIONS, LLC, MINNEAPOLIS, MN. FILED 1-29-2010.

Blueprint OMS

THE MARK CONSISTS OF STANDARD CHARACTERS WITHOUT CLAIM TO ANY PARTICULAR FONT, STYLE, SIZE, OR COLOR.

NO CLAIM IS MADE TO THE EXCLUSIVE RIGHT TO USE "OMS", APART FROM THE MARK AS SHOWN.

FOR COMPUTER SOFTWARE TO ASSIST IN HEALTH CARE CLINIC MANAGEMENT AND PATIENT TRACKING, SPECIFICALLY FOR USE WITH CLINICS THAT OPERATE AUDIOMETERS (U.S. CLS. 21, 23, 26, 36 AND 38).

DOMINIC FATHY, EXAMINING ATTORNEY

SN 77-923,696. AAF-MCQUAY INC., LOUISVILLE, KY. FILED 1-29-2010.

SAAFDTECT

THE MARK CONSISTS OF STANDARD CHARACTERS WITHOUT CLAIM TO ANY PARTICULAR FONT, STYLE, SIZE, OR COLOR.

FOR GAS DETECTORS FOR DETECTING THE PRESENCE OF GAS (U.S. CLS. 21, 23, 26, 36 AND 38).

FIRST USE 1-19-2010; IN COMMERCE 1-19-2010.

SIMON TENG, EXAMINING ATTORNEY

CLASS 9—(Continued).

SN 77-923,760. ENGINEERED VIGILANCE, LLC, SHARON, MA. FILED 1-29-2010.



THE MARK CONSISTS OF AN ELECTRONIC DEPICTION OF THE WORDS "ENGINEERED VIGILANCE" ACCOMPANIED BY A REVOLVING DESIGN ROTATING AROUND THE FINAL THREE LETTERS OF THE WORD "VIGILANCE" IN THE SEQUENCE SHOWN.

FOR COMPUTER HARDWARE AND SOFTWARE, FOR USE WITH MEDICAL PATIENT MONITORING EQUIPMENT, FOR RECEIVING, PROCESSING, TRANSMITTING AND DISPLAYING DATA; COMPUTER SOFTWARE AND HARDWARE FOR USE WITH SUBJECT MONITORING EQUIPMENT, FOR RECEIVING, PROCESSING, TRANSMITTING AND DISPLAYING DATA, AND PROVIDING BIOFEEDBACK TO THE SUBJECT (U.S. CLS. 21, 23, 26, 36 AND 38).

PAUL E. FAHRENKOPF, EXAMINING ATTORNEY

CLASS 9—(Continued).

SN 77-923,939. VELVETWIRE LLC, SAN FRANCISCO, CA. FILED 1-29-2010.

ADAPTIV

THE MARK CONSISTS OF STANDARD CHARACTERS WITHOUT CLAIM TO ANY PARTICULAR FONT, STYLE, SIZE, OR COLOR.

FOR RESIDENTIAL AND INDUSTRIAL ENVIRONMENTAL MEASUREMENT AND CONTROL SYSTEMS FOR LIGHTING, CLIMATE, IRRIGATION, HOUSEHOLD APPLIANCES, AND WATER HEATERS CONSISTING OF PROGRAMMABLE LOGIC CONTROLLERS, ELECTRICITY, LIGHT, TEMPERATURE AND MOISTURE SENSORS, ELECTRICAL AND MECHANICAL ACTUATORS, AND CONTROL LOGIC COMPUTER FIRMWARE; MEASUREMENT AND CONTROL SOFTWARE CONSISTING OF PERSONAL COMPUTER SOFTWARE, WEB SERVER SOFTWARE AND PORTABLE DEVICE SOFTWARE TO RECEIVE ENVIRONMENTAL INFORMATION FROM AND SEND ENVIRONMENTAL CONTROL SIGNALS TO RESIDENTIAL AND INDUSTRIAL ENVIRONMENTAL MEASUREMENT AND CONTROL SYSTEMS FOR LIGHTING, CLIMATE, IRRIGATION, HOUSEHOLD APPLIANCES, AND WATER HEATERS; ENERGY USAGE ANALYSIS AND FORECASTING SOFTWARE CONSISTING OF PERSONAL COMPUTER SOFTWARE, WEB SERVER SOFTWARE AND PORTABLE DEVICE SOFTWARE TO AGGREGATE AND SUMMARIZE ENERGY USAGE INFORMATION FROM ONE OR MULTIPLE RESIDENTIAL OR INDUSTRIAL ENVIRONMENTAL MEASUREMENT AND CONTROL SYSTEMS (U.S. CLS. 21, 23, 26, 36 AND 38).

RENEE MCCRAY, EXAMINING ATTORNEY

SN 77-923,809. ENGINEERED VIGILANCE, LLC, SHARON, MA. FILED 1-29-2010.



THE MARK CONSISTS OF THE WORDS "ENGINEERED VIGILANCE" ACCOMPANIED BY A THREE PIECE DESIGN IN CIRCULAR PROXIMITY TO THE FINAL THREE LETTERS OF THE WORD "VIGILANCE" AS SHOWN.

FOR COMPUTER HARDWARE AND SOFTWARE, FOR USE WITH MEDICAL PATIENT MONITORING EQUIPMENT, FOR RECEIVING, PROCESSING, TRANSMITTING AND DISPLAYING DATA; COMPUTER SOFTWARE AND HARDWARE FOR USE WITH SUBJECT MONITORING EQUIPMENT, FOR RECEIVING, PROCESSING, TRANSMITTING AND DISPLAYING DATA, AND PROVIDING BIOFEEDBACK TO THE SUBJECT (U.S. CLS. 21, 23, 26, 36 AND 38).

PAUL E. FAHRENKOPF, EXAMINING ATTORNEY

SN 77-924,323. PETTIS,MIKEL H., AKA (EAGLE ST. MUSIC), VACAVILLE, CA. FILED 1-30-2010.

(Eagle St. Music)

THE MARK CONSISTS OF STANDARD CHARACTERS WITHOUT CLAIM TO ANY PARTICULAR FONT, STYLE, SIZE, OR COLOR.

NO CLAIM IS MADE TO THE EXCLUSIVE RIGHT TO USE "MUSIC", APART FROM THE MARK AS SHOWN.

FOR DIGITAL MUSIC DOWNLOADABLE FROM THE INTERNET (U.S. CLS. 21, 23, 26, 36 AND 38).

ESTHER BELENKER, EXAMINING ATTORNEY

CLASS 9—(Continued).

SN 77-924,387. GREENWOOD EMERGENCY VEHICLES, INC., FORMERLY GREENWOOD FIRE APPARATUS, INC., NORTH ATTLEBORO, MA. FILED 1-31-2010.

MAXIM MOTOR COMPANY

THE MARK CONSISTS OF STANDARD CHARACTERS WITHOUT CLAIM TO ANY PARTICULAR FONT, STYLE, SIZE, OR COLOR.

OWNER OF U.S. REG. NO. 3,514,055.

NO CLAIM IS MADE TO THE EXCLUSIVE RIGHT TO USE "MOTOR COMPANY", APART FROM THE MARK AS SHOWN.

FOR FIRE ENGINES (U.S. CLS. 21, 23, 26, 36 AND 38).
COLLEEN KEARNEY, EXAMINING ATTORNEY

SN 77-924,418. OUTSPARK, INC., SAN FRANCISCO, CA. FILED 1-31-2010.

O+

THE MARK CONSISTS OF STANDARD CHARACTERS WITHOUT CLAIM TO ANY PARTICULAR FONT, STYLE, SIZE, OR COLOR.

FOR COMPUTER SOFTWARE, NAMELY, COMPUTER GAME SOFTWARE FOR USE IN UPLOADING, DOWNLOADING AND PLAYING ONLINE COMPUTER GAMES, PROVIDING COMPUTER GAME RESULTS AND RELATED INFORMATION, AND ALLOWING ONLINE COMMUNICATION BETWEEN USERS (U.S. CLS. 21, 23, 26, 36 AND 38).

KATINA MISTER, EXAMINING ATTORNEY

SN 77-924,423. OUTSPARK, INC., SAN FRANCISCO, CA. FILED 1-31-2010.

O PLUS

THE MARK CONSISTS OF STANDARD CHARACTERS WITHOUT CLAIM TO ANY PARTICULAR FONT, STYLE, SIZE, OR COLOR.

FOR COMPUTER SOFTWARE, NAMELY, COMPUTER GAME SOFTWARE FOR USE IN UPLOADING, DOWNLOADING AND PLAYING ONLINE COMPUTER GAMES, PROVIDING COMPUTER GAME RESULTS AND RELATED INFORMATION, AND ALLOWING ONLINE COMMUNICATION BETWEEN USERS (U.S. CLS. 21, 23, 26, 36 AND 38).

KATINA MISTER, EXAMINING ATTORNEY

CLASS 9—(Continued).

SN 77-924,503. SOCIAL MOBILE DESIGNS LLC, MILLBRAE, CA. FILED 2-1-2010.

MonkeyBananaRaffle

THE MARK CONSISTS OF THE WORDS "MONKEY", "BANANA", AND "RAFFLE" APPEARING AS ONE WORD WITHOUT ANY SPACES BETWEEN THEM IN PUPCAT FONT AND WITH A SHADOW AND WITH THE LETTERS "M" AND "B" IN UPPER CASE AND "R" IN LOWER CASE APPEARING SLIGHTLY TALLER THAN THE REST OF THE LETTERS.

FOR INTERACTIVE GAME PROGRAMS (U.S. CLS. 21, 23, 26, 36 AND 38).

MICHELLE DUBOIS, EXAMINING ATTORNEY

SN 77-924,531. ROBERT S ALLEN, KEY WEST, FL. FILED 2-1-2010.

GRABBER

THE MARK CONSISTS OF STANDARD CHARACTERS WITHOUT CLAIM TO ANY PARTICULAR FONT, STYLE, SIZE, OR COLOR.

FOR EXTENSION CORD CONNECTORS MADE FROM POLYMER (U.S. CLS. 21, 23, 26, 36 AND 38).

ALEX KEAM, EXAMINING ATTORNEY

SN 77-924,691. CONSUMERCARTEL, LTD. C/O TRIDENT TRUST COMPANY, TORTOLA, BR.VIRGIN ISLANDS, FILED 2-1-2010.

CONSUMERCARTEL CASHCARD

THE MARK CONSISTS OF STANDARD CHARACTERS WITHOUT CLAIM TO ANY PARTICULAR FONT, STYLE, SIZE, OR COLOR.

NO CLAIM IS MADE TO THE EXCLUSIVE RIGHT TO USE "CASH CARD", APART FROM THE MARK AS SHOWN.

FOR MAGNETICALLY ENCODED DEBIT AND CREDIT CARDS (U.S. CLS. 21, 23, 26, 36 AND 38).

NATALIE POLZER, EXAMINING ATTORNEY

CLASS 9—(Continued).

SN 77-924,692. CONSUMERCARTEL, LTD. C/O TRIDENT TRUST COMPANY, TORTOLA, BR.VIRGIN ISLANDS, FILED 2-1-2010.

CC CASHCARD

THE MARK CONSISTS OF STANDARD CHARACTERS WITHOUT CLAIM TO ANY PARTICULAR FONT, STYLE, SIZE, OR COLOR.

NO CLAIM IS MADE TO THE EXCLUSIVE RIGHT TO USE "CASH CARD", APART FROM THE MARK AS SHOWN.

FOR MAGNETICALLY ENCODED DEBIT AND CREDIT CARDS (U.S. CLS. 21, 23, 26, 36 AND 38).
NATALIE POLZER, EXAMINING ATTORNEY

SN 77-924,760. DE CLERCQ, NATHALIE, WATCHUNG, NJ. FILED 2-1-2010.

Rogue Concepts

THE MARK CONSISTS OF STANDARD CHARACTERS WITHOUT CLAIM TO ANY PARTICULAR FONT, STYLE, SIZE, OR COLOR.

FOR USB (UNIVERSAL SERIAL BUS) HARDWARE: COMPUTER STORAGE DEVICES, NAMELY, FLASH DRIVES; LED SCREENS (U.S. CLS. 21, 23, 26, 36 AND 38).

FIRST USE 11-15-2009; IN COMMERCE 1-1-2010.
DOMINIC J. FERRAIUOLO, EXAMINING ATTORNEY

SN 77-924,869. INTEGRATED-MATRIX-SOLUTIONS, INC., MORAIN, OH. FILED 2-1-2010.

EZDOOR

THE MARK CONSISTS OF STANDARD CHARACTERS WITHOUT CLAIM TO ANY PARTICULAR FONT, STYLE, SIZE, OR COLOR.

FOR ACCESS CONTROL AND ALARM MONITORING SYSTEMS (U.S. CLS. 21, 23, 26, 36 AND 38).

ELLEN B. AWRICH, EXAMINING ATTORNEY

CLASS 9—(Continued).

SN 77-924,947. BLUBERI JEUX ET TECHNOLOGIES INC., AKA BLUBERI GAMING TECHNOLOGIES INC., DRUMMONDVILLE, QUEBEC, CANADA, FILED 2-1-2010.

LUCKY SHAMROCK

THE MARK CONSISTS OF STANDARD CHARACTERS WITHOUT CLAIM TO ANY PARTICULAR FONT, STYLE, SIZE, OR COLOR.

FOR SOFTWARE FOR GAMING MACHINES; GAMING MACHINES WITH VIDEO OUTPUT; GAMING MACHINES FEATURING MECHANICAL REELS (U.S. CLS. 21, 23, 26, 36 AND 38).

NAAKWAMA ANKRAH, EXAMINING ATTORNEY

SN 77-924,955. BLUBERI JEUX ET TECHNOLOGIES INC., AKA BLUBERI GAMING TECHNOLOGIES INC., DRUMMONDVILLE, QUEBEC, CANADA, FILED 2-1-2010.

GROOVY CAT

THE MARK CONSISTS OF STANDARD CHARACTERS WITHOUT CLAIM TO ANY PARTICULAR FONT, STYLE, SIZE, OR COLOR.

FOR SOFTWARE FOR GAMING MACHINES; GAMING MACHINES WITH VIDEO OUTPUT; GAMING MACHINES FEATURING MECHANICAL REELS (U.S. CLS. 21, 23, 26, 36 AND 38).

NAAKWAMA ANKRAH, EXAMINING ATTORNEY

SN 77-925,384. TRAX LIGHTING, INC., SAN DIEGO, CA. FILED 2-1-2010.

Trax Power Light

THE MARK CONSISTS OF STANDARD CHARACTERS WITHOUT CLAIM TO ANY PARTICULAR FONT, STYLE, SIZE, OR COLOR.

NO CLAIM IS MADE TO THE EXCLUSIVE RIGHT TO USE "POWER LIGHT", APART FROM THE MARK AS SHOWN.

FOR LIGHT EMITTING DIODES (LEDS) (U.S. CLS. 21, 23, 26, 36 AND 38).

MICHAEL GAFFAR, EXAMINING ATTORNEY

CLASS 9—(Continued).

SN 77-925,498. ALEKSANDRA B. FRUZYNA, RENO, NV. FILED 2-2-2010.

DATA FROM THE GROUND UP

THE MARK CONSISTS OF STANDARD CHARACTERS WITHOUT CLAIM TO ANY PARTICULAR FONT, STYLE, SIZE, OR COLOR.

FOR COMPUTER GRAPHICS SOFTWARE (U.S. CLS. 21, 23, 26, 36 AND 38).

EUGENIA MARTIN, EXAMINING ATTORNEY

SN 77-925,611. ARMIDILLO BANDZ, INC., AVONDALE ESTATES, GA. FILED 2-2-2010.



THE COLOR(S) BLUE AND ORANGE IS/ARE CLAIMED AS A FEATURE OF THE MARK.

THE MARK CONSISTS OF AN ORANGE ARMADILLO FIGURE ENCIRCLED BY THE WORDS "ARM.ID.ILO BANDZ.COM" IN BLUE AND ORANGE, WITH THE WORDS "SAFETY IN NUMBERZ" PRINTED IN BLUE UNDERNEATH.

FOR NON-METAL IDENTIFICATION BRACELETS FOR CHILDREN FEATURING ELECTRONICALLY ENCODED INFORMATION, SUCH AS A CHILD'S PERSONAL PROFILE, TO EXPEDITE THE IDENTIFICATION AND TRACKING OF LOST OR MISSING CHILDREN (U.S. CLS. 21, 23, 26, 36 AND 38).

CORY BOONE, EXAMINING ATTORNEY

CLASS 9—(Continued).

SN 77-925,738. THE TORO COMPANY, BLOOMINGTON, MN. FILED 2-2-2010.

XTRA SMART

THE MARK CONSISTS OF STANDARD CHARACTERS WITHOUT CLAIM TO ANY PARTICULAR FONT, STYLE, SIZE, OR COLOR.

NO CLAIM IS MADE TO THE EXCLUSIVE RIGHT TO USE "SMART", APART FROM THE MARK AS SHOWN.

FOR AUTOMATIC CONTROLS FOR IRRIGATION SYSTEMS, NAMELY, ELECTRONIC IRRIGATION CONTROLLERS, RAIN SWITCHES, MOISTURE SENSORS, AND WEATHER STATIONS COMPRISING A RAIN GAUGE, SOLAR RADIATION SENSOR, TEMPERATURE SENSOR, WIND SPEED AND/OR RELATIVE HUMIDITY SENSOR COMBINED AS A UNIT (U.S. CLS. 21, 23, 26, 36 AND 38).

NATALIE POLZER, EXAMINING ATTORNEY

SN 77-926,047. MOBINNOVA HONG KONG LIMITED, TAOYUAN CITY, TAIWAN, FILED 2-2-2010.

STAGE XE

THE MARK CONSISTS OF STANDARD CHARACTERS WITHOUT CLAIM TO ANY PARTICULAR FONT, STYLE, SIZE, OR COLOR.

FOR COMPUTER HARDWARE; HAND-HELD COMPUTERS; LAPTOP COMPUTERS; PORTABLE COMPUTERS; COMPUTERS; PERSONAL DIGITAL ASSISTANTS (PDA); DIGITAL IMAGE RECORDERS, NAMELY, DIGITAL IMAGE STORAGES IN THE NATURE OF MEMORY CARDS ON MOBILE PHONES OR PERSONAL DIGITAL ASSISTANTS (PDA) FOR STORAGE OF SOUND OR IMAGES; RADIOTELEPHONY SETS COMPRISING RADIOTELEPHONY TRANSMITTERS, RADIOTELEPHONY RECEIVERS, RADIOTELEPHONY TRANSMITTING AND RECEIVING DEVICES; PORTABLE AND MOBILE TELEPHONES; TELEPHONES FOR USE ON THE INTERNET; ELECTRONIC BOOK READERS; HANDHELD MOBILE DIGITAL ELECTRONIC DEVICES FOR THE SENDING AND RECEIVING OF TELEPHONE CALLS, ELECTRONIC MAIL, AND OTHER DIGITAL DATA. FOR USE AS A DIGITAL FORMAT AUDIO PLAYER, AND FOR USE AS A HANDHELD COMPUTER, PERSONAL DIGITAL ASSISTANT, ELECTRONIC ORGANIZER, ELECTRONIC NOTEPAD, AND CAMERA (U.S. CLS. 21, 23, 26, 36 AND 38).

KELLY BOULTON, EXAMINING ATTORNEY

CLASS 9—(Continued).

SN 77-926,116. JW PUBLIC RELATIONS LLC, MARSHALL, MI. FILED 2-2-2010.

JW PR TOOLKIT

THE MARK CONSISTS OF STANDARD CHARACTERS WITHOUT CLAIM TO ANY PARTICULAR FONT, STYLE, SIZE, OR COLOR.

NO CLAIM IS MADE TO THE EXCLUSIVE RIGHT TO USE "PR TOOLKIT", APART FROM THE MARK AS SHOWN.

FOR DOWNLOADABLE ELECTRONIC PUBLICATIONS IN THE NATURE OF BOOKS, E-BOOKS, MANUALS AND PRESS RELEASES IN THE FIELD OF PUBLIC RELATIONS (U.S. CLS. 21, 23, 26, 36 AND 38).

CYNTHIA SLOAN, EXAMINING ATTORNEY

CLASS 9—(Continued).

SN 77-926,294. GOLDEN EMPEROR INTERNATIONAL LTD., TAIPEI, TAIWAN, FILED 2-2-2010.



THE MARK CONSISTS OF A HAND GRIPPING A LIGHTNING BOLT.

FOR POWER SUPPLIES; ELECTRIC RESISTANCES; CAPACITORS; LIGHT EMITTING DIODES; COMPUTERS; RANDOM ACCESS MEMORY CHIPS, CARDS, AND MODULES; VIDEO GRAPHICS CARDS; USB FLASH MEMORY DRIVE MODULES; FLASH MEMORY CARDS; MP3 PLAYERS; DIGITAL CAMERAS; COMPUTER MOTHERBOARDS; COMPUTER POWER SUPPLIES; COMPUTER EXTERNAL CASES; KEYBOARDS; COMPUTER MOUSE DEVICES (U.S. CLS. 21, 23, 26, 36 AND 38).

FIRST USE 1-0-2010; IN COMMERCE 1-0-2010.
RAUL CORDOVA, EXAMINING ATTORNEY

SN 77-926,268. GOLDEN EMPEROR INTERNATIONAL LTD., TAIPEI, TAIWAN, FILED 2-2-2010.

THORTECH

THE MARK CONSISTS OF STANDARD CHARACTERS WITHOUT CLAIM TO ANY PARTICULAR FONT, STYLE, SIZE, OR COLOR.

FOR POWER SUPPLIES; ELECTRIC RESISTANCES; CAPACITORS; LIGHT EMITTING DIODES; COMPUTERS; RANDOM ACCESS MEMORY CHIPS, CARDS, AND MODULES; VIDEO GRAPHICS CARDS; USB FLASH MEMORY DRIVE MODULES; FLASH MEMORY CARDS; MP3 PLAYERS; DIGITAL CAMERAS; COMPUTER MOTHERBOARDS; COMPUTER POWER SUPPLIES; COMPUTER EXTERNAL CASES; KEYBOARDS; COMPUTER MOUSE DEVICES (U.S. CLS. 21, 23, 26, 36 AND 38).

FIRST USE 1-0-2010; IN COMMERCE 1-0-2010.
RAUL CORDOVA, EXAMINING ATTORNEY

SN 77-926,330. ENERGY NAVIGATOR INC., CALGARY, ALBERTA, CANADA, FILED 2-2-2010.



OWNER OF U.S. REG. NO. 2,665,209.
THE MARK CONSISTS OF THE WORDS "VALUE NAVIGATOR". THE "N" IN "NAVIGATOR" IS IN A SPHERE DESIGN AND IS TILTED TO THE RIGHT SIDE. THERE IS A CONE WHICH SITS ON TOP AND SLIGHTLY TO THE RIGHT SIDE OF THE SPHERE.

FOR SOFTWARE FOR USE IN THE ANALYSIS, EVALUATION AND REPORTING OF OIL AND GAS PROPERTIES AND WELLS (U.S. CLS. 21, 23, 26, 36 AND 38).

FIRST USE 12-0-2006; IN COMMERCE 12-0-2006.
KAREN K. BUSH, EXAMINING ATTORNEY

CLASS 9—(Continued).

SN 77-926,347. OPTIMIZE TECHNOLOGIES, INC., OREGON CITY, OR. FILED 2-2-2010.

EXP

THE MARK CONSISTS OF STANDARD CHARACTERS WITHOUT CLAIM TO ANY PARTICULAR FONT, STYLE, SIZE, OR COLOR.

FOR COMPONENT PARTS FOR LIQUID CHROMATOGRAPHY AND OTHER ANALYTICAL, SYNTHETIC, AND SAMPLE PREPARATORY TECHNIQUES, NAMELY, GUARD COLUMNS, PRE-COLUMN FILTERS, FITTINGS, AND TRAP COLUMNS, ALL OF THE FOREGOING COMPONENT PARTS FOR INSTRUMENTS DESIGNED TO PERFORM LIQUID CHROMATOGRAPHY AND OTHER ANALYTICAL, SYNTHETIC, AND SAMPLE PREPARATORY TECHNIQUES, AND FOR INSTRUMENTS DESIGNED TO PERFORM FLUID TRANSFER IN SCIENTIFIC INSTRUMENTS, SAID INSTRUMENTS FOR USE BY THOSE WORKING IN THE FIELDS OF LIQUID CHROMATOGRAPHY (LC), MASS SPECTROMETRY (MS), LIQUID CHROMATOGRAPHY COMBINED WITH MASS SPECTROMETRY (LC/MS), AND FOR SCIENTIFIC INSTRUMENTATION AND EQUIPMENT UTILIZING LIQUID TRANSFER UNDER PRESSURE TO PERFORM ANALYSIS, TESTING AND MEASUREMENT AS WELL AS GENERAL FLUID TRANSFER IN A LABORATORY OR INDUSTRIAL SETTING (U.S. CLS. 21, 23, 26, 36 AND 38).

FIRST USE 0-0-2007; IN COMMERCE 0-0-2007.

JULIE VEPPUMTHARA, EXAMINING ATTORNEY

SN 77-926,397. FABRIQUE, LTD, STONY CREEK, CT. FILED 2-2-2010.



route
designing for tomorrow

FOR CARRYING CASES FOR NOTEBOOK COMPUTERS (U.S. CLS. 21, 23, 26, 36 AND 38).

MICHAEL GAAFAR, EXAMINING ATTORNEY

SN 77-926,467. FUGOO, INC., IRVINE, CA. FILED 2-2-2010.

JOT-IT

THE MARK CONSISTS OF STANDARD CHARACTERS WITHOUT CLAIM TO ANY PARTICULAR FONT, STYLE, SIZE, OR COLOR.

FOR COMPUTER SOFTWARE, NAMELY, A MESSAGING PLATFORM FOR USE BY MULTIPLE USERS (U.S. CLS. 21, 23, 26, 36 AND 38).

SHANNON TWOHIG, EXAMINING ATTORNEY

CLASS 9—(Continued).

SN 77-926,468. FUGOO, INC., IRVINE, CA. FILED 2-2-2010.

DATE-IT

THE MARK CONSISTS OF STANDARD CHARACTERS WITHOUT CLAIM TO ANY PARTICULAR FONT, STYLE, SIZE, OR COLOR.

FOR COMPUTER PROGRAMS FOR PROVIDING ENHANCED SCHEDULING CAPABILITIES; COMPUTER PROGRAMS FOR MEETING AND EVENT SCHEDULING, MANAGING GROUP CALENDARS, AND TASK DELEGATION (U.S. CLS. 21, 23, 26, 36 AND 38).

SHANNON TWOHIG, EXAMINING ATTORNEY

SN 77-926,474. FUGOO, INC., IRVINE, CA. FILED 2-2-2010.

IN-TOUCH

THE MARK CONSISTS OF STANDARD CHARACTERS WITHOUT CLAIM TO ANY PARTICULAR FONT, STYLE, SIZE, OR COLOR.

FOR COMPUTER SOFTWARE, NAMELY, A USER INTERFACE FOR INTERACTING WITH THIRD-PARTY SOCIAL NETWORK SITES (U.S. CLS. 21, 23, 26, 36 AND 38).

SHANNON TWOHIG, EXAMINING ATTORNEY

SN 77-926,475. FUGOO, INC., IRVINE, CA. FILED 2-2-2010.

SECURE-IT

THE MARK CONSISTS OF STANDARD CHARACTERS WITHOUT CLAIM TO ANY PARTICULAR FONT, STYLE, SIZE, OR COLOR.

FOR COMPUTER SOFTWARE FOR USE IN MANAGEMENT AND TRACKING OF HOUSEHOLD AND PERSONAL INFORMATION (U.S. CLS. 21, 23, 26, 36 AND 38).

SHANNON TWOHIG, EXAMINING ATTORNEY

CLASS 9—(Continued).

SN 77-926,487. NEW LIGHT RECORDS, WEST COVINA, CA. FILED 2-2-2010.



NO CLAIM IS MADE TO THE EXCLUSIVE RIGHT TO USE "RECORDS" AND THE STYLIZED REPRESENTATION OF A CRUCIFIX, APART FROM THE MARK AS SHOWN. THE COLOR(S) BLACK, WHITE, GRAY IS/ARE CLAIMED AS A FEATURE OF THE MARK.

THE MARK CONSISTS OF HALF BLACK AND HALF WHITE RECTANGLE ENCLONG THE WORDS "NEW LIGHT" CONTAINING A GRAY CRUCIFIX IN THE MIDDLE WITH THE WORD "RECORDS" BELOW.

FOR COMPACT DISCS FEATURING MUSIC; DIGITAL MUSIC DOWNLOADABLE FROM THE INTERNET (U.S. CLS. 21, 23, 26, 36 AND 38).

FIRST USE 6-3-1998; IN COMMERCE 6-4-1998. DAVID HOFFMAN, EXAMINING ATTORNEY

SN 77-926,542. OTOVATION, LLC, KING OF PRUSSIA, PA. FILED 2-3-2010.

OTOPRO

THE MARK CONSISTS OF STANDARD CHARACTERS WITHOUT CLAIM TO ANY PARTICULAR FONT, STYLE, SIZE, OR COLOR.

FOR ACOUSTIC AND AUDIOLOGIC TEST EQUIPMENT AND SOFTWARE (U.S. CLS. 21, 23, 26, 36 AND 38).

HEATHER SAPP, EXAMINING ATTORNEY

SN 77-926,562. OTOVATION, LLC, KING OF PRUSSIA, PA. FILED 2-3-2010.

OTOMAP

THE MARK CONSISTS OF STANDARD CHARACTERS WITHOUT CLAIM TO ANY PARTICULAR FONT, STYLE, SIZE, OR COLOR.

FOR ACOUSTIC AND AUDIOLOGIC TEST EQUIPMENT AND SOFTWARE (U.S. CLS. 21, 23, 26, 36 AND 38).

HEATHER SAPP, EXAMINING ATTORNEY

CLASS 9—(Continued).

SN 77-926,589. G&G INTERNATIONAL TRADING CO., INC., DANBURY, CT. FILED 2-3-2010.

AMABILE

THE MARK CONSISTS OF STANDARD CHARACTERS WITHOUT CLAIM TO ANY PARTICULAR FONT, STYLE, SIZE, OR COLOR.

FOR AUDIO ELECTRONIC COMPONENTS, NAMELY, AUDIO AMPLIFIERS, AUDIO SPEAKERS, AUDIO MIXERS AND ELECTRONIC PRODUCTS FOR THE MANIPULATION OF THE FREQUENCY, TIME, AND AMPLITUDE CHARACTERISTICS OF AUDIO SIGNALS, NAMELY, AUDIO PROCESSORS (U.S. CLS. 21, 23, 26, 36 AND 38).

ANDREA BUTLER, EXAMINING ATTORNEY

SN 77-926,643. SIRLADY RECORDS, LLC, WOODSTOCK, NY. FILED 2-3-2010.

SIRLADY

THE MARK CONSISTS OF STANDARD CHARACTERS WITHOUT CLAIM TO ANY PARTICULAR FONT, STYLE, SIZE, OR COLOR.

FOR MUSICAL SOUND RECORDINGS (U.S. CLS. 21, 23, 26, 36 AND 38).

FIRST USE 6-0-2004; IN COMMERCE 6-0-2004. ELLEN PERKINS, EXAMINING ATTORNEY

SN 77-926,755. SIGNATURE GENOMIC LABORATORIES, LLC, SPOKANE, WA. FILED 2-3-2010.

GENOGLYPHIX

THE MARK CONSISTS OF STANDARD CHARACTERS WITHOUT CLAIM TO ANY PARTICULAR FONT, STYLE, SIZE, OR COLOR.

OWNER OF U.S. REG. NOS. 3,409,956, 3,501,643 AND OTHERS.

FOR COMPUTER SOFTWARE FOR SCIENTIFIC ANALYSIS OF GENETIC SEQUENCES; SCIENTIFIC APPARATUS AND INSTRUMENTS FOR DETERMINATION OF GENETIC ATTRIBUTES OF BIOLOGICAL SPECIMENS; COMPUTER SOFTWARE FOR MEDICAL SERVICES, NAMELY, MEDICAL DIAGNOSTIC SOFTWARE AND MEDICAL TESTING SOFTWARE; COMPUTER SOFTWARE FOR CONTROLLING AND MANAGING PATIENT MEDICAL INFORMATION; DOWNLOADABLE SCIENTIFIC AND MEDICAL DATA VIA THE INTERNET; GLASS SLIDES OR CHIPS HAVING MULTI-WELL ARRAYS THAT CAN BE USED IN CHEMICAL ANALYSIS, BIOLOGICAL ANALYSIS OR PATTERNING FOR SCIENTIFIC, LABORATORY OR MEDICAL RESEARCH USE (U.S. CLS. 21, 23, 26, 36 AND 38).

BRIAN NEVILLE, EXAMINING ATTORNEY

CLASS 9—(Continued).

SN 77-926,761. SIGNATURE GENOMIC LABORATORIES, LLC, SPOKANE, WA. FILED 2-3-2010.

PRENATALCHIP

THE MARK CONSISTS OF STANDARD CHARACTERS WITHOUT CLAIM TO ANY PARTICULAR FONT, STYLE, SIZE, OR COLOR.

OWNER OF U.S. REG. NOS. 3,419,022 AND 3,427,406.

FOR COMPUTER SOFTWARE FOR SCIENTIFIC ANALYSIS OF GENETIC SEQUENCES; SCIENTIFIC APPARATUS AND INSTRUMENTS FOR DETERMINATION OF GENETIC ATTRIBUTES OF BIOLOGICAL SPECIMENS; COMPUTER SOFTWARE FOR MEDICAL SERVICES, NAMELY, MEDICAL DIAGNOSTIC SOFTWARE AND MEDICAL TESTING SOFTWARE; COMPUTER SOFTWARE FOR CONTROLLING AND MANAGING PATIENT MEDICAL INFORMATION; DOWNLOADABLE SCIENTIFIC AND MEDICAL DATA VIA THE INTERNET; GLASS SLIDES OR CHIPS HAVING MULTI-WELL ARRAYS THAT CAN BE USED IN CHEMICAL ANALYSIS, BIOLOGICAL ANALYSIS OR PATTERNING FOR SCIENTIFIC, LABORATORY OR MEDICAL RESEARCH USE (U.S. CLS. 21, 23, 26, 36 AND 38).

BRIAN NEVILLE, EXAMINING ATTORNEY

CLASS 9—(Continued).

SN 77-926,824. SIGNATURE GENOMIC LABORATORIES, LLC, SPOKANE, WA. FILED 2-3-2010.

SIGNATURECHIP

THE MARK CONSISTS OF STANDARD CHARACTERS WITHOUT CLAIM TO ANY PARTICULAR FONT, STYLE, SIZE, OR COLOR.

OWNER OF U.S. REG. NOS. 2,948,055, 3,656,435 AND OTHERS.

FOR COMPUTER SOFTWARE FOR SCIENTIFIC ANALYSIS OF GENETIC SEQUENCES; SCIENTIFIC APPARATUS AND INSTRUMENTS FOR DETERMINATION OF GENETIC ATTRIBUTES OF BIOLOGICAL SPECIMENS; COMPUTER SOFTWARE FOR MEDICAL SERVICES, NAMELY, MEDICAL DIAGNOSTIC SOFTWARE AND MEDICAL TESTING SOFTWARE; COMPUTER SOFTWARE FOR CONTROLLING AND MANAGING PATIENT MEDICAL INFORMATION; DOWNLOADABLE SCIENTIFIC AND MEDICAL DATA VIA THE INTERNET; GLASS SLIDES OR CHIPS HAVING MULTI-WELL ARRAYS THAT CAN BE USED IN CHEMICAL ANALYSIS, BIOLOGICAL ANALYSIS OR PATTERNING FOR SCIENTIFIC, LABORATORY OR MEDICAL RESEARCH USE (U.S. CLS. 21, 23, 26, 36 AND 38).

BRIAN NEVILLE, EXAMINING ATTORNEY

SN 77-926,801. SIGNATURE GENOMIC LABORATORIES, LLC, SPOKANE, WA. FILED 2-3-2010.

ONCOCHIP

THE MARK CONSISTS OF STANDARD CHARACTERS WITHOUT CLAIM TO ANY PARTICULAR FONT, STYLE, SIZE, OR COLOR.

FOR COMPUTER SOFTWARE FOR SCIENTIFIC ANALYSIS OF GENETIC SEQUENCES; SCIENTIFIC APPARATUS AND INSTRUMENTS FOR DETERMINATION OF GENETIC ATTRIBUTES OF BIOLOGICAL SPECIMENS; COMPUTER SOFTWARE FOR MEDICAL SERVICES, NAMELY, MEDICAL DIAGNOSTIC SOFTWARE AND MEDICAL TESTING SOFTWARE; COMPUTER SOFTWARE FOR CONTROLLING AND MANAGING PATIENT MEDICAL INFORMATION; DOWNLOADABLE SCIENTIFIC AND MEDICAL DATA VIA THE INTERNET; GLASS SLIDES OR CHIPS HAVING MULTI-WELL ARRAYS THAT CAN BE USED IN CHEMICAL ANALYSIS, BIOLOGICAL ANALYSIS OR PATTERNING FOR SCIENTIFIC, LABORATORY OR MEDICAL RESEARCH USE (U.S. CLS. 21, 23, 26, 36 AND 38).

BRIAN NEVILLE, EXAMINING ATTORNEY

SN 77-926,983. DAVIS INSTRUMENTS CORPORATION, HAYWARD, CA. FILED 2-3-2010.

CarChip Connect

THE MARK CONSISTS OF STANDARD CHARACTERS WITHOUT CLAIM TO ANY PARTICULAR FONT, STYLE, SIZE, OR COLOR.

OWNER OF U.S. REG. NOS. 2,859,100, 2,884,072 AND 3,752,033.

SEC. 2(F) AS TO "CARCHIP".

FOR ELECTRONIC APPARATUS, NAMELY, A DATA LOGGER, FIRMWARE AND CELLULAR MODEM FOR MONITORING AND RECORDING VEHICLE SPEED, ACCELERATION, DISTANCE, TIME IN MOTION, AUTOMOTIVE SYSTEM PARAMETERS, ENGINE LOGGING AND DIAGNOSTICS, TROUBLE CODES, DRIVER PERFORMANCE AND VEHICLE LOCATION (U.S. CLS. 21, 23, 26, 36 AND 38).

KIMBERLY FRYE, EXAMINING ATTORNEY

CLASS 9—(Continued).

SN 77-927,101. CAREFUSION 303, INC., SAN DIEGO, CA. FILED 2-3-2010.

CLASS 9—(Continued).

SN 77-927,460. GLOBAL GAMING GROUP, INC., LAS VEGAS, NV. FILED 2-3-2010.

Pyxisconsultant

THE MARK CONSISTS OF STANDARD CHARACTERS WITHOUT CLAIM TO ANY PARTICULAR FONT, STYLE, SIZE, OR COLOR.

OWNER OF U.S. REG. NO. 2,684,078.

FOR SOFTWARE THAT INTEGRATES PATIENT, COST, TREATMENT AND OUTCOME DATA OF HEALTHCARE INSTITUTIONS (U.S. CLS. 21, 23, 26, 36 AND 38).

FIRST USE 10-31-1999; IN COMMERCE 10-31-1999.
RUSS HERMAN, EXAMINING ATTORNEY

Soccer Safari

THE MARK CONSISTS OF STANDARD CHARACTERS WITHOUT CLAIM TO ANY PARTICULAR FONT, STYLE, SIZE, OR COLOR.

NO CLAIM IS MADE TO THE EXCLUSIVE RIGHT TO USE "SOCCER", APART FROM THE MARK AS SHOWN.

FOR COMPUTER GAME SOFTWARE FOR GAMING MACHINES INCLUDING SLOT MACHINES OR VIDEO LOTTERY TERMINALS; COMPUTER GAME SOFTWARE FOR GAMING MACHINES, NAMELY, SLOT MACHINES AND VIDEO LOTTERY TERMINALS; COMPUTER SOFTWARE AND FIRMWARE FOR GAMES OF CHANCE ON ANY COMPUTERIZED PLATFORM, INCLUDING DEDICATED GAMING CONSOLES, VIDEO BASED SLOT MACHINES, REEL BASED SLOT MACHINES, AND VIDEO LOTTERY TERMINALS; GAMING DEVICES, NAMELY, GAMING MACHINES, SLOT MACHINES, BINGO MACHINES, WITH OR WITHOUT VIDEO OUTPUT; GAMING EQUIPMENT, NAMELY, SLOT MACHINES WITH OR WITHOUT VIDEO OUTPUT (U.S. CLS. 21, 23, 26, 36 AND 38).

MATTHEW PAPPAS, EXAMINING ATTORNEY

SN 77-927,195. FLIR SYSTEMS, INC., WILSONVILLE, OR. FILED 2-3-2010.

COTI

THE MARK CONSISTS OF STANDARD CHARACTERS WITHOUT CLAIM TO ANY PARTICULAR FONT, STYLE, SIZE, OR COLOR.

FOR THERMAL IMAGERS NOT FOR MEDICAL USE (U.S. CLS. 21, 23, 26, 36 AND 38).

LIEF MARTIN, EXAMINING ATTORNEY

SN 77-927,498. INNOVATION IN LEARNING INC., LOS ALTOS HILLS, CA. FILED 2-3-2010.

SN 77-927,272. RERWARE, LLC, LIVONIA, MI. FILED 2-3-2010.

MyBackup

THE MARK CONSISTS OF STANDARD CHARACTERS WITHOUT CLAIM TO ANY PARTICULAR FONT, STYLE, SIZE, OR COLOR.

FOR COMPUTER PROGRAMS FOR CREATING A BACKUP OF THE DATA ON YOUR COMPUTER OR MOBILE DEVICE (U.S. CLS. 21, 23, 26, 36 AND 38).

FIRST USE 12-1-2008; IN COMMERCE 3-1-2009.
WILLIAM ROSSMAN, EXAMINING ATTORNEY

CliniSpace

THE MARK CONSISTS OF STANDARD CHARACTERS WITHOUT CLAIM TO ANY PARTICULAR FONT, STYLE, SIZE, OR COLOR.

FOR VIRTUAL REALITY SOFTWARE FOR TRAINING HEALTHCARE PROFESSIONALS BY SIMULATING CLINICAL HEALTH SPACES (U.S. CLS. 21, 23, 26, 36 AND 38).

JASON BLAIR, EXAMINING ATTORNEY

CLASS 9—(Continued).

SN 77-927,637. MOBILE EPIPHANY, LLC, AURORA, CO. FILED 2-4-2010.



THE MARK CONSISTS OF THE WORDS "TOUCH" IN LARGE ALL CAPS WITH THE LETTER "O" APPEARING AS A MODEL OF THE EARTH ABOVE THE WORD "INSPECT" IN SMALL ALL CAPS WITH A STYLIZED OUTLINE OF A HAND WITH THE POINTER FINGER TOUCHING THE EARTH "O" IN THE WORD "TOUCH".

FOR COMPUTER APPLICATION SOFTWARE FOR HANDHELD MOBILE DEVICES, MOBILE PC DEVICES AND PCS IN THE FIELD OF FIELD DATA COLLECTION AND DECISION SUPPORT (U.S. CLS. 21, 23, 26, 36 AND 38).

JILL C. ALT, EXAMINING ATTORNEY

CLASS 9—(Continued).

SN 77-927,811. BLUE CROSS AND BLUE SHIELD OF MASSACHUSETTS, INC., BOSTON, MA. FILED 2-4-2010.

GOAL GETTER

THE MARK CONSISTS OF STANDARD CHARACTERS WITHOUT CLAIM TO ANY PARTICULAR FONT, STYLE, SIZE, OR COLOR.

FOR DOWNLOADABLE SOFTWARE FOR USE ON MOBILE ELECTRONIC DEVICES TO PROVIDE INFORMATION AND CALCULATIONS IN THE FIELD OF HEALTH AND FITNESS; DOWNLOADABLE SOFTWARE FOR USE AS A PEDOMETER ON MOBILE ELECTRONIC DEVICES (U.S. CLS. 21, 23, 26, 36 AND 38).

ERIN FALK, EXAMINING ATTORNEY

SN 77-927,747. WMS GAMING INC., WAUKEGAN, IL. FILED 2-4-2010.

THE MARK OF THE MUMMY

THE MARK CONSISTS OF STANDARD CHARACTERS WITHOUT CLAIM TO ANY PARTICULAR FONT, STYLE, SIZE, OR COLOR.

FOR COMPONENTS FOR GAMING MACHINES THAT GENERATE OR DISPLAY WAGER OUTCOMES, NAMELY, CONTROLLERS, DISPLAYS, BUTTON PANELS, BOLSTERS, ELECTRICAL WIRING, AND COMPUTER HARDWARE AND SOFTWARE ASSOCIATED THEREWITH; GAMING MACHINES, NAMELY, DEVICES WHICH ACCEPT A WAGER; GAMING SOFTWARE THAT GENERATES OR DISPLAYS WAGER OUTCOMES OF GAMING MACHINES (U.S. CLS. 21, 23, 26, 36 AND 38).

MARIA-VICTORIA SUAREZ, EXAMINING ATTORNEY

SN 77-927,871. NATASUDHARMA, DBA EASYESTATEMANAGER, JAKARTA, INDONESIA, FILED 2-4-2010.

EASYESTATEMANAGER

THE MARK CONSISTS OF STANDARD CHARACTERS WITHOUT CLAIM TO ANY PARTICULAR FONT, STYLE, SIZE, OR COLOR.

FOR COMPUTER SOFTWARE FOR PROVIDING AN ON-LINE DATABASE IN THE FIELD OF TRANSACTION PROCESSING TO UPLOAD TRANSACTIONAL DATA, PROVIDE STATISTICAL ANALYSIS, AND PRODUCE NOTIFICATIONS AND REPORTS (U.S. CLS. 21, 23, 26, 36 AND 38).

FIRST USE 9-1-2009; IN COMMERCE 9-1-2009.

MIDGE BUTLER, EXAMINING ATTORNEY

SN 77-927,807. MYINE ELECTRONICS, LLC, FERNDALE, MI. FILED 2-4-2010.

carmen

THE MARK CONSISTS OF STANDARD CHARACTERS WITHOUT CLAIM TO ANY PARTICULAR FONT, STYLE, SIZE, OR COLOR.

FOR AUDIO RECORDERS (U.S. CLS. 21, 23, 26, 36 AND 38).

FIRST USE 1-7-2010; IN COMMERCE 1-7-2010.

ERIN FALK, EXAMINING ATTORNEY

SN 77-927,908. GLOBAL GAMING GROUP, INC., LAS VEGAS, NV. FILED 2-4-2010.

Private Eye

THE MARK CONSISTS OF STANDARD CHARACTERS WITHOUT CLAIM TO ANY PARTICULAR FONT, STYLE, SIZE, OR COLOR.

FOR COMPUTER GAME SOFTWARE FOR GAMING MACHINES, NAMELY, SLOT MACHINES AND VIDEO LOTTERY TERMINALS (U.S. CLS. 21, 23, 26, 36 AND 38).

MATTHEW PAPPAS, EXAMINING ATTORNEY

CLASS 9—(Continued).

SN 77-927,951. FLIR SYSTEMS, INC., WILSONVILLE, OR.
FILED 2-4-2010.

RANGIR

THE MARK CONSISTS OF STANDARD CHARACTERS WITHOUT CLAIM TO ANY PARTICULAR FONT, STYLE, SIZE, OR COLOR.

FOR COMPUTER SOFTWARE FOR ACQUIRING, CALIBRATING, PROCESSING AND ANALYZING IMAGERY FROM VISIBLE AND INFRARED CAMERA SYSTEMS (U.S. CLS. 21, 23, 26, 36 AND 38).

LIEF MARTIN, EXAMINING ATTORNEY

SN 77-927,954. XM SATELLITE RADIO INC., WASHINGTON, DC. FILED 2-4-2010.

OWNER OF U.S. REG. NO. 3,687,071.

THE MARK CONSISTS OF THE LETTERS AND NUMBER "XMP3I" IN STYLIZED FORM.

FOR DIGITAL AUDIO RADIO RECEIVERS, PARTS AND ACCESSORIES, NAMELY, HEADPHONES, REMOTE CONTROLLERS, ADAPTER KITS COMPRISING AN ANTENNA, DC POWER ADAPTER AND CABLE USED FOR CONNECTING THE RECEIVER TO CAR AUDIO APPARATUS, AND ADAPTER KITS COMPRISING AN ANTENNA, AC POWER ADAPTER AND CABLE USED FOR CONNECTING THE RECEIVER TO HOME AUDIO APPARATUS (U.S. CLS. 21, 23, 26, 36 AND 38).

MICHAEL WEBSTER, EXAMINING ATTORNEY

SN 77-927,959. XM SATELLITE RADIO INC., WASHINGTON, DC. FILED 2-4-2010.

XMP3I

THE MARK CONSISTS OF STANDARD CHARACTERS WITHOUT CLAIM TO ANY PARTICULAR FONT, STYLE, SIZE, OR COLOR.

OWNER OF U.S. REG. NO. 3,687,071.

FOR DIGITAL AUDIO RADIO RECEIVERS, PARTS AND ACCESSORIES, NAMELY, HEADPHONES, REMOTE CONTROLLERS, ADAPTER KITS COMPRISING AN ANTENNA, DC POWER ADAPTER AND CABLE USED FOR CONNECTING THE RECEIVER TO CAR AUDIO APPARATUS, AND ADAPTER KITS COMPRISING AN ANTENNA, AC POWER ADAPTER AND CABLE USED FOR CONNECTING THE RECEIVER TO HOME AUDIO APPARATUS (U.S. CLS. 21, 23, 26, 36 AND 38).

MICHAEL WEBSTER, EXAMINING ATTORNEY

CLASS 9—(Continued).

SN 77-928,022. BOSTON SOFTWARE SYSTEMS, INC., BOSTON, MA. FILED 2-4-2010.

COGNAUTO

THE MARK CONSISTS OF STANDARD CHARACTERS WITHOUT CLAIM TO ANY PARTICULAR FONT, STYLE, SIZE, OR COLOR.

FOR COMPUTER SOFTWARE USED FOR WORKPLACE AUTOMATION, NAMELY, USED TO AUTOMATE CLERICAL MANUAL WORKFLOW TASKS; COMPUTER SOFTWARE TO AUTOMATE WORK FLOW AND TASK MANAGEMENT; COMPUTER SOFTWARE TO AUTOMATE MANUAL PROCESSES AND TO AUTOMATE THE INTEGRATION OF COMPUTER APPLICATIONS, SYSTEMS, AND DEVICES (U.S. CLS. 21, 23, 26, 36 AND 38).

ELLEN B. AWRICH, EXAMINING ATTORNEY

SN 77-928,059. IDEA ENGINE, INC., ROCKY RIVER, OH. FILED 2-4-2010.

SyncShow

THE MARK CONSISTS OF STANDARD CHARACTERS WITHOUT CLAIM TO ANY PARTICULAR FONT, STYLE, SIZE, OR COLOR.

FOR WEB SITE DEVELOPMENT SOFTWARE (U.S. CLS. 21, 23, 26, 36 AND 38).

FIRST USE 3-30-2007; IN COMMERCE 3-30-2007.

ZHALEH DELANEY, EXAMINING ATTORNEY

SN 77-928,077. GLOBAL TECHNOLOGY ASSOCIATES, INC., ORLANDO, FL. FILED 2-4-2010.

SSL Sentinel

THE MARK CONSISTS OF STANDARD CHARACTERS WITHOUT CLAIM TO ANY PARTICULAR FONT, STYLE, SIZE, OR COLOR.

NO CLAIM IS MADE TO THE EXCLUSIVE RIGHT TO USE "SSL", APART FROM THE MARK AS SHOWN.

FOR COMPUTER FIREWALL SOFTWARE FOR SSL VPN SECURE ELECTRONIC COMMUNICATIONS FOR USE IN THE FIELDS OF REMOTE DATA ACCESS, ACCESS CONTROL, AND INFORMATION FLOW CONTROL FOR LOCAL AREA, WIDE AREA AND GLOBAL COMPUTER NETWORKS (U.S. CLS. 21, 23, 26, 36 AND 38).

FIRST USE 12-14-2009; IN COMMERCE 12-14-2009.

ALEXANDER L. POWERS, EXAMINING ATTORNEY

CLASS 9—(Continued).

SN 77-928,133. PIANO FOR LIFE, INC., EDGEWOOD, WA.
FILED 2-4-2010.

PIANO for QUITTERS

THE MARK CONSISTS OF STANDARD CHARACTERS WITHOUT CLAIM TO ANY PARTICULAR FONT, STYLE, SIZE, OR COLOR.

NO CLAIM IS MADE TO THE EXCLUSIVE RIGHT TO USE "PIANO", APART FROM THE MARK AS SHOWN.

FOR DVDS FEATURING PIANO LESSONS (U.S. CLS. 21, 23, 26, 36 AND 38).

FIRST USE 5-1-1996; IN COMMERCE 1-1-1997.

ALICE BENMAMAN, EXAMINING ATTORNEY

CLASS 9—(Continued).

SN 77-928,289. SALVATORE MATTEO, LOS ANGELES, CA.
FILED 2-4-2010.

ZedPC

THE MARK CONSISTS OF STANDARD CHARACTERS WITHOUT CLAIM TO ANY PARTICULAR FONT, STYLE, SIZE, OR COLOR.

FOR COMPUTER STANDS SPECIALLY DESIGNED FOR HOLDING A COMPUTER AND ACCESSORIES THEREFOR; ELECTRONIC APPARATUSES, NAMELY, STAND ALONE DISPLAYS FOR COMPUTERS, MONITORS, AND ACCESSORIES THEREFOR; ELECTRONIC APPARATUSES, NAMELY, STAND ALONE DISPLAYS FOR COMPUTER, TELEVISION, OR VIDEO MONITORS AND COMPUTER ACCESSORIES; MONITOR DISPLAY STANDS SPECIALLY DESIGNED FOR HOLDING A COMPUTER, TELEVISION, OR VIDEO MONITOR (U.S. CLS. 21, 23, 26, 36 AND 38).

ALYSSA STEEL, EXAMINING ATTORNEY

SN 77-928,187. KENMEC MECHANICAL ENGINEERING CO. LTD., TAIPEI, TAIWAN, FILED 2-4-2010.



THE MARK CONSISTS OF THE WORD "TIARA" BEING PART OF A CROWN DESIGN AND HAVE A LINE UNDERNEATH IT; UNDERNEATH THE LINE ARE SIX SQUARES AND ANOTHER LINE UNDERNEATH THE SQUARES. ABOVE THE WORD "TIARA" IS THE TOP OF A CROWN.

FOR PHOTOVOLTAIC CELLS; SOLAR BATTERIES; APPARATUS FOR CONVERTING ELECTRONIC RADIATION TO ELECTRICAL ENERGY, NAMELY, PHOTOVOLTAIC SOLAR MODULES AND ELECTRONIC AND MANUAL CONTROLS OF PHOTOVOLTAIC ELEMENTS (U.S. CLS. 21, 23, 26, 36 AND 38).

JUDITH HELFMAN, EXAMINING ATTORNEY

SN 77-928,291. FLANNEL, GRAND RAPIDS, MI. FILED 2-4-2010.

Nooma Stories

THE MARK CONSISTS OF STANDARD CHARACTERS WITHOUT CLAIM TO ANY PARTICULAR FONT, STYLE, SIZE, OR COLOR.

OWNER OF U.S. REG. NO. 2,813,688.

NO CLAIM IS MADE TO THE EXCLUSIVE RIGHT TO USE "STORIES", APART FROM THE MARK AS SHOWN.

THE WORDING "NOOMA" HAS NO MEANING IN A FOREIGN LANGUAGE.

FOR DIGITAL MATERIALS, NAMELY, DVDS, CDS, DOWN-LOADABLE AUDIO FILES, AND DOWN-LOADABLE VIDEO FILES, FEATURING FULL-LENGTH AND SHORT FILMS IN THE FIELD OF SPIRITUALITY (U.S. CLS. 21, 23, 26, 36 AND 38).

FIRST USE 1-31-2008; IN COMMERCE 1-31-2008.

DORITT L. CARROLL, EXAMINING ATTORNEY

CLASS 9—(Continued).

SN 77-928,353. WU, CHUN RONG, RICHMOND, CANADA, FILED 2-4-2010.



THE MARK CONSISTS OF A GRAPHIC IMAGE ON THE LEFT SIDE AND THE LITERAL ELEMENT "RELACART" ON THE RIGHT.

FOR ACOUSTIC SOUND ALARMS; AMPLIFIER FOR WIRELESS COMMUNICATIONS; AMPLIFIERS; ANTENNAS; APPARATUS FOR TRANSMITTING AND REPRODUCING SOUND OR IMAGES; AUDIO AMPLIFIERS; AUDIO ELECTRONIC COMPONENTS, NAMELY, SURROUND SOUND SYSTEMS; AUDIO HEADPHONES; DIGITAL SIGNAL PROCESSORS; EARPHONES AND HEADPHONES; HEADPHONES; LOUDSPEAKERS, HEADPHONES, MICROPHONES AND CD PLAYERS; MICROPHONE STANDS; MICROPHONES (U.S. CLS. 21, 23, 26, 36 AND 38).

TINA MAI, EXAMINING ATTORNEY

CLASS 9—(Continued).

SN 77-928,407. CONCEALFAB CORPORATION, COLORADO SPRINGS, CO. FILED 2-4-2010.

HIDE IN PLAIN SIGHT

THE MARK CONSISTS OF STANDARD CHARACTERS WITHOUT CLAIM TO ANY PARTICULAR FONT, STYLE, SIZE, OR COLOR.

FOR ANTENNA CONCEALMENT DEVICES, NAMELY, RADIO FREQUENCY TRANSPARENT ENCLOSURES, STRUCTURES AND SCREEN WALLS SPECIFICALLY ADAPTED TO HOLD AND CONCEAL ANTENNAS (U.S. CLS. 21, 23, 26, 36 AND 38).

JASON BLAIR, EXAMINING ATTORNEY

SN 77-928,415. AMERICAN RELIANCE, INC., AKA AMREL, EL MONTE, CA. FILED 2-4-2010.

FLEXPEDIENT

THE MARK CONSISTS OF STANDARD CHARACTERS WITHOUT CLAIM TO ANY PARTICULAR FONT, STYLE, SIZE, OR COLOR.

FOR HANDHELD COMPUTERS; LAPTOP COMPUTERS; MOBILE COMPUTERS; NOTEBOOK COMPUTERS; PERSONAL DIGITAL ASSISTANTS (PDA); TABLET COMPUTER (U.S. CLS. 21, 23, 26, 36 AND 38).

CAROLYN CATALDO, EXAMINING ATTORNEY

SN 77-928,392. RAYSPAN CORPORATION, SAN DIEGO, CA. FILED 2-4-2010.

RAYSPAN

THE MARK CONSISTS OF STANDARD CHARACTERS WITHOUT CLAIM TO ANY PARTICULAR FONT, STYLE, SIZE, OR COLOR.

OWNER OF U.S. REG. NO. 3,566,415.

FOR AMPLIFIER FOR WIRELESS COMMUNICATIONS; ANTENNAE FILTERS; ANTENNAS; ANTENNAS FOR RADIO, FOR TELEVISION; ANTENNAS FOR WIRELESS COMMUNICATIONS APPARATUS; COMPUTER HARDWARE, NAMELY, WIRELESS ACCESS POINT (WAP) DEVICES; DEVICES FOR WIRELESS RADIO TRANSMISSION; INTEGRATED CIRCUITS AND INTEGRATED CIRCUIT CORES FOR USE IN WIRELESS COMMUNICATIONS AND WIRELESS COMMUNICATION EQUIPMENT AND APPARATI AND DIGITAL SIGNAL PROCESSORS (DSP); MICROWAVE ANTENNAE; WIRELESS POS (POINT OF SERVICE) DEVICES; WIRELESS TELEPHONES; WIRELESS TELEPHONY APPARATUS (U.S. CLS. 21, 23, 26, 36 AND 38).

FIRST USE 4-0-2006; IN COMMERCE 4-16-2006.

FRED MANDIR, EXAMINING ATTORNEY

SN 77-928,467. WIZARD LIZARD, LLC, SANTA ANA, CA. FILED 2-4-2010.

EZBUY

THE MARK CONSISTS OF STANDARD CHARACTERS WITHOUT CLAIM TO ANY PARTICULAR FONT, STYLE, SIZE, OR COLOR.

FOR COMPUTER SOFTWARE, NAMELY, POINT OF SALE COMPUTER SOFTWARE USED TO GATHER INFORMATION, SIGNATURES AND PAYMENT FOR ONLINE INSURANCE TRANSACTIONS (U.S. CLS. 21, 23, 26, 36 AND 38).

FIRST USE 1-1-2009; IN COMMERCE 2-1-2010.

ELI HELLMAN, EXAMINING ATTORNEY

CLASS 9—(Continued).

SN 77-928,521. ROCKY MOUNTAIN VENTURES COMPANY, FORT COLLINS, CO. FILED 2-4-2010.

FLIP-PAL

THE MARK CONSISTS OF STANDARD CHARACTERS WITHOUT CLAIM TO ANY PARTICULAR FONT, STYLE, SIZE, OR COLOR.

FOR HARD COPY IMAGE CAPTURING DEVICES, NAMELY, OPTICAL SCANNERS (U.S. CLS. 21, 23, 26, 36 AND 38).

DORITT L. CARROLL, EXAMINING ATTORNEY

SN 77-928,614. CONNOR, PATRICK BRIEN, LUBBOCK, TX. FILED 2-4-2010.

iTourSmart

THE MARK CONSISTS OF STANDARD CHARACTERS WITHOUT CLAIM TO ANY PARTICULAR FONT, STYLE, SIZE, OR COLOR.

FOR COMMUNICATIONS SOFTWARE FOR CONNECTING COMPUTER NETWORK USERS; COMPUTER DATABASE MANAGEMENT SOFTWARE FOR USE IN PERSONALIZING THE CONTENT OF E-MAIL COMMUNICATIONS; COMPUTER E-COMMERCE SOFTWARE TO ALLOW USERS TO PERFORM ELECTRONIC BUSINESS TRANSACTIONS VIA A GLOBAL COMPUTER NETWORK; COMPUTER SOFTWARE FOR COMMUNICATING WITH USERS OF HAND-HELD COMPUTERS; COMPUTER SOFTWARE FOR USE IN CUSTOMER RELATIONSHIP MANAGEMENT (CRM); COMPUTER SOFTWARE FOR WIRELESS CONTENT DELIVERY (U.S. CLS. 21, 23, 26, 36 AND 38).

JOHN HWANG, EXAMINING ATTORNEY

SN 77-928,669. QUICKOFFICE, INC, PLANO, TX. FILED 2-4-2010.

Quickoffice Connect

THE MARK CONSISTS OF STANDARD CHARACTERS WITHOUT CLAIM TO ANY PARTICULAR FONT, STYLE, SIZE, OR COLOR.

OWNER OF U.S. REG. NOS. 2,834,857, 2,984,847 AND 3,166,543.

NO CLAIM IS MADE TO THE EXCLUSIVE RIGHT TO USE "CONNECT", APART FROM THE MARK AS SHOWN.

FOR COMPUTER SOFTWARE FOR USE ON MOBILE PHONES WHICH ENABLES ACCESS TO INTERNET SERVICES (U.S. CLS. 21, 23, 26, 36 AND 38).

BRENDAN MCCAULEY, EXAMINING ATTORNEY

CLASS 9—(Continued).

SN 77-928,688. DVIDE ARTS INCORPORATED, MEMPHIS, TN. FILED 2-5-2010.

LAND OF LEGEND

THE MARK CONSISTS OF STANDARD CHARACTERS WITHOUT CLAIM TO ANY PARTICULAR FONT, STYLE, SIZE, OR COLOR.

FOR COMPUTER GAME PROGRAMS; COMPUTER GAME SOFTWARE; ELECTRONIC GAME PROGRAMS; ELECTRONIC GAME SOFTWARE; INTERACTIVE MULTIMEDIA COMPUTER GAME PROGRAM; INTERACTIVE VIDEO GAME PROGRAMS; VIDEO AND COMPUTER GAME PROGRAMS; VIDEO GAME SOFTWARE; GAME SOFTWARE FOR PLAYING ON MOBILE PHONES (U.S. CLS. 21, 23, 26, 36 AND 38).

PAUL E. FAHRENKOPF, EXAMINING ATTORNEY

SN 77-928,689. REGINALD PAUL KENNEDY, DBA SWINDOE, TUCSON, AZ. FILED 2-5-2010.

SwinDoe

THE MARK CONSISTS OF STANDARD CHARACTERS WITHOUT CLAIM TO ANY PARTICULAR FONT, STYLE, SIZE, OR COLOR.

FOR MUSICAL SOUND RECORDINGS; MUSICAL VIDEO RECORDINGS (U.S. CLS. 21, 23, 26, 36 AND 38).

FIRST USE 5-11-2001; IN COMMERCE 9-12-2006.

PAUL E. FAHRENKOPF, EXAMINING ATTORNEY

SN 77-928,802. KENT SCIENTIFIC CORPORATION, TORRINGTON, CT. FILED 2-5-2010.

OxiMouse

THE MARK CONSISTS OF STANDARD CHARACTERS WITHOUT CLAIM TO ANY PARTICULAR FONT, STYLE, SIZE, OR COLOR.

FOR ELECTRIC OR ELECTRONIC SENSORS FOR MEASURING PHYSIOLOGIC PARAMETERS OF AN ANIMAL SUBJECT (U.S. CLS. 21, 23, 26, 36 AND 38).

FIRST USE 1-29-2010; IN COMMERCE 2-5-2010.

HENRY S. ZAK, EXAMINING ATTORNEY

CLASS 9—(Continued).

SN 77-928,944. MARINE ROBOTICS RESEARCH, SAN JOSE, CA. FILED 2-5-2010.



NO CLAIM IS MADE TO THE EXCLUSIVE RIGHT TO USE "MARINE ROBOTICS RESEARCH", APART FROM THE MARK AS SHOWN.

THE COLOR(S) BLUE IS/ARE CLAIMED AS A FEATURE OF THE MARK.

THE MARK CONSISTS OF THE WORDING "MARINE ROBOTICS RESEARCH" IN BLUE BELOW WHICH ARE STYLIZED BLUE LINES.

FOR REMOTELY-CONTROLLED SUB-AQUATIC VIDEO CAMERA CONTAINING A TV CAMERA, TRANSMITTER, RECEIVER AND MICROPHONE TO RECORD, DETECT, MEASURE, SURVEY AND LOCATE OBJECTS UNDERWATER (U.S. CLS. 21, 23, 26, 36 AND 38).

REBECCA POVARCHUK, EXAMINING ATTORNEY

SN 77-929,038. VALUE RECLAMATION, LLC, WAYLAND, MA. FILED 2-5-2010.

EuroReader

THE MARK CONSISTS OF STANDARD CHARACTERS WITHOUT CLAIM TO ANY PARTICULAR FONT, STYLE, SIZE, OR COLOR.

FOR EYEWEAR; EYEWEAR CASES; SPORTS EYEWEAR (U.S. CLS. 21, 23, 26, 36 AND 38).

FIRST USE 12-11-2009; IN COMMERCE 12-11-2009.

WENDY JUN, EXAMINING ATTORNEY

CLASS 9—(Continued).

SN 77-929,054. MEADWESTVACO CORPORATION, RICHMOND, VA. FILED 2-5-2010.



THE MARK CONSISTS OF SEPARATED SHEETS OF PAPER COMING OFF A STACK.

FOR COMPUTER SOFTWARE PROGRAMS FEATURING INSTRUCTIONAL MATERIALS FOR CREATING RESEARCH PAPERS FOR HIGH SCHOOL AND COLLEGE STUDENTS (U.S. CLS. 21, 23, 26, 36 AND 38).

FIRST USE 11-1-2009; IN COMMERCE 11-1-2009.

KRISTIN DAHLING, EXAMINING ATTORNEY

SN 77-929,071. MEADWESTVACO CORPORATION, RICHMOND, VA. FILED 2-5-2010.



THE MARK CONSISTS OF THE WORD "BUILDER" AND A LOGO CONSISTING OF A STACK OF PAPER WITH SHEETS OF PAPER COMING OFF THE TOP.

FOR COMPUTER SOFTWARE PROGRAMS FEATURING INSTRUCTIONAL MATERIALS FOR CREATING RESEARCH PAPERS FOR HIGH SCHOOL AND COLLEGE STUDENTS (U.S. CLS. 21, 23, 26, 36 AND 38).

FIRST USE 11-1-2009; IN COMMERCE 11-1-2009.

KRISTIN DAHLING, EXAMINING ATTORNEY

SN 77-929,099. QUALITY INNOVATIVE SYSTEMS, INC., PARAGOULD, AR. FILED 2-5-2010.

UBSREADY

THE MARK CONSISTS OF STANDARD CHARACTERS WITHOUT CLAIM TO ANY PARTICULAR FONT, STYLE, SIZE, OR COLOR.

FOR COMPUTER SOFTWARE FOR APPLICATION AND DATABASE INTEGRATION OF UTILITY BILLING SYSTEMS (U.S. CLS. 21, 23, 26, 36 AND 38).

SANI KHOURI, EXAMINING ATTORNEY

CLASS 9—(Continued).

SN 77-929,177. LU, GARY, CERRITOS, CA. AND ZHENG, JENNY, CERRITOS, CA. FILED 2-5-2010.



THE MARK CONSISTS OF A SOLID SPHERE WITH RECTANGULAR PIECES CUT OUT FORMING THE LETTERS "M" AND "E" WITHIN IT.

FOR AUDIO HEADPHONES; COMPUTERS, NAMELY, NETBOOKS; DIGITAL AUDIO PLAYERS; DIGITAL PHOTO FRAMES FOR DISPLAYING DIGITAL PICTURES, VIDEO CLIPS AND MUSIC; EARPHONES AND HEADPHONES; HEADPHONES; MEDIA PLAYERS; MP3 PLAYERS; MP4 PLAYERS; MUSIC HEADPHONES; PORTABLE LISTENING DEVICES, NAMELY, MP3 PLAYERS; PORTABLE MEDIA PLAYERS; PORTABLE TELEVISIONS; PROTECTIVE CARRYING CASES FOR PORTABLE MUSIC PLAYERS, NAMELY, MP3 PLAYERS; STEREO HEADPHONES (U.S. CLS. 21, 23, 26, 36 AND 38).

FIRST USE 8-1-2009; IN COMMERCE 2-1-2010.
RAUL CORDOVA, EXAMINING ATTORNEY

SN 77-929,183. LRW TECHNOLOGIES, INC., GLEN BURNIE, MD. FILED 2-5-2010.

PINECONE

THE MARK CONSISTS OF STANDARD CHARACTERS WITHOUT CLAIM TO ANY PARTICULAR FONT, STYLE, SIZE, OR COLOR.

FOR WIRELESS COMMUNICATION DEVICE FEATURING VOICE, DATA AND IMAGE TRANSMISSION INCLUDING VOICE, TEXT AND PICTURE MESSAGING, A VIDEO AND STILL IMAGE CAMERA, ALSO FUNCTIONAL TO PURCHASE MUSIC, GAMES, VIDEO AND SOFTWARE APPLICATIONS OVER THE AIR FOR DOWNLOADING TO THE DEVICE (U.S. CLS. 21, 23, 26, 36 AND 38).

GRETCHEN ULRICH, EXAMINING ATTORNEY

CLASS 9—(Continued).

SN 77-929,204. VRSIM, INC., EAST HARTFORD, CT. FILED 2-5-2010.

PAINTOMETER

THE MARK CONSISTS OF STANDARD CHARACTERS WITHOUT CLAIM TO ANY PARTICULAR FONT, STYLE, SIZE, OR COLOR.

FOR COMPUTER SOFTWARE FOR USE IN ESTIMATING SPRAY PAINTING EFFECTIVENESS (U.S. CLS. 21, 23, 26, 36 AND 38).

KEVIN DINALLO, EXAMINING ATTORNEY

SN 77-929,330. STRASSER, LAUREL D., MULBERRY, FL. AND STRASSER, MARK E., MULBERRY, FL. FILED 2-5-2010.

BlingSlinger

THE MARK CONSISTS OF STANDARD CHARACTERS WITHOUT CLAIM TO ANY PARTICULAR FONT, STYLE, SIZE, OR COLOR.

FOR HAND-HELD MICROPHONE SLEEVES (U.S. CLS. 21, 23, 26, 36 AND 38).

FIRST USE 11-1-2009; IN COMMERCE 11-1-2009.
JAMES GRIFFIN, EXAMINING ATTORNEY

SN 77-929,346. EAMES OFFICE LLC, BARRE, VT. FILED 2-5-2010.

EAMES CENTURY MODERN

THE MARK CONSISTS OF STANDARD CHARACTERS WITHOUT CLAIM TO ANY PARTICULAR FONT, STYLE, SIZE, OR COLOR.

OWNER OF U.S. REG. NOS. 2,268,455, 2,503,112 AND 2,709,587.

NO CLAIM IS MADE TO THE EXCLUSIVE RIGHT TO USE "CENTURY MODERN", APART FROM THE MARK AS SHOWN.

FOR PRINTING FONTS THAT CAN BE DOWNLOADED PROVIDED BY MEANS OF ELECTRONIC TRANSMISSION; TYPEFACE FONTS RECORDED ON MAGNETIC MEDIA (U.S. CLS. 21, 23, 26, 36 AND 38).

FIRST USE 2-1-2010; IN COMMERCE 2-1-2010.
INGRID C. EULIN, EXAMINING ATTORNEY

CLASS 9—(Continued).

SN 77-929,349. FREMANTLEMEDIA OPERATIONS B.V.,
1217 GP HILVERSUM, NETHERLANDS, FILED 2-5-2010.

SHOWCASE SHOWDOWN

THE MARK CONSISTS OF STANDARD CHARACTERS WITHOUT CLAIM TO ANY PARTICULAR FONT, STYLE, SIZE, OR COLOR.

OWNER OF U.S. REG. NO. 3,039,601.

FOR GAMING MACHINES, NAMELY, DEVICES WHICH ACCEPT A WAGER; GAMING MACHINES, NAMELY, SLOT MACHINES AND VIDEO LOTTERY TERMINALS; COMPUTER GAME SOFTWARE; DECORATIVE MAGNETS; DOWNLOADABLE COMPUTER GAME PROGRAMS; DOWNLOADABLE COMPUTER GRAPHICS; DOWNLOADABLE IMAGE FILE CONTAINING ARTWORK, TEXT, AUDIO, VIDEO, GAMES AND INTERNET WEB LINKS RELATING TO A GAME SHOW; ELECTRONIC DIARIES; ELECTRONIC DAY PLANNERS; ELECTRONIC GAME SOFTWARE FOR CELLULAR TELEPHONES; INTERACTIVE VIDEO GAME PROGRAMS; MAGNETIC CODED GIFT CARDS; MOBILE TELEPHONES; PRE-PAID TELEPHONE CALLING CARDS, MAGNETICALLY ENCODED; PRE-RECORDED ELECTRONIC AND DIGITAL MEDIA FEATURING A GAME SHOW; VIDEO GAME SOFTWARE; DIGITAL PHOTO FRAMES FOR DISPLAYING DIGITAL PHOTOS; PRE-RECORDED AUDIO AND VIDEO MEDIA, NAMELY, VIDEO CASSETTES, DIGITAL VIDEO DISCS, DIGITAL VERSATILE DISCS, DOWNLOADABLE AUDIO AND VIDEO RECORDINGS, DVDS AND HIGH DEFINITION DIGITAL DISCS FEATURING GAME SHOWS; DOWNLOADABLE ELECTRONIC NEWSLETTERS IN THE FIELD OF GAME SHOWS; DOWNLOADABLE ELECTRONIC PUBLICATIONS IN THE NATURE OF MAGAZINES AND BOOKS IN THE FIELD OF GAME SHOWS (U.S. CLS. 21, 23, 26, 36 AND 38).

RENEE MCCRAY, EXAMINING ATTORNEY

CLASS 9—(Continued).

SN 77-929,378. CUSTOM COMPOSITES, LLC, OKLAHOMA CITY, OK. FILED 2-5-2010.

Pol-E-Gold

THE MARK CONSISTS OF STANDARD CHARACTERS WITHOUT CLAIM TO ANY PARTICULAR FONT, STYLE, SIZE, OR COLOR.

FOR FIRE EXTINGUISHING APPARATUS (U.S. CLS. 21, 23, 26, 36 AND 38).

CARRIE GENOVESE, EXAMINING ATTORNEY

SN 77-929,494. WMS GAMING INC., WAUKEGAN, IL. FILED 2-5-2010.

SN 77-929,355. DISCOUNT TWO WAY RADIO CORPORATION, HARBOR CITY, CA. FILED 2-5-2010.



NO CLAIM IS MADE TO THE EXCLUSIVE RIGHT TO USE "ENHANCED AUDIO CLARITY", APART FROM THE MARK AS SHOWN.

THE MARK CONSISTS OF A STYLIZED "X" FORMED FROM TWO CRESCENTS AND THE WORD "SOUND" IN A STYLIZED FONT IMMEDIATELY TO THE RIGHT OF THE "X" CREATING THE WORD "XSOUND". THE SECOND LINE BELOW "XSOUND" IS "ENHANCED AUDIO CLARITY" IN AN ITALIC SANS-SERIF FONT.

FOR COMMUNICATIONS HEADSETS FOR USE WITH COMMUNICATION RADIOS, INTERCOM SYSTEMS, OR OTHER COMMUNICATIONS NETWORK TRANSCIEVERS; EARPHONES AND HEADPHONES; MICROPHONES FOR COMMUNICATION DEVICES; RADIO TRANSCIEVERS; WIRELESS TRANSCIEVER RADIO (U.S. CLS. 21, 23, 26, 36 AND 38).

FIRST USE 2-1-2010; IN COMMERCE 2-1-2010.

JANET LEE, EXAMINING ATTORNEY

QUEEN OF THE WILD

THE MARK CONSISTS OF STANDARD CHARACTERS WITHOUT CLAIM TO ANY PARTICULAR FONT, STYLE, SIZE, OR COLOR.

FOR COMPONENTS FOR GAMING MACHINES THAT GENERATE OR DISPLAY WAGER OUTCOMES, NAMELY, CONTROLLERS, DISPLAYS, BUTTON PANELS, BOLSTERS, ELECTRICAL WIRING, AND COMPUTER HARDWARE AND SOFTWARE ASSOCIATED THEREWITH; GAMING MACHINES, NAMELY, DEVICES WHICH ACCEPT A WAGER; GAMING SOFTWARE THAT GENERATES OR DISPLAYS WAGER OUTCOMES OF GAMING MACHINES (U.S. CLS. 21, 23, 26, 36 AND 38).

MARIA-VICTORIA SUAREZ, EXAMINING ATTORNEY

CLASS 9—(Continued).

SN 77-929,548. LU, GARY, CERRITOS, CA. AND ZHENG, JENNY, CERRITOS, CA. FILED 2-5-2010.



THE COLOR(S) GREEN, ORANGE, AND BLACK IS/ARE CLAIMED AS A FEATURE OF THE MARK.

THE MARK CONSISTS OF A SOLID SPHERE WITH RECTANGULAR SHAPES CUT OUT TO FORM THE LETTERS "M" AND "E". THE LETTER "M" IS COLORED GREEN AND THE LETTER "E" IS COLORED ORANGE. THE WORD "MULTIELEMENTS" IS VERTICALLY CENTERED TO THE RIGHT OF THE SHAPE IN A BLACK COLOR.

FOR COMPUTERS, NAMELY, NETBOOKS; DIGITAL AUDIO PLAYERS; DIGITAL PHOTO FRAMES FOR DISPLAYING DIGITAL PICTURES, VIDEO CLIPS AND MUSIC; MP3 PLAYERS; MP4 PLAYERS; PORTABLE LISTENING DEVICES, NAMELY, MP3 PLAYERS; PORTABLE MEDIA PLAYERS; PORTABLE TELEVISIONS; PROTECTIVE CARRYING CASES FOR PORTABLE MUSIC PLAYERS, NAMELY, MP3 PLAYERS (U.S. CLS. 21, 23, 26, 36 AND 38).

FIRST USE 8-1-2009; IN COMMERCE 2-1-2010.
RAUL CORDOVA, EXAMINING ATTORNEY

CLASS 9—(Continued).

SN 77-929,574. LU, GARY, CERRITOS, CA. AND ZHENG, JENNY, CERRITOS, CA. FILED 2-5-2010.



THE COLOR(S) GREEN, ORANGE, AND BLACK IS/ARE CLAIMED AS A FEATURE OF THE MARK.

THE MARK CONSISTS OF A SOLID SPHERE WITH RECTANGULAR SHAPES CUT OUT TO FORM THE LETTERS "M" AND "E". THE "M" IS COLORED GREEN AND THE "E" IS COLORED ORANGE. THE WORD "MULTIELEMENTS" APPEARS CENTERED VERTICALLY TO THE RIGHT OF THE SHAPE. THE WORDS, "IT'S ALL ABOUT ME" APPEAR IN SMALLER FONT SIZE UNDER THE "MULTIELEMENTS" WORD ALIGNED TO THE RIGHT. ALL TEXT IS BLACK IN COLOR.

FOR COMPUTERS, NAMELY, NETBOOKS; DIGITAL AUDIO PLAYERS; DIGITAL PHOTO FRAMES FOR DISPLAYING DIGITAL PICTURES, VIDEO CLIPS AND MUSIC; MP3 PLAYERS; MP4 PLAYERS; PORTABLE LISTENING DEVICES, NAMELY, MP3 PLAYERS; PORTABLE MEDIA PLAYERS; PORTABLE TELEPHONES (U.S. CLS. 21, 23, 26, 36 AND 38).

FIRST USE 8-1-2009; IN COMMERCE 2-1-2010.
RAUL CORDOVA, EXAMINING ATTORNEY

SN 77-929,572. VOLERE INC., DBA V-DIMENSION, INC., PASADENA, CA. FILED 2-5-2010.

MyNet

THE MARK CONSISTS OF STANDARD CHARACTERS WITHOUT CLAIM TO ANY PARTICULAR FONT, STYLE, SIZE, OR COLOR.

FOR COMPUTER BAGS, NAMELY, NETBOOK CARRYING BAGS, SOLAR CHARGING NETBOOK BACKPACKS, SOLAR CHARGING NETBOOK MESSENGER BAGS, AND SOLAR CHARGING NETBOOK SLING BAGS (U.S. CLS. 21, 23, 26, 36 AND 38).

ROBIN MITTLER, EXAMINING ATTORNEY

SN 77-929,580. ANDREAS PAPADAKIS, AKA ANTREAS ALTER, THESSALONIKI, GREECE, FILED 2-5-2010.

REAL WAVES

THE MARK CONSISTS OF STANDARD CHARACTERS WITHOUT CLAIM TO ANY PARTICULAR FONT, STYLE, SIZE, OR COLOR.

FOR DOWNLOADABLE VIRTUAL GOODS, NAMELY, COMPUTER PROGRAMS FEATURING ANIMATED WATER FOR USE IN ONLINE VIRTUAL WORLDS (U.S. CLS. 21, 23, 26, 36 AND 38).

FIRST USE 12-1-2008; IN COMMERCE 12-2-2008.
MARGERY A. TIERNEY, EXAMINING ATTORNEY

CLASS 9—(Continued).

SN 77-929,681. COZYBIT INC., SAN FRANCISCO, CA. FILED 2-5-2010.



THE MARK CONSISTS OF A SMILING FACE COMPOSED OF THE CHARACTERS "F", "2" AND "N" UNDERLINED BY A CURVED ARROW GOING FROM LEFT TO RIGHT.

FOR COMMUNICATIONS SOFTWARE FOR CONNECTING MOBILE PHONE USERS; COMPUTER GRAPHICS SOFTWARE; COMPUTER SOFTWARE FOR COMMUNICATING WITH USERS OF HAND-HELD COMPUTERS (U.S. CLS. 21, 23, 26, 36 AND 38).
COLLEEN DOMBROW, EXAMINING ATTORNEY

SN 77-929,795. CAPITAL SAFETY GROUP EMEA, CARROS CEDEX, FRANCE, FILED 2-6-2010.

ARIANA

THE MARK CONSISTS OF STANDARD CHARACTERS WITHOUT CLAIM TO ANY PARTICULAR FONT, STYLE, SIZE, OR COLOR.

OWNER OF U.S. REG. NO. 2,328,497.
FOR FALL PROTECTION AND FALL ARREST EQUIPMENT, NAMELY, HORIZONTAL LIFELINE ASSEMBLIES (U.S. CLS. 21, 23, 26, 36 AND 38).
JEFFERY COWARD, EXAMINING ATTORNEY

SN 77-930,144. CARLINO, CRISTINA M., PHOENIX, AZ. FILED 2-8-2010.

ARCHETYPE

THE MARK CONSISTS OF STANDARD CHARACTERS WITHOUT CLAIM TO ANY PARTICULAR FONT, STYLE, SIZE, OR COLOR.

FOR DECORATIVE MAGNETS; ELECTRIC HAND-HELD HAIR STYLING IRONS; EYEGLOSS CHAINS AND CORDS; EYEWEAR; EYEWEAR CASES (U.S. CLS. 21, 23, 26, 36 AND 38).
APRIL HESIK, EXAMINING ATTORNEY

CLASS 9—(Continued).

SN 77-930,306. JEFFREY BEEGHLY, SEATTLE, WA. FILED 2-8-2010.

CHORD CAROUSEL

THE MARK CONSISTS OF STANDARD CHARACTERS WITHOUT CLAIM TO ANY PARTICULAR FONT, STYLE, SIZE, OR COLOR.

NO CLAIM IS MADE TO THE EXCLUSIVE RIGHT TO USE "CHORD", APART FROM THE MARK AS SHOWN.
FOR COMPUTER SOFTWARE FOR LEARNING TO PLAY CHORDS; COMPUTER SOFTWARE FOR TEACHING TO PLAY CHORDS (U.S. CLS. 21, 23, 26, 36 AND 38).
DAVID MURRAY, EXAMINING ATTORNEY

SN 77-930,340. THE TIFFEN COMPANY, LLC, HAUPPAUGE, NY. FILED 2-8-2010.

STEADICAM TANGO

THE MARK CONSISTS OF STANDARD CHARACTERS WITHOUT CLAIM TO ANY PARTICULAR FONT, STYLE, SIZE, OR COLOR.

OWNER OF U.S. REG. NOS. 1,706,335, 1,992,950 AND OTHERS.
FOR OPERATOR-SUPPORTED FILM AND VIDEO CAMERA STABILIZERS AND COMPONENTS THEREOF, NAMELY, VEST, MONITOR, POWER SUPPLY, ARTICULATED ARM, BOOM, POST, LIFT, GIMBAL, SPEAKER, INFRARED REMOTE, CONNECTOR AND CASE SOLD AS A UNIT (U.S. CLS. 21, 23, 26, 36 AND 38).
KATHERINE CONNOLLY, EXAMINING ATTORNEY

SN 77-930,343. CALLPOD, INC., CHICAGO, IL. FILED 2-8-2010.

fueltank maestro

THE MARK CONSISTS OF STANDARD CHARACTERS WITHOUT CLAIM TO ANY PARTICULAR FONT, STYLE, SIZE, OR COLOR.

OWNER OF U.S. REG. NO. 3,562,387.
FOR DEVICE BATTERY CHARGERS, NAMELY, BATTERY OPERATED DEVICES THAT CHARGE MULTIPLE ELECTRONIC DEVICES AT ONCE (U.S. CLS. 21, 23, 26, 36 AND 38).
KIMBERLY FRYE, EXAMINING ATTORNEY

CLASS 9—(Continued).

SN 77-930,607. WORLD WRESTLING ENTERTAINMENT, INC., STAMFORD, CT. FILED 2-8-2010.



THE MARK CONSISTS OF TWO STACKED "W" LETTERS WITH A SCAR UNDERNEATH SITTING ON TOP OF THE LETTERS "NXT" APPEARING VERTICALLY.

FOR DOWNLOADABLE RING TONES, GRAPHICS AND MUSIC VIA A GLOBAL COMPUTER NETWORK AND WIRELESS DEVICES; DECORATIVE REFRIGERATOR MAGNETS; VIDEO AND COMPUTER GAME TAPES, VIDEO AND COMPUTER GAME DISCS, VIDEO AND COMPUTER GAME CASSETTES, VIDEO AND COMPUTER GAME CARTRIDGES, VIDEO AND COMPUTER GAME CD-ROMS, VIDEO OUTPUT GAME MACHINES FOR USE WITH TELEVISIONS; VIDEO AND COMPUTER GAME SOFTWARE; CINEMATOGRAPHIC AND TELEVISION FILMS, NAMELY, MOTION PICTURE FILMS IN THE NATURE OF SPORTS ENTERTAINMENT; PRE-RECORDED PHONOGRAPH RECORDS, PRE-RECORDED COMPACT DISCS, PRE-RECORDED VIDEO TAPES, PRE-RECORDED VIDEO CASSETTE TAPES, PRE-RECORDED DVDS AND PRE-RECORDED AUDIO CASSETTES, ALL FEATURING SPORTS ENTERTAINMENT; COIN-FED AMUSEMENT GAMING MACHINES; INTERACTIVE VIDEO GAME PROGRAMS AND COMPUTER GAME CARTRIDGES; MOUSE PADS; DISPOSABLE CAMERAS; SUNGLASSES; SUNGLASS CASES; PRESCRIPTION GLASSES; AND OPTICAL CASES, NAMELY, CASES FOR SPECTACLES AND SUNGLASSES; WALKIE TALKIES, PROTECTIVE HELMETS; SPORTS HELMETS (U.S. CLS. 21, 23, 26, 36 AND 38).

JOHN HWANG, EXAMINING ATTORNEY

CLASS 9—(Continued).

SN 77-930,767. HIGHERGROUND, INC., CANOGA PARK, CA. FILED 2-8-2010.



THE COLOR(S) RED AND GRAY IS/ARE CLAIMED AS A FEATURE OF THE MARK.

THE MARK CONSISTS OF A CIRCULAR DIAL-LIKE LOGO AND THE WORD CALIBRE, WITH THE HAND AND UPPER RIGHT QUADRANT OF THE DIAL IN RED AND THE REMAINDER OF THE MARK IN GRAY.

FOR COMPUTER PROGRAMS USED TO PROVIDE ACCOUNTING AND MANAGEMENT FOR TELEPHONE SYSTEMS AND TO RECORD TELEPHONE CONVERSATIONS; COMPUTER SYSTEMS COMPRISING COMPUTER PROCESSING HARDWARE AND COMPUTER PROGRAMS FOR ACCOUNTING, RECORDING TELEPHONE CONVERSATIONS AND MANAGEMENT OF TELECOMMUNICATION CALL CENTERS (U.S. CLS. 21, 23, 26, 36 AND 38).

BRIAN CALLAGHAN, EXAMINING ATTORNEY

SN 77-930,776. ARCHER DANIELS MIDLAND COMPANY, DECATUR, IL. FILED 2-8-2010.

AEROS

THE MARK CONSISTS OF STANDARD CHARACTERS WITHOUT CLAIM TO ANY PARTICULAR FONT, STYLE, SIZE, OR COLOR.

FOR COMPUTER SOFTWARE FOR AGENT USE IN CONNECTION WITH CLAIMS AND POLICY PROCESSING IN THE FIELD OF CROP INSURANCE (U.S. CLS. 21, 23, 26, 36 AND 38).

LAURIE MAYES, EXAMINING ATTORNEY

SN 77-930,804. HIGHERGROUND, INC., CANOGA PARK, CA. FILED 2-8-2010.

Calibre

THE MARK CONSISTS OF STANDARD CHARACTERS WITHOUT CLAIM TO ANY PARTICULAR FONT, STYLE, SIZE, OR COLOR.

FOR COMPUTER PROGRAMS USED TO PROVIDE ACCOUNTING AND MANAGEMENT FOR TELEPHONE SYSTEMS AND TO RECORD TELEPHONE CONVERSATIONS; COMPUTER SYSTEMS COMPRISING COMPUTER PROCESSING HARDWARE AND COMPUTER PROGRAMS FOR ACCOUNTING, RECORDING TELEPHONE CONVERSATIONS AND MANAGEMENT OF TELECOMMUNICATION CALL CENTERS (U.S. CLS. 21, 23, 26, 36 AND 38).

BRIAN CALLAGHAN, EXAMINING ATTORNEY

CLASS 9—(Continued).

SN 77-930,852. TRITON MEDIA GROUP, LLC, SHERMAN OAKS, CA. FILED 2-8-2010.

SAM BROADCASTER

THE MARK CONSISTS OF STANDARD CHARACTERS WITHOUT CLAIM TO ANY PARTICULAR FONT, STYLE, SIZE, OR COLOR.

FOR DOWNLOADABLE COMPUTER SOFTWARE FOR STREAMING AUDIO FOR USE IN RADIO BROADCASTING (U.S. CLS. 21, 23, 26, 36 AND 38).

FIRST USE 11-0-2002; IN COMMERCE 11-0-2002.
PATRICIA EVANKO, EXAMINING ATTORNEY

SN 77-930,890. SMARTORG, INC., MENLO PARK, CA. FILED 2-8-2010.

SMARTORG

THE MARK CONSISTS OF STANDARD CHARACTERS WITHOUT CLAIM TO ANY PARTICULAR FONT, STYLE, SIZE, OR COLOR.

FOR COMPUTER SOFTWARE THAT PROVIDES REAL-TIME, INTEGRATED BUSINESS MANAGEMENT INTELLIGENCE BY COMBINING INFORMATION FROM VARIOUS DATABASES AND PRESENTING IT IN AN EASY-TO-UNDERSTAND USER INTERFACE (U.S. CLS. 21, 23, 26, 36 AND 38).

FIRST USE 4-13-2001; IN COMMERCE 4-13-2001.
JESSICA A. POWERS, EXAMINING ATTORNEY

SN 77-930,899. RAYSPAN CORPORATION, SAN DIEGO, CA. FILED 2-8-2010.

MTMRF

THE MARK CONSISTS OF STANDARD CHARACTERS WITHOUT CLAIM TO ANY PARTICULAR FONT, STYLE, SIZE, OR COLOR.

FOR AMPLIFIER FOR WIRELESS COMMUNICATIONS; ANTENNAE FILTERS; ANTENNAS; ANTENNAS FOR RADIO; FOR TELEVISION; ANTENNAS FOR WIRELESS COMMUNICATIONS APPARATUS; COMPUTER HARDWARE, NAMELY, WIRELESS ACCESS POINT (WAP) DEVICES; DEVICES FOR WIRELESS RADIO TRANSMISSION; INTEGRATED CIRCUITS AND INTEGRATED CIRCUIT CORES FOR USE IN WIRELESS COMMUNICATIONS AND WIRELESS COMMUNICATION EQUIPMENT AND APPARATI AND DIGITAL SIGNAL PROCESSORS (DSP); MICROWAVE ANTENNAE; WIRELESS POS (POINT OF SERVICE) DEVICES; WIRELESS TELEPHONES; WIRELESS TELEPHONY APPARATUS (U.S. CLS. 21, 23, 26, 36 AND 38).

FRED MANDIR, EXAMINING ATTORNEY

CLASS 9—(Continued).

SN 77-931,271. KEY OVATION, LLC, CEDAR PARK, TX. FILED 2-9-2010.

GOLDTOUCH

THE MARK CONSISTS OF STANDARD CHARACTERS WITHOUT CLAIM TO ANY PARTICULAR FONT, STYLE, SIZE, OR COLOR.

FOR COMPUTER KEYBOARDS; COMPUTER PERIPHERAL DEVICES; KEYBOARDS (U.S. CLS. 21, 23, 26, 36 AND 38).

FIRST USE 6-1-1998; IN COMMERCE 6-1-1998.
H. M. FISHER, EXAMINING ATTORNEY

SN 77-931,296. GOODWICKET LLC, POCATELLO, ID. FILED 2-9-2010.

ICONCAL

THE MARK CONSISTS OF STANDARD CHARACTERS WITHOUT CLAIM TO ANY PARTICULAR FONT, STYLE, SIZE, OR COLOR.

FOR COMPUTER SOFTWARE FOR CALENDARS AND ORGANIZING (U.S. CLS. 21, 23, 26, 36 AND 38).

CYNTHIA SLOAN, EXAMINING ATTORNEY

SN 77-931,347. ROBERT P. FELTON, SAN FRANCISCO, CA. FILED 2-9-2010.

Powerhouse

THE MARK CONSISTS OF STANDARD CHARACTERS WITHOUT CLAIM TO ANY PARTICULAR FONT, STYLE, SIZE, OR COLOR.

FOR COMPUTER GAME PROGRAMS; COMPUTER GAME SOFTWARE; COMPUTER GAME SOFTWARE FOR PERSONAL COMPUTERS AND HOME VIDEO GAME CONSOLES; COMPUTER GAME SOFTWARE FOR USE ON MOBILE AND CELLULAR PHONES; COMPUTER-GAMING SOFTWARE; ELECTRONIC GAME PROGRAMS; ELECTRONIC GAME SOFTWARE; ELECTRONIC GAME SOFTWARE FOR CELLULAR TELEPHONES; ELECTRONIC GAME SOFTWARE FOR HANDHELD ELECTRONIC DEVICES; GAME SOFTWARE; INTERACTIVE GAME PROGRAMS; INTERACTIVE GAME SOFTWARE; INTERACTIVE VIDEO GAME PROGRAMS; VIDEO AND COMPUTER GAME PROGRAMS (U.S. CLS. 21, 23, 26, 36 AND 38).

MARK SPARACINO, EXAMINING ATTORNEY

CLASS 9—(Continued).

SN 77-931,358. COMPUTER ASSET MANAGEMENT, INC., RICHARDSON, TX. FILED 2-9-2010.

EZLOCATOR

THE MARK CONSISTS OF STANDARD CHARACTERS WITHOUT CLAIM TO ANY PARTICULAR FONT, STYLE, SIZE, OR COLOR.

FOR COMPUTER SOFTWARE IN THE NATURE OF GREENS MANAGEMENT SOFTWARE FOR SELECTING THE LOCATION AND PLACEMENT OF HOLES ALONG A GOLF COURSE AND GENERATING PIN SHEETS THEREFOR (U.S. CLS. 21, 23, 26, 36 AND 38).

FIRST USE 6-1-2009; IN COMMERCE 6-1-2009.

WILLIAM P. SHANAHAN, EXAMINING ATTORNEY

SN 77-931,374. ICON EYEWEAR, INC., SECAUCUS, NJ. FILED 2-9-2010.

SUN REACTOR

THE MARK CONSISTS OF STANDARD CHARACTERS WITHOUT CLAIM TO ANY PARTICULAR FONT, STYLE, SIZE, OR COLOR.

FOR EYEWEAR; READING GLASSES; SUNGLASSES (U.S. CLS. 21, 23, 26, 36 AND 38).

WILLIAM P. SHANAHAN, EXAMINING ATTORNEY

SN 77-931,420. RUSSELL, STEVEN W., KALISPELL, MT. FILED 2-9-2010.

RADIODYNE

THE MARK CONSISTS OF STANDARD CHARACTERS WITHOUT CLAIM TO ANY PARTICULAR FONT, STYLE, SIZE, OR COLOR.

FOR AERONAUTICAL RADIO COMMUNICATION MACHINES AND APPARATUS; ANTENNAS FOR RADIO, FOR TELEVISION; APPARATUS FOR TRANSMITTING RADIO PROGRAMMES AND RADIO RELAY MESSAGES; BROADBAND RADIOS; CARRYING CASES FOR RADIO PAGERS; COMMUNICATIONS HEADSETS FOR USE WITH COMMUNICATION RADIOS, INTERCOM SYSTEMS, OR OTHER COMMUNICATIONS NETWORK TRANSCIEVERS; CONTINGENCY RESPONSE COMMUNICATION SYSTEM DESIGNED TO PROVIDE RADIO INTEROPERABILITY, STREAMING VIDEO, WIRELESS INTERNET, AND VOIP PHONE; DEVICES FOR WIRELESS RADIO TRANSMISSION; DIGITAL MUSIC SYSTEMS THAT SYNCHRONIZES DIGITAL RADIO FILES STORED ON A HOME UNIT, A CAR UNIT, OR PORTABLE UNIT AND THAT MAY BE BACKED UP TO AN INTERNET DEPOSITORY; DISPATCH RADIOS; ELECTRONIC DEVICES, NAMELY, RADIO FREQUENCY REPEATERS USED IN LONG RANGE COMMUNICATION FOR TRACKING AND

CLASS 9—(Continued).

MONITORING ENERGY USAGE; FILTERS FOR RADIO INTERFERENCE SUPPRESSION; FITTED RADIO COVERS USED TO PROTECT AUTOMOBILE RADIOS; INDUSTRIAL WIRELESS POINT-TO-MULTIPOINT RADIO; INTEROPERABLE COMMUNICATION SYSTEM DESIGNED TO PROVIDE RADIO, STREAMING VIDEO, WIRELESS INTERNET, AND VOIP PHONE; MARINE RADIO COMMUNICATION MACHINES AND APPARATUS; MICROWAVE TRANSMISSION APPARATUS FOR DELIVERING RADIO PROGRAMS AND MESSAGES; MOBILE RADIOS; PORTABLE RADIOS; RADIO AND TELEVISION AERIALS; RADIO CONTROLLED MINIATURE AERIAL TARGETS; RADIO FREQUENCY IDENTIFICATION (RFID) CREDENTIALS, NAMELY, CARDS AND TAGS, AND READERS FOR RADIO FREQUENCY IDENTIFICATION CREDENTIALS; RADIO FREQUENCY IDENTIFICATION (RFID) TAGS; RADIO FREQUENCY IDENTIFICATION TAG READERS; RADIO PAGERS; RADIO RECEIVERS; RADIO RECEIVERS AND MONITORS FOR REPRODUCTION OF SOUND AND SIGNALS; RADIO RECEIVERS AND RADIO SIGNAL TUNERS; RADIO RECEIVERS AND TRANSMITTERS; RADIO RECEIVERS AND TRANSMITTERS FOR MONITORING AND CONTROLLING LIGHT EMITTING DIODES IN A NETWORK OF STREET LIGHTS AND FOR PROCESSING EMERGENCY SIGNALS TRANSMITTED TO INDIVIDUAL STREET LIGHTS; RADIO RELAY CABLES; RADIO SETS; RADIO TELEPHONES; RADIO TRANSCIEVERS; RADIO TRANSMITTERS; RADIO TRANSMITTERS AND RECEIVERS; RADIO TRANSMITTERS AND RECEIVERS FOR REMOTE CONTROLS, RADIO CONTROLS; RADIO TRANSMITTERS, RECEIVERS, AND CONTROLLERS FOR MONITORING AND CONTROLLING PUBLIC LIGHTING; RADIO-FREQUENCY CONTROLLED LOCKS; RADIOS; RADIOS AND TELEPHONES; RADIOS FOR VEHICLES; RADIOS INCORPORATING CLOCKS; RELAYS FOR RADIO AND TV STATIONS; REMOTE CONTROL TRANSMITTER FOR RADIO-CONTROLLED DEVICES; REPEATERS FOR RADIO AND TELEVISION STATIONS; SATELLITE RADIOS; SECURITY LIGHTING SYSTEM FOR VEHICLES USING RADIO FREQUENCY DEVICE; SHORT RANGE RADIOS; SINGLE-CHANNEL RADIO COMMUNICATION MACHINES AND APPARATUS FOR FIXED STATIONS; SOFTWARE DEFINED RADIO; SOUND FILTERS MADE OF CLOTH, FOR RADIO APPARATUS; TELEPHONE AND RADIO LIGHTWAVE DATA LINKS; TRANSMITTING AND RECEIVING APPARATUS FOR RADIO AND TELEVISION BROADCASTING AND FOR LONG-DISTANCE TRANSMISSION; TWO-WAY RADIOS; VACUUM TUBES FOR RADIOS; VEHICLE LOCATING, TRACKING AND SECURITY SYSTEM COMPRISED OF AN ANTENNA AND RADIO TRANSMITTER TO BE PLACED IN A VEHICLE; VEHICLE RADIOS; VEHICLE TRACKING DEVICES COMPRISED OF CELLULAR RADIO MODULES, COMPUTER SOFTWARE AND COMPUTER HARDWARE, SENSORS, TRANSMITTERS, RECEIVERS AND GLOBAL POSITIONING SATELLITE RECEIVERS, ALL FOR USE IN CONNECTION WITH VEHICLE TRACKING, VEHICLE MONITORING AND ANTI-THEFT VEHICLE ALARMS; VINYL COVERS SPECIALLY ADAPTED FOR CELL PHONES, MP3 PLAYERS, LAPTOPS, COMPUTERS, PORTABLE SATELLITE RADIOS, PERSONAL DIGITAL ASSISTANTS, REMOTE CONTROLS, AND TELEVISION SATELLITE RECORDERS; WIRELESS BROADBAND RADIOS; WIRELESS NARROW BAND RADIOS; WIRELESS TRANSCIEVER RADIO (U.S. CLS. 21, 23, 26, 36 AND 38).

KATHERINE E. HALMEN, EXAMINING ATTORNEY

CLASS 9—(Continued).

SN 77-931,427. AUTOMATED FINANCIAL SYSTEMS, INC.,
EXTON, PA. FILED 2-9-2010.

AFSVision

THE MARK CONSISTS OF STANDARD CHARACTERS WITHOUT CLAIM TO ANY PARTICULAR FONT, STYLE, SIZE, OR COLOR.

OWNER OF U.S. REG. NOS. 2,997,541, 3,436,026 AND OTHERS.

FOR COMPUTER SOFTWARE FOR PROCESSING AND REPORTING LOAN INFORMATION; COMPUTER SOFTWARE AND INSTRUCTION MANUALS SOLD AS A UNIT FOR PROCESSING AND REPORTING LOAN INFORMATION; COMPUTER SOFTWARE FOR PROCESSING AND REPORTING LOAN INFORMATION IN MULTIPLE CURRENCIES AND LANGUAGES; COMPUTER SOFTWARE AND INSTRUCTION MANUALS SOLD AS A UNIT FOR PROCESSING AND REPORTING LOAN INFORMATION IN MULTIPLE CURRENCIES AND LANGUAGES (U.S. CLS. 21, 23, 26, 36 AND 38).

MAYUR VAGHANI, EXAMINING ATTORNEY

SN 77-931,457. MATRICAL, INC., DBA MATRICAL
BIOSCIENCE, SPOKANE, WA. FILED 2-9-2010.

ATTA Leaf Cutter

THE MARK CONSISTS OF STANDARD CHARACTERS WITHOUT CLAIM TO ANY PARTICULAR FONT, STYLE, SIZE, OR COLOR.

NO CLAIM IS MADE TO THE EXCLUSIVE RIGHT TO USE "LEAF CUTTER", APART FROM THE MARK AS SHOWN.

FOR AUTOMATED LABORATORY EQUIPMENT MAINLY FOR CUTTING SPECIMENS (U.S. CLS. 21, 23, 26, 36 AND 38).

FIRST USE 8-16-2006; IN COMMERCE 8-16-2006.
MAYUR VAGHANI, EXAMINING ATTORNEY

SN 77-931,533. MATRICAL, INC., DBA MATRICAL
BIOSCIENCE, SPOKANE, WA. FILED 2-9-2010.

Lid X

THE MARK CONSISTS OF STANDARD CHARACTERS WITHOUT CLAIM TO ANY PARTICULAR FONT, STYLE, SIZE, OR COLOR.

NO CLAIM IS MADE TO THE EXCLUSIVE RIGHT TO USE "LID", APART FROM THE MARK AS SHOWN.

FOR AUTOMATED LABORATORY EQUIPMENT USED TO REMOVE AND REPLACE LIDS ON MICROWELL PLATES OR REMOVE AND DISCARD LIDS ON MICROWELL PLATES (U.S. CLS. 21, 23, 26, 36 AND 38).

FIRST USE 2-11-2009; IN COMMERCE 2-11-2009.
MAYUR VAGHANI, EXAMINING ATTORNEY

CLASS 9—(Continued).

SN 77-931,563. SPERIAN EYE & FACE PROTECTION, INC.,
SMITHFIELD, RI. FILED 2-9-2010.

XMF

THE MARK CONSISTS OF STANDARD CHARACTERS WITHOUT CLAIM TO ANY PARTICULAR FONT, STYLE, SIZE, OR COLOR.

FOR MILITARY TACTICAL GOGGLES (U.S. CLS. 21, 23, 26, 36 AND 38).

MICHAEL KEATING, EXAMINING ATTORNEY

SN 77-931,570. ADULT SOURCE MEDIA, INC., CHATSWORTH, CA. FILED 2-9-2010.



THE MARK CONSISTS OF THE INITIALS "ASM" IN STYLIZED FONT CENTERED IN FRONT OF AN OVAL OUTLINED USING A NON-SOLID STYLIZED LINE, RESEMBLING PAINT SPLATTER.

SEC. 2(F) AS TO "ASM".

FOR DIGITAL MATERIALS, NAMELY, PRE-RECORDED VIDEO CASSETTES, DIGITAL VIDEO DISCS, DIGITAL VERSATILE DISCS, DOWNLOADABLE AUDIO AND VIDEO RECORDINGS, DVDS, AND HIGH DEFINITION DIGITAL DISKS FEATURING ADULT ENTERTAINMENT, NAMELY, MOVIES, VIDEOS, PHOTOGRAPHS, ANIMATED FILMS, ANIMATION; PRE-RECORDED DVDS FEATURING ADULT ENTERTAINMENT, NAMELY, MOVIES, VIDEOS, PHOTOGRAPHS AND ANIMATED FILMS (U.S. CLS. 21, 23, 26, 36 AND 38).

FIRST USE 6-0-2003; IN COMMERCE 6-0-2003.
KAREN K. BUSH, EXAMINING ATTORNEY

SN 77-931,610. BEDOX, INC., ARCADIA, CA. FILED 2-9-2010.

SEJAT

THE MARK CONSISTS OF STANDARD CHARACTERS WITHOUT CLAIM TO ANY PARTICULAR FONT, STYLE, SIZE, OR COLOR.

FOR SOLAR BATTERIES (U.S. CLS. 21, 23, 26, 36 AND 38).

ANTHONY RINKER, EXAMINING ATTORNEY

CLASS 9—(Continued).

SN 77-931,642. B.J. & E. ACCESSORIES, INC., MIRAMAR, FL.
FILED 2-9-2010.

VöSK

THE MARK CONSISTS OF STANDARD CHARACTERS WITHOUT CLAIM TO ANY PARTICULAR FONT, STYLE, SIZE, OR COLOR.

THE ENGLISH TRANSLATION OF THE WORD "VOSK" IN THE MARK IS WAX.

FOR CARRYING CASES FOR CELL PHONES; CASES FOR MOBILE PHONES; CELL PHONE COVERS; NEOPRENE LAPTOP COVERS; PROTECTIVE COVERS AND CASES FOR CELL PHONES, LAPTOPS AND PORTABLE MEDIA PLAYERS; PROTECTIVE SLEEVES FOR LAPTOP COMPUTERS (U.S. CLS. 21, 23, 26, 36 AND 38).

SUSAN STIGLITZ, EXAMINING ATTORNEY

SN 77-931,974. MATRICAL, INC., DBA MATRICAL BIOSCIENCE, SPOKANE, WA. FILED 2-9-2010.

Scan X 2D

THE MARK CONSISTS OF STANDARD CHARACTERS WITHOUT CLAIM TO ANY PARTICULAR FONT, STYLE, SIZE, OR COLOR.

NO CLAIM IS MADE TO THE EXCLUSIVE RIGHT TO USE "SCAN" AND "2D", APART FROM THE MARK AS SHOWN.

FOR BAR CODE SCANNERS (U.S. CLS. 21, 23, 26, 36 AND 38).

FIRST USE 12-3-2008; IN COMMERCE 12-3-2008.
MAYUR VAGHANI, EXAMINING ATTORNEY

SN 77-932,027. WORLDWIDE COMMUNICATIONS, INC., SCOTTSDALE, AZ. FILED 2-9-2010.



NO CLAIM IS MADE TO THE EXCLUSIVE RIGHT TO USE "MINDSET", APART FROM THE MARK AS SHOWN.

THE COLOR(S) GRAY, SUN-YELLOW AND BLACK IS/ARE CLAIMED AS A FEATURE OF THE MARK.

THE MARK CONSISTS OF EIGHT TOTAL DAISY LIKE PEDALS ARE POSITIONED IN A CIRCULAR FORM TO CREATE THE FACE OF A CLOCK ALIGNED FLUSH

CLASS 9—(Continued).

RIGHT OF THE TOTAL IMAGE. SEVEN OF THE DAISY-LIKE PEDALS ARE GRAY IN COLOR. THE SINGULAR COLOR EXCEPTION IS THE ONE DAISY-LIKE PEDAL THAT IS POSITIONED BETWEEN THE IMAGINARY 1 AND 2 PLACE ON THE FACE OF THE CLOCK AND THIS DAISY-LIKE PEDAL IS SUN YELLOW. THE WORDS ARE ALIGNED TO THE RIGHT OF THE DAISY-PEDALS OF A CLOCK. THE WORDS ARE "MINUTE MINDSET" AND "IT ONLY TAKES A MINUTE TO CHANGE YOUR MIND" ARE ALL BLACK IN COLOR.

FOR DOWNLOADABLE MULTIMEDIA FILE CONTAINING ARTWORK, TEXT, AUDIO, VIDEO, GAMES, AND INTERNET WEB LINKS RELATING TO PERSONAL GROWTH AND DEVELOPMENT (U.S. CLS. 21, 23, 26, 36 AND 38).

ALEX KEAM, EXAMINING ATTORNEY

SN 77-932,146. TWENTIETH CENTURY FOX FILM CORPORATION, LOS ANGELES, CA. FILED 2-9-2010.

BREAKOUT KINGS

THE MARK CONSISTS OF STANDARD CHARACTERS WITHOUT CLAIM TO ANY PARTICULAR FONT, STYLE, SIZE, OR COLOR.

FOR PRE-RECORDED DVDS FEATURING DRAMA; PRE-RECORDED CDS FEATURING DRAMA AND MUSICAL PERFORMANCES; DOWNLOADABLE AUDIO AND VIDEO RECORDINGS FEATURING DRAMA; DOWNLOADABLE TELEVISION SHOWS AND VIDEO RECORDINGS FEATURING DRAMA; DOWNLOADABLE RING TONES, RING BACKS, GRAPHICS, WALLPAPER, GAMES AND MUSIC VIA A GLOBAL COMPUTER NETWORK AND WIRELESS DEVICES; COMPUTER SCREEN SAVER SOFTWARE; COMPUTER GAME AND VIDEO GAME SOFTWARE; MOUSEPADS; DECORATIVE MAGNETS (U.S. CLS. 21, 23, 26, 36 AND 38).

THEODORE MCBRIDE, EXAMINING ATTORNEY

SN 77-932,450. PB2NJ, INC., DBA GETRIGHTTHERE, CHESAPEAKE, VA. FILED 2-10-2010.

Gizmo

THE MARK CONSISTS OF STANDARD CHARACTERS WITHOUT CLAIM TO ANY PARTICULAR FONT, STYLE, SIZE, OR COLOR.

FOR COMPUTER HARDWARE AND SOFTWARE SYSTEM FOR TRACKING PEOPLE, OBJECTS AND PETS USING GPS DATA ON A DEVICE ON THE TRACKED PEOPLE, OBJECTS AND PETS; VEHICLE MOUNTED GPS SENSOR FOR DETERMINING THE RATE OF MOTION FOR A VEHICLE (U.S. CLS. 21, 23, 26, 36 AND 38).

ELIZABETH KAJUBI, EXAMINING ATTORNEY

CLASS 9—(Continued).

SN 77-932,588. NAVMAN WIRELESS HOLDINGS, L.P., GLENVIEW, IL. FILED 2-10-2010.

JUPITER

THE MARK CONSISTS OF STANDARD CHARACTERS WITHOUT CLAIM TO ANY PARTICULAR FONT, STYLE, SIZE, OR COLOR.

FOR COMPUTER HARDWARE AND SOFTWARE FOR USE IN GLOBAL POSITIONING, WIRELESS NAVIGATION AND TRACKING, AND SATELLITE COMMUNICATIONS (U.S. CLS. 21, 23, 26, 36 AND 38).

FIRST USE 1-0-1998; IN COMMERCE 1-0-1998.
MARGERY A. TIERNEY, EXAMINING ATTORNEY

CLASS 9—(Continued).

SN 77-932,764. ANTHONY PETER VICTOR KOVACS, AKA VATSIM, TORONTO, CANADA, FILED 2-10-2010.

VATSIM

THE MARK CONSISTS OF STANDARD CHARACTERS WITHOUT CLAIM TO ANY PARTICULAR FONT, STYLE, SIZE, OR COLOR.

FOR COMPUTER GAME PROGRAMS; COMPUTER GAME SOFTWARE; COMPUTER GAME SOFTWARE DOWNLOADABLE FROM A GLOBAL COMPUTER NETWORK (U.S. CLS. 21, 23, 26, 36 AND 38).

APRIL HESIK, EXAMINING ATTORNEY

SN 77-932,709. DEERE & COMPANY, MOLINE, IL. FILED 2-10-2010.



OWNER OF U.S. REG. NOS. 2,580,000, 2,626,085 AND OTHERS.

THE MARK CONSISTS OF AN UPWARDLY LEAPING DEER WITHIN A BORDER.

FOR CELL PHONE CASES, LAPTOP COMPUTER CARRYING CASES, MEDIA CASES, NAMELY, PROTECTIVE CASES ESPECIALLY ADAPTED FOR HOLDING ELECTRONIC MEDIA AND PROTECTIVE CARRYING CASES FOR PORTABLE MUSIC PLAYERS, NAMELY, MP3 PLAYERS (U.S. CLS. 21, 23, 26, 36 AND 38).

FIRST USE 12-31-2000; IN COMMERCE 12-31-2000.
DAVID I, EXAMINING ATTORNEY

SN 77-933,036. RAYSPAN CORPORATION, SAN DIEGO, CA. FILED 2-10-2010.

MTMB

THE MARK CONSISTS OF STANDARD CHARACTERS WITHOUT CLAIM TO ANY PARTICULAR FONT, STYLE, SIZE, OR COLOR.

FOR ANTENNAE FILTERS; ANTENNAS; ANTENNAS FOR RADIO, FOR TELEVISION; ANTENNAS FOR WIRELESS COMMUNICATIONS APPARATUS; COMPUTER HARDWARE, NAMELY, WIRELESS ACCESS POINT (WAP) DEVICES; DEVICES FOR WIRELESS RADIO TRANSMISSION; MICROWAVE ANTENNAE; WIRELESS POS (POINT OF SERVICE) DEVICES; WIRELESS TELEPHONES; WIRELESS TELEPHONY APPARATUS (U.S. CLS. 21, 23, 26, 36 AND 38).

FRED MANDIR, EXAMINING ATTORNEY

SN 77-932,755. YSI INCORPORATED, YELLOW SPRINGS, OH. FILED 2-10-2010.

ORCA

THE MARK CONSISTS OF STANDARD CHARACTERS WITHOUT CLAIM TO ANY PARTICULAR FONT, STYLE, SIZE, OR COLOR.

FOR MULTIPARAMETER WATER QUALITY SONDES USING ELECTROCHEMICAL AND OPTICAL SENSORS FOR MEASUREMENT OF THE PROPERTIES OF WATER; SCIENTIFIC INSTRUMENTS AND APPARATUS FOR DATA COLLECTION AND MEASUREMENT OF WATER QUALITY (U.S. CLS. 21, 23, 26, 36 AND 38).

ADA HAN, EXAMINING ATTORNEY

SN 77-933,571. ICON EYEWEAR, INC., SECAUCUS, NJ. FILED 2-11-2010.

FLYPAPER

THE MARK CONSISTS OF STANDARD CHARACTERS WITHOUT CLAIM TO ANY PARTICULAR FONT, STYLE, SIZE, OR COLOR.

FOR READING GLASSES; SUNGLASSES (U.S. CLS. 21, 23, 26, 36 AND 38).

WILLIAM P. SHANAHAN, EXAMINING ATTORNEY

CLASS 9—(Continued).

SN 77-935,571. NEWCARDIO, INC., SANTA CLARA, CA.
FILED 2-15-2010.

Cardio3KG

THE MARK CONSISTS OF STANDARD CHARACTERS WITHOUT CLAIM TO ANY PARTICULAR FONT, STYLE, SIZE, OR COLOR.

FOR SOFTWARE FOR USE WITH MEDICAL DETECTION AND DIAGNOSIS DEVICES, NAMELY, IN THE FIELD OF ELECTROCARDIOGRAPHY (ECG) (U.S. CLS. 21, 23, 26, 36 AND 38).

MARC LEIPZIG, EXAMINING ATTORNEY

SN 77-935,962. WMS GAMING INC., WAUKEGAN, IL.
FILED 2-15-2010.

TOP STAR

THE MARK CONSISTS OF STANDARD CHARACTERS WITHOUT CLAIM TO ANY PARTICULAR FONT, STYLE, SIZE, OR COLOR.

FOR COMPONENTS FOR GAMING MACHINES THAT GENERATE OR DISPLAY WAGER OUTCOMES, NAMELY, CONTROLLERS, DISPLAYS, BUTTON PANELS, BOLSTERS, ELECTRICAL WIRING, AND COMPUTER HARDWARE AND SOFTWARE ASSOCIATED THEREWITH; GAMING MACHINES, NAMELY, DEVICES WHICH ACCEPT A WAGER; GAMING SOFTWARE THAT GENERATES OR DISPLAYS WAGER OUTCOMES OF GAMING MACHINES (U.S. CLS. 21, 23, 26, 36 AND 38).

MARIA-VICTORIA SUAREZ, EXAMINING ATTORNEY

SN 77-937,432. WMS GAMING INC., WAUKEGAN, IL.
FILED 2-17-2010.

HEART AND SOUL

THE MARK CONSISTS OF STANDARD CHARACTERS WITHOUT CLAIM TO ANY PARTICULAR FONT, STYLE, SIZE, OR COLOR.

FOR COMPONENTS FOR GAMING MACHINES THAT GENERATE OR DISPLAY WAGER OUTCOMES, NAMELY, CONTROLLERS, DISPLAYS, BUTTON PANELS, BOLSTERS, ELECTRICAL WIRING, AND COMPUTER HARDWARE AND SOFTWARE ASSOCIATED THEREWITH; GAMING MACHINES, NAMELY, DEVICES WHICH ACCEPT A WAGER; GAMING SOFTWARE THAT GENERATES OR DISPLAYS WAGER OUTCOMES OF GAMING MACHINES (U.S. CLS. 21, 23, 26, 36 AND 38).

MARIA-VICTORIA SUAREZ, EXAMINING ATTORNEY

CLASS 9—(Continued).

SN 77-937,492. JOHNSON & JOHNSON, NEW BRUNSWICK, NJ. FILED 2-17-2010.

ACUVUE ASSURED

THE MARK CONSISTS OF STANDARD CHARACTERS WITHOUT CLAIM TO ANY PARTICULAR FONT, STYLE, SIZE, OR COLOR.

OWNER OF U.S. REG. NOS. 1,458,177, 2,547,208 AND 3,014,623.

FOR CONTACT LENSES (U.S. CLS. 21, 23, 26, 36 AND 38).

TIMOTHY FINNEGAN, EXAMINING ATTORNEY

SN 77-937,617. DAZ PRODUCTIONS, INC., DRAPER, UT.
FILED 2-17-2010.

Victoria

THE MARK CONSISTS OF STANDARD CHARACTERS WITHOUT CLAIM TO ANY PARTICULAR FONT, STYLE, SIZE, OR COLOR.

FOR COMPUTER GRAPHICS SOFTWARE (U.S. CLS. 21, 23, 26, 36 AND 38).

FIRST USE 3-24-2000; IN COMMERCE 3-24-2000.

KAREN K. BUSH, EXAMINING ATTORNEY

SN 77-937,850. DAZ PRODUCTIONS, INC., DRAPER, UT.
FILED 2-17-2010.

Bryce

THE MARK CONSISTS OF STANDARD CHARACTERS WITHOUT CLAIM TO ANY PARTICULAR FONT, STYLE, SIZE, OR COLOR.

FOR LANDSCAPE AND TERRAIN GENERATION COMPUTER SOFTWARE (U.S. CLS. 21, 23, 26, 36 AND 38).

FIRST USE 9-20-1993; IN COMMERCE 2-10-1994.

KAREN K. BUSH, EXAMINING ATTORNEY

CLASS 9—(Continued).

SN 77-937,889. DIGI INTERNATIONAL INC., MINNETONKA, MN. FILED 2-17-2010.

ENERGY DAYTRADER

THE MARK CONSISTS OF STANDARD CHARACTERS WITHOUT CLAIM TO ANY PARTICULAR FONT, STYLE, SIZE, OR COLOR.

NO CLAIM IS MADE TO THE EXCLUSIVE RIGHT TO USE "ENERGY", APART FROM THE MARK AS SHOWN.

FOR COMPUTER HARDWARE AND COMPUTER SOFTWARE, NAMELY, SOFTWARE AND MIDDLEWARE ALLOWING USERS TO MANAGE ENERGY USE (U.S. CLS. 21, 23, 26, 36 AND 38).

PAM WILLIS, EXAMINING ATTORNEY

SN 77-937,956. ADVENT SOFTWARE, INC., SAN FRANCISCO, CA. FILED 2-17-2010.

TAMALE  RMS

OWNER OF U.S. REG. NOS. 3,029,084, 3,167,938 AND OTHERS.

NO CLAIM IS MADE TO THE EXCLUSIVE RIGHT TO USE "RMS", APART FROM THE MARK AS SHOWN.

THE MARK CONSISTS OF THE WORDING "TAMALE RMS" WITH A STYLIZED PEPPER DESIGN IN BETWEEN THE WORDS.

FOR COMPUTER SOFTWARE, NAMELY, RESEARCH MANAGEMENT SOFTWARE; COMPUTER SOFTWARE FOR THE COLLECTION, EDITING, ORGANIZING, MODIFYING, BOOKMARKING, TRANSMISSION, STORAGE AND SHARING OF DATA AND INFORMATION (U.S. CLS. 21, 23, 26, 36 AND 38).

FIRST USE 2-3-2009; IN COMMERCE 2-28-2009.
MEGHAN REINHART, EXAMINING ATTORNEY

SN 77-937,959. DAZ PRODUCTIONS, INC., DRAPER, UT. FILED 2-17-2010.

Mimic

THE MARK CONSISTS OF STANDARD CHARACTERS WITHOUT CLAIM TO ANY PARTICULAR FONT, STYLE, SIZE, OR COLOR.

FOR COMPUTER SOFTWARE, NAMELY, COMPUTER SOFTWARE PROGRAMS FOR GRAPHICS ANIMATION, NAMELY, FOR THE SYNCHRONIZATION OF SPEECH WITH ANIMATED CHARACTERS (U.S. CLS. 21, 23, 26, 36 AND 38).

FIRST USE 4-1-1999; IN COMMERCE 4-1-2000.
KAREN K. BUSH, EXAMINING ATTORNEY

CLASS 9—(Continued).

SN 77-937,979. WMS GAMING INC., WAUKEGAN, IL. FILED 2-17-2010.

JEWELS OF AUSTRALIA

THE MARK CONSISTS OF STANDARD CHARACTERS WITHOUT CLAIM TO ANY PARTICULAR FONT, STYLE, SIZE, OR COLOR.

FOR COMPONENTS FOR GAMING MACHINES THAT GENERATE OR DISPLAY WAGER OUTCOMES, NAMELY, CONTROLLERS, DISPLAYS, BUTTON PANELS, BOLSTERS, ELECTRICAL WIRING, AND COMPUTER HARDWARE AND SOFTWARE ASSOCIATED THEREWITH; GAMING MACHINES, NAMELY, DEVICES WHICH ACCEPT A WAGER; GAMING SOFTWARE THAT GENERATES OR DISPLAYS WAGER OUTCOMES OF GAMING MACHINES (U.S. CLS. 21, 23, 26, 36 AND 38).

MARIA-VICTORIA SUAREZ, EXAMINING ATTORNEY

SN 77-937,985. WMS GAMING INC., WAUKEGAN, IL. FILED 2-17-2010.

RUBY STAR

THE MARK CONSISTS OF STANDARD CHARACTERS WITHOUT CLAIM TO ANY PARTICULAR FONT, STYLE, SIZE, OR COLOR.

FOR COMPONENTS FOR GAMING MACHINES THAT GENERATE OR DISPLAY WAGER OUTCOMES, NAMELY, CONTROLLERS, DISPLAYS, BUTTON PANELS, BOLSTERS, ELECTRICAL WIRING, AND COMPUTER HARDWARE AND SOFTWARE ASSOCIATED THEREWITH; GAMING MACHINES, NAMELY, DEVICES WHICH ACCEPT A WAGER; GAMING SOFTWARE THAT GENERATES OR DISPLAYS WAGER OUTCOMES OF GAMING MACHINES (U.S. CLS. 21, 23, 26, 36 AND 38).

MARIA-VICTORIA SUAREZ, EXAMINING ATTORNEY

SN 77-938,114. ZIZIBIZY, BURBANK, CA. FILED 2-17-2010.

Phone Blouze

THE MARK CONSISTS OF STANDARD CHARACTERS WITHOUT CLAIM TO ANY PARTICULAR FONT, STYLE, SIZE, OR COLOR.

NO CLAIM IS MADE TO THE EXCLUSIVE RIGHT TO USE "PHONE", APART FROM THE MARK AS SHOWN.

FOR DISPOSABLE PHONE GUARD COVER MADE OF PLASTIC MATERIAL (U.S. CLS. 21, 23, 26, 36 AND 38).

FONG HSU, EXAMINING ATTORNEY

CLASS 9—(Continued).

SN 77-938,421. WMS GAMING INC., WAUKEGAN, IL. FILED 2-18-2010.

TROPICAL FISH

THE MARK CONSISTS OF STANDARD CHARACTERS WITHOUT CLAIM TO ANY PARTICULAR FONT, STYLE, SIZE, OR COLOR.

FOR COMPONENTS FOR GAMING MACHINES THAT GENERATE OR DISPLAY WAGER OUTCOMES, NAMELY, CONTROLLERS, DISPLAYS, BUTTON PANELS, BOLSTERS, ELECTRICAL WIRING, AND COMPUTER HARDWARE AND SOFTWARE ASSOCIATED THEREWITH; GAMING MACHINES, NAMELY, DEVICES WHICH ACCEPT A WAGER; GAMING SOFTWARE THAT GENERATES OR DISPLAYS WAGER OUTCOMES OF GAMING MACHINES (U.S. CLS. 21, 23, 26, 36 AND 38).

MARIA-VICTORIA SUAREZ, EXAMINING ATTORNEY

SN 77-939,894. YSI INCORPORATED, YELLOW SPRINGS, OH. FILED 2-19-2010.

CASTAWAY

THE MARK CONSISTS OF STANDARD CHARACTERS WITHOUT CLAIM TO ANY PARTICULAR FONT, STYLE, SIZE, OR COLOR.

FOR ELECTRONIC ENVIRONMENTAL SENSORS AND DATA LOGGERS FOR UNDERWATER USE; COMPUTER SOFTWARE FOR ANALYSIS OF ENVIRONMENTAL DATA (U.S. CLS. 21, 23, 26, 36 AND 38).

ADA HAN, EXAMINING ATTORNEY

SN 77-941,077. KENT SCIENTIFIC CORPORATION, TORRINGTON, CT. FILED 2-22-2010.

MouseSTAT

THE MARK CONSISTS OF STANDARD CHARACTERS WITHOUT CLAIM TO ANY PARTICULAR FONT, STYLE, SIZE, OR COLOR.

FOR ELECTRIC OR ELECTRONIC SENSORS FOR MEASURING PHYSIOLOGICAL PARAMETERS OF AN ANIMAL SUBJECT (U.S. CLS. 21, 23, 26, 36 AND 38).

FIRST USE 2-19-2010; IN COMMERCE 2-19-2010.

HENRY S. ZAK, EXAMINING ATTORNEY

CLASS 9—(Continued).

SN 77-943,460. HOHNER, INC., GLEN ALLEN, VA. FILED 2-24-2010.

HOODOO

THE MARK CONSISTS OF STANDARD CHARACTERS WITHOUT CLAIM TO ANY PARTICULAR FONT, STYLE, SIZE, OR COLOR.

FOR AMPLIFIERS AND WIRELESS MICROPHONES (U.S. CLS. 21, 23, 26, 36 AND 38).

FIRST USE 1-29-2008; IN COMMERCE 1-29-2008.

KATHERINE CONNOLLY, EXAMINING ATTORNEY

SN 77-944,300. MENDOZA, RUBEN, FREDERICK, MD. FILED 2-24-2010.

Smokey South

THE MARK CONSISTS OF STANDARD CHARACTERS WITHOUT CLAIM TO ANY PARTICULAR FONT, STYLE, SIZE, OR COLOR.

FOR DIGITAL MEDIA, NAMELY, COMPACT DISCS, TAPE CASSETTES, CDS, DVDS, AND DOWNLOADABLE AUDIO FILES FEATURING MUSIC (U.S. CLS. 21, 23, 26, 36 AND 38).

BRIDGETT SMITH, EXAMINING ATTORNEY

SN 77-944,322. AVONTUS SOFTWARE CORPORATION, ALBANY, CA. FILED 2-24-2010.

BidMaker

THE MARK CONSISTS OF STANDARD CHARACTERS WITHOUT CLAIM TO ANY PARTICULAR FONT, STYLE, SIZE, OR COLOR.

FOR COMPUTER SOFTWARE FOR ESTIMATING COSTS OF CONSTRUCTION GOODS AND SERVICES (U.S. CLS. 21, 23, 26, 36 AND 38).

FIRST USE 1-1-2000; IN COMMERCE 7-1-2001.

PAUL E. FAHRENKOPF, EXAMINING ATTORNEY

CLASS 9—(Continued).

SN 77-944,922. HALE PRODUCTS, INC., CONSHOHOCKEN, PA. FILED 2-25-2010.

CLASS 9—(Continued).

SN 77-945,507. WORLD WRESTLING ENTERTAINMENT, INC., STAMFORD, CT. FILED 2-25-2010.

1TOUCH

THE MARK CONSISTS OF STANDARD CHARACTERS WITHOUT CLAIM TO ANY PARTICULAR FONT, STYLE, SIZE, OR COLOR.

FOR SWITCHING DEVICE, NAMELY, AN ELECTRONIC SWITCH TO CONTROL ELECTRICAL SYSTEMS IN HEAVY DUTY VEHICLES (U.S. CLS. 21, 23, 26, 36 AND 38).

MICHELE SWAIN, EXAMINING ATTORNEY

OVER THE LIMIT

SN 77-944,924. BROADSOFT, INC., GAITHERSBURG, MD. FILED 2-25-2010.

V2CONNECT

THE MARK CONSISTS OF STANDARD CHARACTERS WITHOUT CLAIM TO ANY PARTICULAR FONT, STYLE, SIZE, OR COLOR.

FOR SOFTWARE USED TO INTEGRATE VOICE AND VIDEO TELECOMMUNICATIONS FOR USE IN CONFERENCING, VOICE MAIL, AND MESSAGING, AND TO PROVIDE MOBILE TELEPHONE CONNECTIVITY (U.S. CLS. 21, 23, 26, 36 AND 38).

SALLY SHIH, EXAMINING ATTORNEY

THE MARK CONSISTS OF STANDARD CHARACTERS WITHOUT CLAIM TO ANY PARTICULAR FONT, STYLE, SIZE, OR COLOR.

FOR DOWNLOADABLE RING TONES, GRAPHICS AND MUSIC VIA A GLOBAL COMPUTER NETWORK AND WIRELESS DEVICES; DECORATIVE REFRIGERATOR MAGNETS; VIDEO AND COMPUTER GAME TAPES, VIDEO AND COMPUTER GAME DISCS, VIDEO AND COMPUTER GAME CASSETTES, VIDEO AND COMPUTER GAME CARTRIDGES, VIDEO AND COMPUTER GAME CD-ROMS, VIDEO OUTPUT GAME MACHINES FOR USE WITH TELEVISIONS; VIDEO AND COMPUTER GAME SOFTWARE; CINEMATOGRAPHIC AND TELEVISION FILMS, NAMELY, MOTION PICTURE FILMS IN THE NATURE OF SPORTS ENTERTAINMENT; PRE-RECORDED PHONOGRAPH RECORDS, PRE-RECORDED COMPACT DISCS, PRE-RECORDED VIDEO TAPES, PRE-RECORDED VIDEO CASSETTE TAPES, PRE-RECORDED DVDS AND PRE-RECORDED AUDIO CASSETTES, ALL FEATURING SPORTS ENTERTAINMENT; COIN-FED AMUSEMENT GAMING MACHINES; INTERACTIVE VIDEO GAME PROGRAMS AND COMPUTER GAME CARTRIDGES; MOUSE PADS; DISPOSABLE CAMERAS; SUNGLASSES; SUNGLASS CASES; PRESCRIPTION GLASSES; AND OPTICAL CASES, NAMELY, CASES FOR SPECTACLES AND SUNGLASSES; WALKIE TALKIES, PROTECTIVE HELMETS; SPORTS HELMETS (U.S. CLS. 21, 23, 26, 36 AND 38).

JOHN HWANG, EXAMINING ATTORNEY

SN 77-945,262. BBK TOBACCO & FOODS, LLP, DBA HBI INTERNATIONAL, PHOENIX, AZ. FILED 2-25-2010.

iTester

THE MARK CONSISTS OF STANDARD CHARACTERS WITHOUT CLAIM TO ANY PARTICULAR FONT, STYLE, SIZE, OR COLOR.

FOR MICROHARDNESS TESTERS, DIAMOND TESTERS (U.S. CLS. 21, 23, 26, 36 AND 38).

EDWARD NELSON, EXAMINING ATTORNEY

CLASS 9—(Continued).

SN 77-945,510. WORLD WRESTLING ENTERTAINMENT, INC., STAMFORD, CT. FILED 2-25-2010.

FATAL FOUR WAY

THE MARK CONSISTS OF STANDARD CHARACTERS WITHOUT CLAIM TO ANY PARTICULAR FONT, STYLE, SIZE, OR COLOR.

FOR DOWNLOADABLE RING TONES, GRAPHICS AND MUSIC VIA A GLOBAL COMPUTER NETWORK AND WIRELESS DEVICES; DECORATIVE REFRIGERATOR MAGNETS; VIDEO AND COMPUTER GAME TAPES, VIDEO AND COMPUTER GAME DISCS, VIDEO AND COMPUTER GAME CASSETTES, VIDEO AND COMPUTER GAME CARTRIDGES, VIDEO AND COMPUTER GAME CD-ROMS, VIDEO OUTPUT GAME MACHINES FOR USE WITH TELEVISIONS; VIDEO AND COMPUTER GAME SOFTWARE; CINEMATOGRAPHIC AND TELEVISION FILMS, NAMELY, MOTION PICTURE FILMS IN THE NATURE OF SPORTS ENTERTAINMENT; PRE-RECORDED PHONOGRAPH RECORDS, PRE-RECORDED COMPACT DISCS, PRE-RECORDED VIDEO TAPES, PRE-RECORDED VIDEO CASSETTE TAPES, PRE-RECORDED DVDS AND PRE-RECORDED AUDIO CASSETTES, ALL FEATURING SPORTS ENTERTAINMENT; COIN-FED AMUSEMENT GAMING MACHINES; INTERACTIVE VIDEO GAME PROGRAMS AND COMPUTER GAME CARTRIDGES; MOUSE PADS; DISPOSABLE CAMERAS; SUNGLASSES; SUNGLASS CASES; PRESCRIPTION GLASSES; AND OPTICAL CASES, NAMELY, CASES FOR SPECTACLES AND SUNGLASSES; WALKIE TALKIES, PROTECTIVE HELMETS; SPORTS HELMETS (U.S. CLS. 21, 23, 26, 36 AND 38).

JOHN HWANG, EXAMINING ATTORNEY

SN 77-945,516. WORLD WRESTLING ENTERTAINMENT, INC., STAMFORD, CT. FILED 2-25-2010.

MONEY IN THE BANK

THE MARK CONSISTS OF STANDARD CHARACTERS WITHOUT CLAIM TO ANY PARTICULAR FONT, STYLE, SIZE, OR COLOR.

OWNER OF U.S. REG. NO. 3,532,434.
FOR DOWNLOADABLE RING TONES, GRAPHICS AND MUSIC VIA A GLOBAL COMPUTER NETWORK AND WIRELESS DEVICES; DECORATIVE REFRIGERATOR MAGNETS; VIDEO TAPES, VIDEO DISCS, VIDEO CASSETTES, CINEMATOGRAPHIC AND TELEVISION FILMS, NAMELY, MOTION PICTURE FILMS IN THE NATURE OF SPORTS ENTERTAINMENT; PRE-RECORDED PHONOGRAPH RECORDS, PRE-RECORDED COMPACT DISCS, PRE-RECORDED VIDEO TAPES, PRE-RECORDED VIDEO CASSETTE TAPES, PRE-RECORDED DVDS AND PRE-RECORDED AUDIO CASSETTES, ALL FEATURING SPORTS ENTERTAINMENT; DISPOSABLE CAMERAS; SUNGLASSES; SUNGLASS CASES; PRESCRIPTION GLASSES; AND OPTICAL CASES, NAMELY, CASES FOR SPECTACLES AND SUNGLASSES; WALKIE TALKIES, PROTECTIVE HELMETS; SPORTS HELMETS (U.S. CLS. 21, 23, 26, 36 AND 38).

JOHN HWANG, EXAMINING ATTORNEY

CLASS 9—(Continued).

SN 77-946,006. LOORZ, VICTORIA, VENTURA, CA. AND LOORZ, ALEC, VENTURA, CA. FILED 2-26-2010.

IMATTER

THE MARK CONSISTS OF STANDARD CHARACTERS WITHOUT CLAIM TO ANY PARTICULAR FONT, STYLE, SIZE, OR COLOR.

FOR COMPUTER SOFTWARE FOR MOBILE DEVICES FOR USERS TO INTERACT AND PARTICIPATE IN CHARITABLE PROJECTS IN THE FIELD OF GLOBAL WARMING (U.S. CLS. 21, 23, 26, 36 AND 38).

FIRST USE 2-10-2010; IN COMMERCE 2-10-2010.
STEVEN JACKSON, EXAMINING ATTORNEY

SN 77-948,389. CALLPOD, INC., CHICAGO, IL. FILED 3-2-2010.

fueltank metho

THE MARK CONSISTS OF STANDARD CHARACTERS WITHOUT CLAIM TO ANY PARTICULAR FONT, STYLE, SIZE, OR COLOR.

OWNER OF U.S. REG. NO. 3,562,387.
FOR DEVICE BATTERY CHARGERS, NAMELY, BATTERY OPERATED DEVICES THAT CHARGE MULTIPLE ELECTRONIC DEVICES AT ONCE (U.S. CLS. 21, 23, 26, 36 AND 38).

KIMBERLY FRYE, EXAMINING ATTORNEY

SN 77-948,425. SEATTLE PACIFIC INDUSTRIES, INC., SEATTLE, WA. FILED 3-2-2010.

UNION

THE MARK CONSISTS OF STANDARD CHARACTERS WITHOUT CLAIM TO ANY PARTICULAR FONT, STYLE, SIZE, OR COLOR.

OWNER OF U.S. REG. NOS. 2,927,728, 3,076,424 AND 3,082,240.
FOR EYEGLASSES (U.S. CLS. 21, 23, 26, 36 AND 38).
GEORGE LORENZO, EXAMINING ATTORNEY

CLASS 9—(Continued).

SN 77-950,623. WMS GAMING INC., WAUKEGAN, IL. FILED 3-4-2010.

MY CHARM

THE MARK CONSISTS OF STANDARD CHARACTERS WITHOUT CLAIM TO ANY PARTICULAR FONT, STYLE, SIZE, OR COLOR.

OWNER OF U.S. REG. NO. 3,270,329.
 FOR COMPONENTS FOR GAMING MACHINES THAT GENERATE OR DISPLAY WAGER OUTCOMES, NAMELY, CONTROLLERS, DISPLAYS, BUTTON PANELS, BOLSTERS, ELECTRICAL WIRING, AND COMPUTER HARDWARE AND SOFTWARE ASSOCIATED THEREWITH; GAMING MACHINES, NAMELY, DEVICES WHICH ACCEPT A WAGER; GAMING SOFTWARE THAT GENERATES OR DISPLAYS WAGER OUTCOMES OF GAMING MACHINES (U.S. CLS. 21, 23, 26, 36 AND 38).

MARIA-VICTORIA SUAREZ, EXAMINING ATTORNEY

SN 77-951,380. DATA LTD., INC., LAPORTE, IN. FILED 3-5-2010.

MOBILE COMPUTERS AS TOUGH AS THE PEOPLE THAT USE THEM

THE MARK CONSISTS OF STANDARD CHARACTERS WITHOUT CLAIM TO ANY PARTICULAR FONT, STYLE, SIZE, OR COLOR.

FOR TABLET COMPUTERS (U.S. CLS. 21, 23, 26, 36 AND 38).

JENNIFER DIXON, EXAMINING ATTORNEY

SN 77-952,191. ZOOSK, INC., SAN FRANCISCO, CA. FILED 3-5-2010.

ZOOSK

THE MARK CONSISTS OF STANDARD CHARACTERS WITHOUT CLAIM TO ANY PARTICULAR FONT, STYLE, SIZE, OR COLOR.

FOR DOWNLOADABLE COMPUTER SOFTWARE FOR ONLINE SOCIAL NETWORKING (U.S. CLS. 21, 23, 26, 36 AND 38).

FIRST USE 1-12-2009; IN COMMERCE 1-12-2009.
 GINA HAYES, EXAMINING ATTORNEY

CLASS 9—(Continued).

SN 77-952,192. ZOOSK, INC., SAN FRANCISCO, CA. FILED 3-5-2010.



THE MARK CONSISTS OF WORD "ZOOSK" WITH A HEART IMAGE OVER THE SECOND LETTER "O".

FOR DECORATIVE MAGNETS; MOUSEPADS (U.S. CLS. 21, 23, 26, 36 AND 38).

FIRST USE 2-25-2010; IN COMMERCE 2-25-2010.
 GINA HAYES, EXAMINING ATTORNEY

SN 77-952,837. WMS GAMING INC., WAUKEGAN, IL. FILED 3-8-2010.

GOLDEN AGE

THE MARK CONSISTS OF STANDARD CHARACTERS WITHOUT CLAIM TO ANY PARTICULAR FONT, STYLE, SIZE, OR COLOR.

FOR COMPONENTS FOR GAMING MACHINES THAT GENERATE OR DISPLAY WAGER OUTCOMES, NAMELY, CONTROLLERS, DISPLAYS, BUTTON PANELS, BOLSTERS, ELECTRICAL WIRING, AND COMPUTER HARDWARE AND SOFTWARE ASSOCIATED THEREWITH; GAMING MACHINES, NAMELY, DEVICES WHICH ACCEPT A WAGER; GAMING SOFTWARE THAT GENERATES OR DISPLAYS WAGER OUTCOMES OF GAMING MACHINES (U.S. CLS. 21, 23, 26, 36 AND 38).

MARIA-VICTORIA SUAREZ, EXAMINING ATTORNEY

SN 77-956,888. CLINICON CORPORATION, OCEANSIDE, CA. FILED 3-11-2010.

SUREGUIDE

THE MARK CONSISTS OF STANDARD CHARACTERS WITHOUT CLAIM TO ANY PARTICULAR FONT, STYLE, SIZE, OR COLOR.

FOR OPTICAL FIBER CABLES (U.S. CLS. 21, 23, 26, 36 AND 38).

KATHY DE JONGE, EXAMINING ATTORNEY

CLASS 9—(Continued).

SN 77-959,116. DEEP BLUE DISCOVERIES, INC., SANDWICH, MA. FILED 3-15-2010.



OWNER OF U.S. REG. NOS. 3,421,923 AND 3,421,973. NO CLAIM IS MADE TO THE EXCLUSIVE RIGHT TO USE "DISCOVERIES", APART FROM THE MARK AS SHOWN.

THE COLOR(S) BLUE, WHITE AND BLACK IS/ARE CLAIMED AS A FEATURE OF THE MARK.

THE MARK CONSISTS OF THE WORDS "DEEP BLUE DISCOVERIES" IN WHITE, A BLACK AND WHITE SCUBA DIVER SWIMMING THROUGH THE LETTER "D", AND A WHITE WAVE, ALL ON A BLUE BACKGROUND.

FOR EDUCATIONAL DVDS IN THE FIELDS OF MARINE EXPLORATION (U.S. CLS. 21, 23, 26, 36 AND 38).

FIRST USE 10-19-2006; IN COMMERCE 10-19-2006.
CHERYL CLAYTON, EXAMINING ATTORNEY

SN 77-959,426. SORLOX CORPORATION, IRVINE, CA. FILED 3-15-2010.

SORLOX

THE MARK CONSISTS OF STANDARD CHARACTERS WITHOUT CLAIM TO ANY PARTICULAR FONT, STYLE, SIZE, OR COLOR.

FOR SCIENTIFIC APPARATUS, NAMELY, APPARATUS FOR COMPRESSING PLASMA TO A HIGH ENERGY STATE (U.S. CLS. 21, 23, 26, 36 AND 38).

DOUGLAS LEE, EXAMINING ATTORNEY

CLASS 9—(Continued).

SN 77-959,754. NEWER TECHNOLOGY, INC., WOODSTOCK, IL. FILED 3-16-2010.

NUPAD

THE MARK CONSISTS OF STANDARD CHARACTERS WITHOUT CLAIM TO ANY PARTICULAR FONT, STYLE, SIZE, OR COLOR.

FOR ACCESSORIES FOR COMPUTER MOUSE USERS, NAMELY, MOUSE PADS (U.S. CLS. 21, 23, 26, 36 AND 38).

PAM WILLIS, EXAMINING ATTORNEY

SN 77-961,916. RAYTHEON COMPANY, WALTHAM, MA. FILED 3-18-2010.

TACLINK

THE MARK CONSISTS OF STANDARD CHARACTERS WITHOUT CLAIM TO ANY PARTICULAR FONT, STYLE, SIZE, OR COLOR.

FOR COMPUTER INTERFACE SYSTEMS, NAMELY, HARDWARE AND SOFTWARE FOR INTERFACING HOST COMPUTER WITH MILITARY OR TACTICAL COMMUNICATIONS EQUIPMENT (U.S. CLS. 21, 23, 26, 36 AND 38).

FIRST USE 8-11-1999; IN COMMERCE 8-11-1999.
KIM SAITO, EXAMINING ATTORNEY

SN 77-969,728. ENGINEERED VIGILANCE, LLC, SHARON, MA. FILED 3-26-2010.

HealthTablet

THE MARK CONSISTS OF STANDARD CHARACTERS WITHOUT CLAIM TO ANY PARTICULAR FONT, STYLE, SIZE, OR COLOR.

FOR COMPUTER HARDWARE AND SOFTWARE, FOR USE WITH MEDICAL PATIENT MONITORING EQUIPMENT, FOR RECEIVING, PROCESSING, TRANSMITTING AND DISPLAYING DATA; COMPUTER SOFTWARE AND HARDWARE FOR USE WITH MEDICAL MONITORING EQUIPMENT, FOR RECEIVING, PROCESSING, TRANSMITTING AND DISPLAYING DATA (U.S. CLS. 21, 23, 26, 36 AND 38).

PAUL E. FAHRENKOPF, EXAMINING ATTORNEY

CLASS 9—(Continued).

SN 77-969,732. EMC CORPORATION, HOPKINTON, MA. FILED 3-26-2010.

V-CX

THE MARK CONSISTS OF STANDARD CHARACTERS WITHOUT CLAIM TO ANY PARTICULAR FONT, STYLE, SIZE, OR COLOR.
 FOR COMPUTER HARDWARE; COMPUTER SOFTWARE FOR DATA STORAGE AND DATA MANAGEMENT (U.S. CLS. 21, 23, 26, 36 AND 38).
 H. M. FISHER, EXAMINING ATTORNEY

SN 77-969,746. ENGINEERED VIGILANCE, LLC, SHARON, MA. FILED 3-26-2010.

**The Future of Healthcare
 Is Just A Breath Away**

THE MARK CONSISTS OF STANDARD CHARACTERS WITHOUT CLAIM TO ANY PARTICULAR FONT, STYLE, SIZE, OR COLOR.
 FOR COMPUTER HARDWARE AND SOFTWARE, FOR USE WITH MEDICAL PATIENT MONITORING EQUIPMENT, FOR RECEIVING, PROCESSING, TRANSMITTING AND DISPLAYING DATA; COMPUTER SOFTWARE AND HARDWARE FOR USE WITH MEDICAL MONITORING EQUIPMENT, FOR RECEIVING, PROCESSING, TRANSMITTING AND DISPLAYING DATA (U.S. CLS. 21, 23, 26, 36 AND 38).
 PAUL E. FAHRENKOPF, EXAMINING ATTORNEY

SN 77-969,772. ENGINEERED VIGILANCE, LLC, SHARON, MA. FILED 3-26-2010.

**The Future Is Just A
 Breath Away**

THE MARK CONSISTS OF STANDARD CHARACTERS WITHOUT CLAIM TO ANY PARTICULAR FONT, STYLE, SIZE, OR COLOR.
 FOR COMPUTER HARDWARE AND SOFTWARE, FOR USE WITH MEDICAL PATIENT MONITORING EQUIPMENT, FOR RECEIVING, PROCESSING, TRANSMITTING AND DISPLAYING DATA; COMPUTER SOFTWARE AND HARDWARE FOR USE WITH MEDICAL MONITORING EQUIPMENT, FOR RECEIVING, PROCESSING, TRANSMITTING AND DISPLAYING DATA (U.S. CLS. 21, 23, 26, 36 AND 38).
 PAUL E. FAHRENKOPF, EXAMINING ATTORNEY

CLASS 9—(Continued).

SN 78-954,583. SLIDE, INC., SAN FRANCISCO, CA. FILED 8-17-2006.

SLIDE.COM

THE MARK CONSISTS OF STANDARD CHARACTERS WITHOUT CLAIM TO ANY PARTICULAR FONT, STYLE, SIZE, OR COLOR.
 OWNER OF U.S. REG. NOS. 3,169,728, 3,673,049 AND OTHERS.
 SEC. 2(F).
 FOR DOWNLOADABLE COMPUTER SOFTWARE AND COMPUTER SOFTWARE TO ENHANCE THE EXPERIENCE OF ONLINE BROWSING OF PRODUCTS AND SERVICES AND SHOPPING AND TO SEND, CREATE AND RECEIVE DIGITAL IMAGES, COMPUTER GRAPHICS, TEXT, METADATA, VIDEO AND PHOTOGRAPHS, AND HYPERLINKS AND HYPERLINKED FILES, TO AND FROM OTHER USERS AND INFORMATION STORES, VIA A COMPUTER AND COMMUNICATIONS NETWORK (U.S. CLS. 21, 23, 26, 36 AND 38).
 KRISTIN DAHLING, EXAMINING ATTORNEY

SN 79-054,063. AR VISUAL PTE LTD, SINGAPORE, FILED 5-8-2008.

comm

OWNER OF INTERNATIONAL REGISTRATION 0964914 DATED 5-8-2008, EXPIRES 5-8-2018.
 FOR AUDIO-VIDEO ACCESSORIES, NAMELY, ELECTRIC SWITCHES, POWER SWITCHES, ELECTRONIC SWITCHES FOR AUDIO AND VIDEO SIGNALS, VIDEO GRAPHICS CONTROLLERS, POWER CONTROLLERS, ELECTRICAL CONTROLLERS, MATRIX SWITCHERS FOR AUDIO AND VIDEO SIGNALS, SIGNAL SPLITTERS FOR ELECTRONIC APPARATUS; AUDIO AND VIDEO SELECTORS, NAMELY, ELECTRONIC SWITCHERS FOR AUDIO AND VIDEO SIGNALS; ALL THE AFOREMENTIONED GOODS BEING USED TO STREAM AUDIO-VIDEO DATA, AUDIO OR VIDEO DATA FROM A COMPUTER, DVD PLAYER, VIDEO CASSETTE RECORDER, OR A CASSETTE PLAYER TO A PROJECTOR (U.S. CLS. 21, 23, 26, 36 AND 38).
 CHRISTINE MARTIN, EXAMINING ATTORNEY

SN 79-055,780. KABUSHIKI KAISHA MIX STYLE, JAPAN, FILED 6-27-2008.

mix←style

OWNER OF INTERNATIONAL REGISTRATION 0969503 DATED 6-27-2008, EXPIRES 6-27-2018.
 THE MARK CONSISTS OF THE WORDING "MIX-STYLE" WITH THE RIGHT PORTION OF THE LETTER "X" AND THE HYPHEN FORMING A LEFT-POINTING ARROW.
 FOR HEADPHONES; EARPHONES (U.S. CLS. 21, 23, 26, 36 AND 38).
 LIEF MARTIN, EXAMINING ATTORNEY

CLASS 9—(Continued).

SN 79-063,968. HORIBA, LTD, KYOTO, JAPAN, FILED 8-21-2008.

I N M

THE MARK CONSISTS OF STANDARD CHARACTERS WITHOUT CLAIM TO ANY PARTICULAR FONT, STYLE, SIZE, OR COLOR.

OWNER OF INTERNATIONAL REGISTRATION 0989735 DATED 8-21-2008, EXPIRES 8-21-2018.

FOR PLANT MANAGEMENT AND INDUSTRIAL INSTRUMENTATION, NAMELY, ANALYTICAL INSTRUMENTS FOR ENVIRONMENTAL PURPOSES, COMBUSTION CONTROL, NITROGEN OXIDE REMOVAL EQUIPMENT CONTROL, NAMELY, EXHAUST GAS ANALYZERS FOR THE MONITORING OF COMBUSTION SOURCES; MEASURING OR MONITORING INSTRUMENTS AND APPARATUS, NAMELY, EXHAUST GAS ANALYZERS FOR ENVIRONMENTAL PURPOSES, ENVIRONMENTAL MONITORING, COMBUSTION CONTROL, NITROGEN OXIDE REMOVAL EQUIPMENT CONTROL; EXHAUST GAS ANALYZERS FOR USE IN ENERGY-CONSUMING INDUSTRIES, COMBUSTION FACILITIES, POWER PLANTS, GAS CO-GENERATION AND COGENERATION PLANTS; ANALYTICAL INSTRUMENTS FOR GAS IN A STACK, DUCT, FURNACE, NAMELY, EXHAUST GAS ANALYZERS FOR MEASURING NITROGEN OXIDE AND OXYGEN CONCENTRATIONS; CURRENT LIMIT TYPE ANALYZER, NAMELY, EXHAUST GAS ANALYZERS FOR THE MONITORING OF COMBUSTION SOURCES; ANALYTICAL INSTRUMENTS COMPRISING ZIRCONIA SENSORS, NAMELY, EXHAUST GAS ANALYZERS FOR MEASURING NITROGEN OXIDE AND OXYGEN CONCENTRATIONS; EXHAUST GAS ANALYZER COMPRISING ZIRCONIA SENSOR FOR USE IN ENERGY-CONSUMING INDUSTRIES, COMBUSTION FACILITIES, POWER PLANTS, GAS COGENERATION, CO-GENERATION PLANTS, STACKS, DUCTS, FURNACES; EXHAUST GAS ANALYZER COMPRISING A SAMPLING PIPE INSERTED DIRECTLY INTO A STACK, DUCT, FURNACE; SAMPLING PIPES FOR MEASURING OR MONITORING INSTRUMENTS OR APPARATUS, ELECTRICAL CONTROLLERS, SENSORS FOR SENSING NITROGEN OXIDE AND OXYGEN CONCENTRATIONS; METALLIC FILTERS, NAMELY, METALLIC FILTERS FOR MEASURING OR MONITORING INSTRUMENTS AND APPARATUS, SINTERED FILTERS, NAMELY, SINTERED FILTERS FOR MEASURING OR MONITORING INSTRUMENTS AND APPARATUS, DUST PROTECTIVE COVERS OF FILTER FOR MEASURING OR MONITORING INSTRUMENTS AND APPARATUS (U.S. CLS. 21, 23, 26, 36 AND 38).

SCOTT BIBB, EXAMINING ATTORNEY

CLASS 9—(Continued).

SN 79-066,291. SOCOMEC, BENFELD, FRANCE, FILED 9-2-2008.



OWNER OF INTERNATIONAL REGISTRATION 0996090 DATED 9-2-2008, EXPIRES 9-2-2018.

OWNER OF U.S. REG. NO. 2,104,834.

THE COLOR(S) BLUE AND YELLOW IS/ARE CLAIMED AS A FEATURE OF THE MARK.

THE MARK CONSISTS OF THE COLORS BLUE AND YELLOW WITH THE COLORS YELLOW AND BLUE APPEARING IN THE WAVY LINE DESIGN ELEMENT, TO THE RIGHT IS THE WORDING "SOCOMEC" IN BLUE.

FOR SCIENTIFIC, MEASURING, SIGNALING, CHECKING, SUPERVISING APPARATUS AND INSTRUMENTS, NAMELY, TESTING AND CONTROL DEVICES FOR ELECTRICAL ENERGY, NAMELY, AMMETERS, VOLTMETERS, FREQUENCY METERS, WATT METERS, OHMMETERS, AND COUNTING DEVICES FOR ELECTRICAL ENERGY, NAMELY, MONITORS OF ENERGY CONSUMPTION; MEASURING APPARATUS FOR ELECTRICAL ENERGY, APPARATUS, INSTRUMENTS AND EQUIPMENT FOR CONDUCTING, SWITCHING, TRANSFORMING, ACCUMULATING, REGULATING OR CONTROLLING ELECTRICITY, NAMELY, ELECTRICAL SWITCHES, ELECTRICAL DISCONNECTOR SWITCHES, ELECTRICAL FUSE SWITCHES, ISOLATORS, NAMELY, DISCONNECTOR SWITCHES, CIRCUIT BREAKERS, FUSES, FUSE CARRIERS, NAMELY, FUSE CLIPS AND PANEL-MOUNTED FUSE HOLDERS FOR USE WITH ELECTRONIC GLASS AND CERAMIC FUSES, DISCONNECTORS, NAMELY, ELECTRICAL PLUG DEVICES ENABLING CONNECTION AND DISCONNECTION OF POWER AND/OR CONTROL CABLES, CONTACT CIRCUIT BREAKERS AND REMOTE CONTROL SWITCHES, ELECTRICAL COMPONENTS IN THE NATURE OF ELECTRIC CONTACTORS, ELECTRIC CONNECTORS, ELECTRIC RELAYS, COMMUTATORS, CHARGER RECTIFIERS, ELECTRONIC OR ELECTRIC POWER RECTIFIERS AND VOLTAGE REGULATORS, CONVERTERS, FREQUENCY CONVERTERS, IN PARTICULAR FOR AERONAUTICS, CURRENT, VOLTAGE AND FREQUENCY CONVERTERS AND TRANSFORMERS, STATIC INVERTERS, ELECTRICAL AND ELECTRONIC INVERTERS, SENSORS, NAMELY, CURRENT, TENSION AND ELECTRICAL POWER SENSORS, ELECTRIC METERS, PANEL METERS, NAMELY, AN ELECTRONIC INSTRUMENT THAT DISPLAYS AN INPUT SIGNAL IN EITHER A DIGITAL OR ANALOG FORM, ELECTRIC HOUR METERS, HOUSINGS FOR ELECTRICAL EQUIPMENT, NAMELY, CABINETS, ELECTRICAL ENCLOSURES, CASES, CASINGS; CABLES AND CONNECTORS FOR ELECTRIC CABLES, BATTERIES, BATTERY CHARGERS, CONVERTERS WITH BATTERIES, ACCUMULATORS, ELECTRICAL CELLS, CELL COMPONENTS, NAMELY, BATTERY COMPONENTS, ELECTRICAL OUTLETS, ELECTRIC INSULATORS FOR CIRCUIT PROTECTION, NAMELY, ELECTRICALLY INSULATED HOUSINGS FOR ELECTRICAL APPARATUS MADE FROM SYNTHETIC PLASTIC MATERIAL AND LIGHTNING ARRESTER ELECTRIC INSULATORS, THERMAL REGULATION DEVICES, NAMELY, THERMOSTATS, CHARGE TRANSFER UNITS, NAMELY, POWER SUPPLY CHANGEOVER SWITCHES, INVERTERS, VOLTAGE REGULATORS, ACTIVE FILTERS, NAMELY, LOW PASS INDUCTOR FILTER USED IN HIGH POWER ELECTRICAL APPLICATIONS, REPHASING CAPACITORS, ANALYZER ELECTRICAL CONTROLLERS, ELECTRICAL PROGRAMMABLE CONTROLLERS TO SUPERVISE AND PROTECT CIRCUITS, PERSONS AND PROPERTY; INSTRUMENTS AND APPARATUS TO MEASURE ELECTRICAL QUANTITIES AND PARAMETERS, ELECTRICAL COMPUTER TERMINALS; ELECTRICAL CIRCUIT BOARDS AND ELECTRIC DISTRIBUTION CONSOLES FOR ELECTRONIC DISPLAY, AND FOR DISTRIBUTION OF ELECTRICITY, ELECTRIC BOARDS OF INTEGRATED CIRCUITS, ELECTRIC SWITCHBOARDS, ELECTRIC PANELS TO SWITCH, CONTROL AND CUT OFF ELECTRICITY, NAMELY, ELECTRICAL DISTRIBUTION SYSTEMS, NAMELY, POWER DISTRIBUTION PANELS, NAMELY, ELECTRICAL CABINETS, ELECTRICAL ENCLOSURES, CAS-

CLASS 9—(Continued).

INGS; ELECTRIC ENCLOSURES TO CONNECT, PROTECT AND CUT OFF ELECTRICITY, NAMELY, ASSEMBLY PROFILES AND PLATES; SUPPORTS FOR BOARDS, FOR PRINTED CIRCUITS AND FOR ELECTRONIC CIRCUIT CARDS, NAMELY, CIRCUIT-MOUNTING BRACKETS; POWER SUPPLIES, NAMELY, UNINTERRUPTIBLE STATIC ELECTRIC POWER SUPPLY CIRCUITS, REMOTE-CONTROLLED ELECTRICAL CIRCUITS; CIRCUIT TESTERS AND MONITORS FOR MONITORING ELECTRIC CURRENT AND ELECTRICAL SIGNALS, ELECTRIC INSULATION VOLTAGE MONITORS, DETECTORS AND INSULATORS, NAMELY, VOLTAGE DETECTOR AND ISOLATION CUT OFF ELECTRICITY, NAMELY, ELECTRICAL DISTRIBUTION SYSTEMS, NAMELY, POWER DISTRIBUTION PANELS, NAMELY, ELECTRICAL CABINETS, ELECTRICAL ENCLOSURES, CASINGS; ELECTRIC ENCLOSURES TO CONNECT, PROTECT AND CUT OFF ELECTRICITY, NAMELY, ASSEMBLY PROFILES AND PLATES; SUPPORTS FOR BOARDS, FOR PRINTED CIRCUITS AND FOR ELECTRONIC CIRCUIT CARDS, NAMELY, CIRCUIT-MOUNTING BRACKETS; POWER SUPPLIES, NAMELY, UNINTERRUPTIBLE STATIC ELECTRIC POWER SUPPLY CIRCUITS, REMOTE-CONTROLLED ELECTRICAL CIRCUITS; CIRCUIT TESTERS AND MONITORS FOR MONITORING ELECTRIC CURRENT AND ELECTRICAL SIGNALS, ELECTRIC INSULATION VOLTAGE MONITORS, DETECTORS AND INSULATORS, NAMELY, VOLTAGE DETECTOR AND ISOLATION DEVICES; PROTECTION DEVICES, NAMELY, FUSIBLE VOLTAGE PROTECTORS AND CIRCUITS FOR UNINTERRUPTIBLE STATIC ELECTRIC POWER SUPPLY, NAMELY, CHANGEOVER SWITCHES OF POWER SUPPLIES, WIRELESS RADIO TRANSMISSION DEVICES USING CARRIER CURRENT; ELECTRICAL SYSTEMS AND EQUIPMENT, NAMELY, ELECTRICAL DISTRIBUTION, AND CONTROL PROTECTION SYSTEMS AND EQUIPMENT, SYSTEMS FOR DISTRIBUTION, FOR CONNECTION AND CONNECTING ELECTRICAL CIRCUITS, NAMELY, DISTRIBUTION BLOCKS, SWITCHES, CHANGEOVER SWITCHES, MOTOR START-UP AND AUTOMATION SYSTEMS AND AUTOMATED EQUIPMENT, NAMELY, CONTROL UNITS FOR REGULATING START-UP ELECTRICAL MOTORS, COMPENSATION SYSTEM, NAMELY, CURRENT COMPENSATION DEVICES, NAMELY, UNINTERRUPTIBLE POWER SUPPLY (PS), CURRENT FILTERS, BATTERIES OF CAPACITORS; UNINTERRUPTIBLE POWER SUPPLY SYSTEMS, NAMELY, CHANGEOVER POWER SUPPLY SWITCHES; INFORMATION PROCESSING EQUIPMENT, NAMELY, MONITORING DEVICES AND COMPUTERS, COMPUTER PERIPHERAL DEVICES, COMPUTER NETWORKS, NAMELY, CABLES, MONITORS, SERVERS, MODEMS AND NETWORK CARDS, DATA GATHERING STATIONS, NAMELY, MONITORING DEVICES, PROGRAMMABLE LOGIC CONTROLLERS, CALCULATORS, DATA PROCESSING ACCESSORIES FOR CALCULATORS, NAMELY, PRINTERS, MEMORY MODULES, INTERFACE CIRCUITS, CALCULATOR SOFTWARE, ELECTRONIC AND ELECTRICAL COMPONENTS FOR COMPUTERS AND ELECTRICAL CONTROL DEVICES; MONITORING AND WARNING DEVICES, NAMELY, COMPUTERS, MICROCOMPUTERS, MICRO CALCULATORS, MICROORGANISERS AND MICROCONTROLLERS, THEIR PERIPHERAL DEVICES AND THEIR ELEMENTS, NAMELY, SCREENS, KEYBOARDS, PRINTERS, SCANNERS, DIGITAL DISPLAY TABLES, MEMORY CIRCUITS, GRAPHICS CARDS, SOUND CARDS, MOTHER BOARDS, MEMORY CARDS, TELECOMMUNICATION INTERFACE CARDS, POWER SUPPLY, CONNECTING AND TELECOMMUNICATION CABLES, PANELS OF INDUSTRIAL AUTOMATA, NAMELY, DIGITAL DISPLAY PANELS FOR AUTOMATES, COMPUTER PROGRAMS, NAMELY, SOFTWARE FOR THE TREATMENT OF ELECTRICAL DATA ISSUED FROM ELECTRICAL DEVICES FOR USE IN DATABASE MANAGEMENT, USE AS A SPREADSHEET, USE IN WORD PROCESSING, SOFTWARE PACKAGES FOR USE IN DATABASE MANAGEMENT, USE AS A SPREADSHEET, WORD PROCESSING, BLANK DATA AND MAGNETIC RECORDING CARRIERS, NAMELY, COMPUTER DISCS, FLOPPY COMPUTER DISCS, MAGNETIC COMPUTER TAPES, AUDIO CASSETTES, OPTICAL DISCS (U.S. CLS. 21, 23, 26, 36 AND 38).

SCOTT BIBB, EXAMINING ATTORNEY

CLASS 9—(Continued).

SN 79-067,670. BEIJING TIANYU; COMMUNICATION EQUIPMENT CO., LTD., BEIJING, CHINA, FILED 3-24-2009.



OWNER OF INTERNATIONAL REGISTRATION 0999824 DATED 3-24-2009, EXPIRES 3-24-2019.

THE NON-LATIN CHARACTERS IN THE MARK TRANSLITERATE TO "TIAN YU" AND THIS MEANS "THE VOICE OUTSIDE SPACE" OR "WORDS FROM HEAVEN" IN ENGLISH.

FOR MULTIMEDIA SOFTWARE RECORDED ON CD-ROM FEATURING GAMES AND ELECTRONIC BOOKS, RECORDED COMPUTER SOFTWARE FOR USE ON MOBILE PHONES AND ENCODING AND DECODING AUDIO AND VIDEO DATA, COMPUTER OPERATING SYSTEMS, PRINTERS FOR USE WITH COMPUTERS, SATELLITE NAVIGATIONAL APPARATUS, NAMELY, A GLOBAL POSITIONING SYSTEM, PORTABLE PHONES, SOUND RECORDING APPARATUS, CAMERAS FOR PHOTOGRAPHY, GALVANIC CELLS, BATTERY CHARGERS, CAMCORDERS, HEADPHONES (U.S. CLS. 21, 23, 26, 36 AND 38).

LINDA ORNDORFF, EXAMINING ATTORNEY

SN 79-068,907. OPM S.P.A., ITALY, FILED 3-24-2009.



PRIORITY DATE OF 11-4-2008 IS CLAIMED.

OWNER OF INTERNATIONAL REGISTRATION 1002948 DATED 3-24-2009, EXPIRES 3-24-2019.

THE MARK CONSISTS OF THE WORD "OPM" WRITTEN IN PARTICULAR FULL BLOCK LETTERS AND UNDERLINED; ON THE RIGHT OF THE SAID WORD THERE ARE THE WORDS "VALUE CELL" IN BLOCK LETTERS, THAT ARE INSIDE AN ALMOST RECTANGULAR SQUARE WITH ROUNDED CORNERS DOWN LEFT AND UP RIGHT; THE WORDS "VALUE" AND "CELL" ARE DIVIDED BY THE STYLIZED IMAGE OF A MACHINE TOOL.

FOR WEIGHING APPARATUS AND INSTRUMENTS; CALCULATING MACHINES; DATA PROCESSING EQUIPMENT AND COMPUTERS (U.S. CLS. 21, 23, 26, 36 AND 38).

MAYUR VAGHANI, EXAMINING ATTORNEY

CLASS 9—(Continued).

SN 79-069,003. ACTIWAVE AB, SWEDEN, FILED 12-17-2008.

actiwave

THE MARK CONSISTS OF STANDARD CHARACTERS WITHOUT CLAIM TO ANY PARTICULAR FONT, STYLE, SIZE, OR COLOR.

PRIORITY DATE OF 6-25-2008 IS CLAIMED.
OWNER OF INTERNATIONAL REGISTRATION 1003158 DATED 12-17-2008, EXPIRES 12-17-2018.

FOR APPARATUS FOR REPRODUCTION OF SOUND OR IMAGES, NAMELY, LOUDSPEAKERS, AUDIO AMPLIFIERS AND DIGITAL AUDIO PLAYERS (U.S. CLS. 21, 23, 26, 36 AND 38).

JAMES STEIN, EXAMINING ATTORNEY

SN 79-069,130. KRAUSS-MAFFEI WEGMANN GMBH & CO. KG, 80997 MÜNCHEN, FED REP GERMANY, FILED 3-26-2009.

MilCIG

PRIORITY DATE OF 9-30-2008 IS CLAIMED.
OWNER OF INTERNATIONAL REGISTRATION 1003506 DATED 3-26-2009, EXPIRES 3-26-2019.

THE MARK CONSISTS OF THE LITERAL ELEMENT "MILCIG" IN STYLIZED LETTERING.

THE WORDING "MILCIG" HAS NO MEANING IN A FOREIGN LANGUAGE.

FOR COMPUTER SIMULATION SOFTWARE FOR SIGHT SYSTEMS IN THE NATURE OF OBSERVATION DEVICES, DISPLAY DEVICES, NAMELY, LIQUID CRYSTAL DISPLAY PROJECTORS, MULTIMEDIA PROJECTORS, PICTURE PROJECTORS, VIDEO PROJECTORS, COMPUTER SCREENS, FLAT PANEL DISPLAY SCREENS, PROJECTION SCREENS, VIDEO SCREENS, COMPUTER MONITORS, VIDEO MONITORS FOR USE IN MILITARY VEHICLES, CORNER-REFLECTOR MIRRORS, PERISCOPES, TELESCOPES, SPYGLASSES; COMPUTER GRAPHICS SOFTWARE; COMPUTER GRAPHICS SOFTWARE FOR MAKING THREE-DIMENSIONAL MODELS OF OPEN LANDSCAPES AND URBAN STRUCTURES SUCH AS HOUSES, BUILDINGS, STREETS, CITIES, VEHICLES, WEAPONS; VIRTUAL REALITY SOFTWARE FOR GENERATING VIRTUAL FORCES, THREE-DIMENSIONAL MODELS OF OPEN LANDSCAPES AND URBAN STRUCTURES SUCH AS HOUSES, BUILDINGS, STREETS, CITIES, VEHICLES, WEAPONS; VIRTUAL REALITY SOFTWARE FOR BATTLE FIELD SIMULATION; APPARATUSES FOR IMAGE GENERATION AND IMAGE PRESENTATION, NAMELY, APPARATUSES FOR RECORDING, TRANSMISSION AND REPRODUCTION OF IMAGES, RASTER IMAGES PROCESSORS, PLAYING DEVICES FOR IMAGE CARRIERS, LIQUID CRYSTAL DISPLAY PROJECTORS, MULTIMEDIA PROJECTORS, PICTURE PROJECTORS, VIDEO PROJECTORS, COMPUTER SCREENS, FLAT PANEL DISPLAY SCREENS, PROJECTION SCREENS, VIDEO SCREENS, COMPUTER MONITORS, VIDEO MONITORS (U.S. CLS. 21, 23, 26, 36 AND 38).

RONALD DELGIZZI, EXAMINING ATTORNEY

CLASS 9—(Continued).

SN 79-070,487. CHARLES OWEN; AND COMPANY (BOW) LIMITED, RHOSTYLLEN, WREXHAM LL14 4BJ, UNITED KINGDOM, FILED 6-3-2009.

GRpx

THE MARK CONSISTS OF STANDARD CHARACTERS WITHOUT CLAIM TO ANY PARTICULAR FONT, STYLE, SIZE, OR COLOR.

PRIORITY DATE OF 12-5-2008 IS CLAIMED.
OWNER OF INTERNATIONAL REGISTRATION 1006683 DATED 6-3-2009, EXPIRES 6-3-2019.

FOR PROTECTIVE HELMETS FOR USE IN OR IN RELATION TO EQUESTRIANISM (U.S. CLS. 21, 23, 26, 36 AND 38).

KATHY DE JONGE, EXAMINING ATTORNEY

SN 79-070,737. BLACKMAGIC DESIGN PTY LTD, AUSTRALIA, FILED 6-12-2009.

Blackmagic UltraScope

THE MARK CONSISTS OF STANDARD CHARACTERS WITHOUT CLAIM TO ANY PARTICULAR FONT, STYLE, SIZE, OR COLOR.

PRIORITY DATE OF 4-15-2009 IS CLAIMED.
OWNER OF INTERNATIONAL REGISTRATION 1007248 DATED 6-12-2009, EXPIRES 6-12-2019.

FOR COMPUTER HARDWARE, NAMELY, VIDEO CAPTURE AND DISPLAY CARDS; COMPUTER SOFTWARE FOR THE ANALYSIS OF VIDEO AND AUDIO SIGNALS AND FOR USE IN CONJUNCTION WITH VIDEO CARDS IN THE BROADCAST, FEATURE FILM AND POST PRODUCTION INDUSTRIES; COMPUTER SOFTWARE FOR THE TRANSMISSION OF VIDEO AND IMAGES OVER COMPUTER NETWORKS INCLUDING GLOBAL COMPUTER NETWORKS AND THE WORLD WIDE WEB; AUDIO VISUAL EQUIPMENT, APPARATUS AND ACCESSORIES, NAMELY, ELECTRONIC TEST EQUIPMENT FOR THE ANALYSIS OF VIDEO AND AUDIO SIGNALS; COMPUTER SOFTWARE FOR AUDIO VISUAL APPLICATIONS, NAMELY, CONTROL AND PROCESSING SOFTWARE FOR AUDIO VISUAL APPLICATIONS THAT ANALYZE VIDEO AND AUDIO SIGNALS AND WAVEFORMS; NONE OF THE FOREGOING BEING OR FOR USE IN INTERACTIVE GAMES AND GAMING SYSTEMS OR IN INTERACTIVE INTERNET AND TELEVISION GAMES, INCLUDING ELECTRONIC GAMES AND GAMES FOR SLOT MACHINES (U.S. CLS. 21, 23, 26, 36 AND 38).

JULIE WATSON, EXAMINING ATTORNEY

CLASS 9—(Continued).

SN 79-070,738. BLACKMAGIC DESIGN PTY LTD, AUSTRALIA, FILED 6-12-2009.

UltraScope

THE MARK CONSISTS OF STANDARD CHARACTERS WITHOUT CLAIM TO ANY PARTICULAR FONT, STYLE, SIZE, OR COLOR.

PRIORITY DATE OF 4-15-2009 IS CLAIMED.

OWNER OF INTERNATIONAL REGISTRATION 1007249 DATED 6-12-2009, EXPIRES 6-12-2019.

FOR COMPUTER HARDWARE, NAMELY, VIDEO CAPTURE AND DISPLAY CARDS; COMPUTER SOFTWARE FOR THE ANALYSIS OF VIDEO AND AUDIO SIGNALS AND FOR USE IN CONJUNCTION WITH VIDEO CARDS IN THE BROADCAST, FEATURE FILM AND POST PRODUCTION INDUSTRIES; COMPUTER SOFTWARE FOR THE TRANSMISSION OF VIDEO AND IMAGES OVER COMPUTER NETWORKS INCLUDING GLOBAL COMPUTER NETWORKS AND THE WORLD WIDE WEB; AUDIO VISUAL EQUIPMENT, APPARATUS AND ACCESSORIES, NAMELY, ELECTRONIC TEST EQUIPMENT FOR THE ANALYSIS OF VIDEO AND AUDIO SIGNALS; COMPUTER SOFTWARE FOR AUDIO VISUAL APPLICATIONS, NAMELY, CONTROL AND PROCESSING SOFTWARE FOR AUDIO VISUAL APPLICATIONS THAT ANALYZE VIDEO AND AUDIO SIGNALS AND WAVEFORMS; NONE OF THE FOREGOING BEING OR FOR USE IN INTERACTIVE GAMES AND GAMING SYSTEMS OR IN INTERACTIVE INTERNET AND TELEVISION GAMES, INCLUDING ELECTRONIC GAMES AND GAMES FOR SLOT MACHINES (U.S. CLS. 21, 23, 26, 36 AND 38).

JULIE WATSON, EXAMINING ATTORNEY

SN 79-070,847. TASK GEOMODELLING LIMITED, BRIDGE OF DON, ABERDEEN AB23 8GX, UNITED KINGDOM, FILED 3-9-2009.



OWNER OF INTERNATIONAL REGISTRATION 1007520 DATED 3-9-2009, EXPIRES 3-9-2019.

THE COLOR(S) ORANGE, BLUE, RED, GRAY, BLACK, WHITE, AND PURPLE IS/ARE CLAIMED AS A FEATURE OF THE MARK.

THE MARK CONSISTS OF A KEY DESIGN WITH THE CIRCLE PART OF THE KEY IN ORANGE WITH VARIOUS LINES IN RED, BLUE, AND PURPLE, WITH A WHITE CIRCULAR GLARE AND GRAY SHADOW IN BOTTOM RIGHT CORNER; THE STEM OF THE KEY PROTRUDES TO THE LEFT FROM THE CIRCLE AND IS IN GRAY AND BLACK; AND THE WORD "ATTITUDE" IS IN RED WITH BLACK SHADOW OVER THE KEY DESIGN.

FOR GEOLOGICAL COMPUTER SOFTWARE FOR ANALYZING DATA FROM OIL-FIELD EXPLOITATION AND GEOLOGICAL PROSPECTING RESEARCH AND SURVEYS (U.S. CLS. 21, 23, 26, 36 AND 38).

MAYUR VAGHANI, EXAMINING ATTORNEY

CLASS 9—(Continued).

SN 79-073,089. FLYAUDIO CORPORATION (CHINA), CHINA, FILED 6-5-2009.



PRIORITY DATE OF 4-2-2009 IS CLAIMED.

OWNER OF INTERNATIONAL REGISTRATION 1013756 DATED 6-5-2009, EXPIRES 6-5-2019.

THE MARK CONSISTS OF THE STYLIZED WORDING FLY AUDIO WITH AN ARC DESIGN THROUGH THE WORDING AUDIO.

FOR REFLECTING DISCS, FOR WEAR, FOR THE PREVENTION OF TRAFFIC ACCIDENTS; ELECTRIC NAVIGATIONAL INSTRUMENTS; NAVIGATIONAL INSTRUMENTS FOR VEHICLES; MUSICAL JUKE BOXES; VEHICLE RADIOS; VIDEO RECORDERS; SPEED MEASURING APPARATUS, NAMELY, SPEEDOMETERS; ELECTRIC THEFT PREVENTION INSTALLATIONS, NOT FOR USE FOR VEHICLES; BATTERY CHARGERS; GALVANIC CELLS, NAMELY, GALVANIC BATTERIES (U.S. CLS. 21, 23, 26, 36 AND 38).

BERNICE MIDDLETON, EXAMINING ATTORNEY

SN 79-073,194. WENZEL VOLUMETRIK GMBH, FED REP GERMANY, FILED 7-22-2009.



PRIORITY DATE OF 1-23-2009 IS CLAIMED.

OWNER OF INTERNATIONAL REGISTRATION 1014148 DATED 7-22-2009, EXPIRES 7-22-2019.

NO CLAIM IS MADE TO THE EXCLUSIVE RIGHT TO USE "VOLUMETRIC", APART FROM THE MARK AS SHOWN.

THE COLOR(S) BLACK, AQUAMARINE AND TURQUOISE IS/ARE CLAIMED AS A FEATURE OF THE MARK.

THE MARK CONSISTS OF A HEXAGONAL DESIGN, WHERE THE INTERIOR OF THE HEXAGON CONSISTS OF RAYS CONNECTING FROM THE CENTER, WHERE THE TOP THIRD OF THE RAYS ARE IN THE COLOR AQUAMARINE, THE LOWER LEFT THIRD OF THE RAYS ARE IN THE COLOR TURQUOISE, AND THE LOWER RIGHT THIRD OF THE RAYS ARE IN THE COLOR BLACK; TO THE RIGHT OF THE HEXAGON IS THE WORD "VOLUMETRIK" IN THE COLOR BLACK.

FOR MEASURING AND TESTING APPARATUS, NAMELY, TECHNICAL MEASURING, TESTING AND CHECKING APPARATUS AND INSTRUMENTS FOR MEASURING, TESTING AND CHECKING THE TEMPERATURE, PRESSURE, QUANTITY AND CONCENTRATION OF GAS AND LIQUIDS, ELECTRONIC APPARATUS FOR ELECTROPHYSIOLOGICAL MEASUREMENT AND TESTING OF CELLS; MEASURING AND TESTING MACHINES AND INSTRUMENTS, NAMELY, ASTRONOMETRIC MEASURING MACHINES AND INSTRUMENTS, COORDINATE MEASURING MACHINES, INSTRUMENTS FOR DETECTING AND MEASURING TWO-DIMENSIONAL DISTRIBUTION OF FORCE AND PRESSURE, CONTROLLED VOLUME PUMPS, NON-MEDICAL CT TOMOGRAPHS; MEASURING AND TESTING SOFTWARE, NAMELY, COMPUTER SOFTWARE FOR MEASURING AND CALCULATING THE VOLUME AND DIMENSIONS OF TUMOR GROWTHS; COMPUTER SOFTWARE FOR OPERATING NON-MEDICAL CT TOMOGRAPHS FOR OBTAINING VOLUME AND DIMENSIONAL DATA (U.S. CLS. 21, 23, 26, 36 AND 38).

ADA HAN, EXAMINING ATTORNEY

CLASS 9—(Continued).

SN 79-073,254. ELECTRÓNICA INTEGRAL DE SONIDO, S.A., SPAIN, FILED 7-23-2009.



PRIORITY DATE OF 3-6-2009 IS CLAIMED.
OWNER OF INTERNATIONAL REGISTRATION 1014335
DATED 7-23-2009, EXPIRES 7-23-2019.

FOR ELECTRO-ACOUSTIC TRANSDUCERS, NAMELY, LOUDSPEAKERS, AMPLIFIERS, SOUND CONTROLLERS FOR VOLUME AND CHANNEL SELECTION, LOUDSPEAKER CABINETS, MICROPHONES, AND ACCESSORIES FOR THESE DEVICES, NAMELY, POWER SOURCES IN THE NATURE OF ELECTRICAL POWER SUPPLIES, MICROPHONE CONSOLES, PLASTIC COVERS AND ADJUSTABLE RINGS FOR LOUDSPEAKERS AND REGULATORS AND COVER PLATES AND CABLES, ALL FOR CONTROLLING AND DISTRIBUTING SOUND (U.S. CLS. 21, 23, 26, 36 AND 38).

HEATHER SAPP, EXAMINING ATTORNEY

SN 79-073,323. ENDRESS+HAUSER CONDUCTA GSELLSCHAFT; FÜR MESS- UND REGELTECHNIK MBH + CO. KG, FED REP GERMANY, FILED 5-27-2009.

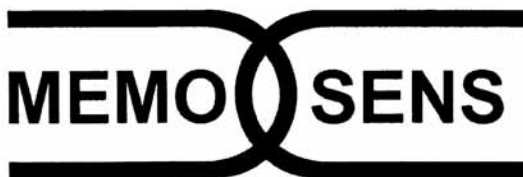

PRIORITY DATE OF 11-27-2008 IS CLAIMED.
OWNER OF INTERNATIONAL REGISTRATION 1014504
DATED 5-27-2009, EXPIRES 5-27-2019.

OWNER OF U.S. REG. NO. 3,038,939.

THE MARK CONSISTS OF THE WORDING "MEMO SENS" IN STYLIZED FONT INSIDE TWO INTERCONNECTING U SHAPED DESIGNS.

THE WORDING "MEMO SENS" HAS NO MEANING IN A FOREIGN LANGUAGE.

FOR ELECTRIC AMPEROMETRIC SENSORS FOR SENSING THE CONCENTRATION OF DISSOLVED GASSES IN FLUIDS; ELECTRIC AMPEROMETRIC TRANSMITTERS FOR SENSING THE CONCENTRATION OF DISSOLVED GASSES IN FLUIDS; ELECTRIC POTENTIOMETRIC SENSORS FOR SENSING PH OR OXIDATION-REDUCTION-POTENTIALS; ELECTRIC POTENTIOMETRIC TRANSMITTERS FOR SENSING PH OR OXIDATION-REDUCTION-POTENTIALS; ELECTRIC DIGITAL POTENTIOMETRIC SENSORS FOR SENSING FOR SENSING PH OR OXIDATION-REDUCTION-POTENTIALS AND ELECTRIC TRANSMITTERS; ELECTRIC DIGITAL SENSORS FOR SENSING PARAMETERS OF FLUIDS, NAMELY, PH, OXIDATION REDUCTION POTENTIAL, CARBON DIOXIDE CONTENTS TOTAL ORGANIC CONTENTS, TURBIDITY, OXYGEN CONTENT, CHLORINE CONTENT, ACETIC ACID CONTENT, NITRATE CONTENT, CONDUCTIVITY, BIOLOGICAL OXYGEN DEMAND, CHEMICAL OXYGEN DEMAND, TEMPERATURE, OR PRESSURE, COMPRISING A CONNECTOR PLUG WITH INDUCTIVE COUPLING FOR THE TRANSMISSION OF MEASURED DATA, NAMELY, THE MEASURED VALUE OF THE RESPECTIVE SENSED PARAMETER, FOR USE IN THE FIELDS OF INDUSTRIAL PROCESS AUTOMATION, WATER ANALYSIS, ENVIRONMENTAL ANALYSIS, WASTE WATER TREATMENT, BREWERIES, FOOD PROCESSING, CHEMICAL PROCESSING, PHARMACEUTICAL PROCESSING, AND PETROCHEMICAL

CLASS 9—(Continued).

PROCESSING, RESPECTIVELY; ELECTRONIC SEMI-CONDUCTOR MEMORY MODULES FOR STORING ELECTRIC SENSOR PARAMETERS, CALIBRATION DATA, AND DATA OF ELECTRONIC SIGNATURES; INTERCONNECTING ELECTRICAL CABLES; INTERCONNECTING ELECTRICAL CABLES FOR PROVIDING A GALVANICALLY ISOLATED CONNECTION BETWEEN SENSORS FOR MEASURING PH-VALUES AND OTHER ELECTROCHEMICAL POTENTIALS, ANALYZING DEVICES, NAMELY, MEASURING TRANSMITTERS FOR MEASURING PARAMETERS OF FLUIDS, NAMELY, PH, OXIDATION REDUCTION POTENTIAL, CARBON DIOXIDE CONTENTS TOTAL ORGANIC CONTENTS, TURBIDITY, OXYGEN CONTENT, CHLORINE CONTENT, ACETIC ACID CONTENT, NITRATE CONTENT, CONDUCTIVITY, BIOLOGICAL OXYGEN DEMAND, CHEMICAL OXYGEN DEMAND, TEMPERATURE, OR PRESSURE, COMPRISING A CONNECTOR PLUG WITH INDUCTIVE COUPLING FOR THE TRANSMISSION OF MEASURED DATA, NAMELY, THE MEASURED VALUE OF THE RESPECTIVE SENSED PARAMETER, FOR USE IN THE FIELDS OF INDUSTRIAL PROCESS AUTOMATION, WATER ANALYSIS, ENVIRONMENTAL ANALYSIS, WASTE WATER TREATMENT, BREWERIES, FOOD PROCESSING, CHEMICAL PROCESSING, PHARMACEUTICAL PROCESSING, AND PETROCHEMICAL PROCESSING, RESPECTIVELY, AND PERSONAL COMPUTERS; INTERCONNECTION COMPUTER CABLES FOR PROVIDING CONNECTION FOR DIGITIZED ANALOG SIGNALS (U.S. CLS. 21, 23, 26, 36 AND 38).

WILLIAM ROSSMAN, EXAMINING ATTORNEY

SN 79-073,886. HEALTHSTATS INTERNATIONAL PTE LTD, SINGAPORE, SINGAPORE, FILED 9-18-2009.



PRIORITY DATE OF 3-23-2009 IS CLAIMED.
OWNER OF INTERNATIONAL REGISTRATION 1015973
DATED 9-18-2009, EXPIRES 9-18-2019.

OWNER OF U.S. REG. NO. 3,117,361.

FOR APPLICATION SOFTWARE FOR ASSISTING IN THE EVALUATION AND DISPLAY OF BLOOD PRESSURE PULSE WAVES, AND FOR BLOOD PRESSURE MEASURING AND ANALYSIS; COMPUTER SOFTWARE FOR ASSISTING IN THE EVALUATION AND DISPLAY OF BLOOD PRESSURE PULSE WAVES (U.S. CLS. 21, 23, 26, 36 AND 38).

CHARISMA HAMPTON, EXAMINING ATTORNEY

CLASS 9—(Continued).

SN 79-073,913. DAVID WARR, MENTONE VIC 3194, AUSTRALIA, FILED 8-31-2009.



PRIORITY DATE OF 5-5-2009 IS CLAIMED.
OWNER OF INTERNATIONAL REGISTRATION 1016048
DATED 8-31-2009, EXPIRES 8-31-2019.

FOR COMPUTER HARDWARE AND COMPUTER SOFTWARE FOR FILTERING ONLINE GAMBLING SITES AND PRINTED INSTRUCTION MANUALS SOLD AS A UNIT IN CONNECTION THEREWITH (U.S. CLS. 21, 23, 26, 36 AND 38).
REGINA DRUMMOND, EXAMINING ATTORNEY

SN 79-074,623. DAVID WARR, AUSTRALIA, FILED 8-31-2009.



PRIORITY DATE OF 5-5-2009 IS CLAIMED.
OWNER OF INTERNATIONAL REGISTRATION 1018028
DATED 8-31-2009, EXPIRES 8-31-2019.

FOR COMPUTER HARDWARE AND COMPUTER SOFTWARE FOR FILTERING ONLINE GAMBLING SITES AND PRINTED INSTRUCTION MANUALS SOLD AS A UNIT IN CONNECTION THEREWITH (U.S. CLS. 21, 23, 26, 36 AND 38).
REGINA DRUMMOND, EXAMINING ATTORNEY

CLASS 9—(Continued).

SN 79-074,908. UVEX SPORTS GMBH & CO. KG, FED REP GERMANY, FILED 9-10-2009.

XENOVA

THE MARK CONSISTS OF STANDARD CHARACTERS WITHOUT CLAIM TO ANY PARTICULAR FONT, STYLE, SIZE, OR COLOR.

OWNER OF INTERNATIONAL REGISTRATION 1018718
DATED 9-10-2009, EXPIRES 9-10-2019.

THE WORDING "XENOVA" HAS NO MEANING IN A FOREIGN LANGUAGE.

FOR PROTECTIVE GOGGLES FOR MOTORCYCLISTS, SKI GOGGLES, SPORTS GOGGLES, SUNGLASSES, CYCLING GOGGLES, GOLFING GOGGLES, SHOOTING GOGGLES, EQUESTRIAN GOGGLES, DIVING GOGGLES, SWIMMING GOGGLES, READING GLASSES, PROTECTIVE GOGGLES FOR WORKERS LASER PROTECTION GLASSES, SPECTACLES, SPECTACLE FRAMES AND LENSES; SPECTACLE LENSES MADE OF PLASTIC; SPECTACLE CASES; LASER EQUIPMENT FOR NON-MEDICAL PURPOSES, NAMELY, LASER PROTECTION WINDOWS, LASER PROTECTION CURTAINS; PROTECTIVE HELMETS FOR WORKERS, FOR MOTORCYCLISTS, FOR CYCLISTS, FOR SKIERS, FOR SKI JUMPERS, FOR BOB-SLEDDERS, FOR SLEIGH RIDERS, FOR SKELETON RACERS, FOR ROLLERBLADERS, FOR INLINE SKATERS, FOR SNOWBOARDERS, FOR CANOEISTS, FOR HANG GLIDERS, FOR PARAGLIDERS; SPORTS HELMETS; ALPINE SPORTS HELMETS, EQUESTRIAN HELMETS; PROTECTIVE FACE SCREENS FOR WORKERS, PROTECTIVE SHIELDS FOR WORKERS, IN PAD/RULER PROTECTIVE SHIELDS FOR WELDERS; SAFETY FOOTWEAR, NAMELY, PROTECTIVE INDUSTRIAL SHOES, PROTECTIVE INDUSTRIAL BOOTS SHOES FOR PROTECTION AGAINST ACCIDENTS; SAFETY CLOTHING FOR WORKERS, NAMELY, PROTECTIVE CLOTHING; PROTECTIVE LASER TEXTILES, NAMELY, CLOTHING FOR PROTECTION AGAINST RADIATION, PROTECTIVE GLOVES FOR INDUSTRIAL USE; RESPIRATORS, NOT FOR ARTIFICIAL RESPIRATION, IN PARTICULAR RESPIRATOR MASKS AND DEVICES FOR WORKERS, PROTECTIVE EAR COVERINGS, EAR PLUGS, BANDED HEARING PROTECTION FOR WORKERS, NAMELY, HEARING PROTECTION HEADSETS NOT FOR MEDICAL USE; FALL PROTECTION SYSTEMS FOR WORKERS, NAMELY, PROTECTIVE NETS, PROTECTIVE TARPULINS, SAFETY SIGNALING LCD PANELS, SAFETY DISPLAY PANELS, SAFETY HARNESSES OTHER THAN FOR VEHICLES OR SPORTS PURPOSES, HARNESSES OTHER THAN FOR VEHICLES OR SPORTS PURPOSES INCORPORATED IN INDUSTRIAL SAFETY CLOTHING, SAFETY LANYARDS, ELASTIC SHOCK ABSORBING LANYARDS, FALL PROTECTION EQUIPMENT FOR FALL RESTRAINT AND FALL ARREST, NAMELY, ROPE LIFELINES, SAFETY ROPES; PARTS OF THE AFOREMENTIONED GOODS (U.S. CLS. 21, 23, 26, 36 AND 38).
GINA HAYES, EXAMINING ATTORNEY

CLASS 9—(Continued).

SN 79-075,546. NOKIA CORPORATION, FINLAND, FILED 10-13-2009.

XSERIES

THE MARK CONSISTS OF STANDARD CHARACTERS WITHOUT CLAIM TO ANY PARTICULAR FONT, STYLE, SIZE, OR COLOR.

PRIORITY DATE OF 4-15-2009 IS CLAIMED.

OWNER OF INTERNATIONAL REGISTRATION 1019960 DATED 10-13-2009, EXPIRES 10-13-2019.

FOR MOBILE TELEPHONES; ACCESSORIES AND REPLACEMENT PARTS FOR MOBILE TELEPHONES, NAMELY, BATTERIES, BATTERY CHARGERS, DATA CABLES, HEADPHONES, INSTRUCTIONAL DVDS CONTAINING INFORMATION ABOUT HOW TO USE THE MOBILE TELEPHONE, MEMORY CARDS AND USER GUIDES SOLD AS A UNIT WITH MOBILE TELEPHONES (U.S. CLS. 21, 23, 26, 36 AND 38).

REBECCA POVARCHUK, EXAMINING ATTORNEY

SN 85-002,596. INNOVATION IN LEARNING INC., LOS ALTOS HILLS, CA. FILED 3-31-2010.

DynaPatient

THE MARK CONSISTS OF STANDARD CHARACTERS WITHOUT CLAIM TO ANY PARTICULAR FONT, STYLE, SIZE, OR COLOR.

FOR VIRTUAL REALITY SOFTWARE FOR TRAINING HEALTHCARE PROFESSIONALS BY SIMULATING VIRTUAL HEALTHCARE PATIENTS (U.S. CLS. 21, 23, 26, 36 AND 38).

JASON BLAIR, EXAMINING ATTORNEY

SN 85-003,255. GOLDSTEIN, IRA, RALEIGH, NC. AND GOLDSTEIN, DAVID, RALEIGH, NC. FILED 3-31-2010.



THE COLOR(S) PURPLE, BLUE, WHITE, BLACK, GREEN, RED, YELLOW, AND SILVER IS/ARE CLAIMED AS A FEATURE OF THE MARK.

THE MARK CONSISTS OF THE WORDING "THE WORLD OF ART" IN THE COLORS PURPLE AND BLUE WITH A WHITE OUTLINE PLACED ABOVE THE WORDING "YOUR PLACE TO LEARN, SHARE & ENJOY ART" IN THE COLOR WHITE. THE WORDING IS PLACED ON A BLACK BACKGROUND WITH AN ARTIST'S PALETTE WITH A MAP OF THE WORLD THEREON IN THE COLORS BLUE AND GREEN AND A BLACK OUTLINE. THREE PAINTBRUSHES IN THE COLORS RED, BLUE, YELLOW, SILVER AND BLACK PROTRUDE FROM THE RIGHT SIDE OF THE PALETTE.

FOR DIGITAL MEDIA, NAMELY, DVDS FEATURING FINE ART INSTRUCTION (U.S. CLS. 21, 23, 26, 36 AND 38).

FIRST USE 12-1-2008; IN COMMERCE 12-1-2008.

LESLIE RICHARDS, EXAMINING ATTORNEY

CLASS 9—(Continued).

SN 85-003,390. SIGNATURE GENOMIC LABORATORIES, LLC, SPOKANE, WA. FILED 3-31-2010.

TURNING COMPLEXITY INTO MEANING

THE MARK CONSISTS OF STANDARD CHARACTERS WITHOUT CLAIM TO ANY PARTICULAR FONT, STYLE, SIZE, OR COLOR.

FOR COMPUTER SOFTWARE FOR SCIENTIFIC ANALYSIS OF GENETIC SEQUENCES; COMPUTER SOFTWARE FOR MEDICAL SERVICES, NAMELY, MEDICAL DIAGNOSTIC SOFTWARE AND MEDICAL TESTING SOFTWARE; COMPUTER SOFTWARE FOR CONTROLLING AND MANAGING PATIENT MEDICAL INFORMATION; DOWNLOADABLE SCIENTIFIC AND MEDICAL DATA VIA THE INTERNET; GLASS SLIDES OR CHIPS HAVING MULTI-WELL ARRAYS THAT CAN BE USED IN CHEMICAL ANALYSIS, BIOLOGICAL ANALYSIS OR PATTERNING FOR SCIENTIFIC, LABORATORY OR MEDICAL RESEARCH USE (U.S. CLS. 21, 23, 26, 36 AND 38).

DAVID YONTEF, EXAMINING ATTORNEY

SN 85-003,554. RAYSPAN CORPORATION, SAN DIEGO, CA. FILED 3-31-2010.

Metarray.n

THE MARK CONSISTS OF STANDARD CHARACTERS WITHOUT CLAIM TO ANY PARTICULAR FONT, STYLE, SIZE, OR COLOR.

OWNER OF U.S. REG. NOS. 3,591,800, 3,759,025 AND 3,782,748.

FOR AMPLIFIER FOR WIRELESS COMMUNICATIONS; ANTENNA PARAMETER MEASURING APPARATUS; ANTENNAE FILTERS; ANTENNAS; ANTENNAS FOR RADIO, FOR TELEVISION; CAR ANTENNAE; COMPUTER SOFTWARE FOR WIRELESS CONTENT DELIVERY; ELECTRONIC COMPONENTS, NAMELY, PIEZOELECTRIC SWITCHES; INTEGRATED CIRCUITS AND INTEGRATED CIRCUIT CORES FOR USE IN WIRELESS COMMUNICATIONS AND WIRELESS COMMUNICATION EQUIPMENT AND APPARATUS AND DIGITAL SIGNAL PROCESSORS (DSP); MICROWAVE ANTENNAE; MOBILE COMPUTING AND OPERATING PLATFORMS CONSISTING OF DATA TRANSCEIVERS, WIRELESS NETWORKS AND GATEWAYS FOR COLLECTION AND MANAGEMENT OF DATA; PARABOLIC ANTENNAE; RECONFIGURABLE PROCESSORS FOR USE IN WIRELESS COMMUNICATION HANDSETS AND NETWORK EQUIPMENT IN THE FIELD OF WIDEBAND COMMUNICATIONS; TELEMATICS APPARATUS, NAMELY, WIRELESS IN-

CLASS 9—(Continued).

TERNET DEVICES WHICH PROVIDE TELEMATIC SERVICES AND HAVE A CELLULAR PHONE FUNCTION; TELEVISION ANTENNAS; WIRELESS COMMUNICATION DEVICE FEATURING VOICE, DATA AND IMAGE TRANSMISSION INCLUDING VOICE, TEXT AND PICTURE MESSAGING, A VIDEO AND STILL IMAGE CAMERA, ALSO FUNCTIONAL TO PURCHASE MUSIC, GAMES, VIDEO AND SOFTWARE APPLICATIONS OVER THE AIR FOR DOWNLOADING TO THE DEVICE; WIRELESS COMPUTER PERIPHERALS; WIRELESS CONTROLLER TO MONITOR AND CONTROL THE FUNCTIONING OF OTHER ELECTRONIC DEVICES; WIRELESS NARROWBAND RADIOS; WIRELESS POS (POINT OF SERVICE) DEVICES; WIRELESS REMOTE TEMPERATURE AND HUMIDITY MONITORS FOR BUILDING MAINTENANCE; WIRELESS TRANSCIEVERS WITH COLLECTION AND DISPLAY TECHNOLOGY FOR THE STATUS AND TRACKING OF RETAIL GOODS FROM THE BACKDOOR TO THE SHELF; WIRELESS VISITOR SIGNAL CHIMES (U.S. CLS. 21, 23, 26, 36 AND 38).

FRED MANDIR, EXAMINING ATTORNEY

CLASS 9—(Continued).

SN 85-010,990. QUALCOMM INCORPORATED, SAN DIEGO, CA. FILED 4-9-2010.



THE MARK CONSISTS OF A STYLIZED MAN DESIGN, FOR COMPUTER SOFTWARE, NAMELY, COMPUTER SOFTWARE DEVELOPMENT TOOLS; COMPUTER SOFTWARE USED TO FACILITATE INTERFACES BETWEEN COMPUTER SOFTWARE AND/OR COMPUTER HARDWARE USED IN WIRELESS COMMUNICATION DEVICES, OR WITHIN MIXED NETWORKS EMPLOYING WIRELESS AND NON-WIRELESS COMMUNICATION DEVICES; COMPUTER SOFTWARE APPLICATIONS FOR CERTIFYING THAT OTHER COMPUTER SOFTWARE APPLICATIONS MEET CERTAIN STANDARDS; COMPUTER SOFTWARE USED TO INTERPRET INFORMATION, AND TO INTEGRATE, INTERPRET AND ORGANIZE DATA BETWEEN DIFFERENT WIRELESS AND/OR NON-WIRELESS DEVICES AND COMPUTER SOFTWARE APPLICATIONS; COMPUTER SOFTWARE FOR DEVELOPING AND MANAGING DISTRIBUTED APPLICATION COMPUTER SOFTWARE IN A WIRELESS OR MIXED NETWORK EMPLOYING WIRELESS AND NON-WIRELESS COMMUNICATION INTERFACES; COMPUTER SOFTWARE FOR USE IN ADVERTISING AND MARKETING, NAMELY, PROMOTING THE GOODS AND SERVICES OF OTHERS; COMPUTER SOFTWARE FOR DISSEMINATION OF ADVERTISING FOR OTHERS VIA AN ON-LINE COMMUNICATIONS NETWORK ON THE INTERNET; COMPUTER SOFTWARE FOR MARKETING, ADVERTISING AND PROMOTING THE RETAIL GOODS AND SERVICES OF OTHERS TO WIRELESS COMMUNICATION DEVICES AND/OR COMPUTERS; COMPUTER SOFTWARE FOR SHOPPING GOODS AND SERVICES OF OTHERS USED IN WIRELESS COMMUNICATION DEVICES AND/OR COMPUTERS, NON-WIRELESS COMMUNICATION DEVICES AND/OR COMPUTERS, OR MIXED NETWORKS EMPLOYING WIRELESS AND NON-WIRELESS COMMUNICATION DEVICES AND/OR COMPUTERS; COMPUTER SOFTWARE FOR SHOPPING RETAIL GOODS AND SERVICES OF OTHERS USED IN WIRELESS COMMUNICATION DEVICES AND/OR COMPUTERS, NON-WIRELESS COMMUNICATION DEVICES AND/OR COMPUTERS, OR MIXED NETWORKS EMPLOYING WIRELESS AND NON-WIRELESS COMMUNICATION DEVICES AND/OR COMPUTERS; COMPUTER SOFTWARE FOR COMMUNICATIONS BETWEEN MEMBERS OF AN ON-LINE COMMUNITY (U.S. CLS. 21, 23, 26, 36 AND 38).

BRIDGETT SMITH, EXAMINING ATTORNEY

SN 85-003,889. ALLSTATE INSURANCE COMPANY, NORTHBROOK, IL. FILED 4-1-2010.

CARMOR VEHICLE CARE CENTER

THE MARK CONSISTS OF STANDARD CHARACTERS WITHOUT CLAIM TO ANY PARTICULAR FONT, STYLE, SIZE, OR COLOR.

OWNER OF U.S. REG. NOS. 3,713,383 AND 3,729,968.

NO CLAIM IS MADE TO THE EXCLUSIVE RIGHT TO USE "VEHICLE CARE CENTER", APART FROM THE MARK AS SHOWN.

FOR COMPUTER SOFTWARE FOR USE ON DEVICES WITH INTERNET ACCESSIBILITY, NAMELY, PROVIDING VEHICLE MAINTENANCE INFORMATION (U.S. CLS. 21, 23, 26, 36 AND 38).

MICHAEL SOUDERS, EXAMINING ATTORNEY

CLASS 10—MEDICAL APPARATUS

SN 76-698,418. BIOMEDTRIX, INC., BOONTON, NJ. FILED 7-15-2009.

I-LOC

THE MARK CONSISTS OF STANDARD CHARACTERS WITHOUT CLAIM TO ANY PARTICULAR FONT, STYLE, SIZE, OR COLOR.

FOR MEDICAL AND SURGICAL APPARATUS AND INSTRUMENTS, NAMELY, DEVICES USED IN ORTHOPEDIC SURGERY TO POSITION SURGICAL INSTRUMENTS, IMPLANTS AND/OR PATIENTS' LIMBS, NAMELY, INTERLOCKING NAIL HAVING A SELF-TAPING, TAPERED LOCKING DESIGN FOR SURGICAL IMPLANTATION DEVICES (U.S. CLS. 26, 39 AND 44).

MARLENE BELL, EXAMINING ATTORNEY

SN 76-698,419. BIOMEDTRIX, INC., BOONTON, NJ. FILED 7-15-2009.

ILOC

THE MARK CONSISTS OF STANDARD CHARACTERS WITHOUT CLAIM TO ANY PARTICULAR FONT, STYLE, SIZE, OR COLOR.

FOR MEDICAL AND SURGICAL APPARATUS AND INSTRUMENTS, NAMELY, DEVICES USED IN ORTHOPEDIC SURGERY TO POSITION SURGICAL INSTRUMENTS, IMPLANTS AND/OR PATIENTS' LIMBS, NAMELY, INTERLOCKING NAIL HAVING A SELF-TAPING, TAPERED LOCKING DESIGN FOR SURGICAL IMPLANTATION DEVICES (U.S. CLS. 26, 39 AND 44).

MARLENE BELL, EXAMINING ATTORNEY

SN 76-698,420. BIOMEDTRIX, INC., BOONTON, NJ. FILED 7-15-2009.

I-Loc

FOR MEDICAL AND SURGICAL APPARATUS AND INSTRUMENTS, NAMELY, DEVICES USED IN ORTHOPEDIC SURGERY TO POSITION SURGICAL INSTRUMENTS, IMPLANTS AND/OR PATIENTS' LIMBS, NAMELY, INTERLOCKING NAIL HAVING A SELF-TAPING, TAPERED LOCKING DESIGN FOR SURGICAL IMPLANTATION DEVICES (U.S. CLS. 26, 39 AND 44).

MARLENE BELL, EXAMINING ATTORNEY

CLASS 10—(Continued).

SN 77-548,586. PYNG MEDICAL CORP., RICHMOND, B.C., CANADA, FILED 8-15-2008.

FASTx

THE MARK CONSISTS OF STANDARD CHARACTERS WITHOUT CLAIM TO ANY PARTICULAR FONT, STYLE, SIZE, OR COLOR.

PRIORITY CLAIMED UNDER SEC. 44(D) ON CANADA APPLICATION NO. 1403620, FILED 7-14-2008, REG. NO. TMA765628, DATED 5-3-2010, EXPIRES 5-3-2025.

OWNER OF U.S. REG. NO. 2,120,144.

FOR VASCULAR ACCESS DEVICE FOR THE INFUSION OF DRUGS AND FLUIDS INTO THE BLOODSTREAM BY INJECTION INTO THE BONE MARROW, NAMELY, AN INTRODUCER, AN INFUSION TUBE, A TARGET/STRAIN RELIEF PATCH AND PROTECTOR DOME (U.S. CLS. 26, 39 AND 44).

MICHELE SWAIN, EXAMINING ATTORNEY

SN 77-552,501. SPINAL ELEMENTS, INC., CARLSBAD, CA. FILED 8-21-2008.

MAGNUM+

THE MARK CONSISTS OF STANDARD CHARACTERS WITHOUT CLAIM TO ANY PARTICULAR FONT, STYLE, SIZE, OR COLOR.

FOR MEDICAL DEVICES, NAMELY, VERTEBRAL BODY REPLACEMENTS, SPINAL PROSTHETICS, SPINAL FUSION IMPLANTS OF ARTIFICIAL MATERIALS, POLYMER ORTHOPEDIC IMPLANTS FOR SPINE SURGERY, SPINAL INTERBODY DEVICES, SURGICAL INSTRUMENTS FOR SPINE SURGERY, AND SPECIFICALLY EXCLUDING SUTURE ANCHORS AND BONE ANCHORS FOR USE IN ORTHOPEDIC PROCEDURES INVOLVING THE RE-ATTACHMENT OF SOFT TISSUE TO BONE (U.S. CLS. 26, 39 AND 44).

ALLISON HOLTZ, EXAMINING ATTORNEY

SN 77-578,064. NOVOSTENT CORPORATION, MOUNTAIN VIEW, CA. FILED 9-24-2008.

SAMBA

THE MARK CONSISTS OF STANDARD CHARACTERS WITHOUT CLAIM TO ANY PARTICULAR FONT, STYLE, SIZE, OR COLOR.

FOR VASCULAR PROSTHESES AND VASCULAR PROSTHESES DELIVERY SYSTEMS CONSISTING PRIMARILY OF STENTS, BALLOONS, GUIDE WIRES AND CATHETERS (U.S. CLS. 26, 39 AND 44).

RAUL CORDOVA, EXAMINING ATTORNEY

CLASS 10—(Continued).

SN 77-605,136. ANTHOGRYR, SALLANCHES, FRANCE, FILED 10-31-2008.

AXIOM

THE MARK CONSISTS OF STANDARD CHARACTERS WITHOUT CLAIM TO ANY PARTICULAR FONT, STYLE, SIZE, OR COLOR.

PRIORITY CLAIMED UNDER SEC. 44(D) ON ERPN CMNTY TM OFC APPLICATION NO. 007359508, FILED 10-30-2008.

OWNER OF ERPN CMNTY TM OFC REG. NO. 007359508, DATED 8-6-2009, EXPIRES 10-30-2018.

FOR MEDICAL, DENTAL AND VETERINARY APPARATUS AND INSTRUMENTS FOR USE IN DENTAL SURGERY; ORTHOPEDIC ARTICLES, NAMELY, ARTICLES FOR DENTAL AND FACIAL SURGERY; ARTIFICIAL TEETH; DENTAL IMPLANTS (U.S. CLS. 26, 39 AND 44).

MARGERY A. TIERNEY, EXAMINING ATTORNEY

SN 77-663,243. PACIFIC DIRECT, LLC, MADISON, WI. FILED 2-4-2009.

SCHWINN

THE MARK CONSISTS OF STANDARD CHARACTERS WITHOUT CLAIM TO ANY PARTICULAR FONT, STYLE, SIZE, OR COLOR.

OWNER OF U.S. REG. NOS. 1,909,799, 1,909,911 AND 1,910,207.

SEC. 2(F).

FOR PORTABLE HEART MONITORS (U.S. CLS. 26, 39 AND 44).

THOMAS MANOR, EXAMINING ATTORNEY

SN 77-698,964. C. R. BARD, INC., MURRAY HILL, NJ. FILED 3-25-2009.

RADIA

THE MARK CONSISTS OF STANDARD CHARACTERS WITHOUT CLAIM TO ANY PARTICULAR FONT, STYLE, SIZE, OR COLOR.

OWNER OF U.S. REG. NO. 1,633,098.

THE ENGLISH TRANSLATION OF "RADIA" IN THE MARK IS RADIATES.

FOR MEDICAL DEVICES AND APPARATUS, NAMELY, STEERABLE DIAGNOSTIC CATHETER AND PARTS AND FITTINGS THEREFOR, SPECIFICALLY EXCLUDING THE RADIOLOGICAL FIELD (U.S. CLS. 26, 39 AND 44).

GRETCHEN ULRICH, EXAMINING ATTORNEY

CLASS 10—(Continued).

SN 77-725,921. GAMBRO LUNDIA AB, SE-220 10 LUND, SWEDEN, FILED 4-30-2009.

PORACTON

THE MARK CONSISTS OF STANDARD CHARACTERS WITHOUT CLAIM TO ANY PARTICULAR FONT, STYLE, SIZE, OR COLOR.

PRIORITY CLAIMED UNDER SEC. 44(D) ON ERPN CMNTY TM OFC APPLICATION NO. 007480437, FILED 12-11-2008, REG. NO. 007480437, DATED 1-31-2010, EXPIRES 12-11-2018.

FOR MEDICAL APPARATUSES AND INSTRUMENTS FOR EXTRACORPOREAL BLOOD TREATMENT; MEDICAL APPARATUSES AND INSTRUMENTS FOR THE TREATMENT OF KIDNEY FAILURE; MEDICAL APPARATUSES AND INSTRUMENTS FOR THE PREPARATION FOR MEDICAL USE OF HEMODIALYSIS LIQUIDS AND SUBSTITUTION LIQUIDS FOR HEMOFILTRATION AND HEMODIAFILTRATION; HEMODIALYSIS MACHINES; HEMOFILTRATION MACHINES; HEMODIAFILTRATION MACHINES; HEMODIALYZERS; HEMOFILTERS; FILTERS FOR HEMODIALYSIS LIQUID; FILTERS FOR SUBSTITUTION LIQUID FOR HEMOFILTRATION AND HEMODIAFILTRATION; FILTER AND SEPARATION COMPONENTS FOR MEDICAL EQUIPMENT, NAMELY, MEMBRANES FOR HEMODIALYZERS, MEMBRANES FOR HEMOFILTERS, MEMBRANES FOR FILTERS FOR HEMODIALYSIS LIQUID, AND MEMBRANES FOR FILTERS FOR HEMODIALYSIS LIQUIDS AND SUBSTITUTION LIQUIDS FOR HEMOFILTRATION AND HEMODIAFILTRATION (U.S. CLS. 26, 39 AND 44).

MICHELLE DUBOIS, EXAMINING ATTORNEY

SN 77-768,893. WARSAW ORTHOPEDIC, INC., WARSAW, IN. FILED 6-26-2009.

AFFINITY

THE MARK CONSISTS OF STANDARD CHARACTERS WITHOUT CLAIM TO ANY PARTICULAR FONT, STYLE, SIZE, OR COLOR.

FOR INTERBODY FUSION SPINAL SYSTEM COMPRISED PRIMARILY OF THREADED HOLLOW TAPERED-ROOT CAGES AND IMPLANT APPLICATION TOOLS AND INSTRUMENTS AND COMPONENT PARTS THEREFOR FOR USE IN SPINAL IMPLANT PROCEDURES (U.S. CLS. 26, 39 AND 44).

FIRST USE 3-30-1999; IN COMMERCE 3-30-1999.

JOHN SCHUYLER YARD, EXAMINING ATTORNEY

CLASS 10—(Continued).

SN 77-790,481. RESONANT MEDICAL INC., MONTREAL, CANADA, FILED 7-27-2009.

CLARITY

THE MARK CONSISTS OF STANDARD CHARACTERS WITHOUT CLAIM TO ANY PARTICULAR FONT, STYLE, SIZE, OR COLOR.

FOR MEDICAL IMAGING COMPUTER SYSTEMS COMPRISING ONE OR MORE IMAGING APPARATUS AND DATA PROCESSORS FOR USE IN DIRECT ASSOCIATION WITH MEDICAL APPARATUS FOR CANCER THERAPY FOR TREATMENT PLANNING, DELIVERY, GUIDANCE AND MONITORING THROUGH ANATOMY VISUALIZATION AND PATIENT POSITIONING, AND THE GENERATION, FUSION AND ANALYSIS OF CORRESPONDING DATA (U.S. CLS. 26, 39 AND 44).

FIRST USE 9-30-2007; IN COMMERCE 3-31-2008.
PATRICIA EVANKO, EXAMINING ATTORNEY

SN 77-794,772. INNERSPACE MEDICAL, INC., TUSTIN, CA. FILED 7-31-2009.

AIRPULSE

THE MARK CONSISTS OF STANDARD CHARACTERS WITHOUT CLAIM TO ANY PARTICULAR FONT, STYLE, SIZE, OR COLOR.

FOR MEDICAL DEVICES FOR MEASURING PRESSURE IN PATIENTS, NAMELY, CENTRAL VENOUS PRESSURE, ARTERIAL BLOOD PRESSURE, INTRAUTERINE PRESSURE, ESOPHAGEAL PRESSURE, PRESSURE RELATED TO THE DIAGNOSIS OF INCONTINENCE, AND PRESSURE RELATED TO THE DIAGNOSIS OF AN ENLARGED PROSTATE GLAND (U.S. CLS. 26, 39 AND 44).

DAVID TAYLOR, EXAMINING ATTORNEY

SN 77-796,707. LANG DENTAL MANUFACTURING CO., INC., WHEELING, IL. FILED 8-4-2009.

AQUAPRES

THE MARK CONSISTS OF STANDARD CHARACTERS WITHOUT CLAIM TO ANY PARTICULAR FONT, STYLE, SIZE, OR COLOR.

FOR DENTAL EQUIPMENT, NAMELY, HIGH CAPACITY HYDRAULIC PRESSURE CURING UNITS DESIGNED FOR USE WITH SELF-CURING ACRYLIC RESINS (U.S. CLS. 26, 39 AND 44).

FIRST USE 1-0-1981; IN COMMERCE 1-0-1981.

KATHLEEN LORENZO, EXAMINING ATTORNEY

CLASS 10—(Continued).

SN 77-804,909. ADVANCED IMAGING RESEARCH, INC., CLEVELAND, OH. FILED 8-14-2009.

SREE MEDICAL

THE MARK CONSISTS OF STANDARD CHARACTERS WITHOUT CLAIM TO ANY PARTICULAR FONT, STYLE, SIZE, OR COLOR.

NO CLAIM IS MADE TO THE EXCLUSIVE RIGHT TO USE "MEDICAL", APART FROM THE MARK AS SHOWN.

THE ENGLISH TRANSLATION OF "SREE" IN THE MARK IS A MASCULINE TITLE OF VENERATION, NAMELY, MISTER.

FOR MEDICAL EQUIPMENT FOR USE IN MAGNETIC RESONANCE IMAGING, NAMELY, RF COILS AND ACCESSORIES THEREFOR, NAMELY, INCUBATORS FOR BABIES, RESPIRATORS FOR ARTIFICIAL RESPIRATION, VENTILATORS FOR SUPPLYING OXYGEN/AIR TO A PATIENT'S LUNGS, ELECTROCARDIOGRAM LEADS AND MONITOR FOR MEASURING A PATIENT'S HEART RATE AND PULSE, SATURATED PARTIAL PRESSURE OXYGEN MONITOR FOR MEASURING A PATIENT'S BLOOD OXYGENATION LEVEL, THERMOMETERS FOR MEASURING A PATIENT'S TEMPERATURE AT THE AUXILIARY NODES/ARMPITS, NAVEL, PALM AND FEET, OXYGEN AND AIR CYLINDERS FOR SUPPLYING OXYGEN/AIR TO A PATIENT, PRESSURE REDUCER FOR RELIEVING OXYGEN/AIR PRESSURE BEFORE REACHING A PATIENT, FLOW TUBE FOR MEASURING OXYGEN/AIR FLOW VOLUME AND RATE TO A PATIENT, AND INJECTOR FOR INJECTING IMAGE CONTRAST DYES INTO A PATIENT (U.S. CLS. 26, 39 AND 44).

BRIAN CALLAGHAN, EXAMINING ATTORNEY

SN 77-806,685. ELECTROCORE LLC, MORRIS PLAINS, NJ. FILED 8-18-2009.

ELECTROCORE

THE MARK CONSISTS OF STANDARD CHARACTERS WITHOUT CLAIM TO ANY PARTICULAR FONT, STYLE, SIZE, OR COLOR.

FOR MEDICAL DEVICES, NAMELY, NERVE AND MUSCLE TISSUE STIMULATORS; MEDICAL DEVICES FOR TREATING BREATHING AILMENTS, NAMELY, ASTHMA AND BRONCHIAL CONSTRICTION, GASTRIC MOTILITY, GASTRIC AILMENTS, AND CIRCULATORY AILMENTS, THE FOREGOING TREATMENT ACCOMPLISHED BY ELECTRICALLY STIMULATING AND MODULATING NERVE AND MUSCLE TISSUE (U.S. CLS. 26, 39 AND 44).

NANCY CLARKE, EXAMINING ATTORNEY

CLASS 10—(Continued).

SN 77-807,772. ELECTROCORE LLC, MORRIS PLAINS, NJ.
FILED 8-19-2009.

RESOLUTION

THE MARK CONSISTS OF STANDARD CHARACTERS WITHOUT CLAIM TO ANY PARTICULAR FONT, STYLE, SIZE, OR COLOR.

FOR MEDICAL DEVICES, NAMELY, NERVE AND MUSCLE TISSUE STIMULATORS; MEDICAL DEVICES FOR TREATING GASTRIC MOTILITY AND GASTRIC AILMENTS, THE FOREGOING TREATMENT ACCOMPLISHED BY ELECTRICALLY STIMULATING AND MODULATING NERVE AND MUSCLE TISSUE (U.S. CLS. 26, 39 AND 44).

NANCY CLARKE, EXAMINING ATTORNEY

SN 77-807,781. ELECTROCORE LLC, MORRIS PLAINS, NJ.
FILED 8-19-2009.

RESOLVE

THE MARK CONSISTS OF STANDARD CHARACTERS WITHOUT CLAIM TO ANY PARTICULAR FONT, STYLE, SIZE, OR COLOR.

FOR MEDICAL DEVICES, NAMELY, NERVE AND MUSCLE TISSUE STIMULATORS; MEDICAL DEVICES FOR TREATING BREATHING AILMENTS, NAMELY, ASTHMA AND BRONCHIAL CONSTRICTION, THE FOREGOING TREATMENT ACCOMPLISHED BY ELECTRICALLY STIMULATING AND MODULATING NERVE AND MUSCLE TISSUE (U.S. CLS. 26, 39 AND 44).

NANCY CLARKE, EXAMINING ATTORNEY

SN 77-808,266. SKELETAL DYNAMICS, LLC, MIAMI, FL.
FILED 8-19-2009.

VIDEO-BLADE

THE MARK CONSISTS OF STANDARD CHARACTERS WITHOUT CLAIM TO ANY PARTICULAR FONT, STYLE, SIZE, OR COLOR.

FOR MUSCULOSKELETAL DEVICES, NAMELY, RIGID AND FLEXIBLE ENDOSCOPES AND VIDEO-SCOPES USED FOR MEDICAL AND SURGICAL PROCEDURES AND PARTS AND FITTINGS THEREOF; MEDICAL DEVICES, APPARATUS AND INSTRUMENTS FOR USE IN SURGERY; MEDICAL DIAGNOSIS DEVICES, APPARATUS AND INSTRUMENTS FOR USE IN ORTHOPEDIC, CARDIOVASCULAR AND GASTRO-INTESTINAL DIAGNOSIS (U.S. CLS. 26, 39 AND 44).

ERNEST SHOSHO, EXAMINING ATTORNEY

CLASS 10—(Continued).

SN 77-808,276. SKELETAL DYNAMICS, LLC, MIAMI, FL.
FILED 8-19-2009.

**ENHANCING LIVES THROUGH
INNOVATION**

THE MARK CONSISTS OF STANDARD CHARACTERS WITHOUT CLAIM TO ANY PARTICULAR FONT, STYLE, SIZE, OR COLOR.

FOR MUSCULOSKELETAL DEVICES, NAMELY, RIGID AND FLEXIBLE ENDOSCOPES AND VIDEO-SCOPES USED FOR MEDICAL AND SURGICAL PROCEDURES AND PARTS AND FITTINGS THEREOF; MEDICAL DEVICES, APPARATUS AND INSTRUMENTS FOR USE IN SURGERY; MEDICAL DIAGNOSIS DEVICES, APPARATUS AND INSTRUMENTS FOR USE IN ORTHOPEDIC, CARDIOVASCULAR AND GASTRO-INTESTINAL DIAGNOSIS (U.S. CLS. 26, 39 AND 44).

ERNEST SHOSHO, EXAMINING ATTORNEY

SN 77-808,406. SMITHS MEDICAL PM, INC., WAUKESHA, WI. FILED 8-19-2009.



OWNER OF U.S. REG. NOS. 1,800,050 AND 2,643,494.

THE MARK CONSISTS OF A PARALLELOGRAM WITH TWO ROUNDED-CORNERS. THE STYLIZED LETTERS "BCI" APPEAR INSIDE OF THE IMAGE.

FOR MEDICAL INSTRUMENTS AND APPARATUS FOR MONITORING BLOOD PROPERTIES AND VITAL SIGNS; MEDICAL DEVICES, NAMELY, PULSE OXIMETERS AND PULSE OXIMETER SENSORS AND PROBES; PULSE RATE MONITORS AND SENSORS; VITAL SIGNS MONITORS AND SENSORS; BLOOD PRESSURE MONITORS AND SENSORS; MEDICAL TEMPERATURE MONITORS AND SENSORS; ECG MONITORS AND SENSORS; CARBON DIOXIDE MONITORS AND SENSORS; MEDICAL GAS MONITORS AND SENSORS; ELECTRODES FOR MEDICAL USE; AND STANDS, SUPPORTS, COVERS, PARTS AND FITTINGS THEREFOR (U.S. CLS. 26, 39 AND 44).

FIRST USE 6-23-2009; IN COMMERCE 6-23-2009.

EDWARD NELSON, EXAMINING ATTORNEY

CLASS 10—(Continued).

SN 77-817,107. TRUPHATEK INTERNATIONAL LTD., NETANYA SOUTH, ISRAEL, FILED 9-1-2009.

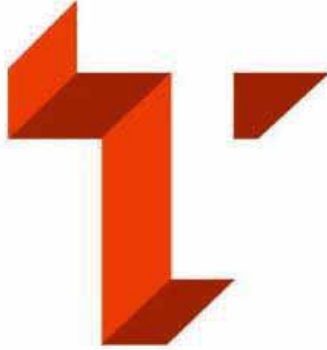

THE COLOR(S) RED AND WHITE IS/ARE CLAIMED AS A FEATURE OF THE MARK.

THE MARK CONSISTS OF A THREE DIMENSIONAL RED AND WHITE "T".

FOR MEDICAL INSTRUMENTS FOR USE IN MANAGING AND MAINTAINING THE AIRWAY IN ANESTHESIOLOGY PROCEDURES (U.S. CLS. 26, 39 AND 44).

STEVEN JACKSON, EXAMINING ATTORNEY

CLASS 10—(Continued).

SN 77-833,293. ENDOSOMATIC SYSTEMS INC., ITHACA, NY, FILED 9-23-2009.

EndoGear

THE MARK CONSISTS OF STANDARD CHARACTERS WITHOUT CLAIM TO ANY PARTICULAR FONT, STYLE, SIZE, OR COLOR.

FOR BIO-TELEMETRIC SYSTEMS COMPRISED OF IMPLANTABLE ELECTRONIC CIRCUITRY, AMPLIFIERS AND PHYSIOLOGICAL SENSORS, NAMELY, STRAIN GAUGES, TEMPERATURE SENSORS, PIEZO-ELECTRIC TRANSDUCERS AND ELECTRODES TO MEASURE TEMPERATURE, BLOOD FLOW, BLOOD PRESSURE, ELECTROCARDIOGRAMS (ECG), ELECTROMYOGRAMS (EMG), ELECTROENCEPHALOGRAMS (EEG), ACTIVITY AND RESPIRATION; IMPLANTABLE INFUSION PUMP TO DELIVER PHYSIOLOGICAL SOLUTIONS, PHARMACEUTICALS, TOXINS AND DRUGS; EXTERNAL ELECTRONIC APPARATUS TO REMOTELY CONTROL THE FOREGOING GOODS, AND SOFTWARE INCORPORATED IN THE FOREGOING BIO-TELEMETRIC SYSTEMS FOR THE PURPOSES OF ACTIVATING THE DEVICE AND FOR SCHEDULING AND RECORDING MEASUREMENTS MADE BY THE DEVICE, ALL OF THE FOREGOING USED FOR MEASURING INTERNAL PHYSIOLOGICAL AND BIOLOGICAL SIGNALS INCLUDING TEMPERATURE, BLOOD FLOW, BLOOD PRESSURE, AND PHYSIOLOGICAL PARAMETERS DURING ELECTROCARDIOGRAMS (ECG), ELECTROMYOGRAMS (EMG) AND ELECTROENCEPHALOGRAMS (EEG), THE FOREGOING SOLD AS A UNIT AND USED FOR VETERINARY RESEARCH (U.S. CLS. 26, 39 AND 44).

FIRST USE 9-30-2009; IN COMMERCE 9-30-2009.

NANCY CLARKE, EXAMINING ATTORNEY

SN 77-818,796. SPECTRASCIENCE, INC., SAN DIRGO, CA, FILED 9-2-2009.

SPECTRASCIENCE

THE MARK CONSISTS OF STANDARD CHARACTERS WITHOUT CLAIM TO ANY PARTICULAR FONT, STYLE, SIZE, OR COLOR.

FOR FORCEPS FOR MEDICAL USE; LASERS FOR MEDICAL PURPOSES; MEDICAL DEVICE AND SURGICAL INSTRUMENT FOR USE IN DIAGNOSIS AND SURGERY OF THE GASTRO-INTESTINAL TRACT (U.S. CLS. 26, 39 AND 44).

FIRST USE 8-19-1996; IN COMMERCE 8-19-1996.

SEAN CROWLEY, EXAMINING ATTORNEY

SN 77-838,637. BACK IN FIVE, LLC, LOS ANGELES, CA, FILED 9-30-2009.



THE COLOR(S) BLUE AND WHITE IS/ARE CLAIMED AS A FEATURE OF THE MARK.

THE MARK CONSISTS SOLELY OF THE COLOR COMBINATION OF WHITE AND BLUE AS APPLIED TO THE ENTIRE SURFACE OF A MEDICAL DEVICE FOR RELIEF OF BACK PAIN COMPRISING A GENERALLY T-SHAPED

CLASS 10—(Continued).

BODY, WHEREIN A LOWER PORTION IS WHITE, A CENTRAL PORTION IS ENTIRELY BLUE, AND THE UPPER PORTION COMPRISING THE CROSSING ARM OF THE "T" IS WHITE HAVING TWO DISCREET ISLANDS OF BLUE SYMMETRICALLY PLACED ON THE ARM. THE DOTTED OUTLINE SHOWING THE GOODS IS INTENDED TO SHOW THE POSITION OF THE COLOR COMBINATION ON THE GOODS AND NEITHER THE BROKEN LINES NOR THE CONFIGURATION OF THE GOODS IS CLAIMED AS A FEATURE OF THE MARK.

SEC. 2(F).

FOR A DEVICE FOR PREVENTING OR RELIEVING PAIN IN THE LOWER BACK, NAMELY, EQUIPMENT FOR MOVEMENT AND STRETCHING OF THE LOWER BACK FOR MEDICAL AND/OR THERAPEUTIC PURPOSES (U.S. CLS. 26, 39 AND 44).

FIRST USE 11-30-2002; IN COMMERCE 12-1-2007.

HANNO RITTNER, EXAMINING ATTORNEY

SN 77-838,857. JOHNSON & JOHNSON, NEW BRUNSWICK, NJ. FILED 10-1-2009.

DELICA

THE MARK CONSISTS OF STANDARD CHARACTERS WITHOUT CLAIM TO ANY PARTICULAR FONT, STYLE, SIZE, OR COLOR.

THE ENGLISH TRANSLATION OF "DELICA" IN THE MARK IS "MANUFACTURED".

FOR LANCETS AND LANCING DEVICE TO BE USED WITH BLOOD GLUCOSE MONITORING DEVICES (U.S. CLS. 26, 39 AND 44).

JANET LEE, EXAMINING ATTORNEY

SN 77-839,964. MEDIT INC., WINNIPEG, CANADA, FILED 10-2-2009.

MEDIT

THE MARK CONSISTS OF STANDARD CHARACTERS WITHOUT CLAIM TO ANY PARTICULAR FONT, STYLE, SIZE, OR COLOR.

PRIORITY CLAIMED UNDER SEC. 44(D) ON CANADA APPLICATION NO. 1440696, FILED 6-8-2009.

FOR ENDOSCOPIC EQUIPMENT; LIGHT EMITTING DIODE (LED) DEVICES FOR ENERGY-EFFICIENT REPLACEMENT OF STANDARD TUNGSTEN-FILAMENT LIGHTING INCORPORATED INTO HAND-HELD MEDICAL INSTRUMENTS; RIGID AND FLEXIBLE MEDICAL ENDOSCOPES; FIBER OPTIC ENDOSCOPIC MEDICAL INSTRUMENTS FOR ENDOSCOPIC MEDICAL PROCEDURES, BUT NOT FOR LABORATORY USE IN THE FIELDS OF HISTOLOGY, CYTOLOGY OR PATHOLOGY (U.S. CLS. 26, 39 AND 44).

FIRST USE 6-1-2003; IN COMMERCE 6-11-2007.

LINDA ESTRADA, EXAMINING ATTORNEY

CLASS 10—(Continued).

SN 77-840,253. JDS APPAREL, DBA RONWEAR, NORTH-FIELD, OH. FILED 10-2-2009.



NO CLAIM IS MADE TO THE EXCLUSIVE RIGHT TO USE "WEAR" AND "CLOTHING", APART FROM THE MARK AS SHOWN.

THE COLOR(S) WHITE AND SAGE GREEN IS/ARE CLAIMED AS A FEATURE OF THE MARK.

THE MARK CONSISTS OF THE STYLIZED WORDING "RON WEAR PORT-ABLE CLOTHING" IN WHITE ON A RECTANGULAR SAGE GREEN BACKGROUND.

FOR MEDICAL TREATMENT APPAREL (U.S. CLS. 26, 39 AND 44).

MARK PILARO, EXAMINING ATTORNEY

SN 77-867,378. SPINESMITH PARTNERS, L.P., AUSTIN, TX. FILED 11-6-2009.

VISUALIF

THE MARK CONSISTS OF STANDARD CHARACTERS WITHOUT CLAIM TO ANY PARTICULAR FONT, STYLE, SIZE, OR COLOR.

FOR MEDICAL APPARATUS, NAMELY, AN INTER-BODY SPINAL FUSION DEVICE (U.S. CLS. 26, 39 AND 44).

NELSON SNYDER, EXAMINING ATTORNEY

SN 77-873,049. NEUROLOGICA CORP., DANVERS, MA. FILED 11-16-2009.

RADREDUX

THE MARK CONSISTS OF STANDARD CHARACTERS WITHOUT CLAIM TO ANY PARTICULAR FONT, STYLE, SIZE, OR COLOR.

FOR MEDICAL EQUIPMENT, NAMELY, COMPUTED TOMOGRAPHY (CT) APPARATUS; COMPUTER SOFTWARE FOR ENHANCING IMAGES GENERATED BY A CT IMAGING MACHINE (U.S. CLS. 26, 39 AND 44).

WARREN L. OLANDRIA, EXAMINING ATTORNEY

CLASS 10—(Continued).

SN 77-873,335. HEADROOM LIMITED, INC., WESTON, FL. FILED 11-16-2009.

BOOBOOLOON

THE MARK CONSISTS OF STANDARD CHARACTERS WITHOUT CLAIM TO ANY PARTICULAR FONT, STYLE, SIZE, OR COLOR.

FOR MEDICAL PROTECTIVE DEVICES FOR ANIMALS, NAMELY, COLLARS THAT PREVENT ANIMALS FROM REACHING WOUNDS, RASHES AND OTHER INJURIES (U.S. CLS. 26, 39 AND 44).

FIRST USE 9-5-2009; IN COMMERCE 9-5-2009.
WENDY GOODMAN, EXAMINING ATTORNEY

CLASS 10—(Continued).

SN 77-893,703. SEMPERMED USA, INC., CLEARWATER, FL. FILED 12-15-2009.

We Are People Protection

THE MARK CONSISTS OF STANDARD CHARACTERS WITHOUT CLAIM TO ANY PARTICULAR FONT, STYLE, SIZE, OR COLOR.

NO CLAIM IS MADE TO THE EXCLUSIVE RIGHT TO USE "PROTECTION", APART FROM THE MARK AS SHOWN.

FOR GLOVES FOR MEDICAL PURPOSES (U.S. CLS. 26, 39 AND 44).

FIRST USE 1-4-2010; IN COMMERCE 1-4-2010.
HEATHER BIDDULPH, EXAMINING ATTORNEY

SN 77-877,904. HAYS, DEYONA, MOUNDS, OK. FILED 11-20-2009.

Equilamp

THE MARK CONSISTS OF STANDARD CHARACTERS WITHOUT CLAIM TO ANY PARTICULAR FONT, STYLE, SIZE, OR COLOR.

FOR MEDICAL EXAMINATION LAMPS FOR USE BY VETERINARIANS ON ANIMALS (U.S. CLS. 26, 39 AND 44).

DAWN HAN, EXAMINING ATTORNEY

SN 77-907,699. NEUROLOGICA CORP., DANVERS, MA. FILED 1-8-2010.

BODYTOM

THE MARK CONSISTS OF STANDARD CHARACTERS WITHOUT CLAIM TO ANY PARTICULAR FONT, STYLE, SIZE, OR COLOR.

FOR MEDICAL IMAGING MACHINE, NAMELY, COMPUTED TOMOGRAPHY (CT) APPARATUS AND MEDICAL APPARATUS AND INSTRUMENTS FOR USE IN POSITRON EMISSION TOMOGRAPHY (PET) IMAGING; COMPUTER SOFTWARE FOR ENHANCING IMAGES GENERATED BY A MEDICAL IMAGING MACHINE (U.S. CLS. 26, 39 AND 44).

WARREN L. OLANDRIA, EXAMINING ATTORNEY

SN 77-881,140. DELUCA, JAMES T., FOREST HILLS, NY. AND DELUCA, PAUL, PLANDOME MANOR, NY. FILED 11-25-2009.

SECOND CHANCE

THE MARK CONSISTS OF STANDARD CHARACTERS WITHOUT CLAIM TO ANY PARTICULAR FONT, STYLE, SIZE, OR COLOR.

FOR MEDICAL DEVICE, NAMELY, A LIFE-SAVING ANTI-CHOKING APPARATUS TO FACILITATE REMOVAL OF LODGED OBJECTS (U.S. CLS. 26, 39 AND 44).

TEJBIR SINGH, EXAMINING ATTORNEY

SN 77-911,020. ATRIUM MEDICAL CORPORATION, HUDSON, NH. FILED 1-13-2010.

XPRESS-WAY

THE MARK CONSISTS OF STANDARD CHARACTERS WITHOUT CLAIM TO ANY PARTICULAR FONT, STYLE, SIZE, OR COLOR.

FOR CATHETERS (U.S. CLS. 26, 39 AND 44).
JOSETTE BEVERLY, EXAMINING ATTORNEY

CLASS 10—(Continued).

SN 77-917,199. WONDERCLIP LLC, ROGERS, AR. FILED 1-21-2010.

WUNDERCLIP

THE MARK CONSISTS OF STANDARD CHARACTERS WITHOUT CLAIM TO ANY PARTICULAR FONT, STYLE, SIZE, OR COLOR.

FOR HEALTH PRODUCTS, NAMELY, HANDHELD THERAPEUTIC ACUPRESSURE DEVICES; ACUPRESSURE THERAPY PRODUCTS, NAMELY, DEVICES FOR STIMULATING ACUPRESSURE THERAPY POINTS OF USE IN THE TREATMENT OF PAIN, MOTION SICKNESS, NAUSEA, HEADACHES, MIGRAINES AND ASSOCIATED SYMPTOMS (U.S. CLS. 26, 39 AND 44).
THOMAS MANOR, EXAMINING ATTORNEY

SN 77-917,211. WONDERCLIP LLC, ROGERS, AR. FILED 1-21-2010.

WONDERCLIP

THE MARK CONSISTS OF STANDARD CHARACTERS WITHOUT CLAIM TO ANY PARTICULAR FONT, STYLE, SIZE, OR COLOR.

FOR HEALTH PRODUCTS, NAMELY, HANDHELD THERAPEUTIC ACUPRESSURE DEVICES; ACUPRESSURE THERAPY PRODUCTS, NAMELY, DEVICES FOR STIMULATING ACUPRESSURE THERAPY POINTS OF USE IN THE TREATMENT OF PAIN, MOTION SICKNESS, NAUSEA, HEADACHES, MIGRAINES AND ASSOCIATED SYMPTOMS (U.S. CLS. 26, 39 AND 44).
THOMAS MANOR, EXAMINING ATTORNEY

SN 77-920,915. COURTENAY CHARLES R, ORLANDO, FL. FILED 1-27-2010.

***Eye*★POD**

THE MARK CONSISTS OF THE WORD "EYE" IN ITALICS CAPITALIZED AS SHOWN, JOINED BY A FIVE POINTED STAR TO THE WORD "POD" IN ALL CAPITAL LETTERS.

FOR EYE DROP DISPENSING DEVICE AND INTEGRATED CONTACT LENS INSERTER AND REMOVER, ALL SOLD AS A UNIT (U.S. CLS. 26, 39 AND 44).
FIRST USE 5-6-2008; IN COMMERCE 12-14-2009.
KAREN BRACEY, EXAMINING ATTORNEY

CLASS 10—(Continued).

SN 77-922,696. QUIDEL CORPORATION, SAN DIEGO, CA. FILED 1-28-2010.

QUICKVUER

THE MARK CONSISTS OF STANDARD CHARACTERS WITHOUT CLAIM TO ANY PARTICULAR FONT, STYLE, SIZE, OR COLOR.

OWNER OF U.S. REG. NOS. 2,103,404, 2,749,808 AND 3,426,296.

FOR MEDICAL DIAGNOSTIC APPARATUS COMPRISED OF AN OPTICS WINDOW, A PORT FOR A LATERAL FLOW STRIP, AND AN ILLUMINATING DEVICE, SPECIFICALLY ADAPTED FOR READING IN VITRO MEDICAL TEST RESULTS (U.S. CLS. 26, 39 AND 44).
ZHALEH DELANEY, EXAMINING ATTORNEY

SN 77-923,124. MENTOR WORLDWIDE LLC, SANTA BARBARA, CA. FILED 1-29-2010.

MEMORYSHAPE

THE MARK CONSISTS OF STANDARD CHARACTERS WITHOUT CLAIM TO ANY PARTICULAR FONT, STYLE, SIZE, OR COLOR.

FOR BREAST IMPLANTS NOT COMPRISING LIVING TISSUE (U.S. CLS. 26, 39 AND 44).
JAMES GRIFFIN, EXAMINING ATTORNEY

SN 77-923,326. DAVE CRUZ, DAVIS, CA. FILED 1-29-2010.

CSAR MED RUCK

THE MARK CONSISTS OF STANDARD CHARACTERS WITHOUT CLAIM TO ANY PARTICULAR FONT, STYLE, SIZE, OR COLOR.

NO CLAIM IS MADE TO THE EXCLUSIVE RIGHT TO USE "MED RUCK", APART FROM THE MARK AS SHOWN. FOR BACKPACKS FOR HOLDING MEDICAL GEAR AND MEDICAL SUPPLIES IN GENERAL, SOLD EMPTY (U.S. CLS. 26, 39 AND 44).
FIRST USE 7-10-2007; IN COMMERCE 7-10-2007.

JERI J. FICKES, EXAMINING ATTORNEY

CLASS 10—(Continued).

SN 77-925,883. RADMAN RADIOLOGICAL CORPORATION, VIRGINIA BEACH, VA. FILED 2-2-2010.

RAD BAG

THE MARK CONSISTS OF STANDARD CHARACTERS WITHOUT CLAIM TO ANY PARTICULAR FONT, STYLE, SIZE, OR COLOR.

NO CLAIM IS MADE TO THE EXCLUSIVE RIGHT TO USE "BAG", APART FROM THE MARK AS SHOWN.

FOR MEDICAL DEVICES, NAMELY, XRAY CASSETTE COVERS (U.S. CLS. 26, 39 AND 44).

FIRST USE 12-31-1995; IN COMMERCE 12-31-1995.
RONALD MCMORROW, EXAMINING ATTORNEY

SN 77-925,960. RADMAN RADIOLOGICAL CORPORATION, VIRGINIA BEACH, VA. FILED 2-2-2010.



THE MARK CONSISTS OF THE LETTERS "RMR", WITH THE FIRST "R" REVERSED, TOGETHER WITH THE IMAGE OF A DOCTOR WHOSE TORSO IS A SKELETON.

FOR MEDICAL DEVICES, NAMELY, XRAY CASSETTE COVERS (U.S. CLS. 26, 39 AND 44).

FIRST USE 12-31-1995; IN COMMERCE 12-31-1995.
RONALD MCMORROW, EXAMINING ATTORNEY

SN 77-926,180. NUVIMEDIX LLC, MCALLEN, TX. FILED 2-2-2010.



THE COLOR(S) RED, ORANGE, YELLOW, LIME GREEN, KELLY GREEN, AQUA, BLUE, PURPLE, AND GRAY IS/ARE CLAIMED AS A FEATURE OF THE MARK.

THE MARK CONSISTS OF MULTIPLE OVALS (OR RECLINING CIRCLES) COMPRISING WHAT APPEARS TO BE THE OUTLINE OF A LARGE CIRCLE THAT IS

CLASS 10—(Continued).

TILTED AWAY FROM THE VIEWER (THE OUTLINED RECLINING CIRCLE). THE OVALS THAT FORM THE CIRCUMFERENCE OF THE OUTLINED RECLINING CIRCLE IN A COUNTERCLOCKWISE DIRECTION BEGINNING AT THE 6 O'CLOCK POSITION ARE ORDERED AS FOLLOWS: RED (6 O'CLOCK), ORANGE, YELLOW, LIME GREEN, KELLY GREEN (12 O'CLOCK), AQUA, BLUE, PURPLE. THE NINTH OVAL IN THE MIDDLE OF THE OUTLINED RECLINING CIRCLE IS GRAY. THE LOWER-CASE LETTERING, "NUVIMEDIX", IS GRAY.

FOR INTEGRATED MEDICAL EXAMINATION SYSTEMS COMPRISING MEDICAL DEVICES AND COMPUTER SOFTWARE FOR INFORMATION MANAGEMENT FOR USE IN WEB-BASED PHYSICAL EXAMINATION AND ASSESSMENT OF PATIENTS IN A REMOTE, CLINICAL SETTING (U.S. CLS. 26, 39 AND 44).

FIRST USE 12-14-2009; IN COMMERCE 1-6-2010.
DEBRA LEE, EXAMINING ATTORNEY

SN 77-926,345. PROSEPPRA, INC., PLEASANTON, CA. FILED 2-2-2010.

PROSEPPRA

THE MARK CONSISTS OF STANDARD CHARACTERS WITHOUT CLAIM TO ANY PARTICULAR FONT, STYLE, SIZE, OR COLOR.

FOR MASSAGE APPARATUS AND INSTRUMENTS; ELECTRONIC MASSAGE APPARATUS, NAMELY, ELECTRIC PERCUSSION AND/OR VIBRATING MASSAGER; MASSAGE CHAIR; MASSAGE PILLOWS AND CUSHIONS (U.S. CLS. 26, 39 AND 44).

JULIE VEPPUMTHARA, EXAMINING ATTORNEY

SN 77-926,825. SPEECHEASY INTERNATIONAL, LLC, GREENVILLE, NC. FILED 2-3-2010.

EXPRESSIT

THE MARK CONSISTS OF STANDARD CHARACTERS WITHOUT CLAIM TO ANY PARTICULAR FONT, STYLE, SIZE, OR COLOR.

FOR SPEECH THERAPY DEVICE, NAMELY, APPARATUS TO AMELIORATE STUTTERING BY CHANGING THE SOUND OF THE USER'S VOICE IN HIS OR HER EAR COMPRISED OF A RECEIVER, AUDITORY DELAY AND/OR FREQUENCY SHIFT CIRCUIT, AND TRANSMITTER WHICH IS CONFIGURED FOR POSITIONING IN OR ADJACENT TO THE EAR (U.S. CLS. 26, 39 AND 44).

MAUREEN DALL, EXAMINING ATTORNEY

CLASS 10—(Continued).

SN 77-926,925. PROSEPPA, INC., PLEASANTON, CA. FILED 2-3-2010.

PENGUIN

THE MARK CONSISTS OF STANDARD CHARACTERS WITHOUT CLAIM TO ANY PARTICULAR FONT, STYLE, SIZE, OR COLOR.

FOR MASSAGE APPARATUS AND INSTRUMENTS; ELECTRONIC MASSAGE APPARATUS, NAMELY, ELECTRIC PERCUSSION AND/OR VIBRATING MASSAGER; MASSAGE CHAIR; MASSAGE PILLOWS AND CUSHIONS (U.S. CLS. 26, 39 AND 44).

JULIE VEPPUMTHARA, EXAMINING ATTORNEY

CLASS 10—(Continued).

SN 77-927,176. VEEDER, MATTHEW P., SEATTLE, WA. FILED 2-3-2010.

TORNADO NASAL STRIPS

THE MARK CONSISTS OF STANDARD CHARACTERS WITHOUT CLAIM TO ANY PARTICULAR FONT, STYLE, SIZE, OR COLOR.

NO CLAIM IS MADE TO THE EXCLUSIVE RIGHT TO USE "NASAL STRIPS", APART FROM THE MARK AS SHOWN.

FOR NASAL ASPIRATORS (U.S. CLS. 26, 39 AND 44).
THOMAS MANOR, EXAMINING ATTORNEY

SN 77-927,123. HOMEWAY TECHNOLOGY CO., LTD., TAINAN COUNTY, TAIWAN, FILED 2-3-2010.



THE MARK CONSISTS OF THE WORDING "GOOD-ARCH" WITH A DESIGN DEPICTING TWO FEET ABOVE THE WORDING AND CHINESE AND JAPANESE CHARACTERS APPEARING BELOW THE WORDING.

THE NON-LATIN CHARACTERS IN THE MARK TRANSLITERATE TO "JIAO NO YAN JING" AND THIS MEANS "FOOT OF EYE MIRROR" IN ENGLISH.

FOR ORTHOPEDIC FOOTWEAR, ORTHOPEDIC SOLES (U.S. CLS. 26, 39 AND 44).

FIRST USE 6-1-2005; IN COMMERCE 12-28-2006.
ELIZABETH KAJUBI, EXAMINING ATTORNEY

surgitat

THE MARK CONSISTS OF THE STYLIZED TEXT "SURGITAT".

FOR A TEMPORARY PEEL-AND-STICK SKIN APPLIQUE TO BE APPLIED TO PATIENT FOR PREOPERATIVE SITE MARKING SO THAT ATTENDING SURGEON, NURSE, ANESTHESIOLOGIST CAN INITIAL SITE TO ENSURE ACCURACY, ACCOUNTABILITY AND PATIENT SAFETY (U.S. CLS. 26, 39 AND 44).

MATTHEW PAPPAS, EXAMINING ATTORNEY

SN 77-927,491. SITES MEDICAL, INC., COLUMBIA CITY, IN. FILED 2-3-2010.

biofuzze

THE MARK CONSISTS OF STANDARD CHARACTERS WITHOUT CLAIM TO ANY PARTICULAR FONT, STYLE, SIZE, OR COLOR.

FOR MEDICAL, SURGICAL AND ORTHOPAEDIC IMPLANTS MADE OF ARTIFICIAL MATERIALS (U.S. CLS. 26, 39 AND 44).

MATTHEW PAPPAS, EXAMINING ATTORNEY

CLASS 10—(Continued).

SN 77-927,508. SITES MEDICAL, INC., COLUMBIA CITY, IN.
FILED 2-3-2010.

biofuse

THE MARK CONSISTS OF STANDARD CHARACTERS WITHOUT CLAIM TO ANY PARTICULAR FONT, STYLE, SIZE, OR COLOR.

FOR MEDICAL, SURGICAL AND ORTHOPAEDIC IMPLANTS MADE OF ARTIFICIAL MATERIALS (U.S. CLS. 26, 39 AND 44).

MATTHEW PAPPAS, EXAMINING ATTORNEY

CLASS 10—(Continued).

SN 77-927,933. MICROAIRE SURGICAL INSTRUMENTS, LLC, AKA MICROAIRE, CHARLOTTESVILLE, VA.
FILED 2-4-2010.

SmartRelease

THE MARK CONSISTS OF STANDARD CHARACTERS WITHOUT CLAIM TO ANY PARTICULAR FONT, STYLE, SIZE, OR COLOR.

FOR SURGICAL ENDOSCOPIC INSTRUMENTS AND APPARATUSES FOR USE IN SURGERIES AND PROCEDURES THAT CUT, TRANSECT, INCISE, SEVER, AND/OR SCORE SOFT TISSUE INCLUDING LIGAMENTS AND FASCIA (U.S. CLS. 26, 39 AND 44).

APRIL ROACH, EXAMINING ATTORNEY

SN 77-927,518. SITES MEDICAL, INC., COLUMBIA CITY, IN.
FILED 2-3-2010.

biosync

THE MARK CONSISTS OF STANDARD CHARACTERS WITHOUT CLAIM TO ANY PARTICULAR FONT, STYLE, SIZE, OR COLOR.

FOR MEDICAL, SURGICAL AND ORTHOPAEDIC IMPLANTS MADE OF ARTIFICIAL MATERIALS (U.S. CLS. 26, 39 AND 44).

MATTHEW PAPPAS, EXAMINING ATTORNEY

SN 77-928,099. INVUITY, INC., SAN FRANCISCO, CA.
FILED 2-4-2010.

BRITEPOINT

THE MARK CONSISTS OF STANDARD CHARACTERS WITHOUT CLAIM TO ANY PARTICULAR FONT, STYLE, SIZE, OR COLOR.

OWNER OF U.S. REG. NO. 3,603,538.
FOR MEDICAL AND SURGICAL DEVICES, NAMELY, SURGICAL RETRACTORS AND SURGICAL INSTRUMENTS AND APPARATUS FOR USE IN MEDICAL PROCEDURES (U.S. CLS. 26, 39 AND 44).

DAVID YONTEF, EXAMINING ATTORNEY

SN 77-927,822. ATICO INTERNATIONAL USA, INC., FT. LAUDERDALE, FL. FILED 2-4-2010.

Little Giggles

THE MARK CONSISTS OF STANDARD CHARACTERS WITHOUT CLAIM TO ANY PARTICULAR FONT, STYLE, SIZE, OR COLOR.

FOR BABY BOTTLES (U.S. CLS. 26, 39 AND 44).

DEIRDRE ROBERTSON, EXAMINING ATTORNEY

SN 77-928,181. MAKO SURGICAL CORP., FORT LAUDERDALE, FL. FILED 2-4-2010.

VIZADISC

THE MARK CONSISTS OF STANDARD CHARACTERS WITHOUT CLAIM TO ANY PARTICULAR FONT, STYLE, SIZE, OR COLOR.

FOR SURGICAL INSTRUMENTS, NAMELY, TRACKING ARRAYS USED DURING SURGERY TO TRACK MOVEMENT OF PATIENT ANATOMY, SURGICAL INSTRUMENTS, AND SURGICAL SYSTEMS (U.S. CLS. 26, 39 AND 44).

JUDITH HELFMAN, EXAMINING ATTORNEY

CLASS 10—(Continued).

SN 77-928,262. DENTSPLY INTERNATIONAL INC., YORK, PA. FILED 2-4-2010.

VORTEX

THE MARK CONSISTS OF STANDARD CHARACTERS WITHOUT CLAIM TO ANY PARTICULAR FONT, STYLE, SIZE, OR COLOR.

FOR DENTAL INSTRUMENTS, NAMELY, DENTAL ROOT FILES USED IN ROOT CANAL THERAPY PROCEDURES (U.S. CLS. 26, 39 AND 44).

FIRST USE 5-26-2009; IN COMMERCE 5-26-2009.

NICHOLAS COLEMAN, EXAMINING ATTORNEY

CLASS 10—(Continued).

SN 77-929,933. TIFFANY D DAVIS, DBA HANSBURY HAYES INTERNATIONAL, WILMINGTON, DE. FILED 2-7-2010.

**Hansbury Hayes
International**

THE MARK CONSISTS OF STANDARD CHARACTERS WITHOUT CLAIM TO ANY PARTICULAR FONT, STYLE, SIZE, OR COLOR.

NO CLAIM IS MADE TO THE EXCLUSIVE RIGHT TO USE "INTERNATIONAL", APART FROM THE MARK AS SHOWN.

FOR INTEGRATED MEDICAL EXAMINATION SYSTEMS COMPRISING MEDICAL DEVICES AND COMPUTER SOFTWARE FOR INFORMATION MANAGEMENT FOR USE IN WEB-BASED PHYSICAL EXAMINATION AND ASSESSMENT OF PATIENTS IN A REMOTE, CLINICAL SETTING; MEDICAL EQUIPMENT ACCESSORIES, NAMELY, ELECTRODIAGNOSTIC AUTOMATED CONSTANT CURRENT SINUSOID WAVEFORM NEUROSELECTIVE SENSORY NERVE TESTING DEVICES, NAMELY, DISPOSABLE ELECTRODES; MEDICAL IMAGE PROCESSORS; MEDICAL ULTRASOUND APPARATUS (U.S. CLS. 26, 39 AND 44).

DAVID MURRAY, EXAMINING ATTORNEY

SN 77-930,809. CROSTA, ROBERTO ALFONSO, QUILMES, ARGENTINA, AND MARTINEZ CAIADO, ANDREA CECILIA, QUILMES, ARGENTINA, FILED 2-8-2010.



OWNER OF ARGENTINA REG. NO. 1.922.089, DATED 4-14-2003, EXPIRES 4-14-2013.

NO CLAIM IS MADE TO THE EXCLUSIVE RIGHT TO USE "DENT", APART FROM THE MARK AS SHOWN.

THE MARK CONSISTS OF THE WORDS "ROSTER DENT" DECREASING IN SIZE TOWARD THE RIGHT. A SCREW IS DISPLAYED BEHIND THE LETTER "T" OF THE WORD "DENT". THE LITERAL ELEMENT AND SCREW DESIGN ARE DISPLAYED WITHIN AN OVAL.

FOR DENTAL IMPLANTS (U.S. CLS. 26, 39 AND 44).

LINDSEY RUBIN, EXAMINING ATTORNEY

SN 77-929,009. GIRLY GAL, INC, NORTH LAS VEGAS, NV. FILED 2-5-2010.



THE COLOR(S) BLACK, WHITE AND PINK IS/ARE CLAIMED AS A FEATURE OF THE MARK.

THE MARK CONSISTS OF THE FOLLOWING: THE WORD "TABOO", STYLIZED, IN THE COLOR PINK BENEATH WHICH IS THE WORD "ESSENTIALS" IN THE COLOR PINK WITHIN A WHITE SCROLL DESIGN, ALL OF WHICH IS SUPERIMPOSED ON A BLACK OVAL BACKGROUND.

FOR ADULT SEXUAL STIMULATION AIDS, NAMELY, VIBRATORS AND MASTURBATION SLEEVES (U.S. CLS. 26, 39 AND 44).

FIRST USE 1-1-2010; IN COMMERCE 1-1-2010.

BARNEY CHARLON, EXAMINING ATTORNEY

SN 77-930,830. ARES TRADING S.A., AUBONNE, SWITZERLAND, FILED 2-8-2010.

REBISTYLE

THE MARK CONSISTS OF STANDARD CHARACTERS WITHOUT CLAIM TO ANY PARTICULAR FONT, STYLE, SIZE, OR COLOR.

FOR PEN INJECTOR FOR THE TREATMENT OF MULTIPLE SCLEROSIS (U.S. CLS. 26, 39 AND 44).

ALICE BENMAMAN, EXAMINING ATTORNEY

CLASS 10—(Continued).

SN 77-931,502. HOUTZ, NANCY J., LOVELAND, CO. FILED 2-9-2010.

ComPphys

THE MARK CONSISTS OF STANDARD CHARACTERS WITHOUT CLAIM TO ANY PARTICULAR FONT, STYLE, SIZE, OR COLOR.

FOR COMFORT PADS TO BE WORN UNDER COMPRESSION HOSE AND OTHER MEDICAL DEVICES CAUSING DISCOMFORT (U.S. CLS. 26, 39 AND 44).

FIRST USE 11-1-2009; IN COMMERCE 12-24-2009.
DANNEAN HETZEL, EXAMINING ATTORNEY

SN 77-931,749. SITES MEDICAL, LLC, COLUMBIA CITY, IN. FILED 2-9-2010.



THE COLOR(S) BLUE AND ORANGE IS/ARE CLAIMED AS A FEATURE OF THE MARK.

THE MARK CONSISTS OF THREE BLUE ARCS OF INCREASING SIZE FROM LEFT TO RIGHT FOLLOWED BY THREE ORANGE ARCS OF DECREASING SIZE FROM LEFT TO RIGHT, WHERE THE BLUE ARCS ARE DRAWN UP FROM A CENTER LINE AND THE ORANGE ARCS ARE DRAWN DOWN FROM THE SAME CENTER LINE.

FOR MEDICAL, SURGICAL AND ORTHOPAEDIC IMPLANTS MADE OF ARTIFICIAL MATERIALS (U.S. CLS. 26, 39 AND 44).

JOHN WILKE, EXAMINING ATTORNEY

SN 77-932,392. INNOVASIS INC., SALT LAKE CITY, UT. FILED 2-10-2010.

ShadowFix

THE MARK CONSISTS OF STANDARD CHARACTERS WITHOUT CLAIM TO ANY PARTICULAR FONT, STYLE, SIZE, OR COLOR.

FOR MEDICAL DEVICES, NAMELY, SPINAL IMPLANTS COMPOSED OF ARTIFICIAL MATERIALS (U.S. CLS. 26, 39 AND 44).

WILLIAM P. SHANAHAN, EXAMINING ATTORNEY

CLASS 10—(Continued).

SN 77-933,323. MICROAIRE SURGICAL INSTRUMENTS, LLC, AKA MICROAIRE, CHARLOTTESVILLE, VA. FILED 2-11-2010.

LipoTower

THE MARK CONSISTS OF STANDARD CHARACTERS WITHOUT CLAIM TO ANY PARTICULAR FONT, STYLE, SIZE, OR COLOR.

FOR SURGICAL EQUIPMENT FOR USE WITH LIPO-SUCTION, LIPOLYSIS, LIPOPLASTY AND LIPO INJECTION AND REINJECTION; CANNULAE; SURGICAL APPARATUS AND INSTRUMENTS FOR USE IN LIPO-SUCTION LIPOLYSIS, LIPOPLASTY AND LIPO INJECTION AND REINJECTION, NAMELY, HANDLES FOR RECEIVING CANNULAE; ASPIRATION UNITS, NAMELY, ASPIRATORS FOR USE DURING LIPO-SUCTION, LIPOLYSIS, LIPOPLASTY AND LIPO INJECTION AND REINJECTION; SURGICAL APPARATUS AND INSTRUMENTS FOR USE IN LIPO-SUCTION LIPOLYSIS, LIPOPLASTY AND LIPO INJECTION AND REINJECTION, NAMELY, TUMESCENT INFILTRATION UNITS; SURGICAL APPARATUS AND INSTRUMENTS, NAMELY, INFUSION PUMPS; FILTERS, NAMELY, FILTERS FOR ASPIRATION UNITS; TUBING, NAMELY, TUBING FOR USE WITH CANNULAS (U.S. CLS. 26, 39 AND 44).

APRIL ROACH, EXAMINING ATTORNEY

SN 77-936,299. SMITH & NEPHEW, INC., MEMPHIS, TN. FILED 2-16-2010.

VISIONAIRE

THE MARK CONSISTS OF STANDARD CHARACTERS WITHOUT CLAIM TO ANY PARTICULAR FONT, STYLE, SIZE, OR COLOR.

FOR INSTRUMENTS FOR USE IN ORTHOPEDIC SURGERY (U.S. CLS. 26, 39 AND 44).

SOPHIA S. KIM, EXAMINING ATTORNEY

CLASS 10—(Continued).

SN 77-945,585. SALVIN DENTAL SPECIALTIES, INC., CHARLOTTE, NC. FILED 2-26-2010.

SALVIN ENLIGHTEN LED SYSTEM

THE MARK CONSISTS OF STANDARD CHARACTERS WITHOUT CLAIM TO ANY PARTICULAR FONT, STYLE, SIZE, OR COLOR.

OWNER OF U.S. REG. NOS. 2,422,333, 3,591,013 AND OTHERS.

NO CLAIM IS MADE TO THE EXCLUSIVE RIGHT TO USE "LED SYSTEM", APART FROM THE MARK AS SHOWN.

FOR LED LIGHT SOURCE FOR DENTAL HEADLAMP, LIGHTED INSTRUMENT CABLE AND CORRESPONDING BATTERY PACK AND CHARGER, ALL SOLD AS A UNIT (U.S. CLS. 26, 39 AND 44).

FIRST USE 8-13-2009; IN COMMERCE 8-13-2009.
JOSETTE BEVERLY, EXAMINING ATTORNEY

SN 77-949,588. DENTSPLY INTERNATIONAL INC., YORK, PA. FILED 3-3-2010.

M-WIRE

THE MARK CONSISTS OF STANDARD CHARACTERS WITHOUT CLAIM TO ANY PARTICULAR FONT, STYLE, SIZE, OR COLOR.

FOR DENTAL INSTRUMENTS, NAMELY, DENTAL ROOT FILES USED IN ROOT CANAL THERAPY PROCEDURES (U.S. CLS. 26, 39 AND 44).

FIRST USE 10-15-2007; IN COMMERCE 10-15-2007.
NICHOLAS COLEMAN, EXAMINING ATTORNEY

SN 77-951,996. BAXTER INTERNATIONAL INC., DEERFIELD, IL. FILED 3-5-2010.

AQUASPIKE

THE MARK CONSISTS OF STANDARD CHARACTERS WITHOUT CLAIM TO ANY PARTICULAR FONT, STYLE, SIZE, OR COLOR.

FOR FOUR-WAY MEDICAL TUBING MANIFOLD USED FOR USE IN CONTINUOUS AND INTERMITTENT RENAL REPLACEMENT THERAPIES, HEMOFILTRATION, HEMODIALYSIS, HEMODIAFILTRATION, AND ULTRAFILTRATION; PARTS AND FITTINGS FOR ALL THE AFORESAID GOODS (U.S. CLS. 26, 39 AND 44).

FIRST USE 6-6-2008; IN COMMERCE 6-6-2008.
CHRIS WELLS, EXAMINING ATTORNEY

CLASS 10—(Continued).

SN 77-956,351. NUK USA LLC, HACKENSACK, NJ. FILED 3-11-2010.

ULTIMATE

THE MARK CONSISTS OF STANDARD CHARACTERS WITHOUT CLAIM TO ANY PARTICULAR FONT, STYLE, SIZE, OR COLOR.

FOR CUPS ADAPTED FOR FEEDING BABIES AND CHILDREN (U.S. CLS. 26, 39 AND 44).

FRANK LATTUCA, EXAMINING ATTORNEY

SN 77-956,878. CLINICON CORPORATION, OCEANSIDE, CA. FILED 3-11-2010.

SUREPROBE

THE MARK CONSISTS OF STANDARD CHARACTERS WITHOUT CLAIM TO ANY PARTICULAR FONT, STYLE, SIZE, OR COLOR.

FOR LASERS FOR SURGICAL AND MEDICAL USE (U.S. CLS. 26, 39 AND 44).

KATHY DE JONGE, EXAMINING ATTORNEY

SN 77-956,882. CLINICON CORPORATION, OCEANSIDE, CA. FILED 3-11-2010.

SURELEASE

THE MARK CONSISTS OF STANDARD CHARACTERS WITHOUT CLAIM TO ANY PARTICULAR FONT, STYLE, SIZE, OR COLOR.

FOR LASERS FOR SURGICAL AND MEDICAL USE (U.S. CLS. 26, 39 AND 44).

KATHY DE JONGE, EXAMINING ATTORNEY

CLASS 10—(Continued).

SN 77-962,791. NEW COLOR IRIS LLC, NEW YORK, NY.
FILED 3-18-2010.

BrightOcular

THE MARK CONSISTS OF STANDARD CHARACTERS WITHOUT CLAIM TO ANY PARTICULAR FONT, STYLE, SIZE, OR COLOR.

FOR INTRAOCULAR IMPLANTS FOR CHANGING EYE COLOR; OCULAR IMPLANTS (U.S. CLS. 26, 39 AND 44).

STEVEN JACKSON, EXAMINING ATTORNEY

SN 77-964,428. MAKO SURGICAL CORP., FORT LAUDERDALE, FL. FILED 3-22-2010.

RESTORIS CLASSIC

THE MARK CONSISTS OF STANDARD CHARACTERS WITHOUT CLAIM TO ANY PARTICULAR FONT, STYLE, SIZE, OR COLOR.

OWNER OF U.S. REG. NO. 3,522,351.
FOR ORTHOPEDIC JOINT IMPLANTS (U.S. CLS. 26, 39 AND 44).

JUDITH HELFMAN, EXAMINING ATTORNEY

SN 77-969,983. DISCUS DENTAL, LLC, CULVER CITY, CA.
FILED 3-26-2010.

DREAMLITE

THE MARK CONSISTS OF STANDARD CHARACTERS WITHOUT CLAIM TO ANY PARTICULAR FONT, STYLE, SIZE, OR COLOR.

FOR DENTAL INSTRUMENTS, NAMELY, DENTAL CURING LIGHTS AND INTRAORAL LIGHT SYSTEMS (U.S. CLS. 26, 39 AND 44).

JAY BESCH, EXAMINING ATTORNEY

CLASS 10—(Continued).

SN 78-466,201. JOHNSON & JOHNSON, NEW BRUNSWICK, NJ. FILED 8-12-2004.

LPS

THE MARK CONSISTS OF STANDARD CHARACTERS WITHOUT CLAIM TO ANY PARTICULAR FONT, STYLE, SIZE, OR COLOR.

FOR SURGICAL INSTRUMENTS USED IN ARTHROSCOPIC SURGERY OF THE SHOULDER, KNEE, WRIST, ELBOW AND ANKLE (U.S. CLS. 26, 39 AND 44).

ZHALEH DELANEY, EXAMINING ATTORNEY

SN 78-920,363. HANSEN MEDICAL, INC., MOUNTAIN VIEW, CA. FILED 6-29-2006.

ARTISAN

THE MARK CONSISTS OF STANDARD CHARACTERS WITHOUT CLAIM TO ANY PARTICULAR FONT, STYLE, SIZE, OR COLOR.

FOR MEDICAL DEVICES, NAMELY, CATHETERS, GUIDEWIRES, SHEATHS, SHEATH GUIDES, GUIDE CATHETERS AND PARTS AND FITTINGS THEREFOR, NONE OF THE AFORESAID FOR USE ON OR IN CONNECTION WITH ORTHOPEDICS PRODUCTS (U.S. CLS. 26, 39 AND 44).

JOHN WILKE, EXAMINING ATTORNEY

SN 79-071,668. GUANGZHOU IMPROVE MEDICAL INSTRUMENTS; CO., LTD, 510660 GUANGZHOU CITY, GUANGDONG, CHINA, FILED 7-1-2009.

IMPROVACUTER

OWNER OF INTERNATIONAL REGISTRATION 1009714 DATED 7-1-2009, EXPIRES 7-1-2019.

FOR NEEDLES FOR MEDICAL PURPOSES; CANNULAE; BLOOD TESTING APPARATUS; SYRINGES FOR INJECTIONS; CATHETERS; NURSING APPLIANCES, NAMELY, NURSING BOTTLES, BREAST PUMPS; APPARATUS FOR USE IN MEDICAL ANALYSIS; MEDICAL APPARATUS AND INSTRUMENTS FOR MONITORING OXYMETORY, GAS ANALYSIS, VITAL SIGNS, BLOOD PROPERTIES AND RESPIRATORY EVENTS; SURGICAL APPARATUS AND INSTRUMENTS (U.S. CLS. 26, 39 AND 44).

KARANENDRA S. CHHINA, EXAMINING ATTORNEY

CLASS 10—(Continued).

SN 79-072,761. PETERS SURGICAL, FRANCE, FILED 6-29-2009.

PETERS SURGICAL

THE MARK CONSISTS OF STANDARD CHARACTERS WITHOUT CLAIM TO ANY PARTICULAR FONT, STYLE, SIZE, OR COLOR.

PRIORITY DATE OF 2-12-2009 IS CLAIMED.
OWNER OF INTERNATIONAL REGISTRATION 1012873 DATED 6-29-2009, EXPIRES 6-29-2019.

NO CLAIM IS MADE TO THE EXCLUSIVE RIGHT TO USE "SURGICAL", APART FROM THE MARK AS SHOWN.

FOR SURGICAL, MEDICAL, DENTAL AND VETERINARY APPARATUS AND INSTRUMENTS, NAMELY, SURGICAL SUTURES; SUTURE MATERIALS AND NEEDLES; MEDICAL AND SURGICAL CATHETERS; DRAINAGE APPLIANCES FOR SURGICAL AND MEDICAL PROCEDURES; MEDICAL AND SURGICAL KNIVES AND CUTTERS; SURGICAL BLADES; SURGICAL STAPLERS; ORTHOTICS FOR NECK, ARM, CLAVICLE, SHOULDER KNEE, ANKLE, WRIST, FINGER, HIP AND STERNUM (U.S. CLS. 26, 39 AND 44).

SCOTT BIBB, EXAMINING ATTORNEY

CLASS 11—ENVIRONMENTAL CONTROL APPARATUS

SN 76-699,527. METAL INDUSTRIES, INC., CLEARWATER, FL. FILED 9-21-2009.



OWNER OF U.S. REG. NO. 1,595,184.
THE COLOR(S) YELLOW, RED, BLUE, GREEN AND BLACK IS/ARE CLAIMED AS A FEATURE OF THE MARK.

THE MARK CONSISTS OF THE WORD "USAIRE" AND A SERIES OF WAVY LINES SUPERIMPOSED OVER AND BEYOND THE VERTICAL EDGES OF A SQUARE. THE COLOR GREEN APPEARS AS A LINE IN THE FORM OF A WAVE. THE COLOR RED APPEARS AS A LINE IN THE FORM OF A WAVE AND IN THE LETTERS OF THE WORD "USAIRE". THE COLOR YELLOW APPEARS AS A LINE IN THE FORM OF A WAVE. THE COLOR BLUE APPEARS AS A LINE IN THE FORM OF A WAVE. THE COLOR BLACK APPEARS IN THE SQUARE.

FOR VENTILATION FAN ACCESSORIES, NAMELY, GRILLES FOR USE IN AIR CONDITIONING, HEATING AND VENTILATING SYSTEMS; RESISTERS AND DIFFUSERS FOR USE IN AIR CONDITIONING, HEATING AND VENTILATING SYSTEMS; LIFE SAFETY FIRE DAMPERS AND MECHANICAL AIR CONTROLLERS IN THE NATURE VENTILATING LOUVERS FOR USE IN AIR CONDITIONING, HEATING AND VENTILATING SYSTEMS (U.S. CLS. 13, 21, 23, 31 AND 34).

WILLIAM ROSSMAN, EXAMINING ATTORNEY

SN 79-076,203. ANN SUMMERS LIMITED, UNITED KINGDOM, FILED 10-20-2009.

RAMPANT RABBIT G-PULSE

THE MARK CONSISTS OF STANDARD CHARACTERS WITHOUT CLAIM TO ANY PARTICULAR FONT, STYLE, SIZE, OR COLOR.

PRIORITY DATE OF 7-9-2009 IS CLAIMED.
OWNER OF INTERNATIONAL REGISTRATION 1021821 DATED 10-20-2009, EXPIRES 10-20-2019.

OWNER OF U.S. REG. NO. 2,938,376.

FOR MESSAGE DEVICES, NAMELY, DEVICES FOR MASSAGING OR VIBRATING PORTIONS OF THE FACE AND BODY AND PACIFIERS FOR MASSAGING THE LIPS; ADULT SEXUAL AIDS FOR ASSISTING IN COPULATION AND MASTURBATION, NAMELY, VIBRATING AND NON-VIBRATING REPRODUCTIONS OF PARTS OF THE MALE AND FEMALE ANATOMIES, PENISES, VAGINAS, PUMPS, RINGS, CLAMPS, STIMULATORS, VIBRATORS, DILDOS, DONGS, BUTT PLUGS, PENIS EXTENSIONS, RINGS TO BE WORN ABOUT THE PENIS, SLEEVES ON VIBRATORS SOLD TOGETHER WITH THE VIBRATORS, SLEEVES FOR VIBRATORS, EXTENSIONS SOLD TOGETHER WITH THE MASSAGING DEVICES, HARNESSSES, MASTURBATORS, NIPPLE CLAMPS, NIPPLE AROUSERS, BODY PROSTHESES, LOVE DOLLS, INFLATABLE REPRODUCTIONS OF BODY PARTS, ELECTRICAL APPLIANCES FOR MASSAGING THE BODY, ADULT SEXUAL AID KITS COMPRISED OF TWO OR MORE OF THE AFORESAID GOODS (U.S. CLS. 26, 39 AND 44).

BILL DAWE, EXAMINING ATTORNEY

SN 76-699,528. METAL INDUSTRIES, INC., CLEARWATER, FL. FILED 9-21-2009.



OWNER OF U.S. REG. NO. 976,802.
THE COLOR(S) YELLOW, RED, BLUE, GREEN, AND BLACK IS/ARE CLAIMED AS A FEATURE OF THE MARK.

THE MARK CONSISTS OF THE WORD "METALAIRE" AND A SERIES OF WAVY LINES SUPERIMPOSED OVER AND BEYOND THE VERTICAL EDGES OF A SQUARE. THE COLOR GREEN APPEARS AS A LINE IN THE FORM OF A WAVE. THE COLOR RED APPEARS AS A LINE IN THE FORM OF A WAVE. THE COLOR YELLOW APPEARS AS A LINE IN THE FORM OF A WAVE. THE COLOR BLUE APPEARS AS A LINE IN THE FORM OF A WAVE AND IN THE LETTERS OF THE WORD "METALAIRE". THE COLOR BLACK APPEARS IN THE SQUARE.

FOR RESISTERS FOR USE IN AIR CONDITIONING, HEATING AND VENTILATING SYSTEMS; AIR CONDITIONING DAMPERS, VENTILATING LOUVERS, VENTILATION FAN ACCESSORIES, NAMELY, GRILLES, FOR USE IN AIR CONDITIONING, HEATING AND VENTILATING SYSTEMS; AIR TERMINAL UNITS IN THE NATURE OF AIR CLEANING AND CONDITIONING UNITS FOR USE IN AIR CONDITIONING, HEATING AND VENTILATING SYSTEMS (U.S. CLS. 13, 21, 23, 31 AND 34).

WILLIAM ROSSMAN, EXAMINING ATTORNEY

CLASS 11—(Continued).

SN 76-700,567. STONE SOURCE, INC., PLYMOUTH, MN.
FILED 11-27-2009.

LOM

THE MARK CONSISTS OF THE WORDING "LOM" WITH A LINE OVER THE "O".
FOR SINKS, BIDETS, COMMODOES, IN THE NATURE OF WASHSTANDS, BASINS, AND WASHPOTS, WATER CLOSETS, URINALS, BATH TUBS, HOT TUBS, SHOWERS, WATER PLUMBING FIXTURES, NAMELY, SINKS, TOILETS, FAUCETS, AND TOILET SEATS (U.S. CLS. 13, 21, 23, 31 AND 34).

FIRST USE 9-29-2009; IN COMMERCE 9-29-2009.
RAMONA ORTIGA, EXAMINING ATTORNEY

SN 77-416,827. WILLIAM G. SYKES, VIRGINIA BEACH, VA.
FILED 3-8-2008.



THE COLOR(S) BLUE IS/ARE CLAIMED AS A FEATURE OF THE MARK.

THE MARK CONSISTS OF THE COLOR BLUE APPEARS IN THE TWO WAVED SHAPED FIGURES ENTERING A BOX SHAPED FIGURE FROM THE LEFT, THE BOX ALSO APPEARING IN BLUE.

FOR VENTILATING LOUVERS; ELECTRIC FANS FOR CRAWLSPACE BOARDS (U.S. CLS. 13, 21, 23, 31 AND 34).

FIRST USE 2-1-2001; IN COMMERCE 3-1-2001.
DANNEAN HETZEL, EXAMINING ATTORNEY

SN 77-716,894. IMPLUS FOOTCARE, LLC, DURHAM, NC.
FILED 4-18-2009.

THE TAILGATER

THE MARK CONSISTS OF STANDARD CHARACTERS WITHOUT CLAIM TO ANY PARTICULAR FONT, STYLE, SIZE, OR COLOR.

FOR NON-ELECTRIC POCKET WARMERS, NAMELY, CHEMICALLY-ACTIVATED HEATING PACKETS FOR WARMING HANDS (U.S. CLS. 13, 21, 23, 31 AND 34).

FIRST USE 8-1-2009; IN COMMERCE 8-1-2009.
DAWN HAN, EXAMINING ATTORNEY

CLASS 11—(Continued).

SN 77-726,031. SHAFER ENTERPRISES LLC, STOCK-BRIDGE, GA. FILED 4-30-2009.

AQUA VEST

NO CLAIM IS MADE TO THE EXCLUSIVE RIGHT TO USE "VEST", APART FROM THE MARK AS SHOWN.

THE MARK CONSISTS OF THE TERMS "AQUA VEST" WITH SNOW CAP LETTERING.

FOR PERSONAL COOLING SYSTEMS INCORPORATED INTO A VEST FOR SUPPLYING COOL AIR, COOL WATER, OR BOTH TO A WEARER'S CHEST AREA TO COOL THE WEARER'S CHEST AREA, COMPRISED OF A COOLER FOR HOUSING ICE, DRY ICE, AND WATER, A CONDUIT SYSTEM FOR PROVIDING COOL AIR AND COOL WATER FROM THE COOLER TO THE VEST, AND AN APPARATUS FOR FORCING COOL AIR OR COOL WATER THROUGH THE CONDUIT SYSTEM AND THE VEST, ALL SOLD AS A UNIT; AND PERSONAL COOLING SYSTEMS INCORPORATED INTO A VEST COMPRISED OF A COOLER FOR HOUSING ICE, DRY ICE, AND WATER, CAPABLE OF GENERATING COOL AIR AND WATER, A CONDUIT SYSTEM FOR PROVIDING COOL AIR OR COOL WATER FROM THE COOLER TO THE VEST, AN APPARATUS THAT FORCES COOL AIR OR COOL WATER THROUGH THE CONDUIT SYSTEM AND THE VEST, AN ELECTRICAL CONTACT FOR CONNECTING THE PERSONAL COOLING SYSTEM TO A SOURCE OF ELECTRICITY, A HEAT EXCHANGER, AND A MICRO-PROCESSOR, ALL SOLD AS A UNIT (U.S. CLS. 13, 21, 23, 31 AND 34).

FIRST USE 3-1-2008; IN COMMERCE 3-1-2008.
TEJBIR SINGH, EXAMINING ATTORNEY

SN 77-744,145. HORIZON TECHNOLOGY, INC., SALEM, NH. FILED 5-26-2009.

ATLANTIC

THE MARK CONSISTS OF STANDARD CHARACTERS WITHOUT CLAIM TO ANY PARTICULAR FONT, STYLE, SIZE, OR COLOR.

FOR SOLID PHASE EXTRACTION DISKS FOR REMOVING CHEMICAL COMPOUNDS FROM WATER FOR TESTING AND ANALYSIS (U.S. CLS. 13, 21, 23, 31 AND 34).

FIRST USE 3-0-2007; IN COMMERCE 3-0-2007.
EUGENIA MARTIN, EXAMINING ATTORNEY

CLASS 11—(Continued).

SN 77-767,880. SEARS BRANDS, LLC, HOFFMAN ESTATES, IL. FILED 6-25-2009.



THE COLOR(S) WHITE AND ORANGE IS/ARE CLAIMED AS A FEATURE OF THE MARK.

THE MARK CONSISTS OF A STYLIZED ORANGE AND WHITE CLOCK OUTLINED IN BLACK WITH WHITE HANDS AND TWO WHITE ARCS WITHIN THE CLOCK, ONE OF WHICH HAS AN ARROW AT ITS END. THE COLOR BLACK IN THE DRAWING ONLY REPRESENTS OUTLINING AND IS NOT PART OF THE MARK.

FOR LCD PANELS SOLD AS COMPONENT PARTS OF CLOTHES DRYERS FEATURING DRYER CYCLE OPTIONS THAT ALLOW USERS TO PROGRAM DRYER CYCLE TIME (U.S. CLS. 13, 21, 23, 31 AND 34).

MORGAN WYNNE, EXAMINING ATTORNEY

SN 77-773,072. FIVES, PARIS, FRANCE, FILED 7-2-2009.

FIVES NORTH AMERICAN

THE MARK CONSISTS OF STANDARD CHARACTERS WITHOUT CLAIM TO ANY PARTICULAR FONT, STYLE, SIZE, OR COLOR.

PRIORITY CLAIMED UNDER SEC. 44(D) ON ERP CMNTY TM OFC APPLICATION NO. 008367096, FILED 6-16-2009, REG. NO. 008367096, DATED 1-26-2010, EXPIRES 6-16-2019.

OWNER OF U.S. REG. NOS. 3,627,162, 3,708,809 AND OTHERS.

NO CLAIM IS MADE TO THE EXCLUSIVE RIGHT TO USE "NORTH AMERICAN", APART FROM THE MARK AS SHOWN.

FOR PARTS OF COMBUSTION APPARATUS, NAMELY, GAS, OIL, AND DUAL FUEL BURNERS FOR INDUSTRIAL FURNACES, KILNS, OVENS, DRYERS AND BOILERS; HEAT EXCHANGERS, NAMELY, RECUPERATORS AND REGENERATORS FOR INDUSTRIAL FURNACES, KILNS, OVENS, DRYERS AND BOILERS; INDUSTRIAL AIR FILTERS; COLD AND HOT AIR BLOWERS (U.S. CLS. 13, 21, 23, 31 AND 34).

SCOTT BIBB, EXAMINING ATTORNEY

CLASS 11—(Continued).

SN 77-773,270. PRESBY ENVIRONMENTAL, INC., WHITE-FIELD, NH. FILED 7-2-2009.

BIO-ACCELERATOR

THE MARK CONSISTS OF STANDARD CHARACTERS WITHOUT CLAIM TO ANY PARTICULAR FONT, STYLE, SIZE, OR COLOR.

FOR LIQUID FLOW CONTROL DEVICE FOR USE IN CENTRALIZED WASTE WATER AND SEPTIC WASTE WATER TREATMENT FOR REMOVING HUMAN WASTE COMPRISED PRIMARILY OF NON-METALLIC PIPES AND GEOTEXTILE FILTER FABRIC NOT FOR USE IN PROCESSING WASTES FROM FOOD PROCESSING PLANTS (U.S. CLS. 13, 21, 23, 31 AND 34).

TINA BROWN, EXAMINING ATTORNEY

SN 77-780,933. WATERLESS CO., INC., VISTA, CA. FILED 7-14-2009.

WATERLESS

THE MARK CONSISTS OF STANDARD CHARACTERS WITHOUT CLAIM TO ANY PARTICULAR FONT, STYLE, SIZE, OR COLOR.

OWNER OF U.S. REG. NO. 1,997,950.

SEC. 2(F).

FOR URINALS (U.S. CLS. 13, 21, 23, 31 AND 34).

FIRST USE 5-0-1991; IN COMMERCE 6-0-1991.

BRIDGETT SMITH, EXAMINING ATTORNEY

SN 77-784,865. STREET GLOW HOLDINGS CORP, WAYNE, NJ. FILED 7-20-2009.

XTRASLIM

THE MARK CONSISTS OF STANDARD CHARACTERS WITHOUT CLAIM TO ANY PARTICULAR FONT, STYLE, SIZE, OR COLOR.

FOR SLIM AND FLEXIBLE LIGHTING STRIPS FOR ACCESSORIZING AUTOMOBILES, MOTORCYCLES, BICYCLES, WATERCRAFT (U.S. CLS. 13, 21, 23, 31 AND 34).

ERIN FALK, EXAMINING ATTORNEY

CLASS 11—(Continued).

SN 77-792,839. LISM INC., DBA GREEN JOINT VENTURES, SALINAS, CA. FILED 7-29-2009.

GREEN JOINT VENTURES

THE MARK CONSISTS OF STANDARD CHARACTERS WITHOUT CLAIM TO ANY PARTICULAR FONT, STYLE, SIZE, OR COLOR.

NO CLAIM IS MADE TO THE EXCLUSIVE RIGHT TO USE "GREEN", APART FROM THE MARK AS SHOWN.

FOR HYDROPONICS GROW BOX IN THE NATURE OF A CLOSED ENVIRONMENT EQUIPPED WITH LIGHTS, EXHAUST SYSTEM, HYDROPONICS GROWING CONTAINER AND ODOR CONTROL SYSTEM, FEATURING ENVIRONMENTALLY-FRIENDLY TECHNOLOGIES; SOLAR COLLECTORS; SOLAR ENERGY BASED COOLING APPARATUS; SOLAR HEAT COLLECTION PANELS; SOLAR LIGHT FIXTURES, NAMELY, INDOOR AND OUTDOOR SOLAR POWERED LIGHTING UNITS AND FIXTURES (U.S. CLS. 13, 21, 23, 31 AND 34).

KRISTINA MORRIS, EXAMINING ATTORNEY

SN 77-801,743. DAIKIN INDUSTRIES, LTD., OSAKA, JAPAN, FILED 8-11-2009.

HEXAGON

THE MARK CONSISTS OF STANDARD CHARACTERS WITHOUT CLAIM TO ANY PARTICULAR FONT, STYLE, SIZE, OR COLOR.

FOR AIR CONDITIONING APPARATUS AND INSTALLATIONS; AIR COOLING APPARATUS AND INSTALLATIONS; AIR HEATING APPARATUS AND INSTALLATIONS; WATER HEATERS; REFRIGERATING MACHINES, APPARATUS AND INSTALLATIONS; FREEZING MACHINES, APPARATUS AND INSTALLATIONS FOR INDUSTRIAL PURPOSES; COOLING MACHINES, APPARATUS AND INSTALLATIONS FOR INDUSTRIAL PURPOSES; AIR-COOLED CHILLERS FOR INDUSTRIAL USE; WATER-COOLED CHILLERS FOR INDUSTRIAL USE; AIR-COOLED HEAT PUMP CHILLERS; COOLANT CIRCULATION APPARATUS AND INSTALLATIONS FOR INDUSTRIAL PURPOSES (U.S. CLS. 13, 21, 23, 31 AND 34).

LEIGH CAROLINE CASE, EXAMINING ATTORNEY

CLASS 11—(Continued).

SN 77-802,111. GLOBE UNION (BERMUDA) TRADING LTD., HAMILTON, BERMUDA, FILED 8-11-2009.

GERBER PLUS

THE MARK CONSISTS OF STANDARD CHARACTERS WITHOUT CLAIM TO ANY PARTICULAR FONT, STYLE, SIZE, OR COLOR.

OWNER OF U.S. REG. NOS. 1,172,156, 1,197,796 AND 2,127,185.

FOR PLUMBING FITTINGS, NAMELY, SHOWER VALVES (U.S. CLS. 13, 21, 23, 31 AND 34).

KATHERINE CHANG, EXAMINING ATTORNEY

SN 77-805,691. FRYMASTER LLC, SHREVEPORT, LA. FILED 8-17-2009.

PASTA MAGIC

THE MARK CONSISTS OF STANDARD CHARACTERS WITHOUT CLAIM TO ANY PARTICULAR FONT, STYLE, SIZE, OR COLOR.

OWNER OF U.S. REG. NOS. 1,029,993, 1,171,097 AND 1,294,014.

NO CLAIM IS MADE TO THE EXCLUSIVE RIGHT TO USE "PASTA", APART FROM THE MARK AS SHOWN.

FOR FOOD SERVICE EQUIPMENT, NAMELY, ELECTRIC AND GAS HOT WATER REETHERMALIZING UNIT FOR HEATING AND HOLDING FOOD (U.S. CLS. 13, 21, 23, 31 AND 34).

MICHAEL LITZAU, EXAMINING ATTORNEY

SN 77-815,000. ALTO-SHAAM, INC., MENOMONEE FALLS, WI. FILED 8-28-2009.

COMBICLEAN

THE MARK CONSISTS OF STANDARD CHARACTERS WITHOUT CLAIM TO ANY PARTICULAR FONT, STYLE, SIZE, OR COLOR.

OWNER OF U.S. REG. NOS. 1,638,273 AND 2,282,794.

FOR COMMERCIAL COOKING OVENS; PARTS FOR COMMERCIAL COOKING OVENS, NAMELY, AN INTEGRAL COMPONENT OF FINISHED COMMERCIAL COOKING OVENS THAT AUTOMATICALLY CLEANS THE OVEN USING JETS OF WATER (U.S. CLS. 13, 21, 23, 31 AND 34).

REBECCA SMITH, EXAMINING ATTORNEY

CLASS 11—(Continued).

SN 77-815,005. ALTO-SHAAM, INC., MENOMONEE FALLS, WI. FILED 8-28-2009.

COMBISMOKE

THE MARK CONSISTS OF STANDARD CHARACTERS WITHOUT CLAIM TO ANY PARTICULAR FONT, STYLE, SIZE, OR COLOR.

OWNER OF U.S. REG. NOS. 1,638,273 AND 2,282,794.
 FOR COMMERCIAL COOKING OVENS; PARTS FOR COMMERCIAL COOKING OVENS, NAMELY, AN OPTIONAL, INTEGRAL COMPONENT OF FINISHED COMMERCIAL COOKING OVENS THAT ALLOWS THE SMOKING AS WELL AS THE CONVECTION AND STEAM COOKING OF FOOD PRODUCTS (U.S. CLS. 13, 21, 23, 31 AND 34).

REBECCA SMITH, EXAMINING ATTORNEY

SN 77-832,303. CHART INC., GARFIELD HEIGHTS, OH. FILED 9-22-2009.

IPSMR

THE MARK CONSISTS OF STANDARD CHARACTERS WITHOUT CLAIM TO ANY PARTICULAR FONT, STYLE, SIZE, OR COLOR.

FOR APPARATUS AND EQUIPMENT FOR NATURAL GAS LIQUEFACTION, NAMELY, HEAT EXCHANGERS, SEPARATORS FOR THE CLEANING, PURIFICATION, REFRIGERATION AND LIQUEFACTION OF GASES AND LIQUIDS (U.S. CLS. 13, 21, 23, 31 AND 34).

ROBERT STRUCK, EXAMINING ATTORNEY

SN 77-844,444. RESEARCH COTTRELL DRY COOLING, INC., SOMERVILLE, NJ. FILED 10-8-2009.

CTEC

THE MARK CONSISTS OF STANDARD CHARACTERS WITHOUT CLAIM TO ANY PARTICULAR FONT, STYLE, SIZE, OR COLOR.

FOR HEAT EXCHANGERS AND FLUID CONDENSING EQUIPMENT FOR COOLING VAPOR GENERATED FOR DRIVING TURBINES ASSOCIATED WITH ENERGY GENERATING DEVICES (U.S. CLS. 13, 21, 23, 31 AND 34).

ROBIN CHOSID, EXAMINING ATTORNEY

CLASS 11—(Continued).

SN 77-852,705. BULL OUTDOOR PRODUCTS, INC., RIALTO, CA. FILED 10-20-2009.

BULLET

THE MARK CONSISTS OF STANDARD CHARACTERS WITHOUT CLAIM TO ANY PARTICULAR FONT, STYLE, SIZE, OR COLOR.

FOR APPARATUS FOR OUTDOOR FOOD PREPARATION, NAMELY, CUSTOM MADE OUTDOOR BARBECUES WITH FOOD PREPARATION STATIONS COMPRISED OF BARBECUE GRILLS, COOKING OVENS, SINKS AND/OR REFRIGERATORS (U.S. CLS. 13, 21, 23, 31 AND 34).

FIRST USE 2-10-1997; IN COMMERCE 3-15-2001.
 AMEEN IMAM, EXAMINING ATTORNEY

SN 77-856,699. ZOKU, LLC, HOBOKEN, NJ. FILED 10-24-2009.

QUICK POPS

THE MARK CONSISTS OF STANDARD CHARACTERS WITHOUT CLAIM TO ANY PARTICULAR FONT, STYLE, SIZE, OR COLOR.

NO CLAIM IS MADE TO THE EXCLUSIVE RIGHT TO USE "POPS", APART FROM THE MARK AS SHOWN.

FOR FOOD AND BEVERAGE COOLING AND HEATING RECEPTACLES CONTAINING HEAT EXCHANGE FLUID FOR HOUSEHOLD PURPOSES (U.S. CLS. 13, 21, 23, 31 AND 34).

FIRST USE 7-9-2009; IN COMMERCE 7-9-2009.
 GEOFFREY FOSDICK, EXAMINING ATTORNEY

CLASS 11—(Continued).

SN 77-862,846. KROHNER, KEVIN A, VENICE, CA. FILED 11-2-2009.

"Illuminating technology for a cooler planet"

THE MARK CONSISTS OF STANDARD CHARACTERS WITHOUT CLAIM TO ANY PARTICULAR FONT, STYLE, SIZE, OR COLOR.

NO CLAIM IS MADE TO THE EXCLUSIVE RIGHT TO USE "ILLUMINATING TECHNOLOGY", APART FROM THE MARK AS SHOWN.

FOR LED (LIGHT EMITTING DIODE) LIGHTING FIXTURES; LED (LIGHT EMITTING DIODES) LIGHTING FIXTURES FOR USE IN DISPLAY, COMMERCIAL, INDUSTRIAL, RESIDENTIAL, AND ARCHITECTURAL ACCENT LIGHTING APPLICATIONS; LED AND HID LIGHT FIXTURES; LED LIGHT ASSEMBLIES FOR STREET LIGHTS, SIGNS, COMMERCIAL LIGHTING, AUTOMOBILES, BUILDINGS, AND OTHER ARCHITECTURAL USES; LED LIGHT BULBS; LED LIGHTING FIXTURES FOR INDOOR AND OUTDOOR LIGHTING APPLICATIONS (U.S. CLS. 13, 21, 23, 31 AND 34).

THOMAS MANOR, EXAMINING ATTORNEY

SN 77-884,005. CONAIR CORPORATION, STAMFORD, CT. FILED 12-2-2009.

COFFEE PLUS

THE MARK CONSISTS OF STANDARD CHARACTERS WITHOUT CLAIM TO ANY PARTICULAR FONT, STYLE, SIZE, OR COLOR.

NO CLAIM IS MADE TO THE EXCLUSIVE RIGHT TO USE "COFFEE", APART FROM THE MARK AS SHOWN.

FOR ELECTRIC COFFEE BREWERS; ELECTRIC COFFEE MACHINES; ELECTRIC COFFEE MAKERS; ELECTRIC COFFEE POTS (U.S. CLS. 13, 21, 23, 31 AND 34).

SUSAN STIGLITZ, EXAMINING ATTORNEY

SN 77-885,126. PANASIA CO., LTD., GANGSEO-GU, BUSAN, REPUBLIC OF KOREA, FILED 12-3-2009.

GLOEN PATROL

THE MARK CONSISTS OF STANDARD CHARACTERS WITHOUT CLAIM TO ANY PARTICULAR FONT, STYLE, SIZE, OR COLOR.

OWNER OF REPUBLIC OF KOREA REG. NO. 0671270, DATED 7-21-2006, EXPIRES 7-21-2016.

FOR WATER STERILIZERS, WATER PURIFICATION APPARATUS, INSTALLATIONS FOR PURIFYING WASTEWATER, AIR PURIFYING APPARATUS, SEAWATER STERILIZERS (U.S. CLS. 13, 21, 23, 31 AND 34).

SOPHIA S. KIM, EXAMINING ATTORNEY

CLASS 11—(Continued).

SN 77-895,563. MICROFILTER CO., LTD., JINCHEON-GUN, CHUNBUK, REPUBLIC OF KOREA, FILED 12-17-2009.



THE COLOR(S) BLUE, YELLOW AND RED IS/ARE CLAIMED AS A FEATURE OF THE MARK.

THE MARK CONSISTS OF THE WORD "FLUUX" APPEARING IN BLUE WITH THREE HORIZONTAL BARS APPEARING TO THE LEFT, THE TOP BAR APPEARING IN BLUE, THE MIDDLE BAR APPEARING IN YELLOW AND THE LOWEST BAR APPEARING IN RED.

THE WORDING "FLUUX" HAS NO MEANING IN A FOREIGN LANGUAGE.

FOR WATER PURIFIERS FOR HOUSEHOLD USE; NON-ELECTRIC WATER PURIFIERS FOR HOUSEHOLD USE; ELECTRIC WATER PURIFIERS FOR HOUSEHOLD USE; ICE WATER PURIFIERS FOR HOUSEHOLD USE; FILTRATION APPARATUS FOR WATER PURIFIERS FOR HOUSEHOLD USE; ION WATER PURIFIERS FOR HOUSEHOLD USE; ELECTROLYTIC WATER PURIFIERS FOR HOUSEHOLD USE; CARTRIDGE FILTERS FOR WATER PURIFIERS FOR HOUSEHOLD USE; FILTERS FOR WATER PURIFIERS FOR HOUSEHOLD USE; FILTER CARTRIDGES FOR WATER PURIFIERS; BIDET; ICE-MAKING MACHINE; ICE MACHINES; AIR PURIFYING APPARATUS (U.S. CLS. 13, 21, 23, 31 AND 34).

DAVID TAYLOR, EXAMINING ATTORNEY

SN 77-899,778. GEOCOMFORT, INC, GREENVILLE, IL. FILED 12-23-2009.



OWNER OF U.S. REG. NO. 2,838,003.

NO CLAIM IS MADE TO THE EXCLUSIVE RIGHT TO USE "GEOHERMAL SYSTEMS", APART FROM THE MARK AS SHOWN.

THE COLOR(S) GREEN AND BLACK IS/ARE CLAIMED AS A FEATURE OF THE MARK.

THE MARK CONSISTS OF TWO GREEN EVERGREEN TREES WITH A GREEN ARC. THE STYLIZED GREEN LETTERS "GEO", STYLIZED BLACK LETTERS "COMFORT", AND THE WORDS "GEOHERMAL SYSTEMS" IN BLACK APPEAR TO THE RIGHT OF THE DESIGN.

FOR GROUND SOURCE AND WATER SOURCE HEAT-PUMPS RELATED TO GEOHERMAL HEATING, COOLING AND HOT WATER APPLICATIONS IN MAJOR MARKET AND RESIDENTIAL MARKETS (U.S. CLS. 13, 21, 23, 31 AND 34).

FIRST USE 1-1-2009; IN COMMERCE 1-30-2009.

GISELLE AGOSTO, EXAMINING ATTORNEY

CLASS 11—(Continued).

SN 77-917,510. BAD DUST CONTAINMENT SYSTEMS, LLC, EAST HADDAM, CT. FILED 1-22-2010.

BAD DUST

THE MARK CONSISTS OF STANDARD CHARACTERS WITHOUT CLAIM TO ANY PARTICULAR FONT, STYLE, SIZE, OR COLOR.

NO CLAIM IS MADE TO THE EXCLUSIVE RIGHT TO USE "DUST", APART FROM THE MARK AS SHOWN.

FOR MODULAR AND REUSABLE AIR CONTAINMENT SYSTEMS COMPOSED OF ELECTRIC FANS, FABRIC AND CLOSURES TO CONTAIN AIRBORNE PARTICULATE MATTER AND CREATE A DEFINABLE WORKSPACE (U.S. CLS. 13, 21, 23, 31 AND 34).

WARREN L. OLANDRIA, EXAMINING ATTORNEY

CLASS 11—(Continued).

SN 77-923,804. FEIT ELECTRIC COMPANY, INC., PICO RIVERA, CA. FILED 1-29-2010.

PERFORMANCE LED

THE MARK CONSISTS OF STANDARD CHARACTERS WITHOUT CLAIM TO ANY PARTICULAR FONT, STYLE, SIZE, OR COLOR.

OWNER OF U.S. REG. NO. 2,776,209.

NO CLAIM IS MADE TO THE EXCLUSIVE RIGHT TO USE "LED", APART FROM THE MARK AS SHOWN.

FOR LED (LIGHT EMITTING DIODE) LIGHTING FIXTURES; LED LIGHT BULBS (U.S. CLS. 13, 21, 23, 31 AND 34).

FIRST USE 3-16-2009; IN COMMERCE 3-16-2009.

KATHRYN COWARD, EXAMINING ATTORNEY

SN 77-922,718. LIFE+GEAR, INC., SOLANA BEACH, CA. FILED 1-28-2010.

HIGHLAND

THE MARK CONSISTS OF STANDARD CHARACTERS WITHOUT CLAIM TO ANY PARTICULAR FONT, STYLE, SIZE, OR COLOR.

FOR FLASHLIGHT HOLDERS; FLASHLIGHTS (U.S. CLS. 13, 21, 23, 31 AND 34).

KELLY CHOE, EXAMINING ATTORNEY

SN 77-924,406. EZ GROOM, INC, NOVI, MI. FILED 1-31-2010.

EZ DRY

THE MARK CONSISTS OF STANDARD CHARACTERS WITHOUT CLAIM TO ANY PARTICULAR FONT, STYLE, SIZE, OR COLOR.

NO CLAIM IS MADE TO THE EXCLUSIVE RIGHT TO USE "DRY", APART FROM THE MARK AS SHOWN.

FOR ELECTRIC HOT AIR HAND DRYERS; HAIR DRYERS; HAND-HELD ELECTRIC HAIR DRYERS; PORTABLE ELECTRIC WARM AIR DRYER; STATIONARY HAIR DRYERS FOR ANIMAL GROOMING (U.S. CLS. 13, 21, 23, 31 AND 34).

FIRST USE 1-1-2005; IN COMMERCE 1-1-2005.

REBECCA POVARCHUK, EXAMINING ATTORNEY

SN 77-922,950. FEIT ELECTRIC COMPANY, INC., PICO RIVERA, CA. FILED 1-28-2010.

GREEN PLANET

THE MARK CONSISTS OF STANDARD CHARACTERS WITHOUT CLAIM TO ANY PARTICULAR FONT, STYLE, SIZE, OR COLOR.

FOR ELECTRIC LIGHT BULBS; LIGHTING PRODUCTS, NAMELY, INCANDESCENT, FLUORESCENT AND COMPACT FLUORESCENT LIGHTING FIXTURES AND HALOGEN LAMPS (U.S. CLS. 13, 21, 23, 31 AND 34).

KATHRYN COWARD, EXAMINING ATTORNEY

SN 77-924,730. VALENTINO BEAUTY PURE, BELMAR, NJ. FILED 2-1-2010.

VALENTINO
Beauty Pure Air Filtration

NO CLAIM IS MADE TO THE EXCLUSIVE RIGHT TO USE "AIR FILTRATION", APART FROM THE MARK AS SHOWN.

THE MARK CONSISTS OF THE STYLIZED WORDS "VALENTINO BEAUTY PURE AIR FILTRATION".

FOR AIR FILTRATION UNITS (U.S. CLS. 13, 21, 23, 31 AND 34).

SAMUEL E. SHARPER JR., EXAMINING ATTORNEY

CLASS 11—(Continued).

SN 77-924,832. RITE-HITE HOLDING CORPORATION, MILWAUKEE, WI. FILED 2-1-2010.

REVOLT

THE MARK CONSISTS OF STANDARD CHARACTERS WITHOUT CLAIM TO ANY PARTICULAR FONT, STYLE, SIZE, OR COLOR.
FOR CEILING FANS (U.S. CLS. 13, 21, 23, 31 AND 34).
SHANNON TWOHIG, EXAMINING ATTORNEY

SN 77-924,949. ELECTRALED, INC., LARGO, FL. FILED 2-1-2010.

ELECTRALED

THE MARK CONSISTS OF STANDARD CHARACTERS WITHOUT CLAIM TO ANY PARTICULAR FONT, STYLE, SIZE, OR COLOR.
OWNER OF U.S. REG. NO. 2,794,642.
FOR LED (LIGHT EMITTING DIODES) LIGHTING FIXTURES FOR USE IN DISPLAY, COMMERCIAL, INDUSTRIAL, AND RESIDENTIAL LIGHTING APPLICATIONS (U.S. CLS. 13, 21, 23, 31 AND 34).
NAAKWAMA ANKRAH, EXAMINING ATTORNEY

SN 77-924,958. ELECTRALED, INC., LARGO, FL. FILED 2-1-2010.



OWNER OF U.S. REG. NO. 3,045,626.
THE MARK CONSISTS OF THE LETTER "E" WITH A JAGGED LIGHTNING BOLT BEHIND THE LETTER.
FOR LED (LIGHT EMITTING DIODES) LIGHTING FIXTURES FOR USE IN DISPLAY, COMMERCIAL, INDUSTRIAL, AND RESIDENTIAL LIGHTING APPLICATIONS (U.S. CLS. 13, 21, 23, 31 AND 34).
NAAKWAMA ANKRAH, EXAMINING ATTORNEY

CLASS 11—(Continued).

SN 77-925,621. VALVE TECK, INCORPORATED, MEMPHIS, TN. FILED 2-2-2010.



THE MARK CONSISTS OF A STYLIZED DEPICTION OF A STREAM OF WATER WITH STYLIZED BUBBLES PASSING THROUGH A THREADED VALVE INSERT, WITH THE WORD "CALIFLO" SUPERIMPOSED ON THE STREAM OF WATER.
FOR METAL FLOW RESTRICTOR USED IN HVAC VALVES (U.S. CLS. 13, 21, 23, 31 AND 34).
FIRST USE 3-8-2002; IN COMMERCE 3-8-2002.
CORY BOONE, EXAMINING ATTORNEY

SN 77-925,982. FEIT ELECTRIC COMPANY, INC., PICO RIVERA, CA. FILED 2-2-2010.

PROPEL

THE MARK CONSISTS OF STANDARD CHARACTERS WITHOUT CLAIM TO ANY PARTICULAR FONT, STYLE, SIZE, OR COLOR.
FOR ELECTRIC LIGHT BULBS; LIGHTING PRODUCTS, NAMELY, INCANDESCENT, FLUORESCENT AND COMPACT FLUORESCENT LIGHTING FIXTURES AND HALOGEN LAMPS; LED (LIGHT EMITTING DIODE) LIGHTING FIXTURES, LED LIGHT BULBS (U.S. CLS. 13, 21, 23, 31 AND 34).
KATHRYN COWARD, EXAMINING ATTORNEY

SN 77-926,444. MASTER HOME PRODUCTS LTD., DBA MHP INTERNATIONAL LTD., SKOKIE, IL. FILED 2-2-2010.

MASTER LIGHTING

THE MARK CONSISTS OF STANDARD CHARACTERS WITHOUT CLAIM TO ANY PARTICULAR FONT, STYLE, SIZE, OR COLOR.
NO CLAIM IS MADE TO THE EXCLUSIVE RIGHT TO USE "LIGHTING", APART FROM THE MARK AS SHOWN.
FOR LIGHTING FIXTURES, LAMPS, AND LIGHT BULBS (U.S. CLS. 13, 21, 23, 31 AND 34).
PRISCILLA MILTON, EXAMINING ATTORNEY

CLASS 11—(Continued).

SN 77-927,566. WOW TOILET, LLC, WESTMINSTER, CA.
FILED 2-3-2010.

WOW TOILET

THE MARK CONSISTS OF STANDARD CHARACTERS WITHOUT CLAIM TO ANY PARTICULAR FONT, STYLE, SIZE, OR COLOR.

NO CLAIM IS MADE TO THE EXCLUSIVE RIGHT TO USE "TOILET", APART FROM THE MARK AS SHOWN.

FOR TOILET TANKS (U.S. CLS. 13, 21, 23, 31 AND 34).

FIRST USE 10-5-2009; IN COMMERCE 10-5-2009.

KAELIE KUNG, EXAMINING ATTORNEY

CLASS 11—(Continued).

SN 77-928,609. CHAFFEE, KEVIN R., BATESVILLE, IN.
FILED 2-4-2010.

ENVIROFILTER

THE MARK CONSISTS OF STANDARD CHARACTERS WITHOUT CLAIM TO ANY PARTICULAR FONT, STYLE, SIZE, OR COLOR.

FOR WASTE WATER PURIFICATION UNITS (U.S. CLS. 13, 21, 23, 31 AND 34).

FIRST USE 1-28-2000; IN COMMERCE 1-28-2000.

FLORENTINA BLANDU, EXAMINING ATTORNEY

SN 77-927,599. WUXI ZHONGHUI MAGNETIC ENERGY LIGHTS CO., LTD., WUXI, JIANGSU, CHINA, FILED 2-3-2010.

THE MARK CONSISTS OF STYLIZED WORD "MELRIVE" AND LIGHT BULB DEVICE WHICH IS BETWEEN LETTERS "L" AND "R".

FOR AIR PURIFYING APPARATUS AND MACHINES; ELECTRIC LAMPS; ELECTRIC LIGHTING FIXTURES; LAMPS; LAMPS FOR OUTDOOR USE; LIGHT BULBS; LIGHTS FOR VEHICLES; SAFETY LAMPS FOR UNDERGROUND USE; THEATRICAL STAGE LIGHTING APPARATUS; ULTRAVIOLET RAY LAMPS, NOT FOR MEDICAL PURPOSES (U.S. CLS. 13, 21, 23, 31 AND 34).

FIRST USE 7-11-2008; IN COMMERCE 7-11-2008.

BARBARA RUTLAND, EXAMINING ATTORNEY

SN 77-928,664. CHEN, JUN, DBA WAKABA COOKER, MONMOUTH JCT, NJ. FILED 2-4-2010.

THE MARK CONSISTS OF STANDARD CHARACTERS WITHOUT CLAIM TO ANY PARTICULAR FONT, STYLE, SIZE, OR COLOR.

THE ENGLISH TRANSLATION OF "WAKABA" IS "YOUNG LEAF".

FOR ELECTRIC COFFEE MAKERS; ELECTRIC COFFEE MAKERS; ELECTRIC CREPE MAKERS; ELECTRIC SOYMILK MAKER; ELECTRIC WAFFLE MAKER; ELECTRIC YOGURT MAKERS; ELECTRICAL ICE-CREAM MAKERS; ICE CREAM MAKERS (U.S. CLS. 13, 21, 23, 31 AND 34).

FIRST USE 8-3-2009; IN COMMERCE 11-30-2009.

FRED MANDIR, EXAMINING ATTORNEY

SN 77-928,274. CURTIS PHILLIPS, CHATTANOOGA, TN.
FILED 2-4-2010.

THE MARK CONSISTS OF STANDARD CHARACTERS WITHOUT CLAIM TO ANY PARTICULAR FONT, STYLE, SIZE, OR COLOR.

FOR CHEMICALLY-ACTIVATED LIGHT STICKS; CHEMICALLY-ACTIVATED LIGHT STICKS AND LIGHT STICK MOUNTING BRACKETS FOR SKATEBOARDS, SOLD TOGETHER AS A UNIT (U.S. CLS. 13, 21, 23, 31 AND 34).

JORDAN BAKER, EXAMINING ATTORNEY

SN 77-928,751. CHAFFEE, KEVIN R., BATESVILLE, IN.
FILED 2-5-2010.

THE MARK CONSISTS OF STANDARD CHARACTERS WITHOUT CLAIM TO ANY PARTICULAR FONT, STYLE, SIZE, OR COLOR.

FOR WASTE WATER PURIFICATION UNITS (U.S. CLS. 13, 21, 23, 31 AND 34).

FLORENTINA BLANDU, EXAMINING ATTORNEY

CLASS 11—(Continued).

SN 77-928,759. CHAFFEE, KEVIN R., BATESVILLE, IN.
FILED 2-5-2010.

ENVIROMBR

THE MARK CONSISTS OF STANDARD CHARACTERS
WITHOUT CLAIM TO ANY PARTICULAR FONT, STYLE,
SIZE, OR COLOR.
FOR WASTE WATER PURIFICATION UNITS (U.S.
CLS. 13, 21, 23, 31 AND 34).
FLORENTINA BLANDU, EXAMINING ATTORNEY

SN 77-929,224. MESTEK, INC., WESTFIELD, MA. FILED 2-5-
2010.

VANGUARD

THE MARK CONSISTS OF STANDARD CHARACTERS
WITHOUT CLAIM TO ANY PARTICULAR FONT, STYLE,
SIZE, OR COLOR.
FOR ENCLOSURES FOR HYDRONIC BASEBOARD
HEATING ELEMENTS (U.S. CLS. 13, 21, 23, 31 AND 34).
FIRST USE 6-0-2009; IN COMMERCE 6-0-2009.
SUE LAWRENCE, EXAMINING ATTORNEY

SN 77-929,356. STEMLITE INCORPORATED, CASTAIC, CA.
FILED 2-5-2010.

Stemlite

THE MARK CONSISTS OF STANDARD CHARACTERS
WITHOUT CLAIM TO ANY PARTICULAR FONT, STYLE,
SIZE, OR COLOR.
FOR BICYCLE LIGHTS (U.S. CLS. 13, 21, 23, 31 AND
34).
KELLEY WELLS, EXAMINING ATTORNEY

CLASS 11—(Continued).

SN 77-929,694. LENNOX INDUSTRIES INC., RICHARDSON,
TX. FILED 2-5-2010.

LANDMARK

THE MARK CONSISTS OF STANDARD CHARACTERS
WITHOUT CLAIM TO ANY PARTICULAR FONT, STYLE,
SIZE, OR COLOR.
FOR ROOFTOP HVAC UNITS (U.S. CLS. 13, 21, 23, 31
AND 34).
FIRST USE 8-23-2007; IN COMMERCE 2-4-2008.
WILLIAM BRECKENFELD, EXAMINING ATTORNEY

SN 77-929,718. WATER4HUMANS CORP., SAINT AUGUS-
TINE, FL. FILED 2-6-2010.

WATER4HUMANS

THE MARK CONSISTS OF STANDARD CHARACTERS
WITHOUT CLAIM TO ANY PARTICULAR FONT, STYLE,
SIZE, OR COLOR.
FOR FILTERS FOR DRINKING WATER (U.S. CLS. 13,
21, 23, 31 AND 34).
FIRST USE 2-5-2010; IN COMMERCE 2-5-2010.
CYNTHIA SLOAN, EXAMINING ATTORNEY

SN 77-930,199. YU-TING HUANG, TAICHUNG CITY, TAI-
WAN, FILED 2-8-2010.

STARFORCE

THE MARK CONSISTS OF STANDARD CHARACTERS
WITHOUT CLAIM TO ANY PARTICULAR FONT, STYLE,
SIZE, OR COLOR.
FOR BICYCLE LIGHTS; FLASHLIGHTS; ELECTRIC
LIGHTS; MULTI-PURPOSE, ELECTRIC COUNTERTOP
FOOD PREPARATION APPARATUS FOR COOKING,
BAKING, BROILING, ROASTING, TOASTING, SEAR-
ING, BROWNING, BARBECUING AND GRILLING
FOOD; ELECTRIC GRIDDLES; ELECTRIC LAMPS;
SEARCHLIGHTS; WATER FILTERING APPARATUS;
BUTANE TORCH FOR COOKING; LIGHTERS PRIMAR-
ILY FOR LIGHTING GRILLS, FIREPLACES AND CAN-
DLES (U.S. CLS. 13, 21, 23, 31 AND 34).
FIRST USE 11-1-2009; IN COMMERCE 11-1-2009.
DAVID ELTON, EXAMINING ATTORNEY

CLASS 11—(Continued).

SN 77-930,285. XIAO PEI TAO, SHANGHAI, CHINA, FILED 2-8-2010.

FLASHTORCH

THE MARK CONSISTS OF STANDARD CHARACTERS WITHOUT CLAIM TO ANY PARTICULAR FONT, STYLE, SIZE, OR COLOR.
FOR FLASHLIGHTS (U.S. CLS. 13, 21, 23, 31 AND 34).
CHRISTOPHER BUONGIORNO, EXAMINING ATTORNEY

SN 77-930,327. DECTRON, INC., MONTREAL, QUEBEC, CANADA, FILED 2-8-2010.

DECTRON PURGE

THE MARK CONSISTS OF STANDARD CHARACTERS WITHOUT CLAIM TO ANY PARTICULAR FONT, STYLE, SIZE, OR COLOR.
OWNER OF U.S. REG. NO. 3,401,490.
NO CLAIM IS MADE TO THE EXCLUSIVE RIGHT TO USE "PURGE", APART FROM THE MARK AS SHOWN.
FOR VENTILATION APPARATUS FOR INDUSTRIAL AIR-CONDITIONING EQUIPMENT (U.S. CLS. 13, 21, 23, 31 AND 34).
MICHAEL KEATING, EXAMINING ATTORNEY

SN 77-930,355. BROADA, INC., DBA BROADA LIGHTING, CITY OF INDUSTRY, CA. FILED 2-8-2010.

DIM-BRITE

THE MARK CONSISTS OF STANDARD CHARACTERS WITHOUT CLAIM TO ANY PARTICULAR FONT, STYLE, SIZE, OR COLOR.
FOR ELECTRIC LIGHT BULBS; FLUORESCENT ELECTRIC LIGHT BULBS; LAMP BULBS; LIGHT BULBS; LIGHTBULBS (U.S. CLS. 13, 21, 23, 31 AND 34).
REBECCA POVARCHUK, EXAMINING ATTORNEY

CLASS 11—(Continued).

SN 77-930,719. DECTRON, INC., MONTREAL, QUEBEC, CANADA, FILED 2-8-2010.

DRY-O-TRON PURGE

THE MARK CONSISTS OF STANDARD CHARACTERS WITHOUT CLAIM TO ANY PARTICULAR FONT, STYLE, SIZE, OR COLOR.
OWNER OF U.S. REG. NO. 1,173,094.
NO CLAIM IS MADE TO THE EXCLUSIVE RIGHT TO USE "PURGE", APART FROM THE MARK AS SHOWN.
FOR VENTILATION APPARATUS FOR INDUSTRIAL AIR-CONDITIONING EQUIPMENT (U.S. CLS. 13, 21, 23, 31 AND 34).
MICHAEL KEATING, EXAMINING ATTORNEY

SN 77-930,741. OEM DIRECT SALES, INC., BROOKLYN, NY. FILED 2-8-2010.

POWER THERM DIRECTFIRE

THE MARK CONSISTS OF STANDARD CHARACTERS WITHOUT CLAIM TO ANY PARTICULAR FONT, STYLE, SIZE, OR COLOR.
FOR STATIONARY ELECTRICAL, HEATING AND COOLING SYSTEMS, COMPRISING INTEGRATED BOILER-MICROTURBINE SYSTEMS FOR USE IN LARGE MULTIFAMILY, COMMERCIAL, AND INDUSTRIAL BUILDINGS (U.S. CLS. 13, 21, 23, 31 AND 34).
FLORENTINA BLANDU, EXAMINING ATTORNEY

SN 77-931,265. JOSEPH DANIEL KENNEDY, METTER, GA. FILED 2-9-2010.

UNFOLD, COOK & GO

THE MARK CONSISTS OF STANDARD CHARACTERS WITHOUT CLAIM TO ANY PARTICULAR FONT, STYLE, SIZE, OR COLOR.
FOR PORTABLE STOVES (U.S. CLS. 13, 21, 23, 31 AND 34).
H. M. FISHER, EXAMINING ATTORNEY

CLASS 11—(Continued).

SN 77-931,311. BURNABY, JOHN, SANTA BARBARA, CA.
FILED 2-9-2010.

MATZAP

THE MARK CONSISTS OF STANDARD CHARACTERS WITHOUT CLAIM TO ANY PARTICULAR FONT, STYLE, SIZE, OR COLOR.

FOR DISINFECTING ULTRAVIOLET LAMPS HOUSED IN A CONTAINER OR COVER FOR DISINFECTING OBJECTS PLACED THEREIN (U.S. CLS. 13, 21, 23, 31 AND 34).

FIRST USE 1-23-2010; IN COMMERCE 1-23-2010.
SETH A. RAPPAPORT, EXAMINING ATTORNEY

SN 77-931,459. RAB LIGHTING INC., NORTHVALE, NJ.
FILED 2-9-2010.

RBAY

THE MARK CONSISTS OF STANDARD CHARACTERS WITHOUT CLAIM TO ANY PARTICULAR FONT, STYLE, SIZE, OR COLOR.

FOR LIGHTING FIXTURES (U.S. CLS. 13, 21, 23, 31 AND 34).

KHANH LE, EXAMINING ATTORNEY

CLASS 11—(Continued).

SN 77-932,628. RYLAND TANIGUCHI, SEATTLE, WA.
FILED 2-10-2010.

Ecosewage

THE MARK CONSISTS OF STANDARD CHARACTERS WITHOUT CLAIM TO ANY PARTICULAR FONT, STYLE, SIZE, OR COLOR.

FOR ENVIRONMENTAL CONTROL APPARATUS, NAMELY, PARTICLE ACTIVATORS FOR USE IN SOIL REMEDIATION, DRINKING WATER TREATMENT, MUNICIPAL AND INDUSTRIAL WASTEWATER TREATMENT; SEPTIC TANKS; SEWAGE DISPOSAL PLANTS; SEWAGE PURIFICATION APPARATUS; SEWAGE PURIFICATION INSTALLATIONS; SEWAGE TREATMENT PLANTS; SUSTAINABLE ONSITE WATER RECYCLING AND WASTEWATER TREATMENT SYSTEMS; THICKENING AND DEWATERING MACHINES FOR USE IN TREATMENT OF LIQUIDS INCLUDING WATER, INDUSTRIAL EFFLUENT AND SEWAGE; WASTE WATER PURIFICATION UNITS; WATER CONDITIONING UNITS; WATER COOLERS; WATER COOLING TOWERS; WATER DESALINATION PLANTS; WATER FILTERING DEVICES, NAMELY, WATER PURIFICATION INSTALLATIONS FOR WASTE WATER AND SEWAGE CONSISTING OF CURTAINS AND TEXTILE FABRICS; WATER PURIFICATION AND FILTRATION APPARATUS; WATER PURIFICATION MACHINES; WATER PURIFICATION TANKS; WATER PURIFICATION UNITS; WATER PURIFICATION, SEDIMENTATION AND FILTRATION APPARATUS FOR CLARIFICATION, THICKENING AND FILTRATION OF WATER, WASTE WATER AND INDUSTRIAL WATER; WATER PURIFIERS; WATER PURIFYING APPARATUS; WATER TREATMENT APPARATUS, NAMELY, CLARIFICATION AND THICKENING MACHINES FOR USE IN TREATMENT OF LIQUIDS IN THE NATURE OF WATER, WASTE WATER AND INDUSTRIAL WATER; WATER TREATMENT EQUIPMENT, NAMELY, ULTRAVIOLET STERILIZATION UNITS (U.S. CLS. 13, 21, 23, 31 AND 34).

TRACY WHITTAKER-BROWN, EXAMINING ATTORNEY

SN 77-932,953. THE SUNRIDER CORPORATION, DBA SUNRIDER INTERNATIONAL, TORRANCE, CA. FILED 2-10-2010.

SUNRIDER

THE MARK CONSISTS OF STANDARD CHARACTERS WITHOUT CLAIM TO ANY PARTICULAR FONT, STYLE, SIZE, OR COLOR.

OWNER OF U.S. REG. NOS. 1,972,103, 3,674,233 AND OTHERS.

FOR WATER PURIFIERS; AIR PURIFIERS; AIR PURIFICATION UNITS; WATER PURIFICATION UNITS; AIR FILTERS FOR DOMESTIC USE; WATER FILTERS; FILTERS MADE OF FIBER FOR WATER FILTRATION (U.S. CLS. 13, 21, 23, 31 AND 34).

DOMINIC J. FERRAIUOLO, EXAMINING ATTORNEY

CLASS 11—(Continued).

SN 77-932,961. THE SUNRIDER CORPORATION, DBA SUNRIDER INTERNATIONAL, TORRANCE, CA. FILED 2-10-2010.



OWNER OF U.S. REG. NOS. 1,972,103, 3,674,233 AND OTHERS.
 THE MARK CONSISTS OF A STYLIZED SUN DESIGN OVER THE WORD "SUNRIDER".
 FOR WATER PURIFIERS; AIR PURIFIERS; AIR PURIFICATION UNITS; WATER PURIFICATION UNITS; AIR FILTERS FOR DOMESTIC USE; WATER FILTERS; FILTERS MADE OF FIBER FOR WATER FILTRATION (U.S. CLS. 13, 21, 23, 31 AND 34).
 DOMINIC J. FERRAIUOLO, EXAMINING ATTORNEY

SN 77-935,054. APTWATER, INC., PLEASANT HILL, CA. FILED 2-12-2010.



THE MARK CONSISTS OF A CHEMICAL STRUCTURE OF THREE CONNECTED CIRCLES INSIDE AN IMAGE OF A WATER DROP WHICH IS NEXT TO THE STYLIZED WORD "APTwater".
 FOR WATER TREATMENT EQUIPMENT FOR INJECTING HYDROGEN PEROXIDE, OZONE AND OTHER CHEMICALS AND COMPOUNDS INTO CONTAMINATED WATERS AND SUBSURFACES FOR THE TREATMENT THEREFOR; WATER TREATMENT UNITS USING OXIDATION FOR DOMESTIC, COMMERCIAL AND INDUSTRIAL USE (U.S. CLS. 13, 21, 23, 31 AND 34).
 FIRST USE 2-11-2010; IN COMMERCE 2-11-2010.
 PRISCILLA MILTON, EXAMINING ATTORNEY

SN 77-940,664. CHAFFEE, KEVIN R., BATESVILLE, IN. FILED 2-20-2010.

ENVIROSBR

THE MARK CONSISTS OF STANDARD CHARACTERS WITHOUT CLAIM TO ANY PARTICULAR FONT, STYLE, SIZE, OR COLOR.
 FOR SEWAGE TREATMENT PLANTS (U.S. CLS. 13, 21, 23, 31 AND 34).
 FLORENTINA BLANDU, EXAMINING ATTORNEY

CLASS 11—(Continued).

SN 77-945,580. UOP LLC, DES PLAINES, IL. FILED 2-26-2010.

SIMULFLOW

THE MARK CONSISTS OF STANDARD CHARACTERS WITHOUT CLAIM TO ANY PARTICULAR FONT, STYLE, SIZE, OR COLOR.
 FOR MASS TRANSFER DEVICES, NAMELY, FRACTIONATION TRAYS AND DISTILLATION COLUMNS (U.S. CLS. 13, 21, 23, 31 AND 34).
 CHRISTOPHER BUONGIORNO, EXAMINING ATTORNEY

SN 77-953,997. AS IP HOLDCO, LLC, PISCATAWAY, NJ. FILED 3-9-2010.

**PERFORMANCE DESIGNED
 AROUND YOU**

THE MARK CONSISTS OF STANDARD CHARACTERS WITHOUT CLAIM TO ANY PARTICULAR FONT, STYLE, SIZE, OR COLOR.
 FOR SANITARY FITTINGS AND FIXTURES, NAMELY, TOILETS, SINKS, FAUCETS, PLUMBING FITTINGS IN THE NATURE OF DRAINS AND BATH FILLERS, SHOWERS, BATHTUBS, WHIRLPOOL BATHS, AND PARTS THEREFOR (U.S. CLS. 13, 21, 23, 31 AND 34).
 SIMON TENG, EXAMINING ATTORNEY

SN 77-967,016. CHEVRON INTELLECTUAL PROPERTY LLC, SAN RAMON, CA. FILED 3-24-2010.

SKY CHIEF

THE MARK CONSISTS OF STANDARD CHARACTERS WITHOUT CLAIM TO ANY PARTICULAR FONT, STYLE, SIZE, OR COLOR.
 FOR GLASS LANTERN GLOBES (U.S. CLS. 13, 21, 23, 31 AND 34).
 MARK SHINER, EXAMINING ATTORNEY

CLASS 11—(Continued).

SN 77-968,274. CHEVRON INTELLECTUAL PROPERTY LLC, SAN RAMON, CA. FILED 3-25-2010.

FIRE-CHIEF

THE MARK CONSISTS OF STANDARD CHARACTERS WITHOUT CLAIM TO ANY PARTICULAR FONT, STYLE, SIZE, OR COLOR.

FOR GLASS LANTERN GLOBES (U.S. CLS. 13, 21, 23, 31 AND 34).

MARK SHINER, EXAMINING ATTORNEY

SN 78-848,944. EUREKA LIGHTING INC., MONTREAL, QUÉBEC, CANADA, FILED 3-29-2006.

ARKITEK

THE MARK CONSISTS OF STANDARD CHARACTERS WITHOUT CLAIM TO ANY PARTICULAR FONT, STYLE, SIZE, OR COLOR.

PRIORITY CLAIMED UNDER SEC. 44(D) ON CANADA APPLICATION NO. 1293602, FILED 3-14-2006, REG. NO. TMA763,497, DATED 4-8-2010, EXPIRES 4-8-2025.

FOR INCANDESCENT AND GAS TUBE LIGHTING FIXTURES, INCLUDING RECESSED, TRACK, WALL, CEILING, PENDANT, AND STRIP LIGHTING FIXTURES; INCANDESCENT AND GAS TUBE SPECIALTY LIGHTING FIXTURES, INCLUDING SUBMERSIBLE ENCLOSED AND GASKETED, LANDSCAPE, LIGHTING FIXTURES; FURNITURE CABINET, DISPLAY CASE, AND SHOWCASE LIGHTING FIXTURES; BASE CONDUCTORS AND FIBER OPTIC LIGHTING FIXTURES; INCANDESCENT AND GAS TUBE PORTABLE LUMINARIES (U.S. CLS. 13, 21, 23, 31 AND 34).

ARETHA SOMERVILLE, EXAMINING ATTORNEY

CLASS 11—(Continued).

SN 79-066,343. UFO ISIKLA ISITMA SISTEMLERI; SANAYI VE TICARET LTD. STI., HADIMKOY - ISTANBUL, TURKEY, FILED 8-29-2008.



PRIORITY DATE OF 5-12-2008 IS CLAIMED. OWNER OF INTERNATIONAL REGISTRATION 0996251 DATED 8-29-2008, EXPIRES 8-29-2018.

THE COLOR(S) WHITE, ORANGE IS/ARE CLAIMED AS A FEATURE OF THE MARK.

BASED ON WHITE BACKGROUND, CHARACTERS OF "UFO" ARE ORANGE COLOUR.

THE TRANSLITERATION OF THE NON-LATIN CHARACTERS IN THE MARK IS: UNIDENTIFIED FLYING OBJECT.

FOR APPARATUS FOR HEATING AND STEAM GENERATING, NAMELY, ELECTRIC STOVES AS PART OF HEATING INSTALLATIONS; BOILERS FOR CENTRAL HEATING AND NATURAL GAS INSTALLATIONS; ELECTRICAL STEAM BOILERS; HEAT EXCHANGERS; GAS BURNERS; EQUIPMENT FOR HEATING SYSTEMS, NAMELY, PORTABLE, WALL-MOUNTED AND STAND-MOUNTED ELECTRIC HEATERS, INFRARED FILA-MENTS AND REFLECTOR MODULES; WATER HEATERS USED ALSO AS HEATING SYSTEM; WATER HEATERS; RADIATORS; HEAT PUMPS; ELECTRICAL WATER BOILERS; SOLAR ENERGY COLLECTORS AND APPARATUS OF HERMETIC DESIGN AND MADE OF SPECIFIC PLATE GLASS; AIR CONDITIONING AND VENTILATION APPARATUS, NAMELY, AIR CONDITIONERS; ELECTRIC FANS, NAMELY, HOT AIR BLOWERS; VENTILATORS FOR HOUSEHOLD, INDUSTRIAL AND COMMERCIAL USE; AIR CONDITIONERS, INCLUDING FOR VEHICLES; AIR DISINFECTANTS AND AIR CLEANING APPARATUS FOR USE INDOORS AND IN PARTIALLY-ENCLOSED SPACES, NAMELY, AIR IONIZERS AND AIR CLEANSERS UTILIZING ULTRASONIC TECHNOLOGY; REFRIGERANTS, NAMELY, REFRIGERATORS; DEEP FREEZERS; ICE CHESTS; ICE MACHINES AND APPARATUS, INDUSTRIAL COOLING INSTALLATION; WATER COOLING TOWERS (U.S. CLS. 13, 21, 23, 31 AND 34).

SCOTT BIBB, EXAMINING ATTORNEY

SN 79-072,751. OTV SA, SAINT MAURICE, FRANCE, FILED 6-12-2009.

biopROtector

PRIORITY DATE OF 12-18-2008 IS CLAIMED. OWNER OF INTERNATIONAL REGISTRATION 1012851 DATED 6-12-2009, EXPIRES 6-12-2019.

THE MARK CONSISTS OF THE WORDING "BIOPROTECTOR" IN STYLIZED FONT.

FOR WATER TREATMENT EQUIPMENT, NAMELY, FIXED BED UNITS, NAMELY, A VESSEL WITH BIO-FILM CARRIERS USED TO PREVENT MEMBRANE FOULING IN WATER TREATMENT INSTALLATIONS (U.S. CLS. 13, 21, 23, 31 AND 34).

WILLIAM ROSSMAN, EXAMINING ATTORNEY

CLASS 11—(Continued).

SN 79-073,100. NIKLES TEC ITALIA S.R.L., ITALY, FILED 7-17-2009.



PRIORITY DATE OF 3-12-2009 IS CLAIMED.
 OWNER OF INTERNATIONAL REGISTRATION 1013789
 DATED 7-17-2009, EXPIRES 7-17-2019.
 FOR AIR AND WATER MIXING SYSTEMS, NAMELY,
 A COMBINATION OF SPRAY NOZZLES, DIRECTIONAL
 PLATES AND WATER CHAMBER FOR MIXING AIR
 AND WATER FOR SUPPLYING APPARATUS, NAMELY,
 SHOWER HEAD AND KITCHEN FAUCETS (U.S. CLS.
 13, 21, 23, 31 AND 34).
 DORITT L. CARROLL, EXAMINING ATTORNEY

CLASS 12—(Continued).

SN 77-509,064. DAYCO PRODUCTS, LLC, TULSA, OK.
 FILED 6-26-2008.

89230

THE MARK CONSISTS OF STANDARD CHARACTERS
 WITHOUT CLAIM TO ANY PARTICULAR FONT, STYLE,
 SIZE, OR COLOR.
 SEC. 2(F).
 FOR AUTOMOTIVE POWER TRANSMISSION COM-
 PONENTS, NAMELY, AUTOMATIC BELT TENSIONERS
 (U.S. CLS. 19, 21, 23, 31, 35 AND 44).
 FIRST USE 9-2-1999; IN COMMERCE 9-2-1999.
 KRISTIN DAHLING, EXAMINING ATTORNEY

SN 77-509,073. DAYCO PRODUCTS, LLC, TULSA, OK.
 FILED 6-26-2008.

CLASS 12—VEHICLES

SN 76-685,102. PALUSZKIEWICZ, CARL, MISSISSAUGA,
 ONTARIO, CANADA, FILED 12-19-2007.

BAGGER SHADES

THE MARK CONSISTS OF STANDARD CHARACTERS
 WITHOUT CLAIM TO ANY PARTICULAR FONT, STYLE,
 SIZE, OR COLOR.

PRIORITY CLAIMED UNDER SEC. 44(D) ON CANADA
 APPLICATION NO. 1370734, FILED 10-29-2007.

NO CLAIM IS MADE TO THE EXCLUSIVE RIGHT TO
 USE "BAGGER", APART FROM THE MARK AS SHOWN.

FOR MOTORCYCLE WIND DEFLECTOR ACCES-
 SORIES, NAMELY, DECORATIVE OVERLAYS FOR DIS-
 PLAY AGAINST MOTORCYCLE WIND DEFLECTORS,
 MOTORCYCLE WIND DEFLECTOR ACCESSORY SUP-
 PORTS FOR SUPPORTING DECORATIVE OVERLAYS
 AGAINST WIND DEFLECTORS, MOTORCYCLE WIND
 DEFLECTOR ACCESSORY SUPPORTS FOR SUPPORT-
 ING ONE OR MORE ANTENNA ABOUT WIND DE-
 FLECTORS, MOTORCYCLE WIND DEFLECTOR
 ACCESSORY SUPPORTS FOR SUPPORTING MOTOR-
 CYCLE LIGHTENING ABOUT WIND DEFLECTORS,
 MOTORCYCLE WIND DEFLECTOR ACCESSORY SUP-
 PORTS FOR SUPPORTING ONE OR MORE RUNNING
 LIGHT ABOUT WIND DEFLECTORS, MOTORCYCLE
 WIND DEFLECTOR ACCESSORY SUPPORTS FOR SUP-
 PORTING ONE OR MORE BRAKE LIGHTS ABOUT
 WIND DEFLECTORS, MOTORCYCLE WIND DEFLEC-
 TOR ACCESSORY SUPPORTS FOR SUPPORTING ONE
 OR MORE PAIRS OF TURN SIGNAL INDICATORS
 ABOUT WIND DEFLECTORS (U.S. CLS. 19, 21, 23, 31,
 35 AND 44).
 DAVID TOOLEY, EXAMINING ATTORNEY

89231

THE MARK CONSISTS OF STANDARD CHARACTERS
 WITHOUT CLAIM TO ANY PARTICULAR FONT, STYLE,
 SIZE, OR COLOR.
 SEC. 2(F).
 FOR AUTOMOTIVE POWER TRANSMISSION COM-
 PONENTS, NAMELY, AUTOMATIC BELT TENSIONERS
 (U.S. CLS. 19, 21, 23, 31, 35 AND 44).
 FIRST USE 9-2-1999; IN COMMERCE 9-2-1999.
 KRISTIN DAHLING, EXAMINING ATTORNEY

SN 77-509,085. DAYCO PRODUCTS, LLC, TULSA, OK.
 FILED 6-26-2008.

89233

THE MARK CONSISTS OF STANDARD CHARACTERS
 WITHOUT CLAIM TO ANY PARTICULAR FONT, STYLE,
 SIZE, OR COLOR.

SEC. 2(F).
 FOR AUTOMOTIVE POWER TRANSMISSION COM-
 PONENTS, NAMELY, AUTOMATIC BELT TENSIONERS
 (U.S. CLS. 19, 21, 23, 31, 35 AND 44).
 FIRST USE 1-9-2002; IN COMMERCE 1-9-2002.
 KRISTIN DAHLING, EXAMINING ATTORNEY

CLASS 12—(Continued).

SN 77-538,222. POWERBRONZE INTERNATIONAL LIMITED, WEST SUSSEX, UNITED KINGDOM, FILED 8-4-2008.



OWNER OF UNITED KINGDOM REG. NO. 2325792, DATED 2-20-2004, EXPIRES 3-6-2013.

THE COLOR(S) RED, WHITE AND BLACK IS/ARE CLAIMED AS A FEATURE OF THE MARK.

THE MARK CONSISTS OF A BLACK AND RED OVAL CONTAINING THE LETTERING "POWERBRONZE" IN LOWERCASE LETTERS, EXCEPT FOR AN UPPER-CASE "P". THE COLOR RED APPEARS IN THE LETTERS OF THE WORD "POWERBRONZE" AND IN THE BOTTOM HALF OF THE BACKGROUND; THE COLOR BLACK IS IN THE TOP HALF OF THE BACKGROUND; THE COLOR WHITE APPEARS IN A CURVED SWISH DESIGN ON THE RIGHT SIDE AND ON THE LEFT SIDE OF THE BACKGROUND; THE COLOR WHITE ALSO APPEARS ON THE OUTLINE OF THE LETTERS OF THE WORD "POWERBRONZE".

FOR WINDSCREENS, HEADLIGHT PROTECTORS, AND FAIRINGS, ALL FOR MOTOR VEHICLES; TAIL GUARDS, MUDGUARDS, AND MUDGUARD EXTENSIONS FOR LAND VEHICLES; STRUCTURAL PARTS OF MOTOR VEHICLES, NAMELY, SEAT COWLS AND EXHAUST BRACKETS; BODY PANELS FOR MOTOR VEHICLES; TAIL RISERS, NAMELY, SPOILERS FOR VEHICLES; CAR SPOILERS; FUEL TANK CAPS FOR MOTOR VEHICLES; FRAME SLIDERS; MOTORCYCLE PARTS KIT COMPOSED PRIMARILY OF FOOT RESTS; REAR BUMPERS AND FENDERS ALL FOR LAND VEHICLES; AUTOMOTIVE BELLY PANS FOR MOTORCYCLES; MOTORCYCLE RADIATOR COVERS AND RADIATOR GRILLS (U.S. CLS. 19, 21, 23, 31, 35 AND 44).
BERYL GARDNER, EXAMINING ATTORNEY

CLASS 12—(Continued).

SN 77-577,597. AXLETECH INTERNATIONAL IP HOLDING, L.L.C., TROY, MI. FILED 9-24-2008.



OWNER OF U.S. REG. NO. 2,867,334.

NO CLAIM IS MADE TO THE EXCLUSIVE RIGHT TO USE "BRAND", APART FROM THE MARK AS SHOWN.

THE MARK CONSISTS OF A CIRCULAR FRAGMENT OF TWO MESHING GEARS WITH THE WORDS "SOMA A BRAND OF AXLETECH" DISPLAYED AROUND THE CIRCULAR FRAGMENT OF MESHING GEARS.

FOR LAND VEHICLE PARTS, NAMELY, AXLES, DIFFERENTIAL CARRIER ASSEMBLIES, SUSPENSION SYSTEMS FOR TRUCKS, MILITARY VEHICLES AND OFF ROAD VEHICLES, BRAKES, TRANSFER CASES, WHEEL ENDS, DRIVELINES AND PROPELLER SHAFTS OF LAND VEHICLE DRIVE TRAINS; LAND VEHICLE PARTS, NAMELY, DRIVE TRAIN COMPONENTS IN THE NATURE OF DRIVE SHAFTS, UNIVERSAL JOINTS, GEARS, AXLE SHAFTS AND WHEEL HUBS; LAND VEHICLE PARTS, NAMELY, SUSPENSION COMPONENTS IN THE NATURE OF SPRINGS, COIL SPRINGS, AIR SPRINGS, LEAF SPRINGS, BALL JOINTS, CONTROL ARMS AND AXLE CARRIERS (U.S. CLS. 19, 21, 23, 31, 35 AND 44).

FIRST USE 6-1-2007; IN COMMERCE 6-1-2008.

COLLEEN DOMBROW, EXAMINING ATTORNEY

SN 77-636,741. KONINKLIJKE GAZELLE NV, 6951 BPDIEREN, NETHERLANDS, FILED 12-19-2008.

GAZELLE

THE MARK CONSISTS OF STANDARD CHARACTERS WITHOUT CLAIM TO ANY PARTICULAR FONT, STYLE, SIZE, OR COLOR.

OWNER OF U.S. REG. NO. 3,041,011.

FOR BICYCLES FOR ADULTS AND CHILDREN (U.S. CLS. 19, 21, 23, 31, 35 AND 44).

FIRST USE 0-0-1938; IN COMMERCE 11-22-1999.

VERNA BETH RIRIE, EXAMINING ATTORNEY

CLASS 12—(Continued).

SN 77-724,039. LINGLONG NORTH AMERICA, LLC, COPLEY, OH. FILED 4-28-2009.

ATLAS

THE MARK CONSISTS OF STANDARD CHARACTERS WITHOUT CLAIM TO ANY PARTICULAR FONT, STYLE, SIZE, OR COLOR.

FOR TIRES; TIRES FOR LAND VEHICLES, AUTOMOBILE TIRES, TRUCK TIRES (U.S. CLS. 19, 21, 23, 31, 35 AND 44).

FIRST USE 4-28-2009; IN COMMERCE 4-28-2009.
JENNIFER MARTIN, EXAMINING ATTORNEY

CLASS 12—(Continued).

SN 77-783,954. KIMBLE MANUFACTURING COMPANY, SPRING LAKE, MI. FILED 7-17-2009.



THE MARK CONSISTS OF FIVE STYLIZED CIRCLES INSIDE A STYLIZED CIRCLE.

FOR CONCRETE MIXING TRUCKS AND TRUCK STRUCTURAL PARTS, NAMELY, FITTINGS, FENDERS, METAL LADDERS, CONCRETE MIXING DRUMS, MOUNTING ASSEMBLIES AND SUB-FRAMES SOLD AS COMPONENTS OF CONCRETE MIXER TRUCKS; HYDRAULIC SYSTEMS ADAPTED FOR USE ON CONCRETE MIXING TRUCKS COMPRISING HYDRAULIC PUMPS, HYDRAULIC MOTORS, CYLINDERS, CONTROL VALVES, TUBING AND HOSES (U.S. CLS. 19, 21, 23, 31, 35 AND 44).

CHRISIE B. KING, EXAMINING ATTORNEY

SN 77-749,796. CONSULTING AVIATION SERVICES, INC., DBA CAS, KENNESAW, GA. FILED 6-2-2009.

Vortex Control Finlets

THE MARK CONSISTS OF STANDARD CHARACTERS WITHOUT CLAIM TO ANY PARTICULAR FONT, STYLE, SIZE, OR COLOR.

NO CLAIM IS MADE TO THE EXCLUSIVE RIGHT TO USE "VORTEX CONTROL", APART FROM THE MARK AS SHOWN.

FOR STRUCTURAL PARTS FOR AIRPLANES, NAMELY, DEVICES FOR IMPROVING DRAG, REDUCING FUEL CONSUMPTION, AND INCREASING RANGE OF THE AIRPLANE (U.S. CLS. 19, 21, 23, 31, 35 AND 44).

FIRST USE 4-6-2004; IN COMMERCE 5-20-2009.
MIDGE BUTLER, EXAMINING ATTORNEY

SN 77-787,928. KIMBLE MANUFACTURING COMPANY, SPRING LAKE, MI. FILED 7-23-2009.



THE MARK CONSISTS OF THE TERMS "KIMBLE HARD-WEAR" WITH A CURVED LINE GOING OVER THE TERM "KIMBLE".

FOR CONCRETE MIXING TRUCKS AND TRUCK STRUCTURAL PARTS, NAMELY, FITTINGS, FENDERS, METAL LADDERS, CONCRETE MIXING DRUMS, MOUNTING ASSEMBLIES AND SUB-FRAMES SOLD AS COMPONENTS OF CONCRETE MIXER TRUCKS; HYDRAULIC SYSTEMS ADAPTED FOR USE ON CONCRETE MIXING TRUCKS COMPRISING HYDRAULIC PUMPS, HYDRAULIC MOTORS, CYLINDERS, CONTROL VALVES, TUBING AND HOSES (U.S. CLS. 19, 21, 23, 31, 35 AND 44).

CHRISIE B. KING, EXAMINING ATTORNEY

SN 77-783,947. WAYNE ENGINEERING CORPORATION, CEDAR FALLS, IA. FILED 7-17-2009.

QUANTUM

THE MARK CONSISTS OF STANDARD CHARACTERS WITHOUT CLAIM TO ANY PARTICULAR FONT, STYLE, SIZE, OR COLOR.

FOR REFUSE TRUCKS (U.S. CLS. 19, 21, 23, 31, 35 AND 44).

FIRST USE 12-23-2008; IN COMMERCE 12-23-2008.
KATHERINE CHANG, EXAMINING ATTORNEY

CLASS 12—(Continued).

SN 77-792,942. OPEN RANGE RV COMPANY, SHIPSHA-
NA, IN. FILED 7-30-2009.



THE MARK CONSISTS OF AN ARTISTIC RENDERING
OF A FRONT VIEW OF FIVE GALLOPING HORSES WITH
THE WORDS "ROLLING THUNDER".

FOR RECREATIONAL VEHICLES, NAMELY, TOW-
ABLE TRAILERS (U.S. CLS. 19, 21, 23, 31, 35 AND 44).
FIRST USE 6-16-2009; IN COMMERCE 6-24-2009.
DANIEL CAPSHAW, EXAMINING ATTORNEY

CLASS 12—(Continued).

SN 77-802,255. MONTARE LLC, DBA DUTCH DOG DESIGN,
REDMOND, WA. FILED 8-11-2009.

DoggyRide

THE MARK CONSISTS OF STANDARD CHARACTERS
WITHOUT CLAIM TO ANY PARTICULAR FONT, STYLE,
SIZE, OR COLOR.

OWNER OF NETHERLANDS REG. NO. 0742169, DATED
8-6-2003, EXPIRES 8-6-2013.

FOR BICYCLE TRAILERS (RIYAKAH); STROLLERS
(U.S. CLS. 19, 21, 23, 31, 35 AND 44).

KIM MONINGHOFF, EXAMINING ATTORNEY

SN 77-794,153. HEARTSTRINGS, INC., ROGERS, AR. FILED
7-31-2009.

HYDRAULINK

THE MARK CONSISTS OF STANDARD CHARACTERS
WITHOUT CLAIM TO ANY PARTICULAR FONT, STYLE,
SIZE, OR COLOR.

FOR TRACTOR HITCHES; TRACTOR HITCH PARTS,
NAMELY, HYDRAULIC AND PNEUMATIC TRACTOR
HITCH COUPLERS; TRACTOR PARTS, NAMELY, HY-
DRAULIC AND PNEUMATIC TRACTOR HITCH COU-
PLERS; HITCHES FOR TRAILERS (U.S. CLS. 19, 21, 23,
31, 35 AND 44).

JULIE VEPPUMTHARA, EXAMINING ATTORNEY

SN 77-803,963. SHB INTERNATIONAL INC, ALSIP, IL.
FILED 8-13-2009.

CLEARVIEW

THE COLOR(S) BLUE AND WHITE IS/ARE CLAIMED AS
A FEATURE OF THE MARK.

THE MARK CONSISTS OF THE UNDERLINED WORD-
ING "CLEARVIEW" IN BLUE WITH THE DESIGN OF A
BLUE WINDSHIELD IN PLACE OF THE "V" WITH A
WHITE WINDSHIELD WIPER.

FOR VEHICLE PARTS, NAMELY, WINDSHIELD WI-
PERS (U.S. CLS. 19, 21, 23, 31, 35 AND 44).

KRISTIN DAHLING, EXAMINING ATTORNEY

SN 77-795,775. MIYAKI CO., LTD, SHIZUOKA, JAPAN,
FILED 8-3-2009.

KASHIMACOAT

THE MARK CONSISTS OF STANDARD CHARACTERS
WITHOUT CLAIM TO ANY PARTICULAR FONT, STYLE,
SIZE, OR COLOR.

FOR VEHICLE PARTS, NAMELY, SHOCK ABSOR-
BERS; SHOCK ABSORBERS FOR AUTOMOBILES;
TWO-WHEELED MOTOR VEHICLES; BICYCLES; BI-
CYCLES PARTS, NAMELY, FORKS AND STRUCTURAL
PARTS OF BICYCLES (U.S. CLS. 19, 21, 23, 31, 35 AND
44).

RONALD MCMORROW, EXAMINING ATTORNEY

SN 77-833,053. GOLFIT LTD., TEL KATZIR, ISRAEL, FILED
9-23-2009.

SWIGO

THE MARK CONSISTS OF STANDARD CHARACTERS
WITHOUT CLAIM TO ANY PARTICULAR FONT, STYLE,
SIZE, OR COLOR.

FOR LOCOMOTIVES, NAMELY, VEHICLES FOR LO-
COMOTION BY LAND, AIR, WATER OR RAIL; MOTOR
VEHICLES, NAMELY, AUTOMOBILES, TRUCKS, VANS,
SPORT UTILITY VEHICLES AND STRUCTURAL PARTS
THEREFOR; LAND VEHICLES AND STRUCTURAL
PARTS THEREFOR (U.S. CLS. 19, 21, 23, 31, 35 AND 44).

SKYE YOUNG, EXAMINING ATTORNEY

CLASS 12—(Continued).

SN 77-835,796. TILLICUM INTERNATIONAL INC., DBA VENTURE OUTDOORS, BRIGHAM CITY, UT. FILED 9-26-2009.

VOModular

THE MARK CONSISTS OF STANDARD CHARACTERS WITHOUT CLAIM TO ANY PARTICULAR FONT, STYLE, SIZE, OR COLOR.
 FOR PONTOON BOATS (U.S. CLS. 19, 21, 23, 31, 35 AND 44).
 FIRST USE 9-1-2009; IN COMMERCE 9-1-2009.
 PAM WILLIS, EXAMINING ATTORNEY

SN 77-844,383. HENDERSON PRODUCTS, INC., MANCHESTER, IA. FILED 10-8-2009.

FIRST RESPONSE

THE MARK CONSISTS OF STANDARD CHARACTERS WITHOUT CLAIM TO ANY PARTICULAR FONT, STYLE, SIZE, OR COLOR.
 FOR TRUCK BODIES FEATURING INTEGRATED SPREADERS FOR SPREADING ICE AND SNOW CONTROL PRODUCTS (U.S. CLS. 19, 21, 23, 31, 35 AND 44).
 FIRST USE 9-0-2003; IN COMMERCE 9-0-2003.
 JAMES MACFARLANE, EXAMINING ATTORNEY

SN 77-874,396. AMERICAN OMNI TRADING COMPANY, HOUSTON, TX. FILED 11-17-2009.

VENEZIA

THE MARK CONSISTS OF STANDARD CHARACTERS WITHOUT CLAIM TO ANY PARTICULAR FONT, STYLE, SIZE, OR COLOR.
 THE ENGLISH TRANSLATION OF "VENEZIA" IS VENICE.
 FOR TIRES (U.S. CLS. 19, 21, 23, 31, 35 AND 44).
 RAMONA ORTIGA, EXAMINING ATTORNEY

CLASS 12—(Continued).

SN 77-892,513. KALIL, ANTHONY, PALM CITY, FL. FILED 12-14-2009.

SIRIO

THE MARK CONSISTS OF STANDARD CHARACTERS WITHOUT CLAIM TO ANY PARTICULAR FONT, STYLE, SIZE, OR COLOR.
 THE ENGLISH TRANSLATION OF THE WORD "SIRIO" IN THE MARK IS SIRIUS, THE BRIGHT STAR.
 FOR ELECTRIC BOATS (U.S. CLS. 19, 21, 23, 31, 35 AND 44).
 ALEX KEAM, EXAMINING ATTORNEY

SN 77-895,681. KAPORCH, THOMAS, SAN JUAN CAPISTRANO, CA. FILED 12-17-2009.

NuAge Electric Vehicles

THE MARK CONSISTS OF STANDARD CHARACTERS WITHOUT CLAIM TO ANY PARTICULAR FONT, STYLE, SIZE, OR COLOR.
 NO CLAIM IS MADE TO THE EXCLUSIVE RIGHT TO USE "ELECTRIC VEHICLES", APART FROM THE MARK AS SHOWN.
 THE ENGLISH TRANSLATION OF THE WORD "NUAGE" IN THE MARK IS CLOUD.
 FOR ELECTRIC VEHICLES, NAMELY, LAND VEHICLES (U.S. CLS. 19, 21, 23, 31, 35 AND 44).
 KATHERINE E. HALMEN, EXAMINING ATTORNEY

SN 77-912,068. BENNCHE, INC., CARROLLTON, TX. FILED 1-14-2010.



THE MARK CONSISTS OF A HORSE DESIGN ABOVE A SWALLOW DESIGN, ALL ABOVE THE WORDING "BENNCHE".
 FOR ATVS (ALL TERRAIN VEHICLES); MOTORCYCLES; UTILITY TYPE VEHICLES; ELECTRICAL VEHICLES, NAMELY, MOTORIZED GOLF CARTS (U.S. CLS. 19, 21, 23, 31, 35 AND 44).
 FIRST USE 1-4-2010; IN COMMERCE 1-4-2010.
 TINA MAI, EXAMINING ATTORNEY

CLASS 12—(Continued).

SN 77-920,155. GLOBAL LEAK DETECTION USA, INC., HUNTINGTON BEACH, CA. FILED 1-26-2010.

POP-IT

THE MARK CONSISTS OF STANDARD CHARACTERS WITHOUT CLAIM TO ANY PARTICULAR FONT, STYLE, SIZE, OR COLOR.

FOR FUEL CAP ADAPTORS, NAMELY, ADAPTORS TO BE ATTACHED TO THE FILLER NECK OF THE FUEL TANK OF MOTOR VEHICLES TO ENABLE THE FUEL TANK AND ITS VAPOR LINES TO BE TESTED FOR LEAKS (U.S. CLS. 19, 21, 23, 31, 35 AND 44).

FIRST USE 7-1-2009; IN COMMERCE 7-1-2009.
SALLY SHIH, EXAMINING ATTORNEY

SN 77-921,360. WHITE BEAR LLC, DBA WHITE BEAR LLC, WEST BEND, WI. FILED 1-27-2010.

BEVCON
PLUS
BEVERAGE CONTAINMENT
SYSTEM

THE MARK CONSISTS OF STANDARD CHARACTERS WITHOUT CLAIM TO ANY PARTICULAR FONT, STYLE, SIZE, OR COLOR.

NO CLAIM IS MADE TO THE EXCLUSIVE RIGHT TO USE "BEVERAGE CONTAINMENT SYSTEM", APART FROM THE MARK AS SHOWN.

FOR CUP HOLDERS FOR USE IN VEHICLES (U.S. CLS. 19, 21, 23, 31, 35 AND 44).

RAUL CORDOVA, EXAMINING ATTORNEY

SN 77-924,067. WORLDWIDE AEROS CORP., MONTEBELLO, CA. FILED 1-29-2010.



THE COLOR(S) BLUE IS/ARE CLAIMED AS A FEATURE OF THE MARK.

THE MARK CONSISTS OF A BLUE STYLIZED LETTER "A" INSIDE AN OVAL WITH BLUE OUTLINE, AND THE WORD "AEROS" IN BLUE WITH THE LETTER "O" TURNED SIDEWAYS. THE WHITE IN THE DRAWING REPRESENTS BACKGROUND, OUTLINING, SHADING, AND/OR TRANSPARENT AREAS AND IS NOT PART OF THE MARK.

THE WORDING "AEROS" HAS NO MEANING IN A FOREIGN LANGUAGE.

FOR AEROSTATS; AIRSHIPS (U.S. CLS. 19, 21, 23, 31, 35 AND 44).

FIRST USE 6-1-1994; IN COMMERCE 9-1-1994.
ROBIN MITTLER, EXAMINING ATTORNEY

CLASS 12—(Continued).

SN 77-925,235. EVOLI III SPA, I-84025 EBOLI (SA), ITALY, FILED 2-1-2010.

WSP ITALY

THE MARK CONSISTS OF STANDARD CHARACTERS WITHOUT CLAIM TO ANY PARTICULAR FONT, STYLE, SIZE, OR COLOR.

NO CLAIM IS MADE TO THE EXCLUSIVE RIGHT TO USE "ITALY", APART FROM THE MARK AS SHOWN.

FOR TIRE TUBES FOR VEHICLES; TIRES; TIRES FOR LAND VEHICLES; TIRES FOR VEHICLES; TUBULAR TYRES; VEHICLE WHEEL RIMS; VEHICLE WHEEL RIMS AND STRUCTURAL PARTS THEREFOR; VEHICLE WHEELS; WHEEL COVERS; WHEEL HUBS FOR LAND VEHICLES; WHEEL RIMS; WHEEL RIMS; WHEEL RIMS FOR MOTOR CARS; WHEELS (U.S. CLS. 19, 21, 23, 31, 35 AND 44).

FIRST USE 1-8-2007; IN COMMERCE 10-0-2007.
LINDA POWELL, EXAMINING ATTORNEY

SN 77-925,438. XTREME MACHINE CORP., JACKSONVILLE, IL. FILED 2-1-2010.

Tattoo

THE MARK CONSISTS OF STANDARD CHARACTERS WITHOUT CLAIM TO ANY PARTICULAR FONT, STYLE, SIZE, OR COLOR.

FOR VEHICLE WHEEL RIMS; VEHICLE WHEEL RIMS AND STRUCTURAL PARTS THEREFOR; VEHICLE WHEELS; WHEEL RIMS; WHEEL RIMS; WHEELS FOR BICYCLES, CYCLES (U.S. CLS. 19, 21, 23, 31, 35 AND 44).

FIRST USE 12-0-2009; IN COMMERCE 12-0-2009.
GENE MACIOL, EXAMINING ATTORNEY

SN 77-926,806. BFS BRANDS, LLC, NASHVILLE, TN. FILED 2-3-2010.

GROUND GRIP

THE MARK CONSISTS OF STANDARD CHARACTERS WITHOUT CLAIM TO ANY PARTICULAR FONT, STYLE, SIZE, OR COLOR.

FOR VEHICLE TIRES (U.S. CLS. 19, 21, 23, 31, 35 AND 44).

HOWARD B. LEVINE, EXAMINING ATTORNEY

CLASS 12—(Continued).

SN 77-927,909. GOLDEN TECHNOLOGIES, INC., OLD FORGE, PA. FILED 2-4-2010.

LiteRider^{GOLDEN}

THE MARK CONSISTS OF THE WORD "LITERIDER" WITH THE WORD "GOLDEN" OVER THE LETTERS "ER" IN THE WORD "LITERIDER" IN A STYLIZED FONT. FOR MOTORIZED PERSONAL MOBILITY SCOOTERS (U.S. CLS. 19, 21, 23, 31, 35 AND 44).
SUE LAWRENCE, EXAMINING ATTORNEY

SN 77-928,147. CELLARS INTERNATIONAL, INC., SAN MARCOS, CA. FILED 2-4-2010.

DOBERMAN SYSTEMS

THE MARK CONSISTS OF STANDARD CHARACTERS WITHOUT CLAIM TO ANY PARTICULAR FONT, STYLE, SIZE, OR COLOR.
NO CLAIM IS MADE TO THE EXCLUSIVE RIGHT TO USE "SYSTEMS", APART FROM THE MARK AS SHOWN.
FOR STORAGE AND CONTAINER SYSTEM SPECIALLY ADAPTED FOR USE WITH VEHICLES, NAMELY, A COLLAPSIBLE BOX SHAPED CONTAINER THAT FOLDS AND IS STORED BEHIND THE REAR SEAT BACKS OF AUTOMOBILES (U.S. CLS. 19, 21, 23, 31, 35 AND 44).
JAMES LOVELACE, EXAMINING ATTORNEY

SN 77-928,232. KUSTOM CYCLES, INC., MITCHELL, SD. FILED 2-4-2010.

FLARE

THE MARK CONSISTS OF STANDARD CHARACTERS WITHOUT CLAIM TO ANY PARTICULAR FONT, STYLE, SIZE, OR COLOR.
FOR MOTORCYCLE PARTS AND COMPONENTS, NAMELY, MOTORCYCLE WINDSHIELDS (U.S. CLS. 19, 21, 23, 31, 35 AND 44).
FIRST USE 12-13-2007; IN COMMERCE 12-13-2007.
DAVID COLLIER, EXAMINING ATTORNEY

CLASS 12—(Continued).

SN 77-928,246. TEXTRON INC., PROVIDENCE, RI. FILED 2-4-2010.

2FIVE

THE MARK CONSISTS OF STANDARD CHARACTERS WITHOUT CLAIM TO ANY PARTICULAR FONT, STYLE, SIZE, OR COLOR.
FOR ELECTRIC ON-ROAD AND OFF-ROAD LOW-SPEED VEHICLES, NAMELY, CARS USED AS PERSONAL RESIDENTIAL AND NEIGHBORHOOD VEHICLES, PLANT PERSONNEL CARRIER CARS, BAGGAGE CARRIER CARS, GENERAL UTILITY AND MAINTENANCE CARS, MOTEL AND RESORT CARS AND GOLF CARS (U.S. CLS. 19, 21, 23, 31, 35 AND 44).
DAVID COLLIER, EXAMINING ATTORNEY

SN 77-928,284. MENAHEM, DAVID, FOUNTAIN VALLEY, CA. FILED 2-4-2010.

UNIVEGA

THE MARK CONSISTS OF STANDARD CHARACTERS WITHOUT CLAIM TO ANY PARTICULAR FONT, STYLE, SIZE, OR COLOR.
FOR BICYCLES (U.S. CLS. 19, 21, 23, 31, 35 AND 44).
FIRST USE 2-3-2010; IN COMMERCE 2-3-2010.
MARIA-VICTORIA SUAREZ, EXAMINING ATTORNEY

SN 77-928,317. AERODYNAMIC TRAILER SYSTEMS, LLC, AUBURN TOWNSHIP, OH. FILED 2-4-2010.

SmartTail

THE MARK CONSISTS OF STANDARD CHARACTERS WITHOUT CLAIM TO ANY PARTICULAR FONT, STYLE, SIZE, OR COLOR.
FOR PRODUCTS TO IMPROVE FUEL ECONOMY BY REDUCING AERODYNAMIC DRAG, NAMELY, INFLATABLE BLADDERS INSTALLED ON THE REAR FACE OF A VEHICLE (U.S. CLS. 19, 21, 23, 31, 35 AND 44).
ANTHONY RINKER, EXAMINING ATTORNEY

CLASS 12—(Continued).

SN 77-928,340. AERODYNAMIC TRAILER SYSTEMS, LLC, AUBURN TOWNSHIP, OH. FILED 2-4-2010.

WindTamer

THE MARK CONSISTS OF STANDARD CHARACTERS WITHOUT CLAIM TO ANY PARTICULAR FONT, STYLE, SIZE, OR COLOR.

FOR PRODUCTS TO IMPROVE FUEL ECONOMY BY REDUCING AERODYNAMIC DRAG, NAMELY, A CONTOURED AIR DEFLECTOR MOUNTED ON THE UNDERCARRIAGE OF A VEHICLE (U.S. CLS. 19, 21, 23, 31, 35 AND 44).

ANTHONY RINKER, EXAMINING ATTORNEY

SN 77-928,947. SAAB AUTOMOBILE AB, TROLLHATTAN, SWEDEN, FILED 2-5-2010.

94X

THE MARK CONSISTS OF STANDARD CHARACTERS WITHOUT CLAIM TO ANY PARTICULAR FONT, STYLE, SIZE, OR COLOR.

FOR MOTOR LAND VEHICLES, NAMELY, AUTOMOBILES, SPORT UTILITY VEHICLES, TRUCKS, VANS, ENGINES THEREFOR AND STRUCTURAL PARTS THEREOF EXCLUDING TIRES (U.S. CLS. 19, 21, 23, 31, 35 AND 44).

SHAILA SETTLES, EXAMINING ATTORNEY

SN 77-929,079. INTERNATIONAL TRUCK INTELLECTUAL PROPERTY COMPANY, LLC, WARRENVILLE, IL. FILED 2-5-2010.

TerraStar

THE MARK CONSISTS OF STANDARD CHARACTERS WITHOUT CLAIM TO ANY PARTICULAR FONT, STYLE, SIZE, OR COLOR.

FOR MOTOR VEHICLES, SPECIFICALLY COMMERCIAL TRUCKS (U.S. CLS. 19, 21, 23, 31, 35 AND 44).

THOMAS MANOR, EXAMINING ATTORNEY

CLASS 12—(Continued).

SN 77-930,700. ISUZU COMMERCIAL TRUCK OF AMERICA, INC., ANAHEIM, CA. FILED 2-8-2010.

ECO-MAX

THE MARK CONSISTS OF STANDARD CHARACTERS WITHOUT CLAIM TO ANY PARTICULAR FONT, STYLE, SIZE, OR COLOR.

FOR DIESEL ENGINES FOR LAND VEHICLES; ENGINES FOR LAND VEHICLES; INTERNAL COMBUSTION ENGINES FOR LAND VEHICLES (U.S. CLS. 19, 21, 23, 31, 35 AND 44).

KIMBERLY FRYE, EXAMINING ATTORNEY

SN 77-930,727. JACK ZIMMERMAN, PORT CLINTON, OH. FILED 2-8-2010.



NO CLAIM IS MADE TO THE EXCLUSIVE RIGHT TO USE "COFFEE", APART FROM THE MARK AS SHOWN.

THE MARK CONSISTS OF A PERSPECTIVE VIEW OF A CANOE WITH THE WORD "THE" BETWEEN TWO PADDLES IN THE PASSENGER COMPARTMENT AND THE WORDS "COFFEE CANOE" ON THE SIDE OF THE CANOE.

FOR HOLDER FOR THERMALLY-INSULATED BEVERAGE BOTTLES FOR USE IN VEHICLES (U.S. CLS. 19, 21, 23, 31, 35 AND 44).

FIRST USE 1-28-2010; IN COMMERCE 1-28-2010.

VIVIAN MICZNIK FIRST, EXAMINING ATTORNEY

CLASS 12—(Continued).

SN 77-932,555. VOLVO CAR CORPORATION, AKA VOLVO PERSONVAGNAR AB, GÖTEBORG, SWEDEN, FILED 2-10-2010.

V40

THE MARK CONSISTS OF STANDARD CHARACTERS WITHOUT CLAIM TO ANY PARTICULAR FONT, STYLE, SIZE, OR COLOR.

OWNER OF ERPN CMNTY TM OFC REG. NO. 000028662, DATED 7-23-1999, EXPIRES 4-1-2016.

OWNER OF U.S. REG. NO. 2,813,240.

FOR LAND MOTOR VEHICLES, NAMELY, AUTOMOBILES AND THEIR ENGINES; EXTERIOR INSIGNIA BADGES FOR VEHICLES; VEHICLE ROOFTOP CARRIERS; SPARE TIRE COVERS; MOTOR VEHICLE COVERS; BUG DEFLECTORS FOR MOTOR VEHICLES; RUNNING BOARDS FOR MOTOR VEHICLES; MUD FLAPS FOR MOTOR VEHICLES; HITCH PLUGS FOR MOTOR VEHICLES; SUNSHADES AND LICENSE PLATE FRAMES FOR MOTOR VEHICLES; WINDSHIELDS FOR MOTOR VEHICLES; WINDOWS FOR MOTOR VEHICLES (U.S. CLS. 19, 21, 23, 31, 35 AND 44).

WENDY JUN, EXAMINING ATTORNEY

SN 77-934,734. MICHAEL MITCHELL, DBA MKM CUSTOMS, LINCOLN, CA. FILED 2-12-2010.

Sinister Diesel

THE MARK CONSISTS OF STANDARD CHARACTERS WITHOUT CLAIM TO ANY PARTICULAR FONT, STYLE, SIZE, OR COLOR.

NO CLAIM IS MADE TO THE EXCLUSIVE RIGHT TO USE "DIESEL", APART FROM THE MARK AS SHOWN.

FOR DIESEL ENGINES FOR LAND VEHICLES; DIESEL MOTORS FOR LAND VEHICLES (U.S. CLS. 19, 21, 23, 31, 35 AND 44).

FIRST USE 1-22-2009; IN COMMERCE 11-15-2009.

FRED MANDIR, EXAMINING ATTORNEY

SN 77-935,609. INTERNATIONAL TRUCK INTELLECTUAL PROPERTY COMPANY, LLC, WARRENVILLE, IL. FILED 2-15-2010.

DXM

THE MARK CONSISTS OF STANDARD CHARACTERS WITHOUT CLAIM TO ANY PARTICULAR FONT, STYLE, SIZE, OR COLOR.

FOR MOTOR VEHICLE SUSPENSION SYSTEM (U.S. CLS. 19, 21, 23, 31, 35 AND 44).

THOMAS MANOR, EXAMINING ATTORNEY

CLASS 12—(Continued).

SN 77-943,369. PRIDE MOBILITY PRODUCTS CORPORATION, EXETER, PA. FILED 2-24-2010.

PURSUIT

THE MARK CONSISTS OF STANDARD CHARACTERS WITHOUT CLAIM TO ANY PARTICULAR FONT, STYLE, SIZE, OR COLOR.

FOR ELECTRICALLY POWERED SCOOTERS FOR USE PRINCIPALLY BY ELDERLY, INFIRM AND DISABLED PERSONS, INCLUDING REPAIR AND REPLACEMENT PARTS THEREFOR (U.S. CLS. 19, 21, 23, 31, 35 AND 44).

TOBY BULLOFF, EXAMINING ATTORNEY

SN 77-944,435. INTERNATIONAL TRUCK INTELLECTUAL PROPERTY COMPANY, LLC, WARRENVILLE, IL. FILED 2-25-2010.

MODEC

THE MARK CONSISTS OF STANDARD CHARACTERS WITHOUT CLAIM TO ANY PARTICULAR FONT, STYLE, SIZE, OR COLOR.

FOR ALL ELECTRIC DRIVE MOTOR VEHICLES, NAMELY, TRUCKS, AND BUSES (U.S. CLS. 19, 21, 23, 31, 35 AND 44).

THOMAS MANOR, EXAMINING ATTORNEY

CLASS 12—(Continued).

SN 79-056,678. IRONMAN 4X4 PTY. LTD., AUSTRALIA, FILED 5-19-2008.



OWNER OF INTERNATIONAL REGISTRATION 0971739 DATED 5-19-2008, EXPIRES 5-19-2018.

THE COLOR(S) GREEN, YELLOW, BLACK, RED, ORANGE, WHITE IS/ARE CLAIMED AS A FEATURE OF THE MARK.

THE MARK CONSISTS OF A STYLIZED MAN WITH A SHAVED HEAD. HE IS COLORED WITH SEGMENTS OF YELLOW, BLACK AND GREEN, WITH WHITE TEETH AND FINGERNAILS AND ORANGE EYES; HE IS SQUEEZING A RECTANGLE INSIDE WHICH IS THE WHITE WORDS "IRONMAN 4X4 ACCESSORIES" ON A BLACK BACKGROUND. THE RECTANGLE HAS A BORDER OF ALTERNATING SEGMENTS OF ORANGE, RED AND YELLOW.

FOR MOTOR VEHICLE PARTS AND ACCESSORIES, NAMELY, SHOCK ABSORBING SPRINGS FOR MOTOR VEHICLES, LEAF SPRINGS, COIL SPRINGS, TORSION BARS, BULL BARS; AUTOMOTIVE AFTERMARKET PARTS, NAMELY, MOBILE STORAGE TANKS AND CARGO STORAGE BINS ESPECIALLY ADAPTED TO FIT IN TRUCKS OR SUVs (U.S. CLS. 19, 21, 23, 31, 35 AND 44).

LINDA MICKLEBURGH, EXAMINING ATTORNEY

CLASS 12—(Continued).

SN 85-001,923. INTERNATIONAL TRUCK INTELLECTUAL PROPERTY COMPANY, LLC, WARRENVILLE, IL. FILED 3-30-2010.

ONYX

THE MARK CONSISTS OF STANDARD CHARACTERS WITHOUT CLAIM TO ANY PARTICULAR FONT, STYLE, SIZE, OR COLOR.

FOR RECREATIONAL VEHICLES, NAMELY, TRAVEL TRAILERS (U.S. CLS. 19, 21, 23, 31, 35 AND 44).

THOMAS MANOR, EXAMINING ATTORNEY

SN 79-076,052. ZHEJIANG JINJIA AUTO PARTS CO., LTD., RUIAN, ZHEJIANG, CHINA, FILED 9-2-2009.

锦 佳
JINJIA

OWNER OF INTERNATIONAL REGISTRATION 1021435 DATED 9-2-2009, EXPIRES 9-2-2019.

THE MARK CONSISTS OF TWO CHINESE CHARACTERS THAT TOGETHER MEAN "BEAUTIFUL" IN ENGLISH, ALL OVER THE STYLIZED WORDING "JINJIA."

THE ENGLISH TRANSLATION OF THE WORD "JINJIA" IN THE MARK IS "BEAUTIFUL."

THE NON-LATIN CHARACTERS IN THE MARK TRANSLITERATE TO "JIN JIA" AND THIS MEANS "BEAUTIFUL" IN ENGLISH.

FOR AUTOMOTIVE SPARE PARTS NOT INCLUDING TIRES, NAMELY, HYDRAULIC CIRCUITS FOR VEHICLES, ELECTRIC MOTORS FOR MOTOR CARS, DRIVING MOTORS FOR LAND VEHICLES, TURBINES FOR LAND VEHICLES, AUTOMOBILE BUMPERS, PROPULSION MECHANISMS FOR LAND VEHICLES IN THE NATURE OF ENGINES FOR LAND VEHICLES, TRANSMISSION MECHANISMS FOR LAND VEHICLES, AIR PUMPS OF AUTOMOBILES, ENGINES FOR LAND VEHICLES, GAS CAPS FOR LAND VEHICLES (U.S. CLS. 19, 21, 23, 31, 35 AND 44).

MAUREEN DALL, EXAMINING ATTORNEY

SN 85-004,521. WORLD TRIATHLON CORPORATION, TAMPA, FL. FILED 4-1-2010.

IRONMAN

THE MARK CONSISTS OF STANDARD CHARACTERS WITHOUT CLAIM TO ANY PARTICULAR FONT, STYLE, SIZE, OR COLOR.

OWNER OF U.S. REG. NOS. 1,258,881, 3,328,979 AND OTHERS.

FOR HAND PUMPS USED TO INFLATE BICYCLE TIRES, WHICH ARE MARKETED IN ASSOCIATION WITH CONTESTS CONSISTING OF SWIMMING, BIKING AND RUNNING (U.S. CLS. 19, 21, 23, 31, 35 AND 44).

JUDITH HELFMAN, EXAMINING ATTORNEY

CLASS 13—FIREARMS

SN 77-666,247. SAGE CONTROL ORDNANCE, INC., OSCODA, MI. FILED 2-9-2009.



THE NAME(S), PORTRAIT(S), AND/OR SIGNATURE(S) SHOWN IN THE MARK DOES NOT IDENTIFY A PARTICULAR LIVING INDIVIDUAL.

THE MARK CONSISTS OF A LITERAL ELEMENT CONSISTING OF THE WORD "DEUCE" IN STYLIZED CURSIVE LETTERS AND A DESIGN ELEMENT CONSISTING OF A SILHOUETTE DRAWING OF A SPADE, THE SPADE BEING THE TYPE COMMONLY SEEN ON PLAYING CARDS, WHEREIN THE WORD "DEUCE" IS ANGLED AND SUPERIMPOSED UPON THE SILHOUETTE DRAWING OF THE SPADE.

FOR PROJECTILE LAUNCHERS, NAMELY, PROJECTILE LAUNCHERS FOR FIRING LESS-LETHAL AMMUNITION FOR USE IN LAW-ENFORCEMENT AND MILITARY APPLICATIONS (U.S. CLS. 2 AND 9).

RONALD DELGIZZI, EXAMINING ATTORNEY

SN 77-795,807. ALEXANDER INDUSTRIES, INC., DBA ALEXANDER ARMS, RADFORD, VA. FILED 8-3-2009.

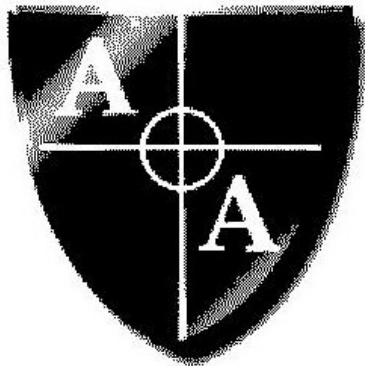

THE MARK CONSISTS OF A SHIELD WITH CROSSHAIRS AND A CIRCLE IN THE CENTER, AND THE LETTERS "AA".

FOR AMMUNITION; AMMUNITION CASINGS; AMMUNITION FOR FIREARMS; CARTRIDGE CASES; CARTRIDGE DIES; GUN AND RIFLE CASES; GUN CARTRIDGES; LOADING TOOLS FOR WEAPONS, NAMELY, RELOADING DIES, RE-CAPPERS AND LOADING BLOCKS; RIFLE CARTRIDGES; RIFLES; RIFLES AND PARTS THEREOF; SHELL CASINGS; SMALL ARMS AMMUNITION (U.S. CLS. 2 AND 9).

FIRST USE 5-6-2001; IN COMMERCE 5-6-2001.

LYDIA BELZER, EXAMINING ATTORNEY

CLASS 13—(Continued).

SN 77-877,397. MIDWEST FIREWORKS MANUFACTURING CO., INC. II, DBA PACIFIC FIREWORKS, LAS VEGAS, NV. FILED 11-20-2009.

COCK BRAND

THE MARK CONSISTS OF STANDARD CHARACTERS WITHOUT CLAIM TO ANY PARTICULAR FONT, STYLE, SIZE, OR COLOR.

NO CLAIM IS MADE TO THE EXCLUSIVE RIGHT TO USE "BRAND", APART FROM THE MARK AS SHOWN.

FOR FIREWORKS (U.S. CLS. 2 AND 9).

FIRST USE 12-26-1999; IN COMMERCE 12-26-1999.

SANJEEV VOHRA, EXAMINING ATTORNEY

SN 77-889,019. TACTICAL LINK, INC., MAPLE VALLEY, WA. FILED 12-8-2009.

BATTERY ASSIST LEVER

THE MARK CONSISTS OF STANDARD CHARACTERS WITHOUT CLAIM TO ANY PARTICULAR FONT, STYLE, SIZE, OR COLOR.

NO CLAIM IS MADE TO THE EXCLUSIVE RIGHT TO USE "LEVER", APART FROM THE MARK AS SHOWN.

FOR BOLT CARRIER GROUP POSITIONING APPARATUS FOR A FIREARM; ACTUATOR FOR LOCKING AND RELEASING A FIREARM BOLT FOR RELOADING AND CLEARING STOPPAGES (U.S. CLS. 2 AND 9).

FIRST USE 9-21-2009; IN COMMERCE 9-21-2009.

MARK T. MULLEN, EXAMINING ATTORNEY

SN 77-924,818. SAEILO ENTERPRISES, INC., PEARL RIVER, NY. FILED 2-1-2010.

X45

THE MARK CONSISTS OF STANDARD CHARACTERS WITHOUT CLAIM TO ANY PARTICULAR FONT, STYLE, SIZE, OR COLOR.

FOR FIREARMS (U.S. CLS. 2 AND 9).

FIRST USE 8-15-2009; IN COMMERCE 1-19-2010.

FLORENTINA BLANDU, EXAMINING ATTORNEY

CLASS 13—(Continued).

SN 77-931,487. THE SHARPS RIFLE COMPANY, LLC, SAINT CHARLES, MO. FILED 2-9-2010.

Volcanic Repeating Arms

THE MARK CONSISTS OF STANDARD CHARACTERS WITHOUT CLAIM TO ANY PARTICULAR FONT, STYLE, SIZE, OR COLOR.

NO CLAIM IS MADE TO THE EXCLUSIVE RIGHT TO USE "REPEATING ARMS", APART FROM THE MARK AS SHOWN.

FOR FIREARMS (U.S. CLS. 2 AND 9).
KATHERINE CONNOLLY, EXAMINING ATTORNEY

SN 77-958,780. THE SHARPS RIFLE COMPANY, LLC, SAINT CHARLES, MO. FILED 3-15-2010.

Curtis & Harvey

THE MARK CONSISTS OF STANDARD CHARACTERS WITHOUT CLAIM TO ANY PARTICULAR FONT, STYLE, SIZE, OR COLOR.

FOR BLACK GUN POWDER, SMOKELESS GUN POWDER, EXPLOSIVE PRIMERS (U.S. CLS. 2 AND 9).
KATHERINE CONNOLLY, EXAMINING ATTORNEY

CLASS 14—JEWELRY

SN 77-537,209. CHAGOURY, ANNE MARIE, PARIS, FRANCE, FILED 8-1-2008.



THE NAME(S), PORTRAIT(S), AND/OR SIGNATURE(S) SHOWN IN THE MARK IDENTIFIES ANNE MARIE "CHAGOURY", WHOSE CONSENT(S) TO REGISTER IS MADE OF RECORD.

THE MARK CONSISTS OF THE WORDS "MINI DREAMZ" ABOVE A RIBBON WITH A BUTTERFLY AT THE TOP NEXT TO THE "Z" IN "DREAMZ" AND THE WORDS "BY A.M. CHAGOURY" UNDERNEATH THE RIBBON.

FOR BRACELETS; BROOCHES; CHARMS; DIAMOND JEWELRY; GEMSTONE JEWELRY; JEWELRY; JEWELRY CHAINS; JEWELRY, NAMELY, PRECIOUS METAL PLATED REAL LEAVES AND FLOWERS; JEWELRY, NAMELY, STONE PENDANTS; PINS BEING JEWELRY; RINGS; WATCHES AND JEWELRY (U.S. CLS. 2, 27, 28 AND 50).

FIRST USE 7-11-2008; IN COMMERCE 7-11-2008.
DARRYL SPRUILL, EXAMINING ATTORNEY

CLASS 14—(Continued).

SN 77-585,699. COOLEY, DAWN, DBA BEAD BEAUTIFUL, FOWLER, IN. FILED 10-4-2008.

BEAD BEAUTIFUL

THE MARK CONSISTS OF STANDARD CHARACTERS WITHOUT CLAIM TO ANY PARTICULAR FONT, STYLE, SIZE, OR COLOR.

FOR JEWELRY (U.S. CLS. 2, 27, 28 AND 50).
FIRST USE 11-1-2000; IN COMMERCE 11-1-2000.
LINDA MICKLEBURGH, EXAMINING ATTORNEY

SN 77-759,058. BYERS, WENDY, ROCHESTER, MN. FILED 6-13-2009.

Tie 1 On!

THE MARK CONSISTS OF STANDARD CHARACTERS WITHOUT CLAIM TO ANY PARTICULAR FONT, STYLE, SIZE, OR COLOR.

FOR ANKLE BRACELETS; BANGLE BRACELETS; BRACELETS; BRACELETS; BRACELETS OF PRECIOUS METAL; CHARITY BRACELETS; IDENTIFICATION BRACELETS; NYLON ANKLE BRACELETS; NYLON BRACELETS; PLASTIC BRACELETS IN THE NATURE OF JEWELRY; RUBBER OR SILICON WRISTBANDS IN THE NATURE OF A BRACELET; STAINLESS STEEL JEWELRY BRACELETS; WATCH BRACELETS (U.S. CLS. 2, 27, 28 AND 50).

MARTHA FROMM, EXAMINING ATTORNEY

SN 77-791,086. CARTIER INTERNATIONAL N.V., CURA-CAO, NETHERLD ANTILLES, FILED 7-28-2009.

MORPHOSIS

THE MARK CONSISTS OF STANDARD CHARACTERS WITHOUT CLAIM TO ANY PARTICULAR FONT, STYLE, SIZE, OR COLOR.

FOR CUFF-LINKS; JEWELRY, INCLUDING RINGS, BRACELETS, EARRINGS, NECKLACES, AND BROOCHES; WATCHES; CHRONOMETERS; AND CLOCKS (U.S. CLS. 2, 27, 28 AND 50).

ADA HAN, EXAMINING ATTORNEY

CLASS 14—(Continued).

SN 77-791,096. CARTIER INTERNATIONAL N.V., CURA-CAO, NETHERLD ANTILLES, FILED 7-28-2009.

SO PRETTY DE CARTIER

THE MARK CONSISTS OF STANDARD CHARACTERS WITHOUT CLAIM TO ANY PARTICULAR FONT, STYLE, SIZE, OR COLOR.

OWNER OF U.S. REG. NOS. 411,975, 2,749,359 AND OTHERS.

THE ENGLISH TRANSLATION OF "DE CARTIER" IN THE MARK IS "OF CARTIER".

FOR CUFF-LINKS; JEWELRY, INCLUDING RINGS, BRACELETS, EARRINGS, NECKLACES, AND BROOCHES; PRECIOUS GEMSTONES; CHRONOMETERS; WATCHES; AND CLOCKS (U.S. CLS. 2, 27, 28 AND 50).

ADA HAN, EXAMINING ATTORNEY

SN 77-799,892. XAVIER ZAMARRIPA, LLC, ROWLETT, TX, FILED 8-7-2009.

XAVIER ZAMARRIPA

THE MARK CONSISTS OF STANDARD CHARACTERS WITHOUT CLAIM TO ANY PARTICULAR FONT, STYLE, SIZE, OR COLOR.

THE NAME IN THE MARK IDENTIFIES A LIVING INDIVIDUAL WHOSE CONSENT TO REGISTER IS OF RECORD.

FOR PRECIOUS AND SEMI-PRECIOUS METAL SCULPTURES; CUFF LINKS (U.S. CLS. 2, 27, 28 AND 50).

FIRST USE 9-10-1994; IN COMMERCE 9-10-1994.

IRA J. GOODSID, EXAMINING ATTORNEY

SN 77-822,847. SANDBERG & SIKORSKI CORPORATION, NEW YORK, NY, FILED 9-9-2009.

FOREVER YOURS

THE MARK CONSISTS OF STANDARD CHARACTERS WITHOUT CLAIM TO ANY PARTICULAR FONT, STYLE, SIZE, OR COLOR.

OWNER OF U.S. REG. NOS. 747,266 AND 2,895,413.

FOR JEWELRY (U.S. CLS. 2, 27, 28 AND 50).

SUE LAWRENCE, EXAMINING ATTORNEY

CLASS 14—(Continued).

SN 77-844,495. CRAZELETS LLC, DRIPPING SPRINGS, TX, FILED 10-8-2009.

Crazelets

THE MARK CONSISTS OF STANDARD CHARACTERS WITHOUT CLAIM TO ANY PARTICULAR FONT, STYLE, SIZE, OR COLOR.

FOR BRACELETS; JEWELRY (U.S. CLS. 2, 27, 28 AND 50).

FIRST USE 9-9-2009; IN COMMERCE 9-9-2009.

DANNEAN HETZEL, EXAMINING ATTORNEY

SN 77-871,892. JASON MADACHY FOUNDATION, CONCORD, OH, FILED 11-13-2009.



THE MARK CONSISTS OF THE DESIGN OF A STETHOSCOPE WITH THE BOTTOM HALF WRAPPED AROUND THE WORDS "EXCEL IN LEAVING A MARK".

FOR LAPEL PIN (U.S. CLS. 2, 27, 28 AND 50).

FIRST USE 11-1-2009; IN COMMERCE 11-1-2009.

BARBARA A. GOLD, EXAMINING ATTORNEY

SN 77-883,321. MIKI CORPORATION, TOKYO, JAPAN, FILED 12-1-2009.

JOYAUX COUTURE MAKI

THE MARK CONSISTS OF STANDARD CHARACTERS WITHOUT CLAIM TO ANY PARTICULAR FONT, STYLE, SIZE, OR COLOR.

PRIORITY CLAIMED UNDER SEC. 44(D) ON JAPAN APPLICATION NO. 2009-042471, FILED 6-8-2009, REG. NO. 5291189, DATED 12-25-2009, EXPIRES 12-25-2019.

OWNER OF U.S. REG. NOS. 3,310,279 AND 3,459,937.

NO CLAIM IS MADE TO THE EXCLUSIVE RIGHT TO USE "JOYAUX COUTURE", APART FROM THE MARK AS SHOWN.

THE ENGLISH TRANSLATION OF "JOYAUX" IN THE MARK IS JEWEL.

FOR BROOCHES; CLOCKS AND WATCHES; COSTUME JEWELRY; EARRINGS; GEMSTONES; JEWELRY AND IMITATION JEWELRY; NECKLACES; PENDANTS; PERSONAL ORNAMENTS OF PRECIOUS METAL; RINGS; TIE PINS (U.S. CLS. 2, 27, 28 AND 50).

RICHARD WHITE, EXAMINING ATTORNEY

CLASS 14—(Continued).

SN 77-884,383. THE PRUDENTIAL INSURANCE COMPANY OF AMERICA, NEWARK, NJ. FILED 12-2-2009.



OWNER OF U.S. REG. NOS. 1,576,352 AND 1,616,000. THE MARK CONSISTS OF A ROCK DESIGN. FOR JEWELRY (U.S. CLS. 2, 27, 28 AND 50). FIRST USE 5-31-2008; IN COMMERCE 5-31-2008. LAKEISHA LEWIS, EXAMINING ATTORNEY

SN 77-911,354. SEIKO HOLDINGS KABUSHIKI KAISHA, TA SEIKO HOLDINGS CORPORATION, TOKYO, JAPAN, FILED 1-13-2010.

SCUBAMASTER

THE MARK CONSISTS OF STANDARD CHARACTERS WITHOUT CLAIM TO ANY PARTICULAR FONT, STYLE, SIZE, OR COLOR.

OWNER OF JAPAN REG. NO. 2721296, DATED 5-9-1997, EXPIRES 5-9-2017.

OWNER OF U.S. REG. NO. 2,822,804. FOR WATCHES AND PARTS THEREOF (U.S. CLS. 2, 27, 28 AND 50).

BRENDAN REGAN, EXAMINING ATTORNEY

SN 77-913,513. ZNETSHOWS, INC., GERMANTOWN, MD. FILED 1-16-2010.

Tiaria

THE MARK CONSISTS OF STANDARD CHARACTERS WITHOUT CLAIM TO ANY PARTICULAR FONT, STYLE, SIZE, OR COLOR.

THE WORDING "TIARIA" HAS NO MEANING IN A FOREIGN LANGUAGE.

FOR BEADS FOR USE IN THE MANUFACTURE OF JEWELRY (U.S. CLS. 2, 27, 28 AND 50).

MYRIAH HABEEB, EXAMINING ATTORNEY

CLASS 14—(Continued).

SN 77-916,173. CAROLYN POLLACK, ALBUQUERQUE, NM. FILED 1-20-2010.

THE NAME(S), PORTRAIT(S), AND/OR SIGNATURE(S) SHOWN IN THE MARK IDENTIFIES "CAROLYN POLLACK", WHOSE CONSENT(S) TO REGISTER IS MADE OF RECORD.

THE MARK CONSISTS OF CURSIVE SIGNATURE OF "CAROLYN POLLACK".

FOR JEWELRY (U.S. CLS. 2, 27, 28 AND 50).

FIRST USE 3-0-2002; IN COMMERCE 3-0-2002.

VERNA BETH RIRIE, EXAMINING ATTORNEY

SN 77-918,189. MUNDT, GINA FAYE, SCOTTSDALE, AZ. FILED 1-22-2010.

LOVADOG

THE MARK CONSISTS OF STANDARD CHARACTERS WITHOUT CLAIM TO ANY PARTICULAR FONT, STYLE, SIZE, OR COLOR.

FOR BEADS FOR USE IN THE MANUFACTURE OF JEWELRY; BRACELETS; CHARMS FOR COLLAR JEWELRY AND BRACELET; DIAMOND JEWELRY; EARRINGS; GEMSTONE JEWELRY; GOLD; IDENTIFICATION BRACELETS; JEWELRY, NAMELY, ANKLETS; JEWELRY, NAMELY, ARM CUFFS; JEWELRY, NAMELY, DOG TAGS FOR WEAR BY HUMANS FOR DECORATIVE PURPOSES; JEWELRY, NAMELY, STONE PENDANTS; NECKLACES; PET JEWELRY; PRECIOUS AND SEMI-PRECIOUS CRYSTAL STONES AND BEADS FOR USE IN JEWELRY; RINGS; RUBBER OR SILICON WRISTBANDS IN THE NATURE OF A BRACELET (U.S. CLS. 2, 27, 28 AND 50).

ANNE MADDEN, EXAMINING ATTORNEY

SN 77-918,886. OKO INTERNATIONAL CO., DEERFIELD BEACH, FL. FILED 1-24-2010.

SILVERJET

THE MARK CONSISTS OF STANDARD CHARACTERS WITHOUT CLAIM TO ANY PARTICULAR FONT, STYLE, SIZE, OR COLOR.

FOR TIMEPIECES; WATCH BANDS; WATCHES (U.S. CLS. 2, 27, 28 AND 50).

KATHLEEN LORENZO, EXAMINING ATTORNEY

CLASS 14—(Continued).

SN 77-922,806. HOPE PAIGE DESIGNS, LLC, WEST CONSHOHOCKEN, PA. FILED 1-28-2010.

STAND UP 8

THE MARK CONSISTS OF STANDARD CHARACTERS WITHOUT CLAIM TO ANY PARTICULAR FONT, STYLE, SIZE, OR COLOR.
FOR JEWELRY, PENDANTS, CHARMS AND KEY CHAINS AS JEWELRY (U.S. CLS. 2, 27, 28 AND 50).
STEVEN PEREZ, EXAMINING ATTORNEY

SN 77-922,862. GOLD SILK, INC., ALBUQUERQUE, NM. FILED 1-28-2010.



THE MARK CONSISTS OF A DEPICTION OF A BUTTERFLY WITH THE LOWER RIGHT EDGE OF ONE OF ITS WINGS BALANCING OVER A SEMI-ROUND LINE AND THE STYLIZED LETTERS "GS" INSIDE THE BUTTERFLY.
FOR JEWELRY (U.S. CLS. 2, 27, 28 AND 50).
TEJBIR SINGH, EXAMINING ATTORNEY

CLASS 14—(Continued).

SN 77-922,913. AUDIGIER BRAND MANAGEMENT GROUP, LLC, CULVER CITY, CA. FILED 1-28-2010.



OWNER OF U.S. REG. NOS. 3,612,424 AND 3,653,088.
THE MARK CONSISTS OF THE STYLIZED, INTER-TWINED LETTERS "C" AND "A", ABOVE WHICH APPEARS A CROWN.
FOR WATCHES, CUFFLINKS, AND JEWELRY (U.S. CLS. 2, 27, 28 AND 50).
FIRST USE 8-1-2008; IN COMMERCE 8-1-2008.
SALLY SHIH, EXAMINING ATTORNEY

SN 77-923,344. XOSKELETON, COLUMBIA, MD. FILED 1-29-2010.

DIAMONDFX

THE MARK CONSISTS OF STANDARD CHARACTERS WITHOUT CLAIM TO ANY PARTICULAR FONT, STYLE, SIZE, OR COLOR.
FOR CHRONOGRAPHS FOR USE AS WATCHES; CLOCKS; DIVING WATCHES; WATCH BANDS AND STRAPS; WATCH FACES; WATCHBANDS; WATCHES; WRISTWATCHES, COMPOSED IN PART OF DIAMONDS OR DIAMOND COATING (U.S. CLS. 2, 27, 28 AND 50).
FIRST USE 12-1-2009; IN COMMERCE 12-1-2009.
GISELLE AGOSTO, EXAMINING ATTORNEY

CLASS 14—(Continued).

SN 77-926,152. ALPHA ONE ENTERPRISES, LLC, LEWISVILLE, TX. FILED 2-2-2010.



THE MARK CONSISTS OF THE STYLIZED WORDING "SURVIVOR JOE" AROUND THE PERIMETER OF A SHADED CIRCLE WITH THE DESIGN OF AN EAGLE WITH OUTSTRETCHED WINGS APPEARING IN THE MIDDLE OF THE CIRCLE.

FOR NYLON BRACELETS (U.S. CLS. 2, 27, 28 AND 50).
KATHERINE CONNOLLY, EXAMINING ATTORNEY

SN 77-926,739. MANTRA SHIELD, LLC, NEW YORK, NY. FILED 2-3-2010.



THE COLOR(S) DARK RED, LIGHT RED, RED, YELLOW, AND WHITE IS/ARE CLAIMED AS A FEATURE OF THE MARK.

THE MARK CONSISTS OF A LOTUS FLOWER COLORED IN DARK AND LIGHT RED. IN THE CENTER OF THE LOTUS FLOWER IS A CIRCLE. THE CIRCLE CONSISTS OF A WHITE CRESCENT MOON AND YELLOW SUN. INSIDE THE YELLOW SUN ARE THREE RED STARS AND A RED TRIANGLE CONTAINING A YELLOW COLORED EYE. BELOW THE LOTUS FLOWER ARE THE WORDS "MANTRA SHIELD" IN RED.

FOR JEWELRY (U.S. CLS. 2, 27, 28 AND 50).
SIMON TENG, EXAMINING ATTORNEY

CLASS 14—(Continued).

SN 77-927,118. I.V. CORP., CHICAGO, IL. FILED 2-3-2010.

WORK TO PLAY

THE MARK CONSISTS OF STANDARD CHARACTERS WITHOUT CLAIM TO ANY PARTICULAR FONT, STYLE, SIZE, OR COLOR.

FOR JEWELRY (U.S. CLS. 2, 27, 28 AND 50).
FIRST USE 4-30-2009; IN COMMERCE 4-30-2009.
DEZMONA MIZELLE, EXAMINING ATTORNEY

SN 77-927,781. ROMA DESIGNS, INC., ALPHARETTA, GA. FILED 2-4-2010.

PALMETTO PRIDE

THE MARK CONSISTS OF STANDARD CHARACTERS WITHOUT CLAIM TO ANY PARTICULAR FONT, STYLE, SIZE, OR COLOR.

FOR JEWELRY (U.S. CLS. 2, 27, 28 AND 50).
DANIEL CAPSHAW, EXAMINING ATTORNEY

SN 77-928,290. COMBINE INTERNATIONAL, INC., TROY, MI. FILED 2-4-2010.

DESCENT

THE MARK CONSISTS OF STANDARD CHARACTERS WITHOUT CLAIM TO ANY PARTICULAR FONT, STYLE, SIZE, OR COLOR.

FOR JEWELRY (U.S. CLS. 2, 27, 28 AND 50).
HOWARD SMIGA, EXAMINING ATTORNEY

SN 77-928,412. A TRILLION DREAMS, LLC, LAS VEGAS, NV. FILED 2-4-2010.

MEEO MIA

THE MARK CONSISTS OF STANDARD CHARACTERS WITHOUT CLAIM TO ANY PARTICULAR FONT, STYLE, SIZE, OR COLOR.

FOR JEWELRY (U.S. CLS. 2, 27, 28 AND 50).
CAROLYN CATALDO, EXAMINING ATTORNEY

CLASS 14—(Continued).

SN 77-928,629. COMBINE INTERNATIONAL, INC., TROY, MI. FILED 2-4-2010.

MOM ROCKS

THE MARK CONSISTS OF STANDARD CHARACTERS WITHOUT CLAIM TO ANY PARTICULAR FONT, STYLE, SIZE, OR COLOR.

FOR JEWELRY (U.S. CLS. 2, 27, 28 AND 50).
HOWARD SMIGA, EXAMINING ATTORNEY

SN 77-928,630. AMY R. LESHANSKI, NEW YORK, NY. FILED 2-4-2010.

Seed to Bloom

THE MARK CONSISTS OF STANDARD CHARACTERS WITHOUT CLAIM TO ANY PARTICULAR FONT, STYLE, SIZE, OR COLOR.

FOR JEWELRY (U.S. CLS. 2, 27, 28 AND 50).
HOWARD SMIGA, EXAMINING ATTORNEY

SN 77-928,811. INVICTA WATCH COMPANY OF AMERICA, INC., HOLLYWOOD, FL. FILED 2-5-2010.

TRITNITE

THE MARK CONSISTS OF STANDARD CHARACTERS WITHOUT CLAIM TO ANY PARTICULAR FONT, STYLE, SIZE, OR COLOR.

FOR WATCHES (U.S. CLS. 2, 27, 28 AND 50).
ANTHONY RINKER, EXAMINING ATTORNEY

SN 77-929,942. BERTHIAUME, BRIDGET ANN, DBA HEART OF A COWGIRL, VAIL, AZ. FILED 2-7-2010.

Heart of a Cowgirl

THE MARK CONSISTS OF STANDARD CHARACTERS WITHOUT CLAIM TO ANY PARTICULAR FONT, STYLE, SIZE, OR COLOR.

FOR COSTUME JEWELRY (U.S. CLS. 2, 27, 28 AND 50).
FIRST USE 3-15-2008; IN COMMERCE 3-15-2008.
RUSS HERMAN, EXAMINING ATTORNEY

CLASS 14—(Continued).

SN 77-930,150. CARLINO, CRISTINA M., PHOENIX, AZ. FILED 2-8-2010.

ARCHETYPE

THE MARK CONSISTS OF STANDARD CHARACTERS WITHOUT CLAIM TO ANY PARTICULAR FONT, STYLE, SIZE, OR COLOR.

FOR CLOCKS; JEWELRY; JEWELRY BOXES; JEWELRY CASES; JEWELRY ORGANIZERS; WATCHES (U.S. CLS. 2, 27, 28 AND 50).
APRIL HESIK, EXAMINING ATTORNEY

SN 77-930,342. GEDDES, MARGARET, LOS ANGELES, CA. FILED 2-8-2010.



NO CLAIM IS MADE TO THE EXCLUSIVE RIGHT TO USE "CITY OF ANGELS" AND "JEWELRY", APART FROM THE MARK AS SHOWN.

THE MARK CONSISTS OF THE STYLIZED TEXT "CITY OF ANGELS JEWELRY" WITH A HALO DESIGN.
FOR BRACELETS; CHARMS; EARRINGS; NECKLACES; PENDANTS; RINGS (U.S. CLS. 2, 27, 28 AND 50).
FIRST USE 3-1-2009; IN COMMERCE 4-1-2009.
KATHERINE E. HALMEN, EXAMINING ATTORNEY

CLASS 14—(Continued).

SN 77-931,316. BAREFOOT GEMS HOLDING, LLC, KATONAH, NY. FILED 2-9-2010.



THE COLOR(S) BLACK AND MAGENTA IS/ARE CLAIMED AS A FEATURE OF THE MARK.

THE MARK CONSISTS OF BLACK STYLIZED LOWER-CASE LETTERS "BG" WITH A SERIES OF FIVE MAGENTA GEMS ARRANGED IN THE FASHION OF TOE PRINTS BELOW THE "B" AND ABOVE THE "G".

FOR JEWELRY (U.S. CLS. 2, 27, 28 AND 50).
FIRST USE 1-25-2008; IN COMMERCE 1-25-2008.
LESLEY LAMOTHE, EXAMINING ATTORNEY



SN 77-932,545. GEDDES, MARGARET, LOS ANGELES, CA. FILED 2-10-2010.



THE MARK CONSISTS OF A HALO OR CROWN WITH RAYS OF LIGHT.

FOR BRACELETS; CHARMS; EARRINGS; JEWELRY; NECKLACES; PENDANTS; PINS BEING JEWELRY; RINGS (U.S. CLS. 2, 27, 28 AND 50).

FIRST USE 3-1-2009; IN COMMERCE 4-1-2009.
KATHERINE E. HALMEN, EXAMINING ATTORNEY

CLASS 14—(Continued).

SN 77-938,956. A TRILLION DREAMS, LLC, LAS VEGAS, NV. FILED 2-18-2010.



THE MARK CONSISTS OF TWO SQUARES ON TOP OF A SEMI CIRCLE FOLLOWED BY ANOTHER SEMI CIRCLE OVER TWO SQUARES.

FOR JEWELRY (U.S. CLS. 2, 27, 28 AND 50).
CAROLYN CATALDO, EXAMINING ATTORNEY



SN 77-942,822. HOPE PAIGE DESIGNS, LLC, WEST CONSHOHOCKEN, PA. FILED 2-23-2010.

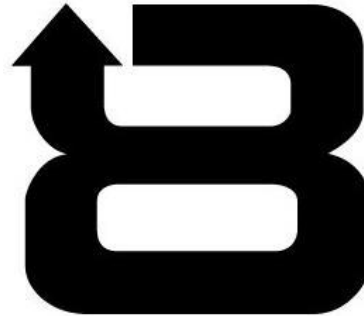

THE MARK CONSISTS OF A STYLIZED "8". THE UPPER LEFT PORTION OF THE "8" APPEARS AS AN ARROW POINTING UPWARD.

FOR JEWELRY, PENDANTS, CHARMS AND KEY CHAINS AS JEWELRY (U.S. CLS. 2, 27, 28 AND 50).
STEVEN PEREZ, EXAMINING ATTORNEY



SN 78-924,540. GUESS?, INC., LOS ANGELES, CA. FILED 7-7-2006.

SPORTING PINK

THE MARK CONSISTS OF STANDARD CHARACTERS WITHOUT CLAIM TO ANY PARTICULAR FONT, STYLE, SIZE, OR COLOR.

NO CLAIM IS MADE TO THE EXCLUSIVE RIGHT TO USE "PINK", APART FROM THE MARK AS SHOWN.
FOR WATCHES (U.S. CLS. 2, 27, 28 AND 50).
ZHALEH DELANEY, EXAMINING ATTORNEY

CLASS 14—(Continued).

SN 79-073,264. MONTBLANC-SIMPLO GMBH, FED REP GERMANY, FILED 9-1-2009.

PERCE-NEIGE

THE MARK CONSISTS OF STANDARD CHARACTERS WITHOUT CLAIM TO ANY PARTICULAR FONT, STYLE, SIZE, OR COLOR.

PRIORITY DATE OF 4-7-2009 IS CLAIMED.

OWNER OF INTERNATIONAL REGISTRATION 1014366 DATED 9-1-2009, EXPIRES 9-1-2019.

THE ENGLISH TRANSLATION OF "PERCE-NEIGE" IN THE MARK IS "SNOWDROP."

FOR CUFF-LINKS, TIE CLIPS, RINGS, BRACELETS, EARRINGS, NECKLACES, BROOCHES, WATCHES, CHRONOMETERS, CLOCKS, WATCH STRAPS, WATCH BRACELETS, BOXES OF PRECIOUS METALS FOR WATCHES AND JEWELLERY (U.S. CLS. 2, 27, 28 AND 50).

VIVIAN MICZNIK FIRST, EXAMINING ATTORNEY

SN 79-076,241. BESKA BEHEER B.V., NETHERLANDS, FILED 11-3-2009.

Nici van Galen

THE MARK CONSISTS OF STANDARD CHARACTERS WITHOUT CLAIM TO ANY PARTICULAR FONT, STYLE, SIZE, OR COLOR.

OWNER OF INTERNATIONAL REGISTRATION 0995626 DATED 1-22-2009, EXPIRES 1-22-2019.

THE NAME(S), PORTRAIT(S), AND/OR SIGNATURE(S) SHOWN IN THE MARK DOES NOT IDENTIFY A PARTICULAR LIVING INDIVIDUAL.

THE WORDING "NICI VAN GALEN" HAS NO MEANING IN A FOREIGN LANGUAGE.

FOR PRECIOUS STONES, SEMI PRECIOUS STONES, JEWELRY IN THE NATURE OF CHARMS AND PERSONAL ORNAMENTS; JEWELRY (U.S. CLS. 2, 27, 28 AND 50).

ANDREA HACK, EXAMINING ATTORNEY

SN 85-027,360. NU VISION GROUP LLC, NEW YORK, NY, FILED 4-30-2010.

ROCK & FREEDOM

THE MARK CONSISTS OF STANDARD CHARACTERS WITHOUT CLAIM TO ANY PARTICULAR FONT, STYLE, SIZE, OR COLOR.

FOR HOROLOGICAL AND CHRONOMETRIC INSTRUMENTS AND CASES THEREFOR; JEWELRY; JEWELRY BOXES; JEWELRY CASES (U.S. CLS. 2, 27, 28 AND 50).

JUSTINE D. PARKER, EXAMINING ATTORNEY

CLASS 15—MUSICAL INSTRUMENTS

SN 76-210,248. PERSIS INTERNATIONAL, INC., CHICAGO, IL. FILED S.R. 2-15-2001; AM. P.R. 8-19-2002.

SOHMER

SEC. 2(F).

FOR PIANOS (U.S. CLS. 2, 21 AND 36).

FIRST USE 4-23-2001; IN COMMERCE 6-26-2001.

WON TEAK OH, EXAMINING ATTORNEY

SN 77-423,847. DAVID EVANS, DUBLIN, IRELAND, FILED 3-17-2008.

THE EDGE

THE MARK CONSISTS OF STANDARD CHARACTERS WITHOUT CLAIM TO ANY PARTICULAR FONT, STYLE, SIZE, OR COLOR.

PRIORITY CLAIMED UNDER SEC. 44(D) ON ERP CMNTY TM OFC APPLICATION NO. 6447759, FILED 11-19-2007, REG. NO. 6447759, DATED 11-21-2008, EXPIRES 11-19-2017.

FOR MUSICAL INSTRUMENTS, NAMELY, WIND INSTRUMENTS AND STRING INSTRUMENTS, NAMELY, STRIKING STRING INSTRUMENTS, BOWING STRING INSTRUMENTS, AND PLUCKING STRING INSTRUMENTS, NAMELY, ELECTRIC GUITARS, BASS GUITARS, ACOUSTIC GUITARS, BANJOS, HARPS, SITARS, AND HARPSICHOIDS (U.S. CLS. 2, 21 AND 36).

NANCY CLARKE, EXAMINING ATTORNEY

SN 77-752,530. RAND, DONALD L, DBA CLARK ORCHESTRA ROLLS, WALDOBORO, ME. FILED 6-4-2009.



THE MARK CONSISTS OF THE WORDING "CLARK ORCHESTRA ROLLS" WITH A GEOMETRIC DESIGN, NAMELY THE WORD "ORCHESTRA" APPEARING ON A DIAMOND-SHAPED OBJECT SUPERIMPOSED ON THE WORDS "CLARK" AND "ROLLS" ON A RECTANGULAR BACKGROUND.

SEC. 2(F).

FOR PERFORATED MUSIC ROLLS FOR USE IN PLAYER PIANOS (U.S. CLS. 2, 21 AND 36).

FIRST USE 7-8-1992; IN COMMERCE 7-8-1992.

KRISTIN DAHLING, EXAMINING ATTORNEY

CLASS 15—(Continued).

SN 77-837,171. PAUL REED SMITH GUITARS, LIMITED PARTNERSHIP, STEVENSVILLE, MD. FILED 9-29-2009.

MODERN EAGLE

THE MARK CONSISTS OF STANDARD CHARACTERS WITHOUT CLAIM TO ANY PARTICULAR FONT, STYLE, SIZE, OR COLOR.

FOR GUITARS (U.S. CLS. 2, 21 AND 36).
FIRST USE 1-0-2004; IN COMMERCE 1-0-2004.
MARGERY A. TIERNEY, EXAMINING ATTORNEY

SN 77-840,954. NAKAMURA, MASAYOSHI, DBA GAAI DRUMS & CO., SHERMAN OAKS, CA. FILED 10-4-2009.

Gaai

THE MARK CONSISTS OF THE STYLIZED WORD "GAAI" BETWEEN TWO CURVED LINES THAT CREATE A DRUM SHAPE.

THE ENGLISH TRANSLATION OF "GAAI" IS ELEGANT LOVE.

FOR DRUMS (U.S. CLS. 2, 21 AND 36).
FIRST USE 8-8-2008; IN COMMERCE 11-11-2008.
MAUREEN DALL, EXAMINING ATTORNEY

SN 77-870,098. ROLAND CORPORATION, SHIZUOKA, JAPAN, FILED 11-11-2009.

LUCINA

THE MARK CONSISTS OF STANDARD CHARACTERS WITHOUT CLAIM TO ANY PARTICULAR FONT, STYLE, SIZE, OR COLOR.

FOR MUSIC SYNTHESIZERS (U.S. CLS. 2, 21 AND 36).
FIRST USE 3-27-2010; IN COMMERCE 4-19-2010.
JANICE KIM, EXAMINING ATTORNEY

CLASS 15—(Continued).

SN 77-870,409. SCHOOL OF ROCK, LLC, TEANECK, NJ. FILED 11-11-2009.

SCHOOL OF ROCK

THE MARK CONSISTS OF THE WORDS "SCHOOL OF ROCK" WITH A DESIGN OF A GUITAR REPLACING THE LETTER "O" IN THE WORD "ROCK".

FOR MUSICAL INSTRUMENTS, NAMELY, GUITARS, LAP GUITARS, HAWAIIAN STEEL GUITARS, DRUMS, PIANOS, ELECTRONIC KEYBOARDS, MUSIC SYNTHESIZERS, AND HARMONICAS; MUSICAL INSTRUMENTS OF THE FRETTED-TYPE, NAMELY, GUITARS, ELECTRIC GUITARS, LAP GUITARS, HAWAIIAN STEEL GUITARS, MANDOLINS, BANJOS, UKELELES, AND ELECTRIC BASSES; ACCESSORIES AND REPLACEMENT PARTS FOR GUITARS, NAMELY, STRINGS, GUITAR PICKS, CASES, CASE COVERS USED TO STORE, CARRY AND TRANSPORT MUSICAL INSTRUMENTS, TUNING APPARATUS FOR MUSICAL INSTRUMENTS, NAMELY, A MACHINE-TYPE TUNING HEAD, GUITAR BRIDGES, FINGERBOARDS, FINGERRESTS, TAILPIECES, VIBRATO TAILPIECES, TRUSS ROD COVERS, NECK STRAPS, STRING MUTES, STRING DAMPERS AND BINDING; GUITAR STANDS, END PINS FOR GUITAR STRINGS, CAPOS, PICK POUCHES, GUITAR STRAPS, TUNING FORKS, ARMRESTS FOR GUITARS AND BANJOS, PICKGUARDS, TUNERS, CO-ORDINATOR RODS, TENSION HOOKS AND NUTS, HEADS, TENSION RINGS, AND RESONATOR BANDS, ALL FOR MUSICAL INSTRUMENTS; MUSIC PITCH PIPES; STRINGS FOR FRETTED MUSICAL INSTRUMENTS AND FOR VIOLINS, AND MUSICAL INSTRUMENT STRINGS (U.S. CLS. 2, 21 AND 36).
GINA HAYES, EXAMINING ATTORNEY

SN 77-913,913. XCASE CORPORATION, OLIVE BRANCH, MS. FILED 1-18-2010.

XCASE

NO CLAIM IS MADE TO THE EXCLUSIVE RIGHT TO USE "CASE", APART FROM THE MARK AS SHOWN.

THE MARK CONSISTS OF STYLIZED LETTERS "XCASE", WHERE "X" IS LARGER THAN "CASE".

FOR CASES FOR MUSICAL INSTRUMENTS (U.S. CLS. 2, 21 AND 36).

FIRST USE 1-18-2003; IN COMMERCE 7-1-2005.
CHARLES L. JENKINS, EXAMINING ATTORNEY

CLASS 15—(Continued).

SN 77-928,369. PATRINO, STEVEN J., HAYWARD, CA. FILED 2-4-2010.

GUARDIAN

THE MARK CONSISTS OF STANDARD CHARACTERS WITHOUT CLAIM TO ANY PARTICULAR FONT, STYLE, SIZE, OR COLOR.

FOR MUSICAL INSTRUMENT ACCESSORIES, NAMELY, GUITAR CASES AND CARRYING AND STORAGE BAGS FOR GUITARS (U.S. CLS. 2, 21 AND 36).

FIRST USE 12-1-2003; IN COMMERCE 12-1-2003. ELIZABETH KAJUBI, EXAMINING ATTORNEY

CLASS 15—(Continued).

SN 77-929,261. STEVEN J. PATRINO, HAYWARD, CA. FILED 2-5-2010.

KOLOA

THE MARK CONSISTS OF STANDARD CHARACTERS WITHOUT CLAIM TO ANY PARTICULAR FONT, STYLE, SIZE, OR COLOR.

FOR UKULELES (U.S. CLS. 2, 21 AND 36). FIRST USE 1-3-2007; IN COMMERCE 1-3-2007. ELIZABETH KAJUBI, EXAMINING ATTORNEY

SN 77-928,913. HOHNER INC., GLEN ALLEN, VA. FILED 2-5-2010.

HOODOO BLUES

THE MARK CONSISTS OF STANDARD CHARACTERS WITHOUT CLAIM TO ANY PARTICULAR FONT, STYLE, SIZE, OR COLOR.

FOR HARMONICAS (U.S. CLS. 2, 21 AND 36). FIRST USE 1-26-2010; IN COMMERCE 1-26-2010. KATHERINE CONNOLLY, EXAMINING ATTORNEY

SN 77-929,408. RUTTENBERG, SAM, CHERRY HILL, NJ. FILED 2-5-2010.

HINGESTIX

THE MARK CONSISTS OF STANDARD CHARACTERS WITHOUT CLAIM TO ANY PARTICULAR FONT, STYLE, SIZE, OR COLOR.

FOR DRUMSTICKS (U.S. CLS. 2, 21 AND 36). FIRST USE 1-0-2010; IN COMMERCE 1-0-2010. KIMBERLY FRYE, EXAMINING ATTORNEY

SN 77-928,945. HOHNER INC., GLEN ALLEN, VA. FILED 2-5-2010.

MARINE BAND THUNDERBIRD

THE MARK CONSISTS OF STANDARD CHARACTERS WITHOUT CLAIM TO ANY PARTICULAR FONT, STYLE, SIZE, OR COLOR.

OWNER OF U.S. REG. NO. 45,837. FOR HARMONICAS AND HARMONICA CASES (U.S. CLS. 2, 21 AND 36). KATHERINE CONNOLLY, EXAMINING ATTORNEY

SN 77-929,947. HARRY FLEISHMAN, DBA FLEISHMAN INSTRUMENTS, SEBASTOPOL, CA. FILED 2-7-2010.

AntiGravity

THE MARK CONSISTS OF STANDARD CHARACTERS WITHOUT CLAIM TO ANY PARTICULAR FONT, STYLE, SIZE, OR COLOR.

FOR ELECTRIC GUITARS (U.S. CLS. 2, 21 AND 36). RENEE MCCRAY, EXAMINING ATTORNEY

CLASS 15—(Continued).

SN 77-930,794. LEGENDARY GEAR, MEMPHIS, TN. FILED 2-8-2010.

WOOGIE BOARD

THE MARK CONSISTS OF STANDARD CHARACTERS WITHOUT CLAIM TO ANY PARTICULAR FONT, STYLE, SIZE, OR COLOR.

NO CLAIM IS MADE TO THE EXCLUSIVE RIGHT TO USE "BOARD", APART FROM THE MARK AS SHOWN.

FOR AMPLIFIED WASHBOARD BUILT FOR PURPOSE OF PLAYING AS A MUSICAL INSTRUMENT (U.S. CLS. 2, 21 AND 36).

TOBY BULLOFF, EXAMINING ATTORNEY

CLASS 16—(Continued).

SN 77-081,920. COLBERT PACKAGING CORPORATION, LAKE FOREST, IL. FILED 1-12-2007.

SN 77-930,796. VISUAL SOUND LLC, SPRING HILL, TN. FILED 2-8-2010.

GarageTone

THE MARK CONSISTS OF STANDARD CHARACTERS WITHOUT CLAIM TO ANY PARTICULAR FONT, STYLE, SIZE, OR COLOR.

FOR ELECTRONIC EFFECTS PEDALS FOR USE WITH MUSICAL INSTRUMENTS; FOOT PEDALS FOR USE IN CONNECTION WITH MUSICAL INSTRUMENTS.; GUITAR PEDALS; SOUND EFFECT PEDALS FOR MUSICAL INSTRUMENTS (U.S. CLS. 2, 21 AND 36).

FIRST USE 2-28-2009; IN COMMERCE 9-29-2009.
GEORGE LORENZO, EXAMINING ATTORNEY

ComplyPak**CLASS 16—PAPER GOODS AND PRINTED MATTER**

SN 76-699,874. POTPOURRI GROUP, INC, CHELMSFORD, MA. FILED 10-15-2009.

**CATALOG
FAVORITES**

OWNER OF U.S. REG. NO. 2,661,941.

NO CLAIM IS MADE TO THE EXCLUSIVE RIGHT TO USE "CATALOG", APART FROM THE MARK AS SHOWN.

FOR MAIL ORDER CATALOGS FEATURING APPAREL, JEWELRY, HARDWARE, SPORTING GOODS, TOYS AND GAMES, FOOD AND HOME FURNISHINGS, DOMESTICS, TEXTILE GOODS, AND ELECTRONICS (U.S. CLS. 2, 5, 22, 23, 29, 37, 38 AND 50).

FIRST USE 6-0-2001; IN COMMERCE 6-0-2001.
AARON BRODSKY, EXAMINING ATTORNEY

THE MARK CONSISTS OF STANDARD CHARACTERS WITHOUT CLAIM TO ANY PARTICULAR FONT, STYLE, SIZE, OR COLOR.

FOR TEAR RESISTANT AND CHILD RESISTANT PAPERBOARD PACKAGING (U.S. CLS. 2, 5, 22, 23, 29, 37, 38 AND 50).

SIMON TENG, EXAMINING ATTORNEY

CLASS 16—(Continued).

SN 77-216,471. NAVON, ILANA, JERUSALEM, ISRAEL, AND COHEN, RIVKA, JERUSALEM, ISRAEL, FILED 6-27-2007.



CLASS 16—(Continued).

SN 77-480,512. PUSSYCAT DOLLS, LLC, SANTA MONICA, CA. FILED 5-21-2008.



PRIORITY CLAIMED UNDER SEC. 44(D) ON ISRAEL APPLICATION NO. 196712, FILED 1-4-2007, REG. NO. 196712, DATED 1-4-2007, EXPIRES 4-1-2017.

THE COLOR(S) PINK, BLUE AND WHITE IS/ARE CLAIMED AS A FEATURE OF THE MARK.

THE COLOR PINK APPEARS IN THE DEPICTION OF A HUMAN HAND. THE COLORS BLUE AND WHITE APPEAR IN THE SQUARE THAT FORMS THE BACKGROUND OF THE MARK.

FOR PAPER, CARDBOARD AND GOODS MADE FROM THESE MATERIALS, NAMELY, PAPER ADVERTISEMENT BOARDS, CARDBOARD ADVERTISEMENT BOARDS, CARDBOARD BOXES, PAPER BOXES, PAPER-BASED IDENTIFICATION CARDS, PAPER BADGES, PAPER-BASED FILE FOLDERS, PRINTED PAPER SIGNS, PRINTED CARDBOARD SIGNS; PRINTED MATTER, NAMELY, ALMANACS, ATLASES, NOTEBOOKS, MAGAZINES IN THE FIELD OF PSYCHOLOGY, EDUCATION, ANATOMY, HEALTH AND HISTORY, PAPER FLAGS, INDEX CARDS, GREETING CARDS, PRINTED PERIODICALS IN THE FIELD OF PSYCHOLOGY, EDUCATION, ANATOMY, HEALTH AND HISTORY, ART PRINTS, POSTCARDS, NOTE CARDS, POSTERS, SERIES OF BOOKS IN THE FIELD OF PSYCHOLOGY, EDUCATION, ANATOMY, HEALTH AND HISTORY, CALENDARS, CATALOGS IN THE FIELD OF PSYCHOLOGY, EDUCATION, ANATOMY, HEALTH AND HISTORY, AND STICKERS; PHOTOGRAPH AND SCRAPBOOK ALBUMS; WRITING MATERIALS, NAMELY, PENS, PENCILS, MARKERS, ERASERS, PENCIL SHARPENERS; PAPER TABLE MATS, PAPER RIBBONS, PAPER BAGS, PLASTIC BAGS FOR GENERAL PURPOSES AND SMALL PLASTIC BAGS, NAMELY, WRAPPINGS AND POUCHES FOR PACKAGING PURPOSES, PAPER TABLE NAPKINS, PAPER FACE TOWELS; PHOTOGRAPHS; PRINTED TEACHING AIDS AND INSTRUCTIONAL MATERIAL, EXCEPT APPARATUS, IN THE FIELDS OF EDUCATION, PSYCHOLOGY, HISTORY AND PHYSIOLOGY (U.S. CLS. 2, 5, 22, 23, 29, 37, 38 AND 50).

EVELYN BRADLEY, EXAMINING ATTORNEY

THE MARK CONSISTS OF THE WORDS "PUSSYCAT DOLLS" WITHIN A HEART, WITH THE WORD "PUSSYCAT" PLACED ON A BANNER DISPLAYED ACROSS THE UPPER PART OF THE HEART, THE WORD "DOLLS" DISPLAYED ON THE HEART UNDER THE BANNER AND AN ORNAMENTAL DESIGN ON THE TOP OF THE HEART.

FOR BOOKS AND MAGAZINES IN THE FIELDS OF MUSIC, ENTERTAINMENT, ART AND/OR CULTURE; ADDRESS BOOKS; APPOINTMENT BOOKS; CALENDARS; GREETING CARDS; POST CARDS; PEN AND PENCIL CASES; PENCIL SHARPENERS; PENS; PENCILS; DATE BOOKS; BUMPER STICKERS; DECALS; NOTE PADS; STICKERS; RUBBER STAMPS; TEMPORARY TATTOOS; POSTERS; MILK BOTTLE CAPS USED FOR TRADING; TRADING CARDS; MONEY CLIPS; AND STATIONERY (U.S. CLS. 2, 5, 22, 23, 29, 37, 38 AND 50).

GEORGIA CARTY, EXAMINING ATTORNEY

CLASS 16—(Continued).

SN 77-583,760. NINTENDO OF AMERICA INC., REDMOND, WA. FILED 10-2-2008.

WiiMusic

THE MARK CONSISTS OF STANDARD CHARACTERS WITHOUT CLAIM TO ANY PARTICULAR FONT, STYLE, SIZE, OR COLOR.

PRIORITY CLAIMED UNDER SEC. 44(D) ON JAPAN APPLICATION NO. 2008-056941, FILED 7-11-2008, REG. NO. 5250566, DATED 7-24-2009, EXPIRES 7-24-2019.

OWNER OF U.S. REG. NO. 3,482,582.

FOR NOTEBOOKS; MECHANICAL PENCILS; PENCIL CASES; STATIONERY; STUDY MATERIALS, NAMELY, FLASH CARDS; TRADING CARDS; MAGAZINES FEATURING VIDEO GAMES, VIDEO GAMES SYSTEMS AND ACCESSORIES; CATALOGS FEATURING VIDEO GAMES, VIDEO GAMES SYSTEMS AND ACCESSORIES; PAMPHLETS FEATURING VIDEO GAMES, VIDEO GAMES SYSTEMS AND ACCESSORIES; OTHER PRINTED MATTER, NAMELY, POSTERS; BANNERS OF PAPER; FLAGS OF PAPER; PRINTED MATTER AND PUBLICATIONS, NAMELY, ADDRESS BOOKS; BOOK COVERS; BOOKMARKS; BOOKPLATES; CARDBOARD GIFT BOXES; CHILDREN'S BOOKS; COLORING BOOKS AND CHILDREN'S ACTIVITY BOOKS; COMIC BOOKS; DECORATIVE FIGURES ATTACHABLE TO PENCILS; DRAWING RULERS; DRY ERASE WRITING BOARDS; ERASERS; FELT-TIP MARKERS; GIFT WRAPPING PAPER; GREETING CARDS; INVITATION CARDS; IRON-ON TRANSFERS; MAGAZINES, BOOKS, BOOKLETS AND MANUALS REGARDING VIDEO GAMES; MAGNETIC SLATE BOARDS FOR WRITING; MEMO BOARDS; MEMO PADS; NEWSPAPER CARTOONS; NOTEPADS; PAPER BANNERS; PAPER DECORATIONS MOUNTABLE ON DOORS; PAPERBACK BOOKS FOR CHILDREN; PENCIL BOXES WITH MAGNETIC CLOSURES; PENCIL SHARPENERS; PENCILS; PENS; PICTURE STORYBOOKS; POSTCARDS; POSTERS; MULTI-RING BINDERS; SCORE BOOKS; SCRAPBOOKS AND STAMP COLLECTOR BOOKS; SCRATCH PADS; STATIONERY-TYPE PORTFOLIOS; STICKER ALBUMS; STICKERS; STORYBOOK AND AUDIO CASSETTES PACKAGED AS A UNIT (U.S. CLS. 2, 5, 22, 23, 29, 37, 38 AND 50).

FRED MANDIR, EXAMINING ATTORNEY

SN 77-639,037. PHOENIX RESINS INCORPORATED, CINCINNATI, OH. FILED 12-23-2008.

FLEXBOND 5000

THE MARK CONSISTS OF STANDARD CHARACTERS WITHOUT CLAIM TO ANY PARTICULAR FONT, STYLE, SIZE, OR COLOR.

FOR FLEXIBLE POLYURETHANE ADHESIVES FOR HOUSEHOLD USE SOLD AS A FINISHED PRODUCT READY TO USE (U.S. CLS. 2, 5, 22, 23, 29, 37, 38 AND 50).

FIRST USE 7-13-2007; IN COMMERCE 7-13-2007.

HELENE LIWINSKI, EXAMINING ATTORNEY

CLASS 16—(Continued).

SN 77-666,518. HOFFMASTER GROUP, INC., INDIANAPOLIS, IN. FILED 2-9-2009.

BAKE & TAKE

THE MARK CONSISTS OF STANDARD CHARACTERS WITHOUT CLAIM TO ANY PARTICULAR FONT, STYLE, SIZE, OR COLOR.

FOR PLASTIC GIFT BAGS FOR BAKED GOODS; GIFT BAGS AND CONTAINERS FOR BAKED GOODS MADE OF PAPER (U.S. CLS. 2, 5, 22, 23, 29, 37, 38 AND 50).

TEJBIR SINGH, EXAMINING ATTORNEY

SN 77-716,807. TOMPKINS, TROY A, AKA TROY CLE, EAST ORANGE, NJ. FILED 4-17-2009.

Horribly Marvelous

THE MARK CONSISTS OF STANDARD CHARACTERS WITHOUT CLAIM TO ANY PARTICULAR FONT, STYLE, SIZE, OR COLOR.

FOR PRINTED MATTER AND PAPER GOODS, NAMELY, BOOKS FEATURING CHARACTERS FROM ANIMATED, ACTION ADVENTURE, FANTASY, COMEDY OR DRAMA FEATURES, COMIC BOOKS, CHILDREN'S AND YOUNG ADULT BOOKS, MAGAZINES FEATURING CHARACTERS FROM ANIMATED, ACTION ADVENTURE, COMEDY AND DRAMA FEATURES, COLORING BOOKS, CHILDREN'S AND YOUNG ADULT ACTIVITY BOOKS; STATIONERY, WRITING PAPER, ENVELOPES, NOTEBOOKS, DIARIES, NOTE CARDS, GREETING CARDS, TRADING CARDS; LITHOGRAPHS; PENS, PENCILS, CASES FOR PENS AND PENCILS, ERASERS, CRAYONS, MARKERS, COLORED PENCILS, PAINTING SETS FOR CHILDREN, CHALK AND CHALKBOARDS; DECALS, HEAT TRANSFER PAPER; POSTERS; MOUNTED AND UNMOUNTED PHOTOGRAPHS; BOOK COVERS, BOOK MARKS, POSTCARDS, CALENDARS, GIFT WRAPPING PAPER; PAPER PARTY FAVORS AND PAPER PARTY DECORATIONS, NAMELY, PAPER NAPKINS, PAPER DOILIES, PAPER PLACE MATS, CREPE PAPER, PRINTED INVITATIONS, PAPER TABLE CLOTHS, PAPER CAKE DECORATIONS; PRINTED IRON-ON AND PLASTIC TRANSFERS FOR EMBROIDERY OR FABRIC APPLIQUES; PRINTED PATTERNS FOR COSTUMES, PAJAMAS, SWEATSHIRTS AND T-SHIRTS (U.S. CLS. 2, 5, 22, 23, 29, 37, 38 AND 50).

YAT SYE, LEE, EXAMINING ATTORNEY

CLASS 16—(Continued).

SN 77-722,987. BUYWITHME, INC., BOSTON, MA. FILED 4-27-2009.

BUYWITHME

THE MARK CONSISTS OF STANDARD CHARACTERS WITHOUT CLAIM TO ANY PARTICULAR FONT, STYLE, SIZE, OR COLOR.

FOR PRINTED CONSUMER COUPONS, GIFT CARDS, PRINTED GIFT CERTIFICATES, PRINTED VOUCHERS (U.S. CLS. 2, 5, 22, 23, 29, 37, 38 AND 50).

KHANH LE, EXAMINING ATTORNEY

SN 77-724,288. MY HEART'S WISH, INC., BROOKLYN PARK, MN. FILED 4-28-2009.

J.O.T. JOURNAL. ORGANIZE. THRIVE

THE MARK CONSISTS OF STANDARD CHARACTERS WITHOUT CLAIM TO ANY PARTICULAR FONT, STYLE, SIZE, OR COLOR.

NO CLAIM IS MADE TO THE EXCLUSIVE RIGHT TO USE "JOURNAL. ORGANIZE.", APART FROM THE MARK AS SHOWN.

FOR SERIES OF LIFE EVENT THEMED WRITING JOURNALS IN THE FORM OF BINDERS, NOTEBOOKS, AND ORGANIZERS (U.S. CLS. 2, 5, 22, 23, 29, 37, 38 AND 50).

ROBIN CHOSID, EXAMINING ATTORNEY

SN 77-729,586. AMERICAN BIBLE SOCIETY, NEW YORK, NY. FILED 5-5-2009.

God Sets You Free

THE MARK CONSISTS OF STANDARD CHARACTERS WITHOUT CLAIM TO ANY PARTICULAR FONT, STYLE, SIZE, OR COLOR.

FOR BIBLES, NEW TESTAMENTS, PRINTED PERIODICALS, NEWSLETTERS, BROCHURES, INFORMATIONAL FLYERS, PRINTED DONOR REPORTS, CATALOGS, PRINTED MATERIALS IN THE NATURE OF TRACTS ALL IN THE FIELD OF RELIGION AND OUTREACH MINISTRY TO THE INCARCERATED (U.S. CLS. 2, 5, 22, 23, 29, 37, 38 AND 50).

KAPIL BHANOT, EXAMINING ATTORNEY

CLASS 16—(Continued).

SN 77-730,775. STARR MAP COMPANY LLC, LA CONNER, WA. FILED 5-6-2009.

DISCOVERY MAP

THE MARK CONSISTS OF STANDARD CHARACTERS WITHOUT CLAIM TO ANY PARTICULAR FONT, STYLE, SIZE, OR COLOR.

STARR MAP COMPANY, LLC IS PERMITTED TO USE THE MARK, "DISCOVERY MAP", ANYWHERE EXCEPT IN THE STATE OF WASHINGTON PURSUANT TO CONCURRENT USE PROCEEDING NO. 94002092 AND KING COUNTY SUPERIOR COURT JUDGMENT NO. 00-2-14945-0 SEA

OWNER OF U.S. REG. NOS. 2,308,880 AND 3,234,851.

NO CLAIM IS MADE TO THE EXCLUSIVE RIGHT TO USE "MAP", APART FROM THE MARK AS SHOWN.

FOR PRINTED MAPS; PRINTED GUIDES FOR TRAVEL AND SIGHTSEEING (U.S. CLS. 2, 5, 22, 23, 29, 37, 38 AND 50).

FIRST USE 10-0-1996; IN COMMERCE 10-0-1996.

JULIE GUTTADAURO, EXAMINING ATTORNEY

SN 77-769,694. THE CHRISTIAN FAMILY PUBLICATION, INC., PELHAM, AL. FILED 6-27-2009.

DALLAS CHRISTIAN FAMILY

THE MARK CONSISTS OF STANDARD CHARACTERS WITHOUT CLAIM TO ANY PARTICULAR FONT, STYLE, SIZE, OR COLOR.

OWNER OF U.S. REG. NOS. 3,625,214 AND 3,671,676.

NO CLAIM IS MADE TO THE EXCLUSIVE RIGHT TO USE "DALLAS", APART FROM THE MARK AS SHOWN. SEC. 2(F) AS TO "CHRISTIAN FAMILY".

FOR PUBLICATIONS, NAMELY, MAGAZINES IN THE FIELD OF CHRISTIAN VALUES, FAMILY ISSUES AND RELIGION (U.S. CLS. 2, 5, 22, 23, 29, 37, 38 AND 50).

FIRST USE 1-31-2010; IN COMMERCE 1-31-2010.

KARANENDRA S. CHHINA, EXAMINING ATTORNEY

CLASS 16—(Continued).

SN 77-769,695. THE CHRISTIAN FAMILY PUBLICATION, INC., PELHAM, AL. FILED 6-27-2009.

FORT WORTH CHRISTIAN FAMILY

THE MARK CONSISTS OF STANDARD CHARACTERS WITHOUT CLAIM TO ANY PARTICULAR FONT, STYLE, SIZE, OR COLOR.

OWNER OF U.S. REG. NOS. 3,625,214 AND 3,671,676.

NO CLAIM IS MADE TO THE EXCLUSIVE RIGHT TO USE "FORT WORTH", APART FROM THE MARK AS SHOWN.

SEC. 2(F) AS TO "CHRISTIAN FAMILY".

FOR PUBLICATIONS, NAMELY, MAGAZINES IN THE FIELD OF CHRISTIAN VALUES, FAMILY ISSUES AND RELIGION (U.S. CLS. 2, 5, 22, 23, 29, 37, 38 AND 50).

KARANENDRA S. CHHINA, EXAMINING ATTORNEY

CLASS 16—(Continued).

SN 77-780,973. THE CHRISTIAN FAMILY PUBLICATION, INC., PELHAM, AL. FILED 7-14-2009.

TUSCALOOSA CHRISTIAN FAMILY

THE MARK CONSISTS OF STANDARD CHARACTERS WITHOUT CLAIM TO ANY PARTICULAR FONT, STYLE, SIZE, OR COLOR.

OWNER OF U.S. REG. NOS. 2,765,951, 3,625,214 AND OTHERS.

NO CLAIM IS MADE TO THE EXCLUSIVE RIGHT TO USE "TUSCALOOSA", APART FROM THE MARK AS SHOWN.

SEC. 2(F) AS TO "CHRISTIAN FAMILY".

FOR PUBLICATIONS, NAMELY, MAGAZINES IN THE FIELD OF CHRISTIAN VALUES, FAMILY ISSUES AND RELIGION (U.S. CLS. 2, 5, 22, 23, 29, 37, 38 AND 50).

FIRST USE 12-2-2002; IN COMMERCE 12-2-2002.

KARANENDRA S. CHHINA, EXAMINING ATTORNEY

SN 77-782,527. INDIANA HEMOPHILIA & THROMBOSIS CENTER, INC., INDIANAPOLIS, IN. FILED 7-16-2009.

VERITAS-PRN

THE MARK CONSISTS OF STANDARD CHARACTERS WITHOUT CLAIM TO ANY PARTICULAR FONT, STYLE, SIZE, OR COLOR.

THE ENGLISH TRANSLATION OF "VERITAS" IN THE MARK IS TRUTH.

FOR HEMOPHILIA TREATMENT ADHERENCE QUESTIONNAIRES (U.S. CLS. 2, 5, 22, 23, 29, 37, 38 AND 50).

FIRST USE 10-31-2008; IN COMMERCE 10-31-2008.

SHANNON TWOHIG, EXAMINING ATTORNEY

SN 77-780,632. BELLEROPHON PUBLICATIONS, INC., NEW YORK, NY. FILED 7-14-2009.



OWNER OF U.S. REG. NOS. 1,196,240, 2,218,342 AND 2,462,817.

NO CLAIM IS MADE TO THE EXCLUSIVE RIGHT TO USE "BOOKS", APART FROM THE MARK AS SHOWN.

THE MARK CONSISTS OF THE WORD "METROPOLIS" PRESENTED VERTICALLY AND FORMING THE SHAPE OF A SKYSCRAPER BOTH APPEARING OVER THE WORD "BOOKS" WHICH IS PRESENTED HORIZONTALLY.

FOR PRINTED MATTER, NAMELY, BOOKS IN THE FIELD OF ARCHITECTURE AND DESIGN (U.S. CLS. 2, 5, 22, 23, 29, 37, 38 AND 50).

FIRST USE 7-0-2004; IN COMMERCE 7-0-2004.

KATHERINE M. DUBRAY, EXAMINING ATTORNEY

SN 77-783,864. FIBERMARK NORTH AMERICA, INC., BRATTLEBORO, VT. FILED 7-17-2009.

SENZO

THE MARK CONSISTS OF STANDARD CHARACTERS WITHOUT CLAIM TO ANY PARTICULAR FONT, STYLE, SIZE, OR COLOR.

FOR PAPER COVER STOCK COATED WITH RESINOUS AND PLASTIC LATEX FILM FOR USE AS A COVERING FOR THE PACKAGING AND PUBLISHING INDUSTRIES (U.S. CLS. 2, 5, 22, 23, 29, 37, 38 AND 50).

JASON TURNER, EXAMINING ATTORNEY

CLASS 16—(Continued).

SN 77-784,778. JAMES T. RAMSEY, PORTSMOUTH, VA. FILED 7-20-2009.

LifeCheck

THE MARK CONSISTS OF STANDARD CHARACTERS WITHOUT CLAIM TO ANY PARTICULAR FONT, STYLE, SIZE, OR COLOR.

FOR PRINTED VOUCHER FOR USE IN CONNECTION WITH THE PURCHASE OF LIFE GUARD PRODUCTS (U.S. CLS. 2, 5, 22, 23, 29, 37, 38 AND 50).

EDWARD FENNESSY, EXAMINING ATTORNEY

SN 77-789,108. THE FOOD PROJECT, INC., LINCOLN, MA. FILED 7-24-2009.

REAL FOOD CHALLENGE

THE MARK CONSISTS OF STANDARD CHARACTERS WITHOUT CLAIM TO ANY PARTICULAR FONT, STYLE, SIZE, OR COLOR.

NO CLAIM IS MADE TO THE EXCLUSIVE RIGHT TO USE "REAL FOOD", APART FROM THE MARK AS SHOWN.

FOR PRINTED EDUCATIONAL MATERIAL, NAMELY, BROCHURES, FLYERS, PAMPHLETS, POSTERS, AND TRAINING GUIDES AND MANUALS, ALL IN THE FIELDS OF FARM-TO-CAFETERIA FOOD AND AGRICULTURAL PROGRAMS, GARDENING, FAIR TRADE, ORGANIC AND SUSTAINABLE FOOD PRACTICES, FARMWORKERS' RIGHTS, RELATIONSHIPS WITH LOCAL FARMERS, AND IN THE FIELD OF EDUCATIONAL CAMPAIGNS RELATED TO SAME (U.S. CLS. 2, 5, 22, 23, 29, 37, 38 AND 50).

FIRST USE 10-20-2006; IN COMMERCE 10-20-2006.

LINDA POWELL, EXAMINING ATTORNEY

SN 77-789,726. LECOCQ, PASCAL G., DBA PASCAL LECOCQ, OAKLAND PARK, FL. FILED 7-26-2009.

PASCAL LECOCQ

THE MARK CONSISTS OF STANDARD CHARACTERS WITHOUT CLAIM TO ANY PARTICULAR FONT, STYLE, SIZE, OR COLOR.

THE NAME "PASCAL LECOCQ" IDENTIFIES A LIVING INDIVIDUAL WHOSE CONSENT IS OF RECORD.

FOR PAINTINGS AND THEIR REPRODUCTIONS (U.S. CLS. 2, 5, 22, 23, 29, 37, 38 AND 50).

FIRST USE 1-28-1977; IN COMMERCE 1-28-1977.

SIMON TENG, EXAMINING ATTORNEY

CLASS 16—(Continued).

SN 77-789,734. EASTLAND, WINTER L., CANYON LAKE, TX. FILED 7-26-2009.

The Cedar Post Queen

THE MARK CONSISTS OF STANDARD CHARACTERS WITHOUT CLAIM TO ANY PARTICULAR FONT, STYLE, SIZE, OR COLOR.

FOR PRINTED PUBLICATIONS, NAMELY, BOOKS, HAND-OUTS, WORKBOOKS, MAGAZINES, NEWSLETTERS, POSTCARDS, AND PRINTED TEACHING MATERIALS IN THE FIELDS OF LIFE, LIBERTY, AND THE PURSUIT OF HAPPINESS AS THEY RELATE TO CHRISTIANITY AND LIVING A CHRISTIAN LIFE (U.S. CLS. 2, 5, 22, 23, 29, 37, 38 AND 50).

ELISSA GARBER KON, EXAMINING ATTORNEY

SN 77-791,451. WIZARD SEAFOODS, INC., FALL CITY, WA. FILED 7-28-2009.

CRAB WIZARD

THE MARK CONSISTS OF STANDARD CHARACTERS WITHOUT CLAIM TO ANY PARTICULAR FONT, STYLE, SIZE, OR COLOR.

NO CLAIM IS MADE TO THE EXCLUSIVE RIGHT TO USE "CRAB", APART FROM THE MARK AS SHOWN.

FOR A SERIES OF BOOKS AND WRITTEN ARTICLES IN THE FIELD OF COOKING; A SERIES OF BOOKS, WRITTEN ARTICLES, HANDOUTS AND WORKSHEETS IN THE FIELD OF COOKING; BOOKS IN THE FIELD OF COOKING; COOK BOOKS; PUBLICATIONS, NAMELY, MAGAZINES, BOOKS, PAMPHLETS IN THE FIELDS OF COOKING; RECIPE BOOKS (U.S. CLS. 2, 5, 22, 23, 29, 37, 38 AND 50).

KATINA MISTER, EXAMINING ATTORNEY

SN 77-792,612. MARKER, SUSAN LORDI, KANSAS CITY, MO. FILED 7-29-2009.

WILLOW TREE

THE MARK CONSISTS OF STANDARD CHARACTERS WITHOUT CLAIM TO ANY PARTICULAR FONT, STYLE, SIZE, OR COLOR.

OWNER OF U.S. REG. NOS. 2,687,795 AND 3,572,110.

FOR GREETING CARDS, BLANK JOURNALS, APPOINTMENT BOOKS, GUEST BOOKS, PHOTOGRAPH ALBUMS, WEDDING ALBUMS, GIFT ENCLOSURE CARDS, PERSONALIZED INVITATIONS (U.S. CLS. 2, 5, 22, 23, 29, 37, 38 AND 50).

GINA HAYES, EXAMINING ATTORNEY

CLASS 16—(Continued).

SN 77-795,171. FROM YOU TO ME LIMITED, TA FROM YOU TO ME, BATH, UNITED KINGDOM, FILED 8-3-2009.

from you to me

THE MARK CONSISTS OF STANDARD CHARACTERS WITHOUT CLAIM TO ANY PARTICULAR FONT, STYLE, SIZE, OR COLOR.

OWNER OF UNITED KINGDOM REG. NO. 2493815, DATED 7-28-2008, EXPIRES 7-28-2018.

FOR BLANK JOURNAL BOOKS; RECIPE BOOKS; MEMORY BOOKS FOR RECORDING INFORMATION ABOUT BABIES; MEMORY BOOKS FOR RECORDING INFORMATION ABOUT CHILDREN; MEMORY BOOKS FOR RECORDING FAMILY HISTORY, MEMORIES AND ANECDOTES; PRINTED BOOKS FEATURING QUESTIONS FOR THE RECIPIENT TO COMPLETE AND CAPTURE THEIR MEMORIES AND ANECDOTES; GIFT BOOKS FEATURING FAMILY MEMORIES AND ANECDOTES (U.S. CLS. 2, 5, 22, 23, 29, 37, 38 AND 50).

BERYL GARDNER, EXAMINING ATTORNEY

SN 77-797,952. SAINT LOUIS UNIVERSITY, ST. LOUIS, MO. FILED 8-5-2009.

BE A BILLIKEN

THE MARK CONSISTS OF STANDARD CHARACTERS WITHOUT CLAIM TO ANY PARTICULAR FONT, STYLE, SIZE, OR COLOR.

OWNER OF U.S. REG. NO. 1,662,548.

FOR LEATHER DOCUMENT PORTFOLIOS (U.S. CLS. 2, 5, 22, 23, 29, 37, 38 AND 50).

FIRST USE 7-10-2008; IN COMMERCE 2-2-2009.

LINDA E. BLOHM, EXAMINING ATTORNEY

SN 77-799,988. WALKER ENTERPRISES, INC., PEORIA, AZ. FILED 8-7-2009.



TUXEDO WHOLESALER

NO CLAIM IS MADE TO THE EXCLUSIVE RIGHT TO USE "TUXEDO WHOLESALER", APART FROM THE MARK AS SHOWN.

THE MARK CONSISTS OF A STYLIZED TUXEDO WITH VERTICAL STRIPES IN THE SHIRT OR VEST AREA, TO THE LEFT OF THE WORDS "TUXEDO WHOLESALER".

FOR CATALOGS IN THE FIELD OF TUXEDOS (U.S. CLS. 2, 5, 22, 23, 29, 37, 38 AND 50).

FIRST USE 12-31-1983; IN COMMERCE 12-31-1983.

ELISSA GARBER KON, EXAMINING ATTORNEY

CLASS 16—(Continued).

SN 77-803,247. CLEMENTINE PAPER, INC., SANTA MONICA, CA. FILED 8-12-2009.

MINTGREEN

THE MARK CONSISTS OF STANDARD CHARACTERS WITHOUT CLAIM TO ANY PARTICULAR FONT, STYLE, SIZE, OR COLOR.

OWNER OF U.S. REG. NO. 3,533,776.

FOR OFFICE SUPPLIES, NAMELY, STATIONERY, PRINTED INVITATIONS AND ENVELOPES; BLANK JOURNAL BOOKS; PHOTO ALBUMS; NOTEBOOKS; NOTE PADS; NOTE CARDS; PAPER GIFT BAGS; GIFT BOXES; GIFT WRAP PAPER; GIFT TISSUE PAPER; BINDERS; THREE-RING BINDERS; PAPER EXPANDING FILES; FILE FOLDERS; CLIP BOARDS; INDEX DIVIDERS; ADHESIVE LABELS (U.S. CLS. 2, 5, 22, 23, 29, 37, 38 AND 50).

ESTHER A. BORSUK, EXAMINING ATTORNEY

SN 77-803,863. MUSOPIA STUDIOS, INC., NAPERVILLE, IL. FILED 8-13-2009.



THE MARK CONSISTS OF THE WORD "MUSOPIA", WHICH IS A NOVELTY NAME; THIS WORD IS COMBINED TO A CIRCULAR GRAPHIC REPRESENTATION SHOWING A FANCIFUL DESIGNED MUSIC NOTES WITH SMILING FACE SURROUNDED BY A STYLIZED HALO.

FOR PRINTED MATERIALS IN THE FIELD OF EARLY CHILDHOOD MUSIC EDUCATION, NAMELY, SERIES OF FICTION BOOKS AND SHORT STORIES, COLORING BOOKS, CHILDREN'S ACTIVITY BOOKS, INSTRUCTION BOOKS AND TEACHING AIDS BOOKS SOLD TOGETHER WITH COMPACT DISCS, PUZZLES OR TOY MUSICAL INSTRUMENTS; SONG BOOKS, SHEET MUSIC, FLASH CARDS, STICKERS AND MUSIC CATALOGS (U.S. CLS. 2, 5, 22, 23, 29, 37, 38 AND 50).

ZACHARY BELLO, EXAMINING ATTORNEY

CLASS 16—(Continued).

SN 77-837,126. IN TOUCH MINISTRIES, INC., ATLANTA, GA. FILED 9-29-2009.

IN TOUCH MINISTRIES

THE MARK CONSISTS OF STANDARD CHARACTERS WITHOUT CLAIM TO ANY PARTICULAR FONT, STYLE, SIZE, OR COLOR.

OWNER OF U.S. REG. NOS. 1,211,426 AND 1,332,925.

NO CLAIM IS MADE TO THE EXCLUSIVE RIGHT TO USE "MINISTRIES", APART FROM THE MARK AS SHOWN.

FOR HOUSE MARK FOR A FULL LINE OF PUBLICATIONS, INSTRUCTIONAL AND TEACHING MATERIALS, AND PRINTED MATERIALS, NAMELY, BROCHURES, REPORTS, BOOKLETS, BOOKS, MAGAZINES, PAMPHLETS, NEWSLETTERS, ACTIVITY AND COLORING BOOKS, AND CALENDARS, ALL IN THE FIELDS OF SPIRITUALITY, RELIGION, ETHICS, SOCIAL ISSUES, CULTURAL ISSUES, RELATIONSHIPS, AND LIFESTYLE; RELIGIOUS GREETING CARDS; NOTEBOOKS; JOURNALS; STATIONERY; PENS (U.S. CLS. 2, 5, 22, 23, 29, 37, 38 AND 50).

FIRST USE 6-0-1980; IN COMMERCE 6-0-1980.

SOPHIA S. KIM, EXAMINING ATTORNEY

SN 77-842,710. NICHOLS PUBLISHING COMPANY, DUBUQUE, IA. FILED 10-6-2009.

GARDEN & GREENHOUSE

THE MARK CONSISTS OF STANDARD CHARACTERS WITHOUT CLAIM TO ANY PARTICULAR FONT, STYLE, SIZE, OR COLOR.

SEC. 2(F).

FOR PRINTED PERIODICALS IN THE FIELD OF GARDENING (U.S. CLS. 2, 5, 22, 23, 29, 37, 38 AND 50).

FIRST USE 11-1-2001; IN COMMERCE 11-1-2001.

KIM MONINGHOFF, EXAMINING ATTORNEY

SN 77-843,346. RUSSELL EVAN JOHNSON, EPHRAIM, UT. FILED 10-7-2009.

Poor Teacher Rich Speaker

THE MARK CONSISTS OF STANDARD CHARACTERS WITHOUT CLAIM TO ANY PARTICULAR FONT, STYLE, SIZE, OR COLOR.

NO CLAIM IS MADE TO THE EXCLUSIVE RIGHT TO USE "SPEAKER", APART FROM THE MARK AS SHOWN.

FOR A SERIES OF BOOKS, WRITTEN ARTICLES, HANDOUTS AND WORKSHEETS IN THE FIELD OF SPEAKING, CONSULTING, TRAINING AND DEVELOPMENT (U.S. CLS. 2, 5, 22, 23, 29, 37, 38 AND 50).

FIRST USE 9-15-2009; IN COMMERCE 9-15-2009.

ERIN FALK, EXAMINING ATTORNEY

CLASS 16—(Continued).

SN 77-847,907. KABBALAH CENTRE INTERNATIONAL, INC., LOS ANGELES, CA. FILED 10-13-2009.



THE KABBALAH CENTRE
learn transform connect

OWNER OF U.S. REG. NOS. 2,709,764, 2,885,664 AND OTHERS.

THE COLOR(S) GRAY, AQUA BLUE AND MAROON IS/ARE CLAIMED AS A FEATURE OF THE MARK.

THE MARK CONSISTS OF A SERIES OF DOTS CONNECTED BY LINES FORMING AN AQUA BLUE GEOMETRIC DESIGN, WITH A SMALL STYLIZED GRAY LION DESIGN TO ITS LEFT, AND TO ITS RIGHT THE WORDS "THE KABBALAH CENTRE" IN MAROON ABOVE THE WORDS "LEARN TRANSFORM CONNECT" IN GRAY.

SEC. 2(F) AS TO "THE KABBALAH CENTRE".

FOR BOOKS, MAGAZINES AND NEWSLETTERS IN THE FIELD OF RELIGION AND SPIRITUALITY (U.S. CLS. 2, 5, 22, 23, 29, 37, 38 AND 50).

COLLEEN KEARNEY, EXAMINING ATTORNEY

SN 77-849,079. NCD ACQUISITIONS INC., SANTA FE SPRINGS, CA. FILED 10-15-2009.

File Rite

THE MARK CONSISTS OF STANDARD CHARACTERS WITHOUT CLAIM TO ANY PARTICULAR FONT, STYLE, SIZE, OR COLOR.

NO CLAIM IS MADE TO THE EXCLUSIVE RIGHT TO USE "FILE", APART FROM THE MARK AS SHOWN.

FOR BUSINESS FORMS, LETTER FILES, TAGS FOR INDEX CARDS, INDEX CARDS, LETTERING AND NUMBERING GUIDES; DOCUMENT FILES AND DOCUMENT HOLDERS; PLASTIC PAGES FOR HOLDING PHOTOGRAPHS, NEGATIVES, SLIDES, X-RAY TRANSPARENCIES; STATIONARY-TYPE PORTFOLIOS (U.S. CLS. 2, 5, 22, 23, 29, 37, 38 AND 50).

FIRST USE 9-21-1998; IN COMMERCE 9-21-1998.

LESLEY LAMOTHE, EXAMINING ATTORNEY

CLASS 16—(Continued).

SN 77-850,328. GRAY, LAMETREA M., CHICAGO, IL. FILED 10-16-2009.



THE NAME IN THE MARK IDENTIFIES LAMETREA MARIE GRAY A LIVING INDIVIDUAL WHOSE CONSENT IS OF RECORD.

THE COLOR(S) BLUE AND MAGENTA IS/ARE CLAIMED AS A FEATURE OF THE MARK.

THE MARK CONSISTS OF THE WORDS "MARIE'S MUSINGS" IN BLUE SCRIPT FONT, WITH MAGENTA HEART SHAPES DOTTING EACH LETTER "I", MAGENTA RIBBON DESIGNS EXTENDING FROM THE FIRST "M" OF "MARIE'S" AND LAST "S" OF "MUSINGS", A MAGENTA HEART-SHAPED RIBBON DESIGN CONNECTING "MARIE'S" AND "MUSINGS", AND THE PHRASE "START A CONVERSATION . . . IN YOUR HEART" IN BLUE PRINT BELOW "MARIE'S MUSINGS". NO CLAIM IS MADE TO THE WHITE BACKGROUND.

FOR GREETING CARDS; STATIONERY; NOTE CARDS; BLANK WRITING JOURNALS; SEALS FOR ENVELOPES; GIFT BAGS (U.S. CLS. 2, 5, 22, 23, 29, 37, 38 AND 50).

ALYSSA STEEL, EXAMINING ATTORNEY

CLASS 16—(Continued).

SN 77-864,052. MCLEAN COMMUNICATIONS INC., MANCHESTER, NH. FILED 11-3-2009.

NEW HAMPSHIRE MAGAZINE

THE MARK CONSISTS OF STANDARD CHARACTERS WITHOUT CLAIM TO ANY PARTICULAR FONT, STYLE, SIZE, OR COLOR.

NO CLAIM IS MADE TO THE EXCLUSIVE RIGHT TO USE "MAGAZINE", APART FROM THE MARK AS SHOWN. SEC. 2(F).

FOR MONTHLY MAGAZINE FEATURING PEOPLE, BUSINESS, CULTURE, ISSUES, EVENTS, PRODUCTS, SERVICES, POLITICS, ENTERTAINMENT OF INTEREST IN NEW HAMPSHIRE (U.S. CLS. 2, 5, 22, 23, 29, 37, 38 AND 50).

FIRST USE 5-10-1999; IN COMMERCE 5-10-1999.

JILL PRATER, EXAMINING ATTORNEY

SN 77-853,211. PORAK DE VARNA, VICTOR, DENVER, CO. AND PORAK DE VARNA, DANIELLE, DENVER, CO. FILED 10-20-2009.

Chez Madame

THE MARK CONSISTS OF STANDARD CHARACTERS WITHOUT CLAIM TO ANY PARTICULAR FONT, STYLE, SIZE, OR COLOR.

"MADAME" DOES NOT IDENTIFY A PARTICULAR LIVING INDIVIDUAL.

THE ENGLISH TRANSLATION OF "CHEZ MADAME" IN THE MARK IS AT MADAM'S.

FOR A SERIES OF BOOKS AND WRITTEN ARTICLES IN THE FIELD OF COOKING, ENTERTAINMENT, STYLE, ETIQUETTE, NUTRITION; A SERIES OF BOOKS, WRITTEN ARTICLES, HANDOUTS AND WORKSHEETS IN THE FIELD OF COOKING, ENTERTAINMENT, STYLE, ETIQUETTE, NUTRITION; BOOKS IN THE FIELD OF COOKING, ENTERTAINMENT, STYLE, ETIQUETTE, NUTRITION; COOK BOOKS; RECIPE BOOKS (U.S. CLS. 2, 5, 22, 23, 29, 37, 38 AND 50).

DARRYL SPRUILL, EXAMINING ATTORNEY

SN 77-864,325. BIZWORLD FOUNDATION, SAN FRANCISCO, CA. FILED 11-3-2009.

BIZWORLD

THE MARK CONSISTS OF STANDARD CHARACTERS WITHOUT CLAIM TO ANY PARTICULAR FONT, STYLE, SIZE, OR COLOR.

OWNER OF U.S. REG. NO. 2,385,392.

FOR EDUCATIONAL CURRICULUM MATERIALS COMPRISED OF PRINTED COURSE GUIDE, INSTRUCTIONS AND TEACHING AIDES FOR EDUCATIONAL ACTIVITIES IN THE FIELDS OF ENTREPRENEURSHIP, BUSINESS, MANAGEMENT, MARKETING, AND FINANCE (U.S. CLS. 2, 5, 22, 23, 29, 37, 38 AND 50).

STEPHANIE ALI, EXAMINING ATTORNEY

CLASS 16—(Continued).

SN 77-870,500. SCHOOL OF ROCK, LLC, TEANECK, NJ.
FILED 11-11-2009.

CLASS 16—(Continued).

SN 77-874,623. AMANDA BLU & CO., L.L.C., PRAIRIE
VILLAGE, KS. FILED 11-17-2009.



AMANDA BLU

THE MARK CONSISTS OF THE WORDS "SCHOOL OF ROCK" WITH A DESIGN OF A GUITAR REPLACING THE LETTER "O" IN THE WORD "ROCK".

FOR MAGAZINES IN THE FIELDS OF ENTERTAINMENT, POP CULTURE, AND MUSIC; BOOKS IN THE FIELDS OF ENTERTAINMENT, POP CULTURE AND MUSIC; PRINT MEDIA, NAMELY, MAGAZINES, JOURNALS, AND MANUALS COVERING PRIMARILY THE FIELDS OF ENTERTAINMENT, POP CULTURE, AND MUSIC; PRINT MEDIA, NAMELY, BROCHURES, POSTERS, MAGAZINES, PHOTOGRAPHS, SHEET MUSIC, AND JEWEL CASE INSERTS, ALL IN THE FIELD OF MUSIC; PUBLICATIONS, NAMELY, MAGAZINES FEATURING ARTICLES ON MUSIC, ENTERTAINMENT, MUSIC EDUCATION, BANDS, ARTISTS, PERFORMANCES AND RELATED TOPICS OF GENERAL INTEREST; PUBLICATIONS, NAMELY, MAGAZINES IN THE FIELDS OF MUSIC, MUSICAL PERFORMERS AND PERFORMANCES, GROUPS AND ARTISTS; PUBLICATIONS, NAMELY, MAGAZINES THAT FEATURE ADVERTISEMENTS FOR PRE-RECORDED CDS AND DVDS, CONCERTS, MUSICAL PERFORMANCES, TOURS, MUSICAL INSTRUMENTS, MUSICAL MAGAZINES; SYNDICATED COLUMNS AND A SERIES OF ARTICLES IN THE FIELD OF MUSIC; PRINTED GUIDES FOR TEACHING OTHERS HOW TO PLAY MUSICAL INSTRUMENTS; SHEET MUSIC (U.S. CLS. 2, 5, 22, 23, 29, 37, 38 AND 50).

GINA HAYES, EXAMINING ATTORNEY

THE MARK CONSISTS OF STANDARD CHARACTERS WITHOUT CLAIM TO ANY PARTICULAR FONT, STYLE, SIZE, OR COLOR.

THE NAME(S), PORTRAIT(S), AND/OR SIGNATURE(S) SHOWN IN THE MARK IDENTIFIES AMANDA BLU FERREL, WHOSE CONSENT(S) TO REGISTER IS MADE OF RECORD.

FOR SCRAPBOOK ALBUMS, MEMORY BOOKS, PHOTOGRAPH ALBUMS; SCRAPBOOKING, PHOTO ALBUM AND PAPER CRAFTING SUPPLIES AND EMBELLISHMENTS, NAMELY, PAPER AND PAPER CARD STOCK SHEETS, BACKGROUND PAPERS, PRINTED PAPERS, PATTERNED AND SOLID PAPER CARD STOCK, PAPER AND CARD STOCK STICKERS CONTAINING LETTERS, WORDS OR OTHER ORNAMENTAL DESIGNS, LETTERS AND ORNAMENTAL DECORATIONS MADE OF CHIPBOARD PAPER, PAPER RUB-ON IMAGES, PAPER SHAPES AND DESIGNS, PAPER BORDER TRIM, AND PAPER CUTOUTS; SCRAPBOOK AND PHOTO ALBUM COVERS, SCRAPBOOK AND PHOTO ALBUM PAGE REFILLS, AND PLASTIC SLEEVES FOR HOLDING AND PROTECTING SCRAPBOOK AND PHOTO ALBUM CONTENTS; SCRAPBOOK AND PHOTO ALBUM KITS COMPRISED PRIMARILY OF SCRAPBOOK AND PHOTO ALBUMS, PAPER SHEETS, BACKGROUND PAPERS, PRINTED PAPERS, PATTERNED AND SOLID PAPER CARD STOCK, PAPER SHAPES AND DESIGNS, PAPER BORDER TRIM, BUTTONS, PAPER CUT OUTS, PAPER AND CARD STOCK STICKERS, AND PAPER RUB-ON IMAGES (U.S. CLS. 2, 5, 22, 23, 29, 37, 38 AND 50).

FIRST USE 11-0-2003; IN COMMERCE 11-0-2003.

MICHELE SWAIN, EXAMINING ATTORNEY

CLASS 16—(Continued).

SN 77-876,683. GIFT CARD IMPRESSIONS, LLC, OVERLAND PARK, KS. FILED 11-19-2009.

WHERE INNOVATION MEETS
GIFTING

THE MARK CONSISTS OF STANDARD CHARACTERS WITHOUT CLAIM TO ANY PARTICULAR FONT, STYLE, SIZE, OR COLOR.

FOR GIFT CARDS, PAPER GIFT CARD HOLDERS, PAPER HOLDERS SPECIALLY ADAPTED FOR HOLDING GIFT CARDS, GIFT PACKAGING MADE OF PAPER, GIFT CARD PACKAGING MADE OF PAPER, PAPER GIFT TAGS, WRAPPING PAPER, PLASTIC GIFT WRAP, PAPER GIFT WRAPPING RIBBONS, ENVELOPES, CARDBOARD PACKAGING, PACKAGING CONTAINERS OF PAPER, PAPER POUCHES FOR PACKAGING, PLASTIC BAGS FOR PACKAGING, PLASTIC OR PAPER BAGS FOR MERCHANDISE PACKAGING, FABRIC GIFT BAGS, MERCHANDISE BAGS, PAPER BAGS, PAPER GIFT BAGS, PAPER GIFT BAGS FOR WINE, TEXTILE GIFT BAGS FOR WINE, PAPER PARTY BAGS, STICKERS, STICKERS AND TRANSFERS, DESK BASKETS FOR DESK ACCESSORIES, BOXES OF PAPER OR CARDBOARD, FIBERBOARD BOXES, GIFT BOXES, PAPERBOARD BOXES, PAPERBOARD, TREATED PAPER FOR WRAPPING FLOWERS AND FLORAL DISPLAYS, FLORAL PACKAGING, NAMELY, PAPER FOR WRAPPING FLOWERS, MUSICAL GREETING CARDS, CARDBOARD HANG TAGS, PAPER HANG TAGS, PAPER IDENTIFICATION TAGS (U.S. CLS. 2, 5, 22, 23, 29, 37, 38 AND 50).

THOMAS MANOR, EXAMINING ATTORNEY

SN 77-876,753. GIFT CARD IMPRESSIONS, LLC, OVERLAND PARK, KS. FILED 11-19-2009.

WRAP IT WITH INNOVATION

THE MARK CONSISTS OF STANDARD CHARACTERS WITHOUT CLAIM TO ANY PARTICULAR FONT, STYLE, SIZE, OR COLOR.

FOR GIFT CARDS, PAPER GIFT CARD HOLDERS, PAPER HOLDERS SPECIALLY ADAPTED FOR HOLDING GIFT CARDS, GIFT PACKAGING MADE OF PAPER, GIFT CARD PACKAGING MADE OF PAPER, PAPER GIFT TAGS, WRAPPING PAPER, PLASTIC GIFT WRAP, PAPER GIFT WRAPPING RIBBONS, ENVELOPES, CARDBOARD PACKAGING, PACKAGING CONTAINERS OF PAPER, PAPER POUCHES FOR PACKAGING, PLASTIC BAGS FOR PACKAGING, PLASTIC OR PAPER BAGS FOR MERCHANDISE PACKAGING, FABRIC GIFT BAGS, MERCHANDISE BAGS, PAPER BAGS, PAPER GIFT BAGS, PAPER GIFT BAGS FOR WINE, TEXTILE GIFT BAGS FOR WINE, PAPER PARTY BAGS, STICKERS, STICKERS AND TRANSFERS, DESK BASKETS FOR DESK ACCESSORIES, BOXES OF PAPER OR CARDBOARD, FIBERBOARD BOXES, GIFT BOXES, PAPERBOARD BOXES, PAPERBOARD, TREATED PAPER FOR WRAPPING FLOWERS AND FLORAL DISPLAYS, FLORAL PACKAGING, NAMELY, PAPER FOR WRAPPING FLOWERS, MUSICAL GREETING CARDS, CARDBOARD HANG TAGS, PAPER HANG TAGS, PAPER IDENTIFICATION TAGS (U.S. CLS. 2, 5, 22, 23, 29, 37, 38 AND 50).

THOMAS MANOR, EXAMINING ATTORNEY

CLASS 16—(Continued).

SN 77-884,845. MARKETING AGENT & KNOWLEDGE COACH, LLC, WEST CHESTER, OH. FILED 12-2-2009.

Empowering Expressions

THE MARK CONSISTS OF STANDARD CHARACTERS WITHOUT CLAIM TO ANY PARTICULAR FONT, STYLE, SIZE, OR COLOR.

NO CLAIM IS MADE TO THE EXCLUSIVE RIGHT TO USE "EMPOWERING", APART FROM THE MARK AS SHOWN.

FOR A SERIES OF BOOKS, WRITTEN ARTICLES, HANDOUTS AND WORKSHEETS IN THE FIELD OF MARKETING/ADVERTISING AND BRANDING TO ENHANCE AND IMPROVE POSITIVE PERSONAL ATTRIBUTES/EQUITY WITH EMPOWERING TOOLS FOR INDIVIDUALS, ORGANIZATIONS, AND COMMUNITIES (U.S. CLS. 2, 5, 22, 23, 29, 37, 38 AND 50).

ANNE E. GUSTASON, EXAMINING ATTORNEY

SN 77-886,570. POPULATION REFERENCE BUREAU, AKA PRB, WASHINGTON, DC. FILED 12-4-2009.



THE COLOR(S) BLUE, GRAY, AND WHITE IS/ARE CLAIMED AS A FEATURE OF THE MARK.

THE MARK CONSISTS OF THE FOLLOWING: A SOLID RECTANGLE WHERE THE LEFT HAND SIDE IS IN BLUE AND THE RIGHT HAND SIDE IS IN GRAY, WITH A VERTICAL WHITE LINE DIVIDING THE TWO COLORS AND THE LETTERS "PRB" IN WHITE ON THE BLUE PORTION OF THE RECTANGLE AND THE WORDING "INFORM EMPOWER ADVANCE" IN WHITE ON THE GRAY PORTION OF THE RECTANGLE.

FOR PUBLICATIONS, NAMELY, BROCHURES, BOOKLETS, AND TEACHING MATERIALS IN THE FIELD OF POPULATION AND HEALTH (U.S. CLS. 2, 5, 22, 23, 29, 37, 38 AND 50).

FIRST USE 2-15-2009; IN COMMERCE 2-15-2009.
COLLEEN KEARNEY, EXAMINING ATTORNEY

CLASS 16—(Continued).

SN 77-887,375. THE UNIVERSITY OF ARIZONA ALUMNI ASSOCIATION, TUCSON, AZ. FILED 12-7-2009.

WILDCAT FOR LIFE

THE MARK CONSISTS OF STANDARD CHARACTERS WITHOUT CLAIM TO ANY PARTICULAR FONT, STYLE, SIZE, OR COLOR.

FOR PAPER GOODS AND PRINTED MATERIALS, NAMELY, BROCHURES, NEWSPAPERS, JOURNALS, BULLETINS, EVENT PROGRAMS, CATALOGS, PRINTED INSTRUCTIONAL, EDUCATION, AND TEACHING MATERIALS, BOOKS AND MAGAZINES, ALL IN THE FIELD OF HIGHER EDUCATION AND FEATURING SPORTS, POLITICAL ISSUES, EDUCATIONAL ISSUES, TRAVEL, BUSINESS AND ALUMNI AFFAIRS ISSUES; SCHOOL YEAR BOOKS, CLASS GRADUATION ALBUMS, MEDIA GUIDES FEATURING ACADEMIC, ATHLETIC AND ALUMNI EVENTS AND INFORMATION; TELEPHONE AND ADDRESS DIRECTORIES, REGISTERS, NAMELY, LEDGER BOOKS FOR RECEIVING RECORD ENTRIES; PAPER STATIONERY, NOTEBOOKS, STATIONERY-TYPE PORTFOLIOS, BINDERS, BOOK COVERS, BOOK ENDS, ANNOUNCEMENT CARDS, POSTCARDS FEATURING ACADEMIC LIFE, FOLDERS, WRAPPING PAPER, NOTECARDS, NOTE-PADS, POCKET AND DESK DIARIES, DATE BOOKS, APPOINTMENT BOOKS, DESK PADS, MEMO PADS, SCRAP BOOKS, PAPER WEIGHTS, PEN HOLDERS, PENCIL HOLDERS, ADDRESS BOOKS, PRINTED AWARDS, PRINTED DIPLOMA CERTIFICATES, COVERS FOR DIPLOMA CERTIFICATES, BUSINESS CARDS, STICKERS FEATURING ACADEMIC LIFE, BUMPER STICKERS FEATURING ACADEMIC LIFE, LETTER OPENERS, PERSONAL ORGANIZERS, CHECKBOOK COVERS AND HOLDERS, PENCILS, PENS, DECALS FEATURING ACADEMIC LIFE, PAPER NAPKINS, CREDIT CARDS WITHOUT MAGNETIC CODING, DEBIT CARDS WITHOUT MAGNETIC CODING, AND RUBBER STAMPS (U.S. CLS. 2, 5, 22, 23, 29, 37, 38 AND 50).
JUDITH HELFMAN, EXAMINING ATTORNEY

SN 77-891,722. KENYON, HOWARD, WEST FRIENDSHIP, MD. FILED 12-11-2009.

WELT GEEZER

THE MARK CONSISTS OF STANDARD CHARACTERS WITHOUT CLAIM TO ANY PARTICULAR FONT, STYLE, SIZE, OR COLOR.

THE NAME(S), PORTRAIT(S), AND/OR SIGNATURE(S) SHOWN IN THE MARK DOES NOT IDENTIFY A PARTICULAR LIVING INDIVIDUAL.

FOR CHILDREN'S BOOKS; GREETING CARDS (U.S. CLS. 2, 5, 22, 23, 29, 37, 38 AND 50).
STEPHANIE ALI, EXAMINING ATTORNEY

CLASS 16—(Continued).

SN 77-899,320. AIR CONDITIONING CONTRACTORS OF AMERICA, ARLINGTON, VA. FILED 12-22-2009.

MANUAL SPS

THE MARK CONSISTS OF STANDARD CHARACTERS WITHOUT CLAIM TO ANY PARTICULAR FONT, STYLE, SIZE, OR COLOR.

OWNER OF U.S. REG. NOS. 2,662,195, 2,721,051 AND OTHERS.

NO CLAIM IS MADE TO THE EXCLUSIVE RIGHT TO USE "MANUAL", APART FROM THE MARK AS SHOWN.

FOR BOOKS AND PUBLICATIONS, NAMELY, MANUALS AND GUIDES IN THE FIELD OF TESTING AND BALANCING AIR AND WATER FLOW IN RESIDENTIAL AND COMMERCIAL HVAC APPLICATIONS (U.S. CLS. 2, 5, 22, 23, 29, 37, 38 AND 50).
BRIAN PINO, EXAMINING ATTORNEY

SN 77-902,180. MOBERLY, JULIE BERET, DBA THE SEASONS COMPANY, HARVARD, MA. FILED 12-29-2009.



THE COLOR(S) GREEN AND BROWN IS/ARE CLAIMED AS A FEATURE OF THE MARK.

THE MARK CONSISTS OF THE WORDING "SEASONS" IN PANTONE 5777 GREEN USING THE STYLIZED FONT "RUTHIE" NEXT TO A STYLIZED LEAF DESIGN GRADATING FROM PMS 5777 GREEN TO PMS 462 BROWN. BELOW THESE ELEMENTS IS THE WORDING "THROUGH THE YEAR WITH ORDER, GRACE AND JOY" IN PMS 462 BROWN USING THE FONT MYRIAD REGULAR CONDENSED.

FOR AGENDAS; FILE FOLDERS; STATIONERY (U.S. CLS. 2, 5, 22, 23, 29, 37, 38 AND 50).

FIRST USE 10-11-2009; IN COMMERCE 10-11-2009.
STEVEN PEREZ, EXAMINING ATTORNEY

SN 77-902,476. SIGN DIMENSIONS, ROLLA, MO. FILED 12-29-2009.



NO CLAIM IS MADE TO THE EXCLUSIVE RIGHT TO USE "AERO GRAPHIX", APART FROM THE MARK AS SHOWN.

THE COLOR(S) WHITE, VIOLET, ORANGE, AND BLACK IS/ARE CLAIMED AS A FEATURE OF THE MARK.

THE MARK CONSISTS OF THE STYLIZED WORDING "AERO GRAPHIX" AND AN AIRPLANE DESIGN. WHITE APPEARS IN THE LETTER "X" AND AROUND THE

CLASS 16—(Continued).

WORDING AND AIRPLANE WITHIN THE FIRST OUTLINE. BLACK APPEARS IN THE CANOPY SHADE OF THE PLANE. VIOLET APPEARS IN THE INNERMOST OUTLINE OF THE WORDING AND AIRPLANE. ORANGE FILLS THE WORDING AND AIRPLANE DESIGN, EXCEPT FOR IN THE WHITE-FILLED LETTER "X" WHICH CONTAINS AN INNER OUTLINE OF ORANGE. BLACK AS IT APPEARS IN THE OUTER OUTLINING AROUND THE MARK IS NOT A FEATURE OF THE MARK AND REPRESENTS THE BORDERS OF THE MARK.

FOR DIGITALLY PRINTED PRESSURE SENSITIVE VINYL DECALS, VINYL WRAPS, SIGNS, BANNERS, AND COLOR GRAPHICS FOR APPLICATION TO OR USE WITH MODEL AIRCRAFT AND FULL SCALE AIRCRAFT (U.S. CLS. 2, 5, 22, 23, 29, 37, 38 AND 50).

FIRST USE 7-15-1997; IN COMMERCE 1-1-2000.

REBECCA POVARCHUK, EXAMINING ATTORNEY

SN 77-906,999. JACKSON, TAYDAMA S, DOUGLASVILLE, GA. FILED 1-7-2010.

Learn Naked

THE MARK CONSISTS OF STANDARD CHARACTERS WITHOUT CLAIM TO ANY PARTICULAR FONT, STYLE, SIZE, OR COLOR.

FOR PRINTED EDUCATIONAL MATERIALS IN THE FIELD OF STATISTICAL LITERACY (U.S. CLS. 2, 5, 22, 23, 29, 37, 38 AND 50).

FIRST USE 10-4-2009; IN COMMERCE 10-4-2009.
STEPHEN AQUILA, EXAMINING ATTORNEY

SN 77-907,653. SANDHILLS PUBLISHING COMPANY, LINCOLN, NE. FILED 1-8-2010.



OWNER OF U.S. REG. NOS. 1,434,674, 2,552,049 AND OTHERS.

NO CLAIM IS MADE TO THE EXCLUSIVE RIGHT TO USE "MACHINERY", APART FROM THE MARK AS SHOWN.

THE MARK CONSISTS OF THE TERM "MACHINERY" IN A RECTANGLE ABOVE THE TERM "TRADER" IN A SMALLER RECTANGLE TO THE LEFT OF THE WORDING "EUROMARKETBOOK" IN STYLIZED FORM WITH THE LETTER "E" IN THE FORM OF THE EURO CURRENCY SYMBOL OF A "C" WITH TWO PARALLEL HASH MARKS THROUGH ITS CENTER, AND A LINE THAT RUNS THROUGH THE "TRADER" RECTANGLE AND UNDERLINE THE WORDING "EUROMARKETBOOK".

FOR NEWSPAPER FEATURING RENTAL AND AUCTION INFORMATION FOR THE HEAVY CONSTRUCTION INDUSTRY (U.S. CLS. 2, 5, 22, 23, 29, 37, 38 AND 50).

SALLY SHIH, EXAMINING ATTORNEY

CLASS 16—(Continued).

SN 77-913,391. KIM, NAHYUN, FOREST HILLS, NY. FILED 1-15-2010.



THE COLOR(S) RED, BLUE, WHITE, BLACK IS/ARE CLAIMED AS A FEATURE OF THE MARK.

THE MARK CONSISTS OF A WHITE RECTANGLE WITH A BLUE PERIMETER, INSIDE OF WHICH ARE THE WORDS "SEA OF KOREA" WHICH APPEAR IN BLUE AND ARE LOCATED INSIDE OF A BLUE CIRCLE. THE PERIMETER OF THE CIRCLE IS BLACK AND RED.

FOR GRAPHIC PRINTS AND REPRESENTATIONS (U.S. CLS. 2, 5, 22, 23, 29, 37, 38 AND 50).

ROBERT C. CLARK JR., EXAMINING ATTORNEY

SN 77-916,419. ROWE, JOANNA R., FORMERLY MORGAN, JOANNA R., LONG BEACH, CA. FILED 1-21-2010.

Lil' Jo's Doodles

THE MARK CONSISTS OF STANDARD CHARACTERS WITHOUT CLAIM TO ANY PARTICULAR FONT, STYLE, SIZE, OR COLOR.

NO CLAIM IS MADE TO THE EXCLUSIVE RIGHT TO USE "DOODLES", APART FROM THE MARK AS SHOWN.

FOR ILLUSTRATIONS (U.S. CLS. 2, 5, 22, 23, 29, 37, 38 AND 50).

AARON BRODSKY, EXAMINING ATTORNEY

SN 77-916,713. THOMAS PUBLISHING COMPANY, NEW YORK, NY. FILED 1-21-2010.

THOMCAT

THE MARK CONSISTS OF STANDARD CHARACTERS WITHOUT CLAIM TO ANY PARTICULAR FONT, STYLE, SIZE, OR COLOR.

FOR ANNUAL DIRECTORY FOR MANUFACTURED GOODS AND MANUFACTURER INFORMATION (U.S. CLS. 2, 5, 22, 23, 29, 37, 38 AND 50).

ANNE E. GUSTASON, EXAMINING ATTORNEY

CLASS 16—(Continued).

SN 77-916,906. MCCAIN, VERONICA G., POTOMAC FALLS, VA. FILED 1-21-2010.

Clothes Mates

THE MARK CONSISTS OF STANDARD CHARACTERS WITHOUT CLAIM TO ANY PARTICULAR FONT, STYLE, SIZE, OR COLOR.

NO CLAIM IS MADE TO THE EXCLUSIVE RIGHT TO USE "CLOTHES", APART FROM THE MARK AS SHOWN.

FOR BLANK OR PARTIALLY PRINTED PAPER LABELS; PARTIALLY PRINTED FORMS; PRINTED PRODUCTS, NAMELY, LISTS FEATURING WARDROBE OUTFITS TO BE WORN FOR PURPOSES OF CLOSET ORGANIZATION (U.S. CLS. 2, 5, 22, 23, 29, 37, 38 AND 50).

FIRST USE 12-9-2009; IN COMMERCE 12-9-2009.
JULIE WATSON, EXAMINING ATTORNEY



SN 77-917,966. LESTER, JOSEPH, RENO, NV. FILED 1-22-2010.

SKYLINE

THE MARK CONSISTS OF STANDARD CHARACTERS WITHOUT CLAIM TO ANY PARTICULAR FONT, STYLE, SIZE, OR COLOR.

FOR PENCIL HOLDERS (U.S. CLS. 2, 5, 22, 23, 29, 37, 38 AND 50).

KATHRYN COWARD, EXAMINING ATTORNEY



SN 77-921,141. LA SUBASTA, INC., HOUSTON, TX. FILED 1-27-2010.

BUENAS OFERTAS

THE MARK CONSISTS OF STANDARD CHARACTERS WITHOUT CLAIM TO ANY PARTICULAR FONT, STYLE, SIZE, OR COLOR.

THE NON-LATIN CHARACTERS IN THE MARK TRANSLITERATE TO GOOD OFFERING AND THIS MEANS GOOD DEAL IN ENGLISH.

FOR NEWSPAPERS IN SPANISH LANGUAGE FOR GENERAL CIRCULATION FEATURING A LISTING OF ITEMS FOR SALE AIMED AT THE HISPANIC COMMUNITY (U.S. CLS. 2, 5, 22, 23, 29, 37, 38 AND 50).

FIRST USE 1-12-2010; IN COMMERCE 1-12-2010.
CHRIS WELLS, EXAMINING ATTORNEY

CLASS 16—(Continued).

SN 77-921,209. WEBER, ERICH, CENTRAL POINT, OR. FILED 1-27-2010.

A 1001 Reasons Not To...

THE MARK CONSISTS OF STANDARD CHARACTERS WITHOUT CLAIM TO ANY PARTICULAR FONT, STYLE, SIZE, OR COLOR.

FOR SERIES OF NON-FICTION BOOKS IN THE FIELDS OF HEALTH CARE AND MEDICINE (U.S. CLS. 2, 5, 22, 23, 29, 37, 38 AND 50).

STEVEN PEREZ, EXAMINING ATTORNEY



SN 77-923,381. CONNOR PAPER LLC, MONTCLAIR, NJ. FILED 1-29-2010.

• CONNOR NEW YORK

NO CLAIM IS MADE TO THE EXCLUSIVE RIGHT TO USE "NEW YORK", APART FROM THE MARK AS SHOWN.

THE MARK CONSISTS OF THE WORD "CONNOR" WITH A DOT ABOVE THE NAME AND THE WORD "NEW YORK" BELOW.

FOR STATIONERY (U.S. CLS. 2, 5, 22, 23, 29, 37, 38 AND 50).

FIRST USE 12-22-2009; IN COMMERCE 12-22-2009.
BRIAN PINO, EXAMINING ATTORNEY

CLASS 16—(Continued).

SN 77-923,568. NATIONAL SECURITY AGENCY, FORT MEADE, MD. FILED 1-29-2010.



NO CLAIM IS MADE TO THE EXCLUSIVE RIGHT TO USE "COMMITTEE ON NATIONAL SECURITY SYSTEMS", APART FROM THE MARK AS SHOWN.

THE MARK CONSISTS OF A GLOBE HAVING MERIDIANS AND PARALLEL LINES, WITH A LINE OF STARS OUTLINING THE NORTHERN HEMISPHERE, TWO BANNERS ACROSS THE MIDDLE OF THE GLOBE, AND A PAIR OF OLIVE BRANCHES BELOW THE GLOBE. THE WORDING "COMMITTEE ON NATIONAL SECURITY SYSTEMS" APPEARS ABOVE THE GLOBE AND STARS. THE WORDING "CNSS" APPEARS IN ONE BANNER AND THE WORDING "SYSTEMS SECURITY FOR THE 21ST CENTURY" APPEARS ON THE OTHER BANNER.

FOR FOLDERS; LETTERHEAD PAPER; PRINTED CERTIFICATES; PRINTED INSTRUCTIONAL, EDUCATIONAL, AND TEACHING MATERIALS IN THE FIELD OF INFORMATION ASSURANCE; PUBLICATIONS, NAMELY, BROCHURES, BOOKLETS, AND TEACHING MATERIALS IN THE FIELD OF INFORMATION ASSURANCE (U.S. CLS. 2, 5, 22, 23, 29, 37, 38 AND 50).
FIRST USE 10-17-2001; IN COMMERCE 4-10-2002.

MARK SHINER, EXAMINING ATTORNEY

CLASS 16—(Continued).

SN 77-923,724. INTERSTATE RESOURCES, ARLINGTON, VA. FILED 1-29-2010.



THE MARK CONSISTS OF A BOX BORDERED IN BLACK WITH A BLACK BAND AT THE TOP WITH THE WORD "INTERSTATE" IN WHITE LETTERING WITHIN, AN EMPTY WHITE BAND, AND A BLACK BAND AT THE BOTTOM WITH THE WORD "RESOURCES" IN WHITE LETTERING WITHIN.

FOR WOOD PULP PAPER, KRAFT PAPER, CORRUGATED CARDBOARD, CARDBOARD PACKAGING, COATED CORRUGATED BOXES, WAXED CORRUGATED BOXES, PRINTED CORRUGATED BOXES, CORRUGATED DISPLAY BOXES, CARDBOARD INNER PACKS, CORRUGATED CARDBOARD BOXES, CORRUGATED BOXES, CORRUGATED CARDBOARD SHEETS, CORRUGATING MEDIUM, NAMELY, FLUTING PAPER, PAPER LINER BOARD, PAPER LINER BOARD FOR CORRUGATED CARDBOARD AND BOXES (U.S. CLS. 2, 5, 22, 23, 29, 37, 38 AND 50).

ALEXANDER L. POWERS, EXAMINING ATTORNEY

SN 77-923,715. INTERSTATE RESOURCES, ARLINGTON, VA. FILED 1-29-2010.

INTERSTATE RESOURCES

THE MARK CONSISTS OF STANDARD CHARACTERS WITHOUT CLAIM TO ANY PARTICULAR FONT, STYLE, SIZE, OR COLOR.

FOR WOOD PULP PAPER, KRAFT PAPER, CORRUGATED CARDBOARD, CARDBOARD PACKAGING, COATED CORRUGATED BOXES, WAXED CORRUGATED BOXES, PRINTED CORRUGATED BOXES, CORRUGATED DISPLAY BOXES, CARDBOARD INNER PACKS, CORRUGATED CARDBOARD BOXES, CORRUGATED BOXES, CORRUGATED CARDBOARD SHEETS, CORRUGATING MEDIUM, NAMELY, FLUTING PAPER, PAPER LINER BOARD, PAPER LINER BOARD FOR CORRUGATED CARDBOARD AND BOXES (U.S. CLS. 2, 5, 22, 23, 29, 37, 38 AND 50).

ALEXANDER L. POWERS, EXAMINING ATTORNEY

SN 77-924,234. ALLEN-BRANCA PUBLISHING, INC., LIGHTHOUSE POINT, FL. FILED 1-30-2010.



NO CLAIM IS MADE TO THE EXCLUSIVE RIGHT TO USE "GIRL", APART FROM THE MARK AS SHOWN.

THE MARK CONSISTS OF THE STYLIZED WORD "GIRL" WITH THE LETTER "L" IN PARENTHESES.

FOR MAGAZINES FEATURING CURRENT EVENTS, NEWS, REVIEWS, ENTERTAINMENT, AND BUSINESSES FOR AND ABOUT THE LESBIAN COMMUNITY (U.S. CLS. 2, 5, 22, 23, 29, 37, 38 AND 50).

FIRST USE 5-0-2005; IN COMMERCE 7-0-2005.

WILLIAM P. SHANAHAN, EXAMINING ATTORNEY

CLASS 16—(Continued).

SN 77-924,576. U.S. MARINE CORPS, A COMPONENT OF THE U.S. DEPARTMENT OF THE NAVY, WASHINGTON, DC. FILED 2-1-2010.

MARINES

THE MARK CONSISTS OF STANDARD CHARACTERS WITHOUT CLAIM TO ANY PARTICULAR FONT, STYLE, SIZE, OR COLOR.

SEC. 2(F).

FOR MAGAZINES FEATURING NEWS AND FEATURES RELEVANT TO THE U.S. MARINE CORPS AND U.S. MILITARY; MAGAZINES IN THE FIELD OF NEWS AND FEATURES RELEVANT TO THE U.S. MARINE CORPS AND U.S. MILITARY (U.S. CLS. 2, 5, 22, 23, 29, 37, 38 AND 50).

FIRST USE 7-31-1983; IN COMMERCE 7-31-1983.

ELISSA GARBER KON, EXAMINING ATTORNEY

SN 77-924,773. E5 GLOBAL MEDIA, LLC, NEW YORK, NY. FILED 2-1-2010.

BOOK OF RECORD

THE MARK CONSISTS OF STANDARD CHARACTERS WITHOUT CLAIM TO ANY PARTICULAR FONT, STYLE, SIZE, OR COLOR.

FOR PRINTED PERIODICALS IN THE FIELD OF MUSIC AND ENTERTAINMENT (U.S. CLS. 2, 5, 22, 23, 29, 37, 38 AND 50).

DOMINIC J. FERRAIUOLO, EXAMINING ATTORNEY

SN 77-925,210. MIAMI-DADE GAY & LESBIAN CHAMBER OF COMMERCE, MIAMI, FL. FILED 2-1-2010.

CLARITY

THE MARK CONSISTS OF THE STYLIZED WORD "CLARITY".

FOR MAGAZINES PROVIDING GENERAL BUSINESS NEWS AND INFORMATION TO THE LGBT COMMUNITY AND GENERAL CORPORATE MARKET IN THE SOUTH FLORIDA REGION (U.S. CLS. 2, 5, 22, 23, 29, 37, 38 AND 50).

ELLEN BURNS, EXAMINING ATTORNEY

CLASS 16—(Continued).

SN 77-925,608. NATIONAL CURRICULUM & TRAINING INSTITUTE INC., PHOENIX, AZ. FILED 2-2-2010.

COG TALK

THE MARK CONSISTS OF STANDARD CHARACTERS WITHOUT CLAIM TO ANY PARTICULAR FONT, STYLE, SIZE, OR COLOR.

FOR PRINTED INSTRUCTIONAL, EDUCATIONAL, AND TEACHING MATERIALS IN THE FIELD OF CRIMINAL JUSTICE (U.S. CLS. 2, 5, 22, 23, 29, 37, 38 AND 50).

FIRST USE 1-30-2010; IN COMMERCE 1-30-2010.
ALICE BENMAMAN, EXAMINING ATTORNEY

SN 77-926,283. CAPUCILLI, ALYSSA S., NEW YORK, NY. AND SCHORIES, PAT, NEW YORK, NY. FILED 2-2-2010.

BISCUIT

THE MARK CONSISTS OF STANDARD CHARACTERS WITHOUT CLAIM TO ANY PARTICULAR FONT, STYLE, SIZE, OR COLOR.

FOR SERIES OF CHILDREN'S BOOKS (U.S. CLS. 2, 5, 22, 23, 29, 37, 38 AND 50).

FIRST USE 5-0-1996; IN COMMERCE 5-0-1996.
JOHN SCHUYLER YARD, EXAMINING ATTORNEY

SN 77-926,410. LEVINE, ED, POTOMAC FALLS, VA. FILED 2-2-2010.



THE MARK CONSISTS OF A ROUND CIRCLE WITH THE WORDS IN BOLD "GUNS SAVE LIVES" CENTERED AND ONE WORD PER LINE ON THE CIRCLE.

FOR STICKERS (U.S. CLS. 2, 5, 22, 23, 29, 37, 38 AND 50).

FIRST USE 1-1-2007; IN COMMERCE 1-1-2007.
INGA ERVIN, EXAMINING ATTORNEY

CLASS 16—(Continued).

SN 77-926,581. LA-CO INDUSTRIES, INC., ELK GROVE VILLAGE, IL. FILED 2-3-2010.

PRESSMARKER

THE MARK CONSISTS OF STANDARD CHARACTERS WITHOUT CLAIM TO ANY PARTICULAR FONT, STYLE, SIZE, OR COLOR.

FOR FIBER-TIPPED INK MARKER (U.S. CLS. 2, 5, 22, 23, 29, 37, 38 AND 50).
DAVID MURRAY, EXAMINING ATTORNEY

SN 77-926,901. PAXMAN, PAMELA, LUCAS, TX. FILED 2-3-2010.

FLIGHT PLANS FOR THE HEART

THE MARK CONSISTS OF STANDARD CHARACTERS WITHOUT CLAIM TO ANY PARTICULAR FONT, STYLE, SIZE, OR COLOR.

FOR PUBLICATIONS, NAMELY, BOOKS, HAND-OUTS, WORKBOOKS, CARDS IN THE FIELDS OF INSPIRATION AND PERSONAL DEVELOPMENT (U.S. CLS. 2, 5, 22, 23, 29, 37, 38 AND 50).
EMILY CARLSEN, EXAMINING ATTORNEY

SN 77-927,156. GENERAL PENCIL COMPANY, INC., JERSEY CITY, NJ. FILED 2-3-2010.

DRAW AND PAINT

THE MARK CONSISTS OF STANDARD CHARACTERS WITHOUT CLAIM TO ANY PARTICULAR FONT, STYLE, SIZE, OR COLOR.

SEC. 2(F).
FOR ARTISTS' PENCILS (U.S. CLS. 2, 5, 22, 23, 29, 37, 38 AND 50).
FIRST USE 6-0-1941; IN COMMERCE 6-0-1941.
KRISTIN CARLSON, EXAMINING ATTORNEY

CLASS 16—(Continued).

SN 77-927,344. BY GEORGE! INC., LAKE FOREST, CA. FILED 2-3-2010.

Spluff

THE MARK CONSISTS OF STANDARD CHARACTERS WITHOUT CLAIM TO ANY PARTICULAR FONT, STYLE, SIZE, OR COLOR.

FOR ARTS AND CRAFT PAINT KITS (U.S. CLS. 2, 5, 22, 23, 29, 37, 38 AND 50).
LOURDES AYALA, EXAMINING ATTORNEY

SN 77-927,502. CHICAGO SYMPHONY ORCHESTRA, CHICAGO, IL. FILED 2-3-2010.

ORCHESTRA EXPLORERS

THE MARK CONSISTS OF STANDARD CHARACTERS WITHOUT CLAIM TO ANY PARTICULAR FONT, STYLE, SIZE, OR COLOR.

NO CLAIM IS MADE TO THE EXCLUSIVE RIGHT TO USE "ORCHESTRA", APART FROM THE MARK AS SHOWN.

FOR PRINTED EDUCATIONAL MATERIALS IN THE FIELD OF MUSIC; PRINTED PUBLICATIONS, NAMELY, PRINTED INSTRUCTIONAL, EDUCATIONAL AND TEACHING MATERIALS IN THE FIELD OF MUSIC; PRINTED PUBLICATIONS, NAMELY, EDUCATIONAL BOOKS, WORKSHEETS, LESSON PLANS, EVALUATION FORMS, AND MUSIC EXERCISE BOOKS, IN THE FIELD OF MUSIC (U.S. CLS. 2, 5, 22, 23, 29, 37, 38 AND 50).

JASON BLAIR, EXAMINING ATTORNEY

SN 77-927,543. AVANTI PRESS, INC., DETROIT, MI. FILED 2-3-2010.

KNOCK-OUTS

THE MARK CONSISTS OF STANDARD CHARACTERS WITHOUT CLAIM TO ANY PARTICULAR FONT, STYLE, SIZE, OR COLOR.

FOR GREETING CARDS AND INVITATION CARDS (U.S. CLS. 2, 5, 22, 23, 29, 37, 38 AND 50).
JAMES LOVELACE, EXAMINING ATTORNEY

CLASS 16—(Continued).

SN 77-927,666. NIRMAL, SINGH, SOUTH OZONE PARK, NY. FILED 2-4-2010.

**Forget the dog
beware of wife**

THE MARK CONSISTS OF STANDARD CHARACTERS WITHOUT CLAIM TO ANY PARTICULAR FONT, STYLE, SIZE, OR COLOR.
FOR BUMPER STICKERS (U.S. CLS. 2, 5, 22, 23, 29, 37, 38 AND 50).
KAPIL BHANOT, EXAMINING ATTORNEY

CLASS 16—(Continued).

SN 77-928,009. ALSIP ACQUISITION, LLC, ALSIP, IL. FILED 2-4-2010.

FUTURE REMARK

THE MARK CONSISTS OF STANDARD CHARACTERS WITHOUT CLAIM TO ANY PARTICULAR FONT, STYLE, SIZE, OR COLOR.
FOR PAPER; PAPER LABELS (U.S. CLS. 2, 5, 22, 23, 29, 37, 38 AND 50).
FIRST USE 1-0-2010; IN COMMERCE 1-0-2010.
JAMES A. RAUEN, EXAMINING ATTORNEY

SN 77-927,868. RUSEF, RAMSEY, HANOVER PARK, IL. FILED 2-4-2010.

Billy The Monster Hunter

THE MARK CONSISTS OF STANDARD CHARACTERS WITHOUT CLAIM TO ANY PARTICULAR FONT, STYLE, SIZE, OR COLOR.
FOR COMIC BOOKS (U.S. CLS. 2, 5, 22, 23, 29, 37, 38 AND 50).
FIRST USE 2-0-2009; IN COMMERCE 2-0-2009.
STEVEN JACKSON, EXAMINING ATTORNEY

SN 77-928,139. THE FEDERATED GROUP, INC., ARLINGTON HEIGHTS, IL. FILED 2-4-2010.

GRAB-A-SIZE

THE MARK CONSISTS OF STANDARD CHARACTERS WITHOUT CLAIM TO ANY PARTICULAR FONT, STYLE, SIZE, OR COLOR.
FOR PAPER TOWELS (U.S. CLS. 2, 5, 22, 23, 29, 37, 38 AND 50).
ALICE BENMAMAN, EXAMINING ATTORNEY

SN 77-928,000. ALSIP ACQUISITION, LLC, ALSIP, IL. FILED 2-4-2010.

FUTURE CHOICE

THE MARK CONSISTS OF STANDARD CHARACTERS WITHOUT CLAIM TO ANY PARTICULAR FONT, STYLE, SIZE, OR COLOR.
FOR PAPER (U.S. CLS. 2, 5, 22, 23, 29, 37, 38 AND 50).
FIRST USE 1-0-2010; IN COMMERCE 1-0-2010.
JAMES A. RAUEN, EXAMINING ATTORNEY

SN 77-928,188. WORLD TRIATHLON CORPORATION, TAMPA, FL. FILED 2-4-2010.

LAVA

THE MARK CONSISTS OF STANDARD CHARACTERS WITHOUT CLAIM TO ANY PARTICULAR FONT, STYLE, SIZE, OR COLOR.
FOR MAGAZINES FEATURING SWIMMING, BIKING, RUNNING AND TRIATHLONS (U.S. CLS. 2, 5, 22, 23, 29, 37, 38 AND 50).
JUDITH HELFMAN, EXAMINING ATTORNEY

CLASS 16—(Continued).

SN 77-928,408. TAYLOR, SCOTT C., CAMARILLO, CA.
FILED 2-4-2010.

The 15-Minute Landlord

THE MARK CONSISTS OF STANDARD CHARACTERS WITHOUT CLAIM TO ANY PARTICULAR FONT, STYLE, SIZE, OR COLOR.

NO CLAIM IS MADE TO THE EXCLUSIVE RIGHT TO USE "LANDLORD", APART FROM THE MARK AS SHOWN.

FOR A SERIES OF BOOKS, WRITTEN ARTICLES, HANDOUTS AND WORKSHEETS IN THE FIELD OF REAL ESTATE RENTALS (U.S. CLS. 2, 5, 22, 23, 29, 37, 38 AND 50).

JASON BLAIR, EXAMINING ATTORNEY

SN 77-928,428. HI-INDUSTRIES, LLC, GOLDEN VALLEY, MN. FILED 2-4-2010.

TOAST-ITS

THE MARK CONSISTS OF STANDARD CHARACTERS WITHOUT CLAIM TO ANY PARTICULAR FONT, STYLE, SIZE, OR COLOR.

FOR PRINTED NOVELTY WINE LABELS (U.S. CLS. 2, 5, 22, 23, 29, 37, 38 AND 50).

FIRST USE 12-12-2009; IN COMMERCE 12-12-2009.

TRACY CROSS, EXAMINING ATTORNEY

SN 77-928,502. GFK HEALTHCARE, LP, NEW YORK, NY.
FILED 2-4-2010.

PIPELINE

THE MARK CONSISTS OF STANDARD CHARACTERS WITHOUT CLAIM TO ANY PARTICULAR FONT, STYLE, SIZE, OR COLOR.

FOR NEWSLETTERS RELATING TO NEWS AND VIEWS ON HEALTH CARE MARKETING RESEARCH (U.S. CLS. 2, 5, 22, 23, 29, 37, 38 AND 50).

FIRST USE 1-7-2010; IN COMMERCE 1-7-2010.

KELLY TRUSILO, EXAMINING ATTORNEY

CLASS 16—(Continued).

SN 77-928,583. WORLD WRESTLING ENTERTAINMENT, INC., STAMFORD, CT. FILED 2-4-2010.

LEGENDARY

THE MARK CONSISTS OF STANDARD CHARACTERS WITHOUT CLAIM TO ANY PARTICULAR FONT, STYLE, SIZE, OR COLOR.

FOR HANGTAGS; PACKAGING, NAMELY, BLISTER CARDS, PAPER FOR WRAPPING AND PACKAGING, PAPER POUCHES FOR PACKAGING, PLASTIC BAGS FOR PACKAGING, PLASTIC BUBBLE PACKS FOR WRAPPING OR PACKAGING; COLLECTOR ALBUMS, NAMELY, FOR STICKER COLLECTABLE CARDS, PHOTO COLLECTABLES; LABELS, NAMELY, PRINTED PAPER LABELS, PRINTED SHIPPING LABELS; FOLDERS; PLASTIC BAGS FOR GENERAL USE; STICKERS; FRAMED PICTURES; PENS; PENCILS; POSTERS; NOTEBOOKS; TRADING CARDS; CALENDARS; PAPER TABLECLOTHS; PHOTOGRAPHS; BROCHURES, MAGAZINES, AND NEWSPAPERS; POSTCARDS; GREETING CARDS; PICTURES; DECALS; COLORING BOOKS; CHILDREN'S ACTIVITY BOOKS; SOUVENIR PROGRAMS; BOOKS FEATURING PICTORIAL BIOGRAPHIES; COMIC BOOKS; BOOK COVERS; PAPER BOOK MARKERS; PAPER LUNCH BAGS; PICTURE BOOKS; MEMO PADS; DATE BOOKS; ADDRESS BOOKS; AGENDA BOOKS; PENCIL SHARPENERS; RUBBER STAMPS; STAMP PADS; COLLECTOR STAMPS, NAMELY, COMMEMORATIVE STAMP SHEETS; CUSTOMIZED PERSONAL CHECKS; CHECKBOOK COVERS AND RETURN ADDRESS LABELS NOT OF TEXTILE; PAPER BANNERS; PRINTED PAPER SIGNS FOR DOORS; PENCIL CASES; SCRIBBLE PAD; PHOTO ALBUMS; BUMPER STICKERS; WINDOW DECALS; LITHOGRAPHS; PAPER PARTY BAGS; PAPER PARTY FAVORS, NAMELY, PAPER HATS; STENCILS FOR TRACING DESIGNS ONTO PAPER; PAPER GIFT WRAP; PAPER CAKE DECORATIONS (U.S. CLS. 2, 5, 22, 23, 29, 37, 38 AND 50).

JOHN HWANG, EXAMINING ATTORNEY

SN 77-928,736. JOHNSON & JOHNSON, NEW BRUNSWICK, NJ. FILED 2-5-2010.

**WHEN A BABY IS BORN, SO IS
A MOTHER**

THE MARK CONSISTS OF STANDARD CHARACTERS WITHOUT CLAIM TO ANY PARTICULAR FONT, STYLE, SIZE, OR COLOR.

FOR PRINTED MATERIALS, NAMELY, BROCHURES AND PAMPHLETS FEATURING INFORMATION ON THE CARE AND WELL-BEING OF BABIES (U.S. CLS. 2, 5, 22, 23, 29, 37, 38 AND 50).

FIRST USE 12-31-2008; IN COMMERCE 12-31-2008.

TIMOTHY FINNEGAN, EXAMINING ATTORNEY

CLASS 16—(Continued).

SN 77-928,820. UNKNOWN GAMES, LLC, COLUMBUS, OH. FILED 2-5-2010.

STINKYSMELLS

THE MARK CONSISTS OF STANDARD CHARACTERS WITHOUT CLAIM TO ANY PARTICULAR FONT, STYLE, SIZE, OR COLOR.

FOR ADDRESS BOOKS, BINDERS, BOOK COVERS, CALENDARS, CHILDREN'S BOOKS, DECORATIVE PAPER CENTERPIECES, DIARIES, ERASERS, FOLDERS, GIFT WRAPPING PAPER, GIFT CARDS, GREETING CARDS, MEMO PADS, COIL-BOUND NOTEBOOKS, PAPER GIFT BAGS, PAPER PENNANTS, PENS, PENCILS, PENCIL BOXES AND CASES, POSTERS, TRADING CARDS (U.S. CLS. 2, 5, 22, 23, 29, 37, 38 AND 50).
TOBY BULLOFF, EXAMINING ATTORNEY

SN 77-928,907. NITYANAND BANSAL, EDGEWATER, NJ. FILED 2-5-2010.

VICCK & BLONDIE

THE MARK CONSISTS OF STANDARD CHARACTERS WITHOUT CLAIM TO ANY PARTICULAR FONT, STYLE, SIZE, OR COLOR.

FOR CATALOGS IN THE FIELD OF CLOTHING, ACCESSORIES, JEWELRY, SHOES (U.S. CLS. 2, 5, 22, 23, 29, 37, 38 AND 50).
BRIDGETT SMITH, EXAMINING ATTORNEY

SN 77-929,082. MEADWESTVACO CORPORATION, RICHMOND, VA. FILED 2-5-2010.



THE MARK CONSISTS OF A STACK OF SEPARATED SHEETS OF PAPER.

FOR BROCHURES IN THE FIELD OF CREATING AND WRITING RESEARCH PAPERS, NOTEBOOKS, REPORT COVERS (U.S. CLS. 2, 5, 22, 23, 29, 37, 38 AND 50).

KRISTIN DAHLING, EXAMINING ATTORNEY

CLASS 16—(Continued).

SN 77-929,103. MEADWESTVACO CORPORATION, RICHMOND, VA. FILED 2-5-2010.



THE MARK CONSISTS OF THE WORD "BUILDER" AND A LOGO CONSISTING OF A STACK OF SEPARATED SHEETS OF PAPER.

FOR BROCHURES IN THE FIELD OF CREATING AND WRITING RESEARCH PAPERS, NOTEBOOKS, REPORT COVERS (U.S. CLS. 2, 5, 22, 23, 29, 37, 38 AND 50).

KRISTIN DAHLING, EXAMINING ATTORNEY

SN 77-929,527. MILLER, SANDRA M., SOLVANG, CA. FILED 2-5-2010.

JUST PAY NO

THE MARK CONSISTS OF STANDARD CHARACTERS WITHOUT CLAIM TO ANY PARTICULAR FONT, STYLE, SIZE, OR COLOR.

FOR PHOTOGRAPHIC PRINTS; PICTORIAL PRINTS; PRINTED MATTER, NAMELY, NEWSPAPERS, PHOTOGRAPHS, MAGAZINES, BOOKS, PRINTED PERIODICALS, NEWSLETTERS, AND BROCHURES ALL IN THE FIELDS OF SECURITIES, OPTIONS AND OTHER FINANCIAL INSTRUMENTS (U.S. CLS. 2, 5, 22, 23, 29, 37, 38 AND 50).

WANDA KAY PRICE, EXAMINING ATTORNEY

SN 77-929,756. WORLD TRIATHLON CORPORATION, TAMPA, FL. FILED 2-6-2010.

LAVAMAG

THE MARK CONSISTS OF STANDARD CHARACTERS WITHOUT CLAIM TO ANY PARTICULAR FONT, STYLE, SIZE, OR COLOR.

FOR MAGAZINES FEATURING SWIMMING, BIKING, RUNNING AND TRIATHLONS (U.S. CLS. 2, 5, 22, 23, 29, 37, 38 AND 50).

JUDITH HELFMAN, EXAMINING ATTORNEY

CLASS 16—(Continued).

SN 77-930,102. ARNETT, VIRGINIA E., NEWPORT BEACH, CA. FILED 2-8-2010.

The Christmas Card Lady

THE MARK CONSISTS OF STANDARD CHARACTERS WITHOUT CLAIM TO ANY PARTICULAR FONT, STYLE, SIZE, OR COLOR.

NO CLAIM IS MADE TO THE EXCLUSIVE RIGHT TO USE "CHRISTMAS CARD", APART FROM THE MARK AS SHOWN.

FOR ART PRINTS; CALENDARS; GREETING CARDS; POSTERS; STATIONERY (U.S. CLS. 2, 5, 22, 23, 29, 37, 38 AND 50).

FIRST USE 0-0-1993; IN COMMERCE 0-0-1993.

RONALD MCMORROW, EXAMINING ATTORNEY

CLASS 16—(Continued).

SN 77-930,210. KISH, LOUIS A, SANTA ANA, CA. FILED 2-8-2010.

STAY-CAP

THE MARK CONSISTS OF STANDARD CHARACTERS WITHOUT CLAIM TO ANY PARTICULAR FONT, STYLE, SIZE, OR COLOR.

FOR BALL PENS; BALL POINT PENS; BALL-POINT PENS; FELT TIP MARKERS; FIBER-TIP MARKERS; HIGHLIGHTING MARKERS; MARKERS; SCHOOL SUPPLY KITS CONTAINING VARIOUS COMBINATIONS OF SELECTED SCHOOL SUPPLIES, NAMELY, WRITING INSTRUMENTS, PENS, PENCILS, MECHANICAL PENCILS, ERASERS, MARKERS, CRAYONS, HIGHLIGHTER PENS, FOLDERS, NOTEBOOKS, PAPER, PROTRACTORS, PAPER CLIPS, PENCIL SHARPENERS, WRITING GRIPS, GLUE AND BOOK MARKS (U.S. CLS. 2, 5, 22, 23, 29, 37, 38 AND 50).

JESSICA A. POWERS, EXAMINING ATTORNEY

SN 77-930,169. CARLINO, CRISTINA M., PHOENIX, AZ. FILED 2-8-2010.

ARCHETYPE

THE MARK CONSISTS OF STANDARD CHARACTERS WITHOUT CLAIM TO ANY PARTICULAR FONT, STYLE, SIZE, OR COLOR.

FOR ADDRESS BOOKS; APPOINTMENT BOOKS; ART PADS; ART PAPER; ARTISTS' BRUSHES; ARTISTS' PENCILS; ARTISTS' PENS; ARTS AND CRAFT CLAY KITS; ARTS AND CRAFT PAINT KITS; BABY BOOKS; BLANK JOURNALS; CALENDARS; COLORING BOOKS; COSMETIC PENCIL SHARPENERS; CRAYONS; DECORATIVE PAPER BOWS FOR WRAPPING; FRAMED ART PRINTS; GIFT BAGS; GIFT BOXES; GIFT CARDS; GIFT WRAPPING PAPER; GREETING CARDS; LETTER OPENERS; MARKERS; NOTE CARDS; PAPER NAPKINS; PAPER TABLE LINENS; PHOTOGRAPH ALBUMS; PRINTED INVITATIONS; SCRAPBOOK ALBUMS (U.S. CLS. 2, 5, 22, 23, 29, 37, 38 AND 50).

APRIL HESIK, EXAMINING ATTORNEY

SN 77-930,377. ANITA GOODESIGN, INC., CHARLOTTE, NC. FILED 2-8-2010.

ANITA GOODESIGN

THE MARK CONSISTS OF STANDARD CHARACTERS WITHOUT CLAIM TO ANY PARTICULAR FONT, STYLE, SIZE, OR COLOR.

THE NAME(S), PORTRAIT(S), AND/OR SIGNATURE(S) SHOWN IN THE MARK DOES NOT IDENTIFY A PARTICULAR LIVING INDIVIDUAL.

FOR EMBROIDERY DESIGN PATTERNS (U.S. CLS. 2, 5, 22, 23, 29, 37, 38 AND 50).

FIRST USE 6-30-2005; IN COMMERCE 6-30-2005.

LESLEY LAMOTHE, EXAMINING ATTORNEY

CLASS 16—(Continued).

SN 77-930,442. WORLD WRESTLING ENTERTAINMENT, INC., STAMFORD, CT. FILED 2-8-2010.



THE MARK CONSISTS OF TWO STACKED "W" LETTERS WITH A SCAR UNDERNEATH SITTING ON TOP OF THE LETTERS "NXT" APPEARING VERTICALLY.

FOR PAPER HANGTAGS, CARDBOARD HANGTAGS; PACKAGING, NAMELY BLISTER CARDS, PAPER FOR WRAPPING AND PACKAGING, PAPER POUCHES FOR PACKAGING, PLASTIC BAGS FOR PACKAGING, PLASTIC BUBBLE PACKS FOR WRAPPING OR PACKAGING; COLLECTOR ALBUMS, NAMELY, FOR STICKER COLLECTABLE CARDS, PHOTO COLLECTABLES; LABELS, NAMELY, PRINTED PAPER LABELS, PRINTED SHIPPING LABELS; RETURN ADDRESS LABELS NOT OF TEXTILE; FOLDERS; PLASTIC BAGS FOR GENERAL USE; PAPER TABLEWARE, NAMELY, PAPER PLACE MATS, PAPER TABLE MATS, PAPER NAPKINS, PAPER TABLE LINENS, PAPER TABLECLOTHS; PAPER LUNCH BAGS; STICKERS; BUMPER STICKERS; WINDOW DECALS; PENS; PENCILS; PENCIL SHARPENERS; PENCIL CASES; CHALK; ERASERS, NAMELY, RUBBER ERASERS, CHALK ERASERS, BLACKBOARD ERASERS; POSTERS; NOTEBOOKS; TRADING CARDS; CALENDARS; PHOTOGRAPHS; FRAMED PICTURES; PHOTOGRAPHIC PRINTS; PICTURES; PHOTO ALBUMS; BROCHURES, NEWSLETTERS, MAGAZINES, AND NEWSPAPERS CONCERNING SPORTS ENTERTAINMENT; POSTCARDS; GREETING CARDS; DECALS; TEMPORARY TATTOO TRANSFERS; COLORING BOOKS; CHILDREN'S ACTIVITY BOOKS; SOUVENIR PROGRAMS CONCERNING SPORTS ENTERTAINMENT; BOOKS FEATURING PICTORIAL BIOGRAPHIES; AUTOGRAPH BOOKS; COMIC BOOKS; PICTURE BOOKS; STICKER ALBUMS; BOOK COVERS; PAPER BOOK MARKERS; BOOKPLATES; MEMO PADS; SCRIBBLE PADS; DATE BOOKS; ADDRESS BOOKS; AGENDA BOOKS; RUBBER STAMPS; STAMP PADS; COLLECTIBLE PREPAID TELEPHONE CARDS NOT MAGNETICALLY ENCODED; COLLECTOR STAMPS, NAMELY, COMMEMORATIVE STAMP SHEETS; CUSTOMIZED PERSONAL CHECKS; CHECKBOOK COVERS; PAPER BANNERS; PRINTED PAPER SIGNS FOR DOORS; DRAWING RULERS; LITHOGRAPHS; PAPER PARTY BAGS; PAPER PARTY FAVORS, NAMELY, PAPER HATS; STENCILS FOR TRACING DESIGNS ONTO PAPER; PAPER GIFT WRAP; PAPER CAKE DECORATIONS (U.S. CLS. 2, 5, 22, 23, 29, 37, 38 AND 50).
JOHN HWANG, EXAMINING ATTORNEY

CLASS 16—(Continued).

SN 77-930,965. KRIMSON KING ART & SUPPLY, PORTLAND, OR. FILED 2-8-2010.



THE MARK CONSISTS OF THE WORDING "KRIMSON KING" AND STYLIZED BACK TO BACK LETTER "K"'S THAT RESEMBLE A CROWN.

FOR GRAPHIC FINE ART REPRODUCTION PRINTS (U.S. CLS. 2, 5, 22, 23, 29, 37, 38 AND 50).

FIRST USE 1-1-2009; IN COMMERCE 1-1-2009.
DOUGLAS LEE, EXAMINING ATTORNEY

SN 77-930,966. DARTLEY, BEATRICE, MANHATTAN BEACH, CA. FILED 2-8-2010.

SARAH B. SMITTEN

THE MARK CONSISTS OF STANDARD CHARACTERS WITHOUT CLAIM TO ANY PARTICULAR FONT, STYLE, SIZE, OR COLOR.

THE NAME "SARAH B. SMITTEN" DOES NOT IDENTIFY A LIVING INDIVIDUAL.

FOR PAPER GOODS, NAMELY, STATIONERY, NOTEBOOKS, NOTE CARDS AND NOTEPADS (U.S. CLS. 2, 5, 22, 23, 29, 37, 38 AND 50).

DOUGLAS LEE, EXAMINING ATTORNEY

SN 77-931,017. ECOLOGY ACTION OF THE MID-PENINSULA, DBA BOUNTIFUL GARDENS, WILLITS, CA. FILED 2-8-2010.

Bountiful Gardens

THE MARK CONSISTS OF STANDARD CHARACTERS WITHOUT CLAIM TO ANY PARTICULAR FONT, STYLE, SIZE, OR COLOR.

NO CLAIM IS MADE TO THE EXCLUSIVE RIGHT TO USE "GARDENS", APART FROM THE MARK AS SHOWN. FOR CATALOGS IN THE FIELD OF SEEDS, GARDENING SUPPLIES, BOOKS (U.S. CLS. 2, 5, 22, 23, 29, 37, 38 AND 50).

FIRST USE 1-31-1984; IN COMMERCE 1-31-1984.
JORDAN BAKER, EXAMINING ATTORNEY

CLASS 16—(Continued).

SN 77-931,449. VAN GOBES, MICHELLE, GREENSBORO, NC. FILED 2-9-2010.

CHIC CHATEAU

THE MARK CONSISTS OF STANDARD CHARACTERS WITHOUT CLAIM TO ANY PARTICULAR FONT, STYLE, SIZE, OR COLOR.

FOR CHARITABLE FUND-RAISING FOR OTHERS (U.S. CLS. 2, 5, 22, 23, 29, 37, 38 AND 50).

FIRST USE 3-0-2009; IN COMMERCE 9-0-2009.

MARIA-VICTORIA SUAREZ, EXAMINING ATTORNEY

SN 77-931,599. INK MEDIA, MT. KISCO, NY. FILED 2-9-2010.

ANIMAL FARM

THE MARK CONSISTS OF STANDARD CHARACTERS WITHOUT CLAIM TO ANY PARTICULAR FONT, STYLE, SIZE, OR COLOR.

FOR CARDS, NAMELY, GREETING CARDS AND STATIONERY; CORRESPONDENCE CARDS; GREETING CARDS; PICTURE CARDS (U.S. CLS. 2, 5, 22, 23, 29, 37, 38 AND 50).

FIRST USE 1-1-2010; IN COMMERCE 1-1-2010.

WENDY JUN, EXAMINING ATTORNEY

SN 77-931,681. HEALTH COMMUNICATIONS, INC., DEER-FIELD BEACH, FL. FILED 2-9-2010.

VOWS

THE MARK CONSISTS OF STANDARD CHARACTERS WITHOUT CLAIM TO ANY PARTICULAR FONT, STYLE, SIZE, OR COLOR.

FOR A SERIES OF ROMANCE NOVELS (U.S. CLS. 2, 5, 22, 23, 29, 37, 38 AND 50).

DOUGLAS LEE, EXAMINING ATTORNEY

CLASS 16—(Continued).

SN 77-931,837. HEALTH COMMUNICATIONS, INC., DEER-FIELD BEACH, FL. FILED 2-9-2010.

VOWS LIFE . . . ROMANTICIZED

THE MARK CONSISTS OF STANDARD CHARACTERS WITHOUT CLAIM TO ANY PARTICULAR FONT, STYLE, SIZE, OR COLOR.

FOR A SERIES OF ROMANCE NOVELS (U.S. CLS. 2, 5, 22, 23, 29, 37, 38 AND 50).

DOUGLAS LEE, EXAMINING ATTORNEY

SN 77-932,052. SEATTLE PACIFIC INDUSTRIES, INC., SEATTLE, CA. FILED 2-9-2010.

UB

THE MARK CONSISTS OF STANDARD CHARACTERS WITHOUT CLAIM TO ANY PARTICULAR FONT, STYLE, SIZE, OR COLOR.

OWNER OF U.S. REG. NOS. 2,452,994, 2,455,084 AND OTHERS.

FOR WRITING INSTRUMENTS (U.S. CLS. 2, 5, 22, 23, 29, 37, 38 AND 50).

FIRST USE 6-1-1994; IN COMMERCE 6-1-1994.

GEORGE LORENZO, EXAMINING ATTORNEY

SN 77-932,091. SEATTLE PACIFIC INDUSTRIES, INC., SEATTLE, WA. FILED 2-9-2010.

UNIONBAY

THE MARK CONSISTS OF STANDARD CHARACTERS WITHOUT CLAIM TO ANY PARTICULAR FONT, STYLE, SIZE, OR COLOR.

OWNER OF U.S. REG. NOS. 1,306,070, 2,441,584 AND OTHERS.

FOR WRITING INSTRUMENTS (U.S. CLS. 2, 5, 22, 23, 29, 37, 38 AND 50).

FIRST USE 6-1-1994; IN COMMERCE 6-1-1994.

GEORGE LORENZO, EXAMINING ATTORNEY

CLASS 16—(Continued).

SN 77-932,485. KILBANE, MARGARET M., DETROIT LAKES, MN. FILED 2-10-2010.

LAKEGIRL

THE MARK CONSISTS OF STANDARD CHARACTERS WITHOUT CLAIM TO ANY PARTICULAR FONT, STYLE, SIZE, OR COLOR.

OWNER OF U.S. REG. NOS. 3,062,427, 3,411,417 AND 3,494,644.

FOR PHOTOGRAPHIC PRINTS, GICLEE PRINTS, ART PRINTS ON CANVAS, ART PRINTS, AND GREETING CARDS (U.S. CLS. 2, 5, 22, 23, 29, 37, 38 AND 50).

JENNY PARK, EXAMINING ATTORNEY

SN 77-932,652. GROWTHMINE, LLC, EULESS, TX. FILED 2-10-2010.

GROWTHMINE

THE MARK CONSISTS OF STANDARD CHARACTERS WITHOUT CLAIM TO ANY PARTICULAR FONT, STYLE, SIZE, OR COLOR.

FOR PRINTED MATERIALS, NAMELY, BOOKS, INSTRUCTIONAL MANUALS AND INFORMATIONAL MATERIALS IN THE FIELD OF BUSINESS MANAGEMENT (U.S. CLS. 2, 5, 22, 23, 29, 37, 38 AND 50).

JENNY PARK, EXAMINING ATTORNEY

SN 77-932,684. THE NORMAN ROCKWELL FAMILY AGENCY, INC., LAGRANGEVILLE, NY. FILED 2-10-2010.



OWNER OF U.S. REG. NOS. 1,666,322, 3,172,850 AND 3,458,489.

THE NAME(S), PORTRAIT(S), AND/OR SIGNATURE(S) SHOWN IN THE MARK DOES NOT IDENTIFY A PARTICULAR LIVING INDIVIDUAL.

THE MARK CONSISTS OF A FIVE POINT STAR IN A SQUARE WITH THE WORDING "NORMAN ROCKWELL" APPEARING IN A BANNER TO THE RIGHT.

FOR CALENDARS (U.S. CLS. 2, 5, 22, 23, 29, 37, 38 AND 50).

FIRST USE 10-1-2009; IN COMMERCE 10-1-2009.

JAY FLOWERS, EXAMINING ATTORNEY

CLASS 16—(Continued).

SN 77-932,856. SWEET PEA DESIGNS, BIRMINGHAM, AL. FILED 2-10-2010.

SWEET PEA DESIGNS

THE MARK CONSISTS OF STANDARD CHARACTERS WITHOUT CLAIM TO ANY PARTICULAR FONT, STYLE, SIZE, OR COLOR.

OWNER OF U.S. REG. NO. 3,543,393.

NO CLAIM IS MADE TO THE EXCLUSIVE RIGHT TO USE "DESIGNS", APART FROM THE MARK AS SHOWN.

FOR STATIONERY; STICKERS FOR USE AS INVITATIONS; ANNOUNCEMENT CARDS; PHOTO CARDS; NOTE CARDS; ENCLOSURE CARDS; PAPER ID TAGS; ENVELOPES; ADDRESS LABELS; EVENT PROGRAMS, NAMELY, WEDDING PROGRAMS; PLACE CARDS; AND PRINTED PATTERNS (U.S. CLS. 2, 5, 22, 23, 29, 37, 38 AND 50).

FIRST USE 11-1-1988; IN COMMERCE 11-1-1988.

MICHAEL ENGEL, EXAMINING ATTORNEY

SN 77-932,874. HAWAII GLOBAL EXCHANGE, INC., DBA PACIFIC TELECARD & WIRELESS, HONOLULU, HI. FILED 2-10-2010.

Masterpiece

THE MARK CONSISTS OF STANDARD CHARACTERS WITHOUT CLAIM TO ANY PARTICULAR FONT, STYLE, SIZE, OR COLOR.

FOR PRE-PAID TELEPHONE CALLING CARDS, NOT MAGNETICALLY ENCODED (U.S. CLS. 2, 5, 22, 23, 29, 37, 38 AND 50).

FIRST USE 12-4-2009; IN COMMERCE 12-4-2009.

ALLISON SCHRODY, EXAMINING ATTORNEY

CLASS 16—(Continued).

SN 77-933,114. DR. SEUSS ENTERPRISES, L.P., LA JOLLA, CA. FILED 2-10-2010.



OWNER OF U.S. REG. NOS. 2,719,570 AND 3,544,337.
 THE MARK CONSISTS OF THE STYLIZED IMAGE OF TWO CREATURES WITH FULL HAIR AND BIG EYES SITTING SIDE-BY-SIDE. THE CREATURE ON THE LEFT IS WEARING A SHIRT THAT SAYS "THING 1" AND THE CREATURE ON THE RIGHT IS WEARING A SHIRT THAT SAYS "THING 2".
 FOR FLASH CARDS (U.S. CLS. 2, 5, 22, 23, 29, 37, 38 AND 50).
 FIRST USE 6-0-2008; IN COMMERCE 6-0-2008.
 APRIL ROACH, EXAMINING ATTORNEY

SN 77-933,115. DR. SEUSS ENTERPRISES, L.P., LA JOLLA, CA. FILED 2-10-2010.



OWNER OF U.S. REG. NOS. 2,698,199, 3,619,120 AND OTHERS.
 THE MARK CONSISTS OF THE STYLIZED IMAGE OF A FURRY CREATURE WITH WHISKERS WEARING A HAT.
 FOR FLASH CARDS (U.S. CLS. 2, 5, 22, 23, 29, 37, 38 AND 50).
 FIRST USE 6-0-2008; IN COMMERCE 6-0-2008.
 APRIL ROACH, EXAMINING ATTORNEY

CLASS 16—(Continued).

SN 77-933,202. HEALTH COMMUNICATIONS, INC., DEER-FIELD BEACH, FL. FILED 2-11-2010.



THE MARK CONSISTS OF THE WORD "VOVS" IN STYLIZED LETTERING WITH TWO INTERLOCKING RINGS FORMING THE LETTER "O". UNDERNEATH WHICH IS THE WORDING "LIFE . . . ROMANTICIZED".
 FOR A SERIES OF ROMANCE NOVELS (U.S. CLS. 2, 5, 22, 23, 29, 37, 38 AND 50).
 DOUGLAS LEE, EXAMINING ATTORNEY

SN 77-934,402. INSPHERE INSURANCE SOLUTIONS, INC., NORTH RICHLAND HILLS, TX. FILED 2-12-2010.

INSPHERE INSPIRE

THE MARK CONSISTS OF STANDARD CHARACTERS WITHOUT CLAIM TO ANY PARTICULAR FONT, STYLE, SIZE, OR COLOR.
 FOR MAGAZINE DIRECTED TO INSURANCE AGENTS CONTAINING INFORMATION IN THE FIELD OF HEALTH INSURANCE (U.S. CLS. 2, 5, 22, 23, 29, 37, 38 AND 50).
 JENNIFER MARTIN, EXAMINING ATTORNEY

SN 77-935,369. ARNETT, VIRGINIA E., NEWPORT BEACH, CA. FILED 2-13-2010.



THE MARK CONSISTS OF A WOMAN SEATED ON A STOOL HOLDING A FILE FOLDER AND READING A CARD.
 FOR ART PRINTS; CALENDARS; GREETING CARDS; POSTERS; STATIONERY (U.S. CLS. 2, 5, 22, 23, 29, 37, 38 AND 50).
 FIRST USE 0-0-1993; IN COMMERCE 0-0-1993.
 RONALD MCMORROW, EXAMINING ATTORNEY

CLASS 16—(Continued).

SN 77-935,376. GOLDEN GATE PAPER COMPANY, INC., DEL MAR, CA. FILED 2-13-2010.



NO CLAIM IS MADE TO THE EXCLUSIVE RIGHT TO USE "PAPER", APART FROM THE MARK AS SHOWN.

THE MARK CONSISTS OF THE WORDS "GOLDEN GATE PAPER" TO THE LEFT OF A STYLIZED IMAGE OF THE "GOLDEN GATE BRIDGE" WITH A STYLIZED PAPER ROLL TO THE RIGHT OF THE BRIDGE.

FOR BATHROOM TISSUE; COARSE TISSUE; DISPOSABLE NAPKINS; DISPOSABLE PAPER SHEETS FOR PERSONAL HYGIENIC USE IN THE NATURE OF DISPOSABLE HEADREST COVERS NOT FOR MEDICAL USE; FACE TOWELS OF PAPER; FACIAL TISSUE; HAND TOWELS OF PAPER; HANDKERCHIEFS OF PAPER; HYGIENIC PAPER; NAPKIN PAPER; NAPKINS OF PAPER FOR REMOVING MAKE-UP; PACKAGING MATERIALS MADE OF RECYCLED PAPER; PAPER HAND-TOWELS; PAPER HANDKERCHIEFS; PAPER HANDTOWELS; PAPER NAPKINS; PAPER PLACE MATS; PAPER TABLE CLOTHS; PAPER TABLE LINENS; PAPER TABLECLOTHS; PAPER TISSUES; PAPER TISSUES FOR COSMETIC USE; PAPER TOILET BOWL LINERS; PAPER TOWELS; PLACE MATS OF PAPER; TABLE CLOTHS OF PAPER; TABLE LINENS OF PAPER; TABLE MATS OF PAPER; TABLE NAPKINS OF PAPER; TISSUE PAPER; TISSUES OF PAPER FOR REMOVING MAKE-UP; TOILET PAPER; TOILET SEAT COVER PAPER; TOILET TISSUE; TOILET TRAINING TARGETS MADE OF PAPER (U.S. CLS. 2, 5, 22, 23, 29, 37, 38 AND 50).

WILLIAM BRECKENFELD, EXAMINING ATTORNEY

SN 77-936,773. CARLINO, CRISTINA M., PHOENIX, AZ. FILED 2-16-2010.

ART OF GRACE

THE MARK CONSISTS OF STANDARD CHARACTERS WITHOUT CLAIM TO ANY PARTICULAR FONT, STYLE, SIZE, OR COLOR.

OWNER OF U.S. REG. NOS. 3,581,660, 3,610,321 AND OTHERS.

FOR ADDRESS BOOKS; APPOINTMENT BOOKS; ART PADS; ART PAPER; ARTISTS' BRUSHES; ARTISTS' PENCILS; ARTISTS' PENS; ARTS AND CRAFT CLAY KITS; ARTS AND CRAFT PAINT KITS; BABY BOOKS; BLANK JOURNALS; CALENDARS; COLORING BOOKS; CRAYONS; DECORATIVE PAPER BOWS FOR WRAPPING; FRAMED ART PRINTS; GIFT BAGS; GIFT BOXES; GIFT CARDS; GIFT WRAPPING PAPER; GREETING CARDS; LETTER OPENERS; MARKERS; NOTE CARDS; PAPER NAPKINS; PAPER TABLE LINENS; PHOTOGRAPH ALBUMS; PRINTED INVITATIONS; SCRAPBOOK ALBUMS (U.S. CLS. 2, 5, 22, 23, 29, 37, 38 AND 50).

JULIE WATSON, EXAMINING ATTORNEY

CLASS 16—(Continued).

SN 77-936,992. MAKO SURGICAL CORP., FORT LAUDERDALE, FL. FILED 2-16-2010.

MAKOVIEW

THE MARK CONSISTS OF STANDARD CHARACTERS WITHOUT CLAIM TO ANY PARTICULAR FONT, STYLE, SIZE, OR COLOR.

OWNER OF U.S. REG. NOS. 3,256,819 AND 3,524,523.

FOR BROCHURES AND BOOKLETS IN THE NATURE OF NEWSLETTERS IN THE FIELDS OF ROBOTIC TECHNOLOGY FOR SURGICAL USE (U.S. CLS. 2, 5, 22, 23, 29, 37, 38 AND 50).

FIRST USE 7-31-2009; IN COMMERCE 7-31-2009.

JUDITH HELFMAN, EXAMINING ATTORNEY

SN 77-941,220. BRISTOL-MYERS SQUIBB COMPANY, NEW YORK, NY. FILED 2-22-2010.

SPRYCEL

OWNER OF U.S. REG. NO. 3,114,787.
THE MARK CONSISTS OF THE WORD "SPRYCEL" IN STYLIZED LETTERING AND A DOT OVER THE LETTER "Y" AND A LINE UNDERNEATH.

THE WORDING "SPRYCEL" HAS NO MEANING IN A FOREIGN LANGUAGE.

FOR PRINTED MATTER, NAMELY, BOOKLETS, BROCHURES, PAMPHLETS AND NEWSLETTERS ON THE SUBJECT OF CANCER (U.S. CLS. 2, 5, 22, 23, 29, 37, 38 AND 50).

FIRST USE 10-0-2006; IN COMMERCE 10-0-2006.

SUSAN STIGLITZ, EXAMINING ATTORNEY

CLASS 16—(Continued).

SN 77-943,784. RODDENBERRY PRODUCTIONS, SHERMAN OAKS, CA. FILED 2-24-2010.

DAYS MISSING

THE MARK CONSISTS OF STANDARD CHARACTERS WITHOUT CLAIM TO ANY PARTICULAR FONT, STYLE, SIZE, OR COLOR.

FOR COMIC BOOKS AND GRAPHIC NOVELS (U.S. CLS. 2, 5, 22, 23, 29, 37, 38 AND 50).

FIRST USE 7-23-2009; IN COMMERCE 7-23-2009.
REBECCA SMITH, EXAMINING ATTORNEY

SN 77-945,015. WORLD TRIATHLON CORPORATION, TAMPA, FL. FILED 2-25-2010.



THE MARK CONSISTS OF THE WORD "LAVA" IN STYLIZED LETTERING IN THE FORM OF BLOCK LETTERS AND BROKEN HORIZONTAL LINES THROUGH THE TOP PORTION OF THE LAST "A" IN THE WORD. SHADOWING APPEARS BELOW, BETWEEN AND ON THE SIDES OF THE LETTERS TO CREATE A RAISED EFFECT TO THE MARK.

FOR MAGAZINES FEATURING SWIMMING, BIKING, RUNNING AND TRIATHLONS (U.S. CLS. 2, 5, 22, 23, 29, 37, 38 AND 50).

JUDITH HELFMAN, EXAMINING ATTORNEY

SN 77-945,102. GEORGIA-PACIFIC CONSUMER PRODUCTS LP, ATLANTA, GA. FILED 2-25-2010.



THE MARK CONSISTS OF STANDARD CHARACTERS WITHOUT CLAIM TO ANY PARTICULAR FONT, STYLE, SIZE, OR COLOR.

OWNER OF U.S. REG. NOS. 3,420,118 AND 3,522,026.
FOR FILTER PAPER (U.S. CLS. 2, 5, 22, 23, 29, 37, 38 AND 50).

KIMBERLY PERRY, EXAMINING ATTORNEY

CLASS 16—(Continued).

SN 77-945,449. FREMANTLEMEDIA NORTH AMERICA, INC., BURBANK, CA. FILED 2-25-2010.

AMERICAN IDOL

THE MARK CONSISTS OF STANDARD CHARACTERS WITHOUT CLAIM TO ANY PARTICULAR FONT, STYLE, SIZE, OR COLOR.

OWNER OF U.S. REG. NOS. 3,330,238, 3,357,980 AND OTHERS.

FOR DECALS; DECORATIVE PAPER CENTERPIECES; INVITATION CARDS; PAPER NAPKINS; PAPER PARTY BAGS; PAPER PARTY DECORATIONS; PAPER PARTY FAVORS; TEMPORARY TATTOOS (U.S. CLS. 2, 5, 22, 23, 29, 37, 38 AND 50).

FIRST USE 3-1-2006; IN COMMERCE 3-1-2006.
AMEEN IMAM, EXAMINING ATTORNEY

SN 77-945,508. WORLD WRESTLING ENTERTAINMENT, INC., STAMFORD, CT. FILED 2-25-2010.

OVER THE LIMIT

THE MARK CONSISTS OF STANDARD CHARACTERS WITHOUT CLAIM TO ANY PARTICULAR FONT, STYLE, SIZE, OR COLOR.

FOR PAPER HANGTAGS, CARDBOARD HANGTAGS; PACKAGING, NAMELY, BLISTER CARDS, PAPER FOR WRAPPING AND PACKAGING, PAPER POUCHES FOR PACKAGING, PLASTIC BAGS FOR PACKAGING, PLASTIC BUBBLE PACKS FOR WRAPPING OR PACKAGING; COLLECTOR ALBUMS, NAMELY, FOR STICKER COLLECTABLE CARDS, PHOTO COLLECTABLES; LABELS, NAMELY, PRINTED PAPER LABELS, PRINTED SHIPPING LABELS; RETURN ADDRESS LABELS NOT OF TEXTILE; FOLDERS; PLASTIC BAGS FOR GENERAL USE; PAPER TABLEWARE, NAMELY, PAPER PLACE MATS, PAPER TABLE MATS, PAPER NAPKINS, PAPER TABLE LINENS, PAPER TABLECLOTHS; PAPER LUNCH BAGS; STICKERS; BUMPER STICKERS; WINDOW DECALS; PENS; PENCILS; PENCIL SHARPENERS; PENCIL CASES; CHALK; ERASERS, NAMELY, RUBBER ERASERS, CHALK ERASERS, BLACKBOARD ERASERS; POSTERS; NOTEBOOKS; TRADING CARDS; CALENDARS; PHOTOGRAPHS; FRAMED PICTURES; PHOTOGRAPHIC PRINTS; PICTURES; PHOTO ALBUMS; BROCHURES, NEWSLETTERS, MAGAZINES, AND

CLASS 16—(Continued).

NEWSPAPERS CONCERNING SPORTS ENTERTAINMENT; POSTCARDS; GREETING CARDS; DECALS; TEMPORARY TATTOO TRANSFERS; COLORING BOOKS; CHILDREN'S ACTIVITY BOOKS; SOUVENIR PROGRAMS CONCERNING SPORTS ENTERTAINMENT; BOOKS FEATURING PICTORIAL BIOGRAPHIES; AUTOGRAPH BOOKS; COMIC BOOKS; PICTURE BOOKS; STICKER ALBUMS; BOOK COVERS; PAPER BOOK MARKERS; BOOKPLATES; MEMO PADS; SCRIBBLE PADS; DATE BOOKS; ADDRESS BOOKS; AGENDA BOOKS; RUBBER STAMPS; STAMP PADS; COLLECTIBLE PREPAID TELEPHONE CARDS NOT MAGNETICALLY ENCODED; COLLECTOR STAMPS, NAMELY, COMMEMORATIVE STAMP SHEETS; CUSTOMIZED PERSONAL CHECKS; CHECKBOOK COVERS; PAPER BANNERS; PRINTED PAPER SIGNS FOR DOORS; DRAWING RULERS; LITHOGRAPHS; PAPER PARTY BAGS; PAPER PARTY FAVORS, NAMELY, PAPER HATS; STENCILS FOR TRACING DESIGNS ONTO PAPER; PAPER GIFT WRAP; PAPER CAKE DECORATIONS (U.S. CLS. 2, 5, 22, 23, 29, 37, 38 AND 50).
JOHN HWANG, EXAMINING ATTORNEY

SN 77-945,511. WORLD WRESTLING ENTERTAINMENT, INC., STAMFORD, CT. FILED 2-25-2010.

FATAL FOUR WAY

THE MARK CONSISTS OF STANDARD CHARACTERS WITHOUT CLAIM TO ANY PARTICULAR FONT, STYLE, SIZE, OR COLOR.

FOR PAPER HANGTAGS, CARDBOARD HANGTAGS; PACKAGING, NAMELY, BLISTER CARDS, PAPER FOR WRAPPING AND PACKAGING, PAPER POUCHES FOR PACKAGING, PLASTIC BAGS FOR PACKAGING, PLASTIC BUBBLE PACKS FOR WRAPPING OR PACKAGING; COLLECTOR ALBUMS, NAMELY, FOR STICKER COLLECTABLE CARDS, PHOTO COLLECTABLES; LABELS, NAMELY, PRINTED PAPER LABELS, PRINTED SHIPPING LABELS; RETURN ADDRESS LABELS NOT OF TEXTILE; FOLDERS; PLASTIC BAGS FOR GENERAL USE; PAPER TABLEWARE, NAMELY, PAPER PLACE MATS, PAPER TABLE MATS, PAPER NAPKINS, PAPER TABLE LINENS, PAPER TABLECLOTHS; PAPER LUNCH BAGS; STICKERS; BUMPER STICKERS; WINDOW DECALS; PENS; PENCILS; PENCIL SHARPENERS; PENCIL CASES; CHALK; ERASERS, NAMELY, RUBBER ERASERS, CHALK ERASERS, BLACKBOARD ERASERS; POSTERS; NOTEBOOKS; TRADING CARDS; CALENDARS; PHOTOGRAPHS; FRAMED PICTURES; PHOTOGRAPHIC PRINTS; PICTURES; PHOTO ALBUMS; BROCHURES, NEWSLETTERS, MAGAZINES, AND NEWSPAPERS CONCERNING SPORTS ENTERTAINMENT; POSTCARDS; GREETING CARDS; DECALS; TEMPORARY TATTOO TRANSFERS; COLORING BOOKS; CHILDREN'S ACTIVITY BOOKS; SOUVENIR PROGRAMS CONCERNING SPORTS ENTERTAINMENT; BOOKS FEATURING PICTORIAL BIOGRAPHIES; AUTOGRAPH BOOKS; COMIC BOOKS; PICTURE BOOKS; STICKER ALBUMS; BOOK COVERS; PAPER BOOK MARKERS; BOOKPLATES; MEMO PADS; SCRIBBLE PADS; DATE BOOKS; ADDRESS BOOKS; AGENDA BOOKS; RUBBER STAMPS; STAMP PADS; COLLECTIBLE PREPAID TELEPHONE CARDS NOT MAGNETICALLY ENCODED; COLLECTOR STAMPS, NAMELY, COMMEMORATIVE STAMP SHEETS; CUSTOMIZED PERSONAL CHECKS; CHECKBOOK COVERS; PAPER BANNERS; PRINTED PAPER SIGNS FOR DOORS; DRAWING RULERS; LITHOGRAPHS; PAPER PARTY BAGS; PAPER PARTY FAVORS, NAMELY, PAPER HATS; STENCILS FOR TRACING DESIGNS ONTO PAPER; PAPER GIFT WRAP; PAPER CAKE DECORATIONS (U.S. CLS. 2, 5, 22, 23, 29, 37, 38 AND 50).
JOHN HWANG, EXAMINING ATTORNEY

CLASS 16—(Continued).

SN 77-945,521. WORLD WRESTLING ENTERTAINMENT, INC., STAMFORD, CT. FILED 2-25-2010.

MONEY IN THE BANK

THE MARK CONSISTS OF STANDARD CHARACTERS WITHOUT CLAIM TO ANY PARTICULAR FONT, STYLE, SIZE, OR COLOR.

OWNER OF U.S. REG. NO. 3,532,434.

FOR PAPER HANGTAGS, CARDBOARD HANGTAGS; PACKAGING, NAMELY, BLISTER CARDS, PAPER FOR WRAPPING AND PACKAGING, PAPER POUCHES FOR PACKAGING, PLASTIC BAGS FOR PACKAGING, PLASTIC BUBBLE PACKS FOR WRAPPING OR PACKAGING; COLLECTOR ALBUMS, NAMELY, FOR STICKER COLLECTABLE CARDS, PHOTO COLLECTABLES; LABELS, NAMELY, PRINTED PAPER LABELS, PRINTED SHIPPING LABELS; RETURN ADDRESS LABELS NOT OF TEXTILE; FOLDERS; PLASTIC BAGS FOR GENERAL USE; PAPER TABLEWARE, NAMELY, PAPER PLACE MATS, PAPER TABLE MATS, PAPER NAPKINS, PAPER TABLE LINENS, PAPER TABLECLOTHS; PAPER LUNCH BAGS; STICKERS; BUMPER STICKERS; WINDOW DECALS; PENS; PENCILS; PENCIL SHARPENERS; PENCIL CASES; CHALK; ERASERS, NAMELY, RUBBER ERASERS, CHALK ERASERS, BLACKBOARD ERASERS; POSTERS; NOTEBOOKS; TRADING CARDS; CALENDARS; PHOTOGRAPHS; FRAMED PICTURES; PHOTOGRAPHIC PRINTS; PICTURES; PHOTO ALBUMS; BROCHURES, NEWSLETTERS, MAGAZINES, AND NEWSPAPERS CONCERNING SPORTS ENTERTAINMENT; POSTCARDS; GREETING CARDS; DECALS; TEMPORARY TATTOO TRANSFERS; COLORING BOOKS; CHILDREN'S ACTIVITY BOOKS; SOUVENIR PROGRAMS CONCERNING SPORTS ENTERTAINMENT; BOOKS FEATURING PICTORIAL BIOGRAPHIES; AUTOGRAPH BOOKS; COMIC BOOKS; PICTURE BOOKS; STICKER ALBUMS; BOOK COVERS; PAPER BOOK MARKERS; BOOKPLATES; MEMO PADS; SCRIBBLE PADS; DATE BOOKS; ADDRESS BOOKS; AGENDA BOOKS; RUBBER STAMPS; STAMP PADS; COLLECTIBLE PREPAID TELEPHONE CARDS NOT MAGNETICALLY ENCODED; COLLECTOR STAMPS, NAMELY, COMMEMORATIVE STAMP SHEETS; CUSTOMIZED PERSONAL CHECKS; CHECKBOOK COVERS; PAPER BANNERS; PRINTED PAPER SIGNS FOR DOORS; DRAWING RULERS; LITHOGRAPHS; PAPER PARTY BAGS; PAPER PARTY FAVORS, NAMELY, PAPER HATS; STENCILS FOR TRACING DESIGNS ONTO PAPER; PAPER GIFT WRAP; PAPER CAKE DECORATIONS (U.S. CLS. 2, 5, 22, 23, 29, 37, 38 AND 50).
JOHN HWANG, EXAMINING ATTORNEY

CLASS 16—(Continued).

SN 77-962,707. LUCKY PAWS, LLC, COVINGTON, KY.
FILED 3-18-2010.

PARTY 2 GO

THE MARK CONSISTS OF STANDARD CHARACTERS WITHOUT CLAIM TO ANY PARTICULAR FONT, STYLE, SIZE, OR COLOR.

NO CLAIM IS MADE TO THE EXCLUSIVE RIGHT TO USE "PARTY", APART FROM THE MARK AS SHOWN.

FOR PREPACKAGED PET KIT COMPRISING INVITATIONS, PARTY HAT, MICROWAVE PAN, AND PET TREATS IN THE FORM OF ORGANIC MATERIAL TO BE MIXED WITH OTHER MATERIAL AND MICROWAVED IN THE MICROWAVE PAN (U.S. CLS. 2, 5, 22, 23, 29, 37, 38 AND 50).

ODESSA BIBBINS, EXAMINING ATTORNEY

CLASS 16—(Continued).

SN 77-970,117. FREMANTLEMEDIA NORTH AMERICA, INC., BURBANK, CA. FILED 3-26-2010.

DOWNFALL

THE MARK CONSISTS OF STANDARD CHARACTERS WITHOUT CLAIM TO ANY PARTICULAR FONT, STYLE, SIZE, OR COLOR.

FOR POSTERS, CALENDARS, NOTEBOOKS, BINDERS, DAILY ORGANIZERS, MEMOPADS, STICKERS, COMIC BOOKS, WRITING PAPER, ENVELOPES, GREETING CARDS, PAPER COASTERS, PAPER MATS, NEWSPAPERS FOR GENERAL CIRCULATION, BOOKS AND MAGAZINES IN THE FIELD OF GAME SHOWS, NEWSLETTERS IN THE FIELD OF GAME SHOWS, PHOTOGRAPHS, POSTCARDS, TRADING CARDS, CARDBOARD STAND-UP CUTOUTS FEATURING PHOTOGRAPHS OR ARTWORK, PREPAID PHONE DEBIT CARDS WITHOUT MAGNETIC CODING, TRADING CARD MILK BOTTLE CAPS, AND CUSTOMIZED PERSONAL CHECKS, PAPER PARTY DECORATIONS, PAPER PARTY BAGS, PAPER PARTY FAVORS, GIFT CARD HOLDERS; PAPER CAKE DECORATIONS (U.S. CLS. 2, 5, 22, 23, 29, 37, 38 AND 50).

AMEEN IMAM, EXAMINING ATTORNEY

SN 77-967,188. HARDIN, RONALD EUGENE, DBA INSPIRED MINISTRIES, POMONA, CA. FILED 3-24-2010.

His Heart's Collection

THE MARK CONSISTS OF STANDARD CHARACTERS WITHOUT CLAIM TO ANY PARTICULAR FONT, STYLE, SIZE, OR COLOR.

NO CLAIM IS MADE TO THE EXCLUSIVE RIGHT TO USE "COLLECTION", APART FROM THE MARK AS SHOWN.

FOR PUBLICATIONS, NAMELY, BOOKS IN THE FIELDS OF POETRY (U.S. CLS. 2, 5, 22, 23, 29, 37, 38 AND 50).

FIRST USE 7-17-2008; IN COMMERCE 7-17-2008.
ANDREA K. NADELMAN, EXAMINING ATTORNEY

SN 78-466,500. ATMEL CORPORATION, SAN JOSE, CA.
FILED 8-12-2004.

ICE-CREAM

THE MARK CONSISTS OF STANDARD CHARACTERS WITHOUT CLAIM TO ANY PARTICULAR FONT, STYLE, SIZE, OR COLOR.

FOR POSTERS, STATIONERY, BUSINESS CARDS, AND PRINTED PRODUCT GUIDES FEATURING SEMI-CONDUCTOR INTEGRATED CIRCUITS AND ELECTRONIC SYSTEMS (U.S. CLS. 2, 5, 22, 23, 29, 37, 38 AND 50).

KATHY DE JONGE, EXAMINING ATTORNEY

CLASS 16—(Continued).

SN 78-899,835. WITTKÉ, CYNTHIA, CARLSBAD, CA. FILED 6-3-2006.

Nagivator

THE MARK CONSISTS OF STANDARD CHARACTERS WITHOUT CLAIM TO ANY PARTICULAR FONT, STYLE, SIZE, OR COLOR.

FOR CARDS BEARING UNIVERSAL GREETINGS (U.S. CLS. 2, 5, 22, 23, 29, 37, 38 AND 50).

CHRISTOPHER BUONGIORNO, EXAMINING ATTORNEY

SN 85-001,643. INTERNATIONAL DATA GROUP, INC., FRAMINGHAM, MA. FILED 3-30-2010.

MOBILE & WIRELESS WORLD

THE MARK CONSISTS OF STANDARD CHARACTERS WITHOUT CLAIM TO ANY PARTICULAR FONT, STYLE, SIZE, OR COLOR.

OWNER OF U.S. REG. NO. 2,810,526.

NO CLAIM IS MADE TO THE EXCLUSIVE RIGHT TO USE "MOBILE & WIRELESS", APART FROM THE MARK AS SHOWN.

FOR PRINT PUBLICATIONS, NAMELY, MAGAZINES, NEWSLETTERS AND SUPPLEMENTS SOLD THEREWITH, ALL IN THE FIELDS OF COMPUTERS, COMPUTER SOFTWARE, ONLINE SERVICES, HIGH TECHNOLOGY, COMMUNICATIONS, INFORMATION TECHNOLOGY, AND INFORMATION SERVICES (U.S. CLS. 2, 5, 22, 23, 29, 37, 38 AND 50).

JASON BLAIR, EXAMINING ATTORNEY

SN 85-017,034. HEALTH COMMUNICATIONS, INC., DEERFIELD BEACH, FL. FILED 4-19-2010.



True Vows
LIFE . . . ROMANTICIZED

THE MARK CONSISTS OF THE WORDS "TRUE VOWS" IN STYLIZED LETTERING WITH TWO INTERLOCKING RINGS FORMING THE LETTER "O", UNDERNEATH WHICH IS THE WORDING "LIFE . . . ROMANTICIZED" IN STYLIZED LETTERING.

FOR A SERIES OF ROMANCE NOVELS (U.S. CLS. 2, 5, 22, 23, 29, 37, 38 AND 50).

DOUGLAS LEE, EXAMINING ATTORNEY

CLASS 17—RUBBER GOODS

SN 77-403,665. INTERWRAP INC., MISSION, CANADA, FILED 2-22-2008.

FLEXILITE

THE MARK CONSISTS OF STANDARD CHARACTERS WITHOUT CLAIM TO ANY PARTICULAR FONT, STYLE, SIZE, OR COLOR.

PRIORITY CLAIMED UNDER SEC. 44(D) ON CANADA APPLICATION NO. 1365799, FILED 10-1-2007, REG. NO. TMA758006, DATED 1-27-2010, EXPIRES 1-27-2025.

FOR POLYMER SUBSTRATES FOR USE IN THE MANUFACTURE OF AWNINGS, SIGNS AND BILLBOARDS, BANNERS, DIGITAL IMAGING AND PRINTING APPLICATIONS (U.S. CLS. 1, 5, 12, 13, 35 AND 50).

SAIMA MAKHDOOM, EXAMINING ATTORNEY

SN 77-555,568. MITSUI CHEMICALS, INC., TOKYO, JAPAN, FILED 8-26-2008.

PROGRESS

THE MARK CONSISTS OF STANDARD CHARACTERS WITHOUT CLAIM TO ANY PARTICULAR FONT, STYLE, SIZE, OR COLOR.

OWNER OF REPUBLIC OF KOREA REG. NO. 7925256, DATED 7-15-2009, EXPIRES 7-15-2019.

FOR PROCESS FILM, NAMELY, FILMS USED TO LINE MOLDS FOR EASY RELEASE OF MOLDED MATERIALS AND FOR RESIN-ENCAPSULATING; PLASTIC FILM FOR COMMERCIAL AND INDUSTRIAL USE; SEMI-WORKED SYNTHETIC PLASTIC AND SYNTHETIC RESINS AS SEMI-FINISHED PRODUCTS IN FORM OF PELLETS, RODS, FOILS, FOAMS, FIBERS, STRIPS, FILMS AND SHEETS (U.S. CLS. 1, 5, 12, 13, 35 AND 50).

TOBY BULLOFF, EXAMINING ATTORNEY

SN 77-655,286. WOOD, JAMES BURKE, LIGHTHOUSE POINT, FL. AND WOOD, GILMAN BURKE, PRINCETON, NJ. FILED 1-23-2009.

REFLECTIONITE

THE MARK CONSISTS OF STANDARD CHARACTERS WITHOUT CLAIM TO ANY PARTICULAR FONT, STYLE, SIZE, OR COLOR.

FOR FABRIC LAMINATES COMPRISED OF REFLECTIVE FILM AND FABRICS FOR USE IN THE FURTHER MANUFACTURE OF SUN COVERS FOR AUTOMOBILES, ELECTRONIC EQUIPMENT, PEOPLE, LIVESTOCK, AND PLANT PRODUCE; LAMINATES FOR ROOFING COVER MATERIALS (U.S. CLS. 1, 5, 12, 13, 35 AND 50).

MARIA-VICTORIA SUAREZ, EXAMINING ATTORNEY

CLASS 17—(Continued).

SN 77-733,603. SUNSET TINT LLC, DBA SUNSET TINT, SCOTTSDALE, AZ. FILED 5-11-2009.

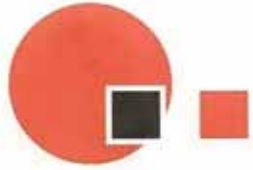

THE COLOR(S) BLACK, CRIMSON IS/ARE CLAIMED AS A FEATURE OF THE MARK.

THE MARK CONSISTS OF A LARGE CRIMSON CIRCLE, WITH A SMALLER BLACK SQUARE PLACED OVER THE BOTTOM RIGHT OF THE CIRCLE AND A SMALLER CRIMSON SQUARE IS LOCATED TO THE RIGHT OF THE LARGE CIRCLE.

FOR TINTED, LAMINATED AND REFLECTIVE PLASTIC FILMS FOR USE IN HOME OR AUTO WINDOWS (U.S. CLS. 1, 5, 12, 13, 35 AND 50).

JASON BLAIR, EXAMINING ATTORNEY

SN 77-780,754. PROTECT-ALL INC., DARIEN, WI. FILED 7-14-2009.

BLISTER SEAL

THE MARK CONSISTS OF STANDARD CHARACTERS WITHOUT CLAIM TO ANY PARTICULAR FONT, STYLE, SIZE, OR COLOR.

SEC. 2(F).

FOR PLASTIC LAMINATING FILM FOR USE IN LAMINATING PAPER OR PLASTIC (U.S. CLS. 1, 5, 12, 13, 35 AND 50).

FIRST USE 7-24-2003; IN COMMERCE 7-24-2003.

WILLIAM P. SHANAHAN, EXAMINING ATTORNEY

SN 77-780,756. PROTECT-ALL INC., DARIEN, WI. FILED 7-14-2009.

CRYSTAL MATTE AR

THE MARK CONSISTS OF STANDARD CHARACTERS WITHOUT CLAIM TO ANY PARTICULAR FONT, STYLE, SIZE, OR COLOR.

NO CLAIM IS MADE TO THE EXCLUSIVE RIGHT TO USE "MATTE AR", APART FROM THE MARK AS SHOWN.

FOR PLASTIC LAMINATING FILM FOR USE IN LAMINATING PAPER OR PLASTIC FOR USE IN THE BOOKBINDING INDUSTRY (U.S. CLS. 1, 5, 12, 13, 35 AND 50).

FIRST USE 2-14-2008; IN COMMERCE 2-14-2008.

WILLIAM P. SHANAHAN, EXAMINING ATTORNEY

CLASS 17—(Continued).

SN 77-795,606. BERRY PLASTICS CORPORATION, EVANSVILLE, IN. FILED 8-3-2009.

ULTRALITE

THE MARK CONSISTS OF STANDARD CHARACTERS WITHOUT CLAIM TO ANY PARTICULAR FONT, STYLE, SIZE, OR COLOR.

FOR BUNDLING FILMS, NAMELY, PLASTIC SHRINKABLE FILMS FOR INDUSTRIAL AND COMMERCIAL PACKAGING (U.S. CLS. 1, 5, 12, 13, 35 AND 50).

KIM MONINGHOFF, EXAMINING ATTORNEY

SN 77-795,615. BERRY PLASTICS CORPORATION, EVANSVILLE, IN. FILED 8-3-2009.

OPTIMIL

THE MARK CONSISTS OF STANDARD CHARACTERS WITHOUT CLAIM TO ANY PARTICULAR FONT, STYLE, SIZE, OR COLOR.

FOR BUNDLING FILMS, NAMELY, PLASTIC SHRINKABLE FILMS FOR INDUSTRIAL AND COMMERCIAL PACKAGING (U.S. CLS. 1, 5, 12, 13, 35 AND 50).

KIM MONINGHOFF, EXAMINING ATTORNEY

SN 77-796,641. ELSTER PERFECTION CORPORATION, MADISON, OH. FILED 8-4-2009.

COPPERSERT

THE MARK CONSISTS OF STANDARD CHARACTERS WITHOUT CLAIM TO ANY PARTICULAR FONT, STYLE, SIZE, OR COLOR.

OWNER OF U.S. REG. NO. 766,204.

FOR POLYETHYLENE TO COPPER TUBE TRANSITION FITTING MADE PRIMARILY OF PLASTIC (U.S. CLS. 1, 5, 12, 13, 35 AND 50).

FIRST USE 8-31-1988; IN COMMERCE 8-31-1988.

KRISTINA MORRIS, EXAMINING ATTORNEY

CLASS 17—(Continued).

SN 77-799,564. SAINT-GOBAIN PERFORMANCE PLASTICS CORPORATION, AURORA, OH. FILED 8-7-2009.

SOLARBOND

THE MARK CONSISTS OF STANDARD CHARACTERS WITHOUT CLAIM TO ANY PARTICULAR FONT, STYLE, SIZE, OR COLOR.

FOR ADHESIVE SEALANTS AND ADHESIVE TAPES FOR INDUSTRIAL AND COMMERCIAL USE IN THE SOLAR INDUSTRY (U.S. CLS. 1, 5, 12, 13, 35 AND 50).
KATHLEEN M. VANSTON, EXAMINING ATTORNEY

SN 77-811,888. SABIC INNOVATIVE PLASTICS IP B.V., BERGEN OP ZOOM, NETHERLANDS, FILED 8-25-2009.

ECO-SHAPES

THE MARK CONSISTS OF STANDARD CHARACTERS WITHOUT CLAIM TO ANY PARTICULAR FONT, STYLE, SIZE, OR COLOR.

FOR PLASTICS IN ROD AND TUBE FORM FOR USE IN FURTHER MANUFACTURE; SEMI-PROCESSED PLASTIC PRODUCTS IN SHEET, FILM, ROD AND TUBE FORM; SEMI-FINISHED PLASTIC PRODUCTS IN SHEET, FILM, ROD AND TUBE FORM FOR USE IN A VARIETY OF INDUSTRIES (U.S. CLS. 1, 5, 12, 13, 35 AND 50).
KRISTIN CARLSON, EXAMINING ATTORNEY

SN 77-858,439. BUILDINGS AND MATTERS, LLC, LINCOLN, MA. FILED 10-27-2009.



THE COLOR(S) RED AND BLACK IS/ARE CLAIMED AS A FEATURE OF THE MARK.

THE MARK CONSISTS OF THE WORDS "THE PUNCTURE SOLUTION", "PUNCTURE" RENDERED IN BLACK LETTERING AND THE WORDS "THE" AND "SOLUTION" RENDERED IN RED LETTERING, WITH AN IMAGE OF A SCREW FORMING PART OF THE "P" IN "PUNCTURE".

FOR A PRE-FORMED PIPE PROTECTIVE DEVICE, MADE PRIMARILY OF PLASTIC, DESIGNED TO PREVENT DAMAGE TO PIPES, ELECTRICAL WIRING, AND ELECTRICAL CONDUITS FROM DRYWALL SCREWS DURING CONSTRUCTION (U.S. CLS. 1, 5, 12, 13, 35 AND 50).
KIMBERLY FRYE, EXAMINING ATTORNEY

CLASS 17—(Continued).

SN 77-858,445. BUILDINGS AND MATTERS, LLC, LINCOLN, MA. FILED 10-27-2009.



THE MARK CONSISTS OF A STYLIZED LETTER "P" WITH A DEPICTION OF A SCREW FORMING PART OF THE LETTER.

FOR A PRE-FORMED PIPE PROTECTIVE DEVICE, MADE PRIMARILY OF PLASTIC, DESIGNED TO PREVENT DAMAGE TO PIPES, ELECTRICAL WIRING, AND ELECTRICAL CONDUITS FROM DRYWALL SCREWS DURING CONSTRUCTION (U.S. CLS. 1, 5, 12, 13, 35 AND 50).
KIMBERLY FRYE, EXAMINING ATTORNEY

SN 77-871,923. ATLANTIC PLASTICS LIMITED, LEEDS, UNITED KINGDOM, FILED 11-13-2009.

TALBOT

THE MARK CONSISTS OF STANDARD CHARACTERS WITHOUT CLAIM TO ANY PARTICULAR FONT, STYLE, SIZE, OR COLOR.

SEC. 2(F).
FOR PIPELINE AND TUBE CONNECTION COMPONENTS, NAMELY, SERVICE FITTINGS, STOP TAPS, PLUG COCKS AND MANIFOLD ALL MADE OF PLASTIC (U.S. CLS. 1, 5, 12, 13, 35 AND 50).
FIRST USE 12-31-2004; IN COMMERCE 12-31-2004.
ESTHER BELENKER, EXAMINING ATTORNEY

CLASS 17—(Continued).

SN 77-875,444. DAIKIN INDUSTRIES, LTD., OSAKA-SHI, OSAKA, JAPAN, FILED 11-18-2009.

Tainets

THE MARK CONSISTS OF STANDARD CHARACTERS WITHOUT CLAIM TO ANY PARTICULAR FONT, STYLE, SIZE, OR COLOR.

PRIORITY CLAIMED UNDER SEC. 44(D) ON JAPAN APPLICATION NO. 2009-059573, FILED 8-5-2009, REG. NO. 5302293, DATED 2-19-2010, EXPIRES 2-19-2020.

FOR NON-METAL SEALING RINGS FOR USE AS CONNECTION SEALS; SEALS MADE OF RUBBER; SEALS MADE OF FLUORO-RUBBER; NON-METAL SEALING O-RINGS FOR USE AS CONNECTION SEALS; O-RINGS MADE OF RUBBER; O-RINGS MADE OF FLUORO-RUBBER (U.S. CLS. 1, 5, 12, 13, 35 AND 50).

PAUL F. GAST, EXAMINING ATTORNEY

CLASS 17—(Continued).

SN 77-917,078. PARAGON FILMS, INC., BROKEN ARROW, OK. FILED 1-21-2010.

COLD FORCE

THE MARK CONSISTS OF STANDARD CHARACTERS WITHOUT CLAIM TO ANY PARTICULAR FONT, STYLE, SIZE, OR COLOR.

OWNER OF U.S. REG. NOS. 3,062,712, 3,715,047 AND OTHERS.

NO CLAIM IS MADE TO THE EXCLUSIVE RIGHT TO USE "COLD", APART FROM THE MARK AS SHOWN.

FOR PLASTIC STRETCH FILM FOR INDUSTRIAL AND COMMERCIAL PACKAGING (U.S. CLS. 1, 5, 12, 13, 35 AND 50).

DAWN FELDMAN, EXAMINING ATTORNEY

SN 77-924,505. ZHENSHI HOLDING GROUP CO., LIMITED, TONGXIANG, ZHEJIANG, CHINA, FILED 2-1-2010.

SN 77-881,309. JIANGSU DILONG PIPE CO.,LTD., YIXING, CHINA, FILED 11-26-2009.



THE MARK CONSISTS OF A DESIGN OF A DRAGON SURROUNDED BY THE WORDING "DILONG" AND TWO CHINESE CHARACTERS.

THE NON-LATIN CHARACTERS IN THE MARK TRANSLITERATE TO "DILONG" AND THIS HAS NO MEANING IN A FOREIGN LANGUAGE.

FOR FLEXIBLE PIPES, NOT OF METAL FOR UNDERGROUND STEAM THERMAL INSULATING APPLICATIONS; SOLDERING THREADS OF PLASTIC; JUNCTIONS, NOT OF METAL FOR POLYETHYLENE PIPE; FLEXIBLE PLASTIC PIPES FOR DELIVERING WATER; BOILER COMPOSITION, NAMELY, ASBESTOS FOR USE AS HEAT INSULATORS; ASBESTOS FELT; ASBESTOS FABRICS; SOUNDPROOFING MATERIALS FOR BUILDINGS AND MACHINERY; GLASS FIBER INSULATION BOARDS AND PIPES FOR USE IN CONSTRUCTION (U.S. CLS. 1, 5, 12, 13, 35 AND 50).

FIRST USE 7-1-2006; IN COMMERCE 7-1-2006.

DAVID ELTON, EXAMINING ATTORNEY



THE MARK CONSISTS OF A DESIGN FORMED BY THE LETTERS "S" AND "Z" TO THE LEFT OF CHINESE CHARACTERS AND THE WORD "ZHENSHI".

THE NON-LATIN CHARACTERS IN THE MARK TRANSLITERATE TO "ZHENSHI" AND THIS HAS NO MEANING IN A FOREIGN LANGUAGE.

FOR ACRYLIC RESIN SHEETING FOR USE IN THE MANUFACTURE OF LAMINATED GLASS; FIBERGLASS FABRICS FOR BUILDING INSULATION; FIBERGLASS INSULATION FOR BUILDINGS; INSULATED PIPE SUPPORTS; INSULATING FABRICS; INSULATION IN THE FORM OF FLOOR COVERINGS; PLASTIC COMPOSITE MATERIAL IN THE FORM OF PROFILES, BOARDS, SHEETS, BLOCKS, RODS, POWDER, AND PELLETS FOR USE IN MANUFACTURING; RUBBER; SEMI-WORKED SYNTHETIC PLASTIC AND SYNTHETIC RESINS AS SEMI-FINISHED PRODUCTS IN FORM OF PELLETS, RODS, FOILS, FOAMS, FIBERS, FILMS AND SHEETS; STRUCTURAL INSULATED CONSTRUCTION PANELS; VULCANIZED FIBER (U.S. CLS. 1, 5, 12, 13, 35 AND 50).

FIRST USE 6-16-1992; IN COMMERCE 2-15-2007.

SHANNON TWOHIG, EXAMINING ATTORNEY

CLASS 17—(Continued).

SN 77-927,004. TRU VUE, INC., MCCOOK, IL. FILED 2-3-2010.

CONSERVATION MASTERPIECE
ACRYLIC

THE MARK CONSISTS OF STANDARD CHARACTERS WITHOUT CLAIM TO ANY PARTICULAR FONT, STYLE, SIZE, OR COLOR.

OWNER OF U.S. REG. NOS. 1,590,941, 1,590,942 AND 3,399,033.

NO CLAIM IS MADE TO THE EXCLUSIVE RIGHT TO USE "ACRYLIC", APART FROM THE MARK AS SHOWN, FOR ACRYLIC SHEETS FOR PICTURE FRAMES AND DISPLAY CASES (U.S. CLS. 1, 5, 12, 13, 35 AND 50).

FIRST USE 12-14-2009; IN COMMERCE 1-26-2010.
KATHLEEN M. VANSTON, EXAMINING ATTORNEY



SN 77-929,268. FLORACRAFT CORPORATION, LUDINGTON, MI. FILED 2-5-2010.

PLASTIFOAM

THE MARK CONSISTS OF STANDARD CHARACTERS WITHOUT CLAIM TO ANY PARTICULAR FONT, STYLE, SIZE, OR COLOR.

FOR PLASTIC FOAM USED FOR ARTS AND CRAFTS (U.S. CLS. 1, 5, 12, 13, 35 AND 50).

FIRST USE 3-8-2010; IN COMMERCE 3-8-2010.
LAKEISHA LEWIS, EXAMINING ATTORNEY



SN 77-931,367. METROPAK INC., RICHARDSON, TX. FILED 2-9-2010.

Intelliplas

THE MARK CONSISTS OF STANDARD CHARACTERS WITHOUT CLAIM TO ANY PARTICULAR FONT, STYLE, SIZE, OR COLOR.

FOR ENVIRONMENTALLY SENSITIVE PLASTIC FILM FOR USE IN BAGS, FOR COMMERCIAL OR INDUSTRIAL PURPOSES (U.S. CLS. 1, 5, 12, 13, 35 AND 50).

CARRIE GENOVESE, EXAMINING ATTORNEY

CLASS 17—(Continued).

SN 77-931,523. NEPTUNE RESEARCH, INC., LAKE PARK, FL. FILED 2-9-2010.

SYNTHO◆GLASS XT

OWNER OF U.S. REG. NO. 1,287,083.
FOR RESIN IMPREGNATED FIBERGLASS TAPE (U.S. CLS. 1, 5, 12, 13, 35 AND 50).

RAUL CORDOVA, EXAMINING ATTORNEY

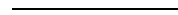

SN 77-953,924. NEPTUNE RESEARCH, INC., LAKE PARK, FL. FILED 3-9-2010.

SYNTHO◆SLEEVE

FOR KITS FOR THE REINFORCEMENT OR CORROSION PROTECTION OF PIPES AND CONVEYANCES CONSISTING PRIMARILY OF RESIN-IMPREGNATED FIBERGLASS TAPE AND A POLYMERIC WRAP (U.S. CLS. 1, 5, 12, 13, 35 AND 50).

RAUL CORDOVA, EXAMINING ATTORNEY



SN 79-073,554. MAPEI S.P.A., ITALY, FILED 2-5-2009.

MAPEBLOX

THE MARK CONSISTS OF STANDARD CHARACTERS WITHOUT CLAIM TO ANY PARTICULAR FONT, STYLE, SIZE, OR COLOR.

PRIORITY DATE OF 8-5-2008 IS CLAIMED.
OWNER OF INTERNATIONAL REGISTRATION 1015111 DATED 2-5-2009, EXPIRES 2-5-2019.

OWNER OF U.S. REG. NO. 3,623,147.
FOR INSULATING COMPOUNDS, INJECTABLE INSULATION PRODUCTS OF SYNTHETIC OIL-PROOF RUBBER FOR WATER-PROOFING AND SEALING OF GALLERIES; BITUMINOUS INSULATING TAPES FOR WATER-PROOFING OF JOINTS BETWEEN FOUNDATIONS AND GALLERY WALLS; PACKING AND INSULATING MATERIALS; LATEX FOR MIXING WITH CEMENT AND SAND AND FOR USING IN CONSTRUCTION (U.S. CLS. 1, 5, 12, 13, 35 AND 50).

JANET LEE, EXAMINING ATTORNEY

CLASS 17—(Continued).

SN 85-002,915. OWENS CORNING INTELLECTUAL CAPITAL, LLC, TOLEDO, OH. FILED 3-31-2010.

TOP IT OFF

THE MARK CONSISTS OF STANDARD CHARACTERS WITHOUT CLAIM TO ANY PARTICULAR FONT, STYLE, SIZE, OR COLOR.

FOR INSULATING MATERIALS (U.S. CLS. 1, 5, 12, 13, 35 AND 50).

ELISSA GARBER KON, EXAMINING ATTORNEY

SN 85-002,929. OWENS CORNING INTELLECTUAL CAPITAL, LLC, TOLEDO, OH. FILED 3-31-2010.

FEEL THE HEAT

THE MARK CONSISTS OF STANDARD CHARACTERS WITHOUT CLAIM TO ANY PARTICULAR FONT, STYLE, SIZE, OR COLOR.

FOR INSULATING MATERIALS (U.S. CLS. 1, 5, 12, 13, 35 AND 50).

ELISSA GARBER KON, EXAMINING ATTORNEY

CLASS 18—LEATHER GOODS

SN 77-175,477. KALLE GMBH, D-65203 WIESBADEN, FED REP GERMANY, FILED 5-8-2007.

NaloCoat

THE MARK CONSISTS OF STANDARD CHARACTERS WITHOUT CLAIM TO ANY PARTICULAR FONT, STYLE, SIZE, OR COLOR.

OWNER OF FED REP GERMANY REG. NO. 005872163, DATED 10-4-2008, EXPIRES 10-4-2018.

OWNER OF U.S. REG. NOS. 1,947,007, 2,443,124 AND OTHERS.

FOR SAUSAGE CASINGS, ARTIFICIAL SAUSAGE SKINS (U.S. CLS. 1, 2, 3, 22 AND 41).

CARYN GLASSER, EXAMINING ATTORNEY

CLASS 18—(Continued).

SN 77-175,696. KALLE GMBH, D-65203 WIESBADEN, FED REP GERMANY, FILED 5-8-2007.

NaloPeel

THE MARK CONSISTS OF STANDARD CHARACTERS WITHOUT CLAIM TO ANY PARTICULAR FONT, STYLE, SIZE, OR COLOR.

OWNER OF FED REP GERMANY REG. NO. 005872098, DATED 7-4-2008, EXPIRES 7-4-2018.

OWNER OF U.S. REG. NOS. 1,947,007, 2,443,124 AND OTHERS.

FOR SAUSAGE CASINGS, ARTIFICIAL SAUSAGE SKINS (U.S. CLS. 1, 2, 3, 22 AND 41).

CARYN GLASSER, EXAMINING ATTORNEY

SN 77-663,069. HIP SHIFT CORP., SAN CLEMENTE, CA. FILED 2-4-2009.



THE MARK CONSISTS OF THE STYLIZED LETTERS "HS".

FOR BELT BAGS AND HIP BAGS; PURSES (U.S. CLS. 1, 2, 3, 22 AND 41).

COLLEEN DOMBROW, EXAMINING ATTORNEY

SN 77-779,160. BROWN-KELLY, PAIGE, DBA MICEL, MILL VALLEY, CA. FILED S.R. 7-12-2009; AM. P.R. 4-16-2010.

Micel

THE MARK CONSISTS OF STANDARD CHARACTERS WITHOUT CLAIM TO ANY PARTICULAR FONT, STYLE, SIZE, OR COLOR.

FOR MULTI-PURPOSE PURSES (U.S. CLS. 1, 2, 3, 22 AND 41).

FRED CARL, EXAMINING ATTORNEY

CLASS 18—(Continued).

SN 77-780,522. MVL RIGHTS LLC, MANHATTAN BEACH, CA. FILED 7-14-2009.

STARK INDUSTRIES

THE MARK CONSISTS OF STANDARD CHARACTERS WITHOUT CLAIM TO ANY PARTICULAR FONT, STYLE, SIZE, OR COLOR.

NO CLAIM IS MADE TO THE EXCLUSIVE RIGHT TO USE "INDUSTRIES", APART FROM THE MARK AS SHOWN.

FOR BACKPACKS; CARRY-ON BAGS; DUFFEL BAGS; FANNY PACKS; GYM BAGS; HANDBAGS; KEY-CASES; KNAPSACKS; LEATHER AND IMITATION LEATHER BAGS; LEATHER HANDBAGS; LEATHER PURSES; LUGGAGE; MESSENGER BAGS; PURSES; SCHOOL BAGS; SCHOOL BOOK BAGS; SHOE BAGS FOR TRAVEL; SPORTS BAGS; TOTE BAGS; UMBRELLAS; WAIST PACKS; WALLETS; WRIST MOUNTED CARRYALL BAGS (U.S. CLS. 1, 2, 3, 22 AND 41).

WON TEAK OH, EXAMINING ATTORNEY

SN 77-797,432. PLAYBOY ENTERPRISES INTERNATIONAL, INC., CHICAGO, IL. FILED 8-5-2009.

THE GIRLS NEXT DOOR

THE MARK CONSISTS OF STANDARD CHARACTERS WITHOUT CLAIM TO ANY PARTICULAR FONT, STYLE, SIZE, OR COLOR.

OWNER OF U.S. REG. NOS. 3,332,339 AND 3,349,663.

FOR ALL-PURPOSE CARRYING BAGS; ATHLETIC BAGS; BACKPACKS; BEACH BAGS; BILLFOLDS; BRIEFCASES; CHANGE PURSES; CLOTHING FOR DOMESTIC PETS; CLUTCH BAGS; COIN PURSES; COLLARS FOR PETS; COSMETIC BAGS SOLD EMPTY; COSMETIC CASES SOLD EMPTY; DUFFEL BAGS; GARMENT BAGS FOR TRAVEL; HANDBAGS; KEY-CASES; LEASHES FOR ANIMALS; LUGGAGE; LUGGAGE TAGS; OVERNIGHT BAGS; PURSES; SHOULDER BAGS; STRAPS FOR HANDBAGS; STRAPS FOR LUGGAGE; TOILETRY CASES SOLD EMPTY; TOTE BAGS; UMBRELLA COVERS; UMBRELLAS; WAIST PACKS; WALLETS; WRISTLET BAGS (U.S. CLS. 1, 2, 3, 22 AND 41).

RAUL CORDOVA, EXAMINING ATTORNEY

CLASS 18—(Continued).

SN 77-797,945. PLAYBOY ENTERPRISES INTERNATIONAL, INC., CHICAGO, IL. FILED 8-5-2009.



OWNER OF U.S. REG. NOS. 871,553, 3,349,663 AND OTHERS.

THE MARK CONSISTS OF THE WORDS "THE GIRLS NEXT DOOR" WITH A RABBIT HEAD DESIGN AS PART OF THE LETTER "I" IN THE WORD "GIRLS".

FOR ALL-PURPOSE CARRYING BAGS; ATHLETIC BAGS; BACKPACKS; BEACH BAGS; BILLFOLDS; BRIEFCASES; CHANGE PURSES; CLUTCH BAGS; COIN PURSES; COLLARS FOR PETS; COSMETIC BAGS SOLD EMPTY; COSMETIC CASES SOLD EMPTY; DUFFEL BAGS; GARMENT BAGS FOR TRAVEL; HANDBAGS; KEY-CASES; LEASHES FOR ANIMALS; LUGGAGE; LUGGAGE TAGS; OVERNIGHT BAGS; PURSES; SHOULDER BAGS; STRAPS FOR HANDBAGS; STRAPS FOR LUGGAGE; TOILETRY CASES SOLD EMPTY; TOTE BAGS; UMBRELLA COVERS; UMBRELLAS; WAIST PACKS; WALLETS; WRISTLET BAGS (U.S. CLS. 1, 2, 3, 22 AND 41).

RAUL CORDOVA, EXAMINING ATTORNEY

SN 77-804,643. STARK, CAROLINE S., BEACHWOOD, OH. FILED 8-14-2009.

FUNKY BAGZZ

THE MARK CONSISTS OF STANDARD CHARACTERS WITHOUT CLAIM TO ANY PARTICULAR FONT, STYLE, SIZE, OR COLOR.

NO CLAIM IS MADE TO THE EXCLUSIVE RIGHT TO USE "BAGS", APART FROM THE MARK AS SHOWN.

FOR ALL-PURPOSE CARRYING BAGS (U.S. CLS. 1, 2, 3, 22 AND 41).

FIRST USE 8-12-2008; IN COMMERCE 8-12-2008.

BRENDAN REGAN, EXAMINING ATTORNEY

CLASS 18—(Continued).

SN 77-834,279. GO AND STOW, BELLEVUE, WA. FILED 9-24-2009.

Because Poop Happens!

THE MARK CONSISTS OF BLACK SCRIPT, FENNARIO STYLE FONT WITH EXCLAMATION POINT PUNCTUATION AT THE END OF "BECAUSE POOP HAPPENS".

FOR PET ACCESSORY, NAMELY, SPECIALLY DESIGNED RIPSTOP NYLON BAG THAT ATTACHES TO THE ANIMALS LEASH FOR HOLDING SUCH ITEMS AS PET WASTE THAT IS ALL READY COLLECTED IN A DISPOSABLE BAG (U.S. CLS. 1, 2, 3, 22 AND 41).

FIRST USE 4-23-2009; IN COMMERCE 4-23-2009.

ALLISON SCHRODY, EXAMINING ATTORNEY

SN 77-849,968. E&E ACQUISITION COMPANY, LLC, PORTLAND, OR. FILED 10-15-2009.

ELLINGTON

THE MARK CONSISTS OF STANDARD CHARACTERS WITHOUT CLAIM TO ANY PARTICULAR FONT, STYLE, SIZE, OR COLOR.

OWNER OF U.S. REG. NOS. 2,351,644 AND 3,307,047.

SEC. 2(F).

FOR HANDBAGS, PURSES, SATCHELS, TRAVEL BAGS, BACKPACKS, AND PACKS FOR CARRYING ON THE SHOULDER AND BACK (U.S. CLS. 1, 2, 3, 22 AND 41).

FIRST USE 1-0-1998; IN COMMERCE 1-0-1998.

JUSTINE D. PARKER, EXAMINING ATTORNEY

SN 77-871,980. MARION INTERNATIONAL CORP., LITTLE FERRY, NJ. FILED 11-13-2009.

it puppy

NO CLAIM IS MADE TO THE EXCLUSIVE RIGHT TO USE "PUPPY", APART FROM THE MARK AS SHOWN.

THE MARK CONSISTS OF THE DESIGN OF A DOG BETWEEN THE LETTER "I" AND THE TERM "PUPPY".

FOR PET PRODUCTS, NAMELY, ACCESSORIES FOR DOGS, NAMELY, HARNESSSES, DOG CLOTHING AND ANIMAL CARRIERS (U.S. CLS. 1, 2, 3, 22 AND 41).

FLORENTINA BLANDU, EXAMINING ATTORNEY

CLASS 18—(Continued).

SN 77-873,743. MISHLY, SHAWN SHLOMO, FLUSHING, NY. FILED 11-16-2009.

OctoLift

THE MARK CONSISTS OF STANDARD CHARACTERS WITHOUT CLAIM TO ANY PARTICULAR FONT, STYLE, SIZE, OR COLOR.

FOR SHOULDER HARNESSSES WITH LOAD STRAPS SPECIALLY ADAPTED FOR CARRYING, HOLDING AND SECURING GROCERY AND SHOPPING BAGS FOR HUMANS (U.S. CLS. 1, 2, 3, 22 AND 41).

TINA MAI, EXAMINING ATTORNEY

SN 77-886,209. DENCO SPORTS LUGGAGE, INC., REDWOOD CITY, CA. FILED 12-4-2009.

DENCO

THE MARK CONSISTS OF STANDARD CHARACTERS WITHOUT CLAIM TO ANY PARTICULAR FONT, STYLE, SIZE, OR COLOR.

THE WORDING "DENCO" HAS NO MEANING IN A FOREIGN LANGUAGE.

FOR LUGGAGE (U.S. CLS. 1, 2, 3, 22 AND 41).

FIRST USE 12-1-2009; IN COMMERCE 12-1-2009.

ANDREA K. NADELMAN, EXAMINING ATTORNEY

SN 77-893,215. LEWIS, KEVIN, MELBOURNE BEACH, FL. FILED 12-14-2009.

bamboodah

THE MARK CONSISTS OF THE STYLIZED TEXT "BAMBOODAH" WITH THE SECOND "B" MADE OF BAMBOO WITH A FEW BAMBOO LEAVES PROTRUDING FROM ABOVE IT.

FOR TOTE BAGS; PURSES; TEXTILE SHOPPING BAGS; BRIEFCASES, ANIMAL CARRIERS AND BACKPACKS; ALL OF THE FOREGOING MADE OF BAMBOO (U.S. CLS. 1, 2, 3, 22 AND 41).

FIRST USE 8-11-2009; IN COMMERCE 8-11-2009.

TASNEEM HUSSAIN, EXAMINING ATTORNEY

CLASS 18—(Continued).

SN 77-896,282. GUTKNECHT, LONA, SAN DIEGO, CA. FILED 12-17-2009.

Lona Gutknecht

THE MARK CONSISTS OF STANDARD CHARACTERS WITHOUT CLAIM TO ANY PARTICULAR FONT, STYLE, SIZE, OR COLOR.

THE NAME "LONA GUTKNECHT" IDENTIFIES A LIVING INDIVIDUAL WHOSE CONSENT IS OF RECORD.

FOR BAGS, NAMELY, WOMEN'S HANDBAGS, PURSES, EVENING BAGS, AND TRAVEL CARRY-ON BAGS, DAY BAGS, NAMELY, DAYPACKS, WORK BAGS, NAMELY, TOOL BAGS SOLD EMPTY, SMALL BAGS, NAMELY, SMALL BAGS FOR MEN (U.S. CLS. 1, 2, 3, 22 AND 41).

FIRST USE 9-0-2004; IN COMMERCE 1-0-2007.
GEORGE LORENZO, EXAMINING ATTORNEY

CLASS 18—(Continued).

SN 77-910,145. HALLMARK LICENSING, INC., KANSAS CITY, MO. FILED 1-12-2010.



OWNER OF U.S. REG. NOS. 864,077, 2,087,804 AND OTHERS.

NO CLAIM IS MADE TO THE EXCLUSIVE RIGHT TO USE "BUSINESS", APART FROM THE MARK AS SHOWN.

THE MARK CONSISTS OF A FIVE-POINTED, OPEN CROWN DESIGN OVER THE WORD "HALLMARK" IN SCRIPT, OVER THE WORDS "BUSINESS CONNECTIONS" IN BLOCK LETTERS.

FOR BUSINESS CARD CASES; LUGGAGE TAGS; TOTE BAGS (U.S. CLS. 1, 2, 3, 22 AND 41).
EMILY CARLSEN, EXAMINING ATTORNEY

SN 77-902,545. PRO-GAIN TRADING LIMITED, KOWLOON, HONG KONG, FILED 12-30-2009.



THE MARK CONSISTS OF A CIRCLE WITH A CURVED LINE INSIDE DISPLAYING TWO HORN-SHAPED TEETH POINTING DOWNWARD. BELOW THE CIRCLE IS THE WORDING "DEVIL NUT HATE AND WAR".

FOR ANIMAL SKINS; BACKPACKS; BRIEFCASES; HANDBAGS; IMITATION LEATHER; LEATHER KEY CASES; LEATHER POUCHES; LEATHER SHOPPING BAGS; LUGGAGE; PURSES; RUCKSACKS; SHOPPING BAGS MADE OF SKIN; SHOPPING BAGS WITH WHEELS ATTACHED; TEXTILE SHOPPING BAGS; TRAVELING BAGS; TRAVELLING TRUNKS; UMBRELLAS; WALLETS (U.S. CLS. 1, 2, 3, 22 AND 41).
YAT SYE, LEE, EXAMINING ATTORNEY

SN 77-916,398. GENRE & MODE, INC., BOZEMAN, MT. FILED 1-20-2010.

REDD LABEL

THE MARK CONSISTS OF STANDARD CHARACTERS WITHOUT CLAIM TO ANY PARTICULAR FONT, STYLE, SIZE, OR COLOR.

NO CLAIM IS MADE TO THE EXCLUSIVE RIGHT TO USE "LABEL", APART FROM THE MARK AS SHOWN.

FOR LEATHER BAGS AND POUCHES SPECIALLY ADAPTED FOR HOLDING DIABETES SUPPLIES; NON-LEATHER BAGS AND POUCHES SPECIALLY ADAPTED FOR HOLDING DIABETES SUPPLIES; WEARABLE STRAP-ON POUCHES WHICH ARE WORN AROUND THE WAIST AND ARE SPECIALLY ADAPTED FOR HOLDING AN INSULIN PUMP (U.S. CLS. 1, 2, 3, 22 AND 41).
AMY ALFIERI, EXAMINING ATTORNEY

CLASS 18—(Continued).

SN 77-917,614. SADDLEBACK LEATHER CO., LLC, SAN ANTONIO, TX. FILED 1-22-2010.

SADDLEBACK LEATHER

THE MARK CONSISTS OF STANDARD CHARACTERS WITHOUT CLAIM TO ANY PARTICULAR FONT, STYLE, SIZE, OR COLOR.

NO CLAIM IS MADE TO THE EXCLUSIVE RIGHT TO USE "LEATHER", APART FROM THE MARK AS SHOWN.

FOR BACKPACKS; BRIEFCASES; POUCHES OF LEATHER; SATCHELS; SUITCASES AND TRAVEL BAGS; MESSENGER BAGS; WALLETS; CHECK HOLDERS IN THE NATURE OF WALLETS; LUGGAGE TAGS; ALL OF THE FOREGOING BEING MADE OF LEATHER (U.S. CLS. 1, 2, 3, 22 AND 41).

FIRST USE 3-16-2005; IN COMMERCE 3-16-2005.
REBECCA POVARCHUK, EXAMINING ATTORNEY

CLASS 18—(Continued).

SN 77-925,383. VANI FURS INC., NEW ROCHELLE, NY. FILED 2-1-2010.



THE MARK CONSISTS OF THE STYLIZED WORDING "MOU" SET ABOVE THE STYLIZED WORDING "XOU," WITH THE BOTTOM OF THE LETTER "M" IN THE TERM "MOU" CONNECTED TO THE TOP OF THE LETTER "X" IN THE TERM "XOU"

THE WORDING "MOU XOU" HAS NO MEANING IN A FOREIGN LANGUAGE.

FOR FUR (U.S. CLS. 1, 2, 3, 22 AND 41).
MICHAEL GAAFAR, EXAMINING ATTORNEY

SN 77-925,652. WEAVER LEATHER LLC, MT. HOPE, OH. FILED 2-2-2010.

The Winner's Brand

THE MARK CONSISTS OF STANDARD CHARACTERS WITHOUT CLAIM TO ANY PARTICULAR FONT, STYLE, SIZE, OR COLOR.

NO CLAIM IS MADE TO THE EXCLUSIVE RIGHT TO USE "BRAND", APART FROM THE MARK AS SHOWN.

FOR TACK MADE OF LEATHER, NAMELY, HALTERS, COLLARS, LEADS AND HARNESES; SHOW CARD HOLDERS MADE OF LEATHER (U.S. CLS. 1, 2, 3, 22 AND 41).

FIRST USE 1-15-2010; IN COMMERCE 1-15-2010.
CAROLINE WOOD, EXAMINING ATTORNEY

Nutty Mutty

SN 77-925,022. JODI MICHELLE PYNN, NEW YORK CITY, NY. AND EDWARD JAMES GABREE JR, CAMPTON, NH. FILED 2-1-2010.

SN 77-927,329. ZEPHYR FARM L.L.C., PORTLAND, OR. FILED 2-3-2010.

CLOUD

THE MARK CONSISTS OF STANDARD CHARACTERS WITHOUT CLAIM TO ANY PARTICULAR FONT, STYLE, SIZE, OR COLOR.

FOR DOG LEASHES; DOG COLLARS; NECKWEAR FOR DOGS; DOG APPAREL; DOG CLOTHING; LEATHER KEY CHAINS; LUGGAGE TAGS; BACKPACKS FOR DOGS; PET TAGS SPECIALLY ADAPTED FOR ATTACHING TO DOG LEASHES OR COLLARS (U.S. CLS. 1, 2, 3, 22 AND 41).

EDWARD FENNESSY, EXAMINING ATTORNEY

THE MARK CONSISTS OF STANDARD CHARACTERS WITHOUT CLAIM TO ANY PARTICULAR FONT, STYLE, SIZE, OR COLOR.

FOR COLLARS FOR PETS (U.S. CLS. 1, 2, 3, 22 AND 41).

FIRST USE 5-31-2008; IN COMMERCE 5-31-2008.
B. PARADEWELAI, EXAMINING ATTORNEY

CLASS 18—(Continued).

SN 77-928,230. ODLO ENTERPRISES, INC., NEW YORK, NY. FILED 2-4-2010.

ORYANY

THE MARK CONSISTS OF STANDARD CHARACTERS WITHOUT CLAIM TO ANY PARTICULAR FONT, STYLE, SIZE, OR COLOR.

THE WORDING "ORYANY" HAS NO MEANING IN A FOREIGN LANGUAGE.

FOR PURSES, POCKETBOOKS, WALLETS AND CHANGE PURSES (U.S. CLS. 1, 2, 3, 22 AND 41).

DAVID COLLIER, EXAMINING ATTORNEY

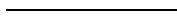

SN 77-928,800. AMERICAN RECREATION PRODUCTS, INC., CHESTERFIELD, MO. FILED 2-5-2010.

MIJO

THE MARK CONSISTS OF STANDARD CHARACTERS WITHOUT CLAIM TO ANY PARTICULAR FONT, STYLE, SIZE, OR COLOR.

THE ENGLISH TRANSLATION OF "MIJO" IN THE MARK IS "MY CHILD".

FOR BABY BACKPACKS; BABY CARRIERS WORN ON THE BODY; BABY CARRYING BAGS; BACKPACKS (U.S. CLS. 1, 2, 3, 22 AND 41).

JAMES LOVELACE, EXAMINING ATTORNEY



SN 77-928,919. LIGHTER CORP., GREENWICH, CT. FILED 2-5-2010.

24U

THE MARK CONSISTS OF STANDARD CHARACTERS WITHOUT CLAIM TO ANY PARTICULAR FONT, STYLE, SIZE, OR COLOR.

FOR BACKPACKS, BOOK BAGS, SPORTS BAGS, BUM BAGS, WALLETS AND HANDBAGS; EVENING HANDBAGS; FASHION HANDBAGS; HANDBAG FRAMES; HANDBAGS; HANDBAGS, PURSES AND WALLETS; LEATHER HANDBAGS; STRAPS FOR HANDBAGS (U.S. CLS. 1, 2, 3, 22 AND 41).

BRIDGETT SMITH, EXAMINING ATTORNEY

CLASS 18—(Continued).

SN 77-929,011. ANDERSON-STIMSON, DAWN, SAN MARCOS, CA. FILED 2-5-2010.

FOR COSMETIC CASES SOLD EMPTY (U.S. CLS. 1, 2, 3, 22 AND 41).

REBECCA POVARCHUK, EXAMINING ATTORNEY



SN 77-930,181. CARLINO, CRISTINA M., PHOENIX, AZ. FILED 2-8-2010.

ARCHETYPE

THE MARK CONSISTS OF STANDARD CHARACTERS WITHOUT CLAIM TO ANY PARTICULAR FONT, STYLE, SIZE, OR COLOR.

FOR ALL-PURPOSE CARRYING BAGS; BACKPACKS; BRIEFCASES; BUSINESS CARD CASES; CLUTCH PURSES; COLLARS FOR PETS; COSMETIC BAGS SOLD EMPTY; DOG CLOTHING; DOG LEASHES; HANDBAGS; IMITATION LEATHER KEY CHAINS; KEY CASES; KEY WALLETS; LEATHER KEY CASES; LEATHER KEY CHAINS; LUGGAGE; LUGGAGE TAGS; UMBRELLAS; WALLETS; WRISTLET BAGS (U.S. CLS. 1, 2, 3, 22 AND 41).

APRIL HESIK, EXAMINING ATTORNEY

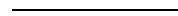

SN 77-930,507. LEATHEN S. STEARN, WESTPORT, CT. FILED 2-8-2010.

OWNER OF U.S. REG. NOS. 1,612,163, 3,124,161 AND OTHERS.

THE MARK CONSISTS OF THE COINED TERM "SCUNCI" IN STYLIZED FONT WITH AN UMLAUT OVER THE LETTER "U."

FOR COSMETIC BAGS SOLD EMPTY; COSMETIC CASES SOLD EMPTY; COSMETIC ORGANIZERS SOLD EMPTY; VANITY CASES SOLD EMPTY; TOILETRY CASES SOLD EMPTY; TOTE BAGS (U.S. CLS. 1, 2, 3, 22 AND 41).

CURTIS FRENCH, EXAMINING ATTORNEY

CLASS 18—(Continued).

SN 77-930,631. WORLD WRESTLING ENTERTAINMENT, INC., STAMFORD, CT. FILED 2-8-2010.



THE MARK CONSISTS OF TWO STACKED "W" LETTERS WITH A SCAR UNDERNEATH SITTING ON TOP OF THE LETTERS "NXT" APPEARING VERTICALLY.

FOR BACKPACKS; LUGGAGE, BARREL BAGS, BEACH BAGS, DUFFEL BAGS, GYM BAGS, ATHLETIC BAGS, ALL-PURPOSE SPORT BAGS, BOOK BAGS, SCHOOL BAGS, TOTE BAGS, TRAVEL BAGS, CARRY-ON BAGS, COSMETIC BAGS SOLD EMPTY, GARMENT BAGS FOR TRAVEL, FANNY PACKS; WALLETS; CREDIT CARD CASES; CHANGE PURSES; LEATHER KEY CHAINS; LEATHER BELTS; THONGS; SOFT LUGGAGE IDENTIFICATION TAGS (U.S. CLS. 1, 2, 3, 22 AND 41).
JOHN HWANG, EXAMINING ATTORNEY

SN 77-930,784. PACPRO, INC., EL MONTE, CA. FILED 2-8-2010.

DIOPHY

THE MARK CONSISTS OF STANDARD CHARACTERS WITHOUT CLAIM TO ANY PARTICULAR FONT, STYLE, SIZE, OR COLOR.

FOR BACKPACKS; COSMETIC CASES SOLD EMPTY; BELT BAGS AND HIP BAGS; DUFFLE BAGS; GARMENT BAGS FOR TRAVEL; HANDBAGS; LUGGAGE; POUCHES AND BAGS SOLD EMPTY FOR ATTACHMENT TO BACKPACKS; POUCHES FOR HOLDING KEYS; POUCHES OF LEATHER; TOILETRY BAGS SOLD EMPTY; TOILETRY CASES SOLD EMPTY; PURSES; ROLL BAGS; TRAVEL BAGS; AND WHEELED BAGS (U.S. CLS. 1, 2, 3, 22 AND 41).

FIRST USE 1-12-2002; IN COMMERCE 1-12-2002.
ANDREA HACK, EXAMINING ATTORNEY

CLASS 18—(Continued).

SN 77-931,180. BLAKEMORE, SEAN, BURBANK, CA. FILED 2-9-2010.

The Walker "Man's other best friend"

THE MARK CONSISTS OF STANDARD CHARACTERS WITHOUT CLAIM TO ANY PARTICULAR FONT, STYLE, SIZE, OR COLOR.

FOR PET PRODUCTS, NAMELY, PET RESTRAINING DEVICES CONSISTING OF LEASHES, COLLARS, HARNESSES, RESTRAINING STRAPS, AND LEASHES WITH LOCKING DEVICES (U.S. CLS. 1, 2, 3, 22 AND 41).
ZHALEH DELANEY, EXAMINING ATTORNEY

SN 77-946,128. COMBAT MEDICAL SYSTEMS, LLC, FAYETTEVILLE, NC. FILED 2-26-2010.

CSI BAG

THE MARK CONSISTS OF STANDARD CHARACTERS WITHOUT CLAIM TO ANY PARTICULAR FONT, STYLE, SIZE, OR COLOR.

NO CLAIM IS MADE TO THE EXCLUSIVE RIGHT TO USE "BAG", APART FROM THE MARK AS SHOWN.

FOR CARRYING BAGS FOR TRANSPORTING THE PERSONAL PROPERTY OF MILITARY MEMBERS WOUNDED IN COMBAT (U.S. CLS. 1, 2, 3, 22 AND 41).
JENNY PARK, EXAMINING ATTORNEY

SN 77-948,449. SEATTLE PACIFIC INDUSTRIES, INC., SEATTLE, WA. FILED 3-2-2010.

UNION

THE MARK CONSISTS OF STANDARD CHARACTERS WITHOUT CLAIM TO ANY PARTICULAR FONT, STYLE, SIZE, OR COLOR.

OWNER OF U.S. REG. NOS. 2,927,728, 3,076,424 AND 3,082,240.

FOR BACKPACKS, BOOK BAGS, SPORTS BAGS, BUM BAGS, WALLETS AND HANDBAGS; LUGGAGE (U.S. CLS. 1, 2, 3, 22 AND 41).

GEORGE LORENZO, EXAMINING ATTORNEY

CLASS 18—(Continued).

SN 77-952,420. ZOOSK, INC., SAN FRANCISCO, CA. FILED 3-6-2010.



THE MARK CONSISTS OF WORD "ZOOSK" WITH A HEART IMAGE OVER THE SECOND LETTER "O". FOR MESSENGER BAGS; PET CLOTHING; TOTE BAGS (U.S. CLS. 1, 2, 3, 22 AND 41). FIRST USE 2-22-2010; IN COMMERCE 2-22-2010. GINA HAYES, EXAMINING ATTORNEY

SN 77-966,401. AMERICAN RECREATION PRODUCTS, INC., CHESTERFIELD, MO. FILED 3-23-2010.

KELTY - THE ACTIVE FAMILY EXPERTS

THE MARK CONSISTS OF STANDARD CHARACTERS WITHOUT CLAIM TO ANY PARTICULAR FONT, STYLE, SIZE, OR COLOR. OWNER OF U.S. REG. NOS. 1,059,258, 1,294,302 AND OTHERS.

FOR BABY CARRIERS WORN ON THE BODY; BACK FRAMES FOR CARRYING CHILDREN (U.S. CLS. 1, 2, 3, 22 AND 41). JAMES LOVELACE, EXAMINING ATTORNEY

SN 78-443,694. STUDIO IP HOLDINGS LLC, WILMINGTON, DE. FILED 6-30-2004.

NOW

THE MARK CONSISTS OF STANDARD CHARACTERS WITHOUT CLAIM TO ANY PARTICULAR FONT, STYLE, SIZE, OR COLOR.

FOR ATHLETIC BAGS; BEACH BAGS; BOOK BAGS; CARRY-ON BAGS; CLUTCH BAGS; COSMETIC BAGS SOLD EMPTY; DIAPER BAGS; DUFFEL BAGS; GARMENT BAGS; GOLF BAGS; GYM BAGS; OVERNIGHT BAGS; SCHOOL BAGS; SHOE BAGS; SHOULDER BAGS; SPORTS BAGS; TOTE BAGS; TRAVEL BAGS (U.S. CLS. 1, 2, 3, 22 AND 41). PRISCILLA MILTON, EXAMINING ATTORNEY

CLASS 18—(Continued).

SN 78-714,223. GERONIMO PRODUCTIONS, INC., NEW YORK, NY. FILED 9-15-2005.

Kit Carson

THE MARK CONSISTS OF STANDARD CHARACTERS WITHOUT CLAIM TO ANY PARTICULAR FONT, STYLE, SIZE, OR COLOR.

OWNER OF U.S. REG. NOS. 1,440,023, 1,829,455 AND OTHERS.

THE NAME(S), PORTRAIT(S), AND/OR SIGNATURE(S) SHOWN IN THE MARK DOES NOT IDENTIFY A PARTICULAR LIVING INDIVIDUAL.

FOR ATHLETIC BAGS; ATTACHE CASES; BACKPACKS; BEACH BAGS; BILLFOLDS; BOOK BAGS; BRIEFCASES; CALLING CARD CASES; CANES; CHANGE PURSES; DUFFEL BAGS; FANNY PACKS; HANDBAGS; KEY CASES; KNAPSACKS; LEATHER KEY CHAINS; PURSES; SADDLERY; SPORTS BAGS; TEXTILE SHOPPING BAGS; TOILETRY CASES SOLD EMPTY; TOTE BAGS; TRAVELING BAGS; UMBRELLAS; WALKING STICKS; WALLETS (U.S. CLS. 1, 2, 3, 22 AND 41).

FIRST USE 2-15-1969; IN COMMERCE 2-15-1969. BARNEY CHARLON, EXAMINING ATTORNEY

CLASS 19—NON-METALLIC BUILDING MATERIALS

SN 76-693,542. MARME, INC., HOUSTON, TX. FILED 10-15-2008.



THE MARK CONSISTS OF A HERALDIC LION IN-SIGNIA.

FOR BUILDING AND CONSTRUCTION PRODUCTS, NAMELY, TRAVERTINE, MARBLE, LIMESTONE, GRANITE, SLATE; STONES; NON-METAL MEDALLIONS; MOSAIC ART TILES MADE OF MARBLE; BORDERS, NAMELY, NON-METAL MOULDINGS AND POOL COPINGS (U.S. CLS. 1, 12, 33 AND 50).

FIRST USE 2-1-2001; IN COMMERCE 2-1-2001. SCOTT BIBB, EXAMINING ATTORNEY

CLASS 19—(Continued).

SN 76-693,543. MARME, INC., HOUSTON, TX. FILED 10-15-2008.

MARME

THE MARK CONSISTS OF STANDARD CHARACTERS WITHOUT CLAIM TO ANY PARTICULAR FONT, STYLE, SIZE, OR COLOR.

SEC. 2(F).

FOR BUILDING AND CONSTRUCTION PRODUCTS, NAMELY, TRAVERTINE, MARBLE, LIMESTONE, GRANITE, SLATE; STONES; NON-METAL MEDALLIONS; MOSAIC ART TILES MADE OF MARBLE; BORDERS, NAMELY, NON-METAL MOULDINGS AND POOL COPINGS (U.S. CLS. 1, 12, 33 AND 50).

FIRST USE 2-1-2001; IN COMMERCE 2-1-2001.
SCOTT BIBB, EXAMINING ATTORNEY

SN 76-699,025. EROSION PREVENTION PRODUCTS, LLC, HOUSTON, TX. FILED 8-17-2009.

CHANNEL LOCK V-LOCK

THE MARK CONSISTS OF STANDARD CHARACTERS WITHOUT CLAIM TO ANY PARTICULAR FONT, STYLE, SIZE, OR COLOR.

OWNER OF U.S. REG. NO. 2,213,362.

FOR VERTICAL INTERLOCKING CONCRETE BLOCKS USED FOR EROSION CONTROL MATS (U.S. CLS. 1, 12, 33 AND 50).

DANNEAN HETZEL, EXAMINING ATTORNEY

SN 77-255,753. FRASERVIEW CEDAR PRODUCTS LTD., SURREY, CANADA, FILED 8-15-2007.

SYLVABOARD

THE MARK CONSISTS OF STANDARD CHARACTERS WITHOUT CLAIM TO ANY PARTICULAR FONT, STYLE, SIZE, OR COLOR.

PRIORITY CLAIMED UNDER SEC. 44(D) ON CANADA APPLICATION NO. 1357370, FILED 7-26-2007, REG. NO. TMA748,645, DATED 9-24-2009, EXPIRES 9-24-2024.

FOR WOOD PRODUCTS, NAMELY, WOOD PANELS AND WOOD SHEETS FOR USE AS EXTERIOR CLADDING, GARAGE DOOR PANELS, INTERIOR WALL PANELS, CEILING TILES AND FURNITURE (U.S. CLS. 1, 12, 33 AND 50).

SHAUNIA CARLYLE, EXAMINING ATTORNEY

CLASS 19—(Continued).

SN 77-676,087. COLUMBIA INSURANCE COMPANY, OMAHA, NE. FILED 2-23-2009.



NO CLAIM IS MADE TO THE EXCLUSIVE RIGHT TO USE "SPORTS SURFACES", APART FROM THE MARK AS SHOWN.

THE MARK CONSISTS OF THE WORDS "SPECTRA SPORTS SURFACES" BENEATH AN ARC OF CIRCLES GRADUALLY DIMINISHING IN SIZE.

FOR ARTIFICIAL SURFACES, NAMELY, ATHLETIC FLOORING AND PLAYGROUND TILES (U.S. CLS. 1, 12, 33 AND 50).

B. PARADEWELAI, EXAMINING ATTORNEY

SN 77-735,863. CUDO STORMWATER PRODUCTS, INC., OCCIDENTAL, CA. FILED 5-13-2009.

CUDO

THE MARK CONSISTS OF STANDARD CHARACTERS WITHOUT CLAIM TO ANY PARTICULAR FONT, STYLE, SIZE, OR COLOR.

FOR DRAINAGE SYSTEM INSERTS FOR STORM WATER MANAGEMENT, NAMELY, PLASTIC AND CONCRETE CATCH AND DETENTION BASINS FOR WATER FOR ENVIRONMENTAL PURPOSES (U.S. CLS. 1, 12, 33 AND 50).

FIRST USE 11-0-2008; IN COMMERCE 11-0-2008.
ANTHONY RINKER, EXAMINING ATTORNEY

SN 77-792,082. DOCK SOCKS, LLC, TEQUESTA, FL. FILED 7-29-2009.



NO CLAIM IS MADE TO THE EXCLUSIVE RIGHT TO USE "DOCK", "DECORATIVE DOCK PILING COVERS" AND "MARINA", APART FROM THE MARK AS SHOWN.

THE MARK CONSISTS OF AN OVAL DESIGN WITH THE STYLIZED WORDING "DOCK" AND "SOCKS" APPEARING ON TOP, THE WORDING "DECORATIVE DOCK PILING COVERS" APPEARING ON THE BOTTOM AND OUTSIDE OF THE OVAL, INSIDE THE OVAL IS A DOCK DESIGN WITH TWO PILING POSTS CONNECTED BY A

CLASS 19—(Continued).

ROPE APPEARING ON EACH SIDE OF THE DOCK, THE FIRST POST IN THE FRONT HAS THE WORDING "MARINA", THE SECOND POST IN THE FRONT IS A TOTEM POLE, THE FIRST POST IN THE BACK HAS ORCHID DESIGNS, THE SECOND POST IN THE BACK HAS THE WORDING "SLOW NO WAKE" WITH THE WORDING "NO" APPEARING INSIDE A CIRCLE, A PELICAN STANDS ON TOP OF THE POST WITH THE WORDING "SLOW NO WAKE", AND THE PELICAN APPEARS BETWEEN "DOCK" AND "SOCKS".

FOR PIER AND BOAT DOCK PILING DECORATIVE AND INFORMATIVE NONMETAL SIGNAGE, NAMELY, BUMPERS OR PADS FOR DOCK PILINGS (U.S. CLS. 1, 12, 33 AND 50).

JENNY PARK, EXAMINING ATTORNEY

CLASS 19—(Continued).

SN 77-805,273. CALSTAR PRODUCTS, INC., NEWARK, CA. FILED 8-14-2009.



NO CLAIM IS MADE TO THE EXCLUSIVE RIGHT TO USE "PRODUCTS", APART FROM THE MARK AS SHOWN. THE COLOR(S) GREEN AND BROWN IS/ARE CLAIMED AS A FEATURE OF THE MARK.

THE MARK CONSISTS OF A GREEN STYLIZED STAR DESIGN WITH THE TERM "CALSTAR" IN GREEN LETTERING AND THE TERM "PRODUCTS" IN BROWN LETTERING.

FOR BUILDING MATERIALS, NAMELY, CONCRETE; BUILDING MATERIALS, NAMELY, SUSTAINABLE CEMENT (U.S. CLS. 1, 12, 33 AND 50).

KEVON CHISOLM, EXAMINING ATTORNEY

SN 77-795,733. USG INTERIORS, INC., CHICAGO, IL. FILED 8-3-2009.

TRUE

THE MARK CONSISTS OF STANDARD CHARACTERS WITHOUT CLAIM TO ANY PARTICULAR FONT, STYLE, SIZE, OR COLOR.

FOR CEILING PANELS, NOT OF METAL (U.S. CLS. 1, 12, 33 AND 50).

ELLEN B. AWRICH, EXAMINING ATTORNEY

SN 77-823,660. PRIMEFORM BUILDING SYSTEMS, LLC, SAN ANTONIO, TX. FILED 9-10-2009.

PRIMEFORM

SN 77-799,648. ROSEBURG FOREST PRODUCTS, ROSEBURG, OR. FILED 8-7-2009.

PAUL BUNYAN

THE MARK CONSISTS OF STANDARD CHARACTERS WITHOUT CLAIM TO ANY PARTICULAR FONT, STYLE, SIZE, OR COLOR.

FOR LUMBER; BUILDING MATERIALS, NAMELY, PLYWOOD, WOOD PANELING; SMALL TIMBERS; ENGINEERED WOOD PRODUCTS; NAMELY, LAMINATED VENEER LUMBER AND I-JOISTS (U.S. CLS. 1, 12, 33 AND 50).

HELENE LIWINSKI, EXAMINING ATTORNEY

THE MARK CONSISTS OF STANDARD CHARACTERS WITHOUT CLAIM TO ANY PARTICULAR FONT, STYLE, SIZE, OR COLOR.

FOR CONCRETE BLOCKS; INSULATED CONCRETE BLOCKS; NON-METAL BUILDING MATERIAL, NAMELY, WALL PANELS, ROOF PANELS, NON-METAL TILES AND ROOF TILES (U.S. CLS. 1, 12, 33 AND 50).

SUSAN LESLIE DUBOIS, EXAMINING ATTORNEY

CLASS 19—(Continued).

SN 77-872,800. SUPERA TECHNICAL SERVICES, INC., DBA SUSTAINABLE INFRASTRUCTURE, NEWMAN, CA. FILED 11-14-2009.



NO CLAIM IS MADE TO THE EXCLUSIVE RIGHT TO USE "SUSTAINABLE" AND THE RECYCLE SYMBOL, APART FROM THE MARK AS SHOWN.

THE COLOR(S) GREEN, GRAY AND WHITE IS/ARE CLAIMED AS A FEATURE OF THE MARK.

THE MARK CONSISTS OF THE LETTERS "S" AND "I" AND A STYLIZED RECYCLE SYMBOL APPEARING IN GREEN AND WHITE WITH A GREEN, GRAY AND WHITE GLOBE. THE WORDS "SUSTAINABLE INFRASTRUCTURE" APPEAR IN GRAY.

FOR COMPOSITE LUMBER MADE USING RECYCLED PLASTIC (U.S. CLS. 1, 12, 33 AND 50).

SAIMA MAKHDOOM, EXAMINING ATTORNEY

SN 77-879,741. HANOVER PREST-PAVING COMPANY, HANOVER, PA. FILED 11-24-2009.

Olde Hanover

THE MARK CONSISTS OF STANDARD CHARACTERS WITHOUT CLAIM TO ANY PARTICULAR FONT, STYLE, SIZE, OR COLOR.

OWNER OF U.S. REG. NOS. 1,038,204 AND 1,480,810. SEC. 2(F) AS TO "HANOVER".

FOR BRICKS; CONCRETE BUILDING MATERIALS, NAMELY, BRICKS AND PAVERS; PAVERS (U.S. CLS. 1, 12, 33 AND 50).

FIRST USE 11-2-2009; IN COMMERCE 11-2-2009.

KYLE PEETE, EXAMINING ATTORNEY

CLASS 19—(Continued).

SN 77-884,168. POTTERS INDUSTRIES, INC., MALVERN, PA. FILED 12-2-2009.

VISILOK

THE MARK CONSISTS OF STANDARD CHARACTERS WITHOUT CLAIM TO ANY PARTICULAR FONT, STYLE, SIZE, OR COLOR.

FOR COMBINATION OF RETROREFLECTIVE GLASS BEADS AND PAINT DRYING ADDITIVE USED IN CONNECTION WITH ROADWAY AND PAVEMENT MARKINGS WHEN MIXED WITH PAINT (U.S. CLS. 1, 12, 33 AND 50).

DOMINICK J. SALEMI, EXAMINING ATTORNEY

SN 77-894,265. EN VOGUE, EL MONTE, CA. FILED 12-16-2009.

JaniceTile

THE MARK CONSISTS OF STANDARD CHARACTERS WITHOUT CLAIM TO ANY PARTICULAR FONT, STYLE, SIZE, OR COLOR.

FOR BUILDING MATERIALS, NAMELY, DECORATED CERAMIC TILES FOR ART LOVERS AND CONSUMERS OF ALL AGES (U.S. CLS. 1, 12, 33 AND 50).

FIRST USE 12-13-2009; IN COMMERCE 12-13-2009.

WILLIAM BRECKENFELD, EXAMINING ATTORNEY

SN 77-912,684. LARKIN, JAMES, W. CHESTERFIELD, NH. FILED 1-15-2010.



THE MARK CONSISTS OF AN IMAGE OF A ROCKET CIRCLING AROUND THE STYLIZED TEXT "ROCK-IT-PATCH".

FOR PATCHES OF DRYWALL BEING PLASTER BASED FOR REPAIRING HOLES IN DRYWALL TYPE SURFACES SUCH AS WALLS AND CEILINGS OF RESIDENTIAL AND/OR COMMERCIAL DWELLINGS OR STRUCTURES SUCH AS HOMES AND PLACES OF BUSINESS (U.S. CLS. 1, 12, 33 AND 50).

DOMINIC FATHY, EXAMINING ATTORNEY

CLASS 19—(Continued).

SN 77-917,990. PINNACLE INTERIOR ELEMENTS, INC., CARROLLTON, TX. FILED 1-22-2010.

AMBERLEIGH

THE MARK CONSISTS OF STANDARD CHARACTERS WITHOUT CLAIM TO ANY PARTICULAR FONT, STYLE, SIZE, OR COLOR.

THE NAME(S), PORTRAIT(S), AND/OR SIGNATURE(S) SHOWN IN THE MARK DOES NOT IDENTIFY A PARTICULAR LIVING INDIVIDUAL.

FOR HARDWOOD FLOORING (U.S. CLS. 1, 12, 33 AND 50).

SETH A. RAPPAPORT, EXAMINING ATTORNEY

SN 77-919,564. SOLISTONE, INC., LA PUENTE, CA. FILED 1-25-2010.



THE COLOR(S) RED AND WHITE IS/ARE CLAIMED AS A FEATURE OF THE MARK.

THE MARK CONSISTS OF STYLIZED LETTERS "S"."O"."L"."I"."S"."T"."O"."N"."E". THE LETTERS ARE IN THE COLOR WHITE AND THE RECTANGULAR BACKGROUND THAT WRAPS AROUND THE LETTERS IS IN THE COLOR RED.

FOR BUILDING STONE; GLASS MOSAICS FOR USE IN BUILDING CONSTRUCTION; MARBLE; NATURAL STONE; NATURAL STONE SLABS AND TILES; STONE FOR BUILDING AND CONSTRUCTION (U.S. CLS. 1, 12, 33 AND 50).

FIRST USE 1-1-2006; IN COMMERCE 1-1-2006.
MARK SPARACINO, EXAMINING ATTORNEY

CLASS 19—(Continued).

SN 77-924,508. ZHENSHI HOLDING GROUP CO., LIMITED, TONGXIANG, ZHEJIANG, CHINA, FILED 2-1-2010.



THE MARK CONSISTS OF A DESIGN FORMED BY THE LETTERS "S" AND "Z" TO THE LEFT OF CHINESE CHARACTERS AND THE WORD "ZHENSHI".

THE WORDING "ZHENSHI" HAS NO MEANING IN A FOREIGN LANGUAGE.

THE NON-LATIN CHARACTERS IN THE MARK TRANSLITERATE TO "ZHENSHI" AND THIS HAS NO MEANING IN A FOREIGN LANGUAGE.

FOR BUILDING GLASS; BUILDING TIMBER; CONCRETE BUILDING MATERIALS, NAMELY, BLOCKS, BRICKS, POSTS, SLABS AND PANELS; GEOTEXTILES FOR USE IN CONNECTION WITH ROAD CONSTRUCTION, RAILROAD CONSTRUCTION, TUNNEL CONSTRUCTION, WATERWAY CONSTRUCTION AND PUBLIC WORKS CONSTRUCTION; GLASS GRANULES FOR MARKING ROADS; NON-METAL DOORS; NON-METAL WINDOWS; PORTABLE NON-METAL BUILDINGS; REFRACTORY CONSTRUCTION MATERIALS, NOT OF METAL; SYNTHETIC FLOORING MATERIALS OR WALL-CLADDINGS; TILES AND PAVING SLABS, NOT OF METAL (U.S. CLS. 1, 12, 33 AND 50).

FIRST USE 6-16-1992; IN COMMERCE 2-15-2007.
SHANNON TWOHIG, EXAMINING ATTORNEY

SN 77-925,002. THE MORGAN CRUCIBLE COMPANY PLC, BERKSHIRE, UNITED KINGDOM, FILED 2-1-2010.

TRI-MOR

THE MARK CONSISTS OF STANDARD CHARACTERS WITHOUT CLAIM TO ANY PARTICULAR FONT, STYLE, SIZE, OR COLOR.

OWNER OF UNITED KINGDOM REG. NO. 757608, DATED 9-14-1956, EXPIRES 9-14-2015.

FOR REFRACTORY MATERIALS IN PLASTIC, GRANULAR OR POWDER FORM FOR USE IN LINING FURNACES AND TANKS AND FOR USE IN BUILDING CONSTRUCTION (U.S. CLS. 1, 12, 33 AND 50).

LYDIA BELZER, EXAMINING ATTORNEY

CLASS 19—(Continued).

SN 77-926,773. AMERICAN TERRAZZO COMPANY LTD., GARLAND, TX. FILED 2-3-2010.

EnviroBlue

THE MARK CONSISTS OF STANDARD CHARACTERS WITHOUT CLAIM TO ANY PARTICULAR FONT, STYLE, SIZE, OR COLOR.

FOR TERRAZZO FLOORING; BUILDING MATERIALS, NAMELY, GLASS AGGREGATE FOR USE IN LANDSCAPING, CONCRETE, PRECAST CONCRETE, AND TERRAZZO PRODUCTS (U.S. CLS. 1, 12, 33 AND 50).

FIRST USE 0-0-2005; IN COMMERCE 0-0-2005.
TOBY BULLOFF, EXAMINING ATTORNEY

CLASS 19—(Continued).

SN 77-926,786. AMERICAN TERRAZZO COMPANY LTD., GARLAND, TX. FILED 2-3-2010.

EGlas Products

THE MARK CONSISTS OF STANDARD CHARACTERS WITHOUT CLAIM TO ANY PARTICULAR FONT, STYLE, SIZE, OR COLOR.

NO CLAIM IS MADE TO THE EXCLUSIVE RIGHT TO USE "PRODUCTS", APART FROM THE MARK AS SHOWN.

FOR TERRAZZO FLOORING; BUILDING MATERIALS, NAMELY, GLASS AND PORCELAIN AGGREGATE FOR USE IN LANDSCAPING, CONCRETE, PRECAST CONCRETE, AND TERRAZZO PRODUCTS (U.S. CLS. 1, 12, 33 AND 50).

TOBY BULLOFF, EXAMINING ATTORNEY

SN 77-926,775. AMERICAN TERRAZZO COMPANY LTD., GARLAND, TX. FILED 2-3-2010.

EnviroPlate

THE MARK CONSISTS OF STANDARD CHARACTERS WITHOUT CLAIM TO ANY PARTICULAR FONT, STYLE, SIZE, OR COLOR.

FOR TERRAZZO FLOORING; BUILDING MATERIALS, NAMELY, GLASS AGGREGATE FOR USE IN LANDSCAPING, CONCRETE, PRECAST CONCRETE, AND TERRAZZO PRODUCTS (U.S. CLS. 1, 12, 33 AND 50).

FIRST USE 0-0-2005; IN COMMERCE 0-0-2005.
TOBY BULLOFF, EXAMINING ATTORNEY

SN 77-926,788. AMERICAN TERRAZZO COMPANY LTD., GARLAND, TX. FILED 2-3-2010.

EnviroShield CAG

THE MARK CONSISTS OF STANDARD CHARACTERS WITHOUT CLAIM TO ANY PARTICULAR FONT, STYLE, SIZE, OR COLOR.

FOR TERRAZZO FLOORING; BUILDING MATERIALS, NAMELY, GLASS AGGREGATE FOR USE IN LANDSCAPING, CONCRETE, PRECAST CONCRETE, AND TERRAZZO PRODUCTS (U.S. CLS. 1, 12, 33 AND 50).

FIRST USE 11-18-2005; IN COMMERCE 11-18-2005.
TOBY BULLOFF, EXAMINING ATTORNEY

SN 77-926,785. AMERICAN TERRAZZO COMPANY LTD., GARLAND, TX. FILED 2-3-2010.

EnviroTerrazzo

THE MARK CONSISTS OF STANDARD CHARACTERS WITHOUT CLAIM TO ANY PARTICULAR FONT, STYLE, SIZE, OR COLOR.

FOR TERRAZZO FLOORING; BUILDING MATERIALS, NAMELY, GLASS AND PORCELAIN AGGREGATE FOR USE IN LANDSCAPING, CONCRETE, PRECAST CONCRETE, AND TERRAZZO PRODUCTS (U.S. CLS. 1, 12, 33 AND 50).

TOBY BULLOFF, EXAMINING ATTORNEY

SN 77-926,790. AMERICAN TERRAZZO COMPANY LTD., GARLAND, TX. FILED 2-3-2010.

EnviroShield AAG

THE MARK CONSISTS OF STANDARD CHARACTERS WITHOUT CLAIM TO ANY PARTICULAR FONT, STYLE, SIZE, OR COLOR.

FOR TERRAZZO FLOORING; BUILDING MATERIALS, NAMELY, GLASS AGGREGATE FOR USE IN LANDSCAPING, CONCRETE, PRECAST CONCRETE, AND TERRAZZO PRODUCTS (U.S. CLS. 1, 12, 33 AND 50).

FIRST USE 11-18-2005; IN COMMERCE 11-18-2005.
TOBY BULLOFF, EXAMINING ATTORNEY

CLASS 19—(Continued).

SN 77-926,791. AMERICAN TERRAZZO COMPANY LTD., GARLAND, TX. FILED 2-3-2010.

EnviroBrown

THE MARK CONSISTS OF STANDARD CHARACTERS WITHOUT CLAIM TO ANY PARTICULAR FONT, STYLE, SIZE, OR COLOR.

FOR TERRAZZO FLOORING; BUILDING MATERIALS, NAMELY, GLASS AGGREGATE FOR USE IN LANDSCAPING, CONCRETE, PRECAST CONCRETE, AND TERRAZZO PRODUCTS (U.S. CLS. 1, 12, 33 AND 50).

FIRST USE 0-0-2005; IN COMMERCE 0-0-2005.
TOBY BULLOFF, EXAMINING ATTORNEY

SN 77-926,803. AMERICAN TERRAZZO COMPANY LTD., GARLAND, TX. FILED 2-3-2010.

EnviroClear

THE MARK CONSISTS OF STANDARD CHARACTERS WITHOUT CLAIM TO ANY PARTICULAR FONT, STYLE, SIZE, OR COLOR.

FOR TERRAZZO FLOORING; BUILDING MATERIALS, NAMELY, GLASS AGGREGATE FOR USE IN LANDSCAPING, CONCRETE, PRECAST CONCRETE, AND TERRAZZO PRODUCTS (U.S. CLS. 1, 12, 33 AND 50).

FIRST USE 0-0-2005; IN COMMERCE 0-0-2005.
TOBY BULLOFF, EXAMINING ATTORNEY

SN 77-926,961. GRANEX INDUSTRIES, INC., SOLON, OH. FILED 2-3-2010.

DELLAVITA

THE MARK CONSISTS OF STANDARD CHARACTERS WITHOUT CLAIM TO ANY PARTICULAR FONT, STYLE, SIZE, OR COLOR.

THE ENGLISH TRANSLATION OF "DELLAVITA" IN THE MARK IS "ANY LIFE".

FOR STONE AND ARTIFICIAL STONE FOR COUNTER TOPS, WALLS AND FLOORING (U.S. CLS. 1, 12, 33 AND 50).

KIM MONINGHOFF, EXAMINING ATTORNEY

CLASS 19—(Continued).

SN 77-927,147. AZEK BUILDING PRODUCTS, INC., SCRANTON, PA. FILED 2-3-2010.



OWNER OF U.S. REG. NOS. 2,696,724, 3,569,527 AND OTHERS.

NO CLAIM IS MADE TO THE EXCLUSIVE RIGHT TO USE "RAIL", APART FROM THE MARK AS SHOWN.

THE COLOR(S) DARK BLUE (PANTONE PMS 2945) AND ORANGE (PANTONE PMS 159) IS/ARE CLAIMED AS A FEATURE OF THE MARK.

THE MARK CONSISTS OF THE WORD "AZEK" IN DARK BLUE ABOVE THE WORD "RAIL" IN ORANGE AND AN ARROW IN ORANGE TO THE RIGHT OF THE WORDS "AZEK" AND "RAIL".

FOR BUILDING PRODUCTS, NAMELY, NON-METAL RAILINGS FOR DECKS, PORCHES AND STAIRS AND NON-METAL RAILING ACCESSORIES, NAMELY, POST CAPS, POST SLEEVES AND POST SKIRTS (U.S. CLS. 1, 12, 33 AND 50).

FIRST USE 1-31-2009; IN COMMERCE 1-31-2009.
JEFFERY COWARD, EXAMINING ATTORNEY

SN 77-927,982. SOLAR HOMES LLC, SAINT CHARLES, IL. FILED 2-4-2010.

**Attainable Sustainable
Homes**

THE MARK CONSISTS OF STANDARD CHARACTERS WITHOUT CLAIM TO ANY PARTICULAR FONT, STYLE, SIZE, OR COLOR.

NO CLAIM IS MADE TO THE EXCLUSIVE RIGHT TO USE "SUSTAINABLE HOMES", APART FROM THE MARK AS SHOWN.

FOR MANUFACTURED HOMES; MANUFACTURED HOUSING, NAMELY, MOBILE HOMES; MANUFACTURED HOUSING, NAMELY, TRANSPORTABLE HOMES; MODULAR HOMES; MODULAR LOG HOMES; PRE-FABRICATED HOMES; PRE-FABRICATED LOG HOMES (U.S. CLS. 1, 12, 33 AND 50).

BRENDAN MCCAULEY, EXAMINING ATTORNEY

CLASS 19—(Continued).

SN 77-928,577. RUF, BERNARD W., NEWBURGH, NY. AND SCHWEITZER, ROY E., NEWBURGH, NY. FILED 2-4-2010.

SAFE & SECURE HOMES

THE MARK CONSISTS OF STANDARD CHARACTERS WITHOUT CLAIM TO ANY PARTICULAR FONT, STYLE, SIZE, OR COLOR.

NO CLAIM IS MADE TO THE EXCLUSIVE RIGHT TO USE "HOMES", APART FROM THE MARK AS SHOWN.

FOR PRE-FABRICATED HOMES (U.S. CLS. 1, 12, 33 AND 50).

KIMBERLY FRYE, EXAMINING ATTORNEY

CLASS 19—(Continued).

SN 77-931,609. NORTHERN HARDWOODS, LLC, CROMWELL, CT. FILED 2-9-2010.



THE MARK CONSISTS OF THE OUTLINE OF A SIX-SIDED SNOWFLAKE.

FOR LUMBER (U.S. CLS. 1, 12, 33 AND 50).

FIRST USE 5-0-1984; IN COMMERCE 5-0-1984.

ANTHONY RINKER, EXAMINING ATTORNEY

SN 77-930,582. OWENS CORNING INTELLECTUAL CAPITAL, LLC, TOLEDO, OH. FILED 2-8-2010.

**THE BEAUTY OF STONE,
PERFECT BY DESIGN.**

THE MARK CONSISTS OF STANDARD CHARACTERS WITHOUT CLAIM TO ANY PARTICULAR FONT, STYLE, SIZE, OR COLOR.

OWNER OF U.S. REG. NO. 3,619,989.
FOR NON-METAL CLADDING FOR CONSTRUCTION AND BUILDING (U.S. CLS. 1, 12, 33 AND 50).

ELISSA GARBER KON, EXAMINING ATTORNEY

SN 77-932,935. CONNOR SPORT COURT INTERNATIONAL, INC., SALT LAKE CITY, UT. FILED 2-10-2010.

SPORTROLL

THE MARK CONSISTS OF STANDARD CHARACTERS WITHOUT CLAIM TO ANY PARTICULAR FONT, STYLE, SIZE, OR COLOR.

FOR RUBBER FLOORING (U.S. CLS. 1, 12, 33 AND 50).

FIRST USE 7-28-2005; IN COMMERCE 7-28-2005.

ZACHARY BELLO, EXAMINING ATTORNEY

SN 77-930,604. OWENS CORNING INTELLECTUAL CAPITAL, LLC, TOLEDO, OH. FILED 2-8-2010.

ARBORTECH

THE MARK CONSISTS OF STANDARD CHARACTERS WITHOUT CLAIM TO ANY PARTICULAR FONT, STYLE, SIZE, OR COLOR.

FOR NON-METAL CEILING AND WALL PANELS (U.S. CLS. 1, 12, 33 AND 50).

ELISSA GARBER KON, EXAMINING ATTORNEY

SN 77-951,339. WORLD WIDE IMPORTS ENTERPRISES, INC., FORT LAUDERDALE, FL. FILED 3-5-2010.



NO CLAIM IS MADE TO THE EXCLUSIVE RIGHT TO USE "NATURE'S ROCKS", APART FROM THE MARK AS SHOWN.

THE MARK CONSISTS OF THE WORDS "NATURE'S ROCKS" IN CAPITAL LETTERS, WHERE THE WORD "NATURE'S" APPEARS DIRECTLY ABOVE THE WORD "ROCKS", AND WHERE THE TAIL OF THE "R" IN "ROCKS" ARCS UNDER THE "O" IN "ROCKS", AND WHERE THE "O" IN "ROCKS" CONTAINS A CIRCLE-SHAPED DEVICE.

FOR NATURAL STONE (U.S. CLS. 1, 12, 33 AND 50).

FIRST USE 11-14-2008; IN COMMERCE 11-14-2008.

ALEXANDER L. POWERS, EXAMINING ATTORNEY

CLASS 19—(Continued).

SN 77-966,222. OWENS CORNING INTELLECTUAL CAPITAL, LLC, TOLEDO, OH. FILED 3-23-2010.

V-CLASS

THE MARK CONSISTS OF STANDARD CHARACTERS WITHOUT CLAIM TO ANY PARTICULAR FONT, STYLE, SIZE, OR COLOR.

FOR NON-METAL WINDOWS (U.S. CLS. 1, 12, 33 AND 50).

ELISSA GARBER KON, EXAMINING ATTORNEY

CLASS 19—(Continued).

SN 85-005,161. OWENS CORNING INTELLECTUAL CAPITAL, LLC, TOLEDO, OH. FILED 4-2-2010.

THE MARK CONSISTS OF A STYLIZED LETTER "V" AND STYLIZED WORD "CLASS".

FOR NON-METAL DOORS; NON-METAL WINDOWS (U.S. CLS. 1, 12, 33 AND 50).

ELISSA GARBER KON, EXAMINING ATTORNEY

SN 78-875,188. FAAY VIANEN B.V., 4131 PJ VIANEN, NETHERLANDS, FILED 5-3-2006.

FAAY

THE MARK CONSISTS OF STANDARD CHARACTERS WITHOUT CLAIM TO ANY PARTICULAR FONT, STYLE, SIZE, OR COLOR.

FOR NON-METALLIC BUILDING MATERIALS, NAMELY, FASCIA, SOFFITS, AND DECKING BOARDS; NON-METALLIC TRANSPORTABLE BUILDINGS; DIVIDING WALLS, SECONDARY WALLS, INSULATING WALLS, DIVIDING WALLS FOR BUILDINGS ALL NOT MADE OF METAL; CEILING COMPONENTS, NAMELY, NON-METALLIC MOLDING FOR WALLS AND BUILDINGS NOT MADE OF METAL (U.S. CLS. 1, 12, 33 AND 50).

CAROLINE WOOD, EXAMINING ATTORNEY

CLASS 20—FURNITURE AND ARTICLES NOT OTHERWISE CLASSIFIED

SN 77-480,641. OMEGA IP CO., WATERLOO, IA. FILED 5-21-2008.

DYNASTY

THE MARK CONSISTS OF STANDARD CHARACTERS WITHOUT CLAIM TO ANY PARTICULAR FONT, STYLE, SIZE, OR COLOR.

FOR MADE-TO-ORDER KITCHEN AND BATHROOM CABINETS THAT WHEN INSTALLED ARE PERMANENTLY AFFIXED OR MOUNTED TO THE WALLS OR FLOORS OF A BUILDING (U.S. CLS. 2, 13, 22, 25, 32 AND 50).

FIRST USE 11-30-1989; IN COMMERCE 11-30-1989.
KIM SAITO, EXAMINING ATTORNEY

SN 85-005,113. OWENS CORNING INTELLECTUAL CAPITAL, LLC, TOLEDO, OH. FILED 4-2-2010.

V-CLASS

THE MARK CONSISTS OF STANDARD CHARACTERS WITHOUT CLAIM TO ANY PARTICULAR FONT, STYLE, SIZE, OR COLOR.

FOR NON-METAL DOORS (U.S. CLS. 1, 12, 33 AND 50).

ELISSA GARBER KON, EXAMINING ATTORNEY

SN 77-675,153. TIMOTHY LUGER, PARK CITY, UT. FILED 2-20-2009.

GLAMOUR ROD

THE MARK CONSISTS OF STANDARD CHARACTERS WITHOUT CLAIM TO ANY PARTICULAR FONT, STYLE, SIZE, OR COLOR.

NO CLAIM IS MADE TO THE EXCLUSIVE RIGHT TO USE "ROD", APART FROM THE MARK AS SHOWN.

FOR CURTAIN RODS (U.S. CLS. 2, 13, 22, 25, 32 AND 50).

LOURDES AYALA, EXAMINING ATTORNEY

CLASS 20—(Continued).

SN 77-769,653. SHUMSKY ENTERPRISES, INC., DAYTON, OH. FILED 6-27-2009.

COGZ

THE MARK CONSISTS OF STANDARD CHARACTERS WITHOUT CLAIM TO ANY PARTICULAR FONT, STYLE, SIZE, OR COLOR.

FOR INCENTIVE REWARD TOKENS PRIMARILY COMPOSED OF PLASTIC FOR USE IN RECOGNITION OF EMPLOYEE PERFORMANCE, WELLNESS, SALES AND YEARS OF SERVICE INCENTIVE REWARD PROGRAMS (U.S. CLS. 2, 13, 22, 25, 32 AND 50).

AISHA CLARKE, EXAMINING ATTORNEY

SN 77-783,252. FORTUNE INTERNATIONAL (SH) LIMITED, SHANGHAI, CHINA, FILED 7-17-2009.

Jennifer's

THE COLOR(S) GREEN AND BLACK IS/ARE CLAIMED AS A FEATURE OF THE MARK.

THE MARK CONSISTS OF THE STYLIZED WORD "JENNIFER" IN BLACK WITH THE "S" IN GREEN.

FOR BOLSTERS; FURNITURE; FURNITURE FITTINGS, NOT OF METAL; MIRRORS; NON-METAL LADDERS; NONMETAL CONTAINERS FOR STORAGE OR TRANSPORT; PICTURE FRAMES; WINDOW FITTINGS, NOT OF METAL; WORKS OF ART OF WOOD, WAX, PLASTER OR PLASTIC; WORKS OF ART OF BAMBOO (U.S. CLS. 2, 13, 22, 25, 32 AND 50).

FIRST USE 3-11-2007; IN COMMERCE 3-11-2007.

KATHERINE M. DUBRAY, EXAMINING ATTORNEY

CLASS 20—(Continued).

SN 77-792,698. MATTHEW BENNETT, DBA MELONHEAD MODERN, SANTA ANA, CA. FILED 7-29-2009.



NO CLAIM IS MADE TO THE EXCLUSIVE RIGHT TO USE "MODERN", APART FROM THE MARK AS SHOWN.

THE COLOR(S) YELLOW, BLACK AND WHITE IS/ARE CLAIMED AS A FEATURE OF THE MARK.

THE MARK CONSISTS OF THE WORDS "MELONHEAD MODERN" IN BLACK UPPERCASE STYLIZED FONT. CENTERED ABOVE THE WORDS IS A DESIGN FEATURING A SMILEY FACE, A CIRCLE OUTLINED IN BLACK AND FILLED WITH YELLOW. THE CIRCLE HAS TWO BLACK EYES AND A BLACK SMILE AND IS WEARING BLACK GLASSES. THE DETAILS OF THE GLASSES ARE SHOWN IN WHITE.

FOR FURNITURE (U.S. CLS. 2, 13, 22, 25, 32 AND 50).

FIRST USE 3-0-2009; IN COMMERCE 3-0-2009.

PRISCILLA MILTON, EXAMINING ATTORNEY

SN 77-793,290. WARNER BROS. ENTERTAINMENT INC., BURBANK, CA. FILED 7-30-2009.

HEDWIG

THE MARK CONSISTS OF STANDARD CHARACTERS WITHOUT CLAIM TO ANY PARTICULAR FONT, STYLE, SIZE, OR COLOR.

OWNER OF U.S. REG. NOS. 2,483,583, 2,502,927 AND 3,628,288.

FOR SLEEPING BAGS, PLASTIC CAKE DECORATIONS, NON-METAL AND NON-LEATHER KEY CHAINS, CHAIR PADS, DECK CHAIRS, CORKS FOR BOTTLES, DRINKING STRAWS, PICTURE FRAMES, PILLOWS AND SEAT CUSHIONS, BOOSTER SEATS, INFANT WALKERS, BASSINETS, HIGH CHAIRS, HAND-HELD FLAT AND FOLDING FANS, DECORATIVE MOBILES, AND SOFT-SCULPTURE WALL DECORATIONS (U.S. CLS. 2, 13, 22, 25, 32 AND 50).

JOHN SCHUYLER YARD, EXAMINING ATTORNEY

CLASS 20—(Continued).

SN 77-793,412. WARNER BROS. ENTERTAINMENT INC., BURBANK, CA. FILED 7-30-2009.

HOGWARTS

THE MARK CONSISTS OF STANDARD CHARACTERS WITHOUT CLAIM TO ANY PARTICULAR FONT, STYLE, SIZE, OR COLOR.

OWNER OF U.S. REG. NOS. 2,491,427, 2,802,671 AND OTHERS.

FOR SLEEPING BAGS, PLASTIC CAKE DECORATIONS, NON-METAL AND NON-LEATHER KEY CHAINS, CHAIR PADS, DECK CHAIRS, CORKS FOR BOTTLES, DRINKING STRAWS, PICTURE FRAMES, PILLOWS AND SEAT CUSHIONS, BOOSTER SEATS, INFANT WALKERS, BASSINETS, HIGH CHAIRS, HAND-HELD FLAT AND FOLDING FANS, DECORATIVE MOBILES, AND SOFT-SCULPTURE WALL DECORATIONS (U.S. CLS. 2, 13, 22, 25, 32 AND 50).
JOHN SCHUYLER YARD, EXAMINING ATTORNEY

CLASS 20—(Continued).

SN 77-796,745. WHOLE SPACE INDUSTRIES LTD., TAIPEI, TAIWAN, FILED 8-4-2009.



NO CLAIM IS MADE TO THE EXCLUSIVE RIGHT TO USE "HOME" AND "CHILD SAFE & ENVIRONMENTALLY RESPONSIBLE PRODUCTS FOR YOUR HOME", APART FROM THE MARK AS SHOWN.

THE MARK CONSISTS OF THE WORDS "HOME BASICS" IN A RECTANGLE AND A RECTANGULAR BLACK BACKGROUND BEHIND THE WORD "BASICS" WITH THE WORDS "CHILD SAFE & ENVIRONMENTALLY RESPONSIBLE PRODUCTS FOR YOUR HOME" BELOW THE RECTANGLE.

FOR WOVEN WOOD WINDOW SHADES, ROLL-UP WINDOW SHADES, ROMAN WINDOW SHADES, VENETIAN BLINDS (U.S. CLS. 2, 13, 22, 25, 32 AND 50).

MARK SPARACINO, EXAMINING ATTORNEY

SN 77-797,837. HERMAN MILLER, INC., ZEELAND, MI. FILED 8-5-2009.

GEIGER LEVELS

THE MARK CONSISTS OF STANDARD CHARACTERS WITHOUT CLAIM TO ANY PARTICULAR FONT, STYLE, SIZE, OR COLOR.

FOR OFFICE FURNITURE (U.S. CLS. 2, 13, 22, 25, 32 AND 50).

DEIRDRE ROBERTSON, EXAMINING ATTORNEY

SN 77-793,799. WARNER BROS. ENTERTAINMENT INC., BURBANK, CA. FILED 7-30-2009.

THE THREE BROOMSTICKS

THE MARK CONSISTS OF STANDARD CHARACTERS WITHOUT CLAIM TO ANY PARTICULAR FONT, STYLE, SIZE, OR COLOR.

FOR SLEEPING BAGS, PLASTIC CAKE DECORATIONS, NON-METAL AND NON-LEATHER KEY CHAINS, CHAIR PADS, DECK CHAIRS, CORKS FOR BOTTLES, DRINKING STRAWS, PICTURE FRAMES, PILLOWS AND SEAT CUSHIONS, BOOSTER SEATS, INFANT WALKERS, BASSINETS, HIGH CHAIRS, HAND-HELD FLAT AND FOLDING FANS, DECORATIVE MOBILES, AND SOFT-SCULPTURE WALL DECORATIONS (U.S. CLS. 2, 13, 22, 25, 32 AND 50).
JOHN SCHUYLER YARD, EXAMINING ATTORNEY

SN 77-797,932. REYNOLDS PACKAGING LLC, RICHMOND, VA. FILED 8-5-2009.

CATER-TIME

THE MARK CONSISTS OF STANDARD CHARACTERS WITHOUT CLAIM TO ANY PARTICULAR FONT, STYLE, SIZE, OR COLOR.

OWNER OF U.S. REG. NOS. 1,507,800 AND 1,510,995. FOR PLASTIC SERVING TRAYS AND BOWLS (U.S. CLS. 2, 13, 22, 25, 32 AND 50).

FIRST USE 9-0-2006; IN COMMERCE 9-0-2006.
DAWN FELDMAN, EXAMINING ATTORNEY

CLASS 20—(Continued).

SN 77-805,548. MOORE, CHRISTOPHER H., WOODSTOCK, GA. FILED 8-16-2009.

QUICK TOE

THE MARK CONSISTS OF STANDARD CHARACTERS WITHOUT CLAIM TO ANY PARTICULAR FONT, STYLE, SIZE, OR COLOR.

NO CLAIM IS MADE TO THE EXCLUSIVE RIGHT TO USE "TOE", APART FROM THE MARK AS SHOWN.

FOR KITCHEN CABINETS (U.S. CLS. 2, 13, 22, 25, 32 AND 50).

FIRST USE 8-21-2004; IN COMMERCE 8-21-2004.
MARK SPARACINO, EXAMINING ATTORNEY

SN 77-807,514. NAPSEAT LLC, AUSTIN, TX. FILED 8-18-2009.



THE MARK CONSISTS OF A SEAT DESIGN WITH THE STYLIZED TEXT "NAPSEAT" OVER IT.

FOR CHAIRS, NAMELY, CHAIRS FOR USE AS SEATS THAT CAN ALSO UNFOLD FLAT ONTO THE FLOOR FOR THE PURPOSE OF RESTING OR TAKING A NAP (U.S. CLS. 2, 13, 22, 25, 32 AND 50).

TRACY WHITTAKER-BROWN, EXAMINING ATTORNEY

SN 77-822,061. POTOMAC CORPORATION, DBA CRESCENT CARDBOARD COMPANY, WHEELING, IL. FILED 9-8-2009.

EASY CRAFT

THE MARK CONSISTS OF STANDARD CHARACTERS WITHOUT CLAIM TO ANY PARTICULAR FONT, STYLE, SIZE, OR COLOR.

NO CLAIM IS MADE TO THE EXCLUSIVE RIGHT TO USE "CRAFT", APART FROM THE MARK AS SHOWN.

FOR SHADOW BOXES AND PICTURE FRAMES (U.S. CLS. 2, 13, 22, 25, 32 AND 50).

KIMBERLY PERRY, EXAMINING ATTORNEY

CLASS 20—(Continued).

SN 77-850,146. DACO, DBA DAUPHIN NORTH AMERICA, BOONTON, NJ. FILED 10-16-2009.

KONSTRUX

THE MARK CONSISTS OF STANDARD CHARACTERS WITHOUT CLAIM TO ANY PARTICULAR FONT, STYLE, SIZE, OR COLOR.

FOR MODULAR TABLE SYSTEM COMPRISING TABLE TOPS AND LEGS FOR THE MODULAR ASSEMBLY/DISASSEMBLY OF ONE OF MORE TABLES (U.S. CLS. 2, 13, 22, 25, 32 AND 50).

VIVIAN MICZNIK FIRST, EXAMINING ATTORNEY

SN 77-850,716. TY INC., WESTMONT, IL. FILED 10-16-2009.



OWNER OF U.S. REG. NOS. 2,730,653, 2,821,245 AND OTHERS.

THE MARK CONSISTS OF THE WORDING "TY BEANIE BOO'S" AND A DESIGN. THE DESIGN CONSISTS OF THE WORD "TY" WITHIN A HEART TO THE LEFT OF TWO STYLIZED ANIMALS WITH TAILS THAT ARE BEHIND THE WORD "BEANIE" WHICH IS ABOVE THE WORD "BOO'S". THE TWO "O'S" IN "BOO'S" ARE DEPICTED AS EYES. THE ENTIRE MARK IS WITHIN A RECTANGLE WITH A CURVED TOP.

FOR DISPLAY CASES FOR MERCHANDISE; VINYL HANGER USED BY THE REAL ESTATE INDUSTRY TO HANG PROMOTIONAL MATERIAL ON DOORS (U.S. CLS. 2, 13, 22, 25, 32 AND 50).

ANDREA HACK, EXAMINING ATTORNEY

SN 77-886,811. CAMBRO MANUFACTURING COMPANY, HUNTINGTON BEACH, CA. FILED 12-4-2009.

Versa Food Bar

THE MARK CONSISTS OF STANDARD CHARACTERS WITHOUT CLAIM TO ANY PARTICULAR FONT, STYLE, SIZE, OR COLOR.

NO CLAIM IS MADE TO THE EXCLUSIVE RIGHT TO USE "FOOD BAR", APART FROM THE MARK AS SHOWN.

FOR A PORTABLE FOOD SERVICE BAR FOR RESTAURANTS, HOTELS, SCHOOLS, AND INSTITUTIONAL FOOD PROVIDERS COMPRISED OF CABINETS, SHELVING, PANS, SALAD BOWLS, AND STORAGE RACKS (U.S. CLS. 2, 13, 22, 25, 32 AND 50).

FIRST USE 11-23-2009; IN COMMERCE 11-23-2009.
RAMONA ORTIGA, EXAMINING ATTORNEY

CLASS 20—(Continued).

SN 77-893,177. WERZALIT GMBH + CO. KG, OBERSTENFELD, FED REP GERMANY, FILED 12-14-2009.

WERZALIT

THE MARK CONSISTS OF STANDARD CHARACTERS WITHOUT CLAIM TO ANY PARTICULAR FONT, STYLE, SIZE, OR COLOR.

OWNER OF U.S. REG. NOS. 973,727 AND 1,375,705.

THE WORDING "WERZALIT" HAS NO MEANING IN A FOREIGN LANGUAGE.

FOR COFFINS AND COFFIN PARTS; NON-METAL PALLETS AND PALLET SPACER BLOCKS; FURNITURE PARTS, NAMELY, BED SLATS (U.S. CLS. 2, 13, 22, 25, 32 AND 50).

FIRST USE 0-0-1980; IN COMMERCE 0-0-1980.

MELISSA VALLILLO, EXAMINING ATTORNEY

SN 77-895,664. RPI INDUSTRIES INC, MEDFORD, NJ, FILED 12-17-2009.

PIVOTEER

THE MARK CONSISTS OF THE WORD "PIVOTEER" IN A STYLIZED FORM, WITH THE HORIZONTAL PORTION OF THE LETTER "T" ANGLED ACROSS THE VERTICAL PORTION. THE GRADATION IN THE COLOR BLACK REPRESENTS SHADING; COLOR IS NOT CLAIMED AS A FEATURE OF THE MARK.

FOR SNEEZE GUARDS FOR PROTECTING SALAD BARS AND FOOD COUNTERS (U.S. CLS. 2, 13, 22, 25, 32 AND 50).

JAMES A. RAUEN, EXAMINING ATTORNEY

SN 77-896,352. STEPHENS SCOTT, REDDING, CA. FILED 12-18-2009.

THE CLYDSDALE

THE MARK CONSISTS OF STANDARD CHARACTERS WITHOUT CLAIM TO ANY PARTICULAR FONT, STYLE, SIZE, OR COLOR.

FOR SAW HORSES (U.S. CLS. 2, 13, 22, 25, 32 AND 50).

WENDY GOODMAN, EXAMINING ATTORNEY

CLASS 20—(Continued).

SN 77-897,023. FAIRYTALE WISHES, INC., HIGHLAND PARK, IL. FILED 12-18-2009.



NO CLAIM IS MADE TO THE EXCLUSIVE RIGHT TO USE "INC.", APART FROM THE MARK AS SHOWN.

THE MARK CONSISTS OF A FROG WEARING A CROWN NEXT TO THE WORDS "FAIRYTALE WISHES INC." WITH TWO SPIRAL DESIGNS INCORPORATING MULTIPLE STARS, ONE NEXT TO THE FROG AND ONE SURROUNDING THE FROG AND "FAIRYTALE WISHES INC."

FOR NOVELTY GOODS IN THE NATURE OF A PLACEBO SPRAY USED TO LESSEN A CHILD'S REACTION TO A FEARFUL SITUATION (U.S. CLS. 2, 13, 22, 25, 32 AND 50).

FIRST USE 5-15-2009; IN COMMERCE 5-15-2009.

ANDREA BUTLER, EXAMINING ATTORNEY

SN 77-899,360. HIP INNOVATIONS, LLC, WILLISTON, VT. FILED 12-22-2009.



THE MARK CONSISTS OF THE STYLIZED WORDING OF "TOTAL PILLOW" WITH A GENERALLY CIRCULAR SEGMENTED DESIGN REPLACING THE LETTER "O" IN "PILLOW".

FOR FLEXIBLE CUSHION (U.S. CLS. 2, 13, 22, 25, 32 AND 50).

NELSON SNYDER, EXAMINING ATTORNEY

SN 77-906,340. ABSOLUTELYNEW, SAN FRANCISCO, CA. FILED 1-6-2010.

Side Solution

THE MARK CONSISTS OF STANDARD CHARACTERS WITHOUT CLAIM TO ANY PARTICULAR FONT, STYLE, SIZE, OR COLOR.

NO CLAIM IS MADE TO THE EXCLUSIVE RIGHT TO USE "SIDE", APART FROM THE MARK AS SHOWN.

FOR BED PILLOWS; HEAD SUPPORTING PILLOWS; NECK-SUPPORTING PILLOWS (U.S. CLS. 2, 13, 22, 25, 32 AND 50).

FIRST USE 5-1-2008; IN COMMERCE 8-1-2008.

MARK PILARO, EXAMINING ATTORNEY

CLASS 20—(Continued).

SN 77-913,541. EVRIHOLDER PRODUCTS LLC, ANAHEIM, CA. FILED 1-16-2010.

HANG N' HIDE

THE MARK CONSISTS OF STANDARD CHARACTERS WITHOUT CLAIM TO ANY PARTICULAR FONT, STYLE, SIZE, OR COLOR.

NO CLAIM IS MADE TO THE EXCLUSIVE RIGHT TO USE "HANG", APART FROM THE MARK AS SHOWN.

FOR COLLAPSIBLE LAUNDRY HOLDERS IN THE NATURE OF CLOSET ACCESSORIES, NAMELY, CLOTHES BARS, SLIDING CLOTHES RAILS, CLOTHES RODS AND STORAGE RACKS (U.S. CLS. 2, 13, 22, 25, 32 AND 50).

FIRST USE 11-20-2006; IN COMMERCE 12-21-2006.
GINA FINK, EXAMINING ATTORNEY

SN 77-915,413. SAVANH, BOBBY B, PORTLAND, OR. FILED 1-19-2010.

MAGIC LIFT

THE MARK CONSISTS OF STANDARD CHARACTERS WITHOUT CLAIM TO ANY PARTICULAR FONT, STYLE, SIZE, OR COLOR.

NO CLAIM IS MADE TO THE EXCLUSIVE RIGHT TO USE "LIFT", APART FROM THE MARK AS SHOWN.

FOR ADJUSTABLE BAR HANGERS NOT OF METAL FOR FLUORESCENT LIGHTING FIXTURES, LAMPS AND REFLECTORS FOR USE IN HORTICULTURE AND HYDROPONICS (U.S. CLS. 2, 13, 22, 25, 32 AND 50).
TARA PATE, EXAMINING ATTORNEY

SN 77-920,846. KURT LING, DBA CUSTOMER KINETICS, ALPHARETTA, GA. FILED 1-26-2010.

**PURE LATEXBLISS THE
WORLD'S BEST BEDS**

THE MARK CONSISTS OF STANDARD CHARACTERS WITHOUT CLAIM TO ANY PARTICULAR FONT, STYLE, SIZE, OR COLOR.

NO CLAIM IS MADE TO THE EXCLUSIVE RIGHT TO USE "THE WORLD'S BEST BEDS", APART FROM THE MARK AS SHOWN.

FOR MATTRESSES AND PILLOWS (U.S. CLS. 2, 13, 22, 25, 32 AND 50).

SUE LAWRENCE, EXAMINING ATTORNEY

CLASS 20—(Continued).

SN 77-921,551. CAVALIER PRODUCTS, INC, PIQUA, OH. FILED 1-27-2010.



NO CLAIM IS MADE TO THE EXCLUSIVE RIGHT TO USE "HI-TEMP", "HEARTH & INDUSTRIAL GLASS COMPANY" AND "GLASS", APART FROM THE MARK AS SHOWN.

THE MARK CONSISTS OF THE LITERAL ELEMENT "CPI" FOLLOWED BY THE LITERAL ELEMENT "HI-TEMP" BELOW WHICH APPEARS THE LITERAL ELEMENTS "HEARTH & INDUSTRIAL" APPEARING ABOVE "GLASS COMPANY". TO THE RIGHT OF THE LITERAL ELEMENTS "HEARTH & INDUSTRIAL" AND "GLASS COMPANY" APPEARS THE LITERAL ELEMENT "GLASS" WITH FLAMES COMING FROM THE TOP OF THE TWO "SS".

FOR FIREPLACE SCREENS AND GLASS DOORS FOR FIREPLACES FOR SCREENING PURPOSES (U.S. CLS. 2, 13, 22, 25, 32 AND 50).

THOMAS MANOR, EXAMINING ATTORNEY

SN 77-921,706. INTERCON INCORPORATED, SALT LAKE CITY, UT. FILED 1-27-2010.

Imagio Home

THE MARK CONSISTS OF STANDARD CHARACTERS WITHOUT CLAIM TO ANY PARTICULAR FONT, STYLE, SIZE, OR COLOR.

NO CLAIM IS MADE TO THE EXCLUSIVE RIGHT TO USE "HOME", APART FROM THE MARK AS SHOWN.

THE WORDING "IMAGIO" HAS NO MEANING IN A FOREIGN LANGUAGE.

FOR FURNITURE (U.S. CLS. 2, 13, 22, 25, 32 AND 50).
FIRST USE 11-10-2009; IN COMMERCE 11-17-2009.

HENRY S. ZAK, EXAMINING ATTORNEY

CLASS 20—(Continued).

SN 77-923,840. ARCHTECH ELECTRONICS CORP, DAYTON, NJ. FILED 1-29-2010.



THE COLOR(S) BLUE, RED AND DARK BLUE IS/ARE CLAIMED AS A FEATURE OF THE MARK.
 THE MARK CONSISTS OF THE STYLIZED TEXT "NET-LOCK", WITH "NET" IN BLUE, "LOCK" IN RED, AND A DARK BLUE HYPHEN. ABOVE THE TEXT IS A DARK BLUE OUTLINE OF A CONNECTOR PLUG.
 FOR LOCKS OF PLASTIC FOR ELECTRICAL AND COMMUNICATION NETWORK CABLE CONNECTORS (U.S. CLS. 2, 13, 22, 25, 32 AND 50).
 REBECCA EISINGER, EXAMINING ATTORNEY

SN 77-924,003. SMITH DRAPERIES, INC., DBA STEVENSON & VESTAL, BURLINGTON, NC. FILED 1-29-2010.

Safe-T-Shade

THE MARK CONSISTS OF STANDARD CHARACTERS WITHOUT CLAIM TO ANY PARTICULAR FONT, STYLE, SIZE, OR COLOR.
 FOR WINDOW SHADES (U.S. CLS. 2, 13, 22, 25, 32 AND 50).
 CHERYL CLAYTON, EXAMINING ATTORNEY

SN 77-924,920. CAL-MARBLE FURN. MFG. CORP., SOUTH EL MONTE, CA. FILED 2-1-2010.

CREATIVITY WITH A CAUSE

THE MARK CONSISTS OF STANDARD CHARACTERS WITHOUT CLAIM TO ANY PARTICULAR FONT, STYLE, SIZE, OR COLOR.
 FOR FURNITURE (U.S. CLS. 2, 13, 22, 25, 32 AND 50).
 FIRST USE 10-16-2009; IN COMMERCE 10-16-2009.
 BRENDAN REGAN, EXAMINING ATTORNEY

CLASS 20—(Continued).

SN 77-926,296. GO-TO-PLASTICS, INC., EDMONDS, WA. FILED 2-2-2010.



NO CLAIM IS MADE TO THE EXCLUSIVE RIGHT TO USE "TANKS", APART FROM THE MARK AS SHOWN.
 FOR WATER TANKS OF PLASTIC FOR HOUSEHOLD, INDUSTRIAL, AND AGRICULTURAL PURPOSES (U.S. CLS. 2, 13, 22, 25, 32 AND 50).
 FIRST USE 9-26-2007; IN COMMERCE 9-26-2007.
 RAUL CORDOVA, EXAMINING ATTORNEY

SN 77-926,974. LAWRENCE INDUSTRIES, INC., THOMASVILLE, NC. FILED 2-3-2010.

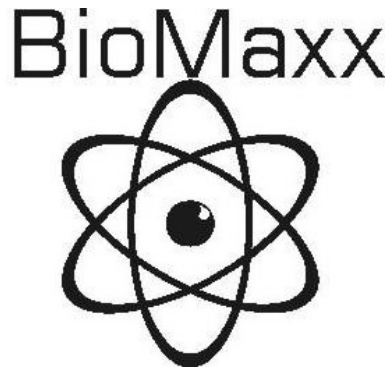

THE MARK CONSISTS OF THE TERM "BIOMAXX" OVER A NUCLEUS WITH THREE INTERSECTING CIRCLES.
 FOR NON-METAL WINDOW HARDWARE, NAMELY, LATCHES AND LOCKS (U.S. CLS. 2, 13, 22, 25, 32 AND 50).
 VIVIAN MICZNIK FIRST, EXAMINING ATTORNEY

SN 77-927,300. BROOKE MEDLOCK, OMAHA, NE. FILED 2-3-2010.

THE FACELIFT PILLOW

THE MARK CONSISTS OF STANDARD CHARACTERS WITHOUT CLAIM TO ANY PARTICULAR FONT, STYLE, SIZE, OR COLOR.
 NO CLAIM IS MADE TO THE EXCLUSIVE RIGHT TO USE "PILLOW", APART FROM THE MARK AS SHOWN.
 FOR PILLOWS (U.S. CLS. 2, 13, 22, 25, 32 AND 50).
 MARK SHINER, EXAMINING ATTORNEY

CLASS 20—(Continued).

SN 77-927,942. THAYER COGGIN, INC., HIGH POINT, NC.
FILED 2-4-2010.

Thayer Coggin

THE MARK CONSISTS OF STANDARD CHARACTERS WITHOUT CLAIM TO ANY PARTICULAR FONT, STYLE, SIZE, OR COLOR.

THE NAME(S), PORTRAIT(S), AND/OR SIGNATURE(S) SHOWN IN THE MARK DOES NOT IDENTIFY A PARTICULAR LIVING INDIVIDUAL.

FOR FURNITURE (U.S. CLS. 2, 13, 22, 25, 32 AND 50).
FIRST USE 0-0-1953; IN COMMERCE 0-0-1953.
MARK T. MULLEN, EXAMINING ATTORNEY

SN 77-928,625. CHAFFEE, KEVIN R., BATESVILLE, IN.
FILED 2-4-2010.

ENVIROTANK

THE MARK CONSISTS OF STANDARD CHARACTERS WITHOUT CLAIM TO ANY PARTICULAR FONT, STYLE, SIZE, OR COLOR.

FOR WATER TANKS OF PLASTIC FOR HOUSEHOLD, INDUSTRIAL, AND AGRICULTURAL PURPOSES (U.S. CLS. 2, 13, 22, 25, 32 AND 50).

FLORENTINA BLANDU, EXAMINING ATTORNEY

SN 77-928,915. DORYA USA, LLC, DBA DORYA INTERIORS, PALM BEACH, FL. FILED 2-5-2010.

DORYA

THE MARK CONSISTS OF STANDARD CHARACTERS WITHOUT CLAIM TO ANY PARTICULAR FONT, STYLE, SIZE, OR COLOR.

FOR FURNITURE (U.S. CLS. 2, 13, 22, 25, 32 AND 50).
BRIDGETT SMITH, EXAMINING ATTORNEY

CLASS 20—(Continued).

SN 77-928,986. WHEELER, MICHAEL, STONY BROOK, NY.
FILED 2-5-2010.

WALLBALLS

THE MARK CONSISTS OF STANDARD CHARACTERS WITHOUT CLAIM TO ANY PARTICULAR FONT, STYLE, SIZE, OR COLOR.

FOR HAT RACKS (U.S. CLS. 2, 13, 22, 25, 32 AND 50).
GEORGE LORENZO, EXAMINING ATTORNEY

SN 77-929,430. DREAMWELL, LTD., LAS VEGAS, NV. FILED 2-5-2010.

BETTER SLEEP FOR THE TWO OF YOU

THE MARK CONSISTS OF STANDARD CHARACTERS WITHOUT CLAIM TO ANY PARTICULAR FONT, STYLE, SIZE, OR COLOR.

FOR MATTRESSES AND BOX SPRINGS (U.S. CLS. 2, 13, 22, 25, 32 AND 50).

ANDREA SAUNDERS, EXAMINING ATTORNEY

SN 77-929,569. LAFEVER, KEVIN, FAIRFAX, VA. FILED 2-5-2010.

RED TAIL WOODS
KEVIN LAFEVER



NO CLAIM IS MADE TO THE EXCLUSIVE RIGHT TO USE "WOODS", APART FROM THE MARK AS SHOWN.

THE NAME "KEVIN LAFEVER" IDENTIFIES A LIVING INDIVIDUAL WHOSE CONSENT IS OF RECORD.

THE MARK CONSISTS OF THE STYLIZED TEXT "RED TAIL WOODS KEVIN LAFEVER" WITH A HAWK IN THE MIDDLE.

FOR FURNITURE (U.S. CLS. 2, 13, 22, 25, 32 AND 50).
FIRST USE 9-22-2005; IN COMMERCE 9-22-2005.
ROBIN MITTLER, EXAMINING ATTORNEY

CLASS 20—(Continued).

SN 77-930,670. ESTEE BEDDING COMPANY, CHICAGO, IL.
FILED 2-8-2010.

MADE TO RIDE

THE MARK CONSISTS OF STANDARD CHARACTERS WITHOUT CLAIM TO ANY PARTICULAR FONT, STYLE, SIZE, OR COLOR.

FOR MATTRESSES FOR TRUCK SLEEPER CABS (U.S. CLS. 2, 13, 22, 25, 32 AND 50).

JAMES LOVELACE, EXAMINING ATTORNEY

SN 77-930,826. HIP HOORAY LLC, MINNEAPOLIS, MN.
FILED 2-8-2010.

THE MARK CONSISTS OF THE STYLIZED WORDS "HIP HOORAY" IN WHICH THE "I" IS REPLACED WITH "!" AND WHERE "HOO" APPEARS ABOVE "RAY", WHERE "HIP" APPEARS IN LARGER TEXT AND TO THE LEFT.

FOR (BASED ON USE IN COMMERCE) PLASTIC BANNERS; PLASTIC PENNANTS (BASED ON INTENT TO USE) DECORATIVE MOBILES; FIGURES OF WOOD; STATUETTES OF WOOD (U.S. CLS. 2, 13, 22, 25, 32 AND 50).

FIRST USE 1-4-2010; IN COMMERCE 2-1-2010.
ADA HAN, EXAMINING ATTORNEY

SN 77-931,458. KEETSA, INC., SAN FRANCISCO, CA. FILED
2-9-2010.

The Keetsa Pillow Plus

THE MARK CONSISTS OF STANDARD CHARACTERS WITHOUT CLAIM TO ANY PARTICULAR FONT, STYLE, SIZE, OR COLOR.

OWNER OF U.S. REG. NOS. 3,488,163 AND 3,712,756.

NO CLAIM IS MADE TO THE EXCLUSIVE RIGHT TO USE "PILLOW", APART FROM THE MARK AS SHOWN.

THE WORDING "KEETSA" HAS NO MEANING IN A FOREIGN LANGUAGE.

FOR BEDS, MATTRESSES, PILLOWS AND BOLSTERS; MATTRESSES; MATTRESSES AND PILLOWS; SLEEP PRODUCTS, NAMELY, MATTRESSES, SPRING MATTRESSES, BOX SPRINGS AND MATTRESS FOUNDATIONS; SPRING MATTRESSES (U.S. CLS. 2, 13, 22, 25, 32 AND 50).

FIRST USE 12-1-2009; IN COMMERCE 12-15-2009.
KELLEY WELLS, EXAMINING ATTORNEY

CLASS 20—(Continued).

SN 77-931,507. GINOCCHIO, MARK H., ST. PETERSBURG, FL. FILED 2-9-2010.

TUFF CUFF

THE MARK CONSISTS OF STANDARD CHARACTERS WITHOUT CLAIM TO ANY PARTICULAR FONT, STYLE, SIZE, OR COLOR.

FOR NON-METAL CLAMPS, CLASPS AND CLIPS FOR BUNDLING OF LOOSE AND/OR CONTINUOUS MATERIAL, SUCH AS CABLE, CORD, EXTRUSIONS, TUBING, FOLIAGE, METAL, PAPER, PLASTIC, ROPES, TEXTILES, WIRE AND WOOD (U.S. CLS. 2, 13, 22, 25, 32 AND 50).

TEJBIR SINGH, EXAMINING ATTORNEY

SN 77-931,549. JOHNSON HEALTH TECH NORTH AMERICA, INC., COTTAGE GROVE, WI. FILED 2-9-2010.

Inner Balance

THE MARK CONSISTS OF STANDARD CHARACTERS WITHOUT CLAIM TO ANY PARTICULAR FONT, STYLE, SIZE, OR COLOR.

FOR CHAIRS; COUCHES; CUSHIONS; EASY-CHAIRS; FOOT RESTS; FOOT STOOLS; FURNITURE; INFLATABLE FURNITURE; INFLATABLE NECK SUPPORT CUSHIONS; INFLATABLE PILLOWS; LIVING ROOM FURNITURE; LOUNGE CHAIRS; LOVE SEATS; NECK SUPPORT CUSHIONS; NECK-SUPPORTING PILLOWS; PORCH SWINGS; RECLINERS; RECLINING ARM-CHAIRS; RECLINING CHAIRS; RESIDENTIAL AND COMMERCIAL FURNITURE; SEAT CUSHIONS; SEATING FURNITURE; SEATS; SOFAS; UPHOLSTERED FURNITURE (U.S. CLS. 2, 13, 22, 25, 32 AND 50).

PAUL CROWLEY, EXAMINING ATTORNEY

SN 77-931,725. ESTEE BEDDING COMPANY, CHICAGO, IL.
FILED 2-9-2010.

ECO-RIDE

THE MARK CONSISTS OF STANDARD CHARACTERS WITHOUT CLAIM TO ANY PARTICULAR FONT, STYLE, SIZE, OR COLOR.

FOR MATTRESSES FOR TRUCK SLEEPER CABS (U.S. CLS. 2, 13, 22, 25, 32 AND 50).

JAMES LOVELACE, EXAMINING ATTORNEY

CLASS 20—(Continued).

SN 77-932,094. CHEERFUL CHILD, WALNUT CREEK, CA.
FILED 2-9-2010.

Cheerful Child

THE MARK CONSISTS OF STANDARD CHARACTERS WITHOUT CLAIM TO ANY PARTICULAR FONT, STYLE, SIZE, OR COLOR.

NO CLAIM IS MADE TO THE EXCLUSIVE RIGHT TO USE "CHILD", APART FROM THE MARK AS SHOWN.

FOR MULTI-PURPOSE, PORTABLE AND FOLDABLE HEAT-RESISTANT INFANT AND CHILD MAT, THAT CAN BE USED TO LAY OVER AN INFANT/CHILD'S CAR SEAT, AND FORM-FIT INTO A BUCKET-SHAPE FOR INSERTION INTO A BUCKET SWING, A RESTAURANT HIGH CHAIR, AND SHOPPING CART SEAT, WITH THE ADDITIONAL USE AS A BABY CHANGING PAD WHEN FLIPPED ONTO THE OTHER SIDE (U.S. CLS. 2, 13, 22, 25, 32 AND 50).

REBECCA GILBERT, EXAMINING ATTORNEY

SN 77-932,484. KILBANE, MARGARET M., DETROIT LAKES, MN. FILED 2-10-2010.

LAKEGIRL

THE MARK CONSISTS OF STANDARD CHARACTERS WITHOUT CLAIM TO ANY PARTICULAR FONT, STYLE, SIZE, OR COLOR.

OWNER OF U.S. REG. NOS. 3,062,427, 3,411,417 AND 3,494,644.

FOR PICTURE FRAMES, PILLOWS (U.S. CLS. 2, 13, 22, 25, 32 AND 50).

JENNY PARK, EXAMINING ATTORNEY

SN 77-936,645. BRENDA LEE WELLS, STATEN ISLAND, NY.
FILED 2-16-2010.

Brenda Lee

THE MARK CONSISTS OF STANDARD CHARACTERS WITHOUT CLAIM TO ANY PARTICULAR FONT, STYLE, SIZE, OR COLOR.

THE NAME "BRENDA LEE" IDENTIFIES "BRENDA LEE WELLS", WHOSE CONSENT IS PRESUMED.

FOR BEAUTY SALON FURNITURE, NAMELY, STYLING STATIONS (U.S. CLS. 2, 13, 22, 25, 32 AND 50).

ROBERT C. CLARK JR., EXAMINING ATTORNEY

CLASS 20—(Continued).

SN 77-941,781. STEELCASE INC., GRAND RAPIDS, MI.
FILED 2-22-2010.

DENIZEN

THE MARK CONSISTS OF STANDARD CHARACTERS WITHOUT CLAIM TO ANY PARTICULAR FONT, STYLE, SIZE, OR COLOR.

FOR FURNITURE FOR OFFICE AND HOME OFFICE ENVIRONMENTS (U.S. CLS. 2, 13, 22, 25, 32 AND 50).

FIRST USE 6-12-2009; IN COMMERCE 6-12-2009.

JULIE VEPPUMTHARA, EXAMINING ATTORNEY

SN 77-941,854. STEELCASE INC., GRAND RAPIDS, MI.
FILED 2-22-2010.

NODE

THE MARK CONSISTS OF STANDARD CHARACTERS WITHOUT CLAIM TO ANY PARTICULAR FONT, STYLE, SIZE, OR COLOR.

FOR FURNITURE FOR OFFICE AND EDUCATIONAL ENVIRONMENTS (U.S. CLS. 2, 13, 22, 25, 32 AND 50).

JULIE VEPPUMTHARA, EXAMINING ATTORNEY

SN 77-943,569. DORYA USA, LLC, DBA DORYA INTERIORS, PALM BEACH, FL. FILED 2-24-2010.

LIVING EXCELLENCE

THE MARK CONSISTS OF STANDARD CHARACTERS WITHOUT CLAIM TO ANY PARTICULAR FONT, STYLE, SIZE, OR COLOR.

FOR FURNITURE (U.S. CLS. 2, 13, 22, 25, 32 AND 50).

BRIDGETT SMITH, EXAMINING ATTORNEY

CLASS 20—(Continued).

SN 77-944,048. BUILD-A-BEAR RETAIL MANAGEMENT, INC., ST. LOUIS, MO. FILED 2-24-2010.

COMFY STUFF BY
BUILD-A-BEAR WORKSHOP

THE MARK CONSISTS OF STANDARD CHARACTERS WITHOUT CLAIM TO ANY PARTICULAR FONT, STYLE, SIZE, OR COLOR.
OWNER OF U.S. REG. NOS. 2,722,224, 2,843,811 AND OTHERS.
FOR PILLOWS (U.S. CLS. 2, 13, 22, 25, 32 AND 50).
ALICIA COLLINS, EXAMINING ATTORNEY

CLASS 20—(Continued).

SN 77-947,627. DREAMWELL, LTD., LAS VEGAS, NV. FILED 3-1-2010.

BEAUTYSOFT

THE MARK CONSISTS OF STANDARD CHARACTERS WITHOUT CLAIM TO ANY PARTICULAR FONT, STYLE, SIZE, OR COLOR.
FOR MATTRESSES AND BOX SPRINGS (U.S. CLS. 2, 13, 22, 25, 32 AND 50).
ANDREA SAUNDERS, EXAMINING ATTORNEY

SN 77-945,482. FREMANTLEMEDIA NORTH AMERICA, INC., BURBANK, CA. FILED 2-25-2010.

AMERICAN IDOL

THE MARK CONSISTS OF STANDARD CHARACTERS WITHOUT CLAIM TO ANY PARTICULAR FONT, STYLE, SIZE, OR COLOR.
OWNER OF U.S. REG. NOS. 3,257,662, 3,683,826 AND OTHERS.
FOR PARTY ORNAMENTS OF PLASTIC; VINYL BANNERS (U.S. CLS. 2, 13, 22, 25, 32 AND 50).
FIRST USE 3-1-2006; IN COMMERCE 3-1-2006.
AMEEN IMAM, EXAMINING ATTORNEY

SN 77-961,079. VIA, INC., SPARKS, NV. FILED 3-17-2010.

DUALITY

THE MARK CONSISTS OF STANDARD CHARACTERS WITHOUT CLAIM TO ANY PARTICULAR FONT, STYLE, SIZE, OR COLOR.
FOR OFFICE FURNITURE (U.S. CLS. 2, 13, 22, 25, 32 AND 50).
JUDITH HELFMAN, EXAMINING ATTORNEY

SN 77-947,291. DREAMWELL, LTD., LAS VEGAS, NV. FILED 3-1-2010.

QUINTESSENCE

THE MARK CONSISTS OF STANDARD CHARACTERS WITHOUT CLAIM TO ANY PARTICULAR FONT, STYLE, SIZE, OR COLOR.
FOR MATTRESSES AND BOX SPRINGS (U.S. CLS. 2, 13, 22, 25, 32 AND 50).
ANDREA SAUNDERS, EXAMINING ATTORNEY

SN 77-966,280. AMERICAN RECREATION PRODUCTS, INC., CHESTERFIELD, MO. FILED 3-23-2010.

KELTY - THE ACTIVE FAMILY
EXPERTS

THE MARK CONSISTS OF STANDARD CHARACTERS WITHOUT CLAIM TO ANY PARTICULAR FONT, STYLE, SIZE, OR COLOR.
OWNER OF U.S. REG. NOS. 1,059,258, 1,294,302 AND OTHERS.
FOR FURNITURE FOR CAMPING; OUTDOOR FURNITURE; SLEEPING BAGS (U.S. CLS. 2, 13, 22, 25, 32 AND 50).
JAMES LOVELACE, EXAMINING ATTORNEY

CLASS 20—(Continued).

SN 77-967,524. VITRA PATENTE AG, CH-4127 BIRSFELDEN, SWITZERLAND, FILED 3-24-2010.



THE MARK CONSISTS OF THE CONFIGURATION OF A CHAIR.

SEC. 2(F).

FOR CHAIRS (U.S. CLS. 2, 13, 22, 25, 32 AND 50).

FIRST USE 0-0-1974; IN COMMERCE 0-0-1974.

LINDA MICKLEBURGH, EXAMINING ATTORNEY

SN 77-979,558. JAB DISTRIBUTORS LLC, GLENVIEW, IL. FILED 3-5-2008.

PROTECT-A-PILLOW

THE MARK CONSISTS OF STANDARD CHARACTERS WITHOUT CLAIM TO ANY PARTICULAR FONT, STYLE, SIZE, OR COLOR.

FOR PILLOWS (U.S. CLS. 2, 13, 22, 25, 32 AND 50).

RUSS HERMAN, EXAMINING ATTORNEY

SN 79-068,470. SHENZHENSHI RENHAO JIAJU; FAZHAN YOUXIAN GONGSI, CHINA, FILED 4-7-2009.

D.N.Y 迪诺雅

OWNER OF INTERNATIONAL REGISTRATION 1001854 DATED 4-7-2009, EXPIRES 4-7-2019.

THE ENGLISH TRANSLATION OF THE FOREIGN WORD(S) IN THE MARK IS "ENLIGHTEN, PROMISE" AND "ELEGANT".

THE TRANSLITERATION OF THE NON-LATIN CHARACTERS IN THE MARK IS "DI NUO YA".

FOR FURNITURE; LETTER BOXES, NOT OF METAL OR MASONRY; INFLATABLE PUBLICITY OBJECTS; FURNITURE PARTITIONS OF WOOD; WORK BENCHES; PILLOWS; SLATTED INDOOR BLINDS (U.S. CLS. 2, 13, 22, 25, 32 AND 50).

ANNE FARRELL, EXAMINING ATTORNEY

CLASS 20—(Continued).

SN 85-021,385. PACIFIC WORLD CORPORATION, LAKE FOREST, CA. FILED 4-23-2010.

GEO GIRL

THE MARK CONSISTS OF STANDARD CHARACTERS WITHOUT CLAIM TO ANY PARTICULAR FONT, STYLE, SIZE, OR COLOR.

FOR FOAM TOE SEPARATORS FOR USE IN PEDICURES (U.S. CLS. 2, 13, 22, 25, 32 AND 50).

JOHN HWANG, EXAMINING ATTORNEY

CLASS 21—HOUSEWARES AND GLASS

SN 76-701,195. UNIQUE INDUSTRIES, INC., PHILADELPHIA, PA. FILED 1-14-2010.

PREMIER STYLZ

THE MARK CONSISTS OF STANDARD CHARACTERS WITHOUT CLAIM TO ANY PARTICULAR FONT, STYLE, SIZE, OR COLOR.

OWNER OF U.S. REG. NO. 3,219,279.

FOR PLASTIC PLATES AND PLASTIC BEVERAGEWARE (U.S. CLS. 2, 13, 23, 29, 30, 33, 40 AND 50).

FIRST USE 10-2-2009; IN COMMERCE 10-2-2009.

CARYN GLASSER, EXAMINING ATTORNEY

SN 77-527,717. BLO PLASTIX INC., VANCOUVER, CANADA, FILED 7-21-2008.

blō

PRIORITY CLAIMED UNDER SEC. 44(D) ON CANADA APPLICATION NO. 1402001, FILED 7-3-2008, REG. NO. TMA760,647, DATED 3-2-2010, EXPIRES 3-2-2025.

THE MARK CONSISTS OF THE WORD "BLO" WITH A STRAIGHT HORIZONTAL LINE OVER THE LETTER "O". FOR PLASTIC BOTTLES, SOLD EMPTY (U.S. CLS. 2, 13, 23, 29, 30, 33, 40 AND 50).

FIRST USE 6-0-2002; IN COMMERCE 6-0-2002.

RON FAIRBANKS, EXAMINING ATTORNEY

CLASS 21—(Continued).

SN 77-652,180. HANCHANG PAPER CO., LTD., GYEONG-SANGNAM-DO, REPUBLIC OF KOREA, FILED 1-19-2009.



OWNER OF REPUBLIC OF KOREA REG. NO. 812429, DATED 1-25-2010, EXPIRES 1-25-2020.

THE COLOR(S) GREEN AND WHITE IS/ARE CLAIMED AS A FEATURE OF THE MARK.

THE MARK CONSISTS OF THE WORDING "GREENUS" IN GREEN LETTERS, THE BACKGROUND OF THE TREE IS GREEN, THE TREE, LEAVES AND BIRD ARE WHITE.

FOR PAPER CUPS AND LIDS THEREFOR, COATED WITH PLA (POLYLACTIC ACID) (U.S. CLS. 2, 13, 23, 29, 30, 33, 40 AND 50).

EUGENIA MARTIN, EXAMINING ATTORNEY

SN 77-683,265. 2193928 ONTARIO LIMITED, WOODBRIDGE, CANADA, FILED 3-4-2009.



PRIORITY CLAIMED UNDER SEC. 44(D) ON CANADA APPLICATION NO. 1426331, FILED 1-30-2009, REG. NO. 762921, DATED 3-30-2010, EXPIRES 3-30-2025.

NO CLAIM IS MADE TO THE EXCLUSIVE RIGHT TO USE "SERVING", APART FROM THE MARK AS SHOWN.

THE MARK CONSISTS OF A DESIGN OF A SERVING TRAY WITH THE WORDS "SERVING SOLUTIONS" IN THE CENTER OF THE DESIGN.

FOR PLASTIC FOOD TRAYS (U.S. CLS. 2, 13, 23, 29, 30, 33, 40 AND 50).

DAVID MURRAY, EXAMINING ATTORNEY

CLASS 21—(Continued).

SN 77-683,393. 2193928 ONTARIO LIMITED, WOODBRIDGE, CANADA, FILED 3-4-2009.

SERVING SOLUTIONS

THE MARK CONSISTS OF STANDARD CHARACTERS WITHOUT CLAIM TO ANY PARTICULAR FONT, STYLE, SIZE, OR COLOR.

PRIORITY CLAIMED UNDER SEC. 44(D) ON CANADA APPLICATION NO. 1426335, FILED 1-30-2009, REG. NO. 762922, DATED 3-30-2010, EXPIRES 3-30-2025.

NO CLAIM IS MADE TO THE EXCLUSIVE RIGHT TO USE "SERVING", APART FROM THE MARK AS SHOWN.

FOR PLASTIC FOOD TRAYS (U.S. CLS. 2, 13, 23, 29, 30, 33, 40 AND 50).

DAVID MURRAY, EXAMINING ATTORNEY

SN 77-699,002. NATURALYARDS, LLC, ASHLAND, OR, FILED 3-25-2009.

NATURALYARDS

THE MARK CONSISTS OF STANDARD CHARACTERS WITHOUT CLAIM TO ANY PARTICULAR FONT, STYLE, SIZE, OR COLOR.

FOR PLANTERS FOR PLANTS, FLOWERS, TREES AND SHRUBS; EQUIPMENT FOR GARDEN PLANTING, NAMELY, PLANTERS FOR FLOWERS AND PLANTS WHICH CAN BE SEPARATELY COMBINED WITH OPTIONAL EQUIPMENT FOR IRRIGATION; PLANTERS FOR FLOWERS AND PLANTS COMPRISING PLANTERS AND ATTACHED TRELLIS; KITS FOR MAKING RAISED PLANTERS FOR FLOWERS AND PLANTS (U.S. CLS. 2, 13, 23, 29, 30, 33, 40 AND 50).

AARON BRODSKY, EXAMINING ATTORNEY

SN 77-748,701. FOUNTAIN OF YOU, INC., DBA PARISIAN SLIM, EXTON, PA. FILED 6-1-2009.

PARISIAN SLIM

THE MARK CONSISTS OF STANDARD CHARACTERS WITHOUT CLAIM TO ANY PARTICULAR FONT, STYLE, SIZE, OR COLOR.

NO CLAIM IS MADE TO THE EXCLUSIVE RIGHT TO USE "PARISIAN", APART FROM THE MARK AS SHOWN.

FOR TABLEWARE, NAMELY, PLATES, BOWLS, CUPS, SERVING PLATTERS, SERVING BOWLS, SAUCERS, MUGS, DRINKING GLASSES, PLASTIC WATER BOTTLES SOLD EMPTY, SERVINGWARE FOR SERVING FOOD; RECIPE BOXES (U.S. CLS. 2, 13, 23, 29, 30, 33, 40 AND 50).

JAMES A. RAUEN, EXAMINING ATTORNEY

CLASS 21—(Continued).

SN 77-760,781. G&S METAL PRODUCTS COMPANY, INC., CLEVELAND, OH. FILED 6-16-2009.

CHILL & CARRY

THE MARK CONSISTS OF STANDARD CHARACTERS WITHOUT CLAIM TO ANY PARTICULAR FONT, STYLE, SIZE, OR COLOR.

FOR HOUSEHOLD CONTAINERS FOR FOOD (U.S. CLS. 2, 13, 23, 29, 30, 33, 40 AND 50).

JOHN DALIER, EXAMINING ATTORNEY

SN 77-797,972. LANITA COX, SUWANEE, GA. FILED 8-5-2009.

LANITA WARE

THE MARK CONSISTS OF STANDARD CHARACTERS WITHOUT CLAIM TO ANY PARTICULAR FONT, STYLE, SIZE, OR COLOR.

NO CLAIM IS MADE TO THE EXCLUSIVE RIGHT TO USE "WARE", APART FROM THE MARK AS SHOWN.

FOR DINNERWARE, NAMELY, PLATES, STEAMWARE, NAMELY, CHAMPAGNE FLUTES, WINE GLASSES, MARTINI GLASSES, AND TUMBLERS (U.S. CLS. 2, 13, 23, 29, 30, 33, 40 AND 50).

REBECCA GILBERT, EXAMINING ATTORNEY

SN 77-798,194. ARCHER JR., JAMES B. GOLDEN, CO. FILED 8-5-2009.

EASY HEALTHY GREEN

THE MARK CONSISTS OF STANDARD CHARACTERS WITHOUT CLAIM TO ANY PARTICULAR FONT, STYLE, SIZE, OR COLOR.

NO CLAIM IS MADE TO THE EXCLUSIVE RIGHT TO USE "GREEN", APART FROM THE MARK AS SHOWN.

FOR HOUSEHOLD UTENSILS, NAMELY, KITCHEN TOOLS IN THE NATURE OF SPOUTS FOR POURING AND STRAINING (U.S. CLS. 2, 13, 23, 29, 30, 33, 40 AND 50).

FIRST USE 8-5-2009; IN COMMERCE 8-5-2009.
JENNIFER VASQUEZ, EXAMINING ATTORNEY

CLASS 21—(Continued).

SN 77-823,425. HIP INNOVATIONS, LLC, WILLISTON, VT. FILED 9-10-2009.



NO CLAIM IS MADE TO THE EXCLUSIVE RIGHT TO USE "MEATBALL", APART FROM THE MARK AS SHOWN. THE MARK CONSISTS OF "MEATBALL EXPRESS" IN STYLIZED DESIGN WITH A SWIRL.

FOR APPARATUS, NAMELY, A MOLD FOR FORMING BALL-LIKE OR ROUNDISH FOOD PRODUCTS (U.S. CLS. 2, 13, 23, 29, 30, 33, 40 AND 50).

BRIAN NEVILLE, EXAMINING ATTORNEY

SN 77-823,429. HIP INNOVATIONS, LLC, WILLISTON, VT. FILED 9-10-2009.

MEATBALL EXPRESS

THE MARK CONSISTS OF STANDARD CHARACTERS WITHOUT CLAIM TO ANY PARTICULAR FONT, STYLE, SIZE, OR COLOR.

NO CLAIM IS MADE TO THE EXCLUSIVE RIGHT TO USE "MEATBALL", APART FROM THE MARK AS SHOWN.

FOR APPARATUS, NAMELY, A MOLD FOR FORMING BALL-LIKE OR ROUNDISH FOOD PRODUCTS (U.S. CLS. 2, 13, 23, 29, 30, 33, 40 AND 50).

BRIAN NEVILLE, EXAMINING ATTORNEY

SN 77-834,308. HOME BOX OFFICE, INC., NEW YORK, NY. FILED 9-24-2009.

FANGHUNTER

THE MARK CONSISTS OF STANDARD CHARACTERS WITHOUT CLAIM TO ANY PARTICULAR FONT, STYLE, SIZE, OR COLOR.

FOR COSMETIC BRUSHES, EYE SHADOW BRUSHES, EYEBROW BRUSHES, LIP BRUSHES, MAKE-UP BRUSHES, NAIL BRUSHES, POWDER PUFFS; MUGS, DRINKING GLASSES, SHOT GLASSES, DISHES, PLATES, BOWLS, CUPS, SAUCERS AND SERVING TRAYS MADE OF GLASSWARE, PORCELAIN, CERAMIC OR EARTHENWARE; WINE BUCKETS, WINE OPENERS, COOLERS FOR WINE, NON-ELECTRIC COFFEE POTS, COFFEE STIRRERS AND NON-ELECTRICAL COFFEE GRINDERS; HOUSEHOLD UTENSILS, NAMELY, GRATERS, SPATULAS AND ROLLING PINS; CONTAINERS FOR HOUSEHOLD OR KITCHEN USE; PORCELAIN FIGURINES (U.S. CLS. 2, 13, 23, 29, 30, 33, 40 AND 50).

ODESSA BIBBINS, EXAMINING ATTORNEY

CLASS 21—(Continued).

SN 77-836,251. DNC UK LIMITED, WEYBRIDGE, SURREY, UNITED KINGDOM, FILED 9-28-2009.

CLIC-TITE

THE MARK CONSISTS OF STANDARD CHARACTERS WITHOUT CLAIM TO ANY PARTICULAR FONT, STYLE, SIZE, OR COLOR.

PRIORITY CLAIMED UNDER SEC. 44(D) ON ERPN CMNTY TM OFC APPLICATION NO. 008578817, FILED 9-28-2009, REG. NO. 008578817, DATED 3-22-2010, EXPIRES 9-28-2019.

FOR CONTAINERS FOR HOUSEHOLD USE; PLASTIC STORAGE CONTAINERS FOR HOUSEHOLD OR DOMESTIC USE; STRUCTURAL PARTS AND FITTINGS FOR ALL OF THE AFORESAID (U.S. CLS. 2, 13, 23, 29, 30, 33, 40 AND 50).

ROBIN CHOSID, EXAMINING ATTORNEY

CLASS 21—(Continued).

SN 77-851,171. EVRIHOLDER PRODUCTS LLC, ANAHEIM, CA, FILED 10-17-2009.

SOLUTION SOLVER

THE MARK CONSISTS OF STANDARD CHARACTERS WITHOUT CLAIM TO ANY PARTICULAR FONT, STYLE, SIZE, OR COLOR.

FOR NON-ELECTRIC KITCHEN AND HOUSEHOLD TOOLS, NAMELY, DUSTERS, CLEANING CLOTHS AND WINDOW BLIND BRUSHES AND DUSTERS (U.S. CLS. 2, 13, 23, 29, 30, 33, 40 AND 50).

BRIDGETT SMITH, EXAMINING ATTORNEY

SN 77-837,581. SPECIALIZED PACKAGING SOLUTIONS, INC., NEWARK, CA, FILED 9-29-2009.

EZ-Lite Recycler

THE MARK CONSISTS OF STANDARD CHARACTERS WITHOUT CLAIM TO ANY PARTICULAR FONT, STYLE, SIZE, OR COLOR.

NO CLAIM IS MADE TO THE EXCLUSIVE RIGHT TO USE "RECYCLER", APART FROM THE MARK AS SHOWN. FOR RECYCLABLE REFUSE BINS FOR METAL CANS AND OTHER RECYCLABLE ITEMS (U.S. CLS. 2, 13, 23, 29, 30, 33, 40 AND 50).

FIRST USE 11-10-2008; IN COMMERCE 7-31-2009.
ROBIN CHOSID, EXAMINING ATTORNEY

SN 77-842,082. OMNI INTERNATIONAL, LLC, BEDFORD, NH, FILED 10-6-2009.



THE MARK CONSISTS OF A STYLIZED LETTER "O" MORPHED WITH THE LETTER "I" THAT APPEARS AS AN OPEN OVAL WITH A SMALLER CIRCLE ABOVE IT, ALL OF WHICH ENCIRCLES THE CENTER PORTION OF THE WORDING "OMNISAFE".

FOR DISPOSABLE LATEX, VINYL AND NITRILE GLOVES FOR GENERAL USE (U.S. CLS. 2, 13, 23, 29, 30, 33, 40 AND 50).

KAPIL BHANOT, EXAMINING ATTORNEY

SN 77-873,940. THE LIBMAN COMPANY, ARCOLA, IL, FILED 11-17-2009.



THE MARK CONSISTS OF A STYLIZED LEAF.

FOR MOPS, DUST MOPS, FLOOR MOPS, MICROFIBER MOPS, ROLLER MOPS, SPONGE MOPS, SPONGE MOPS FEATURING SCRUB BRUSHES, SPRAY MOPS, STRIP MOPS, TWIST MOPS, WET MOPS, AND REFILLS FOR MOPS; BROOMS, CORN BROOMS, HARD BROOMS, PLASTIC BROOMS, PUSH BROOMS, WHISK BROOMS; BRUSHES, NAMELY, BATH BRUSHES, BRUSHES FOR BOTTLES, BRUSHES FOR PARQUET FLOORS, BRUSHES FOR TILE, BRUSHES FOR VEGETABLES, CLEANING BRUSHES FOR HOUSEHOLD USE, DISHWASHING BRUSHES, DUSTING BRUSHES, FLOOR BRUSHES, GRILL BRUSHES FOR BARBECUE GRILLS, LINT BRUSHES, POT CLEANING BRUSHES, ROOFING BRUSHES, SCRAPING BRUSHES, SCRUBBING BRUSHES, TOILET BRUSHES, WIRE BRUSHES NOT BEING MACHINE PARTS; DUSTERS, FEATHER DUSTERS, MICROFIBER CLEANING DUSTERS; CLEANING SPONGES, MICROFIBER CLEANING SPONGES, SCOURING SPONGES, SCRUB SPONGES, SPONGES FOR HOUSEHOLD PURPOSES, AND REFILLS FOR CLEANING SPONGES; CLEANING CLOTHS, CLEANING PADS, CLOTH FOR WIPING OR DUSTING, DUSTING CLOTHS, MICROFIBER CLEANING CLOTHS; BUCKETS, PAILS, PLASTIC BUCKETS; DUST PANS, DUSTING GLOVES, LINT ROLLERS AND REFILLS FOR LINT ROLLERS, METAL WOOL FOR CLEANING, SCOOPS, SOAP DISPENSERS AND SOAP HOLDERS, SQUEEGEES FOR HOUSEHOLD USE, TOILET BRUSH HOLDERS (U.S. CLS. 2, 13, 23, 29, 30, 33, 40 AND 50).

BERYL GARDNER, EXAMINING ATTORNEY

CLASS 21—(Continued).

SN 77-885,068. DART INDUSTRIES INC., ORLANDO, FL.
FILED 12-3-2009.

FORGET ME NOT

THE MARK CONSISTS OF STANDARD CHARACTERS WITHOUT CLAIM TO ANY PARTICULAR FONT, STYLE, SIZE, OR COLOR.

FOR PLASTIC HOUSEHOLD STORAGE CONTAINERS FOR FOOD (U.S. CLS. 2, 13, 23, 29, 30, 33, 40 AND 50).

FIRST USE 8-7-2000; IN COMMERCE 8-7-2000.
AARON BRODSKY, EXAMINING ATTORNEY

CLASS 21—(Continued).

SN 77-898,101. WAYNE LAPPEMAN, CORAL SPRINGS, FL.
FILED 12-21-2009.

FLIPPIE SPONGE

THE MARK CONSISTS OF STANDARD CHARACTERS WITHOUT CLAIM TO ANY PARTICULAR FONT, STYLE, SIZE, OR COLOR.

NO CLAIM IS MADE TO THE EXCLUSIVE RIGHT TO USE "SPONGE", APART FROM THE MARK AS SHOWN.

FOR SPONGES FOR HOUSEHOLD PURPOSES (U.S. CLS. 2, 13, 23, 29, 30, 33, 40 AND 50).

ROBERT C. CLARK JR., EXAMINING ATTORNEY

SN 77-895,783. JIANGMEN YING YOU TRADING CO., LTD.,
JIANGMEN, GUANGDONG, CHINA, FILED 12-17-2009.



THE NAME "YING YOU" DOES NOT IDENTIFY A LIVING INDIVIDUAL.

THE MARK CONSISTS OF THE LETTERS "YY" IMMEDIATELY NEXT TO AND ABUTTING ONE OTHER AND SURROUNDED BY A BORDER WITH A TRIANGULAR SHAPE ABOVE BOTH LETTERS TO REPRESENT THE APPEARANCE OF A HOUSE.

THE ENGLISH TRANSLATION OF THE WORDING "YING YOU" IN THE MARK IS WINNING AND SMOOTHLY IN BUSINESS.

FOR CRUETS NOT OF PRECIOUS METAL; HOUSEHOLD UTENSILS NOT OF PRECIOUS METAL, NAMELY, POT AND PAN SCRAPERS, ROLLING PINS, SPATULAS, TURNERS, WHISKS, KITCHEN TONGS, GRATERS, SIEVES, STRAINERS, AND SKIMMERS; HAND OPERATED PEPPER MILLS; CONTAINERS FOR HOUSEHOLD OR KITCHEN USE NOT OF PRECIOUS METAL; DINNERWARE; WINE BOTTLE CRADLES; WINE GLASSES; WINE OPENERS; WINE STRAINERS; WINE POURERS; WINE BUCKETS; TEA SERVICES NOT OF PRECIOUS METAL; PAILS; HOLDERS FOR TOILET PAPER; GARBAGE CANS; CLOTHES DRYING RACKS; BATHROOM GLASS HOLDER NOT OF PRECIOUS METAL; BATHROOM PAILS; JUGS NOT OF PRECIOUS METAL; ICE PAILS; ALL-PURPOSE PORTABLE HOUSEHOLD CONTAINERS (U.S. CLS. 2, 13, 23, 29, 30, 33, 40 AND 50).

ELI HELLMAN, EXAMINING ATTORNEY

SN 77-909,535. STONEHOCKER, MITCH, SECAUCUS, NJ.
AND GALAN, CHRISTINE, SECAUCUS, NJ. FILED 1-11-2010.

COOKING COLLAR

THE MARK CONSISTS OF STANDARD CHARACTERS WITHOUT CLAIM TO ANY PARTICULAR FONT, STYLE, SIZE, OR COLOR.

NO CLAIM IS MADE TO THE EXCLUSIVE RIGHT TO USE "COOKING", APART FROM THE MARK AS SHOWN.

FOR REMOVABLE INSULATED COVERS AND WRAPS SPECIFICALLY DESIGNED FOR STOVE TOP POTS AND PANS (U.S. CLS. 2, 13, 23, 29, 30, 33, 40 AND 50).

DEBRA LEE, EXAMINING ATTORNEY

SN 77-915,231. INDUSTRIAL DE ESPUMAS PLASTICAS, S.A.
DE C.V., MEXICO CITY, MEXICO, FILED 1-19-2010.

ALMOND FOODSERVICE

THE MARK CONSISTS OF STANDARD CHARACTERS WITHOUT CLAIM TO ANY PARTICULAR FONT, STYLE, SIZE, OR COLOR.

NO CLAIM IS MADE TO THE EXCLUSIVE RIGHT TO USE "FOODSERVICE", APART FROM THE MARK AS SHOWN.

FOR BOWLS; PLATES (U.S. CLS. 2, 13, 23, 29, 30, 33, 40 AND 50).

KATHERINE M. DUBRAY, EXAMINING ATTORNEY

CLASS 21—(Continued).

SN 77-920,133. BATTAT INCORPORATED, PLATTSBURGH, NY. FILED 1-26-2010.

I-STORE

THE MARK CONSISTS OF STANDARD CHARACTERS WITHOUT CLAIM TO ANY PARTICULAR FONT, STYLE, SIZE, OR COLOR.
FOR PLASTIC STORAGE CONTAINERS FOR DOMESTIC USE (U.S. CLS. 2, 13, 23, 29, 30, 33, 40 AND 50).
AARON BRODSKY, EXAMINING ATTORNEY

SN 77-923,586. GLOBAL TV CONCEPTS, DEERFIELD BEACH, FL. FILED 1-29-2010.

BIG TOP COOKIE

THE MARK CONSISTS OF STANDARD CHARACTERS WITHOUT CLAIM TO ANY PARTICULAR FONT, STYLE, SIZE, OR COLOR.

OWNER OF U.S. REG. NO. 3,724,761.
NO CLAIM IS MADE TO THE EXCLUSIVE RIGHT TO USE "COOKIE", APART FROM THE MARK AS SHOWN.
FOR SILICONE BAKING MOLDS (U.S. CLS. 2, 13, 23, 29, 30, 33, 40 AND 50).
DANIEL CAPSHAW, EXAMINING ATTORNEY

CLASS 21—(Continued).

SN 77-924,513. ZHENSHI HOLDING GROUP CO., LIMITED, TONGXIANG, ZHEJIANG, CHINA, FILED 2-1-2010.



THE MARK CONSISTS OF A DESIGN FORMED BY THE LETTERS "S" AND "Z" TO THE LEFT OF CHINESE CHARACTERS AND THE WORD "ZHENSHI".

THE WORDING "ZHENSHI" HAS NO MEANING IN A FOREIGN LANGUAGE.

THE NON-LATIN CHARACTERS IN THE MARK TRANSLITERATE TO "ZHENSHI" AND THIS HAS NO MEANING IN A FOREIGN LANGUAGE.

FOR COMBS; GLASS BOWLS; GLASS BOWLS FOR LIVE GOLDFISH; GLASS BOXES; GLASS CARAFES; GLASS DISHES; GLASS FIBERS FOR NON-TEXTILE PURPOSES; GLASS THREADS; HOUSEHOLD UTENSILS, NAMELY, GRATERS; HOUSEHOLD UTENSILS, NAMELY, KITCHEN TONGS; HOUSEHOLD UTENSILS, NAMELY, SIEVES; HOUSEHOLD UTENSILS, NAMELY, SKIMMERS; HOUSEHOLD UTENSILS, NAMELY, SPATULAS; HOUSEHOLD UTENSILS, NAMELY, STRAINERS; HOUSEHOLD UTENSILS, NAMELY, TURNERS; PRESSURIZED AND GRAVITY OPERATED WATERING AND NUTRIENT FEEDING CONTAINERS; SYNTHETIC FIBERS FOR THE MANUFACTURE OF BRUSHES, NAMELY, TOOTHBRUSHES, HAIR BRUSHES AND CLEANING BRUSHES; TOOTHBRUSHES; WORKS OF ART MADE OF GLASS; WORKS OF ART MADE OF PORCELAIN (U.S. CLS. 2, 13, 23, 29, 30, 33, 40 AND 50).
FIRST USE 6-16-1992; IN COMMERCE 2-15-2007.

SHANNON TWOHIG, EXAMINING ATTORNEY

SN 77-924,922. POLYTUF BRANDS, INC., CUYAHOGA FALLS, OH. FILED 2-1-2010.

TOP DROP

THE MARK CONSISTS OF STANDARD CHARACTERS WITHOUT CLAIM TO ANY PARTICULAR FONT, STYLE, SIZE, OR COLOR.

FOR DROP CLOTHS (U.S. CLS. 2, 13, 23, 29, 30, 33, 40 AND 50).
FIRST USE 7-23-2009; IN COMMERCE 7-23-2009.
BRENDAN REGAN, EXAMINING ATTORNEY

CLASS 21—(Continued).

SN 77-926,111. BARBARIAN CO., LTD., SUGINAMI-KU; TOKYO, JAPAN, FILED 2-2-2010.

ECOPARADISE

THE MARK CONSISTS OF STANDARD CHARACTERS WITHOUT CLAIM TO ANY PARTICULAR FONT, STYLE, SIZE, OR COLOR.

OWNER OF U.S. REG. NOS. 3,454,214 AND 3,502,103.
FOR CASES OF PLASTIC IN THE NATURE OF PLASTIC CONTAINERS USED TO KEEP FOOD GOODS AND COSMETIC GOODS FRESH FOR HOUSEHOLD USE; CASES OF PLASTIC IN THE NATURE OF PLASTIC CONTAINERS USED TO ACCELERATE THE FERMENTATION PROCESS IN FOOD GOODS AND COSMETIC GOODS FOR HOUSEHOLD USE (U.S. CLS. 2, 13, 23, 29, 30, 33, 40 AND 50).

AMEEN IMAM, EXAMINING ATTORNEY

SN 77-926,551. GARDEN-AIRE, LLC, FINDLAY, OH. FILED 2-3-2010.

GARDEN-AIRE

THE MARK CONSISTS OF STANDARD CHARACTERS WITHOUT CLAIM TO ANY PARTICULAR FONT, STYLE, SIZE, OR COLOR.

FOR PLANTERS FOR FLOWERS AND PLANTS (U.S. CLS. 2, 13, 23, 29, 30, 33, 40 AND 50).
FIRST USE 9-0-2008; IN COMMERCE 9-0-2008.
EDWARD NELSON, EXAMINING ATTORNEY

SN 77-926,730. DOMMERHOLT JOHAN, EPSE, NETHERLANDS, FILED 2-3-2010.

LADY CHAMP

THE MARK CONSISTS OF STANDARD CHARACTERS WITHOUT CLAIM TO ANY PARTICULAR FONT, STYLE, SIZE, OR COLOR.

FOR BATHROOM PAILS; GARBAGE CANS; PAILS; TRASH CANS; TRASH CONTAINERS FOR HOUSEHOLD USE (U.S. CLS. 2, 13, 23, 29, 30, 33, 40 AND 50).

MARIAM MAHMOUDI, EXAMINING ATTORNEY

CLASS 21—(Continued).

SN 77-927,069. SMS VENTURES, LLC, GERMANTOWN, TN. FILED 2-3-2010.

Murphy's Mugs

THE MARK CONSISTS OF STANDARD CHARACTERS WITHOUT CLAIM TO ANY PARTICULAR FONT, STYLE, SIZE, OR COLOR.

NO CLAIM IS MADE TO THE EXCLUSIVE RIGHT TO USE "MUGS", APART FROM THE MARK AS SHOWN.

FOR A SLEEVE WITH HANDLES TO BE PLACED OVER BOTTLES, MUGS, CUPS AND OTHER BEVERAGEWARE (U.S. CLS. 2, 13, 23, 29, 30, 33, 40 AND 50).

FIRST USE 2-1-2010; IN COMMERCE 2-1-2010.
KEVON CHISOLM, EXAMINING ATTORNEY

SN 77-927,144. MAN CAVE, LLC, MINNEAPOLIS, MN. FILED 2-3-2010.

THE KINGS STOCK

THE MARK CONSISTS OF STANDARD CHARACTERS WITHOUT CLAIM TO ANY PARTICULAR FONT, STYLE, SIZE, OR COLOR.

FOR WOOD COOKING PLANKS FOR USE IN GRILLING (U.S. CLS. 2, 13, 23, 29, 30, 33, 40 AND 50).

FIRST USE 4-3-2009; IN COMMERCE 4-3-2009.
MAYUR VAGHANI, EXAMINING ATTORNEY

SN 77-927,724. MYJOY CORPORATION, INC., DBA PEACE PRAYER BOWLS, BASALT, CO. FILED 2-4-2010.



THE MARK CONSISTS OF THE TERMS "EAT IN PEACE" WRITTEN IN A STYLIZED, CURSIVE FONT ABOVE THE DESIGN OF A BOWL BEING SUPPORTED BY TWO OUTSTRETCHED HANDS.

FOR BOWLS (U.S. CLS. 2, 13, 23, 29, 30, 33, 40 AND 50).
FIRST USE 8-31-2007; IN COMMERCE 8-31-2007.
VERNA BETH RIRIE, EXAMINING ATTORNEY

CLASS 21—(Continued).

SN 77-928,119. KOHL'S ILLINOIS, INC., AURORA, IL. FILED 2-4-2010.

THE BIG ONE

THE MARK CONSISTS OF STANDARD CHARACTERS WITHOUT CLAIM TO ANY PARTICULAR FONT, STYLE, SIZE, OR COLOR.

OWNER OF U.S. REG. NOS. 2,811,148, 3,565,050 AND OTHERS.

FOR BARBECUE TOOLS SETS COMPRISED OF COOKING SKEWERS, CORN COB HOLDERS, CLEANING BRUSHES FOR HOUSEHOLD USE, SPATULAS, TONGS, FORKS, BASTING BRUSHES, STEAK KNIVES, AND OVEN MITTS ALL SOLD AS A UNIT (U.S. CLS. 2, 13, 23, 29, 30, 33, 40 AND 50).

JESSICA A. POWERS, EXAMINING ATTORNEY



SN 77-928,752. RANIR, LLC, GRAND RAPIDS, MI. FILED 2-5-2010.

ACCUBRUSH

THE MARK CONSISTS OF STANDARD CHARACTERS WITHOUT CLAIM TO ANY PARTICULAR FONT, STYLE, SIZE, OR COLOR.

FOR MANUAL TOOTHBRUSHES (U.S. CLS. 2, 13, 23, 29, 30, 33, 40 AND 50).

SANJEEV VOHRA, EXAMINING ATTORNEY



SN 77-928,851. BURGER POCKET PRESS CO., DEERFIELD, FL. FILED 2-5-2010.

BURGER POCKET PRESS TAKE YOUR BURGER TO THE EXTREME

THE MARK CONSISTS OF STANDARD CHARACTERS WITHOUT CLAIM TO ANY PARTICULAR FONT, STYLE, SIZE, OR COLOR.

NO CLAIM IS MADE TO THE EXCLUSIVE RIGHT TO USE "BURGER" AND "PRESS", APART FROM THE MARK AS SHOWN.

FOR KITCHEN UTENSILS FOR FORMING A CAVITY IN A GROUND MEAT PRODUCT (U.S. CLS. 2, 13, 23, 29, 30, 33, 40 AND 50).

ESTHER BELENKER, EXAMINING ATTORNEY

CLASS 21—(Continued).

SN 77-929,506. LUSK, SAMANTHA, DBA HY GENIE PRODUCTS, HOUSTON, TX. FILED 2-5-2010.

Wall Buttlер

THE MARK CONSISTS OF STANDARD CHARACTERS WITHOUT CLAIM TO ANY PARTICULAR FONT, STYLE, SIZE, OR COLOR.

FOR DISPENSERS FOR CLEANING AND DISINFECTING SOLUTIONS (U.S. CLS. 2, 13, 23, 29, 30, 33, 40 AND 50).

JENNIFER MARTIN, EXAMINING ATTORNEY



SN 77-929,767. NORA WILLIAMS AND NAOMI YOUNG, AZTEC, NM. FILED 2-6-2010.

LAYNEEBUG

THE MARK CONSISTS OF STANDARD CHARACTERS WITHOUT CLAIM TO ANY PARTICULAR FONT, STYLE, SIZE, OR COLOR.

FOR PILL BOXES FOR PERSONAL USE (U.S. CLS. 2, 13, 23, 29, 30, 33, 40 AND 50).

SANJEEV VOHRA, EXAMINING ATTORNEY



SN 77-929,962. EVRIHOLDER PRODUCTS LLC, ANAHEIM, CA. FILED 2-7-2010.

SweetBake

THE MARK CONSISTS OF STANDARD CHARACTERS WITHOUT CLAIM TO ANY PARTICULAR FONT, STYLE, SIZE, OR COLOR.

FOR PAPER BAKING CUPS (U.S. CLS. 2, 13, 23, 29, 30, 33, 40 AND 50).

CAROLYN CATALDO, EXAMINING ATTORNEY

CLASS 21—(Continued).

SN 77-930,034. JOSHUA CARLSON, DBA OUTVISION INC, FALLBROOK, CA. FILED 2-8-2010.



THE MARK CONSISTS OF THE TERMS "THE GRILLION" WITH AN ONION IN THE LETTER "O".

FOR UTENSILS FOR BARBECUES, NAMELY, FORKS, TONGS, TURNERS (U.S. CLS. 2, 13, 23, 29, 30, 33, 40 AND 50).

Laurie Mayes, Examining Attorney

SN 77-930,212. CARLINO, CRISTINA M., PHOENIX, AZ. FILED 2-8-2010.

ARCHETYPE

THE MARK CONSISTS OF STANDARD CHARACTERS WITHOUT CLAIM TO ANY PARTICULAR FONT, STYLE, SIZE, OR COLOR.

FOR BAKEWARE; BASKETS OF WICKER; BATH BRUSHES; BATH SPONGES; BEVERAGE GLASSWARE; BIRD FEEDERS; BIRD HOUSES; BOWLS; BREAD BOXES; BROOMS; CANDLE HOLDERS; CANDLE SNUFFERS; CANDLESTICKS; CARAFES; CERAMIC FIGURINES; CLEANING SPONGES; COASTERS, NOT OF PAPER AND OTHER THAN TABLE LINEN; CONTAINERS FOR HOUSEHOLD USE; COSMETIC BRUSHES; DECANTERS; DECORATIVE PLATES; DINNERWARE; DISPENSERS FOR FACIAL TISSUES; DISPENSERS FOR LIQUID SOAP; DISPENSERS FOR PAPER TOWELS; DISPOSABLE DINNERWARE, NAMELY, PLATES, SERVING TRAYS AND BOWLS; DUST PANS; FACIAL SPONGES FOR APPLYING MAKE-UP; FEATHER DUSTERS; FLOWER BASKETS; FLOWER POTS; GARDENING GLOVES; GLASS JARS; HAIR BRUSHES; HAIR COMBS; LAUNDRY BASKETS; NAPKIN RINGS; OVENWARE; PET BRUSHES; PET FEEDING DISHES; PET TREAT JARS; PICNIC BASKETS SOLD EMPTY; PLASTIC WATER BOTTLES SOLD EMPTY; SALT AND PEPPER MILLS; SALT AND PEPPER SHAKERS; SERVINGWARE FOR SERVING FOOD AND DRINKS; STAINED GLASS; VASES (U.S. CLS. 2, 13, 23, 29, 30, 33, 40 AND 50).

April Hesik, Examining Attorney

CLASS 21—(Continued).

SN 77-930,493. BELLASVAGO ENTERPRISES, LLC, HILLSBORO, OR. FILED 2-8-2010.

TORKSCREW

THE MARK CONSISTS OF STANDARD CHARACTERS WITHOUT CLAIM TO ANY PARTICULAR FONT, STYLE, SIZE, OR COLOR.

FOR WINE OPENERS (U.S. CLS. 2, 13, 23, 29, 30, 33, 40 AND 50).

William Breckenfeld, Examining Attorney

SN 77-931,683. TV WINNERS INC., MADISON, NJ. FILED 2-9-2010.

Light in a Bottle

THE MARK CONSISTS OF STANDARD CHARACTERS WITHOUT CLAIM TO ANY PARTICULAR FONT, STYLE, SIZE, OR COLOR.

FOR APPLICATOR BRUSH FOR APPLYING NAIL POLISH (U.S. CLS. 2, 13, 23, 29, 30, 33, 40 AND 50).

David Collier, Examining Attorney

SN 77-931,686. TV WINNERS INC., MADISON, NJ. FILED 2-9-2010.

Tap the Cap

THE MARK CONSISTS OF STANDARD CHARACTERS WITHOUT CLAIM TO ANY PARTICULAR FONT, STYLE, SIZE, OR COLOR.

FOR APPLICATOR BRUSH FOR APPLYING NAIL POLISH (U.S. CLS. 2, 13, 23, 29, 30, 33, 40 AND 50).

David Collier, Examining Attorney

CLASS 21—(Continued).

SN 77-932,483. KILBANE, MARGARET M., DETROIT LAKES, MN. FILED 2-10-2010.

LAKEGIRL

THE MARK CONSISTS OF STANDARD CHARACTERS WITHOUT CLAIM TO ANY PARTICULAR FONT, STYLE, SIZE, OR COLOR.

OWNER OF U.S. REG. NOS. 3,062,427, 3,411,417 AND 3,494,644.

FOR MUGS, CUPS, SERVING PLATTERS (U.S. CLS. 2, 13, 23, 29, 30, 33, 40 AND 50).

JENNY PARK, EXAMINING ATTORNEY

CLASS 21—(Continued).

SN 77-952,419. ZOOSK, INC., SAN FRANCISCO, CA. FILED 3-6-2010.



SN 77-932,547. MBONG, MOSES, PINOLE, CA. FILED 2-10-2010.



THE MARK CONSISTS OF THE WORDING "THE SEXIER SIDE OF SIPPING" BELOW A DRAWING OF A COUPLE HUGGING EACH OTHER OVER WHICH THE LETTERS "GB" ARE SUPERIMPOSED.

FOR SHOT GLASSES (U.S. CLS. 2, 13, 23, 29, 30, 33, 40 AND 50).

HANNO RITTNER, EXAMINING ATTORNEY

THE MARK CONSISTS OF WORD "ZOOSK" WITH A HEART IMAGE OVER THE SECOND LETTER "O".

FOR MUGS; PET FEEDING AND DRINKING BOWLS (U.S. CLS. 2, 13, 23, 29, 30, 33, 40 AND 50).

FIRST USE 2-25-2010; IN COMMERCE 2-25-2010.

GINA HAYES, EXAMINING ATTORNEY

SN 77-954,213. CAMELBAK PRODUCTS, LLC, PETALUMA, CA. FILED 3-9-2010.

QUANTUM

SN 77-934,416. DI VITTO, FRANCE, PELHAM MANOR, NY. FILED 2-12-2010.

LIFE TREE MOSAICS

THE MARK CONSISTS OF STANDARD CHARACTERS WITHOUT CLAIM TO ANY PARTICULAR FONT, STYLE, SIZE, OR COLOR.

NO CLAIM IS MADE TO THE EXCLUSIVE RIGHT TO USE "MOSAICS", APART FROM THE MARK AS SHOWN.

FOR DECORATIVE MOSAICS UTILIZING BROKEN CHINA, POTTERY, FOUND ITEMS OR TESSERA, TILES, AND GLASS, NOT FOR BUILDINGS (U.S. CLS. 2, 13, 23, 29, 30, 33, 40 AND 50).

TASNEEM HUSSAIN, EXAMINING ATTORNEY

THE MARK CONSISTS OF STANDARD CHARACTERS WITHOUT CLAIM TO ANY PARTICULAR FONT, STYLE, SIZE, OR COLOR.

FOR HYDRATION SYSTEMS COMPRISED OF A DRINKING RESERVOIR, A DRINKING TUBE, AND A MOUTHPIECE; DRINKING RESERVOIRS FOR HYDRATION SYSTEMS COMPRISED OF A DRINKING RESERVOIR, A DRINKING TUBE, AND A MOUTHPIECE (U.S. CLS. 2, 13, 23, 29, 30, 33, 40 AND 50).

TRACY CROSS, EXAMINING ATTORNEY

CLASS 21—(Continued).

SN 79-072,113. SAS NOUVELLE PILLIVUYT, FRANCE,
FILED 4-21-2009.



OWNER OF INTERNATIONAL REGISTRATION 1011020
DATED 4-21-2009, EXPIRES 4-21-2019.

OWNER OF U.S. REG. NO. 2,706,007.

NO CLAIM IS MADE TO THE EXCLUSIVE RIGHT TO
USE "PORCELAINE" OR "FRANCE", APART FROM THE
MARK AS SHOWN.

THE MARK CONSISTS OF A BUILDING SURROUNDED
BY A CIRCLE, WITH THE WORDING "PORCELAINE"
FORMING THE TOP PORTION OF THE CIRCLE, THE
WORDING "DU REUSSY" FORMING THE BOTTOM PORTION
OF THE CIRCLE, AND THE WORDING "FRANCE"
APPEARING BELOW THE CIRCLE.

THE ENGLISH TRANSLATION OF "PORCELAINE DU
REUSSY" IN THE MARK IS PORCELAIN OF REUSSY.

FOR TABLEWARE SERVICES MADE OF PORCELAIN,
NAMELY, SERVICES FOR HOUSEHOLD AND KITCHEN
USE COMPRISING PORCELAIN CROCKERY,
NAMELY, MUGS, SAUCERS, PLATES, AND CUPS,
DISHWARE, SERVINGWARE FOR SERVING FOOD,
DISHS, SALAD DISHS, PLATES, BUTTER DISHS,
BOWLS, CANDLE HOLDERS OF PORCELAIN, PITCHERS,
VASES, FLOWERPOT HOLDERS, COFFEE SETS,
NAMELY, SETS COMPRISING COFFEE CUPS, SAUCERS,
CREAMER PITCHERS, SUGAR BOWLS, CAFETIERES
FOR MAKING COFFEE, DECANTERS, CHEESE-DISH
COVERS, EGGCUPS, CUPS FOR SERVING FRUIT,
KNIFE RESTS, HOUSEHOLD JUGS, COOKERY AND
BAKING MOLDS, PIE AND FLAN DISHS, PIE SERVER,
SALT AND PEPPER HOLDERS, TEAPOTS, CHEESE
SERVING AND CUTTING DISHS, SMALL BOTTLES
SOLD EMPTY, FLOWER POTS, SUPPORTS FOR
FLOWER ARRANGEMENTS, NAMELY, FLOWER POT
HOLDERS, BASINS, VEGETABLE DISHS, PIE SERVERS,
SALT CELLARS, SUGAR BOWLS, CUPS, TEA
SERVICES AND TEAPOTS; ALL THE FOREGOING
GOODS MADE OF PORCELAIN (U.S. CLS. 2, 13, 23,
29, 30, 33, 40 AND 50).

LIEF MARTIN, EXAMINING ATTORNEY

CLASS 21—(Continued).

SN 79-074,019. GUANGZHOU LONG CHAU; PLASTIC &
HARDWARE MANUFACTORY LTD., GUANGDONG
PROVINCE, CHINA, FILED 4-16-2009.



OWNER OF INTERNATIONAL REGISTRATION 1016364
DATED 4-16-2009, EXPIRES 4-16-2019.

THE MARK CONSISTS OF THE WORDING "HOCO-
MAID" IN A RECTANGLE DESIGN WITH ROUNDED
CORNERS.

THE WORDING "HOCOMAID" HAS NO MEANING IN A
FOREIGN LANGUAGE.

FOR VACUUM BOTTLES; GLASS RECEPTACLES,
NAMELY, GLASS BEVERAGWARE, GLASS CARAFES;
DRINKING VESSELS; COFFEE SERVICES, NOT OF
PRECIOUS METAL; TEAPOTS, NOT OF PRECIOUS
METAL; PITCHERS, NOT OF PRECIOUS METAL;
DRINKING FLASKS FOR TRAVELERS; BOTTLE
GOURDS; NON-ELECTRIC IRON KETTLES (U.S. CLS.
2, 13, 23, 29, 30, 33, 40 AND 50).

LINDA ORNDORFF, EXAMINING ATTORNEY

CLASS 22—CORDAGE AND FIBERS

SN 77-924,515. ZHENSHI HOLDING GROUP CO., LIMITED,
TONGXIANG, ZHEJIANG, CHINA, FILED 2-1-2010.



THE MARK CONSISTS OF A DESIGN FORMED BY THE
LETTERS "S" AND "Z" TO THE LEFT OF CHINESE
CHARACTERS AND THE WORD "ZHENSHI".

THE WORDING "ZHENSHI" HAS NO MEANING IN A
FOREIGN LANGUAGE.

THE NON-LATIN CHARACTERS IN THE MARK TRANS-
LITERATE TO "ZHENSHI" AND THIS HAS NO MEANING
IN A FOREIGN LANGUAGE.

FOR CARBON FIBERS FOR TEXTILE USE; CHEMI-
CAL FIBERS FOR TEXTILE USE; FISHING NETS;
GLASS FIBERS FOR TEXTILE USE; HANGING MESH
NET USED FOR STORING SPORTS BALLS; PADDING
MATERIALS NOT OF RUBBER, PAPER OR PLASTIC;
RAW FIBROUS TEXTILE MATERIALS; SACKS OR
BAGS FOR THE TRANSPORTATION OR STORAGE OF
MATERIALS IN BULK; SWIMMING POOL SKIMMING
NETS; TARPULINS; TEXTILE FIBERS (U.S. CLS. 1, 2,
7, 19, 22, 42 AND 50).

FIRST USE 6-16-1992; IN COMMERCE 2-15-2007.
SHANNON TWOHIG, EXAMINING ATTORNEY

CLASS 22—(Continued).

SN 77-926,856. LEE, MARK, ENGLEWOOD CLIFFS, NJ.
FILED 2-3-2010.

Flinkies

THE MARK CONSISTS OF STANDARD CHARACTERS WITHOUT CLAIM TO ANY PARTICULAR FONT, STYLE, SIZE, OR COLOR.

FOR CABLE TIES AND STRAPS FOR FASTENING AND SECURING OBJECTS SUCH AS BUNDLES OF WIRE TOGETHER; STRAPS FOR SECURING BUNDLES (U.S. CLS. 1, 2, 7, 19, 22, 42 AND 50).

KATHERINE CONNOLLY, EXAMINING ATTORNEY

CLASS 22—(Continued).

SN 77-930,743. BOINGY LLC, TIGARD, OR. FILED 2-8-2010.

GRAPPLE

THE MARK CONSISTS OF STANDARD CHARACTERS WITHOUT CLAIM TO ANY PARTICULAR FONT, STYLE, SIZE, OR COLOR.

FOR TETHERS IN THE NATURE OF RUBBER CORDS THAT ARE SECURED BY A SUCTION CUP TO A FLAT SURFACE TO HOLD CHILDREN'S TOYS AND UTENSILS (U.S. CLS. 1, 2, 7, 19, 22, 42 AND 50).

ANDREA HACK, EXAMINING ATTORNEY

SN 77-928,495. PROCON PACIFIC, LLC, OAKBROOK, IL.
FILED 2-4-2010.

PROCON LICE BAG

THE MARK CONSISTS OF STANDARD CHARACTERS WITHOUT CLAIM TO ANY PARTICULAR FONT, STYLE, SIZE, OR COLOR.

OWNER OF U.S. REG. NO. 3,442,052.

NO CLAIM IS MADE TO THE EXCLUSIVE RIGHT TO USE "LICE BAG", APART FROM THE MARK AS SHOWN.

FOR POLYPROPYLENE BAGS USED FOR THE STORAGE OF PERSONAL BELONGINGS TO PREVENT OR MINIMIZE LICE INFESTATION (U.S. CLS. 1, 2, 7, 19, 22, 42 AND 50).

ROBIN MITTLER, EXAMINING ATTORNEY

SN 77-932,770. A-TOWN ENTERPRISES, LLC, AURORA, CO.
FILED 2-10-2010.

Worn & Re-Born

THE MARK CONSISTS OF STANDARD CHARACTERS WITHOUT CLAIM TO ANY PARTICULAR FONT, STYLE, SIZE, OR COLOR.

FOR LAUNDRY BAGS; HOUSEHOLD UTILITY BAGS, NAMELY, MULTI-PURPOSE CLOTH BAGS (U.S. CLS. 1, 2, 7, 19, 22, 42 AND 50).

DAVID MURRAY, EXAMINING ATTORNEY

SN 77-930,215. CARLINO, CRISTINA M., PHOENIX, AZ.
FILED 2-8-2010.

ARCHETYPE

THE MARK CONSISTS OF STANDARD CHARACTERS WITHOUT CLAIM TO ANY PARTICULAR FONT, STYLE, SIZE, OR COLOR.

FOR LAUNDRY BAGS; MULTI-PURPOSE CLOTH BAGS; SHOE BAGS FOR STORAGE (U.S. CLS. 1, 2, 7, 19, 22, 42 AND 50).

APRIL HESIK, EXAMINING ATTORNEY

CLASS 23—YARNS AND THREADS

SN 77-840,649. BERROCO, INC., UXBRIDGE, MA. FILED 10-2-2009.

BERROCO ORIGAMI

THE MARK CONSISTS OF STANDARD CHARACTERS WITHOUT CLAIM TO ANY PARTICULAR FONT, STYLE, SIZE, OR COLOR.

OWNER OF U.S. REG. NOS. 1,597,403 AND 3,059,150.

FOR YARN (U.S. CL. 43).

STEPHANIE ALI, EXAMINING ATTORNEY

CLASS 23—(Continued).

SN 77-924,516. ZHENSHI HOLDING GROUP CO., LIMITED, TONGXIANG, ZHEJIANG, CHINA, FILED 2-1-2010.



THE MARK CONSISTS OF A DESIGN FORMED BY THE LETTERS "S" AND "Z" TO THE LEFT OF CHINESE CHARACTERS AND THE WORD "ZHENSHI".

THE WORDING "ZHENSHI" HAS NO MEANING IN A FOREIGN LANGUAGE.

THE NON-LATIN CHARACTERS IN THE MARK TRANSLITERATE TO ZHENSHI AND THIS HAS NO MEANING IN A FOREIGN LANGUAGE.

FOR DARNING THREAD AND YARN; FIBERGLASS THREAD FOR TEXTILE USE; MIXED SPUN THREADS AND YARNS; RAYON YARN; SEWING THREAD AND YARN; SILK THREADS AND YARNS; SPUN SILK; SPUN WOOL; THREAD; YARN (U.S. CL. 43).

FIRST USE 6-16-1992; IN COMMERCE 2-15-2007.
SHANNON TWOHIG, EXAMINING ATTORNEY

CLASS 24—FABRICS

SN 77-797,462. MARTHA STEWART LIVING OMNIMEDIA, INC., NEW YORK, NY. FILED 8-5-2009.

BODY + SOUL

THE MARK CONSISTS OF STANDARD CHARACTERS WITHOUT CLAIM TO ANY PARTICULAR FONT, STYLE, SIZE, OR COLOR.

OWNER OF U.S. REG. NO. 2,154,203.

FOR BED SHEETS, MATTRESS PADS, PILLOW CASES, PILLOW SHAMS, COMFORTERS, QUILTS, BED SPREADS, BED SKIRTS, DUVETS, COMFORTER COVERS, BED BLANKETS, AFGHANS, TOWELS, POT HOLDERS, DISH CLOTHS, TABLE CLOTHS NOT OF PAPER, CLOTH NAPKINS, TEXTILE PLACE MATS, UNFITTED FABRIC FURNITURE COVERS AND SHOWER CURTAINS; FABRIC WINDOW TREATMENTS, NAMELY, TOPPERS, TIERS, CURTAINS, CURTAIN VALANCES, TEXTILE CURTAIN TIE-BACKS, DRAPERIES, AND TAB TOPS (U.S. CLS. 42 AND 50).

DOUGLAS LEE, EXAMINING ATTORNEY

CLASS 24—(Continued).

SN 77-799,820. WHOLE SPACE INDUSTRIES LTD., TAIPEI, TAIWAN, FILED 8-7-2009.



NO CLAIM IS MADE TO THE EXCLUSIVE RIGHT TO USE "HOME" AND "CHILD SAFE & ENVIRONMENTALLY RESPONSIBLE PRODUCTS FOR YOUR HOME", APART FROM THE MARK AS SHOWN.

FOR BAMBOO CURTAINS (U.S. CLS. 42 AND 50).
FIRST USE 7-28-2009; IN COMMERCE 7-28-2009.
MARK SPARACINO, EXAMINING ATTORNEY

SN 77-813,370. SAINT LOUIS UNIVERSITY, ST. LOUIS, MO. FILED 8-26-2009.

BE A BILLIKEN

THE MARK CONSISTS OF STANDARD CHARACTERS WITHOUT CLAIM TO ANY PARTICULAR FONT, STYLE, SIZE, OR COLOR.

OWNER OF U.S. REG. NO. 1,662,548.

FOR TABLECLOTHS OF TEXTILES (U.S. CLS. 42 AND 50).

FIRST USE 7-10-2008; IN COMMERCE 8-14-2009.
LINDA E. BLOHM, EXAMINING ATTORNEY

SN 77-892,027. PEOPLETOWELS, LLC, PALM BEACH, FL. FILED 12-11-2009.

CHANGE IS AT HAND

THE MARK CONSISTS OF STANDARD CHARACTERS WITHOUT CLAIM TO ANY PARTICULAR FONT, STYLE, SIZE, OR COLOR.

FOR HAND TOWELS; HAND TOWELS OF TEXTILE; HAND-TOWELS MADE OF TEXTILE FABRICS; JAPANESE COTTON TOWELS (TENUGUI); TOWELS (U.S. CLS. 42 AND 50).

FIRST USE 7-17-2009; IN COMMERCE 10-21-2009.
NANCY CLARKE, EXAMINING ATTORNEY

CLASS 24—(Continued).

SN 77-909,696. ARDEN CORPORATION, BINGHAM FARMS, MI. FILED 1-12-2010.

EVERFINE

THE MARK CONSISTS OF STANDARD CHARACTERS WITHOUT CLAIM TO ANY PARTICULAR FONT, STYLE, SIZE, OR COLOR.

FOR POLYPROPYLENE FABRIC FOR TEXTILE USE, NAMELY, OLEFIN (U.S. CLS. 42 AND 50).
TIMOTHY FINNEGAN, EXAMINING ATTORNEY

CLASS 24—(Continued).

SN 77-921,173. CAPUCILLI, ALYSSA S., NEW YORK, NY. AND SCHORIES, PAT, NEW YORK, NY. FILED 1-27-2010.



THE MARK CONSISTS OF THE LITERAL ELEMENTS "BISCUIT" AND "THE LITTLE YELLOW PUPPY" IN STYLIZED LETTERING, A CIRCULAR RING, AND A FANCIFUL REPRESENTATION OF A PUPPY. THE WORD "BISCUIT" APPEARS IN THE TOP OF THE RING AND THE WORDS "THE LITTLE YELLOW PUPPY" APPEAR ALONG THE BOTTOM OF THE RING. AT THE CENTER OF THE RING IS A FANCIFUL REPRESENTATION OF A PUPPY.

FOR TEXTILES AND TEXTILE GOODS, NOT INCLUDED IN OTHER CLASSES, NAMELY, BED BLANKETS, RECEIVING BLANKETS, BABY BLANKETS, BLANKET THROWS, COMFORTERS, QUILTS, AFGHANS, BLANKETS FOR OUTDOOR USE, BED LINEN, BED SHEETS AND SHEET SETS, BED SKIRTS, BED PADS, BED CANOPIES, PILLOW CASES, COVERS, AND SHAMS, MATTRESS COVERS AND PADS, COVERS FOR CUSHIONS, DUVETS AND DUVET COVERS, EIDER-DOWNS AND EIDERDOWN COVERS, CRIB BUMPERS, CRIB SHEETS, CRIB COMFORTERS, CRIB RUFFLES, KITCHEN TOWELS, DISH CLOTHS, DUST RUFFLES, POT HOLDERS, BARBECUE MITTS, OVEN MITTS, WASHING MITTS, WASHING GLOVES, TEXTILE PLACE MATS, PLACE MATS NOT OF PAPER, TEXTILE NAPKINS, CLOTH DOILIES, CLOTH AND FELT PENNANTS, DINING LINENS, TOWELS, BEACH TOWELS, GOLF TOWELS, HOODED TOWELS, HANDKERCHIEFS, BATH LINEN, HOUSEHOLD LINEN, WASH CLOTHS, SHOWER CURTAINS, CLOTH BANNERS, PRINTED TEXTILE LABELS, CLOTH COASTERS, CLOTH AND FABRIC FLAGS, TEXTILE WALL HANGINGS, TEXTILE WALL HANGINGS IN THE NATURE OF CLOTH POSTERS, CURTAINS, DRAPERY AND DRAPERIES, SHROUDS, SWAGS, POUFS, PUFFS, FABRIC VALANCES, TAPESTRIES OF TEXTILE, LAP RUGS, BED AND TABLE COVERS, NAMELY, BED SPREADS, COVERLETS, TABLE LINEN, TABLE CLOTHS NOT OF PAPER, FABRIC TABLE RUNNERS, AND FABRIC TABLE TOPPERS (U.S. CLS. 42 AND 50).

JOHN SCHUYLER YARD, EXAMINING ATTORNEY

SN 77-916,139. WP IP LLC, NEW YORK, NY. FILED 1-20-2010.

DREAM SPUN

THE MARK CONSISTS OF STANDARD CHARACTERS WITHOUT CLAIM TO ANY PARTICULAR FONT, STYLE, SIZE, OR COLOR.

FOR COTTON CLOTH WASH CLOTHS, BED SHEETS, BATH SHEETS, BATH TOWELS, KITCHEN TOWELS, DISH TOWELS, COMFORTERS, BED BLANKETS, BLANKET THROWS, AND PILLOW CASES (U.S. CLS. 42 AND 50).

KATHERINE M. DUBRAY, EXAMINING ATTORNEY

CLASS 24—(Continued).

SN 77-922,697. BROOKWOOD COMPANIES, INC., NEW YORK, NY. FILED 1-28-2010.



THE MARK CONSISTS OF THE LETTER B WITH THE LETTER W OVERLAPPING THE BOTTOM PART OF THE LETTER B AND THE LETTERS F AND R WITH THE LETTER R UNDER THE LETTER F.

FOR FLAME RETARDANT FABRICS FOR CLOTHING (U.S. CLS. 42 AND 50).

MORGAN WYNNE, EXAMINING ATTORNEY

CLASS 24—(Continued).

SN 77-924,522. ZHENSHI HOLDING GROUP CO., LIMITED, TONGXIANG, ZHEJIANG, CHINA, FILED 2-1-2010.



THE MARK CONSISTS OF A DESIGN FORMED BY THE LETTERS "S" AND "Z" TO THE LEFT OF CHINESE CHARACTERS AND THE WORD "ZHENSHI".

THE WORDING "ZHENSHI" HAS NO MEANING IN A FOREIGN LANGUAGE.

THE NON-LATIN CHARACTERS IN THE MARK TRANSLITERATE TO "ZHENSHI" AND THIS HAS NO MEANING IN A FOREIGN LANGUAGE.

FOR CASHMERE FABRIC; CHEMICAL FIBER FABRICS; CHENILLE FABRIC; COTTON CLOTH; COTTON FABRIC; COVERINGS OF PLASTIC FOR FURNITURE; CURTAINS OF TEXTILE OR PLASTIC; FELTS; FIBRE-GLASS FABRICS FOR TEXTILE USE; QUILTS; SILK CLOTH; SILK FABRICS; TOWELS; WOOLEN CLOTH; WOVEN FABRICS (U.S. CLS. 42 AND 50).

FIRST USE 6-16-1992; IN COMMERCE 2-15-2007.

SHANNON TWOHIG, EXAMINING ATTORNEY

SN 77-923,737. THE DOLLFUS MIEG COMPANY, INC., KEARNY, NJ. FILED 1-29-2010.

CHARLES CRAFT

THE MARK CONSISTS OF STANDARD CHARACTERS WITHOUT CLAIM TO ANY PARTICULAR FONT, STYLE, SIZE, OR COLOR.

NO CLAIM IS MADE TO THE EXCLUSIVE RIGHT TO USE "CRAFT", APART FROM THE MARK AS SHOWN.

THE NAME "CHARLES CRAFT" DOES NOT IDENTIFY A LIVING INDIVIDUAL.

FOR PRECUT FABRICS FOR MAKING NEEDLE-CRAFTS, AFGHANS, BLANKETS, BOOKMARKS, BREAD COVERS, GROWTH CHARTS, JAR TOPPERS, PILLOWS, POTHOLDERS, SACHET BAGS, SCRAPBOOK AND PHOTO ALBUM COVERS, AND TOWELS (U.S. CLS. 42 AND 50).

JULIE WATSON, EXAMINING ATTORNEY

SN 77-927,825. LAURIN INTERNATIONAL INC., SAUK RAPIDS, MN. FILED 2-4-2010.

L66

THE MARK CONSISTS OF STANDARD CHARACTERS WITHOUT CLAIM TO ANY PARTICULAR FONT, STYLE, SIZE, OR COLOR.

FOR WATER REPELLENT FABRIC RESISTANT TO PUNCTURE, TEARS, ABRASION, MILDEW AND ROT, FOR USE IN THE MANUFACTURE OF SPORT BAGS, EQUIPMENT BAGS, DUFFLE BAGS, CAMERA BAGS, GOLF BAGS, AND GARMENT BAGS, AND FOR USE IN THE MANUFACTURE OF PROTECTIVE CLOTHING AND FOOTWEAR AND FOR USE IN THE MANUFACTURE OF UPHOLSTERY FOR COMMERCIAL PURPOSES (U.S. CLS. 42 AND 50).

MARK SHINER, EXAMINING ATTORNEY

CLASS 24—(Continued).

SN 77-928,388. MICHAEL C. COHEN, CHICAGO, IL. FILED 2-4-2010.

TOWEL TWIRL

THE MARK CONSISTS OF STANDARD CHARACTERS WITHOUT CLAIM TO ANY PARTICULAR FONT, STYLE, SIZE, OR COLOR.

NO CLAIM IS MADE TO THE EXCLUSIVE RIGHT TO USE "TOWEL", APART FROM THE MARK AS SHOWN.

FOR TOWELS (U.S. CLS. 42 AND 50).
THOMAS MANOR, EXAMINING ATTORNEY

CLASS 24—(Continued).

SN 77-930,184. TRUE BLUE OUTFITTERS LLC, BOISE, ID. FILED 2-8-2010.

WRAPALAP

THE MARK CONSISTS OF STANDARD CHARACTERS WITHOUT CLAIM TO ANY PARTICULAR FONT, STYLE, SIZE, OR COLOR.

FOR BLANKET THROWS; BLANKETS FOR OUTDOOR USE (U.S. CLS. 42 AND 50).

JOSETTE BEVERLY, EXAMINING ATTORNEY

SN 77-929,209. THE BOPPY COMPANY, LLC, GOLDEN, CO. FILED 2-5-2010.

LOOK FOR THE BOPPY SHAPE!

THE MARK CONSISTS OF STANDARD CHARACTERS WITHOUT CLAIM TO ANY PARTICULAR FONT, STYLE, SIZE, OR COLOR.

OWNER OF U.S. REG. NO. 3,287,159.
FOR BEDDING FOR INFANTS AND BABIES, NAMELY, COMFORTERS, CRIB BUMPER PADS, CRIB SHEETS, DUST RUFFLES, DUVET COVERS, SLIP COVERS FOR BUMPER PADS; COVERS NOT OF PAPER FOR DIAPER CHANGING PADS (U.S. CLS. 42 AND 50).
FIRST USE 12-15-2009; IN COMMERCE 12-15-2009.
DOMINICK J. SALEMI, EXAMINING ATTORNEY

SN 77-930,222. CARLINO, CRISTINA M., PHOENIX, AZ. FILED 2-8-2010.

ARCHETYPE

THE MARK CONSISTS OF STANDARD CHARACTERS WITHOUT CLAIM TO ANY PARTICULAR FONT, STYLE, SIZE, OR COLOR.

FOR BATH GLOVES; BATH LINEN; BATH TOWELS; BEACH TOWELS; BED BLANKETS; BED PADS; BED SHEETS; BED SKIRTS; BED SPREADS; BED THROWS; COMFORTERS; COVERLETS; CURTAINS; HANDKERCHIEFS; KITCHEN LINENS; KITCHEN TOWELS; SHOWER CURTAIN LINERS; SHOWER CURTAINS; TABLE LINEN; TABLE PADS; TEXTILE WALL HANGINGS; VINYL PLACE MATS (U.S. CLS. 42 AND 50).
APRIL HESIK, EXAMINING ATTORNEY

SN 77-929,253. THE NORTH FACE APPAREL CORP, WILMINGTON, DE. FILED 2-5-2010.

BOMBASTIC

THE MARK CONSISTS OF STANDARD CHARACTERS WITHOUT CLAIM TO ANY PARTICULAR FONT, STYLE, SIZE, OR COLOR.

FOR FABRICS FOR THE MANUFACTURE OF BACKPACKS (U.S. CLS. 42 AND 50).
ANGELA M. MICHELI, EXAMINING ATTORNEY

SN 77-932,482. MARGARET M. KILBANE,, DETROIT LAKES, MN. FILED 2-10-2010.

LAKEGIRL

THE MARK CONSISTS OF STANDARD CHARACTERS WITHOUT CLAIM TO ANY PARTICULAR FONT, STYLE, SIZE, OR COLOR.

OWNER OF U.S. REG. NOS. 3,062,427, 3,411,417 AND 3,494,644.
FOR TOWELS (U.S. CLS. 42 AND 50).
KATHY DE JONGE, EXAMINING ATTORNEY

CLASS 24—(Continued).

SN 77-944,073. BUILD-A-BEAR RETAIL MANAGEMENT, INC., ST. LOUIS, MO. FILED 2-24-2010.

COMFY STUFF BY
BUILD-A-BEAR WORKSHOP

THE MARK CONSISTS OF STANDARD CHARACTERS WITHOUT CLAIM TO ANY PARTICULAR FONT, STYLE, SIZE, OR COLOR.

OWNER OF U.S. REG. NOS. 2,722,224, 2,843,811 AND OTHERS.

FOR BED LINENS (U.S. CLS. 42 AND 50).
ALICIA COLLINS, EXAMINING ATTORNEY

SN 79-059,621. HAINING CHENGRUDAN; REINFORCEMENT FABRICS CO., LTD., CHINA, FILED 8-5-2008.



OWNER OF INTERNATIONAL REGISTRATION 0979117 DATED 8-5-2008, EXPIRES 8-5-2018.

THE MARK CONSISTS OF A LARGE STYLIZED LETTER "C" WITH A SERIES OF ANGLED VERTICAL STRIPES DESCENDING FROM ITS UPPER ARC. BELOW THE LETTER ARE THE INITIALS "C.R.D" ABOVE THREE SMALLER CHINESE CHARACTERS PRESENTED BETWEEN TWO SHORT HORIZONTAL LINES.

THE FIRST NON-LATIN CHARACTER IN THE MARK TRANSLITERATES TO "CHENG", WHICH MEANS "SUCCEEDED; BECOME" IN ENGLISH. THE SECOND CHARACTER TRANSLITERATES TO "RU", WHICH MEANS "AS IF; LIKE" IN ENGLISH. THE THIRD CHARACTER TRANSLITERATES TO "DAN", WHICH MEANS "DAWN; DAY BREAK" IN ENGLISH. TOGETHER THE WORDING PRONOUNCED "CHENG RU DAN" HAS NO MEANING IN A FOREIGN LANGUAGE.

FOR FIBERGLASS FABRICS FOR TEXTILE USE; FABRIC FOR TEXTILE USE; KNITTED FABRICS; COTTON FABRIC; FABRICS FOR USE IN THE MANUFACTURE OF CLOTHING; TEXTILE USED AS LINING FOR CLOTHING; PLAIN-KNITTED FABRIC; KNITTED FABRIC; FABRICS FOR TEXTILE USE; GLASS CLOTHS; TEXTILE FABRICS FOR THE MANUFACTURE OF CLOTHING; FABRICS THAT MAY OR MAY NOT HAVE PRINTED PATTERNS AND DESIGNS THEREON FOR USE IN TEXTILE APPLICATIONS, NAMELY, THE MANUFACTURE OF APPAREL, UPHOLSTERY, SIGNAGE, FLAGS, BANNERS AND WALLPAPER; FILTERING MATERIALS OF TEXTILE, NAMELY, CHEESE CLOTH; NON-WOVEN FABRIC (U.S. CLS. 42 AND 50).
STEVEN PEREZ, EXAMINING ATTORNEY

CLASS 24—(Continued).

SN 79-074,168. RATTI S.P.A., I-22070 GUANZATE (CO), ITALY, FILED 7-24-2009.

setamarina

OWNER OF INTERNATIONAL REGISTRATION 0756945 DATED 4-11-2001, EXPIRES 4-11-2011.

THE MARK CONSISTS OF THE FANCIFUL WORDING "SETAMARINA" REPRODUCED IN ORIGINAL PRINTING CHARACTERS.

FOR TEXTILES MADE OF SILK OR MADE MAINLY OF SILK (U.S. CLS. 42 AND 50).

WANDA KAY PRICE, EXAMINING ATTORNEY

CLASS 25—CLOTHING

SN 76-701,226. WALLS INDUSTRIES, INC., CLEBURNE, TEXAS, CLEBURNE, TX. FILED 1-19-2010.

BIG SMITH

THE MARK CONSISTS OF STANDARD CHARACTERS WITHOUT CLAIM TO ANY PARTICULAR FONT, STYLE, SIZE, OR COLOR.

OWNER OF U.S. REG. NOS. 437,038 AND 3,262,064.
FOR CLOTHING, NAMELY, SOCKS, HOSIERY, AND BELTS; OUTDOOR CLOTHING, NAMELY, SWEAT-SHIRTS, DUNGAREES, SHIRTS, DENIM SHIRTS, HUNTING VESTS, INSULATED JACKETS; FOOTWEAR, HEADGEAR, NAMELY, HEADWEAR, CAPS (U.S. CLS. 22 AND 39).

TAMARA FRAZIER, EXAMINING ATTORNEY

SN 77-197,093. TAUHIDAH NEAL, BROOKLYN, NY. FILED 6-4-2007.



THE COLOR(S) RED, YELLOW, GREEN AND BLACK IS/ARE CLAIMED AS A FEATURE OF THE MARK.

THE MARK CONSISTS OF A BAR IN THE COLORS RED, YELLOW AND GREEN ABOVE THE WORDING "JAMROCK". THE WORD "JAMROCK" IS IN THE COLOR BLACK.

FOR JERSEYS (U.S. CLS. 22 AND 39).

DAVID MURRAY, EXAMINING ATTORNEY

CLASS 25—(Continued).

SN 77-330,574. THE RITZ HOTEL, LIMITED, PARIS CEDEX, FRANCE, FILED 11-15-2007.

RITZ PARIS

THE MARK CONSISTS OF STANDARD CHARACTERS WITHOUT CLAIM TO ANY PARTICULAR FONT, STYLE, SIZE, OR COLOR.

OWNER OF U.S. REG. NO. 2,790,268.
NO CLAIM IS MADE TO THE EXCLUSIVE RIGHT TO USE "PARIS", APART FROM THE MARK AS SHOWN.
FOR BATHROBES (U.S. CLS. 22 AND 39).
KELLY TRUSILO, EXAMINING ATTORNEY

SN 77-532,671. AGOGE SPORTS, NEEDHAM, MA. FILED 7-28-2008.

BRING ON THE PAIN

THE MARK CONSISTS OF STANDARD CHARACTERS WITHOUT CLAIM TO ANY PARTICULAR FONT, STYLE, SIZE, OR COLOR.

FOR HATS; PANTS; PULLOVERS; T-SHIRTS (U.S. CLS. 22 AND 39).
MARK T. MULLEN, EXAMINING ATTORNEY

SN 77-545,875. PEPE JEANS LONDON LLC, NEW YORK, NY. FILED 8-13-2008.

UNITED KINGDOM BY PEPE JEANS LONDON

THE MARK CONSISTS OF STANDARD CHARACTERS WITHOUT CLAIM TO ANY PARTICULAR FONT, STYLE, SIZE, OR COLOR.

OWNER OF U.S. REG. NOS. 1,861,869, 2,886,126 AND OTHERS.

NO CLAIM IS MADE TO THE EXCLUSIVE RIGHT TO USE "UNITED KINGDOM" AND "JEANS" AND "LONDON", APART FROM THE MARK AS SHOWN.

FOR CLOTHING, NAMELY, JEANS, BLOUSES, DRESSES, JACKETS, JERSEYS, OVERALLS, PANTS, PULLOVERS, SHIRTS, SHORTS, SKIRTS, SWEATERS, SWEATSHIRTS, T-SHIRTS (U.S. CLS. 22 AND 39).
KELLY BOULTON, EXAMINING ATTORNEY

CLASS 25—(Continued).

SN 77-610,308. ARNOLD, DONNA, OCEANSIDE, CA. AND MILLER, ERNIE, ESCONDIDO, CA. AND ARNOLD III, EARL, OCEANSIDE, CA. AND MILLER, LEIGH, ESCONDIDO, CA. FILED 11-7-2008.

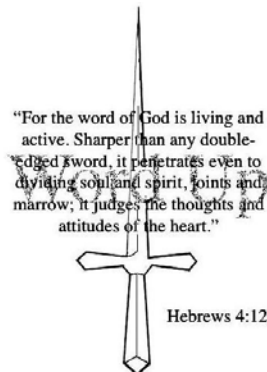

NO CLAIM IS MADE TO THE EXCLUSIVE RIGHT TO USE "FOR THE WORD OF GOD IS LIVING AND ACTIVE. SHARPER THAN ANY DOUBLE-EDGED SWORD, IT PENETRATES EVEN TO DIVIDING SOUL AND SPIRIT, JOINTS AND MARROW; IT JUDGES THE THOUGHTS AND ATTITUDES OF THE HEART" AND "HEBREWS 4:12", APART FROM THE MARK AS SHOWN.

THE STIPPLING IS A FEATURE OF THE MARK.
THE MARK CONSISTS OF THE WORDING "WORD UP" IN LARGE STYLIZED LETTERING COMPRISED OF STIPPLING SUPERIMPOSED ACROSS THE BIBLICAL TEXT "FOR THE WORD OF GOD IS LIVING AND ACTIVE, SHARPER THAN ANY DOUBLE-EDGED SWORD, IT PENETRATES EVEN TO DIVIDING SOUL AND SPIRIT, JOINTS AND MARROW; IT JUDGES THE THOUGHTS AND ATTITUDES OF THE HEART". AN IMAGE OF A SWORD APPEARS TO PIERCE UP THROUGH THE WORDING "WORD UP" AND THE BIBLICAL TEXT IN THE MARK. THE BIBLICAL REFERENCE "HEBREWS 4:12" APPEARS AT THE LOWER RIGHT OF THE DRAWING BESIDE THE SWORD HANDLE.

FOR HATS; JACKETS; PAJAMAS; PANTS; SHIRTS; SHOES; SHORTS; SWIMWEAR; TOPS (U.S. CLS. 22 AND 39).
ZHALEH DELANEY, EXAMINING ATTORNEY

SN 77-616,438. RUFF MAGIC ENTERTAINMENT, LLC, NEWARK, NJ. FILED 11-18-2008.

World Freerunning & Parkour Federation

THE MARK CONSISTS OF STANDARD CHARACTERS WITHOUT CLAIM TO ANY PARTICULAR FONT, STYLE, SIZE, OR COLOR.

NO CLAIM IS MADE TO THE EXCLUSIVE RIGHT TO USE "FREERUNNING & PARKOUR FEDERATION", APART FROM THE MARK AS SHOWN.

FOR CLOTHING, NAMELY, T-SHIRTS, HATS, SWEATSHIRTS, SWEATPANTS AND WRISTBANDS (U.S. CLS. 22 AND 39).
JUSTINE D. PARKER, EXAMINING ATTORNEY

CLASS 25—(Continued).

SN 77-622,054. GOUAULT-KUCZER, SEBASTIEN, LOS ANGELES, CA. FILED 11-25-2008.

KAMAG

THE MARK CONSISTS OF STANDARD CHARACTERS WITHOUT CLAIM TO ANY PARTICULAR FONT, STYLE, SIZE, OR COLOR.

THE ENGLISH TRANSLATION OF "KAMAG" IN THE MARK IS "RELATIVE".

FOR BATHING SUITS; BEACHWEAR; BELTS; BELTS MADE OF LEATHER; BLAZERS; BLOUSES; BOTTOMS; BOXER SHORTS; BRAS; BRIEFS; CAMISOLES; CAPS; CARDIGANS; COATS; DENIMS; DRESSES; EVENING GOWNS; FOOTWEAR; FROCKS; GLOVES; GOLF SHIRTS; GOWNS; HALTER TOPS; HEAD SCARVES; HEADWEAR; HOODS; HOSIERY; JACKETS; JEANS; JERSEYS; JOGGING PANTS; JOGGING SUITS; LADIES' UNDERWEAR; LEATHER BELTS; LEATHER COATS; LEATHER HEADWEAR; LEATHER JACKETS; LEATHER PANTS; LEATHER SHOES; LEATHER SLIPPERS; LINGERIE; LOUNGEWEAR; NECKTIES; NIGHTWEAR; OVERALLS; PAJAMAS; PANTIES, SHORTS AND BRIEFS; PANTS; POLO SHIRTS; ROBES; SANDALS; SCARVES; SHIRTS; SHOES; SHORTS; SHOULDER SCARVES; SILK SCARVES; SKIRT SUITS; SKIRTS; SKIRTS AND DRESSES; SLACKS; SLEEPWEAR; SLIPPERS; SOCKS; SPORTS BRA; STRAPLESS BRAS; SUITS; SUITS OF LEATHER; SWEAT PANTS; SWEAT SHIRTS; SWEATERS; SWIMSUITS; T-SHIRTS; TOPS; TROUSERS; TROUSERS OF LEATHER; TUBE TOPS; TURTLENECKS; UNDERSHIRTS; UNDERWEAR; VESTS; WRAPS (U.S. CLS. 22 AND 39).

SEAN CROWLEY, EXAMINING ATTORNEY

CLASS 25—(Continued).

SN 77-634,627. WHEELER DAVID T JR, ROYAL OAK, MI. FILED S.R. 12-16-2008; AM. P.R. 10-14-2009.



NO CLAIM IS MADE TO THE EXCLUSIVE RIGHT TO USE "JEANS", APART FROM THE MARK AS SHOWN.

THE MARK CONSISTS OF THE STYLIZED WORDING "PAID JEANS", EACH ON A SEPARATE LINE, WITH THE LETTER "S" DISPLAYED AS A DOLLAR SIGN AND A SHADED RECTANGLE AND LINE APPEARING BENEATH THE WORDING.

FOR A-SHIRTS; ATHLETIC APPAREL, NAMELY, SHIRTS, PANTS, JACKETS, FOOTWEAR, HATS AND CAPS, ATHLETIC UNIFORMS; BALLOON PANTS; BASEBALL CAPS; BED JACKETS; BERMUDA SHORTS; BIB OVERALLS; BOARD SHORTS; BODY SHIRTS; BOMBER JACKETS; BOXER SHORTS; BUTTON-FRONT ALOHA SHIRTS; CAMP SHIRTS; CAPRI PANTS; CARGO PANTS; DENIM JACKETS; DENIMS; DOWN JACKETS; DRESS SHIRTS; FISHERMAN'S JACKETS; FISHING VESTS; FLEECE SHORTS; FLEECE VESTS; FUR COATS AND JACKETS; FUR JACKETS; GOLF SHIRTS; GYM SHORTS; HEAVY JACKETS; HOODED SWEAT SHIRTS; HUNTING VESTS; JACKET LINERS; JACKETS; JACKETS AND SOCKS; JEANS; JOGGING PANTS; KNIT SHIRTS; KNITTED CAPS; LEATHER JACKETS; LEATHER PANTS; LIGHT-REFLECTING JACKETS; LONG JACKETS; LONG SLEEVED VESTS; LONG-SLEEVED SHIRTS; LOUNGE PANTS; MEN'S AND WOMEN'S JACKETS, COATS, TROUSERS, VESTS; MOISTURE-WICKING SPORTS PANTS; MOISTURE-WICKING SPORTS SHIRTS; NIGHT SHIRTS; NON-DISPOSABLE CLOTH TRAINING PANTS; NURSE OVERALLS; NURSE PANTS; OPEN-NECKED SHIRTS; OVERALLS; PADDED JACKETS; PADDING JACKETS; PANTIES, SHORTS AND BRIEFS; PANTS; PETTI-PANTS; PIQUE SHIRTS; POLO SHIRTS; QUILTED VESTS; RAIN JACKETS; RAINPROOF JACKETS; REVERSIBLE JACKETS; RUGBY SHIRTS; RUGBY SHORTS; SCIENTIFIC AND TECHNOLOGICAL APPAREL, NAMELY, SHIRTS, PANTS, JACKETS, FOOTWEAR, HATS AND CAPS, UNIFORMS; SHELL JACKETS; SHIRT FRONTS; SHIRT YOKES; SHIRTS; SHIRTS FOR SUITS; SHORT OVERCOAT FOR KIMONO (HAORI); SHORT PETTICOATS; SHORT SETS; SHORT TROUSERS; SHORT-SLEEVED OR LONG-SLEEVED T-SHIRTS; SHORT-SLEEVED SHIRTS; SHORTS; SKI JACKETS; SKI PANTS; SLEEP SHIRTS; SLEEVED OR SLEEVELESS JACKETS; SLIDING SHORTS; SMOKING JACKETS; SNOW PANTS; SNOWBOARD PANTS; SPORT SHIRTS; SPORTS JACKETS; SPORTS PANTS; SPORTS SHIRTS; SPORTS SHIRTS WITH SHORT SLEEVES; STRETCH PANTS; STUFF JACKETS; SUEDE JACKETS; SWEAT JACKETS; SWEAT PANTS; SWEAT SHIRTS; SWEAT SHORTS; T-SHIRTS; TAP PANTS; TEE SHIRTS; TOBOGGAN HATS, PANTS AND CAPS; TRACK JACKETS; TRACK PANTS; TRAVEL CLOTHING CONTAINED IN A PACKAGE COMPRISING REVERSIBLE JACKETS, PANTS, SKIRTS, TOPS AND A BELT OR SCARF; TRIATHLON CLOTHING, NAMELY, TRIATHLON TIGHTS, TRIATHLON SHORTS, TRIATHLON SINGLETS, TRIATHLON SHIRTS, TRIATHLON SUITS; UNDERWEAR, NAMELY, BOY SHORTS; VEST EXTENDERS; VESTED SUITS; VESTS; WALKING SHORTS; WATERPROOF JACKETS AND PANTS; WEARABLE GARMENTS AND CLOTHING, NAMELY, SHIRTS; WIND PANTS; WIND RESISTANT JACKETS; WIND SHIRTS; WIND VESTS; WIND-JACKETS; WORKING OVERALLS; YOGA PANTS; YOGA SHIRTS (U.S. CLS. 22 AND 39).

FIRST USE 1-1-1990; IN COMMERCE 1-1-1997.
GENE MACIOL, EXAMINING ATTORNEY

CLASS 25—(Continued).

SN 77-641,154. ANDORRA AUSTRALIA PTY LTD., HEIDELBERG WEST, AUSTRALIA, FILED 12-30-2008.

PRIVATE PROPERTY

THE MARK CONSISTS OF STANDARD CHARACTERS WITHOUT CLAIM TO ANY PARTICULAR FONT, STYLE, SIZE, OR COLOR.

OWNER OF AUSTRALIA REG. NO. 574619, DATED 3-17-1992, EXPIRES 3-17-2019.

FOR CLOTHING, NAMELY, LINGERIE AND UNDERWEAR (U.S. CLS. 22 AND 39).

MICHAEL LITZAU, EXAMINING ATTORNEY

SN 77-650,461. JUMP APPAREL CO., INC., NEW YORK, NY. FILED 1-15-2009.

ONYX Nite

THE MARK CONSISTS OF THE WORDS "ONYX NITE" IN STYLIZED FORMAT.

FOR CLOTHING AND APPAREL, NAMELY, DRESSES, EVENING AND DAY-INTO-EVENING DRESSES, SOCIAL OCCASION DRESSES, SHIRTS, BLOUSES, JUMPSUITS, SWEATERS, SHORTS, JEANS, T-SHIRTS, SWEATSHIRTS, SWEATPANTS, HEAD BANDS, BELTS, SWEAT BANDS, SHAWLS, UNDERGARMENTS, TIGHTS, BICYCLE SHORTS, SCARVES, TIES, SWIM SUITS AND FOOTWEAR (U.S. CLS. 22 AND 39).

FIRST USE 0-0-1993; IN COMMERCE 0-0-1993. KIMBERLY FRYE, EXAMINING ATTORNEY

CLASS 25—(Continued).

SN 77-662,256. MANIFATTURA CORONA S.P.A., CASALSERUGO (PADOVA), ITALY, FILED 2-3-2009.



OWNER OF ITALY REG. NO. 848658, DATED 12-21-2002, EXPIRES 3-14-2011.

THE NAME(S), PORTRAIT(S), AND/OR SIGNATURE(S) SHOWN IN THE MARK DOES NOT IDENTIFY A PARTICULAR LIVING INDIVIDUAL.

THE MARK CONSISTS OF "EDDIE PEN EP" IN A STYLIZED FONT.

FOR (BASED ON INTENT TO USE) (BASED ON 44(E)) PULLOVERS, GLOVES, CARDIGANS; CLOTHING, NAMELY, JERSEYS; SWEATERS, TIGHTS, SHORTS, BABIES' SHORTS, PEDAL PUSHERS, BABIES' PEDAL PUSHERS, HIP-HUGGERS, BABIES' HIP-HUGGERS, LEGGINGS, SKIRTS, JACKETS, JERKINS, SHIRTS, VESTS, GOOSE DOWN VESTS, BABIES' GOOSE DOWN VESTS, WAISTCOATS, JUMPERS, TRACK SUITS, BLOUSES, JEANS, DUNGAREES, BABIES' DUNGAREES, BABIES' OVERALLS, PANTIES, BERMUDA SHORTS, BABIES' BERMUDA SHORTS, T-SHIRTS, SWEAT-SHIRTS, SUITS AND DRESSES, OVERCOATS, ANORAKS, GOOSE DOWN JACKETS, BABIES GOOSE DOWN JACKETS, COATS, RAINCOATS, BABIES' PANTS; CLOTHING, NAMELY, BELTS AND SASHES; HATS, CAPS; (BASED ON USE IN COMMERCE) TROUSERS (U.S. CLS. 22 AND 39).

FIRST USE 12-31-1992; IN COMMERCE 2-29-1996. ROBIN CHOSID, EXAMINING ATTORNEY

SN 77-670,651. BLUME FOREVER, FORMERLY ***** , NEW YORK, NY. FILED 2-13-2009.

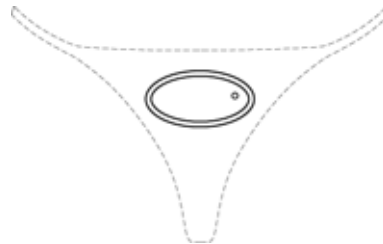

OWNER OF U.S. REG. NO. 2,996,597. THE MARK CONSISTS OF AN OVAL WITHIN AN OVAL AND A SMALL CIRCLE REPRESENTING A RHINESTONE TO THE RIGHT INSIDE THE INNER OVAL. THE DOTTED LINES ARE NOT PART OF THE MARK AND SERVE ONLY TO SHOW POSITION OF THE MARK.

SEC. 2(F). FOR UNDERWEAR (U.S. CLS. 22 AND 39). FIRST USE 5-1-2001; IN COMMERCE 5-1-2001. KATHLEEN LORENZO, EXAMINING ATTORNEY

CLASS 25—(Continued).

SN 77-680,150. ROCKY BRANDS WHOLESALE LLC, NELSONVILLE, OH. FILED 2-27-2009.

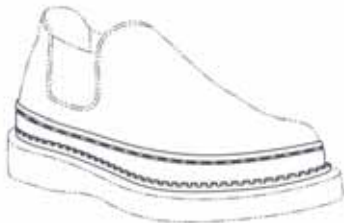

THE MARK CONSISTS OF A DESIGN OF A RUBBER BAND WITH A PROJECTING RIDGELINE AT THE TOP, CRISSCROSSED PATTERN, AND A NOTCHED DESIGN AT THE BOTTOM, ALL ENCIRCLING A SHOE. THE SHADING IN THE DRAWING IS USED TO INDICATE THE WIDTH AND ROUNDING OF THE NOTCHED DESIGN AND IS NOT USED TO INDICATE COLOR. THE BROKEN LINES IN THE DRAWING ARE USED TO INDICATE PLACEMENT OF THE MARK ON THE GOODS AND ARE NOT PART OF THE MARK ITSELF.

SEC. 2(F).

FOR FOOTWEAR (U.S. CLS. 22 AND 39).
FIRST USE 6-30-1996; IN COMMERCE 6-30-1996.
WILLIAM VERHOSEK, EXAMINING ATTORNEY

SN 77-702,658. PECORARO, GINA M., ROCKY POINT, NY. FILED 3-30-2009.



NO CLAIM IS MADE TO THE EXCLUSIVE RIGHT TO USE "CLOTHING", APART FROM THE MARK AS SHOWN.

THE MARK CONSISTS OF THE NUMBER "7" WITH THREE HORIZONTAL LINES NEXT TO IT ON THE RIGHT HAND SIDE (REPRESENTING THE LETTER E). UNDERNEATH THAT, THE WORDS "SEVEN EVEN" WILL APPEAR. BENEATH "SEVEN EVEN", THE WORD "CLOTHING" WILL APPEAR.

FOR HATS; HOODED SWEAT SHIRTS; PANTS; T-SHIRTS; TANK TOPS (U.S. CLS. 22 AND 39).

ELI HELLMAN, EXAMINING ATTORNEY

SN 77-716,447. KUHLMAN, BRUCE F., SAN RAFAEL, CA. FILED 4-17-2009.

Rock & Roll Mojo

THE MARK CONSISTS OF STANDARD CHARACTERS WITHOUT CLAIM TO ANY PARTICULAR FONT, STYLE, SIZE, OR COLOR.

FOR WEARABLE GARMENTS AND CLOTHING, NAMELY, SHIRTS (U.S. CLS. 22 AND 39).

REBECCA SMITH, EXAMINING ATTORNEY

CLASS 25—(Continued).

SN 77-723,368. MYRIAM ESTHER GUEZ, TA BUBA ROSE, NORWOOD, MA. FILED 4-27-2009.



THE NAME(S), PORTRAIT(S), AND/OR SIGNATURE(S) SHOWN IN THE MARK DOES NOT IDENTIFY A PARTICULAR LIVING INDIVIDUAL.

THE COLOR(S) PINK, PURPLE, CREAM, GREEN AND WHITE IS/ARE CLAIMED AS A FEATURE OF THE MARK.

THE MARK CONSISTS OF THE STYLIZED WORDING "BUBA ROSE" IN PINK OUTLINED IN DARK PINK, TO THE RIGHT OF AN IMAGE OF A GIRL DOLL WITH EYES, MOUTH, HAIR IN PURPLE. THE FACE, BODY, HANDS, BOWS AND FEET REPRESENTED AS YARN FRINGES IN PINK. THE DOLL IN THE IMAGE IS WEARING A CREAM COLOR SWEATER WITH A BRIGHT PINK AND WHITE ROSE WITH A GREEN STALK.

FOR SWEATERS, DRESSES, SHIRTS, PANTS, BELTS, BOOTIES, SOCKS, HATS, SKIRTS, GLOVES, MADE OF CASHMERE AND 100% COTTON (U.S. CLS. 22 AND 39).

FIRST USE 4-20-2009; IN COMMERCE 4-26-2009.

ELLEN B. AWRICH, EXAMINING ATTORNEY

SN 77-723,447. TONY BANILLA, DBA NY FIGHTER, ASTORIA, NY. FILED 4-27-2009.

NY FIGHTER

THE MARK CONSISTS OF STANDARD CHARACTERS WITHOUT CLAIM TO ANY PARTICULAR FONT, STYLE, SIZE, OR COLOR.

NO CLAIM IS MADE TO THE EXCLUSIVE RIGHT TO USE "NY", APART FROM THE MARK AS SHOWN.

FOR A-SHIRTS; ATHLETIC APPAREL, NAMELY, SHIRTS, PANTS, JACKETS, FOOTWEAR, HATS AND CAPS, ATHLETIC UNIFORMS; BODY SHIRTS; BUT-TON-FRONT ALOHA SHIRTS; CAMP SHIRTS; CLOTHING FOR ATHLETIC USE, NAMELY, PADDED SHIRTS; DRESS SHIRTS; GOLF PANTS, SHIRTS AND SKIRTS; GOLF SHIRTS; HOODED SWEAT SHIRTS; KNIT SHIRTS; LONG-SLEEVED SHIRTS; MOISTURE-WICKING SPORTS SHIRTS; NIGHT SHIRTS; OPEN-NECKED SHIRTS; OVER SHIRTS; PIQUE SHIRTS; POLO SHIRTS; RUGBY SHIRTS; SCIENTIFIC AND TECHNOLOGICAL APPAREL, NAMELY, SHIRTS, PANTS, JACKETS, FOOTWEAR, HATS AND CAPS, UNIFORMS; SHIRT FRONTS; SHIRT YOKES; SHIRTS; SHIRTS FOR SUITS; SHORT-SLEEVED OR LONG-SLEEVED T-SHIRTS; SHORT-SLEEVED SHIRTS; SLEEP SHIRTS; SPORT SHIRTS; SPORTS SHIRTS; SPORTS SHIRTS WITH SHORT SLEEVES; SWEAT SHIRTS; T-SHIRTS; TEE SHIRTS; TRIATHLON CLOTHING, NAMELY, TRIATHLON TIGHTS, TRIATHLON SHORTS, TRIATHLON SINGLETTS, TRIATHLON SHIRTS, TRIATHLON SUITS; TURTLE NECK SHIRTS; WEARABLE GARMENTS AND CLOTHING, NAMELY, SHIRTS; WIND SHIRTS; YOGA SHIRTS (U.S. CLS. 22 AND 39).

FRANK LATTUCA, EXAMINING ATTORNEY

CLASS 25—(Continued).

SN 77-723,517. KINCH L.L.C., PHOENIX, AZ. FILED 4-27-2009.

KINCH

THE MARK CONSISTS OF STANDARD CHARACTERS WITHOUT CLAIM TO ANY PARTICULAR FONT, STYLE, SIZE, OR COLOR.
FOR CLOTHING, NAMELY, T-SHIRTS (U.S. CLS. 22 AND 39).

FIRST USE 7-1-2005; IN COMMERCE 7-1-2005.
CHARLES L. JENKINS, EXAMINING ATTORNEY

SN 77-728,578. KFR, INC., ATLANTA, GA. FILED 5-4-2009.



NO CLAIM IS MADE TO THE EXCLUSIVE RIGHT TO USE "RECTANGLE LABEL SHAPE" AND "PREMIUM QUALITY", APART FROM THE MARK AS SHOWN.

THE COLOR(S) RED, WHITE, BLUE, BLACK AND GOLD IS/ARE CLAIMED AS A FEATURE OF THE MARK.

THE MARK CONSISTS OF A CONFIGURATION OF A RECTANGULAR PRODUCT LABEL CONSISTING OF A WHITE RECTANGLE WITH DIAGONAL RED AND WHITE STRIPES AND A DIAGONAL INCOMPLETE BLUE RECTANGLE WITH WHITE STARS. THE WORDING "DESIGN-AMERICA" APPEARS IN GOLD WITHIN A BLUE BOX WITH GOLD OUTLINING SUPERIMPOSED OVER THE STARS AND STRIPES. THE WORDING "PREMIUM QUALITY" APPEARS IN BLACK WITH GOLD OUTLINING. THE RECTANGULAR LABEL SHAPE SHOWN IN BROKEN LINES IS NOT PART OF THE MARK AND SERVES ONLY TO SHOW THE POSITION OF THE MARK.

FOR HOSIERY; SOCKS AND HOSIERY; NON-RESTRICTIVE SOCKS (U.S. CLS. 22 AND 39).

FIRST USE 4-1-2009; IN COMMERCE 4-1-2009.
INGRID C. EULIN, EXAMINING ATTORNEY

SN 77-740,774. WRIGHT, KRIS, VIRGINIA BEACH, VA. AND MARK METZGER, VIRGINIA BEACH, VA. FILED 5-19-2009.

ATYPICAL

THE MARK CONSISTS OF THE WORDS "ATYPICAL" IN STYLIZED FORM WITH THE "A" APPEARING IN THE SHAPE OF A TRIANGLE OR THE GREEK LETTER DELTA. FOR FOOTWEAR (U.S. CLS. 22 AND 39).

ALEXANDER L. POWERS, EXAMINING ATTORNEY

CLASS 25—(Continued).

SN 77-741,577. DAVID TEXTILES, INC., CITY OF COMMERCE, CA. FILED 5-20-2009.

DAVID TEXTILES, INC.

THE MARK CONSISTS OF STANDARD CHARACTERS WITHOUT CLAIM TO ANY PARTICULAR FONT, STYLE, SIZE, OR COLOR.

NO CLAIM IS MADE TO THE EXCLUSIVE RIGHT TO USE "TEXTILES, INC.", APART FROM THE MARK AS SHOWN.

FOR CLOTHING FOR WOMEN AND CHILDREN, NAMELY, JEANS, PANTS, SKIRTS, SHORTS, SHIRTS, BLOUSES, TANKS, DRESSES, BLAZERS, JACKETS, OVERALLS; HALLOWEEN, MARDI GRAS, CHILDREN'S DRESS-UP, COSTUME PARTY, AND FOLK COSTUMES; FOOTWEAR, INCLUDING SHOES AND BOOTS; CLOTHING ACCESSORIES, NAMELY, SOCKS, HATS, MITTENS, GLOVES, BELTS, SCARVES; SLEEP WEAR AND INTIMATES, NAMELY, PAJAMAS, CAMISOLES, BRIEFS, BOXERS, PANTIES; ATHLETIC WEAR, NAMELY, LEGGINGS, LEGWARMERS, TRACK SUITS, SWEATSHIRTS AND SWEAT PANTS, HEAD AND WRIST BANDS; OUTERWEAR, NAMELY, PONCHOS, JACKETS, SWEATERS, SHAWLS, HATS, MITTENS, GLOVES, VESTS; AND SWIMWEAR, INCLUDING BIKINIS, SWIM TRUNKS, AND SWIMSUITS (U.S. CLS. 22 AND 39).

KIMBERLY FRYE, EXAMINING ATTORNEY

SN 77-756,323. DUBROWSKI, NATHAN, TAMPA, FL. FILED 6-10-2009.

SORRY I'M HOT.

THE MARK CONSISTS OF STANDARD CHARACTERS WITHOUT CLAIM TO ANY PARTICULAR FONT, STYLE, SIZE, OR COLOR.

FOR CLOTHING, NAMELY, HATS, CAPS, SHIRTS, PANTS, SHORTS, JOGGING SUITS, AND PAJAMAS (U.S. CLS. 22 AND 39).

SHAUNIA CARLYLE, EXAMINING ATTORNEY

CLASS 25—(Continued).

SN 77-764,378. BING, CRYSTAL, D, TAMPA, FL. FILED 6-19-2009.



THE MARK CONSISTS OF DUAL LINES FORMING TWO OPPOSING "J" CURVES MOUNTED ON TOP OF A "Y".

FOR CASUAL WEAR, NAMELY, SHORTS, SKIRTS, DRESSES AND PANTS; EVENING WEAR, NAMELY, EVENING DRESSES; SWIM WEAR (U.S. CLS. 22 AND 39).

FIRST USE 1-3-2004; IN COMMERCE 1-31-2004.
JANET LEE, EXAMINING ATTORNEY

SN 77-768,953. COLON, IDRISA, STATEN ISLAND, NY.
FILED 6-26-2009.

EDRES 1973

THE MARK CONSISTS OF STANDARD CHARACTERS WITHOUT CLAIM TO ANY PARTICULAR FONT, STYLE, SIZE, OR COLOR.

FOR CLOTHING, NAMELY, SHIRTS, EMBROIDERED SHIRTS, T-SHIRTS, SHORTS, SPORT SHIRTS, SWEAT SHIRTS, SWEAT PANTS, VESTS, BELTS, FOOTWEAR, UNDERWEAR, WARM-UP SUITS, JACKETS, JERSEYS, TANK TOPS, SWEATERS, PANTS, JEANS, SPORT COATS, COATS, HEADBANDS, OVERCOATS, JACKETS, PARKAS, SCARVES, HEADWEAR, HATS, BASEBALL CAPS, EMBROIDERED CAPS, KNITTED HATS, SHOES, SLIPPERS, BOOTS, BLOUSES, DRESSES, SKIRTS, TOPS, AND JUMPERS (U.S. CLS. 22 AND 39).

DOMINICK J. SALEMI, EXAMINING ATTORNEY

CLASS 25—(Continued).

SN 77-771,300. MORPHINE GENERATION, INC., LOS ANGELES, CA. FILED 6-30-2009.

YOUNG MACHINES

THE MARK CONSISTS OF STANDARD CHARACTERS WITHOUT CLAIM TO ANY PARTICULAR FONT, STYLE, SIZE, OR COLOR.

FOR CLOTHING FOR MEN AND WOMEN, NAMELY, JACKETS, SWEATSHIRTS, SWEATERS, SHIRTS, T-SHIRTS, TANK TOPS, VESTS, BOTTOMS, SKIRTS, DRESSES, KNITWEAR, NAMELY, TOPS AND BOTTOMS, AND WOVENS, NAMELY, TOPS AND BOTTOMS; CLOTHING ACCESSORIES, NAMELY, BELTS, HATS, SCARVES, GLOVES, AND SHOES (U.S. CLS. 22 AND 39).
FIRST USE 8-1-2008; IN COMMERCE 1-3-2009.

KARANENDRA S. CHHINA, EXAMINING ATTORNEY

SN 77-771,527. TERRASYSTEMS ECOSHIRT, INC., AKA TERRASYSTEMS/ECOSHIRT, INC., NEW YORK, NY.
FILED 6-30-2009.

ECO TEE

THE MARK CONSISTS OF STANDARD CHARACTERS WITHOUT CLAIM TO ANY PARTICULAR FONT, STYLE, SIZE, OR COLOR.

OWNER OF U.S. REG. NOS. 2,408,756, 2,911,325 AND 2,967,351.

NO CLAIM IS MADE TO THE EXCLUSIVE RIGHT TO USE "TEE", APART FROM THE MARK AS SHOWN.

FOR CLOTHING, NAMELY, SHIRTS, PANTS, SHORTS, JEANS, BOTTOMS, COATS, JACKETS, SKIRTS, DRESSES, BLOUSES, LOUNGE WEAR, NECKWEAR, SOCKS, SUITS, SWEATERS, GYM SHORTS AND TANK TOPS, JERSEYS, UNDERWEAR AND ATHLETIC UNIFORMS; BEACHWEAR; HATS, CAPS, BELTS (U.S. CLS. 22 AND 39).

ESTHER BELENKER, EXAMINING ATTORNEY

CLASS 25—(Continued).

SN 77-773,130. ATKINSON LLC, BRONXVILLE, NY. FILED 7-2-2009.



THE MARK CONSISTS OF AN IMAGE OF TWO STYLIZED CURVED LINES OF CHANGING PROPORTIONS SEPARATELY REPRESENTING A WINKING EYE.

FOR A-SHIRTS; AFTER SKI BOOTS; ANKLE BOOTS; ANKLE SOCKS; ANORAKS; ASCOTS; ATHLETIC FOOTWEAR; ATHLETIC UNIFORMS; BABY DOLL PYJAMAS; BALLOON PANTS; BANDANAS; BASEBALL CAPS; BASKETBALL SNEAKERS; BATH SLIPPERS; BATHING COSTUMES; BATHING COSTUMES FOR WOMEN; BATHING TRUNKS; BEACH COVER-UPS; BEACH FOOTWEAR; BEANIES; BEDJACKETS; BELTS; BERETS; BERMUDA SHORTS; BIKINIS; BLAZERS; BLOOMERS; BLOUSES; BLOUSONS; BOARD SHORTS; BODY SHAPERS; BODY SUITS; BOTTOMS; BOW TIES; BOXER BRIEFS; BOXER SHORTS; BRALETTES; BRAS; BRASSIERES; BREECHES; BRIEFS; BUSTIERS; BUSTLE HOLDER BANDS FOR OBI (OBIAGE); BUSTLES FOR OBI-KNOTS (OBIAGE-SHIN); BUTTON-FRONT ALOHA SHIRTS; CAFTANS; CAMISETTES; CAMISOLES; CAMP SHIRTS; CANVAS SHOES; CAP VISORS; CAPES; CAPRI PANTS; CAPRIS; CAPS; CARDIGANS; CARGO PANTS; CHEF'S HATS; CHEMISES; CLOGS; COATS FOR MEN AND WOMEN; CORSETS; CREW NECK SWEATERS; CREWNECKS; CROP TOPS; CULOTTES; DENIM JACKETS; DRESS SHIRTS; DRESS SUITS; DRESSES; DRESSING GOWNS; DUNGAREES; ESPADRILLES; EVENING DRESSES; EVENING GOWNS; FLEECE PULLOVER; FLIPPLOPS; FOOTWEAR; FOUNDATION GARMENTS; FUR JACKETS; G-STRINGS; GARTER BELTS; GIRDLES; GLOVES; GOLF CAPS; GOLF SHIRTS; GOLF SHOES; GOLF TROUSERS; GYM SHORTS; HALLOWEEN COSTUMES; HALTER TOPS; HEAD SCARVES; HEAD BANDS; HOODS; HOUSECOATS; HOSIERY; INTIMATES, NAMELY, UNDERWEAR, BRAS, AND LINGERIE; JACKETS; JODHPURS; JOGGING OUTFITS; JOGGING SUITS; JOGGING PANTS; JUMPERS; JUMPSUITS; KILTS; KNICKERS; KNITTED UNDERWEAR; LADIES BOOTS; LADIES SUITS; LADIES UNDERWEAR; LEATHER PANTS; LEATHER JACKETS; LEATHER SHOES; LEG WARMERS; LEOTARDS AND TIGHTS FOR WOMEN; LINGERIE; LONG SLEEVED VESTS; LONG SLEEVED SHIRTS; LOUNGE PANTS; LOUNGEWEAR; MEN AND WOMEN JACKETS; TROUSERS, COATS, VESTS; MEN'S SOCKS; MEN'S SUITS; MINISKIRTS; MITTENS; MOCCASINS; MOCK TURTLE-NECK SWEATERS; MOCKNECKS; MONEY BELTS; MORNING COATS; MUFFLERS; NECKTIES; NECK WEAR; NEGLIGENCE; NIGHT GOWNS; NIGHT SHIRTS; NIGHTCAPS; NIGHTDRESSES; NIGHTGOWNS; NIGHTTIES; NIGHTWEAR; PANTIES; PANTIES, SHORTS AND BRIEFS; PANTS; PANTSUITS; PANTYHOSE; PARKAS; PEDAL PUSHERS; PETTICOATS; PINAFORES; PIQUET SHORTS; POLO SHIRTS; PONCHOS; PULLOVERS; PYJAMAS; QUILTED VESTS; RAINBOOTS; RAINCOATS; RAINJACKETS; RAINWEAR; RIDING BOOTS; RIDING COATS; RIDING GLOVES; ROMPERS; RUBBER SHOES; RUBBERS; RUGBY SHOES; RUGBY SHORTS; RUGBY TOPS; RUNNING SHORTS; SANDAL CLOGS; SANDALS; SARIS; SARONGS; SASHES; SCARVES; SCHOOL UNIFORMS; SHAMPOO CAPES; SHAWLS; HEADSCARVES; SHIFTS; SHIRTS; SHIRTS FOR SUITS; SHORT TROUSERS; SHORT-SLEEVED OR LONG-SLEEVED T-SHIRTS; SHORT-SLEEVED SHIRTS; SHORTS; SHOULDER SCARVES; SHOULDER WRAPS; SHOWER CAPS; SILK SCARVES; SINGLETS; SKATING OUTFITS; SKI AND SNOWBOARD SHOES; SKI BIBS; SKI BOOT BAGS; SKI GLOVES; SKI JACKETS; SKI MASKS; SKI PANTS; SKI SUITS; SKI SUITS FOR COMPETITION; SKIRT SUITS; SKIRTS; SKIRTS AND DRESSES; SKI WEAR; SKORTS; SKULL CAPS; SLACKS; SLEEPMASKS; SLEEP SHIRTS; SLEEPING GARMENTS; SLEEPWEAR; SLEEVED OR SLEEVELESS JACKETS; SLEEVELESS JERSEYS; SLIP-

CLASS 25—(Continued).

PERS; SLIPS; SMALL HATS; SMOCKS; SMOKING JACKETS; SNEAKERS; SNOWBOARDING SUITS; SNOWPANTS; SNOWSUITS; SNOWBOARD BOOTS; SNOWBOARD GLOVES; SNOWBOARD MITTENS; SNOWBOARD PANTS; SOCCER BOOTS; SOCCER SHOES; SOCKS; STOCKINGS; SPORT COATS; SPORT SHIRTS; SPORTS BRA; SPORTS JACKETS; SPORTS JERSEYS; SPORTS UNIFORMS; SPORTS SHIRTS; SPORT SHIRTS WITH SHORT SLEEVES; STOLE, STRAPLESS BRAS; STRAPS FOR BRAS; STUFF JACKETS; SUEDE JACKETS; SUIT JACKETS; SUITS COATS; SUITS; SUITS OF LEATHER; SUN SLEEVES; SUN VISORS; SUNSUITS; SURFWEAR; SUSPENDER BELTS FOR MEN; SUSPENDER BELTS FOR WOMEN; SUSPENDERS; SWADDLING CLOTHES; SWEAT BANDS; SWEATPANTS; SWEATSHIRTS; SWEATSHORTS; SWEAT SUITS; SWEATBANDS; SWEATERS; SWEATSOCKS; SWIM CAPS; SWIM TRUNKS; SWIM WEAR; SWIM WEAR FOR GENTLEMEN AND LADIES; SWIMMING COSTUMES; SWIMMING TRUNKS; SWIMSUITS AND SWIMWEAR; T-SHIRTS; TANK TOPS; TANK-TOPS; TANKINIS; TAP PANTS; TAP SHOES; TEDDIES; TEE SHIRTS; TENNIS SHOES; TENNIS WEAR; THERMAL SOCKS; THERMAL UNDERWEAR; THONGS; TIES; TIGHTS; TOBOGGAN HATS, PANTS AND HATS; TOGAS; TOPCOATS; TRACK AND FIELD SHOES; TRACK PANTS; TRACK SUITS; TRAINING SHOES; TRAINING SUITS; TRENCH COATS; TROUSERS; TRUNKS; TUBE TOPS; TUNICS; TURBANS; TURTLENECK SWEATERS; TURTLENECKS; TUXEDO BELTS; TUXEDOS; TWIN SETS; UNDER GARMENTS; UNDERCLOTHES; UNDERPANTS; UNDERSHIRTS; V-NECK SWEATERS; VEILS; VESTS; VISORS; VOLLEYBALL SHOES; WAIST BELTS; WAIST BANDS; WAISTCOATS; WALKING SHORTS; WARM-UP SUITS; WATER SOCKS; WATERPROOF JACKETS AND PANTS; WEDDING DRESSES; WEDDING GOWNS; WET SUIT GLOVES; WET SUITS; WET SUITS FOR WATER-SKIING AND SUB-AQUA; WIND COATS; WIND PANTS; WIND RESISTANT JACKETS; WIND SHORTS; WINDCHEATERS; WINDJAMMERS; WINTER BOOTS; WOMENS' SHOES; WOMENS' UNDERWEAR; WOOLLEN SOCKS; WOOLLY HATS; WORK SHOES AND BOOTS; WORKING OVERALLS; WOVEN OR KNITTED UNDERWEAR; YOGA PANTS; YOGA SHIRTS; ZOOT SUITS (U.S. CLS. 22 AND 39).

ALEX KEAM, EXAMINING ATTORNEY

SN 77-777,869. OTTO INTERNATIONAL, INC., FAIRBURN, GA. FILED 7-9-2009.

COMFY FIT

THE MARK CONSISTS OF STANDARD CHARACTERS WITHOUT CLAIM TO ANY PARTICULAR FONT, STYLE, SIZE, OR COLOR.

FOR HEADWEAR; CAPS; SUN VISORS; SPORT SHIRTS (U.S. CLS. 22 AND 39).

AISHA CLARKE, EXAMINING ATTORNEY

CLASS 25—(Continued).

SN 77-780,535. MVL RIGHTS LLC, MANHATTAN BEACH, CA. FILED 7-14-2009.

STARK INDUSTRIES

THE MARK CONSISTS OF STANDARD CHARACTERS WITHOUT CLAIM TO ANY PARTICULAR FONT, STYLE, SIZE, OR COLOR.

NO CLAIM IS MADE TO THE EXCLUSIVE RIGHT TO USE "INDUSTRIES", APART FROM THE MARK AS SHOWN.

FOR BEACH SHOES; BELTS; CAPS; COATS; GLOVES; HALLOWEEN COSTUMES; HALLOWEEN COSTUMES AND MASKS SOLD IN CONNECTION THEREWITH; HATS; HEADBANDS; JACKETS; MASQUERADE COSTUMES AND MASKS SOLD IN CONNECTION THEREWITH; OVERALLS; PANTS; RAINWEAR; ROBES; SANDALS; SCARVES; SHIRTS; SHOES; SHORTS; SLACKS; SLEEPING GARMENTS; SNEAKERS; SOCKS; SUSPENDERS; SWEAT PANTS; SWEAT SHIRTS; SWIM WEAR; T-SHIRTS; TIES; UNDERWEAR; VESTS; VISORS (U.S. CLS. 22 AND 39).

WON TEAK OH, EXAMINING ATTORNEY

SN 77-780,580. CUTTERS, LLC, INDIANAPOLIS, IN. FILED 7-14-2009.

Cutters

THE MARK CONSISTS OF STANDARD CHARACTERS WITHOUT CLAIM TO ANY PARTICULAR FONT, STYLE, SIZE, OR COLOR.

FOR NON-TECHNICAL FASHION SHIRTS RELATED TO A CYCLING TEAM (U.S. CLS. 22 AND 39).

FIRST USE 4-30-1984; IN COMMERCE 4-30-1986.
KIMBERLY FRYE, EXAMINING ATTORNEY

SN 77-783,676. MICHAEL ORLANDO, BELLMORE, NY. FILED 7-17-2009.

MICHAEL CAPESHE

THE MARK CONSISTS OF STANDARD CHARACTERS WITHOUT CLAIM TO ANY PARTICULAR FONT, STYLE, SIZE, OR COLOR.

THE NAME(S), PORTRAIT(S), AND/OR SIGNATURE(S) SHOWN IN THE MARK DOES NOT IDENTIFY A PARTICULAR LIVING INDIVIDUAL.

FOR FASHION, NAMELY, SHIRTS AND HATS (U.S. CLS. 22 AND 39).

LINDA ESTRADA, EXAMINING ATTORNEY

CLASS 25—(Continued).

SN 77-785,024. INK ARMOR, LLC, LONG BEACH, CA. FILED 7-20-2009.

INK ARMOR

THE MARK CONSISTS OF STANDARD CHARACTERS WITHOUT CLAIM TO ANY PARTICULAR FONT, STYLE, SIZE, OR COLOR.

FOR CLOTHING, NAMELY, SHIRTS, HATS, SLEEVES AND STOCKINGS (U.S. CLS. 22 AND 39).

FIRST USE 6-1-2009; IN COMMERCE 6-1-2009.
FRED CARL, EXAMINING ATTORNEY

SN 77-785,100. RUTHANN GREENBLAT, DIAMOND BAR, CA. FILED 7-20-2009.

ARM CHARM

THE MARK CONSISTS OF STANDARD CHARACTERS WITHOUT CLAIM TO ANY PARTICULAR FONT, STYLE, SIZE, OR COLOR.

NO CLAIM IS MADE TO THE EXCLUSIVE RIGHT TO USE "ARM", APART FROM THE MARK AS SHOWN.

FOR WOMEN'S CLOTHING, NAMELY, ATTACHABLE SLEEVES FOR GARMENTS (U.S. CLS. 22 AND 39).

MICHELE SWAIN, EXAMINING ATTORNEY

SN 77-785,870. ASI APPAREL, INC., BALL GROUND, GA. FILED 7-21-2009.



NO CLAIM IS MADE TO THE EXCLUSIVE RIGHT TO USE "APPAREL", APART FROM THE MARK AS SHOWN.

THE COLOR(S) BLACK, ORANGE AND TEAL IS/ARE CLAIMED AS A FEATURE OF THE MARK.

THE MARK CONSISTS OF THE CAPITAL LETTERS "ASI" IN BLACK WITH THE "A" PARTIALLY SUPERIMPOSED OVER A TRIANGLE. THE TRIANGLE IS TEAL COLORED, WITH THE POINT OF THE TRIANGLE BEING ORANGE. A PORTION OF THE TRIANGLE IS COLORED ORANGE WITHIN THE LETTER "A". THE WORDING "APPAREL" APPEARS IN BLACK UNDER THE WORDING "ASI". THERE IS A TEAL RECTANGLE RUNNING ALONG THE BOTTOM OF THE ENTIRE MARK.

FOR CLOTHING, NAMELY, HATS, SHIRTS, PANTS, SOCKS AND UNDERGARMENTS (U.S. CLS. 22 AND 39).

MATTHEW EINSTEIN, EXAMINING ATTORNEY

CLASS 25—(Continued).

SN 77-789,282. WELLINGTON'S WORLD LLC, DBA SETH WELLINGTON, PETALUMA, CA. FILED 7-24-2009.

SETH WELLINGTON

THE MARK CONSISTS OF STANDARD CHARACTERS WITHOUT CLAIM TO ANY PARTICULAR FONT, STYLE, SIZE, OR COLOR.

THE NAME "SETH WELLINGTON" IDENTIFIES A LIVING INDIVIDUAL WHOSE CONSENT IS OF RECORD.

FOR MEN'S CLOTHING, NAMELY, SHIRTS, SHORTS, PANTS, OVERALLS, TROUSERS, SWEATERS, SWEATSHIRTS, JACKETS, VESTS, SPORTS COATS, SUITS, TUXEDOS, SWIM TRUNKS, HATS, GLOVES, MITTENS, SPORTS CAPS, ATHLETIC PANTS, ATHLETIC SHORTS, ATHLETIC SHIRTS, ATHLETIC JACKETS, LOUNGE PANTS, PAJAMAS, ROBES, SOCKS, UNDERWEAR, UNDERSHIRTS, BELTS, TIES, BOW TIES, POCKET SQUARES, SUSPENDERS, SCARVES, SHOES, SLIPPERS; WOMEN'S CLOTHING, NAMELY, SHIRTS, BLOUSES, SHORTS, PANTS, TROUSERS, LEGGINGS, HOSIERY, SKIRTS, JUMPERS, OVERALLS, DRESSES, VESTS, JACKETS, SHRUGS, BLAZERS, SWEATERS, SWEATSHIRTS, SCARVES, UNDERWEAR, BRAS, LINGERIE, LOUNGE PANTS, PAJAMAS, ROBES, HATS, SPORTS CAPS, ATHLETIC PANTS, ATHLETIC SHORTS, ATHLETIC SHIRTS, ATHLETIC JACKETS, SWIMSUITS, SOCKS, SHOES, SLIPPERS, GLOVES, MITTENS; CHILDREN'S CLOTHING, NAMELY, SHIRTS, SHORTS, PANTS, TROUSERS, SKIRTS, SKORTS, LEGGINGS, DRESSES, OVERALLS, JUMPERS, JACKETS, VESTS, SWEATERS, SWEATSHIRTS, LOUNGE PANTS, PAJAMAS, ROBES, SOCKS, SHOES, SLIPPERS, SWIMSUITS, UNDERWEAR, HATS, SCARVES, GLOVES, MITTENS, BABY BIBS NOT OF PAPER, CLOTH BIBS, PLASTIC BABY BIBS; INFANT WEAR; FOOTWEAR; HEADWEAR; NECKWEAR; RAINWEAR; SKIWEAR; SURF WEAR; SWIM WEAR; SPORTSWEAR, NAMELY, SHIRTS, SHORTS, PANTS, JACKETS, SWEATSHIRTS, SOCKS, UNDERWEAR, UNDERSHIRTS, SPORTS BRAS, HATS, SWEATBANDS, SHOES, CLEATS FOR ATTACHMENT TO SPORTS SHOES, GOLF CLEATS, SOCCER SHOES, GLOVES, MITTENS, SCARVES; UNDERWEAR; UNDERGARMENTS; OUTER WEAR, NAMELY, JACKETS, SHORTS, PANTS, SNOW PANTS, VESTS, OVERALLS, JUMPERS, SOCKS, SHOES, BOOTS, SCARVES, MITTENS, GLOVES, HATS; BELTS; GLOVES; LINGERIE; SUSPENDERS; TIES; SOCKS; WRISTBANDS; HATS; CAPS (U.S. CLS. 22 AND 39).

STEVEN JACKSON, EXAMINING ATTORNEY

CLASS 25—(Continued).

SN 77-794,955. KENNEDY, MARY B, DBA SAY-DO-SELL-BUY-STUFF, NOBLESVILLE, IN. AND HUDSON, KAREN, DBA SAY-DO-SELL-BUY-STUFF, LAKE ORION, MI. AND HERNANDEZ, LOLITA, DBA SAY-DO-SELL-BUY-STUFF, DETROIT, MI. FILED 8-1-2009.



THE MARK CONSISTS OF THE WORDING "SOMETHIN'S" ABOVE A DESIGN OF STICK FIGURE LEGS WITH SHOES WALKING. TWO CURVED LINES APPEAR IN FRONT OF THE RIGHT SHOE TO INDICATE MOTION. UNDERNEATH THE DESIGN APPEARS THE WORDING "GOTTA HAPPEN. . .". THE WORDING AND DESIGN ARE ALL ENCLOSED IN A SHADED RECTANGLE.

FOR BASEBALL CAPS; CAPS; CAPS WITH VISORS; FLEECE PULLOVERS; HOODED SWEAT SHIRTS; LONG-SLEEVED SHIRTS; NIGHT SHIRTS; POLO SHIRTS; SHORT-SLEEVED SHIRTS; SWEAT SHIRTS; T-SHIRTS (U.S. CLS. 22 AND 39).

KAPIL BHANOT, EXAMINING ATTORNEY

SN 77-795,560. TERRASYSTEMS ECOSHIRT, INC., NEW YORK, NY. FILED 8-3-2009.

ECO WEAR

THE MARK CONSISTS OF STANDARD CHARACTERS WITHOUT CLAIM TO ANY PARTICULAR FONT, STYLE, SIZE, OR COLOR.

OWNER OF U.S. REG. NOS. 2,408,756, 2,911,325 AND 2,967,351.

NO CLAIM IS MADE TO THE EXCLUSIVE RIGHT TO USE "WEAR", APART FROM THE MARK AS SHOWN.

FOR CLOTHING, NAMELY, SHIRTS, PANTS, SHORTS, JEANS, BOTTOMS, COATS, JACKETS, SKIRTS, DRESSES, BLOUSES, LOUNGE WEAR, NECKWEAR, SOCKS, SUITS, SWEATERS, GYM SHORTS AND TANK TOPS, JERSEYS, UNDERWEAR AND ATHLETIC UNIFORMS; BEACHWEAR; HATS, CAPS, BELTS (U.S. CLS. 22 AND 39).

ESTHER BELENKER, EXAMINING ATTORNEY

CLASS 25—(Continued).

SN 77-795,584. TERRASYSTEMS ECOSHIRT, INC., NEW YORK, NY. FILED 8-3-2009.

ECO JEAN

THE MARK CONSISTS OF STANDARD CHARACTERS WITHOUT CLAIM TO ANY PARTICULAR FONT, STYLE, SIZE, OR COLOR.

OWNER OF U.S. REG. NOS. 2,408,756, 2,911,325 AND 2,967,351.

NO CLAIM IS MADE TO THE EXCLUSIVE RIGHT TO USE "JEAN", APART FROM THE MARK AS SHOWN.

FOR CLOTHING, NAMELY, SHIRTS, PANTS, SHORTS, JEANS, BOTTOMS, COATS, JACKETS, SKIRTS, DRESSES, BLOUSES, LOUNGE WEAR, NECKWEAR, SOCKS, SUITS, SWEATERS, GYM SHORTS AND TANK TOPS, JERSEYS, UNDERWEAR AND ATHLETIC UNIFORMS; BEACHWEAR; HATS, CAPS, BELTS (U.S. CLS. 22 AND 39).

ESTHER BELENKER, EXAMINING ATTORNEY

SN 77-797,961. SAINT LOUIS UNIVERSITY, ST. LOUIS, MO. FILED 8-5-2009.

BE A BILLIKEN

THE MARK CONSISTS OF STANDARD CHARACTERS WITHOUT CLAIM TO ANY PARTICULAR FONT, STYLE, SIZE, OR COLOR.

OWNER OF U.S. REG. NO. 1,662,548.

FOR CLOTHING, NAMELY, T-SHIRTS AND POLO SHIRTS (U.S. CLS. 22 AND 39).

FIRST USE 7-10-2008; IN COMMERCE 8-1-2008.

LINDA E. BLOHM, EXAMINING ATTORNEY

SN 77-799,158. DIRADOUR REAL ESTATE HOLDING COMPANY LIMITED, MISSISSAUGA, ONTARIO, CANADA, FILED 8-6-2009.

IRON TREAD

THE MARK CONSISTS OF STANDARD CHARACTERS WITHOUT CLAIM TO ANY PARTICULAR FONT, STYLE, SIZE, OR COLOR.

PRIORITY CLAIMED UNDER SEC. 44(D) ON CANADA APPLICATION NO. 1434752, FILED 4-16-2009.

NO CLAIM IS MADE TO THE EXCLUSIVE RIGHT TO USE "TREAD", APART FROM THE MARK AS SHOWN.

FOR MEN'S, WOMEN'S AND CHILDREN'S FOOTWEAR, NAMELY, SHOES, WINTER BOOTS, HIKING BOOTS, DEMI BOOTS, AND WORK BOOTS (U.S. CLS. 22 AND 39).

DAWN FELDMAN, EXAMINING ATTORNEY

CLASS 25—(Continued).

SN 77-799,439. AZIZO, SARAH RINETTE, BROOKLYN, NY. FILED 8-7-2009.

RINETTE

THE MARK CONSISTS OF STANDARD CHARACTERS WITHOUT CLAIM TO ANY PARTICULAR FONT, STYLE, SIZE, OR COLOR.

FOR HEADBANDS (U.S. CLS. 22 AND 39).

FRANK LATTUCA, EXAMINING ATTORNEY

SN 77-799,659. THE EUPORIA GROUP, INCORPORATED, COUNTRY CLUB HILLS, IL. FILED 8-7-2009.



THE MARK CONSISTS OF A STYLIZED LETTER "L" WITH A SHEEP STANDING TO THE RIGHT OF THE LETTER "L".

FOR SHOES FOR MEN, WOMEN, CHILDREN, AND TODDLERS; CLOTHING AND RELATED ACCESSORIES FOR MEN, WOMEN, CHILDREN, TODDLERS, AND INFANTS, NAMELY, DRESSES, SUITS, BLOUSES, SHIRTS, SWEATSHIRTS, SWEATERS, VESTS, PANTS, SHORTS, BODYSUITS, SOCKS, BELTS, TIES, HATS, CAPS, AND CLOTH DIAPERS (U.S. CLS. 22 AND 39).

AARON BRODSKY, EXAMINING ATTORNEY

CLASS 25—(Continued).

SN 77-800,725. BRISKY, CURT, FERNDALE, WA. FILED 8-10-2009.



THE MARK CONSISTS OF THE IMAGE OF A QUESTION MARK FEATURED INSIDE THE DESIGN OF A TRIANGLE WITH THE STYLIZED TEXT "WYE?" AND THE WORDING "WHAT'S YOUR EXPOSURE?" FEATURED BELOW THE DESIGN.

FOR T-SHIRTS (U.S. CLS. 22 AND 39).
FIRST USE 1-1-1985; IN COMMERCE 1-1-1986.
CHARISMA HAMPTON, EXAMINING ATTORNEY

CLASS 25—(Continued).

SN 77-801,146. CABOT HOSIERY MILLS, INC., NORTH-FIELD, VT. FILED 8-10-2009.



OWNER OF U.S. REG. NOS. 3,098,272 AND 3,144,805.
THE STIPPLING IS FOR SHADING PURPOSES ONLY.
THE MARK CONSISTS OF A TRIANGLE WITH A "C" SHAPE THROUGH IT AND THE WORD "CABOT" BE-NEATH IT.

FOR SOCKS (U.S. CLS. 22 AND 39).
FIRST USE 9-25-2009; IN COMMERCE 9-25-2009.
ZHALEH DELANEY, EXAMINING ATTORNEY

SN 77-801,081. GLIFE52 INC., WILMINGTON, DE. FILED 8-10-2009.

G-Life

THE MARK CONSISTS OF STANDARD CHARACTERS WITHOUT CLAIM TO ANY PARTICULAR FONT, STYLE, SIZE, OR COLOR.

PRIORITY CLAIMED UNDER SEC. 44(D) ON CANADA APPLICATION NO. 1445806, FILED 7-23-2009.

FOR CLOTHING, NAMELY, SHIRTS; SWEATERS; PANTS; JACKETS; T-SHIRTS; SHORTS; SOCKS; SHOES; CAPS; SWEAT CLOTHING, NAMELY, SWEAT PANTS, SWEAT SHORTS, SWEAT SOCKS, SWEAT JACKETS, SWEAT SHIRTS, SWEAT SUITS; RAINWEAR AND WIND OUTER GARMENTS, NAMELY, WIND COATS, PANTS, SHIRTS (U.S. CLS. 22 AND 39).

DOMINIC FATHY, EXAMINING ATTORNEY

SN 77-802,439. PAITSON, DAVID, MONTGOMERY, TX. FILED 8-11-2009.



NO CLAIM IS MADE TO THE EXCLUSIVE RIGHT TO USE "COLUMBUS", APART FROM THE MARK AS SHOWN.

THE MARK CONSISTS OF THE WORDS "COLUMBUS CHILL" WITH ICICLE STRIPINGS GOING THROUGH THE WORDS IN AN ANGLE.

FOR HATS (U.S. CLS. 22 AND 39).
PAUL E. FAHRENKOPF, EXAMINING ATTORNEY

CLASS 25—(Continued).

SN 77-803,601. AERO DESIGN AND MANUFACTURING COMPANY, INC., DULUTH, MN. FILED 8-13-2009.



OWNER OF U.S. REG. NOS. 2,558,414, 3,299,991 AND OTHERS.

NO CLAIM IS MADE TO THE EXCLUSIVE RIGHT TO USE "DESIGN & MANUFACTURING COMPANY INC.", "TRADE MARK", "SINCE 1982", "DULUTH, MINNESOTA - USA", "TECHNOLOGIES", AND "FABRICS", APART FROM THE MARK AS SHOWN.

THE MARK CONSISTS OF A BANNER CONTAINING THE WORDS "AERO DESIGN & MANUFACTURING COMPANY INC." WITH A ROW OF STARS BENEATH AND THE WORD "PROTEKT" BENEATH THAT WITH THE LETTERS "R" AND "K" BACKWARDS, WITH A MOTORCYCLIST ON THE RIGHT AND LEFT SIDES, WITH THE WORD "TRADE" TO THE LEFT OF THE LEFT MOTORCYCLE AND THE WORD "MARK" TO THE RIGHT OF THE RIGHT MOTORCYCLE, WITH A HAMMER HITTING AN ANVIL INSIDE A CIRCLE BETWEEN THE MOTORCYCLES, WITH THE WORDS "SINCE 1982" BENEATH THAT AND WITH THE WORDS "DULUTH, MINNESOTA - USA" ON A VERTICAL BAR BENEATH THAT AND BENEATH THAT, THE WORDS "FLYING W TECHNOLOGIES", "TF3", WITH THE "3" IN "TF3" BEING IN SUPERScript FORM, AND "BLASTING ZONE FABRICS", WITH ALL OF THE FOREGOING INSIDE A RECTANGLE.

FOR CLOTHING, NAMELY, JEANS (U.S. CLS. 22 AND 39).

ELLEN B. AWRICH, EXAMINING ATTORNEY

CLASS 25—(Continued).

SN 77-806,019. M COLLECTIVE, INC., LOS ANGELES, CA. FILED 8-17-2009.

FACTORY

THE MARK CONSISTS OF STANDARD CHARACTERS WITHOUT CLAIM TO ANY PARTICULAR FONT, STYLE, SIZE, OR COLOR.

FOR CLOTHING FOR MEN AND WOMEN, NAMELY, JACKETS, SWEATSHIRTS, SWEATERS, SHIRTS, T-SHIRTS, TANK TOPS, VESTS, BOTTOMS, SKIRTS, DRESSES, KNITWEAR, NAMELY, TOPS AND BOTTOMS, AND WOVENS, NAMELY, TOPS AND BOTTOMS (U.S. CLS. 22 AND 39).

GINA HAYES, EXAMINING ATTORNEY

SN 77-805,345. MS SON LLC, PALMDALE, CA. FILED 8-14-2009.



NO CLAIM IS MADE TO THE EXCLUSIVE RIGHT TO USE "ORIGINAL VINTAGE", APART FROM THE MARK AS SHOWN.

THE NAME(S), PORTRAIT(S), AND/OR SIGNATURE(S) SHOWN IN THE MARK IDENTIFIES "RAVI SHARMA", WHOSE CONSENT(S) TO REGISTER IS MADE OF RECORD.

THE MARK CONSISTS OF A SOLID HORIZONTAL LINE WITH A STYLIZED AUTOMOBILE AT THE RIGHT END AND THE TEXT "JB ORIGINAL VINTAGE".

FOR CLOTHING, NAMELY, T-SHIRTS, SWEATSHIRTS, HOODED PULL OVER SHIRTS, POLO SHIRTS, SPORT SHIRTS, SHORTS, PANTS, JACKETS, HATS, CAPS, UNDERWEAR, SLEEPWEAR, SWIMWEAR, SHOES, SOCKS, SANDALS, AND FLIP FLOPS (U.S. CLS. 22 AND 39).

FIRST USE 12-28-2005; IN COMMERCE 12-28-2005.
ANDREA HACK, EXAMINING ATTORNEY

FACTORY BY ERIK HART

THE MARK CONSISTS OF STANDARD CHARACTERS WITHOUT CLAIM TO ANY PARTICULAR FONT, STYLE, SIZE, OR COLOR.

THE NAME(S), PORTRAIT(S), AND/OR SIGNATURE(S) SHOWN IN THE MARK IDENTIFIES "ERIK HART", WHOSE CONSENT(S) TO REGISTER IS MADE OF RECORD.

FOR CLOTHING FOR MEN AND WOMEN, NAMELY, JACKETS, SWEATSHIRTS, SWEATERS, SHIRTS, T-SHIRTS, TANK TOPS, VESTS, BOTTOMS, SKIRTS, DRESSES, KNITWEAR, NAMELY, TOPS AND BOTTOMS, AND WOVENS, NAMELY, TOPS AND BOTTOMS (U.S. CLS. 22 AND 39).

GINA HAYES, EXAMINING ATTORNEY

CLASS 25—(Continued).

SN 77-807,009. OSTERMANN, JOHN, SPRING, TX. FILED 8-18-2009.



NO CLAIM IS MADE TO THE EXCLUSIVE RIGHT TO USE "LIL' WHOOPERS", APART FROM THE MARK AS SHOWN.

THE COLOR(S) MAROON IS/ARE CLAIMED AS A FEATURE OF THE MARK.

THE MARK CONSISTS OF THE TEXT "LIL' WHOOPERS" A HAND WITH INDEX FINGER AND THUMB EXTENDED AND THE REMAINING THREE FINGERS FOLDED INWARD. TEXT AND ALL PARTS OF THE HANDS ARE A MAROON COLOR.

FOR CHILDREN'S AND INFANT'S APPAREL, NAMELY, JUMPERS, OVERALL SLEEPWEAR, PAJAMAS, ROMPERS AND ONE-PIECE GARMENTS (U.S. CLS. 22 AND 39).

FRED MANDIR, EXAMINING ATTORNEY

SN 77-807,227. SEARS BRANDS, LLC, HOFFMAN ESTATES, IL. FILED 8-18-2009.

AIRO-PAC

THE MARK CONSISTS OF STANDARD CHARACTERS WITHOUT CLAIM TO ANY PARTICULAR FONT, STYLE, SIZE, OR COLOR.

FOR FOOTWEAR (U.S. CLS. 22 AND 39).
JOHN GARTNER, EXAMINING ATTORNEY

SN 77-807,490. MATTEL, INC., EL SEGUNDO, CA. FILED 8-18-2009.

MAGIC 8 BALL

THE MARK CONSISTS OF STANDARD CHARACTERS WITHOUT CLAIM TO ANY PARTICULAR FONT, STYLE, SIZE, OR COLOR.

OWNER OF U.S. REG. NOS. 743,727, 2,981,646 AND 3,129,960.

FOR CLOTHING, NAMELY, T-SHIRTS, TANK TOPS, LOUNGEWEAR, HOODED SWEATSHIRTS, PAJAMAS, ROBES, UNDERWEAR AND BOXERS (U.S. CLS. 22 AND 39).

TRACY CROSS, EXAMINING ATTORNEY

CLASS 25—(Continued).

SN 77-808,261. KUNSTADT, ROBERT, NEW YORK, NY. FILED 8-19-2009.

BORN TO ROCK

THE MARK CONSISTS OF STANDARD CHARACTERS WITHOUT CLAIM TO ANY PARTICULAR FONT, STYLE, SIZE, OR COLOR.

OWNER OF U.S. REG. NO. 1,846,682.

FOR T-SHIRTS (U.S. CLS. 22 AND 39).

FIRST USE 0-0-1994; IN COMMERCE 0-0-1994.

AARON BRODSKY, EXAMINING ATTORNEY

SN 77-810,338. HAY, GARY, DOTHAN, AL. FILED 8-21-2009.

SCRUBS 101

THE MARK CONSISTS OF STANDARD CHARACTERS WITHOUT CLAIM TO ANY PARTICULAR FONT, STYLE, SIZE, OR COLOR.

NO CLAIM IS MADE TO THE EXCLUSIVE RIGHT TO USE "SCRUBS", APART FROM THE MARK AS SHOWN.

FOR CLOTHING, NAMELY, SHIRTS, TOPS, SMOCKS, PANTS, BOTTOMS, JACKETS, LAB COATS, HEADWEAR, CAPS, SHOES; NURSE'S APPAREL, NAMELY, MEDICAL UNIFORMS (U.S. CLS. 22 AND 39).

FIRST USE 5-1-2009; IN COMMERCE 5-1-2009.

MATTHEW MCDOWELL, EXAMINING ATTORNEY

SN 77-813,012. BCNY INTERNATIONAL, INC., HICKISVILLE, NY. FILED 8-26-2009.

Pillow Walkers

NO CLAIM IS MADE TO THE EXCLUSIVE RIGHT TO USE "WALKERS", APART FROM THE MARK AS SHOWN.

THE MARK CONSISTS OF THE STYLIZED WORDS "PILLOW WALKERS".

FOR FOOTWEAR (U.S. CLS. 22 AND 39).

KELLY TRUSILO, EXAMINING ATTORNEY

CLASS 25—(Continued).

SN 77-813,484. MANHATTAN BEACHWEAR, LLC, CY-PRESS, CA. FILED 8-26-2009.



NO CLAIM IS MADE TO THE EXCLUSIVE RIGHT TO USE "LA PLAYA", APART FROM THE MARK AS SHOWN. THE MARK CONSISTS OF THE STYLIZED WORDS "LA PLAYA" APPEARING AGAINST AN IRREGULAR BACKGROUND RESEMBLING BRUSH STROKES. THE DESIGN OF A FANCIFUL FLOWER APPEARS BEHIND THE WORDS "LA PLAYA".

THE ENGLISH TRANSLATION OF "LA PLAYA" IN THE MARK IS "THE BEACH".
FOR SWIMWEAR; BEACH COVERUPS; COVERUPS (U.S. CLS. 22 AND 39).

WENDY GOODMAN, EXAMINING ATTORNEY

SN 77-821,775. DR. ING. H.C. F. PORSCHE AKTIENGESELLSCHAFT, STUTTGART-ZUFFENHAUSEN, FED REP GERMANY, FILED 9-8-2009.

CAYENNE

THE MARK CONSISTS OF STANDARD CHARACTERS WITHOUT CLAIM TO ANY PARTICULAR FONT, STYLE, SIZE, OR COLOR.

OWNER OF FED REP GERMANY REG. NO. 39935813, DATED 1-14-2009, EXPIRES 6-30-2019.

OWNER OF U.S. REG. NOS. 2,467,212, 2,714,872 AND OTHERS.

FOR CLOTHING, NAMELY, ANORAKS, BEACHWEAR, BELTS, BLAZERS, BLOUSES, BLOUSONS, BODY SUITS, CARDIGANS, COATS, DRESSES, FOOTWEAR, FOUL WEATHER GEAR, GLOVES, HEADWEAR, INFANTWEAR, JACKETS, JEANS, JOGGING SUITS, LEATHER COATS, LEATHER JACKETS, OVERALLS, PANTS, PARKAS, SCARVES, SHORTS, SKI WEAR, SKIRTS, SLACKS, SLEEPWEAR, SNOW SUITS, SOCKS, SUITS, SUN VISORS, SWEAT BANDS, SWEATSHIRTS, SWEATERS, TENNIS WEAR, NECKTIES, TIGHTS, TRACKSUITS, TROUSERS, UNDERWEAR, VESTS AND WRIST BANDS (U.S. CLS. 22 AND 39).

CHRISTINE MARTIN, EXAMINING ATTORNEY

CLASS 25—(Continued).

SN 77-821,983. MOURNING, TRACY WILSON, MIAMI, FL. FILED 9-8-2009.

HONEY CHILD

THE MARK CONSISTS OF STANDARD CHARACTERS WITHOUT CLAIM TO ANY PARTICULAR FONT, STYLE, SIZE, OR COLOR.

OWNER OF U.S. REG. NOS. 2,669,693, 2,762,056 AND 2,804,780.

NO CLAIM IS MADE TO THE EXCLUSIVE RIGHT TO USE "CHILD", APART FROM THE MARK AS SHOWN.

FOR FULL LINE OF CHILDREN'S CLOTHING, NAMELY, SHIRTS, TOPS, PANTS, BOTTOMS, BLOUSES, SKIRTS, JUMPERS, SHORTS, JACKETS, DRESSES; HEADWEAR; AND FOOTWEAR (U.S. CLS. 22 AND 39).

MYRIAH HABEEB, EXAMINING ATTORNEY

SN 77-822,214. THIN MAN PRODUCTIONS, INC., NEW YORK, NY. FILED 9-8-2009.

TELL-ALL POCKET JEANS

THE MARK CONSISTS OF STANDARD CHARACTERS WITHOUT CLAIM TO ANY PARTICULAR FONT, STYLE, SIZE, OR COLOR.

NO CLAIM IS MADE TO THE EXCLUSIVE RIGHT TO USE "POCKET JEANS", APART FROM THE MARK AS SHOWN.

FOR CLOTHING ITEMS, NAMELY, A SPECIALIZED GARMENT POCKET THAT CAN BE SIMPLY LEFT IN ITS TRADITIONALLY INSERTED POSITION, FOR THE FUNCTION OF HOLDING PERSONAL EFFECTS OF THE WEARER, BUT MAY ALSO BE TURNED INSIDE-OUT, FOR THE PURPOSE OF INDICATING THE WEARER'S RELATIONSHIP STATUS (U.S. CLS. 22 AND 39).

RAMONA ORTIGA, EXAMINING ATTORNEY

SN 77-823,272. TATUAJE CIGARS, INC., LOS ANGELES, CA. FILED 9-9-2009.

TATUAJE

THE MARK CONSISTS OF STANDARD CHARACTERS WITHOUT CLAIM TO ANY PARTICULAR FONT, STYLE, SIZE, OR COLOR.

OWNER OF U.S. REG. NO. 2,836,665.

THE ENGLISH TRANSLATION OF "TATUAJE" IN THE MARK IS "TATTOO".

FOR CLOTHING, NAMELY, HATS; SHIRTS; SCARVES AND UNDERWEAR (U.S. CLS. 22 AND 39).

HANNO RITTNER, EXAMINING ATTORNEY

CLASS 25—(Continued).

SN 77-826,794. DANSKO, LLC, WEST GROVE, PA. FILED 9-15-2009.

DANSOX

THE MARK CONSISTS OF STANDARD CHARACTERS WITHOUT CLAIM TO ANY PARTICULAR FONT, STYLE, SIZE, OR COLOR.

FOR HOSIERY; SOCKS (U.S. CLS. 22 AND 39).
MELISSA VALLILLO, EXAMINING ATTORNEY

SN 77-828,501. HOME BOX OFFICE, INC., NEW YORK, NY. FILED 9-17-2009.

TRUBIES

THE MARK CONSISTS OF STANDARD CHARACTERS WITHOUT CLAIM TO ANY PARTICULAR FONT, STYLE, SIZE, OR COLOR.

FOR CLOTHING, NAMELY, LINGERIE, PANTIES, UNDERWEAR, BRAS, NIGHTGOWNS, NIGHT SHIRTS, PAJAMAS, SLEEPWEAR, CAMISOLES, HOSIERY, ROBES, GARTERS, LOUNGEWEAR, PANTS, VESTS, JACKETS, T-SHIRTS, TANK TOPS, SWEAT SHIRTS, SWEAT PANTS, SHIRTS, SCARVES, COATS, JEANS, SOCKS, SWIMWEAR AND BATHROBES; SPORTSWEAR, NAMELY, SPORTS SHIRTS, SPORTS PANTS, SPORTS JERSEYS, HOODED PULLOVERS, HOODED SWEAT SHIRTS, HOODED JACKETS AND HALLOWEEN COSTUMES; HEADWEAR, NAMELY, HATS, VISORS AND CAPS; FOOTWEAR (U.S. CLS. 22 AND 39).

ODESSA BIBBINS, EXAMINING ATTORNEY

SN 77-829,015. MCKOY, STEVEN, TRENTON, NJ. FILED 9-17-2009.

Lav'alore

THE MARK CONSISTS OF STANDARD CHARACTERS WITHOUT CLAIM TO ANY PARTICULAR FONT, STYLE, SIZE, OR COLOR.

THE WORDING "LAV'ALORE" HAS NO MEANING IN A FOREIGN LANGUAGE.

FOR CLOTHING, NAMELY, JACKETS, COATS, FLEECE PULLOVERS, SWEATERS, JEANS, PANTS, OVERALLS, SWEAT PANTS, SWEATSHIRTS, T-SHIRTS, POLO SHIRTS, TANK TOPS, SHORTS, UNDERWEAR, BRIEFS, THERMAL UNDERWEAR, SWIM SUITS, TRUNKS, YOGA PANTS, CAPRI PANTS, SPORTS BRAS, BANDANAS, SHOES, LEATHER BELTS, FABRIC BELTS, CAPS, HATS, BEANIES, VISORS (U.S. CLS. 22 AND 39).
ANTHONY RINKER, EXAMINING ATTORNEY

CLASS 25—(Continued).

SN 77-830,008. VALERIA RONCOLI STUDIO LLC, NEW HAVEN, CT. FILED 9-18-2009.



THE COLOR(S) RED, BLACK AND WHITE IS/ARE CLAIMED AS A FEATURE OF THE MARK.

THE MARK CONSISTS OF RED LIPS, BLACK LIP OUTLINE AND THE WORDING "BELLA ZADORE" UNDERNEATH THE RED LIPS, ALL ENCIRCLED IN BLACK OVAL ON A WHITE BACKGROUND.

THE ENGLISH TRANSLATION OF "BELLA" IN THE MARK IS BEAUTIFUL. THE WORDING "ZADORE" HAS NO MEANING IN A FOREIGN LANGUAGE.

FOR CLOTHING, NAMELY, JACKETS, JEANS, RAINWEAR, ROBES, SHIRTS, SHORTS, PANTS, SKIRTS, SLEEPWEAR, SUITS, VESTS, COATS, DRESSES, GLOVES AND MITTENS, SWEATERS, SCARVES; KERICHS, HATS, CAPS; SPORTSWEAR, NAMELY, T-SHIRTS, SWEAT SUITS, HEADWEAR, SWEATSHIRTS, SWIM WEAR, GOLF WEAR, AND TENNIS WEAR; UNDER GARMENTS; UNDERWEAR, NAMELY, PANTIES, SLIPS, LINGERIE, HOSIERY; BEACHWEAR, BODY SUITS, EXERCISE SUITS, NECKWEAR, NIGHTWEAR, GOWNS (U.S. CLS. 22 AND 39).

FIRST USE 6-10-2006; IN COMMERCE 6-10-2006.

JANICE KIM, EXAMINING ATTORNEY

SN 77-830,613. GOODJOE, INC., FREMONT, CA. FILED 9-20-2009.



THE MARK CONSISTS OF STYLIZED LETTER "G" AND "J" FORMING A SIDE PROFILE OF A SMILING FACE, WITH THE STYLIZED LETTER "J" FORMING THE EYE AND NOSE, AND WITH THE STYLIZED WORD "GOODJOE" APPEARING DIRECTLY UNDERNEATH.

FOR WEARABLE GARMENTS, APPAREL AND ACCESSORIES, NAMELY, SHIRTS, PANTS, SHORTS, JACKETS, SWEATERS, SOCKS, HATS, GLOVES, SHOES, AND UNDER GARMENTS (U.S. CLS. 22 AND 39).

FIRST USE 7-7-2008; IN COMMERCE 12-22-2008.

KAREN BRACEY, EXAMINING ATTORNEY

CLASS 25—(Continued).

SN 77-830,717. ROCKER RX, LLC, BEVERLY, MA. FILED 9-21-2009.

ROCKER RX

THE MARK CONSISTS OF STANDARD CHARACTERS WITHOUT CLAIM TO ANY PARTICULAR FONT, STYLE, SIZE, OR COLOR.

NO CLAIM IS MADE TO THE EXCLUSIVE RIGHT TO USE "ROCKER", APART FROM THE MARK AS SHOWN. FOR FOOTWEAR (U.S. CLS. 22 AND 39). STEVEN JACKSON, EXAMINING ATTORNEY

CLASS 25—(Continued).

SN 77-831,885. KOHL'S ILLINOIS, INC., AURORA, IL. FILED 9-22-2009.

INSTINCT IS A VIRTUE

THE MARK CONSISTS OF STANDARD CHARACTERS WITHOUT CLAIM TO ANY PARTICULAR FONT, STYLE, SIZE, OR COLOR.

FOR APPAREL, NAMELY, SHIRTS, PANTS, SHORTS, AND SWEATERS, OUTERWEAR IN THE NATURE OF COATS, JACKETS, BLAZERS, AND VESTS, SWIMWEAR AND APPAREL ACCESSORIES IN THE NATURE OF BELTS, HATS, SCARVES, AND GLOVES (U.S. CLS. 22 AND 39).

MARTHA FROMM, EXAMINING ATTORNEY

SN 77-832,344. ROBERT S. PATTERSON, GOLDEN, CA. FILED 9-22-2009.

SN 77-831,686. ROCK FIT, LLC, COMMERCE, CA. FILED 9-22-2009.

MARIKA

THE MARK CONSISTS OF STANDARD CHARACTERS WITHOUT CLAIM TO ANY PARTICULAR FONT, STYLE, SIZE, OR COLOR.

OWNER OF U.S. REG. NOS. 2,378,205, 3,016,107 AND OTHERS.

THE NAME(S), PORTRAIT(S), AND/OR SIGNATURE(S) SHOWN IN THE MARK DOES NOT IDENTIFY A PARTICULAR LIVING INDIVIDUAL.

THE WORDING "MARIKA" HAS NO MEANING IN A FOREIGN LANGUAGE.

FOR BIKE TIGHTS, ANKLE TIGHTS, SKIRTS, TOPS, BRA TOPS, SHORTS, TEE-SHIRTS, HATS AND HEADBANDS; WOMEN'S, MEN'S AND KIDS' EXERCISE WEAR, YOGA CLOTHING, ACCESSORIES, INTIMATE APPAREL AND EXERCISE WEAR EMPLOYING SEAMLESS TECHNOLOGY, NAMELY, BELTS, BLAZERS, BLOUSES, BOOTS, BRAS, CAPS, COATS, DRESSES, GLOVES, GOWNS, HALTER TOPS, HATS, HEADBANDS, JACKETS, JEANS, JOGGING SUITS, LEOTARDS, LINGERIE, MITTENS, PAJAMAS, PANTS, PANTYHOSE, ROBES, SANDALS, SARONGS, SCARVES, SHIRTS, SHOES, SHORTS, SKIRTS, SLIPPERS, SNEAKERS, SOCKS, STOCKINGS, SUITS, SWEAT PANTS, SWEAT SHIRTS, SWEAT SHORTS, SWEAT SUITS, SWEATERS, SWIMSUITS, TANK TOPS, TIES, UNDERWEAR AND VESTS (U.S. CLS. 22 AND 39).

DOMINIC FATHY, EXAMINING ATTORNEY



THE COLOR(S) RED, BLACK, GREEN, YELLOW, BLUE, WHITE, BROWN AND GREY IS/ARE CLAIMED AS A FEATURE OF THE MARK.

THE MARK CONSISTS OF AN OVAL FRAME WITH AN OUTER RING IN RED AN INNER RING IN BLACK; ALONG THE FRAME, THE WORDS "THE UGLY IGUANA" ARE WRITTEN IN A BLACK FONT WITH GREEN OUTLINE; WITHIN THE FRAME IS AN IMAGE OF A GREEN IGUANA, WITH A WHITE BELLY, BLACK STRIPES ON THE TAIL, BLACK NOSTRILS, WEARING BLACK SUNGLASSES AND A BLACK SOMBRERO WITH RED TRIM AND A YELLOW OUTLINE; THE IGUANA IS HOLDING A GLASS OUTLINED IN GREY WITH WHITE LIQUID AND A RED STRAW AND LEANING ON A PALM TREE WITH A BROWN TRUNK AND GREEN FRONDS, BOTH OUTLINED IN BLACK; A WHITE BOTTLE WITH BLACK STRIPES AND A YELLOW LABEL OUTLINED IN BLACK CONTAINING YELLOW LIQUID APPEARS ON THE WHITE SAND; A GREY SHADOW OF THE IGUANA, PALM TREE AND BOTTLE APPEAR ON THE SAND; BEHIND THE SAND IS A BLUE OCEAN WITH WHITE WAVES, AND YELLOW SUN SETTING WITH A YELLOW REFLECTION ON THE OCEAN; ABOVE THE OCEAN, THE SKY APPEARS IN BLUE WITH YELLOW DOTS.

FOR HATS; JEANS; SHIRTS; SWEATERS; T-SHIRTS (U.S. CLS. 22 AND 39).

FIRST USE 1-0-2008; IN COMMERCE 1-0-2008.

HEATHER BIDDULPH, EXAMINING ATTORNEY

CLASS 25—(Continued).

SN 77-833,934. BESO APPAREL, LLC, ASTORIA, NY. FILED 9-24-2009.

BESO

THE MARK CONSISTS OF STANDARD CHARACTERS WITHOUT CLAIM TO ANY PARTICULAR FONT, STYLE, SIZE, OR COLOR.

OWNER OF U.S. REG. NO. 2,657,496.
THE ENGLISH TRANSLATION OF "BESO" IN THE MARK IS "KISS".

FOR CLOTHING, NAMELY, PANTIES, TANK TOPS, SWEAT PANTS, SLEEPWEAR, SHIRTS, NIGHT GOWNS, PAJAMAS, SWEAT SHORTS, SWIMWEAR, T-SHIRTS, UNDERWEAR; FLIP FLOPS (U.S. CLS. 22 AND 39).

MARC LEIPZIG, EXAMINING ATTORNEY

SN 77-833,968. BESO APPAREL, LLC, ASTORIA, NY. FILED 9-24-2009.



OWNER OF U.S. REG. NO. 2,657,496.
THE MARK CONSISTS OF THE WORD "BESO", WHERE THE "BES" PORTION IS IN LETTER CHARACTER FORM AND THE "O" PORTION TAKES THE FORM OF LIPS.

THE ENGLISH TRANSLATION OF "BESO" IN THE MARK IS "KISS".

FOR CLOTHING, NAMELY, PANTIES, TANK TOPS, SWEAT PANTS, SLEEPWEAR, SHIRTS, NIGHT GOWNS, PAJAMAS, SWEAT SHORTS, SWIMWEAR, T-SHIRTS, UNDERWEAR; FLIP FLOPS (U.S. CLS. 22 AND 39).

MARC LEIPZIG, EXAMINING ATTORNEY

SN 77-834,145. BIGGIE SEZ, LLC, MUSTANG, OK. FILED 9-24-2009.

I Find Your Lack of Beer Disturbing

THE MARK CONSISTS OF STANDARD CHARACTERS WITHOUT CLAIM TO ANY PARTICULAR FONT, STYLE, SIZE, OR COLOR.

FOR CLOTHING AND HEADGEAR, NAMELY, T-SHIRTS, BALL CAPS, SUN VISORS (U.S. CLS. 22 AND 39).

THEODORE MCBRIDE, EXAMINING ATTORNEY

CLASS 25—(Continued).

SN 77-834,311. LUCKY BONES, LLC, RYE, NY. FILED 9-24-2009.



THE NAME(S), PORTRAIT(S), AND/OR SIGNATURE(S) SHOWN IN THE MARK DOES NOT IDENTIFY A PARTICULAR LIVING INDIVIDUAL.

FOR BATHROBES; BED JACKETS; CHEMISES; DRESSING GOWNS AND BATH ROBES; LINGERIE; LOUNGEWEAR; NEGLIGÉES; NIGHTGOWNS; PAJAMAS; PEIGNOIRS; ROBES; SLEEPWEAR; SLIPPERS; T-SHIRTS (U.S. CLS. 22 AND 39).

JENNY PARK, EXAMINING ATTORNEY

SN 77-836,320. CASSPA, LLC, NORWALK, CT. FILED 9-28-2009.

Frick & Frack T's

THE MARK CONSISTS OF STANDARD CHARACTERS WITHOUT CLAIM TO ANY PARTICULAR FONT, STYLE, SIZE, OR COLOR.

NO CLAIM IS MADE TO THE EXCLUSIVE RIGHT TO USE "T'S", APART FROM THE MARK AS SHOWN.

FOR T-SHIRTS (U.S. CLS. 22 AND 39).

KARANENDRA S. CHHINA, EXAMINING ATTORNEY

SN 77-836,756. YARILIS FREYRE, PLANTATION, FL. FILED 9-28-2009.

For the hunter with a Chronic addiction

THE MARK CONSISTS OF STANDARD CHARACTERS WITHOUT CLAIM TO ANY PARTICULAR FONT, STYLE, SIZE, OR COLOR.

FOR A-SHIRTS; ADHESIVE BRAS; ADULT NOVELTY GAG CLOTHING ITEM, NAMELY, SOCKS; AFTER SKI BOOTS; ALBS; AMERICAN FOOTBALL BIBS; ANGLERS' SHOES; ANKLE BOOTS; ANKLE GARTERS; ANKLE SOCKS; ANKLETS; ANORAK; ANORAKS; ANTI-PERSPIRANT SOCKS; APRES-SKI SHOES; APRONS; ASCOTS; ATHLETIC APPAREL, NAMELY, SHIRTS, PANTS, JACKETS, FOOTWEAR, HATS AND CAPS, ATHLETIC UNIFORMS; ATHLETIC FOOTWEAR; ATHLETIC SHOES; ATHLETIC UNIFORMS; BABUSHKAS; BABY BIBS NOT OF PAPER; BABY BODYSUITS; BABY BOTTOMS; BABY BUNTING; BABY DOLL PYJAMAS; BABY LAYETTES FOR CLOTHING; BABY TOPS; BALACLAVAS; BALL GOWNS; BALLET SHOES; BALLET SLIPPERS; BALLOON PANTS; BALLROOM DANCING SHOES; BANDANAS; BANDEAUX; BARBER SMOCKS; BASEBALL CAPS; BASEBALL SHOES; BASEBALL UNIFORMS; BASELAYER BOTTOMS; BASELAYER TOPS; BASKETBALL SNEAKERS; BATH SLIPPERS; BATHING CAPS; BATHING COSTUMES; BATHING COSTUMES FOR WOMEN; BATHING SUITS;

CLASS 25—(Continued).

BATHING SUITS FOR MEN; BATHING TRUNKS; BATHROBES; BEACH COVER-UPS; BEACH COVERUPS; BEACH FOOTWEAR; BEACH SHOES; BEACHWEAR; BEANIES; BED JACKETS; BELTS; BELTS FOR CLOTHING; BELTS MADE FROM IMITATION LEATHER; BELTS MADE OF LEATHER; BELTS MADE OUT OF CLOTH; BELTS OF TEXTILE; BERETS; BERMUDA SHORTS; BIB OVERALLS; BIB OVERALLS FOR HUNTING; BIB SHORTS; BIB TIGHTS; BIBS NOT OF CLOTH OR PAPER; BIBS NOT OF PAPER; BICYCLE GLOVES; BICYCLING GLOVES; BIKINIS; BLAZERS; BLOOMERS; BLOUSES; BLOUSONS; BOARD SHORTS; BOAS; BODICES; BODY LINEN; BODY SHAPERS; BODY SHIRTS; BODY STOCKINGS; BODY SUITS; BOLEROS; BOMBER JACKETS; BONNETS; BOOTIES; BOOTS; BOOTS FOR MOTORCYCLING; BOOTS FOR SPORT; BOTTOMS; BOW TIES; BOWLING SHOES; BOXER BRIEFS; BOXER SHORTS; BOXING SHOES; BOXING SHORTS; BRACES; BRALETTES; BRAS; BRASSIERES; BREECHES; BRIDESMAID DRESSES; BRIEFS; BRIEFS; BUCKET CAPS; BUSTIERS; BUSTLE HOLDER BANDS FOR OBI (OBIAGE); BUSTLES FOR OBI-KNOTS (OBIAGE-SHIN); BUTTON-FRONT ALOHA SHIRTS; CAFTANS; CAGOULES; CAMISETTES; CAMISOLES; CAMOUFLAGE GLOVES; CAMOUFLAGE JACKETS; CAMOUFLAGE PANTS; CAMOUFLAGE SHIRTS; CAMOUFLAGE VESTS; CAMP SHIRTS; CANVAS SHOES; CAP PEAKS; CAP VISORS; CAPELETS; CAPES; CAPES FOR USE IN SALONS AND BARBER SHOPS; CAPRI PANTS; CAPRIS; CAPS; CAPS WITH VISORS; CARDIGANS; CARGO PANTS; CASSOCKS; CHAPS; CHASUBLES; CHEF'S HATS; CHEMISES; CHEMISETTES; CHILDREN'S AND INFANT'S APPAREL, NAMELY, JUMPERS, OVERALL SLEEPWEAR, PAJAMAS, ROMPERS AND ONE-PIECE GARMENTS; CHILDREN'S AND INFANTS' CLOTH BIBS; CHILDREN'S CLOTH EATING BIBS; CHILDREN'S HEADWEAR; CHOIR ROBES; CLAM DIGGERS; CLEATS FOR ATTACHMENT TO SPORTS SHOES; CLIMBING BOOTS; CLIMBING FOOTWEAR; CLOAKS; CLOGS; CLOTH BIBS; CLOTH BIBS FOR ADULT DINERS; CLOTH BIBS FOR USE BY SENIOR CITIZENS OR PHYSICALLY- OR MENTALLY-CHALLENGED PERSONS; CLOTH DIAPERS; CLOTHING FOR ATHLETIC USE, NAMELY, PADDED ELBOW COMPRESSION SLEEVES; CLOTHING FOR ATHLETIC USE, NAMELY, PADDED PANTS; CLOTHING FOR ATHLETIC USE, NAMELY, PADDED SHIRTS; CLOTHING FOR ATHLETIC USE, NAMELY, PADDED SHORTS; CLOTHING FOR WEAR IN JUDO PRACTICES; CLOTHING FOR WEAR IN WRESTLING GAMES; CLOTHING ITEMS, NAMELY, ADHESIVE POCKETS THAT MAY BE AFFIXED DIRECTLY TO THE BODY AS A DECORATIVE PIECE OF CLOTHING WITH UTILITY; CLOTHING ITEMS, NAMELY, ADHESIVE POCKETS THAT MAY BE AFFIXED DIRECTLY TO THE INSIDE OF CLOTHING FOR STORAGE AND SAFEKEEPING OF PERSONAL ITEMS; CLOTHING, NAMELY, ARM WARMERS; CLOTHING, NAMELY, BASE LAYERS; CLOTHING, NAMELY, FOLK COSTUMES; CLOTHING, NAMELY, HAND-WARMERS; CLOTHING, NAMELY, KHAKIS; CLOTHING, NAMELY, KNEE WARMERS; CLOTHING, NAMELY, MATERNITY BANDS; CLOTHING, NAMELY, NECK TUBES; CLOTHING, NAMELY, THOBES; CLOTHING, NAMELY, WRAP-AROUNDS; COATS; COATS FOR MEN AND WOMEN; COATS MADE OF COTTON; COATS OF DENIM; COBBLERS' APRONS; COLLAR PROTECTORS; COLLARS; COMBATIVE SPORTS UNIFORMS; COMBINATIONS; COMPETITORS' NUMBERS OF TEXTILE; CORSELETS; CORSETS; COSTUMES FOR USE IN CHILDREN'S DRESS UP PLAY; COSTUMES FOR USE IN ROLE-PLAYING GAMES; COVERALLS; COVERUPS; CRAVATES; CRAVATS; CREEPERS; CREW NECK SWEATERS; CREW NECKS; CROP TOPS; CROSS-COUNTRY GLOVES; CROSS-COUNTRY MITTENS; CUFFS; CULOTTES; CUMMERBUNDS; CYCLING SHOES; CYCLISTS' JERSEYS; DANCE COSTUMES; DANCE SHOES; DANCE SLIPPERS; DECK-SHOES; DENIM JACKETS; DENIMS; DETACHABLE NECKPIECES FOR KIMONOS (HANERI); DICKIES; DISPOSABLE SLIPPERS; DISPOSABLE UNDERWEAR; DO RAGS; DOWN JACKETS; DRESS SHIELDS; DRESS SHIRTS; DRESS SUITS; DRESSES; DRESSES MADE FROM SKINS; DRESSES THAT MAY ALSO BE USED AS TOWELS; DRESSING GOWNS; DRESSING GOWNS AND BATH ROBES; DRIVERS; DRY SUITS; DUNGAREES; DUST COATS; DUSTERS; EAR BANDS; EAR MUFFS; EAR WARMERS; EARBANDS; EMBOSSED

CLASS 25—(Continued).

SOLES AND HEELS OF RUBBER OR OF PLASTIC MATERIALS; ESPADRILLES; EUROPEAN FOOTBALL BIBS; EVENING DRESSES; EVENING GOWNS; EYE-SHADES; FABRIC BELTS; FABRIC SOLD AS AN INTEGRAL COMPONENT OF FINISHED CLOTHING ITEMS, NAMELY, HUNTING PANTS AND SHIRTS; FICHUS; FINISHED TEXTILE LININGS FOR GARMENTS; FISHERMEN'S JACKETS; FISHING SHIRTS; FISHING VESTS; FISHING WADERS; FITTED SHOE OR BOOT COVERING TO PROTECT THE SHOES OR BOOT FROM WATER OR OTHER DAMAGE; FITTED SWIMMING COSTUMES WITH BRA CUPS; FLEECE PULLOVERS; FLEECE SHORTS; FLEECE VESTS; FLIGHT SUITS; FLIP FLOPS; FOAM PEDICURE SLIPPERS; FOOTBALL BOOTS AND STUDS THEREFOR; FOOTBALL SHOES; FOOTIES; FOOTWEAR; FOOTWEAR FOR MEN; FOOTWEAR FOR MEN AND WOMEN; FOOTWEAR FOR TRACK AND FIELD ATHLETICS; FOOTWEAR FOR WOMEN; FOOTWEAR MADE OF WOOD; FOOTWEAR NOT FOR SPORTS; FOOTWEAR, NAMELY, PUMPS; FOOTWEAR, NAMELY, RUBBERS; FOOTWEAR, NAMELY, WORK BOOTS; FOUL WEATHER GEAR; FOULARDS; FOUNDATION GARMENTS; FOUNDATION GARMENTS WORN AROUND THE MIDSECTION OR THIGHS TO KEEP THE STOMACH IN AND CREATE A SLIMMING EFFECT; FROCKS; FULL-LENGTH KIMONOS (NAGAGI); FUR CLOAKS; FUR COATS; FUR COATS AND JACKETS; FUR HATS; FUR JACKETS; FUR MUFFS; FUR STOLE; G-STRINGS; GABERDINES; GAITERS; GALOSHES; GARTER BELTS; GARTERS; GAUCHOS; GIFT PACKAGES SOLD AS A UNIT CONSISTING PRIMARILY OF A SWEATSHIRT AND ALSO INCLUDING A PHOTO FRAME, A COFFEE MUG, AND A TOTE BAG; GILETS; GIRDLES; GLOVES; GLOVES AS CLOTHING; GLOVES FOR PERSONAL HAND CONDITIONING USE; GLOVES INCLUDING THOSE MADE OF SKIN, HIDE OR FUR; GOLF CAPS; GOLF CLEATS; GOLF PANTS, SHIRTS AND SKIRTS; GOLF SHIRTS; GOLF SHOES; GOLF SHORTS; GOLF SPIKES; GOLF TROUSERS; GOWNS; GREATCOATS; GYM PANTS; GYM SHORTS; GYM SUITS; GYMNASTIC SHOES; HALLOWEEN COSTUMES; HALLOWEEN COSTUMES AND MASKS SOLD IN CONNECTION THEREWITH; HALTER TOPS; HANDBALL SHOES; HAT BANDS; HATS; HATS FOR INFANTS, BABIES, TODDLERS AND CHILDREN; HEAD SCARVES; HEAD SWEATBANDS; HEAD WEAR; HEADBANDS; HEADBANDS AGAINST SWEATING; HEADBANDS FOR CLOTHING; HEADGEAR, NAMELY, HATS; HEADWEAR; HEAVY COATS; HEAVY JACKETS; HEEL INSERTS; HEEL PIECES FOR SHOES; HEELS; HIGH RAIN CLOGS (ASHIDA); HIKING BOOTS; HIP-GUARDS ESPECIALLY MADE FOR FISHING; HOCKEY SHOES; HOODED PULLOVERS; HOODED SWEAT SHIRTS; HOODS; HOODS; HORSE-RIDING BOOTS; HOSE; HOUSECOATS; HUNTING BOOT BAGS; HUNTING JACKETS; HUNTING PANTS; HUNTING SHIRTS; HUNTING VESTS; INFANT AND TODDLER ONE PIECE CLOTHING; INFANT CLOTH DIAPERS; INFANT DIAPER COVERS; INFANT SLEEPERS; INFANT WEAR; INFANTS' SHOES AND BOOTS; INFANTS' TROUSERS; INFANTWEAR; INNER SOLES; INSOLES; INSOLES; INSOLES FOR FOOTWEAR; JACKET LINERS; JACKETS; JACKETS AND SOCKS; JANDALS; JAPANESE FOOTWEAR OF RICE STRAW (WARAJI); JAPANESE SLEEPING ROBES (NEMAKI); JAPANESE SPLIT-TOED WORK FOOTWEAR (JIKATABI); JAPANESE STYLE CLOGS AND SANDALS; JAPANESE STYLE SANDALS (ZORI); JAPANESE STYLE SANDALS OF FELT; JAPANESE STYLE SANDALS OF LEATHER; JAPANESE STYLE SOCKS (TABI COVERS); JAPANESE STYLE SOCKS (TABI); JAPANESE STYLE WOODEN CLOGS (GETA); JAPANESE TOE-STRAP SANDALS (ASAURA-ZORI); JEANS; JERKINS; JERSEYS; JODHPURS; JOGGING OUTFITS; JOGGING PANTS; JOGGING SUITS; JUDO SUITS; JUMPERS; JUMPSUITS; KAFTANS; KARATE SUITS; KENDO OUTFITS; KERCHEFS; KILTS; KIMONOS; KNEE HIGHS; KNEE-HIGH STOCKINGS; KNICKERS; KNIT FACE MASKS; KNIT SHIRTS; KNITTED CAPS; KNITTED GLOVES; KNITTED UNDERWEAR; KNOT CAPS; KNOTTED CAPS; LAB COATS; LACE BOOTS; LADIES' BOOTS; LADIES' SUITS; LADIES' UNDERWEAR; LAYETTES; LEATHER BELTS; LEATHER COATS; LEATHER HEADWEAR; LEATHER JACKETS; LEATHER PANTS; LEATHER SHOES; LEATHER SLIPPERS; LEG SHAPERS; LEG WARMERS; LEG-WARMERS; LEGGINGS; LEISURE SHOES; LEISURE SUITS; LEOTARDS; LEOTARDS AND TIGHTS

CLASS 25—(Continued).

FOR WOMEN, MEN AND CHILDREN OF NYLON, COTTON OR OTHER TEXTILE FIBERS; LIGHT-REFLECTING COATS; LIGHT-REFLECTING JACKETS; LINGERIE; LINGERIE ACCESSORIES, NAMELY, REMOVABLE SILICONE BREAST ENHANCER PADS USED IN A BRA; LIVERIES; LOAFERS; LONG JACKETS; LONG JOHNS; LONG SLEEVE PULLOVERS; LONG SLEEVED VESTS; LONG UNDERWEAR; LONG-SLEEVED SHIRTS; LOUNGE PANTS; LOUNGEWEAR; LOW WOODEN CLOGS (HIYORI-GETA); LOW WOODEN CLOGS (KOMA-GETA); MAILLOTS; MANIPLES; MANTILLAS; MANTLES; MANTLES; MARTIAL ARTS UNIFORMS; MARTIAL ARTS UNIFORMS, NAMELY, GIS; MASQUERADE COSTUMES; MASQUERADE COSTUMES AND MASKS SOLD IN CONNECTION THEREWITH; MATERNITY LINGERIE; MATERNITY SLEEPWEAR; MEN'S AND WOMEN'S JACKETS, COATS, TROUSERS, VESTS; MEN'S DRESS SOCKS; MEN'S SOCKS; MEN'S SUITS; MEN'S SUITS, WOMEN'S SUITS; MEN'S UNDERWEAR; METAL FITTINGS FOR JAPANESE STYLE WOODEN CLOGS; MILLINERY, NAMELY, FASCINATORS; MINISKIRTS; MITTENS; MIXED MARTIAL ARTS SUITS; MOCCASINS; MOCK TURTLE-NECK SWEATERS; MOCKNECKS; MOISTURE-WICKING SPORTS BRAS; MOISTURE-WICKING SPORTS PANTS; MOISTURE-WICKING SPORTS SHIRTS; MONEY BELTS; MORNING COATS; MOTORCYCLE GLOVES; MOTORCYCLE JACKETS; MOTORCYCLE RAIN SUITS; MOTORCYCLIST BOOTS; MOUNTAINEERING BOOTS; MOUNTAINEERING SHOES; MUFFLERS; MUFFLERS; MUFFS; MUKLUKS; MULES; MUSCLE TOPS; MUU MUUS; NECK BANDS; NECK GAITERS; NECKERCHIEFS; NECKERCHIEVES; NECKTIES; NECKWEAR; NEGLIGES; NIGHT GOWNS; NIGHT SHIRTS; NIGHTCAPS; NIGHTDRESSES; NIGHT-GOWNS; NIGHTIES; NIGHTWEAR; NIPPLE COVERS, NAMELY, PASTIES; NON-DISPOSABLE CLOTH TRAINING PANTS; NOVELTY HEADWEAR WITH ATTACHED WIGS; NURSE DRESSES; NURSE OVERALLS; NURSE PANTS; ONE PIECE GARMENT FOR INFANTS AND TODDLERS; ONE-PIECE PLAY SUITS; OPEN-NECKED SHIRTS; OUTDOOR GLOVES; OUTDOOR MITTENS; OUTER JACKETS; OVER COATS; OVER SHIRTS; OVER-TROUSERS; OVERALLS; OVERALLS FOR USE IN SALONS AND BARBER SHOPS; OVERCOATS; OVERSHOES; PADDED JACKETS; PADDING JACKETS; PAJAMA BOTTOMS; PAJAMAS; PANTALOONS; PANTIES; PANTIES, SHORTS AND BRIEFS; PANTS; PANTSUITS; PANTYHOSE; PAPER APRONS; PAPER HATS FOR USE AS CLOTHING ITEMS; PAPER SHOES USED WHEN GOING THROUGH METAL DETECTORS TO KEEP FEET AND SOCKS CLEAN; PARAMENTS; PAREOS; PAREU; PAREUS; PARKAS; PARTS OF CLOTHING, NAMELY, GUSSETS FOR TIGHTS, GUSSETS FOR STOCKINGS, GUSSETS FOR BATHING SUITS, GUSSETS FOR UNDERWEAR, GUSSETS FOR LEOTARDS AND GUSSETS FOR FOOTLETS; PARTS OF CLOTHING, NAMELY, UNDERARM GUSSETS; PARTY HATS; PATIENT SLIPPERS; PEDAL PUSHERS; PEDICURE SANDALS; PEDICURE SLIPPERS; PEIGNOIRS; PELERINES; PELISSES; PERSPIRATION ABSORBENT STRAP TO BE USED IN THE BILL OF A HAT; PERSPIRATION ABSORBENT UNDERWEAR CLOTHING; PETTI-PANTS; PETTICOATS; PINAFORES; PIQUE SHIRTS; PLASTIC APRONS; PLASTIC BABY BIBS; PLAY SUITS; PLEATED SKIRTS FOR FORMAL KIMONOS (HAKAMA); PLUS FOURS; POCKET KERCHIEFS; POCKET SQUARES; POLO SHIRTS; PONCHOS; PRAM SUITS; PROTECTIVE METAL MEMBERS FOR SHOES AND BOOTS; PROTECTIVE NECK AND ARM GUARDS MADE OF NEOPRENE OR OTHER MATERIALS TO PREVENT WETSUIT CHAFFING; PULLOVERS; PUMPS; PUTTEES AND GAITERS; PYJAMAS; QUILTED VESTS; RACE NUMBER BELTS THAT HOLD A PAPER NUMBER ON THE RACE PARTICIPANT'S FRONT OR BACK DURING COMPETITION; RAIN BOOTS; RAIN COATS; RAIN HATS; RAIN JACKETS; RAIN SLICKERS; RAIN SUITS; RAIN TROUSERS; RAINCOATS; RAINPROOF JACKETS; RAINWEAR; RASH GUARDS; REMOVABLE COLLARS; REVERSIBLE JACKETS; RIDING BOOTS; RIDING COATS; RIDING GLOVES; RIDING SHOES; ROBES; ROMPERS; RUANAS; RUBBER SHOES; RUBBER SOLES FOR JIKATABI; RUBBERS; RUGBY SHIRTS; RUGBY SHOES; RUGBY SHORTS; RUGBY TOPS; RUNNING SHOES; SABOTS; SALOPETTES; SANDAL-CLOGS; SANDALS; SANDALS AND BEACH SHOES; SARIS; SARONGS; SASH BANDS FOR KIMONO (OBI); SASHES;

CLASS 25—(Continued).

SCARFS; SCARVES; SCHOOL UNIFORMS; SCIENTIFIC AND TECHNOLOGICAL APPAREL, NAMELY, SHIRTS, PANTS, JACKETS, FOOTWEAR, HATS AND CAPS, UNIFORMS; SCRUBS NOT FOR MEDICAL PURPOSES; SEDGE HATS (SUGE-GASA); SERAPES; SHAMPOO CAPES; SHAPEWEAR, NAMELY, BODYSUIT; SHAWLS; SHAWLS; SHAWLS AND HEADSCARVES; SHAWLS AND STOLEES; SHELL JACKETS; SHIFTS; SHIRT FRONTS; SHIRT YOKES; SHIRTS; SHIRTS AND SHORT-SLEEVED SHIRTS; SHIRTS FOR INFANTS, BABIES, TODDLERS AND CHILDREN; SHIRTS FOR SUITS; SHOE DOWELS; SHOE INSERTS FOR PRIMARILY NON-ORTHOPEDIC PURPOSES; SHOE PEGS; SHOE SOLES; SHOE STRAPS; SHOES; SHOES SOLES FOR REPAIR; SHORT OVERCOAT FOR KIMONO (HAORI); SHORT PETTICOATS; SHORT SETS; SHORT TROUSERS; SHORT-SLEEVED OR LONG-SLEEVED T-SHIRTS; SHORT-SLEEVED SHIRTS; SHORTALLS; SHIRTS; SHOULDER SCARVES; SHOULDER WRAPS; SHOULDER WRAPS FOR CLOTHING; SHOWER CAPS; SHRUGS; SILK SCARVES; SINGLET; SKATING OUTFITS; SKI AND SNOWBOARD SHOES AND PARTS THEREOF; SKI BIBS; SKI BOOT BAGS; SKI BOOTS; SKI GLOVES; SKI JACKETS; SKI MASKS; SKI PANTS; SKI SUITS; SKI SUITS FOR COMPETITION; SKI TROUSERS; SKI WEAR; SKIING SHOES; SKIRT SUITS; SKIRTS; SKIRTS AND DRESSES; SKIWEAR; SKOOTERS; SKORTS; SKULL CAPS; SKULLIES; SLACKS; SLEEP MASKS; SLEEP SHIRTS; SLEEPING GARMENTS; SLEEPWEAR; SLEEVED OR SLEEVELESS JACKETS; SLEEVELESS JERSEYS; SLIDING SHORTS; SLIPOVERS; SLIPPER SOLES; SLIPPERS; SLIPS; SMALL HATS; SMOCKS; SMOKING JACKETS; SNEAKERS; SNOW BOARDING SUITS; SNOW BOOTS; SNOW PANTS; SNOW SUITS; SNOWBOARD BOOTS; SNOWBOARD GLOVES; SNOWBOARD MITTENS; SNOWBOARD PANTS; SOCCER BIBS; SOCCER BOOTS; SOCCER SHOES; SOCK SUSPENDERS; SOCKS; SOCKS AND STOCKINGS; SOLES; SOLES FOR FOOTWEAR; SOLES FOR JAPANESE STYLE SANDALS; SPORT COATS; SPORT SHIRTS; SPORT STOCKINGS; SPORTS BRA; SPORTS BRAS; SPORTS JACKETS; SPORTS JERSEYS; SPORTS JERSEYS AND BREECHES FOR SPORTS; SPORTS OVERUNIFORMS; SPORTS PANTS; SPORTS SHIRTS; SPORTS SHIRTS WITH SHORT SLEEVES; STOCKINGS; STOCKINGS; STOLEES; STRAPLESS BRAS; STRAPS FOR BRAS; STRETCH PANTS; STRING FASTENERS FOR HAORI (HAORI-HIMO); STUFF JACKETS; SUEDE JACKETS; SUIT COATS; SUITS; SUITS OF LEATHER; SUN SLEEVES; SUN VISORS; SUNDRESSES; SUNSUITS; SURF WEAR; SUSPENDER BELTS; SUSPENDER BELTS FOR MEN; SUSPENDER BELTS FOR WOMEN; SUSPENDERS; SUSPENDERS; SWADDLING CLOTHES; SWEAT BANDS; SWEAT JACKETS; SWEAT PANTS; SWEAT SHIRTS; SWEAT SHORTS; SWEAT SUITS; SWEATBANDS; SWEATERS; SWEATSOCKS; SWIM CAPS; SWIM TRUNKS; SWIM WEAR; SWIM WEAR FOR GENTLEMEN AND LADIES; SWIMMING CAPS; SWIMMING CAPS; SWIMMING COSTUMES; SWIMMING TRUNKS; SWIMSUITS; SWIMWEAR; T-SHIRTS; TABARDS; TAILLEURS; TAMS; TANK TOPS; TANK-TOPS; TANKINIS; TAP PANTS; TAP SHOES; TEDDIES; TEE SHIRTS; TENNIS DRESSES; TENNIS SHOES; TENNIS WEAR; TEXTILE DIAPERS; TEXTILE NAPPIES; THERMAL SOCKS; THERMAL UNDERWEAR; THONGS; THONGS; TIES; TIGHTENING-UP STRINGS FOR KIMONOS (DATEJIME); TIGHTS; TIPS FOR FOOTWEAR; TOBOGGAN HATS, PANTS AND CAPS; TOE BOXES; TOE CAPS; TOE STRAPS FOR JAPANESE STYLE SANDALS; ZORI; TOE STRAPS FOR JAPANESE STYLE WOODEN CLOGS; TOGAS; TONGUE OR PULLSTRAP FOR SHOES AND BOOTS; TOP COATS; TOPCOATS; TOPS; TOQUES; TRACK AND FIELD SHOES; TRACK JACKETS; TRACK PANTS; TRACK SUITS; TRACKSUITS; TRAINING SHOES; TRAINING SUITS; TRAVEL CLOTHING CONTAINED IN A PACKAGE COMPRISING REVERSIBLE JACKETS, PANTS, SKIRTS, TOPS AND A BELT OR SCARF; TRENCH COATS; TRIATHLON CLOTHING, NAMELY, TRIATHLON TIGHTS, TRIATHLON SHORTS, TRIATHLON SINGLET, TRIATHLON SHIRTS, TRIATHLON SUITS; TROUSERS; TROUSERS FOR SWEATING; TROUSERS OF LEATHER; TRUNKS; TUBE TOPS; TUNICS; TUQUES; TURBANS; TURTLE NECK SHIRTS; TURTLE-NECK SWEATERS; TURTLENECKS; TUXEDO BELTS; TUXEDOS; TWIN SETS; UNDER GARMENTS; UNDER-ARM CLOTHING SHIELDS; UNDERCLOTHES; UNDER-

CLASS 25—(Continued).

GARMENT ACCESSORIES, NAMELY, REMOVABLE SILICONE BUTTOCK ENHANCER PADS; UNDERGARMENTS; UNDERGARMENTS, NAMELY, WASPIES; UNDERPANTS; UNDERSHIRTS; UNDERSHIRTS FOR KIMONOS (JUBAN); UNDERSHIRTS FOR KIMONOS (KOSHIMAKI); UNDERSKIRTS; UNDERWEAR; UNDERWEAR, NAMELY, BOY SHORTS; UNIFORMS; UNION SUITS; UNITARDS; UPPERS FOR JAPANESE STYLE SANDALS; UPPERS OF WOVEN RATTAN FOR JAPANESE STYLE SANDALS; V-NECK SWEATERS; VEILS; VEST EXTENDERS; VESTED SUITS; VESTS; VISORS; VOLLEYBALL JERSEYS; VOLLEYBALL SHOES; WAIST BANDS; WAIST BELTS; WAIST CINCHERS; WAIST STRINGS FOR KIMONOS (KOSHIHIMO); WAISTBANDS; WAISTCOATS; WALKING SHORTS; WARM UP OUTFITS; WARM UP SUITS; WATER SOCKS; WATERPROOF JACKETS AND PANTS; WEARABLE GARMENTS AND CLOTHING, NAMELY, SHIRTS; WEDDING DRESSES; WEDDING GOWNS; WET SUIT GLOVES; WET SUITS; WET SUITS FOR WATER-SKIING AND SUB-AQUA; WETSUITS; WIMPLES; WIND COATS; WIND PANTS; WIND RESISTANT JACKETS; WIND SHIRTS; WIND VESTS; WIND-JACKETS; WINDCHEATERS; WINDJAMMERS; WINDSHIRTS; WINTER BOOTS; WOMEN'S CEREMONIAL DRESSES; WOMEN'S HATS AND HOODS; WOMEN'S SHOES; WOMEN'S TOPS, NAMELY, CAMIS; WOMEN'S UNDERWEAR; WOODEN CLOGS; WOODEN MAIN BODIES OF JAPANESE STYLE WOODEN CLOGS; WOODEN SHOES; WOODEN SUPPORTS OF JAPANESE STYLE WOODEN CLOGS; WOOLLEN SOCKS; WOOLLY HATS; WORK SHOES AND BOOTS; WORKING OVERALLS; WOVEN OR KNITTED UNDERWEAR; WRAP BELTS FOR KIMONOS (DATEMAKI); WRAPS; WRIST BANDS; WRISTBANDS; WRISTBANDS CONTAINING A COOLING SUBSTANCE TO COOL THE WEARER; YASHMAGHS; YOGA PANTS; YOGA SHIRTS; ZOOT SUITS; ZORI (U.S. CLS. 22 AND 39).

NAKIA HENRY, EXAMINING ATTORNEY

SN 77-840,824. LITTLE NY ENTERPRISES, INC., DBA CAPITAL KIDZWEAR, ALBANY, NY. FILED 10-3-2009.



NO CLAIM IS MADE TO THE EXCLUSIVE RIGHT TO USE "KIDZWEAR AND THE ALBANY SKYLINE", APART FROM THE MARK AS SHOWN.

THE COLOR(S) RED,BLUE,TEAL,YELLOW AND WHITE IS/ARE CLAIMED AS A FEATURE OF THE MARK.

THE MARK CONSISTS OF THE ALBANY, NY SKYLINE FORMING A BLUE BACKGROUND WITH TWO RED KID IMAGES ON EITHER SIDE. THE STYLIZED WORD "CAPITAL" APPEARS IN TEAL AND FADES TO WHITE WITH A YELLOW STAR IN THE LETTER P. THE WORD "KIDZWEAR" APPEARS UNDERNEATH IN WHITE LOWERCASE LETTERS CUT OUT OF YELLOW RECTANGLE CARRIERS.

FOR CHILDREN'S AND INFANT'S APPAREL, NAMELY, JUMPERS, OVERALL SLEEPWEAR, PAJAMAS, ROMPERS AND ONE-PIECE GARMENTS (U.S. CLS. 22 AND 39).

JASON TURNER, EXAMINING ATTORNEY

CLASS 25—(Continued).

SN 77-844,362. BENSON, AILEEN L, DBA RX UNDIES, BOSTON, MA. FILED 10-8-2009.

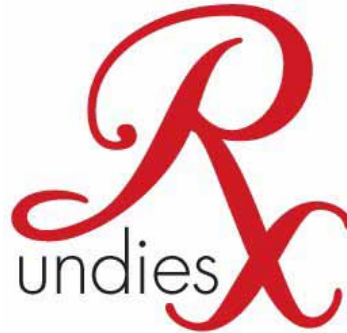

NO CLAIM IS MADE TO THE EXCLUSIVE RIGHT TO USE "UNDIES", APART FROM THE MARK AS SHOWN.

THE COLOR(S) RED, BLACK, WHITE IS/ARE CLAIMED AS A FEATURE OF THE MARK.

THE MARK CONSISTS OF THE "R" AND THE "X" ARE IN A SCRIPTED TYPEFACE AND PART OF THE R ALSO SERVES AS PART OF THE X. THE R AND X ARE IN RED, AND THE WORD "UNDIES" IS IN BLACK. THE BACKGROUND OF THE MARK IS WHITE.

FOR LADIES' UNDERWEAR; THONGS; WOMEN'S UNDERWEAR (U.S. CLS. 22 AND 39).

ELLEN BURNS, EXAMINING ATTORNEY

SN 77-844,741. WELCH, ERIC, DBA NUTPOP CLOTHING, HAZELCREST, IL. FILED 10-8-2009.



THE MARK CONSISTS OF A DEPICTION OF A SQUIRREL APPEARING ABOVE THE STYLIZED WORDING "NUTPOP". THE SQUIRREL HAS AN OVER-SIZED TAIL WHICH SWEEPS FROM THE BACK OVER AND APPEARS BEHIND THE SQUIRREL'S HEAD. THE SQUIRREL IS HOLDING AN ACORN BELOW ITS MOUTH.

FOR (BASED ON USE IN COMMERCE) SHIRTS (BASED ON INTENT TO USE) BELTS; BLOUSES; CAPS; COATS; HATS; HOODS; JACKETS; JERSEYS; PANTS; SHOES; SHORTS; SWEATERS; TIES; TROUSERS (U.S. CLS. 22 AND 39).

FIRST USE 8-16-2009; IN COMMERCE 8-16-2009.

ROBERT LAVACHE, EXAMINING ATTORNEY

CLASS 25—(Continued).

SN 77-844,982. GARCIA, IVAN, DAVIE, FL. FILED 10-9-2009.

Body Jean
"The Perfect Fit Jean."

THE MARK CONSISTS OF STANDARD CHARACTERS WITHOUT CLAIM TO ANY PARTICULAR FONT, STYLE, SIZE, OR COLOR.

NO CLAIM IS MADE TO THE EXCLUSIVE RIGHT TO USE "JEAN" AND "THE PERFECT FIT JEAN.", APART FROM THE MARK AS SHOWN.

FOR JEANS (U.S. CLS. 22 AND 39).

FIRST USE 7-13-2009; IN COMMERCE 7-13-2009.

MARIAM MAHMOUDI, EXAMINING ATTORNEY

SN 77-849,440. CAMLETTES, LLC, POWDER SPRINGS, GA. FILED 10-15-2009.

CAMLETTES

THE MARK CONSISTS OF STANDARD CHARACTERS WITHOUT CLAIM TO ANY PARTICULAR FONT, STYLE, SIZE, OR COLOR.

FOR CLOTHING, NAMELY, CAMISOLES, CROPPED CAMISOLES (U.S. CLS. 22 AND 39).

NAAKWAMA ANKRAH, EXAMINING ATTORNEY

SN 77-851,220. CARY, TYLER D, PITTSTOWN, NJ. FILED 10-18-2009.

FREE2RIDE

THE MARK CONSISTS OF STANDARD CHARACTERS WITHOUT CLAIM TO ANY PARTICULAR FONT, STYLE, SIZE, OR COLOR.

FOR ATHLETIC APPAREL, NAMELY, SHIRTS, PANTS, JACKETS, FOOTWEAR, HATS AND CAPS, ATHLETIC UNIFORMS; BEANIES; HATS; HOODED SWEAT SHIRTS; LONG-SLEEVED SHIRTS; SWEAT SHIRTS; T-SHIRTS; TEE SHIRTS (U.S. CLS. 22 AND 39).

FIRST USE 0-0-2006; IN COMMERCE 6-0-2007.

ALLISON SCHRODY, EXAMINING ATTORNEY

CLASS 25—(Continued).

SN 77-852,392. JUMPCORP, INC., AKA JUMP USA, INC., NEW YORK, NY. FILED 10-20-2009.



THE COLOR(S) MILITARY GREEN IS/ARE CLAIMED AS A FEATURE OF THE MARK.

THE MARK CONSISTS OF THE HIGHLY STYLIZED WORDING "J75" APPEARING IN STENCIL FORM IN THE COLOR MILITARY GREEN WITH SPACES BISECTING THE "J", "7" AND "5".

FOR APRES-SKI SHOES; ATHLETIC SHOES; CANVAS SHOES; DECK-SHOES; DRIVERS; GYMNASTIC SHOES; INFANTS' SHOES AND BOOTS; LEATHER SHOES; LEISURE SHOES; RUBBER SHOES; RUGBY SHOES; RUNNING SHOES; SANDALS AND BEACH SHOES; SOCCER SHOES; TENNIS SHOES; TRACK AND FIELD SHOES; WOMEN'S SHOES; WORK SHOES AND BOOTS (U.S. CLS. 22 AND 39).

FIRST USE 2-1-2007; IN COMMERCE 7-1-2007.

CHARISMA HAMPTON, EXAMINING ATTORNEY

SN 77-853,147. HILL, SHERRI K., NORMAN, OK. FILED 10-20-2009.

sherri couture

THE MARK CONSISTS OF STANDARD CHARACTERS WITHOUT CLAIM TO ANY PARTICULAR FONT, STYLE, SIZE, OR COLOR.

OWNER OF U.S. REG. NOS. 3,149,109 AND 3,631,052.

NO CLAIM IS MADE TO THE EXCLUSIVE RIGHT TO USE "COUTURE", APART FROM THE MARK AS SHOWN. FOR DRESSES; EVENING DRESSES (U.S. CLS. 22 AND 39).

FIRST USE 10-1-2008; IN COMMERCE 10-1-2008.

ELLEN BURNS, EXAMINING ATTORNEY

SN 77-868,695. SWIMWEAR ANYWHERE, INC., FARMINGDALE, NY. FILED 11-9-2009.

MATARI

THE MARK CONSISTS OF STANDARD CHARACTERS WITHOUT CLAIM TO ANY PARTICULAR FONT, STYLE, SIZE, OR COLOR.

THE WORDING "MATARI" HAS NO MEANING IN A FOREIGN LANGUAGE.

FOR CLOTHING, NAMELY, SHIRTS, TOPS, T-SHIRTS, SWIMWEAR, AND SWIMWEAR COVER-UPS (U.S. CLS. 22 AND 39).

FIRST USE 10-31-1994; IN COMMERCE 10-31-1994.

SKYE YOUNG, EXAMINING ATTORNEY

CLASS 25—(Continued).

SN 77-870,457. SCHOOL OF ROCK, LLC, TEANECK, NJ.
FILED 11-11-2009.



THE MARK CONSISTS OF THE WORDS "SCHOOL OF ROCK" WITH A DESIGN OF A GUITAR REPLACING THE LETTER "O" IN THE WORD "ROCK".

FOR ARTICLES OF CLOTHING, NAMELY, SHIRTS, POLO SHIRTS, NIGHT SHIRTS, T-SHIRTS, SWEATSHIRTS, HATS, JACKETS, COATS, SOCKS, PAJAMAS, SLEEP WEAR, AND BASEBALL CAPS (U.S. CLS. 22 AND 39).

GINA HAYES, EXAMINING ATTORNEY

SN 77-870,479. SCHOOL OF ROCK, LLC, TEANECK, NJ.
FILED 11-11-2009.



THE MARK CONSISTS OF THE WORDS "SCHOOL OF ROCK" WITH A DESIGN OF A GUITAR REPLACING THE LETTER "O" IN THE WORD "ROCK".

FOR ARTICLES OF CLOTHING, NAMELY, SHIRTS, POLO SHIRTS, NIGHT SHIRTS, T-SHIRTS, SWEATSHIRTS, HATS, JACKETS, COATS, SOCKS, PAJAMAS, SLEEP WEAR, AND BASEBALL CAPS (U.S. CLS. 22 AND 39).

GINA HAYES, EXAMINING ATTORNEY

SN 77-870,709. BYER CALIFORNIA, SAN FRANCISCO, CA.
FILED 11-11-2009.

Dress Works

THE MARK CONSISTS OF STANDARD CHARACTERS WITHOUT CLAIM TO ANY PARTICULAR FONT, STYLE, SIZE, OR COLOR.

NO CLAIM IS MADE TO THE EXCLUSIVE RIGHT TO USE "DRESS", APART FROM THE MARK AS SHOWN.

FOR CLOTHING, NAMELY, DRESSES, SKIRTS, BLOUSES, SKORTS, SHORTS, SHIRTS, PANTS, JACKETS, SWEATERS, VESTS AND JUMPSUITS (U.S. CLS. 22 AND 39).

WILLIAM VERHOSEK, EXAMINING ATTORNEY

CLASS 25—(Continued).

SN 77-873,713. NORTH AMERICAN SOCCER LEAGUE, LLC,
MIAMI, FL. FILED 11-16-2009.



THE MARK CONSISTS OF THE LETTERS "NASL" ABOVE A SHIELD CONTAINING A SOCCER BALL AND A PORTION OF A SOCCER FIELD.

FOR CLOTHING, NAMELY, HATS, HEADWEAR, CAPS, SHIRTS, T-SHIRTS, SWEATSHIRTS, JERSEYS, JACKETS, SHORTS, BOTTOMS, PANTS, WARM UP SUITS, WRISTBANDS, GLOVES, SOCKS, FOOTWEAR (U.S. CLS. 22 AND 39).

ELLEN PERKINS, EXAMINING ATTORNEY

SN 77-877,452. ALLEY OOP SKIM, INC., DEWEY BEACH,
DE. FILED 11-20-2009.

AO ALLEY OOP

THE MARK CONSISTS OF STANDARD CHARACTERS WITHOUT CLAIM TO ANY PARTICULAR FONT, STYLE, SIZE, OR COLOR.

FOR HATS; JACKETS; SHIRTS; SHORTS; SWEAT SHIRTS; T-SHIRTS (U.S. CLS. 22 AND 39).

FIRST USE 6-1-2005; IN COMMERCE 6-1-2005.

MATTHEW KLINE, EXAMINING ATTORNEY

SN 77-884,639. AMERICAN APOTHECARY CORP., WARREN, NJ. FILED 12-2-2009.



NO CLAIM IS MADE TO THE EXCLUSIVE RIGHT TO USE "AMERICAN", APART FROM THE MARK AS SHOWN.

THE MARK CONSISTS OF THE WORDING "AA" WITH A MAGNIFYING GLASS OVER THE SECOND LETTER "A" ENLARGING IT AND THE WORDING "AMERICAN APOTHECARY" IN STYLIZED FONT.

FOR T-SHIRTS; JEANS; SCARVES; HATS; HOODED SWEAT SHIRTS; HOODED PULLOVERS (U.S. CLS. 22 AND 39).

WILLIAM ROSSMAN, EXAMINING ATTORNEY

CLASS 25—(Continued).

SN 77-884,647. AMERICAN APOTHECARY CORP., WARREN, NJ. FILED 12-2-2009.

AMERICAN APOTHECARY

THE MARK CONSISTS OF STANDARD CHARACTERS WITHOUT CLAIM TO ANY PARTICULAR FONT, STYLE, SIZE, OR COLOR.

NO CLAIM IS MADE TO THE EXCLUSIVE RIGHT TO USE "AMERICAN", APART FROM THE MARK AS SHOWN.

FOR T-SHIRTS; JEANS; SCARVES; HATS; HOODED SWEAT SHIRTS; HOODED PULLOVERS (U.S. CLS. 22 AND 39).

WILLIAM ROSSMAN, EXAMINING ATTORNEY

SN 77-885,900. OOMPH APPAREL LLC, DBA WHOOHA GEAR, LAS VEGAS, NV. FILED 12-3-2009.

Whooha

THE MARK CONSISTS OF STANDARD CHARACTERS WITHOUT CLAIM TO ANY PARTICULAR FONT, STYLE, SIZE, OR COLOR.

FOR ATHLETIC APPAREL, NAMELY, SHIRTS, BRAS, SHORTS, PANTS, JACKETS, HATS AND CAPS, ATHLETIC UNIFORMS, ATHLETIC UNIFORMS CONSISTING OF SOCKS (U.S. CLS. 22 AND 39).

FIRST USE 8-23-2006; IN COMMERCE 8-23-2006.
PAULA MAHONEY, EXAMINING ATTORNEY

SN 77-886,766. SIMON DE WINTER GROUP PTY LTD, CARLTON NORTH VIC, AUSTRALIA, FILED 12-4-2009.

REFINED LINES

THE MARK CONSISTS OF STANDARD CHARACTERS WITHOUT CLAIM TO ANY PARTICULAR FONT, STYLE, SIZE, OR COLOR.

OWNER OF AUSTRALIA REG. NO. 869424, DATED 3-16-2001, EXPIRES 3-16-2011.

FOR LINGERIE, UNDER GARMENTS AND FOUNDATION GARMENTS, NAMELY, UNDERWEAR, BRAS, PANTIES, GIRDLES, CAMISOLES, BRASSIERES, BODICES, CHEMISES, CORSETS, CORSELETTES, THONGS, G-STRINGS, SLIPS, SUSPENDERS, HOSIERY, TIGHTS AND BODY STOCKINGS (U.S. CLS. 22 AND 39).

JOHN HWANG, EXAMINING ATTORNEY

CLASS 25—(Continued).

SN 77-889,894. MIKSHAG, INC., SAN CLEMENTE, CA. FILED 12-9-2009.



NO CLAIM IS MADE TO THE EXCLUSIVE RIGHT TO USE "OUTERWEAR", APART FROM THE MARK AS SHOWN.

THE COLOR(S) RED, GREEN, BLACK, AND GRAY IS/ARE CLAIMED AS A FEATURE OF THE MARK.

THE MARK CONSISTS OF AN IGUANA WITH A GREEN BODY AND RED AND GRAY TRIM. THE WORDS "MAD IGUANA" APPEAR IN THE COLOR BLACK; THE WORD "OUTERWEAR" APPEARS IN THE COLOR GRAY OVER A BLACK RECTANGLE AND THE BACKGROUND APPEARS IN THE COLOR GRAY.

FOR CLOTHING, NAMELY, SWIMWEAR, SHORTS, TEE SHIRTS, DRESSES, WOVEN SHIRTS, KNIT SHIRTS, AND FLEECE TOPS, AND OUTERWEAR, NAMELY, JACKETS, FLEECE TOPS AND FLEECE BOTTOMS (U.S. CLS. 22 AND 39).

FIRST USE 8-25-1999; IN COMMERCE 8-25-1999.
MIDGE BUTLER, EXAMINING ATTORNEY

SN 77-890,500. PATRICIA LANG, DBA EGG QUIRKS, VENETIA, PA. FILED 12-10-2009.

EGGQUIRKS

OWNER OF U.S. REG. NO. 3,752,651.
THE MARK CONSISTS OF THE STYLIZED TEXT "EGG QUIRKS".

FOR SHIRTS; SHORT-SLEEVED SHIRTS; SPORTS SHIRTS WITH SHORT SLEEVES; BLOUSES; SPORTS SHIRTS; CLOTH BIBS; DRESS SHIRTS; GOLF SHIRTS; KNIT SHIRTS; NIGHT SHIRTS; OPEN-NECKED SHIRTS; POLO SHIRTS; SHORT-SLEEVED OR LONG-SLEEVED T-SHIRTS; SLEEP SHIRTS; SPORT SHIRTS; SWEAT SHIRTS; T-SHIRTS (U.S. CLS. 22 AND 39).

FIRST USE 12-10-2009; IN COMMERCE 12-10-2009.
STEPHEN AQUILA, EXAMINING ATTORNEY

CLASS 25—(Continued).

SN 77-891,296. FLORIDA NATIVE GEAR, LLC, JUPITER, FL. FILED 12-11-2009.

FLORIDA NATIVE

THE MARK CONSISTS OF STANDARD CHARACTERS WITHOUT CLAIM TO ANY PARTICULAR FONT, STYLE, SIZE, OR COLOR.

NO CLAIM IS MADE TO THE EXCLUSIVE RIGHT TO USE "FLORIDA", APART FROM THE MARK AS SHOWN.

FOR CLOTHING AND APPAREL FOR MEN, WOMEN, AND CHILDREN, NAMELY, T-SHIRTS, SHIRTS, SWEATSHIRTS, HOODIES, PANTS, SWEATPANTS, SHORTS, ONE-PIECE PLEASURES FOR INFANTS, AND BIBS; SWIMWEAR FOR MEN, WOMEN AND CHILDREN; HEADWEAR FOR MEN, WOMEN, AND CHILDREN; SWIM COVER-UPS AND SARONGS; FOOTWEAR FOR MEN, WOMEN AND CHILDREN (U.S. CLS. 22 AND 39).

FIRST USE 9-15-2009; IN COMMERCE 10-15-2009.
SUSAN STIGLITZ, EXAMINING ATTORNEY

CLASS 25—(Continued).

SN 77-896,727. SOULCYCLE, LLC, NEW YORK, NY. FILED 12-18-2009.

SOULCYCLE

THE MARK CONSISTS OF STANDARD CHARACTERS WITHOUT CLAIM TO ANY PARTICULAR FONT, STYLE, SIZE, OR COLOR.

OWNER OF U.S. REG. NO. 3,264,026.

FOR CLOTHING, NAMELY, PANTS, DRAWSTRING PANTS, SWEAT PANTS, SHORTS, EXERCISE TIGHTS, SHIRTS, TOPS, SLEEVELESS TOPS, THERMAL SHIRTS, LONG-SLEEVE TOPS, SWEATERS, T-SHIRTS, TANK TOPS, SPORTS BRAS, JACKETS, HOODED PULLOVERS, SOCKS, BANDANAS, WRISTBANDS; SHOES, FLIP FLOPS (U.S. CLS. 22 AND 39).

FIRST USE 4-0-2006; IN COMMERCE 4-0-2006.
GEORGE LORENZO, EXAMINING ATTORNEY

SN 77-896,895. SOULCYCLE, LLC, NEW YORK, NY. FILED 12-18-2009.

SN 77-895,839. SUJA, KHALEDUL, LOS ANGELES, CA. FILED 12-17-2009.



THE COLOR(S) DARK BLUE AND YELLOW IS/ARE CLAIMED AS A FEATURE OF THE MARK.

THE MARK CONSISTS OF THE STYLIZED WORD "MIMOSA" APPEARING IN YELLOW ON A DARK BLUE RECTANGULAR BACKGROUND.

FOR A-SHIRTS; CAMISOLES; CAPRI PANTS; CARGO PANTS; DENIMS; KNIT SHIRTS; KNITTED UNDERWEAR; LEG SHAPERS; LEGGINGS; LONG-SLEEVED SHIRTS; PAJAMAS; PANTS; SHORT-SLEEVED OR LONG-SLEEVED T-SHIRTS; SHORT-SLEEVED SHIRTS; SHORTS; SPORT SHIRTS; SPORTS PANTS; SWEAT SHIRTS; T-SHIRTS; TOPS; WOVEN OR KNITTED UNDERWEAR; YOGA PANTS; YOGA SHIRTS (U.S. CLS. 22 AND 39).

GEOFFREY FOSDICK, EXAMINING ATTORNEY



OWNER OF U.S. REG. NO. 3,650,759.

THE MARK CONSISTS OF A BIKE WHEEL WITH MULTIPLE SPOKES.

FOR CLOTHING, NAMELY, PANTS, DRAWSTRING PANTS, SWEAT PANTS, SHORTS, EXERCISE TIGHTS, SHIRTS, TOPS, SLEEVELESS TOPS, THERMAL SHIRTS, LONG-SLEEVE TOPS, SWEATERS, T-SHIRTS, TANK TOPS, SPORTS BRAS, JACKETS, HOODED PULLOVERS, SOCKS, BANDANAS, WRISTBANDS; SHOES, FLIP FLOPS (U.S. CLS. 22 AND 39).

FIRST USE 4-0-2006; IN COMMERCE 4-0-2006.
GEORGE LORENZO, EXAMINING ATTORNEY

CLASS 25—(Continued).

SN 77-896,990. MAJOR LEAGUE LACROSSE LLC, BOSTON, MA. FILED 12-18-2009.



OWNER OF U.S. REG. NOS. 3,280,830, 3,353,771 AND OTHERS.

THE MARK CONSISTS OF THE STYLIZED AND OUTLINED WORD "OUTLAWS" WITH A ROPE DESIGN AROUND THE LETTER O AND THE LETTER S AND THE DESIGN OF A STEER HORN ENCIRCLED WITH BARBED WIRE IN THE MIDDLE OF THE WORD "OUTLAWS" AND WITH THE STYLIZED AND RECTANGULAR OUTLINED WORD "NATION" APPEARING BELOW "OUTLAWS".

FOR CLOTHING, NAMELY, SHIRTS, T-SHIRTS, UNDER SHIRTS, NIGHT SHIRTS, RUGBY SHIRTS, POLO SHIRTS, CARDIGANS, JERSEYS, UNIFORMS, DRESS SHIRTS, PANTS, TROUSERS, SLACKS, JEANS, CULOTTES, CARGO PANTS, DENIM JEANS, OVERALLS, COVERALLS, JUMPERS, JUMP SUITS, SHORTS, BOXER SHORTS, TOPS, CROP TOPS, TANK TOPS, HALTER TOPS, SWEAT SHIRTS, SWEAT SHORTS, SWEAT PANTS, WRAPS, WARM-UP SUITS, JOGGING SUITS, TRACK SUITS, PLAY SUITS, BLOUSES, SKIRTS, DRESSES, SWEATERS, VESTS, FLEECE VESTS, PULL-OVERS, SNOW SUITS, PARKAS, CAPES, ANORAKS, PONCHOS, JACKETS, REVERSIBLE JACKETS, COATS, BLAZERS, SUITS, TURTLENECKS, CLOTH SKI BIBS, SWIMWEAR, BEACHWEAR, TENNIS WEAR, SURF WEAR, SKI WEAR, LAYETTES, INFANTWEAR, INFANTS SLEEPERS, BOOTIES, BABY BIBS NOT OF PAPER, CAPS, SWIM CAPS, BERETS, BEANIES, HATS, VISORS, HEADBANDS, WRIST BANDS, SWEAT BANDS, HEADWEAR, EAR MUFFS, APRONS, SCARVES, BANDANAS, BELTS, SUSPENDERS, NECKWEAR, TIES, NECKERCHIEFS, ASCOTS, UNDERWEAR, THERMAL UNDERWEAR, LONG UNDERWEAR, BRIEFS, SWIM AND BATHING TRUNKS, SPORTS BRAS, PANTIES, THONGS, SOCKS, LOUNGEWEAR, ROBES, SMOCKS, UNDERCLOTHES, PAJAMAS, SLEEPWEAR, NIGHT GOWNS, SARONGS, LEG WARMERS, HOSIERY, PANTYHOSE, BODY STOCKINGS, KNEE HIGHS, LEGGINGS, TIGHTS, LEOTARDS, BODY SUITS, UNITARDS, GLOVES, MITTENS, RAINWEAR, FOOTWEAR, SHOES, SNEAKERS, BOOTS, GALOSHES, SANDALS, FLIP-FLOPS, AND SLIPPERS (U.S. CLS. 22 AND 39).

KELLEY WELLS, EXAMINING ATTORNEY

CLASS 25—(Continued).

SN 77-897,044. MAJOR LEAGUE LACROSSE LLC, BOSTON, MA. FILED 12-18-2009.



OWNER OF U.S. REG. NOS. 3,280,830, 3,353,771 AND OTHERS.

NO CLAIM IS MADE TO THE EXCLUSIVE RIGHT TO USE "LACROSSE", APART FROM THE MARK AS SHOWN.

THE MARK CONSISTS OF THE STYLIZED LETTER "O" WITH THE DESIGN OF A STEER HORN ENCIRCLED WITH BARBED WIRE ACROSS THE MIDDLE OF THE LETTER "O" AND THE STYLIZED WORD "OUTLAWS" APPEARING BELOW THE LETTER "O" AND THE STYLIZED WORD "LACROSSE" SET FORTH BELOW "OUTLAWS".

FOR CLOTHING, NAMELY, SHIRTS, T-SHIRTS, UNDER SHIRTS, NIGHT SHIRTS, RUGBY SHIRTS, POLO SHIRTS, CARDIGANS, JERSEYS, UNIFORMS, DRESS SHIRTS, PANTS, TROUSERS, SLACKS, JEANS, CULOTTES, CARGO PANTS, DENIM JEANS, OVERALLS, COVERALLS, JUMPERS, JUMP SUITS, SHORTS, BOXER SHORTS, TOPS, CROP TOPS, TANK TOPS, HALTER TOPS, SWEAT SHIRTS, SWEAT SHORTS, SWEAT PANTS, WRAPS, WARM-UP SUITS, JOGGING SUITS, TRACK SUITS, PLAY SUITS, BLOUSES, SKIRTS, DRESSES, SWEATERS, VESTS, FLEECE VESTS, PULL-OVERS, SNOW SUITS, PARKAS, CAPES, ANORAKS, PONCHOS, JACKETS, REVERSIBLE JACKETS, COATS, BLAZERS, SUITS, TURTLENECKS, CLOTH SKI BIBS, SWIMWEAR, BEACHWEAR, TENNIS WEAR, SURF WEAR, SKI WEAR, LAYETTES, INFANTWEAR, INFANTS SLEEPERS, BOOTIES, BABY BIBS NOT OF PAPER, CAPS, SWIM CAPS, BERETS, BEANIES, HATS, VISORS, HEADBANDS, WRIST BANDS, SWEAT BANDS, HEADWEAR, EAR MUFFS, APRONS, SCARVES, BANDANAS, BELTS, SUSPENDERS, NECKWEAR, TIES, NECKERCHIEFS, ASCOTS, UNDERWEAR, THERMAL UNDERWEAR, LONG UNDERWEAR, BRIEFS, SWIM AND BATHING TRUNKS, SPORTS BRAS, PANTIES, THONGS, SOCKS, LOUNGEWEAR, ROBES, SMOCKS, UNDERCLOTHES, PAJAMAS, SLEEPWEAR, NIGHT GOWNS, SARONGS, LEG WARMERS, HOSIERY, PANTYHOSE, BODY STOCKINGS, KNEE HIGHS, LEGGINGS, TIGHTS, LEOTARDS, BODY SUITS, UNITARDS, GLOVES, MITTENS, RAINWEAR, FOOTWEAR, SHOES, SNEAKERS, BOOTS, GALOSHES, SANDALS, FLIP-FLOPS, AND SLIPPERS (U.S. CLS. 22 AND 39).

KELLEY WELLS, EXAMINING ATTORNEY

CLASS 25—(Continued).

SN 77-897,075. MAJOR LEAGUE LACROSSE LLC, BOSTON, MA. FILED 12-18-2009.



OWNER OF U.S. REG. NOS. 3,280,830, 3,353,771 AND OTHERS.

NO CLAIM IS MADE TO THE EXCLUSIVE RIGHT TO USE "LACROSSE", APART FROM THE MARK AS SHOWN.

THE MARK CONSISTS OF THE STYLIZED LETTER "B" WITH A STYLIZED DESIGN OF BARBED WIRE WRAPPER AROUND THE CROSS LINE IN THE LETTER "B" WITH THE STYLIZED WORD "BANDITS" APPEARING BELOW THE LETTER "B" AND THE STYLIZED WORD "LACROSSE" SET FORTH UNDER "BANDITS".

FOR CLOTHING, NAMELY, SHIRTS, T-SHIRTS, UNDER SHIRTS, NIGHT SHIRTS, RUGBY SHIRTS, POLO SHIRTS, CARDIGANS, JERSEYS, UNIFORMS, DRESS SHIRTS, PANTS, TROUSERS, SLACKS, JEANS, CULOTTES, CARGO PANTS, DENIM JEANS, OVERALLS, COVERALLS, JUMPERS, JUMP SUITS, SHORTS, BOXER SHORTS, TOPS, CROP TOPS, TANK TOPS, HALTER TOPS, SWEAT SHIRTS, SWEAT SHORTS, SWEAT PANTS, WRAPS, WARM-UP SUITS, JOGGING SUITS, TRACK SUITS, PLAY SUITS, BLOUSES, SKIRTS, DRESSES, SWEATERS, VESTS, FLEECE VESTS, PULL-OVERS, SNOW SUITS, PARKAS, CAPES, ANORAKS, PONCHOS, JACKETS, REVERSIBLE JACKETS, COATS, BLAZERS, SUITS, TURTLENECKS, CLOTH SKI BIBS, SWIMWEAR, BEACHWEAR, TENNIS WEAR, SURF WEAR, SKI WEAR, LAYETTES, INFANTWEAR, INFANTS SLEEPERS, BOOTIES, BABY BIBS NOT OF PAPER, CAPS, SWIM CAPS, BERETS, BEANIES, HATS, VISORS, HEADBANDS, WRIST BANDS, SWEAT BANDS, HEADWEAR, EAR MUFFS, APRONS, SCARVES, BANDANAS, BELTS, SUSPENDERS, NECKWEAR, TIES, NECKERCHIEFS, ASCOTS, UNDERWEAR, THERMAL UNDERWEAR, LONG UNDERWEAR, BRIEFS, SWIM AND BATHING TRUNKS, SPORTS BRAS, PANTIES, THONGS, SOCKS, LOUNGEWEAR, ROBES, SMOCKS, UNDERCLOTHES, PAJAMAS, SLEEPWEAR, NIGHT GOWNS, SARONGS, LEG WARMERS, HOSIERY, PANTYHOSE, BODY STOCKINGS, KNEE HIGHS, LEGGINGS, TIGHTS, LEOTARDS, BODY SUITS, UNITARDS, GLOVES, MITTENS, RAINWEAR, FOOTWEAR, SHOES, SNEAKERS, BOOTS, GALOSHES, SANDALS, FLIP-FLOPS, AND SLIPPERS (U.S. CLS. 22 AND 39).

KELLEY WELLS, EXAMINING ATTORNEY

CLASS 25—(Continued).

SN 77-897,192. MAJOR LEAGUE LACROSSE LLC, BOSTON, MA. FILED 12-18-2009.



OWNER OF U.S. REG. NOS. 3,352,853, 3,482,291 AND OTHERS.

NO CLAIM IS MADE TO THE EXCLUSIVE RIGHT TO USE "JUNIOR", APART FROM THE MARK AS SHOWN.

THE MARK CONSISTS OF THE VERBIAGE "JUNIOR LIZARDS" WITH A FANCIFUL DEPICTION OF A LIZARD WRAPPED AROUND THE "L" IN THE WORD "LIZARDS".

FOR CLOTHING, NAMELY, SHIRTS, T-SHIRTS, UNDER SHIRTS, NIGHT SHIRTS, RUGBY SHIRTS, POLO SHIRTS, CARDIGANS, JERSEYS, UNIFORMS, DRESS SHIRTS, PANTS, TROUSERS, SLACKS, JEANS, CULOTTES, CARGO PANTS, DENIM JEANS, OVERALLS, COVERALLS, JUMPERS, JUMP SUITS, SHORTS, BOXER SHORTS, TOPS, CROP TOPS, TANK TOPS, HALTER TOPS, SWEAT SHIRTS, SWEAT SHORTS, SWEAT PANTS, WRAPS, WARM-UP SUITS, JOGGING SUITS, TRACK SUITS, PLAY SUITS, BLOUSES, SKIRTS, DRESSES, SWEATERS, VESTS, FLEECE VESTS, PULL-OVERS, SNOW SUITS, PARKAS, CAPES, ANORAKS, PONCHOS, JACKETS, REVERSIBLE JACKETS, COATS, BLAZERS, SUITS, TURTLENECKS, CLOTH SKI BIBS, SWIMWEAR, BEACHWEAR, TENNIS WEAR, SURF WEAR, SKI WEAR, LAYETTES, INFANTWEAR, INFANTS SLEEPERS, BOOTIES, BABY BIBS NOT OF PAPER, CAPS, SWIM CAPS, BERETS, BEANIES, HATS, VISORS, HEADBANDS, WRIST BANDS, SWEAT BANDS, HEADWEAR, EAR MUFFS, APRONS, SCARVES, BANDANAS, BELTS, SUSPENDERS, NECKWEAR, TIES, NECKERCHIEFS, ASCOTS, UNDERWEAR, THERMAL UNDERWEAR, LONG UNDERWEAR, BRIEFS, SWIM AND BATHING TRUNKS, SPORTS BRAS, PANTIES, THONGS, SOCKS, LOUNGEWEAR, ROBES, SMOCKS, UNDERCLOTHES, PAJAMAS, SLEEPWEAR, NIGHT GOWNS, SARONGS, LEG WARMERS, HOSIERY, PANTYHOSE, BODY STOCKINGS, KNEE HIGHS, LEGGINGS, TIGHTS, LEOTARDS, BODY SUITS, UNITARDS, GLOVES, MITTENS, RAINWEAR, FOOTWEAR, SHOES, SNEAKERS, BOOTS, GALOSHES, SANDALS, FLIP-FLOPS, AND SLIPPERS (U.S. CLS. 22 AND 39).

KELLEY WELLS, EXAMINING ATTORNEY

CLASS 25—(Continued).

SN 77-897,232. MAJOR LEAGUE LACROSSE LLC, BOSTON, MA. FILED 12-18-2009.



OWNER OF U.S. REG. NOS. 3,352,853, 3,482,291 AND OTHERS.

NO CLAIM IS MADE TO THE EXCLUSIVE RIGHT TO USE "JUNIOR", APART FROM THE MARK AS SHOWN.

THE MARK CONSISTS OF THE VERBIAGE "JUNIOR L" WITH A FANCIFUL DEPICTION OF A LIZARD WRAPPED AROUND THE "L".

FOR CLOTHING, NAMELY, SHIRTS, T-SHIRTS, UNDER SHIRTS, NIGHT SHIRTS, RUGBY SHIRTS, POLO SHIRTS, CARDIGANS, JERSEYS, UNIFORMS, DRESS SHIRTS, PANTS, TROUSERS, SLACKS, JEANS, CULOTTES, CARGO PANTS, DENIM JEANS, OVERALLS, COVERALLS, JUMPERS, JUMP SUITS, SHORTS, BOXER SHORTS, TOPS, CROP TOPS, TANK TOPS, HALTER TOPS, SWEAT SHIRTS, SWEAT SHORTS, SWEAT PANTS, WRAPS, WARM-UP SUITS, JOGGING SUITS, TRACK SUITS, PLAY SUITS, BLOUSES, SKIRTS, DRESSES, SWEATERS, VESTS, FLEECE VESTS, PULL-OVERS, SNOW SUITS, PARKAS, CAPES, ANORAKS, PONCHOS, JACKETS, REVERSIBLE JACKETS, COATS, BLAZERS, SUITS, TURTLENECKS, CLOTH SKI BIBS, SWIMWEAR, BEACHWEAR, TENNIS WEAR, SURF WEAR, SKI WEAR, LAYETTES, INFANTWEAR, INFANTS SLEEPERS, BOOTIES, BABY BIBS NOT OF PAPER, CAPS, SWIM CAPS, BERETS, BEANIES, HATS, VISORS, HEADBANDS, WRIST BANDS, SWEAT BANDS, HEADWEAR, EAR MUFFS, APRONS, SCARVES, BANDANAS, BELTS, SUSPENDERS, NECKWEAR, TIES, NECKERCHIEFS, ASCOTS, UNDERWEAR, THERMAL UNDERWEAR, LONG UNDERWEAR, BRIEFS, SWIM AND BATHING TRUNKS, SPORTS BRAS, PANTIES, THONGS, SOCKS, LOUNGEWEAR, ROBES, SMOCKS, UNDERCLOTHES, PAJAMAS, SLEEPWEAR, NIGHT GOWNS, SARONGS, LEG WARMERS, HOSIERY, PANTYHOSE, BODY STOCKINGS, KNEE HIGHS, LEGGINGS, TIGHTS, LEOTARDS, BODY SUITS, UNITARDS, GLOVES, MITTENS, RAINWEAR, FOOTWEAR, SHOES, SNEAKERS, BOOTS, GALOSHES, SANDALS, FLIP-FLOPS, AND SLIPPERS (U.S. CLS. 22 AND 39).

KELLEY WELLS, EXAMINING ATTORNEY

CLASS 25—(Continued).

SN 77-900,860. RIM ROCKA ATHLETICS LLC, NEW YORK, NY. FILED 12-24-2009.

RIM ROCKA

THE MARK CONSISTS OF STANDARD CHARACTERS WITHOUT CLAIM TO ANY PARTICULAR FONT, STYLE, SIZE, OR COLOR.

OWNER OF U.S. REG. NO. 2,141,568.

FOR ANKLE SOCKS; ATHLETIC SHOES; BASKETBALL SNEAKERS; BEACH SHOES; FLIP FLOPS; FOOTWEAR; HOSIERY; LEISURE SHOES; SANDALS; SHOES; SLIPPERS; SNEAKERS; SOCKS (U.S. CLS. 22 AND 39).

FIRST USE 1-1-2000; IN COMMERCE 1-1-2000.

DAWN HAN, EXAMINING ATTORNEY

SN 77-906,252. NIKE, INC., BEAVERTON, OR. FILED 1-6-2010.

HYPHER COOL

THE MARK CONSISTS OF STANDARD CHARACTERS WITHOUT CLAIM TO ANY PARTICULAR FONT, STYLE, SIZE, OR COLOR.

NO CLAIM IS MADE TO THE EXCLUSIVE RIGHT TO USE "COOL", APART FROM THE MARK AS SHOWN.

FOR APPAREL, NAMELY, SHIRTS, T-SHIRTS, TANK TOPS, UNDERWEAR (U.S. CLS. 22 AND 39).

FIRST USE 9-0-2008; IN COMMERCE 9-0-2008.

AISHA CLARKE, EXAMINING ATTORNEY

CLASS 25—(Continued).

SN 77-907,905. RAMIREZ, RICARDO, HOLLYWOOD, CA. FILED 1-8-2010.



OWNER OF U.S. REG. NO. 2,998,069.
THE MARK CONSISTS OF A SKULL AND CROSS BONES WITH EYES AND NOSE SHOWING TEETH, AND A CROSS ON THE FOREHEAD OVER TWO CHECKERED FLAGS. UNDER THE IMAGE ARE THE NUMBERS "666". UNDER THE NUMBERS ARE THE WORDS "LA MARCA DEL DIABLO" IN STYLIZED FORM.

THE ENGLISH TRANSLATION OF "LA MARCA DEL DIABLO" IN THE MARK IS "THE MARK OF THE DEVIL".
FOR BELTS; BLOUSES; FLEECE PULLOVERS; HATS; HEADGEAR, NAMELY, CAPS; JACKETS; JEANS; PANTS; SHIRTS; SHOES; SHORT-SLEEVED OR LONG-SLEEVED T-SHIRTS; T-SHIRTS; TEE SHIRTS; TOPS (U.S. CLS. 22 AND 39).

FIRST USE 5-1-2003; IN COMMERCE 5-1-2003.
TARAH HARDY, EXAMINING ATTORNEY

SN 77-908,261. BRAZIQUE, GRAPEVINE, TX. FILED 1-8-2010.

BRAZIQUE

THE MARK CONSISTS OF STANDARD CHARACTERS WITHOUT CLAIM TO ANY PARTICULAR FONT, STYLE, SIZE, OR COLOR.

THE WORDING "BRAZIQUE" HAS NO MEANING IN A FOREIGN LANGUAGE.

FOR CLOTHING, NAMELY, LINGERIE, BRAS, SHAPWEAR, NAMELY, GIRDLES, FOUNDATION GARMENTS, MATERNITY BRAS, NURSING BRAS, UNDERWEAR, ATHLETIC BRAS, NAMELY, SPORTS BRAS, BUSTIERS, CORSETS, SLEEPWEAR, HOSIERY, SWIMWEAR, BLOUSES, DRESSES, AND PANTS (U.S. CLS. 22 AND 39).

RONALD DELGIZZI, EXAMINING ATTORNEY

CLASS 25—(Continued).

SN 77-908,440. PROBLEM SOLVED INK, DBA PROBLEM SOLVED, NORTH LAS VEGAS, NV. FILED 1-9-2010.



THE MARK CONSISTS OF THE WORDING "PROBLEM SOLVED" ABOVE STYLIZED BRASS KNUCKLES.

FOR ATHLETIC APPAREL, NAMELY, SHIRTS, PANTS, JACKETS, FOOTWEAR, HATS AND CAPS, ATHLETIC UNIFORMS (U.S. CLS. 22 AND 39).

TOBY BULLOFF, EXAMINING ATTORNEY

SN 77-909,793. FELLS, KENDALL, KANSAS CITY, MO. FILED 1-12-2010.

Ski-zē Coutour

NO CLAIM IS MADE TO THE EXCLUSIVE RIGHT TO USE "COUTURE", APART FROM THE MARK AS SHOWN.

THE MARK CONSISTS OF THE STYLIZED TEXT "SKI-ZE COUTOUR" WITH A "U"-LIKE SYMBOL IN PLACE OF THE DOT OVER THE "I". THERE IS ALSO A HORIZONTAL LINE OVER THE LETTER "E".

FOR BANDANAS; DRESSES; JACKETS; JEANS; SCARVES; SHIRTS; SOCKS; SWEAT SHIRTS (U.S. CLS. 22 AND 39).

SHAUNIA CARLYLE, EXAMINING ATTORNEY

SN 77-913,126. FRENCH MARKET CORPORATION, NEW ORLEANS, LA. FILED 1-15-2010.

FRENCH MARKET

THE MARK CONSISTS OF STANDARD CHARACTERS WITHOUT CLAIM TO ANY PARTICULAR FONT, STYLE, SIZE, OR COLOR.

OWNER OF U.S. REG. NOS. 3,118,696, 3,200,041 AND OTHERS.

FOR CLOTHING, NAMELY, SHIRTS, T-SHIRTS, APRONS, CAPS, HATS, SOCKS, UNDERWEAR, SWEAT-SHIRTS, JACKETS (U.S. CLS. 22 AND 39).

DOMINIC J. FERRAIUOLO, EXAMINING ATTORNEY

CLASS 25—(Continued).

SN 77-914,523. MORI LEE, LLC, BOCA RATON, FL. FILED 1-19-2010.

ANGELINA FACCENDA

THE MARK CONSISTS OF STANDARD CHARACTERS WITHOUT CLAIM TO ANY PARTICULAR FONT, STYLE, SIZE, OR COLOR.

THE NAME(S), PORTRAIT(S), AND/OR SIGNATURE(S) SHOWN IN THE MARK DOES NOT IDENTIFY A PARTICULAR LIVING INDIVIDUAL.

THE ENGLISH TRANSLATION OF "FACCENDA" IN THE MARK IS "THING".

FOR CLOTHING, NAMELY, BRIDAL WEAR IN THE NATURE OF DRESSES, WEDDING DRESSES AND BRIDESMAID DRESSES (U.S. CLS. 22 AND 39).

FIRST USE 9-0-2003; IN COMMERCE 9-0-2003.
MATTHEW PAPPAS, EXAMINING ATTORNEY

SN 77-914,613. CRUMP, LINDSEY, ST. JAMES, MO. FILED 1-19-2010.

Very Aggressive Goat Clothing

THE MARK CONSISTS OF STANDARD CHARACTERS WITHOUT CLAIM TO ANY PARTICULAR FONT, STYLE, SIZE, OR COLOR.

NO CLAIM IS MADE TO THE EXCLUSIVE RIGHT TO USE "CLOTHING", APART FROM THE MARK AS SHOWN.

FOR JACKETS; SHIRTS (U.S. CLS. 22 AND 39).
ANDREA K. NADELMAN, EXAMINING ATTORNEY

SN 77-917,364. HOLLENBERG, MARIA, NEW YORK, NY. AND MANSKY, LEERON, TUCKAHOE, NY. FILED 1-21-2010.

PRIM

THE MARK CONSISTS OF STANDARD CHARACTERS WITHOUT CLAIM TO ANY PARTICULAR FONT, STYLE, SIZE, OR COLOR.

FOR BLOUSES; CAMISOLES; COATS; DENIMS; JACKETS; LEGGINGS; SHORTS; SKIRTS AND DRESSES; SWEATERS; T-SHIRTS; TOPS (U.S. CLS. 22 AND 39).

GENE MACIOL, EXAMINING ATTORNEY

CLASS 25—(Continued).

SN 77-917,435. AROUND THE WORLD APPAREL INC., DBA MISS CHIEVOUS CLOTHING, LOS ANGELES, CA. FILED 1-21-2010.

CHANCE OR FATE CLOTHING

THE MARK CONSISTS OF STANDARD CHARACTERS WITHOUT CLAIM TO ANY PARTICULAR FONT, STYLE, SIZE, OR COLOR.

NO CLAIM IS MADE TO THE EXCLUSIVE RIGHT TO USE "CLOTHING", APART FROM THE MARK AS SHOWN.

FOR MEN'S, WOMEN'S, AND CHILDREN'S CLOTHING, NAMELY, SWEAT SHIRTS, HOODS, PULLOVERS, SPORTS SHIRTS, POLO SHIRTS, KNIT SHIRTS, T-SHIRTS, LONG SLEEVE SHIRTS, JEANS, TROUSERS, SWEAT PANTS, DRESSES, WRISTBANDS, VESTS, BELTS, UNDER GARMENTS, UNDERWEAR, SKIRTS, BLOUSES, SWEATERS, SLEEPWEAR, CLOTH BIBS, APRONS, CLOTHING GLOVES, MITTENS, NECKTIES, SHORTS; HEADGEAR, NAMELY, HATS, HEAD BANDS, VISORS, BANDANAS, HOODS, CAPS, BEANIES, EAR MUFFS, HEADBANDS, SWEATBANDS, BASEBALL CAPS; SOCKS, FOOTWEAR, SHOES, ATHLETIC SHOES, BOOTS, SANDALS, THONGS AND SLIPPERS; JACKETS, BLAZERS, COATS, LEATHER COATS, SPORTS COATS, JACKETS, FLEECE JACKETS, KNIT JACKETS, SWIMWEAR, RAINWEAR, SKI WEAR, AND BEACH WEAR (U.S. CLS. 22 AND 39).

SUSAN LESLIE DUBOIS, EXAMINING ATTORNEY

SN 77-918,133. SACRIFICIAL, LLC, CHARLOTTE, NC. FILED 1-22-2010.

SACRIFICIAL

THE MARK CONSISTS OF STANDARD CHARACTERS WITHOUT CLAIM TO ANY PARTICULAR FONT, STYLE, SIZE, OR COLOR.

FOR CLOTHING, NAMELY, MEN'S, WOMEN'S, AND CHILDREN'S DENIM JEANS, PANTS, SHORTS, DRESS SLACKS, CASUAL SLACKS, LEGGINGS, SUITS, BLAZERS, SKIRTS, DRESSES, SHIRTS, T-SHIRTS, BLOUSES, SWEATERS, TOPS, DRESS SHIRTS, KNIT SHIRTS, TANK TOPS, VESTS, POLO SHIRTS, PULLOVERS, SWEATPANTS, SWEATSHIRTS, JOGGING SUITS, SPORTSWEAR, NAMELY, SPORTS SHIRTS, SPORTS JACKETS, LOUNGEWEAR, SLEEPWEAR, PAJAMAS, CAMISOLES, UNDERWEAR, OUTERWEAR, NAMELY, HATS, CAPS, WIND RESISTANT JACKETS, SPORTS COATS, JACKETS, COATS, RAINWEAR, HEADWEAR, FOOTWEAR, SOCKS AND HOSIERY, SWIMWEAR, SWIMSUITS (U.S. CLS. 22 AND 39).

KATHERINE M. DUBRAY, EXAMINING ATTORNEY

CLASS 25—(Continued).

SN 77-918,541. CREATIVE SPIRIT ENTERPRISES, MORROW, OH. FILED 1-22-2010.



NO CLAIM IS MADE TO THE EXCLUSIVE RIGHT TO USE "ENTERPRISES", APART FROM THE MARK AS SHOWN.

THE MARK CONSISTS OF AN OUTLINE OF A HORSE WEARING A SCARF WITH "CREATIVESPIRIT ENTERPRISES" WRITTEN UNDER IT. THERE IS SHADOW AROUND THE HORSE AND THE WORD "CREATIVE" AND FADED SHADOW AROUND THE SCARF.

FOR EAR WARMERS; HATS; HEADBANDS; SCARVES (U.S. CLS. 22 AND 39).

FIRST USE 10-24-2006; IN COMMERCE 3-25-2007.

JOSETTE BEVERLY, EXAMINING ATTORNEY

SN 77-918,830. VAILE, CARILYN, NEWPORT BEACH, CA. FILED 1-24-2010.

CARILYN VAILE

THE MARK CONSISTS OF STANDARD CHARACTERS WITHOUT CLAIM TO ANY PARTICULAR FONT, STYLE, SIZE, OR COLOR.

THE NAME "CARILYN VAILE" IDENTIFIES A LIVING INDIVIDUAL WHOSE CONSENT IS OF RECORD.

FOR BOTTOMS; BRIDESMAID DRESSES; CAPRI PANTS; CARGO PANTS; DRESSES; DUSTERS; EVENING DRESSES; HALTER TOPS; JERSEYS; LOUNGE PANTS; PANTS; SHORT-SLEEVED OR LONG-SLEEVED T-SHIRTS; SKIRT SUITS; SKIRTS; SKIRTS AND DRESSES; TANK TOPS; TOPS; TRAVEL CLOTHING CONTAINED IN A PACKAGE COMPRISING REVERSIBLE JACKETS, PANTS, SKIRTS, TOPS AND A BELT OR SCARF; WOMEN'S CEREMONIAL DRESSES; WOMEN'S SHOES; WOMEN'S TOPS, NAMELY, CAMIS; WOMEN'S UNDERWEAR; WRAPS; YOGA PANTS (U.S. CLS. 22 AND 39).

BARBARA A. GOLD, EXAMINING ATTORNEY

CLASS 25—(Continued).

SN 77-919,248. BOTT, MARK S., ST. CLAIR SHORES, MI. FILED 1-25-2010.

Tattude Apparel

THE MARK CONSISTS OF STANDARD CHARACTERS WITHOUT CLAIM TO ANY PARTICULAR FONT, STYLE, SIZE, OR COLOR.

NO CLAIM IS MADE TO THE EXCLUSIVE RIGHT TO USE "APPAREL", APART FROM THE MARK AS SHOWN.

FOR ADULT, NOVELTY GAG CLOTHING ITEM, NAMELY, SOCKS; BABY LAYETTES FOR CLOTHING; BELTS; BELTS FOR CLOTHING; BELTS MADE OUT OF CLOTH; BIBS NOT OF CLOTH OR PAPER; BOTTOMS; CHILDREN'S AND INFANTS' CLOTH BIBS; CHILDREN'S CLOTH EATING BIBS; CLOTH BIBS; CLOTH BIBS FOR ADULT DINERS; CLOTH BIBS FOR USE BY SENIOR CITIZENS OR PHYSICALLY- OR MENTALLY- CHALLENGED PERSONS; CLOTH DIAPERS; CLOTHING FOR ATHLETIC USE, NAMELY, PADDED ELBOW COMPRESSION SLEEVES BEING PART OF AN ATHLETIC GARMENT; CLOTHING FOR ATHLETIC USE, NAMELY, PADDED PANTS; CLOTHING FOR ATHLETIC USE, NAMELY, PADDED SHIRTS; CLOTHING FOR ATHLETIC USE, NAMELY, PADDED SHORTS; CLOTHING FOR WEAR IN JUDO PRACTICES; CLOTHING FOR WEAR IN WRESTLING GAMES; CLOTHING ITEMS, NAMELY, ADHESIVE POCKETS THAT MAY BE AFFIXED DIRECTLY TO THE BODY AS A DECORATIVE PIECE OF CLOTHING WITH UTILITY; CLOTHING ITEMS, NAMELY, ADHESIVE POCKETS THAT MAY BE AFFIXED DIRECTLY TO THE INSIDE OF CLOTHING FOR STORAGE AND SAFEKEEPING OF PERSONAL ITEMS; CLOTHING, NAMELY, ARM WARMERS; CLOTHING, NAMELY, BASE LAYERS; CLOTHING, NAMELY, FOLK COSTUMES; CLOTHING, NAMELY, HAND-WARMERS; CLOTHING, NAMELY, KHAKIS; CLOTHING, NAMELY, KNEE WARMERS; CLOTHING, NAMELY, MATERNITY BANDS; CLOTHING, NAMELY, NECK TUBES; CLOTHING, NAMELY, THOBES; CLOTHING, NAMELY, WRAP-AROUNDS; CORSETS; DUSTERS; EYESHADES; FOULARDS; GLOVES AS CLOTHING; HEADBANDS FOR CLOTHING; HOODS; INFANT AND TODDLER ONE PIECE CLOTHING; JACKETS; JERSEYS; LEATHER BELTS; MANTLES; MUFFLERS; PAPER HATS FOR USE AS CLOTHING ITEMS; PARTS OF CLOTHING, NAMELY, GUSSETS FOR TIGHTS, GUSSETS FOR STOCKINGS, GUSSETS FOR BATHING SUITS, GUSSETS FOR UNDERWEAR, GUSSETS FOR LEOTARDS AND GUSSETS FOR FOOTLETS; PARTS OF CLOTHING, NAMELY, UNDERARM GUSSETS; PARTY HATS; PERSPIRATION ABSORBENT UNDERWEAR CLOTHING; POCKET SQUARES; SHIRTS; SHORT SETS; SHOULDER WRAPS; SWADDLING CLOTHES; TIES; TOPS; TRAVEL CLOTHING CONTAINED IN A PACKAGE COMPRISING REVERSIBLE JACKETS, PANTS, SKIRTS, TOPS AND A BELT OR SCARF; TRIATHLON CLOTHING, NAMELY, TRIATHLON TIGHTS, TRIATHLON SHORTS, TRIATHLON SINGLET, TRIATHLON SHIRTS, TRIATHLON SUITS; UNDERARM CLOTHING SHIELDS; WEARABLE GARMENTS AND CLOTHING, NAMELY, SHIRTS; WRAPS (U.S. CLS. 22 AND 39).

ALICIA COLLINS, EXAMINING ATTORNEY

CLASS 25—(Continued).

SN 77-920,176. F.S.I. - FORT LAUDERDALE, INC., DAVIE, FL. FILED 1-26-2010.

CLASS 25—(Continued).

SN 77-920,889. PABLO, NED R., DBA MÄSMÄI, HAGÄTÑA, GUAM, AND PABLO, PAULINE RANAE TECHAIRA, HAGÄTÑA, GUAM, FILED 1-26-2010.

CUTETEEES

THE MARK CONSISTS OF STANDARD CHARACTERS WITHOUT CLAIM TO ANY PARTICULAR FONT, STYLE, SIZE, OR COLOR.

FOR BLOUSES; DRESSES; HATS; PANTS; SCARVES; SHORTS; SKORTS; T-SHIRTS; TOPS; UNDERGARMENTS (U.S. CLS. 22 AND 39).

FIRST USE 1-1-2010; IN COMMERCE 1-1-2010.

AARON BRODSKY, EXAMINING ATTORNEY



SN 77-920,222. NAAGA LLC, IRVINE, CA. FILED 1-26-2010.



NO CLAIM IS MADE TO THE EXCLUSIVE RIGHT TO USE "ESTD 2008", APART FROM THE MARK AS SHOWN.

THE MARK CONSISTS OF THE WORDS "POÈME & POÉSIE" IN STYLIZED LETTERS WITH A LINE UNDERNEATH DEPICTING A BRANCH WITH LEAVES. "ESTD 2008" IS WRITTEN ON THE BOTTOM RIGHT.

THE ENGLISH TRANSLATION OF "POÈME & POÉSIE" IN THE MARK IS "POEM AND POETRY".

FOR BABY BIBS NOT OF PAPER; BABY BODYSUITS; BABY BOTTOMS; BABY LAYETTES FOR CLOTHING; BABY TOPS; CHILDREN'S AND INFANTS' CLOTH BIBS; HATS FOR INFANTS, BABIES, TODDLERS AND CHILDREN; INFANT AND TODDLER ONE PIECE CLOTHING; INFANT WEAR; INFANTS' TROUSERS; ONE PIECE GARMENT FOR INFANTS AND TODDLERS; SHIRTS FOR INFANTS, BABIES, TODDLERS AND CHILDREN (U.S. CLS. 22 AND 39).

REBECCA EISINGER, EXAMINING ATTORNEY

THE MARK CONSISTS OF THE DESIGN OF A LETTER "M" WITH A CURVED LINE AROUND IT THAT APPEARS AS A BREAKING WAVE. BENEATH THE DESIGN IS THE TERM "MÄSMÄI".

THE ENGLISH TRANSLATION OF "MÄSMÄI" IN THE MARK IS "SOAKING WET".

FOR CLOTHING FOR MEN, WOMEN, CHILDREN, AND INFANTS, NAMELY, T-SHIRTS, POLO SHIRTS, SWEAT SHIRTS, JEANS, JACKETS, SHORTS, DRESSES AND WRISTBANDS; HEADGEAR, NAMELY, HATS, BEANIES, HEADBANDS, AND VISORS; FOOTWEAR, NAMELY, SHOES, SANDALS, SLIPPERS, AND SOCKS (U.S. CLS. 22 AND 39).

FIRST USE 9-19-2003; IN COMMERCE 9-19-2003.

ELLEN PERKINS, EXAMINING ATTORNEY

CLASS 25—(Continued).

SN 77-921,180. CAPUCILLI, ALYSSA S., NEW YORK, NY. AND SCHORIES, PAT, NEW YORK, NY. FILED 1-27-2010.



THE MARK CONSISTS OF THE LITERAL ELEMENTS "BISCUIT" AND "THE LITTLE YELLOW PUPPY" IN STYLIZED LETTERING, A CIRCULAR RING, AND A FANCIFUL REPRESENTATION OF A PUPPY. THE WORD "BISCUIT" APPEARS IN THE TOP OF THE RING AND THE WORDS "THE LITTLE YELLOW PUPPY" APPEAR ALONG THE BOTTOM OF THE RING. AT THE CENTER OF THE RING IS A FANCIFUL REPRESENTATION OF A PUPPY.

FOR CLOTHING, NAMELY, SHIRTS, T-SHIRTS, UNDER SHIRTS, NIGHT SHIRTS, RUGBY SHIRTS, POLO SHIRTS, CARDIGANS, JERSEYS, UNIFORMS, PANTS, TROUSERS, BLAZERS, DRESS SHIRTS, SLACKS, JEANS, DENIM JEANS, CULOTTES, CARGO PANTS, OVERALLS, COVERALLS, JUMPERS, JUMP SUITS, SHORTS, BOXER SHORTS, TOPS, CROP TOPS, TANK TOPS, HALTER TOPS, SWEAT SHIRTS, SWEAT SHORTS, SWEAT PANTS, WRAPS, WARM-UP SUITS, JOGGING SUITS, TRACK SUITS, PLAY SUITS, BLOUSES, SKIRTS, DRESSES, SWEATERS, VESTS, FLEECE VESTS, PULLOVERS, SNOW SUITS, PARKAS, CAPES, ANORAKS, PONCHOS, JACKETS, SPORTS JACKETS, REVERSIBLE JACKETS, FLEECE JACKETS, COATS, TURTLENECKS, CLOTH SKI BIBS, BEACHWEAR, TENNIS WEAR, SURF WEAR, SKI WEAR, LAYETTES, INFANTWEAR, INFANTS SLEEPERS, BOOTIES, BABY BIBS NOT OF PAPER, CAPS, SWIM CAPS, BERETS, BEANIES, HATS, VISORS, HEADBANDS, WRIST BANDS, SWEAT BANDS, HEADWEAR, EAR MUFFS, APRONS, SCARVES, BANDANAS, BELTS, SUSPENDERS, NECKWEAR, NECKERCHIEFS, ASCOTS, UNDERWEAR, THERMAL UNDERWEAR, LONG UNDERWEAR, BRIEFS, SWIM AND BATHING TRUNKS, LOUNGEWEAR, ROBES, SMOCKS, UNDERCLOTHES, PAJAMAS, SLEEPWEAR, NIGHTWEAR, LEG WARMERS, PANTYHOSE, BODY STOCKINGS, KNEE HIGHS, LEGGINGS, TIGHTS, LEOTARDS, BODY SUITS, UNITARDS, GLOVES, MITTENS, RAINWEAR, SNEAKERS, BOOTS, RAIN BOOTS, GALOSHES, SANDALS, FLIP-FLOPS, AND SLIPPERS; FOOTWEAR, SHOES, HOSIERY, SOCKS, AND SWIMWEAR; DRESS SHIRTS, TIES, RAIN COATS; HALLOWEEN COSTUMES, COSTUMES FOR USE IN ROLE-PLAYING GAMES, COSTUMES FOR USE IN CHILDREN'S DRESS UP PLAY; ROMPERS; INFANT AND TODDLER ONE PIECE CLOTHING (U.S. CLS. 22 AND 39).

JOHN SCHUYLER YARD, EXAMINING ATTORNEY

CLASS 25—(Continued).

SN 77-921,343. CASUAL FREEDOM INC., CITY OF COMMERCE, CA. FILED 1-27-2010.

INSPIRED BY CASUAL FREEDOM

THE MARK CONSISTS OF STANDARD CHARACTERS WITHOUT CLAIM TO ANY PARTICULAR FONT, STYLE, SIZE, OR COLOR.

NO CLAIM IS MADE TO THE EXCLUSIVE RIGHT TO USE "CASUAL", APART FROM THE MARK AS SHOWN.

FOR WOMEN'S APPAREL, NAMELY, CONTEMPORARY TOPS, SHIRTS, JEANS, PANTS, JACKETS, PRINTED T-SHIRTS, SILK WOVEN BLOUSES, SCARVES AND VESTS (U.S. CLS. 22 AND 39).

MARC LEIPZIG, EXAMINING ATTORNEY

SN 77-921,827. HONEST CONCERTS INC., LOS ANGELES, CA. FILED 1-27-2010.

HONEST CONCERTS

THE MARK CONSISTS OF STANDARD CHARACTERS WITHOUT CLAIM TO ANY PARTICULAR FONT, STYLE, SIZE, OR COLOR.

FOR CLOTHING, NAMELY, TOPS, BOTTOMS, HEADWEAR, FOOTWEAR, SLEEPWEAR, UNDERWEAR, UNDERGARMENTS, BEACHWEAR, JUMPERS, SWEATERS, PULLOVERS, SINGLET, WRISTBANDS, BELTS, SWIM WEAR, JERSEYS, UNIFORMS, ATHLETIC UNIFORMS, OVERALLS, COVERALLS, JUMP SUITS, WRAPS, WARM-UP SUITS, JOGGING SUITS, DRESSES, VESTS, FLEECE VESTS, SNOW SUITS, PARKAS, ANORAKS, PONCHOS, JACKETS, COATS, BLAZERS, SUITS, SWEAT BANDS, EAR MUFFS, APRONS, SCARVES, BANDANAS, SUSPENDERS, NECKWEAR, NECKTIES, TIES, LOUNGEWEAR, ROBES, BATHROBES, HOSIERY, LEG WARMERS, BODYSUITS, LEGGINGS, TIGHTS, LEOTARDS, UNITARDS, GLOVES, MITTENS, AND RAINWEAR (U.S. CLS. 22 AND 39).

KEVIN CORWIN, EXAMINING ATTORNEY

CLASS 25—(Continued).

SN 77-921,946. SMITH, LAUREL B. DBA OTRUN'EM, CHARLOTTESVILLE, VA. FILED 1-27-2010.



THE MARK CONSISTS OF THE WORD "OTRUN'EM" WRITTEN IN ALL LOWERCASE LETTERS WITH A WOMAN IN MID-STRIDE RUNNING ABOVE AND A BIT BEYOND THE "M".

FOR ATHLETIC APPAREL, NAMELY, SHIRTS, PANTS, JACKETS, FOOTWEAR, HATS AND CAPS, ATHLETIC UNIFORMS (U.S. CLS. 22 AND 39).
PATRICIA EVANKO, EXAMINING ATTORNEY

SN 77-921,978. DE FRANCESCHI, IVO, BOCA RATON, FL. FILED 1-28-2010.

BANANA PANCAKE

THE MARK CONSISTS OF STANDARD CHARACTERS WITHOUT CLAIM TO ANY PARTICULAR FONT, STYLE, SIZE, OR COLOR.

FOR CLOTHING PRODUCTS, NAMELY, FOOTWEAR, HEADGEAR, NAMELY, HATS, JACKETS, SOCKS, BELTS, CAPS AND HOODED SWEATERS FOR CONSUMERS (U.S. CLS. 22 AND 39).

MARK T. MULLEN, EXAMINING ATTORNEY

SN 77-922,371. CFBE BRANDS, LLC, WESTPORT, CT. FILED 1-28-2010.



THE MARK CONSISTS OF A RECTANGLE WITH ROUNDED EDGES AND DOTTED BORDER CONTAINING A GLOBE AND THE WORDING "ECO RINSE GIVE EARTH A CHANCE."

FOR CLOTHING, NAMELY, KNIT TOPS, WOVEN PANTS AND SHORTS, DENIM JACKETS AND JEANS (U.S. CLS. 22 AND 39).

CURTIS FRENCH, EXAMINING ATTORNEY

CLASS 25—(Continued).

SN 77-923,247. COLEMAN, DAROLD, OAK PARK, MI. AND COLEMAN, JACQUELINE, L, OAK PARK, MI. FILED 1-29-2010.

what's up pimp

THE MARK CONSISTS OF STANDARD CHARACTERS WITHOUT CLAIM TO ANY PARTICULAR FONT, STYLE, SIZE, OR COLOR.

FOR ATHLETIC APPAREL, NAMELY, SHIRTS, PANTS, JACKETS, FOOTWEAR, HATS AND CAPS, ATHLETIC UNIFORMS; ATHLETIC SHOES; TEE SHIRTS (U.S. CLS. 22 AND 39).

HEATHER THOMPSON, EXAMINING ATTORNEY

SN 77-923,584. BANDEAU-DESIGN, INC., WEST PATERSON, NJ. FILED 1-29-2010.

MySuperBra

THE MARK CONSISTS OF STANDARD CHARACTERS WITHOUT CLAIM TO ANY PARTICULAR FONT, STYLE, SIZE, OR COLOR.

FOR BRASSIERES (U.S. CLS. 22 AND 39).

FIRST USE 7-17-2008; IN COMMERCE 7-7-2009.

BRIDGETT SMITH, EXAMINING ATTORNEY

SN 77-923,931. THE MOUNTAIN CORPORATION, KEENE, NH. FILED 1-29-2010.



OWNER OF U.S. REG. NO. 2,448,417.

NO CLAIM IS MADE TO THE EXCLUSIVE RIGHT TO USE "ORGANIC", APART FROM THE MARK AS SHOWN.

THE MARK CONSISTS OF THE WORD "MOUNTAIN" ON A BACKGROUND FEATURING A MOUNTAIN AND SEVERAL TREES ABOVE THE WORD "ORGANIC" ON A BACKGROUND FEATURING EARTH AND ROOTS.

FOR DRESS SHIRTS; GOLF SHIRTS; HATS; JACKETS; KNIT SHIRTS; OPEN-NECKED SHIRTS; PANTS; POLO SHIRTS; RUGBY SHIRTS; SHIRTS; SHORT-SLEEVED OR LONG-SLEEVED T-SHIRTS; SHORTS; SPORTS SHIRTS; SWEAT SHIRTS; SWEATERS; T-SHIRTS; WIND SHIRTS; ALL OF THE FOREGOING MADE IN WHOLE OR IN PART OF ORGANIC MATERIALS (U.S. CLS. 22 AND 39).

FIRST USE 1-1-2010; IN COMMERCE 1-1-2010.

BRENDAN REGAN, EXAMINING ATTORNEY

CLASS 25—(Continued).

SN 77-924,545. REED4, LLC, DBA SOAK 5, GRAND HAVEN, MI. FILED 2-1-2010.

SOAK 5

THE MARK CONSISTS OF STANDARD CHARACTERS WITHOUT CLAIM TO ANY PARTICULAR FONT, STYLE, SIZE, OR COLOR.

FOR BANDANAS; HATS; HOODED SWEAT SHIRTS; SHORTS; SWEAT PANTS; SWEAT SHIRTS; SWEAT SHORTS; T-SHIRTS (U.S. CLS. 22 AND 39).

ALEX KEAM, EXAMINING ATTORNEY

SN 77-924,615. SMOOTH SOLUTIONS, LLC, LAKE CLARKE SHORES, FL. FILED 2-1-2010.

SEX2SEA

THE MARK CONSISTS OF STANDARD CHARACTERS WITHOUT CLAIM TO ANY PARTICULAR FONT, STYLE, SIZE, OR COLOR.

FOR SWIMWEAR, BATHING SUITS, BIKINIS (U.S. CLS. 22 AND 39).

CYNTHIA SLOAN, EXAMINING ATTORNEY

SN 77-924,669. AMERICAN SPORTSMAN HOLDINGS CO., SPRINGFIELD, MO. FILED 2-1-2010.

DOGWOOD CANYON

THE MARK CONSISTS OF STANDARD CHARACTERS WITHOUT CLAIM TO ANY PARTICULAR FONT, STYLE, SIZE, OR COLOR.

OWNER OF U.S. REG. NOS. 3,397,625 AND 3,571,169. SEC. 2(F).
FOR FOOTWEAR, NAMELY, BOOTS (U.S. CLS. 22 AND 39).

FIRST USE 1-31-2009; IN COMMERCE 1-31-2009.

AMY C. KEAN, EXAMINING ATTORNEY

CLASS 25—(Continued).

SN 77-924,725. SECOND TIER CITY SPORTS, LLC, MANCHESTER, CT. FILED 2-1-2010.



THE MARK CONSISTS OF A DESIGN OF A SNOWMAN PLAYING ICE HOCKEY WITH AN ICE HOCKEY PUCK ABOVE THE LETTERS "MEN" IN THE WORD "SNOWMEN" WHICH IS ABOVE THE STYLIZED TEXT "SYRACUSE SNOWMEN".

FOR HATS; JACKETS; JERSEYS; POLO SHIRTS; SCARVES; SWEAT SHIRTS; T-SHIRTS; TIES (U.S. CLS. 22 AND 39).

SAMUEL E. SHARPER JR., EXAMINING ATTORNEY

SN 77-924,731. GOERNDT, SIGRID, AUSTIN, TX. FILED 2-1-2010.

SIGIBABY

THE MARK CONSISTS OF STANDARD CHARACTERS WITHOUT CLAIM TO ANY PARTICULAR FONT, STYLE, SIZE, OR COLOR.

FOR CLOTHING, NAMELY, TEE SHIRTS, MATERNITY TEE SHIRTS, KNITTED BABY HATS, SWEATERS (U.S. CLS. 22 AND 39).

FIRST USE 11-21-2009; IN COMMERCE 3-1-2010.

SAMUEL E. SHARPER JR., EXAMINING ATTORNEY

SN 77-924,782. PANG, SO WAH, KOWLOON, HONG KONG, FILED 2-1-2010.

WTIGER

THE MARK CONSISTS OF THE STYLIZED LETTERS "WTIGER".

FOR CLOTHING, NAMELY, PANTS, SHIRTS, T-SHIRTS, BELTS, JACKETS, DRESSES, UNDERWEAR, HOSIERY, SLEEPWEAR, BATHING SUITS; FOOTWEAR; HEADWEAR; SHOES; BOOTS; ATHLETIC SHOES; SOCCER SHOES; HIKING BOOTS; SHAWLS AND STOLEES; TIES; SOCKS AND STOCKINGS (U.S. CLS. 22 AND 39).

DOMINIC J. FERRAIUOLO, EXAMINING ATTORNEY

CLASS 25—(Continued).

SN 77-924,813. TRAUTMAN, KRISTEN, SAN MARCOS, TX. FILED 2-1-2010.

Bosco & Stache

THE MARK CONSISTS OF STANDARD CHARACTERS WITHOUT CLAIM TO ANY PARTICULAR FONT, STYLE, SIZE, OR COLOR.
FOR BATHING SUITS; JACKETS; PANTS; SHIRTS; SHOES (U.S. CLS. 22 AND 39).
FLORENTINA BLANDU, EXAMINING ATTORNEY

CLASS 25—(Continued).

SN 77-925,283. SCHLESINGER, MARGARET M, CASPER, WY. FILED 2-1-2010.

PonThro

THE MARK CONSISTS OF STANDARD CHARACTERS WITHOUT CLAIM TO ANY PARTICULAR FONT, STYLE, SIZE, OR COLOR.
FOR PONCHOS (U.S. CLS. 22 AND 39).
FIRST USE 1-10-2010; IN COMMERCE 1-10-2010.
LAURA HAMMEL, EXAMINING ATTORNEY

SN 77-925,036. L.A. GEAR, INC., LOS ANGELES, CA. FILED 2-1-2010.



OWNER OF U.S. REG. NOS. 1,792,665, 2,160,298 AND OTHERS.
THE MARK CONSISTS OF "L" WITH A STYLIZED "A".
SEC. 2(F) AS TO "LA".
FOR FOOTWEAR (U.S. CLS. 22 AND 39).
FIRST USE 2-3-1992; IN COMMERCE 2-3-1992.
KATHY DE JONGE, EXAMINING ATTORNEY

SN 77-925,302. 4453069 CANADA, DBA WIKIBOOT CORPORATION, BROSSARD QUEBEC STATE, CANADA, FILED 2-1-2010.

WIKIBOOT

THE MARK CONSISTS OF STANDARD CHARACTERS WITHOUT CLAIM TO ANY PARTICULAR FONT, STYLE, SIZE, OR COLOR.
FOR FOOTWEAR; FOOTWEAR FOR MEN; FOOTWEAR FOR MEN AND WOMEN; FOOTWEAR FOR TRACK AND FIELD ATHLETICS; FOOTWEAR FOR WOMEN; FOOTWEAR, NAMELY, WORK BOOTS; IN-SOLES FOR FOOTWEAR; SCIENTIFIC AND TECHNOLOGICAL APPAREL, NAMELY, SHIRTS, PANTS, JACKETS, FOOTWEAR, HATS AND CAPS, UNIFORMS; SOLES FOR FOOTWEAR (U.S. CLS. 22 AND 39).
JAY BESCH, EXAMINING ATTORNEY

SN 77-925,062. DENISE SHIRLEY, VENETIA, PA. FILED 2-1-2010.



THE COLOR(S) SCARLET, GRAY, BLACK, WHITE, AND TAN IS/ARE CLAIMED AS A FEATURE OF THE MARK.
THE MARK CONSISTS OF THE WORDING "BUCKEYE IN THE OVEN" IN SCARLET TEXT, WITH A WHITE OUTLINE, INSIDE A BLACK ARC. BELOW THIS IS A SCARLET, BLACK AND GRAY OVEN. INSIDE THE OVEN IS A TAN, BLACK, AND WHITE BUCKEYE WITH ITS FACE PEERING OUT.
FOR SHIRTS (U.S. CLS. 22 AND 39).
SHANNON TWOHIG, EXAMINING ATTORNEY

SN 77-925,377. STONEHAM, PAUL D., FORT WORTH, TX. FILED 2-1-2010.



THE MARK CONSISTS OF A BIRD WITH STRIPES ON THE CHEST, LARGE EYES, HAIR FEATHERS AND A LARGE BEAK.
FOR LEG WARMERS; SHIRTS; SLEEPWEAR; SOCKS (U.S. CLS. 22 AND 39).
FIRST USE 1-1-2010; IN COMMERCE 1-1-2010.
NAKIA HENRY, EXAMINING ATTORNEY

CLASS 25—(Continued).

SN 77-925,447. KYLE BOZARTH, TA L.U.I. CLOTHING, BAKERSFIELD, CA. FILED 2-1-2010.

L.U.I.
Living Under Influence

THE MARK CONSISTS OF STANDARD CHARACTERS WITHOUT CLAIM TO ANY PARTICULAR FONT, STYLE, SIZE, OR COLOR.

FOR ATHLETIC APPAREL, NAMELY, SHIRTS, PANTS, JACKETS, FOOTWEAR, HATS AND CAPS, ATHLETIC UNIFORMS; CAMOUFLAGE SHIRTS; GOLF SHIRTS; HATS; HOODED SWEAT SHIRTS; LONG-SLEEVED SHIRTS; MOISTURE-WICKING SPORTS SHIRTS; POLO SHIRTS; SHIRTS; SHIRTS AND SHORT-SLEEVED SHIRTS; SHIRTS FOR INFANTS, BABIES, TODDLERS AND CHILDREN; SHORT-SLEEVED OR LONG-SLEEVED T-SHIRTS; SHORT-SLEEVED SHIRTS; SPORT SHIRTS; SPORTS SHIRTS; SPORTS SHIRTS WITH SHORT SLEEVES; SWEAT SHIRTS; T-SHIRTS; TEE SHIRTS; TOBOGGAN HATS, PANTS AND CAPS; WEARABLE GARMENTS AND CLOTHING, NAMELY, SHIRTS (U.S. CLS. 22 AND 39).

ALLISON SCHRODY, EXAMINING ATTORNEY

SN 77-925,514. A GOODWIN COLLECTIONS, LLC, LAS VEGAS, NV. FILED 2-2-2010.



THE MARK CONSISTS OF A MAN TAKING A LARGE STEP FORWARD, FACING LEFT AND EXTENDING HIS RIGHT LEG FORWARD WITH HIS RIGHT ARM UP AND HAND HOOKED DOWN.

FOR WEARABLE GARMENTS AND CLOTHING, NAMELY, SHIRTS (U.S. CLS. 22 AND 39).

MICHAEL SOUDERS, EXAMINING ATTORNEY

CLASS 25—(Continued).

SN 77-925,631. TEES2GO INC., DBA DIRECT TEES USA, BURBANK, CA. FILED 2-2-2010.



THE MARK CONSISTS OF A STYLIZED DESIGN OF A CARTOON DOG WITH A DROOPING FACE. THE DOG IS WEARING A COLLAR WITH THE NAME "DOBEY" HANGING FROM IT.

FOR CLOTHING, NAMELY, T-SHIRTS, TANK TOPS, HOODED SHIRTS, AND HEADWEAR, NAMELY, HATS, CAPS, AND VISORS (U.S. CLS. 22 AND 39).

CORY BOONE, EXAMINING ATTORNEY

SN 77-925,644. STEWART, JR., HAROLD E., GREENVILLE, SC. FILED 2-2-2010.

COURAGEOUSLOVE

THE MARK CONSISTS OF STANDARD CHARACTERS WITHOUT CLAIM TO ANY PARTICULAR FONT, STYLE, SIZE, OR COLOR.

FOR HATS; HOODED SWEAT SHIRTS; LONG-SLEEVED SHIRTS; SHORT-SLEEVED SHIRTS; SWEAT SHIRTS; T-SHIRTS; TANK-TOPS; WOMEN'S TOPS, NAMELY, CAMIS (U.S. CLS. 22 AND 39).

CAROLINE WOOD, EXAMINING ATTORNEY

SN 77-925,685. SELBY, MICHAEL, RENO, NV. FILED 2-2-2010.

TELE TRIBE

THE MARK CONSISTS OF STANDARD CHARACTERS WITHOUT CLAIM TO ANY PARTICULAR FONT, STYLE, SIZE, OR COLOR.

FOR JACKETS; SWEAT SHIRTS; T-SHIRTS (U.S. CLS. 22 AND 39).

KAREN SEVERSON, EXAMINING ATTORNEY

CLASS 25—(Continued).

SN 77-925,705. HODGSON, JACKIE, NEW HOPE, AL. FILED 2-2-2010.

TONY & SAM BONY



"TONY & SAM BONY" DO NOT IDENTIFY ANY LIVING INDIVIDUALS.

THE MARK CONSISTS OF A HOCKEY PLAYER HOLDING A HOCKEY STICK AND SITTING WITH A PENGUIN. THE STYLIZED TEXT "TONY & SAM BONY" APPEARS ABOVE THE DESIGN.

FOR ATHLETIC APPAREL, NAMELY, SHIRTS, PANTS, JACKETS, FOOTWEAR, HATS, BASEBALL CAPS, AND ATHLETIC UNIFORMS (U.S. CLS. 22 AND 39).

FIRST USE 12-20-2009; IN COMMERCE 12-20-2009. CHRISTINE COOPER, EXAMINING ATTORNEY

SN 77-925,843. THRONEBURG, JAMES L., STATESVILLE, NC. FILED 2-2-2010.

YOUR FEET WILL FEEL BETTER

THE MARK CONSISTS OF STANDARD CHARACTERS WITHOUT CLAIM TO ANY PARTICULAR FONT, STYLE, SIZE, OR COLOR.

OWNER OF U.S. REG. NO. 1,813,234. FOR MEN'S, WOMEN'S AND CHILDREN'S SOCKS (U.S. CLS. 22 AND 39).

FIRST USE 8-0-1987; IN COMMERCE 8-0-1987. MICHELE SWAIN, EXAMINING ATTORNEY

SN 77-925,945. PETERSON, LAURA, PALO ALTO, CA. AND HARDING, HEATHER, PALO ALTO, CA. FILED 2-2-2010.

Lovebian

THE MARK CONSISTS OF STANDARD CHARACTERS WITHOUT CLAIM TO ANY PARTICULAR FONT, STYLE, SIZE, OR COLOR.

FOR T-SHIRTS (U.S. CLS. 22 AND 39). BERYL GARDNER, EXAMINING ATTORNEY

CLASS 25—(Continued).

SN 77-926,216. CAULTON, ROBERT J., CERES, CA. FILED 2-2-2010.

soulbound

THE MARK CONSISTS OF STANDARD CHARACTERS WITHOUT CLAIM TO ANY PARTICULAR FONT, STYLE, SIZE, OR COLOR.

FOR CLOTHING, NAMELY, SNOW PANTS, SNOW BOOTS, SNOW SUITS, SNOW JACKETS, VESTS, PARKAS, POLO SHIRTS, SHIRTS, T-SHIRTS, JACKETS, COATS, FLEECE PULLOVERS, FLEECE JACKETS, SWEATERS, WIND SHIRTS, PONCHOS, JEANS, PANTS, OVERALLS, SWEAT PANTS, SWEATSHIRTS, TANK TOPS, SHORTS, SWIM SUITS, TRUNKS, BANDANAS, SHOES, SANDALS, FOOTWEAR, FABRIC BELTS, LEATHER BELTS, CAPS, HATS, VISORS, BEANIES, THERMAL UNDERWEAR, SOCKS, BOXER SHORTS, BRIEFS, UNDERWEAR, PAJAMAS (U.S. CLS. 22 AND 39).

FIRST USE 1-0-2007; IN COMMERCE 7-0-2009. REBECCA EISINGER, EXAMINING ATTORNEY

SN 77-926,376. WEST MICHIGAN BLUES SOCIETY, GRAND RAPIDS, MI. FILED 2-2-2010.



NO CLAIM IS MADE TO THE EXCLUSIVE RIGHT TO USE "WEST MICHIGAN", APART FROM THE MARK AS SHOWN.

THE MARK CONSISTS OF A PERSON HOLDING A GUITAR AND THE STYLIZED TEXT "WEST MICHIGAN BLUES SOCIETY".

FOR HATS; SHIRTS; SWEAT SHIRTS (U.S. CLS. 22 AND 39).

FIRST USE 4-1-1991; IN COMMERCE 4-1-1991. REBECCA SMITH, EXAMINING ATTORNEY

CLASS 25—(Continued).

SN 77-926,470. BRAVADO INTERNATIONAL GROUP MERCHANDISING SERVICES, INC., NEW YORK, NY. FILED 2-2-2010.

AS WORN BY

THE MARK CONSISTS OF STANDARD CHARACTERS WITHOUT CLAIM TO ANY PARTICULAR FONT, STYLE, SIZE, OR COLOR.

FOR T-SHIRTS, SHIRTS, SWEATSHIRTS, SWEATPANTS, SHORTS, HATS, CAPS, TIES, SOCKS, JACKETS, TANK TOPS, PANTS, SWEATERS AND VESTS (U.S. CLS. 22 AND 39).

MATTHEW MCDOWELL, EXAMINING ATTORNEY

SN 77-926,587. SAITEX INTERNATIONAL INC., NEW YORK, NY. FILED 2-3-2010.

D9

THE MARK CONSISTS OF STANDARD CHARACTERS WITHOUT CLAIM TO ANY PARTICULAR FONT, STYLE, SIZE, OR COLOR.

FOR CAPS; FOOTWEAR; HATS; JACKETS; JEANS; JOGGING SUITS; PANTS; SHIRTS; T-SHIRTS; TOPS; TROUSERS; UNDERWEAR (U.S. CLS. 22 AND 39).

PATRICIA EVANKO, EXAMINING ATTORNEY

SN 77-926,742. HEFER, MAX, HIALEAH, FL. FILED 2-3-2010.

OWNER OF U.S. REG. NO. 3,485,975.
FOR CLOTHING, NAMELY, SHIRTS, T-SHIRTS, SHORTS, HATS, CAPS, TOPS, PANTS, DRESSES, SKIRTS, SARONGS, SWIMWEAR AND WETSUITS, SUITS, JACKETS, SWEATERS (U.S. CLS. 22 AND 39).

FIRST USE 12-22-1986; IN COMMERCE 12-22-1986.

SIMON TENG, EXAMINING ATTORNEY

CLASS 25—(Continued).

SN 77-926,748. DUNCAN RIDGE FARM LLC, WOODSTOCK, GA. FILED 2-3-2010.

NO CLAIM IS MADE TO THE EXCLUSIVE RIGHT TO USE "PACA" AND "OUTFITTERS", APART FROM THE MARK AS SHOWN.

FOR HATS; SCARVES; SOCKS; SWEATERS; T-SHIRTS; ALL OF WHICH ARE MADE SUBSTANTIALLY OF ALPACA WOOL FIBERS (U.S. CLS. 22 AND 39).

SIMON TENG, EXAMINING ATTORNEY

SN 77-926,757. SPE-WPF INC., CULVER CITY, CA. FILED 2-3-2010.

THE MARK CONSISTS OF STYLIZED EYES CONTAINED IN A BOX OVER THE WORD "LOOT".

FOR SHIRTS, SWEATSHIRTS, SHOES, HATS AND PANTS (U.S. CLS. 22 AND 39).

ERIN FALK, EXAMINING ATTORNEY

SN 77-926,767. SHERWOOD, AARON, SAINT JOHNS, AZ. AND SHERWOOD, TRACY, SAINT JOHNS, AZ. FILED 2-3-2010.

THE MARK CONSISTS OF THE STYLIZED TEXT "CUZ I CAN".

FOR SHIRTS (U.S. CLS. 22 AND 39).

DAVID H. STINE, EXAMINING ATTORNEY

CLASS 25—(Continued).

SN 77-926,768. HATCOUNTRY LLC, MARLBORO, NJ. FILED 2-3-2010.



THE MARK CONSISTS OF A CIRCLE WITH A COWBOY HAT IN THE CENTER AND A BAND AROUND THE CIRCLE. THE TEXT "HATCOUNTRY" IS DISPLAYED TO THE RIGHT OF THE CIRCLE.

FOR BOOTS; HAT BANDS; HATS; JACKETS; MOCCASINS; PANTS; SHIRTS (U.S. CLS. 22 AND 39). FIRST USE 11-1-2003; IN COMMERCE 11-1-2003. DAVID H. STINE, EXAMINING ATTORNEY

SN 77-926,800. LIPTON, FERNANDE, KATONAH, NY. FILED 2-3-2010.



THE MARK CONSISTS OF THE STYLIZED TEXT "FIJIENS". FOR JEANS (U.S. CLS. 22 AND 39). FIRST USE 12-1-2009; IN COMMERCE 12-1-2009. ANDREA SAUNDERS, EXAMINING ATTORNEY

SN 77-926,865. MARTINEZ, LISA, WASHINGTON, DC. FILED 2-3-2010.

EZ DIAPEE

THE MARK CONSISTS OF STANDARD CHARACTERS WITHOUT CLAIM TO ANY PARTICULAR FONT, STYLE, SIZE, OR COLOR. FOR CLOTH DIAPERS (U.S. CLS. 22 AND 39). PATRICIA EVANKO, EXAMINING ATTORNEY

CLASS 25—(Continued).

SN 77-926,921. BBC INTERNATIONAL LLC, BOCA RATON, FL. FILED 2-3-2010.

SWITCHABLES

THE MARK CONSISTS OF STANDARD CHARACTERS WITHOUT CLAIM TO ANY PARTICULAR FONT, STYLE, SIZE, OR COLOR.

FOR FOOTWEAR (U.S. CLS. 22 AND 39). MARIAM MAHMOUDI, EXAMINING ATTORNEY

SN 77-926,957. 32NORTH CORPORATION, BIDDEFORD, ME. FILED 2-3-2010.

STUDED SNOW TIRES FOR YOUR FEET

THE MARK CONSISTS OF STANDARD CHARACTERS WITHOUT CLAIM TO ANY PARTICULAR FONT, STYLE, SIZE, OR COLOR.

FOR DETACHABLE, MOULDED, ANTI-SKID SOLE ATTACHMENTS FOR SHOES, BOOTS AND FOOTWEAR; DETACHABLE, MOULDED, TRACTION ENHANCING SOLE ATTACHMENTS FOR SHOES, BOOTS AND FOOTWEAR; OVERSHOES (U.S. CLS. 22 AND 39). FIRST USE 1-1-1992; IN COMMERCE 12-0-1992. BARNEY CHARLON, EXAMINING ATTORNEY

SN 77-927,189. HAAS, JASON, CITRUS SPRINGS, FL. FILED 2-3-2010.



THE MARK CONSISTS OF A SKULL AND A PAIR OF CROSSED GOLF CLUBS. THE STYLIZED TEXT "CIRCLE 3" APPEARS BELOW. THE NUMBER "3" IS INSIDE A CIRCLE.

FOR GOLF APPAREL, NAMELY, PANTS, SHIRTS, POLO SHIRTS, HATS, HEADWEAR, LONG-SLEEVED SHIRTS, VESTS, HATS, SHOES, JACKETS, SWEAT SHIRTS, T-SHIRTS, SWEATERS, SOCKS, SKIRTS, SHORTS, AND TANK TOPS (U.S. CLS. 22 AND 39). PRISCILLA MILTON, EXAMINING ATTORNEY

CLASS 25—(Continued).

SN 77-927,193. ROSO, KATHERINE, BROKEN ARROW, OK. FILED 2-3-2010.



THE MARK CONSISTS OF THE STYLIZED TEXT "VIE FOR VIE".
FOR CLOTHING, NAMELY, V-NECK STYLE, MENS SIZED T-SHIRTS (U.S. CLS. 22 AND 39).
PRISCILLA MILTON, EXAMINING ATTORNEY

SN 77-927,209. AOK CLOTHING, INC., AZUSA, CA. FILED 2-3-2010.



THE MARK CONSISTS OF A STYLIZED LETTER OF "A" WHICH FORMS THE SHAPE OF A STAR, NEXT TO SMALLER STYLIZED LETTERS "O" AND "K".
FOR CLOTHING, NAMELY, HATS AND T-SHIRTS (U.S. CLS. 22 AND 39).
FIRST USE 11-30-2006; IN COMMERCE 10-28-2009.
CYNTHIA SLOAN, EXAMINING ATTORNEY

SN 77-927,348. IN-CALIFORNIA, INC., CARLSBAD, CA. AND MEYNARD DESIGNS, INC., CARLSBAD, CA. FILED 2-3-2010.



OWNER OF U.S. REG. NOS. 2,811,422, 3,382,663 AND OTHERS.
THE MARK CONSISTS OF THE WORDS "AIR" AND "SPEED" SEPARATED BY A HIGHLY STYLIZED "AS" CONTAINED WITHIN A TILTED RECTANGULAR SHAPE.
FOR SHOES (U.S. CLS. 22 AND 39).
FIRST USE 11-18-2009; IN COMMERCE 11-18-2009.
B. PARADEWELAI, EXAMINING ATTORNEY

CLASS 25—(Continued).

SN 77-927,366. IN-CALIFORNIA, INC., CARLSBAD, CA. AND MEYNARD DESIGNS, INC., CARLSBAD, CA. FILED 2-3-2010.



OWNER OF U.S. REG. NOS. 2,811,422, 3,382,663 AND OTHERS.
NO CLAIM IS MADE TO THE EXCLUSIVE RIGHT TO USE "FOOTWEAR", APART FROM THE MARK AS SHOWN.

THE MARK CONSISTS OF STYLIZED "AS" ABOVE CROSSED SKATEBOARDS WITH A BANNER BELOW DEPICTING THE WORDS "AIRSPEED FOOTWEAR".
FOR SHOES (U.S. CLS. 22 AND 39).
FIRST USE 11-18-2009; IN COMMERCE 11-18-2009.
B. PARADEWELAI, EXAMINING ATTORNEY

SN 77-927,434. KAVE OUTDOOR GEAR, FORT WORTH, TX. FILED 2-3-2010.



NO CLAIM IS MADE TO THE EXCLUSIVE RIGHT TO USE "OUTDOOR GEAR", APART FROM THE MARK AS SHOWN.

THE MARK CONSISTS OF THE WORDS "KAVE OUTDOOR GEAR". THE LETTER "A" IN "KAVE" IS REPLACED BY A TRIANGLE WITH AN INVERTED Y SYMBOL LOCATED IN THE MIDDLE OF THE TRIANGLE. THE TRIANGLE SYMBOLIZES A MOUNTAIN, AND THE INVERTED Y SYMBOLIZES A CAVE IN THE MOUNTAIN.
FOR CAMOUFLAGE JACKETS; CAMOUFLAGE PANTS; CARGO PANTS; DOWN JACKETS; FISHERMEN'S JACKETS; HEAVY JACKETS; HUNTING JACKETS; HUNTING PANTS; JACKET LINERS; JACKETS; MOISTURE-WICKING SPORTS PANTS; OUTER JACKETS; RAINPROOF JACKETS; SHELL JACKETS; SKI JACKETS; SKI PANTS; SNOW PANTS; SNOWBOARD PANTS; WATERPROOF JACKETS AND PANTS; WIND PANTS; WIND RESISTANT JACKETS; WIND-JACKETS (U.S. CLS. 22 AND 39).
LOURDES AYALA, EXAMINING ATTORNEY

CLASS 25—(Continued).

SN 77-927,630. SCHAIRER, SARA J., FORMERLY HOLLY, SARA J., SAN DIEGO, CA. FILED 2-4-2010.

Compassion it.

THE MARK CONSISTS OF STANDARD CHARACTERS WITHOUT CLAIM TO ANY PARTICULAR FONT, STYLE, SIZE, OR COLOR.

FOR T-SHIRTS (U.S. CLS. 22 AND 39).
BRENDAN MCCAULEY, EXAMINING ATTORNEY

SN 77-927,673. E.F.D. DIAMONDS COMPANY LIMITED, RAMAT GAN, ISRAEL, FILED 2-4-2010.

DIAMONDWEAR

THE MARK CONSISTS OF STANDARD CHARACTERS WITHOUT CLAIM TO ANY PARTICULAR FONT, STYLE, SIZE, OR COLOR.

FOR LINGERIE (U.S. CLS. 22 AND 39).
KATINA MISTER, EXAMINING ATTORNEY

SN 77-927,735. TORRES, MICHAEL S, AUSTIN, TX. FILED 2-4-2010.

Integrity

THE MARK CONSISTS OF STANDARD CHARACTERS WITHOUT CLAIM TO ANY PARTICULAR FONT, STYLE, SIZE, OR COLOR.

FOR ATHLETIC APPAREL, NAMELY, SHIRTS, PANTS, JACKETS, FOOTWEAR, HATS AND CAPS, ATHLETIC UNIFORMS; ATHLETIC FOOTWEAR; ATHLETIC SHOES; ATHLETIC UNIFORMS; BASEBALL CAPS AND HATS; BATHING SUITS; BATHING SUITS FOR MEN; BELTS; BELTS FOR CLOTHING; BODY SHIRTS; BOMBER JACKETS; BOTTOMS; BOXER SHORTS; CLOTHING FOR ATHLETIC USE, NAMELY, PADDED ELBOW COMPRESSION SLEEVES BEING PART OF AN ATHLETIC GARMENT; CLOTHING FOR ATHLETIC USE, NAMELY, PADDED PANTS; CLOTHING FOR ATHLETIC USE, NAMELY, PADDED SHIRTS; CLOTHING FOR ATHLETIC USE, NAMELY, PADDED SHORTS; CLOTHING FOR WEAR IN JUDO PRACTICES; CLOTHING, NAMELY, BASE LAYERS; CLOTHING, NAMELY, KHAKIS; DRESS SHIRTS; DRESS SUITS; FLEECE SHORTS; FOOTBALL SHOES; GLOVES AS CLOTHING; GOLF SHORTS; HATS; HEADBANDS FOR CLOTHING; HEAVY JACKETS; HOODED SWEAT SHIRTS; HOODS; JACKETS; JEANS; JERSEYS; KNIT SHIRTS; LEATHER BELTS; LEATHER JACKETS; LEATHER SHOES; LEISURE SHOES; LEISURE SUITS; LONG-SLEEVED SHIRTS; MEN'S AND WOMEN'S JACKETS, COATS, TROUSERS, VESTS; MEN'S DRESS

CLASS 25—(Continued).

SOCKS; MEN'S SOCKS; MEN'S SUITS; MOISTURE-WICKING SPORTS SHIRTS; NIGHT SHIRTS; OPEN-NECKED SHIRTS; OVER SHIRTS; PARTY HATS; PERSPIRATION ABSORBENT UNDERWEAR CLOTHING; POLO SHIRTS; RUGBY SHIRTS; RUGBY SHORTS; RUNNING SHOES; SHIRTS; SHIRTS AND SHORT-SLEEVED SHIRTS; SHIRTS FOR SUITS; SHOES; SHORT SETS; SHORT-SLEEVED OR LONG-SLEEVED T-SHIRTS; SHORT-SLEEVED SHIRTS; SHORTS; SLEEVELESS JERSEYS; SOCKS; SPORT SHIRTS; SPORTS CAPS AND HATS; SPORTS JACKETS; SPORTS JERSEYS; SPORTS JERSEYS AND BREECHES FOR SPORTS; SPORTS SHIRTS; SPORTS SHIRTS WITH SHORT SLEEVES; SUIT COATS; SUITS; SWEAT SHIRTS; SWEAT SUITS; T-SHIRTS; TEE SHIRTS; TIES; TOPS; TRAINING SUITS; TRIATHLON CLOTHING, NAMELY, TRIATHLON TIGHTS, TRIATHLON SHORTS, TRIATHLON SINGLETTS, TRIATHLON SHIRTS, TRIATHLON SUITS; UNDERARM CLOTHING SHIELDS; WEARABLE GARMENTS AND CLOTHING, NAMELY, SHIRTS (U.S. CLS. 22 AND 39).

MARIA-VICTORIA SUAREZ, EXAMINING ATTORNEY

SN 77-927,748. TORRES, MICHAEL S, AUSTIN, TX. FILED 2-4-2010.

Work Out. Hang Out. Go Out.

THE MARK CONSISTS OF STANDARD CHARACTERS WITHOUT CLAIM TO ANY PARTICULAR FONT, STYLE, SIZE, OR COLOR.

FOR APPAREL FOR DANCERS, NAMELY, TEE SHIRTS, SWEATSHIRTS, PANTS, LEGGINGS, SHORTS AND JACKETS; ATHLETIC APPAREL, NAMELY, SHIRTS, PANTS, JACKETS, FOOTWEAR, HATS AND CAPS, ATHLETIC UNIFORMS; ATHLETIC SHOES; BASEBALL CAPS; BASEBALL CAPS AND HATS; BATHING SUITS; BATHING SUITS FOR MEN; BELTS; BELTS FOR CLOTHING; BODY SHIRTS; BODY SUITS; BOMBER JACKETS; BOTTOMS; BOXER SHORTS; CAP VISORS; CLOTHING FOR ATHLETIC USE, NAMELY, PADDED ELBOW COMPRESSION SLEEVES BEING PART OF AN ATHLETIC GARMENT; CLOTHING FOR ATHLETIC USE, NAMELY, PADDED PANTS; CLOTHING FOR ATHLETIC USE, NAMELY, PADDED SHIRTS; CLOTHING FOR ATHLETIC USE, NAMELY, PADDED SHORTS; CLOTHING, NAMELY, BASE LAYERS; CLOTHING, NAMELY, KHAKIS; DRESS SHIRTS; DRESS SUITS; FOOTBALL SHOES; GLOVES AS CLOTHING; GOLF CAPS; GOLF SHIRTS; GOLF SHORTS; GYM SHORTS; HATS; HEADBANDS FOR CLOTHING; HEAVY JACKETS; HOODED SWEAT SHIRTS; HOODS; JACKETS; JEANS; JERSEYS; JOGGING SUITS; KNIT SHIRTS; LEATHER BELTS; LEATHER JACKETS;

CLASS 25—(Continued).

LEATHER SHOES; LEISURE SHOES; LONG JACKETS; LONG SLEEVED VESTS; LONG-SLEEVED SHIRTS; MEN'S AND WOMEN'S JACKETS, COATS, TROUSERS, VESTS; MEN'S DRESS SOCKS; MEN'S SOCKS; MEN'S SUITS; MEN'S SUITS, WOMEN'S SUITS; NIGHT SHIRTS; PARTY HATS; POLO SHIRTS; RUGBY SHIRTS; RUGBY SHORTS; RUNNING SHOES; SHIRTS; SHIRTS AND SHORT-SLEEVED SHIRTS; SHIRTS FOR SUITS; SHOES; SHORT SETS; SHORT-SLEEVED OR LONG-SLEEVED T-SHIRTS; SHORT-SLEEVED SHIRTS; SHORTS; SLACKS; SOCCER SHOES; SOCKS; SPORT SHIRTS; SPORTS CAPS AND HATS; SPORTS JACKETS; SPORTS SHIRTS; SPORTS SHIRTS WITH SHORT SLEEVES; SPORTS VESTS; SUIT COATS; SUITS; SWEAT JACKETS; SWEAT SHIRTS; T-SHIRTS; TEE SHIRTS; TIES; TOPS; TRAINING SUITS; TRIATHLON CLOTHING, NAMELY, TRIATHLON TIGHTS, TRIATHLON SHORTS, TRIATHLON SINGLETS, TRIATHLON SHIRTS, TRIATHLON SUITS; UNDERARM CLOTHING SHIELDS; VESTS; WEARABLE GARMENTS AND CLOTHING, NAMELY, SHIRTS; YOGA SHIRTS (U.S. CLS. 22 AND 39).

MARIA-VICTORIA SUAREZ, EXAMINING ATTORNEY

SN 77-927,784. HANGZHOU JNBY FINERY CO., LTD., HANGZHOU CITY, ZHEJIANG, CHINA, FILED 2-4-2010.

JNBY

THE MARK CONSISTS OF STANDARD CHARACTERS WITHOUT CLAIM TO ANY PARTICULAR FONT, STYLE, SIZE, OR COLOR.

OWNER OF U.S. REG. NO. 2,842,997.

FOR ARTICLES OF CLOTHING, NAMELY, NECK-TIES, HATS, SHOULDER WRAPS, BELTS, GLOVES, HOSIERY, SCARVES, SHOES, T-SHIRTS, TROUSERS, SHIRTS, COATS, JACKETS, SWEATERS, BLOUSES, SKIRTS AND WATERPROOF CLOTHING, NAMELY, WATERPROOF HATS, WATERPROOF SHOULDER WRAPS AND WATERPROOF CLOAKS (U.S. CLS. 22 AND 39).

FIRST USE 9-4-1994; IN COMMERCE 5-23-2009.

WILLIAM P. SHANAHAN, EXAMINING ATTORNEY

CLASS 25—(Continued).

SN 77-927,802. FITZGERALD, CHRISTINE, DBA LOVE-PATSDOTCOM, NORTH SALEM, NY. FILED 2-4-2010.

BODY FORCE

THE MARK CONSISTS OF STANDARD CHARACTERS WITHOUT CLAIM TO ANY PARTICULAR FONT, STYLE, SIZE, OR COLOR.

NO CLAIM IS MADE TO THE EXCLUSIVE RIGHT TO USE "BODY", APART FROM THE MARK AS SHOWN.

FOR APPAREL FOR DANCERS, NAMELY, TEE SHIRTS, SWEATSHIRTS, PANTS, LEGGINGS, SHORTS AND JACKETS; ATHLETIC APPAREL, NAMELY, SHIRTS, PANTS, JACKETS, FOOTWEAR, HATS AND CAPS, ATHLETIC UNIFORMS; BRIEFS; CHILDREN'S AND INFANT'S APPAREL, NAMELY, JUMPERS, OVER-ALL SLEEPWEAR, PAJAMAS, ROMPERS AND ONE-PIECE GARMENTS; DISPOSABLE UNDERWEAR; KNITTED UNDERWEAR; LADIES' UNDERWEAR; LONG UNDERWEAR; MEN'S UNDERWEAR; PERSPIRATION ABSORBENT UNDERWEAR CLOTHING; SCIENTIFIC AND TECHNOLOGICAL APPAREL, NAMELY, SHIRTS, PANTS, JACKETS, FOOTWEAR, HATS AND CAPS, UNIFORMS; THERMAL UNDERWEAR; UNDERWEAR; WOMEN'S UNDERWEAR (U.S. CLS. 22 AND 39).

FIRST USE 1-15-2010; IN COMMERCE 1-15-2010.

ZACHARY BELLO, EXAMINING ATTORNEY

SN 77-927,803. SEXY STARTS AT THE SOLE, INC., PEMBROKE PINES, FL. FILED 2-4-2010.

Sexy Starts at the Sole

THE MARK CONSISTS OF STANDARD CHARACTERS WITHOUT CLAIM TO ANY PARTICULAR FONT, STYLE, SIZE, OR COLOR.

FOR HIGH HEEL SHOES FOR WOMAN (U.S. CLS. 22 AND 39).

ZACHARY BELLO, EXAMINING ATTORNEY

CLASS 25—(Continued).

SN 77-927,823. COVETED, INC., DBA COVETED, CHICAGO, IL. FILED 2-4-2010.



THE MARK CONSISTS OF AN IMAGE OF A PADLOCK CONTAINING THE LETTERS "CV" ABOVE THE LETTERS "TD" IN THE CENTER OF THE PADLOCK WHERE THE OPENING IN THE LETTER "D" IS FORMED BY A KEY-HOLE.

FOR HATS; JACKETS; JEANS; SHOES; T-SHIRTS (U.S. CLS. 22 AND 39).
TINA BROWN, EXAMINING ATTORNEY

CLASS 25—(Continued).

SN 77-928,143. SOFT WEAR INTIMATES, LLC, SAN DIEGO, CA. FILED 2-4-2010.

LURBEL

THE MARK CONSISTS OF STANDARD CHARACTERS WITHOUT CLAIM TO ANY PARTICULAR FONT, STYLE, SIZE, OR COLOR.

THE WORDING "LURBEL" HAS NO MEANING IN A FOREIGN LANGUAGE.

FOR ATHLETIC APPAREL, NAMELY, SHIRTS, PANTS, JACKETS, FOOTWEAR, HATS AND CAPS, ATHLETIC UNIFORMS; BEACHWEAR; BODY SHIRTS; BODY SUITS; BRIEFS; FOOTWEAR; LADIES' UNDERWEAR; LINGERIE; MEN'S UNDERWEAR; NIGHTWEAR; PANTS; SHIRTS; SHORTS; SOCKS; UNDERGARMENTS (U.S. CLS. 22 AND 39).

JAMES LOVELACE, EXAMINING ATTORNEY

SN 77-928,163. CHEUNG, JULIA, TEMPLE, TX. FILED 2-4-2010.

SN 77-927,953. D4, CHARLOTTE, NC. FILED 2-4-2010.



Citizen Doll

THE MARK CONSISTS OF AN ABSTRACT FISH WITH THE STYLIZED TEXT "DIRTYFIN".

FOR BOARD SHORTS; BOOTS; HATS; JACKETS; PANTS; SHIRTS; SHOES (U.S. CLS. 22 AND 39).
HOWARD SMIGA, EXAMINING ATTORNEY

THE MARK CONSISTS OF STANDARD CHARACTERS WITHOUT CLAIM TO ANY PARTICULAR FONT, STYLE, SIZE, OR COLOR.

FOR BLOUSES; DRESS SHIRTS; JACKETS; LEGGINGS; SHIRTS; SHORTS; SKIRTS AND DRESSES; SWEATERS; T-SHIRTS; TOP COATS; TOPS; TROUSERS; WEARABLE GARMENTS AND CLOTHING, NAMELY, SHIRTS (U.S. CLS. 22 AND 39).

JORDAN BAKER, EXAMINING ATTORNEY

CLASS 25—(Continued).

SN 77-928,215. VERONICA CHONG, LLC, DBA LEGACY DESIGN GROUP, FRISCO, TX. FILED 2-4-2010.



THE MARK CONSISTS OF THE WORDS "SWEET FORTUNE" DIRECTLY ABOVE AND DIRECTLY BELOW ARTISTIC DESIGNS.

FOR BELTS; BLOUSES; BOTTOMS; CAPS; DRESSES; JACKETS; JEANS; NECKWEAR; PANTS; SCARVES; SHAWLS; SHIRTS; SHOULDER WRAPS; SLACKS; SUITS; SWEAT SHIRTS; SWEATERS; T-SHIRTS; TROUSERS (U.S. CLS. 22 AND 39).

BRENDAN MCCAULEY, EXAMINING ATTORNEY

SN 77-928,468. SANTERSERO, JEFFREY, NORTH TONAWANDA, NY. FILED 2-4-2010.



THE MARK CONSISTS OF A DISC SHAPE WITH GUITAR HEADS LOCATED IN CENTER OF IMAGE, SURROUNDED BY AN ORB SHAPED OBJECT, WITH REFLECTION ASPECTS. THE STYLIZED WORDING "ONE ROCK NATION" APPEARS TO THE RIGHT OF THE DESIGN ELEMENT.

FOR SHORT-SLEEVED OR LONG-SLEEVED T-SHIRTS (U.S. CLS. 22 AND 39).

ELI HELLMAN, EXAMINING ATTORNEY

SN 77-928,501. HOOZIE, LLC, SIMPSONVILLE, SC. FILED 2-4-2010.

HOOZIE

THE MARK CONSISTS OF STANDARD CHARACTERS WITHOUT CLAIM TO ANY PARTICULAR FONT, STYLE, SIZE, OR COLOR.

FOR SWEAT SHIRTS; JACKETS; PULLOVERS; ALL OF THE FOREGOING INCORPORATING HOLDERS FOR BEVERAGE CONTAINERS (U.S. CLS. 22 AND 39).

KELLY TRUSILO, EXAMINING ATTORNEY

CLASS 25—(Continued).

SN 77-928,550. YU JIANG NING, STOCKTON, CA. FILED 2-4-2010.

KMJ

THE MARK CONSISTS OF STANDARD CHARACTERS WITHOUT CLAIM TO ANY PARTICULAR FONT, STYLE, SIZE, OR COLOR.

FOR HATS; JEANS; OVER SHIRTS; POLO SHIRTS; SHIRTS; SOCKS; SPORT SHIRTS; T-SHIRTS; UNDERWEAR (U.S. CLS. 22 AND 39).

WILLIAM P. SHANAHAN, EXAMINING ATTORNEY

SN 77-928,551. LIEBZEIT, BRIAN C, LAS VEGAS, NV. FILED 2-4-2010.

Claymaker

THE MARK CONSISTS OF STANDARD CHARACTERS WITHOUT CLAIM TO ANY PARTICULAR FONT, STYLE, SIZE, OR COLOR.

FOR ATHLETIC APPAREL, NAMELY, SHIRTS, PANTS, JACKETS, FOOTWEAR, HATS AND CAPS, ATHLETIC UNIFORMS (U.S. CLS. 22 AND 39).

DOUGLAS LEE, EXAMINING ATTORNEY

SN 77-928,568. DUNBAR, ARLO, COUNCIL BLUFFS, IA. FILED 2-4-2010.

Black Bowl of Doom

THE MARK CONSISTS OF STANDARD CHARACTERS WITHOUT CLAIM TO ANY PARTICULAR FONT, STYLE, SIZE, OR COLOR.

FOR BASEBALL CAPS; SWEAT SHIRTS; T-SHIRTS (U.S. CLS. 22 AND 39).

WILLIAM P. SHANAHAN, EXAMINING ATTORNEY

CLASS 25—(Continued).

SN 77-928,569. CROSSAN, MATHEW, SAN DIEGO, CA.
FILED 2-4-2010.

FAVORITE PASTIME

THE MARK CONSISTS OF STANDARD CHARACTERS
WITHOUT CLAIM TO ANY PARTICULAR FONT, STYLE,
SIZE, OR COLOR.

FOR BEANIES; GLOVES; HATS; JACKETS; PANTS;
SCARVES; SHIRTS; SHOES; SOCKS; SWEAT SHIRTS;
UNDERWEAR (U.S. CLS. 22 AND 39).

JIM RINGLE, EXAMINING ATTORNEY

SN 77-928,574. JUST PEACHY LLC, ORO VALLEY, AZ.
FILED 2-4-2010.

Come 'N Get It

THE MARK CONSISTS OF STANDARD CHARACTERS
WITHOUT CLAIM TO ANY PARTICULAR FONT, STYLE,
SIZE, OR COLOR.

FOR APRONS; CAPS; CHEF'S HATS; SWEAT SHIRTS;
SWIM WEAR; SWIMWEAR; T-SHIRTS; UNDERGAR-
MENTS (U.S. CLS. 22 AND 39).

KIMBERLY FRYE, EXAMINING ATTORNEY

SN 77-928,620. FOSHAN CITY NANHAI JINHEMING IN-
VESTMENT CO., LTD., FOSHAN, GUANGDONG, CHI-
NA, FILED 2-4-2010.



THE MARK CONSISTS OF THE STYLIZED ALPHABET
"X" AND DEVICES RESEMBLING 2 INCOMPLETE "X"S AT
THE BACK.

FOR BATHING TRUNKS; BRACES; FOOTBALL
SHOES; FOOTWEAR; GLOVES AS CLOTHING; HATS;
HOSIERY; LAYETTES; NECKTIES; SHIRTS (U.S. CLS. 22
AND 39).

TINA L. SNAPP, EXAMINING ATTORNEY

CLASS 25—(Continued).

SN 77-928,694. COWGIRL TUFF CO., LITCHFIELD, MN.
FILED 2-5-2010.

DON'T FENCE ME IN

THE MARK CONSISTS OF STANDARD CHARACTERS
WITHOUT CLAIM TO ANY PARTICULAR FONT, STYLE,
SIZE, OR COLOR.

FOR JEANS (U.S. CLS. 22 AND 39).

FIRST USE 1-20-2009; IN COMMERCE 1-20-2009.
COLLEEN DOMBROW, EXAMINING ATTORNEY

SN 77-928,940. SEQUEL LLC, LOS ANGELES, CA. FILED 2-5-
2010.

ROARK

THE MARK CONSISTS OF STANDARD CHARACTERS
WITHOUT CLAIM TO ANY PARTICULAR FONT, STYLE,
SIZE, OR COLOR.

THE NAME "ROARK" DOES NOT IDENTIFY A LIVING
INDIVIDUAL.

FOR HATS; JACKETS; PANTS; SHORTS; SWEAT
SHIRTS; SWIM TRUNKS; T-SHIRTS (U.S. CLS. 22 AND
39).

JAMES MACFARLANE, EXAMINING ATTORNEY

SN 77-928,963. FLOATIMINI, INC., DBA FLOATIMINI, INC.,
EDGEWATER, NJ. FILED 2-5-2010.

FLOATIMINI

THE MARK CONSISTS OF STANDARD CHARACTERS
WITHOUT CLAIM TO ANY PARTICULAR FONT, STYLE,
SIZE, OR COLOR.

FOR SWIMWEAR (U.S. CLS. 22 AND 39).

FIRST USE 8-3-2008; IN COMMERCE 8-3-2008.

DAVID H. STINE, EXAMINING ATTORNEY

CLASS 25—(Continued).

SN 77-928,984. PAULO, GINA, SOQUEL, CA. FILED 2-5-2010.

**Kiss My Cowhide, Sexy,
Rugged and Real**

THE MARK CONSISTS OF STANDARD CHARACTERS WITHOUT CLAIM TO ANY PARTICULAR FONT, STYLE, SIZE, OR COLOR.

FOR CLOTHING CONSISTING IN WHOLE OR IN PART OF LEATHER, NAMELY, JEANS, HATS, SHIRTS, AND JEAN JACKETS (U.S. CLS. 22 AND 39).
REBECCA SMITH, EXAMINING ATTORNEY

SN 77-929,086. PAUL BARCLAY, NEW CARLISLE, OH.
FILED 2-5-2010.

**The Finest sheepskin boots
on planet Earth...Baa None!**

THE MARK CONSISTS OF STANDARD CHARACTERS WITHOUT CLAIM TO ANY PARTICULAR FONT, STYLE, SIZE, OR COLOR.

NO CLAIM IS MADE TO THE EXCLUSIVE RIGHT TO USE "FINEST SHEEPSKIN BOOTS ON PLANET EARTH", APART FROM THE MARK AS SHOWN.

FOR CLOTHING, NAMELY, SHEEPSKIN BOOTS (U.S. CLS. 22 AND 39).

FIRST USE 2-1-2010; IN COMMERCE 2-1-2010.
SARA THOMAS, EXAMINING ATTORNEY

SN 77-929,094. HOTSEXYFIT, NEW YORK, NY. FILED 2-5-2010.

How Does My Butt Look?

THE MARK CONSISTS OF STANDARD CHARACTERS WITHOUT CLAIM TO ANY PARTICULAR FONT, STYLE, SIZE, OR COLOR.

FOR JEANS (U.S. CLS. 22 AND 39).

JUSTINE D. PARKER, EXAMINING ATTORNEY

CLASS 25—(Continued).SN 77-929,098. SYRACUSE UNIVERSITY, SYRACUSE, NY.
FILED 2-5-2010.**OTTO'S ARMY**

THE MARK CONSISTS OF STANDARD CHARACTERS WITHOUT CLAIM TO ANY PARTICULAR FONT, STYLE, SIZE, OR COLOR.

FOR SHIRTS (U.S. CLS. 22 AND 39).

FIRST USE 1-31-2008; IN COMMERCE 1-31-2008.

ERNEST SHOSHO, EXAMINING ATTORNEY

SN 77-929,119. AARON BYERS AND BRANDON PRICE,
DBA CP CORPORATEPUNKCLOTHING, ROCK ISLAND,
IL. FILED 2-5-2010.



THE MARK CONSISTS OF THE ACRONYM "CP" WITH THE LETTER "C" FLOWING INTO THE LETTER "P" WITH A DOWNWARD ARROW AT THE BOTTOM OF THE "P" ON A CIRCULAR BACKGROUND CARRIER.

FOR ATHLETIC APPAREL, NAMELY, SHIRTS, PANTS, JACKETS, FOOTWEAR, HATS AND CAPS, ATHLETIC UNIFORMS; HATS; SHORT-SLEEVED OR LONG-SLEEVED T-SHIRTS (U.S. CLS. 22 AND 39).

FIRST USE 12-14-2005; IN COMMERCE 12-14-2005.

INGRID C. EULIN, EXAMINING ATTORNEY

SN 77-929,124. BAAAB SPORTSWEAR, SAN JOSE, CA.
FILED 2-5-2010.

**Building An Absolute
Awesome Body**

THE MARK CONSISTS OF STANDARD CHARACTERS WITHOUT CLAIM TO ANY PARTICULAR FONT, STYLE, SIZE, OR COLOR.

FOR ATHLETIC APPAREL, NAMELY, SHIRTS, PANTS, JACKETS, FOOTWEAR, HATS AND CAPS, ATHLETIC UNIFORMS (U.S. CLS. 22 AND 39).

KELLEY WELLS, EXAMINING ATTORNEY

CLASS 25—(Continued).

SN 77-929,179. YU JIANG NING, STOCKTON, CA. FILED 2-5-2010.

MISS LATINA

THE MARK CONSISTS OF STANDARD CHARACTERS WITHOUT CLAIM TO ANY PARTICULAR FONT, STYLE, SIZE, OR COLOR.

THE ENGLISH TRANSLATION OF "LATINA" IN THE MARK IS "LATIN WOMAN".

FOR HATS; JEANS; PANTS; SHIRTS; SKIRTS; SOCKS; SWEAT SHIRTS; TEE SHIRTS; UNDERWEAR (U.S. CLS. 22 AND 39).

WILLIAM P. SHANAHAN, EXAMINING ATTORNEY

CLASS 25—(Continued).

SN 77-929,405. RIVERS, MARIE, CHISAGO CITY, MN. FILED 2-5-2010.

SANGRENS

THE MARK CONSISTS OF STANDARD CHARACTERS WITHOUT CLAIM TO ANY PARTICULAR FONT, STYLE, SIZE, OR COLOR.

FOR CLOGS (U.S. CLS. 22 AND 39).
ANDREA BUTLER, EXAMINING ATTORNEY

SN 77-929,432. MUNDY, JILL, IPSWICH, MA. FILED 2-5-2010.

HIPPOCRATES' CHILDREN

THE MARK CONSISTS OF STANDARD CHARACTERS WITHOUT CLAIM TO ANY PARTICULAR FONT, STYLE, SIZE, OR COLOR.

OWNER OF U.S. REG. NO. 3,650,925.

NO CLAIM IS MADE TO THE EXCLUSIVE RIGHT TO USE CHILDREN, APART FROM THE MARK AS SHOWN.

FOR CLOTHING, NAMELY, SHIRTS AND HATS (U.S. CLS. 22 AND 39).

FIRST USE 12-31-2009; IN COMMERCE 12-31-2009.
CYNTHIA SLOAN, EXAMINING ATTORNEY

SN 77-929,229. MUNDY, JILL, IPSWICH, MA. FILED 2-5-2010.

LIVE WITH HOPE

THE MARK CONSISTS OF STANDARD CHARACTERS WITHOUT CLAIM TO ANY PARTICULAR FONT, STYLE, SIZE, OR COLOR.

FOR CLOTHING, NAMELY, SHIRTS AND HATS (U.S. CLS. 22 AND 39).

FIRST USE 12-31-2009; IN COMMERCE 12-31-2009.
CYNTHIA SLOAN, EXAMINING ATTORNEY

SN 77-929,452. DANGHEIRESS, LLC, CHICAGO, IL. FILED 2-5-2010.

DANGHEIRESS

THE MARK CONSISTS OF STANDARD CHARACTERS WITHOUT CLAIM TO ANY PARTICULAR FONT, STYLE, SIZE, OR COLOR.

FOR A-SHIRTS; ADULT NOVELTY GAG CLOTHING ITEM, NAMELY, SOCKS; ANKLE SOCKS; ANKLETS; APPAREL FOR DANCERS, NAMELY, TEE SHIRTS, SWEATSHIRTS, PANTS, LEGGINGS, SHORTS AND JACKETS; ATHLETIC APPAREL, NAMELY, SHIRTS, PANTS, JACKETS, FOOTWEAR, HATS AND CAPS, ATHLETIC UNIFORMS; ATHLETIC FOOTWEAR; BANDANAS; BASEBALL CAPS AND HATS; BATHING SUITS; BATHROBES; BEACH COVERUPS; BEACH SHOES; BEACHWEAR; BEANIES; BELTS; BELTS MADE OUT OF CLOTH; BIKINIS; BOARD SHORTS; BODY SHIRTS; BOMBER JACKETS; BOOTS; BOOTS FOR MOTORCYCLING; BOTTOMS; BOXER SHORTS; BOXING SHORTS; BRAS; CAMOUFLAGE JACKETS; CAMOUFLAGE SHIRTS; CAPRI PANTS; CAPS; CAPS WITH VISORS; CARDIGANS; CARGO PANTS; CHAPS; CHEMISES; CHEMISETTES; CLOTHING FOR ATHLETIC USE, NAMELY, PADDED ELBOW COMPRESSION SLEEVES BEING PART OF AN ATHLETIC GARMENT; CLOTHING FOR ATHLETIC USE, NAMELY, PADDED PANTS; CLOTHING FOR ATH-

SN 77-929,381. ENRIQUE MARRERO, NORTH BERGEN, NJ. FILED 2-5-2010.

**Truly Unique Fighting
Freaks**

THE MARK CONSISTS OF STANDARD CHARACTERS WITHOUT CLAIM TO ANY PARTICULAR FONT, STYLE, SIZE, OR COLOR.

FOR ATHLETIC APPAREL, NAMELY, SHIRTS, PANTS, JACKETS, FOOTWEAR, HATS AND CAPS, ATHLETIC UNIFORMS (U.S. CLS. 22 AND 39).

CARRIE GENOVESE, EXAMINING ATTORNEY

CLASS 25—(Continued).

LETIC USE, NAMELY, PADDED SHIRTS; CLOTHING FOR ATHLETIC USE, NAMELY, PADDED SHORTS; CLOTHING ITEMS, NAMELY, ADHESIVE POCKETS THAT MAY BE AFFIXED DIRECTLY TO THE BODY AS A DECORATIVE PIECE OF CLOTHING WITH UTILITY; CLOTHING ITEMS, NAMELY, ADHESIVE POCKETS THAT MAY BE AFFIXED DIRECTLY TO THE INSIDE OF CLOTHING FOR STORAGE AND SAFEKEEPING OF PERSONAL ITEMS; CLOTHING, NAMELY, ARM WARMERS; CLOTHING, NAMELY, HAND-WARMERS; COATS; COMBINATIONS; CORSETS; COVERUPS; CREW NECKS; CROSS-COUNTRY GLOVES; CROSS-COUNTRY MITTENS; DRESSES; DRESSES THAT MAY ALSO BE USED AS TOWELS; DRESSING GOWNS; DRY SUITS; EAR BANDS; EAR MUFFS; EAR WARMERS; EYESHADES; FLIP FLOPS; FOOTIES; FOOTWEAR; FOOTWEAR, NAMELY, RUBBERS; FOOTWEAR, NAMELY, WORK BOOTS; FUR COATS; FUR HATS; FUR JACKETS; FUR MUFFS; FUR STOLE; G-STRINGS; GARTER BELTS; GARTERS; GLOVES; GLOVES FOR PERSONAL HAND CONDITIONING USE; GYM PANTS; GYM SHORTS; GYM SUITS; HALTER TOPS; HATS; HEAD SCARVES; HEAD WEAR; HEADBANDS; HEELS; HOODED PULLOVERS; HOODED SWEAT SHIRTS; HOODS; JACKET LINERS; JACKETS; JEANS; JERSEYS; JOGGING OUTFITS; JOGGING PANTS; JOGGING SUITS; JUMPERS; JUMPSUITS; KNEE HIGHS; LEG SHAPERS; LEG SHIELDING DEVICE, ATTACHABLE TO AND DETACHABLE FROM A PERSON'S PANTS, COMPRISED OF PADDING TO SHIELD THE LEGS FROM FLYING DEBRIS WHEN MOWING WITH A STRING TRIMMER; LEG WARMERS; LEGGINGS; LIGHT-REFLECTING COATS; LIGHT-REFLECTING JACKETS; LINGERIE; LONG JOHNS; LOUNGE PANTS; LOUNGEWEAR; MINISKIRTS; MITTENS; MOTORCYCLE GLOVES; MOTORCYCLE JACKETS; MOTORCYCLE RAIN SUITS; NECKWEAR; NIGHT SHIRTS; NIGHTDRESSES; NIGHTIES; OVERSHOES; PAJAMAS; PANTS; PARTY HATS; PEDAL PUSHERS; PULLOVERS; RAINWEAR; RIDING BOOTS; RIDING GLOVES; SANDAL-CLOGS; SCARFS; SCRUBS NOT FOR MEDICAL PURPOSES; SHIRTS; SHOES; SHORTS; SKI AND SNOWBOARD SHOES AND PARTS THEREOF; SKI BIBS; SKI BOOT BAGS; SKI BOOTS; SKI GLOVES; SKI JACKETS; SKI MASKS; SKI PANTS; SKI SUITS; SKI TROUSERS; SKI WEAR; SKIING SHOES; SKIRTS; SLEEPWEAR; SLIPPERS; SLIPPER SOCKS; SLIPPERS; SNEAKERS; SNOWBOARDING SUITS; SNOW PANTS; SNOW SUITS; SNOWBOARD BOOTS; SNOWBOARD GLOVES; SNOWBOARD MITTENS; SNOWBOARD PANTS; SOCKS; SPORTS BRAS; SPORTS PANTS; STOCKINGS; SUITS; SUSPENDER BELTS; SWEAT BANDS; SWEAT JACKETS; SWEAT PANTS; SWEAT SHIRTS; SWEAT SHORTS; SWEAT SUITS; SWEATERS; SWEATSOCKS; SWIMWEAR; TANK TOPS; TANKINIS; TEDDIES; TEE SHIRTS; THERMAL SOCKS; THERMAL UNDERWEAR; THONGS; THONGS; TIGHTS; TIPS FOR FOOTWEAR; TOPS; UNDERWEAR; VESTS; WAIST BANDS; WAIST BELTS; WAISTCOATS; WIND PANTS; WIND RESISTANT JACKETS; WIND SHIRTS; WIND VESTS; WRAPS; WRISTBANDS; YOGA PANTS; YOGA SHIRTS (U.S. CLS. 22 AND 39).

SANI KHOURI, EXAMINING ATTORNEY

CLASS 25—(Continued).

SN 77-929,468. KERCHER, JUSTIN A., SEATTLE, WA. FILED 2-5-2010.

DO THE EXTRAORDINARY

THE MARK CONSISTS OF STANDARD CHARACTERS WITHOUT CLAIM TO ANY PARTICULAR FONT, STYLE, SIZE, OR COLOR.

FOR CLOTHING, NAMELY, LONG-SLEEVE T-SHIRTS AND SHORT-SLEEVE T-SHIRTS FOR MEN AND WOMEN (U.S. CLS. 22 AND 39).

FIRST USE 3-0-2008; IN COMMERCE 3-0-2008.
RAUL CORDOVA, EXAMINING ATTORNEY

SN 77-929,650. GOLDEN RULE LA APPAREL INC., LOS ANGELES, CA. FILED 2-5-2010.

Golden Rule LA

THE MARK CONSISTS OF STANDARD CHARACTERS WITHOUT CLAIM TO ANY PARTICULAR FONT, STYLE, SIZE, OR COLOR.

NO CLAIM IS MADE TO THE EXCLUSIVE RIGHT TO USE "LA", APART FROM THE MARK AS SHOWN.

FOR CLOTHING, NAMELY, T-SHIRTS, SWEAT PANTS, SHORTS, SWEAT SHIRTS, LEGGINGS, BRAS, UNDERWEAR, SWIMWEAR, SCARVES, SHAPE WEAR, LINGERIE, AND HOSIERY (U.S. CLS. 22 AND 39).

EDWARD FENNESSY, EXAMINING ATTORNEY

SN 77-929,656. VANDY, KHIET, KENT, WA. FILED 2-5-2010.

must B nice 2B

THE MARK CONSISTS OF STANDARD CHARACTERS WITHOUT CLAIM TO ANY PARTICULAR FONT, STYLE, SIZE, OR COLOR.

FOR T-SHIRTS (U.S. CLS. 22 AND 39).
SALLY SHIH, EXAMINING ATTORNEY

CLASS 25—(Continued).

SN 77-929,786. EBEJER, CHRIS, LONG MELFORD, SUD-BURY, UNITED KINGDOM, FILED 2-6-2010.

Babyglow

THE MARK CONSISTS OF STANDARD CHARACTERS WITHOUT CLAIM TO ANY PARTICULAR FONT, STYLE, SIZE, OR COLOR.
FOR DRESSES; GLOVES; HATS; PAJAMAS; ROM-PERS; SOCKS; T-SHIRTS (U.S. CLS. 22 AND 39).
SANJEEV VOHRA, EXAMINING ATTORNEY

CLASS 25—(Continued).

SN 77-930,027. LINDLEY, SUZANNE M., HUNTINGTON BEACH, CA. FILED 2-7-2010.

LESTERBURGER

THE MARK CONSISTS OF STANDARD CHARACTERS WITHOUT CLAIM TO ANY PARTICULAR FONT, STYLE, SIZE, OR COLOR.
FOR WEARABLE GARMENTS AND CLOTHING, NAMELY, SHIRTS (U.S. CLS. 22 AND 39).
PRISCILLA MILTON, EXAMINING ATTORNEY

SN 77-929,955. JOSEPH STARK, OXNARD, CA. FILED 2-7-2010.

split kook.

THE MARK CONSISTS OF STANDARD CHARACTERS WITHOUT CLAIM TO ANY PARTICULAR FONT, STYLE, SIZE, OR COLOR.
FOR ATHLETIC APPAREL, NAMELY, SHIRTS, PANTS, JACKETS, FOOTWEAR, HATS AND CAPS, ATHLETIC UNIFORMS; HOODED SWEAT SHIRTS (U.S. CLS. 22 AND 39).
PRISCILLA MILTON, EXAMINING ATTORNEY

SN 77-930,128. HANSON, MICHAEL, VIRGINIA BEACH, VA. FILED 2-8-2010.

DUDE and DUETTE
sportswear co.

SN 77-929,988. BICIDICHI, LLC, FRISCO, TX. FILED 2-7-2010.

Power. Freedom. Legs.



THE MARK CONSISTS OF STANDARD CHARACTERS WITHOUT CLAIM TO ANY PARTICULAR FONT, STYLE, SIZE, OR COLOR.
FOR ATHLETIC APPAREL, NAMELY, SHIRTS, PANTS, JACKETS, FOOTWEAR, HATS AND CAPS, ATHLETIC UNIFORMS; CYCLISTS' JERSEYS; JERSEYS; SLEEVELESS JERSEYS; TRIATHLON CLOTHING, NAMELY, TRIATHLON TIGHTS, TRIATHLON SHORTS, TRIATHLON SINGLETTS, TRIATHLON SHIRTS, TRIATHLON SUITS (U.S. CLS. 22 AND 39).
FIRST USE 1-4-2010; IN COMMERCE 1-4-2010.
ROBERT C. CLARK JR., EXAMINING ATTORNEY

NO CLAIM IS MADE TO THE EXCLUSIVE RIGHT TO USE "SPORTSWEAR CO.", APART FROM THE MARK AS SHOWN.
THE MARK CONSISTS OF THE STYLIZED WORDS " DUDE AND DUETTE SPORTSWEAR CO." WITH A FIGURE OF A PERSON BELOW.
FOR HATS; RASH GUARDS; SURF WEAR; T-SHIRTS (U.S. CLS. 22 AND 39).
RONALD MCMORROW, EXAMINING ATTORNEY

CLASS 25—(Continued).

SN 77-930,139. APPEL, ROBERT, RANCHO MIRAGE, CA. FILED 2-8-2010.

LITTLE MISS PRESIDENT

THE MARK CONSISTS OF STANDARD CHARACTERS WITHOUT CLAIM TO ANY PARTICULAR FONT, STYLE, SIZE, OR COLOR.

FOR BABY BIBS NOT OF PAPER; BABY BODYSUITS; BABY BOTTOMS; BABY BUNTING; BABY LAYETTES FOR CLOTHING; BABY TOPS; BIBS NOT OF CLOTH OR PAPER; BONNETS; BOOTIES; CHILDREN'S AND INFANT'S APPAREL, NAMELY, JUMPERS, OVERALL SLEEPWEAR, PAJAMAS, ROMPERS AND ONE-PIECE GARMENTS; CHILDREN'S AND INFANTS' CLOTH BIBS; CHILDREN'S CLOTH EATING BIBS; CHILDREN'S HEADWEAR; CLOTH DIAPERS; HATS FOR INFANTS, BABIES, TODDLERS AND CHILDREN; INFANT AND TODDLER ONE PIECE CLOTHING; INFANT CLOTH DIAPERS; INFANT DIAPER COVERS; INFANT SLEEPERS; INFANT WEAR; INFANTS' SHOES AND BOOTS; INFANTS' TROUSERS; INFANTWEAR (U.S. CLS. 22 AND 39).

GIANCARLO CASTRO, EXAMINING ATTORNEY

SN 77-930,192. VICTORY MEDIA, INC., CORAOPOLIS, PA. FILED 2-8-2010.

Military Spouse Official Gear

THE MARK CONSISTS OF STANDARD CHARACTERS WITHOUT CLAIM TO ANY PARTICULAR FONT, STYLE, SIZE, OR COLOR.

OWNER OF U.S. REG. NOS. 3,292,407, 3,451,571 AND 3,600,570.

NO CLAIM IS MADE TO THE EXCLUSIVE RIGHT TO USE "OFFICIAL GEAR", APART FROM THE MARK AS SHOWN.

FOR CLOTHING, NAMELY, T-SHIRTS, POLO SHIRTS, JACKETS, CAPS, SLEEPWEAR, SWEAT SHIRTS, SWEATPANTS, BANDANAS, TURTLE NECK SHIRTS, VESTS, UNDERGARMENTS, SHORTS AND TANK TOPS (U.S. CLS. 22 AND 39).

FIRST USE 1-6-2010; IN COMMERCE 1-6-2010.

GIANCARLO CASTRO, EXAMINING ATTORNEY

CLASS 25—(Continued).

SN 77-930,329. IMASOGIE, ERIC, HOUSTON, TX. AND NZEOCHA, NWAMAKA, HOUSTON, TX. FILED 2-8-2010.

HUWTHG

THE MARK CONSISTS OF STANDARD CHARACTERS WITHOUT CLAIM TO ANY PARTICULAR FONT, STYLE, SIZE, OR COLOR.

FOR SHORT-SLEEVED OR LONG-SLEEVED SHIRTS (U.S. CLS. 22 AND 39).

H. M. FISHER, EXAMINING ATTORNEY

SN 77-930,341. ORTIZ, ROY, LUBBOCK, TX. FILED 2-8-2010.

Elevated state of mind

THE MARK CONSISTS OF STANDARD CHARACTERS WITHOUT CLAIM TO ANY PARTICULAR FONT, STYLE, SIZE, OR COLOR.

FOR HATS; SHIRTS; SWEATERS (U.S. CLS. 22 AND 39).

BARBARA GAYNOR, EXAMINING ATTORNEY

SN 77-930,421. DEVILMAN LLC, FAIRFIELD, CT. FILED 2-8-2010.



THE MARK CONSISTS OF FIGURE RESEMBLING A DEVIL OR DEMON, HOLDING A PITCHFORK IN ONE HAND AND POINTING WITH ITS OTHER HAND.

FOR CLOTHING, NAMELY, T-SHIRTS AND HATS (U.S. CLS. 22 AND 39).

GEORGE LORENZO, EXAMINING ATTORNEY

CLASS 25—(Continued).

SN 77-930,451. WORLD WRESTLING ENTERTAINMENT, INC., STAMFORD, CT. FILED 2-8-2010.



THE MARK CONSISTS OF TWO STACKED "W" LETTERS WITH A STAR UNDERNEATH SITTING ON TOP OF THE LETTERS "NXT" APPEARING VERTICALLY.

FOR CLOTHING, NAMELY, TOPS, JACKETS, BOTTOMS, UNDERWEAR, PAJAMAS; FOOTWEAR, NAMELY, SHOES, SNEAKERS, SLIPPERS; HEADWEAR, NAMELY, HATS (U.S. CLS. 22 AND 39).

JOHN HWANG, EXAMINING ATTORNEY

SN 77-930,460. VICTORY MEDIA, INC., CORAOPOLIS, PA. FILED 2-8-2010.



NO CLAIM IS MADE TO THE EXCLUSIVE RIGHT TO USE "OFFICIAL GEAR", APART FROM THE MARK AS SHOWN.

THE COLOR(S) PINK, LAVENDER AND PURPLE IS/ARE CLAIMED AS A FEATURE OF THE MARK.

THE MARK CONSISTS OF A HEART COMPRISED OF THE COLORS PINK, LAVENDER AND PURPLE IN A CAMOUFLAGE PATTERN. BELOW THE HEART ARE THE WORDS "MILITARY SPOUSE OFFICIAL GEAR" WITH THE TERMS "MILITARY" AND "OFFICIAL GEAR" IN PURPLE AND THE TERM "SPOUSE" IN PINK.

FOR CLOTHING, NAMELY, T-SHIRTS, POLO SHIRTS, JACKETS, CAPS, SLEEPWEAR, SWEAT SHIRTS, SWEAT PANTS, BANDANAS, TURTLENECK SHIRTS, VESTS, UNDERGARMENTS, SHORTS AND TANK TOPS (U.S. CLS. 22 AND 39).

FIRST USE 1-6-2010; IN COMMERCE 1-6-2010.
GIANCARLO CASTRO, EXAMINING ATTORNEY

CLASS 25—(Continued).

SN 77-930,636. BRITTON, SAMUEL P, NEWPORT BEACH, CA. FILED 2-8-2010.

MEDIUM COOL

THE MARK CONSISTS OF STANDARD CHARACTERS WITHOUT CLAIM TO ANY PARTICULAR FONT, STYLE, SIZE, OR COLOR.

FOR APPAREL FOR DANCERS, NAMELY, TEE SHIRTS, SWEATSHIRTS, PANTS, LEGGINGS, SHORTS AND JACKETS; ATHLETIC APPAREL, NAMELY, SHIRTS, PANTS, JACKETS, FOOTWEAR, HATS AND CAPS, ATHLETIC UNIFORMS; BASEBALL CAPS AND HATS; BELTS FOR CLOTHING; BOOTS; BOOTS FOR MOTORCYCLING; BOOTS FOR SPORT; BOTTOMS; CAPS WITH VISORS; CARGO PANTS; CLOTHING, NAMELY, KHAKIS; COATS; DENIM JACKETS; DENIMS; FOOTWEAR; GLOVES; GLOVES AS CLOTHING; GOLF PANTS, SHIRTS AND SKIRTS; GOLF SHIRTS; GYM PANTS; HATS; HOODED SWEAT SHIRTS; HOODS; JACKETS; JACKETS AND SOCKS; JEANS; JOGGING PANTS; KNIT SHIRTS; LEATHER JACKETS; LONG-SLEEVED SHIRTS; LOUNGE PANTS; MEN'S AND WOMEN'S JACKETS, COATS, TROUSERS, VESTS; MOTORCYCLE GLOVES; MOTORCYCLE JACKETS; OPEN-NECKED SHIRTS; POLO SHIRTS; RIDING GLOVES; RUGBY SHIRTS; SHIRTS; SHIRTS AND SHORT-SLEEVED SHIRTS; SHORT-SLEEVED OR LONG-SLEEVED T-SHIRTS; SKI GLOVES; SKI PANTS; SNOWBOARD GLOVES; SNOWBOARD PANTS; SOCKS; SPORT SHIRTS; SPORTS PANTS; STRETCH PANTS; SWEATERS; SWIMWEAR; T-SHIRTS; TOPS; UNDERWEAR; WEARABLE GARMENTS AND CLOTHING, NAMELY, SHIRTS; YOGA PANTS (U.S. CLS. 22 AND 39).

JANICE KIM, EXAMINING ATTORNEY

SN 77-930,650. KING, MICHAEL, DARNESTOWN, MD. FILED 2-8-2010.

ARROWHEADVA

THE MARK CONSISTS OF STANDARD CHARACTERS WITHOUT CLAIM TO ANY PARTICULAR FONT, STYLE, SIZE, OR COLOR.

FOR CLOTHING, NAMELY, PANTS, SHIRTS, JERSEYS, T-SHIRTS, TOPS, JACKETS, DENIM JACKETS, FUR JACKETS, LEATHER JACKETS, RAIN JACKETS, WIND RESISTANT JACKETS, WRAPAROUNDS, DRESSES, SKIRTS, SHORTS, SHORT SETS, GLOVES, BELTS, BATHING SUITS, WRAPS, AND PAJAMAS; HEADWEAR, NAMELY, HATS AND CAPS (U.S. CLS. 22 AND 39).

PATRICIA EVANKO, EXAMINING ATTORNEY

CLASS 25—(Continued).

SN 77-930,689. MICHAEL KING, DARNESTOWN, MD.
FILED 2-8-2010.



THE MARK CONSISTS OF A GRAPHIC IMAGE OF A POINTED ARROWHEAD ON A RECTANGULAR BACKGROUND CARRIER.

FOR CLOTHING, NAMELY, PANTS, SHIRTS, JERSEYS, T-SHIRTS, TOPS, JACKETS, DENIM JACKETS, FUR JACKETS, LEATHER JACKETS, RAIN JACKETS, WIND RESISTANT JACKETS, WRAPAROUNDS, DRESSES, SKIRTS, SHORTS, SHORT SETS, GLOVES, BELTS, BATHING SUITS, WRAPS, AND PAJAMAS; HEADWEAR, NAMELY, HATS AND CAPS (U.S. CLS. 22 AND 39).

PATRICIA EVANKO, EXAMINING ATTORNEY

SN 77-930,737. RKR VENTURES LLC, LUTHERVILLE, MD.
FILED 2-8-2010.



THE COLOR(S) GREEN AND WHITE IS/ARE CLAIMED AS A FEATURE OF THE MARK.

THE MARK CONSISTS OF A GREEN BACKGROUND WITH THE WORD "TREADDERS" IN WHITE LETTERING CENTERED WITHIN A WHITE GRAPHIC IMAGE OF A FOOTPRINT CREATED WITH WHITE CRESCENTS. A RECTANGULAR GREEN AND WHITE BORDER SURROUND THE PERIMETER.

FOR SLIPPERS (U.S. CLS. 22 AND 39).
FIRST USE 11-1-2006; IN COMMERCE 11-1-2006.
GEORGE LORENZO, EXAMINING ATTORNEY

CLASS 25—(Continued).

SN 77-930,836. LOVE THE TRUTH, LLC., DBA LOVE THE TRUTH, WEST HOLLYWOOD, CA. FILED 2-8-2010.

Love the Truth

THE MARK CONSISTS OF STANDARD CHARACTERS WITHOUT CLAIM TO ANY PARTICULAR FONT, STYLE, SIZE, OR COLOR.

FOR BASEBALL CAPS AND HATS; HOODED SWEAT SHIRTS; JACKETS; JEANS; KNITTED CAPS; LONG-SLEEVED SHIRTS; SHORT-SLEEVED OR LONG-SLEEVED T-SHIRTS; SKULL CAPS; SWEAT PANTS; SWEAT SHIRTS; T-SHIRTS (U.S. CLS. 22 AND 39).

JORDAN BAKER, EXAMINING ATTORNEY

SN 77-930,887. PROPÉT GLOBAL LIMITED, AUBURN, WA.
FILED 2-8-2010.

365 WALKER

THE MARK CONSISTS OF STANDARD CHARACTERS WITHOUT CLAIM TO ANY PARTICULAR FONT, STYLE, SIZE, OR COLOR.

NO CLAIM IS MADE TO THE EXCLUSIVE RIGHT TO USE "WALKER", APART FROM THE MARK AS SHOWN.

FOR FOOTWEAR (U.S. CLS. 22 AND 39).
FIRST USE 8-15-1991; IN COMMERCE 8-15-1991.

JESSICA A. POWERS, EXAMINING ATTORNEY

SN 77-931,002. BE ONE, LLC, DBA KISS MY CLEATS, CHESTERTON, IN. FILED 2-8-2010.

THE COLOR(S) RED, DARK PURPLE, AND LIGHT PURPLE IS/ARE CLAIMED AS A FEATURE OF THE MARK.

THE MARK CONSISTS OF USING ALL STYLIZED LETTERS, THE WORD "KISS" IS DARK PURPLE, "MY" IS LIGHT PURPLE, AND "CLEATS" IS DARK PURPLE. THE LETTER "I" IS DOTTED WITH RED LIPS.

FOR SOCCER SHOES (U.S. CLS. 22 AND 39).
AISHA CLARKE, EXAMINING ATTORNEY

CLASS 25—(Continued).

SN 77-931,032. VICTORIA CHUNG, NORTH LAS VEGAS, NV. FILED 2-8-2010.

Good Mind Clothing

THE MARK CONSISTS OF STANDARD CHARACTERS WITHOUT CLAIM TO ANY PARTICULAR FONT, STYLE, SIZE, OR COLOR.

NO CLAIM IS MADE TO THE EXCLUSIVE RIGHT TO USE "CLOTHING", APART FROM THE MARK AS SHOWN.

FOR BELTS; CAPRI PANTS; CARGO PANTS; DENIMS; DRESS SHIRTS; HALTER TOPS; HATS; HOODED SWEAT SHIRTS; LONG-SLEEVED SHIRTS; LOUNGE PANTS; POLO SHIRTS; SHORT-SLEEVED OR LONG-SLEEVED T-SHIRTS; SWEAT PANTS; SWEAT SHIRTS; TANK-TOPS; UNDER GARMENTS; WOMEN'S HATS AND HOODS; YOGA PANTS (U.S. CLS. 22 AND 39).
RENEE MCCRAY, EXAMINING ATTORNEY

CLASS 25—(Continued).

SN 77-931,277. FIELDER, JONATHAN, OAKDALE, PA. FILED 2-9-2010.



THE MARK CONSISTS OF THE STYLIZED LETTERS "JD" WRITTEN IN CURSIVE.

FOR T-SHIRTS, KNIT SHIRTS, JEANS, SWEATSHIRTS, HOODED SWEATSHIRTS, DRESSES, HATS (U.S. CLS. 22 AND 39).

FIRST USE 5-1-2006; IN COMMERCE 5-1-2006.
CHRISTOPHER BUONGIORNO, EXAMINING ATTORNEY

SN 77-931,338. MAROON 5 PARTNERS, LOS ANGELES, CA. FILED 2-9-2010.



THE MARK CONSISTS OF STANDARD CHARACTERS WITHOUT CLAIM TO ANY PARTICULAR FONT, STYLE, SIZE, OR COLOR.

FOR CLOTHING, NAMELY, SHIRTS, T-SHIRTS, TANK TOPS, POLO SHIRTS, KNIT SHIRTS, JERSEYS, SPORTS SHIRTS, RUGBY SHIRTS, BLOUSES, SWEATERS, SKIRTS, DRESSES, VESTS, JOGGING AND RUNNING SUITS, SWEATPANTS, SWEATSHIRTS, SWEAT SUITS, HOODED SWEATSHIRTS, SWEATERS, JACKETS, PULLOVERS, COATS, PANTS, SHORTS, JEANS, OVERALLS, JUMPERS, RAINWEAR, WIND RESISTANT COATS, PARKAS, SLEEPWEAR, LOUNGEWEAR, UNDERWEAR AND SWIMWEAR; FOOTWEAR; HEADWEAR, NAMELY, HATS, CAPS, VISORS, HEADBANDS AND DO-RAGS; FASHION ACCESSORIES, NAMELY, BANDANAS, BELTS, SUSPENDERS, TIES, GLOVES, MITTENS, WRISTBANDS, SCARVES, SOCKS, HOSIERY, LEGGINGS, STOCKINGS, TIGHTS AND LEGWARMERS; CLOTHING FOR INFANTS, NAMELY, CLOTH BIBS, T-SHIRTS FOR INFANTS AND ONE-PIECE JUMPERS (U.S. CLS. 22 AND 39).

DOUGLAS LEE, EXAMINING ATTORNEY

SN 77-931,040. KRZEMIEN, KELLY C., MIDLOTHIAN, VA. FILED 2-8-2010.

GET YOUR WINGS ON

THE MARK CONSISTS OF STANDARD CHARACTERS WITHOUT CLAIM TO ANY PARTICULAR FONT, STYLE, SIZE, OR COLOR.

FOR CAPS; HATS; SHORT-SLEEVED OR LONG-SLEEVED T-SHIRTS; SHORTS; SWEAT PANTS; SWEAT SHIRTS; SWEAT SHORTS; SWEAT SUITS; TOPS; COATS; JACKETS (U.S. CLS. 22 AND 39).

SETH A. RAPPAPORT, EXAMINING ATTORNEY

CLASS 25—(Continued).

SN 77-931,382. LORI GOLDSTEIN, NEW YORK, NY. FILED 2-9-2010.

INSTANT CHIC

THE MARK CONSISTS OF STANDARD CHARACTERS WITHOUT CLAIM TO ANY PARTICULAR FONT, STYLE, SIZE, OR COLOR.

FOR APPAREL, NAMELY, SWEATERS, PANTS, JACKETS, COATS, SCARVES, T-SHIRTS, DRESSES, SKIRTS, TOPS, HEADWEAR AND FOOTWEAR (U.S. CLS. 22 AND 39).

JANET LEE, EXAMINING ATTORNEY

SN 77-931,388. JARZOMBEK, JEFFREY, CELEBRATION, FL. FILED 2-9-2010.

Asphalt Mafia

THE MARK CONSISTS OF STANDARD CHARACTERS WITHOUT CLAIM TO ANY PARTICULAR FONT, STYLE, SIZE, OR COLOR.

FOR GLOVES; HATS; LONG-SLEEVED SHIRTS; POLO SHIRTS; SHORT-SLEEVED SHIRTS; SPORT SHIRTS; SWEAT SHIRTS; T-SHIRTS (U.S. CLS. 22 AND 39).

ROBIN MITTLER, EXAMINING ATTORNEY

SN 77-931,390. JARZOMBEK, JEFFREY, CELEBRATION, FL. FILED 2-9-2010.

Construction Mafia

THE MARK CONSISTS OF STANDARD CHARACTERS WITHOUT CLAIM TO ANY PARTICULAR FONT, STYLE, SIZE, OR COLOR.

FOR GLOVES; HATS; LONG-SLEEVED SHIRTS; POLO SHIRTS; SHORT-SLEEVED SHIRTS; SPORT SHIRTS; SWEAT SHIRTS; T-SHIRTS (U.S. CLS. 22 AND 39).

ROBIN MITTLER, EXAMINING ATTORNEY

CLASS 25—(Continued).

SN 77-931,392. JARZOMBEK, JEFFREY, CELEBRATION, FL. FILED 2-9-2010.

Playground Mafia

THE MARK CONSISTS OF STANDARD CHARACTERS WITHOUT CLAIM TO ANY PARTICULAR FONT, STYLE, SIZE, OR COLOR.

FOR GLOVES; HATS; LONG-SLEEVED SHIRTS; POLO SHIRTS; SHORT-SLEEVED SHIRTS; SPORT SHIRTS; SWEAT SHIRTS; T-SHIRTS (U.S. CLS. 22 AND 39).

ROBIN MITTLER, EXAMINING ATTORNEY

SN 77-931,405. DOZIER QUMAA A, WESTVILLE, NJ. FILED 2-9-2010.



NO CLAIM IS MADE TO THE EXCLUSIVE RIGHT TO USE "JEANS", APART FROM THE MARK AS SHOWN.

THE COLOR(S) SILVER AND BLACK IS/ARE CLAIMED AS A FEATURE OF THE MARK.

THE MARK CONSISTS OF THE STYLIZED WORDING "QD JEANS" IN SILVER ON A BLACK BACKGROUND.

FOR CAPRI PANTS; CARGO PANTS; DENIM JACKETS; DENIMS; DOWN JACKETS; DRESS SHIRTS; JACKETS; JOGGING PANTS; LONG JACKETS; MEN'S AND WOMEN'S JACKETS, COATS, TROUSERS, VESTS; SHIRTS; SHIRTS AND SHORT-SLEEVED SHIRTS; SHOES; SWEAT JACKETS; WOMEN'S SHOES (U.S. CLS. 22 AND 39).

KATHERINE CONNOLLY, EXAMINING ATTORNEY

SN 77-931,471. HENRY DUBE, CANE RIDGE, TN. FILED 2-9-2010.

GATOR LEGS

THE MARK CONSISTS OF STANDARD CHARACTERS WITHOUT CLAIM TO ANY PARTICULAR FONT, STYLE, SIZE, OR COLOR.

NO CLAIM IS MADE TO THE EXCLUSIVE RIGHT TO USE "LEGS", APART FROM THE MARK AS SHOWN.

FOR LEG SHIELDING DEVICE, ATTACHABLE TO AND DETACHABLE FROM A PERSON'S PANTS, COMPRISED OF PADDING TO SHIELD THE LEGS FROM FLYING DEBRIS WHEN MOWING WITH A STRING TRIMMER (U.S. CLS. 22 AND 39).

MICHAEL WEBSTER, EXAMINING ATTORNEY

CLASS 25—(Continued).

SN 77-931,594. M.A.D. CONCEPTS INC., AVENTURA, FL. FILED 2-9-2010.



THE MARK CONSISTS OF A STYLIZED LETTER "N".
FOR HATS; PANTS; SHIRTS; SHORTS; SWEAT JACKETS; SWEAT PANTS; SWEAT SHIRTS; SWEATERS; SWIMSUITS; T-SHIRTS; UNDERWEAR (U.S. CLS. 22 AND 39).
KATHRYN COWARD, EXAMINING ATTORNEY

SN 77-931,628. NEO-GE MUSIC LLC, MONTCLAIR, NJ. FILED 2-9-2010.

Maniac Royalty

THE MARK CONSISTS OF STANDARD CHARACTERS WITHOUT CLAIM TO ANY PARTICULAR FONT, STYLE, SIZE, OR COLOR.
FOR HATS; JACKETS; PANTS; SHIRTS; SOCKS; SWEAT PANTS; SWEAT SHIRTS (U.S. CLS. 22 AND 39).
TASNEEM HUSSAIN, EXAMINING ATTORNEY

SN 77-931,632. MCLEAN, JOHN D, DBA RUKKUS INDUSTRIES, COQUITLAM, CANADA, FILED 2-9-2010.

RANDI BOY

THE MARK CONSISTS OF STANDARD CHARACTERS WITHOUT CLAIM TO ANY PARTICULAR FONT, STYLE, SIZE, OR COLOR.
FOR APPAREL FOR DANCERS, NAMELY, TEE SHIRTS, SWEATSHIRTS, PANTS, LEGGINGS, SHORTS AND JACKETS; ATHLETIC APPAREL, NAMELY, SHIRTS, PANTS, JACKETS, FOOTWEAR, HATS AND CAPS, ATHLETIC UNIFORMS (U.S. CLS. 22 AND 39).
TEJBIR SINGH, EXAMINING ATTORNEY

CLASS 25—(Continued).

SN 77-931,633. KIM, JAE, TOTOWA, NJ. FILED 2-9-2010.

RAREFIED

THE MARK CONSISTS OF STANDARD CHARACTERS WITHOUT CLAIM TO ANY PARTICULAR FONT, STYLE, SIZE, OR COLOR.
FOR BEACHWEAR; BELTS; BOTTOMS; CAPS; COATS; DRESSES; FOOTWEAR; GLOVES; HOSIERY; JACKETS; JEANS; LINGERIE; LOUNGEWEAR; PANTS; SHIRTS; SHORTS; SKIRTS; SLEEPWEAR; SLIPPERS; SOCKS; SUITS; SWEATERS; SWIMWEAR; TIES; TOPS; UNDERWEAR (U.S. CLS. 22 AND 39).
WENDY JUN, EXAMINING ATTORNEY

SN 77-931,635. NEO-GE MUSIC LLC, MONTCLAIR, NJ. FILED 2-9-2010.

Maniac Princess

THE MARK CONSISTS OF STANDARD CHARACTERS WITHOUT CLAIM TO ANY PARTICULAR FONT, STYLE, SIZE, OR COLOR.
FOR HATS; JACKETS; PANTS; SHIRTS; SOCKS; SWEAT PANTS; SWEAT SHIRTS (U.S. CLS. 22 AND 39).
TASNEEM HUSSAIN, EXAMINING ATTORNEY

SN 77-931,775. CREATIVE SOCIETY, INC., DBA DORSIA, CHICAGO, IL. FILED 2-9-2010.

DORSIA

THE MARK CONSISTS OF STANDARD CHARACTERS WITHOUT CLAIM TO ANY PARTICULAR FONT, STYLE, SIZE, OR COLOR.
FOR CLOTHING FOR MEN, WOMEN AND CHILDREN, NAMELY, CARDIGANS, DRESS SHIRTS, DRESS SUITS, DRESSES, HOODED SWEAT SHIRTS, JACKETS, KNIT SHIRTS, LEATHER JACKETS, LONG-SLEEVED SHIRTS, COATS, TROUSERS, VESTS, MEN'S SUITS, WOMEN'S SUITS, RAIN SUITS, REVERSIBLE JACKETS, SHIRTS, SHIRTS FOR SUITS, SHORT-SLEEVED SHIRTS, SKI SUITS, SKI SUITS FOR COMPETITION, SKIRT SUITS, SKIRTS AND DRESSES, SLACKS, SLEEVED OR SLEEVELESS JACKETS, SPORT SHIRTS, SPORT SHIRTS WITH SHORT SLEEVES, SUEDE JACKETS, T-SHIRTS, TRACK JACKETS AND WIND-RESISTANT JACKET (U.S. CLS. 22 AND 39).
FIRST USE 6-1-2008; IN COMMERCE 5-1-2009.
ANDREA HACK, EXAMINING ATTORNEY

CLASS 25—(Continued).

SN 77-931,872. BJORN GUSTAFSON, DBA SLEDBIANS, COTTONWOOD HEIGHTS, UT. FILED 2-9-2010.

SLEDBIANS

THE MARK CONSISTS OF STANDARD CHARACTERS WITHOUT CLAIM TO ANY PARTICULAR FONT, STYLE, SIZE, OR COLOR.

FOR BEANIES; BOTTOMS; HATS; HOODED SWEAT SHIRTS; LONG-SLEEVED SHIRTS; SHIRTS; SHORT-SLEEVED OR LONG-SLEEVED T-SHIRTS; SNOW PANTS; SNOW SUITS; T-SHIRTS; TOPS (U.S. CLS. 22 AND 39).

JOHN WILKE, EXAMINING ATTORNEY

CLASS 25—(Continued).

SN 77-931,972. AMAL FELAYA LLC, LAS VEGAS, NV. FILED 2-9-2010.

SINIORA

THE MARK CONSISTS OF STANDARD CHARACTERS WITHOUT CLAIM TO ANY PARTICULAR FONT, STYLE, SIZE, OR COLOR.

THE WORDING "SINIORA" HAS NO MEANING IN A FOREIGN LANGUAGE.

FOR CLOTHING AND CLOTHING ACCESSORIES, NAMELY, GOWNS, DRESSES, SHIRTS, SHORTS, PANTS, TOPS, BOTTOMS, ROBES, JACKETS, VESTS, BLAZERS, BLOUSES, COATS, SWEATERS, SKIRTS, SLACKS AND TIGHTS (U.S. CLS. 22 AND 39).

JANICE KIM, EXAMINING ATTORNEY

SN 77-931,993. HASTIN, KORTNEY, HUNTINGTON BEACH, CA. FILED 2-9-2010.

BEHRLE & KORT

THE MARK CONSISTS OF STANDARD CHARACTERS WITHOUT CLAIM TO ANY PARTICULAR FONT, STYLE, SIZE, OR COLOR.

FOR WOMEN'S AND MEN'S CLOTHING, NAMELY, T-SHIRTS, SHIRTS, TOPS, BABY TEES, TANK TOPS, LONG SLEEVE SHIRTS, SHORT SLEEVE SHIRTS, WOVEN SHIRTS, POLO SHIRTS, THERMAL SHIRTS, PANTS, DENIM PANTS, TROUSERS, CARGO PANTS, DENIM SHORTS, SHORTS, WALKING SHORTS, OUTERWEAR, NAMELY, JACKETS, LEATHER JACKETS, COATS, BLAZERS, SWEATSHIRTS, HOODED SWEATSHIRTS, SWEATERS, VESTS, PEA COATS, TOP COATS, OVERCOATS; BELTS, BEANIES, HATS, CAPS; AND FOOTWEAR, NAMELY, MEN'S BOOTS (U.S. CLS. 22 AND 39).

ALEX KEAM, EXAMINING ATTORNEY

SN 77-931,953. GILES, FRANCES, WHITTIER, CA. FILED 2-9-2010.

THE MARK CONSISTS OF THE WORD "STAG" PRINTED ABOVE THE WORD "PARTY" TO SPELL OUT THE TERM: "STAG PARTY". THE LETTERS "P", "A", AND "R" PRESENT IN THE WORDS ARE STYLIZED WITH FILLED IN COUNTERS, MEANING THE NEGATIVE SPACE HAS BEEN MADE SOLID. THE LETTER "G" IS ALSO STYLIZED WITH A LIGHTNING BOLT ADDED TO THE CHARACTER AS WELL AS A TILT TO ITS DISPLAY.

FOR HOODED SWEAT SHIRTS; JACKETS; JEANS; JOGGING PANTS; KNIT SHIRTS; LONG-SLEEVED SHIRTS; LOUNGE PANTS; OPEN-NECKED SHIRTS; PANTS; SHIRTS; SHIRTS AND SHORT-SLEEVED SHIRTS; SHORT-SLEEVED OR LONG-SLEEVED T-SHIRTS; SHORT-SLEEVED SHIRTS; STRETCH PANTS; SWEAT BANDS; SWEAT PANTS; SWEAT SHIRTS; SWEAT SHORTS; T-SHIRTS; TOPS; WEARABLE GARMENTS AND CLOTHING, NAMELY, SHIRTS (U.S. CLS. 22 AND 39).

FIRST USE 11-15-2009; IN COMMERCE 12-2-2009.

JANICE KIM, EXAMINING ATTORNEY

SN 77-932,011. CASUAL COOL INC., DBA CREATIVE WORLDWIDE INC., RIDGEWOOD, NY. FILED 2-9-2010.

**ABSOLUTELY
CREATIVE WORLDWIDE**

THE MARK CONSISTS OF STANDARD CHARACTERS WITHOUT CLAIM TO ANY PARTICULAR FONT, STYLE, SIZE, OR COLOR.

FOR SWEATERS (U.S. CLS. 22 AND 39).

FIRST USE 12-27-2001; IN COMMERCE 6-1-2002.

ALEX KEAM, EXAMINING ATTORNEY

CLASS 25—(Continued).

SN 77-932,017. THE MARCH FIRM, INC., NEW YORK, NY.
FILED 2-9-2010.

ONE GEAR

THE MARK CONSISTS OF STANDARD CHARACTERS WITHOUT CLAIM TO ANY PARTICULAR FONT, STYLE, SIZE, OR COLOR.

NO CLAIM IS MADE TO THE EXCLUSIVE RIGHT TO USE "GEAR", APART FROM THE MARK AS SHOWN.

FOR ATHLETIC APPAREL, NAMELY, SHIRTS, PANTS, JACKETS, FOOTWEAR, HATS AND CAPS, ATHLETIC UNIFORMS; CLEATS FOR ATTACHMENT TO SPORTS SHOES; COATS; GLOVES; HEADBANDS; JUMPSUITS; SHORTS; SOCKS; SPORTS BRAS; TOPS; TRIATHLON CLOTHING, NAMELY, TRIATHLON TIGHTS, TRIATHLON SHORTS, TRIATHLON SING-LETS, TRIATHLON SHIRTS, TRIATHLON SUITS; UN-DERWEAR (U.S. CLS. 22 AND 39).

ALYSSA STEEL, EXAMINING ATTORNEY

SN 77-932,040. THE MARCH FIRM, INC., NEW YORK, NY.
FILED 2-9-2010.

WHAT'S YOUR GEAR?

THE MARK CONSISTS OF STANDARD CHARACTERS WITHOUT CLAIM TO ANY PARTICULAR FONT, STYLE, SIZE, OR COLOR.

NO CLAIM IS MADE TO THE EXCLUSIVE RIGHT TO USE "GEAR", APART FROM THE MARK AS SHOWN.

FOR ATHLETIC APPAREL, NAMELY, SHIRTS, PANTS, JACKETS, FOOTWEAR, HATS AND CAPS, ATHLETIC UNIFORMS; CLEATS FOR ATTACHMENT TO SPORTS SHOES; COATS; GLOVES; HEADBANDS; JUMPSUITS; SHORTS; SOCKS; SPORTS BRAS; TOPS; TRIATHLON CLOTHING, NAMELY, TRIATHLON TIGHTS, TRIATHLON SHORTS, TRIATHLON SING-LETS, TRIATHLON SHIRTS, TRIATHLON SUITS; UN-DERWEAR (U.S. CLS. 22 AND 39).

ALYSSA STEEL, EXAMINING ATTORNEY

SN 77-932,044. U OWE ME, INC, PALO ALTO, CA. FILED 2-9-2010.

UOME

THE MARK CONSISTS OF STANDARD CHARACTERS WITHOUT CLAIM TO ANY PARTICULAR FONT, STYLE, SIZE, OR COLOR.

FOR BOXER SHORTS; CAPS; FOOTWEAR; HATS; SHIRTS; SWEAT SHIRTS; T-SHIRTS; VESTS; VISORS (U.S. CLS. 22 AND 39).

ALEX KEAM, EXAMINING ATTORNEY

CLASS 25—(Continued).

SN 77-932,096. NEO-GE MUSIC LLC, MONTCLAIR, NJ.
FILED 2-9-2010.

Maniac Prince

THE MARK CONSISTS OF STANDARD CHARACTERS WITHOUT CLAIM TO ANY PARTICULAR FONT, STYLE, SIZE, OR COLOR.

FOR HATS; JACKETS; PANTS; SHIRTS; SOCKS; SWEAT PANTS; SWEAT SHIRTS (U.S. CLS. 22 AND 39).

TASNEEM HUSSAIN, EXAMINING ATTORNEY

SN 77-932,106. ARCANA CLOTHING LLC, DEL MAR, CA.
FILED 2-9-2010.



THE MARK CONSISTS OF AN AMBRIGRAM OF THE WORD "ARCANA".

FOR HATS; PANTS; SHIRTS; SWEAT SHIRTS (U.S. CLS. 22 AND 39).

KATHLEEN M. VANSTON, EXAMINING ATTORNEY

SN 77-932,130. SEVEN SEAS JOBBERS INC, LOS ANGELES, CA. FILED 2-9-2010.

DOMINO LUX

THE MARK CONSISTS OF STANDARD CHARACTERS WITHOUT CLAIM TO ANY PARTICULAR FONT, STYLE, SIZE, OR COLOR.

THE ENGLISH TRANSLATION OF "DOMINO" AND "LUX" IN THE MARK IS "GOD" AND "LIGHT" RESPEC-TIVELY.

FOR CLOTHING, NAMELY, T-SHIRTS, KNIT SHIRTS, WOVEN SHIRTS, JEANS, PANTS, SHORTS, HATS, CAPS, COATS, JACKETS, SWEATERS, VEST, SWEAT SHIRTS, SHOES, GLOVES (U.S. CLS. 22 AND 39).

ESTHER A. BORSUK, EXAMINING ATTORNEY

CLASS 25—(Continued).

SN 77-932,291. POLLOCK, HARRIS, DEERFIELD BEACH, FL. FILED 2-10-2010.

therassage

THE MARK CONSISTS OF STANDARD CHARACTERS WITHOUT CLAIM TO ANY PARTICULAR FONT, STYLE, SIZE, OR COLOR.

FOR INSOLES; SLIPPER SOCKS; SLIPPERS; SOCKS (U.S. CLS. 22 AND 39).

JAMES LOVELACE, EXAMINING ATTORNEY

SN 77-932,365. LAIRSEN, MICHAEL R, PLANO, TX. FILED 2-10-2010.

GAMA STUDIO

THE MARK CONSISTS OF STANDARD CHARACTERS WITHOUT CLAIM TO ANY PARTICULAR FONT, STYLE, SIZE, OR COLOR.

NO CLAIM IS MADE TO THE EXCLUSIVE RIGHT TO USE "STUDIO", APART FROM THE MARK AS SHOWN.

FOR WOMEN'S SHOES (U.S. CLS. 22 AND 39).

DAVID MURRAY, EXAMINING ATTORNEY

SN 77-932,421. WHITE, TIMOTHY, BYRAM, MS. FILED 2-10-2010.



It's All About The W

THE MARK CONSISTS OF AN EIGHT POINT STAR WITH A "W" INSIDE OF A CIRCLE, IN THE MIDDLE OF IT. BELOW THERE IS THE STYLIZED TEXT "IT'S ALL ABOUT THE W".

FOR HATS; HEADBANDS; T-SHIRTS; WRISTBANDS (U.S. CLS. 22 AND 39).

CYNTHIA SLOAN, EXAMINING ATTORNEY

CLASS 25—(Continued).

SN 77-932,714. STIKE, TERRY, CHRISTIANSBURG, VA. FILED 2-10-2010.

HIT R GOOD

THE MARK CONSISTS OF STANDARD CHARACTERS WITHOUT CLAIM TO ANY PARTICULAR FONT, STYLE, SIZE, OR COLOR.

FOR HATS; SWEAT SHIRTS; T-SHIRTS (U.S. CLS. 22 AND 39).

DAVID I, EXAMINING ATTORNEY

SN 77-932,765. WIRTH, CHRISTOPHER, FREEHOLD, NJ. FILED 2-10-2010.

Shotty X

THE MARK CONSISTS OF STANDARD CHARACTERS WITHOUT CLAIM TO ANY PARTICULAR FONT, STYLE, SIZE, OR COLOR.

FOR SHIRTS; SWEAT SHIRTS (U.S. CLS. 22 AND 39).

MARK T. MULLEN, EXAMINING ATTORNEY

SN 77-932,778. PIONESSA, WILLIAM M., ADDISON, NY. FILED 2-10-2010.

CoNeck-Tie

THE MARK CONSISTS OF STANDARD CHARACTERS WITHOUT CLAIM TO ANY PARTICULAR FONT, STYLE, SIZE, OR COLOR.

FOR NECKTIES (U.S. CLS. 22 AND 39).

JOHN WILKE, EXAMINING ATTORNEY

CLASS 25—(Continued).

SN 77-932,810. ONE OF A KIND PRODUCTIONS, LLC, LIVONIA, MI. FILED 2-10-2010.

PowerCapes

THE MARK CONSISTS OF STANDARD CHARACTERS WITHOUT CLAIM TO ANY PARTICULAR FONT, STYLE, SIZE, OR COLOR.

FOR CAPES; COSTUMES FOR USE IN CHILDREN'S DRESS UP PLAY; GLOVES; HALLOWEEN COSTUMES AND MASKS SOLD IN CONNECTION THEREWITH; SHIRTS AND SHORT-SLEEVED SHIRTS (U.S. CLS. 22 AND 39).

FIRST USE 6-15-2009; IN COMMERCE 1-1-2010.
SIMON TENG, EXAMINING ATTORNEY

SN 77-932,824. G&K SERVICES, INC., MINNETONKA, MN. FILED 2-10-2010.

EXCEED

THE MARK CONSISTS OF STANDARD CHARACTERS WITHOUT CLAIM TO ANY PARTICULAR FONT, STYLE, SIZE, OR COLOR.

FOR FABRIC SOLD AS AN INTEGRAL COMPONENT OF FINISHED CLOTHING ITEMS, NAMELY, SHIRTS, T-SHIRTS AND POLO SHIRTS (U.S. CLS. 22 AND 39).

FIRST USE 4-1-2007; IN COMMERCE 4-1-2007.
LOURDES AYALA, EXAMINING ATTORNEY

SN 77-932,999. MANGINO, DOMENIC, MADISON, CT. FILED 2-10-2010.

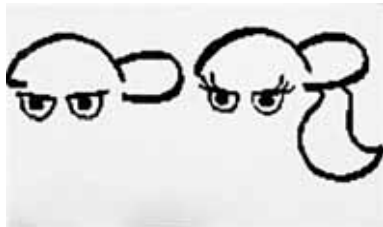

THE MARK CONSISTS OF ONE MALE AND ONE FEMALE CHARACTER CONSISTING OF EYES, A TILTED BASEBALL CAP AND A PONYTAIL ON THE FEMALE.

FOR ATHLETIC APPAREL, NAMELY, SHIRTS, PANTS, JACKETS, FOOTWEAR, HATS AND CAPS, ATHLETIC UNIFORMS (U.S. CLS. 22 AND 39).

MARTHA SANTOMARTINO, EXAMINING ATTORNEY

CLASS 25—(Continued).

SN 77-933,010. MMA LIFE INC., SAINT AUGUSTINE, FL. FILED 2-10-2010.

MMA LIFE

THE MARK CONSISTS OF STANDARD CHARACTERS WITHOUT CLAIM TO ANY PARTICULAR FONT, STYLE, SIZE, OR COLOR.

NO CLAIM IS MADE TO THE EXCLUSIVE RIGHT TO USE "MMA", APART FROM THE MARK AS SHOWN.

FOR ATHLETIC APPAREL, NAMELY, SHIRTS, PANTS, JACKETS, FOOTWEAR, HATS AND CAPS, ATHLETIC UNIFORMS; BASEBALL CAPS AND HATS; BEANIES; BOARD SHORTS; BOXING SHORTS; CAMOUFLAGE JACKETS; CAMOUFLAGE PANTS; CAMOUFLAGE SHIRTS; GYM PANTS; HOODED SWEAT SHIRTS; PANTS; SHIRTS; SHIRTS FOR INFANTS, BABIES, TODDLERS AND CHILDREN; SHORT-SLEEVED OR LONG-SLEEVED T-SHIRTS (U.S. CLS. 22 AND 39).

FIRST USE 2-20-2010; IN COMMERCE 4-20-2010.
GRETCHEN ULRICH, EXAMINING ATTORNEY

SN 77-934,404. CREATIVE SOCIETY, INC., DBA DORSIA, CHICAGO, IL. FILED 2-12-2010.

DIME BY DORSIA

THE MARK CONSISTS OF STANDARD CHARACTERS WITHOUT CLAIM TO ANY PARTICULAR FONT, STYLE, SIZE, OR COLOR.

FOR CLOTHING FOR MEN, WOMEN AND CHILDREN, NAMELY, CARDIGANS, DRESS SHIRTS, DRESS SUITS, DRESSES, HOODED SWEAT SHIRTS, JACKETS, KNIT SHIRTS, LEATHER JACKETS, LONG-SLEEVED SHIRTS, COATS, TROUSERS, VESTS, MEN'S SUITS, WOMEN'S SUITS, RAIN SUITS, REVERSIBLE JACKETS, SHIRTS, SHIRTS FOR SUITS, SHORT-SLEEVED SHIRTS, SKI SUITS, SKI SUITS FOR COMPETITION, SKIRT SUITS, SKIRTS AND DRESSES, SLACKS, SLEEVED OR SLEEVELESS JACKETS, SPORT SHIRTS, SPORT SHIRTS WITH SHORT SLEEVES, SUEDE JACKETS, T-SHIRTS, TRACK JACKETS AND WIND-RESISTANT JACKETS (U.S. CLS. 22 AND 39).

ANDREA HACK, EXAMINING ATTORNEY

CLASS 25—(Continued).

SN 77-934,978. APPIAH-KUMI, GEORGE, EWING, NJ.
FILED 2-12-2010.



THE MARK CONSISTS OF A COMBINATION OF GEOMETRIC FIGURES REPRESENTING A PERSON DANCING.

FOR ADULT NOVELTY GAG CLOTHING ITEM, NAMELY, SOCKS; BELTS FOR CLOTHING; BOTTOMS; CHILDREN'S AND INFANTS' CLOTH BIBS; CLOTH BIBS; CLOTH BIBS FOR ADULT DINERS; CLOTHING, NAMELY, KHAKIS; CLOTHING, NAMELY, MATERNITY BANDS; GLOVES AS CLOTHING; HATS; HEADBANDS FOR CLOTHING; HOODS; INFANT AND TODDLER ONE PIECE CLOTHING; JACKETS; JERSEYS; LEATHER BELTS; T-SHIRTS; TIES; WEARABLE GARMENTS AND CLOTHING, NAMELY, SHIRTS; WRAPS (U.S. CLS. 22 AND 39).

LIEF MARTIN, EXAMINING ATTORNEY

SN 77-936,822. MAROON 5 PARTNERS, LOS ANGELES, CA.
FILED 2-16-2010.

TWO TWO TWO

THE MARK CONSISTS OF STANDARD CHARACTERS WITHOUT CLAIM TO ANY PARTICULAR FONT, STYLE, SIZE, OR COLOR.

FOR CLOTHING, NAMELY, SHIRTS, T-SHIRTS, TANK TOPS, POLO SHIRTS, KNIT SHIRTS, JERSEYS, SPORTS SHIRTS, RUGBY SHIRTS, BLOUSES, SWEATERS, SKIRTS, DRESSES, VESTS, JOGGING AND RUNNING SUITS, SWEATPANTS, SWEATSHIRTS, SWEAT SUITS, HOODED SWEATSHIRTS, SWEATERS, JACKETS, PULLOVERS, COATS, PANTS, SHORTS, JEANS, OVERALLS, JUMPERS, RAINWEAR, WIND RESISTANT COATS, PARKAS, SLEEPWEAR, LOUNGEWEAR, UNDERWEAR AND SWIMWEAR; FOOTWEAR; HEADWEAR, NAMELY, HATS, CAPS, VISORS, HEADBANDS AND DO-RAGS; FASHION ACCESSORIES, NAMELY, BANDANAS, BELTS, SUSPENDERS, TIES, GLOVES, MITTENS, WRISTBANDS, SCARVES, SOCKS, HOSE, LEGGINGS, STOCKINGS, TIGHTS AND LEGWEARERS; CLOTHING FOR INFANTS, NAMELY, CLOTH BIBS, T-SHIRTS FOR INFANTS AND ONE-PIECE JUMPERS (U.S. CLS. 22 AND 39).

DOUGLAS LEE, EXAMINING ATTORNEY

CLASS 25—(Continued).

SN 77-936,943. MAROON 5 PARTNERS, LOS ANGELES, CA.
FILED 2-16-2010.

II II II

THE MARK CONSISTS OF STANDARD CHARACTERS WITHOUT CLAIM TO ANY PARTICULAR FONT, STYLE, SIZE, OR COLOR.

FOR CLOTHING, NAMELY, SHIRTS, T-SHIRTS, TANK TOPS, POLO SHIRTS, KNIT SHIRTS, JERSEYS, SPORTS SHIRTS, RUGBY SHIRTS, BLOUSES, SWEATERS, SKIRTS, DRESSES, VESTS, JOGGING AND RUNNING SUITS, SWEATPANTS, SWEATSHIRTS, SWEAT SUITS, HOODED SWEATSHIRTS, SWEATERS, JACKETS, PULLOVERS, COATS, PANTS, SHORTS, JEANS, OVERALLS, JUMPERS, RAINWEAR, WIND RESISTANT COATS, PARKAS, SLEEPWEAR, LOUNGEWEAR, UNDERWEAR AND SWIMWEAR; FOOTWEAR; HEADWEAR, NAMELY, HATS, CAPS, VISORS, HEADBANDS AND DO-RAGS; FASHION ACCESSORIES, NAMELY, BANDANAS, BELTS, SUSPENDERS, TIES, GLOVES, MITTENS, WRISTBANDS, SCARVES, SOCKS, HOSE, LEGGINGS, STOCKINGS, TIGHTS AND LEGWEARERS; CLOTHING FOR INFANTS, NAMELY, CLOTH BIBS, T-SHIRTS FOR INFANTS AND ONE-PIECE JUMPERS (U.S. CLS. 22 AND 39).

DOUGLAS LEE, EXAMINING ATTORNEY

SN 77-937,040. WIRTH, CHRISTOPHER, FREEHOLD, NJ.
FILED 2-16-2010.

**A positive vibe in a
negative world**

THE MARK CONSISTS OF STANDARD CHARACTERS WITHOUT CLAIM TO ANY PARTICULAR FONT, STYLE, SIZE, OR COLOR.

FOR ATHLETIC APPAREL, NAMELY, SWEAT SHIRTS, SHIRTS, PANTS, JACKETS, FOOTWEAR, HATS AND CAPS, ATHLETIC UNIFORMS (U.S. CLS. 22 AND 39).

MARK T. MULLEN, EXAMINING ATTORNEY

CLASS 25—(Continued).

SN 77-937,599. SKECHERS U.S.A., INC. II, MANHATTAN BEACH, CA. FILED 2-17-2010.

ELASTIKA

THE MARK CONSISTS OF STANDARD CHARACTERS WITHOUT CLAIM TO ANY PARTICULAR FONT, STYLE, SIZE, OR COLOR.

FOR APPAREL, NAMELY, TOPS, SHIRTS, BLOUSES, T-SHIRTS, SWEAT SHIRTS, SPORTS JERSEYS, SWEATERS, BOTTOMS, TROUSERS, PANTS, SWEAT PANTS, SHORTS, JACKETS, COATS, OVERCOATS, PULLOVERS, JUMPERS, DRESSES, SKIRTS, BEACHWEAR, SWIMSUITS, UNDERWEAR, LINGERIE, HEADWEAR, HATS, CAPS, BEANIES, VISORS, TIES, SOCKS, BELTS, GLOVES, SCARVES AND WRISTBANDS (U.S. CLS. 22 AND 39).

INGA ERVIN, EXAMINING ATTORNEY



SN 77-937,608. GENERAL CHUCK YEAGER, INC., PENN VALLEY, CA. FILED 2-17-2010.

Glamorous Glennis

THE MARK CONSISTS OF STANDARD CHARACTERS WITHOUT CLAIM TO ANY PARTICULAR FONT, STYLE, SIZE, OR COLOR.

THE NAME(S), PORTRAIT(S), AND/OR SIGNATURE(S) SHOWN IN THE MARK DOES NOT IDENTIFY A PARTICULAR LIVING INDIVIDUAL.

FOR SPORTS CAPS AND HATS; T-SHIRTS (U.S. CLS. 22 AND 39).

FIRST USE 12-31-1980; IN COMMERCE 12-31-1980.
GIANCARLO CASTRO, EXAMINING ATTORNEY



SN 77-938,991. KOHL'S ILLINOIS, INC., AURORA, IL. FILED 2-18-2010.

SOLE SENSEABILITY

THE MARK CONSISTS OF STANDARD CHARACTERS WITHOUT CLAIM TO ANY PARTICULAR FONT, STYLE, SIZE, OR COLOR.

FOR FOOTWEAR (U.S. CLS. 22 AND 39).
JESSICA A. POWERS, EXAMINING ATTORNEY

CLASS 25—(Continued).

SN 77-938,993. KOHL'S ILLINOIS, INC., AURORA, IL. FILED 2-18-2010.

SOLE (SENSE)ABILITY

THE MARK CONSISTS OF STANDARD CHARACTERS WITHOUT CLAIM TO ANY PARTICULAR FONT, STYLE, SIZE, OR COLOR.

FOR FOOTWEAR (U.S. CLS. 22 AND 39).
JESSICA A. POWERS, EXAMINING ATTORNEY



SN 77-939,656. ANDREW CHRISTIAN, INC., GLENDALE, CA. FILED 2-19-2010.

ALMOST NAKED

THE MARK CONSISTS OF STANDARD CHARACTERS WITHOUT CLAIM TO ANY PARTICULAR FONT, STYLE, SIZE, OR COLOR.

FOR CLOTHING, NAMELY, UNDERWEAR AND SWIMWEAR (U.S. CLS. 22 AND 39).

FIRST USE 11-28-2008; IN COMMERCE 11-28-2008.
REBECCA GILBERT, EXAMINING ATTORNEY



SN 77-940,888. WORLD WRESTLING ENTERTAINMENT, INC., STAMFORD, CT. FILED 2-21-2010.

CHRISTIAN

THE MARK CONSISTS OF STANDARD CHARACTERS WITHOUT CLAIM TO ANY PARTICULAR FONT, STYLE, SIZE, OR COLOR.

FOR CLOTHING, NAMELY, TOPS, JACKETS, BOTTOMS, UNDERWEAR, PAJAMAS; FOOTWEAR, NAMELY, SHOES, SNEAKERS, SLIPPERS; HEADWEAR, NAMELY, HATS (U.S. CLS. 22 AND 39).

JOHN HWANG, EXAMINING ATTORNEY

CLASS 25—(Continued).

SN 77-942,891. K-SWISS INC., WESTLAKE VILLAGE, CA.
FILED 2-23-2010.

SUPER DUPER TUBES

THE MARK CONSISTS OF STANDARD CHARACTERS
WITHOUT CLAIM TO ANY PARTICULAR FONT, STYLE,
SIZE, OR COLOR.

OWNER OF U.S. REG. NO. 1,340,894.
FOR ATHLETIC SHOES; RUNNING SHOES; SHOES
(U.S. CLS. 22 AND 39).
BRIAN CALLAGHAN, EXAMINING ATTORNEY

SN 77-943,037. SKECHERS U.S.A., INC. II, MANHATTAN
BEACH, CA. FILED 2-23-2010.

XF

THE MARK CONSISTS OF STANDARD CHARACTERS
WITHOUT CLAIM TO ANY PARTICULAR FONT, STYLE,
SIZE, OR COLOR.

FOR FOOTWEAR (U.S. CLS. 22 AND 39).
INGA ERVIN, EXAMINING ATTORNEY

SN 77-943,076. AMERICAN SPORTING GOODS CORPORA-
TION, ALISO VIEJO, CA. FILED 2-23-2010.

AVI-MOTION

THE MARK CONSISTS OF STANDARD CHARACTERS
WITHOUT CLAIM TO ANY PARTICULAR FONT, STYLE,
SIZE, OR COLOR.

FOR FOOTWEAR (U.S. CLS. 22 AND 39).
FIRST USE 8-0-2009; IN COMMERCE 8-0-2009.
TEJBIR SINGH, EXAMINING ATTORNEY

CLASS 25—(Continued).

SN 77-943,272. WORLD WRESTLING ENTERTAINMENT,
INC., STAMFORD, CT. FILED 2-24-2010.

NXT ROOKIE

THE MARK CONSISTS OF STANDARD CHARACTERS
WITHOUT CLAIM TO ANY PARTICULAR FONT, STYLE,
SIZE, OR COLOR.

FOR CLOTHING, NAMELY, TOPS, JACKETS, BOT-
TOMS, UNDERWEAR, PAJAMAS; FOOTWEAR,
NAMELY, SHOES, SNEAKERS, SLIPPERS; HEADWEAR,
NAMELY, HATS (U.S. CLS. 22 AND 39).
JOHN HWANG, EXAMINING ATTORNEY

SN 77-944,469. LORI GOLDSTEIN, NEW YORK, NY. FILED
2-25-2010.

FABZ INSTANT CHIC

THE MARK CONSISTS OF STANDARD CHARACTERS
WITHOUT CLAIM TO ANY PARTICULAR FONT, STYLE,
SIZE, OR COLOR.

FOR UNDERGARMENTS (U.S. CLS. 22 AND 39).
JANET LEE, EXAMINING ATTORNEY

CLASS 25—(Continued).

SN 77-944,478. APPEL, ROBERT, RANCHO MIRAGE, CA. FILED 2-25-2010.



THE COLOR(S) BEIGE, BLUE, YELLOW, BLACK AND WHITE IS/ARE CLAIMED AS A FEATURE OF THE MARK.

THE MARK CONSISTS OF A CIRCLE OUTLINED IN YELLOW WITH A BEIGE EXTERIOR AND YELLOW STARS WITH THE WORDS "LITTLE MISS PRESIDENT" IN BLUE, A DARK BLUE INTERIOR WITH A BORDER OF WHITE STARS AND A YOUNG GIRL'S FACE WITH YELLOW HAIR AND A BANNER BELOW WITH THE WORDS "LITTLE MISS PRESIDENT" IN BLACK.

FOR BABY BODYSUITS; BABY BOTTOMS; BABY BUNTING; BABY LAYETTES FOR CLOTHING; BABY TOPS; BIBS NOT OF CLOTH OR PAPER; BIBS NOT OF PAPER; BONNETS; BOOTIES; CHILDREN'S AND INFANT'S APPAREL, NAMELY, JUMPERS, OVERALL SLEEPWEAR, PAJAMAS, ROMPERS AND ONE-PIECE GARMENTS; CHILDREN'S AND INFANTS' CLOTH BIBS; CHILDREN'S CLOTH EATING BIBS; CHILDREN'S HEADWEAR; CLOTH BIBS; CLOTH DIAPERS; HATS FOR INFANTS, BABIES, TODDLERS AND CHILDREN; INFANT AND TODDLER ONE PIECE CLOTHING; INFANT CLOTH DIAPERS; INFANT DIAPER COVERS; INFANT SLEEPERS; INFANT WEAR; INFANTS' SHOES AND BOOTS; INFANTS' TROUSERS; INFANTWEAR (U.S. CLS. 22 AND 39).

GIANCARLO CASTRO, EXAMINING ATTORNEY

CLASS 25—(Continued).

SN 77-945,512. WORLD WRESTLING ENTERTAINMENT, INC., STAMFORD, CT. FILED 2-25-2010.

FATAL FOUR WAY

THE MARK CONSISTS OF STANDARD CHARACTERS WITHOUT CLAIM TO ANY PARTICULAR FONT, STYLE, SIZE, OR COLOR.

FOR CLOTHING, NAMELY, TOPS, TANK TOPS, T-SHIRTS, SHIRTS, SPORT SHIRTS, DRESS SHIRTS, POLO SHIRTS, UNDERSHIRTS, SWEATSHIRTS, SWEATERS, PULLOVERS, BLOUSES, JACKETS, RAINCOATS, OVERCOATS, TOPCOATS, BOTTOMS, TROUSERS, PANTS, JEAN PANTS, JOGGING SUITS, EXERCISE PANTS, EXERCISE SUITS, SWEATPANTS, SHORTS, UNDERWEAR, BOXER SHORTS, SOCKS, CLOTHING TIES, PAJAMAS, BELTS, GLOVES, HALLOWEEN AND MASQUERADE COSTUMES, WRIST BANDS, BANDANNAS; FOOTWEAR, NAMELY, SHOES, SNEAKERS, BOOTS, SLIPPERS; HEADWEAR, NAMELY, HATS, CAPS (U.S. CLS. 22 AND 39).

JOHN HWANG, EXAMINING ATTORNEY

SN 77-945,518. WORLD WRESTLING ENTERTAINMENT, INC., STAMFORD, CT. FILED 2-25-2010.

SN 77-945,019. CASSELS, DEREK, TUSCALOOSA, AL. FILED 2-25-2010.

CUP-N-DUCKS

THE MARK CONSISTS OF STANDARD CHARACTERS WITHOUT CLAIM TO ANY PARTICULAR FONT, STYLE, SIZE, OR COLOR.

FOR HATS; JACKETS; POLO SHIRTS; SHIRTS; T-SHIRTS; VISORS (U.S. CLS. 22 AND 39).

LINDA ESTRADA, EXAMINING ATTORNEY

THE MARK CONSISTS OF STANDARD CHARACTERS WITHOUT CLAIM TO ANY PARTICULAR FONT, STYLE, SIZE, OR COLOR.

OWNER OF U.S. REG. NO. 3,532,434.
FOR CLOTHING, NAMELY, TOPS, TANK TOPS, T-SHIRTS, SHIRTS, SPORT SHIRTS, DRESS SHIRTS, POLO SHIRTS, UNDERSHIRTS, SWEATSHIRTS, SWEATERS, PULLOVERS, BLOUSES, JACKETS, RAINCOATS, OVERCOATS, TOPCOATS, BOTTOMS, TROUSERS, PANTS, JEAN PANTS, JOGGING SUITS, EXERCISE PANTS, EXERCISE SUITS, SWEATPANTS, SHORTS, UNDERWEAR, BOXER SHORTS, SOCKS, CLOTHING TIES, PAJAMAS, BELTS, GLOVES, HALLOWEEN AND MASQUERADE COSTUMES, WRIST BANDS, BANDANNAS; FOOTWEAR, NAMELY, SHOES, SNEAKERS, BOOTS, SLIPPERS; HEADWEAR, NAMELY, HATS, CAPS (U.S. CLS. 22 AND 39).

JOHN HWANG, EXAMINING ATTORNEY

MONEY IN THE BANK

CLASS 25—(Continued).

SN 77-945,566. MIZUNO USA, INC., NORCROSS, GA. FILED 2-26-2010.

AEROLITE [X]

THE MARK CONSISTS OF STANDARD CHARACTERS WITHOUT CLAIM TO ANY PARTICULAR FONT, STYLE, SIZE, OR COLOR.

OWNER OF U.S. REG. NO. 3,034,612.

FOR ATHLETIC FOOTWEAR, ATHLETIC UNIFORMS, GLOVES, GOLF SHIRTS, GOLF SHOES, HATS, HEADBANDS, HEADWEAR, JACKETS, SWEAT PANTS, SWEAT SHIRTS, SUN VISORS, SWEATERS, SWIMSUITS, T-SHIRTS, TANK TOPS, TURTLENECKS, UNDERSHIRTS, VESTS, WARM-UP PANTS, WARM-UP JACKETS, WARM-UP SUITS, WIND-RESISTANT JACKETS, WIND-RESISTANT PANTS, AND WRISTBANDS, CAPS, HATS, HEADBANDS, HEADWEAR (U.S. CLS. 22 AND 39).

CAROLYN CATALDO, EXAMINING ATTORNEY

SN 77-946,329. HAWLEY, DONALD, LAKEWOOD RANCH, FL. FILED 2-26-2010.



THE MARK CONSISTS OF A CHARACTER WEARING A LARGE HAT WITH LARGE EYES, WEARING A SHIRT, PANTS AND A SASH AT THE WAIST. THE CHARACTER'S HANDS AND FEET END IN ROUNDED TIPS.

FOR ANKLE SOCKS; ANKLETS; ATHLETIC APPAREL, NAMELY, SHIRTS, PANTS, JACKETS, FOOTWEAR, HATS AND CAPS, ATHLETIC UNIFORMS; BANDANAS; BASEBALL CAPS; BATHING CAPS BATHING SUITS; BEACH COVER-UPS; BEACH FOOTWEAR; BEACH SHOES; BEACHWEAR; BIKINIS; BLOUSES; BOARD SHORTS; BOXER BRIEFS; BRIEFS; BUTTON-FRONT ALOHA SHIRTS; CAPS; VISORS; CAPRI PANTS; CAPRIS; CAPS CHILDREN'S AND INFANTS' CLOTH BIBS; CHILDREN'S AND INFANT'S APPAREL, NAMELY, JUMPERS, OVERALL SLEEPWEAR, PAJAMAS, ROMPERS AND ONE-PIECE GARMENTS; CHILDREN'S HEADWEAR; COATS FOR MEN AND WOMEN; CYCLISTS' JERSEYS DENIM JACKETS; DENIMS; DICKIES; DRESSES; DUNGAREES; FISHING SHIRTS; FISHING VESTS; FLIP FLOPS; FOOTWEAR FOR MEN AND WOMEN; GLOVES GOLF CAPS; GOLF PANTS, SHIRTS AND SKIRTS; GOLF SHIRTS GOLF SHORTS; GYM PANTS; GYM SHORTS; GYM SUITS; HALTER TOPS; HATS; HATS FOR INFANTS, BABIES, TODDLERS AND CHILDREN; HEAD SCARVES; HEAD SWEATBANDS; HEAD WEAR HOODED PULLOVERS; HOODED SWEAT SHIRTS; HOODS INFANT AND TODDLER ONE PIECE CLOTHING; JACKETS; JEANS; JERSEYS; JOGGING OUTFITS; JOGGING PANTS JOGGING SUITS; JUMPSUITS; LADIES' UNDERWEAR; LEATHER BELTS;

CLASS 25—(Continued).

LEATHER COATS; LEATHER HEADWEAR LEATHER JACKETS; LEG WARMERS; LEISURE SHOES; LEOTARDS AND TIGHTS FOR WOMEN, MEN AND CHILDREN OF NYLON, COTTON OR OTHER TEXTILE FIBERS; LINGERIE; LOUNGEWEAR; MARTIAL ARTS UNIFORMS; MATERNITY SLEEPWEAR; MEN'S AND WOMEN'S JACKETS, COATS, TROUSERS, VESTS; MEN'S UNDERWEAR; MINISKIRTS; MITTENS; MOISTURE-WICKING SPORTS SHIRTS; MOISTURE-WICKING SPORTS PANTS; MOISTURE-WICKING SPORTS BRAS; NECKTIES; ONE PIECE GARMENT FOR INFANTS AND TODDLERS; PAJAMA BOTTOMS; PAJAMAS; PANTIES, SHORTS AND BRIEFS; PANTS; POLO SHIRTS; RAINCOATS; ROBES; RUGBY SHIRTS; SANDALS; SANDALS AND BEACH SHOES; SANDAL-CLOGS SHIRTS; SHIRTS AND SHORT-SLEEVED SHIRTS; SHIRTS FOR INFANTS, BABIES, TODDLERS AND CHILDREN; SHORTS; SHORT-SLEEVED OR LONG-SLEEVED T-SHIRTS; SHORT-SLEEVED SHIRTS; SKIRTS; SKIRTS AND DRESSES; SKIWEAR; SKULL CAPS; SKULLIES; SNOW BOARDING SUITS; SOCKS; SPORTS JERSEYS; SUN-DRESSES; SUNSUITS; SURF WEAR; SUSPENDERS; SWEAT BANDS; SWEAT JACKETS; SWEAT PANTS; SWEAT SHIRTS SWEAT SHORTS; SWEAT SUITS; SWEATBANDS; SWEATERS; SWEATSOCKS; SWIM CAPS; SWIM TRUNKS; SWIM WEAR; SWIMMING CAPS; SWIMSUITS; SWIMWEAR; TANK TOPS; TANKINIS; TEDDIES; TEE SHIRTS; TENNIS WEAR; THONGS; TIES; T-SHIRTS; UNDERWEAR; WET SUITS; WETSUITS; WINDJAMMERS; YOGA PANTS; YOGA SHIRTS (U.S. CLS. 22 AND 39).

ELIZABETH KAJUBI, EXAMINING ATTORNEY

SN 77-946,425. DR. SEUSS ENTERPRISES, L.P., LA JOLLA, CA. FILED 2-26-2010.



THE MARK CONSISTS OF THE STYLIZED IMAGE OF A BIRD WITH A LARGE BEAK.

FOR CLOTHING, NAMELY, T-SHIRTS (U.S. CLS. 22 AND 39).

FIRST USE 10-0-2006; IN COMMERCE 10-0-2006.

APRIL ROACH, EXAMINING ATTORNEY

CLASS 25—(Continued).

SN 77-947,572. CASUAL FREEDOM INC., CITY OF COMMERCE, CA. FILED 3-1-2010.

CASUAL FREEDOM

THE MARK CONSISTS OF STANDARD CHARACTERS WITHOUT CLAIM TO ANY PARTICULAR FONT, STYLE, SIZE, OR COLOR.

NO CLAIM IS MADE TO THE EXCLUSIVE RIGHT TO USE "CASUAL", APART FROM THE MARK AS SHOWN.

FOR CLOTHING, NAMELY, WOMEN'S CONTEMPORARY TOPS, SHIRTS, JEANS, DRESSES, PANTS, JACKETS, T-SHIRTS, BLOUSES, SCARVES, AND VESTS (U.S. CLS. 22 AND 39).

FIRST USE 5-31-2003; IN COMMERCE 2-28-2008.
MARC LEIPZIG, EXAMINING ATTORNEY

SN 77-948,719. CERVANTES, GIOVANNI T, DBA BITCH SLAP!, IRVING, TX. AND CERVANTES KATHY A, DBA BITCH SLAP!, IRVING, WA. AND HUGHES, RONALD L, DBA BITCH SLAP!, IRVING, TX. FILED 3-2-2010.

BITCH SLAP!

THE MARK CONSISTS OF STANDARD CHARACTERS WITHOUT CLAIM TO ANY PARTICULAR FONT, STYLE, SIZE, OR COLOR.

FOR ADULT NOVELTY GAG CLOTHING ITEM, NAMELY, SOCKS; BABY LAYETTES FOR CLOTHING; BELTS; BELTS FOR CLOTHING; BELTS MADE OUT OF CLOTH; BIBS NOT OF CLOTH OR PAPER; BOTTOMS; CHILDREN'S AND INFANTS' CLOTH BIBS; CHILDREN'S CLOTH EATING BIBS; CLOTH BIBS; CLOTH BIBS FOR ADULT DINERS; CLOTH BIBS FOR USE BY SENIOR CITIZENS OR PHYSICALLY- OR MENTALLY-CHALLENGED PERSONS; CLOTH DIAPERS; CLOTHING FOR ATHLETIC USE, NAMELY, PADDED ELBOW COMPRESSION SLEEVES BEING PART OF AN ATHLETIC GARMENT; CLOTHING FOR ATHLETIC USE, NAMELY, PADDED PANTS; CLOTHING FOR ATHLETIC USE, NAMELY, PADDED SHIRTS; CLOTHING FOR ATHLETIC USE, NAMELY, PADDED SHORTS; CLOTHING FOR WEAR IN JUDO PRACTICES; CLOTHING FOR WEAR IN WRESTLING GAMES; CLOTHING ITEMS, NAMELY, ADHESIVE POCKETS THAT MAY BE AFFIXED DIRECTLY TO THE BODY AS A DECORATIVE PIECE OF CLOTHING WITH UTILITY; CLOTHING ITEMS, NAMELY, ADHESIVE POCKETS THAT MAY BE AFFIXED DIRECTLY TO THE INSIDE OF CLOTHING FOR STORAGE AND SAFEKEEPING OF PERSONAL ITEMS; CLOTHING, NAMELY, ARM WARMERS; CLOTHING, NAMELY, BASE LAYERS; CLOTHING, NAMELY, FOLK COSTUMES; CLOTHING, NAMELY, HAND-WARMERS; CLOTHING, NAMELY, KHAKIS; CLOTHING, NAMELY, KNEE WARMERS; CLOTHING, NAMELY, MATERNITY BANDS; CLOTHING, NAMELY, NECK TUBES; CLOTHING, NAMELY, THOBES; CLOTHING, NAMELY, WRAP-AROUNDS; CORSETS; DUSTERS; EYESHADES; FOULARDS; GLOVES AS CLOTHING; HEADBANDS FOR CLOTHING; HOODS; INFANT AND TODDLER ONE PIECE CLOTHING; IN-

CLASS 25—(Continued).

FANT CLOTH DIAPERS; JACKETS; JERSEYS; LEATHER BELTS; MANTLES; MUFFLERS; NON-DISPOSABLE CLOTH TRAINING PANTS; PAPER HATS FOR USE AS CLOTHING ITEMS; PARTS OF CLOTHING, NAMELY, GUSSETS FOR TIGHTS, GUSSETS FOR STOCKINGS, GUSSETS FOR BATHING SUITS, GUSSETS FOR UNDERWEAR, GUSSETS FOR LEOTARDS AND GUSSETS FOR FOOTLETS; PARTS OF CLOTHING, NAMELY, UNDERARM GUSSETS; PARTY HATS; PERSPIRATION ABSORBENT UNDERWEAR CLOTHING; POCKET SQUARES; SHIRTS; SHORT SETS; SHOULDER WRAPS; SHOULDER WRAPS FOR CLOTHING; SWADDLING CLOTHES; TIES; TOPS; TRAVEL CLOTHING CONTAINED IN A PACKAGE COMPRISING REVERSIBLE JACKETS, PANTS, SKIRTS, TOPS AND A BELT OR SCARF; TRIATHLON CLOTHING, NAMELY, TRIATHLON TIGHTS, TRIATHLON SHORTS, TRIATHLON SINGLETTS, TRIATHLON SHIRTS, TRIATHLON SUITS; UNDERARM CLOTHING SHIELDS; WEARABLE GARMENTS AND CLOTHING, NAMELY, SHIRTS; WRAPS (U.S. CLS. 22 AND 39).

DAVID H. STINE, EXAMINING ATTORNEY

SN 77-949,889. SOBEL WESTEX, LAS VEGAS, NV. FILED 3-3-2010.

SOBELCHEF

THE MARK CONSISTS OF STANDARD CHARACTERS WITHOUT CLAIM TO ANY PARTICULAR FONT, STYLE, SIZE, OR COLOR.

OWNER OF U.S. REG. NOS. 2,700,469, 3,590,854 AND OTHERS.

FOR CLOTHING, NAMELY, CHEF'S COATS, CHEF'S PANTS, AND CHEF'S HATS (U.S. CLS. 22 AND 39).

KELLY CHOE, EXAMINING ATTORNEY

SN 77-950,486. MALIBU DREAM GIRL, INC., BELL, CA. FILED 3-4-2010.

AQUA COUTURE

THE MARK CONSISTS OF STANDARD CHARACTERS WITHOUT CLAIM TO ANY PARTICULAR FONT, STYLE, SIZE, OR COLOR.

NO CLAIM IS MADE TO THE EXCLUSIVE RIGHT TO USE "COUTURE", APART FROM THE MARK AS SHOWN, FOR SWIMWEAR (U.S. CLS. 22 AND 39).

FIRST USE 12-31-1998; IN COMMERCE 12-31-1998.
BARNEY CHARLON, EXAMINING ATTORNEY

CLASS 25—(Continued).

SN 77-951,078. AMERICAN SPORTING GOODS CORPORATION, ALISO VIEJO, CA. FILED 3-4-2010.

ARCHROCKER

THE MARK CONSISTS OF STANDARD CHARACTERS WITHOUT CLAIM TO ANY PARTICULAR FONT, STYLE, SIZE, OR COLOR.

FOR FOOTWEAR (U.S. CLS. 22 AND 39).
FIRST USE 7-0-1999; IN COMMERCE 7-0-1999.
TEJBIR SINGH, EXAMINING ATTORNEY

SN 77-954,755. LMT GLOBAL LLC, ONTARIO, CA. FILED 3-9-2010.

Raw Candy

THE MARK CONSISTS OF STANDARD CHARACTERS WITHOUT CLAIM TO ANY PARTICULAR FONT, STYLE, SIZE, OR COLOR.

FOR CLOTHING, NAMELY, SHIRTS, T-SHIRTS, UNDER SHIRTS, NIGHT SHIRTS, RUGBY SHIRTS, POLO SHIRTS, CARDIGANS, JERSEYS, UNIFORMS, PANTS, TROUSERS, SUITS, BLAZERS, DRESS SHIRTS, SLACKS, JEANS, DENIM JEANS, CULOTTES, CARGO PANTS, OVERALLS, COVERALLS, JUMPERS, JUMP SUITS, SHORTS, BOXER SHORTS, TOPS, CROP TOPS, TANK TOPS, HALTER TOPS, SWEAT SHIRTS, SWEAT SHORTS, SWEAT PANTS, WRAPS, WARM-UP SUITS, JOGGING SUITS, TRACK SUITS, PLAY SUITS, BLOUSES, SKIRTS, DRESSES, GOWNS, SWEATERS, VESTS, FLEECE VESTS, PULLOVERS, SNOW SUITS, PARKAS, CAPES, ANORAKS, PONCHOS, JACKETS, SPORTS JACKETS, REVERSIBLE JACKETS, FLEECE JACKETS, COATS, TURTLENECKS, CLOTH SKI BIBS, BEACHWEAR, TENNIS WEAR, SURF WEAR, SKI WEAR, LAYETTES, INFANT WEAR, INFANTS SLEEPERS, BOOTIES, BABY BIBS NOT OF PAPER, CLOTH DIAPERS, CAPS, SWIM CAPS, BERETS, BEANIES, HATS, VISORS, HEADBANDS, WRIST BANDS, SWEAT BANDS, HEADWEAR, EAR MUFFS, APRONS, SCARVES, BANDANAS, BELTS, SUSPENDERS, NECKWEAR, NECKERCHIEFS, ASCOTS, UNDERWEAR, THERMAL UNDERWEAR, LONG UNDERWEAR, BRIEFS, SWIM AND BATHING TRUNKS, BRAS, SPORTS BRAS, BRASSIERES, BUSTIERS, CORSETS, PANTIES, THONGS, GARTERS AND GARTER BELTS, TEDDIES, GIRDLES, FOUNDATION GARMENTS, LOUNGEWEAR, ROBES, SMOCKS, UNDERCLOTHES, PAJAMAS, SLEEPWEAR, NIGHTWEAR, NIGHT GOWNS, LINGERIE, CAMISOLES, NEGLIGÉES, CHEMISES, CHEMISETTES, SLIPS, SARONGS, LEG WARMERS, PANTYHOSE, BODY STOCKINGS, KNEE HIGHS, LEGGINGS, TIGHTS, LEOTARDS, BODY SUITS, UNITARDS, BODY SHAPERS, GLOVES, MITTENS, RAINWEAR, SNEAKERS, BOOTS, GALOSHES, SANDALS, FLIP-FLOPS, AND SLIPPERS; FOOTWEAR, SHOES, HOSE, SOCKS, AND SWIMWEAR; MEN'S FORMALWEAR, NAMELY, SUITS, BLAZERS, JACKETS, TROUSERS, DRESS SHIRTS, TIES, COATS, RAIN COATS AND TRENCH COATS (U.S. CLS. 22 AND 39).
APRIL ROACH, EXAMINING ATTORNEY

CLASS 25—(Continued).

SN 77-955,883. NU VISION GROUP LLC, NEW YORK, NY. FILED 3-10-2010.

ROCK & FREEDOM

THE MARK CONSISTS OF STANDARD CHARACTERS WITHOUT CLAIM TO ANY PARTICULAR FONT, STYLE, SIZE, OR COLOR.

FOR BEACHWEAR; BELTS; BIBS NOT OF CLOTH OR PAPER; BOTTOMS; COVERALLS; COVERUPS; FOOTWEAR; HEAD WEAR; HOODED PULLOVERS; HOSIERY; JACKETS; JOGGING OUTFITS; LINGERIE; LOUNGEWEAR; NECKWEAR; PANTS; PULLOVERS; ROBES; SCARVES; SHIRTS; SHORTS; SLEEPWEAR; SWEAT SUITS; SWEATERS; SWIMWEAR; TOPS; UNDERWEAR; WARM UP OUTFITS (U.S. CLS. 22 AND 39).
JUSTINE D. PARKER, EXAMINING ATTORNEY

SN 77-960,424. KABUSHIKI GAISHA PEACE NOW, SHIBUYA-KU, TOKYO, JAPAN, FILED 3-16-2010.



OWNER OF JAPAN REG. NO. 5165121, DATED 9-5-2008, EXPIRES 9-5-2018.

FOR APRONS; BANDANAS; COATS; DRESS SHIRTS; DRESS SUITS; DRESSES; EAR MUFFS; GLOVES; JACKETS; NECKTIES; PANTS; SCARFS; SHAWLS; SHIRTS; SOCKS; SWEATERS; T-SHIRTS (U.S. CLS. 22 AND 39).
FIRST USE 12-17-2007; IN COMMERCE 11-0-2008.
SETH A. RAPPAPORT, EXAMINING ATTORNEY

SN 77-960,474. SKECHERS U.S.A., INC. II, MANHATTAN BEACH, CA. FILED 3-16-2010.

**MAKE YOUR BOTTOM HALF YOUR
BETTER HALF**

THE MARK CONSISTS OF STANDARD CHARACTERS WITHOUT CLAIM TO ANY PARTICULAR FONT, STYLE, SIZE, OR COLOR.

FOR APPAREL, NAMELY, TOPS, SHIRTS, BLOUSES, T-SHIRTS, SWEAT SHIRTS, SPORTS JERSEYS, SWEATERS, BOTTOMS, TROUSERS, PANTS, SWEAT PANTS, SHORTS, JACKETS, COATS, OVERCOATS, PULLOVERS, JUMPERS, DRESSES, SKIRTS, BEACHWEAR, SWIMSUITS, UNDERWEAR, LINGERIE, HEADWEAR, HATS, CAPS, BEANIES, VISORS, TIES, SOCKS, BELTS, GLOVES, SCARVES AND WRISTBANDS (U.S. CLS. 22 AND 39).
JENNY PARK, EXAMINING ATTORNEY

CLASS 25—(Continued).

SN 77-960,807. SELBY, MICHAEL, RENO, NV. FILED 3-17-2010.

POWDER TRIBE

THE MARK CONSISTS OF STANDARD CHARACTERS WITHOUT CLAIM TO ANY PARTICULAR FONT, STYLE, SIZE, OR COLOR.

FOR HATS; HOODED PULLOVERS; HOODED SWEAT SHIRTS; HOODS; SWEAT SHIRTS; T-SHIRTS (U.S. CLS. 22 AND 39).

KAREN SEVERSON, EXAMINING ATTORNEY

CLASS 25—(Continued).

SN 77-968,106. HAWKES, BONNIE, BUXTON, ME. FILED 3-25-2010.

STRINGBEANIES

THE MARK CONSISTS OF STANDARD CHARACTERS WITHOUT CLAIM TO ANY PARTICULAR FONT, STYLE, SIZE, OR COLOR.

FOR HATS FOR INFANTS, BABIES, TODDLERS AND CHILDREN (U.S. CLS. 22 AND 39).

DARRYL SPRUILL, EXAMINING ATTORNEY

SN 77-962,652. COLOR IMAGE APPAREL, INC., COMMERCE, CA. FILED 3-18-2010.

LITTLE BELLA

THE MARK CONSISTS OF STANDARD CHARACTERS WITHOUT CLAIM TO ANY PARTICULAR FONT, STYLE, SIZE, OR COLOR.

OWNER OF U.S. REG. NOS. 3,158,111, 3,519,794 AND OTHERS.

THE ENGLISH TRANSLATION OF "BELLA" IN THE MARK IS "BEAUTIFUL".

FOR WOMEN'S CLOTHING, NAMELY, TEE SHIRTS, SHORT SLEEVE SHIRTS, LONG SLEEVE SHIRTS, TANK TOPS, FLEECE TOPS, FLEECE PANTS, SHIRTS, PANTS, YOGA PANTS, CAPRI PANTS, SHORTS, BRAS, UNDERWEAR, CAMISOLES, SWEATSHIRTS, POLO SHIRTS, AND JACKETS (U.S. CLS. 22 AND 39).

DANNEAN HETZEL, EXAMINING ATTORNEY

SN 77-968,803. ACI INTERNATIONAL, LOS ANGELES, CA. FILED 3-25-2010.

RUN N FIT

THE MARK CONSISTS OF STANDARD CHARACTERS WITHOUT CLAIM TO ANY PARTICULAR FONT, STYLE, SIZE, OR COLOR.

FOR FOOTWEAR (U.S. CLS. 22 AND 39).

HAI-LY LAM, EXAMINING ATTORNEY

SN 77-965,059. ACI INTERNATIONAL, LOS ANGELES, CA. FILED 3-22-2010.

JOG N TONE

THE MARK CONSISTS OF STANDARD CHARACTERS WITHOUT CLAIM TO ANY PARTICULAR FONT, STYLE, SIZE, OR COLOR.

FOR FOOTWEAR (U.S. CLS. 22 AND 39).

HAI-LY LAM, EXAMINING ATTORNEY

SN 77-970,124. FREMANTLEMEDIA NORTH AMERICA, INC., BURBANK, CA. FILED 3-26-2010.

DOWNFALL

THE MARK CONSISTS OF STANDARD CHARACTERS WITHOUT CLAIM TO ANY PARTICULAR FONT, STYLE, SIZE, OR COLOR.

FOR CLOTHING, NAMELY, HEADWEAR, FOOTWEAR, SHIRTS, PANTS, SHORTS, DRESSES, SKIRTS, BLOUSES, JACKETS, COATS, SWEATERS, SCARVES, GLOVES, UNDERWEAR, FOUNDATION GARMENTS, HOSIERY, NECKTIES, NIGHTWEAR, SWEAT BANDS, SWIMWEAR, LEOTARDS, LEG WARMERS, BELTS, LAYETTES, APRONS, UNIFORMS, BOAS, HALLOWEEN COSTUMES, COSTUMES FOR USE IN ROLE-PLAYING GAMES, INFANTWEAR, RAINWEAR (U.S. CLS. 22 AND 39).

AMEEN IMAM, EXAMINING ATTORNEY

CLASS 25—(Continued).

SN 78-181,419. HYDEN, MIKE, CARLSBAD, NM. FILED 11-4-2002.



FOR CLOTHING, NAMELY, SHIRTS, SHORTS, T-SHIRTS, POLO SHIRTS, GOLF SHIRTS, TANK TOPS, JOGGING SUITS, SOCKS, UNDERWEAR, JACKETS, SWEATERS, VESTS, PANTS, PONCHOS, VISORS, RAINCOATS, HATS, CAPS, CLOTH BABY BIBS, TIES, PAJAMAS, BABY PANTS, BABY BOOTIES AND SHORT SETS, SWEATSHIRTS, MITTENS, GLOVES, KNITTED HATS, SCARVES, HOSIERY, WRIST BANDS, HEAD BANDS, ROBES, APRONS, SHOES, CLOTH DIAPER SETS, WIND RESISTANT JACKETS, JUMPSUITS, SWEATPANTS, OVERALLS, BANDANAS, BEACHWEAR, BATHING SUITS, BELTS, BERMUDA SHORTS, BLOUSES, COATS, DRESSES, GYM SUITS, HEAD WEAR, LEATHER JACKETS, JERSEYS, PULLOVERS, ROMPERS, RAINWEAR, PARKAS, NIGHT SHIRTS, NECKWEAR, V-NECK SWEATERS AND KNIT SHIRTS (U.S. CLS. 22 AND 39).

HOWARD SMIGA, EXAMINING ATTORNEY

CLASS 25—(Continued).

SN 78-181,425. HYDEN, MIKE, CARLSBAD, NM. FILED 11-4-2002.



FOR CLOTHING, NAMELY, SHIRTS, SHORTS, T-SHIRTS, POLO SHIRTS, GOLF SHIRTS, TANK TOPS, JOGGING SUITS, SOCKS, UNDERWEAR, JACKETS, SWEATERS, VESTS, PANTS, PONCHOS, VISORS, RAINCOATS, HATS, CAPS, CLOTH BABY BIBS, TIES, PAJAMAS, BABY PANTS, BABY BOOTIES AND SHORT SETS, SWEATSHIRTS, MITTENS, GLOVES, KNITTED HATS, SCARVES, HOSIERY, WRIST BANDS, HEAD BANDS, ROBES, APRONS, SHOES, CLOTH DIAPER SETS, WIND RESISTANT JACKETS, JUMPSUITS, SWEATPANTS, OVERALLS, BANDANAS, BEACHWEAR, BATHING SUITS, BELTS, BERMUDA SHORTS, BLOUSES, COATS, DRESSES, GYM SUITS, HEAD WEAR, LEATHER JACKETS, JERSEYS, PULLOVERS, ROMPERS, RAINWEAR, PARKAS, NIGHT SHIRTS, NECKWEAR, V-NECK SWEATERS AND KNIT SHIRTS (U.S. CLS. 22 AND 39).

HOWARD SMIGA, EXAMINING ATTORNEY

SN 78-683,035. CHANG, HYOSIK, LOS ANGELES, CA. FILED 8-1-2005.

Cocomo Apparel, Inc.

THE MARK CONSISTS OF STANDARD CHARACTERS WITHOUT CLAIM TO ANY PARTICULAR FONT, STYLE, SIZE, OR COLOR.

NO CLAIM IS MADE TO THE EXCLUSIVE RIGHT TO USE "APPAREL, INC.", APART FROM THE MARK AS SHOWN.

FOR DRESSES; HALTER TOPS; JACKETS; PANTS; SKIRTS; SKIRTS AND DRESSES; TANK TOPS; TANK-TOPS; TOPS (U.S. CLS. 22 AND 39).

FIRST USE 12-1-2000; IN COMMERCE 12-1-2000.

HOWARD B. LEVINE, EXAMINING ATTORNEY

CLASS 25—(Continued).

SN 78-809,095. BANGG! JUST BRING IT!, INC., MANHASSET HILLS, NY. FILED 2-7-2006.

BLING IT!

THE MARK CONSISTS OF STANDARD CHARACTERS WITHOUT CLAIM TO ANY PARTICULAR FONT, STYLE, SIZE, OR COLOR.

FOR BLOUSES; BRIEFS; DENIMS; FOOTWEAR FOR MEN AND WOMEN; HEADGEAR, NAMELY, HATS, CAPS AND HEAD BANDS; JACKETS; NECKWEAR; PANTS; SHIRTS; SHORT-SLEEVED OR LONG-SLEEVED T-SHIRTS; SHORTS; SKIRTS; SLEEP SHIRTS; SPORT SHIRTS; SWEAT PANTS; SWEAT SHIRTS; T-SHIRTS; UNDERWEAR; WOMEN'S UNDERWEAR (U.S. CLS. 22 AND 39).

KELLY TRUSILO, EXAMINING ATTORNEY

SN 79-068,895. DAVID AUSTIN, MIAMI, AUSTRALIA, FILED 5-11-2009.

KANGABOY

THE MARK CONSISTS OF STANDARD CHARACTERS WITHOUT CLAIM TO ANY PARTICULAR FONT, STYLE, SIZE, OR COLOR.

OWNER OF INTERNATIONAL REGISTRATION 1002919 DATED 5-11-2009, EXPIRES 5-11-2019.

FOR T-SHIRTS; SINGLET; VESTS; BASEBALL CAPS AND HATS; SWIM SUITS; SWEAT BANDS; SHORTS; BABY BIBS NOT OF PAPER; BABY BODYSUITS; BABY TOPS; BEACHWEAR; BEANIES; BOARD SHORTS; BOXER BRIEFS; BOXER SHORTS; BRIEFS UNDERWEAR; CHILDREN'S AND INFANT'S APPAREL, NAMELY, JUMPERS, OVERALL SLEEPWEAR, PAJAMAS, ROMPERS AND ONE-PIECE GARMENTS; CHILDREN'S HEADWEAR; CLOTH DIAPERS; FLIP FLOPS FOOTWEAR; FOOTWEAR FOR MEN AND WOMEN; GLOVES; GYM SHORTS; HOODED SWEAT SHIRTS; JACKETS AND SOCKS; MEN'S UNDERWEAR; MUSCLE TOPS; SHORTS; SOCKS; SWIM WEAR (U.S. CLS. 22 AND 39).

JILL C. ALT, EXAMINING ATTORNEY

CLASS 25—(Continued).

SN 79-070,609. NYKY S.R.L., ITALY, FILED 4-1-2009.

momoni

PRIORITY DATE OF 12-16-2008 IS CLAIMED. OWNER OF INTERNATIONAL REGISTRATION 1006941 DATED 4-1-2009, EXPIRES 4-1-2019.

THE MARK CONSISTS OF A SIGN DEPICTING THE WORDING "MOMONI", IN FANCY CHARACTERS.

FOR BRASSIERES; CORSETS, BEING CLOTHING; CORSELETS, SINGLET, PETTICOATS, BODICES, BODY SUITS, LEOTARDS, TANK TOPS, UNDERSHIRTS, VESTS, PANTIES, UNDERPANTS, BRIEFS, G-STRINGS, THONGS, CULOTTES, BOXER SHORTS, DRAWERS, GARTERS; SUSPENDERS, SUSPENDER BELTS; UNDERWEAR, NIGHTGOWNS, PAJAMAS, DRESSING GOWNS, PULLOVERS, BATH ROBES, BATHING SUITS, BATHING CAPS; GLOVES AND MUFFS, BEING CLOTHING; CARDIGANS; JERSEYS, BEING CLOTHING; NECKTIES, NECKERCHIEFS, SCARVES, SWEATERS, SOCKS, STOCKINGS, SWEAT-ABSORBENT STOCKINGS, TIGHTS, TROUSERS, LEGGINGS, SKIRTS, JACKETS, JERKINS, SHIRTS, POLO SHIRTS, WAISTCOATS, JUMPERS, TRACK SUITS, BLOUSES, JEANS, PANTS, BERMUDA SHORTS, SHORTS, T-SHIRTS, SWEAT-SHIRTS, SUITS AND DRESSES, OVERCOATS, ANORAKS, COATS, RAINCOATS, KIMONOS, OVERALLS, SHAWLS, WINDCHEATERS, MITTENS; FOU-LARDS, BEING CLOTHING; PANTYHOSES; DANCE COSTUMES, MASQUERADE COSTUMES, SASHES FOR WEAR; BELTS, BEING CLOTHING; WAISTBANDS, BRACES; LOUNGEWEAR, BEACHWEAR, SLEEPWEAR, HEADWEAR, FOOTWEAR; NON-SLIPPING DEVICES FOR BOOTS AND SHOES, NAMELY, HEELPIECES FOR BOOTS AND SHOES, WELTS FOR BOOTS AND SHOES, HEELS, TIPS FOR FOOTWEAR, SOLES FOR FOOTWEAR, FOOTWEAR UPPERS, INNER SOLES (U.S. CLS. 22 AND 39).

JANICE KIM, EXAMINING ATTORNEY

SN 79-071,511. ORELLANA UNO, S.L., SPAIN, FILED 3-11-2009.



PRIORITY DATE OF 11-3-2008 IS CLAIMED. OWNER OF INTERNATIONAL REGISTRATION 1009299 DATED 3-11-2009, EXPIRES 3-11-2019.

THE MARK CONSISTS OF THE LETTERS "BDDB" INSIDE OF A RECTANGULAR BACKGROUND

FOR CLOTHING, NAMELY, WEDDING DRESSES, COCKTAIL DRESSES, INFANT AND TODDLER ONE-PIECE CLOTHING, SWIMMING SUITS, BIKINIS; INNER WEAR IN THE NATURE OF SLEEPWEAR, PAJAMAS, LOUNGEWEAR, ROBES, BRAS, KNICKERS, LOUNGEWEAR, THERMAL UNDERWEAR, UNDERWEAR, CAMISOLES; BELTS, BLOUSES, SHIRTS, T-SHIRTS, TUNICS, PULLOVERS, TROUSERS, SHORTS, LEGGINGS, SKIRTS, DRESSES, BLAZERS, JACKETS, VESTS, COATS, PONCHOS, BOLEROS, CAPES, PARKAS, GLOVES, HAND WARMERS, MITTENS, SCARVES, MUFFLERS, SOCKS, STOCKINGS, SHOES; HEADWEAR, INCLUDING, HATS, WOVEN CAPS, KNIT CAPS, BROAD-BRIMMED HATS AND BERETS (U.S. CLS. 22 AND 39).

TINA BROWN, EXAMINING ATTORNEY

CLASS 25—(Continued).

SN 79-072,313. AB CREATION CONSEIL, F-75006 PARIS, FRANCE, FILED 8-7-2009.

CITIZEN LOVERS

THE MARK CONSISTS OF STANDARD CHARACTERS WITHOUT CLAIM TO ANY PARTICULAR FONT, STYLE, SIZE, OR COLOR.

OWNER OF INTERNATIONAL REGISTRATION 1011604 DATED 8-7-2009, EXPIRES 8-7-2019.

FOR CLOTHING, NAMELY, T-SHIRTS, SHIRTS, CARDIGANS, BLOUSES, BODY SUITS, COATS, OVERCOATS, PARKAS, JACKETS, PANTS, SKIRTS, DRESSES, PETTICOATS, BELTS, SCARVES, SHAWLS, COLLAR PROTECTORS, KIMONOS, MUFFS, SUITS, TUNICS, WAISTCOATS, JEANS, SHORTS, TROUSERS, JUMPSUITS, UNDERWEAR, BRAS, SLIPS, BUSTIERS, HOTPANTS IN THE NATURE OF TIGHT PANTS AND SHORTS, CAMISOLES, SUSPENDERS, PAJAMAS, CHEMISES, TEDDIES, STUFFED JACKETS, OVERALLS, JUMPERS, JERSEYS, PANTYHOSE, LEGGINGS, TIGHTS, SOCKS, STOCKINGS, LONG JOHNS, SINGLET, SWIMWEAR, BIKINIS, SARONGS, PONCHOS, SARIS, PULLOVERS, BANDANAS, POLO SHIRTS, HOODS, ANORAKS, WIND RESISTANT JACKETS, TANK TOPS, SLIPPERS, NECKWEAR, TIES, MITTENS, RAINWEAR, LINGERIE, GLOVES, SPORTSWEAR, NAMELY, JOGGING SUITS, SKIWEAR, LEOTARD, SWEATPANTS, SWEATSHIRTS, HOSIERY, EAR MUFFS, SHOES; HEADGEAR, NAMELY, CAPS, HATS, HEADBANDS, BERETS; PREGNANCYWEAR IN THE NATURE OF MATERNITY BANDS, BRAS, LINGERIE, JEANS, BLOUSES, SHIRTS, TOPS, SKIRTS, AND PANTS (U.S. CLS. 22 AND 39).

MARCIE MILONE, EXAMINING ATTORNEY

SN 79-072,469. "LOWA" SPORTSCHUHE GMBH, FED REP GERMANY, FILED 6-10-2009.

TRAC

THE MARK CONSISTS OF STANDARD CHARACTERS WITHOUT CLAIM TO ANY PARTICULAR FONT, STYLE, SIZE, OR COLOR.

PRIORITY DATE OF 3-12-2009 IS CLAIMED.

OWNER OF INTERNATIONAL REGISTRATION 1012014 DATED 6-10-2009, EXPIRES 6-10-2019.

FOR CLOTHING, NAMELY, SKI WEAR, JACKETS, ANORAKS AND PARKAS, TROUSERS AND PANTS, SHORTS, T-SHIRTS, SWEATERS AND VESTS; HEADGEAR, NAMELY, HATS AND CAPS; FOOTWEAR; HEELS FOR SHOES, HEEL PIECES FOR SHOES; INSOLES; SHOE BINDERS IN THE NATURE OF SHOE STRAPS; SHOE SOLES; SKI AND HIKING BOOTS; BOOTS; TREKKING SHOES AND SPORTS SHOES (U.S. CLS. 22 AND 39).

MELISSA VALLILLO, EXAMINING ATTORNEY

CLASS 25—(Continued).

SN 79-072,626. GISAD DIS TICARET ANONIM SIRKETI, TURKEY, FILED 6-30-2009.

JAFT

OWNER OF INTERNATIONAL REGISTRATION 1012506 DATED 6-30-2009, EXPIRES 6-30-2019.

FOR UNDERCLOTHING AND OUTER CLOTHING MADE OF ALL KINDS OF MATERIAL OTHER THAN FOR PROTECTIVE PURPOSES, NAMELY, PANTS, SHIRTS, AND UNDERWEAR; SOCKS, FOOTWEAR, HEADWEAR (U.S. CLS. 22 AND 39).

CURTIS FRENCH, EXAMINING ATTORNEY

SN 79-072,807. JUNE INSPIRATION SARL, FRANCE, FILED 7-28-2009.

SpicyJune

THE MARK CONSISTS OF STANDARD CHARACTERS WITHOUT CLAIM TO ANY PARTICULAR FONT, STYLE, SIZE, OR COLOR.

PRIORITY DATE OF 2-2-2009 IS CLAIMED.

OWNER OF INTERNATIONAL REGISTRATION 1013029 DATED 7-28-2009, EXPIRES 7-28-2019.

FOR CLOTHING, NAMELY, BEACHWEAR, BIKINIS, SWIMWEAR, SWIMSUITS, SANDALS AND BEACH SHOES (U.S. CLS. 22 AND 39).

DEBRA LEE, EXAMINING ATTORNEY

SN 79-073,382. LIDL STIFTUNG & CO. KG, NECKARSULM, FED REP GERMANY, FILED 8-10-2009.

Arbonas

THE MARK CONSISTS OF STANDARD CHARACTERS WITHOUT CLAIM TO ANY PARTICULAR FONT, STYLE, SIZE, OR COLOR.

OWNER OF INTERNATIONAL REGISTRATION 1005256 DATED 5-12-2009, EXPIRES 5-12-2019.

THE WORDING "ARBONAS" HAS NO MEANING IN A FOREIGN LANGUAGE.

FOR CLOTHING, NAMELY, SHIRTS, PANTS, SLACKS, JOGGING SUITS, YOGA PANTS, EXERCISE SHORTS, SHORTS, SKIRTS, DRESSES, SOCKS, BLOUSES, T-SHIRTS, TIGHTS, JACKETS, PULLOVERS, SWEATERS, PAJAMAS, BATH ROBES, BATHING SUITS AND TRUNKS, BELTS, TIES, AND UNDERWEAR; FOOTWEAR; HEADGEAR, NAMELY, HATS AND CAPS (U.S. CLS. 22 AND 39).

FLORENTINA BLANDU, EXAMINING ATTORNEY

CLASS 25—(Continued).

SN 79-074,057. POMPEA S.P.A., ITALY, FILED 7-10-2009.



PRIORITY DATE OF 5-11-2009 IS CLAIMED.
 OWNER OF INTERNATIONAL REGISTRATION 1016474 DATED 7-10-2009, EXPIRES 7-10-2019.
 OWNER OF U.S. REG. NOS. 2,196,927, 2,261,992 AND 3,181,050.

THE MARK CONSISTS OF A SIGN DEPICTING A RHOMBOIDAL LABEL WITH PRONOUNCED ROUNDED CORNERS PLACED HORIZONTALLY, HAVING A WIDE BORDER AT THE RIGHT AND LEFT CORNERS THAT THINS AT THE UPPER AND LOWER CORNERS AND BEING OUTLINED BY A LIGHT SHADING, THIS LABEL CONTAINING THE WORDING "POMPEA" IN FANCY CHARACTERS, THE VERTICAL RIGHT-HAND STROKE OF THE LETTER "M" AND THE VERTICAL LEFT-HAND STROKE OF THE SECOND LETTER "P" COINCIDING, ALL PLACED ABOVE THE WORDING "NO STRESS" IN FANCY CHARACTERS OF A SMALLER SIZE, THE BACKGROUND OF WHICH IS SHADED THAT STARTING FROM THE LOWER PART OF THE AFORESAID LABEL EXTENDS DOWNWARDS, COLOUR IS NOT CLAIMED AS A FEATURE OF THE MARK AND IS ONLY FOR SHADING PURPOSES.

THE WORDING "POMPEA" HAS NO MEANING IN A FOREIGN LANGUAGE.

FOR UNDERWEAR, FOUNDATION GARMENTS, SWIMWEAR, BEACHWEAR, SOCKS, STOCKINGS, TIGHTS, JERSEYS, CROP TOPS, PULLOVERS, GLOVES, CARDIGANS, SWEATERS, TROUSERS, LEGGINGS, SKIRTS, JACKETS, JERKINS, SHIRTS, VESTS, WAISTCOATS, JUMPERS, TRACK SUITS, BLOUSES, BLOUSONS, JEANS, SWEAT PANTS, GYM SUITS, KNICKERS, PANTS, SHORTS, T-SHIRTS, SWEAT-SHIRTS, SUITS AND DRESSES, OVERCOATS, COATS, ANORAKS, RAINCOATS, BELTS, SUSPENDERS OR BRACES, NECKWEAR, LOUNGEWEAR, SLEEPWEAR, FOOTWEAR, HEADWEAR (U.S. CLS. 22 AND 39).

VERNA BETH RIRIE, EXAMINING ATTORNEY

SN 79-074,058. POMPEA S.P.A., ITALY, FILED 7-10-2009.



PRIORITY DATE OF 5-11-2009 IS CLAIMED.
 OWNER OF INTERNATIONAL REGISTRATION 1016474 DATED 7-10-2009, EXPIRES 7-10-2019.
 OWNER OF U.S. REG. NOS. 2,261,992 AND 3,181,050.
 THE MARK CONSISTS OF A SIGN DEPICTING A RHOMBOIDAL LABEL WITH PRONOUNCED ROUNDED

CLASS 25—(Continued).

CORNERS PLACED HORIZONTALLY, HAVING A WIDE BORDER AT THE RIGHT AND LEFT CORNERS THAT THINS AT THE UPPER AND LOWER CORNERS AND BEING OUTLINED BY A LIGHT SHADING, THIS LABEL CONTAINING THE WORDING "POMPEA" IN FANCY CHARACTERS, THE VERTICAL RIGHT-HAND STROKE OF THE LETTER M AND THE VERTICAL LEFT-HAND STROKE OF THE SECOND LETTER P COINCIDING. COLOUR IS NOT CLAIMED AS A FEATURE OF THE MARK AND IS ONLY FOR SHADING PURPOSES.

THE WORDING "POMPEA" HAS NO MEANING IN A FOREIGN LANGUAGE.

FOR UNDERWEAR, FOUNDATION GARMENTS, SWIMWEAR, BEACHWEAR, SOCKS, STOCKINGS, TIGHTS, JERSEYS, CROP TOPS, PULLOVERS, GLOVES, CARDIGANS, SWEATERS, TROUSERS, LEGGINGS, SKIRTS, JACKETS, JERKINS, SHIRTS, VESTS, WAISTCOATS, JUMPERS, TRACK SUITS, BLOUSES, BLOUSONS, JEANS, SWEAT PANTS, GYM SUITS, KNICKERS, PANTS, SHORTS, T-SHIRTS, SWEAT-SHIRTS, SUITS AND DRESSES, OVERCOATS, COATS, ANORAKS, RAINCOATS, BELTS, SUSPENDERS OR BRACES, NECKWEAR, LOUNGEWEAR, SLEEPWEAR, FOOTWEAR, HEADWEAR (U.S. CLS. 22 AND 39).

LINDA MICKLEBURGH, EXAMINING ATTORNEY

SN 79-074,558. AS CORPORATION, JAPAN, FILED 7-10-2009.



OWNER OF INTERNATIONAL REGISTRATION 1017855 DATED 7-10-2009, EXPIRES 7-10-2019.

FOR CLOTHING, NAMELY, SHIRTS, PANTS, JACKETS, UNDERWEAR, TIGHTS, SPORT SHIRTS, SWEAT SHIRTS, T-SHIRTS, SPORTS PANTS, STRETCH PANTS, SWEAT PANTS, BOTTOMS, TOPS; PAJAMAS; TRUNKS; CAMISOLES; HATS AND CAPS; BELLY WARMER TIE, NAMELY, A CYLINDRICAL PIECE OF UNDERWEAR (U.S. CLS. 22 AND 39).

ELI HELLMAN, EXAMINING ATTORNEY

SN 79-079,490. ZHEJIANG NIANNIANWANG KNITTING CO., LTD., ZHEJIANG PROVINCE, CHINA, FILED 2-2-2010.



OWNER OF INTERNATIONAL REGISTRATION 1030376 DATED 2-2-2010, EXPIRES 2-2-2020.

FOR CLOTHING, NAMELY, COATS, JACKETS, SHIRTS, BLOUSES, TOPS, SKIRTS, PANTS, DRESSES, BRASSIERES; UNDERGARMENTS, LINGERIE, SKIRTS, PYJAMAS, ROBES, SHORTS, KNITWEAR, T-SHIRTS, SWEATSHIRTS, HATS, SHOES, SOCKS, GLOVES, NECKTIES, GIRDLES BEING FOUNDATION GARMENTS; CLOTHING FOR WEAR IN GYMNASTICS, NAMELY, LEOTARDS AND WARM UP SUITS (U.S. CLS. 22 AND 39).

HOWARD SMIGA, EXAMINING ATTORNEY

CLASS 25—(Continued).

SN 85-001,113. CHEVRON INTELLECTUAL PROPERTY LLC, SAN RAMON, CA. FILED 3-29-2010.

SKY CHIEF

THE MARK CONSISTS OF STANDARD CHARACTERS WITHOUT CLAIM TO ANY PARTICULAR FONT, STYLE, SIZE, OR COLOR.

FOR CLOTHING, NAMELY, T-SHIRTS, JACKETS, CAPS, HATS, KNIT SHIRTS AND SWEATSHIRTS (U.S. CLS. 22 AND 39).

MARK SHINER, EXAMINING ATTORNEY

CLASS 25—(Continued).

SN 85-001,729. PROPÉT GLOBAL LIMITED, AUBURN, WA. FILED 3-30-2010.

PROPÉT

THE MARK CONSISTS OF STANDARD CHARACTERS WITHOUT CLAIM TO ANY PARTICULAR FONT, STYLE, SIZE, OR COLOR.

OWNER OF U.S. REG. NO. 1,800,878.

THE WORDING "PROPÉT" HAS NO MEANING IN A FOREIGN LANGUAGE.

FOR FOOTWEAR (U.S. CLS. 22 AND 39).

FIRST USE 1-1-1992; IN COMMERCE 1-1-1992.

JESSICA A. POWERS, EXAMINING ATTORNEY

SN 85-001,879. SAITEX INTERNATIONAL INC., NEW YORK, NY. FILED 3-30-2010.

SAITEX

THE MARK CONSISTS OF STANDARD CHARACTERS WITHOUT CLAIM TO ANY PARTICULAR FONT, STYLE, SIZE, OR COLOR.

FOR CAPS; FOOTWEAR; HATS; JACKETS; JEANS; JOGGING SUITS; PANTS; SHIRTS; T-SHIRTS; TOPS; TROUSERS; UNDERWEAR (U.S. CLS. 22 AND 39).

PATRICIA EVANKO, EXAMINING ATTORNEY

SN 85-001,279. CHEVRON INTELLECTUAL PROPERTY LLC, SAN RAMON, CA. FILED 3-29-2010.



OWNER OF U.S. REG. NOS. 3,540,724, 3,729,285 AND OTHERS.

THE MARK CONSISTS OF ONE CIRCLE WITH A THICK BORDER WITH THE WORD "CHEVRON" LOCATED INSIDE. THE WORD "CHEVRON" FEATURES A STYLIZED WINGED "V" DESIGN AND IS BRACKETED BY A HORIZONTAL LINE ABOVE AND BELOW THE WORD. THE WORD "GASOLINE" APPEARS UNDERNEATH THE WORD "CHEVRON".

FOR CLOTHING, NAMELY, T-SHIRTS, JACKETS, CAPS, HATS, KNIT SHIRTS AND SWEATSHIRTS (U.S. CLS. 22 AND 39).

MARK SHINER, EXAMINING ATTORNEY

SN 85-002,187. CALLAWAY GOLF COMPANY, CARLSBAD, CA. FILED 3-30-2010.

Corina

THE MARK CONSISTS OF STANDARD CHARACTERS WITHOUT CLAIM TO ANY PARTICULAR FONT, STYLE, SIZE, OR COLOR.

FOR FOOTWEAR; GOLF PANTS, SHIRTS AND SKIRTS; GOLF SHORTS; GOLF TROUSERS; PANTS; SWEAT PANTS; WIND PANTS; WIND RESISTANT JACKETS (U.S. CLS. 22 AND 39).

JOHN DWYER, EXAMINING ATTORNEY

CLASS 25—(Continued).

SN 85-004,283. K-SWISS INC., WESTLAKE VILLAGE, CA. FILED 4-1-2010.

CLASS 25—(Continued).

SN 85-025,054. TARKINSON, HANNAH, DBA PONOMO, PORTLAND, ME. FILED 4-28-2010.

COURTSTYLE

THE MARK CONSISTS OF STANDARD CHARACTERS WITHOUT CLAIM TO ANY PARTICULAR FONT, STYLE, SIZE, OR COLOR.

FOR ATHLETIC SHOES; CAPS; JACKETS; PANTS; SHIRTS; SHOES; SHORTS; SKIRTS; SOCKS; SWEAT SHIRTS; T-SHIRTS; TENNIS SHOES; TOPS; VISORS; WIND RESISTANT JACKETS (U.S. CLS. 22 AND 39).

BRIAN CALLAGHAN, EXAMINING ATTORNEY

ponomo

THE MARK CONSISTS OF STANDARD CHARACTERS WITHOUT CLAIM TO ANY PARTICULAR FONT, STYLE, SIZE, OR COLOR.

OWNER OF U.S. REG. NO. 3,250,822. FOR T-SHIRTS (U.S. CLS. 22 AND 39). FIRST USE 1-15-2003; IN COMMERCE 1-15-2003. DARRYL SPRUILL, EXAMINING ATTORNEY

SN 85-019,598. COLOR IMAGE APPAREL, INC., COMMERCE, CA. FILED 4-21-2010.

BELLA LUXX

THE MARK CONSISTS OF STANDARD CHARACTERS WITHOUT CLAIM TO ANY PARTICULAR FONT, STYLE, SIZE, OR COLOR.

OWNER OF U.S. REG. NOS. 3,158,111, 3,519,794 AND OTHERS.

THE ENGLISH TRANSLATION OF THE WORD "BELLA" IN THE MARK IS "BEAUTIFUL".

FOR WOMEN'S CLOTHING, NAMELY, TEE SHIRTS, SHORT SLEEVE SHIRTS, LONG SLEEVE SHIRTS, TANK TOPS, FLEECE TOPS, SHIRTS, PANTS, SKIRTS, DRESSES, SHORTS, UNDERWEAR, CAMISOLES, AND SWEATSHIRTS (U.S. CLS. 22 AND 39).

DANNEAN HETZEL, EXAMINING ATTORNEY

SN 85-025,102. WORLD WRESTLING ENTERTAINMENT, INC., STAMFORD, CT. FILED 4-28-2010.

FAMOUS & FLAWLESS

SN 85-019,829. COLOR IMAGE APPAREL, INC., COMMERCE, CA. FILED 4-21-2010.

LUXX

THE MARK CONSISTS OF STANDARD CHARACTERS WITHOUT CLAIM TO ANY PARTICULAR FONT, STYLE, SIZE, OR COLOR.

FOR MEN'S CLOTHING, NAMELY, SHIRTS, PANTS, JACKETS, SWEATSHIRTS, GOLF SHIRTS, TEE SHIRTS AND TANK TOPS (U.S. CLS. 22 AND 39).

DANNEAN HETZEL, EXAMINING ATTORNEY

THE MARK CONSISTS OF STANDARD CHARACTERS WITHOUT CLAIM TO ANY PARTICULAR FONT, STYLE, SIZE, OR COLOR.

FOR CLOTHING, NAMELY, TOPS, TANK TOPS, T-SHIRTS, SHIRTS, SPORT SHIRTS, DRESS SHIRTS, POLO SHIRTS, UNDERSHIRTS, SWEATSHIRTS, SWEATERS, PULLOVERS, BLOUSES, JACKETS, RAINCOATS, OVERCOATS, TOPCOATS, BOTTOMS, TROUSERS, PANTS, JEAN PANTS, JOGGING SUITS, EXERCISE PANTS, EXERCISE SUITS, SWEATPANTS, SHORTS, UNDERWEAR, BOXER SHORTS, SOCKS, CLOTHING TIES, PAJAMAS, BELTS, GLOVES, HALLOWEEN AND MASQUERADE COSTUMES, WRIST BANDS, BANDANNAS; FOOTWEAR, NAMELY, SHOES, SNEAKERS, BOOTS, SLIPPERS; HEADWEAR, NAMELY, HATS, CAPS (U.S. CLS. 22 AND 39).

JOHN HWANG, EXAMINING ATTORNEY

CLASS 26—FANCY GOODS

SN 77-695,602. GREEN, JACQUELINE, DBA ELITE HAIR SUPPLY, WEST BLOOMFIELD, MI. FILED 3-20-2009.

Elite Hair Supply

THE MARK CONSISTS OF STANDARD CHARACTERS WITHOUT CLAIM TO ANY PARTICULAR FONT, STYLE, SIZE, OR COLOR.

NO CLAIM IS MADE TO THE EXCLUSIVE RIGHT TO USE "HAIR SUPPLY", APART FROM THE MARK AS SHOWN.

FOR WIGS, HAIRPIECES, AND ADD-IN AND ADD-ON HAIR ACCESSORIES CONSTRUCTED PRIMARILY OF SYNTHETIC AND/OR HUMAN HAIR (U.S. CLS. 37, 39, 40, 42 AND 50).

FIRST USE 3-1-2005; IN COMMERCE 3-1-2005.
ALYSSA STEEL, EXAMINING ATTORNEY

SN 77-785,376. WIDEAWAKE-DEATHROW ENTERTAINMENT LLC, CALABASAS, CA. FILED 7-20-2009.

DEATH ROW RECORDS

THE MARK CONSISTS OF STANDARD CHARACTERS WITHOUT CLAIM TO ANY PARTICULAR FONT, STYLE, SIZE, OR COLOR.

FOR ORNAMENTAL NOVELTY PINS (U.S. CLS. 37, 39, 40, 42 AND 50).

DAVID TOOLEY, EXAMINING ATTORNEY

SN 77-801,317. WIDEAWAKE-DEATHROW ENTERTAINMENT LLC, CALABASAS, CA. FILED 8-10-2009.



THE MARK CONSISTS OF THE WORDS "DEATH ROW RECORDS" IN FANCIFUL LETTERING SURROUNDING A DESIGN OF A HOODED PERSON STRAPPED TO AN ELECTRIC CHAIR.

FOR ORNAMENTAL NOVELTY PINS (U.S. CLS. 37, 39, 40, 42 AND 50).

DAVID TOOLEY, EXAMINING ATTORNEY

CLASS 26—(Continued).

SN 77-926,751. JON RENAU COLLECTION INC., VISTA, CA. FILED 2-3-2010.

SmartLace

THE MARK CONSISTS OF STANDARD CHARACTERS WITHOUT CLAIM TO ANY PARTICULAR FONT, STYLE, SIZE, OR COLOR.

FOR HAIR PIECES AND WIGS; WIGS; WIGS, HAIRPIECES, AND ADD-IN AND ADD-ON HAIR ACCESSORIES CONSTRUCTED PRIMARILY OF SYNTHETIC AND/OR HUMAN HAIR (U.S. CLS. 37, 39, 40, 42 AND 50).

FIRST USE 3-6-2009; IN COMMERCE 3-6-2009.
ERIN FALK, EXAMINING ATTORNEY

SN 77-928,631. FOSHAN CITY NANHAI JINHEMING INVESTMENT CO., LTD., FOSHAN, GUANGDONG, CHINA, FILED 2-4-2010.



THE MARK CONSISTS OF THE STYLIZED ALPHABET "X" AND DEVICES RESEMBLING 2 INCOMPLETE "X"S AT THE BACK.

FOR BELT CLASPS; BUCKLES FOR CLOTHING; BUTTONS; CLOTHING HOOKS; FASTENINGS FOR BRACES AND SUSPENDERS; LACE TRIMMING; ORNAMENTAL NOVELTY BADGES; SHOE BUCKLES; SHOE ORNAMENTS NOT OF PRECIOUS METAL; ZIPPERS (U.S. CLS. 37, 39, 40, 42 AND 50).

TINA L. SNAPP, EXAMINING ATTORNEY

SN 77-929,872. DIFFERENCE MAKERS INTERNATIONAL, INC, CARDIFF, CA. FILED 2-6-2010.

WHO I AM MAKES A DIFFERENCE

THE MARK CONSISTS OF STANDARD CHARACTERS WITHOUT CLAIM TO ANY PARTICULAR FONT, STYLE, SIZE, OR COLOR.

SEC. 2(F).

FOR RIBBONS (U.S. CLS. 37, 39, 40, 42 AND 50).

FIRST USE 9-0-1982; IN COMMERCE 9-0-1982.

KAELIE KUNG, EXAMINING ATTORNEY

CLASS 26—(Continued).

SN 77-930,134. WIDLAKE-HERRING, AMBER, GRAHAM, TX. FILED 2-8-2010.

LAINNEY LOU'S

THE MARK CONSISTS OF STANDARD CHARACTERS WITHOUT CLAIM TO ANY PARTICULAR FONT, STYLE, SIZE, OR COLOR.
FOR HAIR BOWS (U.S. CLS. 37, 39, 40, 42 AND 50).
GIANCARLO CASTRO, EXAMINING ATTORNEY

SN 77-930,497. CARLINO, CRISTINA M., PHOENIX, AZ. FILED 2-8-2010.

ARCHETYPE

THE MARK CONSISTS OF STANDARD CHARACTERS WITHOUT CLAIM TO ANY PARTICULAR FONT, STYLE, SIZE, OR COLOR.
FOR ARTIFICIAL FLOWER ARRANGEMENTS IN CONTAINERS; ARTIFICIAL FRUIT; ARTIFICIAL PLANTS; ARTIFICIAL TOPIARIES; ARTIFICIAL WREATHS; BOWS FOR WRAPPING; DECORATIVE RIBBONS (U.S. CLS. 37, 39, 40, 42 AND 50).
JULIE WATSON, EXAMINING ATTORNEY

SN 85-021,387. PACIFIC WORLD CORPORATION, LAKE FOREST, CA. FILED 4-23-2010.

GEO GIRL

THE MARK CONSISTS OF STANDARD CHARACTERS WITHOUT CLAIM TO ANY PARTICULAR FONT, STYLE, SIZE, OR COLOR.
FOR HAIR ACCESSORIES, NAMELY, ADD-IN HAIR EXTENSIONS CONSTRUCTED PRIMARILY OF SYNTHETIC AND/OR HUMAN HAIR, HAIR BARRETTES, HEAD BANDS AND HAIR TIES (U.S. CLS. 37, 39, 40, 42 AND 50).
JOHN HWANG, EXAMINING ATTORNEY

CLASS 27—FLOOR COVERINGS

SN 77-023,590. PEACHTREE INTERNATIONAL LIMITED, HAMILTON HM, MX, BERMUDA, FILED 10-18-2006.



PRIORITY CLAIMED UNDER SEC. 44(D) ON UNITED KINGDOM APPLICATION NO. 2436077, FILED 10-18-2006, REG. NO. 2436077, DATED 10-19-2006, EXPIRES 10-19-2016.
FOR HARD SURFACE COVERINGS FOR FLOORS; VINYL FLOOR COVERINGS (U.S. CLS. 19, 20, 37, 42 AND 50).
AISHA SALEM, EXAMINING ATTORNEY

SN 77-690,319. BEAULIEU GROUP, LLC, DALTON, GA. FILED 3-13-2009.

SHER-FRESH

THE MARK CONSISTS OF STANDARD CHARACTERS WITHOUT CLAIM TO ANY PARTICULAR FONT, STYLE, SIZE, OR COLOR.
FOR CARPET FINISH OR SURFACE TREATMENT COMPOSITION SOLD AS A COMPONENT OF FINISHED, TREATED OR COATED CARPETS TO DESTROY ODORS (U.S. CLS. 19, 20, 37, 42 AND 50).
TIMOTHY FINNEGAN, EXAMINING ATTORNEY

SN 77-796,795. COLOUR & DESIGN, INC., NORTH LITTLE ROCK, AR. FILED 8-4-2009.

KADEN

THE MARK CONSISTS OF STANDARD CHARACTERS WITHOUT CLAIM TO ANY PARTICULAR FONT, STYLE, SIZE, OR COLOR.
FOR WALLPAPER; WALLPAPER IN THE NATURE OF ROOMSIZE DECORATIVE ADHESIVE WALL COVERINGS; NON-TEXTILE WALL COVERINGS; VINYL WALLCOVERINGS (U.S. CLS. 19, 20, 37, 42 AND 50).
ALLISON SCHRODY, EXAMINING ATTORNEY

CLASS 27—(Continued).

SN 77-796,799. COLOUR & DESIGN, INC., NORTH LITTLE ROCK, AR. FILED 8-4-2009.

TOBA

THE MARK CONSISTS OF STANDARD CHARACTERS WITHOUT CLAIM TO ANY PARTICULAR FONT, STYLE, SIZE, OR COLOR.

FOR WALLPAPER; WALLPAPER IN THE NATURE OF ROOMSIZE DECORATIVE ADHESIVE WALL COVERINGS; NON-TEXTILE WALL COVERINGS; VINYL WALLCOVERINGS (U.S. CLS. 19, 20, 37, 42 AND 50).
ALLISON SCHRODY, EXAMINING ATTORNEY

SN 77-797,874. CONNOR SPORT COURT INTERNATIONAL, INC., SALT LAKE CITY, UT. FILED 8-5-2009.

ECOLAWN

THE MARK CONSISTS OF STANDARD CHARACTERS WITHOUT CLAIM TO ANY PARTICULAR FONT, STYLE, SIZE, OR COLOR.

FOR ARTIFICIAL TURF; SYNTHETIC LAWNS; SYNTHETIC GRASSES (U.S. CLS. 19, 20, 37, 42 AND 50).
DEIRDRE ROBERTSON, EXAMINING ATTORNEY

SN 77-924,980. CONGOLEUM CORPORATION, MERCERVILLE, NJ. FILED 2-1-2010.

SMARTLINK

THE MARK CONSISTS OF STANDARD CHARACTERS WITHOUT CLAIM TO ANY PARTICULAR FONT, STYLE, SIZE, OR COLOR.

FOR PLASTIC FLOOR COVERING HAVING A WATER RESISTANT, SMOOTH OR EMBOSSED SURFACE IN ROLLS OR TILES (U.S. CLS. 19, 20, 37, 42 AND 50).
WARREN L. OLANDRIA, EXAMINING ATTORNEY

CLASS 27—(Continued).

SN 77-926,525. SHEN ZHEN JIAN CHEN INDUSTRIAL CO., LTD., GUANGDONG, CHINA, FILED 2-3-2010.



THE MARK CONSISTS OF THE WORD "BONICA" AND A ROUNDED-ANGLED HEXAGON WITH TWO CONCENTRIC DIAMONDS INSIDE TO THE LEFT OF THE WORD.

THE WORDING "BONICA" HAS NO MEANING IN A FOREIGN LANGUAGE.

FOR FLOOR COVERINGS OF RUBBER AND SYNTHETIC RUBBER; FLOOR MATS; GYMNASIUM EXERCISE MATS; HARD SURFACE COVERINGS FOR FLOORS; NON-TEXTILE WALL HANGINGS; PLASTIC BATH MATS; RUBBER MATS; TAPESTRY-STYLE WALL HANGINGS, NOT OF TEXTILE; WALLPAPER (U.S. CLS. 19, 20, 37, 42 AND 50).
DAVID ELTON, EXAMINING ATTORNEY

SN 77-928,048. HELLAS CONSTRUCTION, INC., AUSTIN, TX. FILED 2-4-2010.

VELOCITY

THE MARK CONSISTS OF STANDARD CHARACTERS WITHOUT CLAIM TO ANY PARTICULAR FONT, STYLE, SIZE, OR COLOR.

FOR SYNTHETIC TURF (U.S. CLS. 19, 20, 37, 42 AND 50).
MICHAEL GAAFAR, EXAMINING ATTORNEY

SN 77-930,124. FROM THE FOREST, LLC, WESTON, WI. FILED 2-8-2010.

TOUCH

THE MARK CONSISTS OF STANDARD CHARACTERS WITHOUT CLAIM TO ANY PARTICULAR FONT, STYLE, SIZE, OR COLOR.

FOR FLOOR COVERINGS (U.S. CLS. 19, 20, 37, 42 AND 50).
RONALD MCMORROW, EXAMINING ATTORNEY

CLASS 27—(Continued).

SN 77-930,509. CARLINO, CRISTINA M., PHOENIX, AZ.
FILED 2-8-2010.

ARCHETYPE

THE MARK CONSISTS OF STANDARD CHARACTERS
WITHOUT CLAIM TO ANY PARTICULAR FONT, STYLE,
SIZE, OR COLOR.

FOR AREA RUGS; BATH MATS; DOOR MATS; NON-
TEXTILE WALL HANGINGS; PET FEEDING MATS;
WALLCOVERINGS (U.S. CLS. 19, 20, 37, 42 AND 50).
JULIE WATSON, EXAMINING ATTORNEY

CLASS 27—(Continued).

SN 77-937,774. TENEX CORPORATION, WINNETKA, IL.
FILED 2-17-2010.

TENEX PLANET-SAVER

THE MARK CONSISTS OF STANDARD CHARACTERS
WITHOUT CLAIM TO ANY PARTICULAR FONT, STYLE,
SIZE, OR COLOR.

FOR CHAIR MATS (U.S. CLS. 19, 20, 37, 42 AND 50).
MATTHEW KLINE, EXAMINING ATTORNEY

SN 77-932,729. FUTURE FOAM, INC., MIDDLETON, WI.
FILED 2-10-2010.

STEP AHEAD

THE MARK CONSISTS OF STANDARD CHARACTERS
WITHOUT CLAIM TO ANY PARTICULAR FONT, STYLE,
SIZE, OR COLOR.

FOR CARPET UNDERLAYMENT (U.S. CLS. 19, 20, 37,
42 AND 50).
ELIZABETH HUGHITT, EXAMINING ATTORNEY

CLASS 28—TOYS AND SPORTING GOODS

SN 76-684,693. DJPZ HOLDINGS LTD., FREEPORT, NY.
FILED 12-6-2007.

TOUR EDITION

THE MARK CONSISTS OF STANDARD CHARACTERS
WITHOUT CLAIM TO ANY PARTICULAR FONT, STYLE,
SIZE, OR COLOR.

FOR GOLF CLUB HEADS (U.S. CLS. 22, 23, 38 AND
50).
FIRST USE 9-28-1982; IN COMMERCE 9-28-1982.
JORDAN BAKER, EXAMINING ATTORNEY

SN 77-937,613. TENEX CORPORATION, WINNETKA, IL.
FILED 2-17-2010.

TENEX

THE MARK CONSISTS OF STANDARD CHARACTERS
WITHOUT CLAIM TO ANY PARTICULAR FONT, STYLE,
SIZE, OR COLOR.

FOR CHAIR MATS (U.S. CLS. 19, 20, 37, 42 AND 50).
MATTHEW KLINE, EXAMINING ATTORNEY

SN 76-701,422. POOF-SLINKY, INC., PLYMOUTH, MI.
FILED 2-1-2010.

BATTLEFIELD BLAST

THE MARK CONSISTS OF STANDARD CHARACTERS
WITHOUT CLAIM TO ANY PARTICULAR FONT, STYLE,
SIZE, OR COLOR.

FOR TOYS, GAMES AND PLAYTHINGS, NAMELY,
BOARD GAMES FEATURING MOVEABLE GAME
PIECES (U.S. CLS. 22, 23, 38 AND 50).
FONG HSU, EXAMINING ATTORNEY

CLASS 28—(Continued).

SN 76-701,424. POOF-SLINKY, INC., PLYMOUTH, MI.
FILED 2-1-2010.

CAREFUL

THE MARK CONSISTS OF STANDARD CHARACTERS WITHOUT CLAIM TO ANY PARTICULAR FONT, STYLE, SIZE, OR COLOR.

FOR TOYS, GAMES AND PLAYTHINGS, NAMELY, ACTION SKILL GAMES FEATURING STACKABLE GAME PIECES (U.S. CLS. 22, 23, 38 AND 50).

FONG HSU, EXAMINING ATTORNEY

SN 76-701,425. POOF-SLINKY, INC., PLYMOUTH, MI.
FILED 2-1-2010.

STEADY FREDDY

THE MARK CONSISTS OF STANDARD CHARACTERS WITHOUT CLAIM TO ANY PARTICULAR FONT, STYLE, SIZE, OR COLOR.

FOR TOYS, GAMES, AND PLAYTHINGS, NAMELY, ACTION SKILL GAMES FEATURING A BALANCING FIGURE AND BALANCE WEIGHTS USED THEREWITH (U.S. CLS. 22, 23, 38 AND 50).

FONG HSU, EXAMINING ATTORNEY

SN 76-701,426. POOF-SLINKY, INC., PLYMOUTH, MI.
FILED 2-1-2010.

UP! AGAINST TIME

THE MARK CONSISTS OF STANDARD CHARACTERS WITHOUT CLAIM TO ANY PARTICULAR FONT, STYLE, SIZE, OR COLOR.

FOR TOYS, GAMES AND PLAYTHINGS, NAMELY, ACTION SKILL GAMES FEATURING A BALL TRACK AND STACKABLE GAME PIECES SOLD THEREWITH (U.S. CLS. 22, 23, 38 AND 50).

FONG HSU, EXAMINING ATTORNEY

CLASS 28—(Continued).

SN 76-701,427. POOF-SLINKY, INC., PLYMOUTH, MI.
FILED 2-1-2010.

TILTON' MILTON

THE MARK CONSISTS OF STANDARD CHARACTERS WITHOUT CLAIM TO ANY PARTICULAR FONT, STYLE, SIZE, OR COLOR.

FOR TOYS, GAMES AND PLAYTHINGS, NAMELY, ACTION SKILL BOARD GAMES AND GAME PIECES SOLD THEREWITH (U.S. CLS. 22, 23, 38 AND 50).

FONG HSU, EXAMINING ATTORNEY

SN 76-701,428. POOF-SLINKY, INC., PLYMOUTH, MI.
FILED 2-1-2010.

IMPACT

THE MARK CONSISTS OF STANDARD CHARACTERS WITHOUT CLAIM TO ANY PARTICULAR FONT, STYLE, SIZE, OR COLOR.

FOR TOYS, GAMES AND PLAYTHINGS, NAMELY, ACTION SKILL GAMES FEATURING BALL AND TRACK WITH PENDULUM TO HIT BALL IN PLAY (U.S. CLS. 22, 23, 38 AND 50).

FIRST USE 10-31-2009; IN COMMERCE 10-31-2009.

FONG HSU, EXAMINING ATTORNEY

SN 76-701,949. POOF-SLINKY, INC., PLYMOUTH, MI.
FILED 3-8-2010.

BONGO KONGO

THE MARK CONSISTS OF STANDARD CHARACTERS WITHOUT CLAIM TO ANY PARTICULAR FONT, STYLE, SIZE, OR COLOR.

FOR CHILDREN'S ACTION SKILL GAMES FEATURING GAME PIECES AND A MOVEABLE ACTION FIGURE (U.S. CLS. 22, 23, 38 AND 50).

FONG HSU, EXAMINING ATTORNEY

CLASS 28—(Continued).

SN 77-446,686. CLOUDCO, INC., CLEVELAND, OH. FILED 4-11-2008.

MARYOKU YUMMY

THE MARK CONSISTS OF STANDARD CHARACTERS WITHOUT CLAIM TO ANY PARTICULAR FONT, STYLE, SIZE, OR COLOR.

FOR ACTION FIGURES AND ACCESSORIES THEREFOR; ACTION FIGURES; ACTION SKILL GAMES; ACTION-TYPE TARGET GAMES; ADULTS' AND CHILDREN'S PARTY GAMES; AIR MATTRESSES FOR RECREATIONAL USE; BABY MULTIPLE ACTIVITY TOYS; BABY RATTLES; BADMINTON GAME PLAYING EQUIPMENT; BAGS SPECIALLY ADAPTED FOR SPORTS EQUIPMENT; BALLOONS; BALLS FOR GAMES; BASEBALLS; BASEBALL MITTS; BASEBALL BATS; BASEBALL GLOVES; BATH TOYS; BATHTUB TOYS; BATTERY OPERATED ACTION TOYS; BEACH BALLS; BEAN BAGS; BEAN BAG DOLLS; BENDABLE TOYS; BOARD GAMES; BOBBLE HEAD DOLLS; BOARDS USED IN THE PRACTICE OF WATER SPORTS; BUBBLE MAKING WAND AND SOLUTION SETS; CAPS FOR TOY PISTOLS; CARD GAMES; CASES FOR ACTION FIGURES; CASES FOR PLAY ACCESSORIES; CASES FOR TOY STRUCTURES; CASES FOR TOY VEHICLES; CHILDREN'S WIRE CONSTRUCTION AND ART ACTIVITY TOYS; CHILDREN'S MULTIPLE ACTIVITY TABLES; CHILDREN'S ACTIVITY TABLES CONTAINING MANIPULATIVE TOYS WHICH CONVERT TO EASELS; CHRISTMAS STOCKINGS; CHRISTMAS TREE DECORATIONS; CHRISTMAS TREE ORNAMENTS; CHRISTMAS TREE ORNAMENTS WITH A MUSIC FEATURE; CHRISTMAS TREE SKIRTS; COLLECTABLE TOY FIGURES; CONSTRUCTION TOYS; CONFETTI; COSTUME MASKS; CRAFT SETS FOR DECORATING BALLOONS; CRIB MOBILES; CRIB TOYS; DICE; DISC TOSS TOYS; DOLL ACCESSORIES; DOLL CASES; DOLL CLOTHING; DOLL COSTUMES; DOLL FURNITURE; DOLL HOUSE FURNISHINGS; DOLL HOUSES; DOLLS AND ACCESSORIES THEREFOR; DOLLS AND PLAYSETS THEREFOR; DOMINOES; DRAWING TOYS; EASTER EGG COLORING KITS; EGG DECORATING KITS; ELECTRIC ACTION TOYS; ELECTRONIC LEARNING TOYS; ELECTRONIC EDUCATIONAL GAME MACHINES FOR CHILDREN; ELECTRONIC GAME EQUIPMENT WITH A WATCH FUNCTION; EQUIPMENT SOLD AS A UNIT FOR PLAYING A MEMORY GAME; ELECTRONIC TOY VEHICLES; EQUIPMENT SOLD AS A UNIT FOR PLAYING A MEMORY GAME; FLIES FOR USE IN FISHING; FLOATING RECREATIONAL LOUNGE CHAIRS; FLYING DISCS; FOOTBALLS; GAME TABLES; GOLF ACCESSORY POUCHES; GOLF GLOVES; HAND PUPPETS; HEAD COVERS FOR GOLF CLUBS; INFANT ACTION CRIB TOYS; INFANT TOYS; INFANT RATTLES; INFANT SWINGS; INFLATABLE BOP BAGS; INFLATABLE INNER TUBES FOR AQUATIC RECREATIONAL USE; INFLATABLE TOYS; INFLATABLE BATH TOYS; INFLATABLE RIDE-ON TOYS; INFLATABLE TOYS; INFLATABLE POOLS FOR RECREATIONAL USE; JACK-IN-THE-BOXES; JUMP ROPES; JIGSAW PUZZLES; JUMP ROPES; KICK BOARD FLOTATION DEVICES FOR RECREATIONAL USE; KITES; KITS FOR BUILDING OUTDOOR PLAY EQUIPMENT; MAGIC TRICKS; MANIPULATIVE GAMES; MANIPULATIVE PUZZLES; MARBLES; MARIONETTE PUPPETS; MECHANICAL TOYS; MEMORY GAMES; MOBILES FOR CHILDREN; MODELED PLASTIC TOY FIGURINES; MOLDED TOY FIGURES; MUSIC BOX TOYS; MUSICAL TOYS; NET BALLS; NON-ELECTRONIC TOY VEHICLES; PADDLE BALL GAMES; PADDLE BALLS; PADDLES FOR USE IN PADDLE BALL GAMES; PAPER AIRPLANES; PAPER DOLLS; PAPER FACE MASKS; PAPER STREAMERS; PARLOR GAMES; PARTY FAVORS IN THE NATURE OF SMALL TOYS; PARTY FAVORS IN THE NATURE OF CRACKERS AND NOISEMAKERS; PERSONAL EXERCISE MATS; PET TOYS; PINBALL-TYPE GAMES; PINATAS; PLAY FIGURES; PLAY HOUSES; PLAY MATS CONTAINING INFANT

CLASS 28—(Continued).

TOYS; PLAY MATS FOR USE WITH TOY VEHICLES; PLAY TENTS; PLAY WANDS; PLAY TUNNELS; PLAY YARDS IN THE NATURE OF OUTDOOR PLAY STRUCTURES; PLAYING CARDS; PLAYING CARD CASES; PLAYGROUND BALLS; PLAYSET BUILDINGS; PLAYSETS FOR DOLLS; PLUSH TOYS; POOL CUSHIONS; POP UP TOYS; PORCELAIN DOLLS; PORTABLE SUPPORT STRUCTURES FOR DANCE AND OTHER EXERCISES; POSITIONABLE TOY FIGURES; PRINTING TOYS; PROMOTIONAL GAME CARDS; PROMOTIONAL GAME MATERIALS; PROTECTIVE CARRYING CASES SPECIALLY ADAPTED FOR HANDHELD VIDEO GAMES; PULL TOYS; PUNCHING TOYS; PUPPETS; PUSH TOYS; PUZZLES; RADIO CONTROLLED MODEL VEHICLES; RADIO CONTROLLED TOY VEHICLES; RAG DOLLS; RIDE-ON TOYS; RING BUOYS FOR RECREATIONAL USE; RING GAMES; ROCKING HORSES; ROLE PLAYING GAMES; ROLLER SKATES; RUBBER BALLS; RUBBER CHARACTER TOYS; SEE-SAWS; SANDBOX TOYS; SKIPPING ROPE; SNOW SLEDS FOR RECREATIONAL USE; SNOW BOARDS; SOCCER BALLS; SOFT SCULPTURE DOLLS; SOFT SCULPTURE PLUSH TOYS; SOFT SCULPTURE DOLLS; SOFT SCULPTURE TOYS; SPINNING TOPS; SPORTBALLS; STUFFED DOLLS AND ANIMALS; STUFFED PUPPETS; STUFFED TOYS; SWIM BOARDS FOR RECREATIONAL USE; SWIM FINNS; SWIM FLOATS FOR RECREATIONAL USE; SWIMMING GLOVES; SWING SETS; TABLE TENNIS BALLS; TABLETOP UNITS FOR PLAYING ELECTRONIC GAMES OTHER THAN IN CONJUNCTION WITH A TELEVISION OR COMPUTER; TALKING TOYS; TARGET GAMES; TARGETS; TEACHING MATERIALS IN THE FORM OF CARD GAMES; TEDDY BEARS; TENNIS BALLS; TENNIS RACKET COVERS; TENNIS RACKETS; TETHER BALLS; TINSEL FOR DECORATING CHRISTMAS TREES; TOSSING DISC TOYS; TOY ACTION FIGURES AND ACCESSORIES THEREFOR; TOY ACTION FIGURES; TOY ARMOR; TOY BOWS AND ARROWS; TOY BAKEWARE AND COOKWARE; TOY BOXES; TOY BUILDINGS AND ACCESSORIES THEREFOR; TOY CHRISTMAS TREES; TOY CLOCKS AND WATCHES; TOY CONSTRUCTION SETS; TOY FIGURES; TOY FURNITURE; TOY GLIDERS; TOY HOOP SETS; TOY MOBILES; TOY MODEL HOBBY CRAFT KITS; TOY MODELING DOUGH; TOY NOISEMAKERS; TOY PISTOLS; TOY PUTTY; TOY ROCKETS; TOY SNOW GLOBES; TOY STAMPS; TOY SWORDS; TOY VEHICLES AND ACCESSORIES THEREFOR; TOY MAILBOXES; TOY NOISEMAKERS; TOY PIANOS; TOY ROBOTS; TOY WATER GLOBES; TOY, NAMELY, BATTERY-POWERED COMPUTER GAME WITH LCD SCREEN WHICH FEATURES ANIMATION AND SOUND EFFECTS; TRADING CARD GAMES; TRANSFORMING ROBOTIC TOY VEHICLES; TRANSFORMING ROBOTIC TOYS; TWIRLING BATONS; VOLLEYBALL GAME PLAYING EQUIPMENT; VOLLEYBALLS; WAKE BOARDS; WATER PISTOLS; WATER SKI ROPE BRIDGES; WATER SQUIRTING TOYS; WATER WING SWIM AIDS FOR RECREATIONAL USE; WIND-UP TOYS; WIND-UP WALKING TOYS; YO-YOS (U.S. CLS. 22, 23, 38 AND 50).

TEJBIR SINGH, EXAMINING ATTORNEY

CLASS 28—(Continued).

SN 77-633,711. DRAZ ATHLETICS, LLC, DECORAH, IA. FILED 12-16-2008.

TRAIN YOUR GAME

THE MARK CONSISTS OF STANDARD CHARACTERS WITHOUT CLAIM TO ANY PARTICULAR FONT, STYLE, SIZE, OR COLOR.

FOR ATHLETIC TRAINING AIDS, NAMELY, DEVICES TO BE WORN ON THE BODY FOR STRENGTHENING AND CONDITIONING, NAMELY, WEIGHTED GLOVES, RESISTANT KNEE BRACES AND WEIGHT LIFTING GLOVES (U.S. CLS. 22, 23, 38 AND 50).

GRETCHEN ULRICH, EXAMINING ATTORNEY

SN 77-665,090. SHOT TEC INC., OKOTOKS, ALBERTA, CANADA, FILED 2-6-2009.

SHOT TEC

THE MARK CONSISTS OF STANDARD CHARACTERS WITHOUT CLAIM TO ANY PARTICULAR FONT, STYLE, SIZE, OR COLOR.

PRIORITY CLAIMED UNDER SEC. 44(D) ON CANADA APPLICATION NO. 1426845, FILED 2-5-2009, REG. NO. TMA766,161, DATED 5-7-2010, EXPIRES 5-7-2025.

FOR HOCKEY TRAINING DEVICE COMPRISED OF A SIMULATED HOCKEY PUCK ON A HORIZONTAL TRACK TO PROVIDE RESISTANCE TRAINING IN SHOOTING A HOCKEY PUCK (U.S. CLS. 22, 23, 38 AND 50).

DAWN FELDMAN, EXAMINING ATTORNEY

SN 77-725,570. FREEWIND SPORTS CO., LTD., TAIPEI COUNTY, TAIWAN, FILED 4-29-2009.



THE MARK CONSISTS OF THE WORDS "FREE" AND "WIND" IN STYLIZED FONT WITH A MISCELLANEOUS DESIGN OF A CRESCENT SHAPED STROKE AFTER FREE AND BEFORE WIND.

FOR ROLLER AND ICE SKATES; SNOWBOARD BINDINGS AND ACCESSORIES; SNOW BOARDS; SKI BINDINGS AND PARTS THEREFORE; WATERSKI BINDINGS; MOUNTAINEERING EQUIPMENT, NAMELY, HOOKS; SKIS; SKI POLES (U.S. CLS. 22, 23, 38 AND 50).

FIRST USE 1-1-1998; IN COMMERCE 4-8-1998.

JULIE WATSON, EXAMINING ATTORNEY

CLASS 28—(Continued).

SN 77-737,420. HUMAN ENERGY CONCEALMENT SYSTEMS, LLC, JOHN DAY, OR. FILED 5-14-2009.

6TH SENSE

THE MARK CONSISTS OF STANDARD CHARACTERS WITHOUT CLAIM TO ANY PARTICULAR FONT, STYLE, SIZE, OR COLOR.

FOR HUNTING BLINDS (U.S. CLS. 22, 23, 38 AND 50).

LINDA POWELL, EXAMINING ATTORNEY

SN 77-773,328. JAMZ FITNESS, INC., WEST PALM BEACH, FL. FILED 7-2-2009.



THE MARK CONSISTS OF THE WORDS "PURE COMFORT" SUPERIMPOSED ON A CLOUD AND SPHERICAL DESIGN.

FOR SPORTING ARTICLES AND APPARATUS, NAMELY, INFLATABLE MATTRESSES FOR RECREATIONAL USE (U.S. CLS. 22, 23, 38 AND 50).

FIRST USE 1-15-2009; IN COMMERCE 1-15-2009.

JOHN DWYER, EXAMINING ATTORNEY

SN 77-773,739. JAMZ FITNESS, INC., WEST PALM BEACH, FL. FILED 7-2-2009.



NO CLAIM IS MADE TO THE EXCLUSIVE RIGHT TO USE "BEACH", APART FROM THE MARK AS SHOWN.

THE MARK CONSISTS OF THE WORDS "PURE BEACH" SUPERIMPOSED ON A SURFBOARD DESIGN.

FOR SPORTING ARTICLES AND APPARATUS, EXPRESSLY EXCLUDING ALL CLOTHING ITEMS, NAMELY, SWIMMING POOL FLOATING RECREATIONAL LOUNGE CHAIR; WATER AND POOL TOYS, NAMELY, BODY BOARDS, SWIM FINS, SWIM FLOATS FOR RECREATIONAL USE; BEACH TOYS, NAMELY, TOY SAND PAILS, TOY SHOVELS AND BUCKETS, BEACH BALLS; WATER SPORTS GAMES, NAMELY, VOLLEYBALL GAME PLAYING EQUIPMENT, FLYING DISKS (U.S. CLS. 22, 23, 38 AND 50).

FIRST USE 1-15-2009; IN COMMERCE 1-15-2009.

JOHN DWYER, EXAMINING ATTORNEY

CLASS 28—(Continued).

SN 77-779,733. AVENTURES ÉDITION INC., BLAINVILLE, CANADA, FILED 7-13-2009.

The Yes No game

THE MARK CONSISTS OF STANDARD CHARACTERS WITHOUT CLAIM TO ANY PARTICULAR FONT, STYLE, SIZE, OR COLOR.
 NO CLAIM IS MADE TO THE EXCLUSIVE RIGHT TO USE "GAME", APART FROM THE MARK AS SHOWN.
 FOR BOARD GAMES (U.S. CLS. 22, 23, 38 AND 50).
 CHARLOTTE CORWIN, EXAMINING ATTORNEY

SN 77-780,527. MVL RIGHTS LLC, MANHATTAN BEACH, CA, FILED 7-14-2009.

STARK INDUSTRIES

THE MARK CONSISTS OF STANDARD CHARACTERS WITHOUT CLAIM TO ANY PARTICULAR FONT, STYLE, SIZE, OR COLOR.
 NO CLAIM IS MADE TO THE EXCLUSIVE RIGHT TO USE "INDUSTRIES", APART FROM THE MARK AS SHOWN.
 FOR ACTION FIGURES AND ACCESSORIES THEREFOR; ARCADE GAMES; BALLOONS; BALLS FOR GAMES; BATTERY OPERATED ACTION TOYS; BEAN BAG DOLLS; BENDABLE TOYS; BOARD GAMES; BOBBLE HEAD DOLLS; CARD GAMES; CHESS SETS; CHILDREN'S MULTIPLE ACTIVITY TOYS; CHRISTMAS TREE DECORATIONS; COIN-OPERATED VIDEO GAMES; DOLLS AND ACCESSORIES THEREFOR; FLYING DISCS; GAME TABLES; HAND HELD UNIT FOR PLAYING VIDEO GAMES OTHER THAN THOSE ADAPTED FOR USE WITH AN EXTERNAL DISPLAY SCREEN OR MONITOR; INFLATABLE BOP BAGS; INFLATABLE POOLS FOR RECREATIONAL USE; INFLATABLE TOYS; JIGSAW PUZZLES; JUMP ROPES; KITES; MECHANICAL ACTION TOYS; PINBALL GAMES; PINBALL-TYPE GAMES; PLAYING CARDS; PLAYSETS FOR USE WITH TOY ACTION FIGURES AND FOR MAKE BELIEVE PLAY BATTLE OR ADVENTURE ACTIVITIES; PLUSH TOYS; PUPPETS; RADIO CONTROLLED TOY VEHICLES; ROLE PLAYING GAMES; ROLLER SKATES; RUBBER BALLS; SNOW BOARDS; SNOW SLEDS FOR RECREATIONAL USE; SOFT SCULPTURE TOYS; STUFFED TOY ANIMALS; SURF BOARDS; SURF FINS; SWIM BOARDS FOR RECREATIONAL USE; SWIM FINS; TARGET GAMES; TOY ACTION FIGURES AND ACCESSORIES THEREFOR; TOY MASKS; TOY MODEL HOBBYCRAFT KITS; TOY VEHICLES; TOY WATCHES; TOY WEAPONS; WATER SQUIRTING TOYS; YO-YOS (U.S. CLS. 22, 38 AND 50).
 WON TEAK OH, EXAMINING ATTORNEY

CLASS 28—(Continued).

SN 77-794,481. NIKE, INC., BEAVERTON, OR. FILED 7-31-2009.

DMC

THE MARK CONSISTS OF STANDARD CHARACTERS WITHOUT CLAIM TO ANY PARTICULAR FONT, STYLE, SIZE, OR COLOR.
 FOR COATINGS, FORMING AN INTEGRAL COMPONENT OF GOLF BALLS, FOR USE IN IMPROVING PERFORMANCE AND DURABILITY (U.S. CLS. 22, 23, 38 AND 50).
 HENRY S. ZAK, EXAMINING ATTORNEY

SN 77-795,021. WILLIAMS, SYLVIA JEAN, NEW ORLEANS, LA. FILED 8-1-2009.



THE COLOR(S) RED, YELLOW, BLUE, GREEN, BLACK, PURPLE, AND WHITE IS/ARE CLAIMED AS A FEATURE OF THE MARK.
 THE MARK CONSISTS OF A RED OUTLINED TOP RIGHT RECTANGLE, BLUE OUTLINED BOTTOM RIGHT RECTANGLE, YELLOW OUTLINED TOP LEFT RECTANGLE, GREEN OUTLINED BOTTOM LEFT RECTANGLE. THE RECTANGLES CONSIST OF ALTERNATING WHITE AND BLACK STRIPES CONTAINING OPPOSITE COLORED WORDING, WITH THE BLACK STRIPES BEING UNDERLINED BY THE RESPECTIVE COLOR OF THE RECTANGLE, AND WITH 4 BLACK AND WHITE YIN YANG SYMBOLS PER EACH SET OF PAIRED STRIPES IN EACH RECTANGLE. THERE IS A STYLIZED BLACK AND WHITE CIRCULAR SOLAR ECLIPSE DESIGN IN THE CENTER OF THE MARK WITH 4 RADIATING LIGHTS WHICH MAKE A VERTICAL/HORIZONTAL CROSS, THE WORDS "MIND", "BODY", "HEART", AND "CREED" ARE IN BLUE AND AT ANGLES JUST OUTSIDE OF THE STYLIZED SOLAR ECLIPSE DESIGN, WITH ALL OF THEM BEING ON TOP OF THE COLORS OF THE ADJACENT RECTANGLE. THE YELLOW RECTANGLE CONTAINS THE WORDS: "FOCUS ON NEED", "DREAMS", "UNBIASED VETTING", "HOLISM", "STRUCTURE", "TIMETABLE", "HABIT", "CREATIVITY". THE RED RECTANGLE CONTAINS THE WORDS: "ENCOURAGEMENT", "RESPECT", "GRACIOUSNESS", "APPRECIATION", "SELF RELIANCE", "SHARING", "EX-

CLASS 28—(Continued).

PRESSION", "WONDER". THE BLUE RECTANGLE CONTAINS THE WORDS: "EMPATHY", "CHOICE", "PLAY RISK", "RESPONSIBILITY", "QUALITY", "FAIRNESS", "PRIVACY", "HONESTY". THE GREEN RECTANGLE CONTAINS THE WORDS "DEFENSE", "SUSTAINABILITY", "BODILY INPUT", "BODILY OUTPUT", "PREPARATION", "RELAXATION", "DISCIPLINE", AND "EMPOWERMENT". THE WORDS "NEED HEED HEED NEED" ARE IN RED/BLACK GRADIENTS ON A YELLOW BACKGROUND AND PURPLE BEHIND THAT.

FOR ACTION SKILL GAMES; ACTION-TYPE TARGET GAMES; AMUSEMENT GAME MACHINES; ARCADE GAMES; ARCADE-TYPE ELECTRONIC EDUCATION VIDEO GAMES; ARCADE-TYPE ELECTRONIC VIDEO GAMES; BOARD GAMES; CARD GAME FOR BUSINESS TRAINING; CARD GAMES; COIN-OPERATED VIDEO GAMES; DICE GAMES; EDUCATIONAL CARD GAMES; ELECTRONIC GAMES FOR THE TEACHING OF CHILDREN; ELECTRONIC TARGETS FOR GAMES AND SPORTS; EQUIPMENT SOLD AS A UNIT FOR PLAYING A MEMORY GAME; EQUIPMENT SOLD AS A UNIT FOR PLAYING ACTION TYPE TARGET GAMES; EQUIPMENT SOLD AS A UNIT FOR PLAYING BOARD GAMES; EQUIPMENT SOLD AS A UNIT FOR PLAYING CARD GAMES; EXERCISE MACHINES INCORPORATING ELECTRONIC AND VIDEO GAME CONTROLLERS; GAME EQUIPMENT SOLD AS A UNIT FOR PLAYING MIND-BODY EMOTIONAL AND PSYCHOLOGICAL GAMES FOR ADULT COUPLES AND INDIVIDUALS; GAMING EQUIPMENT, NAMELY, GAME WHEELS; HAND HELD UNIT FOR PLAYING ELECTRONIC GAMES; HAND HELD UNIT FOR PLAYING VIDEO GAMES; MANIPULATIVE GAMES; MEMORY GAMES; OUTDOOR ACTIVITY GAMES FEATURING MUSIC/DANCE/EXERCISE SKILLS FOR HEALTHY BODIES AND MINDS; PARLOUR GAMES; PARTY GAMES; PLAYING CARDS AND CARD GAMES; POSITIONABLE PRINTED TOY FIGURES FOR USE IN GAMES; POSITIONABLE THREE DIMENSIONAL TOYS FOR USE IN GAMES; POSITIONABLE TWO DIMENSIONAL TOYS FOR USE IN GAMES; PRINTED POSITIONABLE TOYS FOR USE IN CHILDREN'S BOARD GAMES; PROMOTIONAL GAME CARDS; PROMOTIONAL GAME MATERIALS; PUZZLE GAMES; ROLE PLAYING GAMES; SCRATCH CARDS FOR PLAYING LOTTERY GAMES; STAND ALONE VIDEO GAME MACHINES; STAND ALONE VIDEO OUTPUT GAME MACHINES; TOYS, NAMELY, A DISK TO TOSS IN PLAYING A GAME WHEREIN OTHER DISKS ARE FLIPPED AND COLLECTED; TRADING CARD GAMES (U.S. CLS. 22, 23, 38 AND 50).

KARANENDRA S. CHHINA, EXAMINING ATTORNEY

SN 77-797,215. AMERICA'S DRIVE-IN BRAND PROPERTIES LLC, WICHITA, KS. FILED 8-5-2009.

FIT SONIC

THE MARK CONSISTS OF STANDARD CHARACTERS WITHOUT CLAIM TO ANY PARTICULAR FONT, STYLE, SIZE, OR COLOR.

NO CLAIM IS MADE TO THE EXCLUSIVE RIGHT TO USE "FIT", APART FROM THE MARK AS SHOWN.

FOR EDUCATIONAL TOYS TO PROMOTE PHYSICAL FITNESS, NAMELY, BALLS FOR SPORTS, FLYING DISCS AND PLAYING CARDS FEATURING FITNESS INFORMATION (U.S. CLS. 22, 23, 38 AND 50).

AMY HELLA, EXAMINING ATTORNEY

CLASS 28—(Continued).

SN 77-798,638. HUMANA INC., LOUISVILLE, KY. FILED 8-6-2009.

HG4H

THE MARK CONSISTS OF STANDARD CHARACTERS WITHOUT CLAIM TO ANY PARTICULAR FONT, STYLE, SIZE, OR COLOR.

FOR PUZZLE GAMES; ELECTRONIC EDUCATIONAL GAME MACHINES FOR CHILDREN; BOARD GAMES; TOY, NAMELY, BATTERY-POWERED COMPUTER GAME WITH LCD SCREEN WHICH FEATURES ANIMATION AND SOUND EFFECTS (U.S. CLS. 22, 23, 38 AND 50).

HELENE LIWINSKI, EXAMINING ATTORNEY

SN 77-798,663. HUMANA INC., LOUISVILLE, KY. FILED 8-6-2009.

RACE AGAINST TIME

THE MARK CONSISTS OF STANDARD CHARACTERS WITHOUT CLAIM TO ANY PARTICULAR FONT, STYLE, SIZE, OR COLOR.

FOR PUZZLE GAMES; ELECTRONIC EDUCATIONAL GAME MACHINES FOR CHILDREN; BOARD GAMES; TOY, NAMELY, BATTERY-POWERED COMPUTER GAME WITH LCD SCREEN WHICH FEATURES ANIMATION AND SOUND EFFECTS (U.S. CLS. 22, 23, 38 AND 50).

HELENE LIWINSKI, EXAMINING ATTORNEY

SN 77-800,160. THE GREEN HORNET, INC., LOS ANGELES, CA. FILED 8-7-2009.

Black Beauty

THE MARK CONSISTS OF STANDARD CHARACTERS WITHOUT CLAIM TO ANY PARTICULAR FONT, STYLE, SIZE, OR COLOR.

OWNER OF U.S. REG. NO. 2,253,939.

FOR TOYS, GAMES, AND PLAYTHINGS, NAMELY, ACTION FIGURES AND ACCESSORIES THEREFOR, PLUSH TOYS, MUSICAL TOYS, KITES, BALLOONS, YO-YOS, RIDE-ON TOYS, TOY VEHICLES, SCALE MODEL VEHICLES, TOY VEHICLE TRACKS, RADIO CONTROLLED MODEL VEHICLES, CASES FOR TOY AND MODEL VEHICLES, FLYING DISCS, BOARD GAMES, JIGSAW AND MANIPULATIVE PUZZLES, SKATEBOARDS, WATER SQUIRTING TOYS, BALLS, NAMELY, RUBBER ACTION BALLS, SPORT BALLS, BEACH BALLS, INFLATABLE TOYS, AND ARCADE-TYPE ELECTRONIC VIDEO GAMES (U.S. CLS. 22, 23, 38 AND 50).

DAVID COLLIER, EXAMINING ATTORNEY

CLASS 28—(Continued).

SN 77-827,772. THE GOLDBERGER COMPANY, LLC, NEW YORK, NY. FILED 9-16-2009.

BABY BLOSSOMS

THE MARK CONSISTS OF STANDARD CHARACTERS WITHOUT CLAIM TO ANY PARTICULAR FONT, STYLE, SIZE, OR COLOR.

NO CLAIM IS MADE TO THE EXCLUSIVE RIGHT TO USE "BABY", APART FROM THE MARK AS SHOWN.

FOR DOLLS AND ACCESSORIES THEREOF (U.S. CLS. 22, 23, 38 AND 50).

FIRST USE 6-29-2009; IN COMMERCE 6-29-2009.
INGA ERVIN, EXAMINING ATTORNEY

CLASS 28—(Continued).

SN 77-864,753. ARROW INTERNATIONAL, INC., CLEVELAND, OH. FILED 11-4-2009.

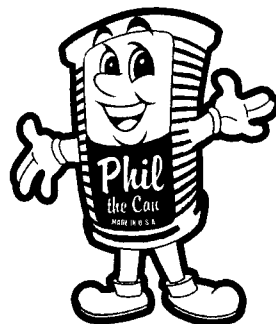

NO CLAIM IS MADE TO THE EXCLUSIVE RIGHT TO USE "MADE IN U.S.A.", APART FROM THE MARK AS SHOWN.

THE MARK CONSISTS OF A CARICATURE OF A CAN WITH ARMS AND LEGS AND A FACE WITH THE WORDING "PHIL THE CAN MADE IN THE U.S.A." APPEARING ON THE CAN.

FOR TICKETS FOR PLAYING GAMES OF CHANCE, NAMELY, PULL TAB TICKETS; LOTTERY TICKETS; TICKETS FOR USE IN GAMES OF CHANCE, NAMELY, DISPOSABLE TICKET SETS FOR PLAYING GAMES OF CHANCE; PRINTED GAME CARDS; LOTTERY CARDS (U.S. CLS. 22, 23, 38 AND 50).

DAVID I, EXAMINING ATTORNEY

SN 77-835,018. HOME BOX OFFICE, INC., NEW YORK, NY. FILED 9-25-2009.

FANGHUNTER

THE MARK CONSISTS OF STANDARD CHARACTERS WITHOUT CLAIM TO ANY PARTICULAR FONT, STYLE, SIZE, OR COLOR.

FOR TOYS, NAMELY, ACTION FIGURES, MODELED PLASTIC TOY FIGURINES; BOARD GAMES; PLAYING CARDS AND GAMING EQUIPMENT, NAMELY, POKER CHIPS; COSTUME MASKS; CHRISTMAS TREE ORNAMENTS; NOVELTY ITEMS, NAMELY, FAKE TEETH (U.S. CLS. 22, 23, 38 AND 50).

ODESSA BIBBINS, EXAMINING ATTORNEY

SN 77-870,435. SCHOOL OF ROCK, LLC, TEANECK, NJ. FILED 11-11-2009.



SN 77-854,830. THE HOUSE ON F STREET, LLC, CLEVELAND, OH. FILED 10-22-2009.

OPERATION SPY

THE MARK CONSISTS OF STANDARD CHARACTERS WITHOUT CLAIM TO ANY PARTICULAR FONT, STYLE, SIZE, OR COLOR.

OWNER OF U.S. REG. NO. 3,410,194.

NO CLAIM IS MADE TO THE EXCLUSIVE RIGHT TO USE "SPY", APART FROM THE MARK AS SHOWN.

FOR TOYS, NAMELY, TOY BINOCULARS, TOY PAPER SHREDDERS, TOY MOTION ALARMS, TOY REAR-VIEW SUNGLASSES, AND TOY LISTENING DEVICES, NAMELY, MICROPHONES AND EARPHONES (U.S. CLS. 22, 23, 38 AND 50).

FIRST USE 4-15-2008; IN COMMERCE 4-15-2008.
SUSAN STIGLITZ, EXAMINING ATTORNEY

THE MARK CONSISTS OF THE WORDS "SCHOOL OF ROCK" WITH A DESIGN OF A GUITAR REPLACING THE LETTER "O" IN THE WORD "ROCK".

FOR GAMES, NAMELY, CARD GAMES, ARCADE GAMES, PARTY GAMES, PARLOR GAMES, MANIPULATIVE GAMES AND ACTION SKILL GAMES; TOYS AND PLAYTHINGS, NAMELY, BOARD GAMES, DOLLS, DOLL CLOTHING, DOLL ACCESSORIES, TOY ACTION FIGURES, ELECTRONIC PARLOR GAMES, PLUSH TOYS, AND ROLE-PLAYING GAMES; TOY INSTRUMENTS, NAMELY, GUITARS, DRUMS AND KEYBOARDS (U.S. CLS. 22, 23, 38 AND 50).

GINA HAYES, EXAMINING ATTORNEY

CLASS 28—(Continued).

SN 77-870,475. SCHOOL OF ROCK, LLC, TEANECK, NJ. FILED 11-11-2009.



The logo for "SCHOOL OF ROCK" features the words "SCHOOL OF ROCK" in a bold, stylized, blocky font. The letter "O" in "ROCK" is replaced by a graphic of a guitar.

THE MARK CONSISTS OF THE WORDS "SCHOOL OF ROCK" WITH A DESIGN OF A GUITAR REPLACING THE LETTER "O" IN THE WORD "ROCK".

FOR GAMES, NAMELY, CARD GAMES, ARCADE GAMES, PARTY GAMES, PARLOR GAMES, MANIPULATIVE GAMES AND ACTION SKILL GAMES; TOYS AND PLAYTHINGS, NAMELY, BOARD GAMES, DOLLS, DOLL CLOTHING, DOLL ACCESSORIES, TOY ACTION FIGURES, ELECTRONIC PARLOR GAMES, PLUSH TOYS, AND ROLE-PLAYING GAMES; TOY INSTRUMENTS, NAMELY, GUITARS, DRUMS AND KEYBOARDS (U.S. CLS. 22, 23, 38 AND 50).
GINA HAYES, EXAMINING ATTORNEY

CLASS 28—(Continued).

SN 77-887,421. L-3 COMMUNICATIONS AEROSPACE ELECTRONICS, BURLINGTON, MA. FILED 12-7-2009.



The logo for "PitchSight" features a circular target symbol with a baseball inside, positioned to the left of the word "PitchSight" in a sans-serif font.

THE MARK CONSISTS OF BASEBALL INSIDE A TARGET TO LEFT OF THE WORD "PITCHSIGHT".

FOR BASEBALL AND SOFTBALL TRAINING APPARATUS USED IN PITCHING SKILLS DEVELOPMENT (U.S. CLS. 22, 23, 38 AND 50).

FIRST USE 1-1-2009; IN COMMERCE 4-1-2009.
JESSICA FATHY, EXAMINING ATTORNEY

SN 77-882,894. PATRICE CONTE, PHOENIX, AZ. FILED 12-1-2009.

Quetzal and Coatl Toys

THE MARK CONSISTS OF STANDARD CHARACTERS WITHOUT CLAIM TO ANY PARTICULAR FONT, STYLE, SIZE, OR COLOR.

NO CLAIM IS MADE TO THE EXCLUSIVE RIGHT TO USE "TOYS", APART FROM THE MARK AS SHOWN.

FOR TOY ACTION FIGURES AND ACCESSORIES THEREFOR (U.S. CLS. 22, 23, 38 AND 50).

PAUL E. FAHRENKOPF, EXAMINING ATTORNEY

SN 77-889,314. I-CANDY INTERNATIONAL LLC, NEW YORK, NY. FILED 12-9-2009.

I-POP

THE MARK CONSISTS OF STANDARD CHARACTERS WITHOUT CLAIM TO ANY PARTICULAR FONT, STYLE, SIZE, OR COLOR.

FOR NOVELTY TOY ITEM IN THE NATURE OF A DISPENSER OF CANDY (U.S. CLS. 22, 23, 38 AND 50).

CHERYL CLAYTON, EXAMINING ATTORNEY

SN 77-887,417. L-3 COMMUNICATIONS AEROSPACE ELECTRONICS, BURLINGTON, MA. FILED 12-7-2009.

PitchSight

THE MARK CONSISTS OF STANDARD CHARACTERS WITHOUT CLAIM TO ANY PARTICULAR FONT, STYLE, SIZE, OR COLOR.

FOR BASEBALL AND SOFTBALL TRAINING APPARATUS USED IN PITCHING SKILLS DEVELOPMENT (U.S. CLS. 22, 23, 38 AND 50).

FIRST USE 1-1-2009; IN COMMERCE 4-1-2009.
JESSICA FATHY, EXAMINING ATTORNEY

SN 77-896,084. SOULCYCLE, LLC, NEW YORK, NY. FILED 12-17-2009.

SOULCYCLE

THE MARK CONSISTS OF STANDARD CHARACTERS WITHOUT CLAIM TO ANY PARTICULAR FONT, STYLE, SIZE, OR COLOR.

OWNER OF U.S. REG. NO. 3,264,026.
FOR STATIONARY EXERCISE BICYCLES; EXERCISE WEIGHTS (U.S. CLS. 22, 23, 38 AND 50).

GEORGE LORENZO, EXAMINING ATTORNEY

CLASS 28—(Continued).

SN 77-896,201. SOULCYCLE, LLC, NEW YORK, NY. FILED 12-17-2009.



OWNER OF U.S. REG. NO. 3,650,759.
 THE MARK CONSISTS OF A BIKE WHEEL WITH MULTIPLE SPOKES.
 FOR STATIONARY EXERCISE BICYCLES; EXERCISE WEIGHTS (U.S. CLS. 22, 23, 38 AND 50).
 GEORGE LORENZO, EXAMINING ATTORNEY

CLASS 28—(Continued).

SN 77-913,646. DW PUBLICATIONS, L.L.C., DOYLESTOWN, PA. FILED 1-17-2010.

Outhouse

THE MARK CONSISTS OF STANDARD CHARACTERS WITHOUT CLAIM TO ANY PARTICULAR FONT, STYLE, SIZE, OR COLOR.

FOR ACTION-TYPE TARGET GAMES; EQUIPMENT SOLD AS A UNIT FOR PLAYING ACTION TYPE TARGET GAMES; OUTDOOR ACTIVITY GAMES IN THE NATURE OF TOSSING GAME PIECES AT A TARGET; TARGET GAMES (U.S. CLS. 22, 23, 38 AND 50).

FIRST USE 9-5-2009; IN COMMERCE 9-5-2009.
 ANDREA SAUNDERS, EXAMINING ATTORNEY

SN 77-918,586. LANARD TOYS LIMITED, TSIMSHATSUI EAST, HONG KONG, FILED 1-22-2010.

COO COO CRITTERS

THE MARK CONSISTS OF STANDARD CHARACTERS WITHOUT CLAIM TO ANY PARTICULAR FONT, STYLE, SIZE, OR COLOR.

NO CLAIM IS MADE TO THE EXCLUSIVE RIGHT TO USE "CRITTERS", APART FROM THE MARK AS SHOWN.
 FOR STUFFED AND PLUSH TOYS; BATTERY-OPERATED ACTION TOYS; MOTORIZED PLUSH ANIMALS (U.S. CLS. 22, 23, 38 AND 50).

FIRST USE 1-1-2010; IN COMMERCE 1-1-2010.
 CHRIS WELLS, EXAMINING ATTORNEY

SN 77-921,176. ALCHEMY3, LLC, ALPHARETTA, GA. FILED 1-27-2010.

Box Office Bucks

THE MARK CONSISTS OF THE STYLIZED LETTER "P" THAT CONTAINS THE DESIGN OF A HEXAGONAL NUT.

FOR BAGS FOR SKATEBOARDS; BALL BEARINGS FOR SKATEBOARDS; NUTS AND BOLTS FOR SKATEBOARDS; PROTECTIVE PADDING FOR SKATEBOARDING; SKATEBOARD DECKS; SKATEBOARD GRIP TAPES; SKATEBOARD RAILS; SKATEBOARD RISER PADS; SKATEBOARD WHEELS; SKATEBOARDS (U.S. CLS. 22, 23, 38 AND 50).

FIRST USE 10-1-2008; IN COMMERCE 10-1-2008.
 DAWN HAN, EXAMINING ATTORNEY

THE MARK CONSISTS OF STANDARD CHARACTERS WITHOUT CLAIM TO ANY PARTICULAR FONT, STYLE, SIZE, OR COLOR.

FOR LOTTERY CARDS; LOTTERY TICKETS (U.S. CLS. 22, 23, 38 AND 50).

KEVIN CORWIN, EXAMINING ATTORNEY

CLASS 28—(Continued).

SN 77-921,748. FLYING FROG PRODUCTIONS, LLC, LYNNWORD, WA. FILED 1-27-2010.

CONQUEST OF PLANET EARTH

THE MARK CONSISTS OF STANDARD CHARACTERS WITHOUT CLAIM TO ANY PARTICULAR FONT, STYLE, SIZE, OR COLOR.

FOR BOARD GAMES; EQUIPMENT SOLD AS A UNIT FOR PLAYING BOARD GAMES (U.S. CLS. 22, 23, 38 AND 50).

AARON BRODSKY, EXAMINING ATTORNEY

SN 77-922,668. GAMAKATSU USA, INC., TACOMA, WA. FILED 1-28-2010.

GAMAKATSU

THE MARK CONSISTS OF STANDARD CHARACTERS WITHOUT CLAIM TO ANY PARTICULAR FONT, STYLE, SIZE, OR COLOR.

OWNER OF U.S. REG. NO. 2,067,199.

FOR FISHING RODS (U.S. CLS. 22, 23, 38 AND 50).
REGINA DRUMMOND, EXAMINING ATTORNEY

SN 77-922,903. UNIQUE SPORTS PRODUCTS, INC., ALPHARETTA, GA. FILED 1-28-2010.

TOURNA

THE MARK CONSISTS OF STANDARD CHARACTERS WITHOUT CLAIM TO ANY PARTICULAR FONT, STYLE, SIZE, OR COLOR.

OWNER OF U.S. REG. NOS. 1,117,774 AND 2,182,974.

FOR RACKET GRIP TAPE; RACKET GRIP WRAP; GRIPS FOR SPORTS EQUIPMENT IN THE NATURE OF TAPE WRAP; SPORTS EQUIPMENT, NAMELY, GRIPS FOR RACKETS; GRIPS FOR TENNIS RACKETS; GRIPS FOR RACQUETBALL RACKETS; GRIPS FOR SQUASH RACKETS; REPLACEMENT GRIPS FOR SPORTS RACKETS; SPORTS EQUIPMENT, NAMELY, VIBRATION DAMPENERS FOR RACKETS; STRINGS FOR SPORTS RACKETS; TENNIS RACKET STRINGS; GUT FOR TENNIS RACKETS; GUTS FOR RACKETS FOR TENNIS, RACQUETBALL AND SQUASH ROSIN BAGS AND ROSIN POWDER FOR RACKET SPORTS USE; RESIN STICKS FOR SPORTS RACKETS; TOWELS FOR PROVIDING GRIP PROTECTION FOR SPORTS RACKETS; TENNIS GLOVES; HAND MITTS FOR TENNIS; SPORTS EQUIPMENT, NAMELY, DEVICES FOR TESTING RACKET STRING TENSION; STRING LOCKING DEVICES FOR SPORTS RACKETS; STRING STENCIL INK FOR SPORTS RACKETS; SPORTS EQUIPMENT, NAMELY, TENNIS TRAINING DEVICES THAT INCORPORATE TENNIS BALLS WITH A STRING OR ROPE ATTACHED; SPORTS EQUIPMENT, NAMELY, TENNIS

CLASS 28—(Continued).

TRAINING DEVICES IN THE FORM OF SIX-KNOBBED BALLS FOR IMPROVING REFLEXES; TENNIS BALLS; FOAM BALLS FOR RACKET SPORTS TRAINING; CONTAINERS TO MAINTAIN AND EXTEND THE USEFUL LIFE OF TENNIS BALLS; CONTAINERS TO MAINTAIN AND EXTEND THE USEFUL LIFE OF RACQUETBALL BALLS; SPORTS EQUIPMENT, NAMELY, CLIPS TO HOLD TENNIS BALLS ON WAISTBAND DURING PLAY; LEAD TAPE AND STRIPS FOR SPORTS RACKETS; GUARD TAPE FOR SPORTS RACKETS; BANDS FOR SECURING SPORTS RACKET GRIP TAPE; CAPS FOR THE BUTT END OF SPORTS RACKETS; SPORTS EQUIPMENT, NAMELY, TENNIS ELBOW GUARDS, SPLINTS, AND AIR PRESSURE PILLOWS; SPORTS EQUIPMENT, NAMELY, TENNIS BALL CARRIERS; TENNIS NETS; ACCESSORIES FOR TENNIS NETS, NAMELY, CENTER STRAPS; SPORTS EQUIPMENT, NAMELY, WRIST CORDS FOR RACQUETBALL RACKETS; AND SPORTS EQUIPMENT, NAMELY, SHAPERS FOR RACQUETBALL GLOVES (U.S. CLS. 22, 23, 38 AND 50).

FIRST USE 12-31-2009; IN COMMERCE 12-31-2009.
VERNA BETH RIRIE, EXAMINING ATTORNEY

SN 77-923,251. KOWKUCHAPAUUKWA PRODUCTIONS LLC, DENVER, CO. FILED 1-29-2010.

WO-JO

THE MARK CONSISTS OF STANDARD CHARACTERS WITHOUT CLAIM TO ANY PARTICULAR FONT, STYLE, SIZE, OR COLOR.

FOR GAME SET COMPRISING CARD DECK, TIMER AND CUBE FOR PLAYING A WORD GAME (U.S. CLS. 22, 23, 38 AND 50).

HEATHER THOMPSON, EXAMINING ATTORNEY

SN 77-923,736. GAMO OUTDOOR USA, INC., FT. LAUDERDALE, FL. FILED 1-29-2010.

KAVIA

THE MARK CONSISTS OF STANDARD CHARACTERS WITHOUT CLAIM TO ANY PARTICULAR FONT, STYLE, SIZE, OR COLOR.

FOR SLING SHOTS; BLOWGUNS FOR USE WITH DARTS AND PAINTBALLS (U.S. CLS. 22, 23, 38 AND 50).
COLLEEN DOMBROW, EXAMINING ATTORNEY

CLASS 28—(Continued).

SN 77-924,154. BEVERLY HILLS TEDDY BEAR COMPANY,
NEWHALL, CA. FILED 1-29-2010.

GlowCrazy

THE MARK CONSISTS OF STANDARD CHARACTERS
WITHOUT CLAIM TO ANY PARTICULAR FONT, STYLE,
SIZE, OR COLOR.

FOR DRAWING TOYS, NAMELY, A GLOW IN THE
DARK KIT COMPRISING PHOSPHORESCENT SHEETS,
PHOSPHORESCENT FABRIC, STENCILS, A GUIDE
BOOK, A BATTERY POWERED LIGHT PEN AND
ACCESSORIES THEREFOR (U.S. CLS. 22, 23, 38 AND 50).
LESLEY LAMOTHE, EXAMINING ATTORNEY

CLASS 28—(Continued).

SN 77-925,288. SONIC TECHNOLOGY PRODUCTS, INC.,
GRASS VALLEY, CA. FILED 2-1-2010.

ToneMaster

THE MARK CONSISTS OF STANDARD CHARACTERS
WITHOUT CLAIM TO ANY PARTICULAR FONT, STYLE,
SIZE, OR COLOR.

FOR SPORTING GOODS, NAMELY, A SPORTS
TRAINING DEVICE TO IMPROVE STRENGTH, TON-
ING, CONDITIONING, BALANCE, AND PROPRIOCEP-
TION (U.S. CLS. 22, 23, 38 AND 50).
WON TEAK OH, EXAMINING ATTORNEY

SN 77-924,261. HOUSE OF INGRI, LLC, NEW YORK, NY.
FILED 1-30-2010.

HOUSE OF INGRI

THE MARK CONSISTS OF STANDARD CHARACTERS
WITHOUT CLAIM TO ANY PARTICULAR FONT, STYLE,
SIZE, OR COLOR.

FOR DOLLS; DOLLS AND ACCESSORIES THEREFOR;
DOLLS FOR PLAYING; PLUSH DOLLS; PLUSH TOYS;
SOFT SCULPTURE DOLLS; SOFT SCULPTURE PLUSH
TOYS; STUFFED AND PLUSH TOYS (U.S. CLS. 22, 23, 38
AND 50).

FIRST USE 1-1-2003; IN COMMERCE 4-1-2003.
BRENDAN REGAN, EXAMINING ATTORNEY

SN 77-925,721. KID FOR LIFE! INC., SELBYVILLE, DE.
FILED 2-2-2010.

YOU DON'T KNOW ME!

THE MARK CONSISTS OF STANDARD CHARACTERS
WITHOUT CLAIM TO ANY PARTICULAR FONT, STYLE,
SIZE, OR COLOR.

FOR BOARD GAMES (U.S. CLS. 22, 23, 38 AND 50).
MICHELE SWAIN, EXAMINING ATTORNEY

SN 77-924,957. EMMONS AND EMMONS INC., TULSA, OK.
FILED 2-1-2010.

i love fiberart

THE MARK CONSISTS OF STANDARD CHARACTERS
WITHOUT CLAIM TO ANY PARTICULAR FONT, STYLE,
SIZE, OR COLOR.

FOR HOBBY CRAFT KIT COMPRISING FIBER ART
(U.S. CLS. 22, 23, 38 AND 50).

FIRST USE 1-1-2008; IN COMMERCE 8-1-2008.
NAAKWAMA ANKRAH, EXAMINING ATTORNEY

SN 77-926,016. BATTAT INCORPORATED, PLATTSBURGH,
NY. FILED 2-2-2010.

CUDDLEEZ

THE MARK CONSISTS OF STANDARD CHARACTERS
WITHOUT CLAIM TO ANY PARTICULAR FONT, STYLE,
SIZE, OR COLOR.

FOR STUFFED AND PLUSH TOYS; TOY FIGURES
(U.S. CLS. 22, 23, 38 AND 50).

AARON BRODSKY, EXAMINING ATTORNEY

CLASS 28—(Continued).

SN 77-926,057. BATTAT INCORPORATED, PLATTSBURGH, NY. FILED 2-2-2010.

EEZ

THE MARK CONSISTS OF STANDARD CHARACTERS WITHOUT CLAIM TO ANY PARTICULAR FONT, STYLE, SIZE, OR COLOR.

FOR STUFFED AND PLUSH TOYS; TOY FIGURES (U.S. CLS. 22, 23, 38 AND 50).

AARON BRODSKY, EXAMINING ATTORNEY

SN 77-926,132. MOOSE #81, LLC, MINNEAPOLIS, MN. FILED 2-2-2010.

MOOSE 81

THE MARK CONSISTS OF STANDARD CHARACTERS WITHOUT CLAIM TO ANY PARTICULAR FONT, STYLE, SIZE, OR COLOR.

FOR CARD GAMES (U.S. CLS. 22, 23, 38 AND 50).
DEZMONA MIZELLE, EXAMINING ATTORNEY

SN 77-926,183. MATSUMOTO, SUSAN M. LANTANA, FL. AND LONGORIA, JOSE, MIAMI, FL. AND KENNEDY, MELVIN R, LANTANA, FL. FILED 2-2-2010.

FUNKY DUCK

THE MARK CONSISTS OF STANDARD CHARACTERS WITHOUT CLAIM TO ANY PARTICULAR FONT, STYLE, SIZE, OR COLOR.

NO CLAIM IS MADE TO THE EXCLUSIVE RIGHT TO USE "DUCK", APART FROM THE MARK AS SHOWN.

FOR BATH TOYS (U.S. CLS. 22, 23, 38 AND 50).
DEBRA LEE, EXAMINING ATTORNEY

CLASS 28—(Continued).

SN 77-926,316. PLAFKIN-HURWITZ, MARSHA, LAKE OSWEGO, OR. FILED 2-2-2010.



OWNER OF U.S. REG. NO. 2,495,533.

NO CLAIM IS MADE TO THE EXCLUSIVE RIGHT TO USE "ART", APART FROM THE MARK AS SHOWN.

THE MARK CONSISTS OF THE WORDS "ART AS RESPONSAS" AND A ZIG-ZAG GRAPHIC ELEMENT.

THE ENGLISH TRANSLATION OF "RESPONSA" IN THE MARK IS "RABBINIC ANSWER TO A RELIGIOUS QUESTION".

FOR POSITIONABLE THREE DIMENSIONAL TOYS FOR USE IN GAMES, NAMELY, SPINNING TOPS (U.S. CLS. 22, 23, 38 AND 50).

FIRST USE 1-1-2003; IN COMMERCE 1-1-2003.

MICHAEL KAZAZIAN, EXAMINING ATTORNEY

SN 77-926,709. AYLIO INTERNATIONAL INC., BROOKLYN, NY. FILED 2-3-2010.

AYLIO

THE MARK CONSISTS OF STANDARD CHARACTERS WITHOUT CLAIM TO ANY PARTICULAR FONT, STYLE, SIZE, OR COLOR.

THE WORDING "AYLIO" HAS NO MEANING IN A FOREIGN LANGUAGE.

FOR MANUALLY-OPERATED EXERCISE EQUIPMENT (U.S. CLS. 22, 23, 38 AND 50).

FIRST USE 4-29-2008; IN COMMERCE 4-29-2008.

EDWARD NELSON, EXAMINING ATTORNEY

SN 77-927,130. THE OAKHURST GROUP CORP., DEERFIELD, IL. FILED 2-3-2010.

EXERSKYS

THE MARK CONSISTS OF STANDARD CHARACTERS WITHOUT CLAIM TO ANY PARTICULAR FONT, STYLE, SIZE, OR COLOR.

FOR FITNESS MACHINES AND EQUIPMENT, NAMELY, WEIGHTS, TREADMILLS, ROWING MACHINES, STAIR STEPPING MACHINES, RESISTANCE MACHINES, STATIONARY CYCLES (U.S. CLS. 22, 23, 38 AND 50).

MARGARET POWER, EXAMINING ATTORNEY

CLASS 28—(Continued).

SN 77-927,241. SHREDDER DOG, INC., BRECKENRIDGE, CO. FILED 2-3-2010.

GO DOGGER

THE MARK CONSISTS OF STANDARD CHARACTERS WITHOUT CLAIM TO ANY PARTICULAR FONT, STYLE, SIZE, OR COLOR.

OWNER OF U.S. REG. NO. 3,635,913.
FOR DOG TOYS; PET TOYS; PET TOYS MADE OF ROPE; SQUEEZABLE SQUEAKING TOYS; STUFFED AND PLUSH TOYS; TOYS FOR DOMESTIC PETS (U.S. CLS. 22, 23, 38 AND 50).

SHAUNIA CARLYLE, EXAMINING ATTORNEY

CLASS 28—(Continued).

SN 77-928,681. TOYNAMI, INC, VAN NUYS, CA. FILED 2-5-2010.

COLD-BLOODED COLLECTIBLES

THE MARK CONSISTS OF STANDARD CHARACTERS WITHOUT CLAIM TO ANY PARTICULAR FONT, STYLE, SIZE, OR COLOR.

NO CLAIM IS MADE TO THE EXCLUSIVE RIGHT TO USE "COLLECTIBLES", APART FROM THE MARK AS SHOWN.

FOR PLAYTHINGS, NAMELY, TOY FIGURES, MOLD-LED PLASTIC TOY FIGURES, MOLDED TOY FIGURES, TOY MODEL PLASTIC FIGURINES, PLASTIC CHARACTER TOYS, TOY ACTION FIGURES (U.S. CLS. 22, 23, 38 AND 50).

PAUL E. FAHRENKOPF, EXAMINING ATTORNEY

SN 77-927,330. MAN CAVE, LLC, MINNEAPOLIS, MN. FILED 2-3-2010.

MAN CAVE

THE MARK CONSISTS OF STANDARD CHARACTERS WITHOUT CLAIM TO ANY PARTICULAR FONT, STYLE, SIZE, OR COLOR.

OWNER OF U.S. REG. NO. 3,666,615.
FOR GAMING EQUIPMENT, NAMELY, POKER CHIPS, POKER CHIP CASES, AND PLAYING CARDS (U.S. CLS. 22, 23, 38 AND 50).

FIRST USE 4-3-2009; IN COMMERCE 4-3-2009.
MAYUR VAGHANI, EXAMINING ATTORNEY

SN 77-928,727. ZULA USA, LLC, BURBANK, CA. FILED 2-5-2010.

DELIRIA

THE MARK CONSISTS OF STANDARD CHARACTERS WITHOUT CLAIM TO ANY PARTICULAR FONT, STYLE, SIZE, OR COLOR.

FOR STUFFED TOYS (U.S. CLS. 22, 23, 38 AND 50).

JOHN WILKE, EXAMINING ATTORNEY

SN 77-928,556. ZOBMONDO!! ENTERTAINMENT LLC, LOS ANGELES, CA. FILED 2-4-2010.

That's A Stretch

THE MARK CONSISTS OF STANDARD CHARACTERS WITHOUT CLAIM TO ANY PARTICULAR FONT, STYLE, SIZE, OR COLOR.

FOR BOARD GAMES; CARD GAMES; PARTY GAMES (U.S. CLS. 22, 23, 38 AND 50).

ZACHARY BELLO, EXAMINING ATTORNEY

SN 77-928,749. JOSEPH G. JULIAN, PITTSBURGH, PA. FILED 2-5-2010.

WILDCARD BASEBALL

THE MARK CONSISTS OF STANDARD CHARACTERS WITHOUT CLAIM TO ANY PARTICULAR FONT, STYLE, SIZE, OR COLOR.

NO CLAIM IS MADE TO THE EXCLUSIVE RIGHT TO USE "BASEBALL", APART FROM THE MARK AS SHOWN.

FOR BOARD GAMES; EQUIPMENT SOLD AS A UNIT FOR PLAYING BOARD GAMES (U.S. CLS. 22, 23, 38 AND 50).

LEIGH LOWRY, EXAMINING ATTORNEY

CLASS 28—(Continued).

SN 77-928,755. ZULA USA, LLC, BURBANK, CA. FILED 2-5-2010.

CLOID

THE MARK CONSISTS OF STANDARD CHARACTERS WITHOUT CLAIM TO ANY PARTICULAR FONT, STYLE, SIZE, OR COLOR.

FOR STUFFED TOYS (U.S. CLS. 22, 23, 38 AND 50).
JOHN WILKE, EXAMINING ATTORNEY

SN 77-928,764. CALHOUN, MICHAEL SEAN, SOUTH RIDING, VA. FILED 2-5-2010.

GOBBLER DOWN CUSTOM CALLS

THE MARK CONSISTS OF STANDARD CHARACTERS WITHOUT CLAIM TO ANY PARTICULAR FONT, STYLE, SIZE, OR COLOR.

NO CLAIM IS MADE TO THE EXCLUSIVE RIGHT TO USE "CUSTOM CALLS", APART FROM THE MARK AS SHOWN.

FOR HUNTING GAME CALLS (U.S. CLS. 22, 23, 38 AND 50).

FIRST USE 3-1-2009; IN COMMERCE 3-1-2009.
BRIDGETT SMITH, EXAMINING ATTORNEY

SN 77-928,780. SCHYLLING ASSOCIATES, INC., ROWLEY, MA. FILED 2-5-2010.

ECOPLAY

THE MARK CONSISTS OF STANDARD CHARACTERS WITHOUT CLAIM TO ANY PARTICULAR FONT, STYLE, SIZE, OR COLOR.

FOR GAMES AND PLAYTHINGS, NAMELY, TOY BOXES AND CHESTS, BATH TOYS, BATHTUB TOYS, BATTERY OPERATED ACTION TOYS, BENDABLE TOYS, CAPS FOR TOY PISTOLS, CASES FOR TOY VEHICLES, CHILDREN'S MULTIPLE ACTIVITY TOYS, CHILDREN'S WIRE CONSTRUCTION AND ART ACTIVITY TOYS, CLOCKWORK TOYS OF METAL, CLOCKWORK TOYS OF PLASTIC, COLLECTABLE TOY FIGURES, CONSTRUCTION TOYS, DISC TOSS TOYS, DOG TOYS, DRAWING TOYS, ELECTRONIC LEARNING TOYS, ELECTRONICALLY OPERATED TOY MOTOR VEHICLES, FANTASY CHARACTER TOYS, FLYING SAUCER TOYS, INFANT ACTION CRIB TOYS, INFANT DEVELOPMENT TOYS, INFANT TOYS, INFLATABLE BATH TOYS, INFLATABLE TOYS, LEVER ACTION TOYS, MECHANICAL ACTION TOYS, MECHANICAL TOYS, MODELED PLASTIC TOY FIGURINES, MOLDED TOY FIGURES, MUSIC BOX TOYS, MUSICAL TOYS, NON-RIDING TRANSPORTATION TOYS, PARTY FAVORS IN THE NATURE OF SMALL TOYS, PLASTIC CHARACTER TOYS, PLUSH TOYS,

CLASS 28—(Continued).

POSITIONABLE TOY FIGURES, PRINTING TOYS, PULL TOYS, PUNCHING TOYS, PUSH TOYS, REMOTE CONTROL TOYS, NAMELY, ROBOTS AND KITES, RIDE-ON TOYS, RUBBER CHARACTER TOYS, SAND TOYS, SANDBOX TOYS, SKETCHING TOYS, SQUEEZABLE SQUEAKING TOYS, SQUEEZE TOYS, STACKING TOYS, TALKING TOYS, TOSSING DISC TOYS, TOY ACTION FIGURES AND ACCESSORIES THEREFOR, TOY AIRPLANES, TOY ANIMALS AND ACCESSORIES THEREFOR, TOY ARMOR, TOY BAKEWARE AND COOKWARE, TOY BANKS, TOY BOWS AND ARROWS, TOY BOXES, TOY BUILDING BLOCKS, TOY BUILDING BLOCKS CAPABLE OF INTERCONNECTION, TOY BUTTERFLY NETS, TOY CAP PISTOLS, TOY CLOCKS AND WATCHES, TOY CONSTRUCTION BLOCKS, TOY CONSTRUCTION SETS, TOY FIGURES, TOY FURNITURE, TOY GLIDERS, TOY GUNS, TOY HARMONICAS, TOY HOOP SETS, TOY MAIL BOXES, TOY MASKS, TOY MODEL CARS, TOY MODEL HOBBYCRAFT KITS, TOY MODEL KIT CARS, TOY MODEL TRAIN SETS, TOY MODELING DOUGH, TOY MUSIC BOXES, TOY NOISEMAKERS, TOY PIANOS, TOY PISTOLS, TOY PRISM GLASSES, TOY PUTTY, TOY ROBOTS, TOY ROCKETS, TOY SAFES, TOY SCOOTERS, TOY SETS OF CARPENTERS' TOOLS, TOY SNOW GLOBES, TOY SWORDS, TOY TRAINS, TOY VEHICLES, TOY WATER GLOBES, TOY WEAPONS, TOY XYLOPHONES, TOY POP GUNS, DISK TOSS GAME WHEREIN OTHER DISKS ARE FLIPPED AND COLLECTED, WATER SQUIRTING TOYS, WIND-UP TOYS, WIND-UP WALKING TOYS, JACK - IN - THE - BOXES, TOY DISH SETS (U.S. CLS. 22, 23, 38 AND 50).

FIRST USE 2-1-2010; IN COMMERCE 2-1-2010.
JOHN WILKE, EXAMINING ATTORNEY

SN 77-928,809. UNKNOWN GAMES, LLC, COLUMBUS, OH. FILED 2-5-2010.

STINKYSMELLS

THE MARK CONSISTS OF STANDARD CHARACTERS WITHOUT CLAIM TO ANY PARTICULAR FONT, STYLE, SIZE, OR COLOR.

FOR ACTION SKILL GAMES; ARCADE-TYPE ELECTRONIC VIDEO GAMES; BATH TOYS, BENDABLE TOYS, BOARD GAMES, COLLECTABLE TOY FIGURES; DOLLS AND ACCESSORIES THEREFOR; HAND PUPPETS; PLUSH TOYS; RUBBER CHARACTER TOYS; STUFFED TOYS; TOY ACTION FIGURES AND ACCESSORIES THEREFOR (U.S. CLS. 22, 23, 38 AND 50).

TOBY BULLOFF, EXAMINING ATTORNEY

SN 77-928,845. ETIQUETTE & PROTOCOL INTERNATIONAL, INC., HOLBROOK, NY. FILED 2-5-2010.

GLOBE WHIZ

THE MARK CONSISTS OF STANDARD CHARACTERS WITHOUT CLAIM TO ANY PARTICULAR FONT, STYLE, SIZE, OR COLOR.

FOR BOARD GAMES AND GAME COMPONENT PIECES SOLD AS A UNIT THEREWITH (U.S. CLS. 22, 23, 38 AND 50).

KEVIN DINALLO, EXAMINING ATTORNEY

CLASS 28—(Continued).

SN 77-928,881. CALHOUN, MICHAEL SEAN, SOUTH RIDING, VA. FILED 2-5-2010.

EXOTIC DANCER

THE MARK CONSISTS OF STANDARD CHARACTERS WITHOUT CLAIM TO ANY PARTICULAR FONT, STYLE, SIZE, OR COLOR.

FOR HUNTING GAME CALLS (U.S. CLS. 22, 23, 38 AND 50).

FIRST USE 3-1-2009; IN COMMERCE 3-1-2009.
BRIDGETT SMITH, EXAMINING ATTORNEY

SN 77-928,916. CALHOUN, MICHAEL SEAN, SOUTH RIDING, VA. FILED 2-5-2010.

THE MISTRESS

THE MARK CONSISTS OF STANDARD CHARACTERS WITHOUT CLAIM TO ANY PARTICULAR FONT, STYLE, SIZE, OR COLOR.

FOR HUNTING GAME CALLS (U.S. CLS. 22, 23, 38 AND 50).

FIRST USE 3-1-2009; IN COMMERCE 3-1-2009.
BRIDGETT SMITH, EXAMINING ATTORNEY

SN 77-929,161. TECHNIQUE GOLF, L.L.C., DBA TIGER SHARK GOLF NORTH AMERICA, WARREN, MI. FILED 2-5-2010.

PRESSURE ZONE

THE MARK CONSISTS OF STANDARD CHARACTERS WITHOUT CLAIM TO ANY PARTICULAR FONT, STYLE, SIZE, OR COLOR.

FOR GOLF CLUB GRIPS (U.S. CLS. 22, 23, 38 AND 50).
FIRST USE 10-5-2009; IN COMMERCE 10-5-2009.
TINA MAI, EXAMINING ATTORNEY

CLASS 28—(Continued).

SN 77-929,214. BROOKLYN WORKSHOP, INC., BROOKLYN, NY. FILED 2-5-2010.

FREERIDER

THE MARK CONSISTS OF STANDARD CHARACTERS WITHOUT CLAIM TO ANY PARTICULAR FONT, STYLE, SIZE, OR COLOR.

FOR EXERCISE EQUIPMENT FOR LATERAL MOVEMENT IN A SKATING MOTION; IN-LINE ROLLER SKATES; IN-LINE SKATES; SKATEBOARDS; SNOW BOARDS; SNOW SKIS (U.S. CLS. 22, 23, 38 AND 50).

FIRST USE 9-12-2004; IN COMMERCE 1-1-2010.
DAVID H. STINE, EXAMINING ATTORNEY

SN 77-929,504. BONDRA, ADAM SCOTT, NEWPORT COAST, CA. FILED 2-5-2010.

SKYRO

THE MARK CONSISTS OF STANDARD CHARACTERS WITHOUT CLAIM TO ANY PARTICULAR FONT, STYLE, SIZE, OR COLOR.

FOR FLYING TOYS AND ACCESSORIES THEREFOR (U.S. CLS. 22, 23, 38 AND 50).

SANI KHOURI, EXAMINING ATTORNEY

SN 77-929,612. CALLAWAY GOLF COMPANY, CARLSBAAD, CA. FILED 2-5-2010.

C-Tech

THE MARK CONSISTS OF STANDARD CHARACTERS WITHOUT CLAIM TO ANY PARTICULAR FONT, STYLE, SIZE, OR COLOR.

FOR GOLF GLOVES (U.S. CLS. 22, 23, 38 AND 50).
JOHN DWYER, EXAMINING ATTORNEY

CLASS 28—(Continued).

SN 77-929,948. DEBORAH RANDOLPH, DBA TUMMY TOTS, PASO ROBLES, CA. AND DANA SHAW, DBA TUMMY TOTS, PASO ROBLES, CA. FILED 2-7-2010.



THE MARK CONSISTS OF THE WORDING "TUMMY TOTS" IN A STYLIZED FONT AND A DESIGN THAT CONSISTS OF THREE SMILEY FACES WHICH APPEAR IN THE LETTER "T" OF TUMMY.

FOR PLUSH TOYS (U.S. CLS. 22, 23, 38 AND 50).
RENEE MCCRAY, EXAMINING ATTORNEY

CLASS 28—(Continued).

SN 77-930,474. WORLD WRESTLING ENTERTAINMENT, INC., STAMFORD, CT. FILED 2-8-2010.



THE MARK CONSISTS OF TWO STACKED "W" LETTERS WITH A STAR UNDERNEATH SITTING ON TOP OF THE LETTERS "NXT" APPEARING VERTICALLY.

FOR TOY ACTION FIGURES AND ACCESSORIES THEREFOR; CASES FOR ACTION FIGURES; TOY VEHICLES; BOARD GAMES; PLAYING CARDS; TOY SPINNING TOPS; STAND ALONE VIDEO OUTPUT GAME MACHINES FEATURING WRESTLING; ARCADE GAMES RELATED TO WRESTLING; PINBALL GAMES RELATED TO WRESTLING; HAND-HELD UNITS FOR PLAYING ELECTRONIC GAME; TABLETOP ACTION SKILL GAMES RELATED TO WRESTLING; JIGSAW PUZZLES; KITES; TOY WRESTLING RINGS; DOLLS; BOBBLE-HEAD DOLLS; PUPPETS; STUFFED TOY ANIMALS; CARD GAMES; TOY GUITARS; WATER GUNS; VINYL PRODUCTS FOR PLAYING IN A POOL, NAMELY, FLOATING PILLOW BACK LOUNGE CHAIR, INFLATABLE TOY RAFTS FOR AQUATIC RECREATIONAL USE; CHRISTMAS TREE DECORATIONS; COSTUME MASKS; TOY BELTS, DOLL FURNITURE; PARTY FAVORS IN THE NATURE OF CRACKERS AND NOISEMAKERS; SKATEBOARDS; WINDUP TOYS; TOY SCOOTERS; KNEE AND ELBOW PADS FOR ATHLETIC USE; YO-YO'S; PLASTIC MODEL KITS FOR MAKING TOY VEHICLES; NOVELTY TOYS, NAMELY, TOY BANKS MADE OF TIN; TOY GUM MACHINES; TOY FOAM HANDS; CONFETTI (U.S. CLS. 22, 23, 38 AND 50).

JOHN HWANG, EXAMINING ATTORNEY

SN 77-930,219. BADLANDS INC., ETOBICOKE, ONTARIO, CANADA, FILED 2-8-2010.

INKA

THE MARK CONSISTS OF STANDARD CHARACTERS WITHOUT CLAIM TO ANY PARTICULAR FONT, STYLE, SIZE, OR COLOR.

FOR PAINTBALLS (U.S. CLS. 22, 23, 38 AND 50).
CHRISTOPHER BUONGIORNO, EXAMINING ATTORNEY

CLASS 28—(Continued).

SN 77-930,531. CARLINO, CRISTINA M., PHOENIX, AZ. FILED 2-8-2010.

ARCHETYPE

THE MARK CONSISTS OF STANDARD CHARACTERS WITHOUT CLAIM TO ANY PARTICULAR FONT, STYLE, SIZE, OR COLOR.

FOR ACTION FIGURES AND ACCESSORIES THEREFOR; BATHTUB TOYS; BATTERY OPERATED ACTION TOYS; BENDABLE TOYS; BOARD GAMES; BUBBLE MAKING WAND AND SOLUTION SETS; CARD GAMES; CHILDREN'S MULTIPLE ACTIVITY TOYS; CHRISTMAS STOCKINGS; CHRISTMAS TREE ORNAMENTS AND DECORATIONS; CHRISTMAS TREE SKIRTS; CRIB TOYS; DOLLS AND ACCESSORIES THEREFOR; ELECTRONIC LEARNING TOYS; MECHANICAL TOYS; PET TOYS; PUZZLES; STUFFED AND PLUSH TOYS; TOY ANIMALS AND ACCESSORIES THEREFOR; TOY BAKWARE AND COOKWARE; TOY BUILDING BLOCKS (U.S. CLS. 22, 23, 38 AND 50).

APRIL HESIK, EXAMINING ATTORNEY

CLASS 28—(Continued).

SN 77-930,598. SHURE PRODUCTS, INC., CHICAGO, IL. FILED 2-8-2010.

Sweethearts

THE MARK CONSISTS OF STANDARD CHARACTERS WITHOUT CLAIM TO ANY PARTICULAR FONT, STYLE, SIZE, OR COLOR.

FOR DOLLS (U.S. CLS. 22, 23, 38 AND 50).
ERIN FALK, EXAMINING ATTORNEY

SN 77-930,624. SHURE PRODUCTS, INC., CHICAGO, IL. FILED 2-8-2010.

Stable Pals

THE MARK CONSISTS OF STANDARD CHARACTERS WITHOUT CLAIM TO ANY PARTICULAR FONT, STYLE, SIZE, OR COLOR.

NO CLAIM IS MADE TO THE EXCLUSIVE RIGHT TO USE "STABLE", APART FROM THE MARK AS SHOWN.
FOR DOLLS (U.S. CLS. 22, 23, 38 AND 50).
ERIN FALK, EXAMINING ATTORNEY

SN 77-930,674. JR COMPANIES, INC., NEW HOPE, PA. FILED 2-8-2010.

THE REALITY BUTTON

THE MARK CONSISTS OF STANDARD CHARACTERS WITHOUT CLAIM TO ANY PARTICULAR FONT, STYLE, SIZE, OR COLOR.

NO CLAIM IS MADE TO THE EXCLUSIVE RIGHT TO USE "BUTTON", APART FROM THE MARK AS SHOWN.
FOR ELECTRONIC NOVELTY TOY ITEM, NAMELY, A DESK OR TABLE MOUNTED BUTTON-ACTUATED TOY WHICH, UPON ACTUATION, PLAYS A RECORDED MESSAGE (U.S. CLS. 22, 23, 38 AND 50).
DAVID MILLER, EXAMINING ATTORNEY

SN 77-930,538. STEWART, BRANDON C, SAN FRANCISCO, CA. FILED 2-8-2010.

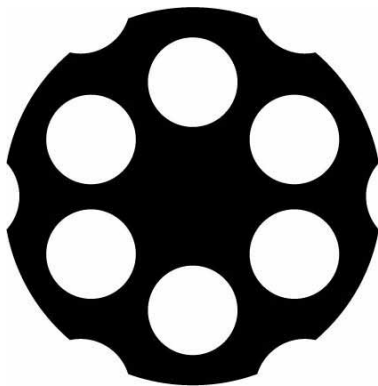

THE MARK CONSISTS OF A SIX SHOOTER GUN CYLINDER, WITH SIX CIRCLES DEPICTING WHERE BULLETS ARE LOADED AND SIX GROOVES ON THE OUTER EDGE LOCATED IN BETWEEN CIRCLES.

FOR BAGS FOR SKATEBOARDS; BALL BEARINGS FOR SKATEBOARDS; HARNESSES SPECIALLY ADAPTED FOR CARRYING SNOWBOARDS, SKIS AND SKATEBOARDS; NUTS AND BOLTS FOR SKATEBOARDS; PROTECTIVE PADDING FOR SKATEBOARDING; SKATEBOARD DECKS; SKATEBOARD GRIP TAPES; SKATEBOARD RAILS; SKATEBOARD RISER PADS; SKATEBOARD TRUCKS; SKATEBOARD WHEELS; SKATEBOARDS (U.S. CLS. 22, 23, 38 AND 50).
KATHERINE CHANG, EXAMINING ATTORNEY

CLASS 28—(Continued).

SN 77-931,272. MATTEL, INC., EL SEGUNDO, CA. FILED 2-9-2010.

ELECTRO CUTIES

THE MARK CONSISTS OF STANDARD CHARACTERS WITHOUT CLAIM TO ANY PARTICULAR FONT, STYLE, SIZE, OR COLOR.

FOR TOYS, GAMES AND PLAYTHINGS, NAMELY, TOY FIGURES AND ACCESSORIES THEREFOR; TOY ANIMAL FIGURES AND ACCESSORIES THEREFOR (U.S. CLS. 22, 23, 38 AND 50).

JAMES LOVELACE, EXAMINING ATTORNEY

SN 77-931,278. MATTEL, INC., EL SEGUNDO, CA. FILED 2-9-2010.

CAKEAPHANT

THE MARK CONSISTS OF STANDARD CHARACTERS WITHOUT CLAIM TO ANY PARTICULAR FONT, STYLE, SIZE, OR COLOR.

FOR TOYS, GAMES AND PLAYTHINGS, NAMELY, TOY FIGURES AND ACCESSORIES THEREFOR (U.S. CLS. 22, 23, 38 AND 50).

JAMES LOVELACE, EXAMINING ATTORNEY

SN 77-931,282. MATTEL, INC., EL SEGUNDO, CA. FILED 2-9-2010.

CROSSFADE

THE MARK CONSISTS OF STANDARD CHARACTERS WITHOUT CLAIM TO ANY PARTICULAR FONT, STYLE, SIZE, OR COLOR.

FOR TOYS, GAMES AND PLAYTHINGS, NAMELY, TOY FIGURES AND ACCESSORIES THEREFOR; TOY ANIMAL FIGURES AND ACCESSORIES THEREFOR (U.S. CLS. 22, 23, 38 AND 50).

JAMES LOVELACE, EXAMINING ATTORNEY

CLASS 28—(Continued).

SN 77-931,336. TRALY (U.S.A.), INC., BOCA RATON, FL. FILED 2-9-2010.

Road Rage Diverter

THE MARK CONSISTS OF STANDARD CHARACTERS WITHOUT CLAIM TO ANY PARTICULAR FONT, STYLE, SIZE, OR COLOR.

FOR TOYS, NAMELY, NOISEMAKER FOR USE WITHIN AUTOMOBILES (U.S. CLS. 22, 23, 38 AND 50).

DOUGLAS LEE, EXAMINING ATTORNEY

SN 77-931,745. SHATAH, THAYNE, APOLLO BEACH, FL. FILED 2-9-2010.

United Kettlebells.com UKB

THE MARK CONSISTS OF STANDARD CHARACTERS WITHOUT CLAIM TO ANY PARTICULAR FONT, STYLE, SIZE, OR COLOR.

NO CLAIM IS MADE TO THE EXCLUSIVE RIGHT TO USE "KETTLEBELLS.COM", APART FROM THE MARK AS SHOWN.

FOR FITNESS EQUIPMENT, NAMELY, KETTLEBELLS, FITNESS ROPES, INDIAN CLUBS, WEIGHTS, BARBELLS, BUMPER PLATES, PULL UP BARS AND POWER RACKS (U.S. CLS. 22, 23, 38 AND 50).

FIRST USE 2-1-2010; IN COMMERCE 2-1-2010.

KATHY DE JONGE, EXAMINING ATTORNEY

SN 77-931,938. THE NORMAN ROCKWELL FAMILY AGENCY, INC., LAGRANGEVILLE, NY. FILED 2-9-2010.



OWNER OF U.S. REG. NOS. 1,666,322, 3,172,850 AND 3,458,489.

THE NAME(S), PORTRAIT(S), AND/OR SIGNATURE(S) SHOWN IN THE MARK DOES NOT IDENTIFY A PARTICULAR LIVING INDIVIDUAL.

THE MARK CONSISTS OF A FIVE POINT STAR IN A SQUARE WITH THE WORDING "NORMAN ROCKWELL" APPEARING IN A BANNER TO THE RIGHT.

FOR GAMES AND PLAYTHINGS, NAMELY, BOARD GAMES, CARD GAMES, PLAYING CARDS, AND CHRISTMAS TREE ORNAMENTS (U.S. CLS. 22, 23, 38 AND 50).

JAY FLOWERS, EXAMINING ATTORNEY

CLASS 28—(Continued).

SN 77-932,006. MGM HOLDINGS LLC, CHEYENNE, WY. FILED 2-9-2010.

CLASS 28—(Continued).

SN 77-934,331. MATTEL, INC., EL SEGUNDO, CA. FILED 2-12-2010.

AUTO-POPPER

SUB-TERNIA

THE MARK CONSISTS OF STANDARD CHARACTERS WITHOUT CLAIM TO ANY PARTICULAR FONT, STYLE, SIZE, OR COLOR.
FOR TARGETS (U.S. CLS. 22, 23, 38 AND 50).
FIRST USE 4-0-1995; IN COMMERCE 4-0-1995.
ANNE E. GUSTASON, EXAMINING ATTORNEY

THE MARK CONSISTS OF STANDARD CHARACTERS WITHOUT CLAIM TO ANY PARTICULAR FONT, STYLE, SIZE, OR COLOR.
FOR TOYS, GAMES AND PLAYTHINGS, NAMELY, TOY ACTION FIGURES AND ACCESSORIES THEREFOR (U.S. CLS. 22, 23, 38 AND 50).
JAMES LOVELACE, EXAMINING ATTORNEY

SN 77-933,290. HEARTLAND SOLUTIONS, INC., GRAIN VALLEY, MO. FILED 2-11-2010.

SN 77-934,332. MATTEL, INC., EL SEGUNDO, CA. FILED 2-12-2010.

RACK ENVY

GWILDOR

THE MARK CONSISTS OF STANDARD CHARACTERS WITHOUT CLAIM TO ANY PARTICULAR FONT, STYLE, SIZE, OR COLOR.
FOR HUNTER'S SCENT CAMOUFLAGE (U.S. CLS. 22, 23, 38 AND 50).
FIRST USE 2-5-2010; IN COMMERCE 2-5-2010.
WILLIAM BRECKENFELD, EXAMINING ATTORNEY

THE MARK CONSISTS OF STANDARD CHARACTERS WITHOUT CLAIM TO ANY PARTICULAR FONT, STYLE, SIZE, OR COLOR.
FOR TOYS, GAMES AND PLAYTHINGS, NAMELY, TOY ACTION FIGURES AND ACCESSORIES THEREFOR (U.S. CLS. 22, 23, 38 AND 50).
JAMES LOVELACE, EXAMINING ATTORNEY

SN 77-933,719. EDUCATIONAL INSIGHTS, INC., GARDENA, CA. FILED 2-11-2010.

SN 77-934,335. MATTEL, INC., EL SEGUNDO, CA. FILED 2-12-2010.

RACK YOUR BRAIN

CERATUS

THE MARK CONSISTS OF STANDARD CHARACTERS WITHOUT CLAIM TO ANY PARTICULAR FONT, STYLE, SIZE, OR COLOR.
FOR GAMES, NAMELY, STRATEGY GAMES (U.S. CLS. 22, 23, 38 AND 50).
KATHLEEN LORENZO, EXAMINING ATTORNEY

THE MARK CONSISTS OF STANDARD CHARACTERS WITHOUT CLAIM TO ANY PARTICULAR FONT, STYLE, SIZE, OR COLOR.
FOR TOYS, GAMES AND PLAYTHINGS, NAMELY, TOY ACTION FIGURES AND ACCESSORIES THEREFOR (U.S. CLS. 22, 23, 38 AND 50).
JAMES LOVELACE, EXAMINING ATTORNEY

CLASS 28—(Continued).

SN 77-934,338. MATTEL, INC., EL SEGUNDO, CA. FILED 2-12-2010.

CATRA

THE MARK CONSISTS OF STANDARD CHARACTERS WITHOUT CLAIM TO ANY PARTICULAR FONT, STYLE, SIZE, OR COLOR.

FOR TOYS, GAMES AND PLAYTHINGS, NAMELY, TOY ACTION FIGURES AND ACCESSORIES THEREFOR (U.S. CLS. 22, 23, 38 AND 50).

JAMES LOVELACE, EXAMINING ATTORNEY

SN 77-934,339. MATTEL, INC., EL SEGUNDO, CA. FILED 2-12-2010.

SPEED-A-SALT

THE MARK CONSISTS OF STANDARD CHARACTERS WITHOUT CLAIM TO ANY PARTICULAR FONT, STYLE, SIZE, OR COLOR.

FOR TOYS, GAMES AND PLAYTHINGS, NAMELY, TOY VEHICLES AND ACCESSORIES THEREFOR (U.S. CLS. 22, 23, 38 AND 50).

JAMES LOVELACE, EXAMINING ATTORNEY

SN 77-937,130. MITCHELL, RONNIE, SOUTHLAKE, TX. FILED 2-16-2010.

RAKESPEARE

THE MARK CONSISTS OF STANDARD CHARACTERS WITHOUT CLAIM TO ANY PARTICULAR FONT, STYLE, SIZE, OR COLOR.

FOR BASEBALL BASES; BASEBALL BAT BAGS; BASEBALL BAT CASES; BASEBALL BAT RACKS; BASEBALL BATS; BASEBALL BATTING GLOVES; BASEBALL BATTING TEES; BASEBALL GLOVE CONDITIONING OIL; BASEBALL GLOVES; BASEBALL MITTS; BASEBALL PITCHING SCREENS; BASEBALL PLATE BRUSHES; BASEBALLS; CHEST PROTECTORS; GRIP TAPES FOR BASEBALL BATS (U.S. CLS. 22, 23, 38 AND 50).

ZACHARY BELLO, EXAMINING ATTORNEY

CLASS 28—(Continued).

SN 77-938,253. BLACK MOUNTAIN PRODUCTS, SPRING GROVE, IL. FILED 2-17-2010.



THE MARK CONSISTS OF A STYLIZED MOUNTAIN WITH THE LETTERS "B.M.P." INSIDE/BASE OF THE MOUNTAIN.

FOR MANUALLY-OPERATED EXERCISE EQUIPMENT FOR PHYSICAL FITNESS PURPOSES (U.S. CLS. 22, 23, 38 AND 50).

ROBIN CHOSID, EXAMINING ATTORNEY

SN 77-940,544. MGM HOLDINGS LLC, CALDWELL, ID. FILED 2-19-2010.

BC-C ZONE

THE MARK CONSISTS OF STANDARD CHARACTERS WITHOUT CLAIM TO ANY PARTICULAR FONT, STYLE, SIZE, OR COLOR.

FOR TARGETS (U.S. CLS. 22, 23, 38 AND 50). FIRST USE 9-12-2008; IN COMMERCE 9-12-2008.

ANNE E. GUSTASON, EXAMINING ATTORNEY

SN 77-940,551. MGM HOLDINGS LLC, CALDWELL, ID. FILED 2-19-2010.

WHIRLY-GIG

THE MARK CONSISTS OF STANDARD CHARACTERS WITHOUT CLAIM TO ANY PARTICULAR FONT, STYLE, SIZE, OR COLOR.

FOR TARGETS (U.S. CLS. 22, 23, 38 AND 50). FIRST USE 5-2-2003; IN COMMERCE 5-2-2003.

ANNE E. GUSTASON, EXAMINING ATTORNEY

CLASS 28—(Continued).

SN 77-942,554. WORLD SPORTS PRODUCTS, INC., ST. GEORGE, UT. FILED 2-23-2010.

Big Play

THE MARK CONSISTS OF STANDARD CHARACTERS WITHOUT CLAIM TO ANY PARTICULAR FONT, STYLE, SIZE, OR COLOR.

FOR SPORTS EQUIPMENT, NAMELY, BALL CAGES, BALL NET, BALL TARGET, BALL PITCHING SCREENS, FOR BASEBALL, SOFTBALL, SOCCER, GOLF, FOOTBALL, AND TENNIS (U.S. CLS. 22, 23, 38 AND 50).

FIRST USE 1-10-2009; IN COMMERCE 1-10-2009.
BARBARA RUTLAND, EXAMINING ATTORNEY

SN 77-943,274. WORLD WRESTLING ENTERTAINMENT, INC., STAMFORD, CT. FILED 2-24-2010.

NXT ROOKIE

THE MARK CONSISTS OF STANDARD CHARACTERS WITHOUT CLAIM TO ANY PARTICULAR FONT, STYLE, SIZE, OR COLOR.

FOR TOYS, NAMELY, ACTION FIGURES AND ACCESSORIES THEREFOR; CASES FOR ACTION FIGURES; TOY WRESTLING RINGS; TOY VEHICLES; BOARD GAMES; PLAYING CARDS; PUZZLES; STUFFED TOYS; PLUSH TOYS; TOY BELTS; KNEE AND ELBOW PADS FOR ATHLETIC USE; TOY FOAM HANDS; COSTUME MASKS; DOLLS (U.S. CLS. 22, 23, 38 AND 50).

JOHN HWANG, EXAMINING ATTORNEY

SN 77-944,098. BUILD-A-BEAR RETAIL MANAGEMENT, INC., ST. LOUIS, MO. FILED 2-24-2010.

COMFY STUFF BY BUILD-A-BEAR WORKSHOP

THE MARK CONSISTS OF STANDARD CHARACTERS WITHOUT CLAIM TO ANY PARTICULAR FONT, STYLE, SIZE, OR COLOR.

OWNER OF U.S. REG. NOS. 2,722,224, 2,843,811 AND OTHERS.

FOR TOYS, NAMELY, TOY ACCESSORIES IN THE NATURE OF TOY CLOTHING AND TOY BED LINENS (U.S. CLS. 22, 23, 38 AND 50).

ALICIA COLLINS, EXAMINING ATTORNEY

CLASS 28—(Continued).

SN 77-945,471. FREMANTLEMEDIA NORTH AMERICA, INC., BURBANK, CA. FILED 2-25-2010.

AMERICAN IDOL

THE MARK CONSISTS OF STANDARD CHARACTERS WITHOUT CLAIM TO ANY PARTICULAR FONT, STYLE, SIZE, OR COLOR.

OWNER OF U.S. REG. NOS. 3,064,528, 3,683,826 AND OTHERS.

FOR PARTY FAVORS IN THE NATURE OF SMALL TOYS; PARTY GAMES; PINATAS (U.S. CLS. 22, 23, 38 AND 50).

FIRST USE 3-1-2006; IN COMMERCE 3-1-2006.
AMEEN IMAM, EXAMINING ATTORNEY

SN 77-945,509. WORLD WRESTLING ENTERTAINMENT, INC., STAMFORD, CT. FILED 2-25-2010.

OVER THE LIMIT

THE MARK CONSISTS OF STANDARD CHARACTERS WITHOUT CLAIM TO ANY PARTICULAR FONT, STYLE, SIZE, OR COLOR.

FOR TOY ACTION FIGURES AND ACCESSORIES THEREFOR; CASES FOR ACTION FIGURES; TOY VEHICLES; BOARD GAMES; PLAYING CARDS; TOY SPINNING TOPS; STAND ALONE VIDEO OUTPUT GAME MACHINES FEATURING WRESTLING; ARCADE GAMES RELATED TO WRESTLING; PINBALL GAMES RELATED TO WRESTLING; HAND-HELD UNITS FOR PLAYING ELECTRONIC GAME; TABLETOP ACTION SKILL GAMES RELATED TO WRESTLING; JIGSAW PUZZLES; KITES; TOY WRESTLING RINGS; DOLLS; BOBBLE-HEAD DOLLS; PUPPETS; STUFFED TOY ANIMALS; CARD GAMES; TOY GUITARS; WATER GUNS; VINYL PRODUCTS FOR PLAYING IN A POOL, NAMELY, FLOATING PILLOW BACK LOUNGE CHAIR, INFLATABLE TOY RAFTS FOR AQUATIC RECREATIONAL USE; CHRISTMAS TREE DECORATIONS; COSTUME MASKS; TOY BELTS, DOLL FURNITURE; PARTY FAVORS IN THE NATURE OF CRACKERS AND NOISEMAKERS; SKATEBOARDS; BOWLING BALLS AND ACCESSORIES, NAMELY, BOWLING GLOVES, WRIST SUPPORTS, BOWLING BALL BAGS; WINDUP TOYS; TOY SCOOTERS; BOWLING PINS; KNEE AND ELBOW PADS FOR ATHLETIC USE; YO-YO'S; PLASTIC MODEL KITS FOR MAKING TOY VEHICLES; POOL CUES; NOVELTY TOYS, NAMELY, TOY BANKS MADE OF TIN; TOY GUM MACHINES; TOY CANDY BOWL MECHANICAL DISPENSERS; TOY STICK GUM DISPENSERS; TOY GUM FIGURE MAKERS; TOY FOAM HANDS; CONFETTI (U.S. CLS. 22, 23, 38 AND 50).

JOHN HWANG, EXAMINING ATTORNEY

CLASS 28—(Continued).

SN 77-945,513. WORLD WRESTLING ENTERTAINMENT, INC., STAMFORD, CT. FILED 2-25-2010.

FATAL FOUR WAY

THE MARK CONSISTS OF STANDARD CHARACTERS WITHOUT CLAIM TO ANY PARTICULAR FONT, STYLE, SIZE, OR COLOR.

FOR TOY ACTION FIGURES AND ACCESSORIES THEREFOR; CASES FOR ACTION FIGURES; TOY VEHICLES; BOARD GAMES; PLAYING CARDS; TOY SPINNING TOPS; STAND ALONE VIDEO OUTPUT GAME MACHINES FEATURING WRESTLING; ARCADE GAMES RELATED TO WRESTLING; PINBALL GAMES RELATED TO WRESTLING; HAND-HELD UNITS FOR PLAYING ELECTRONIC GAME; TABLE-TOP ACTION SKILL GAMES RELATED TO WRESTLING; JIGSAW PUZZLES; KITES; TOY WRESTLING RINGS; DOLLS; BOBBLE-HEAD DOLLS; PUPPETS; STUFFED TOY ANIMALS; CARD GAMES; TOY GUITARS; WATER GUNS; VINYL PRODUCTS FOR PLAYING IN A POOL, NAMELY, FLOATING PILLOW BACK LOUNGE CHAIR, INFLATABLE TOY RAFTS FOR AQUATIC RECREATIONAL USE; CHRISTMAS TREE DECORATIONS; COSTUME MASKS; TOY BELTS, DOLL FURNITURE; PARTY FAVORS IN THE NATURE OF CRACKERS AND NOISEMAKERS; SKATEBOARDS; BOWLING BALLS AND ACCESSORIES, NAMELY, BOWLING GLOVES, WRIST SUPPORTS, BOWLING BALL BAGS; WINDUP TOYS; TOY SCOOTERS; BOWLING PINS; KNEE AND ELBOW PADS FOR ATHLETIC USE; YO-YO'S; PLASTIC MODEL KITS FOR MAKING TOY VEHICLES; POOL CUES; NOVELTY TOYS, NAMELY, TOY BANKS MADE OF TIN; TOY GUM MACHINES; TOY CANDY BOWL MECHANICAL DISPENSERS; TOY STICK GUM DISPENSERS; TOY GUM FIGURE MAKERS; TOY FOAM HANDS; CONFETTI (U.S. CLS. 22, 23, 38 AND 50).

JOHN HWANG, EXAMINING ATTORNEY

CLASS 28—(Continued).

SN 77-945,517. WORLD WRESTLING ENTERTAINMENT, INC., STAMFORD, CT. FILED 2-25-2010.

MONEY IN THE BANK

THE MARK CONSISTS OF STANDARD CHARACTERS WITHOUT CLAIM TO ANY PARTICULAR FONT, STYLE, SIZE, OR COLOR.

OWNER OF U.S. REG. NO. 3,532,434.

FOR TOY ACTION FIGURES AND ACCESSORIES THEREFOR; CASES FOR ACTION FIGURES; TOY VEHICLES; BOARD GAMES; PLAYING CARDS; TOY SPINNING TOPS; STAND ALONE VIDEO OUTPUT GAME MACHINES FEATURING WRESTLING; ARCADE GAMES RELATED TO WRESTLING; PINBALL GAMES RELATED TO WRESTLING; HAND-HELD UNITS FOR PLAYING ELECTRONIC GAME; TABLE-TOP ACTION SKILL GAMES RELATED TO WRESTLING; JIGSAW PUZZLES; KITES; TOY WRESTLING RINGS; DOLLS; BOBBLE-HEAD DOLLS; PUPPETS; STUFFED TOY ANIMALS; CARD GAMES; TOY GUITARS; WATER GUNS; VINYL PRODUCTS FOR PLAYING IN A POOL, NAMELY, FLOATING PILLOW BACK LOUNGE CHAIR, INFLATABLE TOY RAFTS FOR AQUATIC RECREATIONAL USE; CHRISTMAS TREE DECORATIONS; COSTUME MASKS; TOY BELTS, DOLL FURNITURE; PARTY FAVORS IN THE NATURE OF CRACKERS AND NOISEMAKERS; SKATEBOARDS; BOWLING BALLS AND ACCESSORIES, NAMELY, BOWLING GLOVES, WRIST SUPPORTS, BOWLING BALL BAGS; WINDUP TOYS; TOY SCOOTERS; BOWLING PINS; KNEE AND ELBOW PADS FOR ATHLETIC USE; YO-YO'S; PLASTIC MODEL KITS FOR MAKING TOY VEHICLES; POOL CUES; NOVELTY TOYS, NAMELY, TOY BANKS MADE OF TIN; TOY GUM MACHINES; TOY CANDY BOWL MECHANICAL DISPENSERS; TOY STICK GUM DISPENSERS; TOY GUM FIGURE MAKERS; TOY FOAM HANDS; CONFETTI (U.S. CLS. 22, 23, 38 AND 50).

JOHN HWANG, EXAMINING ATTORNEY

SN 77-966,018. CALLAWAY GOLF COMPANY, CARLSBAD, CA. FILED 3-23-2010.

White Damascus

THE MARK CONSISTS OF STANDARD CHARACTERS WITHOUT CLAIM TO ANY PARTICULAR FONT, STYLE, SIZE, OR COLOR.

NO CLAIM IS MADE TO THE EXCLUSIVE RIGHT TO USE "WHITE", APART FROM THE MARK AS SHOWN.

FOR GOLF CLUBS; HEAD COVERS FOR GOLF CLUBS (U.S. CLS. 22, 23, 38 AND 50).

JOHN DWYER, EXAMINING ATTORNEY

CLASS 28—(Continued).

SN 77-968,830. FREMANTLEMEDIA OPERATIONS B.V.,
1217 GP HILVERSUM, NETHERLANDS, FILED 3-25-2010.

PRESS YOUR LUCK

THE MARK CONSISTS OF STANDARD CHARACTERS WITHOUT CLAIM TO ANY PARTICULAR FONT, STYLE, SIZE, OR COLOR.

OWNER OF U.S. REG. NOS. 2,666,877, 3,415,760 AND OTHERS.

FOR TARGET GAMES; BOARD GAMES AND CARD GAMES; KITES; TOY ACTION FIGURES; DISC TOSS TOYS; TOY BOWS AND ARROWS; BALLS OF ALL KINDS; DOLLS AND PLAYSETS THEREFOR; PLUSH TOYS; TOY VEHICLES; TOY BUCKET AND SHOVEL SETS; ROLLER SKATES; TOY MODEL HOBBYCRAFT KITS; TOY ROCKETS; TOY GUNS; TOY HOLSTERS; MUSICAL TOYS; JIGSAW PUZZLES; BADMINTON SETS; BUBBLE MAKING WANDS AND SOLUTION SETS; MODELED PLASTIC TOY FIGURINES; TOY BANKS; PUPPETS; TOY BALLOONS; YO-YOS; SKATEBOARDS; TOY SCOOTERS; FACE MASKS; STAND ALONE VIDEO GAME MACHINES; LCD GAME MACHINES; LOTTERY TICKETS AND SCRATCH CARDS FOR PLAYING LOTTERY GAMES; CONFETTI; COIN-OPERATED AMUSEMENT MACHINES; PLAYING CARDS; PAPER PARTY HATS; HAND HELD UNITS FOR PLAYING ELECTRONIC GAMES OTHER THAN THOSE ADAPTED FOR USE WITH AN EXTERNAL DISPLAY SCREEN OR MONITOR, BUT SPECIFICALLY EXCLUDING DICE GAMES AND COMPUTER SOFTWARE GAMES (U.S. CLS. 22, 23, 38 AND 50).

FIRST USE 10-1-2008; IN COMMERCE 10-1-2008.

RENEE MCCRAY, EXAMINING ATTORNEY

SN 78-549,653. CANO, LARRY R., NEWPORT BEACH, CA.
FILED 1-19-2005.

RALLY KIDS

THE MARK CONSISTS OF STANDARD CHARACTERS WITHOUT CLAIM TO ANY PARTICULAR FONT, STYLE, SIZE, OR COLOR.

FOR TOYS IN THE NATURE OF STUFFED DOLLS (U.S. CLS. 22, 23, 38 AND 50).

DEBRA LEE, EXAMINING ATTORNEY

SN 78-948,627. EATON CORPORATION, CLEVELAND, OH.
FILED 8-9-2006.

OPTIK

THE MARK CONSISTS OF STANDARD CHARACTERS WITHOUT CLAIM TO ANY PARTICULAR FONT, STYLE, SIZE, OR COLOR.

FOR GOLF CLUB GRIPS (U.S. CLS. 22, 23, 38 AND 50).

FRED CARL, EXAMINING ATTORNEY

CLASS 28—(Continued).

SN 79-060,190. BABY ART BVBA, BELGIUM, FILED 5-5-2008.



OWNER OF INTERNATIONAL REGISTRATION 0980392 DATED 5-5-2008, EXPIRES 5-5-2018.

THE MARK CONSISTS OF A HIGHLY STYLIZED DEPICTION OF THE TERM "HOPPOP" WHEREIN THE TOP OF THE LETTER "H" AND THE BOTTOM OF THE LETTER "P'S ARE REPRESENTED BY A TEARDROP SHAPE.

THE WORDING "HOPPOP" HAS NO MEANING IN A FOREIGN LANGUAGE.

FOR INFANT TOYS, BATH TOYS, RIDE-ON TOYS (U.S. CLS. 22, 23, 38 AND 50).

MYRIAH HABEEB, EXAMINING ATTORNEY

SN 79-074,032. MOHAMMED KHAN, LONDON, UNITED KINGDOM, FILED 7-13-2009.

ROCK TEDDY

THE MARK CONSISTS OF STANDARD CHARACTERS WITHOUT CLAIM TO ANY PARTICULAR FONT, STYLE, SIZE, OR COLOR.

PRIORITY DATE OF 4-29-2009 IS CLAIMED.

OWNER OF INTERNATIONAL REGISTRATION 1016395 DATED 7-13-2009, EXPIRES 7-13-2019.

NO CLAIM IS MADE TO THE EXCLUSIVE RIGHT TO USE "TEDDY", APART FROM THE MARK AS SHOWN.

FOR PLUSH TOYS AND TEDDY BEARS (U.S. CLS. 22, 23, 38 AND 50).

WANDA KAY PRICE, EXAMINING ATTORNEY

CLASS 28—(Continued).

SN 85-001,299. CHEVRON INTELLECTUAL PROPERTY LLC, SAN RAMON, CA. FILED 3-29-2010.



OWNER OF U.S. REG. NOS. 3,540,724, 3,723,190 AND OTHERS.

THE MARK CONSISTS OF ONE CIRCLE WITH A THICK BORDER WITH THE WORD "CHEVRON" LOCATED INSIDE. THE WORD "CHEVRON" FEATURES A STYLIZED WINGED "V" DESIGN AND IS BRACKETED BY A HORIZONTAL LINE ABOVE AND BELOW THE WORD. THE WORD "GASOLINE" APPEARS UNDERNEATH THE WORD "CHEVRON".

FOR TOY TANK TRAILER TRUCKS, TOY TOW TRUCKS, TOY SERVICE STATIONS AND GAS PUMPS, MODEL KITS FOR ANTIQUE DELIVERY VEHICLES, DIE-CAST CARS, TRAINS AND AIRPLANES, AND WOODEN TOY TRAIN SETS (U.S. CLS. 22, 23, 38 AND 50).

MARK SHINER, EXAMINING ATTORNEY

CLASS 28—(Continued).

SN 85-001,621. BUZZ BEE TOYS, INC., MT. LAUREL, NJ. FILED 3-30-2010.

ULTIMATE SNIPE BLAST

THE MARK CONSISTS OF STANDARD CHARACTERS WITHOUT CLAIM TO ANY PARTICULAR FONT, STYLE, SIZE, OR COLOR.

FOR TOY PROJECTILE SHOOTERS AND ACCESSORIES THEREFOR (U.S. CLS. 22, 23, 38 AND 50).

BRENDAN MCCAULEY, EXAMINING ATTORNEY

SN 85-023,396. ETIQUETTE & PROTOCOL INTERNATIONAL, INC., HOLBROOK, NY. FILED 4-26-2010.



SN 85-001,617. BUZZ BEE TOYS, INC., MT. LAUREL, NJ. FILED 3-30-2010.

ULTIMATE RAPID BLAST

THE MARK CONSISTS OF STANDARD CHARACTERS WITHOUT CLAIM TO ANY PARTICULAR FONT, STYLE, SIZE, OR COLOR.

FOR TOY PROJECTILE SHOOTERS AND ACCESSORIES THEREFOR (U.S. CLS. 22, 23, 38 AND 50).

BRENDAN MCCAULEY, EXAMINING ATTORNEY

THE COLOR(S) BLUE, GREEN, BLACK AND WHITE IS/ ARE CLAIMED AS A FEATURE OF THE MARK.

THE MARK CONSISTS OF THE STYLIZED TERMS "GLOBE WHIZ", AN ELLIPSE AND THE COLOR BLUE APPEARING IN THE BACKGROUND WITHIN THE ELLIPSE; THE COLOR GREEN APPEARING IN THE LETTERS OF THE STYLIZED WORD "GLOBE"; THE COLOR BLACK IN THE STYLIZED WORD "WHIZ" IN THE CENTER OF THE ELLIPSE AND SUPERIMPOSED ON THE STYLIZED WORD "GLOBE", AND IN THE TRIANGLE ABOVE THE WORD "WHIZ" AND IN THE PERIMETER OF THE ELLIPSE; AND THE COLOR WHITE FORMING A BORDER ON THE LETTERS OF THE STYLIZED WORDS "GLOBE WHIZ".

FOR BOARD GAMES AND GAME COMPONENT PIECES SOLD AS A UNIT THEREWITH (U.S. CLS. 22, 23, 38 AND 50).

KEVIN DINALLO, EXAMINING ATTORNEY

CLASS 29—MEATS AND PROCESSED FOODS

SN 77-471,250. GOODNESS GARDENS INC., NEW HAMPTON, NY. FILED 5-11-2008.



NO CLAIM IS MADE TO THE EXCLUSIVE RIGHT TO USE "FRUIT", APART FROM THE MARK AS SHOWN.

THE STIPPLING IS FOR SHADING PURPOSES ONLY.

THE MARK CONSISTS OF THE STYLIZED WORDING "SQUEEZY FRUIT" WITH AN INVERTED STYLIZED DROP BETWEEN THE "U" AND THE "E".

FOR FRUIT PUREES (U.S. CL. 46).

FIRST USE 3-15-2008; IN COMMERCE 4-1-2008.

LOURDES AYALA, EXAMINING ATTORNEY

SN 77-545,805. THE SHOLL GROUP II, INC., EDEN PRAIRIE, MN. FILED 8-13-2008.

PATIO GRILLERS

THE MARK CONSISTS OF STANDARD CHARACTERS WITHOUT CLAIM TO ANY PARTICULAR FONT, STYLE, SIZE, OR COLOR.

NO CLAIM IS MADE TO THE EXCLUSIVE RIGHT TO USE "GRILLERS", APART FROM THE MARK AS SHOWN.

FOR PREPARED VEGETABLES SOLD WITH OR WITHOUT A SAUCE (U.S. CL. 46).

MICHAEL ENGEL, EXAMINING ATTORNEY

SN 77-663,699. HINDLEY, ANNA, MILL VALLEY, CA. AND CAMERON, BIRGIT IGEL, MILL VALLEY, CA. FILED 2-4-2009.

ONEBAR

THE MARK CONSISTS OF STANDARD CHARACTERS WITHOUT CLAIM TO ANY PARTICULAR FONT, STYLE, SIZE, OR COLOR.

FOR FRUIT-BASED SNACK FOOD (U.S. CL. 46).

FIRST USE 2-4-2009; IN COMMERCE 2-4-2009.

SETH A. RAPPAPORT, EXAMINING ATTORNEY

CLASS 29—(Continued).

SN 77-688,848. DEACON DOG BRANDS LLC, PACIFIC PALISADES, CA. FILED 3-11-2009.

FRIED AND GONE TO HEAVEN

THE MARK CONSISTS OF STANDARD CHARACTERS WITHOUT CLAIM TO ANY PARTICULAR FONT, STYLE, SIZE, OR COLOR.

FOR FROZEN ENTREES CONSISTING PRIMARILY OF MEAT, SEAFOOD, POULTRY, OR VEGETABLES; PACKAGED ENTREES CONSISTING PRIMARILY OF MEAT, SEAFOOD, POULTRY, OR VEGETABLES; FROZEN APPETIZERS CONSISTING PRIMARILY OF MEAT, SEAFOOD, POULTRY, OR VEGETABLES; PACKAGED APPETIZERS CONSISTING PRIMARILY OF MEAT, SEAFOOD, POULTRY, OR VEGETABLES; FROZEN SIDE DISHES CONSISTING PRIMARILY OF MEAT, SEAFOOD, POULTRY, OR VEGETABLES; PACKAGED SIDE DISHES CONSISTING PRIMARILY OF MEAT, SEAFOOD, POULTRY, OR VEGETABLES (U.S. CL. 46).

REBECCA POVARCHUK, EXAMINING ATTORNEY

SN 77-703,362. THE GREAT ATLANTIC & PACIFIC TEA COMPANY, INC., MONTVALE, NJ. FILED 3-31-2009.

SIERRA RANCH

THE MARK CONSISTS OF STANDARD CHARACTERS WITHOUT CLAIM TO ANY PARTICULAR FONT, STYLE, SIZE, OR COLOR.

NO CLAIM IS MADE TO THE EXCLUSIVE RIGHT TO USE "RANCH", APART FROM THE MARK AS SHOWN.

FOR FRESH MEATS (U.S. CL. 46).

THOMAS MANOR, EXAMINING ATTORNEY

SN 77-728,709. BERNARD MATTHEWS NEW ZEALAND LIMITED, WAIPUKURAU, NEW ZEALAND, FILED 5-4-2009.

OVATION

THE MARK CONSISTS OF STANDARD CHARACTERS WITHOUT CLAIM TO ANY PARTICULAR FONT, STYLE, SIZE, OR COLOR.

FOR MEAT (U.S. CL. 46).

EMILY CARLSEN, EXAMINING ATTORNEY

CLASS 29—(Continued).

SN 77-748,181. MADRANGE, FEYTIAT, FRANCE, FILED 5-29-2009.



OWNER OF U.S. REG. NOS. 1,493,337, 2,733,891 AND 3,249,760.

NO CLAIM IS MADE TO THE EXCLUSIVE RIGHT TO USE "MAISON DE QUALITE FONDEE EN 1924", APART FROM THE MARK AS SHOWN.

THE COLOR(S) WHITE, BLACK, RED, GOLD, BLUE IS/ ARE CLAIMED AS A FEATURE OF THE MARK.

THE MARK CONSISTS OF A LABEL WHOSE SIDE PANELS ARE BLUE AND WHOSE CENTER PORTION IS YELLOW WITH THE WORD "BUFFET" IN STYLIZED PRINT IN BLUE AGAINST THE YELLOW BACKGROUND; ABOVE THAT IS A RECTANGLE SPLIT HORIZONTALLY WITH THE TOP BLACK AND THE BOTTOM RED; THE WORD "MADRANGE" APPEARS IN WHITE AGAINST THE BLACK BACKGROUND; THE WORDING "MAISON DE QUALITE FONDEE EN 1924" APPEARS IN GOLD AGAINST THE RED BACKGROUND ALONG WITH A REPRESENTATION OF A HOUSE, ALSO IN GOLD AGAINST THE RED BACKGROUND.

THE ENGLISH TRANSLATION OF "MAISON DE QUALITE FONDEE EN 1924" IN THE MARK IS "HOUSE OF QUALITY FOUNDED IN 1924".

FOR MEAT, FISH, POULTRY AND GAME; MEAT EXTRACTS; PRESERVED FRUITS, DRIED AND COOKED FRUITS AND VEGETABLES, JELLIES, JAMS, CRANBERRY SAUCE, APPLE SAUCE, EGGS, MILK, MILK PRODUCTS EXCLUDING ICE CREAM, ICE MILK AND FROZEN YOGURT; EDIBLE OILS AND FATS; MEAT, POULTRY, FISH, GAME AND VEGETABLE PRESERVES; CHARCUTERIE; HAM AND PROCEED MEAT, NAMELY, CURED HAM; SAUSAGES MEAT-BASED MOUSSE, FISH MOUSSE, VEGETABLE MOUSSE; AND PREPARED MEALS CONSISTING PRIMARILY OF MEAT, POULTRY, GAME, VEGETABLE AND FISH (U.S. CL. 46).

FIRST USE 12-1-2005; IN COMMERCE 12-1-2005.
BERYL GARDNER, EXAMINING ATTORNEY

SN 77-751,501. JBARA, FATEH, MONROE TOWNSHIP, NJ. FILED 6-3-2009.

AL DURRA

THE MARK CONSISTS OF STANDARD CHARACTERS WITHOUT CLAIM TO ANY PARTICULAR FONT, STYLE, SIZE, OR COLOR.

THE WORDING "AL DURRA" HAS NO MEANING IN A FOREIGN LANGUAGE.

FOR TOMATO PASTE (U.S. CL. 46).
REBECCA SMITH, EXAMINING ATTORNEY

CLASS 29—(Continued).

SN 77-751,621. JBARA, FATEH, MONROE TOWNSHIP, NJ. FILED 6-3-2009.

DURRA

THE MARK CONSISTS OF STANDARD CHARACTERS WITHOUT CLAIM TO ANY PARTICULAR FONT, STYLE, SIZE, OR COLOR.

THE WORDING "DURRA" HAS NO MEANING IN A FOREIGN LANGUAGE.

FOR TOMATO PASTE (U.S. CL. 46).
REBECCA SMITH, EXAMINING ATTORNEY

SN 77-758,784. GARDEN PROTEIN INTERNATIONAL INC., RICHMOND, BC, CANADA, FILED 6-12-2009.

GARDEN PROTEIN

THE MARK CONSISTS OF STANDARD CHARACTERS WITHOUT CLAIM TO ANY PARTICULAR FONT, STYLE, SIZE, OR COLOR.

PRIORITY CLAIMED UNDER SEC. 44(D) ON CANADA APPLICATION NO. 1432016, FILED 3-23-2009.

OWNER OF CANADA REG. NO. TMA761337, DATED 3-10-2010, EXPIRES 3-10-2025.

OWNER OF U.S. REG. NO. 3,545,141.

NO CLAIM IS MADE TO THE EXCLUSIVE RIGHT TO USE "PROTEIN", APART FROM THE MARK AS SHOWN.

FOR (BASED ON USE IN COMMERCE) FORMED TEXTURED VEGETABLE PROTEIN FOR USE AS A MEAT EXTENDER OR MEAT SUBSTITUTE; MEAT SUBSTITUTES; VEGETABLE-BASED MEAT SUBSTITUTES (BASED ON 44(D) PRIORITY APPLICATION) FORMED TEXTURED VEGETABLE PROTEIN FOR USE AS A MEAT EXTENDER OR MEAT SUBSTITUTE; MEAT SUBSTITUTES; VEGETABLE-BASED MEAT SUBSTITUTES (U.S. CL. 46).

FIRST USE 7-31-2005; IN COMMERCE 7-31-2005.
TIMOTHY FINNEGAN, EXAMINING ATTORNEY

SN 77-765,343. JBARA, FATEH, MONROE TOWNSHIP, NJ. FILED 6-22-2009.

AL RAKY

THE MARK CONSISTS OF STANDARD CHARACTERS WITHOUT CLAIM TO ANY PARTICULAR FONT, STYLE, SIZE, OR COLOR.

"AL RAKY" APPEARING IN THE MARK HAS NO SIGNIFICANCE IN THE RELEVANT TRADE OR INDUSTRY OR AS APPLIED TO THE GOODS/SERVICES LISTED IN THE APPLICATION, OR ANY GEOGRAPHICAL SIGNIFICANCE.

FOR PROCESSED OLIVES (U.S. CL. 46).
REBECCA SMITH, EXAMINING ATTORNEY

CLASS 29—(Continued).

SN 77-776,520. MEBO INTERNATIONAL, INC., SUNNY-VALE, CA. FILED 7-8-2009.

MEBO

THE MARK CONSISTS OF STANDARD CHARACTERS WITHOUT CLAIM TO ANY PARTICULAR FONT, STYLE, SIZE, OR COLOR.

OWNER OF U.S. REG. NOS. 1,800,404 AND 2,656,764.

FOR JAMS; CAKES MADE OF FISH AND SEAFOOD; DAIRY-BASED SPREADS; FRUIT-BASED SPREADS; GARLIC-BASED SPREADS; JELLIES; MEAT-BASED SPREADS; VEGETABLE-BASED SPREADS; BANANA CHIPS; FRUIT CHIPS; POTATO CHIPS; SHRIMP CHIPS; SOY CHIPS; VEGETABLE CHIPS; YUCCA CHIPS; CAKES MADE FROM FISH; CAKES MADE FROM SEAFOOD; FRUIT-BASED FOOD BEVERAGES; DAIRY-BASED FOOD BEVERAGES; SOY-BASED SNACK FOODS; VEGETABLE-BASED SNACK FOODS (U.S. CL. 46).

MARIA-VICTORIA SUAREZ, EXAMINING ATTORNEY

SN 77-777,553. PACIFIC AMERICAN FISH COMPANY, INC., VERNON, CA. FILED 7-9-2009.

Snak N'Go

THE MARK CONSISTS OF STANDARD CHARACTERS WITHOUT CLAIM TO ANY PARTICULAR FONT, STYLE, SIZE, OR COLOR.

NO CLAIM IS MADE TO THE EXCLUSIVE RIGHT TO USE "SNACK", APART FROM THE MARK AS SHOWN.

FOR FROZEN APPETIZERS CONSISTING PRIMARILY OF CHICKEN OR SEAFOOD; FROZEN PRE-PACKAGED ENTREES CONSISTING PRIMARILY OF SEAFOOD; MARINATED SEAFOOD; PRE-PACKAGED DINNERS CONSISTING OF SEAFOOD; PREPARED ENTREES CONSISTING PRIMARILY OF SEAFOOD; PREPARED FOOD KITS COMPOSED OF MEAT, POULTRY, FISH, SEAFOOD, AND/OR VEGETABLES AND ALSO INCLUDING SAUCES OR SEASONINGS, READY FOR COOKING AND ASSEMBLY AS A MEAL; SEAFOOD; SEAFOOD, NAMELY, SEAFOOD; SEAFOODS BOILED DOWN IN SOY SAUCE (TSUKUDANI); SEASONED SEAFOOD; TINNED SEAFOOD (U.S. CL. 46).

FIRST USE 7-18-2009; IN COMMERCE 7-18-2009.

KEVON CHISOLM, EXAMINING ATTORNEY

CLASS 29—(Continued).

SN 77-787,781. J&B WHOLESALE DISTRIBUTING, INC., ST. MICHAEL, MN. FILED 7-23-2009.



OWNER OF U.S. REG. NOS. 3,389,811 AND 3,398,597.

NO CLAIM IS MADE TO THE EXCLUSIVE RIGHT TO USE "SEAFOOD COMPANY", APART FROM THE MARK AS SHOWN.

THE COLOR(S) BLUE, GREEN, WHITE, BLACK AND GRAY IS/ARE CLAIMED AS A FEATURE OF THE MARK.

THE MARK CONSISTS OF THE DESIGN OF AN ANCHOR AND THE WORDS "BLUEWAVE SEAFOOD COMPANY" SHOWN INSIDE A RECTANGULAR SHAPE. THE RECTANGLE IS OUTLINED IN THE COLOR BLUE. THE WORD "BLUEWAVE" APPEARS AT THE TOP OF THE RECTANGLE IN BLUE LETTERS, THE WORDS "SEAFOOD COMPANY" APPEAR BELOW IN GREEN LETTERS, AND THE ANCHOR IS TO THE LEFT OF THE WORDING IN BLACK. THE WORDING "BLUEWAVE SEAFOOD COMPANY" IS SHADOWED IN GRAY. THE BACKGROUND OF THE RECTANGLE IS WHITE.

FOR FISH AND SEAFOOD (U.S. CL. 46).

KIM SAITO, EXAMINING ATTORNEY

SN 77-794,750. GEORGE DELALLO COMPANY, INC., MT. PLEASANT, PA. FILED 7-31-2009.

PROVOLINI

THE MARK CONSISTS OF STANDARD CHARACTERS WITHOUT CLAIM TO ANY PARTICULAR FONT, STYLE, SIZE, OR COLOR.

THE WORDING "PROVOLINI" HAS NO MEANING IN A FOREIGN LANGUAGE.

FOR ANTIPASTI CONSISTING PRIMARILY OF OLIVES, MUSHROOMS, CHEESE AND PRESERVED VEGETABLES (U.S. CL. 46).

FIRST USE 7-20-2009; IN COMMERCE 7-20-2009.

PRISCILLA MILTON, EXAMINING ATTORNEY

SN 77-797,187. GOOD HARBOR FILLETT COMPANY LLC, GLOUCESTER, MA. FILED 8-5-2009.

FROZEN FISH FRESH IDEAS

THE MARK CONSISTS OF STANDARD CHARACTERS WITHOUT CLAIM TO ANY PARTICULAR FONT, STYLE, SIZE, OR COLOR.

NO CLAIM IS MADE TO THE EXCLUSIVE RIGHT TO USE "FROZEN FISH", APART FROM THE MARK AS SHOWN.

FOR SEAFOOD; FROZEN SEAFOOD; PROCESSED SEAFOOD; PREPARED SEAFOOD (U.S. CL. 46).

ALYSSA STEEL, EXAMINING ATTORNEY

CLASS 29—(Continued).

SN 77-802,403. GOLDMAN, JAMES, NEW YORK, NY. FILED 8-11-2009.

TURBO MILK

THE MARK CONSISTS OF STANDARD CHARACTERS WITHOUT CLAIM TO ANY PARTICULAR FONT, STYLE, SIZE, OR COLOR.

NO CLAIM IS MADE TO THE EXCLUSIVE RIGHT TO USE "MILK", APART FROM THE MARK AS SHOWN.

FOR DAIRY PRODUCTS EXCLUDING ICE CREAM, ICE MILK AND FROZEN YOGURT; DAIRY-BASED BEVERAGES; MILK; YOGURT DRINKS; YOGURT-BASED BEVERAGES (U.S. CL. 46).

MATTHEW PAPPAS, EXAMINING ATTORNEY

SN 77-802,469. COOPERATIVA AGROPECUÁRIA DE TUBARÃO, TUBARÃO, S.P., BRAZIL, FILED 8-12-2009.



NO CLAIM IS MADE TO THE EXCLUSIVE RIGHT TO USE "REAL GOURMET", APART FROM THE MARK AS SHOWN.

THE MARK CONSISTS OF THE WORDS "REAL GOURMET" IN STYLIZED LETTERS OVER A RIBBON-LIKE BANNER.

FOR PROCESSED HEARTS OF PALM (U.S. CL. 46).

FIRST USE 5-22-2007; IN COMMERCE 7-31-2009.

JAMES STEIN, EXAMINING ATTORNEY

SN 77-814,935. TOPCO HOLDINGS, INC., SKOKIE, IL. FILED 8-28-2009.

GARDEN MIX

THE MARK CONSISTS OF STANDARD CHARACTERS WITHOUT CLAIM TO ANY PARTICULAR FONT, STYLE, SIZE, OR COLOR.

NO CLAIM IS MADE TO THE EXCLUSIVE RIGHT TO USE "MIX", APART FROM THE MARK AS SHOWN.

FOR FROZEN VEGETABLES (U.S. CL. 46).

BRIAN NEVILLE, EXAMINING ATTORNEY

CLASS 29—(Continued).

SN 77-827,180. COLEMAN NATURAL PRODUCTS, INC., GOLDEN, CO. FILED 9-15-2009.



OWNER OF U.S. REG. NO. 3,672,550.

NO CLAIM IS MADE TO THE EXCLUSIVE RIGHT TO USE "THE ORIGINAL BRAT", APART FROM THE MARK AS SHOWN.

THE MARK CONSISTS OF A CIRCLE WITH THE DRAWING OF A BAKER RIDING A MOTORCYCLE IN THE CENTER AND THE WORDS "THE ORIGINAL BRAT HANS" PARTIALLY SURROUNDING THE DRAWING.

FOR (BASED ON USE IN COMMERCE) MEATBALLS; BREAKFAST LINKS; BREAKFAST SAUSAGE; (BASED ON INTENT TO USE) MEAT; FRESH, FROZEN, PROCESSED AND COOKED MEATS; FRESH, FROZEN, PROCESSED AND COOKED POULTRY, BEEF, PORK, LAMB AND GAME; POULTRY, BEEF, PORK, LAMB AND GAME PRODUCTS, NAMELY, PREPACKAGED COOKED AND UNCOOKED MEALS; PROCESSED MEAT; SEASONED POULTRY, BEEF, PORK, LAMB AND GAME; POULTRY, BEEF, PORK, LAMB AND GAME; HAM; BACON; HOT DOGS (U.S. CL. 46).

FIRST USE 5-31-2008; IN COMMERCE 4-30-2009.

SANI KHOURI, EXAMINING ATTORNEY

SN 77-865,532. RIKEN VITAMIN CO., LTD., TOKYO, JAPAN, FILED 11-5-2009.



THE MARK CONSISTS OF CHINESE CHARACTERS SURROUNDED BY A GENERALLY RECTANGULAR SHAPED BORDER.

THE NON-LATIN CHARACTERS IN THE MARK TRANSLITERATE TO SOZAIYOKU AND THIS MEANS MATERIAL POWER IN ENGLISH.

FOR STOCK (U.S. CL. 46).

FIRST USE 5-11-2009; IN COMMERCE 5-11-2009.

JESSICA A. POWERS, EXAMINING ATTORNEY

CLASS 29—(Continued).

SN 77-884,248. CONSERVAS INTERNACIONALES S.A DE C.V., DBA DELICIAS TAPATIAS, GUADALAJARA, MEXICO, FILED 12-2-2009.



NO CLAIM IS MADE TO THE EXCLUSIVE RIGHT TO USE "TAPATIAS", APART FROM THE MARK AS SHOWN. THE COLOR(S) YELLOW IS/ARE CLAIMED AS A FEATURE OF THE MARK.

THE MARK CONSISTS OF THE WORDING "DELICIAS TAPATIAS" IN YELLOW LETTERING IN AN ARC AROUND A YELLOW PREHISPANIC MEXICAN BIRD.

THE ENGLISH TRANSLATION OF "DELICIA" AND "TAPATIAS" IN THE MARK IS "DELIGHTS FROM GUADALAJARA."

FOR MARINATED PORK STEW; MEAT; PORK (U.S. CL. 46).

MARY ROSSMAN, EXAMINING ATTORNEY

SN 77-894,880. CARAPELLI FIRENZE, S.P.A., FIRENZE, ITALY, FILED 12-16-2009.



OWNER OF U.S. REG. NOS. 3,348,901 AND 3,348,902. NO CLAIM IS MADE TO THE EXCLUSIVE RIGHT TO USE "DAL 1893 FIRENZE", APART FROM THE MARK AS SHOWN.

THE COLOR(S) BROWN, BEIGE, GREEN, ORANGE AND VIOLET IS/ARE CLAIMED AS A FEATURE OF THE MARK. THE MARK CONSISTS OF THE ARBITRARY WORDS "DAL 1893 CARAPELLI FIRENZE IL NOBILE". THE WORDS "IL NOBILE", THE INNER BORDER AND THE TWO LINES BORDERING THE RIBBON ARE ORANGE; THE WORDS "DAL 1893 CARAPELLI FIRENZE" AND THE RIBBON ARE GREEN; THE TWO SMALL OLIVES ARE VIOLET; THE FLOWERED BACKGROUND CONSISTS OF A GRADATION OF BROWN AND BEIGE.

THE ENGLISH TRANSLATION OF "IL NOBILE" IN THE MARK IS "NOBLE" OR "NOBLEMAN". THE ENGLISH TRANSLATION OF "DAL 1893" IS "SINCE 1893". THE ENGLISH TRANSLATION OF "FIRENZE" IS "FLORENCE".

FOR EDIBLE OILS AND FATS; OLIVE OIL; EXTRA VIRGIN OLIVE OIL; OLIVES, PRESERVED, DRESSED AND STUFFED; PICKLES (U.S. CL. 46).

FIRST USE 2-16-2001; IN COMMERCE 2-16-2001. DOMINICK J. SALEMI, EXAMINING ATTORNEY

CLASS 29—(Continued).

SN 77-900,889. LEINER, MELVIN, POMPAÑO BEACH, FL. AND MARKS, DARREN, POMPAÑO BEACH, FL. FILED 12-24-2009.



NO CLAIM IS MADE TO THE EXCLUSIVE RIGHT TO USE "STICKS", APART FROM THE MARK AS SHOWN.

THE MARK CONSISTS OF A DESIGN OF A FIVE POINTED STAR OVER WHICH IS A STYLIZED HUMAN SKULL WITH A STYLIZED DNA HELIX ON THE RIGHT SIDE OF THE SKULL. COVERING THE BOTTOM LEFT POINT OF THE STAR IS THE LETTER "D" OF THE TERM "DNA" WHICH IS PRESENTED IN STYLIZED LETTERS FOLLOWED UNDERNEATH BY THE WORD "SHRED" IN STYLIZED LETTERS WHICH IS FOLLOWED UNDERNEATH BY THE TERM "STIX" IN STYLIZED LETTERS.

FOR JERKY (U.S. CL. 46).

FIRST USE 12-15-2009; IN COMMERCE 12-15-2009. GRETCHEN ULRICH, EXAMINING ATTORNEY

SN 77-904,755. TRIDENT SEAFOODS CORPORATION, SEATTLE, WA. FILED 1-4-2010.

Heart Healthy Salmon

NO CLAIM IS MADE TO THE EXCLUSIVE RIGHT TO USE "HEART HEALTHY SALMON", APART FROM THE MARK AS SHOWN.

THE MARK CONSISTS OF THE WORDS "HEART HEALTHY SALMON", WHERE THE "O" IN "SALMON" APPEARS IN THE SHAPE OF A HEART.

FOR SEAFOOD (U.S. CL. 46).

SKYE YOUNG, EXAMINING ATTORNEY

CLASS 29—(Continued).

SN 77-906,219. LM FOODS, L.L.C., CARTERET, NJ. FILED 1-6-2010.

Crab Choice

THE MARK CONSISTS OF STANDARD CHARACTERS WITHOUT CLAIM TO ANY PARTICULAR FONT, STYLE, SIZE, OR COLOR.

NO CLAIM IS MADE TO THE EXCLUSIVE RIGHT TO USE "CRAB", APART FROM THE MARK AS SHOWN.

FOR IMITATION CRAB MEAT MADE WITH FISH PROTEINS, REAL CRAB MEAT, AND ARTIFICIAL FLAVORS AND COLORS (U.S. CL. 46).

KATHERINE M. DUBRAY, EXAMINING ATTORNEY

SN 77-909,752. GREENLAND TRADING CORP., BAYONNE, NJ. FILED 1-12-2010.



THE COLOR(S) WHITE, BLUE, GREEN AND YELLOW IS/ ARE CLAIMED AS A FEATURE OF THE MARK.

THE MARK CONSISTS OF AN ARABIC WORD IN WHITE IN AN OVAL WITH A REPRESENTATION OF THE SUN IN YELLOW BEHIND THE ARABIC WORD IN A FIELD REPRESENTING THE SKY IN BLUE OVER A FIELD REPRESENTING LAND IN GREEN.

THE NON-LATIN CHARACTERS IN THE MARK TRANSLITERATE TO GREENLAND AND THIS MEANS GREENLAND IN ENGLISH.

FOR CHEESE (U.S. CL. 46).

FIRST USE 6-30-1996; IN COMMERCE 6-30-1996.

MARIA-VICTORIA SUAREZ, EXAMINING ATTORNEY

SN 77-918,746. SOUL CREATIONS, CAPISTRANO BEACH, CA. FILED 1-23-2010.

Soul Creations

THE MARK CONSISTS OF STANDARD CHARACTERS WITHOUT CLAIM TO ANY PARTICULAR FONT, STYLE, SIZE, OR COLOR.

FOR NUT AND SEED-BASED SNACK BARS; ORGANIC NUT AND SEED-BASED SNACK BARS; PROTEIN BASED, NUTRIENT-DENSE SNACK BARS (U.S. CL. 46).
FIRST USE 11-1-2009; IN COMMERCE 11-1-2009.

VIVIAN MICZNIK FIRST, EXAMINING ATTORNEY

CLASS 29—(Continued).

SN 77-922,195. FRANK BRUNCKHORST CO., L.L.C., BROOKLYN, NY. FILED 1-28-2010.

IT'LL BOWL YOU OVER.

THE MARK CONSISTS OF STANDARD CHARACTERS WITHOUT CLAIM TO ANY PARTICULAR FONT, STYLE, SIZE, OR COLOR.

FOR CHEESE; PROCESSED MEAT (U.S. CL. 46).

FIRST USE 7-31-2004; IN COMMERCE 7-31-2004.

ANNE E. GUSTASON, EXAMINING ATTORNEY

SN 77-924,319. DIVINEAMERICA, INC., CERRITOS, CA. FILED 1-30-2010.

HEALTH THROUGH DIVINE NATURALS

THE MARK CONSISTS OF STANDARD CHARACTERS WITHOUT CLAIM TO ANY PARTICULAR FONT, STYLE, SIZE, OR COLOR.

OWNER OF U.S. REG. NO. 3,530,181.

NO CLAIM IS MADE TO THE EXCLUSIVE RIGHT TO USE "HEALTH" AND "NATURALS", APART FROM THE MARK AS SHOWN.

FOR FRUIT-BASED ORGANIC FOOD BARS; FRUIT-BASED ORGANIC FOOD BARS, ALSO CONTAINING DRIED FRUITS, SEEDS, NUTS.; FRUIT-BASED SNACK FOOD; NUT AND SEED-BASED SNACK BARS; NUT-BASED SNACK FOODS; NUT-BASED SNACK FOODS, NAMELY, NUT CLUSTERS; ORGANIC NUT AND SEED-BASED SNACK BARS; SNACK MIX CONSISTING OF PRIMARILY OF PROCESSED NUTS, SEEDS, DRIED FRUIT AND ALSO INCLUDING CHOCOLATE; SNACK MIX CONSISTING OF WASABI PEAS, PROCESSED NUTS, DEHYDRATED FRUIT AND/OR RAISINS (U.S. CL. 46).

JACLYN KIDWELL WALKER, EXAMINING ATTORNEY

SN 77-925,106. FREYBE GOURMET FOODS LTD., LANGLEY, BC, CANADA, FILED 2-1-2010.

HEMPERONI

THE MARK CONSISTS OF STANDARD CHARACTERS WITHOUT CLAIM TO ANY PARTICULAR FONT, STYLE, SIZE, OR COLOR.

OWNER OF U.S. REG. NO. 2,809,659.

FOR SAUSAGE; PÂTÉ; COOKED AND PREPARED MEATS; PROCESSED MEATS (U.S. CL. 46).

MARC LEIPZIG, EXAMINING ATTORNEY

CLASS 29—(Continued).

SN 77-925,681. EDWARD TINI, PHILADELPHIA, PA. FILED 2-2-2010.

GoGoRila

THE MARK CONSISTS OF STANDARD CHARACTERS WITHOUT CLAIM TO ANY PARTICULAR FONT, STYLE, SIZE, OR COLOR.

FOR CANNED PEANUTS; CHOCOLATE NUT BUTTER; FRUIT-BASED SNACK FOOD; NUT AND SEED-BASED SNACK BARS; PEANUT BUTTER AND JELLY; NUT-BASED SNACK FOODS; NUT-BASED SNACK FOODS, NAMELY, NUT CLUSTERS; NUT-BASED SNACK FOODS, NAMELY, NUT CRISPS; ORGANIC NUT AND SEED-BASED SNACK BARS; PEANUT BUTTER; PEANUT BUTTER TOPPING; SNACK MIX CONSISTING OF DEHYDRATED FRUIT AND PROCESSED NUTS; SNACK MIX CONSISTING OF PRIMARILY OF PROCESSED NUTS, SEEDS, DRIED FRUIT AND ALSO INCLUDING CHOCOLATE; SOY-BASED SNACK FOODS; VEGETABLE-BASED SNACK FOODS (U.S. CL. 46).

JUSTINE D. PARKER, EXAMINING ATTORNEY

CLASS 29—(Continued).

SN 77-925,849. EDWARD TINI, PHILADELPHIA, PA. FILED 2-2-2010.



THE COLOR(S) BLACK, WHITE, ORANGE, LIGHT ORANGE, GREEN IS/ARE CLAIMED AS A FEATURE OF THE MARK.

THE MARK CONSISTS OF A GORILLA FACE WITH TWO HANDS, BLACK OUTLINE, ORANGE AND LIGHT ORANGE SKIN, WHITE EYES, GREEN HIGHLIGHTS IN HAIR AND ONE HAND HAS THE LETTERS "GOGO" IN LIGHT ORANGE ON IT AND ONE HAND WITH THE LETTERS "RILA" IN LIGHT ORANGE ON IT.

FOR CANNED PEANUTS; CHOCOLATE NUT BUTTER; NUT BUTTERS PEANUT BUTTER AND JELLY; PEANUT BUTTER; PEANUT BUTTER TOPPING; PROCESSED PEANUTS (U.S. CL. 46).

JUSTINE D. PARKER, EXAMINING ATTORNEY

SN 77-926,367. FORTIS FOODS INTERNATIONAL, FRISCO, TX. FILED 2-2-2010.

FORTIS FOODS INTERNATIONAL

THE MARK CONSISTS OF STANDARD CHARACTERS WITHOUT CLAIM TO ANY PARTICULAR FONT, STYLE, SIZE, OR COLOR.

NO CLAIM IS MADE TO THE EXCLUSIVE RIGHT TO USE "FOODS INTERNATIONAL", APART FROM THE MARK AS SHOWN.

FOR BEEF; PORK; POULTRY; PROCESSED LAMB; SEAFOOD (U.S. CL. 46).

DAWN FELDMAN, EXAMINING ATTORNEY

SN 77-925,824. EDWARD TINI, PHILADELPHIA, PA. FILED 2-2-2010.



THE COLOR(S) BLACK, ORANGE, BLUE, GREEN, BROWN, SILVER, LIGHT BLUE, LIGHT GREEN, LIGHT ORANGE AND WHITE IS/ARE CLAIMED AS A FEATURE OF THE MARK.

THE MARK CONSISTS OF A GORILLA WITH BLACK OUTLINE, WHITE EYES, ORANGE AND LIGHT ORANGE SKIN, GREEN AND LIGHT GREEN SHIRT WITH THE LETTER "G" ON THE SHIRT, BLUE AND LIGHT BLUE PANTS, BROWN SHOES AND BROWN BELT WITH SILVER BELT BUCKLE.

FOR CANNED PEANUTS; CHOCOLATE NUT BUTTER; COCOA BUTTER FOR FOOD PURPOSES; NUT BUTTERS; PEANUT BUTTER AND JELLY; PEANUT BUTTER; PEANUT BUTTER TOPPING; PROCESSED PEANUTS (U.S. CL. 46).

JUSTINE D. PARKER, EXAMINING ATTORNEY

SN 77-926,552. KELLOGG NORTH AMERICA COMPANY, BATTLE CREEK, MI. FILED 2-3-2010.

BE NATURAL

THE MARK CONSISTS OF STANDARD CHARACTERS WITHOUT CLAIM TO ANY PARTICULAR FONT, STYLE, SIZE, OR COLOR.

OWNER OF U.S. REG. NO. 2,356,716.

FOR FRUIT-BASED SNACK FOOD; NUT-BASED SNACK FOODS (U.S. CL. 46).

DEIRDRE ROBERTSON, EXAMINING ATTORNEY

CLASS 29—(Continued).

SN 77-927,129. SPECIALTY FOODS GROUP, INC., NEWPORT NEWS, VA. FILED 2-3-2010.

TUB MATES

THE MARK CONSISTS OF STANDARD CHARACTERS WITHOUT CLAIM TO ANY PARTICULAR FONT, STYLE, SIZE, OR COLOR.

FOR LUNCHEON MEATS (U.S. CL. 46).
MARGARET POWER, EXAMINING ATTORNEY

SN 77-927,160. MAN CAVE, LLC, MINNEAPOLIS, MN. FILED 2-3-2010.

THE KINGS STOCK

THE MARK CONSISTS OF STANDARD CHARACTERS WITHOUT CLAIM TO ANY PARTICULAR FONT, STYLE, SIZE, OR COLOR.

FOR CHILI; MEAT; MEAT-BASED SNACK FOODS; PRESERVED MEATS AND SAUSAGES (U.S. CL. 46).
FIRST USE 12-7-2008; IN COMMERCE 12-7-2008.
MAYUR VAGHANI, EXAMINING ATTORNEY

SN 77-927,489. TD MOSER FARMS, L.L.C., GENESEE, ID. FILED 2-3-2010.

SUPER GARBO

THE MARK CONSISTS OF STANDARD CHARACTERS WITHOUT CLAIM TO ANY PARTICULAR FONT, STYLE, SIZE, OR COLOR.

NO CLAIM IS MADE TO THE EXCLUSIVE RIGHT TO USE "SUPER", APART FROM THE MARK AS SHOWN.

FOR FROZEN VEGETABLES, NAMELY, GARBANZO BEANS (U.S. CL. 46).

BRIAN PINO, EXAMINING ATTORNEY

CLASS 29—(Continued).

SN 77-927,528. TD MOSER FARMS, L.L.C., GENESEE, ID. FILED 2-3-2010.



NO CLAIM IS MADE TO THE EXCLUSIVE RIGHT TO USE "GREEN GARBANZOS", APART FROM THE MARK AS SHOWN.

THE MARK CONSISTS OF THE STYLIZED WORDS "GARDEN GREEN" OVER THE STYLIZED WORD "GARBANZOS", WITH A SMALL BIRD DESIGN TO THE RIGHT OF THE WORD "GREEN".

FOR FROZEN VEGETABLES, NAMELY, GARBANZO BEANS (U.S. CL. 46).

BRIAN PINO, EXAMINING ATTORNEY

SN 77-927,532. THE NEST COLLECTIVE, INC., EMERYVILLE, CA. FILED 2-3-2010.

SIPPY SOUPS

THE MARK CONSISTS OF STANDARD CHARACTERS WITHOUT CLAIM TO ANY PARTICULAR FONT, STYLE, SIZE, OR COLOR.

NO CLAIM IS MADE TO THE EXCLUSIVE RIGHT TO USE "SOUPS", APART FROM THE MARK AS SHOWN.

FOR SOUPS (U.S. CL. 46).

BRENDAN MCCAULEY, EXAMINING ATTORNEY

SN 77-927,533. TD MOSER FARMS, L.L.C., GENESEE, ID. FILED 2-4-2010.



NO CLAIM IS MADE TO THE EXCLUSIVE RIGHT TO USE "SUPER", APART FROM THE MARK AS SHOWN.

THE MARK CONSISTS OF THE STYLIZED WORDS "SUPER GARBO" NEXT TO A DESIGN OF A SMILING BEAN IN AN OPEN POD.

FOR FROZEN VEGETABLES, NAMELY, GARBANZO BEANS (U.S. CL. 46).

BRIAN PINO, EXAMINING ATTORNEY

CLASS 29—(Continued).

SN 77-927,715. HIGH LINER FOODS (USA) INCORPORATED, PORTSMOUTH, NH. FILED 2-4-2010.

OUR SEAFOOD, YOUR SIGNATURE

THE MARK CONSISTS OF STANDARD CHARACTERS WITHOUT CLAIM TO ANY PARTICULAR FONT, STYLE, SIZE, OR COLOR.

FOR FROZEN FISH; FROZEN FISH PORTIONS; FROZEN SEAFOOD (U.S. CL. 46).
JIM RINGLE, EXAMINING ATTORNEY

SN 77-927,718. BC-USA, INC., NEW HOLLAND, PA. FILED 2-4-2010.

CHEF ALOUETTE

THE MARK CONSISTS OF STANDARD CHARACTERS WITHOUT CLAIM TO ANY PARTICULAR FONT, STYLE, SIZE, OR COLOR.

OWNER OF U.S. REG. NOS. 2,747,315, 3,024,810 AND OTHERS.

THE NAME "CHEF ALOUETTE" DOES NOT IDENTIFY A LIVING INDIVIDUAL.

THE ENGLISH TRANSLATION OF "ALOUETTE" IS "LARK".

FOR CHEESE AND DAIRY PRODUCTS, EXCLUDING ICE CREAM, ICE MILK AND FROZEN YOGURT (U.S. CL. 46).

ELLEN B. AWRICH, EXAMINING ATTORNEY

SN 77-927,827. BAR-S FOODS CO., PHOENIX, AZ. FILED 2-4-2010.

CORONADO

THE MARK CONSISTS OF STANDARD CHARACTERS WITHOUT CLAIM TO ANY PARTICULAR FONT, STYLE, SIZE, OR COLOR.

FOR FRANKFURTERS AND BOLOGNA (U.S. CL. 46).
FIRST USE 0-0-1982; IN COMMERCE 0-0-1982.
LESLIE RICHARDS, EXAMINING ATTORNEY

CLASS 29—(Continued).

SN 77-927,855. KOHINOOR FOODS USA INC., EDISON, NJ. FILED 2-4-2010.

INDIA ON PLATTER

THE MARK CONSISTS OF STANDARD CHARACTERS WITHOUT CLAIM TO ANY PARTICULAR FONT, STYLE, SIZE, OR COLOR.

NO CLAIM IS MADE TO THE EXCLUSIVE RIGHT TO USE "INDIA", APART FROM THE MARK AS SHOWN.

FOR PREPARED VEGETABLE-BASED ENTREES (U.S. CL. 46).

FIRST USE 4-1-2009; IN COMMERCE 8-13-2009.
RENEE MCCRAY, EXAMINING ATTORNEY

SN 77-928,079. DARIGOLD, INC., SEATTLE, WA. FILED 2-4-2010.



OWNER OF U.S. REG. NO. 2,784,258.

THE MARK CONSISTS OF A STYLIZED SMILING COW WITH SUNGLASSES PUSHED UP ON HIS FOREHEAD AND HOLDING OUT A GLASS OF SPLASHING MILK AND THE WORD "SMOOOTH" PRINTED ON THE COW'S SHIRT.

FOR MILK (U.S. CL. 46).
FIRST USE 8-25-2005; IN COMMERCE 8-25-2005.
ALEXANDER L. POWERS, EXAMINING ATTORNEY

SN 77-928,819. SEAFOOD AMERICA LLC, WARMINSTER, PA. FILED 2-5-2010.

DOCKQUITOS

THE MARK CONSISTS OF STANDARD CHARACTERS WITHOUT CLAIM TO ANY PARTICULAR FONT, STYLE, SIZE, OR COLOR.

FOR SEAFOOD (U.S. CL. 46).
KYLE PEETE, EXAMINING ATTORNEY

CLASS 29—(Continued).

SN 77-929,066. JFC FOOD COMPANY, CHICAGO, IL. FILED 2-5-2010.

EAT300!

THE MARK CONSISTS OF STANDARD CHARACTERS WITHOUT CLAIM TO ANY PARTICULAR FONT, STYLE, SIZE, OR COLOR.

FOR PRE-PACKAGED DINNERS CONSISTING OF PRIMARILY OF MEAT, SEAFOOD OR POULTRY SERVED WITH PASTA, RICE OR VEGETABLES; FROZEN, PREPARED OR PACKAGED MEALS CONSISTING PRIMARILY OF MEAT, FISH, POULTRY OR VEGETABLES (U.S. CL. 46).

KATHLEEN LORENZO, EXAMINING ATTORNEY

SN 77-929,334. MYMENU CANADA INC., KITCHENER, ONTARIO, CANADA, FILED 2-5-2010.

BUTCHER'S GRIND

THE MARK CONSISTS OF STANDARD CHARACTERS WITHOUT CLAIM TO ANY PARTICULAR FONT, STYLE, SIZE, OR COLOR.

FOR MEAT; HAMBURGER MEAT; HAMBURGER PATTIES (U.S. CL. 46).

STEVEN JACKSON, EXAMINING ATTORNEY

SN 77-929,884. COLUMBUS MANUFACTURING, INC., HAYWARD, CA. FILED 2-6-2010.



OWNER OF U.S. REG. NOS. 936,718, 2,066,452 AND 3,509,279.

NO CLAIM IS MADE TO THE EXCLUSIVE RIGHT TO USE "FOUNDED IN SAN FRANCISCO EST. 1917", APART FROM THE MARK AS SHOWN.

THE NAME(S), PORTRAIT(S), AND/OR SIGNATURE(S) SHOWN IN THE MARK DOES NOT IDENTIFY A PARTICULAR LIVING INDIVIDUAL.

THE MARK CONSISTS OF THE WORDING "COLUMBUS FOUNDED IN SAN FRANCISCO EST. 1917" IN A STYLIZED FONT AND A DESIGN THAT CONSISTS OF A BUST OF COLUMBUS IN A CIRCULAR SEAL UNDER THE WORDING "COLUMBUS".

FOR HAM; LUNCHEON MEATS; MEAT, POULTRY AND GAME; TURKEY (U.S. CL. 46).

FIRST USE 11-15-2009; IN COMMERCE 11-15-2009.

RENEE MCCRAY, EXAMINING ATTORNEY

CLASS 29—(Continued).

SN 77-931,142. HIGH LINER FOODS (USA) INCORPORATED, PORTSMOUTH, NH. FILED 2-9-2010.

TELLY THE PELLY

THE MARK CONSISTS OF STANDARD CHARACTERS WITHOUT CLAIM TO ANY PARTICULAR FONT, STYLE, SIZE, OR COLOR.

FOR FROZEN FISH; FROZEN FISH PORTIONS; FROZEN SEAFOOD; FROZEN ENTREES CONSISTING PRIMARILY OF SEAFOOD (U.S. CL. 46).

JIM RINGLE, EXAMINING ATTORNEY

SN 77-931,398. COCOMO JOE LLC, VENICE, CA. FILED 2-9-2010.

GREENBAR

THE MARK CONSISTS OF STANDARD CHARACTERS WITHOUT CLAIM TO ANY PARTICULAR FONT, STYLE, SIZE, OR COLOR.

FOR DAIRY-BASED SNACK FOODS EXCLUDING ICE CREAM, ICE MILK AND FROZEN YOGURT; DEHYDRATED FRUIT SNACKS; DRIED FRUIT-BASED SNACKS; FRUIT AND SOY BASED SNACK FOOD; NUT AND SEED-BASED SNACK BARS; ORGANIC NUT AND SEED-BASED SNACK BARS; POTATO-BASED SNACK FOODS; PROTEIN BASED, NUTRIENT-DENSE SNACK BARS; SNACK MIX CONSISTING OF DEHYDRATED FRUIT AND PROCESSED NUTS; SNACK MIX CONSISTING OF PRIMARILY OF PROCESSED NUTS, SEEDS, DRIED FRUIT AND ALSO INCLUDING CHOCOLATE; SOY-BASED SNACK FOODS; VEGETABLE-BASED SNACK FOODS (U.S. CL. 46).

JILL C. ALT, EXAMINING ATTORNEY

SN 77-931,659. ATHENA PARTNERS,, SEATTLE, WA. FILED 2-9-2010.

ATHENA

THE MARK CONSISTS OF STANDARD CHARACTERS WITHOUT CLAIM TO ANY PARTICULAR FONT, STYLE, SIZE, OR COLOR.

OWNER OF U.S. REG. NO. 2,903,885.

FOR YOGURT; YOGURT-BASED BEVERAGES (U.S. CL. 46).

NICHOLAS ALTREE, EXAMINING ATTORNEY

CLASS 29—(Continued).

SN 77-937,893. WHITEWAVE SERVICES, INC., DALLAS, TX.
FILED 2-17-2010.

BY WOMEN FOR WOMEN

THE MARK CONSISTS OF STANDARD CHARACTERS
WITHOUT CLAIM TO ANY PARTICULAR FONT, STYLE,
SIZE, OR COLOR.
FOR DAIRY-BASED BEVERAGES (U.S. CL. 46).
DOUGLAS LEE, EXAMINING ATTORNEY

SN 77-939,782. SYSCO CORPORATION, HOUSTON, TX.
FILED 2-19-2010.

SAHARA BURST

THE MARK CONSISTS OF STANDARD CHARACTERS
WITHOUT CLAIM TO ANY PARTICULAR FONT, STYLE,
SIZE, OR COLOR.
OWNER OF U.S. REG. NOS. 1,998,647, 2,084,702 AND
2,942,012.
FOR APPLESAUCE; CANNED FRUITS; PROCESSED
FRUITS (U.S. CL. 46).
FIRST USE 4-21-1995; IN COMMERCE 4-21-1995.
RENEE SERVANCE, EXAMINING ATTORNEY

SN 77-942,846. YOPLAIT MARQUES INTERNATIONALES,
PARIS, FRANCE, FILED 2-23-2010.

SIMPLY ... GOGURT

THE MARK CONSISTS OF STANDARD CHARACTERS
WITHOUT CLAIM TO ANY PARTICULAR FONT, STYLE,
SIZE, OR COLOR.
OWNER OF U.S. REG. NOS. 2,427,237, 2,479,618 AND
3,780,528.
FOR DAIRY PRODUCTS EXCLUDING ICE CREAM,
ICE MILK AND FROZEN YOGURT (U.S. CL. 46).
FIRST USE 1-25-2010; IN COMMERCE 1-25-2010.
DOUGLAS LEE, EXAMINING ATTORNEY

CLASS 29—(Continued).

SN 77-955,102. HIGH LINER FOODS (USA) INCORPO-
RATED, PORTSMOUTH, NH. FILED 3-10-2010.

FISHER BOY

THE MARK CONSISTS OF STANDARD CHARACTERS
WITHOUT CLAIM TO ANY PARTICULAR FONT, STYLE,
SIZE, OR COLOR.
OWNER OF U.S. REG. NOS. 2,317,273 AND 3,229,631.
FOR FROZEN CHEESE STICKS; FROZEN POTATO
STICKS; FROZEN CRAB CAKES; FROZEN FISH
STICKS; FROZEN SHRIMP; FROZEN FISH PORTIONS;
FROZEN FISH FILLETS; FROZEN ENTREES CONSIST-
ING PRIMARILY OF MEAT, FISH, POULTRY OR
VEGETABLES (U.S. CL. 46).
FIRST USE 12-31-2004; IN COMMERCE 12-31-2004.
JIM RINGLE, EXAMINING ATTORNEY

SN 77-957,670. SEAFOOD AMERICA LLC, WARMINSTER,
PA. FILED 3-12-2010.

DOCKSLIDERS

THE MARK CONSISTS OF STANDARD CHARACTERS
WITHOUT CLAIM TO ANY PARTICULAR FONT, STYLE,
SIZE, OR COLOR.
FOR SEAFOOD (U.S. CL. 46).
KYLE PEETE, EXAMINING ATTORNEY

SN 77-961,982. KELLOGG NORTH AMERICA COMPANY,
BATTLE CREEK, MI. FILED 3-18-2010.

NOW THAT'S MORE LIKE IT

THE MARK CONSISTS OF STANDARD CHARACTERS
WITHOUT CLAIM TO ANY PARTICULAR FONT, STYLE,
SIZE, OR COLOR.
FOR VEGGIE FOOD PRODUCTS, NAMELY, VEGETA-
BLE BASED MEAT AND EGG SUBSTITUTES, TEX-
TURED VEGETABLE PROTEIN; FROZEN PACKAGED
ENTREES CONSISTING OF VEGETABLE BASED PAT-
TIES OR LINKS (U.S. CL. 46).
DEIRDRE ROBERTSON, EXAMINING ATTORNEY

CLASS 29—(Continued).

SN 79-058,848. SALUMIFICIO FRATELLI BERETTA S.P.A., ITALY, FILED 7-15-2008.

SALAMINI FRATELLI BERETTA

THE MARK CONSISTS OF STANDARD CHARACTERS WITHOUT CLAIM TO ANY PARTICULAR FONT, STYLE, SIZE, OR COLOR.

PRIORITY DATE OF 4-22-2008 IS CLAIMED.

OWNER OF INTERNATIONAL REGISTRATION 0977191 DATED 7-15-2008, EXPIRES 7-15-2018.

OWNER OF U.S. REG. NO. 2,538,943.

NO CLAIM IS MADE TO THE EXCLUSIVE RIGHT TO USE "SALAMINI" AND "FRATELLI", APART FROM THE MARK AS SHOWN.

THE ENGLISH TRANSLATION OF "SALAMINI" AND "FRATELLI" IN THE MARK IS "LITTLE PIECES OF SALAMI AND BROTHERS" RESPECTIVELY.

FOR MEAT, FISH, POULTRY AND GAME; MEAT EXTRACTS; PRESERVED, FROZEN, DRIED AND COOKED FRUITS AND VEGETABLES; JELLIES, JAMS, COMPOTES; EGGS AND MILK; MILK PRODUCTS, NAMELY, BUTTER, BUTTER CREAM, CASEIN FOR FOOD, CHEESE, CREAM; EDIBLE OILS AND FATS (U.S. CL. 46).

JOHN DALIER, EXAMINING ATTORNEY

CLASS 29—(Continued).

SN 85-022,781. HIGH LINER FOODS (USA) INCORPORATED, PORTSMOUTH, NH. FILED 4-26-2010.



THE MARK CONSISTS OF A CARTOON IMAGE OF A PELICAN, STANDING UPRIGHT AND FACING TO THE LEFT. THE PELICAN'S RIGHT WING IS EXTENDED, AND THE LEFT WING IS HOLDING A BEACH BALL.

FOR FROZEN FISH; FROZEN FISH PORTIONS; FROZEN SEAFOOD; FROZEN ENTREES CONSISTING PRIMARILY OF SEAFOOD (U.S. CL. 46).

JIM RINGLE, EXAMINING ATTORNEY

SN 79-075,101. THOLSTRUP CHEESE A/S, DENMARK, FILED 8-27-2009.



PRIORITY DATE OF 3-23-2009 IS CLAIMED.

OWNER OF INTERNATIONAL REGISTRATION 1019209 DATED 8-27-2009, EXPIRES 8-27-2019.

OWNER OF U.S. REG. NOS. 1,328,760 AND 2,538,125.

NO CLAIM IS MADE TO THE EXCLUSIVE RIGHT TO USE "SINCE 1893", APART FROM THE MARK AS SHOWN.

THE COLOR(S) BLUE, RED, GREY AND GOLD IS/ARE CLAIMED AS A FEATURE OF THE MARK.

THE MARK CONSISTS OF THE WORD "CASTELLO" IN BLUE, UPPER CASE LETTERS, WITH HORIZONTAL LINES ABOVE AND BELOW THE WORD IN GOLD, WITH A BROWN CASTLE WITH A RED UNDERLINE CENTERED ABOVE "CASTELLO" AND THE WORDING "SINCE 1893" IN GRAY CENTERED BELOW "CASTELLO".

THE ENGLISH TRANSLATION OF THE WORD "CASTELLO" IN THE MARK IS "CASTLE."

FOR CHEESE (U.S. CL. 46).

ELISSA GARBER KON, EXAMINING ATTORNEY

CLASS 30—STAPLE FOODS

SN 77-414,211. THE PETITE CAFE, LLC, NUTLEY, NJ. FILED 3-5-2008.



NO CLAIM IS MADE TO THE EXCLUSIVE RIGHT TO USE "CAFE AND STUFFED CUPCAKE", APART FROM THE MARK AS SHOWN.

FOR CUPCAKES (U.S. CL. 46).

FIRST USE 11-0-2007; IN COMMERCE 11-0-2007.

SUE LAWRENCE, EXAMINING ATTORNEY

CLASS 30—(Continued).

SN 77-475,426. KELLOGG NORTH AMERICA COMPANY, BATTLE CREEK, MI. FILED 5-15-2008.

FIBERCOMPLETE

THE MARK CONSISTS OF STANDARD CHARACTERS WITHOUT CLAIM TO ANY PARTICULAR FONT, STYLE, SIZE, OR COLOR.

OWNER OF U.S. REG. NO. 849,129.
FOR BREAKFAST CEREALS; CEREAL-BASED SNACK FOODS; READY TO EAT, CEREAL DERIVED FOOD BARS; GRANOLA-BASED SNACK BARS (U.S. CL. 46).
MICHAEL SOUDERS, EXAMINING ATTORNEY

SN 77-517,874. GURUKRIPA FOODS INC., RICHMOND HILL, NY. FILED 7-9-2008.

EVEREST

THE MARK CONSISTS OF STANDARD CHARACTERS WITHOUT CLAIM TO ANY PARTICULAR FONT, STYLE, SIZE, OR COLOR.

FOR RICE (U.S. CL. 46).
JULIE VEPPUMTHARA, EXAMINING ATTORNEY

SN 77-627,242. FRAHN, ALLISON L. DBA ALLI'S SLIM PICKINS LLC, NANUET, NY. FILED 12-5-2008.



THE NAME "ALLI" IDENTIFIES A LIVING INDIVIDUAL WHOSE CONSENT IS OF RECORD.

THE COLOR(S) BROWN, BLUE, YELLOW, AND WHITE IS/ARE CLAIMED AS A FEATURE OF THE MARK.

THE MARK CONSISTS OF A BLUE MUFFIN IN A WHITE AND BLUE WRAPPER WITH A YELLOW HALO ABOVE THE MUFFIN ON THE LEFT AND BLUE WINGS ON THE SIDE OF THE MUFFIN. THE MUFFIN SITS ON TOP OF A YELLOW TAPE-MEASURE EMBOSSED WITH THE WORDS "ALLI'S SLIM PICKINS" IN BROWN WITH BLUE OUTLINE AND BELOW THE TAPE MEASURE THE WORDS "100% TASTE & 0% GUILT" IN YELLOW. THE ENTIRE IMAGE APPEARS OVER A BROWN BACKGROUND.

FOR BAKERY GOODS (U.S. CL. 46).
FIRST USE 8-14-2008; IN COMMERCE 11-8-2008.
AARON BRODSKY, EXAMINING ATTORNEY

CLASS 30—(Continued).

SN 77-681,981. SONAFI, F-78220 VIROFLAY, FRANCE, FILED 3-3-2009.

ANDOA

THE MARK CONSISTS OF STANDARD CHARACTERS WITHOUT CLAIM TO ANY PARTICULAR FONT, STYLE, SIZE, OR COLOR.

OWNER OF FRANCE REG. NO. 083595699, DATED 1-30-2009, EXPIRES 8-27-2018.

THE WORDING "ANDOA" HAS NO MEANING IN A FOREIGN LANGUAGE.

FOR COCOA, CHOCOLATE, AND CHOCOLATE-BASED CONFECTIONERY PRODUCTS (U.S. CL. 46).
SUZANNE BLANE, EXAMINING ATTORNEY

SN 77-733,921. SBD TRADEMARK LIMITED PARTNERSHIP, BOCA RATON, FL. FILED 5-11-2009.

LIFE IS BETTER ON THE BEACH

THE MARK CONSISTS OF STANDARD CHARACTERS WITHOUT CLAIM TO ANY PARTICULAR FONT, STYLE, SIZE, OR COLOR.

FOR READY TO EAT FOOD BARS AND SNACK FOODS MADE WITH WHOLE GRAINS; OATMEAL; WHOLE GRAIN BREADS, WHOLE GRAIN PASTAS, WHOLE GRAIN BREAKFAST CEREALS, WHOLE GRAIN MUFFIN MIXES, AND WHOLE GRAIN PANCAKE MIXES; SUGAR-FREE CHOCOLATE, CHOCOLATES, SUGAR-FREE CHOCOLATE POWDER, COCOA POWDER, SUGAR-FREE CANDY, SUGAR-FREE CHEWING GUM, SUGAR-FREE FLAVORED GELATIN, FAT-FREE AND SUGAR-FREE PUDDING, SUGAR SUBSTITUTES, SALAD DRESSINGS, SALSA, SAUCES, SEASONINGS, SPICES, SUGAR-FREE DESSERTS, NAMELY, SUGAR-FREE COOKIES, CARAMEL POPCORN, PIES, CAKES, CHEESECAKES, BROWNIES, MARSHMALLOW TOPPING, CHOCOLATE TOPPING, CHOCOLATE SYRUP, FLAVORING SYRUP, TOPPING SYRUP AND BAKERY DESSERTS, SUGAR-FREE FROZEN CONFECTIONS, NUTRITIONAL CANDY BARS, PIZZA (U.S. CL. 46).

DARRYL SPRUILL, EXAMINING ATTORNEY

CLASS 30—(Continued).

SN 77-772,866. BUFFALOE, ROGER, WILMINGTON, NC.
FILED 7-1-2009.

COOKIE FIT

THE MARK CONSISTS OF STANDARD CHARACTERS WITHOUT CLAIM TO ANY PARTICULAR FONT, STYLE, SIZE, OR COLOR.

NO CLAIM IS MADE TO THE EXCLUSIVE RIGHT TO USE "COOKIE", APART FROM THE MARK AS SHOWN.

FOR ALL NATURAL, ORGANIC, LOW SUGAR AND HIGH FIBER COOKIES (U.S. CL. 46).

FIRST USE 1-0-1999; IN COMMERCE 1-0-1999.
ANDREA HACK, EXAMINING ATTORNEY

SN 77-781,340. CAO NGUYEN, INC., OKLAHOMA CITY, OK.
FILED 7-15-2009.

Gạo Tiên Vua

THE MARK CONSISTS OF THE WORDS "GAO TIEN VUA" IN VIETNAMESE LETTERING.

THE ENGLISH TRANSLATION OF "GAO TIEN VUA" IN THE MARK IS "RICE OFFERED UP TO THE KING".

FOR RICE (U.S. CL. 46).
FIRST USE 1-16-2009; IN COMMERCE 1-16-2009.
SAIMA MAKHDOOM, EXAMINING ATTORNEY

SN 77-785,362. MALINA, EMILY, WASHINGTON, DC.
FILED 7-20-2009.

Zenyo

THE MARK CONSISTS OF STANDARD CHARACTERS WITHOUT CLAIM TO ANY PARTICULAR FONT, STYLE, SIZE, OR COLOR.

FOR FROZEN YOGURT; FROZEN YOGURT CONFECTIONS; FROZEN YOGURT MIXES (U.S. CL. 46).

INGA ERVIN, EXAMINING ATTORNEY

CLASS 30—(Continued).

SN 77-787,136. MAMA TEA LIMITED, EDINBURGH, UNITED KINGDOM, FILED 7-22-2009.



PRIORITY CLAIMED UNDER SEC. 44(D) ON UNITED KINGDOM APPLICATION NO. 2507063, FILED 1-23-2009, REG. NO. 2507063, DATED 7-31-2009, EXPIRES 7-31-2019.

NO CLAIM IS MADE TO THE EXCLUSIVE RIGHT TO USE "TEA", APART FROM THE MARK AS SHOWN.

THE MARK CONSISTS OF THE PHRASE "MAMA TEA" APPEARING ABOVE A SMALL TEA CUP TILTED AT AN ANGLE AT THE BOTTOM OF A LARGER TEA CUP.

FOR TEAS; TISANES; HERBAL TEA FOR FOOD PURPOSES; HERB TEA FOR FOOD PURPOSES; HERBAL BEVERAGES FOR FOOD PURPOSES; HERBAL BASED BEVERAGES FOR FOOD PURPOSES; CAFFEINE-FREE BEVERAGES, NAMELY, CAFFEINE-FREE COFFEE; CAFFEINE-FREE TEAS, TISANES AND HERBAL INFUSIONS; TEA FOR INFUSIONS; HERBS FOR INFUSIONS; HERBS FOR MAKING HERBAL FOOD BEVERAGES; CAFFEINE-FREE HERBS FOR MAKING INFUSIONS AND HERBAL FOOD BEVERAGES; AROMATIC HERBAL PREPARATIONS FOR MAKING HERBAL INFUSIONS; AROMATIC HERBAL PREPARATIONS FOR MAKING TISANES; PREGNANCY TEAS, TISANES AND HERBAL INFUSIONS; HERBAL TEAS, TISANES AND HERBAL INFUSIONS FOR FOOD PURPOSES FOR PREGNANT WOMEN; HERBAL TEAS, TISANES AND HERBAL INFUSIONS FOR FOOD PURPOSES FOR NURSING MOTHERS; FOOD BEVERAGES MADE OF HERBS; BEVERAGES MADE OF TEA; ICED TEA; AROMATIC TEAS; TEA BASED BEVERAGES; PACKAGED TEA; FRUIT TEAS; GREEN TEAS; FLAVOURINGS OF TEA; TEA BAGS (U.S. CL. 46).

CHRISTINE MARTIN, EXAMINING ATTORNEY

SN 77-793,454. LEE, WEILING J., ALPHARETTA, GA. FILED 7-30-2009.

Rice n Simple

THE MARK CONSISTS OF STANDARD CHARACTERS WITHOUT CLAIM TO ANY PARTICULAR FONT, STYLE, SIZE, OR COLOR.

NO CLAIM IS MADE TO THE EXCLUSIVE RIGHT TO USE "RICE", APART FROM THE MARK AS SHOWN.

FOR PACKAGED MEAL KITS CONSISTING PRIMARILY OF PASTA OR RICE (U.S. CL. 46).

FIRST USE 12-15-2008; IN COMMERCE 12-15-2008.
SETH A. RAPPAPORT, EXAMINING ATTORNEY

CLASS 30—(Continued).

SN 77-798,295. VALRICO FOODS, INC., MEDLEY, FL. FILED 8-6-2009.

DINORONIRUS

THE MARK CONSISTS OF STANDARD CHARACTERS WITHOUT CLAIM TO ANY PARTICULAR FONT, STYLE, SIZE, OR COLOR.

FOR PROCESSED FOODS, NAMELY, PASTA; PACKAGED ENTREES CONSISTING PRIMARILY OF PASTA (U.S. CL. 46).

JOHN DALIER, EXAMINING ATTORNEY

SN 77-799,163. LOGAN-FRAZIER, ANGELA, AKA ANGELA LOGAN, TEANECK, NJ. FILED 8-6-2009.

MORTGAGE APPLE CAKES
FIGHTING FORECLOSURE ONE CAKE AT A TIME



NO CLAIM IS MADE TO THE EXCLUSIVE RIGHT TO USE "APPLE CAKES", APART FROM THE MARK AS SHOWN.

THE MARK CONSISTS OF THE WORDING "MORTGAGE APPLE CAKES" AND "FIGHTING FORECLOSURE ONE CAKE AT A TIME" ENDING WITH A HOUSE IN AN APPLE. FOR CAKES (U.S. CL. 46).

FIRST USE 4-3-2009; IN COMMERCE 4-9-2009.
FONG HSU, EXAMINING ATTORNEY

SN 77-806,893. WESTON FOODS (CANADA) INC., TORONTO, CANADA, FILED 8-18-2009.

WHEATSHEAF BAKERY

THE MARK CONSISTS OF STANDARD CHARACTERS WITHOUT CLAIM TO ANY PARTICULAR FONT, STYLE, SIZE, OR COLOR.

NO CLAIM IS MADE TO THE EXCLUSIVE RIGHT TO USE "BAKERY", APART FROM THE MARK AS SHOWN.

FOR BAKERY PRODUCTS, BREAD, ROLLS, PITA, TORTILLAS, BAGELS, BUNS, BISCUITS, CRACKERS, CROISSANTS, ENGLISH MUFFINS, GRANOLA BASED SNACK BARS, CAKES, PIES, COOKIES, PECAN AND HONEY GRAHAM TWIRL PASTRIES, FRUIT CAKES, PUDDINGS, DOUGHNUTS, PASTRIES, STRUDEL, MUFFINS, SWEET BUNS, BROWNIES, DANISH (U.S. CL. 46).

JERI J. FICKES, EXAMINING ATTORNEY

CLASS 30—(Continued).

SN 77-819,751. NICOLAI, DIANA D., LA MESA, CA. AND DRUMM, JON JASON, CARLSBAD, CA. FILED 9-3-2009.

CHIPZ HAPPEN

THE MARK CONSISTS OF STANDARD CHARACTERS WITHOUT CLAIM TO ANY PARTICULAR FONT, STYLE, SIZE, OR COLOR.

FOR TORTILLA CHIPS; SALSA; HOT SAUCE; SPICY SEASONINGS (U.S. CL. 46).

KRISTIN DAHLING, EXAMINING ATTORNEY

SN 77-828,077. CHOCOLATES EL REY C.A., CARACAS, VENEZUELA, FILED 9-16-2009.



Est. 1929

OWNER OF U.S. REG. NO. 2,007,323.
NO CLAIM IS MADE TO THE EXCLUSIVE RIGHT TO USE "EST. 1929", APART FROM THE MARK AS SHOWN.

THE COLOR(S) BROWN, YELLOW AND BLACK IS/ARE CLAIMED AS A FEATURE OF THE MARK.

THE MARK CONSISTS OF THE FOLLOWING: A BROWN OVAL, OUTLINED IN YELLOW WITH THE WORDS "EL REY" AND A DEPICTION OF A CROWN BOTH WRITTEN IN YELLOW WITHIN THE OVAL. BELOW THE OVAL, IN BLACK, ARE THE WORDS "EST. 1929".

THE ENGLISH TRANSLATION OF "EL REY" IN THE MARK IS "THE KING".

FOR CHOCOLATE; PRODUCTS MADE FROM CHOCOLATE (U.S. CL. 46).

FIRST USE 0-0-1929; IN COMMERCE 0-0-1929.
FRANK LATTUCA, EXAMINING ATTORNEY

SN 77-836,374. BORRELLI, ANDREA, NEWFOUNDLAND, NJ. FILED 9-28-2009.

CAKE HUGGERS

THE MARK CONSISTS OF STANDARD CHARACTERS WITHOUT CLAIM TO ANY PARTICULAR FONT, STYLE, SIZE, OR COLOR.

NO CLAIM IS MADE TO THE EXCLUSIVE RIGHT TO USE "CAKE", APART FROM THE MARK AS SHOWN.

FOR EDIBLE CUPCAKE LINERS THAT BAKE ONTO THE CUPCAKE ITSELF (U.S. CL. 46).

ROBIN CHOSID, EXAMINING ATTORNEY

CLASS 30—(Continued).

SN 77-853,004. EUROPASTRY, S.A., BARCELONA, SPAIN, FILED 10-20-2009.



PRIORITY CLAIMED UNDER SEC. 44(D) ON ERP N CMNTY TM OFC APPLICATION NO. 008454357, FILED 7-28-2009, REG. NO. 008454357, DATED 2-24-2010, EXPIRES 7-28-2019.

NO CLAIM IS MADE TO THE EXCLUSIVE RIGHT TO USE "ORIGINAL BAKERY", APART FROM THE MARK AS SHOWN.

THE NAME(S), PORTRAIT(S), AND/OR SIGNATURE(S) SHOWN IN THE MARK DOES NOT IDENTIFY A PARTICULAR LIVING INDIVIDUAL.

THE MARK CONSISTS OF THE WORDS "AUNT MARIAN ORIGINAL BAKERY" IN STYLIZED LETTERS WITHIN A RECTANGLE.

FOR FROZEN BAKERY PRODUCTS, NAMELY, CAKES AND PASTRIES, MUFFINS, APPLE FRITTERS, CORN FRITTERS, DOUGHNUTS, BAGELS AND CROISSANTS (U.S. CL. 46).

KAREN K. BUSH, EXAMINING ATTORNEY

SN 77-865,635. CONAGRA FOODS RDM, INC., OMAHA, NE, FILED 11-5-2009.

POPPYCOCK

THE MARK CONSISTS OF STANDARD CHARACTERS WITHOUT CLAIM TO ANY PARTICULAR FONT, STYLE, SIZE, OR COLOR.

OWNER OF U.S. REG. NOS. 687,644, 760,408 AND 3,097,960.

FOR SNACK MIX CONSISTING PRIMARILY OF POPPED POPCORN AND ALSO CONTAINING CANDIED NUTS (U.S. CL. 46).

FIRST USE 3-1-1957; IN COMMERCE 3-1-1957.

SETH A. RAPPAPORT, EXAMINING ATTORNEY

SN 77-875,657. TESTAMINTS HOLDING, LLC, HOPATCONG, NJ, FILED 11-18-2009.

COMMANDMINTS

THE MARK CONSISTS OF STANDARD CHARACTERS WITHOUT CLAIM TO ANY PARTICULAR FONT, STYLE, SIZE, OR COLOR.

OWNER OF CANADA REG. NO. TMA592606, DATED 10-20-2003, EXPIRES 10-19-2018.

FOR CANDY MINTS (U.S. CL. 46).

MARIA-VICTORIA SUAREZ, EXAMINING ATTORNEY

CLASS 30—(Continued).

SN 77-877,806. RICH PRODUCTS CORPORATION, BUFFALO, NY, FILED 11-20-2009.

**WHIPPED MEETS CREAMY,
SWEET.**

THE MARK CONSISTS OF STANDARD CHARACTERS WITHOUT CLAIM TO ANY PARTICULAR FONT, STYLE, SIZE, OR COLOR.

NO CLAIM IS MADE TO THE EXCLUSIVE RIGHT TO USE "SWEET", APART FROM THE MARK AS SHOWN.

FOR NON-DAIRY WHIPPED ICINGS AND FROSTINGS (U.S. CL. 46).

MARY ROSSMAN, EXAMINING ATTORNEY

SN 77-882,065. DAYSTAR DESSERTS, LLC, ASHLAND, VA, FILED 11-30-2009.

Daystar Desserts

THE MARK CONSISTS OF STANDARD CHARACTERS WITHOUT CLAIM TO ANY PARTICULAR FONT, STYLE, SIZE, OR COLOR.

NO CLAIM IS MADE TO THE EXCLUSIVE RIGHT TO USE "DESSERTS", APART FROM THE MARK AS SHOWN.

FOR BAKERY DESSERTS; CAKES; CHEESECAKE;

COOKIES; PIES (U.S. CL. 46).

FIRST USE 1-1-1998; IN COMMERCE 10-10-1998.

ESTHER A. BORSUK, EXAMINING ATTORNEY

SN 77-890,674. THINK LIFE 360 LLC, DBA GROUNDS 4 GOOD, EDWARDS, CO. FILED 12-10-2009.

**Grounds 4 Good Coffee
Changing lives one cup at
a time.**

THE MARK CONSISTS OF STANDARD CHARACTERS WITHOUT CLAIM TO ANY PARTICULAR FONT, STYLE, SIZE, OR COLOR.

FOR ROASTED COFFEE BEANS (U.S. CL. 46).

TINA MAI, EXAMINING ATTORNEY

CLASS 30—(Continued).

SN 77-895,395. BEN & JERRY'S HOMEMADE, INC., SOUTH BURLINGTON, VT. FILED 12-17-2009.

BERRY VOLUNTARY

THE MARK CONSISTS OF STANDARD CHARACTERS WITHOUT CLAIM TO ANY PARTICULAR FONT, STYLE, SIZE, OR COLOR.
NO CLAIM IS MADE TO THE EXCLUSIVE RIGHT TO USE "BERRY", APART FROM THE MARK AS SHOWN.
FOR ICE CREAM, FROZEN CONFECTIONS (U.S. CL. 46).
WANDA KAY PRICE, EXAMINING ATTORNEY

SN 77-899,475. MORTON VENTURES, LLC, SALT LAKE CITY, UT. FILED 12-22-2009.

TIBENÀ

THE MARK CONSISTS OF STANDARD CHARACTERS WITHOUT CLAIM TO ANY PARTICULAR FONT, STYLE, SIZE, OR COLOR.
FOR TEA-BASED BEVERAGE (U.S. CL. 46).
EDWARD FENNESSY, EXAMINING ATTORNEY

SN 77-904,847. DAVIS BROS. PIZZA, INC., EAST PEORIA, IL. FILED 1-4-2010.

PIZZAMALE

THE MARK CONSISTS OF STANDARD CHARACTERS WITHOUT CLAIM TO ANY PARTICULAR FONT, STYLE, SIZE, OR COLOR.
FOR TAMALES (U.S. CL. 46).
FIRST USE 1-31-2009; IN COMMERCE 7-1-2009.
DAVID TOOLEY, EXAMINING ATTORNEY

CLASS 30—(Continued).

SN 77-910,724. TODD DAMBLY, FOLSOM, CA. FILED 1-13-2010.

CALIFORNIA STYLE OATMEAL

THE MARK CONSISTS OF STANDARD CHARACTERS WITHOUT CLAIM TO ANY PARTICULAR FONT, STYLE, SIZE, OR COLOR.
NO CLAIM IS MADE TO THE EXCLUSIVE RIGHT TO USE "CALIFORNIA" AND "OATMEAL", APART FROM THE MARK AS SHOWN.
FOR OATMEAL (U.S. CL. 46).
SHAUNIA CARLYLE, EXAMINING ATTORNEY

SN 77-917,305. AUNT NEE'S TASTE OF MEXICO SALSA, LLC, GARDEN CITY, MI. FILED 1-21-2010.

AUNT NEE'S

THE COLOR(S) RED, BLACK IS/ARE CLAIMED AS A FEATURE OF THE MARK.
THE MARK CONSISTS OF THE STYLIZED WORDING "AUNT NEE'S", WITH AN OUTLINING BLACK BORDER AND AN INNER COLOR OF RED.
FOR (BASED ON USE IN COMMERCE) SPICE BLENDS (BASED ON INTENT TO USE) TORTILLA CHIPS (U.S. CL. 46).
FIRST USE 8-1-2008; IN COMMERCE 1-31-2009.
JANET LEE, EXAMINING ATTORNEY

SN 77-917,595. SHAKEDOWN SPICE, LLC, BALTIMORE, MD. FILED 1-22-2010.

SHAKEDOWN SPICE

THE MARK CONSISTS OF STANDARD CHARACTERS WITHOUT CLAIM TO ANY PARTICULAR FONT, STYLE, SIZE, OR COLOR.
NO CLAIM IS MADE TO THE EXCLUSIVE RIGHT TO USE "SPICE", APART FROM THE MARK AS SHOWN.
FOR FOOD SEASONINGS; SEASONINGS (U.S. CL. 46).
SANJEEV VOHRA, EXAMINING ATTORNEY

CLASS 30—(Continued).

SN 77-919,490. ARROWHEAD MILLS, INC., MELVILLE, NY.
FILED 1-25-2010.

GARDEN OF EATIN'

THE MARK CONSISTS OF STANDARD CHARACTERS WITHOUT CLAIM TO ANY PARTICULAR FONT, STYLE, SIZE, OR COLOR.

OWNER OF U.S. REG. NOS. 1,711,976, 3,417,547 AND OTHERS.

FOR TORTILLA CHIPS; GRAIN BASED SNACK CHIPS; PITA CHIPS; MICROWAVE POPCORN; PUFFED CORN SNACKS; CHEESE FLAVORED SNACKS, NAMELY, CHEESE CURLS, CHEESE PUFFED SNACKS; AND TACO SHELLS (U.S. CL. 46).

FIRST USE 0-0-1972; IN COMMERCE 0-0-1972.
SANI KHOURI, EXAMINING ATTORNEY

SN 77-923,341. CAFE MEXICALI LLC, GREELEY, CO. FILED
1-29-2010.

Quesolle'

THE MARK CONSISTS OF STANDARD CHARACTERS WITHOUT CLAIM TO ANY PARTICULAR FONT, STYLE, SIZE, OR COLOR.

THE WORDING "QUESOLLE" HAS NO MEANING IN A FOREIGN LANGUAGE.

FOR PREPARED QUESADILLAS, ROLLED AND SEGMENTED (U.S. CL. 46).

FIRST USE 6-1-2005; IN COMMERCE 11-15-2005.
GISELLE AGOSTO, EXAMINING ATTORNEY

SN 77-924,636. UNCLE OOGIE'S, INC., SEA ISLE CITY, NJ.
FILED 2-1-2010.

BOLI BUNS

THE MARK CONSISTS OF STANDARD CHARACTERS WITHOUT CLAIM TO ANY PARTICULAR FONT, STYLE, SIZE, OR COLOR.

NO CLAIM IS MADE TO THE EXCLUSIVE RIGHT TO USE "BUNS", APART FROM THE MARK AS SHOWN.

FOR DOUGH-ENROBED FOODS CONSISTING OF A DOUGH-BASED WRAPPER WITH FILLINGS CONSISTING PRIMARILY OF MEATS, POULTRY, FISH, FRUITS AND VEGETABLES AND CHEESE (U.S. CL. 46).

FIRST USE 4-1-2009; IN COMMERCE 4-1-2009.
LINDA MICKLEBURGH, EXAMINING ATTORNEY

CLASS 30—(Continued).

SN 77-924,943. MEADOWS, KRISTA N., CANOGA PARK, CA. FILED 2-1-2010.

You Had Me At Cupcake

THE MARK CONSISTS OF STANDARD CHARACTERS WITHOUT CLAIM TO ANY PARTICULAR FONT, STYLE, SIZE, OR COLOR.

FOR BAKERY PRODUCTS, NAMELY, SWEET BAKERY GOODS (U.S. CL. 46).

EDWARD NELSON, EXAMINING ATTORNEY

SN 77-925,043. LUCCHINO, RONALD A., BUFFALO, NY.
FILED 2-1-2010.

DIAVOLO

THE MARK CONSISTS OF STANDARD CHARACTERS WITHOUT CLAIM TO ANY PARTICULAR FONT, STYLE, SIZE, OR COLOR.

THE ENGLISH TRANSLATION OF "DIAVOLO" IN THE MARK IS "DEVIL"

FOR HOT SAUCE (U.S. CL. 46).

FIRST USE 11-24-2006; IN COMMERCE 11-24-2006.
KATHY DE JONGE, EXAMINING ATTORNEY

SN 77-925,409. PERANICK, NICOLE ROSE, JERSEY CITY, NJ. FILED 2-1-2010.

With Love From The Cupboard

THE MARK CONSISTS OF STANDARD CHARACTERS WITHOUT CLAIM TO ANY PARTICULAR FONT, STYLE, SIZE, OR COLOR.

FOR BAKERY GOODS (U.S. CL. 46).

STEVEN R. FINE, EXAMINING ATTORNEY

CLASS 30—(Continued).

SN 77-925,599. ROCK ON, LLC, EAU CLAIRE, WI. FILED 2-2-2010.

ROCK ON! AMERICAN BBQ

THE MARK CONSISTS OF STANDARD CHARACTERS WITHOUT CLAIM TO ANY PARTICULAR FONT, STYLE, SIZE, OR COLOR.

NO CLAIM IS MADE TO THE EXCLUSIVE RIGHT TO USE "AMERICAN BBQ", APART FROM THE MARK AS SHOWN.

FOR BARBEQUE SAUCE (U.S. CL. 46).
FIRST USE 12-6-2009; IN COMMERCE 12-6-2009.
BARBARA RUTLAND, EXAMINING ATTORNEY

SN 77-925,807. COFFEE EXPRESS CO., PLYMOUTH, MI. FILED 2-2-2010.

MOUNTAIN COUNTRY

THE MARK CONSISTS OF STANDARD CHARACTERS WITHOUT CLAIM TO ANY PARTICULAR FONT, STYLE, SIZE, OR COLOR.

OWNER OF U.S. REG. NO. 1,586,998.
FOR COFFEE (U.S. CL. 46).
FIRST USE 5-2-1989; IN COMMERCE 5-2-1989.
ANDREW LEASER, EXAMINING ATTORNEY

SN 77-925,902. DAVID S. ROSENBERG & ASSOCIATES, INC., BALTIMORE, MD. FILED 2-2-2010.

LOVEAU CHOCOLATE

THE MARK CONSISTS OF STANDARD CHARACTERS WITHOUT CLAIM TO ANY PARTICULAR FONT, STYLE, SIZE, OR COLOR.

NO CLAIM IS MADE TO THE EXCLUSIVE RIGHT TO USE "CHOCOLATE", APART FROM THE MARK AS SHOWN.

FOR CHOCOLATE; CONFECTIONERIES, NAMELY, SNACK FOODS, NAMELY, CHOCOLATE (U.S. CL. 46).
HANNO RITTNER, EXAMINING ATTORNEY

CLASS 30—(Continued).

SN 77-926,353. HOHMAN, MELANIE, COSTA MESA, CA. AND HOHMAN, GREGORY, COSTA MESA, CA. FILED 2-2-2010.



NO CLAIM IS MADE TO THE EXCLUSIVE RIGHT TO USE "SENSITIVE SWEETS" OR "WHEAT-FREE GLUTEN-FREE DAIRY-FREE CASEIN-FREE EGG-FREE", APART FROM THE MARK AS SHOWN.

THE STIPPLING IS FOR SHADING PURPOSES ONLY. THE MARK CONSISTS OF THE STYLIZED WORDING "SENSITIVE SWEETS," WITH FIVE POINTED STARS SERVING AS THE DOTS IN THE TWO "I" CHARACTERS IN THE TERM "SENSITIVE", SET INSIDE AN OVAL WITH A CHECKERBOARD STYLE BACKGROUND, WITH A STYLIZED DEPICTION OF A CUPCAKE SUPERIMPOSED OVER A PORTION OF THE LEFT SIDE OF THE OVAL, WITH THE WORDING "SINCE EVERYONE DESERVES A TREAT!" SET BELOW THE OVAL AND FOUR FIVE-POINTED STARS SET BELOW THE WORDING "SINCE EVERYONE DESERVES A TREAT!", WITH THE WORDING "WHEAT-FREE . GLUTEN-FREE . DAIRY-FREE . CASEIN-FREE . EGG-FREE" SET ABOVE THE OVAL, ALL SET INSIDE A CIRCLE.

FOR BAKERY GOODS NOT CONTAINING, OR OTHERWISE PRODUCED USING, WHEAT, GLUTEN, DAIRY PRODUCTS, CASEIN, OR EGGS (U.S. CL. 46).
MICHAEL GAAFAR, EXAMINING ATTORNEY

SN 77-926,669. FAVORITE FLAVORS, LLC, HACKENSACK, NJ. FILED 2-3-2010.

PAPA CANNOLI

THE MARK CONSISTS OF STANDARD CHARACTERS WITHOUT CLAIM TO ANY PARTICULAR FONT, STYLE, SIZE, OR COLOR.

NO CLAIM IS MADE TO THE EXCLUSIVE RIGHT TO USE "CANNOLI", APART FROM THE MARK AS SHOWN.

FOR BAKERY PRODUCTS (U.S. CL. 46).
AMY KERTGATE, EXAMINING ATTORNEY

CLASS 30—(Continued).

SN 77-926,830. THE CHILI COWBOY, LLC, KEY LARGO, FL.
FILED 2-3-2010.



THE MARK CONSISTS OF A COWBOY RIDING A CHILI PEPPER AND THE PHRASE "RIDE THE PEPPER" IN STYLIZED LETTERS RUNNING FROM THE CHILI PEPPER'S STEM TO THE COWBOY'S HAT, ALL OF WHICH EXCEPT THE BOTTOM TIP OF THE CHILI PEPPER AND THE COWBOY'S UPRAISED ARM IS ENCLOSED BY A CIRCLE.

FOR SAUCES, SALSAS, SPICES, AND SPICE BLENDS (U.S. CL. 46).

JANET LEE, EXAMINING ATTORNEY

SN 77-927,060. PASTABLES PRODUCTIONS LLC, NEW YORK, NY. FILED 2-3-2010.

Pasta Out of The Box

THE MARK CONSISTS OF STANDARD CHARACTERS WITHOUT CLAIM TO ANY PARTICULAR FONT, STYLE, SIZE, OR COLOR.

FOR ALIMENTARY PASTA; DOUGH-ENROBED FOODS CONSISTING OF A DOUGH-BASED WRAPPER WITH FILLINGS CONSISTING PRIMARILY OF PASTA AND RICE; DRIED PASTA; FRESH PASTA; PACKAGED MEAL KITS CONSISTING PRIMARILY OF PASTA OR RICE; PACKAGED MEAL MIXES CONSISTING PRIMARILY OF PASTA OR RICE; PASTA; PASTA AND NOODLES; PASTA FOR SOUPS; PASTA SALAD; PASTA SAUCE; PASTA SHELLS; PASTA-WRAPPINGS FOR GYOZA; PREPARED PASTA (U.S. CL. 46).

FIRST USE 1-1-2009; IN COMMERCE 1-1-2009.
KEVON CHISOLM, EXAMINING ATTORNEY

CLASS 30—(Continued).

SN 77-927,145. PATRICIA I. CAPPOLA, ORCHARD PARK, NY. FILED 2-3-2010.

COOKIES AND MORE

THE MARK CONSISTS OF STANDARD CHARACTERS WITHOUT CLAIM TO ANY PARTICULAR FONT, STYLE, SIZE, OR COLOR.

NO CLAIM IS MADE TO THE EXCLUSIVE RIGHT TO USE "COOKIES", APART FROM THE MARK AS SHOWN.

FOR BAKERY GOODS; CHEESECAKE; COOKIES; DANISH PASTRIES; PASTRIES; PASTRY CREAM (U.S. CL. 46).

FIRST USE 10-29-2009; IN COMMERCE 10-29-2009.
JEFFERY COWARD, EXAMINING ATTORNEY

SN 77-927,215. MAN CAVE, LLC, MINNEAPOLIS, MN.
FILED 2-3-2010.

THE KINGS STOCK

THE MARK CONSISTS OF STANDARD CHARACTERS WITHOUT CLAIM TO ANY PARTICULAR FONT, STYLE, SIZE, OR COLOR.

FOR MARINADES; SAUCES; SPICE RUBS; SPICES (U.S. CL. 46).

FIRST USE 12-7-2008; IN COMMERCE 12-7-2008.
MAYUR VAGHANI, EXAMINING ATTORNEY

SN 77-927,458. PEAS OF MIND, LLC, SAN FRANCISCO, CA.
FILED 2-3-2010.

Peas of Pie

THE MARK CONSISTS OF STANDARD CHARACTERS WITHOUT CLAIM TO ANY PARTICULAR FONT, STYLE, SIZE, OR COLOR.

OWNER OF U.S. REG. NO. 2,996,059.

FOR PIZZA (U.S. CL. 46).

FIRST USE 10-1-2009; IN COMMERCE 11-25-2009.
MATTHEW PAPPAS, EXAMINING ATTORNEY

CLASS 30—(Continued).

SN 77-927,721. GOLD RUSH BRANDS, LLC, SCARSDALE, NY. FILED 2-4-2010.

CHEEZ KISSES

THE MARK CONSISTS OF STANDARD CHARACTERS WITHOUT CLAIM TO ANY PARTICULAR FONT, STYLE, SIZE, OR COLOR.

NO CLAIM IS MADE TO THE EXCLUSIVE RIGHT TO USE "CHEESE", APART FROM THE MARK AS SHOWN.

FOR CEREAL-BASED, RICE-BASED AND WHEAT-BASED SNACK FOODS, ALL CONTAINING CHEESE OR CHEESE FLAVORING (U.S. CL. 46).

JAY BESCH, EXAMINING ATTORNEY

SN 77-927,980. SPRINGFIELD BRANDS, LLC, JACKSONVILLE, FL. FILED 2-4-2010.



NO CLAIM IS MADE TO THE EXCLUSIVE RIGHT TO USE "PURE, SIMPLE SWEETS", APART FROM THE MARK AS SHOWN.

THE COLOR(S) RED, BLUE-GREEN AND WHITE IS/ARE CLAIMED AS A FEATURE OF THE MARK.

THE MARK CONSISTS OF A RED CIRCLE WITH A BLUE-GREEN BORDER WITH THE WHITE STYLIZED WORD "SWEET" ABOVE THE BLUE-GREEN STYLIZED WORD "PETE'S" INSIDE THE CIRCLE, ABOVE THE STYLIZED BLUE-GREEN WORDS "PURE, SIMPLE SWEETS".

FOR CANDY; CHOCOLATE; COFFEE; ICE CREAM; TEA (U.S. CL. 46).

NICHOLAS ALTREE, EXAMINING ATTORNEY

CLASS 30—(Continued).

SN 77-928,414. STROM PRODUCTS LTD., BANNOCKBURN, IL. FILED 2-4-2010.

Use your noodle!

THE MARK CONSISTS OF STANDARD CHARACTERS WITHOUT CLAIM TO ANY PARTICULAR FONT, STYLE, SIZE, OR COLOR.

FOR EGG NOODLE SUBSTITUTE MADE FROM FLOUR, CORN FLOUR, AND DRIED EGG WHITES (U.S. CL. 46).

CAROLYN CATALDO, EXAMINING ATTORNEY

SN 77-928,422. SIMPLY EIGHT, KALAMAZOO, MI. FILED 2-4-2010.

Simply Eight

THE MARK CONSISTS OF STANDARD CHARACTERS WITHOUT CLAIM TO ANY PARTICULAR FONT, STYLE, SIZE, OR COLOR.

FOR COOKIES; BISCUITS; CRACKERS; BREAKFAST CEREALS; CEREAL BASED SNACK FOOD; CEREAL BASED SNACK BARS; GRAIN-BASED SNACK FOODS; GRANOLA SNACKS; GRANOLA-BASED SNACK BARS (U.S. CL. 46).

CAROLYN CATALDO, EXAMINING ATTORNEY

SN 77-928,492. RIPE DESIGN INC, MANHATTAN BEACH, CA. FILED 2-4-2010.

Gummi Bear-Rings

THE MARK CONSISTS OF STANDARD CHARACTERS WITHOUT CLAIM TO ANY PARTICULAR FONT, STYLE, SIZE, OR COLOR.

NO CLAIM IS MADE TO THE EXCLUSIVE RIGHT TO USE "GUMMY", APART FROM THE MARK AS SHOWN. FOR CANDY (U.S. CL. 46).

ODESSA BIBBINS, EXAMINING ATTORNEY

CLASS 30—(Continued).

SN 77-928,588. JOY TERIYAKI, INC., PORTLAND, OR.
FILED 2-4-2010.



THE MARK CONSISTS OF A LITTLE BOY IN AN OVAL ABOVE THE WORD "JOY" HOLDING A SPATULA AND WEARING A CHEF'S HAT WITH A TUFT OF HAIR STICKING OUT; WEARING AN APRON, AN OVEN MITT AND A T-SHIRT.

FOR ASIAN-STYLE COOKING SAUCES AND SALAD DRESSING FOR HOME FOOD PREPARATION SOLD IN RETAIL OUTLETS, INCLUDING SUPERMARKETS (U.S. CL. 46).

FIRST USE 12-1-2004; IN COMMERCE 12-1-2004.
JOHN HWANG, EXAMINING ATTORNEY

SN 77-928,615. ANA KARINA SALLES FERNANDEZ, ZAPOPAN, MEXICO, FILED 2-4-2010.

ALEBRIJES

THE MARK CONSISTS OF STANDARD CHARACTERS WITHOUT CLAIM TO ANY PARTICULAR FONT, STYLE, SIZE, OR COLOR.

THE ENGLISH TRANSLATION OF "ALEBRIJES" IN THE MARK IS "STRANGE COLORED MONSTER".

FOR FLAVORING SYRUP; HONEY; HONEY SUBSTITUTES; NATURAL SWEETENER; SUGAR SUBSTITUTES (U.S. CL. 46).

JOHN HWANG, EXAMINING ATTORNEY

SN 77-929,175. CHECKERS DRIVE-IN RESTAURANTS, INC., TAMPA, FL. FILED 2-5-2010.

BACON CHEDDAR WORKS

THE MARK CONSISTS OF STANDARD CHARACTERS WITHOUT CLAIM TO ANY PARTICULAR FONT, STYLE, SIZE, OR COLOR.

NO CLAIM IS MADE TO THE EXCLUSIVE RIGHT TO USE "BACON CHEDDAR", APART FROM THE MARK AS SHOWN.

FOR HAMBURGER SANDWICHES (U.S. CL. 46).
SIMON TENG, EXAMINING ATTORNEY

CLASS 30—(Continued).

SN 77-929,182. CHECKERS DRIVE-IN RESTAURANTS, INC., TAMPA, FL. FILED 2-5-2010.

FLAVOR BUILT BURGERS

THE MARK CONSISTS OF STANDARD CHARACTERS WITHOUT CLAIM TO ANY PARTICULAR FONT, STYLE, SIZE, OR COLOR.

NO CLAIM IS MADE TO THE EXCLUSIVE RIGHT TO USE "FLAVOR" AND "BURGERS", APART FROM THE MARK AS SHOWN.

FOR HAMBURGER SANDWICHES (U.S. CL. 46).
SIMON TENG, EXAMINING ATTORNEY

SN 77-929,318. KMCH NATURAL FOODS, INC., VOLO, IL.
FILED 2-5-2010.



THE COLOR(S) GOLD, WHITE, BLACK, MAROON, RED AND PINK IS/ARE CLAIMED AS A FEATURE OF THE MARK.

THE MARK CONSISTS OF CARTOON CHARACTER OF A GOLD FIG COOKIE SHAPED BODY HAVING AN OBLONG BODY SHAPE WITH A CENTER FILLING IN RED, AND HAVING A PAIR OF BLACK AND WHITE EYES, AN U SHAPED NOSE, AND A SMILING MOUTH IN BLACK SHOWING THE TOP ROW OF TEETH IN WHITE AND ITS TONGUE IN RED; THE CHARACTER HAS TWO LEGS WITH SNEAKERS IN THE COLORS WHITE, MAROON, AND RED ON THE ENDS THEREOF AND HAS TWO ARMS WITH WHITE GLOVES ON HANDS, THE LEFT HAND IS RENDERED WITH A THUMBS UP AND THE RIGHT HAND IS RENDERED WITH FOUR FINGERS EXTENDING; THE CHARACTER IS WEARING A RED AND MAROON BASEBALL CAP TILTED ON THE TOP LEFT SIDE OF THE BODY WITH THE LETTERS "MOT" ABOVE THE LETTERS "CU" CONTAINED WITHIN A PARTIAL PINK AND WHITE HEART SHAPE ON THE FRONT OF THE CAP.

FOR CEREAL BASED PRODUCTS, NAMELY, CEREAL BARS (U.S. CL. 46).

JAMES GRIFFIN, EXAMINING ATTORNEY

CLASS 30—(Continued).

SN 77-929,358. BUC-EE'S, LTD., LAKE JACKSON, TX. FILED 2-5-2010.

BEAVER NUGGETS

THE MARK CONSISTS OF STANDARD CHARACTERS WITHOUT CLAIM TO ANY PARTICULAR FONT, STYLE, SIZE, OR COLOR.

NO CLAIM IS MADE TO THE EXCLUSIVE RIGHT TO USE "NUGGETS", APART FROM THE MARK AS SHOWN. FOR TOASTED CORN PUFFS WITH CRISPED CARAMEL COATING (U.S. CL. 46).

FIRST USE 3-0-2006; IN COMMERCE 3-0-2006.
ANN E. SAPPENFIELD, EXAMINING ATTORNEY

SN 77-929,383. BLOCH & GUGGENHEIMER, INC., PARSIPPANY, NJ. FILED 2-5-2010.

WHERE FLAVOR & HEAT MEET!

THE MARK CONSISTS OF STANDARD CHARACTERS WITHOUT CLAIM TO ANY PARTICULAR FONT, STYLE, SIZE, OR COLOR.

FOR CHICKEN WING SAUCE; HOT SAUCE; PEPPER SAUCE; MARINADES AND SEASONINGS (U.S. CL. 46).
CARRIE GENOVESE, EXAMINING ATTORNEY

SN 77-929,451. HUHMAN, CRAIG, KINGDOM CITY, MO. FILED 2-5-2010.

GEORGIE GIRL'S

THE MARK CONSISTS OF STANDARD CHARACTERS WITHOUT CLAIM TO ANY PARTICULAR FONT, STYLE, SIZE, OR COLOR.

FOR DIPPING SAUCES; READY-MADE SAUCES; RELISH; SALSA; SAUCES; TOMATO-BASED SALSA (U.S. CL. 46).

FIRST USE 6-1-2009; IN COMMERCE 11-7-2009.
SANI KHOURI, EXAMINING ATTORNEY

CLASS 30—(Continued).

SN 77-929,688. PORTAL GOURMET L.L.C., ATLANTA, GA. FILED 2-5-2010.



NO CLAIM IS MADE TO THE EXCLUSIVE RIGHT TO USE "GOURMET SAUCE", APART FROM THE MARK AS SHOWN.

THE COLOR(S) BLACK, WHITE, RED, ORANGE, YELLOW IS/ARE CLAIMED AS A FEATURE OF THE MARK.

THE MARK CONSISTS OF THE STYLIZED WORDING "PORTAL" IN THE COLOR RED, THE STYLIZED WORDING "GOURMET SAUCE" IN THE COLOR YELLOW WITHIN A RED RECTANGULAR CARRIER. THE MARK ALSO CONSISTS OF A BLACK SHAPE THAT SURROUNDS ALL OTHER ELEMENTS OF THE MARK HAVING SQUARE CORNERS ON THE BOTTOM AND COMES TO A POINT AT THE TOP WITH A RECTANGULAR SUBSECTION AT THE TOP, AND ALSO HAS A WHITE AND BLACK OUTLINE SURROUNDING THE SHAPE. THE WORDING "PORTAL" APPEARS WITHIN THE RECTANGULAR SUBSECTION AT THE TOP OF THE MARK, AND THE WORDING "GOURMET SAUCE" APPEARS AT THE BOTTOM OF THE MARK. IN BETWEEN THE WORDING IS THE DESIGN OF DOORWAY CONSISTING OF TWO DOORS PARTIALLY OPENED THAT IS OUTLINED IN WHITE AND HAS A BLACK FILL. IN THE OPENING OF THE DOORS IS THE DESIGN OF SALSA APPEARING IN THE COLORS RED, YELLOW, WHITE AND ORANGE. BELOW THE DOORS IS A SCRIBBLE IN THE COLORS RED, YELLOW AND ORANGE.

FOR SALSA (U.S. CL. 46).
JAY BESCH, EXAMINING ATTORNEY

SN 77-929,973. DR. JOHN'S CANDIES, LLC, GRAND RAPIDS, MI. FILED 2-7-2010.

SIMPLYXYLITOL

THE MARK CONSISTS OF STANDARD CHARACTERS WITHOUT CLAIM TO ANY PARTICULAR FONT, STYLE, SIZE, OR COLOR.

FOR CANDY; SUGAR SUBSTITUTES; SUGARLESS CANDIES (U.S. CL. 46).

FIRST USE 1-1-2010; IN COMMERCE 1-1-2010.
ALEXANDER L. POWERS, EXAMINING ATTORNEY

CLASS 30—(Continued).

SN 77-929,991. KRINGAS, MARY JO, DBA LOWCARB SPECIALTIES, COEUR D ALENE, ID. FILED 2-7-2010.

CHOCOPerfection

THE MARK CONSISTS OF STANDARD CHARACTERS WITHOUT CLAIM TO ANY PARTICULAR FONT, STYLE, SIZE, OR COLOR.

FOR CHOCOLATE; CHOCOLATE AND CHOCOLATES; CHOCOLATE BARS (U.S. CL. 46).
FIRST USE 11-3-2003; IN COMMERCE 11-3-2003.
ROBERT C. CLARK JR., EXAMINING ATTORNEY

SN 77-930,074. GLOBAL SWEET POLYOLS, LLC, REHOBOTH, MA. FILED 2-8-2010.

FRAG-MINTS

THE MARK CONSISTS OF STANDARD CHARACTERS WITHOUT CLAIM TO ANY PARTICULAR FONT, STYLE, SIZE, OR COLOR.

FOR CANDY (U.S. CL. 46).
ALYSSA STEEL, EXAMINING ATTORNEY

SN 77-930,602. COFFEE PRIMERO, LLC, GAINESVILLE, FL. FILED 2-8-2010.

NO CLAIM IS MADE TO THE EXCLUSIVE RIGHT TO USE "COFFEE", APART FROM THE MARK AS SHOWN.

THE MARK CONSISTS OF THE WORD "COFFEE" WITH TWO HORIZONTAL LINES EXTENDING FROM THE RIGHT SIDE OF THE WORD "COFFEE", AND THE WORD "PRIMERO" BELOW AND ONE DIGIT TO THE RIGHT OF THE WORD "COFFEE" WITH TWO HORIZONTAL LINES BELOW THE WORD "PRIMERO" INTERSECTING THE "P" IN THE WORD "PRIMERO".

THE ENGLISH TRANSLATION OF THE WORD "PRIMERO" IN THE MARK IS "FIRST".

FOR COFFEE (U.S. CL. 46).
JAMES STEIN, EXAMINING ATTORNEY

CLASS 30—(Continued).

SN 77-931,102. HERSHEY CHOCOLATE & CONFECTIONERY CORPORATION, WHEAT RIDGE, CO. FILED 2-9-2010.

KISSLETOE

THE MARK CONSISTS OF STANDARD CHARACTERS WITHOUT CLAIM TO ANY PARTICULAR FONT, STYLE, SIZE, OR COLOR.

FOR CANDY (U.S. CL. 46).
TERESA M. RUPP, EXAMINING ATTORNEY

SN 77-931,606. LA MOTTA, JOSEPH, MOUNT LAUREL, NJ. FILED 2-9-2010.

HANDMADE FROM VINE TO DINE

THE MARK CONSISTS OF STANDARD CHARACTERS WITHOUT CLAIM TO ANY PARTICULAR FONT, STYLE, SIZE, OR COLOR.

NO CLAIM IS MADE TO THE EXCLUSIVE RIGHT TO USE "HANDMADE", APART FROM THE MARK AS SHOWN.

FOR TOMATO SAUCE (U.S. CL. 46).
DOMINIC FATHY, EXAMINING ATTORNEY

SN 77-932,018. FRED VAN BUITEN, MENLO PARK, CA. FILED 2-9-2010.

COMPLEMENTABLES

THE MARK CONSISTS OF STANDARD CHARACTERS WITHOUT CLAIM TO ANY PARTICULAR FONT, STYLE, SIZE, OR COLOR.

FOR CANDY (U.S. CL. 46).
ZACHARY BELLO, EXAMINING ATTORNEY

CLASS 30—(Continued).

SN 77-934,843. INGLES MARKETS, INC., ASHEVILLE, NC. FILED 2-12-2010.

GOLDEN CRUNCHERS

THE MARK CONSISTS OF STANDARD CHARACTERS WITHOUT CLAIM TO ANY PARTICULAR FONT, STYLE, SIZE, OR COLOR.
FOR BREAKFAST CEREAL (U.S. CL. 46).
BRENDAN REGAN, EXAMINING ATTORNEY

SN 77-934,853. INGLES MARKETS, INC., ASHEVILLE, NC. FILED 2-12-2010.

GOLDEN KRUNCHERS

THE MARK CONSISTS OF STANDARD CHARACTERS WITHOUT CLAIM TO ANY PARTICULAR FONT, STYLE, SIZE, OR COLOR.
FOR BREAKFAST CEREAL (U.S. CL. 46).
BRENDAN REGAN, EXAMINING ATTORNEY

SN 77-938,879. KELLOGG NORTH AMERICA COMPANY, BATTLE CREEK, MI. FILED 2-18-2010.

NUTRI-GRAIN SUPERFRUIT FUSION

THE MARK CONSISTS OF STANDARD CHARACTERS WITHOUT CLAIM TO ANY PARTICULAR FONT, STYLE, SIZE, OR COLOR.
OWNER OF U.S. REG. NOS. 1,255,456, 3,389,446 AND OTHERS.
NO CLAIM IS MADE TO THE EXCLUSIVE RIGHT TO USE "SUPER FRUIT", APART FROM THE MARK AS SHOWN.
FOR GRAIN-BASED SNACK FOOD BAR; GRAIN-BASED SNACK FOOD BAR ALSO CONTAINING FRUIT; CEREAL-BASED SNACK FOOD BAR (U.S. CL. 46).
DEIRDRE ROBERTSON, EXAMINING ATTORNEY

CLASS 30—(Continued).

SN 77-942,510. SOCIETE DES PRODUITS NESTLE S.A., 1800 VEVEY, SWITZERLAND, FILED 2-23-2010.



THE MARK CONSISTS OF A LEAF IN A CIRCLE WITH THREE BANDS AROUND THE LEAF.
FOR TEA, TEA-BASED BEVERAGES, READY-TO-DRINK TEA BASED BEVERAGES (U.S. CL. 46).
BENJAMIN OKEKE, EXAMINING ATTORNEY

SN 77-943,683. GRUPO BIMBO, S.A.B. DE C.V., MEXICO CITY, MEXICO, FILED 2-24-2010.

RICOLINO

THE MARK CONSISTS OF STANDARD CHARACTERS WITHOUT CLAIM TO ANY PARTICULAR FONT, STYLE, SIZE, OR COLOR.
OWNER OF U.S. REG. NOS. 1,921,091, 2,538,918 AND 3,727,261.
THE WORDING "RICOLINO" HAS NO MEANING IN A FOREIGN LANGUAGE.
FOR CANDY; GUMMY CANDY; BUBBLE GUM; CHEWING GUM; GUM SWEETS; CHILI-FLAVORED CANDY (U.S. CL. 46).
MAUREEN DALL, EXAMINING ATTORNEY

CLASS 30—(Continued).

SN 77-949,295. KRAFT FOODS GLOBAL BRANDS LLC, NORTHFIELD, IL. FILED 3-3-2010.



OWNER OF U.S. REG. NOS. 93,009, 1,928,734 AND OTHERS.

THE COLOR(S) BLUE AND WHITE IS/ARE CLAIMED AS A FEATURE OF THE MARK.

THE MARK CONSISTS OF THE WORD "OREO" WRITTEN ON A SLIGHT DIAGONAL WITH THE FIRST LETTER BEING ON THE LOWER LEFT AND THE LAST LETTER BEING ON THE UPPER RIGHT. THE LETTERS ARE WHITE AND ARE WRITTEN ON A BLUE BACKGROUND. FOR BAKERY GOODS; BISCUITS; COOKIES (U.S. CL. 46).

BILL DAWE, EXAMINING ATTORNEY

SN 77-950,853. KELLOGG NORTH AMERICA COMPANY, BATTLE CREEK, MI. FILED 3-4-2010.

TOWN HOUSE

THE MARK CONSISTS OF STANDARD CHARACTERS WITHOUT CLAIM TO ANY PARTICULAR FONT, STYLE, SIZE, OR COLOR.

OWNER OF U.S. REG. NOS. 587,813, 2,896,257 AND 3,235,078.

FOR CRACKERS (U.S. CL. 46).

FIRST USE 10-4-1940; IN COMMERCE 10-4-1940.

DEIRDRE ROBERTSON, EXAMINING ATTORNEY

SN 77-953,301. CIRANDA, INC., HUDSON, WI. FILED 3-8-2010.

CARIOCA

THE MARK CONSISTS OF STANDARD CHARACTERS WITHOUT CLAIM TO ANY PARTICULAR FONT, STYLE, SIZE, OR COLOR.

FOR TAPIOCA SYRUPS (U.S. CL. 46).

BRIAN NEVILLE, EXAMINING ATTORNEY

CLASS 30—(Continued).

SN 77-960,081. GRUPO BIMBO, S.A. B. DE C.V., MEXICO CITY, MEXICO, FILED 3-16-2010.

SUANDY

THE MARK CONSISTS OF STANDARD CHARACTERS WITHOUT CLAIM TO ANY PARTICULAR FONT, STYLE, SIZE, OR COLOR.

THE WORDING "SUANDY" HAS NO MEANING IN A FOREIGN LANGUAGE.

FOR BREAD (U.S. CL. 46).

MAUREEN DALL, EXAMINING ATTORNEY

SN 77-960,469. RIPE DESIGN INC, MANHATTAN BEACH, CA. FILED 3-16-2010.

GRIND

THE MARK CONSISTS OF STANDARD CHARACTERS WITHOUT CLAIM TO ANY PARTICULAR FONT, STYLE, SIZE, OR COLOR.

FOR CANDY (U.S. CL. 46).

ODESSA BIBBINS, EXAMINING ATTORNEY

SN 77-961,814. HERSHEY CHOCOLATE & CONFECTIONERY CORPORATION, WHEAT RIDGE, CO. FILED 3-18-2010.

TOTALLY TWISTED

THE MARK CONSISTS OF STANDARD CHARACTERS WITHOUT CLAIM TO ANY PARTICULAR FONT, STYLE, SIZE, OR COLOR.

FOR CANDY (U.S. CL. 46).

TERESA M. RUPP, EXAMINING ATTORNEY

CLASS 30—(Continued).

SN 85-009,150. PERFETTI VAN MELLE BENELUX B.V., BREDA, NETHERLANDS, FILED 4-8-2010.

DEVOUR THE SOUR

THE MARK CONSISTS OF STANDARD CHARACTERS WITHOUT CLAIM TO ANY PARTICULAR FONT, STYLE, SIZE, OR COLOR.
FOR CONFECTIONERY, NAMELY, CANDIES AND CHEWING GUM (U.S. CL. 46).
B. PARADEWELAI, EXAMINING ATTORNEY

CLASS 31—(Continued).

SN 77-448,680. GODDARD, JR., WILLIAM R., ARDMORE, OK. FILED 4-15-2008.

GODDARD RANCH

THE MARK CONSISTS OF STANDARD CHARACTERS WITHOUT CLAIM TO ANY PARTICULAR FONT, STYLE, SIZE, OR COLOR.
NO CLAIM IS MADE TO THE EXCLUSIVE RIGHT TO USE "RANCH", APART FROM THE MARK AS SHOWN.
SEC. 2(F).
FOR LIVESTOCK (U.S. CLS. 1 AND 46).
FIRST USE 1-1-1988; IN COMMERCE 1-1-1988.
MICHAEL GAAFAR, EXAMINING ATTORNEY

SN 77-590,110. SERGIO, RUIZ-TAGLE, SANTIAGO, CHILE, FILED 10-10-2008.



NO CLAIM IS MADE TO THE EXCLUSIVE RIGHT TO USE "RUTA", APART FROM THE MARK AS SHOWN.
THE COLOR(S) ORANGE, GREEN, PURPLE AND BLACK IS/ARE CLAIMED AS A FEATURE OF THE MARK.
THE MARK CONSISTS OF GREEN, PURPLE AND ORANGE STRIPES UNDER AN ORANGE SUN. THE WORDING "RUTA" IS IN BLACK.
THE ENGLISH TRANSLATION OF "RUTA" IN THE MARK IS "ROUTE".
FOR FRESH FRUITS (U.S. CLS. 1 AND 46).
FIRST USE 9-0-2005; IN COMMERCE 9-0-2005.
ALEX KEAM, EXAMINING ATTORNEY

SN 77-785,838. LCN HOLDINGS, INC., DBA LAKE COUNTY NURSERY, PERRY, OH. FILED 7-21-2009.

GOLDEN RUBY

THE MARK CONSISTS OF STANDARD CHARACTERS WITHOUT CLAIM TO ANY PARTICULAR FONT, STYLE, SIZE, OR COLOR.
OWNER OF U.S. REG. NO. 2,976,837.
NO CLAIM IS MADE TO THE EXCLUSIVE RIGHT TO USE "RUBY", APART FROM THE MARK AS SHOWN.
FOR LIVE PLANTS, NAMELY, BARBERRY CULTIVARS (U.S. CLS. 1 AND 46).
FIRST USE 6-25-2009; IN COMMERCE 6-25-2009.
SAIMA MAKHDOOM, EXAMINING ATTORNEY

CLASS 31—NATURAL AGRICULTURAL PRODUCTS

SN 77-130,036. FRUIT SHIPPERS LIMITED, NASSAU, BAHAMAS, FILED 3-13-2007.



THE FOREIGN WORDING IN THE MARK TRANSLATES INTO ENGLISH AS RICH.
FOR LIVE ANIMALS; FRESH FRUITS AND VEGETABLES; FRESH PLANTAINS; SEEDS FOR AGRICULTURAL PURPOSES; LIVE PLANTS AND FLOWERS; FOODSTUFFS FOR ANIMALS; MALT FOR BREWING AND DISTILLING (U.S. CLS. 1 AND 46).
ELI HELLMAN, EXAMINING ATTORNEY

CLASS 31—(Continued).

SN 77-786,656. NATURE'S ABSORBENT, LLC, NILES, MI. FILED 7-22-2009.

Nature's Absorbent

THE MARK CONSISTS OF STANDARD CHARACTERS WITHOUT CLAIM TO ANY PARTICULAR FONT, STYLE, SIZE, OR COLOR.

NO CLAIM IS MADE TO THE EXCLUSIVE RIGHT TO USE "ABSORBENT", APART FROM THE MARK AS SHOWN.

FOR WOOD FIBERS USED TO ABSORB PETROLEUM AND OTHER LIQUID SPILLS, AND ODOR ABSORPTION, FOR HOME AND INDUSTRIAL USE (U.S. CLS. 1 AND 46).

FIRST USE 1-1-1993, THE MARK WAS FIRST USED ANYWHERE IN A DIFFERENT FORM OTHER THAN THAT SOUGHT TO BE REGISTERED AT LEAST AS EARLY AS 01/01/1993.; IN COMMERCE 1-1-1993, THE MARK WAS FIRST USED IN COMMERCE IN A DIFFERENT FORM OTHER THAN THAT SOUGHT TO BE REGISTERED AT LEAST AS EARLY AS 01/01/1993..

MICHELE SWAIN, EXAMINING ATTORNEY

CLASS 31—(Continued).

SN 77-790,307. C.I. UNION DE BANANEROS DE URABA, S.A. - UNIBAN, DBA C.I. UNIBAN S.A., MEDELLIN, COLOMBIA, FILED 7-27-2009.



OWNER OF U.S. REG. NOS. 1,799,567, 3,131,777 AND OTHERS.

THE COLOR(S) BLACK, YELLOW AND WHITE IS/ARE CLAIMED AS A FEATURE OF THE MARK.

THE MARK CONSISTS OF THE STYLIZED WORD "TURBANA" IN BLACK LETTERS AND THREE STYLIZED DEPICTIONS OF YELLOW BANANAS.

THE WORDING "TURBANA" HAS NO MEANING IN A FOREIGN LANGUAGE.

FOR FRESH BANANAS AND FRESH PLANTAINS (U.S. CLS. 1 AND 46).

EDWARD NELSON, EXAMINING ATTORNEY

SN 77-790,285. C.I. UNION DE BANANEROS DE URABA, S.A. - UNIBAN, DBA C.I. UNIBAN S.A., MEDELLIN, COLOMBIA, FILED 7-27-2009.



SN 77-794,743. MARATHON LAND, INC., OXNARD, CA. FILED 7-31-2009.

Green Wave

OWNER OF U.S. REG. NOS. 1,799,567, 3,131,777 AND OTHERS.

THE COLOR(S) RED, YELLOW AND WHITE IS/ARE CLAIMED AS A FEATURE OF THE MARK.

THE MARK CONSISTS OF THE STYLIZED WORD "TURBANA" IN WHITE LETTERS ON A RED OVAL ON WHICH APPEAR THREE STYLIZED DEPICTIONS OF YELLOW BANANAS.

THE WORDING "TURBANA" HAS NO MEANING IN A FOREIGN LANGUAGE.

FOR FRESH BANANAS AND FRESH PLANTAINS (U.S. CLS. 1 AND 46).

EDWARD NELSON, EXAMINING ATTORNEY

THE MARK CONSISTS OF STANDARD CHARACTERS WITHOUT CLAIM TO ANY PARTICULAR FONT, STYLE, SIZE, OR COLOR.

FOR GRASS PRODUCTS, NAMELY, GRASS SOD AND SEED, WITH THE SOD CONSISTING OF ENVIRONMENTALLY FRIENDLY COMPONENTS AND GROWN IN AN ENVIRONMENTALLY FRIENDLY MANNER (U.S. CLS. 1 AND 46).

WANDA KAY PRICE, EXAMINING ATTORNEY

CLASS 31—(Continued).

SN 77-854,748. THE PITCHFORK LAND AND CATTLE COMPANY, GUTHRIE, TX. FILED 10-22-2009.



THE MARK CONSISTS OF A STYLIZED PITCHFORK. FOR LIVESTOCK, NAMELY, CATTLE AND HORSES (U.S. CLS. 1 AND 46).
FIRST USE 0-0-1883; IN COMMERCE 0-0-1883.
AMY HELLA, EXAMINING ATTORNEY

SN 77-894,310. CHIQUITA BRANDS L.L.C., CINCINNATI, OH. FILED 12-16-2009.

CHIQUITA WORLD FLAVORS

THE MARK CONSISTS OF STANDARD CHARACTERS WITHOUT CLAIM TO ANY PARTICULAR FONT, STYLE, SIZE, OR COLOR.
NO CLAIM IS MADE TO THE EXCLUSIVE RIGHT TO USE "FLAVORS", APART FROM THE MARK AS SHOWN.
FOR FRESH FRUITS (U.S. CLS. 1 AND 46).
ANTHONY RINKER, EXAMINING ATTORNEY

SN 77-894,446. DARFORD INDUSTRIES LTD., VERNON BC, CANADA, FILED 12-16-2009.

RETURN THE FAVOR

THE MARK CONSISTS OF STANDARD CHARACTERS WITHOUT CLAIM TO ANY PARTICULAR FONT, STYLE, SIZE, OR COLOR.
FOR PET FOOD (U.S. CLS. 1 AND 46).
KARANENDRA S. CHHINA, EXAMINING ATTORNEY

CLASS 31—(Continued).

SN 77-904,171. OLIVER BENTLEYS, LLC, SAVANNAH, GA. FILED 1-4-2010.

OLLIE B. BISCUITS

THE MARK CONSISTS OF STANDARD CHARACTERS WITHOUT CLAIM TO ANY PARTICULAR FONT, STYLE, SIZE, OR COLOR.

OWNER OF U.S. REG. NO. 3,724,732.

NO CLAIM IS MADE TO THE EXCLUSIVE RIGHT TO USE "BISCUITS", APART FROM THE MARK AS SHOWN.

THE NAME(S), PORTRAIT(S), AND/OR SIGNATURE(S) SHOWN IN THE MARK DOES NOT IDENTIFY A PARTICULAR LIVING INDIVIDUAL.

FOR DOG BISCUITS; DOG TREATS (U.S. CLS. 1 AND 46).

FIRST USE 12-5-2008; IN COMMERCE 12-5-2008.

JOHN SCHUYLER YARD, EXAMINING ATTORNEY

SN 77-924,317. CQIS,LLC, DBA RAW PLANET FOODS, LAS VEGAS NEVADA, NV. FILED 1-30-2010.

Raw Planet Foods

THE MARK CONSISTS OF STANDARD CHARACTERS WITHOUT CLAIM TO ANY PARTICULAR FONT, STYLE, SIZE, OR COLOR.

NO CLAIM IS MADE TO THE EXCLUSIVE RIGHT TO USE "RAW" AND "FOODS", APART FROM THE MARK AS SHOWN.

FOR DIGESTIBLE CHEWING BONES FOR DOGS; DOG BISCUITS; DOG FOOD; DOG TREATS; DOGS; EDIBLE FOOD FOR ANIMALS FOR CHEWING; FOOD FOR ANIMALS; LIVE ANIMALS, NAMELY, DOGS; PET FOOD; PROTEIN MIX FOR DOGS NOT FOR MEDICINAL PURPOSES (U.S. CLS. 1 AND 46).

ANTHONY RINKER, EXAMINING ATTORNEY

SN 77-925,145. CIRCLE J EXTREME, L.L.C., SAREPTA, LA. FILED 2-1-2010.

**feed
it for
LIFE.**

FOR ANIMAL FEED (U.S. CLS. 1 AND 46).
FIRST USE 11-17-2003; IN COMMERCE 11-17-2003.
COLLEEN DOMBROW, EXAMINING ATTORNEY

CLASS 31—(Continued).

SN 77-925,413. DEL MONTE CORPORATION, SAN FRANCISCO, CA. FILED 2-1-2010.

9LIVES

THE MARK CONSISTS OF STANDARD CHARACTERS WITHOUT CLAIM TO ANY PARTICULAR FONT, STYLE, SIZE, OR COLOR.

OWNER OF U.S. REG. NOS. 688,796, 2,054,643 AND 3,263,014.

FOR PET FOOD (U.S. CLS. 1 AND 46).
FIRST USE 2-4-1959; IN COMMERCE 2-4-1959.
DOMINIC FATHY, EXAMINING ATTORNEY

SN 77-925,616. HIGH NOON FEEDS, LLC, BIRD CITY, KS. FILED 2-2-2010.

High Noon Feeds

THE MARK CONSISTS OF STANDARD CHARACTERS WITHOUT CLAIM TO ANY PARTICULAR FONT, STYLE, SIZE, OR COLOR.

NO CLAIM IS MADE TO THE EXCLUSIVE RIGHT TO USE "FEEDS", APART FROM THE MARK AS SHOWN.

FOR ANIMAL FEED (U.S. CLS. 1 AND 46).
FIRST USE 11-30-2002; IN COMMERCE 11-30-2002.
STEVEN R. FINE, EXAMINING ATTORNEY

SN 77-925,790. PIED PIPER PET FOODS, LLC, HAMLIN, TX. FILED 2-2-2010.



THE COLOR(S) RED, BLUE, WHITE IS/ARE CLAIMED AS A FEATURE OF THE MARK.

THE MARK CONSISTS OF RED "S", BLUE "H", BLUE "O", BLUE "W", BLUE STARS, WHITE STAR OUTLINES, RED STREAMERS FROM STARS, RED "A", BLUE "D", BLUE "V", BLUE "A", BLUE "N", BLUE "T", BLUE "A", BLUE "G", BLUE "E".

FOR ANIMAL FEED; ANIMAL FOODSTUFFS (U.S. CLS. 1 AND 46).
CARRIE GENOVESE, EXAMINING ATTORNEY

CLASS 31—(Continued).

SN 77-925,984. DAVE STAUBLE, TORONTO, ONTARIO, CANADA, FILED 2-2-2010.

CARNA4

THE MARK CONSISTS OF STANDARD CHARACTERS WITHOUT CLAIM TO ANY PARTICULAR FONT, STYLE, SIZE, OR COLOR.

FOR DOG FOOD (U.S. CLS. 1 AND 46).
ZACHARY BELLO, EXAMINING ATTORNEY

SN 77-926,081. MARETTI PET PRODUCTS, FORMERLY MORETTI'S, INC, MANITOWAC, WI. FILED 2-2-2010.

NOMS

THE MARK CONSISTS OF STANDARD CHARACTERS WITHOUT CLAIM TO ANY PARTICULAR FONT, STYLE, SIZE, OR COLOR.

THE WORDING "NOMS" HAS NO MEANING IN A FOREIGN LANGUAGE.

FOR PET TREATS (U.S. CLS. 1 AND 46).
VIVIAN MICZNIK FIRST, EXAMINING ATTORNEY

SN 77-926,590. MIDWESTERN PET FOODS, INC., EVANSVILLE, IN. FILED 2-3-2010.

MONTEREY MEDLEY

THE MARK CONSISTS OF STANDARD CHARACTERS WITHOUT CLAIM TO ANY PARTICULAR FONT, STYLE, SIZE, OR COLOR.

FOR CAT FOOD (U.S. CLS. 1 AND 46).
ANDREA BUTLER, EXAMINING ATTORNEY

SN 77-926,591. MIDWESTERN PET FOODS, INC., EVANSVILLE, IN. FILED 2-3-2010.

HARBOR HARVEST

THE MARK CONSISTS OF STANDARD CHARACTERS WITHOUT CLAIM TO ANY PARTICULAR FONT, STYLE, SIZE, OR COLOR.

FOR CAT FOOD (U.S. CLS. 1 AND 46).
ANDREA BUTLER, EXAMINING ATTORNEY

CLASS 31—(Continued).

SN 77-926,594. MIDWESTERN PET FOODS, INC., EVANSVILLE, IN. FILED 2-3-2010.

CATALINA CATCH

THE MARK CONSISTS OF STANDARD CHARACTERS WITHOUT CLAIM TO ANY PARTICULAR FONT, STYLE, SIZE, OR COLOR.

FOR CAT FOOD (U.S. CLS. 1 AND 46).
ANDREA BUTLER, EXAMINING ATTORNEY

SN 77-926,910. CAROL SUE BLUEBERRY FARM, INC., HAMPSTEAD, NC. FILED 2-3-2010.

They taste like summertime!

THE MARK CONSISTS OF STANDARD CHARACTERS WITHOUT CLAIM TO ANY PARTICULAR FONT, STYLE, SIZE, OR COLOR.

FOR FRESH BLUEBERRIES (U.S. CLS. 1 AND 46).
MARIAM MAHMOUDI, EXAMINING ATTORNEY

SN 77-927,270. WISHNATZKI, INC., DBA WISHNATZKI FARMS, PLANT CITY, FL. FILED 2-3-2010.



NO CLAIM IS MADE TO THE EXCLUSIVE RIGHT TO USE "FARMS QUALITY PRODUCE SINCE 1922", APART FROM THE MARK AS SHOWN.

THE COLOR(S) TAN, ORANGE, RED, VIOLET, AND BLUE IS/ARE CLAIMED AS A FEATURE OF THE MARK.

THE MARK CONSISTS OF A PIXIE WITH A RED DRESS, VIOLET WINGS, VIOLET WAND WITH RED STAR, ORANGE HAIR WITH RED STAR, AND TAN SKIN TONES. THE PIXIE IS OUTLINED IN VIOLET. THE WORDING "WISH FARMS" IS IN VIOLET AND THE WORDING "QUALITY PRODUCE SINCE 1922" IS IN RED.

FOR (BASED ON USE IN COMMERCE) FRUITS, NAMELY, STRAWBERRIES (BASED ON INTENT TO USE) FRESH BLUEBERRIES; FRESH FRUIT AND VEGETABLES; FRESH GRAPE CHERRY TOMATOES; FRESH PEPPERS; FRESH TOMATOES; FRESH VEGETABLES; FRESH ZUCCHINI; RAW BLUEBERRIES; RAW PEPPERS; RAW TOMATOES; UNPROCESSED BLUEBERRIES; UNPROCESSED PEPPERS; UNPROCESSED TOMATOES; WATERMELON, FRESH (U.S. CLS. 1 AND 46).

FIRST USE 10-13-2009; IN COMMERCE 1-19-2010.
JULIE WATSON, EXAMINING ATTORNEY

CLASS 31—(Continued).

SN 77-929,491. LBI.LLC, BUFFALO, WY. FILED 2-5-2010.

DURATION

THE MARK CONSISTS OF STANDARD CHARACTERS WITHOUT CLAIM TO ANY PARTICULAR FONT, STYLE, SIZE, OR COLOR.

FOR ANIMAL LITTER; CAT LITTER; CAT LITTER AND LITTER FOR SMALL ANIMALS; CAT LITTERS; COMPRESSED WOOD PARTICLES FOR ABSORBENCY; KITTY LITTER (U.S. CLS. 1 AND 46).

FIRST USE 4-4-2009; IN COMMERCE 4-4-2009.
WANDA KAY PRICE, EXAMINING ATTORNEY

SN 77-930,211. FLORABELLA INTERNATIONAL, LLC, LAYTON, UT. FILED 2-8-2010.

The New Way of Expression

THE MARK CONSISTS OF STANDARD CHARACTERS WITHOUT CLAIM TO ANY PARTICULAR FONT, STYLE, SIZE, OR COLOR.

FOR LIVE FLOWERS (U.S. CLS. 1 AND 46).
FIRST USE 7-14-2009; IN COMMERCE 7-14-2009.
JESSICA A. POWERS, EXAMINING ATTORNEY

SN 77-930,577. AMERICAN SEEDS, LLC, ST. LOUIS, MO. FILED 2-8-2010.



OWNER OF U.S. REG. NO. 1,103,008.

THE MARK CONSISTS OF A STYLIZED DEPICTION OF A GROWING PLANT WITH THE LEAVES OPENING TOWARD THE SKY WITH THE WORD "DIENER" IN ALL CAPS DIRECTLY BELOW THE STEM OF THE PLANT.

FOR AGRICULTURAL SEEDS (U.S. CLS. 1 AND 46).
CHRISIE B. KING, EXAMINING ATTORNEY

CLASS 31—(Continued).

SN 77-930,655. AVO-KING, ORANGE, CA. FILED 2-8-2010.

AVO-KING

THE MARK CONSISTS OF STANDARD CHARACTERS WITHOUT CLAIM TO ANY PARTICULAR FONT, STYLE, SIZE, OR COLOR.

OWNER OF U.S. REG. NO. 3,316,152.
FOR FRESH AVOCADO, RAW AVOCADO, UNPROCESSED AVOCADO (U.S. CLS. 1 AND 46).
FIRST USE 11-11-1991; IN COMMERCE 11-11-1991.
GEORGE LORENZO, EXAMINING ATTORNEY

SN 77-930,730. ALTMAN SPECIALTY PLANTS INC., VISTA, CA. FILED 2-8-2010.

PLANT PLANET

THE MARK CONSISTS OF STANDARD CHARACTERS WITHOUT CLAIM TO ANY PARTICULAR FONT, STYLE, SIZE, OR COLOR.

OWNER OF U.S. REG. NO. 3,708,636.
NO CLAIM IS MADE TO THE EXCLUSIVE RIGHT TO USE "PLANT", APART FROM THE MARK AS SHOWN.
FOR LIVE PLANTS (U.S. CLS. 1 AND 46).
FIRST USE 9-1-2009; IN COMMERCE 1-15-2010.
TINA BROWN, EXAMINING ATTORNEY

SN 77-931,062. COSTA FARMS LLC, GOULDS, FL. FILED 2-9-2010.

TGS TOTAL GROWTH SOLUTIONS

THE MARK CONSISTS OF STANDARD CHARACTERS WITHOUT CLAIM TO ANY PARTICULAR FONT, STYLE, SIZE, OR COLOR.

NO CLAIM IS MADE TO THE EXCLUSIVE RIGHT TO USE "GROWTH", APART FROM THE MARK AS SHOWN.
FOR LIVE FLOWERS AND LIVING PLANTS (U.S. CLS. 1 AND 46).
DAVID COLLIER, EXAMINING ATTORNEY

CLASS 31—(Continued).

SN 77-931,069. COSTA FARMS LLC, GOULDS, FL. FILED 2-9-2010.



NO CLAIM IS MADE TO THE EXCLUSIVE RIGHT TO USE "GROWTH", APART FROM THE MARK AS SHOWN.

THE COLOR(S) YELLOW, GREEN, BEIGE, BLACK, AND LIGHT BLUE IS/ARE CLAIMED AS A FEATURE OF THE MARK.

THE MARK CONSISTS OF A YELLOW STARBURST DESIGN, SURROUNDED BY CRESCENT SWIRLS, WITH THE TOP SWIRL TO THE RIGHT OF THE STARBURST IN GREEN, BECOMING A LEAF, THE SECOND SWIRL, TO THE LEFT OF THE STARBURST, ALSO IN GREEN, THE THIRD SWIRL, ALSO TO THE LEFT, IN BEIGE, AND THE BOTTOM SWIRL, TO THE RIGHT, IN LIGHT BLUE, WITH THE LETTERS "TGS" IN BLACK IN ALL CAPS TO THE RIGHT OF THE STARBURST-SWIRL DESIGN, AND THE WORDS "TOTAL GROWTH SOLUTIONS" UNDERNEATH THE "TGS" ALSO APPEARING IN BLACK.

FOR LIVE FLOWERS AND LIVING PLANTS (U.S. CLS. 1 AND 46).
DAVID COLLIER, EXAMINING ATTORNEY

SN 77-931,267. HUBBARD FEEDS INC., MANKATO, MN. FILED 2-9-2010.

SUMMIT

THE MARK CONSISTS OF STANDARD CHARACTERS WITHOUT CLAIM TO ANY PARTICULAR FONT, STYLE, SIZE, OR COLOR.

OWNER OF U.S. REG. NO. 1,641,703.
FOR ANIMAL FEED (U.S. CLS. 1 AND 46).
FIRST USE 1-29-2010; IN COMMERCE 1-29-2010.
CHRISTOPHER BUONGIORNO, EXAMINING ATTORNEY

SN 77-931,428. SOCIO X, INC., NEW YORK, NY. FILED 2-9-2010.

poochclub

THE MARK CONSISTS OF STANDARD CHARACTERS WITHOUT CLAIM TO ANY PARTICULAR FONT, STYLE, SIZE, OR COLOR.

FOR CAT FOOD; DOG FOOD; PET BEVERAGES; PET FOOD; PET TREATS (U.S. CLS. 1 AND 46).
CURTIS FRENCH, EXAMINING ATTORNEY

CLASS 31—(Continued).

SN 77-931,795. LOEW, VALERIE, FULLERTON, CA. FILED 2-9-2010.

Kittyrageous

THE MARK CONSISTS OF STANDARD CHARACTERS WITHOUT CLAIM TO ANY PARTICULAR FONT, STYLE, SIZE, OR COLOR.

FOR PET TREATS (U.S. CLS. 1 AND 46).
ERIN FALK, EXAMINING ATTORNEY

SN 77-932,619. SOCIETE DES PRODUITS NESTLE S.A., VEVEY, SWITZERLAND, FILED 2-10-2010.

EXPLORE THE GREAT INDOORS

THE MARK CONSISTS OF STANDARD CHARACTERS WITHOUT CLAIM TO ANY PARTICULAR FONT, STYLE, SIZE, OR COLOR.

FOR PET FOOD (U.S. CLS. 1 AND 46).
BENJAMIN OKEKE, EXAMINING ATTORNEY

SN 77-932,683. NEXGEN TURF RESEARCH, LLC, ALBANY, OR. FILED 2-10-2010.

ENHANCER

THE MARK CONSISTS OF STANDARD CHARACTERS WITHOUT CLAIM TO ANY PARTICULAR FONT, STYLE, SIZE, OR COLOR.

FOR LAWN/TURF (U.S. CLS. 1 AND 46).
JENNY PARK, EXAMINING ATTORNEY

SN 77-933,934. OMS INVESTMENTS, INC., LOS ANGELES, CA. FILED 2-11-2010.

PLAY

THE MARK CONSISTS OF STANDARD CHARACTERS WITHOUT CLAIM TO ANY PARTICULAR FONT, STYLE, SIZE, OR COLOR.

OWNER OF U.S. REG. NO. 694,062.
FOR GRASS SEED (U.S. CLS. 1 AND 46).
ANDREA K. NADELMAN, EXAMINING ATTORNEY

CLASS 31—(Continued).

SN 77-941,675. SOCIETE DES PRODUITS NESTLE S.A., VEVEY, SWITZERLAND, FILED 2-22-2010.

HIDDEN GOODNESS

THE MARK CONSISTS OF STANDARD CHARACTERS WITHOUT CLAIM TO ANY PARTICULAR FONT, STYLE, SIZE, OR COLOR.

FOR PET FOOD (U.S. CLS. 1 AND 46).
BENJAMIN OKEKE, EXAMINING ATTORNEY

SN 77-943,661. SOCIETE DES PRODUITS NESTLE S.A., VEVEY, SWITZERLAND, FILED 2-24-2010.

FRISKIES CRISPIES

THE MARK CONSISTS OF STANDARD CHARACTERS WITHOUT CLAIM TO ANY PARTICULAR FONT, STYLE, SIZE, OR COLOR.

OWNER OF U.S. REG. NOS. 668,470 AND 2,412,558.
FOR PET FOOD (U.S. CLS. 1 AND 46).
BENJAMIN OKEKE, EXAMINING ATTORNEY

SN 77-945,729. LOEW, VALERIE M., FULLERTON, CA. FILED 2-26-2010.

It's Better Than Catnip!

THE MARK CONSISTS OF STANDARD CHARACTERS WITHOUT CLAIM TO ANY PARTICULAR FONT, STYLE, SIZE, OR COLOR.

FOR CAT TREATS; PET TREATS (U.S. CLS. 1 AND 46).
MARY CRAWFORD, EXAMINING ATTORNEY

CLASS 31—(Continued).

SN 77-946,005. DEL MONTE CORPORATION, SAN FRANCISCO, CA. FILED 2-26-2010.

ESSENTIALS PLUS+

THE MARK CONSISTS OF STANDARD CHARACTERS WITHOUT CLAIM TO ANY PARTICULAR FONT, STYLE, SIZE, OR COLOR.

OWNER OF U.S. REG. NO. 3,684,196.
FOR PET FOOD (U.S. CLS. 1 AND 46).
FIRST USE 6-11-2009; IN COMMERCE 6-11-2009.
DOMINIC FATHY, EXAMINING ATTORNEY

SN 77-946,342. DEL MONTE CORPORATION, SAN FRANCISCO, CA. FILED 2-26-2010.



OWNER OF U.S. REG. NOS. 1,995,276, 2,835,286 AND OTHERS.

THE COLOR(S) ORANGE, BROWN/RUST, YELLOW, WHITE, GREEN, BLACK AND PINK IS/ARE CLAIMED AS A FEATURE OF THE MARK.

THE MARK CONSISTS OF A DESIGN OF A CAT MADE FROM THE WORDS "MEOW MIX" WITH AN ORANGE, BROWN/RUST AND YELLOW BODY; WHITE PAWS, TALE AND MOUTH; GREEN AND BLACK EYES; BLACK WHISKERS; AND PINK TONGUE.

FOR PET FOOD (U.S. CLS. 1 AND 46).
FIRST USE 5-0-2008; IN COMMERCE 5-0-2008.
DOMINIC FATHY, EXAMINING ATTORNEY

SN 77-959,681. MERRICK PET CARE, INC., AMARILLO, TX. FILED 3-16-2010.

CAMPER'S DELIGHT

THE MARK CONSISTS OF STANDARD CHARACTERS WITHOUT CLAIM TO ANY PARTICULAR FONT, STYLE, SIZE, OR COLOR.

FOR PET FOOD (U.S. CLS. 1 AND 46).
FIRST USE 6-22-2009; IN COMMERCE 6-22-2009.
HELENE LIWINSKI, EXAMINING ATTORNEY

CLASS 31—(Continued).

SN 77-960,989. MERRICK PET CARE, INC., AMARILLO, TX. FILED 3-17-2010.

WISCONSIN WINTER

THE MARK CONSISTS OF STANDARD CHARACTERS WITHOUT CLAIM TO ANY PARTICULAR FONT, STYLE, SIZE, OR COLOR.

FOR PET FOOD (U.S. CLS. 1 AND 46).
FIRST USE 9-28-2009; IN COMMERCE 9-28-2009.
HELENE LIWINSKI, EXAMINING ATTORNEY

SN 77-964,576. SOCIETE DES PRODUITS NESTLE S.A., VEVEY, SWITZERLAND, FILED 3-22-2010.

FRISKIES PULL N PLAY

THE MARK CONSISTS OF STANDARD CHARACTERS WITHOUT CLAIM TO ANY PARTICULAR FONT, STYLE, SIZE, OR COLOR.

OWNER OF U.S. REG. NOS. 668,470 AND 2,412,558.
FOR PET FOOD (U.S. CLS. 1 AND 46).
BENJAMIN OKEKE, EXAMINING ATTORNEY

SN 78-879,079. SOMMARS OVENS, LLC, PORTLAND, OR. FILED 5-8-2006.

growlnola

THE MARK CONSISTS OF STANDARD CHARACTERS WITHOUT CLAIM TO ANY PARTICULAR FONT, STYLE, SIZE, OR COLOR.

FOR ANIMAL FOODSTUFF (U.S. CLS. 1 AND 46).
JAMES LOVELACE, EXAMINING ATTORNEY

CLASS 32—LIGHT BEVERAGES

SN 77-058,105. CJ CORP., SEOUL, REPUBLIC OF KOREA, FILED 12-6-2006.



OWNER OF REPUBLIC OF KOREA REG. NO. 568604, DATED 12-12-2003, EXPIRES 12-12-2013.

OWNER OF U.S. REG. NOS. 3,033,390, 3,033,392 AND OTHERS.

THE MARK CONSISTS OF THE LETTERS "C" AND "J" WITH THREE OVALS.

FOR VEGETABLE JUICES; EXTRACTS OF HOPS FOR MAKING BEER; FRUIT SYRUPS FOR MAKING FRUIT BEVERAGES; LEMONADES; AERATED WATER; GRAPE JUICE BEVERAGES; MINERAL WATER; BEER (U.S. CLS. 45, 46 AND 48).

MAUREEN DALL, EXAMINING ATTORNEY

SN 77-221,740. MAURO, MARIA, NIAGARA FALLS, NY, AND CARROLL, ELIZABETH, NIAGARA FALLS, NY, FILED 7-3-2007.

Tropicanimals

THE MARK CONSISTS OF STANDARD CHARACTERS WITHOUT CLAIM TO ANY PARTICULAR FONT, STYLE, SIZE, OR COLOR.

FOR HEALTHFUL DRINKS, NAMELY, SPRING WATER AND FRUIT JUICES (U.S. CLS. 45, 46 AND 48). MARGERY A. TIERNEY, EXAMINING ATTORNEY

SN 77-493,175. HAITI BEVERAGE SYNDICATE, LTD., TORTOLA, BR.VIRGIN ISLANDS, FILED 6-6-2008.

Zenga

THE MARK CONSISTS OF STANDARD CHARACTERS WITHOUT CLAIM TO ANY PARTICULAR FONT, STYLE, SIZE, OR COLOR.

THE WORDING "ZENGA" HAS NO MEANING IN A FOREIGN LANGUAGE.

FOR NON-ALCOHOLIC BEVERAGES, NAMELY, ENERGY DRINKS (U.S. CLS. 45, 46 AND 48).

B. PARADEWELAI, EXAMINING ATTORNEY

CLASS 32—(Continued).

SN 77-553,756. RED SKY BRANDS, LLC, RYE, NY, FILED 8-22-2008.

MEISTER BRAU

THE MARK CONSISTS OF STANDARD CHARACTERS WITHOUT CLAIM TO ANY PARTICULAR FONT, STYLE, SIZE, OR COLOR.

THE ENGLISH TRANSLATION OF "MEISTER BRAU" IN THE MARK IS "MASTER BREW."

FOR FLAVORED AND UNFLAVORED DRINKING WATER, FRUIT DRINKS, FRUIT JUICES, SOFT DRINKS, CARBONATED AND NON-CARBONATED DRINKING WATER, BEER, SPORTS DRINKS, ENERGY DRINKS AND MALT LIQUOR (U.S. CLS. 45, 46 AND 48).

SAIMA MAKHDOOM, EXAMINING ATTORNEY

SN 77-651,642. FIFTY-SIX HOPE ROAD MUSIC LIMITED, NASSAU, BAHAMAS, FILED 1-16-2009.

MARLEY

THE MARK CONSISTS OF STANDARD CHARACTERS WITHOUT CLAIM TO ANY PARTICULAR FONT, STYLE, SIZE, OR COLOR.

FOR ALE, BEER, BOTTLED WATER, ENERGY DRINKS, FRUIT JUICES AND FRUIT DRINKS, NON-ALCOHOLIC BEER, NON-ALCOHOLIC COCKTAIL MIXES, NON-ALCOHOLIC COCKTAILS, SOFT DRINKS, SPORTS DRINKS (U.S. CLS. 45, 46 AND 48).

EUGENIA MARTIN, EXAMINING ATTORNEY

SN 77-677,862. RED KEG ENTERPRISES, MIDLAND, MI, FILED 2-25-2009.



NO CLAIM IS MADE TO THE EXCLUSIVE RIGHT TO USE "RED KEG", APART FROM THE MARK AS SHOWN.

THE COLOR(S) RED, WHITE AND BLACK IS/ARE CLAIMED AS A FEATURE OF THE MARK.

THE MARK CONSISTS OF A RED COLORED KEG OR BARREL OUTLINED IN BLACK WHEREUPON THE WORDING "RED KEG" APPEARS IN WHITE WITH A BLACK OUTLINE.

FOR BEER (U.S. CLS. 45, 46 AND 48).

ERIN FALK, EXAMINING ATTORNEY

CLASS 32—(Continued).

SN 77-719,752. MISSION PHARMACAL COMPANY, SAN ANTONIO, TX. FILED 4-22-2009.

COMPETITION

THE MARK CONSISTS OF STANDARD CHARACTERS WITHOUT CLAIM TO ANY PARTICULAR FONT, STYLE, SIZE, OR COLOR.
FOR FRUIT FLAVORED SOFT DRINKS (U.S. CLS. 45, 46 AND 48).
SHAUNIA CARLYLE, EXAMINING ATTORNEY

CLASS 32—(Continued).

SN 77-779,086. OREGON BREWING COMPANY, NEWPORT, OR. FILED 7-11-2009.

REBEL

THE MARK CONSISTS OF STANDARD CHARACTERS WITHOUT CLAIM TO ANY PARTICULAR FONT, STYLE, SIZE, OR COLOR.
FOR EXTRACTS OF HOPS FOR MAKING BEER (U.S. CLS. 45, 46 AND 48).
MARIAM MAHMOUDI, EXAMINING ATTORNEY

SN 77-776,567. MEBO INTERNATIONAL, INC., SUNNYVALE, CA. FILED 7-8-2009.

MEBO

THE MARK CONSISTS OF STANDARD CHARACTERS WITHOUT CLAIM TO ANY PARTICULAR FONT, STYLE, SIZE, OR COLOR.
OWNER OF U.S. REG. NOS. 1,800,404 AND 2,656,764.
FOR BEER (U.S. CLS. 45, 46 AND 48).
MARIA-VICTORIA SUAREZ, EXAMINING ATTORNEY

SN 77-779,088. OREGON BREWING COMPANY, NEWPORT, OR. FILED 7-11-2009.

MAVERICK

THE MARK CONSISTS OF STANDARD CHARACTERS WITHOUT CLAIM TO ANY PARTICULAR FONT, STYLE, SIZE, OR COLOR.
FOR EXTRACTS OF HOPS FOR MAKING BEER (U.S. CLS. 45, 46 AND 48).
MARIAM MAHMOUDI, EXAMINING ATTORNEY

SN 77-779,083. OREGON BREWING COMPANY, NEWPORT, OR. FILED 7-11-2009.

INDEPENDENT

THE MARK CONSISTS OF STANDARD CHARACTERS WITHOUT CLAIM TO ANY PARTICULAR FONT, STYLE, SIZE, OR COLOR.
FOR EXTRACTS OF HOPS FOR MAKING BEER (U.S. CLS. 45, 46 AND 48).
NAKIA HENRY, EXAMINING ATTORNEY

SN 77-796,478. PAN AMERICAN GRAIN MFG. CO., INC., GUAYNABO, PUERTO RICO, FILED 8-4-2009.

MANGA COOLER

THE MARK CONSISTS OF STANDARD CHARACTERS WITHOUT CLAIM TO ANY PARTICULAR FONT, STYLE, SIZE, OR COLOR.
NO CLAIM IS MADE TO THE EXCLUSIVE RIGHT TO USE "COOLER", APART FROM THE MARK AS SHOWN.
FOR FRUIT DRINKS; FRUIT JUICES (U.S. CLS. 45, 46 AND 48).
ADA HAN, EXAMINING ATTORNEY

CLASS 32—(Continued).

SN 77-800,678. A&L GROUP LIMITED, BRIARCLIFF MAN-
OR, NY. FILED 8-10-2009.

ESCAPE

THE MARK CONSISTS OF STANDARD CHARACTERS
WITHOUT CLAIM TO ANY PARTICULAR FONT, STYLE,
SIZE, OR COLOR.

FOR NON-ALCOHOLIC BEVERAGES, NAMELY, CAR-
BONATED BEVERAGES, ENERGY DRINKS, FRUIT
FLAVORED DRINKS AND NON-CARBONATED SOFT
DRINKS (U.S. CLS. 45, 46 AND 48).

ALLISON HOLTZ, EXAMINING ATTORNEY

SN 77-815,236. WESTBRAE NATURAL, INC., MELVILLE,
NY. FILED 8-28-2009.

TASTE THE DREAM

THE MARK CONSISTS OF STANDARD CHARACTERS
WITHOUT CLAIM TO ANY PARTICULAR FONT, STYLE,
SIZE, OR COLOR.

FOR SMOOTHIES; AND SOY AND FRUIT JUICE
BEVERAGES NOT BEING A MILK SUBSTITUTE (U.S.
CLS. 45, 46 AND 48).

PAUL E. FAHRENKOPF, EXAMINING ATTORNEY

SN 77-822,224. KING ESTATE WINERY LIMITED PART-
NERSHIP, EUGENE, OR. FILED 9-8-2009.

PINOT ENVY

THE MARK CONSISTS OF STANDARD CHARACTERS
WITHOUT CLAIM TO ANY PARTICULAR FONT, STYLE,
SIZE, OR COLOR.

OWNER OF U.S. REG. NO. 2,528,604.
FOR BEER (U.S. CLS. 45, 46 AND 48).
BRIAN PINO, EXAMINING ATTORNEY

CLASS 32—(Continued).

SN 77-834,449. LEINER, MELVIN, POMPANO BEACH, FL.
AND MARKS, DARREN, POMPANO BEACH, FL. FILED
9-24-2009.



OWNER OF U.S. REG. NOS. 3,363,635, 3,363,679 AND
3,614,326.

NO CLAIM IS MADE TO THE EXCLUSIVE RIGHT TO
USE "ENERGY DRINK", APART FROM THE MARK AS
SHOWN.

THE MARK CONSISTS OF STYLIZED LETTERS "DNA"
IN BLACK OUTLINE WITH WHITE INTERIOR. BELOW
THE STYLIZED LETTERS "DNA" APPEAR THE WORDS
"ENERGY DRINK". ABOVE THE STYLIZED LETTERS
"DNA" THERE APPEARS A FIVE PRONG STAR. WITHIN
THE STAR APPEARS A SKULL AND A "DNA" HELIX,
WHICH APPEARS AS COVERING AT THE BACK OF THE
SKULL.

FOR ENERGY DRINKS, NAMELY, THOSE EN-
HANCED WITH MINERALS, NUTRIENTS, VITAMINS,
AMINO ACIDS, HERBS AND/OR AERATED WATER
(U.S. CLS. 45, 46 AND 48).

FIRST USE 11-18-2009; IN COMMERCE 11-18-2009.
NAPOLEON SHARMA, EXAMINING ATTORNEY

SN 77-840,365. DELMARK BREWING COMPANY, LLC,
DELMAR, DE. FILED 10-2-2009.

**JACQUES AU LANTERNE
FARMHOUSE ALE**

THE MARK CONSISTS OF STANDARD CHARACTERS
WITHOUT CLAIM TO ANY PARTICULAR FONT, STYLE,
SIZE, OR COLOR.

NO CLAIM IS MADE TO THE EXCLUSIVE RIGHT TO
USE "FARMHOUSE ALE", APART FROM THE MARK AS
SHOWN.

THE NAME(S), PORTRAIT(S), AND/OR SIGNATURE(S)
SHOWN IN THE MARK DOES NOT IDENTIFY A PARTI-
CULAR LIVING INDIVIDUAL.

THE ENGLISH TRANSLATION OF "JACQUES AU LAN-
TERNE" IN THE MARK IS "JACK O'LANTERN."
FOR BEER (U.S. CLS. 45, 46 AND 48).

ANNE E. GUSTASON, EXAMINING ATTORNEY

CLASS 32—(Continued).

SN 77-842,245. JEFF GREAVES, NEW YORK, NY. FILED 10-6-2009.

URBAN FUEL

THE MARK CONSISTS OF STANDARD CHARACTERS WITHOUT CLAIM TO ANY PARTICULAR FONT, STYLE, SIZE, OR COLOR.

FOR POWDERS USED IN THE PREPARATION OF FRUIT-BASED BEVERAGES, FRUIT BEVERAGES, FRUIT CONCENTRATES USED AS INGREDIENTS OF BEVERAGES, FRUIT-BASED BEVERAGES, NON-ALCOHOLIC FRUIT JUICE BEVERAGES, SOFT DRINKS, FRUIT FLAVORED SOFT DRINKS, INSTANT AND READY-TO-DRINK WHEY BEVERAGES MADE WITH WHEY PROTEIN ISOLATE (U.S. CLS. 45, 46 AND 48).

FIRST USE 6-7-2006; IN COMMERCE 6-7-2006.
ANNE E. GUSTASON, EXAMINING ATTORNEY

SN 77-850,171. MILLERCOORS LLC, WILMINGTON, DE. FILED 10-16-2009.

COLORADO NATIVE

THE MARK CONSISTS OF STANDARD CHARACTERS WITHOUT CLAIM TO ANY PARTICULAR FONT, STYLE, SIZE, OR COLOR.

NO CLAIM IS MADE TO THE EXCLUSIVE RIGHT TO USE "COLORADO", APART FROM THE MARK AS SHOWN.

FOR BEER (U.S. CLS. 45, 46 AND 48).
FIRST USE 3-28-2010; IN COMMERCE 3-28-2010.
SAMUEL E. SHARPER JR., EXAMINING ATTORNEY

SN 77-869,625. WIS-PAK CENTRAL, INC., WATERTOWN, WI. FILED 11-10-2009.

PIGGLEBERRY PUNCH

THE MARK CONSISTS OF STANDARD CHARACTERS WITHOUT CLAIM TO ANY PARTICULAR FONT, STYLE, SIZE, OR COLOR.

NO CLAIM IS MADE TO THE EXCLUSIVE RIGHT TO USE "PUNCH", APART FROM THE MARK AS SHOWN.

FOR FRUIT DRINKS (U.S. CLS. 45, 46 AND 48).
FIRST USE 8-31-2006; IN COMMERCE 8-31-2006.
KRISTINA MORRIS, EXAMINING ATTORNEY

CLASS 32—(Continued).

SN 77-870,084. WIS-PAK CENTRAL, INC., WATERTOWN, WI. FILED 11-11-2009.

SQUEALIN' BLUE RASPBERRY

THE MARK CONSISTS OF STANDARD CHARACTERS WITHOUT CLAIM TO ANY PARTICULAR FONT, STYLE, SIZE, OR COLOR.

NO CLAIM IS MADE TO THE EXCLUSIVE RIGHT TO USE "BLUE RASPBERRY", APART FROM THE MARK AS SHOWN.

FOR FRUIT DRINKS (U.S. CLS. 45, 46 AND 48).
FIRST USE 8-31-2006; IN COMMERCE 8-31-2006.
KRISTINA MORRIS, EXAMINING ATTORNEY

SN 77-871,010. WIS-PAK CENTRAL, INC., WATERTOWN, WI. FILED 11-12-2009.

GRUNTIN' GRAPE

THE MARK CONSISTS OF STANDARD CHARACTERS WITHOUT CLAIM TO ANY PARTICULAR FONT, STYLE, SIZE, OR COLOR.

NO CLAIM IS MADE TO THE EXCLUSIVE RIGHT TO USE "GRAPE", APART FROM THE MARK AS SHOWN.

FOR FRUIT DRINKS (U.S. CLS. 45, 46 AND 48).
FIRST USE 8-31-2006; IN COMMERCE 8-31-2006.
KRISTINA MORRIS, EXAMINING ATTORNEY

SN 77-878,189. WIS-PAK CENTRAL, INC., WATERTOWN, WI. FILED 11-21-2009.

OINKIN' ORANGE

THE MARK CONSISTS OF STANDARD CHARACTERS WITHOUT CLAIM TO ANY PARTICULAR FONT, STYLE, SIZE, OR COLOR.

NO CLAIM IS MADE TO THE EXCLUSIVE RIGHT TO USE "ORANGE", APART FROM THE MARK AS SHOWN.

FOR FRUIT DRINKS (U.S. CLS. 45, 46 AND 48).
FIRST USE 8-31-2006; IN COMMERCE 8-31-2006.
KRISTINA MORRIS, EXAMINING ATTORNEY

CLASS 32—(Continued).

SN 77-878,634. WIS-PAK CENTRAL, INC., WATERTOWN, WI. FILED 11-23-2009.

SWINE-SATIONAL LIME

THE MARK CONSISTS OF STANDARD CHARACTERS WITHOUT CLAIM TO ANY PARTICULAR FONT, STYLE, SIZE, OR COLOR.

NO CLAIM IS MADE TO THE EXCLUSIVE RIGHT TO USE "LIME", APART FROM THE MARK AS SHOWN. FOR FRUIT DRINKS (U.S. CLS. 45, 46 AND 48). FIRST USE 8-31-2006; IN COMMERCE 8-31-2006. KRISTINA MORRIS, EXAMINING ATTORNEY

CLASS 32—(Continued).

SN 77-886,130. PEPSICO, INC., PURCHASE, NY. FILED 12-4-2009.



SN 77-879,885. SUPER BAKERY INC., PITTSBURGH, PA. FILED 11-24-2009.

BigEasyAde

THE MARK CONSISTS OF STANDARD CHARACTERS WITHOUT CLAIM TO ANY PARTICULAR FONT, STYLE, SIZE, OR COLOR.

FOR FRUIT DRINKS; SPORTS DRINKS (U.S. CLS. 45, 46 AND 48). JOHN WILKE, EXAMINING ATTORNEY

THE COLOR(S) YELLOW AND WHITE IS/ARE CLAIMED AS A FEATURE OF THE MARK.

THE MARK CONSISTS OF A WHITE PENCIL DESIGN SHOWN IN THREE PIECES, AND WITH A WHITE HORIZONTAL LINE TO THE LEFT OF THE PENCIL, BOTH INSIDE A WHITE CIRCULAR CHASING ARROW DESIGN ON A YELLOW CIRCULAR BACKGROUND WITH WHITE SHINE MARKS ACROSS THE TOP RIGHT CURVE. UNDERNEATH THE DESIGN IS A PARTIAL YELLOW SHADOW-LIKE REFLECTION.

FOR SOFT DRINKS (U.S. CLS. 45, 46 AND 48). JENNIFER DIXON, EXAMINING ATTORNEY

SN 77-883,033. UNTAPPED ENERGY, LLC, FRANKLIN LAKES, NJ. FILED 12-1-2009.

Unleash your untapped energy

THE MARK CONSISTS OF STANDARD CHARACTERS WITHOUT CLAIM TO ANY PARTICULAR FONT, STYLE, SIZE, OR COLOR.

FOR NON-ALCOHOLIC BEVERAGES, NAMELY ENERGY DRINKS AND HYPERTONIC DRINKS (U.S. CLS. 45, 46 AND 48).

FIRST USE 8-12-2009; IN COMMERCE 8-12-2009. ELI HELLMAN, EXAMINING ATTORNEY

SN 77-886,795. MODA LICENSING, INC., NEW YORK, NY. FILED 12-4-2009.

UGLY APPLE

THE MARK CONSISTS OF STANDARD CHARACTERS WITHOUT CLAIM TO ANY PARTICULAR FONT, STYLE, SIZE, OR COLOR.

NO CLAIM IS MADE TO THE EXCLUSIVE RIGHT TO USE "APPLE", APART FROM THE MARK AS SHOWN.

FOR APPLE JUICE BEVERAGES; BEER; CARBONATED WATERS; COLAS; ENERGY DRINKS; FRUIT DRINKS AND FRUIT JUICES; FRUIT FLAVORED DRINKS; FRUIT PUNCH; LAGERS; MALT BEER; NON-ALCOHOLIC FRUIT EXTRACTS USED IN THE PREPARATION OF BEVERAGES; NON-ALCOHOLIC FRUIT JUICE BEVERAGES; NON-ALCOHOLIZED WINES; SMOOTHIES; SOFT DRINKS; SWEET CIDER (U.S. CLS. 45, 46 AND 48).

LINDA MICKLEBURGH, EXAMINING ATTORNEY

CLASS 32—(Continued).

SN 77-887,521. KANEKA CORPORATION, KITA-KU, OSAKA, JAPAN, FILED 12-7-2009.

KANEKA QH

THE MARK CONSISTS OF STANDARD CHARACTERS WITHOUT CLAIM TO ANY PARTICULAR FONT, STYLE, SIZE, OR COLOR.

OWNER OF JAPAN REG. NO. 4840897, DATED 2-25-2005, EXPIRES 2-25-2015.

OWNER OF U.S. REG. NOS. 3,071,411, 3,451,010 AND 3,534,420.

NO CLAIM IS MADE TO THE EXCLUSIVE RIGHT TO USE "QH", APART FROM THE MARK AS SHOWN.

THE WORD "KANEKA" IS A COINED TERM AND HAS NO SPECIFIC MEANING OR TRANSLATION.

FOR SPORTS DRINKS; ENERGY DRINKS; FRUIT JUICES AND FRUIT DRINKS, VEGETABLE JUICES AND VEGETABLE DRINKS; SYRUPS, POWDERS, CONCENTRATES AND EFFERVESCENT TABLETS FOR MAKING FRUIT AND SOFT DRINKS AND BEVERAGES; MINERAL WATERS, AERATED WATERS, CARBONATED WATERS, FLAVORED WATERS AND OTHER NONALCOHOLIC BEVERAGES, NAMELY, PUNCHES, SOFT DRINKS, SMOOTHIES AND LEMONADES; TEA DRINKS, NAMELY, SOFT DRINKS FLAVORED WITH TEA (U.S. CLS. 45, 46 AND 48).

KELLEY WELLS, EXAMINING ATTORNEY

SN 77-888,926. PEPSICO, INC., PURCHASE, NY. FILED 12-8-2009.



THE COLOR(S) GREEN AND WHITE IS/ARE CLAIMED AS A FEATURE OF THE MARK.

THE MARK CONSISTS OF A TWO-LEAF DESIGN WITH A WHITE OUTLINE AND GREEN INTERIOR, INSIDE A WHITE CIRCULAR CHASING ARROW DESIGN ON A GREEN CIRCULAR BACKGROUND WITH WHITE SHINE MARKS ACROSS THE TOP RIGHT CURVE. UNDERNEATH THE DESIGN IS A PARTIAL GREEN SHADOW-LIKE REFLECTION.

FOR SOFT DRINKS (U.S. CLS. 45, 46 AND 48).
JENNIFER DIXON, EXAMINING ATTORNEY

CLASS 32—(Continued).

SN 77-901,194. RAMIREZ, DANIEL A, SULTAN, WA. FILED 12-27-2009.



NO CLAIM IS MADE TO THE EXCLUSIVE RIGHT TO USE "MICROBREW", APART FROM THE MARK AS SHOWN.

THE MARK CONSISTS OF TWO BLACK CONCENTRIC CIRCLES. AT THE TOP OF THE MARK IN BETWEEN THE TWO CIRCLES IS THE TERM "HAIKU", AND AT THE BOTTOM OF THE MARK BETWEEN THE TWO CIRCLES IS THE WORD "MICROBREW"; BOTH WORDS ARE IN BLUE. IN THE CENTER OF THE INSIDE CIRCLE IS A DESIGN OF A GOLD PALM TREE WITH GREEN LEAVES AND TWO BROWN COCONUTS.

FOR BEER, ALE, LAGER, STOUT AND PORTER (U.S. CLS. 45, 46 AND 48).

EMILY CARLSEN, EXAMINING ATTORNEY

SN 77-904,416. ROESCH, DEBRA M., PENDLETON, OR. FILED 1-4-2010.

WM. ROESCH BREWING CO.

THE MARK CONSISTS OF STANDARD CHARACTERS WITHOUT CLAIM TO ANY PARTICULAR FONT, STYLE, SIZE, OR COLOR.

NO CLAIM IS MADE TO THE EXCLUSIVE RIGHT TO USE "BREWING CO.", APART FROM THE MARK AS SHOWN.

"WM. ROESCH" DOES NOT IDENTIFY A LIVING INDIVIDUAL.

FOR BEER (U.S. CLS. 45, 46 AND 48).
NANCY CLARKE, EXAMINING ATTORNEY

CLASS 32—(Continued).

SN 77-911,489. FILLION, JOSEPH R., DBA PLYMOUTH BREWING COMPANY, PLYMOUTH, WI. FILED 1-13-2010.



NO CLAIM IS MADE TO THE EXCLUSIVE RIGHT TO USE "PLYMOUTH BREWING COMPANY", APART FROM THE MARK AS SHOWN.

THE COLOR(S) RED, GOLD, BLACK AND WHITE IS/ARE CLAIMED AS A FEATURE OF THE MARK.

THE MARK CONSISTS OF STYLIZED WHITE LETTERS "P B C", INTERTWINED, IN A RED CIRCLE WITH 2 GOLD BANDS AROUND THE CIRCUMFERENCE OF CIRCLE. THE CIRCLE IS SUPERIMPOSED OVER SEVERAL GOLD STALKS OF BARLEY GRAIN. BENEATH THE CIRCLE APPEARS THE WORDING "PLYMOUTH BREWING COMPANY" IN BLACK-OUTLINED, RED LETTERS.

FOR BEER (U.S. CLS. 45, 46 AND 48).
 MARTHA FROMM, EXAMINING ATTORNEY

CLASS 32—(Continued).

SN 77-920,382. MESTRENGTH, INC., CHAPEL HILL, NC. FILED 1-26-2010.

HYDRATION FOR A NEW GENERATION

THE MARK CONSISTS OF STANDARD CHARACTERS WITHOUT CLAIM TO ANY PARTICULAR FONT, STYLE, SIZE, OR COLOR.

NO CLAIM IS MADE TO THE EXCLUSIVE RIGHT TO USE "HYDRATION", APART FROM THE MARK AS SHOWN.

FOR POWDERS USED IN THE PREPARATION OF LIGHT BEVERAGES, NAMELY, POWDERS USED IN THE PREPARATION OF SPORTS DRINKS AND SPORTS BEVERAGES; SPORTS DRINKS; AND CONCENTRATES, SYRUPS OR POWDERS USED IN THE PREPARATION OF SPORTS DRINKS (U.S. CLS. 45, 46 AND 48).

FIRST USE 10-28-2009; IN COMMERCE 10-28-2009.
 LYDIA BELZER, EXAMINING ATTORNEY

SN 77-914,582. STUHRENBERG, CHARLES, MURPHYSBORO, IL. FILED 1-19-2010.

BIG MUDDY BREWING

THE MARK CONSISTS OF STANDARD CHARACTERS WITHOUT CLAIM TO ANY PARTICULAR FONT, STYLE, SIZE, OR COLOR.

NO CLAIM IS MADE TO THE EXCLUSIVE RIGHT TO USE "BREWING", APART FROM THE MARK AS SHOWN.

FOR BEER (U.S. CLS. 45, 46 AND 48).
 FIRST USE 6-1-2009; IN COMMERCE 8-1-2009.
 MATTHEW PAPPAS, EXAMINING ATTORNEY

SN 77-923,253. ORCHID ISLAND JUICE COMPANY, FORT PIERCE, FL. FILED 1-29-2010.

NATALIE'S

THE MARK CONSISTS OF STANDARD CHARACTERS WITHOUT CLAIM TO ANY PARTICULAR FONT, STYLE, SIZE, OR COLOR.

OWNER OF U.S. REG. NOS. 1,753,370 AND 2,288,467.
 THE NAME(S), PORTRAIT(S), AND/OR SIGNATURE(S) SHOWN IN THE MARK DOES NOT IDENTIFY A PARTICULAR LIVING INDIVIDUAL.

FOR FRUIT DRINKS; FRUIT JUICES; LEMONADE (U.S. CLS. 45, 46 AND 48).
 FIRST USE 0-0-1989; IN COMMERCE 0-0-1989.
 HEATHER THOMPSON, EXAMINING ATTORNEY

CLASS 32—(Continued).

SN 77-925,138. FIRST QUALITY WATER & BEVERAGE, LLC, GREAT NECK, NY. FILED 2-1-2010.



NO CLAIM IS MADE TO THE EXCLUSIVE RIGHT TO USE "ECO FRIENDLY MANUFACTURING PROCESS", APART FROM THE MARK AS SHOWN.

THE MARK CONSISTS OF A CIRCLE WITH THE WORDS "ECO FRIENDLY MANUFACTURING PROCESS" IN THE CIRCLE AND THREE ARROWS WITH A DESIGN OF A LEAF IN THE MIDDLE.

FOR BOTTLED WATER (U.S. CLS. 45, 46 AND 48).
TARAH HARDY, EXAMINING ATTORNEY

SN 77-925,781. SPAN AMERICAN INC., COMMACK, NY. FILED 2-2-2010.

LA CHUPACABRA

THE MARK CONSISTS OF STANDARD CHARACTERS WITHOUT CLAIM TO ANY PARTICULAR FONT, STYLE, SIZE, OR COLOR.

THE ENGLISH TRANSLATION OF THE WORD "CHUPACABRA" IN THE MARK IS "GOAT SUCKER."
FOR ENERGY DRINKS (U.S. CLS. 45, 46 AND 48).
KIM MONINGHOFF, EXAMINING ATTORNEY

CLASS 32—(Continued).

SN 77-925,797. SUMMERLAND ESTATE GMBH, ZUG, SWITZERLAND, FILED 2-2-2010.

WAZZAR

THE MARK CONSISTS OF STANDARD CHARACTERS WITHOUT CLAIM TO ANY PARTICULAR FONT, STYLE, SIZE, OR COLOR.

THE WORDING "WAZZAR" HAS NO MEANING IN A FOREIGN LANGUAGE.

FOR NON-ALCOHOLIC, ISOTONIC BEVERAGES CONTAINING COCONUT JUICE, FRUIT JUICES, NATURAL FLAVORS AND PURIFIED WATER; ENERGY DRINKS CONTAINING COCONUT JUICE, FRUIT JUICES, NATURAL FLAVORS AND PURIFIED WATER; SOFT DRINKS CONTAINING COCONUT JUICE, FRUIT JUICES, NATURAL FLAVORS AND PURIFIED WATER THAT ARE AERATED BY FERMENTATION AND/OR CARBONATION (U.S. CLS. 45, 46 AND 48).
CARRIE GENOVESE, EXAMINING ATTORNEY

SN 77-925,953. KALPAN DOSHI, JERSEY CITY, NJ. FILED 2-2-2010.

CONFIDENCE

THE MARK CONSISTS OF STANDARD CHARACTERS WITHOUT CLAIM TO ANY PARTICULAR FONT, STYLE, SIZE, OR COLOR.

FOR BEER (U.S. CLS. 45, 46 AND 48).
BERYL GARDNER, EXAMINING ATTORNEY

SN 77-927,184. BLACK DIAMOND BREWING COMPANY, INC., CONCORD, CA. FILED 2-3-2010.

STEEP
TRAIL
AMBER
ALE

OWNER OF U.S. REG. NO. 3,773,221.

NO CLAIM IS MADE TO THE EXCLUSIVE RIGHT TO USE "AMBER ALE", APART FROM THE MARK AS SHOWN.

THE MARK CONSISTS OF THE WORD "STEEP" IN BLOCK LETTERING AND THE STYLIZED WORD "TRAIL" LAYERED AT AN ANGLE PARTIALLY UNDERNEATH THE WORD "STEEP", AND THE WORDS "AMBER ALE" IN SMALLER BLOCK LETTERS TO THE BOTTOM RIGHT OF "STEEP TRAIL".

FOR BEER, ALE AND LAGER (U.S. CLS. 45, 46 AND 48).
FIRST USE 4-13-2009; IN COMMERCE 4-13-2009.
AARON BRODSKY, EXAMINING ATTORNEY

CLASS 32—(Continued).

SN 77-927,417. SLOBODSKOY, LEONID, AKA REAL ENTERPRISES, DEERFIELD, IL. FILED 2-3-2010.



NO CLAIM IS MADE TO THE EXCLUSIVE RIGHT TO USE "WATER", APART FROM THE MARK AS SHOWN.
 THE MARK CONSISTS OF A FIVE-POINT CROWN DESIGN FORMED BY STYLIZED LEAVES AND THE LETTERS "WHW", ALL INSIDE A CIRCLE WHICH IS INSIDE A SQUARE. BETWEEN THE SQUARE AND THE CIRCLE ARE THE WORDS "WELKIN HEAL WATER".
 FOR BOTTLED DRINKING WATER; DRINKING WATER WITH VITAMINS (U.S. CLS. 45, 46 AND 48).
 IRA J. GOODSaid, EXAMINING ATTORNEY

CLASS 32—(Continued).

SN 77-927,966. BLACK DIAMOND BREWING COMPANY, INC., CONCORD, CA. FILED 2-4-2010.



OWNER OF U.S. REG. NO. 3,773,220.
 NO CLAIM IS MADE TO THE EXCLUSIVE RIGHT TO USE "IPA", APART FROM THE MARK AS SHOWN.
 THE MARK CONSISTS OF THE WORD "JAGGED" IN A BROKEN, JAGGED FORMAT, AND THE WORD "EDGE" IN BLOCK LETTERS PARTIALLY COVERING THE BOTTOM PORTION OF THE WORD "JAGGED" AND THE INITIALS "IPA" IN A BLOCK VERTICAL FORMAT TO THE IMMEDIATE RIGHT OF THE WORD "EDGE".
 FOR BEER, ALE AND LAGER (U.S. CLS. 45, 46 AND 48).
 FIRST USE 4-13-2009; IN COMMERCE 4-13-2009.
 AARON BRODSKY, EXAMINING ATTORNEY

SN 77-927,505. NOBLE BREWING CO., LLC, BEND, OR. FILED 2-3-2010.



NO CLAIM IS MADE TO THE EXCLUSIVE RIGHT TO USE "BREWING COMPANY", "HAND CRAFTED", AND "BEND OR", APART FROM THE MARK AS SHOWN.
 THE MARK CONSISTS OF A CIRCLE OR SEAL WITH THE WORDS "NOBLE BREWING COMPANY" WRITTEN AROUND THE CIRCLE. IN THE CENTER OF THE CIRCLE IS A DRAWING OF A MOUNTAIN CLIMBER IN FRONT OF A MOUNTAIN. ABOVE THE MOUNTAIN ARE THE WORDS "HAND CRAFTED" IN STYLIZED FONT AND AT THE BOTTOM OF THE DRAWING ARE THE WORDS "BEND OR" IN STYLIZED FONT.
 FOR BEER (U.S. CLS. 45, 46 AND 48).
 FIRST USE 5-0-2009; IN COMMERCE 5-0-2009.
 JASON BLAIR, EXAMINING ATTORNEY

SN 77-928,348. ADVANCED WATER, LLC, UPPER GRANDVIEW, NY. FILED 2-4-2010.

ADVANCED JUICE

THE MARK CONSISTS OF STANDARD CHARACTERS WITHOUT CLAIM TO ANY PARTICULAR FONT, STYLE, SIZE, OR COLOR.
 OWNER OF U.S. REG. NO. 3,583,694.
 NO CLAIM IS MADE TO THE EXCLUSIVE RIGHT TO USE "JUICE", APART FROM THE MARK AS SHOWN.
 FOR NON-ALCOHOLIC BEVERAGES CONTAINING FRUIT JUICES; FRUIT DRINKS; FRUIT JUICE; VEGETABLE JUICE; CONCENTRATED FRUIT JUICE; FRUIT-FLAVORED SOFT DRINKS; AND FRUIT DRINKS CONTAINING WATER (U.S. CLS. 45, 46 AND 48).
 ODESSA BIBBINS, EXAMINING ATTORNEY

CLASS 32—(Continued).

SN 77-928,469. NATURAL SWEETENERS LLC, SAN DIEGO, CA. FILED 2-4-2010.



THE COLOR(S) GREEN AND ORANGE IS/ARE CLAIMED AS A FEATURE OF THE MARK.

THE MARK CONSISTS OF A STYLIZED AGAVE PLANT WITH "LEAVES" IN DIFFERING GRADIENTS OF GREEN, AN ORANGE-COLORED "TEARDROP" SHAPE IN THE CENTER, AND THE WORD "NECTAVE" (PRONOUNCED NEK-TAH-VAY) IN GREEN WITH A LEAF-SHAPED AC-CENT OVER THE LETTER "E".

FOR AGAVE NECTAR (U.S. CLS. 45, 46 AND 48).
ELI HELLMAN, EXAMINING ATTORNEY

CLASS 32—(Continued).

SN 77-930,077. INCOMMAND LLC, MIDDLETOWN, OH. FILED 2-8-2010.



OWNER OF U.S. REG. NO. 2,892,961.
THE MARK CONSISTS OF STYLIZED FONT OF THE WORD, "MOERLEIN".
THE WORDING "MOERLEIN" HAS NO MEANING IN A FOREIGN LANGUAGE.
FOR ALCOHOLIC MALT BEVERAGES, NAMELY, BEER (U.S. CLS. 45, 46 AND 48).
FIRST USE 4-30-2007; IN COMMERCE 4-30-2007.
ELISSA GARBER KON, EXAMINING ATTORNEY

SN 77-930,168. LEWIS, SHARON CARPENTER, EASTON, MD. FILED 2-8-2010.

Chick Beer

THE MARK CONSISTS OF STANDARD CHARACTERS WITHOUT CLAIM TO ANY PARTICULAR FONT, STYLE, SIZE, OR COLOR.

NO CLAIM IS MADE TO THE EXCLUSIVE RIGHT TO USE "BEER", APART FROM THE MARK AS SHOWN.

FOR BEER (U.S. CLS. 45, 46 AND 48).
ARETHA SOMERVILLE, EXAMINING ATTORNEY

SN 77-928,952. DOLE FOOD COMPANY, INC., WESTLAKE VILLAGE, CA. FILED 2-5-2010.

DOLE PLUS

THE MARK CONSISTS OF STANDARD CHARACTERS WITHOUT CLAIM TO ANY PARTICULAR FONT, STYLE, SIZE, OR COLOR.

OWNER OF U.S. REG. NOS. 2,246,188, 3,020,982 AND OTHERS.

FOR FRUIT JUICES (U.S. CLS. 45, 46 AND 48).
FIRST USE 8-31-2007; IN COMMERCE 8-31-2007.
JUSTINE D. PARKER, EXAMINING ATTORNEY

SN 77-930,369. SIMON, PETER, OAKHURST, NJ. FILED 2-8-2010.

JEWICE SODA POP "WHAT DON'T I KNOW FROM SODA"

THE MARK CONSISTS OF STANDARD CHARACTERS WITHOUT CLAIM TO ANY PARTICULAR FONT, STYLE, SIZE, OR COLOR.

NO CLAIM IS MADE TO THE EXCLUSIVE RIGHT TO USE "SODA POP", APART FROM THE MARK AS SHOWN.

FOR SOFT DRINKS, NAMELY, ALL NATURAL BREWED SODA THAT CONSISTS OF ORGANIC SUGAR, ORGANIC EXTRACTS, FILTERED WATER, REAL FRUIT JUICES AND NATURAL CARBONATION THROUGH YEAST (U.S. CLS. 45, 46 AND 48).

CHRISTINE MARTIN, EXAMINING ATTORNEY

CLASS 32—(Continued).

SN 77-930,847. BEAR REPUBLIC BREWING CO., INC., CLOVERDALE, CA. FILED 2-8-2010.

BEAR REPUBLIC

THE MARK CONSISTS OF STANDARD CHARACTERS WITHOUT CLAIM TO ANY PARTICULAR FONT, STYLE, SIZE, OR COLOR.

OWNER OF U.S. REG. NO. 2,923,042.
FOR ALES; BEER (U.S. CLS. 45, 46 AND 48).
FIRST USE 4-26-1995; IN COMMERCE 1-24-1996.
INGRID C. EULIN, EXAMINING ATTORNEY

SN 77-930,858. BEAR REPUBLIC BREWING CO., INC., CLOVERDALE, CA. FILED 2-8-2010.

RED ROCKET ALE

THE MARK CONSISTS OF STANDARD CHARACTERS WITHOUT CLAIM TO ANY PARTICULAR FONT, STYLE, SIZE, OR COLOR.

OWNER OF U.S. REG. NO. 2,923,042.
NO CLAIM IS MADE TO THE EXCLUSIVE RIGHT TO USE "ALE", APART FROM THE MARK AS SHOWN.
FOR ALES; BEER (U.S. CLS. 45, 46 AND 48).
FIRST USE 10-0-1994; IN COMMERCE 3-20-1996.
INGRID C. EULIN, EXAMINING ATTORNEY

SN 77-930,863. BEAR REPUBLIC BREWING CO., INC., CLOVERDALE, CA. FILED 2-8-2010.

RACER 5

THE MARK CONSISTS OF STANDARD CHARACTERS WITHOUT CLAIM TO ANY PARTICULAR FONT, STYLE, SIZE, OR COLOR.

OWNER OF U.S. REG. NO. 2,920,887.
FOR ALES; BEER (U.S. CLS. 45, 46 AND 48).
FIRST USE 11-30-1998; IN COMMERCE 11-30-1998.
INGRID C. EULIN, EXAMINING ATTORNEY

CLASS 32—(Continued).

SN 77-931,146. FRANSEE, DANIEL E, DBA BUNKHOUSE BREWERY, WEST BRANCH, MI. FILED 2-9-2010.



NO CLAIM IS MADE TO THE EXCLUSIVE RIGHT TO USE "BREW", APART FROM THE MARK AS SHOWN.

THE MARK CONSISTS OF A DESIGN OF A DEER SKULL ON A SHADED RECTANGULAR BACKGROUND WITH DESIGNS OF WHEAT OR GRAIN IN THE UPPER CORNERS AND DESIGNS OF DIAMONDS IN THE LOWER CORNERS. THE WORDING "BUCKSNORT BREW" APPEARS AROUND THE SKULL DESIGN.

FOR BEER; BEER, ALE AND LAGER; BEER, ALE AND PORTER; BEER, ALE, LAGER, STOUT AND PORTER; BEER, ALE, LAGER, STOUT, PORTER, SHANDY; BLACK BEER; FLAVORED BEERS; MALT BEER; PALE BEER (U.S. CLS. 45, 46 AND 48).

ZHALEH DELANEY, EXAMINING ATTORNEY

SN 77-934,859. WORLD TRIATHLON CORPORATION, TAMPA, FL. FILED 2-12-2010.

IRONMAN TRIATHLON

THE MARK CONSISTS OF STANDARD CHARACTERS WITHOUT CLAIM TO ANY PARTICULAR FONT, STYLE, SIZE, OR COLOR.

OWNER OF U.S. REG. NOS. 1,258,881, 2,869,852 AND OTHERS.

FOR SPORTS DRINKS, NAMELY, FLAVORED NON-CARBONATED ISOTONIC, HYPERTONIC AND HYPOTONIC BEVERAGES MARKETED IN ASSOCIATION WITH CONTESTS CONSISTING OF SWIMMING, BIKING AND RUNNING (U.S. CLS. 45, 46 AND 48).

JUDITH HELFMAN, EXAMINING ATTORNEY

CLASS 32—(Continued).

SN 77-934,873. WORLD TRIATHLON CORPORATION, TAMPA, FL. FILED 2-12-2010.

IRONMAN TRIATHLON

THE MARK CONSISTS OF STANDARD CHARACTERS WITHOUT CLAIM TO ANY PARTICULAR FONT, STYLE, SIZE, OR COLOR.

OWNER OF U.S. REG. NOS. 1,258,881, 2,869,852 AND OTHERS.

FOR DRINKING WATER WITH VITAMINS, STILL WATER, SPRING WATER, MINERAL WATER, FLAVORED WATERS, PROCESSED DRINKING WATER, SPARKLING WATER, AND ALL OF THE FOREGOING GOODS ARE MARKETED IN ASSOCIATION WITH CONTESTS CONSISTING OF SWIMMING, BIKING AND RUNNING (U.S. CLS. 45, 46 AND 48).

JUDITH HELFMAN, EXAMINING ATTORNEY

CLASS 32—(Continued).

SN 77-934,925. WORLD TRIATHLON CORPORATION, TAMPA, FL. FILED 2-12-2010.

IRONMAN

THE MARK CONSISTS OF STANDARD CHARACTERS WITHOUT CLAIM TO ANY PARTICULAR FONT, STYLE, SIZE, OR COLOR.

OWNER OF U.S. REG. NOS. 1,258,881, 2,869,852 AND OTHERS.

FOR SPORTS DRINKS, NAMELY, FLAVORED NON-CARBONATED ISOTONIC, HYPERTONIC AND HYPOTONIC BEVERAGES, WHICH ARE MARKETED IN ASSOCIATION WITH CONTESTS CONSISTING OF SWIMMING, BIKING AND RUNNING (U.S. CLS. 45, 46 AND 48).

JUDITH HELFMAN, EXAMINING ATTORNEY

SN 77-934,892. WORLD TRIATHLON CORPORATION, TAMPA, FL. FILED 2-12-2010.

IRONMAN TRIATHLON

THE MARK CONSISTS OF STANDARD CHARACTERS WITHOUT CLAIM TO ANY PARTICULAR FONT, STYLE, SIZE, OR COLOR.

OWNER OF U.S. REG. NOS. 1,258,881, 2,869,852 AND OTHERS.

FOR WATER-BASED BEVERAGES WITH TEA EXTRACTS AND NON-ALCOHOLIC FRUIT-FLAVORED BEVERAGES, AND ALL OF THE FOREGOING GOODS ARE MARKETED IN ASSOCIATION WITH CONTESTS CONSISTING OF SWIMMING, BIKING AND RUNNING (U.S. CLS. 45, 46 AND 48).

JUDITH HELFMAN, EXAMINING ATTORNEY

SN 77-934,926. WORLD TRIATHLON CORPORATION, TAMPA, FL. FILED 2-12-2010.

IRONMAN TRIATHLON

THE MARK CONSISTS OF STANDARD CHARACTERS WITHOUT CLAIM TO ANY PARTICULAR FONT, STYLE, SIZE, OR COLOR.

OWNER OF U.S. REG. NOS. 1,258,881, 2,869,852 AND OTHERS.

FOR PROTEIN AND CARBOHYDRATE DRINKS FOR USE AS FOOD FILLERS AND NOT FOR USE AS MEAL REPLACEMENTS, WHICH ARE MARKETED IN ASSOCIATION WITH CONTESTS CONSISTING OF SWIMMING, BIKING AND RUNNING (U.S. CLS. 45, 46 AND 48).

JUDITH HELFMAN, EXAMINING ATTORNEY

SN 77-934,910. WORLD TRIATHLON CORPORATION, TAMPA, FL. FILED 2-12-2010.

IRONMAN TRIATHLON

THE MARK CONSISTS OF STANDARD CHARACTERS WITHOUT CLAIM TO ANY PARTICULAR FONT, STYLE, SIZE, OR COLOR.

OWNER OF U.S. REG. NOS. 1,258,881, 2,869,852 AND OTHERS.

FOR FRUIT AND VEGETABLE JUICES; SOFT DRINKS; SYRUPS, NON-ALCOHOLIC FRUIT EXTRACTS AND ESSENCES FOR MAKING NON-ALCOHOLIC, NON-CARBONATED AND CARBONATED SOFT DRINKS, AND ALL OF THE FOREGOING GOODS ARE MARKETED IN ASSOCIATION WITH CONTESTS CONSISTING OF SWIMMING, BIKING AND RUNNING (U.S. CLS. 45, 46 AND 48).

JUDITH HELFMAN, EXAMINING ATTORNEY

SN 77-934,933. WORLD TRIATHLON CORPORATION, TAMPA, FL. FILED 2-12-2010.

IRONMAN

THE MARK CONSISTS OF STANDARD CHARACTERS WITHOUT CLAIM TO ANY PARTICULAR FONT, STYLE, SIZE, OR COLOR.

OWNER OF U.S. REG. NOS. 1,258,881, 2,869,852 AND OTHERS.

FOR DRINKING WATER WITH VITAMINS, STILL WATER, SPRING WATER, MINERAL WATER, FLAVORED WATERS, PROCESSED DRINKING WATER, SPARKLING WATER, AND ALL OF THE FOREGOING GOODS ARE MARKETED IN ASSOCIATION WITH CONTESTS CONSISTING OF SWIMMING, BIKING AND RUNNING (U.S. CLS. 45, 46 AND 48).

JUDITH HELFMAN, EXAMINING ATTORNEY

CLASS 32—(Continued).

SN 77-934,936. WORLD TRIATHLON CORPORATION, TAMPA, FL. FILED 2-12-2010.

IRONMAN TRIATHLON

THE MARK CONSISTS OF STANDARD CHARACTERS WITHOUT CLAIM TO ANY PARTICULAR FONT, STYLE, SIZE, OR COLOR.

OWNER OF U.S. REG. NOS. 1,258,881, 2,869,852 AND OTHERS.

FOR FRUIT JUICES AND ENERGY DRINKS CONTAINING NUTRITIONAL SUPPLEMENTS, WHICH ARE MARKETED IN ASSOCIATION WITH CONTESTS CONSISTING OF SWIMMING, BIKING AND RUNNING (U.S. CLS. 45, 46 AND 48).

JUDITH HELFMAN, EXAMINING ATTORNEY

SN 77-934,940. WORLD TRIATHLON CORPORATION, TAMPA, FL. FILED 2-12-2010.

IRONMAN

THE MARK CONSISTS OF STANDARD CHARACTERS WITHOUT CLAIM TO ANY PARTICULAR FONT, STYLE, SIZE, OR COLOR.

OWNER OF U.S. REG. NOS. 1,258,881, 2,869,852 AND OTHERS.

FOR WATER-BASED BEVERAGES WITH TEA EXTRACTS AND NON-ALCOHOLIC FRUIT-FLAVORED BEVERAGES, AND ALL OF THE FOREGOING GOODS ARE MARKETED IN ASSOCIATION WITH CONTESTS CONSISTING OF SWIMMING, BIKING AND RUNNING (U.S. CLS. 45, 46 AND 48).

JUDITH HELFMAN, EXAMINING ATTORNEY

SN 77-934,948. WORLD TRIATHLON CORPORATION, TAMPA, FL. FILED 2-12-2010.

IRONMAN

THE MARK CONSISTS OF STANDARD CHARACTERS WITHOUT CLAIM TO ANY PARTICULAR FONT, STYLE, SIZE, OR COLOR.

OWNER OF U.S. REG. NOS. 1,258,881, 2,869,852 AND OTHERS.

FOR FRUIT AND VEGETABLE JUICES; SOFT DRINKS; SYRUPS; NON-ALCOHOLIC FRUIT EXTRACTS AND ESSENCES FOR MAKING NON-ALCOHOLIC, NON-CARBONATED AND CARBONATED SOFT DRINKS, AND ALL OF THE FOREGOING GOODS ARE MARKETED IN ASSOCIATION WITH CONTESTS CONSISTING OF SWIMMING, BIKING AND RUNNING (U.S. CLS. 45, 46 AND 48).

JUDITH HELFMAN, EXAMINING ATTORNEY

CLASS 32—(Continued).

SN 77-934,951. WORLD TRIATHLON CORPORATION, TAMPA, FL. FILED 2-12-2010.

IRONMAN

THE MARK CONSISTS OF STANDARD CHARACTERS WITHOUT CLAIM TO ANY PARTICULAR FONT, STYLE, SIZE, OR COLOR.

OWNER OF U.S. REG. NOS. 1,258,881, 2,869,852 AND OTHERS.

FOR PROTEIN AND CARBOHYDRATE DRINKS FOR USE AS FOOD FILLERS AND NOT FOR USE AS MEAL REPLACEMENTS, WHICH ARE MARKETED IN ASSOCIATION WITH CONTESTS CONSISTING OF SWIMMING, BIKING AND RUNNING (U.S. CLS. 45, 46 AND 48).

JUDITH HELFMAN, EXAMINING ATTORNEY

SN 77-934,956. WORLD TRIATHLON CORPORATION, TAMPA, FL. FILED 2-12-2010.

IRONMAN

THE MARK CONSISTS OF STANDARD CHARACTERS WITHOUT CLAIM TO ANY PARTICULAR FONT, STYLE, SIZE, OR COLOR.

OWNER OF U.S. REG. NOS. 1,258,881, 2,869,852 AND OTHERS.

FOR FRUIT JUICES AND ENERGY DRINKS CONTAINING NUTRITIONAL SUPPLEMENTS, WHICH ARE MARKETED IN ASSOCIATION WITH CONTESTS CONSISTING OF SWIMMING, BIKING AND RUNNING (U.S. CLS. 45, 46 AND 48).

JUDITH HELFMAN, EXAMINING ATTORNEY

SN 77-943,010. SKECHERS U.S.A., INC. II, MANHATTAN BEACH, CA. FILED 2-23-2010.

JOIN THE RESISTANCE

THE MARK CONSISTS OF STANDARD CHARACTERS WITHOUT CLAIM TO ANY PARTICULAR FONT, STYLE, SIZE, OR COLOR.

FOR BOTTLED WATER (U.S. CLS. 45, 46 AND 48).

INGA ERVIN, EXAMINING ATTORNEY

CLASS 32—(Continued).

SN 77-950,651. SIMON, PETER, OAKHURST, NJ. FILED 3-4-2010.

SIMON SAYS "DRINK THIS"

THE MARK CONSISTS OF STANDARD CHARACTERS WITHOUT CLAIM TO ANY PARTICULAR FONT, STYLE, SIZE, OR COLOR.

FOR SOFT DRINKS, NAMELY, ALL NATURAL BREWED SODA THAT CONSISTS OF ORGANIC SUGAR, ORGANIC EXTRACTS, FILTERED WATER, REAL FRUIT JUICES AND NATURAL CARBONATION THROUGH YEAST (U.S. CLS. 45, 46 AND 48).

CHRISTINE MARTIN, EXAMINING ATTORNEY

SN 77-951,375. JASON SANTIAGO, PALM BEACH GARDENS, FL. FILED 3-5-2010.

CHEAP SHOTS

THE MARK CONSISTS OF STANDARD CHARACTERS WITHOUT CLAIM TO ANY PARTICULAR FONT, STYLE, SIZE, OR COLOR.

FOR ENERGY DRINKS (U.S. CLS. 45, 46 AND 48).

JOHN DALIER, EXAMINING ATTORNEY

SN 77-966,129. MUSIC ENTERTAINMENT, LLC, AKA TAOS MESA BREWING, TAOS, NM. FILED 3-23-2010.



NO CLAIM IS MADE TO THE EXCLUSIVE RIGHT TO USE "TAOS MESA BREWING NEW MEXICO", APART FROM THE MARK AS SHOWN.

THE MARK CONSISTS OF A METAL BRACKET IN THE FOREGROUND RIVETED IN SPACE BY FOUR SCREWS DISPLAYING THE NAME "TAOS MESA BREWING" (IN UPPER CASE LETTERS) WITH A SILHOUETTED RAVEN, WINGS UP, ALIGHTING ON TOP OF THE BRACKET AT ITS CENTER, OVER A SECOND LAYER CONSISTING OF TWO SETS OF INTERLOCKING GEARS, IN EACH SET ONE LARGE GEAR WITH INTERNAL SPOKES AND ONE SMALL GEAR SOLID IN ITS CENTER, BOTH SETS OF GEARS SYMMETRICALLY POSITIONED AT 45 DEGREE ANGLES BEHIND THE UPPER ENDS OF THE BRACKET, OVER A THIRD LAYER CONSISTING OF THE FRONTAL

CLASS 32—(Continued).

VIEW OF A LARGE CIRCULAR SPROCKET (DEPICTING THE SUN), WITHIN WHICH IS A SMALLER CONCENTRIC CIRCLE CONTAINING CLOUD-LIKE SWIRLS DEPICTING THE REFLECTIVE SURFACE OF A METAL RIVET, AND, AT BOTTOM, BETWEEN THE OUTER EDGE OF THE SMALLER CONCENTRIC CIRCLE OF THE RIVET AND THE INNER EDGE OF THE LARGE, ENCOMPASSING SPROCKET IS THE TERM "NEW MEXICO" (IN UPPER CASE LETTERS) THE WORDS SET IN A CURVE CONSISTENT WITH THE SHAPE OF THE SPROCKET.

FOR BEER; BEER, ALE, LAGER, STOUT, PORTER, SHANDY; BLACK BEER; BREWED MALT-BASED ALCOHOLIC BEVERAGE IN THE NATURE OF A BEER; COFFEE-FLAVORED BEER; DE-ALCOHOLISED BEER; EXTRACTS OF HOPS FOR MAKING BEER; FLAVORED BEERS; MALT BEER; MALT LIQUOR; PALE BEER; PORTER (U.S. CLS. 45, 46 AND 48).

HOWARD SMIGA, EXAMINING ATTORNEY

SN 78-290,051. GREEN MOUNTAIN COFFEE ROASTERS, INC., WATERBURY, VT. FILED 8-20-2003.

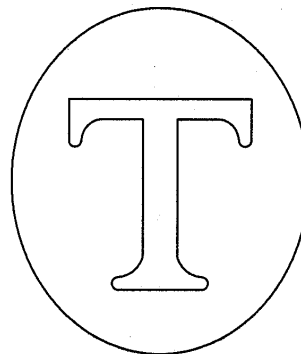

FOR FRUIT BEVERAGES; FRUIT-BASED BEVERAGES; BLENDED FRUIT BEVERAGES; FRUIT BEVERAGES WITH CREAM; FRUIT-BASED BEVERAGES WITH TEA; SOY BEVERAGES NOT BEING MILK SUBSTITUTES; FLAVORED SOY BEVERAGES NOT BEING MILK SUBSTITUTES; AND SOY-BASED BEVERAGES NOT BEING MILK SUBSTITUTES (U.S. CLS. 45, 46 AND 48).

FIRST USE 3-0-1999; IN COMMERCE 3-0-1999.

AMY C. KEAN, EXAMINING ATTORNEY

SN 78-682,753. KING TRIPLE EIGHT COMPANY LLC, SPARKS, NV. FILED 8-1-2005.



FOR NON-ALCOHOLIC BEVERAGES, NAMELY, CARBONATED FLAVORED BEVERAGES (U.S. CLS. 45, 46 AND 48).

FIRST USE 6-1-2006; IN COMMERCE 6-1-2006.

RENEE MCCRAY, EXAMINING ATTORNEY

CLASS 32—(Continued).

SN 78-798,920. AMERICAN HOLDINGS, INC., ATLANTA, GA. FILED 1-25-2006.

ICON

THE MARK CONSISTS OF STANDARD CHARACTERS WITHOUT CLAIM TO ANY PARTICULAR FONT, STYLE, SIZE, OR COLOR.

FOR NON ALCOHOLIC BEVERAGES, NAMELY, DRINKING WATER; SPRING WATER; NATURAL ARTESIAN WATER; SPARKLING WATER; FLAVORED WATER; FRUIT DRINKS; FRUIT FLAVORED DRINKS; FRUIT JUICES AND FRUIT BLENDED JUICES (U.S. CLS. 45, 46 AND 48).

CAROLYN CATALDO, EXAMINING ATTORNEY

CLASS 32—(Continued).

SN 85-025,636. ASPEN PURE, LLC, ASPEN, CO. FILED 4-28-2010.

ASPEN PURE

THE MARK CONSISTS OF STANDARD CHARACTERS WITHOUT CLAIM TO ANY PARTICULAR FONT, STYLE, SIZE, OR COLOR.

OWNER OF U.S. REG. NO. 2,958,731. SEC. 2(F). FOR PREMIUM BOTTLED WATER (U.S. CLS. 45, 46 AND 48).

FIRST USE 2-12-2003; IN COMMERCE 4-1-2003. CAROL SPILS, EXAMINING ATTORNEY

SN 79-076,608. HEINZ WEYERMANN; RÖSTMALZBIER-BRAUEREI BAMBERG GMBH, FED REP GERMANY, FILED 10-19-2009.

Schlottfegerla

THE MARK CONSISTS OF STANDARD CHARACTERS WITHOUT CLAIM TO ANY PARTICULAR FONT, STYLE, SIZE, OR COLOR.

PRIORITY DATE OF 6-5-2009 IS CLAIMED. OWNER OF INTERNATIONAL REGISTRATION 1022848 DATED 10-19-2009, EXPIRES 10-19-2019.

THE ENGLISH TRANSLATION OF "SCHLOTFEGERLA" IN THE MARK IS "CHIMNEY SWEEPER."

FOR ROASTED MALT BEER, MALT BEER, MALT WORT, BEER WORT, BEER, HOP AND MALT EXTRACTS FOR PRODUCING BEER (U.S. CLS. 45, 46 AND 48).

JAMES STEIN, EXAMINING ATTORNEY

CLASS 33—WINES AND SPIRITS

SN 77-115,620. HEATHER WILLENS, PACIFIC PALISADES, CA. FILED 2-25-2007.

4 Chicas

THE MARK CONSISTS OF STANDARD CHARACTERS WITHOUT CLAIM TO ANY PARTICULAR FONT, STYLE, SIZE, OR COLOR.

THE FOREIGN WORDING IN THE MARK TRANSLATES INTO ENGLISH AS GIRLS.

FOR WINE (U.S. CLS. 47 AND 49). JENNIFER VASQUEZ, EXAMINING ATTORNEY

SN 85-001,660. MAGIC HAT IP, LLC, BURLINGTON, VT. FILED 3-30-2010.

HEX

THE MARK CONSISTS OF STANDARD CHARACTERS WITHOUT CLAIM TO ANY PARTICULAR FONT, STYLE, SIZE, OR COLOR.

FOR BEER, ALE, LAGER, STOUT AND PORTER (U.S. CLS. 45, 46 AND 48).

KIMBERLY PERRY, EXAMINING ATTORNEY

SN 77-209,600. OAK HEDGE, LLC, CORONA DEL MAR, CA. FILED 6-19-2007.

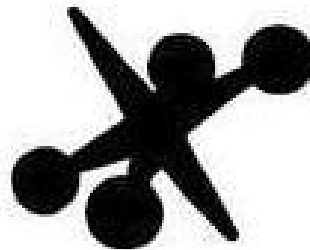

THE MARK CONSISTS OF AN IMAGE OF A SINGLE JACK, A SIX-POINTED OBJECT USED IN THE GAME OF JACKS.

FOR WINE (U.S. CLS. 47 AND 49). FIRST USE 6-5-2007; IN COMMERCE 6-5-2007. BARBARA RUTLAND, EXAMINING ATTORNEY

CLASS 33—(Continued).

SN 77-356,419. VIÑA CACHAGUA, SANTIAGO, CHILE,
FILED 12-19-2007.

TIARA

THE MARK CONSISTS OF STANDARD CHARACTERS
WITHOUT CLAIM TO ANY PARTICULAR FONT, STYLE,
SIZE, OR COLOR.

FOR WINES (U.S. CLS. 47 AND 49).
FIRST USE 10-1-2007; IN COMMERCE 10-1-2007.
INGA ERVIN, EXAMINING ATTORNEY

SN 77-477,606. SIMONE WAREHOUSE, LLC, OLD TAPPAN,
NJ. FILED 5-19-2008.

River Mist

THE MARK CONSISTS OF STANDARD CHARACTERS
WITHOUT CLAIM TO ANY PARTICULAR FONT, STYLE,
SIZE, OR COLOR.

OWNER OF U.S. REG. NO. 3,228,713.
FOR WINE COOLERS (U.S. CLS. 47 AND 49).
FIRST USE 12-1-2005; IN COMMERCE 12-1-2005.
SEAN CROWLEY, EXAMINING ATTORNEY

SN 77-552,085. DISTILLERIA F. LLI CAFFO S.R.L., LIMBADI
(VV), ITALY, FILED 8-20-2008.



NO CLAIM IS MADE TO THE EXCLUSIVE RIGHT TO
USE "LIQUEUR", APART FROM THE MARK AS SHOWN.

THE MARK COMPRISES THE WORDING "NTICE",
STYLIZED, WITH "LIQUEUR" UNDERNEATH AND BE-
LOW. A SUN WITH A MAN AND A WOMEN IN AN
EMBRACE WITH A WAVE UNDERNEATH THEM.

FOR ALCOHOLIC BEVERAGES, NAMELY, WINES,
SPARKLING WINES, LIQUEURS, AND PEAR AND
RASPBERRY BRANDY (U.S. CLS. 47 AND 49).

FIRST USE 8-10-2006; IN COMMERCE 8-10-2006.
NAAKWAMA ANKRAH, EXAMINING ATTORNEY

CLASS 33—(Continued).

SN 77-580,253. CONSORCIO COMERCIAL ZEPPELIN, S.A.
DE C.V., NAVOLATO, MEXICO, FILED 9-26-2008.

RUM OR

PRIORITY CLAIMED UNDER SEC. 44(D) ON MEXICO
APPLICATION NO. 936692, FILED 5-13-2008, REG. NO.
1126411, DATED 10-20-2009, EXPIRES 5-13-2018.

THE MARK CONSISTS OF THE WORD "RUM" ABOVE
THE WORD "OR" IN A COMBINED FORM OF THE WORD
"RUMOR" (IN STYLIZED SCRIPT DESIGN).

FOR RUM; SUGAR CANE JUICE RUM (U.S. CLS. 47
AND 49).

KYLE PEETE, EXAMINING ATTORNEY

SN 77-585,474. CONSORCIO COMERCIAL ZEPPELIN, S.A.
DE C.V., NAVOLATO, MEXICO, FILED 10-3-2008.

RUMOR

OWNER OF MEXICO REG. NO. 1049897, DATED 7-16-
2008, EXPIRES 5-13-2018.

THE MARK CONSISTS OF THE WORD "RUM" FOL-
LOWED BY THE WORD "OR" IN A COMBINED FORM OF
THE WORD "RUMOR" (IN STYLIZED SCRIPT DESIGN).

FOR RUM; SUGAR CANE JUICE RUM (U.S. CLS. 47
AND 49).

KYLE PEETE, EXAMINING ATTORNEY

CLASS 33—(Continued).

SN 77-596,800. RUM CREATION & PRODUCTS INC., TÓR-TOLA, BR.VIRGIN ISLANDS, FILED 10-21-2008.



OWNER OF U.S. REG. NOS. 1,731,470, 2,645,445 AND 3,268,185.

NO CLAIM IS MADE TO THE EXCLUSIVE RIGHT TO USE THE SHAPE OF THE BOTTLE AND "RON" AND "23 AÑOS" AND "PRODUCCION LIMITADA" AND "GRAN RESERVA" AND "VIEJO Y GENUINO RON" AND "MEZCLA DE RONES VIEJOS DE LAS MIELES VIRGENES DE LA CAÑA DE AZUCAR" AND "LICORERA" AND "S.A." AND "PRODUCTO CENTROAMERICANO HECHO EN GUATEMALA" AND "EL EXCESO EN EL CONSUMO DE ESTE PRODUCTO ES DAÑINO PARA LA SALUD DEL CONSUMIDOR", APART FROM THE MARK AS SHOWN.

THE COLOR(S) GOLD, BLACK, RED, WHITE AND TAN IS/ARE CLAIMED AS A FEATURE OF THE MARK.

THE MARK CONSISTS OF A THREE-DIMENSIONAL WEAVED BOTTLE WITH A STRAP IN THE COLOR TAN; WITH A WHITE BAND OUTLINED IN GOLD, BLACK AND RED WITH THE WORDING "23 AÑOS" IN GOLD AND TO ITS SIDES THE WORDING "RON ZACAPA CENTENARIO" IN BLACK; AND UNDERNEATH A GOLD LABEL WITH A RED CIRCLE OUTLINED IN BLACK WITH WHITE LIONS AND A BLACK SHIELD WITH A STAR AND "LZ" IN WHITE; AND UNDERNEATH A WHITE RECTANGLE OUTLINED IN BLACK AND RED AND "PRODUCCION LIMITADA" AND AROUND THE BASE OF THE NOSE OF THE BOTTLE IS A WHITE LABEL OUTLINED IN RED AND BLACK, WITH THE WORDING "EL EXCESO EN EL CONSUMO DE ESTE PRODUCTO ES DAÑINO PARALA SALUDO DEL CONSUMIDOR" IN BLACK, "RON ZACAPA CENTENARIO" IN BLACK AND OUTLINED IN GOLD, A GOLD OVAL WITH "23 AÑOS" IN BLACK AND GOLD CURVED LINING, "VIEJO Y GENUINO RON MEZCLA DE RONES VIEJOS DE LAS MIELES VIRGENES DE LA CAÑA DE AZUCAR" IN BLACK, A GOLD RECTANGLE WITH "ANEJADO Y EMBOTELLADO POR LICORERA ZACAPANECA S.A. ZACAPA GUATEMALA C.A. PRODUCTO CENTROAMERICANO HECHO EN GUATEMAMA" IN BLACK, WITH FOUR GOLD CIRCLES OUTLINED IN BLACK AT THE TOP WITH THE WORDING "GOLD AWARD" AND THE NUMBERS "1998", "1999", "2000", "2001" AND "GRAN RESERVA" IN BLACK.

THE WORDING "RON ZACAPA CENTENARIO" TRANSLATES INTO ENGLISH AS RUM ZACAPA CENTENARY; THE WORDING "23 AÑOS" TRANSLATES INTO ENGLISH AS 23 YEARS; THE WORDING "PRODUCCION LIMITADA" TRANSLATES INTO ENGLISH AS LIMITED PRODUCTION; THE WORDING "GRAN RESERVA" TRANSLATES INTO ENGLISH AS GRAND RESERVE; THE WORDING "VIEJO Y GENUINO RON" TRANSLATES INTO ENGLISH AS OLD AND GENUINE RUM; THE WORDING "MEZCLA DE RONES VIEJOS DE LAS MIELES VIRGENES DE LA CAÑA DE AZUCAR" TRANSLATES INTO ENGLISH AS MIXTURE OF OLD RUMS FROM THE VIRGIN HONEYS OF THE SUGAR CANE; THE WORDING "LICORERA

CLASS 33—(Continued).

ZACAPANECA S.A." TRANSLATES INTO ENGLISH AS LIQUOR FACTORY ZACAPANECA S.A.; THE WORDING "PRODUCTO CENTROAMERICANO HECHO EN GUATEMALA" TRANSLATES INTO ENGLISH AS CENTROAMERICAN PRODUCT MADE IN GUATEMALA; THE WORDING "EL EXCESO EN EL CONSUMO DE ESTE PRODUCTO ES DAÑINO PARA LA SALUD DEL CONSUMIDOR" TRANSLATES INTO ENGLISH AS CONSUMPTION OF THIS PRODUCT IN EXCESS IS HARMFUL FOR THE HEALTH OF THE CONSUMER.

FOR ALCOHOLIC BEVERAGES, NAMELY, RUM, RUM SPIRITS, RUM LIQUORS, RUM COCKTAILS, AND RUM-BASED ALCOHOLIC BEVERAGES (U.S. CLS. 47 AND 49).

MICHELE SWAIN, EXAMINING ATTORNEY

SN 77-651,643. FIFTY-SIX HOPE ROAD MUSIC LIMITED, NASSAU, BAHAMAS, FILED 1-16-2009.

MARLEY

THE MARK CONSISTS OF STANDARD CHARACTERS WITHOUT CLAIM TO ANY PARTICULAR FONT, STYLE, SIZE, OR COLOR.

FOR ALCOHOL BEVERAGES, EXCEPT BEER AND ALCOHOLIC COCKTAIL MIXES (U.S. CLS. 47 AND 49).

EUGENIA MARTIN, EXAMINING ATTORNEY

SN 77-666,117. RUSSIAN STANDARD INTELLECTUAL PROPERTY HOLDING AG, CHAM, SWITZERLAND, FILED 2-9-2009.



THE MARK CONSISTS OF PART OF A CONFIGURATION OF THE CONTAINER FOR THE GOODS. THE CONFIGURATION DESIGN OF THE MARK CONSISTS OF AN ARCHED SHAPE APPEARING AT THE UPPER PORTION OF THE BOTTLE JUST BELOW THE NECK AND A LINE APPEARING JUST BELOW THE MID-WAY POINT OF THE BOTTLE. THE DOTTED OUTLINE OF THE BOTTLE IS NOT PART OF THE MARK BUT MERELY INTENDED TO SHOW THE POSITIONING OF THE LABEL AS APPLIED TO THE BOTTLE.

FOR ALCOHOLIC BEVERAGES, NAMELY, VODKA (U.S. CLS. 47 AND 49).

FIRST USE 10-0-2006; IN COMMERCE 10-0-2006.

JANICE KIM, EXAMINING ATTORNEY

CLASS 33—(Continued).

SN 77-751,341. MEADOWOOD ASSOCIATES, A LIMITED PARTNERSHIP, ST. HELENA, CA. FILED 6-3-2009.

THE NAPA VALLEY RESERVE

THE MARK CONSISTS OF STANDARD CHARACTERS WITHOUT CLAIM TO ANY PARTICULAR FONT, STYLE, SIZE, OR COLOR.

OWNER OF U.S. REG. NOS. 2,973,372, 3,165,896 AND OTHERS.

NO CLAIM IS MADE TO THE EXCLUSIVE RIGHT TO USE "NAPA VALLEY", APART FROM THE MARK AS SHOWN.

SEC. 2(F).

FOR WINES DERIVED FROM GRAPES GROWN IN THE NAPA VALLEY AMERICAN VITICULTURAL AREA APPELLATION OF ORIGIN AND LABELED AND ADVERTISED IN COMPLIANCE WITH U.S. LAWS FOR USE OF THE NAPA VALLEY AMERICAN VITICULTURAL AREA APPELLATION OF ORIGIN (U.S. CLS. 47 AND 49).

FIRST USE 9-30-2004; IN COMMERCE 9-30-2004.

MARK PILARO, EXAMINING ATTORNEY

SN 77-770,112. PEAK SPIRITS, LLC, HOTCHKISS, CO. FILED 6-29-2009.



THE MARK CONSISTS OF THE WORD "MELL" IN BLOCK LETTERS. THE "E" HAS A BROKEN LINE IN THE MIDDLE LINE OF THE "E".

FOR DISTILLED SPIRITS (U.S. CLS. 47 AND 49).

GISELLE AGOSTO, EXAMINING ATTORNEY

SN 77-771,050. INTERCONTINENTAL PACKAGING COMPANY, ST. PAUL, MN. FILED 6-30-2009.

O'DONNELLS

THE MARK CONSISTS OF STANDARD CHARACTERS WITHOUT CLAIM TO ANY PARTICULAR FONT, STYLE, SIZE, OR COLOR.

SEC. 2(F).

FOR CREAM LIQUEURS (U.S. CLS. 47 AND 49).

FIRST USE 8-31-2004; IN COMMERCE 8-31-2004.

KATHRYN COWARD, EXAMINING ATTORNEY

CLASS 33—(Continued).

SN 77-775,543. ROTHBURY WINES PTY LTD, SOUTHBANK VICTORIA, AUSTRALIA, FILED 7-7-2009.

METALA

THE MARK CONSISTS OF STANDARD CHARACTERS WITHOUT CLAIM TO ANY PARTICULAR FONT, STYLE, SIZE, OR COLOR.

OWNER OF AUSTRALIA REG. NO. 185707, DATED 1-31-1964, EXPIRES 1-31-2019.

OWNER OF U.S. REG. NO. 2,766,072.

THE WORDING "METALA" HAS NO MEANING IN A FOREIGN LANGUAGE.

FOR WINES (U.S. CLS. 47 AND 49).

TINA BROWN, EXAMINING ATTORNEY

SN 77-780,184. HAGEN, STEPHEN M. DBA OLD SCHOOL VINEYARDS, JUNCTION CITY, OR. FILED 7-14-2009.

Old School Vineyards

THE MARK CONSISTS OF STANDARD CHARACTERS WITHOUT CLAIM TO ANY PARTICULAR FONT, STYLE, SIZE, OR COLOR.

NO CLAIM IS MADE TO THE EXCLUSIVE RIGHT TO USE "VINEYARDS", APART FROM THE MARK AS SHOWN.

FOR GRAPE WINE (U.S. CLS. 47 AND 49).

ANNE FARRELL, EXAMINING ATTORNEY

SN 77-784,564. TUOPAI YEAST LIQUOR CO., LTD. SICHUAN CHINA, SICHUAN, CHINA, FILED 7-20-2009.



OWNER OF U.S. REG. NO. 3,069,644.

NO CLAIM IS MADE TO THE EXCLUSIVE RIGHT TO USE "THE NON-LATIN CHARACTERS THAT TRANSLITERATE TO 'PAI'", APART FROM THE MARK AS SHOWN.

THE MARK CONSISTS OF CHINESE CHARACTERS.

THE ENGLISH TRANSLATION OF "TUO PAI" IN THE MARK IS "SMALL BAY OR RIVER" AND "BRAND"

FOR DISTILLED SPIRITS; ALCOHOLIC FRUIT EXTRACTS; APERITIFS; SPIRITS; LIQUEURS; WHISKY; ALCOHOLIC BEVERAGES EXCEPT BEER; DRINKING ALCOHOL; COOKING WINE (U.S. CLS. 47 AND 49).

FIRST USE 12-31-1986; IN COMMERCE 1-31-2002.

EMILY CARLSEN, EXAMINING ATTORNEY

CLASS 33—(Continued).

SN 77-790,555. SOCETA' AGRICOLA DEGLI DEI S.R.L., GREVE IN CHIANTI (FI), ITALY, FILED 7-27-2009.

DEGLI DEI

THE MARK CONSISTS OF STANDARD CHARACTERS WITHOUT CLAIM TO ANY PARTICULAR FONT, STYLE, SIZE, OR COLOR.

PRIORITY CLAIMED UNDER SEC. 44(D) ON ITALY APPLICATION NO. MI2009C00092, FILED 1-30-2009, REG. NO. 0001221988, DATED 10-16-2009, EXPIRES 10-16-2019.

THE ENGLISH TRANSLATION OF "DEGLI DEI" IS "OF THE GODS".

FOR ALCOHOLIC BEVERAGES PRODUCED FROM A BREWED MALT BASE WITH NATURAL FLAVORS; ALCOHOLIC FRUIT BEVERAGES, NAMELY, ALCOHOLIC BEVERAGES OF FRUIT, ALCOHOLIC BEVERAGES CONTAINING FRUIT; ALCOHOLIC COFFEE-BASED BEVERAGES, ALCOHOLIC TEA-BASED BEVERAGES; RUM, VODKA, WINE, WHISKY, COGNAC, BRANDY, GRAPPA, ALCOHOLIC BITTERS, ALCOHOLIC APERITIF BITTERS, CHAMPAGNE, SPARKLING WINES, LIQUOR; EAUX-DE-VIE, NAMELY, FRUIT BRANDY (U.S. CLS. 47 AND 49).

JAY BESCH, EXAMINING ATTORNEY

SN 77-794,485. CASTEL FRERES, 33290 BLANQUEFORT, FRANCE, FILED 7-31-2009.

GRAIN D'OC

THE MARK CONSISTS OF STANDARD CHARACTERS WITHOUT CLAIM TO ANY PARTICULAR FONT, STYLE, SIZE, OR COLOR.

THE WORDING "GRAIN D'OC" HAS NO MEANING IN A FOREIGN LANGUAGE.

FOR WINES (U.S. CLS. 47 AND 49).
STEPHANIE ALI, EXAMINING ATTORNEY

SN 77-795,222. CASTEL FRERES, 33290 BLANQUEFORT, FRANCE, FILED 8-3-2009.

JEAN VALESTREL

THE MARK CONSISTS OF STANDARD CHARACTERS WITHOUT CLAIM TO ANY PARTICULAR FONT, STYLE, SIZE, OR COLOR.

THE NAME(S), PORTRAIT(S), AND/OR SIGNATURE(S) SHOWN IN THE MARK DOES NOT IDENTIFY A PARTICULAR LIVING INDIVIDUAL.

FOR WINES (U.S. CLS. 47 AND 49).
STEPHANIE ALI, EXAMINING ATTORNEY

CLASS 33—(Continued).

SN 77-797,642. AGE INTERNATIONAL, INC., FRANKFORT, KY. FILED 8-5-2009.

JACOB SPEARS

THE MARK CONSISTS OF STANDARD CHARACTERS WITHOUT CLAIM TO ANY PARTICULAR FONT, STYLE, SIZE, OR COLOR.

THE NAME "JACOB SPEARS" DOES NOT IDENTIFY A LIVING INDIVIDUAL.

FOR BOURBON WHISKEY (U.S. CLS. 47 AND 49).
SETH A. RAPPAPORT, EXAMINING ATTORNEY

SN 77-797,664. AGE INTERNATIONAL, INC., FRANKFORT, KY. FILED 8-5-2009.

JACOB SPEARS DISTILLING COMPANY

THE MARK CONSISTS OF STANDARD CHARACTERS WITHOUT CLAIM TO ANY PARTICULAR FONT, STYLE, SIZE, OR COLOR.

NO CLAIM IS MADE TO THE EXCLUSIVE RIGHT TO USE "DISTILLING COMPANY", APART FROM THE MARK AS SHOWN.

THE NAME "JACOB SPEARS" DOES NOT IDENTIFY A LIVING INDIVIDUAL.

FOR BOURBON WHISKEY (U.S. CLS. 47 AND 49).
SETH A. RAPPAPORT, EXAMINING ATTORNEY

SN 77-802,363. ONE TRUE VINE, LLC, RUTHERFORD, CA. FILED 8-11-2009.

CHARITY CASE

THE MARK CONSISTS OF STANDARD CHARACTERS WITHOUT CLAIM TO ANY PARTICULAR FONT, STYLE, SIZE, OR COLOR.

FOR WINE (U.S. CLS. 47 AND 49).
SALLY SHIH, EXAMINING ATTORNEY

CLASS 33—(Continued).

SN 77-806,448. MULDER, ROBERT, LOS ANGELES, CA. FILED 8-17-2009.



NO CLAIM IS MADE TO THE EXCLUSIVE RIGHT TO USE "CA", APART FROM THE MARK AS SHOWN.

THE MARK CONSISTS OF THE CAPITAL LETTERS "C" AND "A", AND THE NUMBER "88".

FOR WINE (U.S. CLS. 47 AND 49).

WILLIAM BRECKENFELD, EXAMINING ATTORNEY

SN 77-810,760. ROSMERSHOLM AS, OSLO, NORWAY, FILED 8-23-2009.

Scream Vodka Edvard Munch

THE MARK CONSISTS OF STANDARD CHARACTERS WITHOUT CLAIM TO ANY PARTICULAR FONT, STYLE, SIZE, OR COLOR.

NO CLAIM IS MADE TO THE EXCLUSIVE RIGHT TO USE "VODKA", APART FROM THE MARK AS SHOWN.

THE NAME(S), PORTRAIT(S), AND/OR SIGNATURE(S) SHOWN IN THE MARK DOES NOT IDENTIFY A PARTICULAR LIVING INDIVIDUAL.

FOR VODKA (U.S. CLS. 47 AND 49).

TARAH HARDY, EXAMINING ATTORNEY

SN 77-811,779. ROBERT J WHENNEN, VISTA, CA. FILED 8-25-2009.

21 Booze

THE MARK CONSISTS OF STANDARD CHARACTERS WITHOUT CLAIM TO ANY PARTICULAR FONT, STYLE, SIZE, OR COLOR.

NO CLAIM IS MADE TO THE EXCLUSIVE RIGHT TO USE "BOOZE", APART FROM THE MARK AS SHOWN.

FOR DISTILLED SPIRITS (U.S. CLS. 47 AND 49).

REBECCA SMITH, EXAMINING ATTORNEY

CLASS 33—(Continued).

SN 77-811,783. ROBERT J WHENNEN, VISTA, CA. FILED 8-25-2009.

21 Winery

THE MARK CONSISTS OF STANDARD CHARACTERS WITHOUT CLAIM TO ANY PARTICULAR FONT, STYLE, SIZE, OR COLOR.

NO CLAIM IS MADE TO THE EXCLUSIVE RIGHT TO USE "WINERY", APART FROM THE MARK AS SHOWN.

FOR WINES (U.S. CLS. 47 AND 49).

REBECCA SMITH, EXAMINING ATTORNEY

SN 77-825,201. ISIDRO BORDAS. C. POR A., SANTIAGO, DOMINICAN REP, FILED 9-11-2009.



OWNER OF DOMINICAN REP REG. NO. 173800, DATED 4-30-2009, EXPIRES 4-30-2019.

NO CLAIM IS MADE TO THE EXCLUSIVE RIGHT TO USE "VODKA" OR "HANDCRAFTED AND DISTILLED USING ONLY THE FINEST INGREDIENTS TO ACHIEVE A TRULY 100% NEUTRAL SPIRIT. THIS PREMIUM VODKA IS PAINSTAKINGLY DISTILLED AND FILTERED TO THE MOST EXACTING SPECIFICATIONS. ENJOY!", APART FROM THE MARK AS SHOWN.

THE COLOR(S) DARK BLUE AND LIGHT BLUE IS/ARE CLAIMED AS A FEATURE OF THE MARK.

THE MARK CONSISTS OF THE WORDS "CAYMAN BLUE VODKA" IN BIG STYLIZED LETTERS BELOW OF WHICH APPEARS THE WORDING "HANDCRAFTED AND DISTILLED USING ONLY THE FINEST INGREDIENTS TO ACHIEVE A TRULY 100% NEUTRAL SPIRIT. THIS PREMIUM VODKA IS PAINSTAKINGLY DISTILLED AND FILTERED TO THE MOST EXCITING SPECIFICATIONS. ENJOY!" IN SMALLER LETTERS AND BELOW IT THE DESIGN OF A CROCODILE OR CAYMAN. THE DARK BLUE COLOR APPEARS IN THE WORDING "CAYMAN, VODKA" AND "HANDCRAFTED AND DISTILLED USING ONLY THE FINEST INGREDIENTS TO ACHIEVE A TRULY 100% NEUTRAL SPIRIT. THIS PREMIUM VODKA IS PAINSTAKINGLY DISTILLED AND FILTERED TO THE MOST EXCITING SPECIFICATIONS. ENJOY!"

FOR VODKA (U.S. CLS. 47 AND 49).

ANGELA M. MICHELI, EXAMINING ATTORNEY

CLASS 33—(Continued).

SN 77-828,697. GONZALEZ BYASS, S.A, CADIZ, SPAIN,
FILED 9-17-2009.

THE LONDON N° 1

THE MARK CONSISTS OF STANDARD CHARACTERS WITHOUT CLAIM TO ANY PARTICULAR FONT, STYLE, SIZE, OR COLOR.

OWNER OF ERPN CMNTY TM OFC REG. NO. 7593338, DATED 2-11-2009, EXPIRES 2-11-2019.

NO CLAIM IS MADE TO THE EXCLUSIVE RIGHT TO USE "LONDON", APART FROM THE MARK AS SHOWN.

FOR ALCOHOLIC BEVERAGES, EXCEPT BEERS, NAMELY, WINES, DISTILLED LIQUORS, LIQUEURS AND SPIRITS (U.S. CLS. 47 AND 49).

ALYSSA STEEL, EXAMINING ATTORNEY

SN 77-831,581. SHELLEY GOSSMAN, NEW YORK, NY.
FILED 9-21-2009.



THE COLOR(S) BLACK, BROWN AND TAN IS/ARE CLAIMED AS A FEATURE OF THE MARK.

THE MARK CONSISTS OF THE DESIGN OF AN EN-CIRCLED CROSS IN BROWN AND THE WORDING "BUMBU" IN BLACK ALL ON A BACKGROUND WITH THE APPEARANCE OF TAN PARCHMENT.

FOR DISTILLED SPIRITS (U.S. CLS. 47 AND 49).
KRISTIN DAHLING, EXAMINING ATTORNEY

SN 77-838,543. ABSENTE LLC, PALM COAST, FL. FILED 9-30-2009.

ELISIR M.P. ROUX

THE MARK CONSISTS OF STANDARD CHARACTERS WITHOUT CLAIM TO ANY PARTICULAR FONT, STYLE, SIZE, OR COLOR.

OWNER OF U.S. REG. NOS. 2,484,370 AND 2,591,892.

NO CLAIM IS MADE TO THE EXCLUSIVE RIGHT TO USE "ELISIR", APART FROM THE MARK AS SHOWN.

"M.P. ROUX" IDENTIFIES A LIVING INDIVIDUAL WHOSE CONSENT IS OF RECORD.

THE ENGLISH TRANSLATION OF "ELISIR" IN THE MARK IS "ELIXIR".

FOR LIQUEURS (U.S. CLS. 47 AND 49).

FIRST USE 6-1-2003; IN COMMERCE 6-1-2003.

SETH A. RAPPAPORT, EXAMINING ATTORNEY

CLASS 33—(Continued).

SN 77-844,069. HALTER WINERY LLC, PASO ROBLES, CA.
FILED 10-8-2009.

CÔTES DE PASO

THE MARK CONSISTS OF STANDARD CHARACTERS WITHOUT CLAIM TO ANY PARTICULAR FONT, STYLE, SIZE, OR COLOR.

NO CLAIM IS MADE TO THE EXCLUSIVE RIGHT TO USE "PASO", APART FROM THE MARK AS SHOWN.

THE ENGLISH TRANSLATION OF "CÔTES DE" IN THE MARK IS "HILLS OF".

FOR WINES (U.S. CLS. 47 AND 49).

LURIE KAUFMAN, EXAMINING ATTORNEY

SN 77-848,852. SHILOH WINERY ISRAEL LTD, DBA SHILOH WINERY ISRAEL, SHILOH, ISRAEL, FILED 10-14-2009.



NO CLAIM IS MADE TO THE EXCLUSIVE RIGHT TO USE "SHILOH" AND THE NON-LATIN CHARACTERS THAT TRANSLITERATE TO "SHILOH", APART FROM THE MARK AS SHOWN.

THE COLOR(S) RED, BLACK, WHITE IS/ARE CLAIMED AS A FEATURE OF THE MARK.

THE MARK CONSISTS OF THE FOLLOWING: THE DESIGN OF THE BULL APPEARS IN RED. THE WORDS "SHILOH" AND THE HEBREW LETTERS WHICH TRANSLITERATE TO "SHILOH" APPEAR IN WHITE, WITH A BLACK BACKGROUND.

THE NON-LATIN CHARACTERS IN THE MARK TRANSLITERATE TO "SHILOH" AND THIS MEANS "SHILOH" IN ENGLISH.

FOR FORTIFIED WINES; RED WINES; SWEET WINES; TABLE WINES; WHITE WINE; WINES; WINES AND FORTIFIED WINES (U.S. CLS. 47 AND 49).

FIRST USE 9-9-2005; IN COMMERCE 11-1-2006.

KHANH LE, EXAMINING ATTORNEY

CLASS 33—(Continued).

SN 77-860,920. BULMERS LIMITED, WEST DUBLIN 10, IRELAND, FILED 10-29-2009.

MAGNERS

THE MARK CONSISTS OF STANDARD CHARACTERS WITHOUT CLAIM TO ANY PARTICULAR FONT, STYLE, SIZE, OR COLOR.

OWNER OF U.S. REG. NOS. 2,722,739, 2,847,695 AND 2,985,827.

SEC. 2(F).

FOR HARD CIDER (U.S. CLS. 47 AND 49).
FIRST USE 5-25-2000; IN COMMERCE 5-25-2000.
KYLE PEETE, EXAMINING ATTORNEY

CLASS 33—(Continued).

SN 77-904,184. J. LLORENTE & CIA S.A., (1213) BUENOS AIRES, ARGENTINA, FILED 1-4-2010.

PUEBLO GAUCHO

THE MARK CONSISTS OF STANDARD CHARACTERS WITHOUT CLAIM TO ANY PARTICULAR FONT, STYLE, SIZE, OR COLOR.

THE ENGLISH TRANSLATION OF "PUEBLO GAUCHO" IN THE MARK IS "GAUCHO TOWN".

FOR WINES (U.S. CLS. 47 AND 49).
RON FAIRBANKS, EXAMINING ATTORNEY

SN 77-882,640. KWV INTELLECTUAL PROPERTIES (PTY) LIMITED, PAARL 7624, SOUTH AFRICA, FILED 11-30-2009.

DEROUW

THE MARK CONSISTS OF STANDARD CHARACTERS WITHOUT CLAIM TO ANY PARTICULAR FONT, STYLE, SIZE, OR COLOR.

THE ENGLISH TRANSLATION OF THE WORD "DEROUW" IN THE MARK IS "SORROW" OR "MOURNING".

FOR BRANDY (U.S. CLS. 47 AND 49).
DAVID MURRAY, EXAMINING ATTORNEY

SN 77-914,936. CLAIBORNE & CHURCHILL, INC., DBA CLAIBORNE & CHURCHILL VINTNERS, SAN LUIS OBISPO, CA. FILED 1-19-2010.

Clueless Red

SN 77-884,781. THE WINE GROUP LLC, TRACY, CA. FILED 12-2-2009.

CHEAP DATE

THE MARK CONSISTS OF STANDARD CHARACTERS WITHOUT CLAIM TO ANY PARTICULAR FONT, STYLE, SIZE, OR COLOR.

FOR WINE (U.S. CLS. 47 AND 49).
MICHAEL ENGEL, EXAMINING ATTORNEY

THE MARK CONSISTS OF STANDARD CHARACTERS WITHOUT CLAIM TO ANY PARTICULAR FONT, STYLE, SIZE, OR COLOR.

NO CLAIM IS MADE TO THE EXCLUSIVE RIGHT TO USE "RED", APART FROM THE MARK AS SHOWN.

FOR GRAPE WINE; RED WINE; TABLE WINES; WINE (U.S. CLS. 47 AND 49).

FIRST USE 7-13-2009; IN COMMERCE 1-15-2010.
FRED CARL, EXAMINING ATTORNEY

CLASS 33—(Continued).

SN 77-917,494. CSANKY, ERWIN RYAN, AKA RYAN CSANKY, PORTLAND, OR. FILED 1-22-2010.



NO CLAIM IS MADE TO THE EXCLUSIVE RIGHT TO USE "DISTILLED FROM OREGON HONEY ARTISAN VODKA", APART FROM THE MARK AS SHOWN.

THE COLOR(S) GRAY AND ORANGE IS/ARE CLAIMED AS A FEATURE OF THE MARK.

THE MARK CONSISTS OF "APIA" WRITTEN IN LOWERCASE IN GRAY, WITH AN ORANGE DOT OVER THE "I"; "DISTILLED FROM OREGON HONEY" WRITTEN BELOW IN ORANGE; "ARTISAN VODKA" WRITTEN BELOW IN GRAY CAPITOL LETTERS.

FOR VODKA (U.S. CLS. 47 AND 49).

FIRST USE 8-1-2008; IN COMMERCE 0-0-2009.

DAVID TOOLEY, EXAMINING ATTORNEY

SN 77-917,500. CSANKY, ERWIN RYAN, AKA RYAN CSANKY, PORTLAND, OR. FILED 1-22-2010.

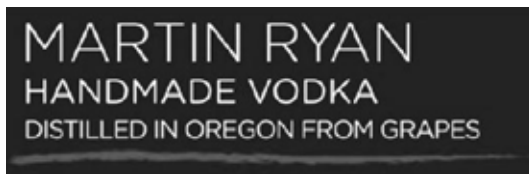

NO CLAIM IS MADE TO THE EXCLUSIVE RIGHT TO USE "HANDMADE VODKA DISTILLED IN OREGON FROM GRAPES", APART FROM THE MARK AS SHOWN.

THE NAME "MARTIN RYAN" DOES NOT IDENTIFY A LIVING INDIVIDUAL.

THE MARK CONSISTS OF THE STYLIZED TEXT "MARTIN RYAN HANDMADE VODKA DISTILLED IN OREGON FROM GRAPES" ABOVE A BRUSH STROKE.

FOR VODKA (U.S. CLS. 47 AND 49).

FIRST USE 8-1-2008; IN COMMERCE 0-0-2009.

DAVID TOOLEY, EXAMINING ATTORNEY

CLASS 33—(Continued).

SN 77-917,895. COMERCIAL EXVINA LIMITADA, TALCA, CHILE, FILED 1-22-2010.

MATAVERDE

THE MARK CONSISTS OF STANDARD CHARACTERS WITHOUT CLAIM TO ANY PARTICULAR FONT, STYLE, SIZE, OR COLOR.

THE ENGLISH TRANSLATION OF "MATA VERDE" IN THE MARK IS "GREEN PLANT".

FOR GRAPE WINE; RED WINE; RED WINES; TABLE WINES; WHITE WINE; WINE; WINES (U.S. CLS. 47 AND 49).

FIRST USE 5-1-2009; IN COMMERCE 10-1-2009.

MATTHEW EINSTEIN, EXAMINING ATTORNEY

SN 77-920,664. REACTOR SPIRITS LTD, SANDVIKA, NORWAY, FILED 1-26-2010.



THE MARK CONSISTS OF A CIRCLE SURROUNDING THE LETTER "V" FOLLOWED BY A CHECK MARK SYMBOL AND A DEGREE SYMBOL.

FOR DISTILLED SPIRITS (U.S. CLS. 47 AND 49).

PRISCILLA MILTON, EXAMINING ATTORNEY

SN 77-921,375. THERESA HIGH, PALISADE, CO. FILED 1-27-2010.

COLTERRIS

THE MARK CONSISTS OF STANDARD CHARACTERS WITHOUT CLAIM TO ANY PARTICULAR FONT, STYLE, SIZE, OR COLOR.

FOR WINE (U.S. CLS. 47 AND 49).

GILBERT SWIFT, EXAMINING ATTORNEY

CLASS 33—(Continued).

SN 77-921,384. THERESA HIGH, PALISADE, CO. FILED 1-27-2010.

PALIS

THE MARK CONSISTS OF STANDARD CHARACTERS WITHOUT CLAIM TO ANY PARTICULAR FONT, STYLE, SIZE, OR COLOR.

FOR LIQUEURS (U.S. CLS. 47 AND 49).
GILBERT SWIFT, EXAMINING ATTORNEY

SN 77-922,254. FOUR BEARS WINERY LLC, SACRAMENTO, CA. FILED 1-28-2010.

SEAN MINOR

THE MARK CONSISTS OF STANDARD CHARACTERS WITHOUT CLAIM TO ANY PARTICULAR FONT, STYLE, SIZE, OR COLOR.

THE NAME(S), PORTRAIT(S), AND/OR SIGNATURE(S) SHOWN IN THE MARK IDENTIFIES "SEAN MINOR", WHOSE CONSENT(S) TO REGISTER IS MADE OF RECORD.

FOR WINES (U.S. CLS. 47 AND 49).
FIRST USE 4-29-2008; IN COMMERCE 4-29-2008.
LINDA M. KING, EXAMINING ATTORNEY

SN 77-922,829. COOK, CONNIE, URBANDEALE, IA. FILED 1-28-2010.

BRING THE ZYNG

THE MARK CONSISTS OF STANDARD CHARACTERS WITHOUT CLAIM TO ANY PARTICULAR FONT, STYLE, SIZE, OR COLOR.

FOR ALCOHOLIC FLAVORED MALT BEVERAGES (U.S. CLS. 47 AND 49).
BRIAN NEVILLE, EXAMINING ATTORNEY

CLASS 33—(Continued).

SN 77-923,316. PALM BAY INTERNATIONAL, INC., PORT WASHINGTON, NY. FILED 1-29-2010.

WINE MADE SIMPLE

THE MARK CONSISTS OF STANDARD CHARACTERS WITHOUT CLAIM TO ANY PARTICULAR FONT, STYLE, SIZE, OR COLOR.

NO CLAIM IS MADE TO THE EXCLUSIVE RIGHT TO USE "WINE", APART FROM THE MARK AS SHOWN.
FOR ALCOHOLIC BEVERAGES, NAMELY, WINE (U.S. CLS. 47 AND 49).
KATHRYN COWARD, EXAMINING ATTORNEY

SN 77-923,370. PALM BAY INTERNATIONAL, INC., PORT WASHINGTON, NY. FILED 1-29-2010.

SIMPLY PINOT GRIGIO

THE MARK CONSISTS OF STANDARD CHARACTERS WITHOUT CLAIM TO ANY PARTICULAR FONT, STYLE, SIZE, OR COLOR.

NO CLAIM IS MADE TO THE EXCLUSIVE RIGHT TO USE "PINOT GRIGIO", APART FROM THE MARK AS SHOWN.

FOR ALCOHOLIC BEVERAGES, NAMELY, WINE (U.S. CLS. 47 AND 49).
KATHRYN COWARD, EXAMINING ATTORNEY

SN 77-923,377. PALM BAY INTERNATIONAL, INC., PORT WASHINGTON, NY. FILED 1-29-2010.

SIMPLY MERLOT

THE MARK CONSISTS OF STANDARD CHARACTERS WITHOUT CLAIM TO ANY PARTICULAR FONT, STYLE, SIZE, OR COLOR.

NO CLAIM IS MADE TO THE EXCLUSIVE RIGHT TO USE "MERLOT", APART FROM THE MARK AS SHOWN.

FOR ALCOHOLIC BEVERAGES, NAMELY, WINE (U.S. CLS. 47 AND 49).
KATHRYN COWARD, EXAMINING ATTORNEY

CLASS 33—(Continued).

SN 77-923,383. PALM BAY INTERNATIONAL, INC., PORT WASHINGTON, NY. FILED 1-29-2010.

SIMPLY PINOT NOIR

THE MARK CONSISTS OF STANDARD CHARACTERS WITHOUT CLAIM TO ANY PARTICULAR FONT, STYLE, SIZE, OR COLOR.

NO CLAIM IS MADE TO THE EXCLUSIVE RIGHT TO USE "PINOT NOIR", APART FROM THE MARK AS SHOWN.

FOR ALCOHOLIC BEVERAGES, NAMELY, WINE (U.S. CLS. 47 AND 49).
KATHRYN COWARD, EXAMINING ATTORNEY

SN 77-923,394. PALM BAY INTERNATIONAL, INC., PORT WASHINGTON, NY. FILED 1-29-2010.

SIMPLY CHARDONNAY

THE MARK CONSISTS OF STANDARD CHARACTERS WITHOUT CLAIM TO ANY PARTICULAR FONT, STYLE, SIZE, OR COLOR.

NO CLAIM IS MADE TO THE EXCLUSIVE RIGHT TO USE "CHARDONNAY", APART FROM THE MARK AS SHOWN.

FOR ALCOHOLIC BEVERAGES, NAMELY, WINE (U.S. CLS. 47 AND 49).
KATHRYN COWARD, EXAMINING ATTORNEY

SN 77-923,400. PALM BAY INTERNATIONAL, INC., PORT WASHINGTON, NY. FILED 1-29-2010.

SIMPLY CABERNET SAUVIGNON

THE MARK CONSISTS OF STANDARD CHARACTERS WITHOUT CLAIM TO ANY PARTICULAR FONT, STYLE, SIZE, OR COLOR.

NO CLAIM IS MADE TO THE EXCLUSIVE RIGHT TO USE "CABERNET SAUVIGNON", APART FROM THE MARK AS SHOWN.

FOR ALCOHOLIC BEVERAGES, NAMELY, WINE (U.S. CLS. 47 AND 49).
KATHRYN COWARD, EXAMINING ATTORNEY

CLASS 33—(Continued).

SN 77-923,412. PALM BAY INTERNATIONAL, INC., PORT WASHINGTON, NY. FILED 1-29-2010.

SIMPLY SAUVIGNON BLANC

THE MARK CONSISTS OF STANDARD CHARACTERS WITHOUT CLAIM TO ANY PARTICULAR FONT, STYLE, SIZE, OR COLOR.

NO CLAIM IS MADE TO THE EXCLUSIVE RIGHT TO USE "SAUVIGNON BLANC", APART FROM THE MARK AS SHOWN.

FOR ALCOHOLIC BEVERAGES, NAMELY, WINE (U.S. CLS. 47 AND 49).
KATHRYN COWARD, EXAMINING ATTORNEY

SN 77-924,042. LOWDEN SCHOOLHOUSE CORPORATION, LOWDEN, WA. FILED 1-29-2010.

L'ECOLE

THE MARK CONSISTS OF STANDARD CHARACTERS WITHOUT CLAIM TO ANY PARTICULAR FONT, STYLE, SIZE, OR COLOR.

OWNER OF U.S. REG. NO. 1,966,650.
THE ENGLISH TRANSLATION OF "L'ECOLE" IN THE MARK IS "SCHOOL".

FOR WINE (U.S. CLS. 47 AND 49).
FIRST USE 8-16-1985; IN COMMERCE 3-5-1990.
JOHN DWYER, EXAMINING ATTORNEY

SN 77-924,532. THE WINE & SPIRITS COMPANY OF ILLINOIS, DBA KAMERYN WINE & SPIRITS, OAK LAWN, IL. FILED 2-1-2010.

Thomas
MacGlynn
Irish Whiskey

NO CLAIM IS MADE TO THE EXCLUSIVE RIGHT TO USE "IRISH WHISKEY", APART FROM THE MARK AS SHOWN.

THE NAME "THOMAS MACGLYNN" DOES NOT IDENTIFY A LIVING INDIVIDUAL.

THE MARK CONSISTS OF "THOMAS MACGLYNN IRISH WHISKEY" CONSIST OF STRAIGHT FORWARD LETTERS EXCEPT FOR THE "M" & "L" IN "MACGLYNN" WHICH CONTAIN CELTIC PATTERN.

FOR WHISKEY (U.S. CLS. 47 AND 49).
ALEX KEAM, EXAMINING ATTORNEY

CLASS 33—(Continued).

SN 77-924,777. CHATEAU DIANA LLC, HEALDSBURG, CA.
FILED 2-1-2010.

HARDING ESTATES

THE MARK CONSISTS OF STANDARD CHARACTERS
WITHOUT CLAIM TO ANY PARTICULAR FONT, STYLE,
SIZE, OR COLOR.

NO CLAIM IS MADE TO THE EXCLUSIVE RIGHT TO
USE "ESTATES", APART FROM THE MARK AS SHOWN.
FOR WINES (U.S. CLS. 47 AND 49).
FIRST USE 8-28-2009; IN COMMERCE 8-28-2009.
DOMINIC J. FERRAIUOLO, EXAMINING ATTORNEY

CLASS 33—(Continued).

SN 77-924,868. YOST, NORMAN, LOMPOC, CA. FILED 2-1-
2010.

**FLYING GOAT
CELLARS**



SN 77-924,796. CHATEAU DIANA LLC, HEALDSBURG, CA.
FILED 2-1-2010.

ELENA

THE MARK CONSISTS OF STANDARD CHARACTERS
WITHOUT CLAIM TO ANY PARTICULAR FONT, STYLE,
SIZE, OR COLOR.

FOR WINES (U.S. CLS. 47 AND 49).
FIRST USE 10-21-2009; IN COMMERCE 10-21-2009.
DOMINIC J. FERRAIUOLO, EXAMINING ATTORNEY

OWNER OF U.S. REG. NO. 3,556,340.
NO CLAIM IS MADE TO THE EXCLUSIVE RIGHT TO
USE "CELLARS", APART FROM THE MARK AS SHOWN.
THE MARK CONSISTS OF A GOAT FLYING OVER THE
GROUND WITH STARS AND MOON IN THE BACK-
GROUND, ENCLOSED IN A BORDER. ABOVE THE DE-
SIGN IS THE WORDING "FLYING GOAT CELLARS".
FOR WINE (U.S. CLS. 47 AND 49).
FIRST USE 4-1-2002; IN COMMERCE 4-1-2002.
SHANNON TWOHIG, EXAMINING ATTORNEY

SN 77-924,916. ICE PIK, LLC, ATTLEBORO, MA. FILED 2-1-
2010.

SN 77-924,798. VINOS UNICO, DBA LUIS MOYA SELEC-
TIONS, SAN FRANCISCO, CA. AND ANA GOMEZ, PTO.
STA. MARIA, CADIZ, SPAIN, FILED 2-1-2010.

la Tercera

THE MARK CONSISTS OF STANDARD CHARACTERS
WITHOUT CLAIM TO ANY PARTICULAR FONT, STYLE,
SIZE, OR COLOR.

THE ENGLISH TRANSLATION OF "LA TERCERA" IN
THE MARK IS "THIRD ONE".
FOR WINE (U.S. CLS. 47 AND 49).
DOMINIC J. FERRAIUOLO, EXAMINING ATTORNEY

Lazy Eight

THE MARK CONSISTS OF STANDARD CHARACTERS
WITHOUT CLAIM TO ANY PARTICULAR FONT, STYLE,
SIZE, OR COLOR.

FOR ALCOHOLIC TEA-BASED BEVERAGE (U.S. CLS.
47 AND 49).
KIMBERLY PERRY, EXAMINING ATTORNEY

CLASS 33—(Continued).

SN 77-924,938. LOPEZ, SILVERIO, DETROIT, MI. FILED 2-1-2010.



THE MARK CONSISTS OF A STYLIZED AGAVE PLANT LEAF, WITH THE DEPICTION OF A CIRCULAR AGAVE PLANT AT ITS BASE. THE WORD "CABRESTO" IS SUPERIMPOSED CENTRALLY ON THIS IMAGE IN LARGE CURSIVE LETTERS.

THE ENGLISH TRANSLATION OF "CABRESTO" IN THE MARK IS "BRIDLE".

FOR TEQUILA (U.S. CLS. 47 AND 49).
FIRST USE 4-4-2008; IN COMMERCE 4-4-2008.
BRENDAN REGAN, EXAMINING ATTORNEY

CLASS 33—(Continued).

SN 77-926,734. DIAGEO CHATEAU & ESTATE WINES COMPANY, NAPA, CA. FILED 2-3-2010.

COASTAL CITRUS

THE MARK CONSISTS OF STANDARD CHARACTERS WITHOUT CLAIM TO ANY PARTICULAR FONT, STYLE, SIZE, OR COLOR.

NO CLAIM IS MADE TO THE EXCLUSIVE RIGHT TO USE "CITRUS", APART FROM THE MARK AS SHOWN, FOR ALCOHOLIC BEVERAGES EXCEPT BEERS (U.S. CLS. 47 AND 49).

MIDGE BUTLER, EXAMINING ATTORNEY

SN 77-926,000. TRADICIONES JALISCIENSES SA DE CV, GUADALAJARA, JALISCO, MEXICO, FILED 2-2-2010.

XQ

THE MARK CONSISTS OF STANDARD CHARACTERS WITHOUT CLAIM TO ANY PARTICULAR FONT, STYLE, SIZE, OR COLOR.

FOR DISTILLED SPIRITS (U.S. CLS. 47 AND 49).
FIRST USE 7-0-1999; IN COMMERCE 7-0-1999.
BRENDAN REGAN, EXAMINING ATTORNEY

CONVICTION

THE MARK CONSISTS OF STANDARD CHARACTERS WITHOUT CLAIM TO ANY PARTICULAR FONT, STYLE, SIZE, OR COLOR.

FOR ALCOHOLIC BEVERAGES EXCEPT BEERS (U.S. CLS. 47 AND 49).

B. PARADEWELAI, EXAMINING ATTORNEY

SN 77-926,580. PERSEDO, LLC, PEARLAND, TX. FILED 2-3-2010.

PERSEDO

THE MARK CONSISTS OF STANDARD CHARACTERS WITHOUT CLAIM TO ANY PARTICULAR FONT, STYLE, SIZE, OR COLOR.

THE WORDING "PERSEDO" HAS NO MEANING IN A FOREIGN LANGUAGE.

FOR ALCOHOLIC BEVERAGES EXCEPT BEERS (U.S. CLS. 47 AND 49).

EDWARD NELSON, EXAMINING ATTORNEY

SN 77-927,411. REYNVAAN FAMILY VINEYARDS, LLC, WALLA WALLA, WA. FILED 2-3-2010.

THE UNNAMED SYRAH

THE MARK CONSISTS OF STANDARD CHARACTERS WITHOUT CLAIM TO ANY PARTICULAR FONT, STYLE, SIZE, OR COLOR.

NO CLAIM IS MADE TO THE EXCLUSIVE RIGHT TO USE "SYRAH", APART FROM THE MARK AS SHOWN.

FOR WINE (U.S. CLS. 47 AND 49).
SCOTT BIBB, EXAMINING ATTORNEY

CLASS 33—(Continued).

SN 77-927,551. BRIO ENTERPRISES, MODESTO, CA. FILED 2-3-2010.



THE MARK CONSISTS OF THE STYLIZED TEXT "GREATER PURPOSE".
FOR WINE (U.S. CLS. 47 AND 49).
JAMES STEIN, EXAMINING ATTORNEY

CLASS 33—(Continued).

SN 77-928,341. DONNAFUGATA S.R.L., MARSALA (TRAPANI), ITALY, FILED 2-4-2010.



THE MARK CONSISTS OF STANDARD CHARACTERS WITHOUT CLAIM TO ANY PARTICULAR FONT, STYLE, SIZE, OR COLOR.
OWNER OF U.S. REG. NO. 2,895,512.
FOR WINE (U.S. CLS. 47 AND 49).
FIRST USE 0-0-2003; IN COMMERCE 0-0-2003.
ANDREA SAUNDERS, EXAMINING ATTORNEY

SN 77-927,720. INNOVATIVE LIQUORS, LLC, HOLLYWOOD, FL. FILED 2-4-2010.



THE MARK CONSISTS OF STANDARD CHARACTERS WITHOUT CLAIM TO ANY PARTICULAR FONT, STYLE, SIZE, OR COLOR.
FOR DISTILLED SPIRITS; SCOTCH (U.S. CLS. 47 AND 49).
JANET LEE, EXAMINING ATTORNEY

SN 77-928,364. SHAKEN, STIRRED, AND STRAIGHT LLC, PARKER, CO. FILED 2-4-2010.



THE MARK CONSISTS OF STANDARD CHARACTERS WITHOUT CLAIM TO ANY PARTICULAR FONT, STYLE, SIZE, OR COLOR.
FOR SPIRITS (U.S. CLS. 47 AND 49).
TRICIA SONNEBORN, EXAMINING ATTORNEY

SN 77-928,066. COOL HAND VINEYARDS, LLC, SANTA BARBARA, CA. FILED 2-4-2010.



THE MARK CONSISTS OF STANDARD CHARACTERS WITHOUT CLAIM TO ANY PARTICULAR FONT, STYLE, SIZE, OR COLOR.
FOR WINE (U.S. CLS. 47 AND 49).
MARC LEIPZIG, EXAMINING ATTORNEY

SN 77-928,401. TURNBULL WINE CELLARS, FORTUNA, CA. FILED 2-4-2010.



THE MARK CONSISTS OF STANDARD CHARACTERS WITHOUT CLAIM TO ANY PARTICULAR FONT, STYLE, SIZE, OR COLOR.
FOR WINE (U.S. CLS. 47 AND 49).
FIRST USE 3-2-2009; IN COMMERCE 3-2-2009.
CAROLYN CATALDO, EXAMINING ATTORNEY

CLASS 33—(Continued).

SN 77-928,413. TURNBULL WINE CELLARS, FORTUNA, CA. FILED 2-4-2010.

LEOPOLDINA

THE MARK CONSISTS OF STANDARD CHARACTERS WITHOUT CLAIM TO ANY PARTICULAR FONT, STYLE, SIZE, OR COLOR.
FOR WINE (U.S. CLS. 47 AND 49).
CAROLYN CATALDO, EXAMINING ATTORNEY

SN 77-928,504. STARS ALIGN GLOBAL BRANDS & DESIGN LLC, RUTHERFORD, CA. FILED 2-4-2010.

YUM/MUY

THE MARK CONSISTS OF STANDARD CHARACTERS WITHOUT CLAIM TO ANY PARTICULAR FONT, STYLE, SIZE, OR COLOR.
FOR WINE (U.S. CLS. 47 AND 49).
KELLY TRUSILO, EXAMINING ATTORNEY

SN 77-929,146. TOOLBOX WINE CO. LLC, DBA TOOLBOX, NAPA, CA. FILED 2-5-2010.



THE COLOR(S) BLACK AND MAUVE IS/ARE CLAIMED AS A FEATURE OF THE MARK.
THE MARK CONSISTS OF THE WORD "TOOLBOX" IN MAUVE AND BLACK, FORMED BY LETTERS THAT RESEMBLE NUTS, BOLTS, CORKSCREWS, RULERS, AND OTHER TOOLS.
FOR WINE; WINES (U.S. CLS. 47 AND 49).
HELENE LIWINSKI, EXAMINING ATTORNEY

CLASS 33—(Continued).

SN 77-929,178. CLOUD NORTH WINERY, FERRISBURG, VT. FILED 2-5-2010.

Happiness Hard Cider

THE MARK CONSISTS OF STANDARD CHARACTERS WITHOUT CLAIM TO ANY PARTICULAR FONT, STYLE, SIZE, OR COLOR.
NO CLAIM IS MADE TO THE EXCLUSIVE RIGHT TO USE "HARD CIDER", APART FROM THE MARK AS SHOWN.
FOR HARD CIDER (U.S. CLS. 47 AND 49).
ELLEN B. AWRICH, EXAMINING ATTORNEY

SN 77-929,277. SCHMID, PETER F., FORT MYERS, FL. FILED 2-5-2010.

PURE VINEYARDS

THE MARK CONSISTS OF STANDARD CHARACTERS WITHOUT CLAIM TO ANY PARTICULAR FONT, STYLE, SIZE, OR COLOR.
NO CLAIM IS MADE TO THE EXCLUSIVE RIGHT TO USE "VINEYARDS", APART FROM THE MARK AS SHOWN.
FOR WINE (U.S. CLS. 47 AND 49).
MICHAEL GAFFAR, EXAMINING ATTORNEY

SN 77-929,566. ST. LUCIA DISTILLERS LTD., CASTRIES, ST.LUCIA, FILED 2-5-2010.

KWEYOL

THE MARK CONSISTS OF STANDARD CHARACTERS WITHOUT CLAIM TO ANY PARTICULAR FONT, STYLE, SIZE, OR COLOR.
THE ENGLISH TRANSLATION OF "KWEYOL" IN THE MARK IS "CREOLE."
FOR DISTILLED SPIRITS (U.S. CLS. 47 AND 49).
ROBIN MITTLER, EXAMINING ATTORNEY

CLASS 33—(Continued).

SN 77-929,571. ST. LUCIA DISTILLERS LTD., CASTRIES, ST.LUCIA, FILED 2-5-2010.

DENROS

THE MARK CONSISTS OF STANDARD CHARACTERS WITHOUT CLAIM TO ANY PARTICULAR FONT, STYLE, SIZE, OR COLOR.

THE WORDING "DENROS" HAS NO MEANING IN A FOREIGN LANGUAGE.

FOR DISTILLED SPIRITS (U.S. CLS. 47 AND 49).
ROBIN MITTLER, EXAMINING ATTORNEY

SN 77-929,697. WELP, SUE, FALLBROOK, CA. FILED 2-5-2010.

MOTHER CLUCKIN' GOOD WINE

THE MARK CONSISTS OF STANDARD CHARACTERS WITHOUT CLAIM TO ANY PARTICULAR FONT, STYLE, SIZE, OR COLOR.

NO CLAIM IS MADE TO THE EXCLUSIVE RIGHT TO USE "WINE", APART FROM THE MARK AS SHOWN.

FOR WINE; WINES (U.S. CLS. 47 AND 49).
WILLIAM BRECKENFELD, EXAMINING ATTORNEY

SN 77-929,699. WELP, SUE, FALLBROOK, CA. FILED 2-5-2010.

PANTS COMIN' DOWN

THE MARK CONSISTS OF STANDARD CHARACTERS WITHOUT CLAIM TO ANY PARTICULAR FONT, STYLE, SIZE, OR COLOR.

FOR WINE; WINES (U.S. CLS. 47 AND 49).
WILLIAM BRECKENFELD, EXAMINING ATTORNEY

CLASS 33—(Continued).

SN 77-929,702. WELP, SUE, FALLBROOK, CA. FILED 2-5-2010.

L.P.R.

THE MARK CONSISTS OF STANDARD CHARACTERS WITHOUT CLAIM TO ANY PARTICULAR FONT, STYLE, SIZE, OR COLOR.

FOR WINE; WINES (U.S. CLS. 47 AND 49).
WILLIAM BRECKENFELD, EXAMINING ATTORNEY

SN 77-929,753. WILLIAM ALLEN WOOTEN, COVINGTON, TN. FILED 2-6-2010.

Dragon Kiss

THE MARK CONSISTS OF STANDARD CHARACTERS WITHOUT CLAIM TO ANY PARTICULAR FONT, STYLE, SIZE, OR COLOR.

FOR ALCOHOLIC BEVERAGES CONTAINING FRUIT; CREAM LIQUEURS; DISTILLED SPIRITS; SPIRITS AND LIQUEURS; WINES AND LIQUEURS (U.S. CLS. 47 AND 49).

MARGARET POWER, EXAMINING ATTORNEY

SN 77-931,417. DIAGEO CHATEAU & ESTATE WINES COMPANY, NAPA, CA. FILED 2-9-2010.



OWNER OF U.S. REG. NO. 2,132,739.
THE MARK CONSISTS OF A DESIGN OF A PLOW ON A GENTLY SLOPING INCLINE WITH A TREE IN THE BACKGROUND.

FOR ALCOHOLIC BEVERAGES EXCEPT BEERS (U.S. CLS. 47 AND 49).

MIDGE BUTLER, EXAMINING ATTORNEY

CLASS 33—(Continued).

SN 77-932,169. CHAMISAL VINEYARDS, LLC, NAPA, CA.
FILED 2-9-2010.

STAINLESS

THE MARK CONSISTS OF STANDARD CHARACTERS WITHOUT CLAIM TO ANY PARTICULAR FONT, STYLE, SIZE, OR COLOR.
FOR WINE (U.S. CLS. 47 AND 49).
FIRST USE 10-10-2007; IN COMMERCE 10-10-2007.
JANICE L. MCMORROW, EXAMINING ATTORNEY

CLASS 33—(Continued).

SN 77-944,849. CHAMISAL VINEYARDS, LLC, NAPA, CA.
FILED 2-25-2010.

MY PINOT IS BIGGER THAN YOUR PINOT

THE MARK CONSISTS OF STANDARD CHARACTERS WITHOUT CLAIM TO ANY PARTICULAR FONT, STYLE, SIZE, OR COLOR.
FOR WINE (U.S. CLS. 47 AND 49).
JANICE L. MCMORROW, EXAMINING ATTORNEY

SN 77-932,175. SEVENROC HOLDINGS, LLC, SHAKER HEIGHTS, OH. FILED 2-9-2010.

Kingfish Spirits

THE MARK CONSISTS OF STANDARD CHARACTERS WITHOUT CLAIM TO ANY PARTICULAR FONT, STYLE, SIZE, OR COLOR.
NO CLAIM IS MADE TO THE EXCLUSIVE RIGHT TO USE "SPIRITS", APART FROM THE MARK AS SHOWN.
FOR LIQUOR AND LIQUEUR BEVERAGES, NAMELY, A WHIPPED CREAM CONTAINING ALCOHOL (U.S. CLS. 47 AND 49).
FIRST USE 4-1-2009; IN COMMERCE 4-1-2009.
CHERYL CLAYTON, EXAMINING ATTORNEY

SN 77-944,870. UNITED STATES DISTILLED PRODUCTS COMPANY, PRINCETON, MN. FILED 2-25-2010.

JONATHAN DRAKE

THE MARK CONSISTS OF STANDARD CHARACTERS WITHOUT CLAIM TO ANY PARTICULAR FONT, STYLE, SIZE, OR COLOR.
THE NAME(S), PORTRAIT(S), AND/OR SIGNATURE(S) SHOWN IN THE MARK DOES NOT IDENTIFY A PARTICULAR LIVING INDIVIDUAL.
FOR DISTILLED SPIRITS (U.S. CLS. 47 AND 49).
ANN E. SAPPENFIELD, EXAMINING ATTORNEY

SN 77-944,571. UNITED STATES DISTILLED PRODUCTS COMPANY, PRINCETON, MN. FILED 2-25-2010.

ASTYN

THE MARK CONSISTS OF STANDARD CHARACTERS WITHOUT CLAIM TO ANY PARTICULAR FONT, STYLE, SIZE, OR COLOR.
FOR DISTILLED SPIRITS (U.S. CLS. 47 AND 49).
ANN E. SAPPENFIELD, EXAMINING ATTORNEY

SN 77-944,914. UNITED STATES DISTILLED PRODUCTS COMPANY, PRINCETON, MN. FILED 2-25-2010.

LUXURIA

THE MARK CONSISTS OF STANDARD CHARACTERS WITHOUT CLAIM TO ANY PARTICULAR FONT, STYLE, SIZE, OR COLOR.
THE ENGLISH TRANSLATION OF "LUXURIA" IN THE MARK IS "EXTRAVAGANCE".
FOR DISTILLED SPIRITS (U.S. CLS. 47 AND 49).
ANN E. SAPPENFIELD, EXAMINING ATTORNEY

CLASS 33—(Continued).

SN 77-949,423. SUTTER HOME WINERY, INC., ST. HELENA, CA. FILED 3-3-2010.

MARIO'S VINEYARD

THE MARK CONSISTS OF STANDARD CHARACTERS WITHOUT CLAIM TO ANY PARTICULAR FONT, STYLE, SIZE, OR COLOR.

OWNER OF U.S. REG. NO. 2,671,176.

NO CLAIM IS MADE TO THE EXCLUSIVE RIGHT TO USE "VINEYARD", APART FROM THE MARK AS SHOWN. FOR ALCOHOLIC BEVERAGES EXCEPT BEERS (U.S. CLS. 47 AND 49).

FIRST USE 7-15-2009; IN COMMERCE 7-15-2009.

JEFF DEFORD, EXAMINING ATTORNEY

SN 77-950,657. NO LIMIT, LLC, WESTPORT, CT. FILED 3-4-2010.



OWNER OF U.S. REG. NO. 3,236,035.

THE NAME "PAUL NEWMAN" DOES NOT IDENTIFY A LIVING INDIVIDUAL.

THE MARK CONSISTS OF "PAUL NEWMAN"'S SIGNATURE WITH A LINE UNDER THE NAME.

FOR WINE (U.S. CLS. 47 AND 49).

BARBARA BROWN, EXAMINING ATTORNEY

SN 77-960,304. ALTVATER GESSLER - J. A. BACZEWSKI INTERNATIONAL (USA) INC., FORT LEE, NJ. FILED 3-16-2010.



THE MARK CONSISTS OF THE STYLIZED LETTERS "JAB" WITH THE RIGHT SIDE OF THE LETTER "A" EXTENDING DOWNWARD TO FORM THE BASE OF A TRAY HOLDING A MARTINI GLASS ON EACH SIDE.

FOR VODKA AND GIN (U.S. CLS. 47 AND 49).

FIRST USE 0-0-1960; IN COMMERCE 0-0-1969.

NAAKWAMA ANKRAH, EXAMINING ATTORNEY

CLASS 33—(Continued).

SN 77-964,899. DIAGEO CHATEAU & ESTATE WINES COMPANY, NAPA, CA. FILED 3-22-2010.



OWNER OF U.S. REG. NOS. 2,536,209, 3,696,412 AND 3,761,236.

NO CLAIM IS MADE TO THE EXCLUSIVE RIGHT TO USE "BOTTLE NO." AND "TRADITIONAL COPPER POT DISTILLED" AND "MASTER DISTILLER", APART FROM THE MARK AS SHOWN.

THE NAME(S), PORTRAIT(S), AND/OR SIGNATURE(S) SHOWN IN THE MARK IDENTIFIES "GERALD WEBB", WHOSE CONSENT(S) TO REGISTER IS MADE OF RECORD.

THE MARK CONSISTS OF A RECTANGULAR LABEL DESIGN WITH THE TOP PORTION CUT OUT TO RESEMBLE A MOON AND MOUNTAIN PEAKS. THE WORDS "MOON MOUNTAIN" APPEAR IN THE CENTER WITH A DESIGN OF MOUNTAINS, CLOUDS, AND AN ANIMAL. THE LOWER PORTION OF THE LABEL IS DIVIDED INTO SIX BOXES. THE WORDS "BOTTLE NO." AND "TRADITIONAL COPPER POT DISTILLED" APPEAR IN TWO OF THE BOXES, AND A SEAL DESIGN WITH THE WORDS "MASTER DISTILLER" IN BLOCK LETTERS AND THE NAME "GERRY WEBB" IN SCRIPT LETTERS APPEAR IN A THIRD BOX.

FOR ALCOHOLIC BEVERAGES EXCEPT BEERS (U.S. CLS. 47 AND 49).

MIDGE BUTLER, EXAMINING ATTORNEY

SN 77-965,012. DIAGEO CHATEAU & ESTATE WINES COMPANY, NAPA, CA. FILED 3-22-2010.



OWNER OF U.S. REG. NO. 2,955,047.

THE MARK CONSISTS OF STYLIZED LETTERS IN A COLLAGE DESIGN WHICH SPELL THE WORD "ENSEMBLE".

FOR ALCOHOLIC BEVERAGES EXCEPT BEERS (U.S. CLS. 47 AND 49).

MIDGE BUTLER, EXAMINING ATTORNEY

CLASS 33—(Continued).

SN 79-048,964. ZAKRITE AKCIONERNE TOVARISTVO; "ALEF-VINAL", UKRAINE, FILED 12-4-2007.

Українка

OWNER OF INTERNATIONAL REGISTRATION 0950741 DATED 12-4-2007, EXPIRES 12-4-2017.

THE TRANSLATION OF THE MARK "UKRAINKA" IS "UKRAINIAN GIRL".

THE TRANSLITERATION OF THE NON-LATIN CHARACTERS IN THE MARK IS: UKRAINKA.

FOR ALCOHOLIC BEVERAGES, NAMELY, VODKA, IN THIS CLASS (U.S. CLS. 47 AND 49).

DARRYL SPRUILL, EXAMINING ATTORNEY

SN 79-066,989. CHATEAU PAVIE; SOCIETE CIVILE AGRICOLE, SAINT EMILION, FRANCE, FILED 3-6-2009.



PRIORITY DATE OF 3-3-2009 IS CLAIMED. OWNER OF INTERNATIONAL REGISTRATION 0997987 DATED 3-6-2009, EXPIRES 3-6-2019.

OWNER OF U.S. REG. NOS. 1,615,975 AND 2,024,815. NO CLAIM IS MADE TO THE EXCLUSIVE RIGHT TO USE "CHATEAU", APART FROM THE MARK AS SHOWN.

THE COLOR(S) GREEN, BEIGE AND BLACK IS/ARE CLAIMED AS A FEATURE OF THE MARK.

REPRESENTATION OF A VINEYARD IN GREEN ON A LABEL BACKGROUND IN CREAM.

THE MARK CONSISTS OF A RECTANGLE IN THE COLOR BEIGE. ON THE TOP HALF OF THE RECTANGLE IS A SMALLER RECTANGLE OUTLINED IN THE COLOR BLACK. INSIDE THIS RECTANGLE APPEARS A VINEYARD IN THE COLORS GREEN, BLACK AND BEIGE, BELOW A BEIGE SKY WITH PATCHES OF BLACK. ON THE BOTTOM HALF OF THE LARGE BEIGE RECTANGLE APPEARS THE WORDING "CHATEAU PAVIE" IN THE COLOR BLACK.

FOR WINES WITH CERTIFIED LABEL OF ORIGIN (AOC WINES) (U.S. CLS. 47 AND 49).

MICHAEL WIENER, EXAMINING ATTORNEY

CLASS 33—(Continued).

SN 79-068,250. CHATEAU PAVIE SOCIETE CIVILE AGRICOLE, SAINT-EMILION, FRANCE, FILED 3-3-2009.



OWNER OF INTERNATIONAL REGISTRATION 0767949 DATED 10-1-2001, EXPIRES 10-1-2011.

OWNER OF U.S. REG. NOS. 1,615,975 AND 2,024,815. NO CLAIM IS MADE TO THE EXCLUSIVE RIGHT TO USE "CHATEAU" AND "1998", APART FROM THE MARK AS SHOWN.

THE MARK CONSISTS OF THE TERMS "CHATEAU PAVIE DECESSE 1998". STYLIZED LINES GO FROM ONE SIDE OF THE TERMS, UNDERNEATH THE WORDING TO THE OTHER SIDE OF THE WORDING. ABOVE THE TERM "CHATEAU" ARE THE DESIGN OF A CROWN WITH UNICORNS ON EACH SIDE. BENEATH THESE ELEMENTS IS A CHATEAU WITH A VINEYARD IN FRONT.

THE WORDING "PAVIE" AND "DECESS" HAS NO MEANING IN A FOREIGN LANGUAGE.

FOR WINE (U.S. CLS. 47 AND 49).

MICHAEL WIENER, EXAMINING ATTORNEY

SN 79-071,650. VINOS PIÑOL, S.L., SPAIN, FILED 7-30-2009.



OWNER OF INTERNATIONAL REGISTRATION 1009669 DATED 7-30-2009, EXPIRES 7-30-2019.

NO CLAIM IS MADE TO THE EXCLUSIVE RIGHT TO USE "VINYA", APART FROM THE MARK AS SHOWN.

THE ENGLISH TRANSLATION OF THE FOREIGN WORD(S) IN THE MARK IS: "VINEYARD OF OUR LADY OF THE DOORWAY."

FOR WINE (U.S. CLS. 47 AND 49).

KELLY TRUSILO, EXAMINING ATTORNEY

CLASS 33—(Continued).

SN 79-072,871. CASTEL FRERES, FRANCE, FILED 8-12-2009.

MALESAN

THE MARK CONSISTS OF STANDARD CHARACTERS WITHOUT CLAIM TO ANY PARTICULAR FONT, STYLE, SIZE, OR COLOR.

OWNER OF INTERNATIONAL REGISTRATION 1013204 DATED 8-12-2009, EXPIRES 8-12-2019.

THE WORDING "MALESAN" HAS NO MEANING IN A FOREIGN LANGUAGE.

FOR WINES, SPIRITS AND LIQUEURS AND EAUX-DE-VIE (U.S. CLS. 47 AND 49).

STEPHANIE ALI, EXAMINING ATTORNEY

SN 79-072,872. CASTEL FRERES, FRANCE, FILED 8-12-2009.

ROCHEMAZET

THE MARK CONSISTS OF STANDARD CHARACTERS WITHOUT CLAIM TO ANY PARTICULAR FONT, STYLE, SIZE, OR COLOR.

OWNER OF INTERNATIONAL REGISTRATION 1013205 DATED 8-12-2009, EXPIRES 8-12-2019.

THE WORDING "ROZEMAZET" HAS NO MEANING IN A FOREIGN LANGUAGE.

FOR WINES (U.S. CLS. 47 AND 49).

STEPHANIE ALI, EXAMINING ATTORNEY

SN 79-072,873. CASTEL FRERES, FRANCE, FILED 8-12-2009.

MONTALCOUR

THE MARK CONSISTS OF STANDARD CHARACTERS WITHOUT CLAIM TO ANY PARTICULAR FONT, STYLE, SIZE, OR COLOR.

OWNER OF INTERNATIONAL REGISTRATION 1013206 DATED 8-12-2009, EXPIRES 8-12-2019.

THE WORDING "MONTALCOUR" HAS NO MEANING IN A FOREIGN LANGUAGE.

FOR ALCOHOLIC BEVERAGES EXCEPT BEERS (U.S. CLS. 47 AND 49).

STEPHANIE ALI, EXAMINING ATTORNEY

SN 79-072,874. CASTEL FRERES, FRANCE, FILED 8-12-2009.

VIRGINIE

THE MARK CONSISTS OF STANDARD CHARACTERS WITHOUT CLAIM TO ANY PARTICULAR FONT, STYLE, SIZE, OR COLOR.

OWNER OF INTERNATIONAL REGISTRATION 1013207 DATED 8-12-2009, EXPIRES 8-12-2019.

THE WORDING "VIRGINIE" HAS NO MEANING IN A FOREIGN LANGUAGE.

FOR WINES (U.S. CLS. 47 AND 49).

STEPHANIE ALI, EXAMINING ATTORNEY

CLASS 33—(Continued).

SN 79-072,875. CASTEL FRERES, FRANCE, FILED 8-12-2009.

COMBE SAINT SAUVEUR

THE MARK CONSISTS OF STANDARD CHARACTERS WITHOUT CLAIM TO ANY PARTICULAR FONT, STYLE, SIZE, OR COLOR.

OWNER OF INTERNATIONAL REGISTRATION 1013208 DATED 8-12-2009, EXPIRES 8-12-2019.

THE NAME(S), PORTRAIT(S), AND/OR SIGNATURE(S) SHOWN IN THE MARK DOES NOT IDENTIFY A PARTICULAR LIVING INDIVIDUAL.

THE WORDING "COMBE SAINT SAUVEUR" HAS NO MEANING IN A FOREIGN LANGUAGE.

FOR WINES (U.S. CLS. 47 AND 49).

STEPHANIE ALI, EXAMINING ATTORNEY

SN 85-000,613. SUTTER HOME WINERY, INC., ST. HELENA, CA. FILED 3-29-2010.

SIDE KICK

THE MARK CONSISTS OF STANDARD CHARACTERS WITHOUT CLAIM TO ANY PARTICULAR FONT, STYLE, SIZE, OR COLOR.

FOR ALCOHOLIC BEVERAGES EXCEPT BEERS (U.S. CLS. 47 AND 49).

JEFF DEFORD, EXAMINING ATTORNEY

SN 85-006,723. SUTTER HOME WINERY, INC., ST. HELENA, CA. FILED 4-5-2010.

CONSTABLE

THE MARK CONSISTS OF STANDARD CHARACTERS WITHOUT CLAIM TO ANY PARTICULAR FONT, STYLE, SIZE, OR COLOR.

FOR ALCOHOLIC BEVERAGES EXCEPT BEERS (U.S. CLS. 47 AND 49).

JEFF DEFORD, EXAMINING ATTORNEY

SN 85-008,290. CHAMISAL VINEYARDS, LLC, NAPA, CA. FILED 4-7-2010.

LUMINARY

THE MARK CONSISTS OF STANDARD CHARACTERS WITHOUT CLAIM TO ANY PARTICULAR FONT, STYLE, SIZE, OR COLOR.

FOR WINE (U.S. CLS. 47 AND 49).

JANICE L. MCMORROW, EXAMINING ATTORNEY

CLASS 34—SMOKERS' ARTICLES

SN 77-789,542. TRADEMARK HOLDINGS CORPORATION,
MAYODAN, NC. FILED 7-24-2009.

GT ONE LITE

THE MARK CONSISTS OF STANDARD CHARACTERS
WITHOUT CLAIM TO ANY PARTICULAR FONT, STYLE,
SIZE, OR COLOR.

OWNER OF U.S. REG. NOS. 2,439,315 AND 2,755,251.
NO CLAIM IS MADE TO THE EXCLUSIVE RIGHT TO
USE "LITE", APART FROM THE MARK AS SHOWN.
FOR CIGARETTES (U.S. CLS. 2, 8, 9 AND 17).
ODESSA BIBBINS, EXAMINING ATTORNEY

SN 77-789,969. BLACK HAWK TOBACCO, INC., PALM
SPRINGS, CA. FILED 7-27-2009.

FANTASY

THE MARK CONSISTS OF STANDARD CHARACTERS
WITHOUT CLAIM TO ANY PARTICULAR FONT, STYLE,
SIZE, OR COLOR.

FOR TOBACCO PRODUCTS, NAMELY, CIGARETTES
AND CIGARS (U.S. CLS. 2, 8, 9 AND 17).
KAPIL BHANOT, EXAMINING ATTORNEY

SN 77-797,992. TATUAJE CIGARS, INC., LOS ANGELES, CA.
FILED 8-5-2009.

SINGLE FARM VINTAGE

THE MARK CONSISTS OF STANDARD CHARACTERS
WITHOUT CLAIM TO ANY PARTICULAR FONT, STYLE,
SIZE, OR COLOR.

NO CLAIM IS MADE TO THE EXCLUSIVE RIGHT TO
USE "SINGLE FARM", APART FROM THE MARK AS
SHOWN.
FOR CIGAR BOXES; CIGARS (U.S. CLS. 2, 8, 9 AND
17).
HANNO RITTNER, EXAMINING ATTORNEY

CLASS 34—(Continued).

SN 77-804,992. TATUAJE CIGARS, INC., LOS ANGELES, CA.
FILED 8-14-2009.

EL TRIUNFADOR

THE MARK CONSISTS OF STANDARD CHARACTERS
WITHOUT CLAIM TO ANY PARTICULAR FONT, STYLE,
SIZE, OR COLOR.

THE ENGLISH TRANSLATION OF THE WORD "EL
TRIUNFADOR" IN THE MARK IS "THE TRIUMPHANT".
FOR CIGAR BOXES; CIGARS (U.S. CLS. 2, 8, 9 AND
17).
FIRST USE 9-10-2008; IN COMMERCE 9-10-2008.
HANNO RITTNER, EXAMINING ATTORNEY

SN 77-822,733. NABIL M. LAWANDY, SAUNDERSTOWN,
RI. FILED 9-9-2009.

GOLDEN ASH

THE MARK CONSISTS OF STANDARD CHARACTERS
WITHOUT CLAIM TO ANY PARTICULAR FONT, STYLE,
SIZE, OR COLOR.

FOR CIGARS (U.S. CLS. 2, 8, 9 AND 17).
TINA L. SNAPP, EXAMINING ATTORNEY

SN 77-889,224. C.A.T. TOBACCO CORP., AKA TORAÑO
CIGARS, MIAMI, FL. FILED 12-9-2009.

VAULT

THE MARK CONSISTS OF STANDARD CHARACTERS
WITHOUT CLAIM TO ANY PARTICULAR FONT, STYLE,
SIZE, OR COLOR.

FOR CIGARS (U.S. CLS. 2, 8, 9 AND 17).
JILL PRATER, EXAMINING ATTORNEY

CLASS 34—(Continued).

SN 77-914,891. SMOKE FREELY, LLC, PHOENIX, AZ. FILED 1-19-2010.

Prado

THE MARK CONSISTS OF STANDARD CHARACTERS WITHOUT CLAIM TO ANY PARTICULAR FONT, STYLE, SIZE, OR COLOR.

THE ENGLISH TRANSLATION OF "PRADO" IS "MEADOW".

FOR ELECTRONIC CIGARETTES FOR USE AS AN ALTERNATIVE TO TRADITIONAL CIGARETTES (U.S. CLS. 2, 8, 9 AND 17).

FIRST USE 12-0-2009; IN COMMERCE 12-0-2009.
AMY KERTGATE, EXAMINING ATTORNEY

SN 77-918,466. DAHER, ALAN, SALISBURY, NC. FILED 1-22-2010.

Click "n" Stick Lighters

THE MARK CONSISTS OF STANDARD CHARACTERS WITHOUT CLAIM TO ANY PARTICULAR FONT, STYLE, SIZE, OR COLOR.

NO CLAIM IS MADE TO THE EXCLUSIVE RIGHT TO USE "LIGHTERS", APART FROM THE MARK AS SHOWN. SEC. 2(F).

FOR CIGARETTE LIGHTERS NOT FOR LAND VEHICLES (U.S. CLS. 2, 8, 9 AND 17).
JILL C. ALT, EXAMINING ATTORNEY

SN 77-921,227. INTERMATCH SWEDEN AB, STOCKHOLM, SWEDEN, FILED 1-27-2010.

SERIE R N

THE MARK CONSISTS OF STANDARD CHARACTERS WITHOUT CLAIM TO ANY PARTICULAR FONT, STYLE, SIZE, OR COLOR.

OWNER OF U.S. REG. NO. 2,780,299.
NO CLAIM IS MADE TO THE EXCLUSIVE RIGHT TO USE "SERIE", APART FROM THE MARK AS SHOWN.

THE ENGLISH TRANSLATION OF "SERIE" IN THE MARK IS "SERIES".

FOR CIGARS (U.S. CLS. 2, 8, 9 AND 17).
LOURDES AYALA, EXAMINING ATTORNEY

CLASS 34—(Continued).

SN 77-921,236. INTERMATCH SWEDEN AB, STOCKHOLM, SWEDEN, FILED 1-27-2010.

SERIE N

THE MARK CONSISTS OF STANDARD CHARACTERS WITHOUT CLAIM TO ANY PARTICULAR FONT, STYLE, SIZE, OR COLOR.

OWNER OF U.S. REG. NO. 2,780,299.
NO CLAIM IS MADE TO THE EXCLUSIVE RIGHT TO USE "SERIE", APART FROM THE MARK AS SHOWN.

THE ENGLISH TRANSLATION OF "SERIE" IN THE MARK IS "SERIES".

FOR CIGARS (U.S. CLS. 2, 8, 9 AND 17).
LOURDES AYALA, EXAMINING ATTORNEY

SN 77-923,429. SOCIAL SMOKE, INC., ARLINGTON, TX. FILED 1-29-2010.

CINAMINT

THE MARK CONSISTS OF STANDARD CHARACTERS WITHOUT CLAIM TO ANY PARTICULAR FONT, STYLE, SIZE, OR COLOR.

FOR TOBACCO (U.S. CLS. 2, 8, 9 AND 17).
FIRST USE 12-28-2009; IN COMMERCE 12-28-2009.
LEIGH CAROLINE CASE, EXAMINING ATTORNEY

SN 77-923,688. PHILIP MORRIS USA INC., RICHMOND, VA. FILED 1-29-2010.

MARLBORO BLEND NO. 52

THE MARK CONSISTS OF STANDARD CHARACTERS WITHOUT CLAIM TO ANY PARTICULAR FONT, STYLE, SIZE, OR COLOR.

OWNER OF U.S. REG. NOS. 632,881, 1,039,412 AND 2,985,808.
NO CLAIM IS MADE TO THE EXCLUSIVE RIGHT TO USE "BLEND", APART FROM THE MARK AS SHOWN.

FOR TOBACCO, RAW OR MANUFACTURED, NAMELY, CIGARS, CIGARETTES, CIGARILLOS, TOBACCO FOR ROLL YOUR OWN CIGARETTES, PIPE TOBACCO, CHEWING TOBACCO, SNUFF TOBACCO, TOBACCO SUBSTITUTES NOT FOR MEDICAL PURPOSES; SMOKERS' ARTICLES, NAMELY, CIGARETTE PAPER AND TUBES, CIGARETTE FILTERS, TOBACCO TINS, CIGARETTE CASES AND ASHTRAYS NOT OF PRECIOUS METALS, THEIR ALLOYS OR COATED THEREWITH; SMOKING PIPES, POCKET APPARATUS FOR ROLLING CIGARETTES, LIGHTERS NOT OF PRECIOUS METALS, AND MATCHES (U.S. CLS. 2, 8, 9 AND 17).

KATHERINE M. DUBRAY, EXAMINING ATTORNEY

CLASS 34—(Continued).

SN 77-923,698. PHILIP MORRIS USA INC., RICHMOND, VA.
FILED 1-29-2010.

MARLBORO BLEND NO. 56

THE MARK CONSISTS OF STANDARD CHARACTERS WITHOUT CLAIM TO ANY PARTICULAR FONT, STYLE, SIZE, OR COLOR.

OWNER OF U.S. REG. NOS. 632,881, 1,039,412 AND 2,985,808.

NO CLAIM IS MADE TO THE EXCLUSIVE RIGHT TO USE "BLEND", APART FROM THE MARK AS SHOWN.

FOR TOBACCO, RAW OR MANUFACTURED, NAMELY, CIGARS, CIGARETTES, CIGARILLOS, TOBACCO FOR ROLL YOUR OWN CIGARETTES, PIPE TOBACCO, CHEWING TOBACCO, SNUFF TOBACCO, TOBACCO SUBSTITUTES NOT FOR MEDICAL PURPOSES; SMOKERS' ARTICLES, NAMELY, CIGARETTE PAPER AND TUBES, CIGARETTE FILTERS, TOBACCO TINS, CIGARETTE CASES AND ASHTRAYS NOT OF PRECIOUS METALS, THEIR ALLOYS OR COATED THEREWITH; SMOKING PIPES, POCKET APPARATUS FOR ROLLING CIGARETTES, LIGHTERS NOT OF PRECIOUS METALS, AND MATCHES (U.S. CLS. 2, 8, 9 AND 17).

KATHERINE M. DUBRAY, EXAMINING ATTORNEY

SN 77-923,727. PHILIP MORRIS USA INC., RICHMOND, VA.
FILED 1-29-2010.

MARLBORO BLEND NO. 89

THE MARK CONSISTS OF STANDARD CHARACTERS WITHOUT CLAIM TO ANY PARTICULAR FONT, STYLE, SIZE, OR COLOR.

OWNER OF U.S. REG. NOS. 632,881, 1,039,412 AND 2,985,808.

NO CLAIM IS MADE TO THE EXCLUSIVE RIGHT TO USE "BLEND", APART FROM THE MARK AS SHOWN.

FOR TOBACCO, RAW OR MANUFACTURED, NAMELY, CIGARS, CIGARETTES, CIGARILLOS, TOBACCO FOR ROLL YOUR OWN CIGARETTES, PIPE TOBACCO, CHEWING TOBACCO, SNUFF TOBACCO, TOBACCO SUBSTITUTES NOT FOR MEDICAL PURPOSES; SMOKERS' ARTICLES, NAMELY, CIGARETTE PAPER AND TUBES, CIGARETTE FILTERS, TOBACCO TINS, CIGARETTE CASES AND ASHTRAYS NOT OF PRECIOUS METALS, THEIR ALLOYS OR COATED THEREWITH; SMOKING PIPES, POCKET APPARATUS FOR ROLLING CIGARETTES, LIGHTERS NOT OF PRECIOUS METALS, AND MATCHES (U.S. CLS. 2, 8, 9 AND 17).

KATHERINE M. DUBRAY, EXAMINING ATTORNEY

CLASS 34—(Continued).

SN 77-923,770. NATIONAL TOBACCO COMPANY, L.P.,
LOUISVILLE, KY. FILED 1-29-2010.

PEACH FRENZY

THE MARK CONSISTS OF STANDARD CHARACTERS WITHOUT CLAIM TO ANY PARTICULAR FONT, STYLE, SIZE, OR COLOR.

NO CLAIM IS MADE TO THE EXCLUSIVE RIGHT TO USE "PEACH", APART FROM THE MARK AS SHOWN.

FOR CIGAR WRAPS (U.S. CLS. 2, 8, 9 AND 17).

FIRST USE 4-2-2009; IN COMMERCE 4-2-2009.

SANI KHOURI, EXAMINING ATTORNEY

SN 77-926,747. BAR-CIG-EE, LYNNWOOD, WA. FILED 2-3-2010.

BAR-CIG-EE

THE MARK CONSISTS OF STANDARD CHARACTERS WITHOUT CLAIM TO ANY PARTICULAR FONT, STYLE, SIZE, OR COLOR.

FOR ELECTRONIC CIGARETTES (U.S. CLS. 2, 8, 9 AND 17).

FIRST USE 9-30-2009; IN COMMERCE 12-22-2009.

SIMON TENG, EXAMINING ATTORNEY

SN 77-929,917. CASEY, ROBERT A., HOWELL, NJ. AND
JOHAL, AJMAR S., CARTERET, NJ. FILED 2-7-2010.

Ms. Menthol

THE MARK CONSISTS OF STANDARD CHARACTERS WITHOUT CLAIM TO ANY PARTICULAR FONT, STYLE, SIZE, OR COLOR.

NO CLAIM IS MADE TO THE EXCLUSIVE RIGHT TO USE "MENTHOL", APART FROM THE MARK AS SHOWN.

FOR CIGARETTES (U.S. CLS. 2, 8, 9 AND 17).

JENNIFER DIXON, EXAMINING ATTORNEY

CLASS 34—(Continued).

SN 77-930,328. SMOKE INN, LLC, WEST PALM BEACH, FL.
FILED 2-8-2010.

ANARCHY

THE MARK CONSISTS OF STANDARD CHARACTERS
WITHOUT CLAIM TO ANY PARTICULAR FONT, STYLE,
SIZE, OR COLOR.
FOR CIGARS (U.S. CLS. 2, 8, 9 AND 17).
COLLEEN KEARNEY, EXAMINING ATTORNEY

CLASS 34—(Continued).

SN 77-953,475. BBK TOBACCO & FOODS, LLP, DBA HBI
INTERNATIONAL, PHOENIX, AZ. FILED 3-8-2010.

HEMPIRE

THE MARK CONSISTS OF STANDARD CHARACTERS
WITHOUT CLAIM TO ANY PARTICULAR FONT, STYLE,
SIZE, OR COLOR.
FOR CIGARETTE PAPERS; CIGARETTE ROLLING
PAPERS (U.S. CLS. 2, 8, 9 AND 17).
FIRST USE 10-31-2005; IN COMMERCE 10-31-2005.
EDWARD NELSON, EXAMINING ATTORNEY

SN 77-933,026. CALICO BRANDS, INC., ONTARIO, CA.
FILED 2-10-2010.

DNA

THE MARK CONSISTS OF STANDARD CHARACTERS
WITHOUT CLAIM TO ANY PARTICULAR FONT, STYLE,
SIZE, OR COLOR.
FOR DISPOSABLE CIGARETTE LIGHTERS (U.S. CLS.
2, 8, 9 AND 17).
FIRST USE 2-1-2008; IN COMMERCE 2-1-2008.
B. PARADEWELAI, EXAMINING ATTORNEY

SN 77-955,167. BBK TOBACCO & FOODS, LLP, DBA HBI
INTERNATIONAL, PHOENIX, AZ. FILED 3-10-2010.

HERBIES

THE MARK CONSISTS OF STANDARD CHARACTERS
WITHOUT CLAIM TO ANY PARTICULAR FONT, STYLE,
SIZE, OR COLOR.
FOR CIGARS (U.S. CLS. 2, 8, 9 AND 17).
EDWARD NELSON, EXAMINING ATTORNEY

SN 77-953,188. BBK TOBACCO & FOODS, LLP, DBA HBI
INTERNATIONAL, PHOENIX, AZ. FILED 3-8-2010.

BLACK N' BLUEBERRY

THE MARK CONSISTS OF STANDARD CHARACTERS
WITHOUT CLAIM TO ANY PARTICULAR FONT, STYLE,
SIZE, OR COLOR.

NO CLAIM IS MADE TO THE EXCLUSIVE RIGHT TO
USE "BLUEBERRY", APART FROM THE MARK AS
SHOWN.

FOR CIGAR TUBES; CIGAR WRAPS; CIGARETTE
PAPERS; CIGARETTE ROLLING PAPERS; CIGARS
(U.S. CLS. 2, 8, 9 AND 17).

FIRST USE 3-24-2005; IN COMMERCE 3-24-2005.
EDWARD NELSON, EXAMINING ATTORNEY

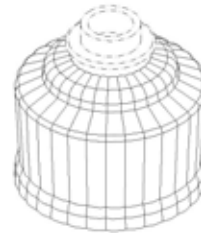

SN 77-959,010. MYA SARAY, LLC, STERLING, VA. FILED 3-
15-2010.

THE MARK CONSISTS OF A THREE-DIMENSIONAL
CONFIGURATION OF A HOOKAH BASE THAT IS GEN-
ERALLY CIRCULAR IN DESIGN AND HAS SEVERAL
GRADUATED LEVELS. THE MATERIAL SHOWN IN BRO-
KEN LINES IS NOT PART OF THE MARK.

SEC. 2(F).

FOR HOOKAHS (U.S. CLS. 2, 8, 9 AND 17).

FIRST USE 11-7-2005; IN COMMERCE 11-7-2005.

SHARON MEIER, EXAMINING ATTORNEY

CLASS 34—(Continued).

SN 77-965,559. MAX ROHR, INC., WILMINGTON, DE. FILED 3-23-2010.

CLASS 35—(Continued).

SN 76-700,312. HUNTER, JEFFREY BLACKFOOT, NEW YORK, NY. FILED 11-10-2009.

KROME

THE MARK CONSISTS OF STANDARD CHARACTERS WITHOUT CLAIM TO ANY PARTICULAR FONT, STYLE, SIZE, OR COLOR.
FOR CIGARS (U.S. CLS. 2, 8, 9 AND 17).
TINA MAI, EXAMINING ATTORNEY

SERVICE MARKS

CLASS 35—ADVERTISING AND BUSINESS

SN 76-695,440. TENNESSEE ACADEMY OF PHYSICIAN ASSISTANTS, MT. JULIET, TN. FILED 1-26-2009.

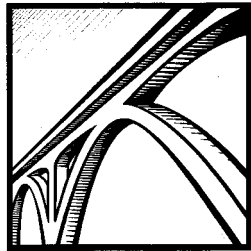

T A P A
TENNESSEE ACADEMY OF
PHYSICIAN ASSISTANTS

NO CLAIM IS MADE TO THE EXCLUSIVE RIGHT TO USE "T A P A TENNESSEE ACADEMY OF PHYSICIAN ASSISTANTS", APART FROM THE MARK AS SHOWN.

THE MARK CONSISTS OF A DESIGN ELEMENT COMPRISING A RECTANGLE CONTAINING A BRIDGE AND THE LITERAL ELEMENTS "T A P A TENNESSEE ACADEMY OF PHYSICIAN ASSISTANTS".

FOR ASSOCIATION SERVICES, NAMELY, PROMOTING THE INTERESTS, GOALS AND OBJECTIVES OF THE PHYSICIAN ASSISTANT COMMUNITY THROUGH PROGRAMS, PUBLICATIONS AND OTHER COMMUNICATIONS IN THE FIELD OF SCIENCE AND MEDICINE (U.S. CLS. 100, 101 AND 102).

FIRST USE 8-1-2008; IN COMMERCE 8-1-2008.
PAUL MORENO, EXAMINING ATTORNEY

NO CLAIM IS MADE TO THE EXCLUSIVE RIGHT TO USE ".COM", APART FROM THE MARK AS SHOWN.

THE COLOR(S) BLUE, LIGHT BLUE, LIGHT GRAY AND WHITE IS/ARE CLAIMED AS A FEATURE OF THE MARK.

THE MARK CONSIST OF A BLUE STYLIZED GLOBE WITH WHITE, LIGHT GRAY, BLUE AND LIGHT BLUE LATITUDE AND LONGITUDE LINES CONTAINING THE WHITE AND LIGHT GRAY STYLIZED WORDING "WHAT'S HOT IN HIP HOP .COM" ABOVE THE STYLIZED WORDING "IF IT'S NOT HERE IT'S NOT HOT" IN LIGHT GRAY WITH A BLUE BORDER.

FOR ADVERTISING SERVICES, ONLINE ADVERTISING SERVICES, ONLINE RETAIL STORE, FEATURING DOWNLOADABLES, PRERECORDED MUSIC AND VIDEO, RING TONES AND PICTURES (U.S. CLS. 100, 101 AND 102).

KRISTINA MORRIS, EXAMINING ATTORNEY

CLASS 35—(Continued).

SN 77-089,944. XINHUA FINANCE MEDIA LIMITED, GEORGE TOWN, CAYMAN ISLANDS, FILED 1-24-2007.



PRIORITY CLAIMED UNDER SEC. 44(D) ON HONG KONG APPLICATION NO. 300799787. FILED 1-18-2007, REG. NO. 300799787, DATED 1-18-2007. EXPIRES 1-17-2017.

OWNER OF U.S. REG. NOS. 3,119,085, 3,180,457 AND OTHERS.

NO CLAIM IS MADE TO THE EXCLUSIVE RIGHT TO USE "FINANCE MEDIA", APART FROM THE MARK AS SHOWN.

THE COLOR(S) BLACK, ORANGE AND SILVER IS/ARE CLAIMED AS A FEATURE OF THE MARK.

THE MARK CONSISTS OF A CHINESE CHARACTER APPEARING IN THE COLORS SILVER AND ORANGE, THE WORDS "XINHUA FINANCE" IN A LOWER CASE, STYLIZED FONT IN THE COLOR BLACK, AND THE WORD "MEDIA," ALSO IN A LOWER CASE, STYLIZED FONT APPEARING IN THE COLOR ORANGE.

THE ENGLISH TRANSLATION OF "XINHUA" IN THE MARK IS "NEW CHINA".

THE NON-LATIN CHARACTER IN THE MARK TRANSLITERATES TO "XIN", AND THIS MEANS NEW IN ENGLISH.

FOR ADVERTISING; BUSINESS RESEARCH; MARKETING STUDIES AND MARKETING RESEARCH (U.S. CLS. 100, 101 AND 102).

NAKIA HENRY, EXAMINING ATTORNEY

CLASS 35—(Continued).

SN 77-280,630. HIP VENTURE COMPANY, INC., PEN ARGYL, PA. FILED 9-16-2007.



NO CLAIM IS MADE TO THE EXCLUSIVE RIGHT TO USE "CO", APART FROM THE MARK AS SHOWN.

THE COLOR(S) BLACK AND WHITE IS/ARE CLAIMED AS A FEATURE OF THE MARK.

THE MARK CONSISTS OF THE STYLIZED WORDING "HIP" IN WHITE AND "HELP IMPROVE THE PLANET HIP VENTURE CO" IN BLACK AROUND A BLACK CIRCLE, WITH BLACK DOTS ON EITHER SIDE OF "HIP VENTURE CO" AND A WHITE LEAF IMAGE WITH BLACK HIGHLIGHTS AS THE DOT OF THE "I" IN THE WORD "HIP" WHICH IS ARRANGED DIAGONALLY ON THE BLACK CIRCLE.

FOR BUSINESS MARKETING SERVICES (U.S. CLS. 100, 101 AND 102).

FIRST USE 9-10-2007; IN COMMERCE 9-10-2007.
HOWARD B. LEVINE, EXAMINING ATTORNEY

SN 77-207,691. SJOVIK LIMITED, ST. PETER PORT, GUERNSEY, FILED 6-15-2007.

POP BEAUTY SODA BAR

THE MARK CONSISTS OF STANDARD CHARACTERS WITHOUT CLAIM TO ANY PARTICULAR FONT, STYLE, SIZE, OR COLOR.

OWNER OF U.S. REG. NOS. 2,859,740 AND 2,859,741.
NO CLAIM IS MADE TO THE EXCLUSIVE RIGHT TO USE "BEAUTY", APART FROM THE MARK AS SHOWN.

FOR RETAIL STORE SERVICES FEATURING COSMETICS, NON-MEDICATED SKIN CARE PREPARATIONS AND BODY AND BEAUTY CARE COSMETICS (U.S. CLS. 100, 101 AND 102).

INGRID C. EULIN, EXAMINING ATTORNEY

SN 77-350,229. JULIE T. ANNÉ, PH.D, SCOTTSDALE, AZ. FILED 12-12-2007.

LIVE GREEN FOR ME

THE MARK CONSISTS OF STANDARD CHARACTERS WITHOUT CLAIM TO ANY PARTICULAR FONT, STYLE, SIZE, OR COLOR.

NO CLAIM IS MADE TO THE EXCLUSIVE RIGHT TO USE "GREEN", APART FROM THE MARK AS SHOWN.

FOR PROMOTING PUBLIC AWARENESS OF ENVIRONMENTAL ISSUES (U.S. CLS. 100, 101 AND 102).

DAWN FELDMAN, EXAMINING ATTORNEY

CLASS 35—(Continued).

SN 77-474,434. THE CRITICAL PATH INSTITUTE (C-PATH), TUCSON, AZ. FILED 5-14-2008.



OWNER OF U.S. REG. NOS. 3,342,298 AND 3,377,391.
NO CLAIM IS MADE TO THE EXCLUSIVE RIGHT TO USE "CRITICAL PATH INSTITUTE", APART FROM THE MARK AS SHOWN.

THE COLOR(S) BLUE AND YELLOW IS/ARE CLAIMED AS A FEATURE OF THE MARK.

THE MARK CONSISTS OF THE COLOR BLUE IN THE CAPITALIZED WORDING "CRITICAL PATH INSTITUTE IMPROVING THE PATH FOR INNOVATIVE THERAPIES" AND IN THE OUTER PORTION OF THE VERTICAL ARC TO THE LEFT OF THE WORDING. THE COLOR YELLOW IS LOCATED IN THE INNER PORTION OF THE VERTICAL ARC TO THE LEFT OF THE WORDING.

FOR PROMOTING COLLABORATION BETWEEN SCIENTISTS FROM ACADEMIA, SCIENTISTS FROM THE RELEVANT INDUSTRIES, AND GOVERNMENT REGULATORS TO ACHIEVE ADVANCES IN THE FIELDS OF THE MEDICAL PRODUCT DEVELOPMENT PROCESS AND MEDICAL PRODUCT DEVELOPMENT (U.S. CLS. 100, 101 AND 102).

FIRST USE 2-29-2008; IN COMMERCE 2-29-2008.
KIM SAITO, EXAMINING ATTORNEY

SN 77-474,465. THE CRITICAL PATH INSTITUTE (C-PATH), TUCSON, AZ. FILED 5-14-2008.



OWNER OF U.S. REG. NOS. 3,342,298 AND 3,377,391.
NO CLAIM IS MADE TO THE EXCLUSIVE RIGHT TO USE "CRITICAL PATH INSTITUTE", APART FROM THE MARK AS SHOWN.

THE COLOR(S) BLUE, YELLOW IS/ARE CLAIMED AS A FEATURE OF THE MARK.

THE MARK CONSISTS OF THE COLOR BLUE IN THE CAPITALIZED WORDING "CRITICAL PATH INSTITUTE" AND IN THE OUTER PORTION OF THE VERTICAL ARC TO THE LEFT OF THE WORDING. THE COLOR YELLOW IS LOCATED IN THE INNER PORTION OF THE VERTICAL ARC TO THE LEFT OF THE WORDING.

FOR PROMOTING COLLABORATION BETWEEN SCIENTISTS FROM ACADEMIA, SCIENTISTS FROM THE RELEVANT INDUSTRIES, AND GOVERNMENT REGULATORS TO ACHIEVE ADVANCES IN THE FIELDS OF THE MEDICAL PRODUCT DEVELOPMENT PROCESS AND MEDICAL PRODUCT DEVELOPMENT (U.S. CLS. 100, 101 AND 102).

FIRST USE 2-29-2008; IN COMMERCE 2-29-2008.
KIM SAITO, EXAMINING ATTORNEY

CLASS 35—(Continued).

SN 77-481,469. LIGHTSOUT MARKETING, LLC, INDIANAPOLIS, IN. FILED 5-22-2008.

SOCIAL SHADOW NETWORK

THE MARK CONSISTS OF STANDARD CHARACTERS WITHOUT CLAIM TO ANY PARTICULAR FONT, STYLE, SIZE, OR COLOR.

NO CLAIM IS MADE TO THE EXCLUSIVE RIGHT TO USE "NETWORK", APART FROM THE MARK AS SHOWN.

FOR BUSINESS CONSULTING SERVICES IN THE AREA OF MARKETING AND ADVERTISING; MARKETING AND ADVERTISING SERVICES (U.S. CLS. 100, 101 AND 102).

HEATHER BIDDULPH, EXAMINING ATTORNEY

SN 77-515,542. STEINER, BART E., PHOENIX, AZ. FILED 7-7-2008.

WATTS

THE MARK CONSISTS OF STANDARD CHARACTERS WITHOUT CLAIM TO ANY PARTICULAR FONT, STYLE, SIZE, OR COLOR.

FOR PROVIDING INCENTIVE AWARD PROGRAMS FOR CUSTOMERS THROUGH THE DISTRIBUTION OF ONLINE AND/OR VIRTUAL UNITS OF CREDITS FOR THE PURPOSE OF PROMOTING AND REWARDING CONSUMER LOYALTY AND TO PURCHASE ADVERTISING, SERVICES, AND/OR PRODUCTS (U.S. CLS. 100, 101 AND 102).

FIRST USE 8-25-2006; IN COMMERCE 8-25-2006.
GISELLE AGOSTO, EXAMINING ATTORNEY

SN 77-558,270. RENAISSANCE CONSIGNMENT CORPORATION, DBA RENAISSANCE, SACRAMENTO, CA. FILED 8-28-2008.



NO CLAIM IS MADE TO THE EXCLUSIVE RIGHT TO USE "FINE CONSIGNMENT", APART FROM THE MARK AS SHOWN.

THE COLOR(S) PURPLE, BLACK AND WHITE IS/ARE CLAIMED AS A FEATURE OF THE MARK.

THE MARK CONSISTS OF A STYLIZED "R" FORMED BY

CLASS 35—(Continued).

A DRESS FORM IN BLACK AND WHITE WITH A WHITE SASH AND BOW TOGETHER WITH THE REMAINDER OF THE "R" IN THE COLOR PURPLE. THE REST OF THE WORD "RENAISSANCE" BEING ONLY THE LETTERS "ENAISSANCE" ARE IN BLACK AND WHITE. THE "I" OF "RENAISSANCE" IS DOTTED WITH A SKEWED HEART SHAPE IN BLACK AND WHITE. UNDER THE LETTERS "RENAISSANCE" AND ABOVE THE SWEEPING TAIL OF THE STYLIZED "R" IS THE WORD "CONSIGNMENT" IN BLACK AND WHITE.

FOR RETAIL CONSIGNMENT STORES FEATURING CURRENT WOMENS DESIGNER FASHIONS, ACCESSORIES AND JEWELRY (U.S. CLS. 100, 101 AND 102).

FIRST USE 12-1-2002; IN COMMERCE 12-1-2002.
ANNE E. GUSTASON, EXAMINING ATTORNEY

CLASS 35—(Continued).

SN 77-629,229. ESSENTIAL MINDS, INC., SAINT JOAN DESPI, SPAIN, FILED 12-9-2008.

SN 77-611,418. GGP LIMITED PARTNERSHIP, CHICAGO, IL. FILED 11-10-2008.

ECOSTANCE

THE MARK CONSISTS OF STANDARD CHARACTERS WITHOUT CLAIM TO ANY PARTICULAR FONT, STYLE, SIZE, OR COLOR.

FOR PROVIDING A WEBSITE FEATURING INFORMATION ABOUT ENERGY USAGE MANAGEMENT IN THE FIELD OF ENVIRONMENTAL BENEFITS FROM ENERGY USE MANAGEMENT (U.S. CLS. 100, 101 AND 102).

BILL DAWE, EXAMINING ATTORNEY

SN 77-624,123. DOT LIB INFORMAÇÃO PROFISSIONAL LTDA, RIO DE JANEIRO, BRAZIL, FILED 12-1-2008.



THE MARK CONSISTS OF THE WORDING "DOT.LIB" IN A STYLIZED FONT.

FOR PROMOTING, ADVERTISING AND MARKETING THE ON-LINE DATABASES AND ELECTRONIC TECHNICAL PUBLICATIONS OF OTHERS (U.S. CLS. 100, 101 AND 102).

KHANH LE, EXAMINING ATTORNEY

PRESCRIPTION BRANDING

THE MARK CONSISTS OF STANDARD CHARACTERS WITHOUT CLAIM TO ANY PARTICULAR FONT, STYLE, SIZE, OR COLOR.

NO CLAIM IS MADE TO THE EXCLUSIVE RIGHT TO USE "BRANDING", APART FROM THE MARK AS SHOWN.

FOR ONLINE RETAIL STORE SERVICES AND RETAIL STORE SERVICES FEATURING CHILDREN'S TOYS, CHILDREN'S FURNITURE, CHILDREN'S BOOKS, VIDEOS AND DVD'S AND CHILDREN'S GAMES; MARKETING THE GOODS AND SERVICES OF OTHERS, NAMELY, ADVERTISING AND PROMOTION SERVICES RELATING TO THE SALE OF ARTICLES AND SERVICES FOR THIRD PARTIES BY THE TRANSMISSION OF ADVERTISING MATERIAL AND THE DISSEMINATION OF ADVERTISING MESSAGES FOR EDUCATING AND ENTERTAINING CHILDREN; ADVERTISING MARKETING AND PROMOTION SERVICES FOR OTHERS IN THE FIELD OF ENTERTAINMENT AND EDUCATION OF CHILDREN; ARRANGING AND CONDUCTING MARKETING PROMOTIONAL EVENTS IN THE FIELD OF ENTERTAINMENT AND EDUCATION OF CHILDREN FOR OTHERS; ADVERTISING, MARKETING AND PROMOTION SERVICES IN THE FIELD OF EDUCATING AND ENTERTAINING CHILDREN; BUSINESS MARKETING SERVICES IN THE FIELD OF EDUCATION AND ENTERTAINMENT OF CHILDREN; MARKETING CONSULTING IN THE FIELD OF ENTERTAINING AND EDUCATING CHILDREN; ON-LINE ADVERTISING AND MARKETING SERVICES IN THE FIELD OF ENTERTAINING AND EDUCATING CHILDREN; PROMOTING THE GOODS AND SERVICES OF OTHERS VIA A GLOBAL COMPUTER NETWORK IN THE FIELD OF ENTERTAINING AND EDUCATING CHILDREN (U.S. CLS. 100, 101 AND 102).

NICHOLAS ALTREE, EXAMINING ATTORNEY

CLASS 35—(Continued).

SN 77-641,445. GLOBAL APERTURE, INC., REDONDO BEACH, CA. FILED 12-30-2008.



THE COLOR(S) BLACK, BLUE, GOLD AND GRAY IS/ ARE CLAIMED AS A FEATURE OF THE MARK.

THE MARK CONSISTS OF A BLACK TRIANGLE WITH CURVED SIDES CENTERED BETWEEN A GOLD TRIANGLE WITH CURVED SIDES, A BLUE TRIANGLE WITH CURVED SIDES AND A GRAY TRIANGLE WITH CURVED SIDES, ALL ABOVE THE STYLIZED BLACK WORDING "GLOBAL APERTURE".

FOR PROVIDING INFORMATION SERVICES IN THE FIELD OF BUSINESS STRATEGIC PLANNING, NAMELY, BUSINESS INITIATIVE STRUCTURING, BUSINESS MANAGEMENT CONSULTING, BUSINESS MEETING MANAGEMENT TRAINING, AND BUSINESS VENTURE MANAGEMENT, EXCLUDING SERVICES IN THE FIELD OF FACILITY, SPACE, PERSONNEL AND TECHNOLOGY MANAGEMENT, AND EXCLUDING SERVICES IN THE FIELD OF COMPUTER SOFTWARE PROGRAMMING AND IMPLEMENTATION TO ASSIST FACILITY AND TECHNOLOGY PERSONNEL MANAGEMENT (U.S. CLS. 100, 101 AND 102).

FIRST USE 12-5-2008; IN COMMERCE 12-5-2008.
KRISTIN CARLSON, EXAMINING ATTORNEY

SN 77-650,151. NEXTLEVEL PERFORMANCE SOLUTIONS, INC., LAS VEGAS, NV. FILED 1-15-2009.

NEXTLEVEL PERFORMANCE SOLUTIONS

THE MARK CONSISTS OF STANDARD CHARACTERS WITHOUT CLAIM TO ANY PARTICULAR FONT, STYLE, SIZE, OR COLOR.

NO CLAIM IS MADE TO THE EXCLUSIVE RIGHT TO USE "PERFORMANCE SOLUTIONS", APART FROM THE MARK AS SHOWN.

FOR BUSINESS CONSULTING AND INFORMATION SERVICES; BUSINESS MANAGEMENT PLANNING; BUSINESS MANAGEMENT SUPERVISION (U.S. CLS. 100, 101 AND 102).

FIRST USE 1-0-2008; IN COMMERCE 2-0-2008.
TRACY FLETCHER, EXAMINING ATTORNEY

CLASS 35—(Continued).

SN 77-650,180. NEXTLEVEL PERFORMANCE SOLUTIONS, INC., LAS VEGAS, NV. FILED 1-15-2009.



NO CLAIM IS MADE TO THE EXCLUSIVE RIGHT TO USE "PERFORMANCE SOLUTIONS", APART FROM THE MARK AS SHOWN.

THE COLOR(S) BLUE AND GOLD IS/ARE CLAIMED AS A FEATURE OF THE MARK.

THE MARK CONSISTS OF A BLUE STYLIZED WORD "NEXTLEVEL" OVER THE GOLD WORDS "PERFORMANCE SOLUTIONS" SUPERIMPOSED OVER A GOLDEN ARROW.

FOR BUSINESS CONSULTING AND INFORMATION SERVICES; BUSINESS MANAGEMENT PLANNING; BUSINESS MANAGEMENT SUPERVISION (U.S. CLS. 100, 101 AND 102).

FIRST USE 1-0-2008; IN COMMERCE 2-0-2008.
TRACY FLETCHER, EXAMINING ATTORNEY

SN 77-658,976. SLIDEME LLC, DBA SLIDEME, SEATTLE, WA. FILED 1-29-2009.

SlideME

THE MARK CONSISTS OF STANDARD CHARACTERS WITHOUT CLAIM TO ANY PARTICULAR FONT, STYLE, SIZE, OR COLOR.

FOR OPERATING ON-LINE MARKETPLACES FOR SELLERS OF GOODS AND/OR SERVICES (U.S. CLS. 100, 101 AND 102).

CHARLES L. JENKINS, EXAMINING ATTORNEY

SN 77-659,630. WASTE MANAGEMENT, INC., HOUSTON, TX. FILED 1-29-2009.

THINK GREEN REWARDS

THE MARK CONSISTS OF STANDARD CHARACTERS WITHOUT CLAIM TO ANY PARTICULAR FONT, STYLE, SIZE, OR COLOR.

OWNER OF U.S. REG. NO. 2,882,547.

NO CLAIM IS MADE TO THE EXCLUSIVE RIGHT TO USE "GREEN REWARDS", APART FROM THE MARK AS SHOWN.

FOR PROMOTING PUBLIC AWARENESS OF ENVIRONMENTAL ISSUES BY ARRANGING AND CONDUCTING AN INCENTIVE AWARD PROGRAM WHICH PROMOTES POSITIVE ENVIRONMENTAL ACTIVITIES SUCH AS RECYCLING, BUYING AND USING PRODUCTS FOR RECYCLING, BURYING AND USING RECYCLED PRODUCTS, AND BUYING AND USING PRODUCTS MADE WITH RECYCLED MATERIALS (U.S. CLS. 100, 101 AND 102).

WENDY GOODMAN, EXAMINING ATTORNEY

CLASS 35—(Continued).

SN 77-659,637. WASTE MANAGEMENT, INC., HOUSTON, TX. FILED 1-29-2009.

THINK GREEN POINTS

THE MARK CONSISTS OF STANDARD CHARACTERS WITHOUT CLAIM TO ANY PARTICULAR FONT, STYLE, SIZE, OR COLOR.

OWNER OF U.S. REG. NO. 2,882,547.

NO CLAIM IS MADE TO THE EXCLUSIVE RIGHT TO USE "GREEN POINTS", APART FROM THE MARK AS SHOWN.

FOR PROMOTING PUBLIC AWARENESS OF ENVIRONMENTAL ISSUES BY ARRANGING AND CONDUCTING AN INCENTIVE AWARD PROGRAM WHICH PROMOTES POSITIVE ENVIRONMENTAL ACTIVITIES SUCH AS RECYCLING, BUYING AND USING PRODUCTS FOR RECYCLING, BURYING AND USING RECYCLED PRODUCTS, AND BUYING AND USING PRODUCTS MADE WITH RECYCLED MATERIALS (U.S. CLS. 100, 101 AND 102).

WENDY GOODMAN, EXAMINING ATTORNEY

CLASS 35—(Continued).

SN 77-661,461. ACCESS COMMUNITY HEALTH NETWORK, CHICAGO, IL. FILED 2-2-2009.

DOMINGO DE EXAMINATE COMADRE

THE MARK CONSISTS OF STANDARD CHARACTERS WITHOUT CLAIM TO ANY PARTICULAR FONT, STYLE, SIZE, OR COLOR.

THE ENGLISH TRANSLATION OF "DOMINGO DE EXAMINATE COMADRE" IN THE MARK IS "SUNDAY OF GETTING EXAMINED, WOMAN FRIEND".

FOR CONDUCTING EVENTS FOR PROMOTING BREAST CANCER AWARENESS AND SCREENINGS, AND FOR PUBLICIZING DIAGNOSTIC AND TREATMENT OPPORTUNITIES FOR WHICH WOMEN MAY BE ELIGIBLE (U.S. CLS. 100, 101 AND 102).

HENRY S. ZAK, EXAMINING ATTORNEY

SN 77-660,088. BUCKLEY, JOHN, BOUND BROOK, NJ. AND LEAMY, MARIA, BOUND BROOK, NJ. FILED 1-30-2009.

Stay Fit Kit

THE MARK CONSISTS OF STANDARD CHARACTERS WITHOUT CLAIM TO ANY PARTICULAR FONT, STYLE, SIZE, OR COLOR.

NO CLAIM IS MADE TO THE EXCLUSIVE RIGHT TO USE "KIT", APART FROM THE MARK AS SHOWN.

FOR ARRANGING AND CONDUCTING MARKETING PROMOTIONAL EVENTS FOR OTHERS; ARRANGING AND CONDUCTING OF FAIRS AND EXHIBITIONS FOR BUSINESS AND ADVERTISING PURPOSES; CORPORATE EVENT MANAGEMENT SERVICES; DISTRIBUTION OF SAMPLES FOR PUBLICITY PURPOSES; ORGANIZING, PROMOTING AND CONDUCTING EXHIBITIONS, TRADESHOWS AND EVENTS FOR BUSINESS PURPOSES; PROVIDING ASSISTANCE, FITNESS EVALUATION AND CONSULTATION TO CORPORATE CLIENTS TO HELP THEIR EMPLOYEES MAKE HEALTH, WELLNESS AND NUTRITIONAL CHANGES IN THEIR DAILY LIVING TO INCREASE PRODUCTIVITY AND LOWER HEALTH CARE COSTS; SAMPLE DISTRIBUTION (U.S. CLS. 100, 101 AND 102).

FIRST USE 12-10-2008; IN COMMERCE 12-10-2008.

SUE LAWRENCE, EXAMINING ATTORNEY

SN 77-661,484. ACCESS COMMUNITY HEALTH NETWORK, CHICAGO, IL. FILED 2-2-2009.

EXAMINATE COMADRE

THE MARK CONSISTS OF STANDARD CHARACTERS WITHOUT CLAIM TO ANY PARTICULAR FONT, STYLE, SIZE, OR COLOR.

THE ENGLISH TRANSLATION OF "EXAMINATE COMADRE" IN THE MARK IS "GET EXAMINED, WOMAN FRIEND".

FOR CONDUCTING EVENTS FOR PROMOTING BREAST CANCER AWARENESS AND SCREENINGS, AND FOR PUBLICIZING DIAGNOSTIC AND TREATMENT OPPORTUNITIES FOR WHICH WOMEN MAY BE ELIGIBLE (U.S. CLS. 100, 101 AND 102).

HENRY S. ZAK, EXAMINING ATTORNEY

CLASS 35—(Continued).

SN 77-664,329. JENMAX FOODS, LLC., OCEANSIDE, CA. FILED 2-5-2009.



NO CLAIM IS MADE TO THE EXCLUSIVE RIGHT TO USE "FOODS, LLC.", APART FROM THE MARK AS SHOWN.

THE COLOR(S) GOLD IS/ARE CLAIMED AS A FEATURE OF THE MARK.

THE MARK CONSISTS OF THE COLOR GOLD THAT APPEARS IN A STYLIZED DESIGN OF A SUN, IN ALL LETTERS AND WORDS OF "JENMAX FOODS, LLC.", IN A HORIZONTAL LINE DRAWN UNDER "JENMAX FOODS, LLC.", AND IN "BUILDING PARTNERSHIPS THAT YOU CAN COUNT ON."

FOR WHOLESALE FOOD DISTRIBUTORSHIP; WHOLESALE STORES FEATURING FOOD; WHOLESALE ORDERING SERVICES IN THE FIELD OF FOOD (U.S. CLS. 100, 101 AND 102).

FIRST USE 1-1-1999; IN COMMERCE 1-1-1999.
DANNEAN HETZEL, EXAMINING ATTORNEY

CLASS 35—(Continued).

SN 77-674,219. AEGIS LIMITED, MUMBAI, MAHARASHTRA, INDIA, FILED 2-19-2009.



THE MARK CONSISTS OF THE WORD "AEGIS" INSIDE A RECTANGLE WITH A SMALL SOLID RECTANGLE UNDERNEATH AND IN BETWEEN THE LETTERS G AND I. A LARGER SOLID RECTANGLE IS UNDER THE LETTER G. A SMALL SOLID RECTANGLE IS ABOVE THE LETTER I. A CROWN DESIGN APPEARS ABOVE THE WORD "ACE". THE PHRASE "ACHIEVING CONTINUOUS EXCELLENCE" IS UNDERNEATH AND TO THE RIGHT OF "AEGIS ACE".

FOR BUSINESS PROCESS OUTSOURCING IN THE AREA OF SOFT SKILLS DEVELOPMENT OF EMPLOYEES (U.S. CLS. 100, 101 AND 102).

FIRST USE 9-0-2007; IN COMMERCE 9-0-2007.
LEIGH CAROLINE CASE, EXAMINING ATTORNEY

SN 77-665,534. EXPERIAN MARKETING SOLUTIONS, INC., COSTA MESA, CA. FILED 2-6-2009.

METRONET

THE MARK CONSISTS OF STANDARD CHARACTERS WITHOUT CLAIM TO ANY PARTICULAR FONT, STYLE, SIZE, OR COLOR.

OWNER OF U.S. REG. NO. 1,522,172.
FOR PROVIDING A DATABASE FEATURING INFORMATION ABOUT BUSINESSES FOR BUSINESS PURPOSES; PROVIDING A DATABASE FEATURING INFORMATION ABOUT INDIVIDUALS, NAMELY, CONTACT INFORMATION, NAMES, ADDRESSES, PHONE NUMBERS FOR BUSINESS PURPOSES (U.S. CLS. 100, 101 AND 102).

FIRST USE 8-1-1987; IN COMMERCE 8-1-1987.
WENDY JUN, EXAMINING ATTORNEY

SN 77-675,718. AMERICAN ASSOCIATION OF ORTHODONTISTS, ST. LOUIS, MO. FILED 2-23-2009.



OWNER OF U.S. REG. NOS. 1,924,327, 2,597,489 AND OTHERS.

NO CLAIM IS MADE TO THE EXCLUSIVE RIGHT TO USE "PAC," "POLITICAL ACTION COMMITTEE" OR "ASSOCIATION OF ORTHODONTISTS", APART FROM THE MARK AS SHOWN.

THE MARK CONSISTS OF THE LETTERS "AAO" OFFSET BY THE LETTERS "PAC" WITH THE "O" AND "P" INTERTWINED. A PARALLEL LINE TRACES THE LETTERS WITH TWO ANGLES FORMING A STEP BELOW THE "O" AND "P". THE PHRASE "AMERICAN ASSOCIATION OF ORTHODONTIST" IS POSITIONED ABOVE THE LETTERS "PAC" AND THE PHRASE "POLITICAL ACTION COMMITTEE" IS POSITIONED BELOW THE LETTERS "PAC". THREE INTERTWINED OFFSET CIRCLES ARE POSITIONED BELOW THE LETTERS "AAO" FADING FROM LIGHT TO DARK.

SEC. 2(F) AS TO "AMERICAN ASSOCIATION OF ORTHODONTISTS".

FOR POLITICAL ACTION COMMITTEE SERVICES, NAMELY, PROMOTING THE INTERESTS OF ORTHODONTISTS AND THEIR PATIENTS IN THE FIELDS OF POLITICS, LEGISLATION, AND REGULATION (U.S. CLS. 100, 101 AND 102).

FIRST USE 0-0-1994; IN COMMERCE 0-0-1994.
GRETCHEN ULRICH, EXAMINING ATTORNEY

CLASS 35—(Continued).

SN 77-678,915. NICHOLS, DANIEL, ROCKVILLE, MD.
FILED 2-26-2009.

Military To Medicine

THE MARK CONSISTS OF STANDARD CHARACTERS WITHOUT CLAIM TO ANY PARTICULAR FONT, STYLE, SIZE, OR COLOR.

FOR EMPLOYMENT HIRING, RECRUITING, PLACEMENT, STAFFING AND CAREER NETWORKING SERVICES FOR MILITARY SPOUSES, MILITARY FAMILY MEMBERS, AND VETERANS OF THE UNITED STATES ARMED SERVICES WITHIN THE HEALTH CARE AND HEALTH SERVICES INDUSTRIES (U.S. CLS. 100, 101 AND 102).

SHAILA SETTLES, EXAMINING ATTORNEY

SN 77-680,238. DEPUY, INC., WARSAW, IN. FILED 2-27-2009.

ORTHOLEAN

THE MARK CONSISTS OF STANDARD CHARACTERS WITHOUT CLAIM TO ANY PARTICULAR FONT, STYLE, SIZE, OR COLOR.

FOR PROVIDING BUSINESS INFORMATION VIA THE INTERNET RELATING TO PROGRAMS FOR HOSPITALS TO CREATE EFFICIENT PROCESSES IN THE DELIVERY OF ORTHOPAEDIC SERVICES; PROVIDING BUSINESS ADVISORY AND CONSULTANCY SERVICES TO HOSPITALS FOR THE CREATION OF EFFICIENT PROCESSES IN THE DELIVERY OF ORTHOPAEDIC SERVICES (U.S. CLS. 100, 101 AND 102).

AMY C. KEAN, EXAMINING ATTORNEY

SN 77-687,975. VONDEGO, INC., TORONTO, ONTARIO, CANADA, FILED 3-11-2009.

VONDEGO

THE MARK CONSISTS OF STANDARD CHARACTERS WITHOUT CLAIM TO ANY PARTICULAR FONT, STYLE, SIZE, OR COLOR.

PRIORITY CLAIMED UNDER SEC. 44(D) ON CANADA APPLICATION NO. 1412202, FILED 9-25-2008, REG. NO. TMA762811, DATED 3-29-2010, EXPIRES 3-29-2025.

THE WORDING "VONDEGO" HAS NO MEANING IN A FOREIGN LANGUAGE.

FOR ADVERTISING SERVICES, NAMELY, SELLING, INSTALLING, MANAGING AND TRACKING OF TRUCK SIDE ADVERTISING (U.S. CLS. 100, 101 AND 102).

TINA MAI, EXAMINING ATTORNEY

CLASS 35—(Continued).

SN 77-691,565. USLAW NETWORK, INC., NORCROSS, GA.
FILED 3-16-2009.

National Counsel Right Next Door

THE MARK CONSISTS OF STANDARD CHARACTERS WITHOUT CLAIM TO ANY PARTICULAR FONT, STYLE, SIZE, OR COLOR.

NO CLAIM IS MADE TO THE EXCLUSIVE RIGHT TO USE "NATIONAL COUNSEL", APART FROM THE MARK AS SHOWN.

FOR BUSINESS NETWORKING (U.S. CLS. 100, 101 AND 102).

FIRST USE 9-1-2008; IN COMMERCE 9-15-2008.

KATHERINE STOIDES, EXAMINING ATTORNEY

SN 77-696,824. CETIS, INC., COLORADO SPRINGS, CO.
FILED 3-23-2009.

PRIORITYCARE

THE MARK CONSISTS OF STANDARD CHARACTERS WITHOUT CLAIM TO ANY PARTICULAR FONT, STYLE, SIZE, OR COLOR.

SEC. 2(F).

FOR CUSTOMER SERVICES IN THE FIELD OF TELECOMMUNICATIONS (U.S. CLS. 100, 101 AND 102).

FIRST USE 0-0-2000; IN COMMERCE 0-0-2000.

EVELYN BRADLEY, EXAMINING ATTORNEY

CLASS 35—(Continued).

SN 77-698,421. LOCK & LOCK CO., LTD., ASAN, REPUBLIC OF KOREA, FILED 3-25-2009.



OWNER OF REPUBLIC OF KOREA REG. NO. 0107004, DATED 10-13-2004, EXPIRES 10-13-2014.

OWNER OF U.S. REG. NOS. 2,509,283, 3,515,324 AND OTHERS.

NO CLAIM IS MADE TO THE EXCLUSIVE RIGHT TO USE "LOCK", APART FROM THE MARK AS SHOWN.

THE MARK CONSISTS OF AN IMAGE OF TWO INTERLOCKING PADLOCKS ABOVE THE WORDS "LOCK & LOCK".

FOR WHOLESALE STORE SERVICES RELATING TO KITCHEN UTENSILS, NAMELY, TRASH CANS, COOKING POTS, NON-ELECTRIC FRYING PANS, BOWLS, DISHES, PLATES, PLASTIC CUPS, GLASSES, CRUETS, KITCHEN LADLES, NON-ELECTRIC KITCHEN CONTAINERS, SERVING TRAYS, BUCKETS, ICE BUCKETS, BASINS, DRINKING VESSELS, THERMAL INSULATED BOTTLES FOR BEVERAGES AND FOOD FOR KEEPING WARM, AND CONTAINERS FOR FOODS AND HOUSEHOLD USE; RETAIL STORE SERVICES RELATING TO KITCHEN UTENSILS, NAMELY, TRASH CANS, COOKING POTS, NON-ELECTRIC FRYING PANS, BOWLS, DISHES, PLATES, PLASTIC CUPS, GLASSES, CRUETS, KITCHEN LADLES, NON-ELECTRIC KITCHEN CONTAINERS, SERVING TRAYS, BUCKETS, ICE BUCKETS, BASINS, DRINKING VESSELS, THERMAL INSULATED BOTTLES FOR BEVERAGES AND FOOD FOR KEEPING WARM, AND CONTAINERS FOR FOODS AND HOUSEHOLD USE; MARKETING AND ADVERTISING SERVICES; AUCTIONEERING; IMPORT-EXPORT OF KITCHENWARE; PROCUREMENT OF KITCHENWARE FOR A THIRD PARTY (U.S. CLS. 100, 101 AND 102).

KATHERINE STOIDES, EXAMINING ATTORNEY

SN 77-707,641. FERGUSON ENTERPRISES, INC., NEWPORT NEWS, VA. FILED 4-6-2009.

Delivering Your Dream

THE MARK CONSISTS OF STANDARD CHARACTERS WITHOUT CLAIM TO ANY PARTICULAR FONT, STYLE, SIZE, OR COLOR.

FOR RETAIL STORE AND WHOLESALE STORE SERVICES FEATURING BATHROOM AND KITCHEN FIXTURES, EQUIPMENT AND BUILDING PRODUCTS AND ELECTRIC LIGHTING FIXTURES (U.S. CLS. 100, 101 AND 102).

FIRST USE 1-1-2008; IN COMMERCE 1-1-2008.
KIM SAITO, EXAMINING ATTORNEY

CLASS 35—(Continued).

SN 77-711,907. SANGHA, PAVAN S, BURNABY, CANADA, FILED 4-10-2009.

guvano.com

THE MARK CONSISTS OF STANDARD CHARACTERS WITHOUT CLAIM TO ANY PARTICULAR FONT, STYLE, SIZE, OR COLOR.

THE WORDING "GUVANO" HAS NO MEANING IN A FOREIGN LANGUAGE.

FOR ADVERTISING AND DIRECTORY SERVICES, NAMELY, PROMOTING THE SERVICES OF OTHERS BY PROVIDING A WEB PAGE FEATURING LINKS TO THE WEBSITES OF OTHERS (U.S. CLS. 100, 101 AND 102).

FIRST USE 1-25-2005; IN COMMERCE 1-25-2005.
THOMAS MANOR, EXAMINING ATTORNEY

SN 77-712,784. NOODLE TIME, INC., MIAMI, FL. FILED 4-13-2009.



THE COLOR(S) RED, BLACK AND WHITE IS/ARE CLAIMED AS A FEATURE OF THE MARK.

THE MARK CONSISTS OF STYLIZED WORDS, "THE CHEF'S TABLE" IN A WHITE FONT EXCEPT FOR THE "C" WHICH IS IN RED. THERE IS A LARGE STYLIZED RED LETTER "C" IN THE BACKGROUND. THE BACKGROUND IS BLACK.

FOR MEMBERSHIP CLUB SERVICES FOR PROMOTING RESTAURANTS THROUGH EMAIL COMMUNICATIONS FEATURING INVITATIONS TO EVENTS AT THE LOCAL RESTAURANT, COMPLIMENTARY BIRTHDAY DINNERS, OPPORTUNITIES TO PARTICIPATE IN GUEST SURVEYS, PROMOTIONAL OFFERS AND EARLY NOTICES OF NEW MENU ITEMS (U.S. CLS. 100, 101 AND 102).

FIRST USE 4-7-2009; IN COMMERCE 4-7-2009.
JENNIFER VASQUEZ, EXAMINING ATTORNEY

CLASS 35—(Continued).

SN 77-714,573. GRUPO EMPRESARIAL DHARMA S.A. DE C.V., MONTERREY, NUEVO LEON, MEXICO, FILED 4-15-2009.

GEDHARMA

THE MARK CONSISTS OF STANDARD CHARACTERS WITHOUT CLAIM TO ANY PARTICULAR FONT, STYLE, SIZE, OR COLOR.

FOR BUSINESS CONSULTING SERVICES, NAMELY, PROVIDING ASSISTANCE IN DEVELOPMENT OF BUSINESS STRATEGIES; BUSINESS OPERATIONS MANAGEMENT SERVICES; PROVIDING BUSINESS MANAGEMENT SERVICES FOR COMPANIES THAT PROVIDE FOOD; AND PROVIDING BUSINESS MANAGEMENT SERVICES FOR COMPANIES THAT PROVIDE ENERGY (U.S. CLS. 100, 101 AND 102).

MICHAEL WEBSTER, EXAMINING ATTORNEY

CLASS 35—(Continued).

SN 77-720,611. RENAISSANCE IMPORTS, INC., MATTHEWS, NC. FILED 4-23-2009.



THE COLOR(S) BLUE AND BLACK IS/ARE CLAIMED AS A FEATURE OF THE MARK.

THE MARK CONSISTS OF A STYLIZED TRIPLE ORB LOGO, FOLLOWED BY THE STYLIZED TERM "RENAISSANCE" WHICH IS UNDERSCORED BY THE PHRASE "STEP INTO OUR SHOES," THE COLOR BLUE WHICH APPEARS IN THE ORB AND "STEP INTO OUR SHOES" PHRASE RESPECTIVELY, AND THE COLOR BLACK WHICH APPEARS IN THE TERM "RENAISSANCE".

FOR IMPORT AGENCY SERVICES IN THE FIELD OF FOOTWEAR FOR MEN, WOMEN AND CHILDREN; WHOLESALE DISTRIBUTORSHIP SERVICES FEATURING FOOTWEAR FOR MEN, WOMEN AND CHILDREN; WHOLESALE STORE SERVICES FEATURING PRIVATE LABEL FOOTWEAR FOR MEN, WOMEN AND CHILDREN; WHOLESALE ORDERING SERVICES IN THE FIELD OF FOOTWEAR FOR MEN, WOMEN AND CHILDREN (U.S. CLS. 100, 101 AND 102).

FIRST USE 10-1-2008; IN COMMERCE 1-1-2009.

RONALD MCMORROW, EXAMINING ATTORNEY

SN 77-720,478. RENAISSANCE IMPORTS, INC., MATTHEWS, NC. FILED 4-23-2009.



SN 77-730,301. BDI PHARMA, INC., COLUMBIA, SC. FILED 5-6-2009.

BDI Pharma

THE MARK CONSISTS OF STYLIZED TRIPLE ORB LOGO FOLLOWED BY THE WORD "RENAISSANCE" AND UNDERSCORED BY THE PHRASE "STEP INTO OUR SHOES".

FOR IMPORT AGENCY SERVICES IN THE FIELD OF FOOTWEAR FOR MEN, WOMEN AND CHILDREN; WHOLESALE DISTRIBUTORSHIP SERVICES FEATURING FOOTWEAR FOR MEN, WOMEN AND CHILDREN; WHOLESALE STORE SERVICES FEATURING PRIVATE LABEL FOOTWEAR FOR MEN, WOMEN AND CHILDREN; WHOLESALE ORDERING SERVICES IN THE FIELD OF FOOTWEAR FOR MEN, WOMEN AND CHILDREN (U.S. CLS. 100, 101 AND 102).

FIRST USE 10-1-2008; IN COMMERCE 1-1-2009.

RONALD MCMORROW, EXAMINING ATTORNEY

THE MARK CONSISTS OF STANDARD CHARACTERS WITHOUT CLAIM TO ANY PARTICULAR FONT, STYLE, SIZE, OR COLOR.

OWNER OF U.S. REG. NO. 3,564,356.

NO CLAIM IS MADE TO THE EXCLUSIVE RIGHT TO USE "PHARMA", APART FROM THE MARK AS SHOWN, FOR WHOLESALE DISTRIBUTORSHIPS FEATURING PHARMACEUTICALS (U.S. CLS. 100, 101 AND 102).

FIRST USE 2-1-2009; IN COMMERCE 2-1-2009.

INGA ERVIN, EXAMINING ATTORNEY

CLASS 35—(Continued).

SN 77-736,310. SANKORA EXECUTIVE SOLUTIONS, INC., HUNTSVILLE, AL. FILED 5-13-2009.

SANKORA EXECUTIVE SOLUTIONS

THE MARK CONSISTS OF STANDARD CHARACTERS WITHOUT CLAIM TO ANY PARTICULAR FONT, STYLE, SIZE, OR COLOR.

NO CLAIM IS MADE TO THE EXCLUSIVE RIGHT TO USE "EXECUTIVE SOLUTIONS", APART FROM THE MARK AS SHOWN.

THE WORDING "SANKORA" HAS NO MEANING IN A FOREIGN LANGUAGE.

FOR HUMAN RESOURCES CONSULTING SERVICES; CONSULTING SERVICES IN THE FIELD OF HUMAN RESOURCES DEVELOPMENT, NAMELY, FOR THE PROMOTION OF EMPLOYEE RETENTION, CAREER GROWTH, AND INCREASING PRODUCTIVITY FOR EMPLOYEES AND EMPLOYERS; CONSULTANCY IN THE FIELD OF BUSINESS LEADERSHIP DEVELOPMENT; BUSINESS MANAGEMENT CONSULTATION IN THE FIELD OF EXECUTIVE AND LEADERSHIP DEVELOPMENT; CONDUCTING BUSINESS RESEARCH AND SURVEYS, NAMELY, CONDUCTING OF WORK-PLACE ASSESSMENTS THROUGH EMPLOYEE INQUIRIES AND INTERVIEWS; DRAFTING REPORTS WITHIN THE FIELD OF HUMAN RESOURCES AND BUSINESS MANAGEMENT, NAMELY, EXPERT EVALUATIONS AND REPORTS RELATING TO BUSINESS MATTERS; MARKETING; PUBLIC RELATIONS CONSULTING; PUBLIC OPINION POLLING; MARKET RESEARCH; MARKET ANALYSIS; BUSINESS MANAGEMENT; CONSULTATION RELATING TO BUSINESS MANAGEMENT; BUSINESS CONSULTANCY; CONSULTANCY IN RELATION TO ORGANIZATION AND MANAGEMENT OF BUSINESSES; PROVIDING REVIEW OF THE DEVELOPMENT OF BUSINESSES WITH RESPECT TO ORGANIZATION; MANAGEMENT CONSULTANCY; BUSINESS MANAGEMENT CONSULTANCY; BUSINESS MANAGEMENT ANALYSIS, NAMELY, ANALYSIS OF PROCESSES; PREPARATION OF COMPILATION OF STATISTICS; BUSINESS CONSULTANCY RELATING TO TEAM MANAGEMENT, CONFLICT MANAGEMENT, QUALITY MANAGEMENT, AND RISK MANAGEMENT; PROVIDING ORGANIZATIONAL DEVELOPMENT CONSULTING SERVICES; CONSULTANCY WITH REGARD TO BUSINESS ANALYSIS; BUSINESS PLANNING IN THE NATURE OF GOAL-SETTING SERVICES AND LEADERSHIP DEVELOPMENT AND MODELING; EMPLOYMENT SELECTION CONSULTING (U.S. CLS. 100, 101 AND 102).

FIRST USE 10-31-2005; IN COMMERCE 10-31-2005. LAKEISHA LEWIS, EXAMINING ATTORNEY

CLASS 35—(Continued).

SN 77-736,702. SANKORA EXECUTIVE SOLUTIONS, INC., HUNTSVILLE, AL. FILED 5-14-2009.



NO CLAIM IS MADE TO THE EXCLUSIVE RIGHT TO USE "EXECUTIVE SOLUTIONS", APART FROM THE MARK AS SHOWN.

THE MARK CONSISTS OF THE WORDS "SANKORA" DISPOSED ABOVE THE WORDS "EXECUTIVE SOLUTIONS" WITH A PARTIAL OUTLINE OF A PLUMED BIRD EXTENDING FROM THE RIGHT SIDE OF THE WORDS WITH THE BIRD FACING LEFT AND A WING EXTENDING FROM THE BIRD AND PARTIALLY OVER THE WORD "SANKORA".

THE WORDING "SANKORA" HAS NO MEANING IN A FOREIGN LANGUAGE.

FOR HUMAN RESOURCES CONSULTING SERVICES; CONSULTING SERVICES IN THE FIELD OF HUMAN RESOURCES DEVELOPMENT, NAMELY, FOR THE PROMOTION OF EMPLOYEE RETENTION, CAREER GROWTH, AND INCREASING PRODUCTIVITY FOR EMPLOYEES AND EMPLOYERS; CONSULTANCY IN THE FIELD OF BUSINESS LEADERSHIP DEVELOPMENT; BUSINESS MANAGEMENT CONSULTATION IN THE FIELD OF EXECUTIVE AND LEADERSHIP DEVELOPMENT; CONDUCTING BUSINESS RESEARCH AND SURVEYS, NAMELY, CONDUCTING OF WORK-PLACE ASSESSMENTS THROUGH EMPLOYEE INQUIRIES AND INTERVIEWS; DRAFTING REPORTS WITHIN THE FIELD OF HUMAN RESOURCES AND BUSINESS MANAGEMENT, NAMELY, EXPERT EVALUATIONS AND REPORTS RELATING TO BUSINESS MATTERS; MARKETING; PUBLIC RELATIONS CONSULTING; PUBLIC OPINION POLLING; MARKET RESEARCH; MARKET ANALYSIS; BUSINESS MANAGEMENT; CONSULTATION RELATING TO BUSINESS MANAGEMENT; BUSINESS CONSULTANCY; CONSULTANCY IN RELATION TO ORGANIZATION AND MANAGEMENT OF BUSINESSES; PROVIDING REVIEW OF THE DEVELOPMENT OF BUSINESSES WITH RESPECT TO ORGANIZATION; MANAGEMENT CONSULTANCY; BUSINESS MANAGEMENT CONSULTANCY; BUSINESS MANAGEMENT ANALYSIS, NAMELY, ANALYSIS OF PROCESSES; PREPARATION OF COMPILATION OF STATISTICS; BUSINESS CONSULTANCY RELATING TO TEAM MANAGEMENT, CONFLICT MANAGEMENT, QUALITY MANAGEMENT, AND RISK MANAGEMENT; PROVIDING ORGANIZATIONAL DEVELOPMENT CONSULTING SERVICES; CONSULTANCY WITH REGARD TO BUSINESS ANALYSIS; BUSINESS PLANNING IN THE NATURE OF GOAL-SETTING SERVICES AND LEADERSHIP DEVELOPMENT AND MODELING; EMPLOYMENT SELECTION CONSULTING (U.S. CLS. 100, 101 AND 102).

FIRST USE 4-15-2009; IN COMMERCE 4-15-2009. LAKEISHA LEWIS, EXAMINING ATTORNEY

CLASS 35—(Continued).

SN 77-742,460. ALPINE ACCESS, INC., DENVER, CO. FILED 5-21-2009.

alpineaccess

CONSULTING

OWNER OF U.S. REG. NO. 3,350,723.

NO CLAIM IS MADE TO THE EXCLUSIVE RIGHT TO USE "CONSULTING", APART FROM THE MARK AS SHOWN.

THE MARK CONSISTS OF THE WORDING "ALPINEACCESS" DISPLAYED IN LOWER CASE FONT APPEARING ABOVE A HORIZONTAL LINE, WHICH IS ABOVE THE WORD "CONSULTING". THE WORD "ALPINE" IS DISPLAYED IN BOLD, AND THE WORD "CONSULTING" IS IN ALL CAPS.

FOR CUSTOMER CARE SERVICES, NAMELY, PROVIDING CUSTOMER SERVICE AND PRODUCT INQUIRY SERVICES FOR OTHERS IN THE FIELD OF TELEPHONY AND INFORMATION TECHNOLOGIES VIA TELECOMMUNICATION, INTERNET AND MULTIMEDIA (U.S. CLS. 100, 101 AND 102).

FIRST USE 5-19-2009; IN COMMERCE 5-19-2009.
 KATHY DE JONGE, EXAMINING ATTORNEY

SN 77-742,864. NEWS HOLDINGS PTY LIMITED, SURRY HILLS NSW, AUSTRALIA, FILED 5-22-2009.

NEWS CORPORATION

THE MARK CONSISTS OF STANDARD CHARACTERS WITHOUT CLAIM TO ANY PARTICULAR FONT, STYLE, SIZE, OR COLOR.

OWNER OF U.S. REG. NOS. 2,048,435, 3,254,935 AND OTHERS.

NO CLAIM IS MADE TO THE EXCLUSIVE RIGHT TO USE "CORPORATION", APART FROM THE MARK AS SHOWN.

FOR PROVIDING A WEBSITE PROMOTING THE REDUCTION OF ENERGY CONSUMPTION, THE USE OF RENEWABLE ENERGY, RECYCLING, AND THE EFFECT OF CARBON EMISSIONS AND CLIMATE CHANGE (U.S. CLS. 100, 101 AND 102).

FIRST USE 6-0-2007; IN COMMERCE 6-0-2007.

CHARLES L. JENKINS, EXAMINING ATTORNEY

CLASS 35—(Continued).

SN 77-744,830. COMALI FOODS, INC., TEMECULA, CA. FILED 5-26-2009.



NO CLAIM IS MADE TO THE EXCLUSIVE RIGHT TO USE "FOODS", APART FROM THE MARK AS SHOWN.

THE MARK CONSISTS OF AN OBLONG STYLIZED CIRCLE WITH THE WORDS "COMALI FOODS" IN STYLIZED FORMAT WITHIN THE SAME.

FOR WHOLESALE FOOD DISTRIBUTORSHIP SERVICES (U.S. CLS. 100, 101 AND 102).

MICHELE SWAIN, EXAMINING ATTORNEY

SN 77-750,954. DKKY, LLC, NEW ORLEANS, LA. FILED 6-3-2009.

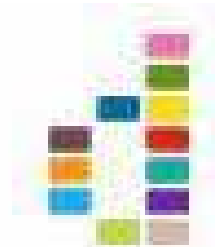

DUKKY

THE COLOR(S) PINK, GREEN, YELLOW, BLUE, BROWN, ORANGE, PURPLE, AQUA, RED AND GRAY IS/ARE CLAIMED AS A FEATURE OF THE MARK.

THE MARK CONSISTS OF THE LETTERS "DUKKY" PRESENTED IN STYLIZED GRAY PRINT. ABOVE THIS WORDING IS A STYLIZED LETTER "D" MADE UP OF TWELVE SMALL RECTANGLES. EACH RECTANGLE IS A DIFFERENT COLOR. THE COLORS OF THE RECTANGLES ARE AS FOLLOWS: PINK, DARK GREEN, YELLOW, DARK BLUE, BROWN, ORANGE, LIGHT BLUE, LIGHT GREEN, LIGHT PINK, PURPLE, AQUA AND RED.

FOR PROMOTING THE GOODS AND SERVICES OF OTHERS BY PROVIDING COUPONS FOR THE GOODS AND SERVICES OF OTHERS; DIRECT MAIL ADVERTISING SERVICES FOR OTHERS; ON-LINE ADVERTISING AND MARKETING SERVICES; ADVERTISING AND MARKETING SERVICES OFFERED THROUGH MOBILE COMMUNICATIONS DEVICES; DISSEMINATION OF ADVERTISING FOR OTHERS VIA AN ON-LINE COMMUNICATIONS NETWORK ON THE INTERNET AND THROUGH MOBILE COMMUNICATIONS NETWORKS; AND ADVERTISING BY TRANSMISSION OF PUBLICITY AND ADVERTISING FOR THIRD PARTIES THROUGH ELECTRONIC AND MOBILE COMMUNICATIONS NETWORKS (U.S. CLS. 100, 101 AND 102).

GRETCHEN ULRICH, EXAMINING ATTORNEY

CLASS 35—(Continued).

SN 77-762,398. ESI INTERNATIONAL, ARLINGTON, VA.
FILED 6-17-2009.

ESI'S REAL-TIME SOURCE

THE MARK CONSISTS OF STANDARD CHARACTERS WITHOUT CLAIM TO ANY PARTICULAR FONT, STYLE, SIZE, OR COLOR.

OWNER OF U.S. REG. NOS. 2,186,364 AND 3,037,698.

NO CLAIM IS MADE TO THE EXCLUSIVE RIGHT TO USE "REAL-TIME SOURCE", APART FROM THE MARK AS SHOWN.

FOR PROVIDING AN ONLINE, SEARCHABLE BUSINESS INFORMATION DATABASE OF BUSINESS INFORMATION, BUSINESS REPORTS, BUSINESS RESOURCES, BUSINESS TEMPLATES, BUSINESS CHECKLISTS, BEST PRACTICE EXAMPLES, AND A GLOSSARY OF PROJECT MANAGEMENT TERMS, ALL IN THE FIELD OF BUSINESS PROJECT MANAGEMENT AND BUSINESS ANALYSIS (U.S. CLS. 100, 101 AND 102).

FIRST USE 6-4-2009; IN COMMERCE 6-4-2009.

JAMES MACFARLANE, EXAMINING ATTORNEY

SN 77-763,997. ALLIED MARINE, LLC, FORT LAUDERDALE, FL. FILED 6-19-2009.

AQUASITION

THE MARK CONSISTS OF STANDARD CHARACTERS WITHOUT CLAIM TO ANY PARTICULAR FONT, STYLE, SIZE, OR COLOR.

FOR ORGANIZING BUSINESS EXPOSITIONS FOR THE RETAIL BOAT, YACHT AND LUXURY GOODS MARKETS; PROVIDING FACILITIES IN THE NATURE OF TEMPORARY RETAIL STORES FEATURING LUXURY PRODUCTS (U.S. CLS. 100, 101 AND 102).

LINDA M. KING, EXAMINING ATTORNEY

SN 77-764,006. ALLIED MARINE, LLC, FORT LAUDERDALE, FL. FILED 6-19-2009.

A BOATIQUE SHOW

THE MARK CONSISTS OF STANDARD CHARACTERS WITHOUT CLAIM TO ANY PARTICULAR FONT, STYLE, SIZE, OR COLOR.

NO CLAIM IS MADE TO THE EXCLUSIVE RIGHT TO USE "SHOW", APART FROM THE MARK AS SHOWN.

FOR ORGANIZING BUSINESS EXPOSITIONS FOR THE RETAIL BOAT, YACHT AND LUXURY GOODS MARKETS; PROVIDING FACILITIES IN THE NATURE OF TEMPORARY RETAIL STORES FEATURING LUXURY PRODUCTS (U.S. CLS. 100, 101 AND 102).

LINDA M. KING, EXAMINING ATTORNEY

CLASS 35—(Continued).

SN 77-765,726. TEACHER NANNIES CARE, INC., DBA TEACHERCARE CORPORATION, SCHAUMBURG, IL.
FILED 6-23-2009.

Teach & Care

THE MARK CONSISTS OF STANDARD CHARACTERS WITHOUT CLAIM TO ANY PARTICULAR FONT, STYLE, SIZE, OR COLOR.

OWNER OF U.S. REG. NO. 2,361,195.

FOR PROVIDING ON-LINE INFORMATION IN THE FIELDS OF EMPLOYMENT COUNSELING AND RECRUITMENT RELATED TO CAREERS IN THE FIELD OF CHILD CARE SPECIALISTS FOR THE CARE AND ENRICHMENT OF CHILDREN; PROVIDING JOB LISTINGS SERVICES; PROVIDING ON-LINE SEARCHABLE DATABASE FEATURING RESUMES; PROVIDING ON-LINE INTERACTIVE EMPLOYMENT COUNSELING AND RECRUITMENT SERVICES; PROVIDING ON-LINE EMPLOYMENT PLACEMENT SERVICES, NAMELY, RESUME MATCHING SERVICES VIA A GLOBAL COMPUTER NETWORK (U.S. CLS. 100, 101 AND 102).

SOPHIA S. KIM, EXAMINING ATTORNEY

SN 77-769,522. CROWN OF THORNS, LLC, IRVINE, CA.
FILED 6-26-2009.



THE COLOR(S) GREEN, BLUE, BLACK AND WHITE IS/ARE CLAIMED AS A FEATURE OF THE MARK.

THE MARK CONSISTS OF A BLUE PLANET WITH GREEN ON IT WEARING WHITE HEADPHONES WITH BLACK ON THE EARPIECE, ALL WITHIN A SQUARE BACKGROUND CARRIER IN THE COLOR BLACK.

FOR PROVIDING AN ONLINE DIRECTORY INFORMATION SERVICE FEATURING INFORMATION REGARDING MUSIC, THE ENVIRONMENT, CLASSIFIEDS, VIRTUAL COMMUNITY AND SOCIAL NETWORKING. ONLINE RETAIL STORE SERVICES IN THE FIELD OF ENTERTAINMENT, NAMELY, MUSICAL AND AUDIOVISUAL WORKS PROVIDED VIA THE INTERNET AND OTHER COMPUTER AND ELECTRONIC COMMUNICATION NETWORKS (U.S. CLS. 100, 101 AND 102).

BARNEY CHARLON, EXAMINING ATTORNEY

CLASS 35—(Continued).

SN 77-769,696. DISCHOUSE CORPORATION, DBA FREE-DOM DISC USA, BRIDGEVILLE, PA. FILED 6-27-2009.

DEFINING QUALITY ONE DISC
AT A TIME

THE MARK CONSISTS OF STANDARD CHARACTERS WITHOUT CLAIM TO ANY PARTICULAR FONT, STYLE, SIZE, OR COLOR.

FOR PREPARATION OF CUSTOM OR NON-CUSTOM ADVERTISING FOR BUSINESSES FOR DISSEMINATION VIA THE WEB, CD OR DVD FOR OPTIONAL UPLOAD OR DOWNLOAD TO A COMPUTER (U.S. CLS. 100, 101 AND 102).

FIRST USE 1-1-2006; IN COMMERCE 6-13-2009.
KARANENDRA S. CHHINA, EXAMINING ATTORNEY

SN 77-773,603. MODERN LIVING PRODUCTS, EULESS, TX. FILED 7-2-2009.



NO CLAIM IS MADE TO THE EXCLUSIVE RIGHT TO USE "PRODUCTS", APART FROM THE MARK AS SHOWN. THE MARK CONSISTS OF AN OPEN RECTANGULAR BOX CONTAINING THE WORDS "MODERN LIVING PRODUCTS".

FOR BUSINESS CONSULTATION IN THE FIELD OF STORAGE AND ORGANIZATION (U.S. CLS. 100, 101 AND 102).

FIRST USE 4-2-2007; IN COMMERCE 4-2-2007.
CAROLYN CATALDO, EXAMINING ATTORNEY

CLASS 35—(Continued).

SN 77-775,327. GONZALEZ, ADA L., DOVER, DE. FILED 7-7-2009.

Transformative Conversations

THE MARK CONSISTS OF STANDARD CHARACTERS WITHOUT CLAIM TO ANY PARTICULAR FONT, STYLE, SIZE, OR COLOR.

FOR BUSINESS CONSULTATION IN THE FIELD OF BUSINESS LEADERSHIP DEVELOPMENT; BUSINESS MANAGEMENT CONSULTATION IN THE FIELD OF EXECUTIVE AND LEADERSHIP DEVELOPMENT; CONSULTING SERVICES IN BUSINESS LEADERSHIP DEVELOPMENT AND BUSINESS MANAGEMENT; EDUCATION LEADERSHIP DEVELOPMENT; PROMOTING PUBLIC INTEREST IN EDUCATION, RECOGNITION, CAREER ADVANCEMENT, AND LEADERSHIP FOR ELITE MANAGERS AND EXECUTIVES IN CORPORATIONS AND PROFESSIONAL SERVICE FIRMS (U.S. CLS. 100, 101 AND 102).

FIRST USE 6-1-2009; IN COMMERCE 6-1-2009.
SHANNON TWOHIG, EXAMINING ATTORNEY

SN 77-775,776. XENITH, LLC, LOWELL, MA. FILED 7-7-2009.

XENITH ACADEMY

THE MARK CONSISTS OF STANDARD CHARACTERS WITHOUT CLAIM TO ANY PARTICULAR FONT, STYLE, SIZE, OR COLOR.

NO CLAIM IS MADE TO THE EXCLUSIVE RIGHT TO USE "ACADEMY", APART FROM THE MARK AS SHOWN.

FOR PROMOTING PUBLIC AWARENESS OF THE NEED FOR RISK REDUCTION AND THE NEED FOR SAFETY IN SPORTS AND OTHER POTENTIALLY HAZARDOUS ACTIVITIES (U.S. CLS. 100, 101 AND 102).

FIRST USE 11-30-2008; IN COMMERCE 11-30-2008.
JACLYN KIDWELL WALKER, EXAMINING ATTORNEY

SN 77-776,865. JEFFREY SCOTT, LAGUNA NIGUEL, CA. FILED 7-8-2009.

SOCIALLY CONSCIOUS DNA

THE MARK CONSISTS OF STANDARD CHARACTERS WITHOUT CLAIM TO ANY PARTICULAR FONT, STYLE, SIZE, OR COLOR.

FOR CONSULTING SERVICES, NAMELY, ASSISTING BUSINESSES IN CREATING AND DEVELOPING CHARITABLE PROGRAMS, NAMELY, SOCIAL PROGRAMS, COMMUNITY DEVELOPMENT PROGRAMS AND CHARITABLE GIVING PROGRAMS (U.S. CLS. 100, 101 AND 102).

TEJBIR SINGH, EXAMINING ATTORNEY

CLASS 35—(Continued).

SN 77-778,469. BUY ALL GOODS HERE ENTERPRISES INC., BAKERSFIELD, CA. FILED 7-10-2009.

Buy All Goods Here Enterprises

THE MARK CONSISTS OF STANDARD CHARACTERS WITHOUT CLAIM TO ANY PARTICULAR FONT, STYLE, SIZE, OR COLOR.

NO CLAIM IS MADE TO THE EXCLUSIVE RIGHT TO USE "ENTERPRISES", APART FROM THE MARK AS SHOWN.

FOR RETAIL STORE AND ON-LINE RETAIL STORE SERVICES FEATURING SEASONAL CONSUMER PRODUCTS AND GENERAL MERCHANDISE INCLUDING HOME AND GARDEN PRODUCTS, OFFICE EQUIPMENT AND SUPPLIES, ENTERTAINMENT PRODUCTS, RECREATION PRODUCTS, CLOTHING, PHOTOGRAPHIC AND OPTICAL PRODUCTS (U.S. CLS. 100, 101 AND 102).

FIRST USE 9-0-2008; IN COMMERCE 9-0-2008.
BRIAN NEVILLE, EXAMINING ATTORNEY

SN 77-780,465. GREYWOLF CONSULTING SERVICES, INC., AUSTIN, TX. FILED 7-14-2009.

TRIPORT CUSTOMER DISCOVERY

THE MARK CONSISTS OF STANDARD CHARACTERS WITHOUT CLAIM TO ANY PARTICULAR FONT, STYLE, SIZE, OR COLOR.

NO CLAIM IS MADE TO THE EXCLUSIVE RIGHT TO USE "CUSTOMER DISCOVERY", APART FROM THE MARK AS SHOWN.

FOR PROSPECTIVE CUSTOMER BUSINESS CONSULTING SERVICES, NAMELY, IDENTIFYING FUNCTIONAL DECISION MAKERS FOR THE DEFINITION, INTEGRATION AND FUNDING DECISIONS ASSOCIATED WITH PROSPECTIVE CUSTOMER OPPORTUNITIES AND EVALUATING AND INTERVIEWING IDENTIFIED DECISION MAKERS (U.S. CLS. 100, 101 AND 102).

FIRST USE 2-16-2009; IN COMMERCE 2-16-2009.
ANDREW LEASER, EXAMINING ATTORNEY

CLASS 35—(Continued).

SN 77-781,011. UNIVERSAL MUSIC - MGB NA LLC, SANTA MONCA, CA. FILED 7-14-2009.

GROOVETOWN

THE MARK CONSISTS OF STANDARD CHARACTERS WITHOUT CLAIM TO ANY PARTICULAR FONT, STYLE, SIZE, OR COLOR.

OWNER OF U.S. REG. NOS. 2,108,923 AND 2,333,182.

FOR DISTRIBUTORSHIPS IN THE FIELD OF MUSIC; DISTRIBUTORSHIPS OF MUSICAL AND THEATRICAL SOUND RECORDINGS AND VIDEO RECORDINGS; ADVERTISING AND PROMOTION SERVICES AND RELATED CONSULTING SERVICES; ADVERTISING AND PUBLICITY SERVICES; ASSOCIATION SERVICES, NAMELY, PROMOTING THE INTERESTS OF MUSICIANS, SINGERS, SONGWRITERS, MUSICAL PERFORMERS AND ARTISTS; COMPUTERIZED ON-LINE ORDERING FEATURING GENERAL MERCHANDISE AND GENERAL CONSUMER GOODS; COMPUTERIZED ON-LINE ORDERING SERVICES IN THE FIELD OF MUSIC; COMPUTERIZED ONLINE RETAIL STORE SERVICES IN THE FIELD OF MUSIC; COMPUTERIZED ON-LINE GIFT ORDERING SERVICES WHICH MATCHES THE GIFT GIVER'S REQUIREMENTS WITH THE GIFT RECIPIENT'S WANTS AND NEEDS; CONDUCTING AN ON-LINE TRADESHOW EXHIBITION IN THE FIELD OF MUSIC, MUSICAL CONCERTS AND MUSIC-RELATED VIDEOS; MAIL ORDER CATALOG SERVICES FEATURING PRERECORDED CDS, CASSETTES AND DVDS FEATURING MUSIC AND MUSIC-RELATED ENTERTAINMENT, CLOTHING AND GENERAL MERCHANDISE; ON-LINE RETAIL STORE SERVICES FEATURING DOWNLOADABLE PRERECORDED MUSIC AND VIDEOS, CLOTHING AND GENERAL MERCHANDISE; ORGANIZATION OF PROMOTIONS USING AUDIO-VISUAL MEDIA; PREPARING AUDIO-VISUAL DISPLAYS IN THE FIELD OF MUSIC; PREPARING AUDIO VISUAL PRESENTATIONS FOR USE IN ADVERTISING; ARRANGING AND CONDUCTING TRADE SHOW EXHIBITIONS IN THE FIELD OF MUSIC AND ENTERTAINMENT; ARRANGING AND CONDUCTING FAIRS AND EXHIBITIONS FOR BUSINESS AND ADVERTISING PURPOSES; PROMOTING AND CONDUCTING TRADE SHOWS IN THE FIELD OF MUSIC; PROMOTING THE CONCERTS OF OTHERS; PROMOTING THE GOODS AND SERVICES OF OTHERS BY ARRANGING FOR SPONSORS TO AFFILIATE THEIR GOODS AND SERVICES WITH CONCERTS AND MUSICAL EVENTS; PROMOTING THE GOODS OF OTHERS BY PREPARING AND PLACING ADVERTISEMENTS IN AN ELECTRONIC MAGAZINE ACCESSED THROUGH A GLOBAL COMPUTER NETWORK; PROVIDING INFORMATION ABOUT THE GOODS AND SERVICES OF OTHERS VIA A GLOBAL COMPUTER NETWORK; RETAIL STORE SERVICES AVAILABLE THROUGH COMPUTER COMMUNICATIONS AND INTERACTIVE TELEVISION FEATURING PRERECORDED CDS, CASSETTES, DVDS AND VIDEO CASSETTES FEATURING MUSIC AND MUSIC-RELATED ENTERTAINMENT AND LICENSED GENERAL CONSUMER MERCHANDISE; SUBSCRIPTIONS TO BOOKS, REVIEWS, NEWSPAPERS OR COMIC BOOKS; MANAGEMENT OF PROFESSIONAL PERFORMING ARTISTS; MANAGEMENT OF PROFESSIONAL ATHLETES; TALENT AGENCY SERVICES; ADVERTISING, INCLUDING PROMOTION OF PRODUCTS AND SERVICES OF THIRD PARTIES THROUGH SPONSORING ARRANGEMENTS AND LICENSE AGREEMENTS RELATING TO INTERNATIONAL SPORTS AND MUSIC EVENTS; COORDINATION OF RECREATIONAL SPORTING OPPORTUNITIES FOR INDIVIDUALS WHO WISH TO PARTICIPATE IN TEAM LEAGUE SPORTS; PROMOTING SPORTS AND MUSIC COMPETITIONS AND EVENTS FOR OTHERS; PROMOTING GOODS AND SERVICES OF OTHERS BY ARRANGING FOR SPONSORS TO AFFILIATE THEIR GOODS AND SERVICES WITH PROFESSIONAL SPORTS AND MUSIC COMPETITIONS; PROMOTING THE INTERESTS OF

CLASS 35—(Continued).

PEOPLE INVOLVED AND CONCERNED WITH SPORTS AND MUSIC; PROVIDING ON LINE REGISTRATION SERVICES FOR SPORTS AND MUSIC COMPETITIONS; COMMERCIAL ADMINISTRATION OF THE LICENSING OF MUSICAL AND NON-MUSICAL SOUND RECORDINGS OF OTHERS; PROMOTING THE GOODS AND SERVICES OF OTHERS VIA A GLOBAL COMPUTER NETWORK WEBSITE WHERE CUSTOMERS PRODUCE THEIR OWN CUSTOMIZED PRERECORDED TELEPHONE MESSAGES IN THE NATURE OF MUSIC, CUSTOMIZED MESSAGES OR BOTH TO BE PLAYED WHILE TELEPHONE CALLERS ARE PLACED ON HOLD (U.S. CLS. 100, 101 AND 102).

DAVID YONTEF, EXAMINING ATTORNEY

SN 77-782,829. LINKEDIN CORPORATION, MOUNTAIN VIEW, CA. FILED 7-16-2009.

LINKEDIN

THE MARK CONSISTS OF STANDARD CHARACTERS WITHOUT CLAIM TO ANY PARTICULAR FONT, STYLE, SIZE, OR COLOR.

OWNER OF U.S. REG. NOS. 3,074,241, 3,074,242 AND 3,303,349.

FOR ADVERTISING AND MARKETING SERVICES, NAMELY, PROMOTING GOODS AND SERVICES FOR BUSINESSES; COMPILATION AND SYSTEMIZATION OF INFORMATION INTO COMPUTER DATABASES; PROVIDING AN ONLINE SEARCHABLE DATABASE FEATURING EMPLOYMENT AND CAREER OPPORTUNITIES AND BUSINESS, EMPLOYMENT AND PROFESSIONAL QUERIES AND ANSWERS; PROVIDING INFORMATION ALL RELATING TO CONSUMER PRODUCTS, SERVICES, EVENTS AND ACTIVITIES IN A PARTICULAR GEOGRAPHIC REGION; ORGANIZING AND CONDUCTING JOB FAIRS; JOB PLACEMENT SERVICES, HUMAN RESOURCES CONSULTING SERVICES; BUSINESS RESEARCH AND SURVEY SERVICES; BUSINESS MONITORING SERVICES, NAMELY, PROVIDING TRACKING DETAILS ABOUT USER CLICK TRAFFIC OR WEBSITE VISITS TO OTHERS; PROMOTING THE GOODS AND SERVICES OF OTHERS VIA A GLOBAL COMPUTER NETWORK; ADVERTISING, MARKETING AND PROMOTIONAL SERVICES RELATED TO ALL INDUSTRIES FOR THE PURPOSE OF FACILITATING NETWORKING AND SOCIALIZING OPPORTUNITIES FOR BUSINESS PURPOSES; ON-LINE RETAIL STORE SERVICES FEATURING DIGITAL MEDIA, CLOTHING, FOOTWEAR, HEADGEAR, PRINTED MATTER, STATIONERY, OFFICE ACCESSORIES, BAGS, GAMES, TOYS AND PINS; CHARITABLE SERVICES, NAMELY, PROMOTING PUBLIC AWARENESS ABOUT COMMUNITY SERVICE; PROVIDING ONLINE CAREER NETWORKING SERVICES AND INFORMATION IN THE FIELDS OF EMPLOYMENT, RECRUITMENT, JOB RESOURCES, AND JOB LISTINGS; PROVIDING ONLINE INTERACTIVE EMPLOYMENT COUNSELING; PERSONNEL RECRUITMENT AND PLACEMENT SERVICES; ELECTRONIC COMMERCE SERVICES, NAMELY, PROVIDING INFORMATION ABOUT PRODUCTS AND SERVICES VIA TELECOMMUNICATION NETWORKS FOR ADVERTISING AND SALES PURPOSES; PROVIDING NETWORKING OPPORTUNITIES FOR INDIVIDUALS SEEKING EMPLOYMENT; ON-LINE PROFESSIONAL NETWORKING OPPORTUNITIES; PROVIDING ONLINE COMPUTER DATABASES AND ONLINE SEARCHABLE DATABASES IN THE FIELDS OF BUSINESS AND PROFESSIONAL NETWORKING (U.S. CLS. 100, 101 AND 102).

BERYL GARDNER, EXAMINING ATTORNEY

CLASS 35—(Continued).

SN 77-783,732. THE FOOD PROJECT, INC., LINCOLN, MA. FILED 7-17-2009.

REAL FOOD CHALLENGE

THE MARK CONSISTS OF STANDARD CHARACTERS WITHOUT CLAIM TO ANY PARTICULAR FONT, STYLE, SIZE, OR COLOR.

NO CLAIM IS MADE TO THE EXCLUSIVE RIGHT TO USE "REAL FOOD", APART FROM THE MARK AS SHOWN.

FOR CHARITABLE SERVICES, NAMELY, TRAINING, CONSULTING, ORGANIZING MEETINGS, AND PROMOTING PUBLIC AWARENESS IN THE FIELDS OF FARM-TO-CAFETERIA FOOD AND AGRICULTURAL PROGRAMS, GARDENING, FAIR TRADE, ORGANIC AND SUSTAINABLE FOOD PRACTICES, FARMWORKERS' RIGHTS, AND RELATIONSHIPS WITH LOCAL FARMERS (U.S. CLS. 100, 101 AND 102).

FIRST USE 11-3-2007; IN COMMERCE 11-3-2007.

LINDA POWELL, EXAMINING ATTORNEY

SN 77-783,943. AIKINS, ANNENA T., DBA BRA-OLGY, AMERICAN CANYON, CA. FILED 7-17-2009.

Bra-ology

THE MARK CONSISTS OF STANDARD CHARACTERS WITHOUT CLAIM TO ANY PARTICULAR FONT, STYLE, SIZE, OR COLOR.

FOR ON-LINE RETAIL STORE SERVICES FEATURING LINGERIE AND UNDERGARMENTS; RETAIL SERVICES BY DIRECT SOLICITATION BY SALES AGENTS IN THE FIELD OF LINGERIE AND UNDERGARMENTS; RETAIL STORE SERVICES FEATURING LINGERIE AND UNDERGARMENTS (U.S. CLS. 100, 101 AND 102).

FIRST USE 6-29-2009; IN COMMERCE 7-8-2009.

MATTHEW PAPPAS, EXAMINING ATTORNEY

CLASS 35—(Continued).

SN 77-785,909. EQUALITY FEDERATION, SAN FRANCISCO, CA. FILED 7-21-2009.



THE COLOR(S) BLUE AND WHITE IS/ARE CLAIMED AS A FEATURE OF THE MARK.

THE MARK CONSISTS OF A BLUE STAR WITH AN UPSIDE DOWN WHITE STAR INSIDE IT.

FOR ASSOCIATION SERVICES, NAMELY, PROMOTING THE INTERESTS OF AND PROVIDING BUSINESS SERVICES IN THE NATURE OF BUSINESS MANAGEMENT CONSULTING TO LGBT ADVOCACY ORGANIZATIONS (U.S. CLS. 100, 101 AND 102).

FIRST USE 7-0-2006; IN COMMERCE 7-0-2006.

KELLY CHOE, EXAMINING ATTORNEY

SN 77-785,984. SOUTHERN GRANITE & MARBLE, INC., RALEIGH, NC. FILED 7-21-2009.

SOUTHERN GRANITE & MARBLE

THE MARK CONSISTS OF STANDARD CHARACTERS WITHOUT CLAIM TO ANY PARTICULAR FONT, STYLE, SIZE, OR COLOR.

NO CLAIM IS MADE TO THE EXCLUSIVE RIGHT TO USE "GRANITE & MARBLE", APART FROM THE MARK AS SHOWN.

SEC. 2(F).

FOR WHOLESALE DISTRIBUTORSHIP FEATURING COUNTERTOPS AND TABLE TOPS (U.S. CLS. 100, 101 AND 102).

FIRST USE 0-0-1999; IN COMMERCE 0-0-1999.

SAIMA MAKHDOOM, EXAMINING ATTORNEY

CLASS 35—(Continued).

SN 77-790,415. MASTERCARD INTERNATIONAL INCORPORATED, PURCHASE, NY. FILED 7-27-2009.

PRICELESS PICKS

THE MARK CONSISTS OF STANDARD CHARACTERS WITHOUT CLAIM TO ANY PARTICULAR FONT, STYLE, SIZE, OR COLOR.

OWNER OF U.S. REG. NOS. 2,709,529, 3,369,907 AND OTHERS.

FOR PROMOTING THE GOODS AND SERVICES OF OTHERS; PROVIDING ONLINE BUSINESS DIRECTORY SERVICES REGARDING THE PRODUCTS AND SERVICES OF OTHERS (U.S. CLS. 100, 101 AND 102).

FIRST USE 7-16-2009; IN COMMERCE 7-16-2009.

JULIE WATSON, EXAMINING ATTORNEY

SN 77-792,111. COLLECTORS PROOF INC., ORCHARD PARK, NY. FILED 7-29-2009.

COLLECTORS PROOF

THE MARK CONSISTS OF STANDARD CHARACTERS WITHOUT CLAIM TO ANY PARTICULAR FONT, STYLE, SIZE, OR COLOR.

NO CLAIM IS MADE TO THE EXCLUSIVE RIGHT TO USE "COLLECTORS", APART FROM THE MARK AS SHOWN.

FOR MAINTAINING A REGISTRY OF SPORTS MEMORABILIA AND COLLECTIBLES (U.S. CLS. 100, 101 AND 102).

JACQUELINE A. LAVINE, EXAMINING ATTORNEY

SN 77-792,301. SOUTHERN GRANITE & MARBLE, INC., RALEIGH, NC. FILED 7-29-2009.



THE MARK CONSISTS OF THE LETTERS "S G M" SUPERIMPOSED OVER AN AMPERSAND.

FOR WHOLESALE DISTRIBUTORSHIP FEATURING COUNTERTOPS AND TABLE TOPS (U.S. CLS. 100, 101 AND 102).

FIRST USE 0-0-1999; IN COMMERCE 0-0-1999.

SAIMA MAKHDOOM, EXAMINING ATTORNEY

CLASS 35—(Continued).

SN 77-794,721. TENSOR ID, TEMECULA, CA. FILED 7-31-2009.

TENSOR ID, INC.

THE MARK CONSISTS OF STANDARD CHARACTERS WITHOUT CLAIM TO ANY PARTICULAR FONT, STYLE, SIZE, OR COLOR.

NO CLAIM IS MADE TO THE EXCLUSIVE RIGHT TO USE "ID, INC.", APART FROM THE MARK AS SHOWN.

FOR WHOLESALE DISTRIBUTORSHIPS FEATURING BARCODE SCANNERS (U.S. CLS. 100, 101 AND 102).

FIRST USE 5-1-2008; IN COMMERCE 5-1-2008.

STEPHANIE ALI, EXAMINING ATTORNEY

SN 77-794,794. PAICH, MILO RAND, TAMPA, FL. FILED 7-31-2009.

INITIALAB

THE MARK CONSISTS OF STANDARD CHARACTERS WITHOUT CLAIM TO ANY PARTICULAR FONT, STYLE, SIZE, OR COLOR.

FOR BUSINESS CONSULTATION, NAMELY, BUSINESS MEETING PLANNING (U.S. CLS. 100, 101 AND 102).

FIRST USE 5-8-2009; IN COMMERCE 5-14-2009.

SALLY SHIH, EXAMINING ATTORNEY

SN 77-795,101. PREWITT, RONALD G., LAS VEGAS, NV. FILED 8-2-2009.

You haven't played...
until you've played Vegas.

THE MARK CONSISTS OF STANDARD CHARACTERS WITHOUT CLAIM TO ANY PARTICULAR FONT, STYLE, SIZE, OR COLOR.

FOR ADVERTISING AND DIRECTORY SERVICES, NAMELY, PROMOTING THE SERVICES OF OTHERS BY PROVIDING A WEB PAGE FEATURING LINKS TO THE WEBSITES OF OTHERS (U.S. CLS. 100, 101 AND 102).

FIRST USE 8-2-2009; IN COMMERCE 8-2-2009.

DAVID TAYLOR, EXAMINING ATTORNEY

CLASS 35—(Continued).

SN 77-795,765. THIRD STREET PARTNERS ATTENTION AGENCY, LLC, INDIANAPOLIS, IN. FILED 8-3-2009.

THIRD STREET

THE MARK CONSISTS OF STANDARD CHARACTERS WITHOUT CLAIM TO ANY PARTICULAR FONT, STYLE, SIZE, OR COLOR.

FOR ADVERTISING SERVICES (U.S. CLS. 100, 101 AND 102).

FIRST USE 12-0-2008; IN COMMERCE 12-0-2008.

LINDA MICKLEBURGH, EXAMINING ATTORNEY

SN 77-796,488. VITROROBERTSON LLC, SAN DIEGO, CA. FILED 8-4-2009.

VITRO

THE MARK CONSISTS OF STANDARD CHARACTERS WITHOUT CLAIM TO ANY PARTICULAR FONT, STYLE, SIZE, OR COLOR.

FOR ADVERTISING AGENCY SERVICES; MARKETING COMMUNICATIONS CONSULTING SERVICES, NAMELY, CONSULTING IN RELATION TO THE VARIOUS COMMUNICATIONS MEANS AND METHODS AVAILABLE IN THE FIELD OF MARKETING; BUSINESS CONSULTATION; BRAND CONSULTING, NAMELY, BRAND IMAGERY CONSULTING SERVICES, CONSULTING IN BRAND CONCEPT AND BRAND DEVELOPMENT SERVICES FOR CORPORATE AND INDIVIDUAL CLIENTS, CONSULTING IN BRAND EVALUATION, CONSULTING IN BRAND POSITIONING SERVICES, AND CONSULTING IN THE DEVELOPMENT, MANAGEMENT AND MARKETING OF BRANDS FOR BUSINESSES; CREATIVE MARKETING DESIGN SERVICES; PUBLIC RELATIONS AND PUBLICITY SERVICES; MEDIA PLANNING SERVICES, NAMELY, PROVIDING CONSULTING SERVICES IN THE FIELD OF FACILITATING THE PLANNING, BUYING, AND SELLING OF MEDIA; EVENT MARKETING SERVICES, NAMELY, ARRANGING AND CONDUCTING MARKETING AND PROMOTION OF PROMOTIONAL EVENTS FOR OTHERS; MARKET RESEARCH SERVICES (U.S. CLS. 100, 101 AND 102).

FIRST USE 10-5-2009; IN COMMERCE 10-5-2009.

MARIAM MAHMOUDI, EXAMINING ATTORNEY

CLASS 35—(Continued).

SN 77-797,206. HESS CORPORATION, NEW YORK, NY. FILED 8-5-2009.

HESS ENERGY

THE MARK CONSISTS OF STANDARD CHARACTERS WITHOUT CLAIM TO ANY PARTICULAR FONT, STYLE, SIZE, OR COLOR.

OWNER OF U.S. REG. NOS. 3,310,764, 3,334,717 AND 3,394,038.

NO CLAIM IS MADE TO THE EXCLUSIVE RIGHT TO USE "ENERGY", APART FROM THE MARK AS SHOWN. SEC. 2(F) AS TO "HESS".

FOR MARKETING CONSULTING AS TO NATURAL GAS, ELECTRICITY, MOTOR OIL AND FUEL (U.S. CLS. 100, 101 AND 102).

IRA J. GOODSAD, EXAMINING ATTORNEY

SN 77-797,791. JOSHUA C. HILL, PLATTSBURG, MO. FILED 8-5-2009.

BALL Z MOTORSPORTS

THE MARK CONSISTS OF STANDARD CHARACTERS WITHOUT CLAIM TO ANY PARTICULAR FONT, STYLE, SIZE, OR COLOR.

NO CLAIM IS MADE TO THE EXCLUSIVE RIGHT TO USE "MOTORSPORTS", APART FROM THE MARK AS SHOWN.

FOR RETAIL STORE AND ON-LINE RETAIL STORE SERVICES FEATURING SPORT BIKE AFTERMARKET PARTS AND ACCESSORIES (U.S. CLS. 100, 101 AND 102).

FIRST USE 7-1-2007; IN COMMERCE 7-1-2007.

REBECCA GILBERT, EXAMINING ATTORNEY

CLASS 35—(Continued).

SN 77-798,517. XANTHUS COMMUNICATIONS LLC, SEATTLE, WA. FILED 8-6-2009.

PR FOR PEOPLE

THE MARK CONSISTS OF STANDARD CHARACTERS WITHOUT CLAIM TO ANY PARTICULAR FONT, STYLE, SIZE, OR COLOR.

NO CLAIM IS MADE TO THE EXCLUSIVE RIGHT TO USE "PR", APART FROM THE MARK AS SHOWN.

FOR ADVERTISING SERVICES, PUBLIC RELATIONS AND MARKETING SERVICES, NAMELY, PROMOTING AND MARKETING THE GOODS AND SERVICES OF OTHERS THROUGH ALL PUBLIC COMMUNICATION MEANS; ADVERTISING, MARKETING AND PROMOTIONAL SERVICES RELATED TO ALL INDUSTRIES FOR THE PURPOSE OF FACILITATING NETWORKING AND SOCIALIZING OPPORTUNITIES FOR BUSINESS PURPOSES; BUSINESS SERVICES, NAMELY, PROCURING QUALIFIED AND CREDENTIALLED THIRD-PARTY EXPERTS, PROFESSIONALS AND OTHER QUALIFIED PERSONNEL AND DOCUMENTATION AND INFORMATION ALL ON BEHALF OF OTHERS (U.S. CLS. 100, 101 AND 102).

FIRST USE 11-28-2007; IN COMMERCE 11-28-2007.

RUSS HERMAN, EXAMINING ATTORNEY

SN 77-799,974. MCDANIEL, TERRY, ALAMO, CA. FILED 8-7-2009.

DashLeader

THE MARK CONSISTS OF STANDARD CHARACTERS WITHOUT CLAIM TO ANY PARTICULAR FONT, STYLE, SIZE, OR COLOR.

FOR WEB BASED REAL ESTATE MARKETING AND PROSPECTING SERVICES IN THE FIELDS OF RESIDENTIAL AND COMMERCIAL PROPERTIES, NAMELY, PROVIDING REAL ESTATE LEADS FOR REAL ESTATE AGENTS (U.S. CLS. 100, 101 AND 102).

MICHELLE DUBOIS, EXAMINING ATTORNEY

SN 77-803,028. UTILIPRO SERVICES, LLC, ATLANTA, GA. FILED 8-12-2009.

UTILIPRO

THE MARK CONSISTS OF STANDARD CHARACTERS WITHOUT CLAIM TO ANY PARTICULAR FONT, STYLE, SIZE, OR COLOR.

FOR HOME WARRANTY SERVICES, NAMELY, ARRANGING FOR REPAIRS AND REPLACEMENT OF MAJOR HOME SYSTEMS, APPLIANCES AND PARTS THEREOF PROVIDED BY OTHERS PURSUANT TO SERVICE AGREEMENTS (U.S. CLS. 100, 101 AND 102).

CURTIS FRENCH, EXAMINING ATTORNEY

CLASS 35—(Continued).

SN 77-803,147. PROJECT C3, LLC, ST. CHARLES, MO. FILED 8-12-2009.

campus canvas

THE MARK CONSISTS OF STANDARD CHARACTERS WITHOUT CLAIM TO ANY PARTICULAR FONT, STYLE, SIZE, OR COLOR.
FOR PROMOTIONAL AND MARKETING SERVICES (U.S. CLS. 100, 101 AND 102).
ANDREA HACK, EXAMINING ATTORNEY

SN 77-803,547. MARY Y DIMOURO, DBA RETAIL MAMA.COM, HUDSON, MA. FILED 8-13-2009.

Retail Mama.com

THE MARK CONSISTS OF STANDARD CHARACTERS WITHOUT CLAIM TO ANY PARTICULAR FONT, STYLE, SIZE, OR COLOR.
NO CLAIM IS MADE TO THE EXCLUSIVE RIGHT TO USE "RETAIL", APART FROM THE MARK AS SHOWN.
FOR BUSINESS MANAGEMENT CONSULTING WITH RELATION TO STRATEGY, MARKETING, PRODUCTION, PERSONNEL AND RETAIL SALE MATTERS (U.S. CLS. 100, 101 AND 102).
FIRST USE 7-17-2009; IN COMMERCE 8-3-2009.
CHRISTINA SOBRAL, EXAMINING ATTORNEY

SN 77-804,733. FIREPOWER MARKETING, INC., BLAINE, WA. FILED 8-14-2009.

ROYALTY REWARDS

THE MARK CONSISTS OF STANDARD CHARACTERS WITHOUT CLAIM TO ANY PARTICULAR FONT, STYLE, SIZE, OR COLOR.
NO CLAIM IS MADE TO THE EXCLUSIVE RIGHT TO USE "REWARDS", APART FROM THE MARK AS SHOWN.
FOR PROVIDING A PURCHASE INCENTIVE REWARD PROGRAM TO PROMOTE THE SALE OF PRODUCTS OR SERVICES OF OTHERS (U.S. CLS. 100, 101 AND 102).
FIRST USE 5-17-2005; IN COMMERCE 5-17-2005.
DAWN HAN, EXAMINING ATTORNEY

CLASS 35—(Continued).

SN 77-804,776. GLOBAL SPECIALTY SOLUTIONS, INC., SOUTH BELOIT, IL. FILED 8-14-2009.

In The Pursuit Of Perfection

THE MARK CONSISTS OF STANDARD CHARACTERS WITHOUT CLAIM TO ANY PARTICULAR FONT, STYLE, SIZE, OR COLOR.
FOR BUSINESS ADMINISTRATION AND MANAGEMENT (U.S. CLS. 100, 101 AND 102).
FIRST USE 10-1-2008; IN COMMERCE 10-1-2008.
ADA HAN, EXAMINING ATTORNEY

SN 77-804,993. GREEN AMERICA, WASHINGTON, DC. FILED 8-14-2009.

BETTER PAPER

THE MARK CONSISTS OF STANDARD CHARACTERS WITHOUT CLAIM TO ANY PARTICULAR FONT, STYLE, SIZE, OR COLOR.
NO CLAIM IS MADE TO THE EXCLUSIVE RIGHT TO USE "PAPER", APART FROM THE MARK AS SHOWN.
FOR PROVIDING AN ONLINE DIRECTORY INFORMATION SERVICE FEATURING INFORMATION REGARDING COLLABORATION AMONG PAPER MANUFACTURERS, MERCHANTS, INVESTORS, BUSINESSES, NONPROFITS AND CONSUMERS TO ENCOURAGE THE PRODUCTION OF ENVIRONMENTALLY-FRIENDLY PAPER (U.S. CLS. 100, 101 AND 102).
FIRST USE 1-1-2009; IN COMMERCE 1-1-2009.
MAYUR VAGHANI, EXAMINING ATTORNEY

SN 77-805,020. GREEN AMERICA, WASHINGTON, DC. FILED 8-14-2009.



NO CLAIM IS MADE TO THE EXCLUSIVE RIGHT TO USE "PAPER", APART FROM THE MARK AS SHOWN.
THE MARK CONSISTS OF "BETTER PAPER FORESTS. CLIMATE. COMMUNITY." STACKED WITH AN ECLIPSE DESIGN ABOVE IT.
FOR PROVIDING AN ONLINE DIRECTORY INFORMATION SERVICE FEATURING INFORMATION REGARDING COLLABORATION AMONG PAPER MANUFACTURERS, MERCHANTS, INVESTORS, BUSINESSES, NONPROFITS AND CONSUMERS TO ENCOURAGE THE PRODUCTION OF ENVIRONMENTALLY-FRIENDLY PAPER (U.S. CLS. 100, 101 AND 102).
FIRST USE 5-1-2009; IN COMMERCE 5-1-2009.
MAYUR VAGHANI, EXAMINING ATTORNEY

CLASS 35—(Continued).

SN 77-807,216. SEARS BRANDS, LLC, HOFFMAN ESTATES, LL. FILED 8-18-2009.

SHOPYOURWAY

THE MARK CONSISTS OF STANDARD CHARACTERS WITHOUT CLAIM TO ANY PARTICULAR FONT, STYLE, SIZE, OR COLOR.

FOR RETAIL DEPARTMENT STORE SERVICES AND ONLINE RETAIL DEPARTMENT STORE SERVICES (U.S. CLS. 100, 101 AND 102).

FIRST USE 3-18-2009; IN COMMERCE 3-18-2009.
JOHN GARTNER, EXAMINING ATTORNEY

SN 77-807,222. SCHNEIDER, PATRICIA A., DBA THE RIGHT CHOICE, BRENTWOOD, CA. FILED 8-18-2009.

The Right Choice

THE MARK CONSISTS OF STANDARD CHARACTERS WITHOUT CLAIM TO ANY PARTICULAR FONT, STYLE, SIZE, OR COLOR.

FOR BUSINESS MANAGEMENT CONSULTATION AND SERVICES, NAMELY, MANAGING AND ADMINISTERING NON-CORE FUNCTIONS, NAMELY, MAILING AND SHIPPING, RECORDS MANAGEMENT, INFORMATION SERVICES, ADMINISTRATION, PAYROLL AND ACCOUNTING, AND TELEMARKETING SERVICES (U.S. CLS. 100, 101 AND 102).

FIRST USE 4-1-2009; IN COMMERCE 4-1-2009.
PAM WILLIS, EXAMINING ATTORNEY

SN 77-808,321. SAFE HARBOR, L.L.C., DBA SAFE HARBOR, SCOTTSDALE, AZ. FILED 8-19-2009.

Safe Harbor

THE MARK CONSISTS OF STANDARD CHARACTERS WITHOUT CLAIM TO ANY PARTICULAR FONT, STYLE, SIZE, OR COLOR.

FOR DATA MANAGEMENT AND REPORTING SERVICE, NAMELY, MONITORING DATA COLLECTED FROM IGNITION INTERLOCK DEVICES, WHICH COLLECTS BLOOD ALCOHOL CONCENTRATION DATA, AND REPORTING THE DATA TO AUTHORIZED THIRD PARTIES (U.S. CLS. 100, 101 AND 102).

FIRST USE 1-1-2001; IN COMMERCE 1-1-2001.
MARGARET POWER, EXAMINING ATTORNEY

CLASS 35—(Continued).

SN 77-808,472. AMERICAN ACADEMY HOLDINGS, LLC, SALT LAKE CITY, UT. FILED 8-19-2009.

CHOC

THE MARK CONSISTS OF STANDARD CHARACTERS WITHOUT CLAIM TO ANY PARTICULAR FONT, STYLE, SIZE, OR COLOR.

FOR TESTING TO DETERMINE PROFESSIONAL COMPETENCY (U.S. CLS. 100, 101 AND 102).
JASON BLAIR, EXAMINING ATTORNEY

SN 77-809,297. GREG A. CARLSON ENTERPRISES, INC., LOS ANGELES, CA. FILED 8-20-2009.



NO CLAIM IS MADE TO THE EXCLUSIVE RIGHT TO USE "POST", APART FROM THE MARK AS SHOWN.

THE STIPPLING IS FOR SHADING PURPOSES ONLY.
THE MARK CONSISTS OF THE STYLIZED TEXT "DT" INSIDE A TRAVEL SUITCASE WITH THE STYLIZED TEXT "POST" TO THE RIGHT OF IT.

FOR PROMOTING THE GOODS AND SERVICES OF OTHERS IN THE FIELD OF TRAVEL AND TOURISM, NAMELY, PROMOTING TRAVEL DEALS OF OTHERS VIA AN ONLINE WEBSITE (U.S. CLS. 100, 101 AND 102).

FIRST USE 7-0-2009; IN COMMERCE 7-0-2009.
COLLEEN KEARNEY, EXAMINING ATTORNEY

CLASS 35—(Continued).

SN 77-810,905. PRGTS, LLC, ATLANTA, GA. FILED 8-24-2009.

PRGX

THE MARK CONSISTS OF STANDARD CHARACTERS WITHOUT CLAIM TO ANY PARTICULAR FONT, STYLE, SIZE, OR COLOR.

FOR PROVIDING BUSINESS AUDITING SERVICES IN THE NATURE OF RECOVERY AUDITING; BUSINESS CONSULTATION IN THE FIELD OF RECOVERY AUDITING; BUSINESS ADVISORY, CONSULTANCY AND INFORMATION SERVICES IN THE FIELD OF BUSINESS AND GOVERNMENT OPTIMIZATION; GOVERNMENT ADVISORY SERVICES, NAMELY, PROVIDING ADVICE AND ASSISTANCE TO GOVERNMENTAL AGENCIES AND DEPARTMENTS RELATING TO IDENTIFYING AND RECOVERING INAPPROPRIATE PAYMENTS; BUSINESS MANAGEMENT CONSULTING FEATURING SPECIALIZATION IN THE USE OF DATA EXTRACTION, TRANSFORMATION AND ANALYSIS CAPABILITIES, NAMELY, DATA PROCESSING, FOR THE REDUCTION OF COSTS AND IMPROVEMENT OF PROCUREMENT AND PAYMENT PROCESSES; PROVIDING BUSINESS CONSULTING, BUSINESS INFORMATION SERVICES IN THE FIELD OF ANALYTICS, BUSINESS OPERATIONAL AND BUSINESS PROCESS IMPROVEMENT AND OUTSOURCING SERVICES FOR THE FINANCE, ACCOUNTING AND PROCUREMENT FUNCTIONS OF COMMERCIAL AND GOVERNMENTAL ENTITIES; ACCOUNTING SERVICES (U.S. CLS. 100, 101 AND 102).

KATHERINE STOIDES, EXAMINING ATTORNEY

CLASS 35—(Continued).

SN 77-813,403. OVERSTOCKDEALS, LLC., HIGHLANDS RANCH, CO. FILED 8-26-2009.

OVERSTOCKDEALS.COM

THE MARK CONSISTS OF STANDARD CHARACTERS WITHOUT CLAIM TO ANY PARTICULAR FONT, STYLE, SIZE, OR COLOR.

SEC. 2(F).

FOR ON-LINE WHOLESALE AND RETAIL STORE SERVICES FEATURING HOME IMPROVEMENT ITEMS, PLUMBING FAUCETS, FIXTURES, ACCESSORIES, AND PARTS, KITCHEN ACCESSORIES, BATHROOM ACCESSORIES, LIGHTING, DOOR HARDWARE, LOCKSETS, AND HANDLESETS, CABINET HARDWARE AND KNOBS, TOOLS AND ACCESSORIES, HARDWARE, WIRING, APPLIANCES, OUTDOOR POWER EQUIPMENT AND ACCESSORIES, GARBAGE DISPOSALS, VANITIES, COUNTERTOPS, MEDICINE CABINETS, MIRRORS, GAS GRILLS, FIREPLACE AND HEARTH PRODUCTS, ELECTRICAL PRODUCTS, WIRING, AND CABLING, ENERGY PRODUCTS, CONTROLS AND TIME SWITCHES, POOL AND SPA CONTROLS AND EQUIPMENT, SECURITY SYSTEMS, WIRELESS CONTROLS, WATER FILTERS, WATER HEATERS, COMMERCIAL PLUMBING FLUSH VALVES, FAUCETS, FIXTURES, PARTS AND SUPPLIES, DOORS AND WINDOWS, CEILING FANS, HEATING, VENTING AND COOLING PRODUCTS, BATH AND OTHER HOME SAFETY PRODUCTS, OUTDOOR STORAGE, PATIO FURNITURE, AND GARAGE DOOR OPENERS (U.S. CLS. 100, 101 AND 102).

FIRST USE 1-10-2008; IN COMMERCE 3-4-2008.
RAUL CORDOVA, EXAMINING ATTORNEY

SN 77-813,612. WINGMEN MOTORCYCLE CLUB, FAYETTEVILLE, NC. FILED 8-26-2009.



NO CLAIM IS MADE TO THE EXCLUSIVE RIGHT TO USE "MC", APART FROM THE MARK AS SHOWN.

THE MARK CONSISTS OF THE FOLLOWING: A STYLIZED LETTER "W" IN WHITE WITH A RED OUTLINE. TO THE RIGHT OF THE LETTER IS A RED CIRCLE CONTAINING THE LETTERS "MC" IN WHITE. UNDERNEATH THE LETTER IS THE PHRASE "THE WINGMEN" IN A STYLIZED RED FONT.

FOR CLUB SERVICES, NAMELY, PROMOTING THE INTERESTS OF MOTORCYCLE RIDING (U.S. CLS. 100, 101 AND 102).

FIRST USE 0-0-1979; IN COMMERCE 0-0-1979.
ERNEST SHOSHO, EXAMINING ATTORNEY

CLASS 35—(Continued).

SN 77-813,693. WINGMEN MOTORCYCLE CLUB, FAYETTEVILLE, NC. FILED 8-26-2009.



NO CLAIM IS MADE TO THE EXCLUSIVE RIGHT TO USE "M C", APART FROM THE MARK AS SHOWN.

THE MARK CONSISTS OF A BLACK GEOMETRIC SHAPE AT THE TOP OF WHICH HAS A WHITE ARC SHAPE WITH THE WORD "WINGMEN" IN A STYLIZED BLACK FONT. UNDERNEATH THE WORD IS A DESIGN OF AN EAGLE IN BLACK, WHITE, RED AND YELLOW. ON THE LEFT SIDE OF THE EAGLE IS A WHITE RECTANGLE WITH THE LETTER "M" IN A BLACK STYLIZED FONT AND ON THE RIGHT SIDE OF THE EAGLE IS A WHITE RECTANGLE WITH THE LETTER "C" IN A BLACK STYLIZED FONT.

FOR CLUB SERVICES, NAMELY, PROMOTING THE INTERESTS OF MOTORCYCLES (U.S. CLS. 100, 101 AND 102).

FIRST USE 0-0-1979; IN COMMERCE 0-0-1979.
ERNEST SHOSHO, EXAMINING ATTORNEY

CLASS 35—(Continued).

SN 77-815,185. UTILIPRO SERVICES, LLC, ATLANTA, GA. FILED 8-28-2009.



NO CLAIM IS MADE TO THE EXCLUSIVE RIGHT TO USE "THE HOME SERVICE EXPERTS", APART FROM THE MARK AS SHOWN.

THE MARK CONSISTS OF THE LETTERS "UTILIPRO" WITH A SILHOUETTE OF A HOUSE IN PLACE OF THE CENTER OF THE "O", ABOVE THE WORDS "THE HOME SERVICE EXPERTS".

FOR HOME WARRANTY SERVICES, NAMELY, ARRANGING FOR REPAIRS AND REPLACEMENT OF MAJOR HOME SYSTEMS, APPLIANCES AND PARTS THEREOF PROVIDED BY OTHERS PURSUANT TO SERVICE AGREEMENTS (U.S. CLS. 100, 101 AND 102).

CURTIS FRENCH, EXAMINING ATTORNEY

SN 77-814,499. GDH INC, MANDEVILLE, LA. FILED 8-27-2009.



NO CLAIM IS MADE TO THE EXCLUSIVE RIGHT TO USE "KIDS", APART FROM THE MARK AS SHOWN.

THE MARK CONSISTS OF SUGAR CANE PLANTS AND THE TEXT "SUGAR CANE KIDS".

FOR RETAIL STORE SERVICES FEATURING CHILDREN'S CLOTHING, BABY CRIBS, FURNITURE AND ACCESSORIES (U.S. CLS. 100, 101 AND 102).

MATTHEW KLINE, EXAMINING ATTORNEY

SN 77-816,269. KIM CHESKY, INDIANAPOLIS, IN. FILED 8-31-2009.

LeadingWise

THE MARK CONSISTS OF STANDARD CHARACTERS WITHOUT CLAIM TO ANY PARTICULAR FONT, STYLE, SIZE, OR COLOR.

FOR BUSINESS CONSULTATION IN THE FIELD OF BUSINESS LEADERSHIP DEVELOPMENT; BUSINESS CONSULTING SERVICES IN THE FIELD OF ORGANIZATIONAL CHANGE MANAGEMENT; BUSINESS MANAGEMENT AND CONSULTATION IN THE FIELD OF STRATEGIC PLANNING AND ORGANIZATIONAL DEVELOPMENT; BUSINESS MANAGEMENT CONSULTATION IN THE FIELD OF EXECUTIVE AND LEADERSHIP DEVELOPMENT; BUSINESS MANAGEMENT CONSULTING IN THE FIELD OF TEAM DEVELOPMENT; BUSINESS ORGANIZATION AND MANAGEMENT CONSULTING; CONSULTING SERVICES IN BUSINESS LEADERSHIP DEVELOPMENT AND BUSINESS MANAGEMENT; EDUCATION LEADERSHIP DEVELOPMENT; HUMAN RESOURCES CONSULTATION; PROVIDING ORGANIZATIONAL DEVELOPMENT CONSULTING SERVICES (U.S. CLS. 100, 101 AND 102).

FIRST USE 5-19-2008; IN COMMERCE 10-30-2009.
DORITT L. CARROLL, EXAMINING ATTORNEY

CLASS 35—(Continued).

SN 77-816,436. CLAREMONT UNIVERSITY CONSORTIUM, CLAREMONT, CA. FILED 8-31-2009.

CUC

THE MARK CONSISTS OF STANDARD CHARACTERS WITHOUT CLAIM TO ANY PARTICULAR FONT, STYLE, SIZE, OR COLOR.

FOR BUSINESS MANAGEMENT AND BUSINESS MANAGEMENT ASSISTANCE TO AN ALLIANCE OF INDEPENDENT COLLEGES; BUSINESS SERVICES, NAMELY, BUSINESS MANAGEMENT OF PHYSICAL PLANT FACILITIES, MAIL ROOM FACILITIES, RETAIL BOOK STORES, AND STUDENT LIBRARIES ALL FOR AN ALLIANCE OF INDEPENDENT COLLEGES; MAIL ROOM SERVICES, NAMELY, MAIL SORTING, HANDLING AND RECEIVING FOR AN ALLIANCE OF INDEPENDENT COLLEGES; PROVIDING ACCOUNTING SERVICES FOR AN ALLIANCE OF INDEPENDENT COLLEGES; BUSINESS SERVICES, NAMELY, OPERATION OF POWER DISTRIBUTION EQUIPMENT AND FACILITIES FOR AN ALLIANCE OF INDEPENDENT COLLEGES; RETAIL BOOK STORE SERVICES FOR AN ALLIANCE OF INDEPENDENT COLLEGES; OPERATION AND ADMINISTRATION OF TELECOMMUNICATION SYSTEMS AND NETWORKS FOR AN ALLIANCE OF INDEPENDENT COLLEGES; OPERATION OF STUDENT AFFAIRS OFFICES RELATING TO STUDENT HOUSING AND FINANCIAL AID FOR AN ALLIANCE OF INDEPENDENT COLLEGES; FINANCIAL SERVICES, NAMELY, PROVIDING ACCOUNTING SERVICES TO AN ALLIANCE OF INDEPENDENT COLLEGES; BUSINESS RISK MANAGEMENT SERVICES (U.S. CLS. 100, 101 AND 102).

FIRST USE 9-26-1967; IN COMMERCE 9-26-1967.
MICHAEL KEATING, EXAMINING ATTORNEY

SN 77-817,763. BUTLER AMERICA LLC, SANTA BARBARA, CA. FILED 9-1-2009.



OWNER OF U.S. REG. NOS. 2,078,380, 2,415,378 AND OTHERS.

NO CLAIM IS MADE TO THE EXCLUSIVE RIGHT TO USE "AMERICA", APART FROM THE MARK AS SHOWN.

THE MARK CONSISTS OF THE WORDS "BUTLER AMERICA" AND AN IMAGE OF A GLOBE SHOWING NORTH AND SOUTH AMERICA AND A LINE SHOWING THE ORBITAL PATH OF THE GLOBE.

FOR OUTSOURCING OF TECHNICAL SERVICES IN THE FIELD OF AEROSPACE, FEDERAL DEFENSE, MANUFACTURING, ENGINEERING, TELECOMMUNICATIONS, INFORMATION TECHNOLOGY AND FLEET MAINTENANCE (U.S. CLS. 100, 101 AND 102).

FIRST USE 8-10-2009; IN COMMERCE 8-10-2009.
BRIAN CALLAGHAN, EXAMINING ATTORNEY

CLASS 35—(Continued).

SN 77-822,156. KEYNRG, INC., HOUSTON, TX. FILED 9-8-2009.

KEYNRG

Live Green - Save Green

THE MARK CONSISTS OF THE WORD "KEYNRG" WITH A LEAF DISPLAYED ABOVE THE LETTER "Y" AND THE WORDS "LIVE GREEN" FOLLOWED BY A TILDE SYMBOL AND THE WORDS "SAVE GREEN" PRINTED BELOW THE WORD "KEYNRG".

FOR SERVICES IN THE NATURE OF ELECTRIC POWER FACTOR CORRECTION SOLUTIONS, NAMELY, CONDUCTING ENERGY AUDITS OF RESIDENTIAL, COMMERCIAL AND INSTITUTIONAL FACILITIES FOR THE PURPOSE OF REDUCING ENERGY COST AND INCREASING EFFICIENCY OF ELECTRICAL SERVICE (U.S. CLS. 100, 101 AND 102).

KEVIN DINALLO, EXAMINING ATTORNEY

SN 77-825,414. TELLBOB INC., WINDSOR, ONTARIO, CANADA, FILED 9-12-2009.



THE MARK CONSISTS OF THE WORDS "TELLBOB" WITH "TELL" PRESENTED IN A CONVERSATION BUBBLE DESIGN AND "BOB" PRESENTED IN A CONTRASTING COLOR WITH THE WORDS "BE HEARD, GET STUFF" UNDERNEATH AND IN A SMALLER TYPEFACE.

FOR PLANNING, PREPARING, CONDUCTING AND MANAGING CUSTOMER SATISFACTION SURVEYS AND MARKET RESEARCH SURVEYS AND POLLS FOR OTHERS, AND COMPILING, ANALYZING AND PUBLISHING THE RESULTS OF SAID SURVEYS; ADVERTISING THE GOODS AND SERVICES OF OTHERS ONLINE AND ON SCREENS LOCATED IN KIOSKS LOCATED IN SHOPPING MALLS, STORES AND RESTAURANTS; PROVIDING AN INTERACTIVE WEBSITE FOR MEMBERS INTERESTED IN PARTICIPATING IN CUSTOMER SATISFACTION SURVEYS AND MARKET RESEARCH SURVEYS AND POLLS; COMPILING, MANAGING, UPDATING AND ANALYZING MARKET RESEARCH DATA AND INFORMATION FOR OTHERS; PROMOTING THE GOODS AND SERVICES OF OTHERS BY ADMINISTERING INCENTIVE REWARDS PROGRAMS FEATURING COUPONS AND REWARDS FOR PARTICIPATING IN CUSTOMER SATISFACTION SURVEYS AND MARKET RESEARCH SURVEYS AND POLLS FOR OTHERS; THE PROVISION OF AN INTERACTIVE WEBSITE TO PERMIT MEMBERS WHO PARTICIPATE IN CUSTOMER SATISFACTION SURVEYS AND MARKET RESEARCH SURVEYS AND POLLS AND WHO RECEIVE REWARDS AS A RESULT OF SUCH PARTICIPATION, TO POST AND TRADE THEIR REWARDS AND COUPONS WITH OTHER MEMBERS (U.S. CLS. 100, 101 AND 102).

ANN E. SAPPENFIELD, EXAMINING ATTORNEY

CLASS 35—(Continued).

SN 77-827,068. SCHOOLHOUSE PARTNERS LLC, SUGARLAND, TX. FILED 9-15-2009.

SCHOOLHOUSE PARTNERS

THE MARK CONSISTS OF STANDARD CHARACTERS WITHOUT CLAIM TO ANY PARTICULAR FONT, STYLE, SIZE, OR COLOR.

NO CLAIM IS MADE TO THE EXCLUSIVE RIGHT TO USE "PARTNERS", APART FROM THE MARK AS SHOWN. FOR CONNECTING QUALIFIED SERVICE PROVIDERS WITH CONSUMERS; PROVIDING RECOMMENDATIONS ON SERVICE PROVIDERS TO CONSUMERS FOR COMMERCIAL PURPOSES (U.S. CLS. 100, 101 AND 102).

SCOTT BIBB, EXAMINING ATTORNEY

SN 77-829,617. SYNDEO INTERACTIVE, LLC, CHARLESTON, SC. FILED 9-18-2009.

BOOMTOWN

THE MARK CONSISTS OF STANDARD CHARACTERS WITHOUT CLAIM TO ANY PARTICULAR FONT, STYLE, SIZE, OR COLOR.

FOR PROVIDING DATA ABOUT PROSPECTIVE REAL ESTATE PURCHASERS TO REAL ESTATE PROFESSIONALS (U.S. CLS. 100, 101 AND 102).

FIRST USE 2-1-2008; IN COMMERCE 2-1-2008.
KAELE KUNG, EXAMINING ATTORNEY

SN 77-830,809. MEKONNEN, SAMUEL A., LOS ANGELES, CA. FILED 9-21-2009.

SELAM MARKET

THE MARK CONSISTS OF STANDARD CHARACTERS WITHOUT CLAIM TO ANY PARTICULAR FONT, STYLE, SIZE, OR COLOR.

NO CLAIM IS MADE TO THE EXCLUSIVE RIGHT TO USE "MARKET", APART FROM THE MARK AS SHOWN. SEC. 2(F).

FOR RETAIL GROCERY STORES (U.S. CLS. 100, 101 AND 102).
FIRST USE 10-15-1994; IN COMMERCE 10-15-1994.
LINDA ORNDORFF, EXAMINING ATTORNEY

CLASS 35—(Continued).

SN 77-831,908. YEGOR KOLTSOV, LOS ANGELES, CA. FILED 9-22-2009.

DR. GANJA

THE MARK CONSISTS OF STANDARD CHARACTERS WITHOUT CLAIM TO ANY PARTICULAR FONT, STYLE, SIZE, OR COLOR.

THE NAME(S), PORTRAIT(S), AND/OR SIGNATURE(S) SHOWN IN THE MARK DOES NOT IDENTIFY A PARTICULAR LIVING INDIVIDUAL.

FOR MEDICAL MARIJUANA REFERRAL SERVICES (U.S. CLS. 100, 101 AND 102).

FIRST USE 7-1-2009; IN COMMERCE 7-1-2009.
LINDA ESTRADA, EXAMINING ATTORNEY

SN 77-832,150. THE SKINNY DIP LLC, VIRGINIA BEACH, VA. FILED 9-22-2009.



NO CLAIM IS MADE TO THE EXCLUSIVE RIGHT TO USE "FROZEN YOGURT BAR", APART FROM THE MARK AS SHOWN.

THE COLOR(S) BLACK, WHITE, GREEN, RED, PURPLE AND GRAY IS/ARE CLAIMED AS A FEATURE OF THE MARK.

THE MARK CONSISTS OF THE LANGUAGE "THE SKINNY DIP" IN GREEN WHERE THE TOP OF THE LETTER "I" IN "SKINNY" IS A RED STRAWBERRY AND WHERE THE "I" IN "DIP" IS A GRAY SPOON. BELOW THE LANGUAGE "THE SKINNY DIP" IN A WHITE OBLONG WITH THE PURPLE LANGUAGE "FROZEN YOGURT BAR". THE SPOON AND THE OBLONG ARE OUTLINED IN BLACK.

FOR RETAIL STORE SERVICES FEATURING FROZEN YOGURT (U.S. CLS. 100, 101 AND 102).
FIRST USE 5-21-2008; IN COMMERCE 5-21-2008.
LAURIE MAYES, EXAMINING ATTORNEY

CLASS 35—(Continued).

SN 77-833,044. GREAT PLAINS CONSERVATION FOUNDATION, SANDTON, SOUTH AFRICA, FILED 9-23-2009.

GREAT PLAINS CONSERVATION
FOUNDATION

THE MARK CONSISTS OF STANDARD CHARACTERS WITHOUT CLAIM TO ANY PARTICULAR FONT, STYLE, SIZE, OR COLOR.

NO CLAIM IS MADE TO THE EXCLUSIVE RIGHT TO USE "CONSERVATION FOUNDATION", APART FROM THE MARK AS SHOWN.

FOR CONSERVATION MANAGEMENT SERVICES, NAMELY, PROVIDING BUSINESS CONSULTING SERVICES AND PROMOTING PUBLIC AWARENESS OF ENVIRONMENTAL ISSUES AND INITIATIVES IN THE FIELDS OF LONG TERM CONSERVATION OF VULNERABLE HABITATS AND ENDANGERED WILDLIFE SPECIES BY INCORPORATING LOW IMPACT CONSERVATION ECOTOURISM, CARBON OFFSET PROGRAMS, THE FACILITATION OF COMMUNITY UPLIFTMENT PROGRAMS AND ECONOMIC UPLIFTMENT OF THE COMMUNITIES TO RESOLVE THE WILDLIFE HUMAN CONFLICT (U.S. CLS. 100, 101 AND 102).

SKYE YOUNG, EXAMINING ATTORNEY

SN 77-834,558. LAROCK ARTISTS INC., NEW YORK, NY. FILED 9-24-2009.

Larock

THE MARK CONSISTS OF STANDARD CHARACTERS WITHOUT CLAIM TO ANY PARTICULAR FONT, STYLE, SIZE, OR COLOR.

FOR ARRANGING PERSONAL APPEARANCES BY PERSONS WORKING IN THE FIELD OF FILM, MUSIC, TELEVISION, ENTERTAINMENT OR SPORT; EMPLOYMENT SERVICES IN THE NATURE OF TALENT CASTING IN THE FIELDS OF MUSIC, VIDEO, AND FILMS; ENTERTAINMENT MARKETING SERVICES, NAMELY, MARKETING, PROMOTION AND ADVERTISING FOR INDEPENDENT RECORDING ARTISTS; PERSONAL MANAGEMENT SERVICES FOR ENTERTAINERS; PROCUREMENT, NAMELY, PURCHASING TICKETS TO ENTERTAINMENT EVENTS FOR OTHERS; PROVIDING CONSUMER INFORMATION SERVICES AND MAKING REFERRALS IN THE FIELD OF ENTERTAINMENT SERVICES FOR PRODUCTS, SERVICES, EVENTS, ACTIVITIES, FACILITIES AND LOCATIONS; TALENT AGENCIES; TALENT RECRUITING SERVICES IN THE FIELD OF ENTERTAINMENT (U.S. CLS. 100, 101 AND 102).

FIRST USE 7-1-2009; IN COMMERCE 7-1-2009.
KRISTIN CARLSON, EXAMINING ATTORNEY

CLASS 35—(Continued).

SN 77-834,731. P.C. RICHARD & SON LONG ISLAND CORPORATION, FARMINGDALE, NY. FILED 9-25-2009.



NO CLAIM IS MADE TO THE EXCLUSIVE RIGHT TO USE THE RECYCLING SYMBOL, APART FROM THE MARK AS SHOWN.

THE COLOR(S) RED, YELLOW, BLUE, GREEN, WHITE, BLACK AND BROWN IS/ARE CLAIMED AS A FEATURE OF THE MARK.

THE MARK CONSISTS OF A FANCIFUL LETTER "R" IN RED OUTLINED IN WHITE SUPERIMPOSED OVER A GRAPHIC DEPICTION OF EARTH IN WHITE, BLUE AND BROWN, SURROUNDED BY A CIRCLE IN WHITE, SURROUNDED BY CIRCLE IN RED, SURROUNDED BY A CIRCLE AND LEAF DESIGN IN GREEN AND A CIRCLE CONSISTING OF CHASING ARROWS IN YELLOW OUTLINED IN BLACK; THE COLOR GREEN APPEARS AS BACKGROUND.

FOR RETAIL STORE SERVICES IN THE FIELD OF APPLIANCES, ELECTRONICS, AND RELATED GOODS FEATURING A BONUS INCENTIVE PROGRAM FOR RECYCLING APPLIANCES, ELECTRONICS AND RELATED GOODS (U.S. CLS. 100, 101 AND 102).

FIRST USE 4-16-2009; IN COMMERCE 4-16-2009.
AISHA SALEM, EXAMINING ATTORNEY

SN 77-838,353. STEVEN A. JOHNSON, DBA FOODSERVICE SOLUTIONS, TACOMA, WA. FILED 9-30-2009.

Foodservice Solutions

THE MARK CONSISTS OF STANDARD CHARACTERS WITHOUT CLAIM TO ANY PARTICULAR FONT, STYLE, SIZE, OR COLOR.

OWNER OF U.S. REG. NO. 1,961,831.

NO CLAIM IS MADE TO THE EXCLUSIVE RIGHT TO USE "FOODSERVICE", APART FROM THE MARK AS SHOWN.

SEC. 2(F).

FOR BUSINESS CONSULTING IN THE FIELD OF FOOD SERVICE, NAMELY, MENU COST ANALYSIS, MANAGEMENT PLANNING AND MARKETING; CONDUCTING MARKETING RESEARCH IN THE FIELD OF PREPARED FOODS, NAMELY, COOK CHILL, SOUS VIDE AND HERMETICALLY PREPARED FOODS (U.S. CLS. 100, 101 AND 102).

FIRST USE 9-1-1991; IN COMMERCE 9-1-1991.

TIMOTHY FINNEGAN, EXAMINING ATTORNEY

CLASS 35—(Continued).

SN 77-839,432. MATTEL, INC., EL SEGUNDO, CA. FILED 10-1-2009.

RED LINE CLUB

THE MARK CONSISTS OF STANDARD CHARACTERS WITHOUT CLAIM TO ANY PARTICULAR FONT, STYLE, SIZE, OR COLOR.

OWNER OF U.S. REG. NO. 3,177,765.

NO CLAIM IS MADE TO THE EXCLUSIVE RIGHT TO USE "CLUB", APART FROM THE MARK AS SHOWN.

FOR CUSTOMER LOYALTY SERVICES AND CUSTOMER CLUB SERVICES FOR COMMERCIAL, PROMOTIONAL AND/OR ADVERTISING PURPOSES (U.S. CLS. 100, 101 AND 102).

FIRST USE 3-31-2002; IN COMMERCE 3-31-2002.

SANJEEV VOHRA, EXAMINING ATTORNEY

CLASS 35—(Continued).

SN 77-845,350. AMAZON TECHNOLOGIES, INC., RENO, NV. FILED 10-9-2009.

1-CLICK COMPARE

THE MARK CONSISTS OF STANDARD CHARACTERS WITHOUT CLAIM TO ANY PARTICULAR FONT, STYLE, SIZE, OR COLOR.

OWNER OF U.S. REG. NO. 2,264,368.

NO CLAIM IS MADE TO THE EXCLUSIVE RIGHT TO USE "COMPARE", APART FROM THE MARK AS SHOWN.

FOR COMPUTER SERVICES IN THE NATURE OF PROVIDING CONSUMER PRODUCT INFORMATION VIA THE INTERNET, NAMELY, COMPARISON INFORMATION FOR A WIDE VARIETY OF PRODUCTS BASED ON PRODUCT CHARACTERISTICS; PROVIDING AN ON-LINE COMPUTER DATABASE IN THE FIELD OF LOCATING PRODUCTS, DESCRIBING PRODUCTS, AND COMPARING PRODUCTS BASED ON DEFINED PRODUCT CHARACTERISTICS; PROVIDING CONSUMER PRODUCT INFORMATION VIA THE INTERNET, NAMELY, PROVIDING A COMPARISON TOOL IN THE NATURE OF A WEBSITE TO ALLOW THE FEATURES OF DIFFERENT PRODUCTS AND SERVICES TO BE EVALUATED (U.S. CLS. 100, 101 AND 102).

KEVIN CORWIN, EXAMINING ATTORNEY

SN 77-841,016. RALPH MÜNZER, DBA DENTALBRAINS E.K., FRIEDRICHSHAFEN, FED REP GERMANY, FILED 10-5-2009.



NO CLAIM IS MADE TO THE EXCLUSIVE RIGHT TO USE "DENTAL", APART FROM THE MARK AS SHOWN.

THE COLOR(S) LIGHT BLUE, DARK BLUE AND BLACK IS/ARE CLAIMED AS A FEATURE OF THE MARK.

THE MARK CONSISTS OF A STYLIZED SIGN, THE LEFT SIDE OF WHICH IS DARK BLUE AND THE RIGHT SIDE OF WHICH IS LIGHT BLUE, TO THE LEFT OF THE WORDING "DENTAL BRAINS" IN BLACK, WHICH SITS ABOVE THE WORDING "WE THINK DENTAL." IN BLACK.

FOR MARKETING CONSULTATION IN THE FIELD OF DENTAL INDUSTRY (U.S. CLS. 100, 101 AND 102).

FIRST USE 10-1-2009; IN COMMERCE 10-1-2009.

MARC LEIPZIG, EXAMINING ATTORNEY

SN 77-846,919. MARKET STUDIES, LLC, SCOTTSDALE, AZ. FILED 10-12-2009.

PLURALITY

THE MARK CONSISTS OF STANDARD CHARACTERS WITHOUT CLAIM TO ANY PARTICULAR FONT, STYLE, SIZE, OR COLOR.

FOR ANALYZING AND COMPILING DATA FOR MEASURING THE PERFORMANCE OF FINANCIAL MARKETS; PROVIDING A FINANCIAL INDEX IN THE NATURE OF QUANTITATIVE MEASUREMENTS FOR ANALYZING INVESTOR ATTITUDES (U.S. CLS. 100, 101 AND 102).

JULIE GUTTADAURO, EXAMINING ATTORNEY

CLASS 35—(Continued).

SN 77-847,878. RANDALL, CHRISTOPHER L., DBA PINGDANGO.COM, NEW YORK, NY. FILED 10-13-2009.



THE COLOR(S) BLACK AND GREEN IS/ARE CLAIMED AS A FEATURE OF THE MARK.

THE MARK CONSISTS OF THE WORD "PINGANDO!" IN WHICH THE LETTERS "G" AND "O" ARE GREEN AND THE REMAINDER IS BLACK; AND THE OVALS/DOTS ON THE TOP AND BOTTOM ARE GREEN.

FOR MARKETING, ADVERTISING, AND PROMOTING THE RETAIL GOODS AND SERVICES OF OTHERS TO WIRELESS ELECTRONIC DEVICES; MATCHING CONSUMERS WITH PROFESSIONALS IN THE FIELD OF RESIDENTIAL AND COMMERCIAL SERVICES VIA COMPUTER NETWORK; PROMOTING THE GOODS AND SERVICES OF OTHERS BY PROVIDING A COMMUNITY-DRIVEN WEB SITE FEATURING USER-SUBMITTED CONTENT IN THE NATURE OF COUPONS, REBATES, PRICE-COMPARISON INFORMATION, PRODUCT REVIEWS, LINKS TO THE RETAIL WEB SITES OF OTHERS, AND DISCOUNT INFORMATION; PROVIDING A WEB-BASED SYSTEM AND ONLINE PORTALS IN THE FIELD OF CONSUMER-TO-BUSINESS COMMERCE FOR CONSUMERS TO ENTER, MANAGE AND MODIFY THEIR CONSUMER PREFERENCE INFORMATION FOR USE BY MERCHANTS TO CREATE AND MANAGE OFFERS FOR DELIVERY TO CONSUMERS; PROVIDING CONSUMER PRODUCT INFORMATION VIA THE INTERNET (U.S. CLS. 100, 101 AND 102).
ROBIN CHOSID, EXAMINING ATTORNEY

SN 77-849,806. ANDIS WINES, LLC, SUTTER CREEK, CA. FILED 10-15-2009.

ANDIS WINES

THE MARK CONSISTS OF STANDARD CHARACTERS WITHOUT CLAIM TO ANY PARTICULAR FONT, STYLE, SIZE, OR COLOR.

NO CLAIM IS MADE TO THE EXCLUSIVE RIGHT TO USE "WINES", APART FROM THE MARK AS SHOWN.

FOR ON-LINE RETAIL STORE SERVICES, FEATURING WINE (U.S. CLS. 100, 101 AND 102).

JEFF DEFORD, EXAMINING ATTORNEY

CLASS 35—(Continued).

SN 77-854,139. CITY OF TAVARES, TAVARES, FL. FILED 10-21-2009.



NO CLAIM IS MADE TO THE EXCLUSIVE RIGHT TO USE "TAVARES", AND "AMERICA'S" AND "CITY", APART FROM THE MARK AS SHOWN.

THE MARK CONSISTS OF AN IMAGE OF A SEAPLANE CREATING A WAVE BETWEEN A SINGLE LINE ON BOTH SIDES OF THE SEAPLANE. THE STYLIZED WORD "TAVARES" IS CENTERED BENEATH THE SEAPLANE. AN EXTENSION FROM THE LETTER "A" AND THE LETTER "S" IN THE WORD "TAVARES", CURVES UNDERNEATH THE WORD "TAVARES" AND CREATES A MIRRORED SEMI-SWIRL. THE WORDS "AMERICA'S SEAPLANE CITY" IS CENTERED BELOW THE WORD "TAVARES".

FOR ADVERTISING SERVICES, NAMELY, PROMOTING BUSINESS AND TOURISM FOR THE CITY OF TAVARES, FLORIDA (U.S. CLS. 100, 101 AND 102).

FIRST USE 10-21-2009; IN COMMERCE 11-23-2009.

MICHELLE DUBOIS, EXAMINING ATTORNEY

SN 77-856,061. GERICO MARKETING SERVICES, INC., OMAHA, NE. FILED 10-23-2009.



OWNER OF U.S. REG. NOS. 1,528,585 AND 2,524,413.
NO CLAIM IS MADE TO THE EXCLUSIVE RIGHT TO USE "ST. LOUIS WORKING WOMEN'S", "SHOW" AND "ST. CHARLES CONVENTION CENTER", APART FROM THE MARK AS SHOWN.

THE MARK CONSISTS OF A BORDERED CIRCLE. THE BORDER HAS TWO BREAKS WHICH FORM SMALLER

CLASS 35—(Continued).

CIRCLES. THE WORDS "ST. LOUIS WORKING WOMEN'S SURVIVAL SHOW" APPEAR INSIDE OF THE CIRCLE. A SINGLE LETTER "W" IS USED TO FORM THE WORDS "WORKING" AND "WOMEN'S" AND IS DISPLAYED IN LARGE FONT. STYLIZED DEPICTIONS OF A COMPUTER MONITOR, TWO TICKETS AND A SHOPPING CART APPEAR DIRECTLY ABOVE THE LETTERS "KING" IN THE WORD "WORKING". THE WORDS "ST. CHARLES CONVENTION CENTER" APPEAR IN THE LOWER BORDER OF THE CIRCLE.

FOR ORGANIZING AND CONDUCTING TRADE-SHOW EXHIBITIONS ON SUBJECTS OF INTEREST TO WORKING WOMEN, NAMELY, CHILD CARE, FASHION, HEALTH, COOKING, COMMUNITY SERVICES, HOME REPAIRS, COMPUTER TECHNOLOGY, FINANCES, AND EDUCATION (U.S. CLS. 100, 101 AND 102).

FIRST USE 9-0-2005; IN COMMERCE 9-0-2005.
TRACY FLETCHER, EXAMINING ATTORNEY

CLASS 35—(Continued).

SN 77-862,455. BE THE CHANGE, INC., CAMBRIDGE, MA. FILED 11-2-2009.



NO CLAIM IS MADE TO THE EXCLUSIVE RIGHT TO USE "INC.", APART FROM THE MARK AS SHOWN.

THE MARK CONSISTS OF A STAR TO THE LEFT OF "BE THE CHANGE, INC." IN A STYLIZED FORMAT.

FOR CREATING AND PROMOTING NATIONAL PUBLIC AWARENESS CAMPAIGNS FOR BUILDING MOMENTUM FOR CITIZEN SERVICE AS A PRACTICAL SOLUTION TO SOCIAL CHALLENGES AND A MEANS TO STRENGTHEN DEMOCRACY (U.S. CLS. 100, 101 AND 102).

FIRST USE 0-0-2007; IN COMMERCE 0-0-2007.
MATTHEW KLINE, EXAMINING ATTORNEY

SN 77-860,391. VISION SERVICE PLAN, DBA VSP, RANCHO CORDOVA, CA. FILED 10-29-2009.

VSP Contact Lens Care Program

SN 77-862,462. BE THE CHANGE, INC., CAMBRIDGE, MA. FILED 11-2-2009.

ServiceNation

THE MARK CONSISTS OF STANDARD CHARACTERS WITHOUT CLAIM TO ANY PARTICULAR FONT, STYLE, SIZE, OR COLOR.

OWNER OF U.S. REG. NOS. 2,324,613 AND 3,410,088.

NO CLAIM IS MADE TO THE EXCLUSIVE RIGHT TO USE "CONTACT LENS CARE PROGRAM", APART FROM THE MARK AS SHOWN.

FOR PROVIDING A MULTI-TIERED GUARANTEED PRICING PROGRAM FOR FEES PAID TO OPTOMETRISTS AND OPHTHALMOLOGISTS IN A PREFERRED PROVIDER NETWORK FOR PROVIDING VISION EXAMINATIONS AND CONTACT LENSES TO PERSONS PARTICIPATING IN A PRE-PAID VISION CARE PLAN (U.S. CLS. 100, 101 AND 102).

FIRST USE 7-1-2009; IN COMMERCE 7-1-2009.
SEAN CROWLEY, EXAMINING ATTORNEY

THE MARK CONSISTS OF STANDARD CHARACTERS WITHOUT CLAIM TO ANY PARTICULAR FONT, STYLE, SIZE, OR COLOR.

FOR PROMOTING PUBLIC AWARENESS OF A NATIONAL SERVICE CAMPAIGN THAT INCREASES SERVICE OPPORTUNITIES AND ELEVATES SERVICE AS A CORE IDEAL AND PROBLEM-SOLVING STRATEGY IN AMERICAN SOCIETY (U.S. CLS. 100, 101 AND 102).

FIRST USE 0-0-2008; IN COMMERCE 0-0-2008.
MATTHEW KLINE, EXAMINING ATTORNEY

CLASS 35—(Continued).

SN 77-864,429. CALIFORNIA AGAINST SLAVERY, FREMONT, CA. FILED 11-4-2009.



NO CLAIM IS MADE TO THE EXCLUSIVE RIGHT TO USE "CALIFORNIA AGAINST SLAVERY" AND THE DESIGN OF THE STATE OF CALIFORNIA, APART FROM THE MARK AS SHOWN.

THE COLOR(S) BLACK, WHITE, YELLOW, AND ORANGE IS/ARE CLAIMED AS A FEATURE OF THE MARK.

THE MARK CONSISTS OF A BLACK RECTANGLE BACKGROUND WITH THE STYLIZED WORD "CALIFORNIA" IN WHITE AT THE TOP AND THE STYLIZED WORDING "AGAINST SLAVERY" IN WHITE AT THE BOTTOM AND WITH A YELLOW AND ORANGE RECTANGLE IN BETWEEN THE WORDING WITH THE STATE OF CALIFORNIA IN BLACK INSIDE THE YELLOW AND ORANGE RECTANGLE AND WITH A YELLOW STAR A THIRD OF THE WAY DOWN FROM THE TOP OF THE STATE DESIGN.

FOR POLITICAL ACTION COMMITTEE SERVICES, NAMELY, PROMOTING THE INTERESTS OF VICTIMS OF HUMAN TRAFFICKING IN THE STATE OF CALIFORNIA IN THE FIELD OF POLITICS; PROMOTING PUBLIC AWARENESS OF THE NEED FOR STRONGER HUMAN TRAFFICKING LAWS IN THE STATE OF CALIFORNIA; LOBBYING SERVICES, NAMELY, PROMOTING THE INTERESTS OF VICTIMS OF HUMAN TRAFFICKING IN THE FIELDS OF LEGISLATION AND REGULATION (U.S. CLS. 100, 101 AND 102).

FIRST USE 10-3-2009; IN COMMERCE 10-3-2009.

KELLEY WELLS, EXAMINING ATTORNEY

CLASS 35—(Continued).

SN 77-865,175. SOCIETY OF GOVERNMENT MEETING PROFESSIONALS, INC., ALEXANDRIA, VA. FILED 11-4-2009.



NO CLAIM IS MADE TO THE EXCLUSIVE RIGHT TO USE "SOCIETY OF GOVERNMENT MEETING PROFESSIONALS", APART FROM THE MARK AS SHOWN.

THE MARK CONSISTS OF A PICTURE OF BUILDINGS WITH THE LETTERS "SGMP" TO THE LEFT OF THE PICTURE AND THE WORDS "SOCIETY OF GOVERNMENT MEETING PROFESSIONALS" BELOW THE LETTERS.

FOR ASSOCIATION SERVICES, NAMELY, PROMOTING THE INTERESTS OF GOVERNMENT MEETING PROFESSIONALS (U.S. CLS. 100, 101 AND 102).

FIRST USE 1-1-2005; IN COMMERCE 1-1-2005.

WILLIAM BRECKENFELD, EXAMINING ATTORNEY

SN 77-865,330. ALLIGATOR DIESEL PERFORMANCE, LLC, DBA ALLIGATOR PERFORMANCE, POST FALLS, ID. FILED 11-4-2009.

NO CLAIM IS MADE TO THE EXCLUSIVE RIGHT TO USE "PERFORMANCE", APART FROM THE MARK AS SHOWN.

THE COLOR(S) GREEN, WHITE AND BLACK IS/ARE CLAIMED AS A FEATURE OF THE MARK.

THE MARK CONSISTS OF THE WORD "ALLIGATOR" APPEARS IN ALL CAPITAL STYLIZED LETTERS DIRECTLY ABOVE THE WORD "PERFORMANCE". THE LETTERS IN THE WORD "ALLIGATOR" APPEAR WITH A DARK GREEN INTERIOR, WITH A WHITE SHADOW LINE APPEARING ON THE LEFTSIDE OF THE LETTERS GRADUALLY FADING AS IT LINE EXTENDS TO THE BOTTOM OF THE LETTERS, WITH THE EDGE OF EACH LETTER SURROUNDED BY A LIGHTER SHADE OF GREEN EDGING. EACH LETTER IN THE WORD "PERFORMANCE" ALSO APPEARS IN ALL STYLIZED CAPITAL LETTERS IN THE COLOR OF BLACK, ALTHOUGH SLIGHTLY SMALLER THAN THE LETTERS APPEARING ABOVE IN THE WORD "ALLIGATOR", WITH EACH LETTER HAVING A ROUGH, WORN APPEARANCE.

FOR ON-LINE RETAIL STORE SERVICES FEATURING PERFORMANCE TRUCK PARTS AND ACCESSORIES (U.S. CLS. 100, 101 AND 102).

FIRST USE 7-29-2008; IN COMMERCE 7-29-2008.

WILLIAM ROSSMAN, EXAMINING ATTORNEY

CLASS 35—(Continued).

SN 77-865,711. AVAYA INC., BASKING RIDGE, NJ. FILED 11-5-2009.

AVAYA CONNECT

THE MARK CONSISTS OF STANDARD CHARACTERS WITHOUT CLAIM TO ANY PARTICULAR FONT, STYLE, SIZE, OR COLOR.

OWNER OF U.S. REG. NOS. 2,696,985 AND 2,697,002.
FOR BUSINESS MANAGEMENT AND CONSULTATION; ADMINISTRATION OF A PARTNERSHIP PROGRAM FOR ENABLING PARTICIPANTS TO OBTAIN DISCOUNTS ON GOODS AND RECEIVE IMPROVED SERVICES; ADMINISTRATION OF A PARTNERSHIP PROGRAM FOR ENABLING PARTICIPANTS TO PROVIDE IMPROVED SERVICES THROUGH DISCOUNTS ON GOODS AND SERVICES; CUSTOMER LOYALTY SERVICES FOR COMMERCIAL, PROMOTIONAL AND/OR ADVERTISING PURPOSES; PROVIDING INFORMATION ON MARKETING, SALES, PROMOTIONAL, INCENTIVE AWARD AND LOYALTY PROGRAMS FOR INDIVIDUALS AND BUSINESSES (U.S. CLS. 100, 101 AND 102).

DAWN HAN, EXAMINING ATTORNEY

SN 77-866,985. OVERTIME SPORTS CONSIGNMENT, CLIFTON, NJ. FILED 11-6-2009.

OVERTIME SPORTS

THE MARK CONSISTS OF STANDARD CHARACTERS WITHOUT CLAIM TO ANY PARTICULAR FONT, STYLE, SIZE, OR COLOR.

NO CLAIM IS MADE TO THE EXCLUSIVE RIGHT TO USE "SPORTS", APART FROM THE MARK AS SHOWN.

FOR RETAIL CONSIGNMENT STORES FEATURING GENTLY USED SPORTING GOODS AND EQUIPMENT, MERCHANDISE, AND APPAREL (U.S. CLS. 100, 101 AND 102).

BILL DAWE, EXAMINING ATTORNEY

SN 77-867,834. CHATTERBLAST MEDIA LLC, PHILADELPHIA, PA. FILED 11-9-2009.

ChatterBlast

THE MARK CONSISTS OF STANDARD CHARACTERS WITHOUT CLAIM TO ANY PARTICULAR FONT, STYLE, SIZE, OR COLOR.

FOR ADVERTISING AND MARKETING SERVICES, NAMELY, PROMOTING THE GOODS AND SERVICES OF OTHERS (U.S. CLS. 100, 101 AND 102).

FIRST USE 11-15-2009; IN COMMERCE 11-15-2009.

STEVEN JACKSON, EXAMINING ATTORNEY

CLASS 35—(Continued).

SN 77-869,324. MAY, RONALD D., ASHLAND, KY. FILED 11-10-2009.

STANDOUT ATHLETES

THE MARK CONSISTS OF STANDARD CHARACTERS WITHOUT CLAIM TO ANY PARTICULAR FONT, STYLE, SIZE, OR COLOR.

NO CLAIM IS MADE TO THE EXCLUSIVE RIGHT TO USE "ATHLETES", APART FROM THE MARK AS SHOWN.

FOR ADMINISTRATION OF COMMUNITY RECREATIONAL SPORTS LEAGUES; ADVERTISING PARTICULARLY SERVICES FOR THE PROMOTION OF GOODS; ADVERTISING SERVICES, NAMELY, PROMOTING AND MARKETING THE GOODS AND SERVICES OF OTHERS THROUGH ALL PUBLIC COMMUNICATION MEANS; ADVERTISING SERVICES, NAMELY, PROMOTING THE BRANDS, GOODS AND SERVICES OF OTHERS; ADVERTISING SERVICES, PUBLIC RELATIONS AND MARKETING SERVICES, NAMELY, PROMOTING AND MARKETING THE GOODS AND SERVICES OF OTHERS THROUGH ALL PUBLIC COMMUNICATION MEANS; ADVERTISING, INCLUDING PROMOTION OF PRODUCTS AND SERVICES OF THIRD PARTIES THROUGH SPONSORING ARRANGEMENTS AND LICENSE AGREEMENTS RELATING TO INTERNATIONAL SPORTS' EVENTS; ADVERTISING, MARKETING AND PROMOTING THE GOODS AND SERVICES OF OTHERS USING KIOSKS; BUSINESS SERVICES, NAMELY, FORMULATION OF BEST PRACTICES FOR SPORTS AND SPORTING GOODS; CATALOG ORDERING SERVICE FEATURING SPORTING GOODS; COMMERCIAL ADMINISTRATION OF THE LICENSING OF THE GOODS AND SERVICES OF OTHERS; COMMERCIAL ADMINISTRATION OF THE LICENSING OF SPORTING GOODS OF OTHERS; COMPUTERIZED ON-LINE ORDERING SERVICES IN THE FIELD OF SPORTING GOODS; COMPUTERIZED ON-LINE RETAIL STORE SERVICES IN THE FIELD OF SPORTING GOODS; COORDINATION OF RECREATIONAL SPORTING OPPORTUNITIES FOR INDIVIDUALS WHO WISH TO PARTICIPATE IN TEAM LEAGUE SPORTS; DISCOUNT STORES IN THE FIELD OF SPORTING GOODS; ELECTRONIC CATALOG SERVICES FEATURING SPORTING GOODS; GENERAL BUSINESS NETWORKING REFERRAL SERVICES, NAMELY, PROMOTING THE GOODS AND SERVICES OF OTHERS BY PASSING BUSINESS LEADS AND REFERRALS AMONG GROUP MEMBERS; ISSUING GIFT CERTIFICATES WHICH MAY THEN BE REDEEMED FOR GOODS OR SERVICES; MAIL ORDER CATALOG SERVICES FEATURING SPORTING GOODS; MARKETING AND CONSULTING SERVICES IN THE FIELD OF PROMOTING AND TRACKING THE GOODS, SERVICES, AND BRANDS OF OTHERS THROUGH ALL PUBLIC COMMUNICATION MEANS, PARTICULARLY SPECIALIZING IN THE USE OF MOBILE, SOCIAL, AND PRINT MEDIA TO DRIVE CONSUMER INTEREST, ENGAGEMENT AND ACTION; MARKETING, ADVERTISING, AND PROMOTING THE RETAIL GOODS AND SERVICES OF OTHERS TO WIRELESS ELECTRONIC DEVICES; MOBILE RETAIL STORE SERVICES FEATURING SPORTING GOODS; ON-LINE ORDERING SERVICES FEATURING SPORTING GOODS; ON-LINE RETAIL STORE SERVICES FEATURING SPORTING GOODS; OPERATING AN ON-LINE SHOPPING SITE IN THE FIELD OF SPORTING GOODS; OPERATING ON-LINE MARKETPLACES FEATURING SPORTING GOODS; PRESENTATION OF GOODS ON COMMUNICATION MEDIA FOR RETAIL PURPOSES; PROCESSING TELEPHONE INQUIRIES REGARDING ADVERTISED GOODS AND SERVICES; PROMOTING SPORTS COMPETITIONS AND/OR EVENTS OF OTHERS; PROMOTING THE GOODS AND SERVICES OF OTHERS BY ARRANGING FOR SPONSORS TO AFFILIATE THEIR GOODS AND SERVICES WITH AN AWARDS PROGRAM, A SPORTS COMPETITION AND SPORTING ACTIVITIES; PROMOTING THE GOODS AND SERVICES OF OTHERS BY ARRANGING FOR

CLASS 35—(Continued).

SPONSORS TO AFFILIATE THEIR GOODS AND SERVICES WITH TRADE SHOWS FEATURING SPORTING GOODS; PROMOTING THE GOODS AND SERVICES OF OTHERS BY DISTRIBUTING ADVERTISING MATERIALS THROUGH A VARIETY OF METHODS; PROMOTING THE GOODS AND SERVICES OF OTHERS BY MEANS OF A PREFERRED CUSTOMER PROGRAM FEATURING DISCOUNTS FOR PURCHASING SPORTING GOODS; PROMOTING THE GOODS AND SERVICES OF OTHERS BY MEANS OF DISTRIBUTING ADVERTISING ON THE INTERNET; PROMOTING THE GOODS AND SERVICES OF OTHERS BY PROVIDING A WEB SITE AT WHICH USERS CAN LINK TO SPORTING GOODS; PROMOTING THE GOODS AND SERVICES OF OTHERS BY PROVIDING HYPERTEXT LINKS TO THE WEB SITES OF OTHERS; PROMOTING THE GOODS AND SERVICES OF OTHERS THROUGH INFOMERCIALS PLAYED ON CUSTOMER POINT OF PURCHASE TELEVISION MONITORS IN RETAIL STORES; PROMOTING THE GOODS AND SERVICES OF OTHERS THROUGH ON-LINE ORDERING AND CATALOGING OF THOSE GOODS AND SERVICES; PROMOTING THE GOODS AND SERVICES OF OTHERS VIA A GLOBAL COMPUTER NETWORK; PROMOTING THE INTERESTS OF PEOPLE INVOLVED AND CONCERNED WITH YOUTH SPORTS; PROMOTING THE SALE OF GOODS AND SERVICES OF OTHERS THROUGH THE DISTRIBUTION OF PRINTED MATERIAL AND PROMOTIONAL CONTESTS; PROVIDING A SEARCHABLE WEBSITE FEATURING THE GOODS AND SERVICES OF OTHER VENDORS; PROVIDING A WEB SITE WHICH FEATURES ADVERTISEMENTS FOR THE GOODS AND SERVICES OF OTHERS ON A GLOBAL COMPUTER NETWORK; PROVIDING ADVERTISING SPACE ON FREE-STANDING VISUAL ADVERTISING SYSTEMS FEATURING THE GOODS AND SERVICES OF OTHERS; PROVIDING AN ON-LINE SHOWROOM FOR THE GOODS OF OTHERS IN THE FIELD OF SPORTING GOODS; PROVIDING CONSUMER INFORMATION IN THE FIELD OF SPORTING GOODS; PROVIDING INFORMATION ABOUT THE GOODS AND SERVICES OF OTHERS VIA THE GLOBAL COMPUTER NETWORK; PROVIDING ON-LINE REGISTRATION SERVICES FOR SPORTING GOODS; PROVIDING SPACE AT A WEB SITE FOR THE ADVERTISEMENT OF THE GOODS AND SERVICES OF OTHERS; PROVISION OF SPACE ON WEBSITES FOR ADVERTISING GOODS AND SERVICES; PUBLICITY AND SALES PROMOTION RELATING TO GOODS AND SERVICES, OFFERED AND ORDERED BY TELECOMMUNICATION OR THE ELECTRONIC WAY; RETAIL SHOPS FEATURING SPORTING GOODS; RETAIL SPORTING GOODS STORES; RETAIL STORE AND ON-LINE RETAIL STORE SERVICES FEATURING SPORTING GOODS; RETAIL STORE SERVICES FEATURING SPORTING GOODS; SPORTS RECRUITING SERVICES FOR HIGH SCHOOL ATHLETES; TALENT RECRUITING SERVICES IN THE FIELD OF SPORTS; WHOLESALE AND RETAIL STORE SERVICES AND ON-LINE RETAIL AND WHOLESALE STORE SERVICES FEATURING SPORTING GOODS (U.S. CLS. 100, 101 AND 102).

FIRST USE 2-1-2006; IN COMMERCE 2-1-2006.
MELISSA VALLILLO, EXAMINING ATTORNEY

CLASS 35—(Continued).

SN 77-870,314. NEW WAVE MEDIA, INC., DBA ADOTUBE, NEW YORK, NY. FILED 11-11-2009.

Polite Preroll

THE MARK CONSISTS OF STANDARD CHARACTERS WITHOUT CLAIM TO ANY PARTICULAR FONT, STYLE, SIZE, OR COLOR.

NO CLAIM IS MADE TO THE EXCLUSIVE RIGHT TO USE "PREROLL", APART FROM THE MARK AS SHOWN.

FOR ADVERTISING AGENCIES; ADVERTISING AND ADVERTISEMENT SERVICES; ADVERTISING AND BUSINESS SERVICES, NAMELY, PROVIDING AN ON-LINE WEBSITES WHERE ADVERTISERS, MARKETERS, AND CONTENT PROVIDERS CAN INTERACT WITH USERS FOR ADVERTISING, BRANDING, AND PROMOTING KNOWLEDGE, PRODUCTS, AND SERVICES, AND TRADESHOWS, ON BEHALF OF THEMSELVES AND OTHERS, AND FOR EVALUATING AND RATING THE SAME, ALL THE FOREGOING RELEVANT TO HUMAN ACTIVITIES AFFECTING CLIMATE CHANGE AND RELATED FIELDS; ADVERTISING AND BUSINESS SERVICES, NAMELY, SECURING AIRTIME ON ALL FORMS OF MEDIA COMMUNICATIONS STATIONS, SYSTEMS, NETWORKS, AND SERVICES FOR THE PURPOSE OF PROMOTING THE GOODS AND SERVICES OF OTHERS; ADVERTISING AND DIRECTORY SERVICES, NAMELY, PROMOTING THE SERVICES OF OTHERS BY PROVIDING A WEB PAGE FEATURING LINKS TO THE WEBSITES OF OTHERS; ADVERTISING AND MARKETING; ADVERTISING AND MARKETING SERVICES, NAMELY, PROMOTING THE GOODS AND SERVICES OF OTHERS; ADVERTISING AND PROMOTIONAL SERVICES; ADVERTISING AND PUBLICITY SERVICES, NAMELY, PROMOTING THE GOODS, SERVICES, BRAND IDENTITY AND COMMERCIAL INFORMATION AND NEWS OF THIRD PARTIES THROUGH PRINT, AUDIO, VIDEO, DIGITAL AND ON-LINE MEDIUM; ADVERTISING SERVICES; ADVERTISING SERVICES, NAMELY, COST-PER-ACTION ON-LINE ADVERTISING; ADVERTISING SERVICES, NAMELY, CREATING CORPORATE AND BRAND IDENTITY FOR OTHERS; ADVERTISING SERVICES, NAMELY, CREATING CORPORATE LOGOS FOR OTHERS; ADVERTISING SERVICES, NAMELY, PRODUCTION OF SPECIAL EFFECTS INCLUDING MODEL-MAKING SERVICES, COMPUTER-GENERATED IMAGERY AND COMPUTER-GENERATED GRAPHICS FOR THE PRODUCTION OF COMMERCIALS; ADVERTISING SERVICES, NAMELY, PROMOTING AND MARKETING THE GOODS AND SERVICES OF OTHERS THROUGH ALL PUBLIC COMMUNICATION MEANS (U.S. CLS. 100, 101 AND 102).

FIRST USE 7-30-2009; IN COMMERCE 7-30-2009.
PAUL CROWLEY, EXAMINING ATTORNEY

CLASS 35—(Continued).

SN 77-871,561. TRILEGIANT CORPORATION, NORWALK, CT. FILED 11-12-2009.



THE COLOR(S) YELLOW-ORANGE, RED AND GREEN IS/ARE CLAIMED AS A FEATURE OF THE MARK.

THE MARK CONSISTS OF THE WORDS "EVERYDAY COOKING AT HOME" INSIDE A YELLOW-ORANGE RECTANGLE. THERE IS A FURTHER DESIGN OF A GREEN HOUSE INSIDE THE RECTANGLE WITH THE WORD "AT" INSIDE THE HOUSE DESIGN. THE WORD "EVERYDAY" IS ABOVE THE WORD "COOKING" WHICH IS IN TURN ABOVE THE WORDS "AT HOME". THE WORDS "EVERYDAY", "COOKING" AND "HOME" ARE IN RED, AND THE WORD "AT" IS IN YELLOW-ORANGE.

FOR CONSUMER MEMBERSHIP PROGRAM AND CLUB ENTITLING THE PARTICIPANTS TO RECEIVE DISCOUNTS, SAVINGS, REBATES AND SPECIAL DEALS ON PRODUCTS, SERVICES AND PUBLICATIONS RELATING TO COOKING, COOKWARE AND BAKEWARE, GROCERY STORES AND RESTAURANTS; PROMOTING THE SALE OF THE GOODS AND SERVICES OF OTHERS BY OPERATING A CONSUMER MEMBERSHIP PROGRAM AND CLUB ENTITLING THE PARTICIPANTS TO RECEIVE DISCOUNTS, SAVINGS, REBATES AND SPECIAL DEALS RELATING TO COOKING, COOKWARE AND BAKEWARE, GROCERY STORES AND RESTAURANTS; AND PROVIDING ALL OF THE FOREGOING SERVICES ELECTRONICALLY BY MEANS OF THE INTERNET (U.S. CLS. 100, 101 AND 102).

JEFFERY COWARD, EXAMINING ATTORNEY

SN 77-874,099. EDIBLE ARRANGEMENTS, LLC, WALLINGFORD, CT. FILED 11-17-2009.

6 PETAL APPROACH

THE MARK CONSISTS OF STANDARD CHARACTERS WITHOUT CLAIM TO ANY PARTICULAR FONT, STYLE, SIZE, OR COLOR.

FOR BUSINESS MANAGEMENT, CONSULTING AND FRANCHISE SERVICES IN THE ESTABLISHMENT AND OPERATION OF RETAIL STORES FOR OTHERS, NAMELY, PROVIDING BUSINESS STRATEGY, OPERATION, MARKETING, PERSONNEL, CUSTOMER RELATIONS AND RETAIL SALES ASSISTANCE RELATING TO THE SALE OF FRUIT, FRUIT PIECES, FRUIT ARRANGEMENTS, FRUIT SAUCES, FRUIT SALADS, SALADS WITH LETTUCE AND FRUIT, FRUIT BASED BEVERAGES, FRUIT BASED JUICES, SMOOTHIES, AND EDIBLE TOPPINGS AT LEAST PARTIALLY COATING THE SAME (U.S. CLS. 100, 101 AND 102).

FIRST USE 7-24-2009; IN COMMERCE 7-24-2009.
MICHAEL KEATING, EXAMINING ATTORNEY

CLASS 35—(Continued).

SN 77-874,917. SALEM BUSINESS ENTERPRISES AND HOLDINGS, DBA SALEM HOLDINGS COMPANY, LOS ANGELES, CA. FILED 11-17-2009.



NO CLAIM IS MADE TO THE EXCLUSIVE RIGHT TO USE "INTIMATES", APART FROM THE MARK AS SHOWN.

THE MARK CONSISTS OF TWO STYLIZED INTERSECTING FEATHERS PICTURED ABOVE THE WORDING "CHELSEA MANOR" UNDER WHICH IS THE TERM "INTIMATES".

FOR RETAIL CLOTHING STORES (U.S. CLS. 100, 101 AND 102).

FIRST USE 11-9-2009; IN COMMERCE 11-16-2009.
TINA L. SNAPP, EXAMINING ATTORNEY

SN 77-875,973. WAYFYND, LLC, DOVER, DE. FILED 11-18-2009.

Wayfynd

THE MARK CONSISTS OF STANDARD CHARACTERS WITHOUT CLAIM TO ANY PARTICULAR FONT, STYLE, SIZE, OR COLOR.

FOR DISSEMINATION OF ADVERTISING FOR OTHERS VIA THE INTERNET; INTERNET ADVERTISING SERVICES; PROMOTING THE GOODS AND SERVICES OF OTHERS BY MEANS OF DISTRIBUTING ADVERTISING ON THE INTERNET; PROVIDING AND RENTAL OF ADVERTISING SPACE ON THE INTERNET (U.S. CLS. 100, 101 AND 102).

FIRST USE 11-17-2009; IN COMMERCE 11-17-2009.
MATTHEW EINSTEIN, EXAMINING ATTORNEY

SN 77-876,026. NCN HOLDCO, LP, IRVING, TX. FILED 11-19-2009.

IZOOM

THE MARK CONSISTS OF STANDARD CHARACTERS WITHOUT CLAIM TO ANY PARTICULAR FONT, STYLE, SIZE, OR COLOR.

FOR MEDICAL CLAIMS MANAGEMENT SERVICES, NAMELY, ELECTRONIC RE-PRICING OF PHYSICIAN, HOSPITAL, AND ANCILLARY MEDICAL CARE PROVIDER TRANSACTIONS VIA THE GLOBAL INFORMATION NETWORK; NEGOTIATED SETTLEMENT SERVICES, NAMELY, NEGOTIATION AND SETTLEMENT OF COMMERCIAL TRANSACTIONS FOR THIRD PARTIES (U.S. CLS. 100, 101 AND 102).

FIRST USE 9-14-2009; IN COMMERCE 9-14-2009.
HEATHER BIDDULPH, EXAMINING ATTORNEY

CLASS 35—(Continued).

SN 77-878,538. PRESIDENTIAL ALL-STARS, LLC, GROSSE
POINTE PARK, MI. FILED 11-23-2009.



NO CLAIM IS MADE TO THE EXCLUSIVE RIGHT TO USE "PRESIDENTIAL", APART FROM THE MARK AS SHOWN.

THE MARK CONSISTS OF AN ILLUSTRATION OF A PATRIOT HOLDING A FLAG WITH THE WORDING "PRESIDENTIAL ALL-STARS" BELOW THE ILLUSTRATION.

FOR ONLINE RETAIL STORE SERVICES IN THE FIELDS OF CLOTHING, HOUSE WARES, STATIONERY ITEMS AND COMPUTER ACCESSORIES (U.S. CLS. 100, 101 AND 102).

LINDA ORNDORFF, EXAMINING ATTORNEY

CLASS 35—(Continued).

SN 77-878,961. INTELEMARKETING CONCEPTS GROUP, LLC, DBA ONTARGET PARTNERS, FRISCO, TX. FILED 11-23-2009.

INTELLIGENCE FOR BUSINESS

THE MARK CONSISTS OF STANDARD CHARACTERS WITHOUT CLAIM TO ANY PARTICULAR FONT, STYLE, SIZE, OR COLOR.

FOR OUTSOURCING SERVICES; MARKET RESEARCH; MARKETING AND CONSULTING SERVICES IN THE FIELD OF PROMOTING AND TRACKING THE GOODS, SERVICES, AND BRANDS OF OTHERS THROUGH ALL PUBLIC COMMUNICATION MEANS, PARTICULARLY SPECIALIZING IN THE USE OF MOBILE, SOCIAL, AND PRINT MEDIA TO DRIVE CONSUMER INTEREST, ENGAGEMENT AND ACTION; MARKETING PLAN DEVELOPMENT; MARKETING CONSULTATION IN THE FIELD OF BUSINESS SERVICES; BUSINESS RESEARCH USING FOCUS GROUPS; BUSINESS RESEARCH SERVICES, NAMELY, PROVIDING ANALYSIS OF RETAIL DATA ON SPECIFIC BUSINESS LOCATIONS; COLLECTION OF MARKET RESEARCH INFORMATION; COMPUTER-ASSISTED BUSINESS INFORMATION AND RESEARCH SERVICES; CONSULTATION SERVICES IN THE FIELD OF COMPANY, BUSINESS SECTOR AND INDUSTRY DATA AND RESEARCH; BUSINESS RESEARCH; BUSINESS FEASIBILITY STUDIES; BUSINESS SURVEYS AND BUSINESS CONSULTATION SERVICES; MARKETING ANALYSIS, MARKET RESEARCH, CONDUCTING MARKETING STUDIES; CONDUCTING MARKETING STUDIES AND MARKETING CONSULTATION; MARKET MANIPULATION, RESEARCH AND ANALYSIS, WHETHER OR NOT VIA THE INTERNET OR BY MEANS OF A COMPUTER DATABASE (U.S. CLS. 100, 101 AND 102).

FIRST USE 1-2-1997; IN COMMERCE 1-2-1997.

NORA BUCHANAN WILL, EXAMINING ATTORNEY

SN 77-884,875. PRUNELLA DARLING, SANDPOINT, ID. FILED 12-2-2009.

prunella darling

THE MARK CONSISTS OF STANDARD CHARACTERS WITHOUT CLAIM TO ANY PARTICULAR FONT, STYLE, SIZE, OR COLOR.

THE NAME "PRUNELLA DARLING" IDENTIFIES THE PSEUDONYM, STAGE NAME, AND NICKNAME OF ANN KASPER, A LIVING INDIVIDUAL WHOSE CONSENT IS OF RECORD.

FOR RETAIL STORE AND ON-LINE RETAIL STORE SERVICES FEATURING APPAREL, JEWELRY, SMALL HOME FURNISHINGS, DISHES, CUPS, SILVERWARE, BLANKETS, AND LUGGAGE (U.S. CLS. 100, 101 AND 102).

FIRST USE 7-16-2009; IN COMMERCE 7-16-2009.

MATTHEW EINSTEIN, EXAMINING ATTORNEY

CLASS 35—(Continued).

SN 77-887,394. THE UNIVERSITY OF ARIZONA ALUMNI ASSOCIATION, TUCSON, AZ. FILED 12-7-2009.

WILDCAT FOR LIFE

THE MARK CONSISTS OF STANDARD CHARACTERS WITHOUT CLAIM TO ANY PARTICULAR FONT, STYLE, SIZE, OR COLOR.

FOR RETAIL STORE SERVICES FEATURING FURNITURE, LAMPS, PAPER GOODS AND PRINTED MATERIALS, NAMELY, BROCHURES, NEWSPAPERS, JOURNALS, BULLETINS, EVENT PROGRAMS, CATALOGS, PRINTED INSTRUCTIONAL, EDUCATION, AND TEACHING MATERIALS, BOOKS AND MAGAZINES, ALL IN THE FIELD OF HIGHER EDUCATION AND FEATURING SPORTS, POLITICAL ISSUES, EDUCATIONAL ISSUES, TRAVEL, BUSINESS AND ALUMNI AFFAIRS ISSUES, SCHOOL YEAR BOOKS, CLASS GRADUATION ALBUMS, MEDIA GUIDES FEATURING ACADEMIC, ATHLETIC AND ALUMNI EVENTS AND INFORMATION, TELEPHONE AND ADDRESS DIRECTORIES, REGISTERS, NAMELY, LEDGER BOOKS FOR RECEIVING RECORD ENTRIES, PAPER STATIONERY, NOTEBOOKS, STATIONERY-TYPE PORTFOLIOS, BINDERS, BOOK COVERS, BOOK ENDS, ANNOUNCEMENT CARDS, POSTCARDS FEATURING ACADEMIC LIFE, FOLDERS, WRAPPING PAPER, NOTECARDS, NOTE-PADS, POCKET AND DESK DIARIES, DATE BOOKS, APPOINTMENT BOOKS, DESK PADS, MEMO PADS, SCRAP BOOKS, PAPER WEIGHTS, PEN HOLDERS, PENCIL HOLDERS, ADDRESS BOOKS, PRINTED AWARDS, PRINTED DIPLOMA CERTIFICATES, COVERS FOR DIPLOMA CERTIFICATES, BUSINESS CARDS, STICKERS FEATURING ACADEMIC LIFE, BUMPER STICKERS FEATURING ACADEMIC LIFE, LETTER OPENERS, PERSONAL ORGANIZERS, CHECKBOOK COVERS AND HOLDERS, PENCILS, PENS, DECALS FEATURING ACADEMIC LIFE, PAPER NAPKINS, CREDIT CARDS WITHOUT MAGNETIC CODING, DEBIT CARDS WITHOUT MAGNETIC CODING, AND RUBBER STAMPS (U.S. CLS. 100, 101 AND 102).

JUDITH HELFMAN, EXAMINING ATTORNEY

SN 77-887,512. INTERSTATE OUTDOOR, INC., SELMA, NC. FILED 12-7-2009.

Interstate Outdoor

THE MARK CONSISTS OF STANDARD CHARACTERS WITHOUT CLAIM TO ANY PARTICULAR FONT, STYLE, SIZE, OR COLOR.

SUBJECT TO CONCURRENT USE PROCEEDING WITH REGISTRATION NOS. 3,126,257 AND 3,153,403 FIRST USED IN COMMERCE APRIL 1, 2004 AND SEPTEMBER 30, 1994 RESPECTIVELY FOR PROVIDING DISPLAYS OF COMMERCIAL ADVERTISING VIA SIGNAGE, OWNED BY INTERSTATE OUTDOOR ADVERTISING, L.P. HAVING AN ADDRESS AT 905 NORTH KINGS HIGHWAY, CHERRY HILL, NJ 09034. APPLICANT CLAIMS EXCLUSIVE RIGHT TO USE THE MARK IN THE AREA COMPRISING NORTH CAROLINA.

NO CLAIM IS MADE TO THE EXCLUSIVE RIGHT TO USE OUTDOOR, APART FROM THE MARK AS SHOWN.

FOR PROVIDING ADVERTISING SPACE ON BILLBOARDS AND IN KIOSKS (U.S. CLS. 100, 101 AND 102).

FIRST USE 2-8-2003; IN COMMERCE 2-8-2003.

HENRY S. ZAK, EXAMINING ATTORNEY

CLASS 35—(Continued).

SN 77-887,595. PROCESS IMPROVEMENT SOLUTIONS, INC., GREENWOOD, IN. FILED 12-7-2009.

Process IS Inc.

THE MARK CONSISTS OF STANDARD CHARACTERS WITHOUT CLAIM TO ANY PARTICULAR FONT, STYLE, SIZE, OR COLOR.

NO CLAIM IS MADE TO THE EXCLUSIVE RIGHT TO USE "INC", APART FROM THE MARK AS SHOWN.

FOR BUSINESS CONSULTATION IN THE FIELD OF PROCESS AND EFFICIENCY IMPROVEMENT (U.S. CLS. 100, 101 AND 102).

FIRST USE 6-30-2009; IN COMMERCE 6-30-2009.

SHAUNIA CARLYLE, EXAMINING ATTORNEY

SN 77-887,631. ANA ROBINSON, NEWPORT BEACH, CA. FILED 12-7-2009.

THE WRITTEN TRADITION

THE MARK CONSISTS OF STANDARD CHARACTERS WITHOUT CLAIM TO ANY PARTICULAR FONT, STYLE, SIZE, OR COLOR.

FOR RETAIL STORE SERVICES AND ONLINE RETAIL STORE SERVICES FEATURING GENERAL CONSUMER MERCHANDISE, STATIONERY PRODUCTS, BOOKS, POSTERS, GREETING CARDS, POSTCARDS, MEMO PADS, PENS, PENCILS, RULERS, ERASERS, JEWELRY, HOUSEWARES, GLASSWARE, MUGS, DECORATIVE HOME FURNISHINGS, HOLIDAY ORNAMENTS, ART, ART OBJECTS, GIFT ITEMS, SOUVENIRS, CD'S AND DVD'S, TOYS, BUTTONS, KEY RINGS, KEY CHAINS, UMBRELLAS, TOTE BAGS, T-SHIRTS, SWEATSHIRTS, AND HATS; ART GALLERIES (U.S. CLS. 100, 101 AND 102).

CHRISTINE MARTIN, EXAMINING ATTORNEY

SN 77-887,824. GENESIS PHYSICIANS GROUP, INC., DALLAS, TX. FILED 12-7-2009.

GenesisConnect

THE MARK CONSISTS OF STANDARD CHARACTERS WITHOUT CLAIM TO ANY PARTICULAR FONT, STYLE, SIZE, OR COLOR.

FOR PROVIDING A WEB-BASED SYSTEM AND ONLINE PORTAL IN THE FIELD OF BUSINESS PRACTICE MANAGEMENT SUPPORT SERVICES FOR PHYSICIAN MEMBERS, NAMELY, PROVIDING GROUP PURCHASING PROGRAMS, PROFESSIONAL BUSINESS CONSULTING, AND MANAGING PATIENT REFERRALS (U.S. CLS. 100, 101 AND 102).

FIRST USE 7-0-2009; IN COMMERCE 7-0-2009.

TRACY CROSS, EXAMINING ATTORNEY

CLASS 35—(Continued).

SN 77-889,090. SILENT CAL PRODUCTIONS, LLC, BURLINGAME, CA. FILED 12-8-2009.

CLASS 35—(Continued).

SN 77-889,990. INTERNATIONAL SALES AND NETWORK MANAGEMENT LLC, SCOTTSDALE, AZ. FILED 12-9-2009.

RICOCHET

Arizona Travel Collection

THE MARK CONSISTS OF STANDARD CHARACTERS WITHOUT CLAIM TO ANY PARTICULAR FONT, STYLE, SIZE, OR COLOR.

FOR PROVIDING AN INTERNET WEBSITE FEATURING NEWS AND INFORMATION IN THE FIELD OF NATIONAL AND INTERNATIONAL POLITICS; PROVIDING AN INTERNET WEBSITE FEATURING INFORMATION IN THE FIELD OF POLITICS AND GOVERNMENT AFFAIRS; PROVIDING INFORMATION, NEWS AND COMMENTARY IN THE FIELD OF POLITICS; PROVIDING INFORMATION IN THE FIELD OF POLITICS AND GOVERNMENT AFFAIRS (U.S. CLS. 100, 101 AND 102).

NELSON SNYDER, EXAMINING ATTORNEY

THE MARK CONSISTS OF STANDARD CHARACTERS WITHOUT CLAIM TO ANY PARTICULAR FONT, STYLE, SIZE, OR COLOR.

NO CLAIM IS MADE TO THE EXCLUSIVE RIGHT TO USE "ARIZONA TRAVEL", APART FROM THE MARK AS SHOWN.

FOR ADVERTISING, MARKETING AND PROMOTION SERVICES (U.S. CLS. 100, 101 AND 102).

YAT SYE, LEE, EXAMINING ATTORNEY

SN 77-889,397. ECOTECH ENERGY SOLUTIONS, ESTES PARK, CO. FILED 12-9-2009.

SN 77-890,250. FRYBURG DOOR, INC., MILLERSBURG, OH. FILED 12-10-2009.



F.D. HARDWOODS

NO CLAIM IS MADE TO THE EXCLUSIVE RIGHT TO USE "ENERGY SOLUTIONS", APART FROM THE MARK AS SHOWN.

THE MARK CONSISTS OF THE STYLIZED TEXT "ECOTECH ENERGY SOLUTIONS". THE TEXT "ECOTECH" IS WRITTEN IN A LINE ABOVE "ENERGY SOLUTIONS" WITH A HORIZONTAL LINE DESIGN IN THE MIDDLE. THERE IS A SUN DESIGN WITH A FAN INSIDE OF IT WITH THREE LINES FOR MOVEMENT. THE SUN DESIGN IN SIDE A CIRCULAR LINE WITH A CIRCLE TO THE RIGHT.

FOR BUSINESS CONSULTING AND ADVISORY SERVICES IN THE FIELD OF ENERGY EFFICIENCY (U.S. CLS. 100, 101 AND 102).

FIRST USE 7-1-2008; IN COMMERCE 7-1-2008.

EDWARD FENNESSY, EXAMINING ATTORNEY

THE MARK CONSISTS OF STANDARD CHARACTERS WITHOUT CLAIM TO ANY PARTICULAR FONT, STYLE, SIZE, OR COLOR.

NO CLAIM IS MADE TO THE EXCLUSIVE RIGHT TO USE "HARDWOODS", APART FROM THE MARK AS SHOWN.

FOR WHOLESALE STORE SERVICES FEATURING WOOD MOLDINGS, WOODEN DRAWER BOXES, WOODEN DRAWER FRONTS, WOODEN DOORS, HARDWOOD PANELS, WOOD FACE FRAMES AND DOOR PANELS NOT OF METAL (U.S. CLS. 100, 101 AND 102).

TRACY CROSS, EXAMINING ATTORNEY

CLASS 35—(Continued).

SN 77-892,753. TRAN LOGISTICS LLC, MIAMI, FL. FILED 12-14-2009.



NO CLAIM IS MADE TO THE EXCLUSIVE RIGHT TO USE "LOGISTICS" AND "LLC.", APART FROM THE MARK AS SHOWN.

THE COLOR(S) YELLOW, GRAY, BLACK AND WHITE IS/ARE CLAIMED AS A FEATURE OF THE MARK.

THE MARK CONSISTS OF THE STYLIZED LETTERS "T" AND "L" IN BLACK AND OUTLINED IN GRAY SUPERIMPOSED OVER A YELLOW DESIGN ELEMENT OUTLINED IN GRAY, THE STYLIZED WORDING "TRAN" IN BLACK, THE STYLIZED WORDING "LOGISTICS" IN WHITE AND OUTLINED IN GRAY, THE STYLIZED WORDING "LLC." IN BLACK, AND A STYLIZED ARROW IN YELLOW AND OUTLINED IN GRAY.

FOR TRANSPORTATION LOGISTICS SERVICES, NAMELY, ARRANGING THE TRANSPORTATION OF GOODS FOR OTHERS (U.S. CLS. 100, 101 AND 102).

FIRST USE 12-0-2004; IN COMMERCE 12-0-2004.

DOMINIC FATHY, EXAMINING ATTORNEY

SN 77-893,087. SUPERMEDIA LLC, DALLAS/FORT WORTH AIRPORT, TX. FILED 12-14-2009.

SUPERMATCH

THE MARK CONSISTS OF STANDARD CHARACTERS WITHOUT CLAIM TO ANY PARTICULAR FONT, STYLE, SIZE, OR COLOR.

FOR ON-LINE ADVERTISING SERVICES FOR OTHERS; ADVERTISING SERVICES, NAMELY, PROMOTING THE GOODS AND SERVICES OF OTHERS VIA THE INTERNET; DISSEMINATION OF ADVERTISING FOR OTHERS VIA THE INTERNET; TELEPHONE DIRECTORY INFORMATION FEATURING BUSINESS LISTINGS AND BUSINESS INFORMATION PROVIDED VIA CELL PHONE OR OTHER MOBILE DEVICES (U.S. CLS. 100, 101 AND 102).

MARC LEIPZIG, EXAMINING ATTORNEY

CLASS 35—(Continued).

SN 77-893,378. TERRY MCDANIEL, ALAMO, CA. FILED 12-15-2009.

CENTRESCORE

THE MARK CONSISTS OF STANDARD CHARACTERS WITHOUT CLAIM TO ANY PARTICULAR FONT, STYLE, SIZE, OR COLOR.

FOR PROVIDING BUSINESS MARKETING INFORMATION, NAMELY, PROVIDING SCORING AND INDEXING SOCIO-ECONOMIC INFORMATION AND ANALYSIS TO DETERMINE THE SOCIAL-ECONOMIC IMPACT ON AN INDIVIDUAL, HOUSEHOLD OR GEOSPATIAL TERRITORY (U.S. CLS. 100, 101 AND 102).

LINDA M. KING, EXAMINING ATTORNEY

SN 77-894,509. BOLD STEPS, INC., WHEATON, IL. FILED 12-16-2009.

Boldmentum

THE MARK CONSISTS OF STANDARD CHARACTERS WITHOUT CLAIM TO ANY PARTICULAR FONT, STYLE, SIZE, OR COLOR.

FOR BUSINESS CONSULTATION IN THE FIELD OF BUSINESS PROCESS ENGINEERING, NAMELY, THE DISCOVERY, CREATION, RE-ENGINEERING, AND IMPLEMENTATION OF IMPROVED BUSINESS PROCESSES (U.S. CLS. 100, 101 AND 102).

LESLIE RICHARDS, EXAMINING ATTORNEY

SN 77-896,239. CLEAN ARMS FOR COMMUNITY, ANAHEIM, CA. FILED 12-17-2009.

PURPOSE BEYOND PRISON

THE MARK CONSISTS OF STANDARD CHARACTERS WITHOUT CLAIM TO ANY PARTICULAR FONT, STYLE, SIZE, OR COLOR.

FOR CHARITABLE SERVICES, NAMELY, ORGANIZING AND CONDUCTING VOLUNTEER PROGRAMS AND COMMUNITY SERVICE PROJECTS FOR AT-RISK YOUTH AND FOR IMPROVING COMMUNITY LIFE (U.S. CLS. 100, 101 AND 102).

FIRST USE 11-17-2009; IN COMMERCE 11-19-2009.

KATHERINE E. HALMEN, EXAMINING ATTORNEY

CLASS 35—(Continued).

SN 77-896,349. CANDICE C SMITH, OLD BROOKVILLE, NY. FILED 12-17-2009.

CONSUMER COMBAT

THE MARK CONSISTS OF STANDARD CHARACTERS WITHOUT CLAIM TO ANY PARTICULAR FONT, STYLE, SIZE, OR COLOR.

NO CLAIM IS MADE TO THE EXCLUSIVE RIGHT TO USE "CONSUMER", APART FROM THE MARK AS SHOWN.

FOR ADVERTISING AND MARKETING SERVICES, NAMELY, PROMOTING THE GOODS AND SERVICES OF OTHERS; ADVERTISING SERVICES; ADVERTISING SERVICES, NAMELY, PROMOTING THE BOOKS OF OTHERS IN THE FIELD OF LAW BY MEANS OF NEWS AND REVIEWS REGARDING SAME; ADVERTISING SERVICES, NAMELY, PROMOTING THE BRANDS, GOODS AND SERVICES OF OTHERS; ADVERTISING SERVICES, NAMELY, PROVIDING A WEBSITE FOR THE PROMOTION OF THE BOOKS OF OTHERS IN THE FIELD OF LAW, INCLUDING NEWS AND REVIEWS REGARDING SAME; ADVERTISING VIA ELECTRONIC MEDIA AND SPECIFICALLY THE INTERNET; ADVICE IN THE FIELD OF BUSINESS MANAGEMENT AND MARKETING; ADVISORY SERVICES FOR PREPARING AND CARRYING OUT COMMERCIAL TRANSACTIONS; ADVISORY SERVICES RELATING TO BUSINESS MANAGEMENT AND BUSINESS OPERATIONS; BUSINESS ADVICE AND INFORMATION; BUSINESS INVESTIGATIONS; COLLECTION OF MARKET RESEARCH INFORMATION; COMMERCIAL INFORMATION AND ADVICE FOR CONSUMERS; COMMERCIAL LOBBYING SERVICES; COMPUTER SERVICES, NAMELY, PROVIDING CONSUMER INFORMATION IN THE FIELD OF ANIMALS AND PETS RELATING TO PET PRODUCTS, PET TREATS AND PET TOYS; COMPUTERIZED ON-LINE ORDERING FEATURING GENERAL MERCHANDISE AND GENERAL CONSUMER GOODS; CONSULTING SERVICES, NAMELY, PROVIDING EXPECTANT PARENTS WITH CONSUMER INFORMATION ON ALL TYPES OF BABY PRODUCTS AND SERVICES; CONSUMER RESEARCH; CONSUMER SURVEY SERVICES; DATA MANAGEMENT SERVICES FOR USE IN DEBT COLLECTION, NAMELY, ELECTRONIC DATA COLLECTION AND ON-LINE CLAIMS MANAGEMENT; INSURANCE LEAD COLLECTION AND MATCHING SERVICES, NAMELY, MATCHING CONSUMER REQUESTS FOR INSURANCE POLICY QUOTES COLLECTED OVER THE INTERNET TO PRE-QUALIFIED INSURANCE BROKERS, AGENTS AND AGENCIES INTERESTED IN THOSE REQUESTS; LOBBYING SERVICES, NAMELY, PROMOTING THE INTERESTS OF INTERNATIONAL, REAL ESTATE AND NONPROFIT COMPANIES IN THE FIELDS OF POLITICS, LEGISLATION, AND REGULATION; LOBBYING SERVICES, NAMELY, PROMOTING THE INTERESTS OF CONSUMERS IN THE FIELDS OF LEGISLATION AND REGULATION; MARKETING, ADVERTISING, AND PROMOTING THE RETAIL GOODS AND SERVICES OF OTHERS TO WIRELESS ELECTRONIC DEVICES; MATCHING BORROWERS WITH POTENTIAL LENDERS IN THE FIELD OF CONSUMER AND MORTGAGE LENDING; MATCHING CONSUMERS WITH PROFESSIONALS IN THE FIELD OF RESIDENTIAL AND COMMERCIAL SERVICES VIA COMPUTER NETWORK; MATCHING CONSUMERS WITH REAL ESTATE PROFESSIONALS IN THE FIELD OF REAL ESTATE SERVICES VIA COMPUTER NETWORK; MEDIATION AND CONCLUSION OF COMMERCIAL TRANSACTIONS FOR OTHERS; MEDIATION OF ADVERTISING; MEDIATION OF AGREEMENTS REGARDING THE SALE AND PURCHASE OF GOODS; MEDIATION OF CONTRACTS FOR PURCHASE AND SALE OF PRODUCTS; MEDIATION OF TRADE BUSINESS FOR THIRD PARTIES; MONITORING CONSUMER CREDIT REPORTS AND PROVIDING AN ALERT AS TO ANY CHANGES THEREIN; PROMOTING THE GOODS AND SERVICES OF OTHERS BY PREPARING AND PLACING

CLASS 35—(Continued).

ADVERTISEMENTS IN AN ELECTRONIC MAGAZINE ACCESSED THROUGH A GLOBAL COMPUTER NETWORK; PROVIDING A WEB-BASED SYSTEM AND ON-LINE PORTALS IN THE FIELD OF CONSUMER-TO-BUSINESS COMMERCE FOR CONSUMERS TO ENTER, MANAGE AND MODIFY THEIR CONSUMER PREFERENCE INFORMATION FOR USE BY MERCHANTS TO CREATE AND MANAGE OFFERS FOR DELIVERY TO CONSUMERS; PROVIDING A WEBSITE FEATURING INFORMATION FOR CONSUMERS IN THE FIELD OF PET FOOD, PET TREATS AND PET TOYS FOR PARTICULAR PET BREEDS; PROVIDING A WEBSITE FEATURING PRODUCTS AND SERVICES RATINGS OF OTHERS IN THE FIELD OF HOME CONTRACT SERVICES RECOMMENDED BY CONSUMERS; PROVIDING ADVERTISING SERVICE TO DISTRIBUTE ADVERTISEMENTS FOR DISPLAY ON INTERNET, NAMELY, IN WEBSITES, SOCIAL CONVERSATIONS OVER THE INTERNET, EMAILS, MICROBLOGS, BLOGS, ELECTRONIC MESSAGES, INSTANT MESSAGES, TEXT MESSAGES, MULTIMEDIA MESSAGES, SOCIAL NETWORKS, STATUS UPDATES, FORUMS, ELECTRONIC BULLETIN BOARDS.; PROVIDING ADVERTISING, MARKETING AND PROMOTIONAL SERVICES, NAMELY, DEVELOPMENT OF ADVERTISING CAMPAIGNS PROVIDED THROUGH CABLE TELEVISION BROADCAST, WEB CASTS, RADIO BROADCASTS, NEWSPAPERS, MAGAZINES, ONLINE BANNERS, OUTDOOR BILLBOARDS, WILD POSTINGS, BUS AND SUBWAY ADS; PROVIDING AN INTERACTIVE WEB SITE FOR PERSONS TO REGISTER COMPLAINTS AGAINST COMPANIES AND/OR SERVICES OF ALL TYPES; PROVIDING AN ON-LINE SEARCHABLE DATABASE FOR POLITICAL CAMPAIGNS WHICH ALLOW USERS TO COLLECT AND ANALYZE POLITICAL INFORMATION ELECTRONICALLY; PROVIDING CONSUMER INFORMATION AND RELATED NEWS IN THE FIELD OF CONSUMER PROTECTION; PROVIDING CONSUMER NEWS AND INFORMATION IN THE FIELD OF EDUCATIONAL PRODUCTS AND SERVICES THAT HELP INDIVIDUALS AND BUSINESSES MAKE AND SAVE MONEY; PROVIDING CONSUMER PRODUCT INFORMATION VIA THE INTERNET; PROVIDING INFORMATION ABOUT AND MAKING REFERRALS IN THE FIELD OF CONSUMER PRODUCTS AND SERVICES FOR RETAIL SERVICES CONCERNING PRODUCTS, SERVICES, EVENTS, ACTIVITIES, ATTRACTIONS AND FACILITIES IN PARTICULAR GEOGRAPHIC LOCATIONS; PROVIDING INFORMATION REGARDING POLITICAL ISSUES, KNOWING HOW TO VOTE AND KNOWING HOW TO REGISTER TO VOTE; PROVIDING RATINGS VIA A GLOBAL COMPUTER NETWORK FOR HOME PRODUCTS AND SERVICES RECOMMENDED BY CONSUMERS; PROVISION OF INFORMATION AND ADVICE TO CONSUMERS REGARDING THE SELECTION OF PRODUCTS AND ITEMS TO BE PURCHASED; RATING THE ENVIRONMENTAL QUALITIES AND IMPACT OF CONSUMER PRODUCTS OF OTHERS FOR THE PURPOSE OF MAKING PURCHASING DECISIONS; SERVICES CONSISTING OF THE REGISTRATION, COLLECTION, TRANSCRIPTION, COMPILATION AND SYSTEMIZATION OF WRITTEN COMMUNICATIONS AND DATA (U.S. CLS. 100, 101 AND 102).

REBECCA SMITH, EXAMINING ATTORNEY

CLASS 35—(Continued).

SN 77-899,302. KING, GRACE, WHITESTONE, NY. FILED 12-22-2009.

GRACEHOPPER

THE MARK CONSISTS OF STANDARD CHARACTERS WITHOUT CLAIM TO ANY PARTICULAR FONT, STYLE, SIZE, OR COLOR.

FOR ONLINE RETAIL STORE SERVICES FEATURING ENVIRONMENTALLY FRIENDLY AND GREEN PRODUCTS, NAMELY, GENERAL CONSUMER MERCHANDISE AND RECYCLED FURNITURE (U.S. CLS. 100, 101 AND 102).

KARANENDRA S. CHHINA, EXAMINING ATTORNEY

CLASS 35—(Continued).

SN 77-900,367. NATIONAL JOINT POWERS ALLIANCE, STAPLES, MN. FILED 12-23-2009.

NJPA

THE MARK CONSISTS OF STANDARD CHARACTERS WITHOUT CLAIM TO ANY PARTICULAR FONT, STYLE, SIZE, OR COLOR.

FOR PROCUREMENT, NAMELY, PURCHASING TECHNOLOGY PRODUCTS AND SERVICES, APPLICATION AND GRAPHICS SOFTWARE, COMPUTER AND TECHNOLOGY EQUIPMENT SUPPLIES, COPY AND FAX MACHINES, CURRICULUM AND EDUCATIONAL SOFTWARE, INTERNET SECURITY HARDWARE AND SOFTWARE, WIRELESS COMMUNICATIONS EQUIPMENT, TELECOMMUNICATION EQUIPMENT AND SERVICE, LONG DISTANCE AND LOCAL PHONE SERVICE, FACILITY AND ORGANIZATION SERVICES, BATTERIES, RECYCLING SERVICES, DOCUMENT AND INFORMATION MANAGEMENT SERVICES, ENVIRONMENTAL/OCCUPATIONAL HEALTH AND SAFETY SERVICES, HEALTH AND SAFETY SERVICES AND SUPPLIES, INDOOR AIR QUALITY SERVICES, MENTORSHIP AND INTERVENTION PROGRAM SERVICES, ONLINE PROCUREMENT SERVICES, SCHOOL-TO-HOME COMMUNICATION SERVICES, SECURITY/FIRE ALARM SYSTEMS, SUBSTITUTE TEACHER SERVICES, WEB DEVELOPMENT SERVICES, ENGINEERING SERVICES, MARKETING SERVICES, ASSET TRACKING AND STUDENT IDENTIFICATION SYSTEMS AND SERVICES, ATHLETIC AND PHYSICAL EDUCATION EQUIPMENT, AUDIO AND VISUAL PRODUCTS, BUSES, CARS, TRUCKS, VANS, CARPETING, COLLEGE FUNDING CONSULTING SERVICES, CUSTODIAL SUPPLIES, DRUG AND ALCOHOL TESTING SERVICES, PRESCRIPTION DRUGS, TOBACCO CESSATION PRODUCTS, FOOD SERVICE PRODUCTS, FUNDRAISING SERVICES, CLASSROOM FURNITURE AND SUPPLIES, CAFETERIA FURNITURE AND SUPPLIES, OFFICE FURNITURE AND SUPPLIES, INSURANCE SERVICES, LEASING AND FINANCING SERVICES, PLAYGROUND EQUIPMENT, PORTABLE/MODULAR CLASSROOM AND OFFICE PRODUCTS, ROOFING/FACILITY WEATHERPROOFING SERVICES, HARDWARE AND TOOLS, ALL THE AFORESAID PROCURED FOR OTHERS (U.S. CLS. 100, 101 AND 102).

FIRST USE 4-14-2003; IN COMMERCE 4-14-2003.

JEFF DEFORD, EXAMINING ATTORNEY

SN 77-899,578. JAMES ANTOYAN, ONTARIO, CA. FILED 12-22-2009.

i411 INLAND EMPIRE

THE MARK CONSISTS OF STANDARD CHARACTERS WITHOUT CLAIM TO ANY PARTICULAR FONT, STYLE, SIZE, OR COLOR.

NO CLAIM IS MADE TO THE EXCLUSIVE RIGHT TO USE "INLAND EMPIRE", APART FROM THE MARK AS SHOWN.

FOR ENTERTAINMENT SERVICES, NAMELY, PROVIDING CONSUMER INFORMATION IN THE FIELD OF ENTERTAINMENT SERVICES FOR DINING, PRODUCTS, SERVICES, EVENTS, ACTIVITIES, FACILITIES AND LOCATIONS PROVIDED THROUGH A WEBSITE OR MOBILE DEVICE APPLICATION (U.S. CLS. 100, 101 AND 102).

FIRST USE 12-10-2009; IN COMMERCE 12-10-2009.

ERIN FALK, EXAMINING ATTORNEY

CLASS 35—(Continued).

SN 77-900,455. GORANGO, LLC, SHERWOOD, OR. FILED 12-23-2009.



THE COLOR(S) GREEN IS/ARE CLAIMED AS A FEATURE OF THE MARK.

THE MARK CONSISTS OF THREE IDENTICALLY SIZED CIRCLES IN A HORIZONTAL LINE, THE LEFT CIRCLE SHADED LIGHT GREEN, THE MIDDLE CIRCLE SHADED MEDIUM GREEN AND THE RIGHT CIRCLE SHADED DARKER GREEN.

FOR BUSINESS AND MARKETING SERVICES, NAMELY, PROVIDING A WEBSITE VIA A GLOBAL COMMUNICATIONS NETWORK FOR PROMOTING GOODS AND SERVICES OF OTHERS IN THE NATURE OF A VIRTUAL MARKETPLACE BY PROVIDING SEARCH ENGINES LINKING CONSUMERS TO BUSINESSES AND BUSINESSES TO CONSUMERS; PROVIDING ONLINE BUSINESS LISTINGS AND BUSINESS DIRECTORY FEATURING COMMERCIAL BUSINESSES FOR CONSUMERS SEARCHING FOR ONE OR MORE BUSINESSES OFFERING GOOD OR SERVICES; PROVIDING A WEBSITE FOR POSTING JOB LISTINGS AND RESUMES; PROVIDING ADVERTISING SPACE ON A WEBSITE VIA THE GLOBAL COMMUNICATIONS NETWORK; ADVERTISING SERVICES, NAMELY, PROMOTING AND ADVERTISING INFORMATION ABOUT THE SERVICES OF OTHERS; CLASSIFIED ADVERTISEMENT SERVICES, NAMELY, PROVIDING CLASSIFIED LISTINGS OF GOODS AND SERVICES; PROVIDING WANT ADS, NAMELY, PROVIDING A WEBSITE WHERE USERS CAN POST ITEMS FOR SALE THROUGH ONLINE CLASSIFIED ADVERTISEMENTS (U.S. CLS. 100, 101 AND 102).

FIRST USE 9-1-2009; IN COMMERCE 9-1-2009.

KATHRYN COWARD, EXAMINING ATTORNEY

SN 77-901,755. ATLANTIC BUSINESS ORGANIZATION CORP., SAN DIEGO, CA. FILED 12-28-2009.

got flu?

THE MARK CONSISTS OF STANDARD CHARACTERS WITHOUT CLAIM TO ANY PARTICULAR FONT, STYLE, SIZE, OR COLOR.

NO CLAIM IS MADE TO THE EXCLUSIVE RIGHT TO USE "FLU", APART FROM THE MARK AS SHOWN.

FOR WHOLESALE DISTRIBUTORSHIPS FEATURING PHARMACEUTICAL PRODUCTS AND FLU VACCINES (U.S. CLS. 100, 101 AND 102).

FIRST USE 3-1-2008; IN COMMERCE 3-1-2008.

KELLEY WELLS, EXAMINING ATTORNEY

CLASS 35—(Continued).

SN 77-904,249. NOCO ENERGY CORP., TONAWANDA, NY. FILED 1-4-2010.



OWNER OF U.S. REG. NOS. 1,792,948 AND 2,076,827.

THE COLOR(S) GREEN, BLUE, RED AND YELLOW IS/ARE CLAIMED AS A FEATURE OF THE MARK.

THE MARK CONSISTS OF THE BODY OF THE FROG WHICH IS GREEN, EXCEPT FOR THE FRONT OF THE BODY FROM NECK TO LEGS WHICH IS RED. THE CAPE THE FROG IS WEARING IS BLUE AND THE NECKLACE WITH WORD "NOCO" IS YELLOW.

FOR RETAIL STORE SERVICES FEATURING CONVENIENT STORE ITEMS AND GASOLINE; PROVIDING INCENTIVE AWARD PROGRAMS FOR CUSTOMERS THROUGH THE DISTRIBUTION OF STORE VALUE CARDS FOR THE PURPOSE OF PROMOTING AND REWARDING CUSTOMER LOYALTY (U.S. CLS. 100, 101 AND 102).

FIRST USE 6-1-2009; IN COMMERCE 6-1-2009.

JANET LEE, EXAMINING ATTORNEY

CLASS 35—(Continued).

SN 77-905,972. ENDLESS GLOW, LLC, LAS VEGAS, NV.
FILED 1-6-2010.

Cash In Pocket

THE MARK CONSISTS OF STANDARD CHARACTERS WITHOUT CLAIM TO ANY PARTICULAR FONT, STYLE, SIZE, OR COLOR.

FOR DISTRIBUTORSHIP SERVICES IN THE FIELD OF COSMETIC PREPARATIONS AND SUNLESS AIRBRUSH TANNING PREPARATIONS AND EQUIPMENT; MULTI-LEVEL MARKETING BUSINESS SERVICES, NAMELY, PROVIDING MARKETING AND INCOME OPPORTUNITIES TO THIRD PARTIES THROUGH THE SALE AND DISTRIBUTION OF COSMETIC PREPARATIONS AND SUNLESS AIRBRUSH TANNING PREPARATIONS AND EQUIPMENT; PARTY PLAN SERVICES, NAMELY, RETAIL SHOP-AT-HOME PARTY SERVICES IN THE FIELD OF COSMETIC PREPARATIONS AND SUNLESS AIRBRUSH TANNING PREPARATIONS AND EQUIPMENT; PROVIDING TECHNICAL AND PROMOTIONAL ASSISTANCE, NAMELY, PROMOTION AND MARKETING SERVICES AND RELATED CONSULTING IN CONNECTION WITH THE IN HOME RETAIL SALES BY INDEPENDENT SALES REPRESENTATIVES OF COSMETIC PREPARATIONS AND SUNLESS AIRBRUSH TANNING PREPARATIONS AND EQUIPMENT; PROVIDING AND IMPLEMENTING INCENTIVE AND AWARDS PROGRAMS FOR INDEPENDENT SALES REPRESENTATIVES TO PROMOTE THE SALE OF PRODUCTS AND SERVICES TO OTHERS AND TO RECRUIT ADDITIONAL INDEPENDENT SALES REPRESENTATIVES; RECRUITING AND CAREER NETWORKING SERVICES RELATING TO INDEPENDENT SALES REPRESENTATIVES IN THE FIELD OF COSMETIC PREPARATIONS AND SUNLESS AIRBRUSH TANNING PREPARATIONS AND EQUIPMENT (U.S. CLS. 100, 101 AND 102).

JENNIFER VASQUEZ, EXAMINING ATTORNEY

SN 77-906,018. FRANK T ROTHAEEMEL, DBA FTRSTRATEGY, ALPHARETTA, GA. FILED 1-6-2010.

ftrStrategy

THE MARK CONSISTS OF STANDARD CHARACTERS WITHOUT CLAIM TO ANY PARTICULAR FONT, STYLE, SIZE, OR COLOR.

FOR BUSINESS MANAGEMENT AND CONSULTATION (U.S. CLS. 100, 101 AND 102).

FIRST USE 3-9-2009; IN COMMERCE 3-9-2009.

DOMINICK J. SALEMI, EXAMINING ATTORNEY

CLASS 35—(Continued).

SN 77-906,470. ARNOLD, THOMAS R., ISSAQUAH, WA.
FILED 1-6-2010.

Pet Hub

THE MARK CONSISTS OF STANDARD CHARACTERS WITHOUT CLAIM TO ANY PARTICULAR FONT, STYLE, SIZE, OR COLOR.

NO CLAIM IS MADE TO THE EXCLUSIVE RIGHT TO USE "PET", APART FROM THE MARK AS SHOWN.

FOR ADVERTISING AND DIRECTORY SERVICES, NAMELY, PROMOTING THE SERVICES OF OTHERS BY PROVIDING A WEB PAGE FEATURING LINKS TO THE WEBSITES OF OTHERS (U.S. CLS. 100, 101 AND 102).

KATHERINE M. DUBRAY, EXAMINING ATTORNEY

SN 77-908,460. PICKELSIMER TRUST, LAS VEGAS, NV.
FILED 1-9-2010.

Pickelsimer

THE MARK CONSISTS OF STANDARD CHARACTERS WITHOUT CLAIM TO ANY PARTICULAR FONT, STYLE, SIZE, OR COLOR.

FOR ADVERTISING AND PUBLICITY SERVICES (U.S. CLS. 100, 101 AND 102).

FIRST USE 0-0-1500; IN COMMERCE 1-1-1757.

PRISCILLA MILTON, EXAMINING ATTORNEY

SN 77-909,121. QUORUM HEALTH RESOURCES, LLC, BRENTWOOD, TN. FILED 1-11-2010.



The logo for Quorum SOLUTIONS features the word "Quorum" in a blue serif font with a red underline, and the word "SOLUTIONS" in a blue sans-serif font below it.

OWNER OF U.S. REG. NOS. 3,257,760 AND 3,737,811.

NO CLAIM IS MADE TO THE EXCLUSIVE RIGHT TO USE "SOLUTIONS", APART FROM THE MARK AS SHOWN.

THE COLOR(S) BLUE AND RED IS/ARE CLAIMED AS A FEATURE OF THE MARK.

THE MARK CONSISTS OF THE COLOR BLUE APPEARING IN THE WORDING "QUORUM SOLUTIONS"; AND THE COLOR RED APPEARING IN THE STRAIGHT VERTICAL LINE IN BETWEEN "QUORUM" AND "SOLUTIONS".

FOR CONSULTING IN THE FIELD OF HOSPITAL OPERATIONS MANAGEMENT (U.S. CLS. 100, 101 AND 102).

MICHELLE DUBOIS, EXAMINING ATTORNEY

CLASS 35—(Continued).

SN 77-909,772. LIEN PHAT CORPORATION, AUSTIN, TX.
FILED 1-12-2010.



THE MARK CONSISTS OF "LP" IN STYLIZED FONT WITH "LIEN PHAT" BELOW IT BOTH IN BLACK LETTERS. THE ENGLISH TRANSLATION OF "LIEN PHAT" IN THE MARK IS "TO PROSPER".

FOR ACCOUNTING SERVICES; ADMINISTRATION OF BUSINESS PAYROLL FOR OTHERS; BOOKKEEPING; INCOME TAX CONSULTATION; INCOME TAX PREPARATION; PAYROLL ADMINISTRATION AND MANAGEMENT SERVICES; PAYROLL PREPARATION; PAYROLL PROCESSING SERVICES; TAX ADVISORY SERVICES; TAX FILING SERVICES; WAGE PAYROLL PREPARATION (U.S. CLS. 100, 101 AND 102).

FIRST USE 1-20-2004; IN COMMERCE 1-20-2004.
THOMAS MANOR, EXAMINING ATTORNEY

CLASS 35—(Continued).

SN 77-909,906. DO SOMETHING!, INC., NEW YORK, NY.
FILED 1-12-2010.

DO SOMETHING

THE MARK CONSISTS OF STANDARD CHARACTERS WITHOUT CLAIM TO ANY PARTICULAR FONT, STYLE, SIZE, OR COLOR.

OWNER OF U.S. REG. NOS. 1,929,622, 3,057,498 AND OTHERS.

FOR CHARITABLE SERVICES, NAMELY, ORGANIZING YOUTHS TO UNDERTAKE PROJECTS TO BENEFIT THE NEEDY AND THE COMMUNITY TO ENCOURAGE LEADERSHIP, CHARACTER, COMPASSION, AND GOOD CITIZENSHIP (U.S. CLS. 100, 101 AND 102).

FIRST USE 9-0-1993; IN COMMERCE 9-0-1993.
GENE MACIOL, EXAMINING ATTORNEY

SN 77-910,789. INKFROG, INC., HIGLEY, AZ. FILED 1-13-2010.

INKFROG

THE MARK CONSISTS OF STANDARD CHARACTERS WITHOUT CLAIM TO ANY PARTICULAR FONT, STYLE, SIZE, OR COLOR.

FOR ONLINE TRADING AND LISTING SERVICES TO FACILITATE TRADING TRANSACTIONS OF GOODS AND SERVICES BY OTHERS VIA A GLOBAL COMMUNICATIONS NETWORK; BUSINESS MANAGEMENT SERVICES IN CONNECTION WITH TRADING TRANSACTIONS PROVIDED FOR OTHERS OVER AN ONLINE WEB SITE ACCESSED THROUGH A GLOBAL COMMUNICATIONS NETWORK; BUSINESS MANAGEMENT ASSISTANCE, NAMELY, CARRYING OUT TASKS NECESSARY FOR THE SMOOTH CONDUCT OF TRADING TRANSACTIONS PROVIDED THROUGH A GLOBAL COMMUNICATIONS NETWORK; PROVIDING ONLINE ADVERTISEMENT POSTINGS AND MANAGEMENT SERVICES FOR SELLERS TO GENERATE ADS AND SCHEDULE THE TIMING OF THE POSTINGS, INCLUDING STARTING AND ENDING EACH POSTING SESSIONS, AND CHANGING THE LAYOUT, TEXT AND/OR IMAGES OF POSTINGS WHILE THE POSTINGS ARE PROGRESSING; PROVIDING ONLINE MARKETING SERVICES FOR OTHERS, NAMELY, PROVIDING REAL-TIME INFORMATION ABOUT ONLINE POSTING TRAFFIC AND WEB SITE VISITORS IN CONNECTION WITH TRADING TRANSACTIONS VIA A GLOBAL COMMUNICATIONS NETWORK (U.S. CLS. 100, 101 AND 102).

FIRST USE 4-1-2002; IN COMMERCE 4-1-2002.
RUSS HERMAN, EXAMINING ATTORNEY

SN 77-909,795. THE NEBRASKA HUMANE SOCIETY, OMAHA, NE. FILED 1-12-2010.

Humane Enterprises

THE MARK CONSISTS OF STANDARD CHARACTERS WITHOUT CLAIM TO ANY PARTICULAR FONT, STYLE, SIZE, OR COLOR.

NO CLAIM IS MADE TO THE EXCLUSIVE RIGHT TO USE "HUMANE", APART FROM THE MARK AS SHOWN.

FOR ADMINISTRATION AND PROCESSING OF PET LICENSES AND REGISTRATIONS FOR STATE AND MUNICIPAL GOVERNMENTAL ORGANIZATIONS (U.S. CLS. 100, 101 AND 102).

MICHAEL ENGEL, EXAMINING ATTORNEY

CLASS 35—(Continued).

SN 77-911,849. ATLANTA JUNIOR GOLF ASSOCIATION, INC., ATLANTA, GA. FILED 1-14-2010.

ATLANTA JUNIOR GOLF

THE MARK CONSISTS OF STANDARD CHARACTERS WITHOUT CLAIM TO ANY PARTICULAR FONT, STYLE, SIZE, OR COLOR.

NO CLAIM IS MADE TO THE EXCLUSIVE RIGHT TO USE "JUNIOR GOLF", APART FROM THE MARK AS SHOWN.

SEC. 2(F).

FOR ASSOCIATION SERVICES, NAMELY, PROMOTING THE INTERESTS OF JUNIOR GOLF (U.S. CLS. 100, 101 AND 102).

FIRST USE 0-0-1974; IN COMMERCE 0-0-1974.

AMY HELLA, EXAMINING ATTORNEY

CLASS 35—(Continued).

SN 77-912,018. ATLANTA JUNIOR GOLF ASSOCIATION, INC., MARIETTA, GA. FILED 1-14-2010.



NO CLAIM IS MADE TO THE EXCLUSIVE RIGHT TO USE "JUNIOR GOLF", APART FROM THE MARK AS SHOWN.

THE COLOR(S) GREEN, WHITE, AND BLUE IS/ARE CLAIMED AS A FEATURE OF THE MARK.

THE MARK CONSISTS OF THE WORD "ATLANTA" IN WHITE LETTERS WITH A BLUE OUTLINE DISPLAYED ABOVE THE WORDS "JUNIOR GOLF" IN WHITE LETTERS IN THE CENTER OF TWO OVAL SHAPES, ONE COMPLETE INNER OVAL FILLED IN GREEN AND ONE BLUE BROKEN OVAL WHICH CONSTITUTES THE BORDER.

SEC. 2(F) AS TO "ATLANTA JUNIOR GOLF".

FOR ASSOCIATION SERVICES, NAMELY, PROMOTING THE INTERESTS OF JUNIOR GOLF (U.S. CLS. 100, 101 AND 102).

FIRST USE 1-1-2007; IN COMMERCE 1-1-2007.

AMY HELLA, EXAMINING ATTORNEY

SN 77-912,010. JU DD LLC, MONTCLAIR, NJ. FILED 1-14-2010.



A BRAND IDEA COMPANY

NO CLAIM IS MADE TO THE EXCLUSIVE RIGHT TO USE "BRAND" AND "COMPANY", APART FROM THE MARK AS SHOWN.

THE MARK CONSISTS OF 2 SQUARES SITTING SIDE BY SIDE - THE FIRST BOX ON THE LEFT CONTAINS LETTERS "JU" AND THE SECOND BOX ON RIGHT CONTAINS THE LETTERS "DD". UNDER THE 2 BOXES IS THE PHRASE "A BRAND IDEA COMPANY".

FOR BRANDING SERVICES, NAMELY, CONSULTING, DEVELOPMENT, MANAGEMENT AND MARKETING OF BRANDS FOR BUSINESSES (U.S. CLS. 100, 101 AND 102).

JASON BLAIR, EXAMINING ATTORNEY

SN 77-912,827. HEART OF VERMONT CHAMBER OF COMMERCE, FORMERLY HARDWICK AREA CHAMBER OF COMMERCE, HARDWICK, VT. FILED 1-15-2010.

Heart of Vermont

THE MARK CONSISTS OF STANDARD CHARACTERS WITHOUT CLAIM TO ANY PARTICULAR FONT, STYLE, SIZE, OR COLOR.

NO CLAIM IS MADE TO THE EXCLUSIVE RIGHT TO USE "VERMONT", APART FROM THE MARK AS SHOWN.

FOR CHAMBER OF COMMERCE SERVICES, NAMELY, PROMOTING BUSINESS AND TOURISM IN THE HARDWICK, VERMONT AREA (U.S. CLS. 100, 101 AND 102).

FIRST USE 1-6-2006; IN COMMERCE 1-1-2007.

HELENE LIWINSKI, EXAMINING ATTORNEY

CLASS 35—(Continued).

SN 77-913,287. INSTITUTE FOR INTERNATIONAL RESEARCH, NEW YORK, NY. FILED 1-15-2010.

**EPIC- ENTREPRENEURIAL
PARTNERSHIPS INNOVATION
CONFERENCE**

THE MARK CONSISTS OF STANDARD CHARACTERS WITHOUT CLAIM TO ANY PARTICULAR FONT, STYLE, SIZE, OR COLOR.

NO CLAIM IS MADE TO THE EXCLUSIVE RIGHT TO USE "ENTREPRENEURIAL PARTNERSHIPS" AND "CONFERENCE", APART FROM THE MARK AS SHOWN.

FOR BUSINESS CONFERENCES, SEMINARS AND TRADESHOWS ON THE SUBJECTS OF ENTREPRENEURSHIP, INNOVATION AND THE COMMERCIALIZATION OF NEW TECHNOLOGIES (U.S. CLS. 100, 101 AND 102).

HEATHER SAPP, EXAMINING ATTORNEY

SN 77-914,237. MCCART CHRISTIAN L, DBA NEVER A DULL MOMENT "NDM" CHARITY FOUNDATION, CARDIFF BY THE SEA, CA. FILED 1-18-2010.

**Never a Dull Moment "NDM"
Charity Foundation**

THE MARK CONSISTS OF STANDARD CHARACTERS WITHOUT CLAIM TO ANY PARTICULAR FONT, STYLE, SIZE, OR COLOR.

NO CLAIM IS MADE TO THE EXCLUSIVE RIGHT TO USE "CHARITY FOUNDATION", APART FROM THE MARK AS SHOWN.

FOR PROMOTING THE CHARITABLE SERVICES OF OTHERS, NAMELY, PROVIDING INDIVIDUALS WITH INFORMATION FOR THE PURPOSE OF MAKING DONATIONS TO CHARITIES (U.S. CLS. 100, 101 AND 102).

RONALD MCMORROW, EXAMINING ATTORNEY

SN 77-914,491. DP PROFESSIONALS, INC., COLUMBIA, SC. FILED 1-19-2010.

ideal fIT.

OWNER OF U.S. REG. NO. 3,610,847.

THE COLOR(S) RED IS/ARE CLAIMED AS A FEATURE OF THE MARK.

THE MARK CONSISTS OF THE WORDS "IDEAL" AND "FIT." WITH "FIT" STYLIZED WITH RED AND CAPITALIZED LETTERS "I" AND "T". THE COLOR BLACK REPRESENTS BACKGROUND/OUTLINING/SHADING/TRANSPARENT AREAS AND IS NOT PART OF THE MARK.

FOR EMPLOYMENT HIRING, RECRUITING, PLACEMENT, STAFFING AND CAREER NETWORKING SERVICES (U.S. CLS. 100, 101 AND 102).

FIRST USE 10-28-2009; IN COMMERCE 1-12-2010.

AARON BRODSKY, EXAMINING ATTORNEY

CLASS 35—(Continued).

SN 77-915,002. BEISE PORK CHOPS, LLC, BUFFALO, MN. FILED 1-19-2010.

BOAR BITES

THE MARK CONSISTS OF STANDARD CHARACTERS WITHOUT CLAIM TO ANY PARTICULAR FONT, STYLE, SIZE, OR COLOR.

NO CLAIM IS MADE TO THE EXCLUSIVE RIGHT TO USE "BOAR", APART FROM THE MARK AS SHOWN.

FOR CONCESSION STANDS FEATURING PORK PRODUCTS AND BEVERAGES (U.S. CLS. 100, 101 AND 102). FIRST USE 8-8-2009; IN COMMERCE 8-8-2009.

ROBERT C. CLARK JR., EXAMINING ATTORNEY

SN 77-915,226. NASHVILLE AREA CHAMBER OF COMMERCE, NASHVILLE, TN. FILED 1-19-2010.



NO CLAIM IS MADE TO THE EXCLUSIVE RIGHT TO USE "NASHVILLE" AND "AREA CHAMBER OF COMMERCE", APART FROM THE MARK AS SHOWN.

THE MARK CONSISTS OF A STYLIZED LETTER "N" ON THE LEFT WITH A MUSIC NOTE IN THE MIDDLE OF THE LETTER "N" AND THE STYLIZED WORD "NASHVILLE" IN LARGER FONT ON THE RIGHT WITH THE WORDS "AREA CHAMBER OF COMMERCE" AND "BELONG ENGAGE LEAD PROSPER" IN SMALLER FONTS LOCATED ON TWO LINES BELOW THE WORD "NASHVILLE". THE WORD ENGAGE ALSO HAS A WAVY LINE BENEATH IT.

FOR CHAMBER OF COMMERCE SERVICES, NAMELY, PROMOTING BUSINESS AND TOURISM IN THE NASHVILLE AREA (U.S. CLS. 100, 101 AND 102).

FIRST USE 10-0-2007; IN COMMERCE 10-0-2007.

JEFF DEFORD, EXAMINING ATTORNEY

CLASS 35—(Continued).

SN 77-915,739. THE DAVID COREY COMPANY, FERNANDINA BEACH, FL. FILED 1-20-2010.



David Corey Company, Inc.

NO CLAIM IS MADE TO THE EXCLUSIVE RIGHT TO USE "THE UNIVERSAL ACCESSIBILITY WHEELCHAIR SYMBOL" AND "COMPANY, INC.", APART FROM THE MARK AS SHOWN.

THE NAME(S), PORTRAIT(S), AND/OR SIGNATURE(S) SHOWN IN THE MARK DOES NOT IDENTIFY A PARTICULAR LIVING INDIVIDUAL.

THE COLOR(S) BLUE, DARK BLUE AND BLACK IS/ARE CLAIMED AS A FEATURE OF THE MARK.

THE MARK CONSISTS OF A BLUE GLOBE WITH MERIDIANS AND PARALLELS CONTAINING A DARK BLUE OUTLINE OF A PERSON IN A WHEELCHAIR UNDER A DARK BLUE SEMI-CIRCLE ROOF WITH A CHIMNEY. UNDER THE GLOBE ARE THE STYLIZED WORDS "DAVID COREY COMPANY, INC." IN BLACK.

FOR ARRANGING OF CONTRACTUAL SERVICES WITH THIRD PARTIES; ARRANGING OF MANAGED CARE CONTRACTUAL SERVICES IN THE FIELDS OF DIAGNOSTIC IMAGING, HOME HEALTH CARE, DURABLE MEDICAL EQUIPMENT, SPECIALTY PHARMACY, AND DIAGNOSTIC LAB SERVICES; BUSINESS ADVISORY SERVICES IN THE FIELDS OF ARCHITECTURE, INTERIOR DESIGN AND URBAN PLANNING DESIGN; BUSINESS ADVISORY SERVICES, NAMELY, SEARCH FOR AND SELECTION OF THE BEST POTENTIAL SUPPLIERS FOR OTHERS; BUSINESS CONSULTATION SERVICES; BUSINESS INTERMEDIARY AND ADVISORY SERVICES IN THE FIELD OF SELLING PRODUCTS AND RENDERING SERVICES; BUSINESS MANAGEMENT AND CONSULTING SERVICES FOR THE HEALTH CARE INDUSTRY, NAMELY, PROVIDING INDUSTRY EXPERTISE AND SUPPLIER PARTNERSHIPS; COST ASSESSMENT SERVICES; FRANCHISE SERVICES, NAMELY, OFFERING BUSINESS MANAGEMENT ASSISTANCE IN THE ESTABLISHMENT AND OPERATION OF HOME HEALTH MODIFICATION FOR OTHERS, NAMELY, INSURANCE COMPANIES; HEALTH CARE UTILIZATION AND REVIEW SERVICES; MANAGEMENT AND BUSINESS CONSULTING SERVICES IN THE FIELD OF HOME HEALTH MODIFICATIONS FOR OTHERS, NAMELY, INSURANCE COMPANIES; PROCUREMENT, NAMELY, PURCHASING HOME HEALTH MODIFICATION EQUIPMENT FOR OTHERS; PROJECT MANAGEMENT SERVICES FOR OTHERS FOR BUSINESS PURPOSES IN THE FIELDS OF ARCHITECTURE, INTERIOR DESIGN, URBAN PLANNING DESIGN; SERVICES RENDERED BY A FRANCHISOR, NAMELY, ASSISTANCE IN THE RUNNING OR MANAGEMENT OF INDUSTRIAL OR COMMERCIAL ENTERPRISES (U.S. CLS. 100, 101 AND 102).

FIRST USE 2-1-2005; IN COMMERCE 2-1-2005.
ELLEN B. AWRICH, EXAMINING ATTORNEY

CLASS 35—(Continued).

SN 77-916,556. MID-WEST PRESORT MAILING SERVICES, INC., CLEVELAND, OH. FILED 1-21-2010.

POSTALRX

NO CLAIM IS MADE TO THE EXCLUSIVE RIGHT TO USE "POSTAL", APART FROM THE MARK AS SHOWN.

THE MARK CONSISTS OF THE WORD "POSTAL" IN ALL CAPITAL LETTERS, WITH THE TERMINAL POINTS OF THE LETTERS (WITH THE EXCEPTION OF THE LETTER "O") ENDING IN A SHORT LINE. THE LETTER "P" IS SLIGHTLY LARGER THAN THE REMAINING LETTERS. THE LETTERS "RX" FOLLOW "POSTAL" IN A LARGER TYPEFACE. THE LEFT LEG OF THE "R" IS BROKEN WHERE THE LOOP OF THE LETTER IS FOUND. THE RIGHT LEG OF THE "R" EXTENDS DOWNWARD AND TO THE RIGHT PAST THE PLANE OF THE LETTERS COMPROMISING THE REMAINDER OF THE MARK.

FOR DIRECT MAIL ADVERTISING; COOPERATIVE MARKETING SERVICES; DATA PROCESSING OF DIRECT MAIL AND MARKETING INFORMATION FOR OTHERS; MAIL SERVICES, NAMELY, MAIL SORTING AND HANDLING (U.S. CLS. 100, 101 AND 102).

FIRST USE 11-12-2009; IN COMMERCE 11-12-2009.
MYRIAH HABEEB, EXAMINING ATTORNEY

SN 77-917,238. VALORE PRINT, INC., GLENDORA, CA. FILED 1-21-2010.

GUMGRAM

THE MARK CONSISTS OF STANDARD CHARACTERS WITHOUT CLAIM TO ANY PARTICULAR FONT, STYLE, SIZE, OR COLOR.

FOR ADVERTISING AND ADVERTISEMENT SERVICES; ADVERTISING AND MARKETING SERVICES, NAMELY, PROMOTING THE GOODS AND SERVICES OF OTHERS; ADVERTISING AND PROMOTIONAL SERVICES; ADVERTISING PARTICULARLY SERVICES FOR THE PROMOTION OF GOODS; ADVERTISING SERVICES, NAMELY, PROMOTING THE BRANDS, GOODS AND SERVICES OF OTHERS (U.S. CLS. 100, 101 AND 102).

KELLY CHOE, EXAMINING ATTORNEY

CLASS 35—(Continued).

SN 77-917,320. PATRIOT COMMUNICATIONS LLC, LOS ANGELES, CA. FILED 1-21-2010.

USGS
U.S. GIFTCARD SALES

THE MARK CONSISTS OF STANDARD CHARACTERS WITHOUT CLAIM TO ANY PARTICULAR FONT, STYLE, SIZE, OR COLOR.

NO CLAIM IS MADE TO THE EXCLUSIVE RIGHT TO USE "U.S. GIFTCARD SALES", APART FROM THE MARK AS SHOWN.

FOR PROMOTING THE SALE OF GIFT CARDS THROUGH THE ADMINISTRATION OF INCENTIVE AWARD PROGRAMS; DEVELOPING PROMOTIONAL CAMPAIGNS FOR BUSINESSES; DEVELOPING CONTESTS AND INCENTIVE AWARD PROGRAMS TO PROMOTE THE SALE OF PRODUCTS AND SERVICES OF OTHERS; DEVELOPING PROMOTIONAL CAMPAIGNS FOR BUSINESSES VIA A GLOBAL COMPUTER NETWORK; AND PROMOTIONAL SERVICES, NAMELY, PROMOTING THE GOODS AND SERVICES OF OTHERS BY MEANS OF PROVIDING GIFT CARDS (U.S. CLS. 100, 101 AND 102).

AARON BRODSKY, EXAMINING ATTORNEY

CLASS 35—(Continued).

SN 77-917,774. NOCO ENERGY CORP., TONAWANDA, NY. FILED 1-22-2010.

NOCO FRIENDS & FAMILY CLUB

THE MARK CONSISTS OF STANDARD CHARACTERS WITHOUT CLAIM TO ANY PARTICULAR FONT, STYLE, SIZE, OR COLOR.

OWNER OF U.S. REG. NOS. 1,946,615 AND 2,076,827.

NO CLAIM IS MADE TO THE EXCLUSIVE RIGHT TO USE "CLUB", APART FROM THE MARK AS SHOWN.

FOR RETAIL STORE SERVICES FEATURING CONVENIENCE STORE ITEMS AND GASOLINE; PROVIDING INCENTIVE AWARD PROGRAMS FOR CUSTOMERS THROUGH THE DISTRIBUTION OF STORE VALUE CARD FOR THE PURPOSE OF PROMOTING AND REWARDING CUSTOMER LOYALTY (U.S. CLS. 100, 101 AND 102).

FIRST USE 6-1-2009; IN COMMERCE 6-1-2009.

JANET LEE, EXAMINING ATTORNEY

SN 77-918,394. IGN ENTERTAINMENT, INC., BRISBANE, CA. FILED 1-22-2010.

SN 77-917,747. FOOD PLUS AMERICA, LLC, CHICAGO, IL. FILED 1-22-2010.

SUPER MAS MARKET



THE MARK CONSISTS OF THE LETTERS "IGN" TO THE RIGHT OF A DESIGN WHICH CONSISTS OF A FOUR-POINTED STAR OVER A CIRCLE.

FOR ADVERTISING, PROMOTION AND MARKETING SERVICES; DISSEMINATION OF ADVERTISING FOR OTHERS VIA THE INTERNET; PROVIDING AND RENTAL OF ADVERTISING SPACE ON THE INTERNET; ON-LINE ADVERTISING AND MARKETING SERVICES; PROVIDING ONLINE CONSUMER PRODUCT INFORMATION REGARDING COMPUTER GAMES AND VIDEO GAMES MANUFACTURED BY OTHERS (U.S. CLS. 100, 101 AND 102).

FIRST USE 12-8-2009; IN COMMERCE 12-8-2009.

LEIGH LOWRY, EXAMINING ATTORNEY

THE MARK CONSISTS OF STANDARD CHARACTERS WITHOUT CLAIM TO ANY PARTICULAR FONT, STYLE, SIZE, OR COLOR.

NO CLAIM IS MADE TO THE EXCLUSIVE RIGHT TO USE "MARKET", APART FROM THE MARK AS SHOWN.

THE ENGLISH TRANSLATION OF THE WORD "MAS" IN THE MARK IS "MORE".

FOR RETAIL GROCERY STORES (U.S. CLS. 100, 101 AND 102).

MARLENE BELL, EXAMINING ATTORNEY

CLASS 35—(Continued).

SN 77-918,521. SILVERSKY GROUP, LLC, RENO, NV. FILED 1-22-2010.

SILVERSKY GROUP

THE MARK CONSISTS OF STANDARD CHARACTERS WITHOUT CLAIM TO ANY PARTICULAR FONT, STYLE, SIZE, OR COLOR.

NO CLAIM IS MADE TO THE EXCLUSIVE RIGHT TO USE "GROUP", APART FROM THE MARK AS SHOWN.

FOR BUSINESS CONSULTING SERVICES RELATED TO MANAGING INTELLECTUAL PROPERTY AND BUSINESS OPERATIONS RELATED TO INTELLECTUAL PROPERTY, NAMELY, BUSINESS CONSULTING IN THE DEVELOPMENT, MANAGEMENT AND MARKETING OF INTELLECTUAL PROPERTY FOR BUSINESS (U.S. CLS. 100, 101 AND 102).

FIRST USE 4-9-2007; IN COMMERCE 5-29-2007.

WILLIAM ROSSMAN, EXAMINING ATTORNEY

CLASS 35—(Continued).

SN 77-920,381. POLYMER MENSCHEN, INC., RENO, NV. FILED 1-26-2010.

POLUMAIRE MENSCHEN

THE MARK CONSISTS OF STANDARD CHARACTERS WITHOUT CLAIM TO ANY PARTICULAR FONT, STYLE, SIZE, OR COLOR.

THE ENGLISH TRANSLATION OF THE WORD "MENSCHEN" IN THE MARK IS "PEOPLE".

THE WORDING "POLUMAIRE" HAS NO MEANING IN A FOREIGN LANGUAGE.

FOR EMPLOYMENT AGENCY SERVICES, NAMELY, EXECUTIVE SEARCH AND RECRUITING SERVICES (U.S. CLS. 100, 101 AND 102).

FIRST USE 10-29-2008; IN COMMERCE 10-29-2008.

MICHAEL GAAFAR, EXAMINING ATTORNEY

SN 77-919,038. THE BOSTON CONSULTING GROUP, INC., BOSTON, MA. FILED 1-25-2010.

IT ADVANTAGE

THE MARK CONSISTS OF STANDARD CHARACTERS WITHOUT CLAIM TO ANY PARTICULAR FONT, STYLE, SIZE, OR COLOR.

NO CLAIM IS MADE TO THE EXCLUSIVE RIGHT TO USE "IT", APART FROM THE MARK AS SHOWN.

FOR PROVIDING BUSINESS MANAGEMENT CONSULTING SERVICES; ADVISING BUSINESSES IN STRATEGIC MANAGEMENT AND DEVELOPMENT OF OVERALL CORPORATE STRATEGY AND BUSINESS INITIATIVES; CORPORATE MANAGEMENT CONSULTING SERVICES TO ASSIST EXECUTIVES IN BUSINESS DECISION MAKING; ADVISING BUSINESSES THROUGH THE USE OF CONSULTING TOOLS AND TECHNIQUES THAT ENABLE STRATEGIC BUSINESS DECISION MAKING; PROVIDING BUSINESS PROJECT MANAGEMENT CONSULTING SERVICES, NAMELY, PREDICTING PROJECT OUTCOMES AND MODIFYING PROJECT IMPLEMENTATION TO INCREASE LIKELIHOOD OF SUCCESS IN BUSINESS TRANSFORMATION PROJECTS (U.S. CLS. 100, 101 AND 102).

FIRST USE 2-0-2009; IN COMMERCE 2-0-2009.

JOHN WILKE, EXAMINING ATTORNEY

SN 77-920,595. THE RENT NET, LLC, CARSON CITY, NV. FILED 1-26-2010.

RENTAL COMP

THE MARK CONSISTS OF STANDARD CHARACTERS WITHOUT CLAIM TO ANY PARTICULAR FONT, STYLE, SIZE, OR COLOR.

NO CLAIM IS MADE TO THE EXCLUSIVE RIGHT TO USE "RENTAL", APART FROM THE MARK AS SHOWN.

FOR PROVIDING AN ONLINE RENTAL MARKETPLACE WHERE VENDORS CAN DISPLAY THEIR RENTAL INVENTORY ITEMS IN A STANDARD FORMATION, ALLOWING PROSPECTIVE RENTERS TO COMPARE SPECIFIC RENTAL ITEMS SIDE-BY-SIDE, AND RENT THE ITEMS (U.S. CLS. 100, 101 AND 102).

FIRST USE 2-1-2009; IN COMMERCE 2-1-2009.

SUNG IN, EXAMINING ATTORNEY

CLASS 35—(Continued).

SN 77-920,631. KASHOLA, DONNA, CAMARILLO, CA. FILED 1-26-2010.



NO CLAIM IS MADE TO THE EXCLUSIVE RIGHT TO USE TEA, APART FROM THE MARK AS SHOWN.

THE COLOR(S) GREEN AND BLACK IS/ARE CLAIMED AS A FEATURE OF THE MARK.

THE MARK CONSISTS OF THE WORDING "ALL THINGS TEA" IN THE COLOR BLACK IN ALL CAPITAL LETTERS WITH THE TWO LEAVES AND A DOT IN THE MIDDLE IN THE COLOR SAGE GREEN. THE WORD "ALL" IS IN CAPITAL LETTERS CENTERED ABOVE THE WORDS "THINGS" AND "TEA". THE WORD "THINGS" IS IN CAPITAL LETTERS CENTERED BETWEEN THE WORDS "ALL" AND "TEA". THE WORD "TEA" IS BELOW THE WORD "THINGS" AND IS IN A LARGER FONT STYLE.

FOR RETAIL STORES FEATURING SPECIALTY TEAS FROM THE FINEST TEA PLANTATIONS, GARDENS AND ESTATES AROUND THE WORLD WHICH ALSO FEATURE ELEGANT AND PRACTICAL ACCOUTREMENTS TO MAKE PREPARING AND DRINKING TEA A SPECIAL EXPERIENCE (U.S. CLS. 100, 101 AND 102).

FIRST USE 8-1-2007; IN COMMERCE 8-1-2007.
CAROL SPILS, EXAMINING ATTORNEY

SN 77-921,008. MISOCIO, INC., MIRAMAR, FL. FILED 1-27-2010.

miSocio

THE MARK CONSISTS OF STANDARD CHARACTERS WITHOUT CLAIM TO ANY PARTICULAR FONT, STYLE, SIZE, OR COLOR.

FOR PROVIDING AN ONLINE DIRECTORY INFORMATION SERVICE FEATURING INFORMATION REGARDING CLASSIFIED ADVERTISEMENTS, SOCIAL NETWORKING, PHOTO SHARING, AND TRANSMISSION OF PHOTOGRAPHIC IMAGES; ADVERTISING AND INFORMATION DISTRIBUTION SERVICES, NAMELY, PROVIDING CLASSIFIED ADVERTISING SPACE VIA THE GLOBAL COMPUTER NETWORK; PROMOTING THE GOODS AND SERVICES OF OTHERS BY MEANS OF DISTRIBUTING ADVERTISING OVER THE INTERNET; PROVIDING ON-LINE COMPUTER DATABASES AND ON-LINE SEARCHABLE DATABASES IN THE FIELD OF CLASSIFIED ADVERTISEMENTS (U.S. CLS. 100, 101 AND 102).

KATHLEEN M. VANSTON, EXAMINING ATTORNEY

CLASS 35—(Continued).

SN 77-921,716. KIDLANDS, INC., MODESGO, CA. FILED 1-27-2010.

KIDLANDS

THE MARK CONSISTS OF STANDARD CHARACTERS WITHOUT CLAIM TO ANY PARTICULAR FONT, STYLE, SIZE, OR COLOR.

THE WORDING "KIDLANDS" HAS NO MEANING IN A FOREIGN LANGUAGE.

FOR RETAIL STORE SERVICES FEATURING FURNITURE (U.S. CLS. 100, 101 AND 102).

FIRST USE 12-31-1992; IN COMMERCE 12-31-1992.
MYRIAH HABEEB, EXAMINING ATTORNEY

SN 77-922,079. C&A INDUSTRIES, INC., OMAHA, NE. FILED 1-28-2010.

ROMANCE REGISTRY

THE MARK CONSISTS OF STANDARD CHARACTERS WITHOUT CLAIM TO ANY PARTICULAR FONT, STYLE, SIZE, OR COLOR.

NO CLAIM IS MADE TO THE EXCLUSIVE RIGHT TO USE "REGISTRY", APART FROM THE MARK AS SHOWN.

FOR TRAVEL REGISTRY SERVICES, NAMELY, A REGISTRY THAT ALLOWS BRIDAL SHOWER AND WEDDING GUESTS TO GIVE A MONETARY AMOUNT TOWARD THE PURCHASE OF A HONEYMOON PACKAGE (U.S. CLS. 100, 101 AND 102).

FIRST USE 11-30-2007; IN COMMERCE 11-30-2007.
DAWN FELDMAN, EXAMINING ATTORNEY

SN 77-922,119. PHOENIX INTANGIBLES HOLDING COMPANY, GREENVILLE, DE. FILED 1-28-2010.



OWNER OF U.S. REG. NOS. 2,814,781 AND 3,664,891.

THE COLOR(S) RED, GOLD, WHITE, BLACK, AND GREEN IS/ARE CLAIMED AS A FEATURE OF THE MARK.

THE MARK CONSISTS OF A ROUNDED, RECTANGULAR PORTION WITH A GREEN BACKGROUND WITH THE WORD "FOODPERKS!" THEREIN IN WHITE AND

CLASS 35—(Continued).

INCLUDING A SMALLER, RED, ROUNDED RECTANGLE NEAR THE TOP OF THE LARGER RECTANGLE WITH THE TERM "GETGO" PRINTED THEREIN IN WHITE AND INCLUDING A GOLD ARROW HAVING A ROUNDED AND DASHED TRAIL STARTING AT THE FIRST "G" OF "GETGO" AND MAKING AN ARC SHAPE WITH THE TIP OF THE ARROW BEING PROVIDED AFTER THE "T" AND INCLUDING A SECOND GOLD ARROW HAVING A ROUNDED AND DASHED TRAIL ARCING OVER THE SECOND "G" OF "GETGO".

FOR RETAIL SUPERMARKET SERVICES; RETAIL CONVENIENCE STORE SERVICES FEATURING FUEL; AND PROMOTING FUEL SALES BY OFFERING DISCOUNTS ON THE PURCHASES OF GOODS AND SERVICES OF OTHERS TO PURCHASERS OF FUEL (U.S. CLS. 100, 101 AND 102).

JANICE L. MCMORROW, EXAMINING ATTORNEY

CLASS 35—(Continued).

SN 77-922,604. THE MODERN WHIG PARTY, WASHINGTON, DC. FILED 1-28-2010.



THE COLOR(S) RED, WHITE AND BLUE IS/ARE CLAIMED AS A FEATURE OF THE MARK.

THE MARK CONSISTS OF AN OWL SITTING ON A BRANCH, THE TOP HALF OF THE OWL BEING BLUE, THE BOTTOM HALF OF THE OWL AND THE BRANCH BEING RED, AND THERE BEING A WHITE LINE DIVIDING THE BLUE AND RED, WITH FOUR WHITE STARS ABOVE THE LINE.

FOR POLITICAL PARTY SERVICES, NAMELY, PROMOTING THE INTERESTS OF A POLITICAL ORGANIZATION (U.S. CLS. 100, 101 AND 102).

FIRST USE 9-30-2008; IN COMMERCE 9-30-2008.

KAREN K. BUSH, EXAMINING ATTORNEY

SN 77-922,593. BITTER END TRADING LLC., ELKINS, NH. FILED 1-28-2010.



SN 77-922,664. EDIBLE ARRANGEMENTS, LLC, WALLINGFORD, CT. FILED 1-28-2010.

RANDOM ACTS OF HAPPINESS

NO CLAIM IS MADE TO THE EXCLUSIVE RIGHT TO USE "TRADING," "INVESTMENT RECOVERY," "VALVES," "INSTRUMENTATION," AND "ELECTRICAL", APART FROM THE MARK AS SHOWN.

THE COLOR(S) BLUE AND WHITE IS/ARE CLAIMED AS A FEATURE OF THE MARK.

THE MARK CONSISTS OF TWO ANCHORS IN BLUE ON EITHER SIDE OF TEXT, WITH THE TEXT IN BLUE STATING: "BITTER END TRADING, INVESTMENT RECOVERY, VALVES, INSTRUMENTATION, ELECTRICAL" AGAINST A WHITE BACKGROUND.

FOR ONLINE RETAIL STORE SERVICES IN THE FIELD OF VALVES, INSTRUMENTATION, AND OTHER FACTORY EQUIPMENT (U.S. CLS. 100, 101 AND 102).

FIRST USE 1-1-2009; IN COMMERCE 1-1-2009.

PAUL E. FAHRENKOPF, EXAMINING ATTORNEY

THE MARK CONSISTS OF STANDARD CHARACTERS WITHOUT CLAIM TO ANY PARTICULAR FONT, STYLE, SIZE, OR COLOR.

FOR ON-LINE AND RETAIL STORE SERVICES IN THE FIELD OF FRESH FRUIT, NAMELY, FRUIT-BASED BEVERAGES, SMOOTHIES, YOGURT, FRUIT-BASED SALADS, FRUIT PIECES, SAUCES CONTAINING CUT FRESH FRUIT, FRUIT ARRANGED IN CONTAINERS AS FLORAL DESIGNS, FRUIT PIECES COVERED IN EDIBLE COATINGS, AND FRUIT AT LEAST PARTIALLY COVERED IN EDIBLE COATINGS AND ARRANGED IN CONTAINERS AS FLORAL DESIGNS (U.S. CLS. 100, 101 AND 102).

FIRST USE 1-13-2010; IN COMMERCE 1-13-2010.

JENNIFER DIXON, EXAMINING ATTORNEY

CLASS 35—(Continued).

SN 77-922,803. SOUTHERN BULLION TRADING, LLC, DALLAS, TX. FILED 1-28-2010.



NO CLAIM IS MADE TO THE EXCLUSIVE RIGHT TO USE "SOUTHERN BULLION TRADING", APART FROM THE MARK AS SHOWN.

THE MARK CONSISTS OF THE WORDS "SOUTHERN BULLION TRADING" NEXT TO A CHARGING BULL WITH THE "S" IN "SOUTHERN" BEING FORMED BY THE TAIL OF THE BULL.

FOR DEALERSHIPS IN THE FIELD OF GOLD, SILVER AND PRECIOUS METALS (U.S. CLS. 100, 101 AND 102).

FIRST USE 12-1-2009; IN COMMERCE 12-1-2009.
ANDREA K. NADELMAN, EXAMINING ATTORNEY

SN 77-922,847. SOUTHERN BULLION TRADING, LLC, DALLAS, TX. FILED 1-28-2010.



NO CLAIM IS MADE TO THE EXCLUSIVE RIGHT TO USE "SOUTHERN BULLION COIN & JEWELRY", APART FROM THE MARK AS SHOWN.

THE MARK CONSISTS OF THE WORDS "SOUTHERN BULLION COIN & JEWELRY" NEXT TO A CHARGING BULL WITH THE "S" IN "SOUTHERN" BEING FORMED BY THE TAIL OF THE BULL.

FOR DEALERSHIPS IN THE FIELD OF GOLD, SILVER AND PRECIOUS METALS (U.S. CLS. 100, 101 AND 102).

FIRST USE 12-1-2009; IN COMMERCE 12-1-2009.
ANDREA K. NADELMAN, EXAMINING ATTORNEY

CLASS 35—(Continued).

SN 77-922,984. TRIFACET, LLC, FENTON, MO. FILED 1-28-2010.



NO CLAIM IS MADE TO THE EXCLUSIVE RIGHT TO USE "CONVERSATIONS", APART FROM THE MARK AS SHOWN.

THE MARK CONSISTS OF A SYMBOL OF THREE PEOPLE AND THE STYLIZED TEXT "TRIFACET CONVERSATIONS WITH A PURPOSE".

FOR SOCIAL MEDIA STRATEGY AND MARKETING CONSULTING FOCUSING ON HELPING CLIENTS CREATE AND EXTEND THEIR PRODUCT AND BRAND STRATEGIES THROUGH THE USE OF SOCIAL MEDIA TO DRIVE CONSUMER INTEREST, ENGAGEMENT AND ACTION (U.S. CLS. 100, 101 AND 102).

FIRST USE 1-19-2010; IN COMMERCE 1-19-2010.
ELIZABETH HUGHITT, EXAMINING ATTORNEY

SN 77-923,192. COMPASSION ASSOCIATES, LLC, DBA COMPASSIONASSOCIATES.ORG, WESTAPTON, NJ. FILED 1-29-2010.

PEOPLE HELPING PEOPLE FEEL
BETTER

THE MARK CONSISTS OF STANDARD CHARACTERS WITHOUT CLAIM TO ANY PARTICULAR FONT, STYLE, SIZE, OR COLOR.

FOR BUSINESS CONSULTING AND MANAGEMENT IN THE FIELD OF CLINICAL TRIALS, NAMELY, CLINICAL DATA AND REGULATORY SUBMISSION MANAGEMENT ON BEHALF OF MEDICAL, BIOPHARMACEUTICAL AND BIOTECHNOLOGY COMPANIES TO ASSIST THEM WITH CLINICAL RESEARCH, CLINICAL TRIALS AND APPLICATIONS FOR DRUG APPROVAL; PROVIDING TECHNICAL CONSULTING SERVICES AND INFORMATION MANAGEMENT SERVICES, NAMELY, CLINICAL DATA AND REGULATORY SUBMISSION MANAGEMENT TO MEDICAL, BIOPHARMACEUTICAL AND BIOTECHNOLOGY COMPANIES TO ASSIST THEM WITH CLINICAL RESEARCH, CLINICAL TRIALS AND APPLICATIONS FOR DRUG APPROVAL; RECRUITMENT ADVERTISEMENT SERVICES, NAMELY, POSTING OF CLINICAL TRIAL NOTICES FOR THE PURPOSE OF RECRUITING PATIENTS FOR PARTICIPATION IN CLINICAL TRIALS FOR THE TESTING OF DRUGS; REGULATORY SUBMISSION MANAGEMENT, NAMELY, ASSISTING OTHERS IN PREPARING AND FILING APPLICATIONS FOR NEW DRUGS WITH GOVERNMENTAL REGULATORY BODIES; RETAIL DRUG STORE SERVICES; RETAIL DRUG STORES; SUPPLYING PRESCRIPTION DRUGS TO HEALTH PLAN PARTICIPANTS FOR THE FUNDING ORGANIZATIONS (U.S. CLS. 100, 101 AND 102).

JIM RINGLE, EXAMINING ATTORNEY

CLASS 35—(Continued).

SN 77-923,260. DUTCH VALLEY FOOD DISTRIBUTORS INC., MYERSTOWN, PA. FILED 1-29-2010.

Dutch Valley Foods

THE MARK CONSISTS OF STANDARD CHARACTERS WITHOUT CLAIM TO ANY PARTICULAR FONT, STYLE, SIZE, OR COLOR.

OWNER OF U.S. REG. NO. 2,993,861.

NO CLAIM IS MADE TO THE EXCLUSIVE RIGHT TO USE "FOODS", APART FROM THE MARK AS SHOWN.

FOR WHOLESALE FOOD DISTRIBUTORSHIP SERVICES (U.S. CLS. 100, 101 AND 102).

FIRST USE 1-31-2000; IN COMMERCE 5-8-2001.

GILBERT SWIFT, EXAMINING ATTORNEY

SN 77-923,360. NAM BRANDS, INC, ENGLEWOOD, NJ. FILED 1-29-2010.

CANSHOP

THE MARK CONSISTS OF STANDARD CHARACTERS WITHOUT CLAIM TO ANY PARTICULAR FONT, STYLE, SIZE, OR COLOR.

FOR WHOLESALE AND RETAIL STORE SERVICES AND ON-LINE RETAIL AND WHOLESALE STORE SERVICES FEATURING MEN'S AND WOMAN'S APPAREL AND FASHION ACCESSORIES (U.S. CLS. 100, 101 AND 102).

FIRST USE 11-5-2009; IN COMMERCE 1-10-2010.

LYDIA BELZER, EXAMINING ATTORNEY

SN 77-923,498. INTERSTREAM, WEST HOLLYWOOD, CA. FILED 1-29-2010.

InterStream

THE MARK CONSISTS OF STANDARD CHARACTERS WITHOUT CLAIM TO ANY PARTICULAR FONT, STYLE, SIZE, OR COLOR.

FOR ASSOCIATION SERVICES, NAMELY, PROMOTING THE PUBLIC INTEREST AND AWARENESS IN PREMIUM BROADBAND DELIVERY AND ENHANCED INTERNET SERVICES (U.S. CLS. 100, 101 AND 102).

FIRST USE 9-0-2002; IN COMMERCE 9-0-2002.

AMEEN IMAM, EXAMINING ATTORNEY

CLASS 35—(Continued).

SN 77-923,810. PUSHKART, LLC, BROOKLYN, NY. FILED 1-29-2010.

PUSHKART

THE MARK CONSISTS OF STANDARD CHARACTERS WITHOUT CLAIM TO ANY PARTICULAR FONT, STYLE, SIZE, OR COLOR.

FOR MARKETING COMMUNICATIONS AND MARKETING CAMPAIGNS; BUSINESS SERVICES, NAMELY, PROVIDING CUSTOMERS WITH INCENTIVES AS PART OF MARKETING STRATEGIES BY MEANS OF COMPUTER; AND DISSEMINATING ADVERTISING MATTER THROUGH A COMPUTER SOCIAL NETWORK (U.S. CLS. 100, 101 AND 102).

KELLY TRUSILO, EXAMINING ATTORNEY

SN 77-923,814. MIDWEST EMERGENCY DEPARTMENT SERVICES, INC., O'FALLON, IL. FILED 1-29-2010.

Meds

OWNER OF U.S. REG. NO. 3,068,092.

THE MARK CONSISTS OF THE LETTERS "MEDS" WITH AN ELECTROCARDIOGRAPHIC TRACING EXTENDING HORIZONTALLY THROUGH THE MIDDLE OF THE LETTERS.

FOR MANAGEMENT OF HEALTH CARE PROFESSIONAL PRACTICES (U.S. CLS. 100, 101 AND 102).

FIRST USE 11-0-2009; IN COMMERCE 11-0-2009.

VERNA BETH RIRIE, EXAMINING ATTORNEY

CLASS 35—(Continued).

SN 77-923,836. PUSHKART, LLC, BROOKLYN, NY. FILED 1-29-2010.



THE MARK CONSISTS OF A STYLIZED SHOPPING CART HOLDING A FAN SYMBOL.

FOR MARKETING COMMUNICATIONS AND MARKETING CAMPAIGNS; BUSINESS SERVICES, NAMELY, PROVIDING CUSTOMERS WITH INCENTIVES AS PART OF MARKETING STRATEGIES BY MEANS OF COMPUTER; AND DISSEMINATING ADVERTISING MATTER THROUGH A COMPUTER SOCIAL NETWORK (U.S. CLS. 100, 101 AND 102).

KELLY TRUSILO, EXAMINING ATTORNEY

CLASS 35—(Continued).

SN 77-923,860. MANCUSO, LINDA ANN, DBA THE VILLAGES HAPPENINGS, THE VILLAGES, FL. AND MANCUSO, RONALD WAYNE, DBA THE VILLAGES HAPPENINGS, THE VILLAGES, FL. FILED 1-29-2010.



NO CLAIM IS MADE TO THE EXCLUSIVE RIGHT TO USE "THE VILLAGES HAPPENINGS", APART FROM THE MARK AS SHOWN.

THE MARK CONSISTS OF A COUPLE DANCING WITH A STYLIZED CAPITAL LETTER "V" SUPERIMPOSED OVER THE COUPLE. THE WORDING "THE VILLAGES HAPPENINGS" APPEARS IN CURSIVE BELOW THE DESIGN ELEMENT.

FOR ADVERTISING AND DIRECTORY SERVICES, NAMELY, PROMOTING THE SERVICES OF OTHERS BY PROVIDING A WEB PAGE FEATURING LINKS TO THE WEBSITES OF OTHERS; PROMOTING THE GOODS AND SERVICES OF OTHERS BY PROVIDING A WEBSITE FEATURING COUPONS, REBATES, PRICE-COMPARISON INFORMATION, PRODUCT REVIEWS, LINKS TO THE RETAIL WEBSITES OF OTHERS, AND DISCOUNT INFORMATION (U.S. CLS. 100, 101 AND 102).

FIRST USE 6-1-2008; IN COMMERCE 11-30-2009.

SETH A. RAPPAPORT, EXAMINING ATTORNEY

SN 77-924,236. PETRO RADO, MARYJANE, HARTFORD, CT. FILED 1-30-2010.

JUST ONE MORE LAST JUST WAR

THE MARK CONSISTS OF STANDARD CHARACTERS WITHOUT CLAIM TO ANY PARTICULAR FONT, STYLE, SIZE, OR COLOR.

FOR PROMOTING COMMERCIAL, TRADE, AND OTHER BUSINESS RELATIONSHIPS BETWEEN MEXICO AND THE UNITED STATES AND/OR CANADA AND THE UNITED STATES AND DEVELOPING AND DISSEMINATING PROMOTIONAL INFORMATION CONCERNING COMMERCIAL, TRADE, AND OTHER BUSINESS RELATIONSHIPS BETWEEN SUCH COUNTRIES AS WELL AS PROVIDING THE PUBLIC RELATIONS AND MARKETING SERVICES FOR SUCH, NAMELY, CONDUCTING MARKETING STUDIES AND THE RESEARCH AND DEVELOPMENT OF NEW MARKETING SYSTEMS AND CAMPAIGNS, NAMELY, THROUGH LIVE PRESENTATIONS AND PRINTED AND FILMED MATERIALS, NAMELY, BROCHURES, CHARTS, PHOTOGRAPHS, AND VIDEOS (U.S. CLS. 100, 101 AND 102).

FIRST USE 9-2-1999; IN COMMERCE 4-17-2001.

WILLIAM P. SHANAHAN, EXAMINING ATTORNEY

SN 77-923,849. CUSTOM NEWSLETTERS, INC., EXTON, PA. FILED 1-29-2010.

THE NEWSLETTER GURU

THE MARK CONSISTS OF STANDARD CHARACTERS WITHOUT CLAIM TO ANY PARTICULAR FONT, STYLE, SIZE, OR COLOR.

NO CLAIM IS MADE TO THE EXCLUSIVE RIGHT TO USE "NEWSLETTER", APART FROM THE MARK AS SHOWN.

FOR BUSINESS MARKETING AND DIRECT MAIL CONSULTING SERVICES (U.S. CLS. 100, 101 AND 102).

FIRST USE 8-17-2006; IN COMMERCE 8-17-2006.

CHARLES L. JENKINS, EXAMINING ATTORNEY

CLASS 35—(Continued).

SN 77-924,270. BIDFIRE, INC., SAN FRANCISCO, CA. FILED 1-30-2010.

BIDFIRE

THE MARK CONSISTS OF STANDARD CHARACTERS WITHOUT CLAIM TO ANY PARTICULAR FONT, STYLE, SIZE, OR COLOR.

FOR ON-LINE AUCTION SERVICES (U.S. CLS. 100, 101 AND 102).
FIRST USE 7-20-2009; IN COMMERCE 7-20-2009.
BRENDAN REGAN, EXAMINING ATTORNEY

CLASS 35—(Continued).

SN 77-924,419. MEDIRESOURCE INC., TORONTO, ONTARIO, CANADA, FILED 1-31-2010.

MEDIRESOURCE

THE MARK CONSISTS OF STANDARD CHARACTERS WITHOUT CLAIM TO ANY PARTICULAR FONT, STYLE, SIZE, OR COLOR.

FOR PROVIDING ONLINE HEALTH NETWORKING, NAMELY, MEDICAL REFERRALS FOR MULTIPLE DISEASES; PROVIDING ONLINE CONSUMER INFORMATION IN THE FIELD OF PHARMACEUTICAL, MEDICAL AND HEALTH PRODUCTS (U.S. CLS. 100, 101 AND 102).

FIRST USE 11-30-1999; IN COMMERCE 11-30-1999.
WILLIAM P. SHANAHAN, EXAMINING ATTORNEY

SN 77-924,275. MCGUIRE, MAXWELL F., PORTLAND, OR. FILED 1-30-2010.

MaxCPA

THE MARK CONSISTS OF STANDARD CHARACTERS WITHOUT CLAIM TO ANY PARTICULAR FONT, STYLE, SIZE, OR COLOR.

FOR BUSINESS ADMINISTRATION AND MANAGEMENT; BOOKKEEPING SERVICES; ACCOUNTING SERVICES; ACCOUNT AND BUSINESS AUDITING SERVICES; TAX PREPARATION; TAX COMPLIANCE AND CONSULTATION SERVICES; TAX ADVISORY SERVICES REGARDING TAX NEWS, TAX POLICY, AND TAX INFORMATION; BUSINESS MANAGEMENT CONSULTING SERVICES; BUSINESS MANAGEMENT CONSULTING SERVICES FOR GOVERNMENT AGENCIES (U.S. CLS. 100, 101 AND 102).

KIM MONINGHOFF, EXAMINING ATTORNEY

SN 77-924,595. DAS CHEAP, INC., ROWLAND HEIGHTS, CA. FILED 2-1-2010.

DASCHEAP

SN 77-924,276. CANTER, NEIL, WESTON, CT. FILED 1-30-2010.

NeoAnalytics

THE MARK CONSISTS OF STANDARD CHARACTERS WITHOUT CLAIM TO ANY PARTICULAR FONT, STYLE, SIZE, OR COLOR.

FOR ANALYSIS OF MARKET RESEARCH DATA AND STATISTICS; MARKETING ANALYSIS SERVICES; MODELING FOR ADVERTISING OR SALES PROMOTION; MODELING SERVICES FOR ADVERTISING OR SALES PROMOTION; STATISTICAL EVALUATIONS OF MARKETING DATA (U.S. CLS. 100, 101 AND 102).

FIRST USE 1-26-2010; IN COMMERCE 1-26-2010.
BRENDAN REGAN, EXAMINING ATTORNEY

THE MARK CONSISTS OF STANDARD CHARACTERS WITHOUT CLAIM TO ANY PARTICULAR FONT, STYLE, SIZE, OR COLOR.

FOR ONLINE RETAIL STORE SERVICES FEATURING GENERAL MERCHANDISE (U.S. CLS. 100, 101 AND 102).

KATHLEEN LORENZO, EXAMINING ATTORNEY

CLASS 35—(Continued).

SN 77-924,643. XL ASSOCIATES, INC., MCLEAN, VA. FILED 2-1-2010.



FOR BUSINESS MANAGEMENT CONSULTING AND ADVISORY SERVICES; MANAGEMENT AND BUSINESS CONSULTING SERVICES IN THE FIELD OF ACQUISITION MANAGEMENT AND GRANTS MANAGEMENT; PROFESSIONAL BUSINESS CONSULTING; PROFESSIONAL STAFFING AND RECRUITING SERVICES; PROVIDING AN EMPLOYER WITH CANDIDATES OR POTENTIAL EMPLOYEES TO FILL TEMPORARY, CONTRACT AND PERMANENT POSITIONS (U.S. CLS. 100, 101 AND 102).

FIRST USE 11-1-2009; IN COMMERCE 11-1-2009.
TAMARA FRAZIER, EXAMINING ATTORNEY

SN 77-924,780. ORLANDO AMATEUR RADIO CLUB, APOKA, FL. FILED 2-1-2010.

HamCation

THE MARK CONSISTS OF STANDARD CHARACTERS WITHOUT CLAIM TO ANY PARTICULAR FONT, STYLE, SIZE, OR COLOR.

FOR ARRANGING AND CONDUCTING TRADE SHOW EXHIBITIONS IN THE FIELD OF RADIOS AND COMPUTERS (U.S. CLS. 100, 101 AND 102).

FIRST USE 8-0-1973; IN COMMERCE 8-0-1973.
DOMINIC J. FERRAIUOLO, EXAMINING ATTORNEY

CLASS 35—(Continued).

SN 77-924,840. FLOK LLC, NEW YORK, NY. FILED 2-1-2010.

SUPER.SIMPLE.

THE MARK CONSISTS OF STANDARD CHARACTERS WITHOUT CLAIM TO ANY PARTICULAR FONT, STYLE, SIZE, OR COLOR.

FOR RETAIL STORE SERVICES IN THE FIELD OF OFFICE PRODUCTS, FURNISHINGS, GENERAL CONSUMER MERCHANDISE, FOOD AND ONLINE RETAIL STORE SERVICES IN THE FIELD OF OFFICE PRODUCTS, FURNISHINGS, GENERAL CONSUMER MERCHANDISE, FOOD (U.S. CLS. 100, 101 AND 102).

TRACY CROSS, EXAMINING ATTORNEY

SN 77-924,877. ANGELA & MIKE'S TRI SHOP, LLC, BALTIMORE, MD. FILED 2-1-2010.

TRI-SPEED MULTISPORT

THE MARK CONSISTS OF STANDARD CHARACTERS WITHOUT CLAIM TO ANY PARTICULAR FONT, STYLE, SIZE, OR COLOR.

NO CLAIM IS MADE TO THE EXCLUSIVE RIGHT TO USE "MULTISPORT", APART FROM THE MARK AS SHOWN.

FOR RETAIL STORE SERVICES FEATURING TRIATHLON, SWIMMING, CYCLING AND RUNNING EQUIPMENT (U.S. CLS. 100, 101 AND 102).

FIRST USE 1-4-1999; IN COMMERCE 1-4-1999.
DAVID YONTEF, EXAMINING ATTORNEY

SN 77-925,001. CRYSTAL ROCK LLC, WATERTOWN, CT. FILED 2-1-2010.

OWNER OF U.S. REG. NOS. 2,423,046, 2,450,626 AND 2,786,852.

NO CLAIM IS MADE TO THE EXCLUSIVE RIGHT TO USE "OFFICE", APART FROM THE MARK AS SHOWN.

THE MARK CONSISTS OF A DEPICTION OF MOUNTAINS ABOVE THE WORDS "CRYSTAL ROCK OFFICE".

FOR RETAIL STORE SERVICES FEATURING OFFICE SUPPLIES, JANITORIAL SUPPLIES, COMPUTERS, COMPUTER ACCESSORIES, FURNITURE AND OFFICE EQUIPMENT (U.S. CLS. 100, 101 AND 102).

TOBY BULLOFF, EXAMINING ATTORNEY

CLASS 35—(Continued).

SN 77-925,085. DRAPHIX, LLC, BIRMINGHAM, AL. FILED 2-1-2010.

CLASS 35—(Continued).

SN 77-925,399. BEVERLY FABRICS, INC., APTOS, CA. FILED 2-1-2010.

TEACHER DIRECT



THE MARK CONSISTS OF STANDARD CHARACTERS WITHOUT CLAIM TO ANY PARTICULAR FONT, STYLE, SIZE, OR COLOR.

SEC. 2(F).

FOR MAIL ORDER AND INTERNET CATALOGUE SERVICES FEATURING TEACHING AND EDUCATION SUPPLIES AND FURNITURE (U.S. CLS. 100, 101 AND 102).

FIRST USE 2-1-2005; IN COMMERCE 2-1-2005.
MARC LEIPZIG, EXAMINING ATTORNEY

THE MARK CONSISTS OF THE STYLIZED WORD, "BEVERLY'S".

FOR WHOLESALE AND RETAIL STORE SERVICES AND ON-LINE RETAIL AND WHOLESALE STORE SERVICES FEATURING FABRIC, TEXTILES, CRAFTS AND ACCESSORIES FOR THE FOREGOING (U.S. CLS. 100, 101 AND 102).

FIRST USE 1-26-1968; IN COMMERCE 1-26-1968.
HELENE LIWINSKI, EXAMINING ATTORNEY

SN 77-925,140. RAWLS, WADE SOLOMON, PHILADELPHIA, PA. FILED 2-1-2010.

SN 77-925,520. LIGHTSPEED CONSULTING, INC, DBA LIGHTSPEED TECHNOLOGY GROUP, CHAPEL HILL, NC. FILED 2-2-2010.

FALLEN SOLDIERS

Less Cycle. More Revenue.

THE MARK CONSISTS OF STANDARD CHARACTERS WITHOUT CLAIM TO ANY PARTICULAR FONT, STYLE, SIZE, OR COLOR.

FOR EMPLOYMENT AGENCY SERVICES, NAMELY, FILLING THE TEMPORARY AND PERMANENT STAFFING NEEDS OF BUSINESSES; EMPLOYMENT COUNSELING SERVICES AND LIFE SKILLS COUNSELING SERVICES FOR THE HOMELESS AND JOBLESS; PROVIDING EMPLOYMENT COUNSELING INFORMATION ON HOW TO SUCCESSFULLY TRANSITION JOBS FOR THE JOBLESS AND HOMELESS; PROVIDING EMPLOYMENT INFORMATION; TESTING TO DETERMINE EMPLOYMENT SKILLS; WORK ANALYSIS TO DETERMINE WORKER SKILL SETS AND OTHER WORKER REQUIREMENTS (U.S. CLS. 100, 101 AND 102).

BENJAMIN OKEKE, EXAMINING ATTORNEY

THE MARK CONSISTS OF STANDARD CHARACTERS WITHOUT CLAIM TO ANY PARTICULAR FONT, STYLE, SIZE, OR COLOR.

FOR MEDICAL BILLING SUPPORT SERVICES (U.S. CLS. 100, 101 AND 102).

MARGERLY A. TIERNEY, EXAMINING ATTORNEY

CLASS 35—(Continued).

SN 77-925,534. JUST MARKETING, INC., ZIONSVILLE, IN. FILED 2-2-2010.

JUST MARKETING

THE MARK CONSISTS OF STANDARD CHARACTERS WITHOUT CLAIM TO ANY PARTICULAR FONT, STYLE, SIZE, OR COLOR.

SEC. 2(F).

FOR ADVERTISING SERVICES, PUBLIC RELATIONS AND MARKETING SERVICES, NAMELY, PROMOTING AND MARKETING THE GOODS AND SERVICES OF OTHERS THROUGH ALL PUBLIC COMMUNICATION MEANS; COMMERCIAL ADMINISTRATION OF THE LICENSING OF THE GOODS AND SERVICES OF OTHERS; CORPORATE EVENT MANAGEMENT SERVICES; PROMOTING THE GOODS AND SERVICES OF OTHERS BY ARRANGING FOR SPONSORS TO AFFILIATE THEIR GOODS AND SERVICES WITH MOTORSPORTS COMPETITIONS; SERVICES WITH REGARD TO PRODUCT PRESENTATION TO THE PUBLIC (U.S. CLS. 100, 101 AND 102).

FIRST USE 2-3-1995; IN COMMERCE 2-3-1995.

MARGERY A. TIERNEY, EXAMINING ATTORNEY

SN 77-925,618. PLAYPEN, INC., GRAPEVINE, TX. FILED 2-2-2010.

Playpen

THE MARK CONSISTS OF STANDARD CHARACTERS WITHOUT CLAIM TO ANY PARTICULAR FONT, STYLE, SIZE, OR COLOR.

FOR THE BRINGING TOGETHER, FOR THE BENEFIT OF OTHERS, OF A VARIETY OF GOODS AND SERVICES, ENABLING CUSTOMERS TO CONVENIENTLY VIEW AND PURCHASE THOSE GOODS AND SERVICES FROM AN INTERNET WEB SITE PARTICULARLY SPECIALIZING IN THE MARKETING OF THE SALE OF GOODS AND SERVICES OF OTHERS (U.S. CLS. 100, 101 AND 102).

CORY BOONE, EXAMINING ATTORNEY

CLASS 35—(Continued).

SN 77-925,786. LANKA DUPONT, DBA UBER HOUSE LLC, SAG HARBOR, NY. FILED 2-2-2010.



THE MARK CONSISTS OF THE STYLIZED WORDING "UBER HOUSE" INSIDE THE DESIGN OF A RECTANGULAR SHAPE, HAVING EIGHT HEXAGON-SHAPED BOLTS AROUND THE PERIMETER OF THE RECTANGLE.

THE ENGLISH TRANSLATION OF THE WORD "UBER" IN THE MARK IS "SUPER."

FOR ART GALLERIES; ON-LINE ART GALLERIES; ON-LINE RETAIL STORE SERVICES FEATURING ART GALLERIES; ON-LINE ART GALLERIES; RETAIL STORE AND ON-LINE RETAIL STORE SERVICES FEATURING ART, CLOTHING AND HEALTH AND BEAUTY PRODUCTS; RETAIL CLOTHING BOUTIQUES; RETAIL CLOTHING STORES (U.S. CLS. 100, 101 AND 102).

FIRST USE 10-18-2007; IN COMMERCE 10-18-2007.

JAY BESCH, EXAMINING ATTORNEY

SN 77-925,796. MEGAWIRE MARKETING, LLC, VANCOUVER, WA. FILED 2-2-2010.

MegaWire Marketing

THE MARK CONSISTS OF STANDARD CHARACTERS WITHOUT CLAIM TO ANY PARTICULAR FONT, STYLE, SIZE, OR COLOR.

NO CLAIM IS MADE TO THE EXCLUSIVE RIGHT TO USE "MARKETING", APART FROM THE MARK AS SHOWN.

FOR BUSINESS MARKETING SERVICES (U.S. CLS. 100, 101 AND 102).

FIRST USE 1-26-2010; IN COMMERCE 1-26-2010.

CARRIE GENOVESE, EXAMINING ATTORNEY

SN 77-926,045. GIMELLI, JOSEPH, HOLLISTER, CA. AND GIMELLI, DEANNA, HOLLISTER, CA. FILED 2-2-2010.

ONE TWO ZERO

THE MARK CONSISTS OF STANDARD CHARACTERS WITHOUT CLAIM TO ANY PARTICULAR FONT, STYLE, SIZE, OR COLOR.

FOR ADVERTISING THROUGH ALL PUBLIC COMMUNICATION MEANS (U.S. CLS. 100, 101 AND 102).

KELLY BOULTON, EXAMINING ATTORNEY

CLASS 35—(Continued).

SN 77-926,289. HEAL THE WORLD FOUNDATION, FORMERLY MELISSA JOHNSON, INDIO, CA. FILED 2-2-2010.

MICHAEL'S ARMY

THE MARK CONSISTS OF STANDARD CHARACTERS WITHOUT CLAIM TO ANY PARTICULAR FONT, STYLE, SIZE, OR COLOR.

FOR ON-LINE RETAIL STORE SERVICES FEATURING MEN, WOMEN AND CHILDRENS CLOTHING ITEMS AND ACCESSORIES, PLUSH TOYS, BOOKS, BLANK JOURNALS AND PAPER PRODUCTS, COFFEE MUGS, HAND BAGS, VIDEO RECORDERS, MAGNETS AND SHIRT PINS.; ORGANIZING AND CONDUCTING CHARITY AUCTIONS FOR CHARITABLE FUND RAISING PURPOSES; PROMOTING PUBLIC AWARENESS OF THE NEED FOR CHARACTER DEVELOPMENT; PROMOTING THE CHARITABLE SERVICES OF OTHERS, NAMELY, PROVIDING INDIVIDUALS WITH INFORMATION FOR THE PURPOSE OF MAKING DONATIONS TO CHARITIES; PROMOTIONAL SERVICES, NAMELY, PROMOTING THE CHARITIES OF OTHERS (U.S. CLS. 100, 101 AND 102).

WARREN L. OLANDRIA, EXAMINING ATTORNEY

SN 77-926,365. SOOVOX INC., SAN DIEGO, CA. FILED 2-2-2010.

Social IQ

THE MARK CONSISTS OF STANDARD CHARACTERS WITHOUT CLAIM TO ANY PARTICULAR FONT, STYLE, SIZE, OR COLOR.

FOR ADVERTISING SERVICES; MARKET RESEARCH (U.S. CLS. 100, 101 AND 102).

DAWN FELDMAN, EXAMINING ATTORNEY

CLASS 35—(Continued).

SN 77-926,424. US UNLOCKED LLC, RIDGEWOOD, NJ. FILED 2-2-2010.

US Unlocked

THE MARK CONSISTS OF STANDARD CHARACTERS WITHOUT CLAIM TO ANY PARTICULAR FONT, STYLE, SIZE, OR COLOR.

NO CLAIM IS MADE TO THE EXCLUSIVE RIGHT TO USE "US", APART FROM THE MARK AS SHOWN.

FOR THE BRINGING TOGETHER, FOR THE BENEFIT OF OTHERS, OF A VARIETY OF GOODS AND SERVICES, ENABLING CUSTOMERS TO CONVENIENTLY VIEW THOSE GOODS FROM AN INTERNET WEBSITE PARTICULARLY SPECIALIZING IN THE MARKETING OF THE SALE OF GOODS AND SERVICES OF OTHERS AND PROVISION OF A WEBSITE FEATURING INFORMATION ON SHOPPING AND SHOPPING AS IT RELATES TO SHOPPING TO MAKE PURCHASES, ALL FEATURING BOOKS, MUSIC, VIDEOTAPES, AUDIOCASSETTES, COMPACT DISCS, BLANK FLOPPY DISCS AND CD-ROMS, PRINTED MATTERS, PHONOGRAPHS, RECORDED MUSIC, TOYS, HOUSEHOLD ELECTRONIC APPLIANCES, APPLIED ELECTRONIC MACHINES AND APPARATUS, PHOTOGRAPHY INSTRUMENTS, MUSICAL INSTRUMENTS AND FITTINGS THEREOF, PHOTOGRAPHS, STATIONERY, JEWELRY, HOROLOGICAL INSTRUMENTS AND PARTS THEREOF, MOTOR VEHICLES AND PARTS AND ACCESSORIES THEREOF, MANUAL AND POWER TOOLS, MEASURING INSTRUMENTS, PHYSICAL AND CHEMICAL INSTRUMENTS, CHEMICALS, SOAPS, PERFUMERY, COSMETICS, PAINTS, ADHESIVE FOR INDUSTRIAL PURPOSES, PRESERVATIVES, LEATHER, IMITATION LEATHER, BAGS AND THEIR SUBSTITUTES, UMBRELLAS, WALKING STICKS, SADDLERY, MATERIALS FOR BUILDING AND CONSTRUCTION, FURNITURE, FABRIC, INDOOR ORNAMENTS OF TEXTILE, TOBACCO NOT FOR MEDICAL USE, SMOKERS ARTICLES, PLANTS, PHARMACEUTICALS, LIGHTS, IRONS AND STEELS, POTS, TABLEWARE, HEATERS, COSMETIC UTENSILS, YARNS AND THREAD FOR TEXTILE USE, KITCHEN AND HOUSEHOLD UTENSILS, GAMES AND PLAYTHINGS, ELECTRONIC PUBLICATIONS AND GREETING CARDS; AND ONLINE MAIL ORDER SERVICES FEATURING BOOKS, MUSIC, VIDEOTAPES, AUDIOCASSETTES, COMPACT DISCS, FLOPPY DISCS AND CD-ROMS, PRINTED MATTERS, PHONOGRAPHS, RECORDED MUSIC, TOYS, HOUSEHOLD ELECTRONIC APPLIANCES, APPLIED ELECTRONIC MACHINES AND APPARATUS, PHOTOGRAPHY INSTRUMENTS, MUSICAL INSTRUMENTS AND FITTINGS THEREOF, PHOTOGRAPHS, STATIONERY, JEWELRY, HOROLOGICAL INSTRUMENTS AND PARTS THEREOF, MOTOR VEHICLES AND PARTS AND ACCESSORIES THEREOF, MANUAL AND POWER TOOLS, MEASURING INSTRUMENTS, PHYSICAL AND CHEMICAL INSTRUMENTS, CHEMICALS, SOAPS, PERFUMERY, COSMETICS, PAINTS, ADHESIVE FOR INDUSTRIAL PURPOSES, PRESERVATIVES, LEATHER, IMITATION LEATHER, BAGS AND THEIR SUBSTITUTES, UMBRELLAS, WALKING STICKS, SADDLERY, MATERIALS FOR BUILDING AND CONSTRUCTION, FURNITURE, FABRIC, INDOOR ORNAMENTS OF TEXTILE, TOBACCO NOT FOR MEDICAL USE, SMOKERS ARTICLES, PLANTS, PHARMACEUTICALS, LIGHTS, IRONS AND STEELS, POTS, TABLEWARE, HEATERS, COSMETIC UTENSILS, YARNS AND THREAD FOR TEXTILE USE, KITCHEN AND HOUSEHOLD UTENSILS, GAMES AND PLAYTHINGS, ELECTRONIC PUBLICATIONS AND GREETING CARDS (U.S. CLS. 100, 101 AND 102).

FIRST USE 1-15-2009; IN COMMERCE 1-15-2009.

SETH A. RAPPAPORT, EXAMINING ATTORNEY

CLASS 35—(Continued).

SN 77-926,497. ORVIS, JAYSON ROSS, HENDERSON, NV. FILED 2-3-2010.

BIZ FU

THE MARK CONSISTS OF STANDARD CHARACTERS WITHOUT CLAIM TO ANY PARTICULAR FONT, STYLE, SIZE, OR COLOR.

NO CLAIM IS MADE TO THE EXCLUSIVE RIGHT TO USE "BIZ", APART FROM THE MARK AS SHOWN.

FOR BUSINESS CONSULTING AND INFORMATION SERVICES (U.S. CLS. 100, 101 AND 102).

FIRST USE 2-1-2010; IN COMMERCE 2-1-2010.

WILLIAM P. SHANAHAN, EXAMINING ATTORNEY

SN 77-926,501. JAYSON ORVIS, HENDERSON, NV. FILED 2-3-2010.

MICRO-BUSINESS FANATIC

THE MARK CONSISTS OF STANDARD CHARACTERS WITHOUT CLAIM TO ANY PARTICULAR FONT, STYLE, SIZE, OR COLOR.

NO CLAIM IS MADE TO THE EXCLUSIVE RIGHT TO USE "MICRO-BUSINESS", APART FROM THE MARK AS SHOWN.

FOR BUSINESS CONSULTING AND INFORMATION SERVICES (U.S. CLS. 100, 101 AND 102).

FIRST USE 8-15-2009; IN COMMERCE 8-15-2009.

WILLIAM P. SHANAHAN, EXAMINING ATTORNEY

SN 77-926,530. BRUCE MARK C, SUMMERTON, SC. FILED 2-3-2010.

Waterbody

THE MARK CONSISTS OF STANDARD CHARACTERS WITHOUT CLAIM TO ANY PARTICULAR FONT, STYLE, SIZE, OR COLOR.

FOR DEVELOPING ADVERTISING CAMPAIGNS FOR OTHERS GEARED TOWARD ENVIRONMENTAL ISSUES; PROMOTING HEALTH AND ENVIRONMENTAL AWARENESS WITHIN PEOPLE SO THAT THEY CAN LEAD A CLEAN AND HEALTHY LIFE; PROMOTING PUBLIC AWARENESS OF ENVIRONMENTAL ISSUES AND INITIATIVES; PROMOTING THE INTERESTS OF PEOPLE CONCERNED WITH HEALTH, COMMUNITY AND ENVIRONMENTAL SUSTAINABILITY ISSUES (U.S. CLS. 100, 101 AND 102).

JACQUELINE A. LAVINE, EXAMINING ATTORNEY

CLASS 35—(Continued).

SN 77-926,569. SIGNATURE HEALTH, INC., WILLOUGHBY, OH. FILED 2-3-2010.

WHEN YOU NEED HELP NOW

THE MARK CONSISTS OF STANDARD CHARACTERS WITHOUT CLAIM TO ANY PARTICULAR FONT, STYLE, SIZE, OR COLOR.

OWNER OF U.S. REG. NO. 3,696,832.

FOR RETAIL PHARMACY SERVICES; INSTITUTIONAL RETAIL PHARMACY SERVICES (U.S. CLS. 100, 101 AND 102).

TRACY WHITTAKER-BROWN, EXAMINING ATTORNEY

SN 77-926,574. SIGNATURE HEALTH, INC., WILLOUGHBY, OH. FILED 2-3-2010.



OWNER OF U.S. REG. NO. 3,696,833.

THE MARK CONSISTS OF THE LETTERS "S" IN STYLIZED FONT ABOVE THE LETTER "H" IN STYLIZED FONT INSIDE A RECTANGLE. A HORIZONTAL LINE APPEARS IN THE CENTER OF THE RECTANGLE WITH "S" ABOVE THE LINE AND "H" BELOW THE LINE.

FOR RETAIL PHARMACY SERVICES; INSTITUTIONAL RETAIL PHARMACY SERVICES (U.S. CLS. 100, 101 AND 102).

TRACY WHITTAKER-BROWN, EXAMINING ATTORNEY

CLASS 35—(Continued).

SN 77-926,633. RICHARD VINAL, EAST SYRACUSE, NY. FILED 2-3-2010.

UNIVERSITY OF HALLOWEEN

THE MARK CONSISTS OF STANDARD CHARACTERS WITHOUT CLAIM TO ANY PARTICULAR FONT, STYLE, SIZE, OR COLOR.

NO CLAIM IS MADE TO THE EXCLUSIVE RIGHT TO USE "HALLOWEEN", APART FROM THE MARK AS SHOWN.

FOR RETAIL STORE SERVICES FEATURING HALLOWEEN COSTUMES (U.S. CLS. 100, 101 AND 102).

TRACY WHITTAKER-BROWN, EXAMINING ATTORNEY

SN 77-926,645. SEBAE DATA SOLUTIONS, INC., OCALA, FL. FILED 2-3-2010.

Bidopia

THE MARK CONSISTS OF STANDARD CHARACTERS WITHOUT CLAIM TO ANY PARTICULAR FONT, STYLE, SIZE, OR COLOR.

FOR ON-LINE AUCTION SERVICES (U.S. CLS. 100, 101 AND 102).

FIRST USE 6-26-2007; IN COMMERCE 6-26-2007.

MIDGE BUTLER, EXAMINING ATTORNEY

SN 77-926,656. WEST, FRANK H., LAS VEGAS, NV. FILED 2-3-2010.

OWN A PIECE

THE MARK CONSISTS OF STANDARD CHARACTERS WITHOUT CLAIM TO ANY PARTICULAR FONT, STYLE, SIZE, OR COLOR.

FOR PROMOTING THE GOODS AND SERVICES OF ATHLETES BY ARRANGING FOR SPONSORSHIP OF THE ATHLETE IN THEIR SPORTS COMPETITION AND SPORTING ACTIVITIES; ARRANGING FOR SPONSORSHIP OF ATHLETES IN THEIR SPORTS COMPETITION AND SPORTING ACTIVITIES; PROMOTING THE GOODS AND SERVICES OF ATHLETES ONLINE; ONLINE RETAIL STORE SERVICES FEATURING CLOTHING AND SPORTS RELATED MEMORABILIA (U.S. CLS. 100, 101 AND 102).

FIRST USE 6-0-2009; IN COMMERCE 11-0-2009.

MIDGE BUTLER, EXAMINING ATTORNEY

CLASS 35—(Continued).

SN 77-926,692. TOTAL EMEDICAL, INC., POMPANO BEACH, FL. FILED 2-3-2010.



OWNER OF U.S. REG. NO. 3,276,477.

NO CLAIM IS MADE TO THE EXCLUSIVE RIGHT TO USE "E MEDICAL.COM", APART FROM THE MARK AS SHOWN.

THE MARK CONSISTS OF THE WORD "TOTAL" WITH A CAPITAL "T" FOLLOWED BY A SUPERSIZED LOWER-CASE "E". UNDERNEATH "TOTALE" AND SLIGHTLY INDENTED IS THE WORD "MEDICAL" WITH A CAPITAL "M" FOLLOWED BY THE ".COM" EXTENSION EXTENDED VERTICALLY ALONG THE LOWERCASE "L". UNDERNEATH THE TERM "MEDICAL" IS THE PHRASE "WHAT THE DOCTOR ORDERED..." WITH A CAPITAL "W" AND "D". UNDERNEATH THE PHRASE "WHAT THE DOCTOR ORDERED..." IS THE PHRASE "MADE SIMPLE." IN A STYLIZED FONT WITH A CAPITAL "M" AND "S".

FOR DISTRIBUTORSHIP SERVICES AND ONLINE CATALOG SERVICES IN THE FIELD OF MEDICAL SUPPLIES AND APPARATUS (U.S. CLS. 100, 101 AND 102).

FIRST USE 2-15-2009; IN COMMERCE 2-15-2009.

DANIEL CAPSHAW, EXAMINING ATTORNEY

SN 77-926,703. BRAD MEHL, WEST ORANGE, NJ. FILED 2-3-2010.

BIG MINDS

THE MARK CONSISTS OF STANDARD CHARACTERS WITHOUT CLAIM TO ANY PARTICULAR FONT, STYLE, SIZE, OR COLOR.

FOR MARKETING, ADVERTISING AND PROMOTING THE GOODS AND SERVICES OF OTHERS IN THE FIELD OF PROFESSIONAL DEVELOPMENT EVENTS, WEBINARS, CONFERENCES, SEMINARS AND TRAINING (U.S. CLS. 100, 101 AND 102).

MARILYN IZZI, EXAMINING ATTORNEY

SN 77-926,731. SLIFER, STEPHEN, CHARLESTON, SC. FILED 2-3-2010.

Numbernomics

THE MARK CONSISTS OF STANDARD CHARACTERS WITHOUT CLAIM TO ANY PARTICULAR FONT, STYLE, SIZE, OR COLOR.

FOR PROVIDING INFORMATION AND ANALYSIS IN THE FIELDS OF ECONOMICS AND BUSINESS; CONSULTING SERVICES, NAMELY, EXPERT ANALYSIS AND MANAGEMENT CONSULTING IN ECONOMICS (U.S. CLS. 100, 101 AND 102).

JIM RINGLE, EXAMINING ATTORNEY

CLASS 35—(Continued).

SN 77-926,759. WOODLAND HILLS TREATMENT CENTER, WOODLAND HILLS, CA. FILED 2-3-2010.



NO CLAIM IS MADE TO THE EXCLUSIVE RIGHT TO USE "WOODLAND HILLS TREATMENT CENTER" AND THE DESIGN OF THE MARIJUANA LEAF, APART FROM THE MARK AS SHOWN.

THE MARK CONSISTS OF A ROUND LOGO CONSISTING OF TWO CONCENTRIC CIRCLES WITHIN WHICH APPEARS THE WORDING "WOODLAND HILLS TREATMENT CENTER WOODLAND HILLS TREATMENT CENTER" AND THE INSIDE OF THE CIRCLE DEPICTS A DESIGN OF 2 HANDS THAT COME UP FROM THE BOTTOM OF THE EMBLEM OF A MARIJUANA LEAF FLOATING ABOVE THE HANDS, BELOW THE CIRCLE APPEARS "WHTC", BELOW WHICH APPEARS THE WORDING "WOODLAND HILLS TREATMENT CENTER".

FOR RETAIL PHARMACY SERVICES (U.S. CLS. 100, 101 AND 102).

FIRST USE 1-1-2010; IN COMMERCE 1-1-2010.
ERIN FALK, EXAMINING ATTORNEY

SN 77-926,836. RED DISTRIBUTION, LLC, NEW YORK, NY. FILED 2-3-2010.

MUSTACHE MANIA

THE MARK CONSISTS OF STANDARD CHARACTERS WITHOUT CLAIM TO ANY PARTICULAR FONT, STYLE, SIZE, OR COLOR.

FOR ON-LINE ADVERTISING AND MARKETING SERVICES; ALTERNATIVE MARKETING SERVICES, NAMELY, ADVERTISING THE GOODS AND SERVICES OF OTHERS BY PROVIDING ON-THE-STREET AND EVENT-SPECIFIC PROMOTIONS IN THE NATURE OF DISTRIBUTING ADVERTISING MATERIALS; INTERNET ADVERTISING SERVICES, NAMELY, ADVERTISING THE GOODS AND SERVICES OF OTHERS BY PROVIDING AN OPT-OUT INTERACTIVE MEMBERS-ONLY WEBSITE, WHEREIN MEMBERS ARE SOLICITED TO PROMOTE CERTAIN MUSICAL ARTISTS AND MUSIC-RELATED EVENTS AND PROJECTS IN THE NATURE OF LIVE MUSICAL PERFORMANCES, MUSIC FESTIVALS, AUTOGRAPH SIGNING PARTIES AND COMPACT DISC RELEASE PARTIES IN EXCHANGE FOR EARNING CREDIT TOWARDS MUSIC-RELATED MERCHANDISE (U.S. CLS. 100, 101 AND 102).

FIRST USE 2-3-2010; IN COMMERCE 2-3-2010.
SOPHIA S. KIM, EXAMINING ATTORNEY

CLASS 35—(Continued).

SN 77-926,868. STAR MIDDLE EAST (USA), INC., HOUSTON, TX. FILED 2-3-2010.

DRILLEQUIP

THE MARK CONSISTS OF STANDARD CHARACTERS WITHOUT CLAIM TO ANY PARTICULAR FONT, STYLE, SIZE, OR COLOR.

FOR RESELLER SERVICES, NAMELY, DISTRIBUTORSHIP SERVICES IN THE FIELD OF OIL WELL DRILLING EQUIPMENT; WHOLESALE DISTRIBUTORSHIPS FEATURING OIL WELL DRILLING EQUIPMENT (U.S. CLS. 100, 101 AND 102).

FIRST USE 6-0-2007; IN COMMERCE 6-0-2007.
KATHERINE CHANG, EXAMINING ATTORNEY

SN 77-926,984. RAPIDPRO MANUFACTURING CORPORATION, LONGMONT, CO. FILED 2-3-2010.

RapidPro Sports

THE MARK CONSISTS OF STANDARD CHARACTERS WITHOUT CLAIM TO ANY PARTICULAR FONT, STYLE, SIZE, OR COLOR.

NO CLAIM IS MADE TO THE EXCLUSIVE RIGHT TO USE "SPORTS", APART FROM THE MARK AS SHOWN.

FOR ON-LINE WHOLESALE AND RETAIL STORE SERVICES FEATURING SPORTING GOODS (U.S. CLS. 100, 101 AND 102).

KIMBERLY FRYE, EXAMINING ATTORNEY

SN 77-927,103. NEW STUDY ABROAD, LLC, SAN DIEGO, CA. FILED 2-3-2010.

New Study Abroad

THE MARK CONSISTS OF STANDARD CHARACTERS WITHOUT CLAIM TO ANY PARTICULAR FONT, STYLE, SIZE, OR COLOR.

NO CLAIM IS MADE TO THE EXCLUSIVE RIGHT TO USE "STUDY ABROAD", APART FROM THE MARK AS SHOWN.

FOR ADMINISTRATION OF CULTURAL AND EDUCATIONAL EXCHANGE PROGRAMS (U.S. CLS. 100, 101 AND 102).

DOUGLAS LEE, EXAMINING ATTORNEY

CLASS 35—(Continued).

SN 77-927,246. SYNAPTIC ADVISORY PARTNERS, LLC, DBA SYNAPTICAP, ANNAPOLIS, MD. FILED 2-3-2010.



THE COLOR(S) RED, GRAY AND BLACK IS/ARE CLAIMED AS A FEATURE OF THE MARK.

THE MARK CONSISTS OF A PRIMARILY RED DESIGN IN A JAGGED PATTERN THAT ROUGHLY APPROXIMATES A SEMI-CIRCLE WITH GRAY AREAS PROTRUDING FROM PORTIONS OF THE RED AREA OF THE DESIGN, ALL OF WHICH ARE INTENDING TO REPRESENT A NERVE ENDING. TO THE RIGHT OF THE UPPER PORTION OF THE SEMI-CIRCLE THE WORD "SYNAPTIC" APPEARS IN BLACK LETTERS FOLLOWED BY THE STYLIZED LETTERS "AP" IN GRAY.

FOR MANAGEMENT AND BUSINESS CONSULTING SERVICES WITH RELATION TO THE DEVELOPMENT OF SALES AND CUSTOMER SUPPORT SYSTEMS AND ORGANIZATION PROCESSES (U.S. CLS. 100, 101 AND 102).

FIRST USE 6-1-2009; IN COMMERCE 6-1-2009.
CYNTHIA SLOAN, EXAMINING ATTORNEY

SN 77-927,251. U.S. MARINE CORPS, A COMPONENT OF THE U.S. DEPARTMENT OF THE NAVY, WASHINGTON, DC. FILED 2-3-2010.

MARINES THE FEW. THE PROUD.

THE MARK CONSISTS OF STANDARD CHARACTERS WITHOUT CLAIM TO ANY PARTICULAR FONT, STYLE, SIZE, OR COLOR.

NO CLAIM IS MADE TO THE EXCLUSIVE RIGHT TO USE "MARINES", APART FROM THE MARK AS SHOWN.

FOR CHARITABLE SERVICES, NAMELY, COORDINATION OF THE PROCUREMENT AND DISTRIBUTION OF HOLIDAY GIFT DONATIONS FROM THE GENERAL PUBLIC TO ORPHANED CHILDREN; CHARITABLE SERVICES, NAMELY, ORGANIZING AND CONDUCTING VOLUNTEER PROGRAMS AND COMMUNITY SERVICE PROJECTS; CHARITABLE SERVICES, NAMELY, ORGANIZING AND CONDUCTING VOLUNTEER PROGRAMS AND COMMUNITY SERVICE PROJECTS AIMED AT INCREASING SUPPORT AND MORALE OF FAMILIES OF DECEASED WAR VETERANS, WAR VETERANS, CURRENT MEMBERS AND FUTURE MEMBERS OF THE U.S. MILITARY; CHARITABLE SERVICES, NAMELY, ORGANIZING AND CONDUCTING VOLUNTEER PROGRAMS AND COMMUNITY SERVICE PROJECTS AIMED AT INCREASING SUPPORT AND MORALE OF MEMBERS OF THE U.S. MILITARY; CHARITABLE SERVICES, NAMELY, ORGANIZING AND DEVELOPING PROJECTS THAT AIM TO IMPROVE THE LIVES OF UNDERPRIVILEGED AND IMPOVERISHED PEOPLE; CONSULTING SERVICES IN THE FIELD OF HUMAN RESOURCES DEVELOPMENT, NAMELY, FOR THE PROMOTION OF EMPLOYEE RETENTION, CAREER GROWTH, AND INCREASED PRODUCTIVITY FOR EMPLOYEES AND EMPLOYERS; DEVELOPING AND COORDINATING VOLUNTEER PROJECTS FOR CHARITABLE ORGANIZATIONS; EMPLOYMENT COUNSELING AND RECRUITING; EMPLOYMENT HIRING,

CLASS 35—(Continued).

RECRUITING, PLACEMENT, STAFFING AND CAREER NETWORKING SERVICES; EMPLOYMENT RECRUITING AND STAFFING SERVICES PROVIDED VIA TEXT MESSAGING; EMPLOYMENT RECRUITING CONSULTATION; INFORMATION IN THE FIELD OF GOVERNMENT AFFAIRS; PROMOTING THE CHARITABLE SERVICES OF OTHERS, NAMELY, PROVIDING INDIVIDUALS WITH INFORMATION FOR THE PURPOSE OF MAKING DONATIONS TO CHARITIES; PROVIDING EMPLOYMENT COUNSELING INFORMATION ON HOW TO SUCCESSFULLY TRANSITION JOBS; PROVIDING EMPLOYMENT COUNSELING INFORMATION ON HOW TO SUCCESSFULLY TRANSITION JOBS FOR MATURE WORKERS; PROVIDING EMPLOYMENT COUNSELING INFORMATION ON HOW TO SUCCESSFULLY TRANSITION JOBS FOR PAST OR PRESENT MILITARY PERSONNEL; PROVIDING EMPLOYMENT INFORMATION; PROVIDING INFORMATION IN THE FIELD OF FOREIGN POLICY; PROVIDING NETWORKING OPPORTUNITIES FOR INDIVIDUALS SEEKING EMPLOYMENT (U.S. CLS. 100, 101 AND 102).

FIRST USE 2-1-2001; IN COMMERCE 2-1-2001.
ELISSA GARBER KON, EXAMINING ATTORNEY

SN 77-927,281. NIXLE, LLC, MOUNT LAUREL, NJ. FILED 2-3-2010.



THE COLOR(S) YELLOW, BLUE AND BLACK IS/ARE CLAIMED AS A FEATURE OF THE MARK.

THE MARK CONSISTS OF THE TERM "WIRE" IN YELLOW FOLLOWED BY THE TERM "WORDS" IN BLUE WITH THE LETTERS OUTLINED IN BLACK AND THE "W" OF THE TERM "WORDS" ENCLOSED IN A CIRCLE WITH YELLOW AT THE TOP.

FOR ADVERTISING, MARKETING AND PROMOTION SERVICES; MARKETING, ADVERTISING, AND PROMOTING THE RETAIL GOODS AND SERVICES OF OTHERS TO WIRELESS ELECTRONIC DEVICES (U.S. CLS. 100, 101 AND 102).

FIRST USE 11-30-2009; IN COMMERCE 11-30-2009.
ANTHONY RINKER, EXAMINING ATTORNEY

SN 77-927,285. NEW STUDY ABROAD, LLC, SAN DIEGO, CA. FILED 2-3-2010.

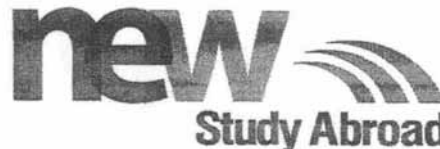

NO CLAIM IS MADE TO THE EXCLUSIVE RIGHT TO USE "STUDY ABROAD", APART FROM THE MARK AS SHOWN.

THE MARK CONSISTS OF THE WORDS "NEW STUDY ABROAD" WITH THE WORD "NEW" ON THE TOP LINE FOLLOWED BY THREE WAVE LIKE DESIGNS OVER THE WORDS "STUDY ABROAD".

FOR ADMINISTRATION OF CULTURAL AND EDUCATIONAL EXCHANGE PROGRAMS (U.S. CLS. 100, 101 AND 102).

DOUGLAS LEE, EXAMINING ATTORNEY

CLASS 35—(Continued).

SN 77-927,359. MAN CAVE, LLC, MINNEAPOLIS, MN. FILED 2-3-2010.

WHERE MEN CAN BE MEN

THE MARK CONSISTS OF STANDARD CHARACTERS WITHOUT CLAIM TO ANY PARTICULAR FONT, STYLE, SIZE, OR COLOR.

FOR INDEPENDENT SALES REPRESENTATIVES IN THE FIELD OF PRODUCTS FOR MEN, NAMELY, BARBECUE TOOLS, BARBECUE GRILL ACCESSORIES, SPICES, SAUCES, MARINADES, RUBS, MEATS, HOME BAR ACCESSORIES, POKER KITS INCLUDING POKER CHIPS, PLAYING CARDS, AND POKER CASES, AND APPAREL (U.S. CLS. 100, 101 AND 102).

FIRST USE 4-3-2009; IN COMMERCE 4-3-2009.
MAYUR VAGHANI, EXAMINING ATTORNEY

CLASS 35—(Continued).

SN 77-927,616. FLEXITA, LLC, WALNUT CREEK, CA. FILED 2-4-2010.

RiteQuote

THE MARK CONSISTS OF STANDARD CHARACTERS WITHOUT CLAIM TO ANY PARTICULAR FONT, STYLE, SIZE, OR COLOR.

FOR MATCHING BORROWERS WITH POTENTIAL LENDERS IN THE FIELD OF CONSUMER AND MORTGAGE LENDING (U.S. CLS. 100, 101 AND 102).

FIRST USE 3-14-2006; IN COMMERCE 6-14-2007.
BRIAN CALLAGHAN, EXAMINING ATTORNEY

SN 77-927,510. TWENTIETH CENTURY FOX FILM CORPORATION, LOS ANGELES, CA. FILED 2-3-2010.

FOXFAST

THE MARK CONSISTS OF STANDARD CHARACTERS WITHOUT CLAIM TO ANY PARTICULAR FONT, STYLE, SIZE, OR COLOR.

FOR ADVERTISING, MARKETING AND PROMOTION SERVICES (U.S. CLS. 100, 101 AND 102).

FIRST USE 12-0-1999; IN COMMERCE 12-0-1999.
THEODORE MCBRIDE, EXAMINING ATTORNEY

SN 77-927,627. BOING FITNESS, HOLLYWOOD, FL. FILED 2-4-2010.



SN 77-927,572. DEBLAUW, LINDA, ARROYO GRANDE, CA. FILED 2-3-2010.

STOP SMOKING NOW GUARANTEED

THE MARK CONSISTS OF STANDARD CHARACTERS WITHOUT CLAIM TO ANY PARTICULAR FONT, STYLE, SIZE, OR COLOR.

FOR PUBLIC ADVOCACY TO PROMOTE AWARENESS OF THE NEED TO QUIT SMOKING (U.S. CLS. 100, 101 AND 102).

SCOTT BIBB, EXAMINING ATTORNEY

NO CLAIM IS MADE TO THE EXCLUSIVE RIGHT TO USE "FITNESS", APART FROM THE MARK AS SHOWN.

THE COLOR(S) ORANGE, BLACK AND WHITE IS/ARE CLAIMED AS A FEATURE OF THE MARK.

THE MARK CONSISTS OF AN ORANGE MAN OUTLINED IN BLACK JUMPING WITH BLACK AND WHITE OVALS DIVIDED INTO HALVES, ON HIS FEET ON TOP OF THE WORDS "BOING!" WRITTEN IN BLACK COLOR; THE DASHED LINE IN ORANGE COLOR SHOWING JUMPING MOVEMENT AND THE WORDS "FITNESS" IS WRITTEN IN ORANGE COLOR JUST BELOW THE WORDS "BOING!".

FOR RETAIL STORE SERVICES IN THE FIELD OF FITNESS PRODUCTS, FITNESS ACCESSORIES, SPORTING GOODS, CLOTHING, FOOTWEAR, HEADWEAR, AND DVDS IN THE FIELD OF FITNESS FOR CONSUMERS (U.S. CLS. 100, 101 AND 102).

FIRST USE 12-7-2009; IN COMMERCE 12-15-2009.
DEIRDRE ROBERTSON, EXAMINING ATTORNEY

CLASS 35—(Continued).

SN 77-927,663. CRUZSTAR, LLC, HUMMELSTOWN, PA. FILED 2-4-2010.

CRUZSTAR

THE MARK CONSISTS OF STANDARD CHARACTERS WITHOUT CLAIM TO ANY PARTICULAR FONT, STYLE, SIZE, OR COLOR.

FOR ON-LINE ORDERING AND INTERNET MARKETING SERVICES IN THE FIELD OF FOOD DELIVERY AND TAKE-OUT (U.S. CLS. 100, 101 AND 102).

FIRST USE 1-14-2008; IN COMMERCE 1-14-2008.
SUSAN STIGLITZ, EXAMINING ATTORNEY

CLASS 35—(Continued).

SN 77-927,683. SURREY SERVICES FOR SENIORS, INC., BERWYN, PA. FILED 2-4-2010.

MLAS

THE MARK CONSISTS OF STANDARD CHARACTERS WITHOUT CLAIM TO ANY PARTICULAR FONT, STYLE, SIZE, OR COLOR.

FOR ORGANIZING, PROMOTING AND CONDUCTING EXHIBITIONS AND TRADESHOWS FOR BUSINESS PURPOSES FEATURING BOOTHS AND DISPLAYS RELATING TO ANTIQUES AND COLLECTIBLES (U.S. CLS. 100, 101 AND 102).

FIRST USE 11-0-2006; IN COMMERCE 11-0-2006.
VERNA BETH RIRIE, EXAMINING ATTORNEY

SN 77-927,664. CRUZSTAR, LLC, HUMMELSTOWN, PA. FILED 2-4-2010.

MENUDRIVE

THE MARK CONSISTS OF STANDARD CHARACTERS WITHOUT CLAIM TO ANY PARTICULAR FONT, STYLE, SIZE, OR COLOR.

FOR ON-LINE ORDERING AND INTERNET MARKETING SERVICES IN THE FIELD OF FOOD DELIVERY AND TAKE-OUT (U.S. CLS. 100, 101 AND 102).

FIRST USE 12-9-2009; IN COMMERCE 12-9-2009.
SUSAN STIGLITZ, EXAMINING ATTORNEY

SN 77-927,716. TRI-STATE WHOLESALE FLOORING, INC., SIOUX FALLS, SD. FILED 2-4-2010.



THE MARK CONSISTS OF A STYLIZED "TSP" WITH AN ARC STARTING AT THE LOWER LEFT AND RISING UPWARD AND RIGHT AND FORMING PART OF THE LETTER "F".

FOR WHOLESALE DISTRIBUTORSHIPS FEATURING FLOORING MATERIALS (U.S. CLS. 100, 101 AND 102).
FIRST USE 4-17-2001; IN COMMERCE 4-17-2001.
JENNIFER DIXON, EXAMINING ATTORNEY

SN 77-927,677. MINDS ON INC., LEWIS CENTER, OH. FILED 2-4-2010.



THE MARK CONSISTS OF AN ABSTRACT LOGO STYLIZATION OF THE LETTER "M" AND "O" TO FORM AN ABSTRACT SHAPE OF A PERSON'S HEAD FOLLOWED BY THE WORDS "MINDS ON".

FOR ADVERTISING AND MARKETING SERVICES AND RELATED CONSULTING (U.S. CLS. 100, 101 AND 102).

FIRST USE 7-5-2002; IN COMMERCE 7-5-2002.
SUSAN STIGLITZ, EXAMINING ATTORNEY

SN 77-927,737. NEW COMPUSA, CORP., PORT WASHINGTON, NY. FILED 2-4-2010.



OWNER OF U.S. REG. NOS. 1,866,040, 2,098,079 AND OTHERS.

THE MARK CONSISTS OF THE WORDING "COMPUSA.PR"; THE LETTERS "USA" HAS FOUR HORIZONTAL LINES AND THE LETTER "A" HAS A DESIGN OF AN INCOMPLETE STAR INSIDE.

FOR ONLINE RETAIL STORE SERVICES FEATURING COMPUTER HARDWARE AND SOFTWARE (U.S. CLS. 100, 101 AND 102).

FIRST USE 4-5-2008; IN COMMERCE 4-28-2008.
RAMONA ORTIGA, EXAMINING ATTORNEY

CLASS 35—(Continued).

SN 77-927,830. GOWAITER, INC., TALLAHASSEE, FL. FILED 2-4-2010.

GOWAITER

THE MARK CONSISTS OF STANDARD CHARACTERS WITHOUT CLAIM TO ANY PARTICULAR FONT, STYLE, SIZE, OR COLOR.

FOR PROVIDING A WEB SITE WHICH ALLOWS FOR THE ORDERING OF FOOD ONLINE AND BY TELEPHONE (U.S. CLS. 100, 101 AND 102).

SHANNON TWOHIG, EXAMINING ATTORNEY

SN 77-927,900. RED DISTRIBUTION, LLC, NEW YORK, NY. FILED 2-4-2010.



OWNER OF U.S. REG. NOS. 3,782,541 AND 3,782,542. THE MARK CONSISTS OF THE HORIZONTAL LITERAL ELEMENT "MUSTACHE" ABOVE A STYLIZED MUSTACHE ALONGSIDE THE HORIZONTAL LITERAL ELEMENT "MANIA" WITH THE LITERAL ELEMENT ".COM" RUNNING VERTICALLY ON THE RIGHTHAND SIDE.

FOR CREATIVE MARKETING DESIGN SERVICES; ON-LINE ADVERTISING AND MARKETING SERVICES (U.S. CLS. 100, 101 AND 102).

FIRST USE 2-3-2010; IN COMMERCE 2-3-2010.

SOPHIA S. KIM, EXAMINING ATTORNEY

SN 77-927,911. MUNDO ART, INC., NEW YORK, NY. FILED 2-4-2010.



NO CLAIM IS MADE TO THE EXCLUSIVE RIGHT TO USE "PRINTS", APART FROM THE MARK AS SHOWN.

THE COLOR(S) GRAY, BLACK, AND RED IS/ARE CLAIMED AS A FEATURE OF THE MARK.

THE MARK CONSISTS OF THE TEXT "PRINTS" IN THE COLOR GRAY, FOLLOWED BY THE TEXT "99" IN THE COLOR BLACK, FOLLOWED BY THE TEXT "5" IN THE COLOR RED.

FOR ON-LINE ART GALLERY; ON-LINE MARKETPLACE FEATURING PHOTO PRINTS (U.S. CLS. 100, 101 AND 102).

FIRST USE 6-10-2009; IN COMMERCE 6-12-2009.

REBECCA EISINGER, EXAMINING ATTORNEY

CLASS 35—(Continued).

SN 77-927,935. UNITED NATIONAL CLOSEOUT STORES, INC., FORT LAUDERDALE, FL. FILED 2-4-2010.



THE MARK CONSISTS OF THE STYLIZED TEXT "UNCS" WITH A FRAME AROUND LIKE A STAMP.

FOR WHOLESALE DISTRIBUTORSHIPS FEATURING VARIOUS PRODUCTS THAT ARE MANUFACTURER OVERSTOCKS AND OVERRUNS (U.S. CLS. 100, 101 AND 102).

FIRST USE 11-1-2002; IN COMMERCE 11-1-2002.

RUSS HERMAN, EXAMINING ATTORNEY

SN 77-928,003. RED HAND, LLC, WASHINGTON, DC. FILED 2-4-2010.

Electronic Employee

THE MARK CONSISTS OF STANDARD CHARACTERS WITHOUT CLAIM TO ANY PARTICULAR FONT, STYLE, SIZE, OR COLOR.

NO CLAIM IS MADE TO THE EXCLUSIVE RIGHT TO USE "EMPLOYEE", APART FROM THE MARK AS SHOWN.

FOR EMPLOYEE RELATIONS INFORMATION SERVICES (U.S. CLS. 100, 101 AND 102).

JAMES A. RAUEN, EXAMINING ATTORNEY

SN 77-928,142. VTECH COMMUNICATIONS, INC., BEAVERTON, OR. FILED 2-4-2010.



THE MARK CONSISTS OF THE WORDING "VTECHDIRECT" IN STYLIZED WORDING WITH AN ARROW POINTING RIGHT EXTENDING FROM THE TOP OF THE FINAL LETTER "T".

FOR PROVIDING A WEB SITE FOR ONLINE BUSINESS-TO-BUSINESS STORE SERVICES FEATURING WIRELINE TELEPHONY PRODUCTS AND WIRELESS FIDELITY STREAMING MUSIC DEVICES; ONLINE BUSINESS-TO-BUSINESS STORE FEATURING WIRELINE TELEPHONY PRODUCTS AND WIRELESS FIDELITY STREAMING MUSIC DEVICES (U.S. CLS. 100, 101 AND 102).

FIRST USE 1-0-2010; IN COMMERCE 1-0-2010.

BARBARA BROWN, EXAMINING ATTORNEY

CLASS 35—(Continued).

SN 77-928,251. CLOOPS, INC., MANHATTAN BEACH, CA.
FILED 2-4-2010.

CLOOPS

THE MARK CONSISTS OF STANDARD CHARACTERS WITHOUT CLAIM TO ANY PARTICULAR FONT, STYLE, SIZE, OR COLOR.

FOR PLACEMENT AND DISSEMINATION OF ADVERTISEMENTS FOR OTHERS VIA THE INTERNET; ONLINE ADVERTISING AND MARKETING SERVICES, NAMELY, PROMOTING THE GOODS AND SERVICES OF OTHERS THROUGH THE DISSEMINATION OF COUPONS, DISCOUNTS, SPECIAL OFFERS, AND PROMOTIONS, AND PROVIDING COUPONS, DISCOUNTS, SPECIAL OFFERS, AND PROMOTIONS VIA THE INTERNET (U.S. CLS. 100, 101 AND 102).

FIRST USE 11-24-2009; IN COMMERCE 11-24-2009.
RENEE MCCRAY, EXAMINING ATTORNEY

CLASS 35—(Continued).

SN 77-928,510. SUNSTONE CIRCUITS LLC, MULINO, OR.
FILED 2-4-2010.

CIRCUIT DESIGN ECOSYSTEM

THE MARK CONSISTS OF STANDARD CHARACTERS WITHOUT CLAIM TO ANY PARTICULAR FONT, STYLE, SIZE, OR COLOR.

OWNER OF U.S. REG. NO. 3,618,482.

NO CLAIM IS MADE TO THE EXCLUSIVE RIGHT TO USE "CIRCUIT DESIGN", APART FROM THE MARK AS SHOWN.

FOR OPERATING AN ONLINE MARKETPLACE FEATURING PRINTED CIRCUIT BOARDS; OPERATING AN ONLINE MARKETPLACE FOR BUYERS AND SELLERS OF GOODS AND/OR SERVICES, NAMELY, SERVICES IN THE NATURE OF DESIGNING, MANUFACTURING AND ASSEMBLING PRINTED CIRCUIT BOARDS (U.S. CLS. 100, 101 AND 102).

MELISSA VALLILLO, EXAMINING ATTORNEY

SN 77-928,316. LIVE CUSTOMER, INC., CARLSBAD, CA.
FILED 2-4-2010.

LIVE CUSTOMER

THE MARK CONSISTS OF STANDARD CHARACTERS WITHOUT CLAIM TO ANY PARTICULAR FONT, STYLE, SIZE, OR COLOR.

FOR ADVERTISING AND MARKETING SERVICES (U.S. CLS. 100, 101 AND 102).

FIRST USE 12-0-2003; IN COMMERCE 12-0-2003.
LINDA E. BLOHM, EXAMINING ATTORNEY

SN 77-928,512. MITCHELL, TYRA, K., COLUMBIA, SC.
FILED 2-4-2010.

JESUS BUTTON

THE MARK CONSISTS OF STANDARD CHARACTERS WITHOUT CLAIM TO ANY PARTICULAR FONT, STYLE, SIZE, OR COLOR.

NO CLAIM IS MADE TO THE EXCLUSIVE RIGHT TO USE "BUTTON", APART FROM THE MARK AS SHOWN.

FOR ADVERTISING THROUGH ALL PUBLIC COMMUNICATION MEANS (U.S. CLS. 100, 101 AND 102).

MELISSA VALLILLO, EXAMINING ATTORNEY

SN 77-928,391. MAPLEHURST BAKERIES, LLC, BROWNSBURG, IN. FILED 2-4-2010.

**YOUR SUCCESS IS THE CORE
OF OUR BUSINESS**

THE MARK CONSISTS OF STANDARD CHARACTERS WITHOUT CLAIM TO ANY PARTICULAR FONT, STYLE, SIZE, OR COLOR.

FOR DISTRIBUTORSHIP SERVICES IN THE FIELD OF BAKERY PRODUCTS (U.S. CLS. 100, 101 AND 102).

FIRST USE 9-0-2009; IN COMMERCE 9-0-2009.
THOMAS MANOR, EXAMINING ATTORNEY

SN 77-928,591. HOLLIS, CHRIS, HOUSTON, TX. FILED 2-4-2010.

ZOYTO

THE MARK CONSISTS OF STANDARD CHARACTERS WITHOUT CLAIM TO ANY PARTICULAR FONT, STYLE, SIZE, OR COLOR.

FOR ORDER FULFILLMENT SERVICES (U.S. CLS. 100, 101 AND 102).

FIRST USE 12-16-1998; IN COMMERCE 12-16-1998.
DAVID MURRAY, EXAMINING ATTORNEY

CLASS 35—(Continued).

SN 77-928,719. SQUARE SYSTEMS LTD, BRISTOL, UNITED KINGDOM, FILED 2-5-2010.

Opinion-8

THE MARK CONSISTS OF STANDARD CHARACTERS WITHOUT CLAIM TO ANY PARTICULAR FONT, STYLE, SIZE, OR COLOR.

FOR BUSINESS RESEARCH AND SURVEYS; CONDUCTING BUSINESS AND MARKET RESEARCH SURVEYS (U.S. CLS. 100, 101 AND 102).

FIRST USE 6-1-2003; IN COMMERCE 6-1-2003.
GINA FINK, EXAMINING ATTORNEY

SN 77-928,765. BREAKERS & CONTROLS NEW JERSEY, INC., DBA SUPERBREAKERS, CLIFTON, NJ. FILED 2-5-2010.



THE COLOR(S) RED, WHITE, BLACK, BLUE, YELLOW, BROWN, TAN IS/ARE CLAIMED AS A FEATURE OF THE MARK.

THE MARK CONSISTS OF A MAN WITH A BROWN MUSTACHE, A YELLOW HARD HAT, A RED CAPE, BLACK CABLE WIRE WRAPPED AROUND HIS RIGHT SHOULDER, A LIGHT TAN LONG-SLEEVE BUTTON DOWN SHIRT, A TAN BELT, BLUE JEANS AND TAN SHOES WITH THE TITLE "SUPERBREAKERS" PLACED TO THE RIGHT SIDE OF THE MAN, WRITTEN SLIGHTLY SLANTED TO THE RIGHT, IN ALL CAPITAL LETTERS IN BLUE, WHITE AND BLACK.

FOR WHOLESALE AND RETAIL STORE SERVICES AND ON-LINE RETAIL AND WHOLESALE STORE SERVICES FEATURING ELECTRICAL COMPONENTS (U.S. CLS. 100, 101 AND 102).

FIRST USE 7-9-2009; IN COMMERCE 7-9-2009.
JEFFERY COWARD, EXAMINING ATTORNEY

CLASS 35—(Continued).

SN 77-928,787. I-MOBILE MARKETING, LLC, SOUTHLAKE, TX. FILED 2-5-2010.



THE COLOR(S) BLUE, LIGHT BLUE, GRAY, BLACK AND WHITE IS/ARE CLAIMED AS A FEATURE OF THE MARK.

THE MARK CONSISTS OF A STYLIZED SMILING CARTOON WHALE WITH A BLUE BODY, A GRAY CHEST, A BLACK EYE, WHITE TEETH, AND THE COLOR WHITE SURROUNDING THE BLACK EYE; THE WHALE IS OUTLINED IN THE COLOR LIGHT BLUE. THE WORDING "MOBIDEALS" APPEARS TO THE RIGHT OF THE WHALE AND IS IN THE COLOR BLUE AND OUTLINED IN THE COLOR LIGHT BLUE.

FOR PROMOTING THE GOODS AND SERVICES OF OTHERS BY PROVIDING A WEBSITE FEATURING COUPONS, REBATES, PRICE-COMPARISON INFORMATION, PRODUCT REVIEWS, LINKS TO THE RETAIL WEBSITES OF OTHERS, AND DISCOUNT INFORMATION (U.S. CLS. 100, 101 AND 102).

COLLEEN DOMBROW, EXAMINING ATTORNEY

SN 77-928,803. CONSUMERS INTERSTATE CORPORATION, NORWICH, CT. FILED 2-5-2010.

THEINTERNETPATENT

THE MARK CONSISTS OF STANDARD CHARACTERS WITHOUT CLAIM TO ANY PARTICULAR FONT, STYLE, SIZE, OR COLOR.

FOR ON-LINE RETAIL STORE SERVICES FEATURING BUILDING MAINTENANCE, JANITORIAL, PACKAGING AND OFFICE SUPPLIES (U.S. CLS. 100, 101 AND 102).

JILL C. ALT, EXAMINING ATTORNEY

CLASS 35—(Continued).

SN 77-928,804. AMERICAN HOME SHIELD CORPORATION, MEMPHIS, TN. FILED 2-5-2010.

LIVE GREEN SAVE GREEN

THE MARK CONSISTS OF STANDARD CHARACTERS WITHOUT CLAIM TO ANY PARTICULAR FONT, STYLE, SIZE, OR COLOR.

FOR PROVIDING CONSUMER INFORMATION IN THE FIELD OF HOME OWNERSHIP; WARRANTY SERVICES, NAMELY, ARRANGING FOR REPAIRS AND REPLACEMENT OF MAJOR HOME SYSTEMS, APPLIANCES AND PARTS THEREOF PROVIDED BY OTHERS PURSUANT TO SERVICE AGREEMENTS; PROVIDING BUSINESS INFORMATION IN THE FIELD OF HOME WARRANTIES TO REAL ESTATE PROFESSIONALS, HOME BUYERS, HOME SELLERS, AND HOME REPAIR CONTRACTORS; PROVIDING CLIENT REFERRAL PROGRAMS IN THE FIELD OF HOME WARRANTIES FOR REAL ESTATE PROFESSIONALS AND HOME REPAIR CONTRACTORS (U.S. CLS. 100, 101 AND 102).

FIRST USE 2-4-2010; IN COMMERCE 2-4-2010.
JOHN WILKE, EXAMINING ATTORNEY

SN 77-928,806. AMERICAN HOME SHIELD CORPORATION, MEMPHIS, TN. FILED 2-5-2010.



THE MARK CONSISTS OF AN OVOID LEAF DESIGN SUPERIMPOSED OVER A HOUSE DESIGN.

FOR PROVIDING CONSUMER INFORMATION IN THE FIELD OF HOME OWNERSHIP; WARRANTY SERVICES, NAMELY, ARRANGING FOR REPAIRS AND REPLACEMENT OF MAJOR HOME SYSTEMS, APPLIANCES AND PARTS THEREOF PROVIDED BY OTHERS PURSUANT TO SERVICE AGREEMENTS; PROVIDING BUSINESS INFORMATION IN THE FIELD OF HOME WARRANTIES TO REAL ESTATE PROFESSIONALS, HOME BUYERS, HOME SELLERS, AND HOME REPAIR CONTRACTORS; PROVIDING CLIENT REFERRAL PROGRAMS IN THE FIELD OF HOME WARRANTIES FOR REAL ESTATE PROFESSIONALS AND HOME REPAIR CONTRACTORS (U.S. CLS. 100, 101 AND 102).

FIRST USE 2-4-2010; IN COMMERCE 2-4-2010.
JOHN WILKE, EXAMINING ATTORNEY

CLASS 35—(Continued).

SN 77-928,807. CONSUMERS INTERSTATE CORPORATION, NORWICH, CT. FILED 2-5-2010.

CLEANINGPRODUCTSWORLD

THE MARK CONSISTS OF STANDARD CHARACTERS WITHOUT CLAIM TO ANY PARTICULAR FONT, STYLE, SIZE, OR COLOR.

FOR ON-LINE RETAIL STORE SERVICES FEATURING BUILDING MAINTENANCE, JANITORIAL, PACKAGING AND OFFICE SUPPLIES (U.S. CLS. 100, 101 AND 102).

JILL C. ALT, EXAMINING ATTORNEY

SN 77-928,812. CONSUMERS INTERSTATE CORPORATION, NORWICH, CT. FILED 2-5-2010.

MOVINGBOXWORLD

THE MARK CONSISTS OF STANDARD CHARACTERS WITHOUT CLAIM TO ANY PARTICULAR FONT, STYLE, SIZE, OR COLOR.

FOR ON-LINE RETAIL STORE SERVICES FEATURING BUILDING MAINTENANCE, JANITORIAL, PACKAGING AND OFFICE SUPPLIES (U.S. CLS. 100, 101 AND 102).

JILL C. ALT, EXAMINING ATTORNEY

SN 77-928,818. CONSUMERS INTERSTATE CORPORATION, NORWICH, CT. FILED 2-5-2010.

GREENSUPPLIESWORLD

THE MARK CONSISTS OF STANDARD CHARACTERS WITHOUT CLAIM TO ANY PARTICULAR FONT, STYLE, SIZE, OR COLOR.

FOR ON-LINE RETAIL STORE SERVICES FEATURING BUILDING MAINTENANCE, JANITORIAL, PACKAGING AND OFFICE SUPPLIES (U.S. CLS. 100, 101 AND 102).

JILL C. ALT, EXAMINING ATTORNEY

CLASS 35—(Continued).

SN 77-928,821. MUNDO ART, INC., NEW YORK, NY. FILED 2-5-2010.

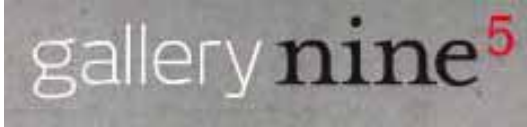

NO CLAIM IS MADE TO THE EXCLUSIVE RIGHT TO USE "GALLERY", APART FROM THE MARK AS SHOWN. THE COLOR(S) GRAY, WHITE, BLACK AND RED IS/ARE CLAIMED AS A FEATURE OF THE MARK.

THE MARK CONSISTS OF THE TEXT "GALLERY" IN THE COLOR WHITE, THE TEXT "NINE" IN THE COLOR BLACK, THE NUMBER "5" IN THE COLOR RED, AND GRAY AS THE BACKGROUND COLOR. "5" IN RED APPEARS IN SMALLER FONT FOLLOWING THE WORD "NINE", REPRESENTED AS AN EXPONENT FIGURE. THE RECTANGULAR SHAPE OF THE GRAY BACKGROUND IN THE DRAWING IS NOT CLAIMED AS A FEATURE OF THE MARK.

FOR ART GALLERIES (U.S. CLS. 100, 101 AND 102).
FIRST USE 4-19-2008; IN COMMERCE 5-25-2008.
REBECCA EISINGER, EXAMINING ATTORNEY

SN 77-928,853. WESTERN WATS CENTER, INC., OREM, UT. FILED 2-5-2010.

Opinionology

THE MARK CONSISTS OF STANDARD CHARACTERS WITHOUT CLAIM TO ANY PARTICULAR FONT, STYLE, SIZE, OR COLOR.

FOR ANALYSIS OF MARKET RESEARCH DATA AND STATISTICS; COLLECTION OF MARKET RESEARCH INFORMATION; CONDUCTING BUSINESS AND MARKET RESEARCH SURVEYS; CONSUMER MARKETING RESEARCH AND CONSULTING RELATED THERETO; MARKET RESEARCH; MARKET RESEARCH AND BUSINESS ANALYSES; MARKET RESEARCH AND MARKET INTELLIGENCE SERVICES; MARKET RESEARCH BY MEANS OF A COMPUTER DATABASE; MARKET RESEARCH CONSULTATION; MARKET RESEARCH SERVICES; MARKET RESEARCH STUDIES; MARKETING RESEARCH SERVICES; MARKETING SERVICES, NAMELY, CONSUMER MARKETING RESEARCH; PROVISION OF MARKET RESEARCH INFORMATION (U.S. CLS. 100, 101 AND 102).

MARLENE BELL, EXAMINING ATTORNEY

SN 77-928,860. SOLARIAT, INC, PELHAM, NY. FILED 2-5-2010.

Solariat

THE MARK CONSISTS OF STANDARD CHARACTERS WITHOUT CLAIM TO ANY PARTICULAR FONT, STYLE, SIZE, OR COLOR.

FOR ADVERTISING AND PUBLICITY SERVICES (U.S. CLS. 100, 101 AND 102).
BRIDGETT SMITH, EXAMINING ATTORNEY

CLASS 35—(Continued).

SN 77-928,863. SIONIC MOBILE CORPORATION, ATLANTA, GA. FILED 2-5-2010.

GeoSense

THE MARK CONSISTS OF STANDARD CHARACTERS WITHOUT CLAIM TO ANY PARTICULAR FONT, STYLE, SIZE, OR COLOR.

FOR ADVERTISEMENT VIA MOBILE PHONE NETWORKS (U.S. CLS. 100, 101 AND 102).

MARLENE BELL, EXAMINING ATTORNEY

SN 77-928,871. BARHAPPY LLC, HOBOKEN, NJ. FILED 2-5-2010.

BarHappy

THE MARK CONSISTS OF STANDARD CHARACTERS WITHOUT CLAIM TO ANY PARTICULAR FONT, STYLE, SIZE, OR COLOR.

FOR PROVIDING A SEARCHABLE ONLINE ADVERTISING WEBSITE AND INFORMATIONAL GUIDE FEATURING THE GOODS AND SERVICES OF OTHER VENDORS VIA THE INTERNET IN THE FIELD OF BARS, RESTAURANTS, AND CLUBS (U.S. CLS. 100, 101 AND 102).

FIRST USE 12-1-2009; IN COMMERCE 12-1-2009.
MICHAEL WEBSTER, EXAMINING ATTORNEY

SN 77-928,877. VICTORS & SPOILS, INC, BOULDER, CO. FILED 2-5-2010.

Victors & Spoils

THE MARK CONSISTS OF STANDARD CHARACTERS WITHOUT CLAIM TO ANY PARTICULAR FONT, STYLE, SIZE, OR COLOR.

FOR ADVERTISING AGENCIES (U.S. CLS. 100, 101 AND 102).

FIRST USE 10-2-2009; IN COMMERCE 10-29-2009.
MICHAEL WEBSTER, EXAMINING ATTORNEY

CLASS 35—(Continued).

SN 77-928,974. MOLDRX OF BUFFALO, LLC, WILLIAMS-VILLE, NY. FILED 2-5-2010.

THE MARK CONSISTS OF THE STYLIZED WORD "INNOV8VE", WITH THE NUMBER "8" APPEARING IN BETWEEN THE LETTER "V".

FOR INDEPENDENT SALES REPRESENTATIVES IN THE FIELD OF ADVERTISING AND MARKETING AIDES, NAMELY, PRINT AND SIGNS (U.S. CLS. 100, 101 AND 102).

DAVID COLLIER, EXAMINING ATTORNEY

CLASS 35—(Continued).

SN 77-929,171. FORD MOTOR COMPANY, DEARBORN, MI. FILED 2-5-2010.

START MORE THAN A CAR

THE MARK CONSISTS OF STANDARD CHARACTERS WITHOUT CLAIM TO ANY PARTICULAR FONT, STYLE, SIZE, OR COLOR.

FOR PROMOTING THE SALE OF GOODS AND SERVICES OF OTHERS IN THE AUTOMOTIVE INDUSTRY BY DISSEMINATION OF PROMOTIONAL MATERIALS AND PRODUCT INFORMATION THROUGH AN ONLINE GLOBAL COMPUTER NETWORK, THROUGH THE DISTRIBUTION OF PRINTED MATERIAL, AUDIO AND VIDEO RECORDINGS, TELEVISION AND RADIO ADVERTISING, ONLINE ADVERTISING, INTERNET WEB SITES, AND PROMOTIONAL CONTESTS (U.S. CLS. 100, 101 AND 102).

LESLIE RICHARDS, EXAMINING ATTORNEY

SN 77-929,003. ROBERT S. GORDON, DBA REFRESH HEALTHCARE CONSULTING, WEST ORANGE, NJ. FILED 2-5-2010.

Extend-A-Rep

THE MARK CONSISTS OF STANDARD CHARACTERS WITHOUT CLAIM TO ANY PARTICULAR FONT, STYLE, SIZE, OR COLOR.

FOR SALES SUPPORT, NAMELY, BUSINESS MARKETING SERVICES (U.S. CLS. 100, 101 AND 102).

FIRST USE 1-14-2010; IN COMMERCE 1-14-2010.

LEIGH CAROLINE CASE, EXAMINING ATTORNEY

SN 77-929,184. INTERLINE BRANDS, INC., JACKSONVILLE, FL. FILED 2-5-2010.

SN 77-929,142. DAWNBREAKER, INC., ROCHESTER, NY. FILED 2-5-2010.

LICA

THE MARK CONSISTS OF STANDARD CHARACTERS WITHOUT CLAIM TO ANY PARTICULAR FONT, STYLE, SIZE, OR COLOR.

FOR BUSINESS ADVICE AND ANALYSIS OF MARKETS; BUSINESS ADVICE AND COMMERCIAL INFORMATION; BUSINESS CONSULTATION; BUSINESS CONSULTATION IN THE FIELD OF LICENSEE ANALYSIS; BUSINESS INFORMATION IN THE FIELD OF LICENSEE ANALYSIS; INFORMATION AND EXPERT OPINIONS RELATING TO COMPANIES AND BUSINESS; MARKET RESEARCH AND BUSINESS ANALYSES (U.S. CLS. 100, 101 AND 102).

FIRST USE 10-31-2008; IN COMMERCE 10-31-2008.

LEIGH CAROLINE CASE, EXAMINING ATTORNEY

AmSan

THE MARK CONSISTS OF STANDARD CHARACTERS WITHOUT CLAIM TO ANY PARTICULAR FONT, STYLE, SIZE, OR COLOR.

OWNER OF U.S. REG. NOS. 2,464,679, 3,076,262 AND OTHERS.

FOR ONLINE CATALOG AND ORDERING SERVICES FEATURING JANITORIAL SUPPLIES AND CLEANING PRODUCTS (U.S. CLS. 100, 101 AND 102).

FIRST USE 6-30-2005; IN COMMERCE 6-30-2005.

ANGELA M. MICHELI, EXAMINING ATTORNEY

CLASS 35—(Continued).

SN 77-929,222. CLARENDON CAPITAL CORPORATION, ATLANTA, GA. FILED 2-5-2010.

The Clear Choice in Outdoor Advertising

THE MARK CONSISTS OF STANDARD CHARACTERS WITHOUT CLAIM TO ANY PARTICULAR FONT, STYLE, SIZE, OR COLOR.

FOR ADVERTISING AND ADVERTISEMENT SERVICES; ADVERTISING AND MARKETING SERVICES, NAMELY, PROMOTING THE GOODS AND SERVICES OF OTHERS; ELECTRONIC BILLBOARD ADVERTISING; OUT-OF-HOME ADVERTISING SERVICES, NAMELY, RENTAL OF ADVERTISING SPACE, AND PREPARING AND PLACING ADVERTISEMENTS FOR OTHERS; PREPARING AND PLACING OUTDOOR ADVERTISEMENTS FOR OTHERS; PROVIDING ADVERTISING SPACE ON BILLBOARDS AND IN KIOSKS; RENTAL OF ADVERTISING SPACE; RENTAL OF SIGNS FOR ADVERTISING PURPOSES (U.S. CLS. 100, 101 AND 102).

DOMINICK J. SALEMI, EXAMINING ATTORNEY

SN 77-929,248. INTERLINE BRANDS, INC., JACKSONVILLE, FL. FILED 2-5-2010.

AmSan

OWNER OF U.S. REG. NOS. 2,369,493, 2,942,331 AND OTHERS.

THE MARK CONSISTS OF THE WORD "AMSAN" WITH A THREE-POINTED STAR IN THE CENTER OF THE "A". FOR ONLINE CATALOG AND ORDERING SERVICES FEATURING JANITORIAL SUPPLIES AND CLEANING PRODUCTS (U.S. CLS. 100, 101 AND 102).

FIRST USE 6-30-2005; IN COMMERCE 6-30-2005.
ANGELA M. MICHELI, EXAMINING ATTORNEY

CLASS 35—(Continued).

SN 77-929,336. THE PATIENT-PHYSICIAN ALLIANCE, INC., BERKELEY, CA. FILED 2-5-2010.

PharmaAlarma

THE MARK CONSISTS OF STANDARD CHARACTERS WITHOUT CLAIM TO ANY PARTICULAR FONT, STYLE, SIZE, OR COLOR.

FOR MEMBERSHIP CLUB SERVICES PROVIDING DISCOUNTS AND PROCESSING REBATES FOR THE SERVICES OF OTHERS (U.S. CLS. 100, 101 AND 102).

STEVEN JACKSON, EXAMINING ATTORNEY

SN 77-929,502. 5THOUGHT SOLUTIONS INC., DBA 5THOUGHT, STUDIO CITY, CA. FILED 2-5-2010.

5Thought

THE MARK CONSISTS OF STANDARD CHARACTERS WITHOUT CLAIM TO ANY PARTICULAR FONT, STYLE, SIZE, OR COLOR.

FOR BUSINESS ADVISORY SERVICES, CONSULTANCY AND INFORMATION (U.S. CLS. 100, 101 AND 102).

NAAKWAMA ANKRAH, EXAMINING ATTORNEY

SN 77-929,516. MARV GOLDEN DISCOUNT SALES, INC., SAN DIEGO, CA. FILED 2-5-2010.

MARVMILES

THE MARK CONSISTS OF STANDARD CHARACTERS WITHOUT CLAIM TO ANY PARTICULAR FONT, STYLE, SIZE, OR COLOR.

FOR CUSTOMER LOYALTY SERVICES AND CUSTOMER CLUB SERVICES, FOR COMMERCIAL, PROMOTIONAL AND/OR ADVERTISING PURPOSES; PROVIDING INCENTIVE AWARD PROGRAMS FOR CUSTOMERS AND EMPLOYEES THROUGH THE DISTRIBUTION OF PREPAID STORED VALUE CARDS FOR THE PURPOSE OF PROMOTING AND REWARDING LOYALTY; PROVIDING INCENTIVE AWARD PROGRAMS FOR CUSTOMERS THROUGH ISSUANCE AND PROCESSING OF LOYALTY POINTS FOR ONLINE PURCHASE OF COMPANY'S GOODS AND SERVICES (U.S. CLS. 100, 101 AND 102).

H. M. FISHER, EXAMINING ATTORNEY

CLASS 35—(Continued).

SN 77-929,520. DENNIS FOLAND, INC., ONTARIO, CA.
FILED 2-5-2010.

MY PRIZE LOCKER...

THE MARK CONSISTS OF STANDARD CHARACTERS WITHOUT CLAIM TO ANY PARTICULAR FONT, STYLE, SIZE, OR COLOR.

NO CLAIM IS MADE TO THE EXCLUSIVE RIGHT TO USE "PRIZE", APART FROM THE MARK AS SHOWN.

FOR PROVIDING INCENTIVE AWARD PROGRAMS FOR SCHOOL FUNDRAISER PARTICIPANTS VIA ISSUANCE OF PRIZES TO PROMOTE THE SALE OF PRODUCTS AND SERVICES OF OTHERS (U.S. CLS. 100, 101 AND 102).

FIRST USE 4-0-2009; IN COMMERCE 4-0-2009.
ZHALEH DELANEY, EXAMINING ATTORNEY

SN 77-929,526. DENNIS FOLAND, INC., ONTARIO, CA.
FILED 2-5-2010.

PRIZE ZONE

THE MARK CONSISTS OF STANDARD CHARACTERS WITHOUT CLAIM TO ANY PARTICULAR FONT, STYLE, SIZE, OR COLOR.

NO CLAIM IS MADE TO THE EXCLUSIVE RIGHT TO USE "PRIZE", APART FROM THE MARK AS SHOWN.

FOR PROVIDING INCENTIVE AWARD PROGRAMS FOR SCHOOL FUNDRAISER PARTICIPANTS VIA ISSUANCE OF PRIZES TO PROMOTE THE SALE OF PRODUCTS AND SERVICES OF OTHERS (U.S. CLS. 100, 101 AND 102).

FIRST USE 4-0-2009; IN COMMERCE 4-0-2009.
ZHALEH DELANEY, EXAMINING ATTORNEY

SN 77-929,570. ALETHEIA RESEARCH AND MANAGEMENT, INC., SANTA MONICA, CA. FILED 2-5-2010.

Aletheia 100 Insider Index

THE MARK CONSISTS OF STANDARD CHARACTERS WITHOUT CLAIM TO ANY PARTICULAR FONT, STYLE, SIZE, OR COLOR.

OWNER OF U.S. REG. NO. 2,346,821.

NO CLAIM IS MADE TO THE EXCLUSIVE RIGHT TO USE "100 INSIDER INDEX", APART FROM THE MARK AS SHOWN.

FOR PROVIDING FINANCIAL INDICES OF SELECT SECURITIES TO ENABLE CONSUMERS TO EVALUATE INVESTMENTS AND MARKET TRENDS IN THE SECURITIES MARKET (U.S. CLS. 100, 101 AND 102).

FIRST USE 9-1-1999; IN COMMERCE 9-1-1999.
ROBIN MITTLER, EXAMINING ATTORNEY

CLASS 35—(Continued).

SN 77-929,577. ABRAMOWITZ, DEAN, IRVINE, CA. FILED 2-5-2010.

ZENZU

THE MARK CONSISTS OF STANDARD CHARACTERS WITHOUT CLAIM TO ANY PARTICULAR FONT, STYLE, SIZE, OR COLOR.

FOR BUSINESS SERVICES, NAMELY, PROVIDING COMPUTER DATABASES REGARDING THE PURCHASE AND SALE OF A WIDE VARIETY OF PRODUCTS AND SERVICES OF OTHERS (U.S. CLS. 100, 101 AND 102).

ADA HAN, EXAMINING ATTORNEY

SN 77-929,583. CASSELS, DEREK, TUSCALOOSA, AL. FILED 2-5-2010.

CUP-N-DUCKS

THE MARK CONSISTS OF STANDARD CHARACTERS WITHOUT CLAIM TO ANY PARTICULAR FONT, STYLE, SIZE, OR COLOR.

FOR ON-LINE RETAIL STORE SERVICES FEATURING HUNTING APPAREL (U.S. CLS. 100, 101 AND 102).

LINDA ESTRADA, EXAMINING ATTORNEY

SN 77-929,592. APPSESSION INC., TORONTO, ONTARIO, CANADA, FILED 2-5-2010.

TARGETIVITY

THE MARK CONSISTS OF STANDARD CHARACTERS WITHOUT CLAIM TO ANY PARTICULAR FONT, STYLE, SIZE, OR COLOR.

FOR ONLINE ADVERTISING AND MARKETING SERVICES FOR OTHERS (U.S. CLS. 100, 101 AND 102).

MARGERY A. TIERNEY, EXAMINING ATTORNEY

CLASS 35—(Continued).

SN 77-929,637. DENNIS FOLAND, INC., ONTARIO, CA. FILED 2-5-2010.

PRIZE BUDDIES

THE MARK CONSISTS OF STANDARD CHARACTERS WITHOUT CLAIM TO ANY PARTICULAR FONT, STYLE, SIZE, OR COLOR.

NO CLAIM IS MADE TO THE EXCLUSIVE RIGHT TO USE "PRIZE", APART FROM THE MARK AS SHOWN.

FOR PROVIDING INCENTIVE AWARD PROGRAMS FOR SCHOOL FUNDRAISER PARTICIPANTS VIA ISSUANCE OF PRIZES TO PROMOTE THE SALE OF PRODUCTS AND SERVICES OF OTHERS (U.S. CLS. 100, 101 AND 102).

FIRST USE 4-0-2009; IN COMMERCE 4-0-2009.
ZHALEH DELANEY, EXAMINING ATTORNEY

SN 77-929,682. FRAIMZ, LLC, PALM BEACH, FL. FILED 2-5-2010.

SPEXCLUB

THE MARK CONSISTS OF STANDARD CHARACTERS WITHOUT CLAIM TO ANY PARTICULAR FONT, STYLE, SIZE, OR COLOR.

FOR ON-LINE RETAIL STORE SERVICES FEATURING EYEWEAR AND EYEWEAR RELATED ACCESSORIES (U.S. CLS. 100, 101 AND 102).

JULIE WATSON, EXAMINING ATTORNEY

SN 77-929,773. RASHE Q. CLARKSON, AKA YUNG FLY, SAINT PETERSBURG, FL. FILED 2-6-2010.

YUNG FLY

THE MARK CONSISTS OF STANDARD CHARACTERS WITHOUT CLAIM TO ANY PARTICULAR FONT, STYLE, SIZE, OR COLOR.

FOR ENTERTAINMENT MARKETING SERVICES, NAMELY, MARKETING, PROMOTION AND ADVERTISING FOR INDEPENDENT RECORDING ARTISTS (U.S. CLS. 100, 101 AND 102).

SANJEEV VOHRA, EXAMINING ATTORNEY

CLASS 35—(Continued).

SN 77-929,789. HEALTHCARE SOLUTIONS LLC, DBA PHARMABID, PORTLAND, OR. FILED 2-6-2010.

PHARMABID

THE MARK CONSISTS OF STANDARD CHARACTERS WITHOUT CLAIM TO ANY PARTICULAR FONT, STYLE, SIZE, OR COLOR.

FOR ORGANISATION OF INTERNET AUCTIONS (U.S. CLS. 100, 101 AND 102).

FIRST USE 3-14-2007; IN COMMERCE 3-14-2007.

LEIGH CAROLINE CASE, EXAMINING ATTORNEY

SN 77-929,876. RIGHTSCUBE, INC., FORMERLY ZIPNANNY, INC., NEW YORK, NY. FILED 2-6-2010.

RightsTrade

THE MARK CONSISTS OF STANDARD CHARACTERS WITHOUT CLAIM TO ANY PARTICULAR FONT, STYLE, SIZE, OR COLOR.

FOR THE BRINGING TOGETHER, FOR THE BENEFIT OF OTHERS, OF A VARIETY OF GOODS AND SERVICES, ENABLING CUSTOMERS TO CONVENIENTLY VIEW AND PURCHASE THOSE GOODS AND SERVICES FROM AN INTERNET WEB SITE PARTICULARLY SPECIALIZING IN THE MARKETING OF THE SALE OF GOODS AND SERVICES OF OTHERS (U.S. CLS. 100, 101 AND 102).

KAELIE KUNG, EXAMINING ATTORNEY

SN 77-929,910. JOHN D HOOD, VANCOUVER, WA. FILED 2-7-2010.

Mustang Youth Lacrosse

THE MARK CONSISTS OF STANDARD CHARACTERS WITHOUT CLAIM TO ANY PARTICULAR FONT, STYLE, SIZE, OR COLOR.

NO CLAIM IS MADE TO THE EXCLUSIVE RIGHT TO USE "YOUTH LACROSSE", APART FROM THE MARK AS SHOWN.

FOR ADMINISTRATION OF COMMUNITY RECREATIONAL SPORTS LEAGUES; COORDINATION OF RECREATIONAL SPORTING OPPORTUNITIES FOR INDIVIDUALS WHO WISH TO PARTICIPATE IN TEAM LEAGUE SPORTS; PROMOTING THE INTERESTS OF PEOPLE INVOLVED AND CONCERNED WITH YOUTH SPORTS; PROVIDING A WEB SITE THAT PROVIDES SPORTS LEAGUE MANAGEMENT; PROVIDING ON-LINE REGISTRATION SERVICES FOR LACROSSE LEAGUES (U.S. CLS. 100, 101 AND 102).

TARAH HARDY, EXAMINING ATTORNEY

CLASS 35—(Continued).

SN 77-930,115. ARNETT, VIRGINIA E., NEWPORT BEACH, CA. FILED 2-8-2010.

The Christmas Card Lady

THE MARK CONSISTS OF STANDARD CHARACTERS WITHOUT CLAIM TO ANY PARTICULAR FONT, STYLE, SIZE, OR COLOR.

NO CLAIM IS MADE TO THE EXCLUSIVE RIGHT TO USE "CHRISTMAS CARD", APART FROM THE MARK AS SHOWN.

FOR CATALOG ORDERING SERVICE FEATURING ART PRINTS, CALENDARS, GREETING CARDS, POSTERS, AND STATIONERY; MAIL ORDER CATALOG SERVICES FEATURING ART PRINTS, CALENDARS, GREETING CARDS, POSTERS, AND STATIONERY; RETAIL STORE AND ON-LINE RETAIL STORE SERVICES FEATURING ART PRINTS, CALENDARS, GREETING CARDS, POSTERS, AND STATIONERY (U.S. CLS. 100, 101 AND 102).

FIRST USE 0-0-1992; IN COMMERCE 0-0-1997.
RONALD MCMORROW, EXAMINING ATTORNEY



SN 77-930,120. COLLINS, SARAH STANTON, OAK HILL, VA. FILED 2-8-2010.

PharManage

THE MARK CONSISTS OF STANDARD CHARACTERS WITHOUT CLAIM TO ANY PARTICULAR FONT, STYLE, SIZE, OR COLOR.

FOR ADMINISTERING MEDICATION REIMBURSEMENT PROGRAMS AND SERVICES; ADMINISTERING PHARMACY REIMBURSEMENT PROGRAMS AND SERVICES; BUSINESS ADVISORY SERVICES, CONSULTANCY AND INFORMATION; BUSINESS INFORMATION REPORTING SERVICES FOR HOSPITALS, NAMELY, PROVIDING HOSPITAL SPECIFIC REPORTS FOR THE PURPOSE OF ANALYZING GOVERNMENT REIMBURSEMENT DATA AND DRIVE BUSINESS DECISION MAKING (U.S. CLS. 100, 101 AND 102).

FIRST USE 7-1-2009; IN COMMERCE 7-1-2009.
RONALD MCMORROW, EXAMINING ATTORNEY

CLASS 35—(Continued).

SN 77-930,127. ARNETT, VIRGINIA E., NEWPORT BEACH, CA. FILED 2-8-2010.



THE MARK CONSISTS OF A WOMAN SEATED ON A STOOL HOLDING A FILE FOLDER AND READING A CARD.

FOR CATALOG ORDERING SERVICE FEATURING ART PRINTS, CALENDARS, GREETING CARDS, POSTERS, STATIONERY; MAIL ORDER CATALOG SERVICES FEATURING ART PRINTS, CALENDARS, GREETING CARDS, POSTERS, STATIONERY; RETAIL STORE AND ON-LINE RETAIL STORE SERVICES FEATURING ART PRINTS, CALENDARS, GREETING CARDS, POSTERS, STATIONERY (U.S. CLS. 100, 101 AND 102).

FIRST USE 0-0-1992; IN COMMERCE 0-0-1997.
RONALD MCMORROW, EXAMINING ATTORNEY



SN 77-930,146. AMERICAN FIDELITY ASSURANCE COMPANY, OKLAHOMA CITY, OK. FILED 2-8-2010.

WE ARE AFA

THE MARK CONSISTS OF STANDARD CHARACTERS WITHOUT CLAIM TO ANY PARTICULAR FONT, STYLE, SIZE, OR COLOR.

FOR EMPLOYMENT HIRING, RECRUITING, PLACEMENT, STAFFING AND CAREER NETWORKING SERVICES (U.S. CLS. 100, 101 AND 102).

FIRST USE 1-22-2009; IN COMMERCE 1-22-2009.
JOSETTE BEVERLY, EXAMINING ATTORNEY

CLASS 35—(Continued).

SN 77-930,166. VAN WINKLE & ASSOCIATES, INC., ATLANTA, GA. FILED 2-8-2010.

ThinkResults

THE MARK CONSISTS OF STANDARD CHARACTERS WITHOUT CLAIM TO ANY PARTICULAR FONT, STYLE, SIZE, OR COLOR.

FOR ADVERTISING AND MARKETING SERVICES, NAMELY, PROMOTING THE GOODS AND SERVICES OF OTHERS (U.S. CLS. 100, 101 AND 102).

FIRST USE 6-30-2006; IN COMMERCE 6-30-2006.
ARETHA SOMERVILLE, EXAMINING ATTORNEY

SN 77-930,319. MORPHOLYTICS, LLC, DBA SUMBAA.COM, NEWARK, NJ. FILED 2-8-2010.



THE COLOR(S) ORANGE IS/ARE CLAIMED AS A FEATURE OF THE MARK.

THE MARK CONSISTS OF ALL LOWER-CASE LETTERS IN ORANGE.

FOR BUSINESS MONITORING AND CONSULTING SERVICES, NAMELY, TRACKING WEB SITES AND APPLICATIONS OF OTHERS TO PROVIDE STRATEGY, INSIGHT, MARKETING, SALES, OPERATION, PRODUCT DESIGN, PARTICULARLY SPECIALIZING IN THE USE OF ANALYTIC AND STATISTIC MODELS FOR THE UNDERSTANDING AND PREDICTING OF CONSUMERS, BUSINESSES, AND MARKET TRENDS AND ACTIONS; BUSINESS MONITORING SERVICES, NAMELY, TRACKING WEB SITES OF OTHERS TO PROVIDE DETAILS ABOUT USER CLICK TRAFFIC OR VISITS TO THE WEB SITE (U.S. CLS. 100, 101 AND 102).

FIRST USE 5-1-2008; IN COMMERCE 7-12-2008.
ALICIA COLLINS, EXAMINING ATTORNEY

CLASS 35—(Continued).

SN 77-930,358. SOFTLINE SOLUTIONS LLC, LOS ANGELES, CA. FILED 2-8-2010.

Softline Solutions

THE MARK CONSISTS OF STANDARD CHARACTERS WITHOUT CLAIM TO ANY PARTICULAR FONT, STYLE, SIZE, OR COLOR.

NO CLAIM IS MADE TO THE EXCLUSIVE RIGHT TO USE "SOLUTIONS", APART FROM THE MARK AS SHOWN.

FOR CONSULTING SERVICES IN THE FIELD OF INTERNET MARKETING; MARKETING AND CONSULTING SERVICES IN THE FIELD OF PROMOTING AND TRACKING THE GOODS, SERVICES, AND BRANDS OF OTHERS THROUGH ALL PUBLIC COMMUNICATION MEANS, PARTICULARLY SPECIALIZING IN THE USE OF MOBILE, SOCIAL, AND PRINT MEDIA TO DRIVE CONSUMER INTEREST, ENGAGEMENT AND ACTION; PROVIDING INFORMATION IN THE FIELD OF MARKETING AND ON-LINE MARKETING MEDIA VIA THE INTERNET (U.S. CLS. 100, 101 AND 102).

FIRST USE 4-1-2008; IN COMMERCE 4-1-2008.
LIEF MARTIN, EXAMINING ATTORNEY

SN 77-930,379. ZIMMERMAN, MARK R., BLACKLICK, OH. AND ZIMMERMAN JR., STEPHAN R., BLACKLICK, OH. FILED 2-8-2010.



NO CLAIM IS MADE TO THE EXCLUSIVE RIGHT TO USE "SCHOOL EQUIPPERS", APART FROM THE MARK AS SHOWN.

THE MARK CONSISTS OF THE LETTERS "S" AND "E" THAT FORM A PENCIL AT THE TOP OF EACH LETTER COMBINED, WITH A LINE STARTING AT THE PENCIL TIP AND ENDING AT THE BASE OF THE "S" IN THE "SE". THE "SE" HAS A SHADOW BEHIND IT OF THE LETTERS. THE WORDS "SCHOOLEQUIPPERS" ARE UNDERNEATH THE "SE".

FOR RESELLER SERVICES, NAMELY, DISTRIBUTORSHIP SERVICES IN THE FIELDS OF SCHOOL EQUIPMENT AND FURNITURE, CORPORATE OFFICE EQUIPMENT AND FURNITURE, RESIDENTIAL OFFICE EQUIPMENT AND FURNITURE, AND HEALTH CARE EQUIPMENT AND FURNITURE (U.S. CLS. 100, 101 AND 102).

FIRST USE 10-14-2009; IN COMMERCE 10-14-2009.
ASMAT KHAN, EXAMINING ATTORNEY

CLASS 35—(Continued).

SN 77-930,415. THAKER, ANAND, VESTAVIA HILLS, AL. FILED 2-8-2010.

NeoMarketing

THE MARK CONSISTS OF STANDARD CHARACTERS WITHOUT CLAIM TO ANY PARTICULAR FONT, STYLE, SIZE, OR COLOR.

FOR CONSULTING SERVICES IN THE FIELD OF INTERNET MARKETING (U.S. CLS. 100, 101 AND 102).
ROBIN CHOSID, EXAMINING ATTORNEY

CLASS 35—(Continued).

SN 77-930,592. DAZBOG COFFEE CO., DENVER, CO. FILED 2-8-2010.

DAZBOG

THE MARK CONSISTS OF STANDARD CHARACTERS WITHOUT CLAIM TO ANY PARTICULAR FONT, STYLE, SIZE, OR COLOR.

OWNER OF U.S. REG. NOS. 3,132,729, 3,147,342 AND OTHERS.

THE ENGLISH TRANSLATION OF "DAZBOG" IN THE MARK IS SUN GOD.

FOR ASSISTANCE IN BUSINESS MANAGEMENT AND PRODUCT COMMERCIALIZATION, WITHIN THE FRAMEWORK OF A FRANCHISE CONTRACT; FRANCHISING, NAMELY, CONSULTATION AND ASSISTANCE IN BUSINESS MANAGEMENT, ORGANIZATION AND PROMOTION (U.S. CLS. 100, 101 AND 102).

FIRST USE 1-1-2006; IN COMMERCE 1-1-2006.

APRIL ROACH, EXAMINING ATTORNEY

SN 77-930,600. POLACY.US LLC, ELMHURST, NY. FILED 2-8-2010.

polacy.us

THE MARK CONSISTS OF THE STYLIZED TEXT "POLACY.US" WITH A FLAG OVER THE LETTER "L".

FOR ADVERTISING AND DIRECTORY SERVICES, NAMELY, PROMOTING THE SERVICES OF OTHERS BY PROVIDING A WEB PAGE FEATURING LINKS TO THE WEBSITES OF OTHERS (U.S. CLS. 100, 101 AND 102).

KATHERINE E. HALMEN, EXAMINING ATTORNEY

SN 77-930,550. EDELMAN, INC., CHICAGO, IL. FILED 2-8-2010.



THE COLOR(S) BLUE, MEDIUM BLUE, AND NAVY BLUE IS/ARE CLAIMED AS A FEATURE OF THE MARK.

THE MARK CONSISTS OF THREE TRIANGLES, EACH ONE SHOWN IN A DIFFERENT SHADE OF BLUE, JOINED AT ONE CORNER SO AS TO FORM THREE SECTIONS OF A RHOMBUS.

FOR PUBLIC RELATIONS (U.S. CLS. 100, 101 AND 102).

FIRST USE 10-1-2002; IN COMMERCE 10-1-2002.

DAVID MURRAY, EXAMINING ATTORNEY

SN 77-930,641. FAN FARMERS LLC, MENLO PARK, CA. FILED 2-8-2010.

WE GROW FANS

THE MARK CONSISTS OF STANDARD CHARACTERS WITHOUT CLAIM TO ANY PARTICULAR FONT, STYLE, SIZE, OR COLOR.

FOR SOCIAL MEDIA STRATEGY AND MARKETING CONSULTANCY FOCUSING ON HELPING CLIENTS CREATE AND EXTEND THEIR PRODUCT AND BRAND STRATEGIES BY BUILDING VIRALLY ENGAGING MARKETING SOLUTIONS (U.S. CLS. 100, 101 AND 102).

DOMINIC FATHY, EXAMINING ATTORNEY

CLASS 35—(Continued).

SN 77-930,642. GFK CUSTOM RESEARCH, LLC, NEW YORK, NY. FILED 2-8-2010.

FUTURE BUY

THE MARK CONSISTS OF STANDARD CHARACTERS WITHOUT CLAIM TO ANY PARTICULAR FONT, STYLE, SIZE, OR COLOR.

FOR RESEARCH AND CONSULTING SERVICES FOCUSING ON THE FUTURE OF SHOPPING DESIGNED TO HELP MARKETERS UNDERSTAND THE NEW SHOPPER MARKETPLACE AND PROVIDE A ROADMAP FOR NEAR-TERM TACTICAL PROGRAMS AND LONGER-TERM STRATEGY AND INNOVATION (U.S. CLS. 100, 101 AND 102).

FIRST USE 3-27-2009; IN COMMERCE 3-27-2009.
ADA HAN, EXAMINING ATTORNEY

CLASS 35—(Continued).

SN 77-930,697. MICHAEL KING, DARNESTOWN, MD. FILED 2-8-2010.



THE MARK CONSISTS OF A GRAPHIC IMAGE OF A POINTED ARROWHEAD ON A RECTANGULAR BACKGROUND CARRIER.

FOR ONLINE RETAIL STORE SERVICES FEATURING CLOTHING; ONLINE RETAIL STORES FEATURING CLOTHING; RETAIL STORE SERVICES FEATURING CLOTHING; MAIL ORDER CATALOG SERVICES IN THE FIELD OF CLOTHING; MAIL ORDER SERVICES IN THE FIELD OF CLOTHING; RETAIL STORES FEATURING CLOTHING (U.S. CLS. 100, 101 AND 102).

PATRICIA EVANKO, EXAMINING ATTORNEY

SN 77-930,699. FATHOM SEO, LLC, VALLEY VIEW, OH. FILED 2-8-2010.

Battle Plan

THE MARK CONSISTS OF STANDARD CHARACTERS WITHOUT CLAIM TO ANY PARTICULAR FONT, STYLE, SIZE, OR COLOR.

FOR ADVERTISING AND MARKETING; BRANDING SERVICES, NAMELY, CONSULTING, DEVELOPMENT, MANAGEMENT AND MARKETING OF BRANDS FOR BUSINESSES; BUSINESS MARKETING CONSULTING SERVICES; BUSINESS MARKETING SERVICES; CONSULTING SERVICES IN THE FIELD OF INTERNET MARKETING; DEVELOPMENT OF MARKETING STRATEGIES AND CONCEPTS; MARKETING ANALYSIS SERVICES; MARKETING AND BRANDING SERVICES, NAMELY, PERFORMING CONSUMER INSIGHT AND BRAND STRATEGY OF COMPANY LOGOS; MARKETING CONSULTING; MARKETING PLAN DEVELOPMENT; ON-LINE ADVERTISING AND MARKETING SERVICES; PLANNING, DESIGN, DEVELOPMENT, MAINTENANCE, TRACKING, REPORTING AND OPTIMIZATION OF ONLINE MARKETING ACTIVITIES FOR THIRD PARTIES; PROMOTING, ADVERTISING AND MARKETING OF THE ON-LINE WEB SITES OF OTHERS; PROMOTION AND MARKETING SERVICES AND RELATED CONSULTING; PROMOTION, ADVERTISING AND MARKETING OF ON-LINE WEBSITES (U.S. CLS. 100, 101 AND 102).

FIRST USE 2-6-2009; IN COMMERCE 2-6-2009.
BARBARA RUTLAND, EXAMINING ATTORNEY

SN 77-930,661. MICHAEL KING, DARNESTOWN, MD. FILED 2-8-2010.

ARROWHEADVA

THE MARK CONSISTS OF STANDARD CHARACTERS WITHOUT CLAIM TO ANY PARTICULAR FONT, STYLE, SIZE, OR COLOR.

FOR ONLINE RETAIL STORE SERVICES FEATURING CLOTHING; ONLINE RETAIL STORES FEATURING CLOTHING; RETAIL STORE SERVICES FEATURING CLOTHING; MAIL ORDER CATALOG SERVICES IN THE FIELD OF CLOTHING; MAIL ORDER SERVICES IN THE FIELD OF CLOTHING; RETAIL STORES FEATURING CLOTHING (U.S. CLS. 100, 101 AND 102).

PATRICIA EVANKO, EXAMINING ATTORNEY

CLASS 35—(Continued).

SN 77-930,704. IST INC., CINCINNATI, OH. FILED 2-8-2010.



THE MARK CONSISTS OF A PARTIALLY SHADED GLOBE IN WHICH LINES OF VARYING THICKNESS INTERSECT AND FORM THE BOUNDARIES FOR THE SHADED PORTIONS.

FOR MANAGEMENT AND BUSINESS CONSULTING SERVICES IN THE FIELD OF INFORMATION SERVICES AND STAFFING (U.S. CLS. 100, 101 AND 102).

FIRST USE 2-8-2010; IN COMMERCE 2-8-2010.
KIMBERLY FRYE, EXAMINING ATTORNEY

SN 77-930,711. WEBSISTANT, L.L.C., GLENDALE, CA. FILED 2-8-2010.

Zinkio

THE MARK CONSISTS OF STANDARD CHARACTERS WITHOUT CLAIM TO ANY PARTICULAR FONT, STYLE, SIZE, OR COLOR.

FOR APPOINTMENT SCHEDULING SERVICES; CAREER PLACEMENT; EMPLOYMENT SERVICES, NAMELY, PROVIDING A WEB SITE WITH ONLINE VIDEO, AUDIO AND TEXTUAL INTERVIEWING APPLICATIONS TO SUPPORT RECRUITING, ADMISSIONS, AND GENERAL CANDIDATE SCREENING PROCESSES; ON-LINE PROFESSIONAL NETWORKING SERVICES; PROVIDING AN ON-LINE SEARCHABLE DATABASE FEATURING EMPLOYMENT OPPORTUNITIES; PROVIDING NETWORKING OPPORTUNITIES FOR INDIVIDUALS SEEKING EMPLOYMENT (U.S. CLS. 100, 101 AND 102).

JAMES STEIN, EXAMINING ATTORNEY

CLASS 35—(Continued).

SN 77-930,732. ENERGY PLUS HOLDINGS LLC, PHILADELPHIA, PA. FILED 2-8-2010.

ENERGY PLUS 

NO CLAIM IS MADE TO THE EXCLUSIVE RIGHT TO USE "ENERGY", APART FROM THE MARK AS SHOWN.

THE MARK CONSISTS OF THE STYLIZED PRESENTATION OF THE WORDS "ENERGY PLUS" IN CAPITAL LETTERS, NEXT TO A DESIGN THAT FORMS A STYLIZED REPRESENTATION OF A PLUS SYMBOL.

FOR PROCUREMENT, NAMELY, PURCHASING OF ENERGY FOR OTHERS; PROVIDING A WEBSITE FEATURING BUSINESS INFORMATION ABOUT ENERGY MANAGEMENT, USE, COSTS AND CONSERVATION; BUSINESS CONSULTATION SERVICES IN THE FIELDS OF ENERGY CONSUMPTION, ENERGY CONSERVATION AND ENERGY USE MANAGEMENT; ENERGY MANAGEMENT SERVICES, NAMELY, FORMULATING ENERGY CONSUMPTION PLANS TO REDUCE ENERGY COSTS AND TO REDUCE RISKS ASSOCIATED WITH CHANGING ENERGY COSTS; BUSINESS INFORMATION SERVICES, NAMELY, PROVIDING INFORMATION REGARDING ENERGY CONSUMPTION AND ENERGY COSTS; ENERGY AUDITING, NAMELY, REVIEW AND ANALYSIS OF ENERGY CONSUMPTION; PREPARING CUSTOMIZED BUSINESS REPORTS FEATURING ENERGY SAVINGS DATA, ENERGY PROFILE DEVELOPMENT, ENERGY PROFILE BENCHMARKING, RATE ANALYSIS AND VERIFICATION, RISK TOLERANCE, PROCUREMENT STRATEGY AND ENERGY PRODUCT SELECTION (U.S. CLS. 100, 101 AND 102).

ELISSA GARBER KON, EXAMINING ATTORNEY

SN 77-930,746. LYNCH, ROBERT W., MOSCOW MILLS, MO. FILED 2-8-2010.

PARTY PARTY

THE MARK CONSISTS OF STANDARD CHARACTERS WITHOUT CLAIM TO ANY PARTICULAR FONT, STYLE, SIZE, OR COLOR.

FOR ASSOCIATION SERVICES, NAMELY, PROMOTING THE INTERESTS OF POLITICAL SATIRISTS (U.S. CLS. 100, 101 AND 102).

ANDREA HACK, EXAMINING ATTORNEY

CLASS 35—(Continued).

SN 77-930,750. BIG METHOD, LLC, VENICE, CA. FILED 2-8-2010.

bigMETHOD

THE MARK CONSISTS OF STANDARD CHARACTERS WITHOUT CLAIM TO ANY PARTICULAR FONT, STYLE, SIZE, OR COLOR.

FOR ADVERTISING AGENCY SPECIALIZING IN THE DESIGN AND EXECUTION OF WORD OF MOUTH, VIRAL, BUZZ AND EXPERIENTIAL MARKETING PROGRAMS; MARKETING AND CONSULTING SERVICES IN THE FIELD OF PROMOTING AND TRACKING THE GOODS, SERVICES, AND BRANDS OF OTHERS THROUGH ALL PUBLIC COMMUNICATION MEANS, PARTICULARLY SPECIALIZING IN THE USE OF MOBILE, SOCIAL, AND PRINT MEDIA TO DRIVE CONSUMER INTEREST, ENGAGEMENT AND ACTION; SOCIAL MEDIA STRATEGY AND MARKETING CONSULTANCY FOCUSING ON HELPING CLIENTS CREATE AND EXTEND THEIR PRODUCT AND BRAND STRATEGIES BY BUILDING VIRALLY ENGAGING MARKETING SOLUTIONS (U.S. CLS. 100, 101 AND 102).
FIRST USE 1-1-2008; IN COMMERCE 2-8-2008.
LAURIE MAYES, EXAMINING ATTORNEY

SN 77-930,789. Y. PATTY CHEN, DBA PATTYC PROPERTY, WELLESLEY, MA. FILED 2-8-2010.

PattyC Property Group (PCPG)

THE MARK CONSISTS OF STANDARD CHARACTERS WITHOUT CLAIM TO ANY PARTICULAR FONT, STYLE, SIZE, OR COLOR.

NO CLAIM IS MADE TO THE EXCLUSIVE RIGHT TO USE "PROPERTY GROUP", APART FROM THE MARK AS SHOWN.

FOR REAL ESTATE MARKETING SERVICES, NAMELY, ON-LINE SERVICES FEATURING REAL TOURS OF RESIDENTIAL AND COMMERCIAL REAL ESTATE (U.S. CLS. 100, 101 AND 102).

FIRST USE 1-1-2005; IN COMMERCE 1-1-2007.
VIVIAN MICZNIK FIRST, EXAMINING ATTORNEY

CLASS 35—(Continued).

SN 77-930,813. TRACY BENDER, DBA THE CENTER FOR MASTERPIECE LIVING, GILROY, CA. FILED 2-8-2010.

MLIVING

THE MARK CONSISTS OF STANDARD CHARACTERS WITHOUT CLAIM TO ANY PARTICULAR FONT, STYLE, SIZE, OR COLOR.

OWNER OF U.S. REG. NOS. 2,810,382, 3,101,176 AND 3,281,947.

FOR ON-LINE RETAIL STORE SERVICES IN THE FIELD OF LIFESTYLE ACCESSORIES AND GIFTS, FEATURING APPAREL, HOUSEHOLD ITEMS, GIFTS AND GIFTWARE, ISSUING GIFT CERTIFICATES, AND DIGITAL PRODUCTS, NAMELY, DIGITAL MAGAZINES, BOOKS AND NEWSPAPERS, E-CARDS, MOBILE GREETINGS, DOWNLOADABLE MUSIC, MOVIES, PHOTOGRAPHS, PODCASTS, GAMES, AND APPLICATIONS, PROVIDED VIA THE INTERNET AND OTHER COMPUTER AND ELECTRONIC COMMUNICATION NETWORKS (U.S. CLS. 100, 101 AND 102).

HOWARD SMIGA, EXAMINING ATTORNEY

SN 77-930,853. TRACE CONSULTING SERVICES, INC., SARASOTA, FL. FILED 2-8-2010.

POWER Modeling

THE MARK CONSISTS OF STANDARD CHARACTERS WITHOUT CLAIM TO ANY PARTICULAR FONT, STYLE, SIZE, OR COLOR.

NO CLAIM IS MADE TO THE EXCLUSIVE RIGHT TO USE "MODELING", APART FROM THE MARK AS SHOWN.

FOR BUSINESS ORGANIZATION AND MANAGEMENT CONSULTING (U.S. CLS. 100, 101 AND 102).

FIRST USE 2-8-2010; IN COMMERCE 2-8-2010.
ANNE E. GUSTASON, EXAMINING ATTORNEY

SN 77-930,888. ZOOSK, INC., SAN FRANCISCO, CA. FILED 2-8-2010.

ZOOSK

THE MARK CONSISTS OF STANDARD CHARACTERS WITHOUT CLAIM TO ANY PARTICULAR FONT, STYLE, SIZE, OR COLOR.

FOR ONLINE ADVERTISING SERVICES (U.S. CLS. 100, 101 AND 102).

GINA HAYES, EXAMINING ATTORNEY

CLASS 35—(Continued).

SN 77-930,987. TAYLOR, AVA, BROOKLYN, NY. FILED 2-8-2010.

YAMA TALENT

THE MARK CONSISTS OF STANDARD CHARACTERS WITHOUT CLAIM TO ANY PARTICULAR FONT, STYLE, SIZE, OR COLOR.

NO CLAIM IS MADE TO THE EXCLUSIVE RIGHT TO USE "TALENT", APART FROM THE MARK AS SHOWN. FOR TALENT AGENCIES; TALENT AGENCIES FOR YOGA TEACHERS (U.S. CLS. 100, 101 AND 102). FIRST USE 6-1-2009; IN COMMERCE 11-8-2009. DAVID COLLIER, EXAMINING ATTORNEY

SN 77-931,161. MOBILITY PLUS LLC, WEST DUNDEE, IL. FILED 2-9-2010.

MOBILITY PLUS

THE MARK CONSISTS OF STANDARD CHARACTERS WITHOUT CLAIM TO ANY PARTICULAR FONT, STYLE, SIZE, OR COLOR.

NO CLAIM IS MADE TO THE EXCLUSIVE RIGHT TO USE "MOBILITY", APART FROM THE MARK AS SHOWN. FOR RETAIL STORE SERVICES AND ON-LINE RETAIL STORE SERVICES FEATURING MOBILITY EQUIPMENT, NAMELY, MOBILITY SCOOTERS, MOBILITY RAMPS, MOBILITY SCOOTER LIFTS FOR AUTOMOBILES AND BUILDINGS, STAIR LIFTS, WHEELCHAIRS, POWERED WHEELCHAIRS, ROLLING WALKERS, LIFT CHAIRS AND RELATED EQUIPMENT AND SUPPLIES (U.S. CLS. 100, 101 AND 102). FIRST USE 8-1-2007; IN COMMERCE 5-0-2008. VIVIAN MICZNIK FIRST, EXAMINING ATTORNEY

SN 77-931,418. SHERRELL L. WILSON INC., SLATON, TX. FILED 2-9-2010.

SLATON BAKERY

THE MARK CONSISTS OF STANDARD CHARACTERS WITHOUT CLAIM TO ANY PARTICULAR FONT, STYLE, SIZE, OR COLOR.

NO CLAIM IS MADE TO THE EXCLUSIVE RIGHT TO USE "BAKERY", APART FROM THE MARK AS SHOWN. SEC. 2(F). FOR RETAIL BAKERY SHOPS; TAKE-OUT BAKERY SERVICES (U.S. CLS. 100, 101 AND 102). FIRST USE 0-0-1923; IN COMMERCE 0-0-2000. CHRISTOPHER BUONGIORNO, EXAMINING ATTORNEY

CLASS 35—(Continued).

SN 77-931,611. RUTSKY, AARON, CANTON, CT. FILED 2-9-2010.

Swequity

THE MARK CONSISTS OF STANDARD CHARACTERS WITHOUT CLAIM TO ANY PARTICULAR FONT, STYLE, SIZE, OR COLOR.

FOR PROMOTING THE GOODS AND SERVICES OF OTHERS BY PROVIDING A WEB SITE AT WHICH USERS CAN LINK TO HOME IMPROVEMENT CONTRACTORS SERVICES (U.S. CLS. 100, 101 AND 102). ANTHONY RINKER, EXAMINING ATTORNEY

SN 77-931,637. DRUGSTORE.COM, INC., BELLEVUE, WA. FILED 2-9-2010.

SIMPLE SHIP

THE MARK CONSISTS OF STANDARD CHARACTERS WITHOUT CLAIM TO ANY PARTICULAR FONT, STYLE, SIZE, OR COLOR.

NO CLAIM IS MADE TO THE EXCLUSIVE RIGHT TO USE "SHIP", APART FROM THE MARK AS SHOWN. FOR ONLINE RETAIL STORE SERVICES IN THE FIELDS OF MEDICINES, HEALTH CARE PRODUCTS, VITAMINS, SKIN CARE PRODUCTS, COSMETICS, DIET AND FITNESS PRODUCTS, HOUSEHOLD PRODUCTS, PET CARE PRODUCTS, FOOD, FEATURING PREFERRED SHIPPING PROGRAM FOR CUSTOMERS (U.S. CLS. 100, 101 AND 102). DEIRDRE ROBERTSON, EXAMINING ATTORNEY

SN 77-931,641. BOSE, GREGORY, TORRANCE, CA. FILED 2-9-2010.

CoinSpace

FOR ON-LINE RETAIL STORE AND ON-LINE AUCTION SERVICES FEATURING COLLECTABLE COINS AND CURRENCY (U.S. CLS. 100, 101 AND 102). SETH A. RAPPAPORT, EXAMINING ATTORNEY

CLASS 35—(Continued).

SN 77-931,644. DRUGSTORE.COM, INC., BELLEVUE, WA.
FILED 2-9-2010.

SIMPLE SHIP EXPRESS

THE MARK CONSISTS OF STANDARD CHARACTERS WITHOUT CLAIM TO ANY PARTICULAR FONT, STYLE, SIZE, OR COLOR.

NO CLAIM IS MADE TO THE EXCLUSIVE RIGHT TO USE "SHIP EXPRESS", APART FROM THE MARK AS SHOWN.

FOR ONLINE RETAIL STORE SERVICES IN THE FIELDS OF MEDICINES, HEALTH CARE PRODUCTS, VITAMINS, SKIN CARE PRODUCTS, COSMETICS, DIET AND FITNESS PRODUCTS, HOUSEHOLD PRODUCTS, PET CARE PRODUCTS, FOOD, FEATURING PREFERRED SHIPPING PROGRAM FOR CUSTOMERS (U.S. CLS. 100, 101 AND 102).

DEIRDRE ROBERTSON, EXAMINING ATTORNEY

SN 77-931,840. GALPIN AUTO SPORTS LLC, VAN NUYS, CA. FILED 2-9-2010.



THE MARK CONSISTS OF AN ABSTRACT RENDERING OF A FACE.

FOR ONLINE RETAIL STORE SERVICES IN THE FIELDS OF AUDIO AND/OR VISUAL RECORDINGS, AUTO PARTS AND ACCESSORIES, BEVERAGES, BEAUTY AIDS, BATH ACCESSORIES, CLOTHING, COSMETICS, JEWELRY, FABRICS AND TEXTILES, HANDBAGS, LUGGAGE, TOILETRIES, TOYS, SOUVENIRS, AND SPORTING GOODS (U.S. CLS. 100, 101 AND 102).

KAREN BRACEY, EXAMINING ATTORNEY

CLASS 35—(Continued).

SN 77-931,846. INVENTORY SALES CO., ST. LOUIS, MO.
FILED 2-9-2010.

ISC

THE MARK CONSISTS OF STANDARD CHARACTERS WITHOUT CLAIM TO ANY PARTICULAR FONT, STYLE, SIZE, OR COLOR.

FOR WHOLESALE ON-LINE STORE SERVICES, WHOLESALE CATALOG ORDERING SERVICES AND WHOLESALE STORE SERVICES FEATURING FASTENERS, HAND AND POWER TOOLS, STUDS AND STRUTS (U.S. CLS. 100, 101 AND 102).

FIRST USE 0-0-1972; IN COMMERCE 0-0-1972.

ANDREA SAUNDERS, EXAMINING ATTORNEY

SN 77-931,850. INVENTORY SALES CO., ST. LOUIS, MO.
FILED 2-9-2010.



THE MARK CONSISTS OF THE STYLIZED LETTERS "ISC" BETWEEN A NUT ON THE LEFT AND A STAR PLACED OVER A CIRCLE TO THE RIGHT, ALL SUPERIMPOSED OVER A GLOBE CONTAINING LONGITUDE AND LATITUDE LINES AND STYLIZED REPRESENTATIONS OF THE CONTINENTS.

FOR WHOLESALE ON-LINE STORE SERVICES, WHOLESALE CATALOG ORDERING SERVICES AND WHOLESALE STORE SERVICES FEATURING FASTENERS, HAND AND POWER TOOLS, STUDS AND STRUTS (U.S. CLS. 100, 101 AND 102).

FIRST USE 11-7-2007; IN COMMERCE 11-7-2007.

ANDREA SAUNDERS, EXAMINING ATTORNEY

SN 77-931,875. PREFERRED PROCUREMENT SOLUTIONS, INC., DBA ZOOZAZZ, LONG BEACH, CA. FILED 2-9-2010.

Zoozazz

THE MARK CONSISTS OF STANDARD CHARACTERS WITHOUT CLAIM TO ANY PARTICULAR FONT, STYLE, SIZE, OR COLOR.

FOR OPERATING AN ON-LINE SHOPPING SITE IN THE FIELD OF DAYCARE, PRESCHOOL, AND SCHOOL EQUIPMENT AND SUPPLIES (U.S. CLS. 100, 101 AND 102).

FIRST USE 9-1-2009; IN COMMERCE 2-2-2010.

JOHN WILKE, EXAMINING ATTORNEY

CLASS 35—(Continued).

SN 77-931,949. HANG, JOHN, LAS VEGAS, NV. FILED 2-9-2010.

BETTER THAN THE GREATEST

THE MARK CONSISTS OF STANDARD CHARACTERS WITHOUT CLAIM TO ANY PARTICULAR FONT, STYLE, SIZE, OR COLOR.
FOR ADVERTISING AND MARKETING (U.S. CLS. 100, 101 AND 102).
JANICE KIM, EXAMINING ATTORNEY



SN 77-931,956. HANG, JOHN, LAS VEGAS, NV. FILED 2-9-2010.

BTTG

THE MARK CONSISTS OF STANDARD CHARACTERS WITHOUT CLAIM TO ANY PARTICULAR FONT, STYLE, SIZE, OR COLOR.
FOR ADVERTISING AND MARKETING (U.S. CLS. 100, 101 AND 102).
JANICE KIM, EXAMINING ATTORNEY



SN 77-932,002. TVI, INC., BELLEVUE, WA. FILED 2-9-2010.

Good deeds. Great deals.

THE MARK CONSISTS OF STANDARD CHARACTERS WITHOUT CLAIM TO ANY PARTICULAR FONT, STYLE, SIZE, OR COLOR.
FOR RETAIL STORE SERVICES FEATURING A WIDE VARIETY OF USED CONSUMER GOODS ORIGINATING FROM CHARITABLE ORGANIZATIONS (U.S. CLS. 100, 101 AND 102).
ALEX KEAM, EXAMINING ATTORNEY

CLASS 35—(Continued).

SN 77-932,075. FAN FARMERS LLC, MENLO PARK, CA. FILED 2-9-2010.

FAN FARMERS

THE MARK CONSISTS OF STANDARD CHARACTERS WITHOUT CLAIM TO ANY PARTICULAR FONT, STYLE, SIZE, OR COLOR.
FOR SOCIAL MEDIA STRATEGY AND MARKETING CONSULTANCY FOCUSING ON HELPING CLIENTS CREATE AND EXTEND THEIR PRODUCT AND BRAND STRATEGIES BY BUILDING VIRALLY ENGAGING MARKETING SOLUTIONS (U.S. CLS. 100, 101 AND 102).
DOMINIC FATHY, EXAMINING ATTORNEY



SN 77-932,278. AROUND TOWN MOVERS, INC, CLIFTON, VA. AND YOUNG, JASON D, CLIFTON, VA. FILED 2-10-2010.



THE COLOR(S) MAROON/DARK RED AND GRAY IS/ ARE CLAIMED AS A FEATURE OF THE MARK.
THE MARK CONSISTS OF A DARK RED TRUCK WITH GRAY WINDOWS AND GRAY WHEELS TRAVELING AROUND A DARK GRAY CITY.
FOR MOVING AND RELOCATION SERVICES, NAMELY, PLANNING AND IMPLEMENTING MOVES OF HOMES AND OFFICES; MOVING AND RELOCATION SERVICES, NAMELY, PLANNING AND IMPLEMENTING MOVES OF HOMES FOR OTHERS; MOVING AND RELOCATION SERVICES, NAMELY, PLANNING AND PROJECT OVERSIGHT OF HOME MOVING FOR OTHERS (U.S. CLS. 100, 101 AND 102).
FIRST USE 9-20-2007; IN COMMERCE 10-10-2007.
FRED MANDIR, EXAMINING ATTORNEY

CLASS 35—(Continued).

SN 77-932,381. SPRINGS CREATIVE PRODUCTS GROUP, LLC, ROCK HILL, SC. FILED 2-10-2010.

ZIGZAG FABRICS

THE MARK CONSISTS OF STANDARD CHARACTERS WITHOUT CLAIM TO ANY PARTICULAR FONT, STYLE, SIZE, OR COLOR.

NO CLAIM IS MADE TO THE EXCLUSIVE RIGHT TO USE "FABRICS", APART FROM THE MARK AS SHOWN.

FOR ON-LINE RETAIL STORE SERVICES FEATURING BEDDING, TOWELS, FABRIC WINDOW TREATMENTS, THROWS, BLANKETS, HOME ACCESSORIES, CRAFT KITS, FABRICS, APPLIQUES, DECORATIONS AND ACCESSORIES FOR HOME SEWING AND CRAFTS (U.S. CLS. 100, 101 AND 102).

SETH A. RAPPAPORT, EXAMINING ATTORNEY

SN 77-932,544. FIDELITY MOTOR GROUP, LLC, LAKE ZURICH, IL. FILED 2-10-2010.

FMG

THE MARK CONSISTS OF STANDARD CHARACTERS WITHOUT CLAIM TO ANY PARTICULAR FONT, STYLE, SIZE, OR COLOR.

FOR NEW AND USED AUTOMOBILE AND MOTOR VEHICLE DEALERSHIP SERVICES; RETAIL, WHOLESALE, AND INTERNET STORE SERVICES FEATURING NEW AND USED AUTOMOBILES AND MOTOR VEHICLES, AND AUTOMOBILES AND MOTOR VEHICLES PARTS AND ACCESSORIES (U.S. CLS. 100, 101 AND 102).

HANNO RITTNER, EXAMINING ATTORNEY

SN 77-932,631. GROWTHMINE, LLC, EULESS, TX. FILED 2-10-2010.

GROWTHMINE

THE MARK CONSISTS OF STANDARD CHARACTERS WITHOUT CLAIM TO ANY PARTICULAR FONT, STYLE, SIZE, OR COLOR.

FOR BUSINESS MANAGEMENT CONSULTING AND ADVISORY SERVICES (U.S. CLS. 100, 101 AND 102).

JENNY PARK, EXAMINING ATTORNEY

CLASS 35—(Continued).

SN 77-932,786. WARD, JIM, CASTLE ROCK, WA. FILED 2-10-2010.

BLOW ME

THE MARK CONSISTS OF STANDARD CHARACTERS WITHOUT CLAIM TO ANY PARTICULAR FONT, STYLE, SIZE, OR COLOR.

FOR VENDING MACHINE SERVICES (U.S. CLS. 100, 101 AND 102).

SIMON TENG, EXAMINING ATTORNEY

SN 77-932,791. HEALTHY HAIR JOURNEY ENTERPRISES, LLC, LAWRENCEVILLE, GA. FILED 2-10-2010.

HEALTHY HAIR JOURNEY ENTERPRISES

THE MARK CONSISTS OF STANDARD CHARACTERS WITHOUT CLAIM TO ANY PARTICULAR FONT, STYLE, SIZE, OR COLOR.

NO CLAIM IS MADE TO THE EXCLUSIVE RIGHT TO USE "HEALTHY HAIR" AND "ENTERPRISES", APART FROM THE MARK AS SHOWN.

FOR ON-LINE RETAIL STORE SERVICES FEATURING HAIR PREPARATIONS, SHAMPOOS, HAIR LOTIONS, HAIR CONDITIONERS AND HAIR OILS (U.S. CLS. 100, 101 AND 102).

FIRST USE 3-20-2008; IN COMMERCE 3-20-2008.

DAVID C. REIHNER, EXAMINING ATTORNEY

SN 77-932,803. WARD, JIM, CASTLE ROCK, WA. FILED 2-10-2010.

DONT BLOW IT

THE MARK CONSISTS OF STANDARD CHARACTERS WITHOUT CLAIM TO ANY PARTICULAR FONT, STYLE, SIZE, OR COLOR.

FOR VENDING MACHINE SERVICES (U.S. CLS. 100, 101 AND 102).

SIMON TENG, EXAMINING ATTORNEY

CLASS 35—(Continued).

SN 77-932,888. COHEN, STEVEN B., CLEVELAND, OH. FILED 2-10-2010.

GHOSTRIGHTERS

THE MARK CONSISTS OF STANDARD CHARACTERS WITHOUT CLAIM TO ANY PARTICULAR FONT, STYLE, SIZE, OR COLOR.
FOR BUSINESS MARKETING CONSULTING SERVICES (U.S. CLS. 100, 101 AND 102).
EUGENIA MARTIN, EXAMINING ATTORNEY

CLASS 35—(Continued).

SN 77-933,045. GREENSLADE, LORI ANN, TOPSFIELD, MA. FILED 2-10-2010.

Symbielle

THE MARK CONSISTS OF STANDARD CHARACTERS WITHOUT CLAIM TO ANY PARTICULAR FONT, STYLE, SIZE, OR COLOR.
FOR BUSINESS NETWORKING; CONSULTING SERVICES IN THE AREA OF SUSTAINABLE BUSINESS SOLUTIONS (U.S. CLS. 100, 101 AND 102).
ESTHER A. BORSUK, EXAMINING ATTORNEY

SN 77-932,943. GLOBAL PRESCRIBER LLC, DENVER, CO. FILED 2-10-2010.

No See

THE MARK CONSISTS OF STANDARD CHARACTERS WITHOUT CLAIM TO ANY PARTICULAR FONT, STYLE, SIZE, OR COLOR.
FOR PROVIDING ADVERTISING, MARKETING AND PROMOTIONAL SERVICES FOR THE PHARMACEUTICAL AND MEDICAL INDUSTRY (U.S. CLS. 100, 101 AND 102).
MICHAEL SOUDERS, EXAMINING ATTORNEY

SN 77-932,985. KAASI ASSOCIATE LLC, HOLBROOK, NY. FILED 2-10-2010.

Kaasi Associate

THE MARK CONSISTS OF STANDARD CHARACTERS WITHOUT CLAIM TO ANY PARTICULAR FONT, STYLE, SIZE, OR COLOR.
NO CLAIM IS MADE TO THE EXCLUSIVE RIGHT TO USE "ASSOCIATE", APART FROM THE MARK AS SHOWN.
THE WORDING "KAASI" HAS NO MEANING IN A FOREIGN LANGUAGE.
FOR FRANCHISING, NAMELY, CONSULTATION AND ASSISTANCE IN BUSINESS MANAGEMENT, ORGANIZATION AND PROMOTION; RESTAURANT FRANCHISING, NAMELY, OFFERING BUSINESS MANAGEMENT ASSISTANCE IN THE ESTABLISHMENT AND/OR OPERATION OF RESTAURANTS; FRANCHISING, NAMELY, OFFERING BUSINESS MANAGEMENT ASSISTANCE IN THE ESTABLISHMENT AND/OR OPERATION OF RESTAURANTS AND FOOD RELATED BUSINESS MANAGEMENT (U.S. CLS. 100, 101 AND 102).
HANNO RITTNER, EXAMINING ATTORNEY

SN 77-933,065. DO YOU SHARE?, LLC, NEW YORK, NY. FILED 2-10-2010.



NO CLAIM IS MADE TO THE EXCLUSIVE RIGHT TO USE "LLC", APART FROM THE MARK AS SHOWN.
THE MARK CONSISTS OF A CIRCLE WITH A APPROXIMATELY 1/2-3/4 INCH BORDER WITHIN THE CIRCLE WITH THE WORDING "DO YOU SHARE LLC", AND A QUESTION MARK APPEARS IN THE CENTER OF THE CIRCLE.
FOR ADVERTISING, MARKETING AND PROMOTION SERVICES (U.S. CLS. 100, 101 AND 102).
DEIRDRE ROBERTSON, EXAMINING ATTORNEY

SN 77-934,311. MURAD, INC., EL SEGUNDO, CA. FILED 2-12-2010.



OWNER OF U.S. REG. NOS. 1,830,098, 2,062,211 AND 2,254,716.
THE MARK CONSISTS OF THE WORD "MURAD" AND STYLIZED "M" DESIGN.
FOR RETAIL STORE SERVICES FEATURING SKIN CARE PRODUCTS, VITAMINS AND NUTRITIONAL SUPPLEMENTS (U.S. CLS. 100, 101 AND 102).
FIRST USE 12-31-1995; IN COMMERCE 12-31-1995.
NICHOLAS ALTREE, EXAMINING ATTORNEY

CLASS 35—(Continued).

SN 77-935,958. FATHOM SEO, LLC, VALLEY VIEW, OH.
FILED 2-15-2010.

Instant Replay

THE MARK CONSISTS OF STANDARD CHARACTERS WITHOUT CLAIM TO ANY PARTICULAR FONT, STYLE, SIZE, OR COLOR.

FOR MARKETING SERVICES, NAMELY, PROVIDING VIDEOS TO PROMOTE BUSINESSES OF THIRD PARTY CUSTOMERS; PLANNING, DESIGN, DEVELOPMENT, MAINTENANCE, TRACKING AND REPORTING OF ONLINE MARKETING ACTIVITIES FOR THIRD PARTIES; PROVIDING ADVERTISING, MARKETING AND PROMOTIONAL SERVICES, NAMELY, DEVELOPMENT OF ADVERTISING CAMPAIGNS PROVIDED THROUGH CABLE TELEVISION BROADCAST, WEB CASTS, RADIO BROADCASTS, NEWSPAPERS, MAGAZINES, ONLINE BANNERS, OUTDOOR BILLBOARDS, WILD POSTINGS, BUS AND SUBWAY ADS (U.S. CLS. 100, 101 AND 102).

FIRST USE 8-2-2007; IN COMMERCE 8-2-2007.
BARBARA RUTLAND, EXAMINING ATTORNEY

SN 77-936,038. JROCKET MARKETING, LLC, RANCHO SANTA FE, CA. FILED 2-15-2010.

JRocket Marketing

THE MARK CONSISTS OF STANDARD CHARACTERS WITHOUT CLAIM TO ANY PARTICULAR FONT, STYLE, SIZE, OR COLOR.

NO CLAIM IS MADE TO THE EXCLUSIVE RIGHT TO USE "MARKETING", APART FROM THE MARK AS SHOWN.

FOR MARKETING CONSULTING (U.S. CLS. 100, 101 AND 102).

FIRST USE 5-1-2001; IN COMMERCE 5-1-2001.
VERNA BETH RIRIE, EXAMINING ATTORNEY

SN 77-936,527. DENNIS FOLAND, INC., ONTARIO, CA.
FILED 2-16-2010.

UNIVERSE OF PRIZES

THE MARK CONSISTS OF STANDARD CHARACTERS WITHOUT CLAIM TO ANY PARTICULAR FONT, STYLE, SIZE, OR COLOR.

NO CLAIM IS MADE TO THE EXCLUSIVE RIGHT TO USE "PRIZES", APART FROM THE MARK AS SHOWN.

FOR PROVIDING INCENTIVE AWARD PROGRAMS FOR SCHOOL FUNDRAISER PARTICIPANTS VIA ISSUANCE OF PRIZES TO PROMOTE THE SALE OF PRODUCTS AND SERVICES OF OTHERS (U.S. CLS. 100, 101 AND 102).

FIRST USE 4-0-2009; IN COMMERCE 4-0-2009.
ZHALEH DELANEY, EXAMINING ATTORNEY

CLASS 35—(Continued).

SN 77-936,792. BATTERIES PLUS, LLC, HARTLAND, WI.
FILED 2-16-2010.

THE REPLACE IT PLACE

THE MARK CONSISTS OF STANDARD CHARACTERS WITHOUT CLAIM TO ANY PARTICULAR FONT, STYLE, SIZE, OR COLOR.

FOR RETAIL STORE SERVICES FEATURING BATTERIES AND LIGHT BULBS (U.S. CLS. 100, 101 AND 102).

MIDGE BUTLER, EXAMINING ATTORNEY

SN 77-937,466. BATTERIES PLUS, LLC, HARTLAND, WI.
FILED 2-17-2010.

ADD POWER TO YOUR LIFE

THE MARK CONSISTS OF STANDARD CHARACTERS WITHOUT CLAIM TO ANY PARTICULAR FONT, STYLE, SIZE, OR COLOR.

FOR RETAIL STORE SERVICES FEATURING BATTERIES AND LIGHT BULBS (U.S. CLS. 100, 101 AND 102).

MIDGE BUTLER, EXAMINING ATTORNEY

SN 77-937,634. JROCKET MARKETING, LLC, RANCHO SANTA FE, CA. FILED 2-17-2010.



NO CLAIM IS MADE TO THE EXCLUSIVE RIGHT TO USE "MARKETING", APART FROM THE MARK AS SHOWN.

THE COLOR(S) RED, WHITE AND BLACK IS/ARE CLAIMED AS A FEATURE OF THE MARK.

THE MARK CONSISTS OF A BLACK RECTANGLE UPON WHICH THE WORDS "JROCKET" IN WHITE LETTERS ARE SET (1) BETWEEN TWO RED FINS (ONE ABOVE "JRO", ONE BELOW "JRO" WITH BOTH FINS TAILING TO THE LEFT) RESEMBLING FINS OF A ROCKET AND (2) JUST TO THE LEFT OF A RED SHAPED CONE RESEMBLING THE CONE OF A ROCKET, PLUS THE WORD "MARKETING" IN RED BLOCK LETTERS DIRECTLY UNDER THE LETTERS "CKET" OF "JROCKET".

FOR MARKETING CONSULTING (U.S. CLS. 100, 101 AND 102).

FIRST USE 5-1-2001; IN COMMERCE 5-1-2001.
VERNA BETH RIRIE, EXAMINING ATTORNEY

CLASS 35—(Continued).

SN 77-938,074. NOVARTIS AG, BASEL, SWITZERLAND,
FILED 2-17-2010.



OWNER OF U.S. REG. NOS. 3,608,891, 3,638,838 AND OTHERS.

THE MARK CONSISTS OF THE WORD "MEET" ABOVE THE WORD "MENVEO". TO THE LEFT OF THE WORDS "MEET MENVEO" ARE TWO STYLIZED FIGURES FACING EACH OTHER TO FORM THE LETTER "M". THE WORDS "MEET MENVEO" AND THE STYLIZED LETTER "M" ARE ENCLOSED WITHIN A RECTANGULAR BORDER.

THE WORDING "MENVEO" HAS NO MEANING IN A FOREIGN LANGUAGE.

FOR MEDICAL PRACTICE MANAGEMENT FOR OTHERS; ONLINE ORDERING SERVICES IN THE FIELD OF VACCINES AND PHARMACEUTICALS; ONLINE RETAIL STORE SERVICES FEATURING VACCINES AND PHARMACEUTICALS; ADMINISTRATION OF PHYSICIAN REIMBURSEMENT PROGRAMS; ADMINISTRATION OF MEDICATION REIMBURSEMENT PROGRAMS AND SERVICES; DISTRIBUTORSHIP SERVICES IN THE FIELD OF PHARMACEUTICALS AND VACCINES; SUPPLY CHAIN MANAGEMENT SERVICES; INVENTORY MANAGEMENT; MANAGEMENT SERVICES PROVIDED TO HEALTHCARE PROVIDERS FOR CONTROLLING VACCINE AND PHARMACEUTICAL INVENTORIES; ARRANGING AND CONDUCTING INCENTIVE REWARD PROGRAMS TO PROMOTE THE SALE OF VACCINES AND PHARMACEUTICALS (U.S. CLS. 100, 101 AND 102).

LAKEISHA LEWIS, EXAMINING ATTORNEY

CLASS 35—(Continued).

SN 77-939,091. THE BOSTON CONSULTING GROUP, INC.,
BOSTON, MA. FILED 2-18-2010.

RIGOR TESTING

THE MARK CONSISTS OF STANDARD CHARACTERS WITHOUT CLAIM TO ANY PARTICULAR FONT, STYLE, SIZE, OR COLOR.

NO CLAIM IS MADE TO THE EXCLUSIVE RIGHT TO USE "TESTING", APART FROM THE MARK AS SHOWN.

FOR PROVIDING BUSINESS MANAGEMENT CONSULTING SERVICES; ADVISING BUSINESSES IN STRATEGIC MANAGEMENT AND DEVELOPMENT OF OVERALL CORPORATE STRATEGY AND BUSINESS INITIATIVES; CORPORATE MANAGEMENT CONSULTING SERVICES TO ASSIST EXECUTIVES IN BUSINESS DECISION MAKING; ADVISING BUSINESSES THROUGH THE USE OF CONSULTING TOOLS AND TECHNIQUES THAT ENABLE STRATEGIC BUSINESS DECISION MAKING; PROVIDING BUSINESS PROJECT MANAGEMENT CONSULTING SERVICES, NAMELY, PREDICTING PROJECT OUTCOMES AND MODIFYING PROJECT IMPLEMENTATION TO INCREASE LIKELIHOOD OF SUCCESS IN BUSINESS TRANSFORMATION PROJECTS (U.S. CLS. 100, 101 AND 102).

FIRST USE 8-18-2009; IN COMMERCE 8-18-2009.

JOHN WILKE, EXAMINING ATTORNEY

SN 77-939,081. THE BOSTON CONSULTING GROUP, INC.,
BOSTON, MA. FILED 2-18-2010.

RIGOR TEST

THE MARK CONSISTS OF STANDARD CHARACTERS WITHOUT CLAIM TO ANY PARTICULAR FONT, STYLE, SIZE, OR COLOR.

NO CLAIM IS MADE TO THE EXCLUSIVE RIGHT TO USE "TEST", APART FROM THE MARK AS SHOWN.

FOR PROVIDING BUSINESS MANAGEMENT CONSULTING SERVICES; ADVISING BUSINESSES IN STRATEGIC MANAGEMENT AND DEVELOPMENT OF OVERALL CORPORATE STRATEGY AND BUSINESS INITIATIVES; CORPORATE MANAGEMENT CONSULTING SERVICES TO ASSIST EXECUTIVES IN BUSINESS DECISION MAKING; ADVISING BUSINESSES THROUGH THE USE OF CONSULTING TOOLS AND TECHNIQUES THAT ENABLE STRATEGIC BUSINESS DECISION MAKING; PROVIDING BUSINESS PROJECT MANAGEMENT CONSULTING SERVICES, NAMELY, PREDICTING PROJECT OUTCOMES AND MODIFYING PROJECT IMPLEMENTATION TO INCREASE LIKELIHOOD OF SUCCESS IN BUSINESS TRANSFORMATION PROJECTS (U.S. CLS. 100, 101 AND 102).

FIRST USE 8-18-2009; IN COMMERCE 8-18-2009.

JOHN WILKE, EXAMINING ATTORNEY

SN 77-939,214. PLUM JAR, LLC, SAN FRANCISCO, CA.
FILED 2-18-2010.

THE MARK CONSISTS OF THE STYLIZED TEXT "BERGINE" WITH A WAVY DESIGN AT THE UPPER LEFT OF THE LETTER "B".

THE WORDING "BERGINE" HAS NO MEANING IN A FOREIGN LANGUAGE.

FOR PROMOTING THE GOODS AND SERVICES OF OTHERS BY PROVIDING A WEB SITE FEATURING EXCLUSIVE PRICING CERTIFICATES, DISTRIBUTING ADVERTISING MATERIALS IN THE FORM OF EXCLUSIVE PRICING CERTIFICATES THROUGH E-MAIL, PROVIDING SERVICE AND PRODUCT DESCRIPTIONS, PROVIDING HYPERTEXT LINKS TO MERCHANT WEB SITES, AND PROVIDING A WEB SITE FEATURING EXCLUSIVE PRICING INFORMATION (U.S. CLS. 100, 101 AND 102).

JAY BESCH, EXAMINING ATTORNEY

CLASS 35—(Continued).

SN 77-939,278. DRUGSTORE.COM, INC., BELLEVUE, WA.
FILED 2-18-2010.

Simple Ship 

NO CLAIM IS MADE TO THE EXCLUSIVE RIGHT TO USE "SHIP", APART FROM THE MARK AS SHOWN.

THE MARK CONSISTS OF THE WORDS "SIMPLE SHIP" WITH A CIRCLE CONTAINING AN IMAGE OF A TRUCK TO THE RIGHT.

FOR ONLINE RETAIL STORE SERVICES IN THE FIELDS OF MEDICINES, HEALTH CARE PRODUCTS, VITAMINS, SKIN CARE PRODUCTS, COSMETICS, DIET AND FITNESS PRODUCTS, HOUSEHOLD PRODUCTS, PET CARE PRODUCTS, FOOD, FEATURING PREFERRED SHIPPING PROGRAM FOR CUSTOMERS (U.S. CLS. 100, 101 AND 102).

DEIRDRE ROBERTSON, EXAMINING ATTORNEY

CLASS 35—(Continued).

SN 77-939,287. DRUGSTORE.COM, INC., BELLEVUE, WA.
FILED 2-18-2010.



NO CLAIM IS MADE TO THE EXCLUSIVE RIGHT TO USE "SHIP", APART FROM THE MARK AS SHOWN.

THE MARK CONSISTS OF A CIRCLE CONTAINING AN IMAGE OF A TRUCK WITH THE WORDS "SIMPLE SHIP" WRITTEN ON THE SIDE.

FOR ONLINE RETAIL STORE SERVICES IN THE FIELDS OF MEDICINES, HEALTH CARE PRODUCTS, VITAMINS, SKIN CARE PRODUCTS, COSMETICS, DIET AND FITNESS PRODUCTS, HOUSEHOLD PRODUCTS, PET CARE PRODUCTS, FOOD, FEATURING PREFERRED SHIPPING PROGRAM FOR CUSTOMERS (U.S. CLS. 100, 101 AND 102).

DEIRDRE ROBERTSON, EXAMINING ATTORNEY

SN 77-939,293. DRUGSTORE.COM, INC., BELLEVUE, WA.
FILED 2-18-2010.

SN 77-939,283. DRUGSTORE.COM, INC., BELLEVUE, WA.
FILED 2-18-2010.

Simple Ship 
Express

NO CLAIM IS MADE TO THE EXCLUSIVE RIGHT TO USE "SHIP" AND "EXPRESS", APART FROM THE MARK AS SHOWN.

THE MARK CONSISTS OF THE WORDS "SIMPLE SHIP EXPRESS" WITH A CIRCLE CONTAINING AN IMAGE OF A TRUCK TO THE RIGHT.

FOR ONLINE RETAIL STORE SERVICES IN THE FIELDS OF MEDICINES, HEALTH CARE PRODUCTS, VITAMINS, SKIN CARE PRODUCTS, COSMETICS, DIET AND FITNESS PRODUCTS, HOUSEHOLD PRODUCTS, PET CARE PRODUCTS, FOOD, FEATURING PREFERRED SHIPPING PROGRAM FOR CUSTOMERS (U.S. CLS. 100, 101 AND 102).

DEIRDRE ROBERTSON, EXAMINING ATTORNEY



NO CLAIM IS MADE TO THE EXCLUSIVE RIGHT TO USE "SHIP EXPRESS", APART FROM THE MARK AS SHOWN.

THE MARK CONSISTS OF A CIRCLE CONTAINING AN IMAGE OF A TRUCK WITH THE WORDS "SIMPLE SHIP EXPRESS" WRITTEN ON THE SIDE.

FOR ONLINE RETAIL STORE SERVICES IN THE FIELDS OF MEDICINES, HEALTH CARE PRODUCTS, VITAMINS, SKIN CARE PRODUCTS, COSMETICS, DIET AND FITNESS PRODUCTS, HOUSEHOLD PRODUCTS, PET CARE PRODUCTS, FOOD, FEATURING PREFERRED SHIPPING PROGRAM FOR CUSTOMERS (U.S. CLS. 100, 101 AND 102).

DEIRDRE ROBERTSON, EXAMINING ATTORNEY

CLASS 35—(Continued).

SN 77-939,600. BATTERIES PLUS, LLC, HARTLAND, WI. FILED 2-19-2010.

EVERY BATTERY. EVERY BULB. EVERY TIME.

THE MARK CONSISTS OF STANDARD CHARACTERS WITHOUT CLAIM TO ANY PARTICULAR FONT, STYLE, SIZE, OR COLOR.

FOR RETAIL STORE SERVICES FEATURING BATTERIES AND LIGHT BULBS (U.S. CLS. 100, 101 AND 102).

MIDGE BUTLER, EXAMINING ATTORNEY

SN 77-940,444. ALETHEIA RESEARCH AND MANAGEMENT, INC., SANTA MONICA, CA. FILED 2-19-2010.

Aletheia Insider Index

THE MARK CONSISTS OF STANDARD CHARACTERS WITHOUT CLAIM TO ANY PARTICULAR FONT, STYLE, SIZE, OR COLOR.

OWNER OF U.S. REG. NO. 2,346,821.

NO CLAIM IS MADE TO THE EXCLUSIVE RIGHT TO USE "INSIDER INDEX", APART FROM THE MARK AS SHOWN.

FOR PROVIDING FINANCIAL INDICES OF SELECT SECURITIES TO ENABLE CONSUMERS TO EVALUATE INVESTMENTS AND MARKET TRENDS IN THE SECURITIES MARKET (U.S. CLS. 100, 101 AND 102).

FIRST USE 9-1-1999; IN COMMERCE 9-1-1999.

ROBIN MITTLER, EXAMINING ATTORNEY

SN 77-941,371. SKYDANCE DESIGN LLC, OKLAHOMA CITY, OK. FILED 2-22-2010.

SKYDANCE BRIDGE

THE MARK CONSISTS OF STANDARD CHARACTERS WITHOUT CLAIM TO ANY PARTICULAR FONT, STYLE, SIZE, OR COLOR.

NO CLAIM IS MADE TO THE EXCLUSIVE RIGHT TO USE "BRIDGE", APART FROM THE MARK AS SHOWN.

FOR CONVENTION AND VISITORS BUREAU SERVICES, NAMELY, PROMOTING BUSINESS, TOURISM AND THE HOLDING OF CONVENTIONS IN THE CITY OF OKLAHOMA CITY, OKLAHOMA AND ADJACENT AREA (U.S. CLS. 100, 101 AND 102).

KAPIL BHANOT, EXAMINING ATTORNEY

CLASS 35—(Continued).

SN 77-943,022. SKECHERS U.S.A., INC. II, MANHATTAN BEACH, CA. FILED 2-23-2010.

JOIN THE RESISTANCE

THE MARK CONSISTS OF STANDARD CHARACTERS WITHOUT CLAIM TO ANY PARTICULAR FONT, STYLE, SIZE, OR COLOR.

FOR PROMOTING PUBLIC AWARENESS OF THE NEED AND IMPORTANCE OF ACHIEVING AND MAINTAINING A HEALTHY BODY WEIGHT AND PHYSICAL FITNESS (U.S. CLS. 100, 101 AND 102).

INGA ERVIN, EXAMINING ATTORNEY

SN 77-945,590. PSA ESSENTIALS, LLC, BLUFFTON, SC. FILED 2-26-2010.



NO CLAIM IS MADE TO THE EXCLUSIVE RIGHT TO USE "STAMPABLE NOTE CARDS", "STAMPS AND EMBOSSEERS" AND "PAPERS, STAMPS, ACCESSORIES", APART FROM THE MARK AS SHOWN.

THE MARK CONSISTS OF A SQUARE WITH A DOT AND THE WORDS "STAMPABLE NOTE CARDS" AND A DOT ON THE LEFT INSIDE SIDE OF THE SQUARE AND THE WORDS "WWW.PSAESSENTIALS.COM" ON THE TOP INSIDE OF THE SQUARE AND A DOT AND THE WORDS "STAMPS AND EMBOSSEERS" AND A DOT ON THE RIGHT INSIDE OF THE SQUARE AND THE WORDS "PAPERS, STAMPS, ACCESSORIES" ON THE BOTTOM INSIDE OF THE SQUARE AND THE WORDS "PSA ESSENTIALS" IN THE CENTER OF THE SQUARE WITH STYLIZED SCROLL IMAGES ABOVE, BELOW AND BEHIND THE "PSA" WORDING.

FOR ON-LINE RETAIL STORE SERVICES FEATURING STAMPS, EMBOSSEERS, NOTE CARDS, CALLING CARDS AND PAPER STATIONARY (U.S. CLS. 100, 101 AND 102).

DAVID MURRAY, EXAMINING ATTORNEY

CLASS 35—(Continued).

SN 77-952,926. INTERNATIONAL TRUCK INTELLECTUAL PROPERTY COMPANY, LLC, WARRENVILLE, IL. FILED 3-8-2010.



OWNER OF U.S. REG. NO. 3,701,935.
THE MARK CONSISTS OF THE WORDS "MY EDGE" COMBINED WITH A SHADED TRIANGLE ON ITS SIDE POINTING RIGHT IN THE LETTER "G".
FOR DIRECT MARKETING SERVICES IN THE FIELD OF VEHICLE PARTS AND REPAIR (U.S. CLS. 100, 101 AND 102).
FIRST USE 1-15-2007. THE MARK WAS FIRST USED ANYWHERE IN A DIFFERENT FORM OTHER THAN THAT SOUGHT TO BE REGISTERED AT LEAST AS EARLY AS 01/15/2007; IN COMMERCE 1-15-2007, THE MARK WAS FIRST USED IN COMMERCE IN A DIFFERENT FORM OTHER THAN THAT SOUGHT TO BE REGISTERED AT LEAST AS EARLY AS 01/15/2007.
THOMAS MANOR, EXAMINING ATTORNEY

SN 77-953,121. ACE HARDWARE CORPORATION, OAK BROOK, IL. FILED 3-8-2010.

**GET IN. GET HELP. GET
OUTSIDE.**

THE MARK CONSISTS OF STANDARD CHARACTERS WITHOUT CLAIM TO ANY PARTICULAR FONT, STYLE, SIZE, OR COLOR.
FOR RETAIL HARDWARE STORE SERVICES IN THE FIELD OF HARDWARE AND RELATED GOODS (U.S. CLS. 100, 101 AND 102).
DAVID I, EXAMINING ATTORNEY

SN 77-953,134. ACE HARDWARE CORPORATION, OAK BROOK, IL. FILED 3-8-2010.

**GET IN. GET HELP. GET
REWARDED.**

THE MARK CONSISTS OF STANDARD CHARACTERS WITHOUT CLAIM TO ANY PARTICULAR FONT, STYLE, SIZE, OR COLOR.
FOR RETAIL HARDWARE STORE SERVICES IN THE FIELD OF HARDWARE AND RELATED GOODS (U.S. CLS. 100, 101 AND 102).
DAVID I, EXAMINING ATTORNEY

CLASS 35—(Continued).

SN 77-956,698. GLOBAL PRESCRIBER LLC, DENVER, CO. FILED 3-11-2010.

No-See

THE MARK CONSISTS OF STANDARD CHARACTERS WITHOUT CLAIM TO ANY PARTICULAR FONT, STYLE, SIZE, OR COLOR.
FOR PROVIDING ADVERTISING, MARKETING AND PROMOTIONAL SERVICES FOR THE PHARMACEUTICAL AND MEDICAL INDUSTRY (U.S. CLS. 100, 101 AND 102).
MICHAEL SOUDERS, EXAMINING ATTORNEY

SN 77-957,214. RUE, DONALD W, FERNLEY, NV. FILED 3-11-2010.

**FROM CONCEPT TO CREATION,
CONTACT TO COMPLETION**

THE MARK CONSISTS OF STANDARD CHARACTERS WITHOUT CLAIM TO ANY PARTICULAR FONT, STYLE, SIZE, OR COLOR.
FOR RETAIL STORE AND ON-LINE RETAIL STORE SERVICES FEATURING CUSTOM EMBROIDERED MERCHANDISE, CUSTOM EMBROIDERED CLOTHING, CAPS, GOLF BAGS, EQUIPMENT BAGS, UNIFORMS, JACKETS, DOG COLLARS, AND CLOTHING (U.S. CLS. 100, 101 AND 102).
WENDY JUN, EXAMINING ATTORNEY

SN 77-958,952. SDI HEALTH LLC, PLYMOUTH MEETING, PA. FILED 3-15-2010.

VOPD

THE MARK CONSISTS OF STANDARD CHARACTERS WITHOUT CLAIM TO ANY PARTICULAR FONT, STYLE, SIZE, OR COLOR.
FOR BUSINESS SERVICES FOR OTHERS, NAMELY, PROVIDING PATIENT, PRESCRIPTION AND RELATED STATISTICAL AND DEMOGRAPHIC INFORMATION IN ORDER TO FACILITATE EFFICIENT SALES, MARKETING AND RELATED BUSINESS ACTIVITIES IN THE HEALTH CARE, PHARMACEUTICAL, VETERINARY, PHARMACOGENOMIC, BIOTECHNICAL AND MEDICAL INDUSTRIES, AS WELL AS PROVIDING CUSTOMIZED STATISTICAL AND STRATEGIC ANALYSES OF PATIENT AND PRESCRIPTION ACTIVITY AND RELATED BUSINESS CONSULTING AND BUSINESS AUDITING SERVICES TO ORGANIZATIONS IN THESE INDUSTRIES (U.S. CLS. 100, 101 AND 102).
KAREN SEVERSON, EXAMINING ATTORNEY

CLASS 35—(Continued).

SN 77-958,957. SDI HEALTH LLC, PLYMOUTH MEETING, PA. FILED 3-15-2010.

VECTOR ONE PAYER DYNAMICS

THE MARK CONSISTS OF STANDARD CHARACTERS WITHOUT CLAIM TO ANY PARTICULAR FONT, STYLE, SIZE, OR COLOR.

OWNER OF U.S. REG. NO. 3,025,065.

NO CLAIM IS MADE TO THE EXCLUSIVE RIGHT TO USE "PAYER", APART FROM THE MARK AS SHOWN.

FOR BUSINESS SERVICES FOR OTHERS, NAMELY, PROVIDING PATIENT, PRESCRIPTION AND RELATED STATISTICAL AND DEMOGRAPHIC INFORMATION IN ORDER TO FACILITATE EFFICIENT SALES, MARKETING AND RELATED BUSINESS ACTIVITIES IN THE HEALTH CARE, PHARMACEUTICAL, VETERINARY, PHARMACOGENOMIC, BIOTECHNICAL AND MEDICAL INDUSTRIES, AS WELL AS PROVIDING CUSTOMIZED STATISTICAL AND STRATEGIC ANALYSES OF PATIENT AND PRESCRIPTION ACTIVITY AND RELATED BUSINESS CONSULTING AND BUSINESS AUDITING SERVICES TO ORGANIZATIONS IN THESE INDUSTRIES (U.S. CLS. 100, 101 AND 102).

KAREN SEVERSON, EXAMINING ATTORNEY

CLASS 35—(Continued).

SN 77-959,077. MANA PRODUCTS, INC., LONG ISLAND CITY, NY. FILED 3-15-2010.

A VISION OF BEAUTY

THE MARK CONSISTS OF STANDARD CHARACTERS WITHOUT CLAIM TO ANY PARTICULAR FONT, STYLE, SIZE, OR COLOR.

FOR ON-LINE RETAIL STORE SERVICES FEATURING COSMETIC, BEAUTY, AND PERSONAL CARE PRODUCTS; RETAIL STORE SERVICES FEATURING COSMETIC, BEAUTY, AND PERSONAL CARE PRODUCTS (U.S. CLS. 100, 101 AND 102).

ALICE BENMAMAN, EXAMINING ATTORNEY

SN 77-961,900. GEORGIA-PACIFIC LLC, ATLANTA, GA. FILED 3-18-2010.

SN 77-958,963. SDI HEALTH LLC, PLYMOUTH MEETING, PA. FILED 3-15-2010.

PAYER DYNAMICS

THE MARK CONSISTS OF STANDARD CHARACTERS WITHOUT CLAIM TO ANY PARTICULAR FONT, STYLE, SIZE, OR COLOR.

NO CLAIM IS MADE TO THE EXCLUSIVE RIGHT TO USE "PAYER", APART FROM THE MARK AS SHOWN.

FOR BUSINESS SERVICES FOR OTHERS, NAMELY, PROVIDING PATIENT, PRESCRIPTION AND RELATED STATISTICAL AND DEMOGRAPHIC INFORMATION IN ORDER TO FACILITATE EFFICIENT SALES, MARKETING AND RELATED BUSINESS ACTIVITIES IN THE HEALTH CARE, PHARMACEUTICAL, VETERINARY, PHARMACOGENOMIC, BIOTECHNICAL AND MEDICAL INDUSTRIES, AS WELL AS PROVIDING CUSTOMIZED STATISTICAL AND STRATEGIC ANALYSES OF PATIENT AND PRESCRIPTION ACTIVITY AND RELATED BUSINESS CONSULTING AND BUSINESS AUDITING SERVICES TO ORGANIZATIONS IN THESE INDUSTRIES (U.S. CLS. 100, 101 AND 102).

KAREN SEVERSON, EXAMINING ATTORNEY



OWNER OF U.S. REG. NOS. 1,581,414, 1,603,264 AND 3,139,736.

THE MARK CONSISTS OF THE LETTERS "GP" IN A TRIANGLE SHAPE IN THE CENTER WITH THE WORDS "GEORGIA-PACIFIC PROFESSIONAL" AROUND THE TRIANGLE IN THE MIDDLE OF A LARGER CIRCLE WITH THE WORDS "HEALTH SMART" ENCIRCLING THAT.

FOR PROMOTING PUBLIC AWARENESS OF THE IMPORTANCE OF PROPER HAND WASHING (U.S. CLS. 100, 101 AND 102).

SUNG IN, EXAMINING ATTORNEY

CLASS 35—(Continued).

SN 77-961,903. GEORGIA-PACIFIC LLC, ATLANTA, GA. FILED 3-18-2010.

GP HEALTHSMART

THE MARK CONSISTS OF STANDARD CHARACTERS WITHOUT CLAIM TO ANY PARTICULAR FONT, STYLE, SIZE, OR COLOR.

OWNER OF U.S. REG. NOS. 1,581,414, 1,603,264 AND 3,139,736.

FOR PROMOTING PUBLIC AWARENESS OF THE IMPORTANCE OF PROPER HAND WASHING (U.S. CLS. 100, 101 AND 102).

SUNG IN, EXAMINING ATTORNEY

SN 77-962,449. ACOSTA, INC., JACKSONVILLE, FL. FILED 3-18-2010.

MATCHPOINT MARKETING

THE MARK CONSISTS OF STANDARD CHARACTERS WITHOUT CLAIM TO ANY PARTICULAR FONT, STYLE, SIZE, OR COLOR.

NO CLAIM IS MADE TO THE EXCLUSIVE RIGHT TO USE "MARKETING", APART FROM THE MARK AS SHOWN.

FOR PRODUCT MERCHANDISING AND BUSINESS MARKETING CONSULTING SERVICES AND DEVELOPING PROMOTIONAL CAMPAIGNS FOR MANUFACTURERS AND RETAILERS IN THE CONSUMER PACKAGED GOODS INDUSTRY (U.S. CLS. 100, 101 AND 102).

FIRST USE 1-1-2001; IN COMMERCE 1-1-2001.

ALEXANDER L. POWERS, EXAMINING ATTORNEY

SN 77-962,833. RUE, DONALD W, FERNLEY, NV. FILED 3-18-2010.

EXCELLENCE WITHOUT EXCUSES

THE MARK CONSISTS OF STANDARD CHARACTERS WITHOUT CLAIM TO ANY PARTICULAR FONT, STYLE, SIZE, OR COLOR.

FOR RETAIL STORE AND ON-LINE RETAIL STORE SERVICES FEATURING CUSTOM EMBROIDERED MERCHANDISE, CUSTOM EMBROIDERED CLOTHING, CAPS, GOLF BAGS, EQUIPMENT BAGS, UNIFORMS, JACKETS, DOG COLLARS, AND CLOTHING (U.S. CLS. 100, 101 AND 102).

WENDY JUN, EXAMINING ATTORNEY

CLASS 35—(Continued).

SN 85-001,141. TVI, INC., BELLEVUE, WA. FILED 3-29-2010.

SAVERS
Good deeds. Great deals.

OWNER OF U.S. REG. NO. 2,107,170.
FOR RETAIL STORE SERVICES FEATURING A WIDE VARIETY OF USED CONSUMER GOODS ORIGINATING FROM CHARITABLE ORGANIZATIONS (U.S. CLS. 100, 101 AND 102).

ALEX KEAM, EXAMINING ATTORNEY

SN 85-004,564. JROCKET MARKETING, LLC, RANCHO SANTA FE, CA. FILED 4-1-2010.

JRocket Marketing Plan-It

THE MARK CONSISTS OF STANDARD CHARACTERS WITHOUT CLAIM TO ANY PARTICULAR FONT, STYLE, SIZE, OR COLOR.

NO CLAIM IS MADE TO THE EXCLUSIVE RIGHT TO USE "MARKETING", APART FROM THE MARK AS SHOWN.

FOR MARKETING CONSULTING (U.S. CLS. 100, 101 AND 102).

FIRST USE 5-1-2001; IN COMMERCE 5-1-2001.

VERNA BETH RIRIE, EXAMINING ATTORNEY

CLASS 35—(Continued).

SN 85-007,552. MISS MATCHED, INC., NEW YORK, NY.
FILED 4-6-2010.

SMART CHOICES. SMART BABY.
LITTLEMISSMATCHED

THE MARK CONSISTS OF STANDARD CHARACTERS WITHOUT CLAIM TO ANY PARTICULAR FONT, STYLE, SIZE, OR COLOR.

OWNER OF U.S. REG. NOS. 3,475,092, 3,565,831 AND OTHERS.

FOR WHOLESALE DISTRIBUTORSHIPS AND RETAIL STORE SERVICES IN THE FIELDS OF CLOTHING, FOOTWEAR, HEADGEAR, CLOTHING ACCESSORIES, TEXTILES AND TEXTILE GOODS, BED SHEETS, QUILTS, BLANKETS, RECEIVING BLANKETS, CRIB SKIRTS, DIAPER CHANGING PADS, FURNITURE, HIGH CHAIRS, BOOSTER SEATS, BATH SEATS, BOUNCER SEATS, DOORWAY BOUNCER SEATS, FOOT TRAY ASSEMBLIES FOR CHILDREN, CHILD'S CHAIRS, PLAYMATS, MATS FOR INFANT PLAYPENS, TOY BOXES AND CHESTS, CHILD'S HOOK-ON PORTABLE HIGH CHAIRS, BABY BOTTLES, NIPPLES, PACIFIERS FOR BABIES, BABY BOTTLE NIPPLES, TEETHING RINGS, PACIFIER CLIPS, FEEDING AND EATING BOWLS AND UTENSILS FOR CHILDREN, BABY MANICURE SCISSORS, BABY FOOD STORAGE CONTAINERS, TETHERS FOR SAFELY ATTACHING TEETHING RINGS AND PACIFIERS TO A CHILD'S WRIST OR CLOTHING, WALL APPLIQUES AND DECALS, CHILDREN'S TOYS, TOYS FOR INFANTS AND TODDLERS, CRIB MOBILES, CRIB ACTIVITY BARS, ACTIVITY MATS FOR USE IN CRIBS, PLUSH DOLLS AND TOYS, PLAY MATS FOR CHILDREN, INFANTS AND TODDLERS, BABY RATTLES, BABY MULTIPLE ACTIVITY TOYS, AND GENERAL PURPOSE STORAGE BINS FOR HOUSEHOLD USE, BOOKS, BAGS (U.S. CLS. 100, 101 AND 102).

DOMINIC J. FERRAIUOLO, EXAMINING ATTORNEY

SN 85-022,738. THE DOLL HOSPITAL & TOY SOLDIER SHOP, INC., BERKLEY, MI. FILED 4-26-2010.

TWITTERJACKS

THE MARK CONSISTS OF STANDARD CHARACTERS WITHOUT CLAIM TO ANY PARTICULAR FONT, STYLE, SIZE, OR COLOR.

FOR DEVELOPING AND IMPLEMENTING A WEB-BASED INCENTIVE AWARD PROGRAM THAT PROMOTES THE PRODUCTS OF ONE VENDOR BY OFFERING THEIR GOODS AS PROMOTIONAL ITEMS WHEN AN INTERNET SHOPPER PURCHASES GOODS MANUFACTURED BY A SECOND VENDOR (U.S. CLS. 100, 101 AND 102).

FIRST USE 6-29-2009; IN COMMERCE 6-29-2009.
MATTHEW EINSTEIN, EXAMINING ATTORNEY

CLASS 36—INSURANCE AND FINANCIAL

SN 76-701,490. TRI-STAR HOME REALTY, SACRAMENTO, CA. FILED 2-4-2010.



NO CLAIM IS MADE TO THE EXCLUSIVE RIGHT TO USE "HOME REALTY", APART FROM THE MARK AS SHOWN.

FOR RESIDENTIAL REAL ESTATE BROKERAGE (U.S. CLS. 100, 101 AND 102).

FIRST USE 7-1-2008; IN COMMERCE 7-1-2008.
LINDA M. KING, EXAMINING ATTORNEY

SN 77-179,415. REGENTS BANCSHARES, INC., LA JOLLA, CA. FILED 5-11-2007.

REGENTS BANK

THE MARK CONSISTS OF STANDARD CHARACTERS WITHOUT CLAIM TO ANY PARTICULAR FONT, STYLE, SIZE, OR COLOR.

NO CLAIM IS MADE TO THE EXCLUSIVE RIGHT TO USE "BANK", APART FROM THE MARK AS SHOWN.

FOR BANKING; INVESTMENT BANKING SERVICES; ON-LINE BANKING SERVICES; FINANCIAL PORTFOLIO MANAGEMENT; FINANCIAL SERVICES IN THE NATURE OF AN INVESTMENT SECURITY (U.S. CLS. 100, 101 AND 102).

FIRST USE 9-14-2001; IN COMMERCE 9-14-2001.
LESLEY LAMOTHE, EXAMINING ATTORNEY

SN 77-226,729. SAFFPAY, INC., SEATTLE, WA. FILED 7-11-2007.

monii

THE MARK CONSISTS OF STANDARD CHARACTERS WITHOUT CLAIM TO ANY PARTICULAR FONT, STYLE, SIZE, OR COLOR.

FOR ELECTRONIC COMMERCE PAYMENT SERVICES, NAMELY, ESTABLISHING ACCOUNTS USED TO PURCHASE GOODS AND SERVICES FROM SELECTED PROVIDERS ON THE INTERNET; ELECTRONIC FUNDS TRANSFER, NAMELY, ACCEPTING PAYMENTS ON BEHALF OF PROVIDERS OF GOODS AND SERVICES; ELECTRONIC PAYMENT, NAMELY, ELECTRONIC PROCESSING AND TRANSMISSION OF BILL PAYMENT DATA (U.S. CLS. 100, 101 AND 102).

MORGAN WYNNE, EXAMINING ATTORNEY

CLASS 36—(Continued).

SN 77-522,928. MONTAGE HOTELS & RESORTS, LLC, LAGUNA BEACH, CA. FILED 7-15-2008.



OWNER OF U.S. REG. NOS. 2,801,152, 2,853,585 AND 3,325,069.

NO CLAIM IS MADE TO THE EXCLUSIVE RIGHT TO USE "RESIDENCES", APART FROM THE MARK AS SHOWN.

THE MARK CONSISTS OF A STYLIZED "M" SHOWN ABOVE THE WORDS "MONTAGE" AND "RESIDENCES".

FOR REAL ESTATE PROCUREMENT FOR OTHERS; REAL ESTATE AGENCY SERVICES; REAL ESTATE BROKERAGE AND MANAGEMENT SERVICES, NAMELY, THE MANAGEMENT, SALE, LEASING AND RENTAL OF CONDOMINIUMS AND APARTMENTS (U.S. CLS. 100, 101 AND 102).

FIRST USE 3-2-2009; IN COMMERCE 3-2-2009.
EMILY CARLSEN, EXAMINING ATTORNEY

SN 77-522,934. MONTAGE HOTELS AND RESORTS, LLC, LAGUNA BEACH, CA. FILED 7-15-2008.

MONTAGE RESIDENCES

THE MARK CONSISTS OF STANDARD CHARACTERS WITHOUT CLAIM TO ANY PARTICULAR FONT, STYLE, SIZE, OR COLOR.

OWNER OF U.S. REG. NOS. 2,801,152, 2,853,585 AND 3,325,069.

NO CLAIM IS MADE TO THE EXCLUSIVE RIGHT TO USE "RESIDENCES", APART FROM THE MARK AS SHOWN.

FOR REAL ESTATE PROCUREMENT FOR OTHERS; REAL ESTATE AGENCY SERVICES; REAL ESTATE BROKERAGE AND MANAGEMENT SERVICES, NAMELY, THE MANAGEMENT, SALE, LEASING AND RENTAL OF CONDOMINIUMS AND APARTMENTS (U.S. CLS. 100, 101 AND 102).

FIRST USE 3-2-2009; IN COMMERCE 3-2-2009.
EMILY CARLSEN, EXAMINING ATTORNEY

CLASS 36—(Continued).

SN 77-525,295. FIREMAN'S FUND INSURANCE COMPANY, NOVATO, CA. FILED 7-17-2008.

HERITAGE PROGRAM

THE MARK CONSISTS OF STANDARD CHARACTERS WITHOUT CLAIM TO ANY PARTICULAR FONT, STYLE, SIZE, OR COLOR.

NO CLAIM IS MADE TO THE EXCLUSIVE RIGHT TO USE "PROGRAM", APART FROM THE MARK AS SHOWN.

FOR PHILANTHROPIC SERVICES CONCERNING MONETARY DONATIONS AND PROVIDING GRANTS TO FUND EQUIPMENT AND VOLUNTEERISM SUPPORT TO FIRE DEPARTMENTS, FIRE SERVICE ORGANIZATIONS, EMERGENCY MEDICAL SERVICE ORGANIZATIONS AND FIRE AND BURN PREVENTION PROGRAMS; ACCEPTING AND ADMINISTERING MONETARY CHARITABLE CONTRIBUTIONS; CHARITABLE FUNDRAISING FOR THE FIRE SERVICE (U.S. CLS. 100, 101 AND 102).

ARETHA SOMERVILLE, EXAMINING ATTORNEY

SN 77-558,107. PLATE-O-PAIR ENTERPRISES, INC., DBA PLATE-O-PAIR, FLOYDS KNOBS, IN. FILED 8-28-2008.



THE NAME(S), PORTRAIT(S), AND/OR SIGNATURE(S) SHOWN IN THE MARK IDENTIFIES "RICHARD CAREY" AND "GLEN R. SNOW", WHOSE CONSENT(S) TO REGISTER IS MADE OF RECORD.

THE MARK CONSISTS OF THE CARICATURE DRAWING OF THE HEADS OF TWO MEN WEARING CHEF'S HATS. THE HATS CONTAIN THE INITIALS "R.C." IN SCRIPT LETTERING ON THE LEFT HAT, AND THE WORD "SNOWBALL" IN SCRIPT LETTERING ON THE RIGHT HAT. THE MAN ON THE LEFT IS WEARING EYEGLASSES, HAS A MUSTACHE, AND IS SMILING. THE MAN ON THE RIGHT IS SMILING. THE MEN'S HEADS ARE SUPERIMPOSED ON A CONCENTRIC CIRCLE DESIGN. THE WORDS "PLATE-O-PAIR" APPEAR IN ALL CAPITAL LETTERS BETWEEN THE TWO CONCENTRIC CIRCLES UNDERNEATH THE HEADS AT THE BOTTOM OF THE DESIGN.

FOR ACCEPTING AND ADMINISTERING MONETARY CHARITABLE CONTRIBUTIONS; CHARITABLE FUND RAISING (U.S. CLS. 100, 101 AND 102).

FIRST USE 4-27-2006; IN COMMERCE 4-27-2006.
JEFFERY COWARD, EXAMINING ATTORNEY

CLASS 36—(Continued).

SN 77-566,464. DUNDEE CORPORATION, TORONTO, ONTARIO, CANADA, FILED 9-10-2008.

DundeeWealth International

THE MARK CONSISTS OF STANDARD CHARACTERS WITHOUT CLAIM TO ANY PARTICULAR FONT, STYLE, SIZE, OR COLOR.

OWNER OF CANADA REG. NO. 754801, DATED 12-8-2009, EXPIRES 12-8-2024.

OWNER OF U.S. REG. NOS. 2,367,541, 3,482,738 AND OTHERS.

NO CLAIM IS MADE TO THE EXCLUSIVE RIGHT TO USE "INTERNATIONAL", APART FROM THE MARK AS SHOWN.

FOR INVESTMENT MANAGEMENT SERVICES, NAMELY, CREATING, MANAGING AND ADMINISTERING MUTUAL FUNDS, THIRD PARTY ASSET MANAGEMENT AND TAX ASSISTED INVESTMENTS; FINANCIAL ADVISORY SERVICES, NAMELY, FINANCIAL PLANNING AND INVESTMENT MANAGEMENT SERVICES; ADMINISTERING LIFE, ACCIDENTAL DEATH AND HEALTH INSURANCE POLICIES; ADMINISTERING BANKING, FINANCIAL AND ESTATE PLANNING SERVICES; CAPITAL MARKETS SERVICES, NAMELY, INVESTMENT BANKING SERVICES AND UNDERWRITING OF THE SALE OF SECURITIES TO THE PUBLIC; PRIVATE PLACEMENTS AND INVESTMENT ADVISORY SERVICES RELATED TO MERGERS AND ACQUISITIONS, DIVESTITURES, RESTRUCTURINGS AND STOCK EXCHANGE LISTINGS, INSTITUTIONAL SALES AND TRADING SERVICES, NAMELY, THE SELLING, PURCHASING AND TRADING OF EQUITY AND EQUITY RELATED SECURITIES AND FIXED INCOME SECURITIES ON BEHALF OF INSTITUTIONAL CLIENTS; INVESTMENT RESEARCH SERVICES, NAMELY, THE PREPARATION OF RESEARCH REPORTS AND OPINIONS TO INDIVIDUAL INVESTORS AND INSTITUTIONAL CLIENTS IN CONNECTION WITH INVESTMENT DECISION MAKING; BANKING SERVICES, NAMELY, GUARANTEED INVESTMENT CERTIFICATES, MORTGAGES, RSP LOANS, INVESTMENT LOANS, STRUCTURED CREDIT AND FIXED INCOME INVESTMENTS (U.S. CLS. 100, 101 AND 102).

ALICIA COLLINS, EXAMINING ATTORNEY

CLASS 36—(Continued).

SN 77-566,470. DUNDEE CORPORATION, TORONTO, ONTARIO, CANADA, FILED 9-10-2008.

DundeeWealth Global Partners

THE MARK CONSISTS OF STANDARD CHARACTERS WITHOUT CLAIM TO ANY PARTICULAR FONT, STYLE, SIZE, OR COLOR.

PRIORITY CLAIMED UNDER SEC. 44(D) ON CANADA APPLICATION NO. 1409342, FILED 9-3-2008, REG. NO. 753822, DATED 11-24-2009, EXPIRES 11-24-2024.

OWNER OF U.S. REG. NOS. 2,367,541, 3,482,738 AND OTHERS.

NO CLAIM IS MADE TO THE EXCLUSIVE RIGHT TO USE "GLOBAL PARTNERS", APART FROM THE MARK AS SHOWN.

FOR INVESTMENT MANAGEMENT SERVICES, NAMELY, CREATING, MANAGING AND ADMINISTERING MUTUAL FUNDS, THIRD PARTY ASSET MANAGEMENT AND TAX ASSISTED INVESTMENTS; FINANCIAL ADVISORY SERVICES, NAMELY, FINANCIAL PLANNING AND INVESTMENT MANAGEMENT SERVICES; ADMINISTERING LIFE, ACCIDENTAL DEATH AND HEALTH INSURANCE POLICIES; ADMINISTERING BANKING, FINANCIAL AND ESTATE PLANNING SERVICES; CAPITAL MARKETS SERVICES, NAMELY, INVESTMENT BANKING SERVICES AND UNDERWRITING OF THE SALE OF SECURITIES TO THE PUBLIC; PRIVATE PLACEMENTS AND INVESTMENT ADVISORY SERVICES RELATED TO MERGERS AND ACQUISITIONS, DIVESTITURES, RESTRUCTURINGS AND STOCK EXCHANGE LISTINGS, INSTITUTIONAL SALES AND TRADING SERVICES, NAMELY, THE SELLING, PURCHASING AND TRADING OF EQUITY AND EQUITY RELATED SECURITIES AND FIXED INCOME SECURITIES ON BEHALF OF INSTITUTIONAL CLIENTS; INVESTMENT RESEARCH SERVICES, NAMELY, THE PREPARATION OF RESEARCH REPORTS AND OPINIONS TO INDIVIDUAL INVESTORS AND INSTITUTIONAL CLIENTS IN CONNECTION WITH INVESTMENT DECISION MAKING; BANKING SERVICES, NAMELY, GUARANTEED INVESTMENT CERTIFICATES, MORTGAGES, RSP LOANS, INVESTMENT LOANS, STRUCTURED CREDIT AND FIXED INCOME INVESTMENTS (U.S. CLS. 100, 101 AND 102).

ALICIA COLLINS, EXAMINING ATTORNEY

SN 77-582,014. OPTIONSPRESS HOLDINGS, INC., CHICAGO, IL. FILED 9-30-2008.

ADVISERSXPRESS

THE MARK CONSISTS OF STANDARD CHARACTERS WITHOUT CLAIM TO ANY PARTICULAR FONT, STYLE, SIZE, OR COLOR.

FOR SECURITIES, OPTIONS, AND FUTURES BROKERAGE SERVICES FOR INDEPENDENT REPRESENTATIVES (U.S. CLS. 100, 101 AND 102).

FIRST USE 9-30-2008; IN COMMERCE 9-30-2008.

YAT SYE, LEE, EXAMINING ATTORNEY

CLASS 36—(Continued).

SN 77-598,861. CEDAR SHOPPING CENTERS PARTNERSHIP, L.P., PORT WASHINGTON, NY. FILED 10-23-2008.

bread & butter shopping
centers

THE MARK CONSISTS OF STANDARD CHARACTERS WITHOUT CLAIM TO ANY PARTICULAR FONT, STYLE, SIZE, OR COLOR.

NO CLAIM IS MADE TO THE EXCLUSIVE RIGHT TO USE "SHOPPING CENTERS", APART FROM THE MARK AS SHOWN.

FOR REAL ESTATE MANAGEMENT SERVICES IN THE FIELD OF SUPERMARKET-ANCHORED SHOPPING CENTERS AND DRUG STORE-ANCHORED CONVENIENCE CENTERS (U.S. CLS. 100, 101 AND 102).

FIRST USE 5-1-2008; IN COMMERCE 5-1-2008.
STEVEN PEREZ, EXAMINING ATTORNEY

CLASS 36—(Continued).

SN 77-634,012. THE ARTHRITIS FOUNDATION, INC., ATLANTA, GA. FILED 12-16-2008.



OWNER OF U.S. REG. NOS. 1,147,410, 3,043,606 AND OTHERS.

NO CLAIM IS MADE TO THE EXCLUSIVE RIGHT TO USE "FOUNDATION" AND "BASH", APART FROM THE MARK AS SHOWN.

THE MARK CONSISTS OF AN OUTLINE OF A SKELETON ARM FACING RIGHT WITH THE WORDS "ARTHRITIS FOUNDATION" ON TOP OF THE WORDS "BONE BASH", AND AN OUTLINE OF A SKELETON ARM FACING LEFT.

SEC. 2(F) AS TO "ARTHRITIS FOUNDATION".
FOR CHARITABLE FUNDRAISING SERVICES; ORGANIZING, ARRANGING AND CONDUCTING CHARITABLE FUNDRAISING EVENTS (U.S. CLS. 100, 101 AND 102).

FIRST USE 7-0-2005; IN COMMERCE 7-0-2005.
YAT SYE, LEE, EXAMINING ATTORNEY

SN 77-628,336. NORTHWEST FARM CREDIT SERVICES ACA, SPOKANE, WA. FILED 12-8-2008.

AGVANTAGE

THE MARK CONSISTS OF STANDARD CHARACTERS WITHOUT CLAIM TO ANY PARTICULAR FONT, STYLE, SIZE, OR COLOR.

OWNER OF U.S. REG. NO. 3,532,382.

FOR BANKING SERVICES; MORTGAGE LENDING SERVICES; AGRICULTURAL, FISHING AND TIMBER LOANS, NAMELY, INSTALLMENTS LOANS, REAL PROPERTY LOAN FINANCING, TIMBER LOAN FINANCING, OPERATIONS LOAN FINANCING, FACILITIES LOAN FINANCING, PRODUCTION LOAN FINANCING, MACHINERY LOAN FINANCING, EQUIPMENT LOAN FINANCING, MARKETING LOAN FINANCING AND WORKING CAPITAL LOAN FINANCING IN THE FIELD OF AGRICULTURE, FISHING AND TIMBER; LOAN FINANCING; PROVIDING CREDIT AND LOAN SERVICES, AND FINANCIAL VALUATION, TO DIRECT SUPPLIERS AND LENDERS OF AGRICULTURAL PRODUCTS; LOAN FINANCING SERVICES; LEASE PURCHASE FINANCING AND LOANS (U.S. CLS. 100, 101 AND 102).

FIRST USE 5-31-2008; IN COMMERCE 5-31-2008.
DAWN HAN, EXAMINING ATTORNEY

SN 77-642,891. TRILINC GLOBAL, LLC, MANHATTAN BEACH, CA. FILED 1-3-2009.

TriLinc Global

THE MARK CONSISTS OF STANDARD CHARACTERS WITHOUT CLAIM TO ANY PARTICULAR FONT, STYLE, SIZE, OR COLOR.

NO CLAIM IS MADE TO THE EXCLUSIVE RIGHT TO USE "GLOBAL", APART FROM THE MARK AS SHOWN.

FOR CAPITAL INVESTMENT SERVICES; EQUITY CAPITAL INVESTMENT; FINANCIAL AND INVESTMENT SERVICES, NAMELY, MANAGEMENT AND BROKERAGE IN THE FIELDS OF STOCKS, BONDS, OPTIONS, COMMODITIES, FUTURES AND OTHER SECURITIES, AND THE INVESTMENT OF FUNDS OF OTHERS; FINANCIAL SERVICES, NAMELY, INVESTMENT ADVICE, INVESTMENT MANAGEMENT, INVESTMENT CONSULTATION AND INVESTMENT OF FUNDS FOR OTHERS, INCLUDING PRIVATE AND PUBLIC EQUITY AND DEBT INVESTMENT SERVICES; FUNDS INVESTMENT; INVESTMENT MANAGEMENT SERVICES IN THE FIELD OF ACQUIRING JOINT VENTURES; INVESTMENT OF FUNDS FOR OTHERS; INVESTMENT SERVICES, NAMELY, ASSET ACQUISITION, CONSULTATION, DEVELOPMENT AND MANAGEMENT SERVICES; MANAGEMENT OF PRIVATE EQUITY FUNDS; PRIVATE EQUITY FUND INVESTMENT SERVICES; VENTURE CAPITAL FUNDING SERVICES TO EMERGING AND START-UP COMPANIES (U.S. CLS. 100, 101 AND 102).

NICHOLAS ALTREE, EXAMINING ATTORNEY

CLASS 36—(Continued).

SN 77-649,999. PMSI MSA SERVICES, INC., TAMPA, FL.
FILED 1-15-2009.

PMSI SETTLEMENT SOLUTIONS

THE MARK CONSISTS OF STANDARD CHARACTERS WITHOUT CLAIM TO ANY PARTICULAR FONT, STYLE, SIZE, OR COLOR.

NO CLAIM IS MADE TO THE EXCLUSIVE RIGHT TO USE "SETTLEMENT SOLUTIONS", APART FROM THE MARK AS SHOWN.

FOR SETTLEMENT SERVICES, NAMELY, CREATING AND SUBMITTING REPORTS RELATING TO MEDICARE SETTLEMENTS ON BEHALF OF SETTLEMENT ADMINISTRATORS AND PROVIDING INFORMATION AND REPORTS TO PERSONS AND COMPANIES INVOLVED IN CLAIM SETTLEMENT (U.S. CLS. 100, 101 AND 102).

FIRST USE 2-28-2009; IN COMMERCE 2-28-2009.
INGA ERVIN, EXAMINING ATTORNEY

SN 77-660,612. ALIAUNE THIAM, ATLANTA, GA. FILED 1-30-2009.

**CHILDREN RISK THEIR LIVES
IN THE DREAM OF FINDING
THE BIG ONE**

THE MARK CONSISTS OF STANDARD CHARACTERS WITHOUT CLAIM TO ANY PARTICULAR FONT, STYLE, SIZE, OR COLOR.

FOR CHARITABLE SERVICES, NAMELY, PROVIDING FINANCIAL SUPPORT FOR THE PURPOSE OF FACILITATING EDUCATIONAL, SOCIAL, AND HEALTHCARE OPPORTUNITIES (U.S. CLS. 100, 101 AND 102).

MATTHEW PAPPAS, EXAMINING ATTORNEY

SN 77-669,683. MISC S.A., ROAD TOWN, TORTOLA, BR. VIRGIN ISLANDS, FILED 2-12-2009.

MY FAIR RATE

THE MARK CONSISTS OF STANDARD CHARACTERS WITHOUT CLAIM TO ANY PARTICULAR FONT, STYLE, SIZE, OR COLOR.

NO CLAIM IS MADE TO THE EXCLUSIVE RIGHT TO USE "RATE", APART FROM THE MARK AS SHOWN.

FOR BANKING SERVICES; INVESTMENT ADVISORY SERVICES (U.S. CLS. 100, 101 AND 102).

CAROLINE WOOD, EXAMINING ATTORNEY

CLASS 36—(Continued).

SN 77-687,839. WESTFUND, LLC, OVERLAND PARK, KS.
FILED 3-10-2009.

WESTFUND

THE MARK CONSISTS OF STANDARD CHARACTERS WITHOUT CLAIM TO ANY PARTICULAR FONT, STYLE, SIZE, OR COLOR.

FOR FINANCIAL SERVICES IN THE NATURE OF TEMPORARY LOANS, NAMELY, HARD MONEY LOANS (U.S. CLS. 100, 101 AND 102).

JENNIFER VASQUEZ, EXAMINING ATTORNEY

SN 77-697,726. DUNDEE CORPORATION, TORONTO, ONTARIO, CANADA, FILED 3-24-2009.

DYNAMIC U.S. VALUE FUND

THE MARK CONSISTS OF STANDARD CHARACTERS WITHOUT CLAIM TO ANY PARTICULAR FONT, STYLE, SIZE, OR COLOR.

OWNER OF CANADA REG. NO. 758939, DATED 2-5-2010, EXPIRES 2-5-2025.

OWNER OF U.S. REG. NOS. 3,043,040, 3,414,507 AND OTHERS.

NO CLAIM IS MADE TO THE EXCLUSIVE RIGHT TO USE "U.S. VALUE FUND", APART FROM THE MARK AS SHOWN.

FOR MUTUAL FUNDS SERVICES, NAMELY, MUTUAL FUND BROKERAGE, MUTUAL FUND DISTRIBUTION AND THE ADMINISTRATION AND MANAGEMENT OF MUTUAL FUNDS, PORTFOLIO SOLUTIONS, CLOSED END INVESTMENTS, TAX ASSISTED INVESTMENT PRODUCTS AND ALTERNATIVE INVESTMENT PRODUCTS (U.S. CLS. 100, 101 AND 102).

TINA L. SNAPP, EXAMINING ATTORNEY

SN 77-699,221. BLUE CROSS AND BLUE SHIELD OF ALABAMA, BIRMINGHAM, AL. FILED 3-25-2009.



NO CLAIM IS MADE TO THE EXCLUSIVE RIGHT TO USE "PREFERRED LTC LONG-TERM CARE", APART FROM THE MARK AS SHOWN.

THE COLOR(S) GOLD AND BLACK IS/ARE CLAIMED AS A FEATURE OF THE MARK.

THE MARK CONSISTS OF THE WORDS "PREFERRED LTC LONG-TERM CARE" APPEARING IN BLACK WITH A FALLING GOLD LEAF.

FOR INSURANCE SERVICES, NAMELY, UNDERWRITING LONG TERM CARE INSURANCE (U.S. CLS. 100, 101 AND 102).

CHARLES L. JENKINS, EXAMINING ATTORNEY

CLASS 36—(Continued).

SN 77-702,959. HLT DOMESTIC IP LLC, MCLEAN, VA. FILED 3-31-2009.

PARC SOLEIL

THE MARK CONSISTS OF STANDARD CHARACTERS WITHOUT CLAIM TO ANY PARTICULAR FONT, STYLE, SIZE, OR COLOR.

THE ENGLISH TRANSLATION OF "PARC SOLEIL" IN THE MARK IS SUN PARK.

FOR VACATION REAL ESTATE TIME-SHARING SERVICES (U.S. CLS. 100, 101 AND 102).

FIRST USE 2-1-2009; IN COMMERCE 2-1-2009.
HELENE LIWINSKI, EXAMINING ATTORNEY

SN 77-721,502. ELEKTRA TRADING & CONSULTING GROUP, S.A. DE C.V., MEXICO CITY, MEXICO, FILED 4-24-2009.



NO CLAIM IS MADE TO THE EXCLUSIVE RIGHT TO USE "DINERO EXPRESS ENVIOS DE DINERO", APART FROM THE MARK AS SHOWN.

THE COLOR(S) GREEN AND WHITE IS/ARE CLAIMED AS A FEATURE OF THE MARK.

THE COLOR GREEN APPEARS IN THE LITERAL ELEMENTS "DEX DINERO EXPRESS ENVIOS DE DINERO" WITH A DARKER SHADE OF GREEN APPEARING IN THE LETTER "D" OF THE MARK "DEX" AND IN THE WORDING "ENVIOS DE DINERO". THE COLOR WHITE APPEARS IN THE BACKGROUND OF THE MARK AND DESIGN. THE RECTANGULAR BORDER IS GREEN.

FOR FINANCIAL SERVICES, NAMELY, ELECTRONIC TRANSFER OF FUNDS, AND MONEY TRANSFER SERVICES (U.S. CLS. 100, 101 AND 102).

PAUL MORENO, EXAMINING ATTORNEY

SN 77-751,259. DELEONARDIS, CHERYL M., HOLLYWOOD, FL. FILED 6-3-2009.

Marching For Hope

THE MARK CONSISTS OF STANDARD CHARACTERS WITHOUT CLAIM TO ANY PARTICULAR FONT, STYLE, SIZE, OR COLOR.

FOR PROVIDING CHARITABLE FUNDRAISING SERVICES ONLINE (U.S. CLS. 100, 101 AND 102).

CORY BOONE, EXAMINING ATTORNEY

CLASS 36—(Continued).

SN 77-754,961. FUENTE MARKETING LTD., TORTOLA, BR. VIRGIN ISLANDS, FILED 6-9-2009.

ANGEL'S SHARE

THE MARK CONSISTS OF STANDARD CHARACTERS WITHOUT CLAIM TO ANY PARTICULAR FONT, STYLE, SIZE, OR COLOR.

FOR CHARITABLE FUND RAISING SERVICES (U.S. CLS. 100, 101 AND 102).

BRENDAN REGAN, EXAMINING ATTORNEY

SN 77-764,231. THE HARFORD MUTUAL INSURANCE COMPANY, BELAIR, MD. FILED 6-19-2009.



NO CLAIM IS MADE TO THE EXCLUSIVE RIGHT TO USE "HARFORD MUTUAL", APART FROM THE MARK AS SHOWN.

THE MARK CONSISTS OF A CLOCK TOWER FACING AWAY FROM TWO LINES OF TEXT AND A DIVIDER; THE TWO LINES OF TEXT ARE POSITIONED ONE OVER THE OTHER WITH A DIVIDER IN BETWEEN; THE TOP LINE OF TEXT IS "HARFORD MUTUAL" AND THE BOTTOM LINE OF TEXT IS "COMMITTED TO MUTUAL SUCCESS"; THE DIVIDER IS FORMED BY A CENTRAL CIRCLE WITH A SINGLE LINE ON EACH SIDE OF THE CIRCLE.

FOR INSURANCE SERVICES, NAMELY, INSURANCE BROKERAGE, INSURANCE AGENCIES AND INSURANCE CONSULTING (U.S. CLS. 100, 101 AND 102).

WENDY GOODMAN, EXAMINING ATTORNEY

SN 77-774,782. FORD MOTOR COMPANY, DEARBORN, MI. FILED 7-6-2009.

HTD LEASING

THE MARK CONSISTS OF STANDARD CHARACTERS WITHOUT CLAIM TO ANY PARTICULAR FONT, STYLE, SIZE, OR COLOR.

NO CLAIM IS MADE TO THE EXCLUSIVE RIGHT TO USE "LEASING", APART FROM THE MARK AS SHOWN.

FOR COLLATERAL AGENT SERVICES, NAMELY, ACQUIRING, MANAGING AND HOLDING MOTOR VEHICLE LIENS, ON BEHALF OF THIRD-PARTY INVESTORS (U.S. CLS. 100, 101 AND 102).

WENDY GOODMAN, EXAMINING ATTORNEY

CLASS 36—(Continued).

SN 77-783,124. PRINCETON WEALTH ADVISORS, PRINCETON, NJ. FILED 7-16-2009.



NO CLAIM IS MADE TO THE EXCLUSIVE RIGHT TO USE "PRINCETON WEALTH ADVISORS", APART FROM THE MARK AS SHOWN.

THE STIPPLING IS FOR SHADING PURPOSES ONLY. THE MARK CONSISTS OF THE STYLIZED TEXT "PRINCETON WEALTH ADVISORS" FEATURED BELOW THE DESIGN OF A SEMI-CIRCLE BISECTING A TRIANGLE IN 3-D FORM. THE STIPPLING APPEARING AT THE ENDS OF THE SEMI-CIRCLE AND WITHIN THE TOP RIGHT OF THE TRIANGLE IS FOR SHADING PURPOSES ONLY.

FOR FINANCIAL SERVICES, NAMELY, INVESTMENT ADVICE, INVESTMENT MANAGEMENT, INVESTMENT CONSULTATION AND INVESTMENT OF FUNDS FOR OTHERS, INCLUDING PRIVATE AND PUBLIC EQUITY AND DEBT INVESTMENT SERVICES (U.S. CLS. 100, 101 AND 102).

FIRST USE 7-1-2007; IN COMMERCE 7-1-2007.
CHARISMA HAMPTON, EXAMINING ATTORNEY

SN 77-785,822. URBAN HEALTH ALLIANCE, SAN JUAN CAPISTRANO, CA. FILED 7-21-2009.



NO CLAIM IS MADE TO THE EXCLUSIVE RIGHT TO USE "RACE FOR THE ENVIRONMENT" AND THE DESCRIPTIVE DESIGN OF THE RECYCLING LOGO, APART FROM THE MARK AS SHOWN.

THE COLOR(S) BLUE, GREEN, BROWN, BLACK IS/ARE CLAIMED AS A FEATURE OF THE MARK.

THE MARK CONSISTS OF A BLACK BRUSH STROKE RUNNER CENTERED ON TOP OF A BLUE AND GREEN GLOBE WITH THE PHRASE "RACE FOR THE ENVIRONMENT" WRAPPING AROUND THE BOTTOM HALF OF THE GLOBE WRITTEN IN BROWN GOODFISH FONT. ON EACH SIDE OF THE PHRASE THERE IS A GREEN RECYCLE SYMBOL.

FOR CHARITABLE FUND RAISING SERVICE BY MEANS OF ORGANIZING AND CONDUCTING FOOT, BICYCLE, AND/OR SWIMMING RACES IN SUPPORT FOR EDUCATION, AWARENESS, AND PREVENTION PROGRAMS ADDRESSING ENVIRONMENTAL HAZARDS AFFECTING THE GENERAL PUBLIC, FAMILIES, AND CHILDREN (U.S. CLS. 100, 101 AND 102).

LYDIA BELZER, EXAMINING ATTORNEY

CLASS 36—(Continued).

SN 77-788,781. STATE FARM MUTUAL AUTOMOBILE INSURANCE COMPANY, BLOOMINGTON, IL. FILED 7-24-2009.



OWNER OF U.S. REG. NOS. 1,087,834 AND 3,378,675. NO CLAIM IS MADE TO THE EXCLUSIVE RIGHT TO USE "INSURANCE", "AUTO", "LIFE", "FIRE", "COMPANIA DE SEGUROS Y SERVICIOS FINANCIEROS", "AUTO", "VIDA", AND "HOGAR", APART FROM THE MARK AS SHOWN.

THE MARK CONSISTS OF A ROUNDED CORNER SQUARE WITHIN IT STATES "STATE FARM INSURANCE" AND IN THE 3 INTERCONNECTING OVALS IN THE SQUARE IT STATES "AUTO LIFE FIRE". OUTSIDE OF THE SQUARE "TU COMPANIA DE SEGUROS Y SERVICIOS FINANCIEROS AUTO VIDA HOGAR".

THE ENGLISH TRANSLATION OF "TU COMPANIA DE SEGUROS Y SERVICIOS FINANCIEROS AUTO VIDA HOGAR" IN THE MARK IS "YOUR COMPANY OF INSURANCE AND FINANCIAL SERVICES AUTO LIFE FIRE".

FOR UNDERWRITING AUTO, HOMEOWNERS, LIFE AND FIRE INSURANCE; SERVICING, NAMELY, INSURANCE ADMINISTRATION IN THE FIELDS OF AUTO, HOMEOWNERS, LIFE AND FIRE INSURANCE; BANKING AND MUTUAL FUND INVESTMENTS AND FINANCIAL ANALYSIS AND CONSULTATION (U.S. CLS. 100, 101 AND 102).

ASMAT KHAN, EXAMINING ATTORNEY

SN 77-788,848. ROYAL CREDIT UNION, EAU CLAIRE, WI. FILED 7-24-2009.

ROYAL CREDIT UNION

THE MARK CONSISTS OF STANDARD CHARACTERS WITHOUT CLAIM TO ANY PARTICULAR FONT, STYLE, SIZE, OR COLOR.

NO CLAIM IS MADE TO THE EXCLUSIVE RIGHT TO USE "CREDIT UNION", APART FROM THE MARK AS SHOWN.

FOR CREDIT UNION SERVICES; CREDIT UNION SERVICES, NAMELY, PROVIDING BANKING SERVICES, SAVINGS ACCOUNT SERVICES, CREDIT CARD SERVICES, SAFE DEPOSIT SERVICES, CHECKING ACCOUNT SERVICES, CERTIFICATES OF DEPOSIT, CONSUMER, COMMERCIAL AND MORTGAGE LOAN SERVICES, SECURITIES BROKERAGE, INDIVIDUAL RETIREMENT ACCOUNTS, DEBIT CARD SERVICES, FINANCIAL PLANNING AND ON-LINE BANKING (U.S. CLS. 100, 101 AND 102).

FIRST USE 0-0-1964; IN COMMERCE 0-0-1964.
BARBARA RUTLAND, EXAMINING ATTORNEY

CLASS 36—(Continued).

SN 77-788,924. STATE FARM MUTUAL AUTOMOBILE INSURANCE COMPANY, BLOOMINGTON, IL. FILED 7-24-2009.



OWNER OF U.S. REG. NOS. 1,087,834, 3,378,675 AND OTHERS.

NO CLAIM IS MADE TO THE EXCLUSIVE RIGHT TO USE "INSURANCE", "AUTO", "LIFE", "FIRE", "COMPANIA DE SEGUROS Y SERVICIOS FINANCIEROS", APART FROM THE MARK AS SHOWN.

THE MARK CONSISTS OF A ROUNDED CORNER SQUARE WITHIN IT STATES "STATE FARM INSURANCE" AND IN THE THREE INTERCONNECTING OVALS IN THE SQUARE IT STATES "AUTO LIFE FIRE", OUTSIDE THE SQUARE IT STATES "TU COMPANIA DE SEGUROS Y SERVICIOS FINANCIEROS".

THE ENGLISH TRANSLATION OF "TU COMPANIA DE SEGUROS Y SERVICIOS FINANCIEROS" IN THE MARK IS "YOUR COMPANY OF INSURANCE AND FINANCIAL SERVICES".

FOR UNDERWRITING AUTO, HOMEOWNERS, LIFE AND FIRE INSURANCE; SERVICING, NAMELY, INSURANCE ADMINISTRATION IN THE FIELDS OF AUTO, HOMEOWNERS, LIFE AND FIRE INSURANCE; BANKING AND MUTUAL FUND INVESTMENTS AND FINANCIAL ANALYSIS AND CONSULTATION (U.S. CLS. 100, 101 AND 102).

ASMAT KHAN, EXAMINING ATTORNEY

CLASS 36—(Continued).

SN 77-789,254. CRH ENTERPRISES, LLC, SAN ANTONIO, TX. FILED 7-24-2009.



THE WORDING "SILUEX" HAS NO MEANING IN A FOREIGN LANGUAGE.

FOR CREDIT TRANSACTION SERVICES, NAMELY, ISSUANCE OF PREPAID CARDS AND PROCESSING ELECTRONIC PAYMENTS MADE USING PREPAID PAYMENT CARDS (U.S. CLS. 100, 101 AND 102).

FIRST USE 6-1-2008; IN COMMERCE 4-1-2009.

AISHA SALEM, EXAMINING ATTORNEY

SN 77-789,235. CRH ENTERPRISES, LLC, SAN ANTONIO, TX. FILED 7-24-2009.



SILUEX

NO CLAIM IS MADE TO THE EXCLUSIVE RIGHT TO USE "STRATEGIC GLOBAL ADVISORS, LLC", APART FROM THE MARK AS SHOWN.

THE COLOR(S) ORANGE, WHITE AND BLACK IS/ARE CLAIMED AS A FEATURE OF THE MARK.

THE MARK CONSISTS OF AN ORANGE CIRCLE CONTAINING CURVED ORANGE AND WHITE STRIPES ACCOMPANIED BY THE WORD "STRATEGIC" IN BLACK TYPEFACE, THE WORD "GLOBAL" IN ORANGE TYPEFACE, AND THE WORDS "ADVISORS, LLC" IN BLACK TYPEFACE.

FOR FINANCIAL SERVICES, NAMELY, INVESTMENT ADVICE, INVESTMENT MANAGEMENT, INVESTMENT CONSULTATION AND INVESTMENT OF FUNDS FOR OTHERS, INCLUDING PUBLIC EQUITY INVESTMENT SERVICES (U.S. CLS. 100, 101 AND 102).

FIRST USE 11-0-2005; IN COMMERCE 11-0-2005.

MICHAEL KEATING, EXAMINING ATTORNEY

THE MARK CONSISTS OF STANDARD CHARACTERS WITHOUT CLAIM TO ANY PARTICULAR FONT, STYLE, SIZE, OR COLOR.

THE WORDING "SILUEX" HAS NO MEANING IN A FOREIGN LANGUAGE.

FOR CREDIT TRANSACTION SERVICES, NAMELY, ISSUANCE OF PREPAID CARDS AND PROCESSING ELECTRONIC PAYMENTS MADE USING PREPAID PAYMENT CARDS (U.S. CLS. 100, 101 AND 102).

FIRST USE 6-1-2008; IN COMMERCE 4-1-2009.

AISHA SALEM, EXAMINING ATTORNEY

CLASS 36—(Continued).

SN 77-795,419. HAAS AUTOMATION, INC., OXNARD, CA.
FILED 8-3-2009.

HAAS CNC RACING

THE MARK CONSISTS OF STANDARD CHARACTERS WITHOUT CLAIM TO ANY PARTICULAR FONT, STYLE, SIZE, OR COLOR.

NO CLAIM IS MADE TO THE EXCLUSIVE RIGHT TO USE "RACING", APART FROM THE MARK AS SHOWN.
SEC. 2(F).

FOR FINANCIAL SPONSORSHIP OF AUTOMOBILE RACING (U.S. CLS. 100, 101 AND 102).

FIRST USE 0-0-1998; IN COMMERCE 0-0-1998.
ANDREW LEASER, EXAMINING ATTORNEY

SN 77-796,740. ODYSSEY HEALTHCARE, INC., DALLAS, TX. FILED 8-4-2009.

CAMP ODYSSEY

THE MARK CONSISTS OF STANDARD CHARACTERS WITHOUT CLAIM TO ANY PARTICULAR FONT, STYLE, SIZE, OR COLOR.

OWNER OF U.S. REG. NOS. 2,071,649, 3,617,002 AND OTHERS.

NO CLAIM IS MADE TO THE EXCLUSIVE RIGHT TO USE "CAMP", APART FROM THE MARK AS SHOWN.

FOR CHARITABLE SERVICES, NAMELY, FINANCIAL SPONSORSHIP OF BEREAVEMENT CAMPS FOR CHILDREN; FINANCIAL SPONSORSHIP OF CHARITABLE ORGANIZATIONS THAT PROVIDE END-OF-LIFE EDUCATION AND SUPPORT TO TERMINALLY ILL PATIENTS AND THEIR FAMILIES (U.S. CLS. 100, 101 AND 102).

MARIAM MAHMOUDI, EXAMINING ATTORNEY

SN 77-799,855. STATE FARM MUTUAL AUTOMOBILE INSURANCE COMPANY, BLOOMINGTON, IL. FILED 8-7-2009.

Discount Double Check

THE MARK CONSISTS OF STANDARD CHARACTERS WITHOUT CLAIM TO ANY PARTICULAR FONT, STYLE, SIZE, OR COLOR.

NO CLAIM IS MADE TO THE EXCLUSIVE RIGHT TO USE "DISCOUNT", APART FROM THE MARK AS SHOWN.

FOR UNDERWRITING AUTO, HOMEOWNERS, LIFE AND FIRE INSURANCE; SERVICING, NAMELY, INSURANCE ADMINISTRATION IN THE FIELDS OF AUTO, HOMEOWNERS, LIFE AND FIRE INSURANCE; BANKING AND MUTUAL FUND INVESTMENTS AND FINANCIAL ANALYSIS AND CONSULTATION (U.S. CLS. 100, 101 AND 102).

ASMAT KHAN, EXAMINING ATTORNEY

CLASS 36—(Continued).

SN 77-801,035. RT ENTERTAINMENT LLC, BIRMINGHAM, MI. FILED 8-10-2009.

CLEAR SCOPE PARTNERS

THE MARK CONSISTS OF STANDARD CHARACTERS WITHOUT CLAIM TO ANY PARTICULAR FONT, STYLE, SIZE, OR COLOR.

NO CLAIM IS MADE TO THE EXCLUSIVE RIGHT TO USE "PARTNERS", APART FROM THE MARK AS SHOWN.
FOR FINANCIAL ADVISEMENT SERVICES IN THE FIELD OF ENTERTAINMENT (U.S. CLS. 100, 101 AND 102).

KATINA MISTER, EXAMINING ATTORNEY

SN 77-804,484. LAURA WINETEER, DBA FRAMES FOR CHANGE, BEVERLY HILLS, CA. FILED 8-13-2009.

FRAMES FOR CHANGE

THE MARK CONSISTS OF STANDARD CHARACTERS WITHOUT CLAIM TO ANY PARTICULAR FONT, STYLE, SIZE, OR COLOR.

NO CLAIM IS MADE TO THE EXCLUSIVE RIGHT TO USE "FRAMES", APART FROM THE MARK AS SHOWN.

FOR FUND RAISING SERVICES, NAMELY, ORGANIZING, ARRANGING AND CONDUCTING FUND RAISING PROGRAMS FOR EMPOWERING PEOPLE TO MAKE POSITIVE CHANGE THROUGH ART (U.S. CLS. 100, 101 AND 102).

FIRST USE 7-1-2009; IN COMMERCE 7-1-2009.
KATINA MISTER, EXAMINING ATTORNEY

SN 77-809,089. ORTHOBANC, LLC, CHATTANOOGA, TN. FILED 8-20-2009.

ORTHOBANC

THE MARK CONSISTS OF STANDARD CHARACTERS WITHOUT CLAIM TO ANY PARTICULAR FONT, STYLE, SIZE, OR COLOR.

FOR PAYMENT MANAGEMENT SERVICES FOR ORTHODONTIC BUSINESSES, NAMELY, PROVIDING ELECTRONIC PROCESSING OF ELECTRONIC FUNDS TRANSFER, ACH, CREDIT CARD, DEBIT CARD, ELECTRONIC CHECK AND ELECTRONIC PAYMENTS; CREDIT RISK MANAGEMENT FOR ORTHODONTIC BUSINESSES (U.S. CLS. 100, 101 AND 102).

FIRST USE 8-22-2001; IN COMMERCE 8-22-2001.
KAPIL BHANOT, EXAMINING ATTORNEY

CLASS 36—(Continued).

SN 77-811,916. BANCO DE SABADELL, S.A., BARCELONA, SPAIN, FILED 8-25-2009.

SABADELL UNITED BANK

THE MARK CONSISTS OF STANDARD CHARACTERS WITHOUT CLAIM TO ANY PARTICULAR FONT, STYLE, SIZE, OR COLOR.

OWNER OF U.S. REG. NOS. 2,423,832 AND 3,395,810. NO CLAIM IS MADE TO THE EXCLUSIVE RIGHT TO USE "BANK", APART FROM THE MARK AS SHOWN.

SEC. 2(F) AS TO "SABADELL". FOR FINANCIAL SERVICES, NAMELY, BANKING AND INVESTMENT MANAGEMENT SERVICES (U.S. CLS. 100, 101 AND 102).

LINDA E. BLOHM, EXAMINING ATTORNEY

CLASS 36—(Continued).

SN 77-846,923. MARKET STUDIES, LLC, SCOTTSDALE, AZ. FILED 10-12-2009.

PLURALITY

THE MARK CONSISTS OF STANDARD CHARACTERS WITHOUT CLAIM TO ANY PARTICULAR FONT, STYLE, SIZE, OR COLOR.

FOR FINANCIAL ANALYSIS; FINANCIAL RESEARCH AND INFORMATION SERVICES; FINANCIAL SERVICES, NAMELY, PROVIDING INFORMATION IN THE FIELDS OF FOREIGN CURRENCY, COMMODITIES, FINANCIAL DERIVATIVES, INTEREST RATE PRODUCTS, AND EQUITIES VIA THE INTERNET AND INTRANET SYSTEMS (U.S. CLS. 100, 101 AND 102).

JULIE GUTTADAURO, EXAMINING ATTORNEY

SN 77-819,358. MCBRIDE REAL ESTATE SERVICES, INC., WASHINGTON, D.C., DC. FILED 9-3-2009.



NO CLAIM IS MADE TO THE EXCLUSIVE RIGHT TO USE "REAL ESTATE SERVICES", APART FROM THE MARK AS SHOWN.

THE COLOR(S) BLUE AND WHITE IS/ARE CLAIMED AS A FEATURE OF THE MARK.

THE MARK CONSISTS OF THE STYLIZED WORD "MCBRIDE M" IN ALL WHITE EXCEPT FOR THE "C" IN "MCBRIDE", WHICH APPEARS IN BLUE, THE WORDING BEING CONTAINED WITHIN A BLUE SHIELD; THE WORDING "REAL ESTATE SERVICES" APPEARS UNDERNEATH IN BLUE.

FOR COMMERCIAL AND RESIDENTIAL REAL ESTATE AGENCY SERVICES (U.S. CLS. 100, 101 AND 102). FIRST USE 1-0-2007; IN COMMERCE 1-0-2007.

TRICIA SONNEBORN, EXAMINING ATTORNEY

SN 77-858,701. CITIGROUP INC., NEW YORK, NY. FILED 10-27-2009.

RESPONSIBLE FINANCE

THE MARK CONSISTS OF STANDARD CHARACTERS WITHOUT CLAIM TO ANY PARTICULAR FONT, STYLE, SIZE, OR COLOR.

NO CLAIM IS MADE TO THE EXCLUSIVE RIGHT TO USE "FINANCE", APART FROM THE MARK AS SHOWN.

FOR FINANCIAL SERVICES, NAMELY, BANKING; CREDIT CARD SERVICES; COMMERCIAL AND CONSUMER LENDING AND FINANCING; REAL ESTATE AND MORTGAGE BROKERAGE; ESTATE TRUST MANAGEMENT, PLANNING AND CONSULTING SERVICES; FIDUCIARY SERVICES, NAMELY, FIDUCIARY REPRESENTATIVE SERVICES; FINANCIAL INVESTMENT IN THE FIELD OF SECURITIES; FUNDS INVESTMENT; INVESTMENT ADVISORY SERVICES; SECURITIES BROKERAGE AND TRADING SERVICES FOR OTHERS; ELECTRONIC FUNDS TRANSFERS; ELECTRONIC CASH TRANSACTIONS; ELECTRONIC CREDIT CARD TRANSACTIONS; ELECTRONIC PAYMENT, NAMELY, ELECTRONIC PROCESSING AND TRANSMISSION OF BILL PAYMENT DATA; ELECTRONIC DEBIT TRANSACTIONS; INSURANCE SERVICES, NAMELY, UNDERWRITING, AND BROKERAGE OF PROPERTY, CASUALTY AND LIFE INSURANCE POLICIES AND ANNUITY CONTRACTS; PROVIDING ONLINE INTERACTIVE NEWS AND INFORMATION IN THE FIELDS OF BANKING AND FINANCE PROVIDED VIA A GLOBAL COMPUTER NETWORK (U.S. CLS. 100, 101 AND 102).

BARBARA A. GOLD, EXAMINING ATTORNEY

CLASS 36—(Continued).

SN 77-860,629. ALLOS VENTURE COMPANY, LLC, CARMEL, IN. FILED 10-29-2009.

ALLOS VENTURES

THE MARK CONSISTS OF STANDARD CHARACTERS WITHOUT CLAIM TO ANY PARTICULAR FONT, STYLE, SIZE, OR COLOR.

NO CLAIM IS MADE TO THE EXCLUSIVE RIGHT TO USE "VENTURES", APART FROM THE MARK AS SHOWN.

FOR CAPITAL INVESTMENT SERVICES; FINANCIAL INVESTMENT IN THE FIELD OF SECURITIES; FUND INVESTMENT CONSULTATION; FUNDS INVESTMENT; INVESTMENT CONSULTATION; INVESTMENT MANAGEMENT; INVESTMENT OF FUNDS FOR OTHERS; VENTURE CAPITAL ADVISORY SERVICES (U.S. CLS. 100, 101 AND 102).

FIRST USE 10-31-2009; IN COMMERCE 10-31-2009.
 NAAKWAMA ANKRAH, EXAMINING ATTORNEY

CLASS 36—(Continued).

SN 77-863,128. DB SQUARED, INC., RENTON, WA. FILED 11-2-2009.



THE MARK CONSISTS OF THE WORDING "DB SQUARED" WITH THE WORDS "SQUARED" PLACED VERTICALLY BETWEEN THE LARGE OUTLINED LETTERS "D" AND "B" WITH THE WORDING "DBSQUAREDINC.COM" UNDERNEATH THE LARGER WORDING "DB SQUARED".

FOR FINANCIAL SERVICES, NAMELY, MONEY LENDING AND ACCOUNTS RECEIVABLE FACTORING (U.S. CLS. 100, 101 AND 102).

FIRST USE 10-26-2009; IN COMMERCE 10-26-2009.
 DOMINIC FATHY, EXAMINING ATTORNEY

SN 77-860,889. CLARITY MANAGEMENT, LP, BEVERLY HILLS, CA. FILED 10-29-2009.

CLARITY CHINA

THE MARK CONSISTS OF STANDARD CHARACTERS WITHOUT CLAIM TO ANY PARTICULAR FONT, STYLE, SIZE, OR COLOR.

OWNER OF U.S. REG. NOS. 2,772,006 AND 2,823,652.

NO CLAIM IS MADE TO THE EXCLUSIVE RIGHT TO USE "CHINA", APART FROM THE MARK AS SHOWN.

FOR INVESTMENT MANAGEMENT AND FINANCIAL MANAGEMENT OF PRIVATE EQUITY AND VENTURE CAPITAL INVESTMENT SERVICES (U.S. CLS. 100, 101 AND 102).

FIRST USE 10-1-2006; IN COMMERCE 10-1-2006.
 ROBERT C. CLARK JR., EXAMINING ATTORNEY

SN 77-864,396. HICKMAN, PAUL L., DBA PRAGMATIC CAPITAL MANAGEMENT, LOS ALTOS, CA. FILED 11-3-2009.

PRAGMATIC

THE MARK CONSISTS OF STANDARD CHARACTERS WITHOUT CLAIM TO ANY PARTICULAR FONT, STYLE, SIZE, OR COLOR.

FOR FINANCIAL INVESTMENT AND MANAGEMENT SERVICES IN THE FIELDS OF REAL ESTATE, INTANGIBLE PROPERTY AND NON-PUBLICLY TRADED COMPANIES (U.S. CLS. 100, 101 AND 102).

CYNTHIA TRIPI, EXAMINING ATTORNEY

CLASS 36—(Continued).

SN 77-867,528. THE ZOE FOUNDATION, INC., POOLER, GA. FILED 11-6-2009.



NO CLAIM IS MADE TO THE EXCLUSIVE RIGHT TO USE "FOUNDATION", APART FROM THE MARK AS SHOWN.

THE MARK CONSISTS OF A STYLIZED LETTER "Z" WITH A STYLIZED DESIGN OF THE FACE OF A WOMAN IN THE UPPER PORTION OF THE LETTER "Z" WITH THE WORDING "THE ZOE FOUNDATION" BENEATH THE LETTER "Z".

FOR CHARITABLE SERVICES, NAMELY, FINANCIAL SUPPORT TO MOTHERS AND THEIR FAMILIES FOLLOWING THE LOSS OF AN INFANT FOR THE PURPOSE OF ASSISTING WITH THE COSTS OF INFANT CREMATION AND BURIAL EXPENSES (U.S. CLS. 100, 101 AND 102).

FIRST USE 6-0-2009; IN COMMERCE 6-0-2009.
PAUL CROWLEY, EXAMINING ATTORNEY

SN 77-868,211. SUTTONADVISORSPLC, LANSING, MI. FILED 11-9-2009.



NO CLAIM IS MADE TO THE EXCLUSIVE RIGHT TO USE "ADVISORS PLC", APART FROM THE MARK AS SHOWN.

THE MARK CONSISTS OF THE WORDING "SUTTON ADVISORS PLC" IN BLOCK LETTERING AND THE WORDING "DEFINE YOUR JOURNEY." IN SCRIPT BELOW THE DESIGN OF THE LETTER "S" WITH A DOLLAR SIGN.

FOR STRATEGIC FINANCIAL ADVISING; FINANCIAL PLANNING; LEGACY FINANCIAL PLANNING; FINANCIAL RISK MANAGEMENT; FIDUCIARY SERVICES, NAMELY, FIDUCIARY REPRESENTATIVE SERVICES; ASSET PROTECTION, NAMELY, FINANCIAL ASSET MANAGEMENT; INHERITANCE FINANCIAL PLANNING; WEALTH MANAGEMENT; PHILANTHROPIC SERVICES CONCERNING MONETARY DONATIONS; FINANCIAL CONSULTATION IN THE FIELD OF ELDER CARE; TRUST SETTLEMENT, NAMELY, FINANCIAL TRUST OPERATIONS; ESTATE PLANNING (U.S. CLS. 100, 101 AND 102).

FIRST USE 8-1-2008; IN COMMERCE 8-1-2008.
LEIGH CAROLINE CASE, EXAMINING ATTORNEY

CLASS 36—(Continued).

SN 77-877,921. MORINEAU, FRANCK, STUDIO CITY, CA. FILED 11-20-2009.



NO CLAIM IS MADE TO THE EXCLUSIVE RIGHT TO USE "WILSHIRE", APART FROM THE MARK AS SHOWN.

THE MARK CONSISTS OF TWO OFFICE BUILDINGS SURROUNDED BY PALM TREES, AND THE TEXT "WILSHIRE WEST" BELOW IN A STYLIZED RECTANGLE.

FOR COMMERCIAL AND INDUSTRIAL REAL ESTATE SERVICES, NAMELY, REAL ESTATE MANAGEMENT AND REAL ESTATE ADVISORY SERVICES (U.S. CLS. 100, 101 AND 102).

FIRST USE 9-1-1999; IN COMMERCE 9-1-1999.
KRISTIN DAHLING, EXAMINING ATTORNEY

SN 77-878,337. A DRINK FOR TOMORROW A NJ NON-PROFIT CORPORATION, MOORESTOWN, NJ. FILED 11-22-2009.



THE COLOR(S) BLUE AND GREEN IS/ARE CLAIMED AS A FEATURE OF THE MARK.

THE MARK CONSISTS OF A BLUE, ADULT-SIZED HANDPRINT OF A RIGHT HAND WITH A DROP OF WATER AS THE PALM. THE WORDS "A DRINK FOR TOMORROW" APPEAR IN ALL CAPS BELOW THE HANDPRINT. THE WORDS "A DRINK FOR" ARE WRITTEN IN BLUE AND THE WORD "TOMORROW" IS WRITTEN IN GREEN. THERE IS A LIGHTER SHADE OF BLUE WITHIN THE WATER DROP/PALM TO MAKE IT LOOK MORE LIKE A WATER DROP. THE HANDPRINT LOOKS AS IF SOMEONE DIPPED HIS OR HER HAND IN PAINT AND PRESSED IT ON PAPER, YET THE PALM IS A WATER DROP.

FOR CHARITABLE FUNDRAISING SERVICES; CHARITABLE SERVICES, NAMELY, ORGANIZING FUNDRAISING SERVICES AND EVENTS TO RAISE FUNDS FOR PROVIDING CLEAN WATER TO PERSONS IN NEED; CHARITABLE FUNDRAISING SERVICES BY MEANS OF ORGANIZING AND CONDUCTING SPECIAL EVENTS (U.S. CLS. 100, 101 AND 102).

FIRST USE 6-10-2009; IN COMMERCE 6-10-2009.
EDWARD FENNESSY, EXAMINING ATTORNEY

CLASS 36—(Continued).

SN 77-882,022. ATOMIC TATTOOS, LLC, LARGO, FL. FILED 11-30-2009.

TATS FOR TOYS

THE MARK CONSISTS OF STANDARD CHARACTERS WITHOUT CLAIM TO ANY PARTICULAR FONT, STYLE, SIZE, OR COLOR.
OWNER OF U.S. REG. NO. 3,703,876.
FOR CHARITABLE SERVICES, NAMELY, CHARITABLE FUNDRAISING SERVICES FOR CHILDREN (U.S. CLS. 100, 101 AND 102).
LINDA ORNDORFF, EXAMINING ATTORNEY

SN 77-882,498. MCKEOWN, CAROL, MONTREAL, QUEBEC, CANADA, FILED 11-30-2009.

PENNYSTOCKCHASER

THE MARK CONSISTS OF STANDARD CHARACTERS WITHOUT CLAIM TO ANY PARTICULAR FONT, STYLE, SIZE, OR COLOR.
PRIORITY CLAIMED UNDER SEC. 44(D) ON CANADA APPLICATION NO. 1460611, FILED 11-26-2009.
FOR PROVIDING A WEBSITE FEATURING STOCK MARKET INFORMATION (U.S. CLS. 100, 101 AND 102).
FIRST USE 4-1-2009; IN COMMERCE 4-1-2009.
MARK PILARO, EXAMINING ATTORNEY

SN 77-885,044. IRONSTATE DEVELOPMENT LLC, HOBOKEN, NJ. FILED 12-3-2009.

URBAN READY LIVING

THE MARK CONSISTS OF STANDARD CHARACTERS WITHOUT CLAIM TO ANY PARTICULAR FONT, STYLE, SIZE, OR COLOR.
FOR MANAGING AND RENTING OF REAL PROPERTY AND APARTMENTS (U.S. CLS. 100, 101 AND 102).
BRIAN NEVILLE, EXAMINING ATTORNEY

CLASS 36—(Continued).

SN 77-885,053. IRONSTATE DEVELOPMENT LLC, HOBOKEN, NJ. FILED 12-3-2009.

URL

THE MARK CONSISTS OF STANDARD CHARACTERS WITHOUT CLAIM TO ANY PARTICULAR FONT, STYLE, SIZE, OR COLOR.
FOR MANAGING AND RENTING OF REAL PROPERTY AND APARTMENTS (U.S. CLS. 100, 101 AND 102).
BRIAN NEVILLE, EXAMINING ATTORNEY

SN 77-885,167. SECURITY FEDERAL PREMIUM PAY PLANS, INC., AIKEN, SC. FILED 12-3-2009.



NO CLAIM IS MADE TO THE EXCLUSIVE RIGHT TO USE "FEDERAL PREMIUM FINANCE", APART FROM THE MARK AS SHOWN.
THE MARK CONSISTS OF THE WORD "SECURITY" OVER THE WORD "FEDERAL" WITH A STYLIZED "SF" DESIGN TO THE RIGHT OF BOTH WORDS, ALL OF WHICH IS OVER A STRAIGHT LINE WITH THE WORDS "PREMIUM FINANCE" UNDER THE LINE.
FOR FINANCING OF INSURANCE PREMIUMS (U.S. CLS. 100, 101 AND 102).
FIRST USE 7-11-2006; IN COMMERCE 7-11-2006.
ESTHER BELENKER, EXAMINING ATTORNEY

SN 77-887,981. ALLIED NATIONAL, INC., OMAHA, NE. FILED 12-7-2009.

ALLIED NATIONAL

THE MARK CONSISTS OF STANDARD CHARACTERS WITHOUT CLAIM TO ANY PARTICULAR FONT, STYLE, SIZE, OR COLOR.
NO CLAIM IS MADE TO THE EXCLUSIVE RIGHT TO USE "NATIONAL", APART FROM THE MARK AS SHOWN.
FOR DEBT RECOVERY AND COLLECTION AGENCIES (U.S. CLS. 100, 101 AND 102).
FIRST USE 1-15-1988; IN COMMERCE 2-1-1988.
NAAKWAMA ANKRAH, EXAMINING ATTORNEY

CLASS 36—(Continued).

SN 77-888,943. SENSATO CAPITAL MANAGEMENT, LLC,
SAN FRANCISCO, CA. FILED 12-8-2009.



NO CLAIM IS MADE TO THE EXCLUSIVE RIGHT TO USE "CAPITAL MANAGEMENT", APART FROM THE MARK AS SHOWN.

THE MARK CONSISTS OF A SHADED CIRCLE DESIGN HORIZONTALLY DISSECTED BY A CURVING "S" OVER THE WORD "SENSATO", ALL OVER THE WORDS "CAPITAL MANAGEMENT".

THE ENGLISH TRANSLATION OF "SENSATO" IN THE MARK IS SENSIBLE.

FOR FINANCIAL SERVICES, NAMELY, INVESTMENT ADVICE, INVESTMENT MANAGEMENT, MANAGEMENT OF INVESTMENT FUNDS AND MANAGEMENT OF SEPARATELY MANAGED CLIENT ACCOUNTS (U.S. CLS. 100, 101 AND 102).

FIRST USE 6-14-2009; IN COMMERCE 6-14-2009.
LAKEISHA LEWIS, EXAMINING ATTORNEY

SN 77-889,619. SENSATO CAPITAL MANAGEMENT, LLC,
SAN FRANCISCO, CA. FILED 12-9-2009.

SENSATO

THE MARK CONSISTS OF STANDARD CHARACTERS WITHOUT CLAIM TO ANY PARTICULAR FONT, STYLE, SIZE, OR COLOR.

THE ENGLISH TRANSLATION OF "SENSATO" IN THE MARK IS SENSIBLE.

FOR FINANCIAL SERVICES, NAMELY, INVESTMENT ADVICE, INVESTMENT MANAGEMENT, MANAGEMENT OF INVESTMENT FUNDS AND MANAGEMENT OF SEPARATELY MANAGED CLIENT ACCOUNTS (U.S. CLS. 100, 101 AND 102).

FIRST USE 12-8-2009; IN COMMERCE 12-8-2009.
LAKEISHA LEWIS, EXAMINING ATTORNEY

CLASS 36—(Continued).

SN 77-889,816. PORTFOLIO RECOVERY ASSOCIATES, INC.,
NORFOLK, VA. FILED 12-9-2009.



OWNER OF U.S. REG. NOS. 2,442,511 AND 2,878,822.
NO CLAIM IS MADE TO THE EXCLUSIVE RIGHT TO USE "PORTFOLIO RECOVERY ASSOCIATES", APART FROM THE MARK AS SHOWN.

THE COLOR(S) GREEN, YELLOW, AND WHITE. IS/ARE CLAIMED AS A FEATURE OF THE MARK.

THE MARK CONSISTS OF ARTWORK AND WORDS CONSISTING OF A FOUR-POINTED GREEN STAR INSIDE A GREEN CIRCLE, WITH THE GREEN STAR AND GREEN CIRCLE UNDERNEATH A YELLOW AND WHITE STAR IN WHICH THE YELLOW AND WHITE HALVES RUN LENGTHWISE IN THE POINTS OF THE STAR. DIRECTLY UNDERNEATH THE ARTWORK ARE THE WORDS "PORTFOLIO RECOVERY ASSOCIATES" AND BELOW IT ARE THE WORDS "WE'RE GIVING DEBT COLLECTION A GOOD NAME.", ALL APPEARING IN GREEN.

FOR SERVICING AND COLLECTING CONSUMER CREDIT ACCOUNTS, NAMELY, DEBT AND CREDIT RECOVERY AND COLLECTION (U.S. CLS. 100, 101 AND 102).

FIRST USE 12-15-2003; IN COMMERCE 12-15-2003.
JASON TURNER, EXAMINING ATTORNEY

SN 77-890,067. VIRGINIA COLLEGE SAVINGS PLAN, RICHMOND, VA. FILED 12-9-2009.

COLLEGEAMERICA

THE MARK CONSISTS OF STANDARD CHARACTERS WITHOUT CLAIM TO ANY PARTICULAR FONT, STYLE, SIZE, OR COLOR.

OWNER OF U.S. REG. NO. 2,822,036.
SEC. 2(F).

FOR FINANCIAL SERVICES, NAMELY, OFFERING INVESTMENT OPPORTUNITIES IN A TAX-DEFERRED SAVINGS PLAN FOR PURPOSES OF EDUCATION (U.S. CLS. 100, 101 AND 102).

FIRST USE 7-27-2001; IN COMMERCE 2-15-2002.
KHANH LE, EXAMINING ATTORNEY

CLASS 36—(Continued).

SN 77-891,455. U-PIC INSURANCE SERVICES, INC., WESTLAKE VILLAGE, CA. FILED 12-11-2009.

U-PIC

THE MARK CONSISTS OF STANDARD CHARACTERS WITHOUT CLAIM TO ANY PARTICULAR FONT, STYLE, SIZE, OR COLOR.

OWNER OF U.S. REG. NO. 2,741,310. FOR INSURANCE SERVICES, NAMELY, INSURANCE AGAINST LOSS OR DAMAGE FOR PACKAGES SHIPPED VIA COMMERCIAL CARRIER (U.S. CLS. 100, 101 AND 102).

FIRST USE 11-5-2001; IN COMMERCE 11-5-2001. ESTHER BELENKER, EXAMINING ATTORNEY

SN 77-893,216. ROCK PROPERTIES, NEWARK, NJ. FILED 12-14-2009.

INSPIRING OUR NEIGHBORS

THE MARK CONSISTS OF STANDARD CHARACTERS WITHOUT CLAIM TO ANY PARTICULAR FONT, STYLE, SIZE, OR COLOR.

FOR REAL ESTATE SERVICES, NAMELY, REAL ESTATE MANAGEMENT, REAL ESTATE LISTING, REAL ESTATE LEASING; REAL ESTATE INVESTMENT SERVICES IN THE NATURE OF PURCHASING AND SELLING REAL ESTATE (U.S. CLS. 100, 101 AND 102).

FIRST USE 6-0-2007; IN COMMERCE 6-0-2007. ARETHA SOMERVILLE, EXAMINING ATTORNEY

SN 77-894,408. AMERICAN COLLEGE COUNSELING, INC., BOCA RATON, FL. FILED 12-16-2009.



NO CLAIM IS MADE TO THE EXCLUSIVE RIGHT TO USE "AMERICAN COLLEGE COUNSELING INC.", APART FROM THE MARK AS SHOWN.

THE COLOR(S) YELLOW, GOLD, BLACK, WHITE, GRAY, BLUE AND RED IS/ARE CLAIMED AS A FEATURE OF THE MARK.

THE MARK CONSISTS OF THE FOLLOWING: A CIRCLE

CLASS 36—(Continued).

WITHIN A CIRCLE, THE RED OUTER CIRCLE OUTLINED IN GOLD CONTAINS THE WORDING "AMERICAN COLLEGE COUNSELING INC. PREPARATION FINANCE APPLICATION" AND POINT MARKERS BETWEEN THE WORDS "PREPARATION, FINANCE AND APPLICATION", ALL IN WHITE. THE GRAY OUTLINED IN BLUE INNER CIRCLE CONTAINS A YELLOW AND GOLD SHIELD WITH A YELLOW AND GOLD OLIVE BRANCH ON EITHER SIDE OF IT AND WITHIN THE PLAQUE A DEPICTION OF A SUNRISE WITH TWO GRYPHON IN GOLD AND BLACK ON TOP OF A BLACK AND WHITE GRADUATION CAP WITH A GOLD STANDARD TASSEL, AT THE BOTTOM OF THE PLAQUE APPEARS A RED AND YELLOW SCROLL WITH THE LETTERS "ACCI" IN RED WRITTEN ON IT.

FOR COLLEGE CONSULTING SERVICES, NAMELY, ASSISTING STUDENTS IN APPLYING FOR SCHOLARSHIPS AND FINANCIAL AID; COLLEGE COUNSELING SERVICES, NAMELY, ASSISTING STUDENTS IN APPLYING FOR SCHOLARSHIPS AND FINANCIAL AID (U.S. CLS. 100, 101 AND 102).

JASON TURNER, EXAMINING ATTORNEY

SN 77-895,669. CANDICE C. SMITH, OLD BROOKVILLE, NY. FILED 12-17-2009.

CONSUMER COMBAT

THE MARK CONSISTS OF STANDARD CHARACTERS WITHOUT CLAIM TO ANY PARTICULAR FONT, STYLE, SIZE, OR COLOR.

NO CLAIM IS MADE TO THE EXCLUSIVE RIGHT TO USE "CONSUMER", APART FROM THE MARK AS SHOWN.

FOR CHECK RECOVERY SERVICES; COLLECTION AGENCIES; COLLECTION OF DEBTS; COLLECTION OF RENTS; CONSUMER CREDIT CONSULTATION; CONSUMER LENDING SERVICES; CREDIT RECOVERY AND COLLECTION; DEBT COLLECTION AGENCIES; DEBT COUNSELING SERVICES; DEBT MANAGEMENT CONSULTATION; DEBT RECOVERY AND COLLECTION AGENCIES; FINANCIAL ADVICE AND CONSULTANCY SERVICES; FINANCIAL SERVICES, NAMELY, DEBT RESOLUTION SERVICES IN THE NATURE OF DEBT SETTLEMENT AND ELIMINATION; FINANCIAL SERVICES, NAMELY, DEBT SETTLEMENT; FINANCIAL SERVICES, NAMELY, MONEY LENDING; FINANCIAL SERVICES, NAMELY, MORTGAGE REFINANCING; HOUSING SERVICES, NAMELY, REAL PROPERTY ACQUISITION AND CONSUMER FINANCING TO FACILITATE HOME OWNERSHIP; LENDING CONSULTANT SERVICES; NEWS REPORTING SERVICES IN THE FIELD OF FINANCIAL NEWS; ON-LINE FINANCIAL PLANNING SERVICES (U.S. CLS. 100, 101 AND 102).

REBECCA SMITH, EXAMINING ATTORNEY

CLASS 36—(Continued).

SN 77-896,002. TRIO ANIMAL FOUNDATION, CHICAGO, IL. FILED 12-17-2009.



NO CLAIM IS MADE TO THE EXCLUSIVE RIGHT TO USE "ANIMAL FOUNDATION", APART FROM THE MARK AS SHOWN.

THE COLOR(S) ARMY GREEN, BLACK AND WHITE IS/ARE CLAIMED AS A FEATURE OF THE MARK.

THE MARK CONSISTS OF A STYLIZED DOG IN ARMY GREEN WITH A WHITE CROSS AROUND ITS NECK. THE WORD "TRIO" IS WRITTEN TO THE RIGHT OF THE DOG IN A LARGE FONT. THE WORDING "ANIMAL FOUNDATION" IS UNDERNEATH THE WORD "TRIO" IN A SMALLER FONT. ALL OF THE WORDING IS IN BLACK.

FOR CHARITABLE SERVICES, NAMELY, ORGANIZING FUNDRAISING SERVICES AND EVENTS TO RAISE FUNDS IN THE FIELD OF ANIMAL WELFARE, TO RAISE AND ADMINISTER FUNDS FOR THE PROVISION OF FINANCIAL ASSISTANCE TO PAY FOR VETERINARY CARE FOR HOMELESS PETS AND THE PROMOTION OF ANIMAL WELFARE, PROPER PET CARE, ANIMAL PROTECTION AND SPAY AND NEUTER (U.S. CLS. 100, 101 AND 102).

FIRST USE 9-18-2009; IN COMMERCE 9-18-2009.
INGA ERVIN, EXAMINING ATTORNEY

SN 77-896,152. KITARA CAPITAL INTERNATIONAL LTD., GRAND CAYMAN, CAYMAN ISLANDS, FILED 12-17-2009.



KITARA CAPITAL

NO CLAIM IS MADE TO THE EXCLUSIVE RIGHT TO USE "CAPITAL", APART FROM THE MARK AS SHOWN.

THE MARK CONSISTS OF BOX FEATURING A HORIZON VIEW.

THE WORDING "KITARA" HAS NO MEANING IN A FOREIGN LANGUAGE.

FOR FINANCIAL SERVICES, NAMELY, FINANCIAL PORTFOLIO MANAGEMENT, OFFERED FOR PROFESSIONAL AND PRIVATE INVESTORS CONSISTING OF BOTH SEPARATE ACCOUNTS AND MUTUAL FUNDS FOR PRIVATE EQUITY AND FIXED INCOME INVESTMENTS; INVESTMENT SERVICES, NAMELY, ASSET ACQUISITION, CONSULTATION, DEVELOPMENT AND MANAGEMENT SERVICES; INVESTMENT SERVICES, NAMELY, ASSET MANAGEMENT; INVESTMENT SERVICES, NAMELY, PROPRIETARY TRADING OF FINANCIAL PRODUCTS IN THE NATURE OF STOCKS, BONDS, OPTIONS, COMMODITIES, FUTURES, WARRANTS, SWAPS, TRACKERS, ETF'S, ETC'S, CFD'S, DEPOSITARY RECEIPTS, CURRENCIES AND OTHER SECURITIES WHICH ARE TRADED ON A REGULATED MARKET ANYWHERE IN THE WORLD; MONETARY AFFAIRS, NAMELY, MONETARY EXCHANGE AND BANKING SERVICES (U.S. CLS. 100, 101 AND 102).

FIRST USE 11-17-2009; IN COMMERCE 11-20-2009.
JACQUELINE A. LAVINE, EXAMINING ATTORNEY

CLASS 36—(Continued).

SN 77-901,572. FLORIDACENTRAL CREDIT UNION, TAMPA, FL. FILED 12-28-2009.

URTUNES CHECKING

THE MARK CONSISTS OF STANDARD CHARACTERS WITHOUT CLAIM TO ANY PARTICULAR FONT, STYLE, SIZE, OR COLOR.

NO CLAIM IS MADE TO THE EXCLUSIVE RIGHT TO USE "CHECKING", APART FROM THE MARK AS SHOWN.

FOR CHECKING ACCOUNT SERVICES (U.S. CLS. 100, 101 AND 102).

ESTHER BELENKER, EXAMINING ATTORNEY

SN 77-904,485. FIRST NATIONAL OF NEBRASKA, INC., OMAHA, NE. FILED 1-4-2010.

**TRIBUTARY CAPITAL
MANAGEMENT**

THE MARK CONSISTS OF STANDARD CHARACTERS WITHOUT CLAIM TO ANY PARTICULAR FONT, STYLE, SIZE, OR COLOR.

NO CLAIM IS MADE TO THE EXCLUSIVE RIGHT TO USE "CAPITAL MANAGEMENT", APART FROM THE MARK AS SHOWN.

FOR FINANCIAL ADVISORY AND CONSULTANCY SERVICES; FINANCIAL INFORMATION AND EVALUATIONS; FINANCIAL MANAGEMENT; FINANCIAL PLANNING AND INVESTMENT ADVISORY SERVICES (U.S. CLS. 100, 101 AND 102).

FIRST USE 1-1-2005; IN COMMERCE 1-1-2005.
REGINA DRUMMOND, EXAMINING ATTORNEY

SN 77-907,219. RELOCALITY LLC, MOUNT PLEASANT, NC. FILED 1-7-2010.

RELOCALITY

THE MARK CONSISTS OF STANDARD CHARACTERS WITHOUT CLAIM TO ANY PARTICULAR FONT, STYLE, SIZE, OR COLOR.

THE WORDING "RELOCALITY" HAS NO MEANING OTHER THAN TRADEMARK SIGNIFICANCE.

FOR PROVIDING INFORMATION IN THE FIELD OF REAL ESTATE AND HOUSING VIA THE INTERNET (U.S. CLS. 100, 101 AND 102).

JESSICA FATHY, EXAMINING ATTORNEY

CLASS 36—(Continued).

SN 77-908,269. ALAMO HEIGHTS NIGHT LLC, SAN ANTONIO, TX. FILED 1-8-2010.

ALAMO HEIGHTS NIGHT

THE MARK CONSISTS OF STANDARD CHARACTERS WITHOUT CLAIM TO ANY PARTICULAR FONT, STYLE, SIZE, OR COLOR.

NO CLAIM IS MADE TO THE EXCLUSIVE RIGHT TO USE "ALAMO HEIGHTS", APART FROM THE MARK AS SHOWN.

FOR CHARITABLE FUNDRAISING (U.S. CLS. 100, 101 AND 102).

FIRST USE 3-15-1987; IN COMMERCE 3-15-1987.
ADA HAN, EXAMINING ATTORNEY

CLASS 36—(Continued).

SN 77-917,478. MCGHEE, MELISSA, ENCINITAS, CA. FILED 1-22-2010.

Save These

THE MARK CONSISTS OF STANDARD CHARACTERS WITHOUT CLAIM TO ANY PARTICULAR FONT, STYLE, SIZE, OR COLOR.

FOR CHARITABLE FUNDRAISING SERVICES BY MEANS OF SELLING SHORT-SLEEVED AND LONG-SLEEVED T-SHIRTS TO RAISE FUNDS FOR BREAST CANCER RESEARCH AND SUPPORT (U.S. CLS. 100, 101 AND 102).

KEVIN CORWIN, EXAMINING ATTORNEY

SN 77-909,135. SUNTRUST BANKS, INC, ORLANDO, FL. FILED 1-11-2010.

Custom Choice Loan

THE MARK CONSISTS OF STANDARD CHARACTERS WITHOUT CLAIM TO ANY PARTICULAR FONT, STYLE, SIZE, OR COLOR.

NO CLAIM IS MADE TO THE EXCLUSIVE RIGHT TO USE "CUSTOM" AND "LOAN", APART FROM THE MARK AS SHOWN.

FOR FINANCING AND LOAN SERVICES, NAMELY, PROVIDING A PRIVATE EDUCATION LOAN THAT OFFERS THE APPROVED BORROWER A CHOICE BETWEEN A FIXED OR VARIABLE INTEREST RATE (U.S. CLS. 100, 101 AND 102).

MICHELLE DUBOIS, EXAMINING ATTORNEY

SN 77-919,209. SUNTRUST BANKS, INC, ORLANDO, FL. FILED 1-25-2010.

SunTrust Advantage Money Market

THE MARK CONSISTS OF STANDARD CHARACTERS WITHOUT CLAIM TO ANY PARTICULAR FONT, STYLE, SIZE, OR COLOR.

OWNER OF U.S. REG. NOS. 3,002,966, 3,314,874 AND OTHERS.

NO CLAIM IS MADE TO THE EXCLUSIVE RIGHT TO USE "MONEY MARKET", APART FROM THE MARK AS SHOWN.

FOR FINANCIAL SERVICES, NAMELY, CONSUMER MONEY MARKET ACCOUNT SERVICES (U.S. CLS. 100, 101 AND 102).

MICHELLE DUBOIS, EXAMINING ATTORNEY

SN 77-911,021. FOUR PARTNERS, LLC, DBA UCR ASSET SERVICES, DALLAS, TX. FILED 1-13-2010.

UCR ASSET SERVICES

THE MARK CONSISTS OF STANDARD CHARACTERS WITHOUT CLAIM TO ANY PARTICULAR FONT, STYLE, SIZE, OR COLOR.

NO CLAIM IS MADE TO THE EXCLUSIVE RIGHT TO USE "ASSET SERVICES", APART FROM THE MARK AS SHOWN.

FOR ASSESSMENT AND MANAGEMENT OF REAL ESTATE; REAL ESTATE MANAGEMENT SERVICES (U.S. CLS. 100, 101 AND 102).

FIRST USE 11-14-2008; IN COMMERCE 11-14-2008.
JOSETTE BEVERLY, EXAMINING ATTORNEY

SN 77-919,300. AMERIPRISE FINANCIAL, INC., MINNEAPOLIS, MN. FILED 1-25-2010.

SECURESOURCE STAGES 2

THE MARK CONSISTS OF STANDARD CHARACTERS WITHOUT CLAIM TO ANY PARTICULAR FONT, STYLE, SIZE, OR COLOR.

OWNER OF U.S. REG. NO. 3,445,935.

FOR FINANCIAL SERVICES, INVESTMENT MANAGEMENT OF AND DISTRIBUTION OF VARIABLE ANNUITIES FEATURING A LIFETIME GUARANTEED WITHDRAWAL BENEFIT RIDER SOLD IN CONJUNCTION THEREWITH (U.S. CLS. 100, 101 AND 102).

DAWN HAN, EXAMINING ATTORNEY

CLASS 36—(Continued).

SN 77-920,093. MONTECASH, LLC, HOUSTON, TX. FILED 1-26-2010.

**PARA MAS DINERO AL
MONEDERO MONTECASH TE
PRESTA PRIMERO**

THE MARK CONSISTS OF STANDARD CHARACTERS WITHOUT CLAIM TO ANY PARTICULAR FONT, STYLE, SIZE, OR COLOR.

THE ENGLISH TRANSLATION OF "PARA MAS DINERO AL MONEDERO" IS FOR MORE MONEY IN THE WALLET AND THE TRANSLATION OF "TE PRESTA PRIMERO" IS LENDS TO YOU FIRST.

FOR CREDIT AND LOAN SERVICES; CURRENCY TRANSFER SERVICES; ELECTRONIC FUNDS TRANSFER; ELECTRONIC FUNDS TRANSFER BY TELECOMMUNICATIONS; ELECTRONIC TRANSFER OF FUNDS; ELECTRONIC TRANSFER OF MONEY; EXCHANGING MONEY; FINANCING AND LOAN SERVICES; LOAN FINANCING; MONEY ORDER PAYMENT GUARANTEE SERVICES; MONEY TRANSFER; PAWN BROKERAGE; PAWN SHOPS; PROVIDING ELECTRONIC PROCESSING OF ELECTRONIC FUNDS TRANSFER, ACH, CREDIT CARD, DEBIT CARD, ELECTRONIC CHECK AND ELECTRONIC PAYMENTS; PROVIDING TEMPORARY LOANS; TEMPORARY LOANS (U.S. CLS. 100, 101 AND 102).

JOHN E. MICHOS, EXAMINING ATTORNEY

SN 77-921,622. HARRIS, LESLIE K, DBA WOMEN ON THE MOVE PROMOTING POSITIVITY IN WOMEN, BOYNTON BEACH, FL. FILED 1-27-2010.



NO CLAIM IS MADE TO THE EXCLUSIVE RIGHT TO USE "WOMEN", "PROMOTING", OR "WOMEN", APART FROM THE MARK AS SHOWN.

THE COLOR(S) GRAY, FUCHSIA IS/ARE CLAIMED AS A FEATURE OF THE MARK.

THE MARK CONSISTS OF STYLIZED WORDING "WOMEN ON THE MOVE", WITH "WOMEN ON THE" IN GRAY AND "MOVE" IN FUCHSIA, FOLLOWED BY THE GRAY WORDING "PROMOTING POSITIVELY IN WOMEN" BETWEEN A FUCHSIA UNDERLINE AND OVERLINE. IN THE BACKGROUND BEHIND "PROMOTING POSITIVELY IN WOMEN" IS THE FADED GRAY ACRONYM "WOTM" IN STYLIZED LETTERS.

FOR PROMOTING POSITIVE INTERACTION BETWEEN WOMEN, BY PROVIDING PHILANTHROPIC MONETARY SERVICES, AS WELL AS ELEEMOSYNARY MONETARY SERVICES FROM WOMEN TO WOMEN/CHARITIES THAT BENEFIT WOMEN (U.S. CLS. 100, 101 AND 102).

FIRST USE 11-20-2009; IN COMMERCE 11-20-2009.

LYDIA BELZER, EXAMINING ATTORNEY

CLASS 36—(Continued).

SN 77-922,852. MIDLAND NATIONAL LIFE INSURANCE COMPANY, WEST DES MOINES, IA. FILED 1-28-2010.

MNL HERITAGE SPWL

THE MARK CONSISTS OF STANDARD CHARACTERS WITHOUT CLAIM TO ANY PARTICULAR FONT, STYLE, SIZE, OR COLOR.

OWNER OF U.S. REG. NOS. 2,501,790, 3,253,105 AND OTHERS.

NO CLAIM IS MADE TO THE EXCLUSIVE RIGHT TO USE "SPWL", APART FROM THE MARK AS SHOWN.

FOR LIFE INSURANCE AND ANNUITY UNDERWRITING SERVICES (U.S. CLS. 100, 101 AND 102).

FIRST USE 4-22-2010; IN COMMERCE 4-22-2010.

ANDREA K. NADELMAN, EXAMINING ATTORNEY

SN 77-923,600. BURLESON, TRAVIS, CARLSBAD, CA. FILED 1-29-2010.

Burleson Pacific

THE MARK CONSISTS OF STANDARD CHARACTERS WITHOUT CLAIM TO ANY PARTICULAR FONT, STYLE, SIZE, OR COLOR.

FOR REAL ESTATE SERVICES, NAMELY, RENTAL, BROKERAGE, LEASING AND MANAGEMENT OF COMMERCIAL PROPERTY, OFFICES AND OFFICE SPACE (U.S. CLS. 100, 101 AND 102).

FIRST USE 0-0-1989; IN COMMERCE 0-0-1989.

BRIDGETT SMITH, EXAMINING ATTORNEY

SN 77-923,616. RIVERFRONT INVESTMENT HOLDING GROUP, LLC, RICHMOND, VA. FILED 1-29-2010.

PRICE MATTERS

THE MARK CONSISTS OF STANDARD CHARACTERS WITHOUT CLAIM TO ANY PARTICULAR FONT, STYLE, SIZE, OR COLOR.

FOR FINANCIAL AND INVESTMENT SERVICES, NAMELY, MANAGEMENT AND BROKERAGE IN THE FIELDS OF STOCKS, BONDS, OPTIONS, COMMODITIES, FUTURES, EXCHANGE TRADED FUNDS AND OTHER SECURITIES, AND THE INVESTMENT OF FUNDS OF OTHERS (U.S. CLS. 100, 101 AND 102).

FIRST USE 12-18-2007; IN COMMERCE 12-18-2007.

KATHRYN COWARD, EXAMINING ATTORNEY

CLASS 36—(Continued).

SN 77-923,659. NORTH AMERICAN COMPANY FOR LIFE AND HEALTH INSURANCE, WEST DES MOINES, IA. FILED 1-29-2010.

NAC LEGACY

THE MARK CONSISTS OF STANDARD CHARACTERS WITHOUT CLAIM TO ANY PARTICULAR FONT, STYLE, SIZE, OR COLOR.
FOR LIFE INSURANCE AND ANNUITY UNDERWRITING SERVICES (U.S. CLS. 100, 101 AND 102).
LAKEISHA LEWIS, EXAMINING ATTORNEY

SN 77-923,758. NEPC, LLC, CAMBRIDGE, MA. FILED 1-29-2010.

YOU DEMAND MORE. SO DO WE.

THE MARK CONSISTS OF STANDARD CHARACTERS WITHOUT CLAIM TO ANY PARTICULAR FONT, STYLE, SIZE, OR COLOR.
FOR RESEARCH AND CONSULTING SERVICES IN THE FIELDS OF INVESTMENT MANAGEMENT AND PENSION MANAGEMENT (U.S. CLS. 100, 101 AND 102).
VERNA BETH RIRIE, EXAMINING ATTORNEY

SN 77-923,807. 66 FEDERAL CREDIT UNION, DBA 66 FEDERAL CREDIT UNION, KU CREDIT UNION, CONOCO PHILLIPS CREDIT UNION, BARTLESVILLE, OK. FILED 1-29-2010.

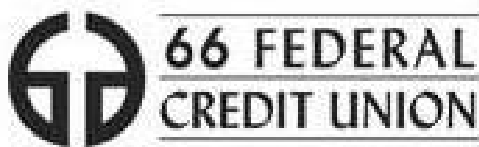

NO CLAIM IS MADE TO THE EXCLUSIVE RIGHT TO USE "FEDERAL CREDIT UNION", APART FROM THE MARK AS SHOWN.
THE MARK CONSISTS OF TWO NUMBER SIXES, FACING EACH OTHER (ONE SIX IS REVERSED) AND FORMING A SEMI CIRCLE. THEN, DIRECTLY TO THE RIGHT, UNDERLINED AND OVER LINED WORDS "66 FEDERAL". BELOW THE WORDS "66 FEDERAL" ARE THE UNDERLINED WORDS "CREDIT UNION".
FOR CREDIT UNION SERVICES; CREDIT UNIONS (U.S. CLS. 100, 101 AND 102).
FIRST USE 1-1-2006; IN COMMERCE 1-1-2006.
PAUL E. FAHRENKOPF, EXAMINING ATTORNEY

CLASS 36—(Continued).

SN 77-924,665. MADISON CAPITAL MANAGEMENT, LLC, GREENWOOD VILLAGE, CO. FILED 2-1-2010.



OWNER OF U.S. REG. NO. 3,605,470.
NO CLAIM IS MADE TO THE EXCLUSIVE RIGHT TO USE "LIQUIDITY INVESTORS", APART FROM THE MARK AS SHOWN.
FOR FINANCIAL MANAGEMENT OF BANKRUPTCY CLAIMS; PROVIDING FINANCING TO COVER ACCOUNTS RECEIVABLES OF OTHERS; MANAGING FINANCIAL INTERESTS IN PARTNERSHIPS (U.S. CLS. 100, 101 AND 102).
FIRST USE 12-31-2000; IN COMMERCE 12-31-2000.
JUDITH HELFMAN, EXAMINING ATTORNEY

SN 77-924,685. MADISON CAPITAL MANAGEMENT, LLC, GREENWOOD VILLAGE, CO. FILED 2-1-2010.



OWNER OF U.S. REG. NO. 3,605,470.
NO CLAIM IS MADE TO THE EXCLUSIVE RIGHT TO USE "CAPITAL MANAGEMENT", APART FROM THE MARK AS SHOWN.
FOR FINANCIAL AND INVESTMENT SERVICES, NAMELY, MANAGEMENT AND BROKERAGE IN THE FIELDS OF STOCKS, BONDS, OPTIONS, COMMODITIES, FUTURES AND OTHER SECURITIES, AND THE INVESTMENT OF FUNDS OF OTHERS (U.S. CLS. 100, 101 AND 102).
FIRST USE 12-31-2000; IN COMMERCE 12-31-2000.
JUDITH HELFMAN, EXAMINING ATTORNEY

CLASS 36—(Continued).

SN 77-924,726. PROJECT ANIMAL WORLDWIDE, INC., TINTON FALLS, NJ. FILED 2-1-2010.

project  animal
worldwide

NO CLAIM IS MADE TO THE EXCLUSIVE RIGHT TO USE "PROJECT ANIMAL" AND "WORLDWIDE", APART FROM THE MARK AS SHOWN.

THE MARK CONSISTS OF THE STYLIZED WORDS "PROJECT ANIMAL WORLDWIDE". AN IMAGE OF A GLOBE WITH PAW PRINTS INSIDE IN BETWEEN THE WORD "PROJECT" AND "ANIMAL".

FOR CHARITABLE SERVICES, NAMELY, ORGANIZING FUNDRAISING SERVICES AND EVENTS TO RAISE FUNDS IN THE FIELD OF ANIMAL WELFARE (U.S. CLS. 100, 101 AND 102).

FIRST USE 12-3-2009; IN COMMERCE 1-22-2010.
SAMUEL E. SHARPER JR., EXAMINING ATTORNEY

SN 77-924,876. MERCHANT INDUSTRY, LLC, LONG ISLAND CITY, NY. FILED 2-1-2010.

 Merchant Industry

NO CLAIM IS MADE TO THE EXCLUSIVE RIGHT TO USE "MERCHANT INDUSTRY", APART FROM THE MARK AS SHOWN.

THE MARK CONSISTS OF THE WORDS "MERCHANT INDUSTRY" IN STYLIZED FONT, A STYLIZED RENDERING OF A GLOBE SURROUNDING THE LETTER "M" COMPRISED OF A DARKENED OVAL WITH TWO LAYERS OF CURVED RINGS AROUND THE SIDES AND A CURVED LINE EMANATING FROM THE GLOBE BELOW THE WORDING.

FOR MERCHANT BANKING AND INVESTMENT BANKING SERVICES (U.S. CLS. 100, 101 AND 102).

FIRST USE 11-19-2007; IN COMMERCE 11-19-2007.
DAVID YONTEF, EXAMINING ATTORNEY

SN 77-925,141. EVOLUTION MARKETS, INC., WHITE PLAINS, NY. FILED 2-1-2010.

EVOSCREEN

THE MARK CONSISTS OF STANDARD CHARACTERS WITHOUT CLAIM TO ANY PARTICULAR FONT, STYLE, SIZE, OR COLOR.

FOR FINANCIAL SERVICES IN THE NATURE OF TRADING COMMODITIES (U.S. CLS. 100, 101 AND 102).

FIRST USE 6-11-2009; IN COMMERCE 6-11-2009.
BENJAMIN OKEKE, EXAMINING ATTORNEY

CLASS 36—(Continued).

SN 77-925,307. PV BROKERAGE INC, PALOS VERDES PENINSULA, CA. FILED 2-1-2010.

WHERE INTEGRITY MEETS
EXPERIENCE

THE MARK CONSISTS OF STANDARD CHARACTERS WITHOUT CLAIM TO ANY PARTICULAR FONT, STYLE, SIZE, OR COLOR.

FOR FINANCIAL CONSULTING; REAL ESTATE BROKERAGE (U.S. CLS. 100, 101 AND 102).

FIRST USE 1-1-2010; IN COMMERCE 1-1-2010.
KELLY CHOE, EXAMINING ATTORNEY

SN 77-925,701. CAY & PARTNERS, LLC, ATLANTA, GA. FILED 2-2-2010.



THE MARK CONSISTS OF A SHIP ON WATER.

FOR INSURANCE AGENCY AND BROKERAGE SERVICES OF COMMERCIAL PROPERTY, CASUALTY, AND SPECIALTY LINES OF INSURANCE; CONSULTING SERVICES REGARDING EMPLOYEE INSURANCE AND FINANCIAL BENEFITS (U.S. CLS. 100, 101 AND 102).

NICHOLAS COLEMAN, EXAMINING ATTORNEY

SN 77-925,727. KELLEY HENTHORN, PARENT OF ELLEN HENTHORN, LEWISBURG, WV. FILED 2-2-2010.

I'M HELPING HAITI

THE MARK CONSISTS OF STANDARD CHARACTERS WITHOUT CLAIM TO ANY PARTICULAR FONT, STYLE, SIZE, OR COLOR.

FOR CHARITABLE FUNDRAISING SERVICES BY MEANS OF SELLING T-SHIRTS, CAR DECALS, AND BUMPER STICKERS TO RAISE FUNDS FOR THOSE IN NEED IN HAITI (U.S. CLS. 100, 101 AND 102).

KATHERINE CONNOLLY, EXAMINING ATTORNEY

CLASS 36—(Continued).

SN 77-925,735. AVILA CAPITAL MARKETS, LLC, NEW YORK, NY. FILED 2-2-2010.



THE COLOR(S) BLUE, GOLD, AND WHITE IS/ARE CLAIMED AS A FEATURE OF THE MARK.

THE MARK CONSISTS OF THE WORDING "ÁVILA" IN STYLIZED BLUE LETTERING WITH A GOLD, WHITE AND BLUE DIAMOND PATTERN DESIGN APPEARING ABOVE THIS TERM.

FOR BANKING AND FINANCING SERVICES; CORPORATE FINANCE SERVICES, NAMELY, CONSULTATION IN THE FIELD OF CAPITAL STRUCTURE; FINANCIAL CONSULTING SERVICES, NAMELY, EXPERT ANALYSIS IN FINANCE; FINANCING SERVICES; PROVIDING INFORMATION AND ADVICE IN THE FIELD OF FINANCE, FINANCIAL INVESTMENTS, FINANCIAL VALUATIONS, AND THE FINANCIAL ASPECTS OF RETIREMENT; PROVIDING INFORMATION AND RESEARCH IN THE FIELD OF FINANCE AND FINANCIAL INVESTMENTS (U.S. CLS. 100, 101 AND 102).

FIRST USE 1-28-2009; IN COMMERCE 1-28-2009.
NATALIE POLZER, EXAMINING ATTORNEY

SN 77-926,037. THE NORTHWESTERN MUTUAL LIFE INSURANCE COMPANY, MILWAUKEE, WI. FILED 2-2-2010.

EVERY LIFE MATTERS

THE MARK CONSISTS OF STANDARD CHARACTERS WITHOUT CLAIM TO ANY PARTICULAR FONT, STYLE, SIZE, OR COLOR.

FOR UNDERWRITING OF LIFE, VARIABLE LIFE, DISABILITY, AND LONG TERM-CARE INSURANCE; BROKERAGE OF GROUP HEALTH INSURANCE; MUTUAL FUND INVESTMENT AND BROKERAGE; INVESTMENT ADVISING; ANNUITY UNDERWRITING; ESTATE AND FIDUCIARY TRUST MANAGEMENT, ESTATE PLANNING, FINANCIAL PLANNING, ESTATE AND TRUST DISTRIBUTION PLANNING, MUTUAL FUND ADMINISTRATION AND DISTRIBUTION (U.S. CLS. 100, 101 AND 102).

KELLY BOULTON, EXAMINING ATTORNEY

CLASS 36—(Continued).

SN 77-926,179. FIRST SAN DIEGO COMPANY, INC., DBA FIRSTGROUP, LA JOLLA, CA. FILED 2-2-2010.

A Legacy of Wise Decisions

THE MARK CONSISTS OF STANDARD CHARACTERS WITHOUT CLAIM TO ANY PARTICULAR FONT, STYLE, SIZE, OR COLOR.

FOR REAL ESTATE SERVICES, NAMELY, RENTAL, BROKERAGE, LEASING AND MANAGEMENT OF COMMERCIAL PROPERTY, OFFICES AND OFFICE SPACE (U.S. CLS. 100, 101 AND 102).

FIRST USE 1-1-2007; IN COMMERCE 1-1-2007.
DEBRA LEE, EXAMINING ATTORNEY

SN 77-926,305. FOR THE NEXT, HILLSBORO, OR. FILED 2-2-2010.

FOR THE NEXT

THE MARK CONSISTS OF STANDARD CHARACTERS WITHOUT CLAIM TO ANY PARTICULAR FONT, STYLE, SIZE, OR COLOR.

FOR CHARITABLE FUNDRAISING SERVICES IN THE NATURE OF ADMINISTERING PROGRAMS THAT ENCOURAGE CONTRIBUTION BY THIRD PARTIES, INCLUDING INDIVIDUALS, TO ORGANIZATIONS WHOSE PRIMARY PURPOSE IS THE PRESERVATION AND SAFEGUARDING OF THE ENVIRONMENT (U.S. CLS. 100, 101 AND 102).

FIRST USE 10-0-2009; IN COMMERCE 10-0-2009.
AARON BRODSKY, EXAMINING ATTORNEY

SN 77-926,614. UNITED CONCORDIA COMPANIES, INC., PITTSBURGH, PA. FILED 2-3-2010.

DART

THE MARK CONSISTS OF STANDARD CHARACTERS WITHOUT CLAIM TO ANY PARTICULAR FONT, STYLE, SIZE, OR COLOR.

FOR ADMINISTERING PREPAID DENTAL AND PPO PLANS AND UNDERWRITING INSURANCE FOR PREPAID AND PPO DENTAL INSURANCE (U.S. CLS. 100, 101 AND 102).

FIRST USE 1-15-2010; IN COMMERCE 1-15-2010.
GEOFFREY FOSDICK, EXAMINING ATTORNEY

CLASS 36—(Continued).

SN 77-926,631. UNITED CONCORDIA COMPANIES, INC., PITTSBURGH, PA. FILED 2-3-2010.

AppointAssist

THE MARK CONSISTS OF STANDARD CHARACTERS WITHOUT CLAIM TO ANY PARTICULAR FONT, STYLE, SIZE, OR COLOR.

FOR ADMINISTERING PREPAID DENTAL AND PPO PLANS AND UNDERWRITING INSURANCE FOR PREPAID AND PPO DENTAL SERVICES (U.S. CLS. 100, 101 AND 102).

GEOFFREY FOSDICK, EXAMINING ATTORNEY

SN 77-926,644. ALLSTATE INSURANCE COMPANY, NORTHBROOK, IL. FILED 2-3-2010.

ALLSTATE DIRECT

THE MARK CONSISTS OF STANDARD CHARACTERS WITHOUT CLAIM TO ANY PARTICULAR FONT, STYLE, SIZE, OR COLOR.

OWNER OF U.S. REG. NOS. 717,683, 2,895,727 AND OTHERS.

NO CLAIM IS MADE TO THE EXCLUSIVE RIGHT TO USE "DIRECT", APART FROM THE MARK AS SHOWN.

FOR INSURANCE SERVICES, NAMELY WRITING AND UNDERWRITING PROPERTY, LIABILITY, LIFE AND CASUALTY INSURANCE; INSURANCE CLAIMS ADMINISTRATION; ISSUANCE AND ADMINISTRATION OF ANNUITIES (U.S. CLS. 100, 101 AND 102).

MICHAEL SOUDERS, EXAMINING ATTORNEY

SN 77-926,671. VISIUM ASSET MANAGEMENT, LP, NEW YORK, NY. FILED 2-3-2010.

VISIUM

THE MARK CONSISTS OF STANDARD CHARACTERS WITHOUT CLAIM TO ANY PARTICULAR FONT, STYLE, SIZE, OR COLOR.

FOR FINANCIAL SERVICES, NAMELY, INVESTMENT MANAGEMENT AND ADVISORY SERVICES (U.S. CLS. 100, 101 AND 102).

FIRST USE 11-1-2005; IN COMMERCE 11-1-2005.

SETH A. RAPPAPORT, EXAMINING ATTORNEY

CLASS 36—(Continued).

SN 77-926,714. BENEFIT PLANS ADMINISTRATIVE SERVICES, INC., UTICA, NY. FILED 2-3-2010.

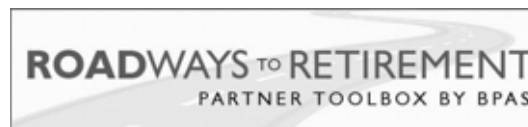

THE MARK CONSISTS OF THE WORDS "ROADWAYS TO RETIREMENT PARTNER TOOLBOX BY BPAS" SUPERIMPOSED OVER A WATERMARK OF A CURVED ROADWAY.

FOR ADMINISTRATION OF EMPLOYEE BENEFIT PLANS CONCERNING INSURANCE AND FINANCE; ADMINISTRATION OF EMPLOYEE WELFARE BENEFIT PLANS CONCERNING INSURANCE AND FINANCE; CONSULTING SERVICES IN THE FIELD OF STATE AND FEDERAL EMPLOYEE BENEFIT PLANS CONCERNING INSURANCE AND FINANCE; PROCESSING, ADMINISTERING AND MANAGING EMPLOYEE BENEFIT PLANS CONCERNING INSURANCE AND FINANCE (U.S. CLS. 100, 101 AND 102).

FIRST USE 1-10-2010; IN COMMERCE 1-10-2010.

JANICE L. MCMORROW, EXAMINING ATTORNEY

SN 77-926,741. GREENLIFE HOLDING COMPANY, LLC, CHICAGO, IL. FILED 2-3-2010.

CONSCIOUS ABOUT MORE THAN YOUR MONEY

THE MARK CONSISTS OF STANDARD CHARACTERS WITHOUT CLAIM TO ANY PARTICULAR FONT, STYLE, SIZE, OR COLOR.

FOR BANKING AND FINANCING SERVICES (U.S. CLS. 100, 101 AND 102).

SIMON TENG, EXAMINING ATTORNEY

SN 77-926,847. BRIDGESTONE RETAIL OPERATIONS, LLC, BLOOMINGDALE, IL. FILED 2-3-2010.



NO CLAIM IS MADE TO THE EXCLUSIVE RIGHT TO USE "TIRE REPAIR & REPLACEMENT PLAN", APART FROM THE MARK AS SHOWN.

THE COLOR(S) RED, BLUE, BLACK AND WHITE IS/ARE CLAIMED AS A FEATURE OF THE MARK.

THE MARK CONSISTS OF THE WORD "PROTECT" IN BLACK, WHICH CONSISTS OF CAPITALIZED LETTERS "PRO" AND LOWERCASE LETTERS "TECT" ABOVE THE WORDING "TIRE REPAIR & REPLACEMENT PLAN" IN BLACK AND BELOW A BLACK AND WHITE ROAD; LAND ON THE LEFT SIDE OF THE ROAD IS RED; LAND ON THE RIGHT SIDE OF THE ROAD IS BLUE.

FOR PROVIDING SUPPLEMENTAL WARRANTIES ON TIRES (U.S. CLS. 100, 101 AND 102).

SOPHIA S. KIM, EXAMINING ATTORNEY

CLASS 36—(Continued).

SN 77-927,048. FIRELAKE CAPITAL MANAGEMENT LLC, PALO ALTO, CA. FILED 2-3-2010.

FIRELAKE

THE MARK CONSISTS OF STANDARD CHARACTERS WITHOUT CLAIM TO ANY PARTICULAR FONT, STYLE, SIZE, OR COLOR.

FOR INVESTMENT SERVICES, NAMELY, VENTURE CAPITAL FUNDING SERVICES TO EMERGING, DEVELOPING, AND LATE-STAGE COMPANIES AND ENTREPRENEURS; CREATION, OPERATION AND MANAGEMENT OF INVESTMENT FUNDS THAT INVEST IN COMPANIES AND ENTREPRENEURS; INVESTMENT CONSULTATION AND ADVICE; ASSET MANAGEMENT; ASSET MANAGEMENT CONSULTATION AND ADVICE; FINANCIAL ADVISORY SERVICES; FINANCIAL RESEARCH AND ANALYSIS, NAMELY, DUE DILIGENCE AND SELECTION SERVICES IN THE FIELD OF VENTURE CAPITAL, PRIVATE EQUITY AND SMALL-CAP PUBLIC COMPANIES (U.S. CLS. 100, 101 AND 102).

FIRST USE 4-1-2002; IN COMMERCE 4-1-2002.
DEZMONA MIZELLE, EXAMINING ATTORNEY

SN 77-927,552. INTEGRATED CAPITAL MANAGEMENT, BOULDER, CO. FILED 2-3-2010.

PERFORM

**SEAMLESS NAVIGATION
FOR YOUR FINANCIAL LIFE**

THE MARK CONSISTS OF THE TEXT "PERFORM" ABOVE WITH A HORIZONTAL LINE BELOW IT, "SEAMLESS NAVIGATION" BELOW THE LINE, "FOR YOUR FINANCIAL LIFE" BELOW "SEAMLESS NAVIGATION" AND A HORIZONTAL LINE BELOW "FOR YOUR FINANCIAL LIFE".

FOR FINANCIAL SERVICES, NAMELY, PERSONAL FINANCIAL ORGANIZATION AND MANAGEMENT FOR OTHERS (U.S. CLS. 100, 101 AND 102).

FIRST USE 9-17-2009; IN COMMERCE 9-17-2009.
DANIEL CAPSHAW, EXAMINING ATTORNEY

CLASS 36—(Continued).

SN 77-927,717. GOLD RUSH BRANDS, LLC, SCARSDALE, NY. FILED 2-4-2010.

HBOS

THE MARK CONSISTS OF STANDARD CHARACTERS WITHOUT CLAIM TO ANY PARTICULAR FONT, STYLE, SIZE, OR COLOR.

FOR BANKING SERVICES; FINANCIAL SERVICES, NAMELY, FINANCIAL ANALYSIS AND CONSULTATION, FINANCIAL SERVICES IN THE FIELD OF MONEY LENDING, INVESTMENT FUND TRANSFER AND TRANSACTION SERVICES (U.S. CLS. 100, 101 AND 102).

JAY BESCH, EXAMINING ATTORNEY

SN 77-927,761. ARI INSURANCE COMPANIES, LAWRENCEVILLE, NJ. FILED 2-4-2010.

Confidence on Wheels

THE MARK CONSISTS OF STANDARD CHARACTERS WITHOUT CLAIM TO ANY PARTICULAR FONT, STYLE, SIZE, OR COLOR.

FOR INSURANCE CARRIER SERVICES; INSURANCE SERVICES, NAMELY, UNDERWRITING COMMERCIAL AUTOMOBILE INSURANCE (U.S. CLS. 100, 101 AND 102).

RUDY R. SINGLETON, EXAMINING ATTORNEY

SN 77-927,842. THE SUSAN G. KOMEN BREAST CANCER FOUNDATION, INC., DALLAS, TX. FILED 2-4-2010.

PROMISE ME

THE MARK CONSISTS OF STANDARD CHARACTERS WITHOUT CLAIM TO ANY PARTICULAR FONT, STYLE, SIZE, OR COLOR.

FOR CHARITABLE FUNDRAISING SERVICES (U.S. CLS. 100, 101 AND 102).

EMILY CARLSEN, EXAMINING ATTORNEY

CLASS 36—(Continued).

SN 77-927,963. CLARKSTON CAPITAL PARTNERS, BIRMINGHAM, MI. FILED 2-4-2010.

CRONOA

THE MARK CONSISTS OF STANDARD CHARACTERS WITHOUT CLAIM TO ANY PARTICULAR FONT, STYLE, SIZE, OR COLOR.

FOR FINANCIAL MANAGEMENT AND CONSULTING SERVICES (U.S. CLS. 100, 101 AND 102).
MICHAEL WEBSTER, EXAMINING ATTORNEY

SN 77-928,029. STOCKCROSS FINANCIAL SERVICES, AKA STOCKCROSS FINANCIAL SERVICES, BEVERLY HILLS, CA. FILED 2-4-2010.

STAND BEHIND THE SHIELD

THE MARK CONSISTS OF STANDARD CHARACTERS WITHOUT CLAIM TO ANY PARTICULAR FONT, STYLE, SIZE, OR COLOR.

FOR FINANCIAL ADMINISTRATION OF STOCK EXCHANGE TRADING OF SHARES AND OTHER FINANCIAL SECURITIES IN FINANCIAL MARKETS; FINANCIAL ADVICE; FINANCIAL ADVICE AND CONSULTANCY SERVICES; FINANCIAL ADVISORY AND CONSULTANCY SERVICES; FINANCIAL AND INVESTMENT SERVICES, NAMELY, MANAGEMENT AND BROKERAGE IN THE FIELDS OF STOCKS, BONDS, OPTIONS, COMMODITIES, FUTURES AND OTHER SECURITIES, AND THE INVESTMENT OF FUNDS OF OTHERS; FINANCIAL ASSET MANAGEMENT; FINANCIAL INFORMATION AND ADVISORY SERVICES; FINANCIAL INVESTMENT BROKERAGE; FINANCIAL PLANNING; FINANCIAL PLANNING AND INVESTMENT ADVISORY SERVICES; FINANCIAL PLANNING CONSULTATION; FINANCIAL PLANNING FOR RETIREMENT; FINANCIAL PLANNING, NAMELY, THE CREATION OF PERSONALIZED STRATEGIES TO ACHIEVE FINANCIAL INDEPENDENCE; FINANCIAL PORTFOLIO ANALYSIS SERVICES; FINANCIAL PORTFOLIO MANAGEMENT; FINANCIAL SERVICES, NAMELY, ADMINISTRATION OF TRANSACTIONS INVOLVING FUNDS DRAWN FROM SECURITIES, STOCKS, FUNDS, EQUITIES, BONDS, CASH, OR OTHER TYPES OF FINANCIAL INVESTMENTS IN RETIREMENT PLANS USING A CHECK OR NEGOTIABLE ORDER OF WITHDRAWAL OVER A GLOBAL DATA NETWORK; FINANCIAL SERVICES, NAMELY, ADMINISTRATION OF TRANSACTIONS INVOLVING FUNDS DRAWN FROM SECURITIES, STOCKS, FUNDS, EQUITIES, BONDS, CASH, OR OTHER TYPES OF FINANCIAL INVESTMENTS IN RETIREMENT PLANS USING A CREDIT OR DEBIT CARD OVER A GLOBAL DATA NETWORK; FINANCIAL SERVICES, NAMELY, ASSISTING OTHERS WITH THE COMPLETION OF FINANCIAL TRANSACTIONS FOR STOCKS, BONDS, SECURITIES AND EQUITIES; FINANCIAL SERVICES, NAMELY, INVESTMENT ADVICE, INVESTMENT MANAGEMENT, INVESTMENT CONSULTATION AND IN-

CLASS 36—(Continued).

VESTMENT OF FUNDS FOR OTHERS, INCLUDING PRIVATE AND PUBLIC EQUITY AND DEBT INVESTMENT SERVICES; FINANCIAL SERVICES, NAMELY, INVESTMENT FUND TRANSFER AND TRANSACTION SERVICES; FINANCIAL SERVICES, NAMELY, WEALTH MANAGEMENT SERVICES; ON-LINE FINANCIAL PLANNING SERVICES; ON-LINE TRADING OF FINANCIAL INSTRUMENTS, SHARES, OPTIONS AND OTHER DERIVATIVE PRODUCTS; ORGANIZATION OF ON-LINE STOCK EXCHANGES FOR THE BENEFIT OF THE TRADE OF STOCKS AND OTHER FINANCIAL SECURITIES; ORGANIZATION OF STOCK EXCHANGES FOR THE BENEFIT OF THE TRADE OF STOCKS AND OTHER FINANCIAL VALUES; PROVIDING A WEB SITE FEATURING PERSONAL FINANCIAL INFORMATION AND FINANCIAL ADVICE; PROVIDING A WEB SITE THAT ASSISTS FINANCIAL PROFESSIONALS IN THE MANAGEMENT OF RETIREMENT ACCOUNTS; PROVIDING A WEBSITE FEATURING NON-DOWNLOADABLE VIDEOS IN THE FIELD OF FINANCIAL PLANNING (U.S. CLS. 100, 101 AND 102).
NICHOLAS ALTREE, EXAMINING ATTORNEY

SN 77-928,054. GODWIN, GREGORY LEE, SOLANA BEACH, CA. FILED 2-4-2010.

AVIDAGENT

THE MARK CONSISTS OF STANDARD CHARACTERS WITHOUT CLAIM TO ANY PARTICULAR FONT, STYLE, SIZE, OR COLOR.

FOR COMMERCIAL AND RESIDENTIAL REAL ESTATE AGENCY SERVICES; PROVIDING A DATABASE OF INFORMATION ABOUT RESIDENTIAL REAL ESTATE LISTINGS IN DIFFERENT NEIGHBORHOODS AND COMMUNITIES; PROVIDING AN INTERNET WEBSITE PORTAL OFFERING INFORMATION IN THE FIELDS OF REAL ESTATE CONCERNING THE PURCHASE AND SALE OF NEW AND RESALE HOMES AND CONDOS; PROVIDING INFORMATION IN THE FIELD OF REAL ESTATE VIA THE INTERNET; PROVIDING REAL ESTATE LISTINGS AND REAL ESTATE INFORMATION VIA THE INTERNET; PROVIDING REAL ESTATE LISTINGS VIA THE INTERNET; REAL ESTATE AGENCIES; REAL ESTATE BROKERAGE; REAL ESTATE LISTING; REAL ESTATE LISTING SERVICES FOR HOUSING RENTALS AND APARTMENT RENTALS (U.S. CLS. 100, 101 AND 102).

FIRST USE 1-29-2010; IN COMMERCE 1-29-2010.
AMEEN IMAM, EXAMINING ATTORNEY

CLASS 36—(Continued).

SN 77-928,241. FIX PROTOCOL LIMITED, LONDON, UNITED KINGDOM, FILED 2-4-2010.

FIXATDL

THE MARK CONSISTS OF STANDARD CHARACTERS WITHOUT CLAIM TO ANY PARTICULAR FONT, STYLE, SIZE, OR COLOR.

OWNER OF U.S. REG. NOS. 3,051,261, 3,051,267 AND OTHERS.

FOR FINANCIAL AND INVESTMENT SERVICES, NAMELY, PROVIDING INFORMATION BY ELECTRONIC MEANS REGARDING FINANCIAL TRANSACTIONS IN THE NATURE OF BROKERAGE AND SECURITIES TRADING (U.S. CLS. 100, 101 AND 102).

FIRST USE 8-0-2007; IN COMMERCE 8-0-2007.
SHAILA SETTLES, EXAMINING ATTORNEY

CLASS 36—(Continued).

SN 77-928,829. TA ASSOCIATES MANAGEMENT L.P., BOSTON, MA. FILED 2-5-2010.

TA ASSOCIATES

THE MARK CONSISTS OF STANDARD CHARACTERS WITHOUT CLAIM TO ANY PARTICULAR FONT, STYLE, SIZE, OR COLOR.

NO CLAIM IS MADE TO THE EXCLUSIVE RIGHT TO USE "ASSOCIATES", APART FROM THE MARK AS SHOWN.

FOR INVESTMENT MANAGEMENT AND PRIVATE EQUITY INVESTMENT SERVICES (U.S. CLS. 100, 101 AND 102).

FIRST USE 0-0-1968; IN COMMERCE 0-0-1968.
BARBARA GAYNOR, EXAMINING ATTORNEY

SN 77-928,306. LOWERCASE VENTURES MANAGEMENT I, LLC, SAN FRANCISCO, CA. FILED 2-4-2010.

LOWERCASE CAPITAL

THE MARK CONSISTS OF STANDARD CHARACTERS WITHOUT CLAIM TO ANY PARTICULAR FONT, STYLE, SIZE, OR COLOR.

NO CLAIM IS MADE TO THE EXCLUSIVE RIGHT TO USE "CAPITAL", APART FROM THE MARK AS SHOWN.

FOR PRIVATE EQUITY AND VENTURE CAPITAL FUND INVESTMENT SERVICES (U.S. CLS. 100, 101 AND 102).

FLORENTINA BLANDU, EXAMINING ATTORNEY

SN 77-928,985. PRIVATE SALE PARTNERS, INC., WESTPORT, CT. FILED 2-5-2010.

Home Selling Made Simple

THE MARK CONSISTS OF STANDARD CHARACTERS WITHOUT CLAIM TO ANY PARTICULAR FONT, STYLE, SIZE, OR COLOR.

NO CLAIM IS MADE TO THE EXCLUSIVE RIGHT TO USE "HOME SELLING", APART FROM THE MARK AS SHOWN.

FOR REAL ESTATE SALES SERVICES FOR RESIDENTIAL PROPERTY OWNERS SELLING THEIR PROPERTY WITHOUT THE ASSISTANCE OF A REAL ESTATE AGENT OR BROKER (U.S. CLS. 100, 101 AND 102).

FIRST USE 3-1-2009; IN COMMERCE 3-1-2009.
INGRID C. EULIN, EXAMINING ATTORNEY

SN 77-928,513. DONALD L. ST. CLAIR, ROSEVILLE, CA. FILED 2-4-2010.

MortgageNudge

THE MARK CONSISTS OF STANDARD CHARACTERS WITHOUT CLAIM TO ANY PARTICULAR FONT, STYLE, SIZE, OR COLOR.

FOR FINANCIAL SERVICES, NAMELY, AMORTIZATION CALCULATIONS AND MORTGAGE ACCELERATION PAYMENT SERVICES (U.S. CLS. 100, 101 AND 102).

APRIL HESIK, EXAMINING ATTORNEY

SN 77-929,020. U.S. ONE, INC., RENO, NV. FILED 2-5-2010.

ONE FUND AND YOU'RE DONE

THE MARK CONSISTS OF STANDARD CHARACTERS WITHOUT CLAIM TO ANY PARTICULAR FONT, STYLE, SIZE, OR COLOR.

FOR INVESTMENT ADVICE (U.S. CLS. 100, 101 AND 102).

JIM RINGLE, EXAMINING ATTORNEY

CLASS 36—(Continued).

SN 77-929,163. C CHANGE INVESTMENTS MANAGEMENT, LLC, CAMBRIDGE, MA. FILED 2-5-2010.



THE MARK CONSISTS OF AN OUTER LETTER "C", AN INNER LETTER "C", INSIDE THE "C"'S ARE ORBITS WITH ELECTRONS, PROTONS AND A DELTA SYMBOL NEXT TO THEM.

FOR INVESTMENT MANAGEMENT SERVICES, NAMELY, INVESTMENT MANAGEMENT SERVICES RELATED TO CLEAN TECHNOLOGY SERVICES; FUND INVESTMENT, NAMELY, FUND INVESTMENTS IN ENVIRONMENTALLY FRIENDLY TECHNOLOGIES, SUSTAINABLE RESOURCES, SUSTAINABLE BUILDINGS, PRODUCTS; FINANCIAL INVESTMENT IN ENVIRONMENTALLY SENSITIVE COMPANIES (U.S. CLS. 100, 101 AND 102).

FIRST USE 8-23-2008; IN COMMERCE 8-23-2008.
TINA MAI, EXAMINING ATTORNEY

CLASS 36—(Continued).

SN 77-929,466. PCP MANAGERS, LLC, SAN FRANCISCO, CA. FILED 2-5-2010.

PARTHENON CAPITAL PARTNERS

THE MARK CONSISTS OF STANDARD CHARACTERS WITHOUT CLAIM TO ANY PARTICULAR FONT, STYLE, SIZE, OR COLOR.

OWNER OF U.S. REG. NO. 2,799,639.

NO CLAIM IS MADE TO THE EXCLUSIVE RIGHT TO USE "CAPITAL PARTNERS", APART FROM THE MARK AS SHOWN.

FOR FINANCIAL SERVICES, NAMELY, INVESTMENT ADVICE, INVESTMENT MANAGEMENT, INVESTMENT CONSULTATION AND INVESTMENT OF FUNDS FOR OTHERS (U.S. CLS. 100, 101 AND 102).

FIRST USE 11-24-2009; IN COMMERCE 11-24-2009.

RAUL CORDOVA, EXAMINING ATTORNEY

SN 77-930,103. EVERBANK, JACKSONVILLE, FL. FILED 2-8-2010.

SN 77-929,347. PRIVATE SALE PARTNERS, INC., WESTPORT, CT. FILED 2-5-2010.

Anytime Transfer Advantage

THE MARK CONSISTS OF STANDARD CHARACTERS WITHOUT CLAIM TO ANY PARTICULAR FONT, STYLE, SIZE, OR COLOR.

FOR REAL ESTATE SALES SERVICES FOR RESIDENTIAL PROPERTY OWNERS SELLING THEIR PROPERTY WITHOUT THE ASSISTANCE OF A REAL ESTATE AGENT OR BROKER (U.S. CLS. 100, 101 AND 102).

FIRST USE 3-1-2009; IN COMMERCE 3-1-2009.
INGRID C. EULIN, EXAMINING ATTORNEY

THE COLOR(S) RED IS/ARE CLAIMED AS A FEATURE OF THE MARK.

THE MARK CONSISTS OF RED SPHERE OVERLAID WITH A WHITE INFINITY SIGN.

FOR BANKING AND FINANCING SERVICES; INVESTMENT BROKERAGE (U.S. CLS. 100, 101 AND 102).
FIRST USE 1-1-2004; IN COMMERCE 1-1-2004.

SAMUEL E. SHARPER JR., EXAMINING ATTORNEY

CLASS 36—(Continued).

SN 77-930,187. AMERICAN FIDELITY ASSURANCE COMPANY, OKLAHOMA CITY, OK. FILED 2-8-2010.

BRINGING BENEFITS AND SERVICES TOGETHER

THE MARK CONSISTS OF STANDARD CHARACTERS WITHOUT CLAIM TO ANY PARTICULAR FONT, STYLE, SIZE, OR COLOR.

FOR INSURANCE BROKERAGE, UNDERWRITING, AND ADMINISTRATION SERVICES, NAMELY, IN THE FIELDS OF LIFE, HEALTH, ACCIDENT, AND DISABILITY INSURANCE (U.S. CLS. 100, 101 AND 102).

FIRST USE 12-17-2009; IN COMMERCE 12-17-2009.
JOSETTE BEVERLY, EXAMINING ATTORNEY

CLASS 36—(Continued).

SN 77-930,646. UNITED COMMUNITY BANKS, INC., BLAIRSVILLE, GA. FILED 2-8-2010.

STRONG BANK. STRONG SERVICE.

THE MARK CONSISTS OF STANDARD CHARACTERS WITHOUT CLAIM TO ANY PARTICULAR FONT, STYLE, SIZE, OR COLOR.

NO CLAIM IS MADE TO THE EXCLUSIVE RIGHT TO USE "BANK" AND "SERVICE", APART FROM THE MARK AS SHOWN.

FOR BANKING SERVICES (U.S. CLS. 100, 101 AND 102).
FIRST USE 10-20-2009; IN COMMERCE 11-16-2009.
ANDREA SAUNDERS, EXAMINING ATTORNEY

SN 77-930,373. ARRAY HEALTH SOLUTIONS INC., SEATTLE, WA. FILED 2-8-2010.



THE MARK CONSISTS OF A SINGLE OBOVATE LEAF AND SHADOW FOLLOWED BY THE TEXT "ARRAY-HEALTH".

FOR ADMINISTRATION OF EMPLOYER HEALTH BENEFIT PLANS, NAMELY, EMPLOYEE ELIGIBILITY TRACKING, PLAN ENROLLMENT, CLAIMS ADMINISTRATION, BILLING, AND FINANCIAL REPORTING (U.S. CLS. 100, 101 AND 102).

FIRST USE 9-1-2008; IN COMMERCE 9-1-2008.
DAVID MURRAY, EXAMINING ATTORNEY

SN 77-930,664. VIP REALTY GROUP, INC., NAPLES, FL. FILED 2-8-2010.



THE MARK CONSISTS OF STANDARD CHARACTERS WITHOUT CLAIM TO ANY PARTICULAR FONT, STYLE, SIZE, OR COLOR.

THE WORDING "NAVIA" HAS NO MEANING IN A FOREIGN LANGUAGE.

FOR REAL ESTATE SERVICES, NAMELY, APPRAISAL OF REAL ESTATE, LEASING OF REAL ESTATE, REAL ESTATE ACQUISITION SERVICES, REAL ESTATE AGENCIES, REAL ESTATE BROKERAGE, REAL ESTATE CONSULTATION, REAL ESTATE ESCROW SERVICES, REAL ESTATE INVESTMENT, REAL ESTATE LENDING SERVICES, REAL ESTATE LISTING, REAL ESTATE MANAGEMENT, REAL ESTATE MULTIPLE LISTING SERVICES, REAL ESTATE PROCUREMENT FOR OTHERS, REAL ESTATE SERVICES IN THE FORM OF PROVIDING PHYSICAL ACCESS TO AVAILABLE PROPERTIES VIA A REMOTE CALL-IN LOCKING DEVICE; VACATION HOME RENTAL SERVICES; RENTAL OF VACATION HOMES, CONDOMINIUMS, CABINS, AND VILLAS; SHORT TERM AND LONG TERM RENTAL OF VACATION HOMES, CONDOMINIUMS, CABINS, AND VILLAS; PROVIDING TEMPORARY LODGING SERVICES, NAMELY, RENTAL OF VACATION HOMES; MORTGAGE AND FINANCIAL SERVICES, NAMELY, MORTGAGE PLANNING, MORTGAGE BANKING, MORTGAGE BROKERAGE, MORTGAGE LENDING, MORTGAGE PROCUREMENT FOR OTHERS, BUYERS PRE-QUALIFICATION OF MORTGAGES FOR MORTGAGE BROKERS AND BANK; INFORMATION SERVICES, NAMELY, PROVIDING INFORMATION IN THE FIELD OF REAL ESTATE VIA THE INTERNET, PROVIDING REAL ESTATE LISTINGS AND REAL ESTATE INFORMATION VIA THE INTERNET, PROVIDING INFORMATION IN THE FIELD OF REAL ESTATE BY MEANS OF LINKING THE WEB SITE TO OTHER WEB SITES FEATURING REAL ESTATE INFORMATION (U.S. CLS. 100, 101 AND 102).

JAMES LOVELACE, EXAMINING ATTORNEY

SN 77-930,638. D. E. SHAW & CO., L.P., NEW YORK, NY. FILED 2-8-2010.



THE MARK CONSISTS OF STANDARD CHARACTERS WITHOUT CLAIM TO ANY PARTICULAR FONT, STYLE, SIZE, OR COLOR.

FOR INVESTMENT ADVISORY AND INVESTMENT MANAGEMENT SERVICES IN THE AREA OF ALTERNATIVE INVESTMENTS (U.S. CLS. 100, 101 AND 102).

TEJBIR SINGH, EXAMINING ATTORNEY

CLASS 36—(Continued).

SN 77-930,754. SARSANY, JAMIE N., DBA FABULOCITY, SAN DIEGO, CA. FILED 2-8-2010.

Fabulocity

THE MARK CONSISTS OF STANDARD CHARACTERS WITHOUT CLAIM TO ANY PARTICULAR FONT, STYLE, SIZE, OR COLOR.

FOR REAL ESTATE AGENCIES; REAL ESTATE BROKERAGE (U.S. CLS. 100, 101 AND 102).
FIRST USE 7-0-2009; IN COMMERCE 7-0-2009.
ADA HAN, EXAMINING ATTORNEY

SN 77-930,769. PARDUE SETTLEMENT SERVICES, INC., DBA COUNCIL SETTLEMENT GROUP, HOUSTON, TX. FILED 2-8-2010.

PLANTING THE SEEDS FOR A SECURE FUTURE

THE MARK CONSISTS OF STANDARD CHARACTERS WITHOUT CLAIM TO ANY PARTICULAR FONT, STYLE, SIZE, OR COLOR.

FOR LIFE INSURANCE BROKERAGE (U.S. CLS. 100, 101 AND 102).
KATHY DE JONGE, EXAMINING ATTORNEY

SN 77-931,190. LULAC REY FEO SCHOLARSHIP COMMITTEE, INC., SAN ANTONIO, TX. FILED 2-9-2010.

REINA LINDA

THE MARK CONSISTS OF STANDARD CHARACTERS WITHOUT CLAIM TO ANY PARTICULAR FONT, STYLE, SIZE, OR COLOR.

THE ENGLISH TRANSLATION OF "REINA LINDA" IN THE MARK IS PRETTY QUEEN.
FOR CHARITABLE FUND RAISING; PROVIDING EDUCATIONAL SCHOLARSHIPS (U.S. CLS. 100, 101 AND 102).
GIANCARLO CASTRO, EXAMINING ATTORNEY

CLASS 36—(Continued).

SN 77-931,657. 20 GATES MANAGEMENT LLC, NEW YORK, NY. FILED 2-9-2010.



THE MARK CONSISTS OF A STONE ARCH WITH THE STYLIZED TEXT "20 GATES".

FOR FINANCIAL SERVICES, NAMELY, ADMINISTRATION OF ASSET BACKED CONDUITS AND SECURITIZATIONS (U.S. CLS. 100, 101 AND 102).
DOMINIC FATHY, EXAMINING ATTORNEY

SN 77-931,747. WHITMAN, CHRIS, PENSACOLA, FL. FILED 2-9-2010.



THE NAME "CHRIS WHITMAN" IDENTIFIES A LIVING INDIVIDUAL WHOSE CONSENT IS OF RECORD.

THE COLOR(S) BLUE, GOLD, BLACK IS/ARE CLAIMED AS A FEATURE OF THE MARK.

THE MARK CONSISTS OF BLUE GRADIENT CIRCLE WITH A GOLD STYLIZED "W" CENTERED WITHIN THE CIRCLE, "CHRIS WHITMAN" IN BLACK ALL CAPS BELOW CIRCULAR MARK, "ENVISION DESIGN ACHIEVE" IN GOLD CENTERED BELOW "CHRIS WHITMAN" IN LOWER CASE DIVIDED BY VERTICAL LINES.

FOR FINANCIAL ADMINISTRATION OF RETIREMENT PLANS; FINANCIAL ADVICE; FINANCIAL ADVICE AND CONSULTANCY SERVICES; FINANCIAL ADVISORY AND CONSULTANCY SERVICES; FINANCIAL ANALYSIS AND CONSULTATION; FINANCIAL AND INVESTMENT SERVICES, NAMELY, MANAGEMENT AND BROKERAGE IN THE FIELDS OF STOCKS, BONDS, OPTIONS, COMMODITIES, FUTURES AND OTHER SECURITIES, AND THE INVESTMENT OF FUNDS OF OTHERS; FINANCIAL ASSET MANAGEMENT; FINANCIAL CONSULTANCY; FINANCIAL CONSULTANCY AND INSURANCE CONSULTANCY; FINANCIAL CONSULTATION; FINANCIAL CONSULTING; FINANCIAL COUNSELING SERVICES, NAMELY, HELPING OTHERS BUILD A BETTER WORKING RELATIONSHIP WITH THEIR MONEY; FINANCIAL PLANNING; FINANCIAL PLANNING AND INVESTMENT ADVISORY SERVICES; FINANCIAL PLANNING CONSULTATION; FINANCIAL PLANNING FOR RETIREMENT; FINANCIAL PLANNING, NAMELY, THE CREATION OF PERSONALIZED STRATEGIES TO ACHIEVE FINANCIAL INDEPENDENCE; FINANCIAL PORTFOLIO ANALYSIS SERVICES; FINANCIAL PORTFOLIO MANAGEMENT; FINANCIAL RESEARCH AND EQUITY RESEARCH BROKERAGE SERVICES; FINANCIAL RISK MANAGEMENT; FINANCIAL RISK MANAGEMENT CONSULTATION; FINANCIAL SERVICES, NAMELY, A TOTAL PORTFOLIO OFFERING FOR HIGH NET WORTH CLIENTS CONSISTING OF BOTH SEPARATE ACCOUNTS AND MUTUAL FUNDS FOR EQUITY AND FIXED INCOME INVESTMENTS (U.S. CLS. 100, 101 AND 102).

FIRST USE 10-21-2009; IN COMMERCE 10-21-2009.
KATHY DE JONGE, EXAMINING ATTORNEY

CLASS 36—(Continued).

SN 77-931,911. STEWART, GREGORY C., SACRAMENTO, CA. FILED 2-9-2010.

CLASS 36—(Continued).

SN 77-936,756. MENTOR INTERNATIONAL LLC, GREENWICH, CT. FILED 2-16-2010.

AVID REALTY

Mentor International

THE MARK CONSISTS OF STANDARD CHARACTERS WITHOUT CLAIM TO ANY PARTICULAR FONT, STYLE, SIZE, OR COLOR.

NO CLAIM IS MADE TO THE EXCLUSIVE RIGHT TO USE "REALTY", APART FROM THE MARK AS SHOWN.

FOR COMMERCIAL AND RESIDENTIAL REAL ESTATE AGENCY SERVICES; REAL ESTATE INVESTMENT SERVICES; REAL ESTATE MANAGEMENT SERVICES; REAL ESTATE MULTIPLE LISTING SERVICES (U.S. CLS. 100, 101 AND 102).

LINDSEY RUBIN, EXAMINING ATTORNEY

THE MARK CONSISTS OF STANDARD CHARACTERS WITHOUT CLAIM TO ANY PARTICULAR FONT, STYLE, SIZE, OR COLOR.

NO CLAIM IS MADE TO THE EXCLUSIVE RIGHT TO USE "INTERNATIONAL", APART FROM THE MARK AS SHOWN.

FOR INVESTMENT MANAGEMENT (U.S. CLS. 100, 101 AND 102).

FIRST USE 1-4-2010; IN COMMERCE 1-4-2010.

DAVID C. REIHNER, EXAMINING ATTORNEY

SN 77-935,826. MARKONE HOLDINGS, LLC, JACKSONVILLE, FL. FILED 2-15-2010.

SN 77-936,797. FIRST NATIONAL OF NEBRASKA, INC., OMAHA, NE. FILED 2-16-2010.



TRIBUTARY FUNDS

THE MARK CONSISTS OF CARTOON SUPERHERO WITH "M1" AND ROTATING ATOMS ON CHEST.

FOR PROVIDING CASH TO HOLDERS OF NOTES AT A DISCOUNTED RATE IN RETURN FOR OWNERSHIP OF THE NOTES (U.S. CLS. 100, 101 AND 102).

FIRST USE 1-29-2010; IN COMMERCE 1-29-2010.

REBECCA SMITH, EXAMINING ATTORNEY

THE MARK CONSISTS OF STANDARD CHARACTERS WITHOUT CLAIM TO ANY PARTICULAR FONT, STYLE, SIZE, OR COLOR.

NO CLAIM IS MADE TO THE EXCLUSIVE RIGHT TO USE "FUNDS", APART FROM THE MARK AS SHOWN.

FOR FINANCIAL AND INVESTMENT MANAGEMENT SERVICES IN THE FIELD OF MUTUAL FUNDS (U.S. CLS. 100, 101 AND 102).

REGINA DRUMMOND, EXAMINING ATTORNEY

CLASS 36—(Continued).

SN 77-937,107. CIMBAL HOLDINGS, LLC, SAN FRANCISCO, CA. FILED 2-16-2010.

CIMBAL

THE MARK CONSISTS OF STANDARD CHARACTERS WITHOUT CLAIM TO ANY PARTICULAR FONT, STYLE, SIZE, OR COLOR.

FOR BANKING AND FINANCING SERVICES; CHECKING ACCOUNT, BILL PAYMENT, CHARGE CARD, CREDIT CARD, DEBIT CARD AND STORED VALUE CARD AUTHORIZATION AND TRANSACTION PROCESSING SERVICES; ELECTRONIC PAYMENT, NAMELY, ELECTRONIC PROCESSING AND TRANSMISSION OF BILL PAYMENT DATA; FINANCIAL TRANSACTION SERVICES, NAMELY, PROVIDING SECURE COMMERCIAL TRANSACTIONS AND PAYMENT OPTIONS OF ELECTRONIC FUNDS USING A MOBILE DEVICE AT A POINT OF SALE VIA A GLOBAL COMMUNICATIONS NETWORK; PROVIDING ELECTRONIC PROCESSING OF ELECTRONIC FUNDS TRANSFER, ACH, CREDIT CARD, DEBIT CARD, ELECTRONIC CHECK TRANSACTIONS AND ELECTRONIC PAYMENTS VIA A GLOBAL COMPUTER NETWORK; CLEARING AND RECONCILING FINANCIAL TRANSACTIONS VIA ELECTRONIC COMMUNICATIONS NETWORKS (U.S. CLS. 100, 101 AND 102).

FIRST USE 1-10-2010; IN COMMERCE 1-10-2010.
ROBERT C. CLARK JR., EXAMINING ATTORNEY

SN 77-943,309. ALLSTATE INSURANCE COMPANY, NORTHBROOK, IL. FILED 2-24-2010.

PROTECTION IS OUR GAME

THE MARK CONSISTS OF STANDARD CHARACTERS WITHOUT CLAIM TO ANY PARTICULAR FONT, STYLE, SIZE, OR COLOR.

OWNER OF U.S. REG. NOS. 3,516,201 AND 3,620,557.
FOR INSURANCE SERVICES, NAMELY, WRITING AND UNDERWRITING INSURANCE IN THE FIELDS OF PROPERTY, LIABILITY AND CASUALTY, AND PROVIDING ANCILLARY SERVICES THERETO, NAMELY, INSURANCE ADMINISTRATION AND CLAIMS ADJUSTMENT IN THE FIELD OF INSURANCE (U.S. CLS. 100, 101 AND 102).

MICHAEL SOUDERS, EXAMINING ATTORNEY

CLASS 36—(Continued).

SN 77-945,722. VIP REALTY GROUP, INC., FORT MYERS, FL. FILED 2-26-2010.

NAVIA.COM

THE MARK CONSISTS OF STANDARD CHARACTERS WITHOUT CLAIM TO ANY PARTICULAR FONT, STYLE, SIZE, OR COLOR.

THE WORDING "NAVIA" HAS NO MEANING IN A FOREIGN LANGUAGE.

FOR REAL ESTATE SERVICES, NAMELY, APPRAISAL OF REAL ESTATE, LEASING OF REAL ESTATE, REAL ESTATE ACQUISITION SERVICES, REAL ESTATE AGENCIES, REAL ESTATE BROKERAGE, REAL ESTATE CONSULTATION, REAL ESTATE ESCROW SERVICES, REAL ESTATE INVESTMENT, REAL ESTATE LENDING SERVICES, REAL ESTATE LISTING, REAL ESTATE MANAGEMENT, REAL ESTATE MULTIPLE LISTING SERVICES, REAL ESTATE PROCUREMENT FOR OTHERS, REAL ESTATE SERVICES IN THE FORM OF PROVIDING PHYSICAL ACCESS TO AVAILABLE PROPERTIES VIA A REMOTE CALL-IN LOCKING DEVICE; VACATION HOME RENTAL SERVICES; RENTAL OF VACATION HOMES, CONDOMINIUMS, CABINS, AND VILLAS; SHORT TERM AND LONG TERM RENTAL OF VACATION HOMES, CONDOMINIUMS, CABINS, AND VILLAS; PROVIDING TEMPORARY LODGING SERVICES, NAMELY, RENTAL OF VACATION HOMES; MORTGAGE AND FINANCIAL SERVICES, NAMELY, MORTGAGE PLANNING, MORTGAGE BANKING, MORTGAGE BROKERAGE, MORTGAGE LENDING, MORTGAGE PROCUREMENT FOR OTHERS, BUYERS PRE-QUALIFICATION OF MORTGAGES FOR MORTGAGE BROKERS AND BANK; INFORMATION SERVICES, NAMELY, PROVIDING INFORMATION IN THE FIELD OF REAL ESTATE VIA THE INTERNET, PROVIDING REAL ESTATE LISTINGS AND REAL ESTATE INFORMATION VIA THE INTERNET, PROVIDING INFORMATION IN THE FIELD OF REAL ESTATE BY MEANS OF LINKING THE WEB SITE TO OTHER WEB SITES FEATURING REAL ESTATE INFORMATION (U.S. CLS. 100, 101 AND 102).

JAMES LOVELACE, EXAMINING ATTORNEY

SN 77-952,778. ALLSTATE INSURANCE COMPANY, NORTHBROOK, IL. FILED 3-8-2010.

GOODFORLIFE

THE MARK CONSISTS OF STANDARD CHARACTERS WITHOUT CLAIM TO ANY PARTICULAR FONT, STYLE, SIZE, OR COLOR.

FOR INSURANCE SERVICES, NAMELY, UNDERWRITING, ISSUING AND ADMINISTRATION OF LIFE INSURANCE, CRITICAL CARE INSURANCE, AND ACCIDENTAL DEATH AND INJURY INSURANCE (U.S. CLS. 100, 101 AND 102).

MICHAEL SOUDERS, EXAMINING ATTORNEY

CLASS 36—(Continued).

SN 77-976,063. EASTERDAY, MARK, SARATOGA, CA. AND SABRINA HUANG, SARATOGA, CA. FILED 5-13-2008.

MESH

THE MARK CONSISTS OF STANDARD CHARACTERS WITHOUT CLAIM TO ANY PARTICULAR FONT, STYLE, SIZE, OR COLOR.

FOR REAL ESTATE BROKERAGE (U.S. CLS. 100, 101 AND 102).

FIRST USE 7-28-2006; IN COMMERCE 7-28-2006.
MICHELLE DUBOIS, EXAMINING ATTORNEY

SN 78-874,334. COMPUCREDIT INTELLECTUAL PROPERTY HOLDINGS CORP. II, LAS VEGAS, NV. FILED 5-2-2006.

ARENA

THE MARK CONSISTS OF STANDARD CHARACTERS WITHOUT CLAIM TO ANY PARTICULAR FONT, STYLE, SIZE, OR COLOR.

FOR FINANCIAL SERVICES, NAMELY, LOANS, SHORT TERM LOANS, DEBIT CARD SERVICES; CREDIT CARD SERVICES (U.S. CLS. 100, 101 AND 102).

JANICE L. MCMORROW, EXAMINING ATTORNEY

SN 78-938,635. CASH YES CARD, LLC, DES PLAINES, IL. FILED 7-27-2006.

CASH YES CARD

THE MARK CONSISTS OF STANDARD CHARACTERS WITHOUT CLAIM TO ANY PARTICULAR FONT, STYLE, SIZE, OR COLOR.

NO CLAIM IS MADE TO THE EXCLUSIVE RIGHT TO USE "CASH" AND "CARD", APART FROM THE MARK AS SHOWN.

FOR FINANCIAL SERVICES, NAMELY, CREDIT AND DEBIT CARD SERVICES (U.S. CLS. 100, 101 AND 102).
JASON TURNER, EXAMINING ATTORNEY

CLASS 36—(Continued).

SN 79-067,847. CHELLOMEDIA PROGRAMMING B.V., NL-1062 HK AMSTERDAM, NETHERLANDS, FILED 4-1-2009.

CHELLO FOUNDATION

THE MARK CONSISTS OF STANDARD CHARACTERS WITHOUT CLAIM TO ANY PARTICULAR FONT, STYLE, SIZE, OR COLOR.

OWNER OF INTERNATIONAL REGISTRATION 1000316 DATED 4-1-2009, EXPIRES 4-1-2019.

NO CLAIM IS MADE TO THE EXCLUSIVE RIGHT TO USE "FOUNDATION", APART FROM THE MARK AS SHOWN.

FOR RAISING FUNDS BY MEANS OF AN ENTERTAINMENT EVENT; FINANCIAL SPONSORSHIP OF THE CARE AND EDUCATION OF ORPHANS IN DEVELOPING COUNTRIES; CHARITABLE FUND-RAISING BY MEANS OF ENTERTAINMENT EVENTS AND SOLICITING DONATIONS; FINANCIAL MANAGEMENT FOR OTHERS OF FUNDS INTENDED FOR CHARITY AND DEVELOPMENT AID; FINANCING OF PROJECTS, ORGANIZATIONS AND INSTITUTIONS IN DEVELOPING COUNTRIES; FINANCIAL ADVISORY SERVICES RELATING TO GRANTS, MICRO CREDITS AND MICRO FINANCING OF PROJECTS, ORGANIZATIONS AND INSTITUTIONS IN DEVELOPING COUNTRIES; FINANCING HUMANITARIAN AID; FINANCIAL SERVICES, NAMELY, ARRANGING AND PROVISION OF CREDIT FOR PERSONS IN NEED; FINANCIAL RESEARCH AND CONSULTANCY IN THE FIELD OF FINANCIAL RISKS AND RISK MANAGEMENT (U.S. CLS. 100, 101 AND 102).

JERI J. FICKES, EXAMINING ATTORNEY

SN 85-012,273. TABLE MOUNTAIN RANCHERIA OF CALIFORNIA, FRIANT, CA. FILED 4-12-2010.



THE MARK CONSISTS OF A CIRCULAR IMAGE, THE CENTER CONTAINING THE PROFILE OF A NATIVE AMERICAN HEAD, THE OUTER BAND OF THE CIRCLE CONTAINING THE WORDS "TABLE MOUNTAIN RANCHERIA", THE BOTTOM PORTION OF THE CIRCLE HAVING FIVE FEATHERS HANGING VERTICALLY.

FOR PHILANTHROPIC SERVICES CONCERNING MONETARY DONATIONS (U.S. CLS. 100, 101 AND 102).
FIRST USE 1-31-1990; IN COMMERCE 1-31-1990.
KATHY DE JONGE, EXAMINING ATTORNEY

CLASS 37—CONSTRUCTION AND REPAIR

SN 76-695,709. TSURUMI MANUFACTURING CO., LTD., OSAKA-SHI, OSAKA 538-0053, JAPAN, FILED 2-9-2009.



OWNER OF JAPAN REG. NO. 3182398, DATED 7-31-1996, EXPIRES 7-31-2016.

NO CLAIM IS MADE TO THE EXCLUSIVE RIGHT TO USE "PUMP", APART FROM THE MARK AS SHOWN.

THE MARK COMPRISES THREE ELLIPTICAL ARCS OF VARYING THICKNESS DISPOSED AROUND A SOLID OVAL AND ABOVE THE WORDS "TSURUMI PUMP".

FOR CONSTRUCTION, CONSULTATION, PLANNING, LAYOUT, AND DEWATERING OF CIVIL ENGINEERING PROJECTS, NAMELY, AIRPORTS, ROADS, BRIDGES, SHOPPING MALLS, BUILDINGS, ATHLETIC FACILITIES, FACTORIES, TUNNELS, WATER PURIFICATION PLANTS, IRRIGATION FACILITIES, AND SEWAGE FACILITIES; PLUMBING; INSTALLATION OF MACHINERY, NAMELY, PUMPS; INSTALLATION OF PUMP ACCESSORIES, NAMELY, ANTI-CORROSION EQUIPMENT, SELF-CLEANING EQUIPMENT, LUBRICATING EQUIPMENT, SLUDGE-HOLDING TANKS, AND SUBMERSIBLE BLOWERS; ELECTRIC REPAIRS AND INSTALLATION WORK OF PH CONTROL EQUIPMENT, MUDDY WATER TREATMENT SYSTEMS, AND ELECTRIC CONTROL PANELS FOR PUMPS AND DEWATERING EQUIPMENT; REPAIRING AND MAINTENANCE OF PUMPS (U.S. CLS. 100, 103 AND 106).

MAYUR VAGHANI, EXAMINING ATTORNEY

SN 77-522,923. MONTAGE HOTELS & RESORTS, LLC, LAGUNA BEACH, CA. FILED 7-15-2008.



OWNER OF U.S. REG. NOS. 2,801,152, 2,853,585 AND 3,325,069.

NO CLAIM IS MADE TO THE EXCLUSIVE RIGHT TO USE "RESIDENCES", APART FROM THE MARK AS SHOWN.

THE MARK CONSISTS OF A STYLIZED "M" SHOWN ON TOP OF THE WORDS "MONTAGE RESIDENCES".

FOR REAL ESTATE DEVELOPMENT SERVICES (U.S. CLS. 100, 103 AND 106).

EMILY CARLSEN, EXAMINING ATTORNEY

CLASS 37—(Continued).

SN 77-522,931. MONTAGE HOTELS & RESORTS, LLC, LAGUNA BEACH, CA. FILED 7-15-2008.

MONTAGE RESIDENCES

THE MARK CONSISTS OF STANDARD CHARACTERS WITHOUT CLAIM TO ANY PARTICULAR FONT, STYLE, SIZE, OR COLOR.

OWNER OF U.S. REG. NOS. 2,801,152, 2,853,585 AND 3,325,069.

NO CLAIM IS MADE TO THE EXCLUSIVE RIGHT TO USE "RESIDENCES", APART FROM THE MARK AS SHOWN.

FOR REAL ESTATE DEVELOPMENT SERVICES (U.S. CLS. 100, 103 AND 106).

EMILY CARLSEN, EXAMINING ATTORNEY

SN 77-596,788. WESTINGHOUSE ELECTRIC COMPANY LLC, CRANBERRY TOWNSHIP, PA. FILED 10-21-2008.

SCALEBLASTER

THE MARK CONSISTS OF STANDARD CHARACTERS WITHOUT CLAIM TO ANY PARTICULAR FONT, STYLE, SIZE, OR COLOR.

FOR CLEANING SERVICES, NAMELY, MECHANICALLY REMOVING SCALE AND SLUDGE FROM TUBES IN STEAM GENERATORS IN NUCLEAR POWER PLANTS (U.S. CLS. 100, 103 AND 106).

KAPIL BHANOT, EXAMINING ATTORNEY

SN 77-604,955. SINTON AIR CONDITIONING AND HEATING, INC., KENNETT SQUARE, PA. FILED 10-31-2008.

GEOHERMAL SMART

THE MARK CONSISTS OF STANDARD CHARACTERS WITHOUT CLAIM TO ANY PARTICULAR FONT, STYLE, SIZE, OR COLOR.

NO CLAIM IS MADE TO THE EXCLUSIVE RIGHT TO USE "GEOHERMAL", APART FROM THE MARK AS SHOWN.

FOR GEOHERMAL HEATING AND COOLING CONTRACTOR SERVICES (U.S. CLS. 100, 103 AND 106).

FIRST USE 10-1-2008; IN COMMERCE 10-1-2008.

LINDA E. BLOHM, EXAMINING ATTORNEY

CLASS 37—(Continued).

SN 77-651,271. QUATTRO PARTNERS LLC, OXNARD, CA. FILED 1-16-2009.

QUATTRO DEVELOPMENT

THE MARK CONSISTS OF STANDARD CHARACTERS WITHOUT CLAIM TO ANY PARTICULAR FONT, STYLE, SIZE, OR COLOR.

NO CLAIM IS MADE TO THE EXCLUSIVE RIGHT TO USE "DEVELOPMENT", APART FROM THE MARK AS SHOWN.

THE ENGLISH TRANSLATION OF "QUATTRO" IN THE MARK IS FOUR.

FOR REAL ESTATE DEVELOPMENT; BUILDING CONSTRUCTION SERVICES; AND CONSULTING IN THE FIELD OF BUILDING CONSTRUCTION (U.S. CLS. 100, 103 AND 106).

YAT SYE, LEE, EXAMINING ATTORNEY

SN 77-651,284. QUATTRO PARTNERS LLC, OXNARD, CA. FILED 1-16-2009.

QUATTRO

THE MARK CONSISTS OF STANDARD CHARACTERS WITHOUT CLAIM TO ANY PARTICULAR FONT, STYLE, SIZE, OR COLOR.

THE ENGLISH TRANSLATION OF "QUATTRO" IN THE MARK IS FOUR.

FOR REAL ESTATE DEVELOPMENT; BUILDING CONSTRUCTION SERVICES; AND CONSULTING IN THE FIELD OF BUILDING CONSTRUCTION (U.S. CLS. 100, 103 AND 106).

YAT SYE, LEE, EXAMINING ATTORNEY

SN 77-681,967. DIGIPOINT, INC, MIAMI, FL. FILED 3-3-2009.

DIGIPOINT

THE MARK CONSISTS OF STANDARD CHARACTERS WITHOUT CLAIM TO ANY PARTICULAR FONT, STYLE, SIZE, OR COLOR.

FOR BUILDING CONSTRUCTION SERVICES, NAMELY, CONSTRUCTING COMPUTER CENTERS WITHIN BUILDINGS, SUCH CENTERS FEATURING VOICE AND DATA TELECOMMUNICATIONS, CABLING SYSTEMS, TELEPHONE SYSTEMS, COMPUTER NETWORKS, SUPPLEMENTAL ELECTRICAL POWER SUPPLY UNITS, AND COMPUTER SECURITY NETWORKS (U.S. CLS. 100, 103 AND 106).

FIRST USE 1-31-2009; IN COMMERCE 1-31-2009.

KAREN K. BUSH, EXAMINING ATTORNEY

CLASS 37—(Continued).

SN 77-752,807. ALL CLEAN CARPET & UPHOLSTERY, INC, WINTER PARK, FL. FILED 6-5-2009.

All Clean Carpet & Upholstery

THE MARK CONSISTS OF STANDARD CHARACTERS WITHOUT CLAIM TO ANY PARTICULAR FONT, STYLE, SIZE, OR COLOR.

NO CLAIM IS MADE TO THE EXCLUSIVE RIGHT TO USE "CLEAN CARPET & UPHOLSTERY", APART FROM THE MARK AS SHOWN.

FOR CARPET AND RUG CLEANING (U.S. CLS. 100, 103 AND 106).

FIRST USE 9-5-2003; IN COMMERCE 9-5-2003.

KATHLEEN M. VANSTON, EXAMINING ATTORNEY

SN 77-755,163. BRUNSWICK AUTOMOTIVE PROFESSIONALS, NORTH BRUNSWICK, NJ. FILED 6-9-2009.

Mobility Mall

THE MARK CONSISTS OF STANDARD CHARACTERS WITHOUT CLAIM TO ANY PARTICULAR FONT, STYLE, SIZE, OR COLOR.

NO CLAIM IS MADE TO THE EXCLUSIVE RIGHT TO USE "MALL", APART FROM THE MARK AS SHOWN.

FOR VEHICLE MODIFICATION SERVICES FOR THE HANDICAPPED; HOME MODIFICATION SERVICES FOR THE HANDICAPPED (U.S. CLS. 100, 103 AND 106).

JANET LEE, EXAMINING ATTORNEY

CLASS 37—(Continued).

SN 77-763,431. HALO CONSTRUCTION, INC., EVERETT, WA. FILED 6-18-2009.



THE MARK CONSISTS OF CAPITAL LETTER "H" COVERED WITH A ROOF WITH A CHIMNEY AND CIRCLED BY A HALO.

FOR GENERAL CONTRACTOR SERVICES, NAMELY, PLUMBING, HEATING AND AIR CONDITIONING, CARPENTRY, DRYWALL, PAINTING, ELECTRICAL, BUILDING AND FRAMING CONTRACTOR SERVICES (U.S. CLS. 100, 103 AND 106).

FIRST USE 11-5-2005; IN COMMERCE 11-5-2005.
DEIRDRE ROBERTSON, EXAMINING ATTORNEY

CLASS 37—(Continued).

SN 77-772,713. L I METAL SYSTEMS, CHINO, CA. FILED 7-1-2009.

EMBER RESISTANT SOLUTIONS

THE MARK CONSISTS OF STANDARD CHARACTERS WITHOUT CLAIM TO ANY PARTICULAR FONT, STYLE, SIZE, OR COLOR.

NO CLAIM IS MADE TO THE EXCLUSIVE RIGHT TO USE "EMBER RESISTANT", APART FROM THE MARK AS SHOWN.

FOR INSTALLATION SERVICES FOR VENTS, GUTTER GUARDS, EAVE BOXING, SOFFIT BOXING, FOR RESIDENTIAL AND COMMERCIAL BUILDINGS (U.S. CLS. 100, 103 AND 106).

FIRST USE 5-10-2008; IN COMMERCE 5-10-2008.
TINA L. SNAPP, EXAMINING ATTORNEY

SN 77-779,865. HEARTS PEST MANAGEMENT, INC., SAN DIEGO, CA. FILED 7-14-2009.



NO CLAIM IS MADE TO THE EXCLUSIVE RIGHT TO USE "PEST MANAGEMENT, INC.", APART FROM THE MARK AS SHOWN.

THE COLOR(S) GREEN, RED, MAROON, BLACK, YELLOW, WHITE, BLUE AND ORANGE IS/ARE CLAIMED AS A FEATURE OF THE MARK.

THE MARK CONSISTS OF THE WORD "HEARTS" IN GREEN. THE WORDING "PEST MANAGEMENT, INC." APPEARS BENEATH IN MAROON. A STRIP OF GREEN GRASS APPEARS BETWEEN "HEARTS" AND "PEST MANAGEMENT, INC." A RED HEART APPEARS OVER AND BETWEEN THE LETTERS "H" AND "E" OF "HEARTS". A BLACK RODENT APPEARS AT THE FOOT OF THE LETTER "H", A BLACK SPIDER APPEARS JUST ABOVE THE FOOT OF THE LETTER "E", AND AN ANT APPEARS AT THE FOOT OF THE LETTER "A". A MAN WITH GLASSES AND ORANGE HAIR AND MUSTACHE APPEARS SPRAYING, WEARING GREEN PANTS AND SHIRT AND YELLOW GLOVES, HAT AND BOOTS, AND A RED SPRAYING DEVICE. A SMALL RED HEART APPEARS ON THE HAT. AN ORANGE RACCOON WITH BLACK PAWS AND MARKINGS ON ITS TAIL IS PERCHED ON TOP OF THE HAT. THE BACKGROUND IS OF A WHITE AND BLUE SKY.

FOR PEST CONTROL; PEST CONTROL AND EXTERMINATION OTHER THAN FOR AGRICULTURAL PURPOSES; TERMITE AND PEST CONTROL (U.S. CLS. 100, 103 AND 106).

FIRST USE 1-1-2005; IN COMMERCE 1-1-2005.
RON FAIRBANKS, EXAMINING ATTORNEY

SEVEN SEAS. ONE COMMUNICATION PROVIDER.

THE MARK CONSISTS OF STANDARD CHARACTERS WITHOUT CLAIM TO ANY PARTICULAR FONT, STYLE, SIZE, OR COLOR.

FOR INSTALLATION OF TELECOMMUNICATION EQUIPMENT, NAMELY, VSATS (VERY SMALL APERTURE TERMINALS) (U.S. CLS. 100, 103 AND 106).

STEVEN R. FINE, EXAMINING ATTORNEY

CLASS 37—(Continued).

SN 77-785,756. AUTOBUILDERS GENERAL CONTRACTING SERVICES, INC., WEST PALM BEACH, FL. FILED 7-21-2009.

QUEST CONTRACTING SERVICES

THE MARK CONSISTS OF STANDARD CHARACTERS WITHOUT CLAIM TO ANY PARTICULAR FONT, STYLE, SIZE, OR COLOR.

NO CLAIM IS MADE TO THE EXCLUSIVE RIGHT TO USE "CONTRACTING SERVICES", APART FROM THE MARK AS SHOWN.

FOR GENERAL CONTRACTING SERVICES, NAMELY, GENERAL CONSTRUCTION CONTRACTING (U.S. CLS. 100, 103 AND 106).

FIRST USE 10-1-1999; IN COMMERCE 10-1-1999.

STEVEN JACKSON, EXAMINING ATTORNEY

SN 77-792,128. FRAKINE, YOURI B., CARMEL, IN. FILED 7-29-2009.

US Housing Consultants

THE MARK CONSISTS OF STANDARD CHARACTERS WITHOUT CLAIM TO ANY PARTICULAR FONT, STYLE, SIZE, OR COLOR.

NO CLAIM IS MADE TO THE EXCLUSIVE RIGHT TO USE "HOUSING CONSULTANTS", APART FROM THE MARK AS SHOWN.

SEC. 2(F).

FOR REAL ESTATE CONSULTING, NAMELY, BUILDING INSPECTION SERVICES IN THE COURSE OF CONSTRUCTION OF RESIDENTIAL PROPERTY THAT IS SUBJECT TO COMPLIANCE WITH FEDERAL, STATE AND LOCAL GOVERNMENT RULES AND REGULATIONS; REAL ESTATE CONSULTING, NAMELY, ENVIRONMENTAL REMEDIATION, NAMELY, WASTE REMOVAL FOR PROPERTIES SUBJECT TO COMPLIANCE WITH FEDERAL, STATE AND LOCAL GOVERNMENT RULES AND REGULATIONS (U.S. CLS. 100, 103 AND 106).

FIRST USE 0-0-2000; IN COMMERCE 0-0-2000.

TASNEEM HUSSAIN, EXAMINING ATTORNEY

CLASS 37—(Continued).

SN 77-792,143. FRAKINE, YOURI B., CARMEL, IN. FILED 7-29-2009.

USHC

THE MARK CONSISTS OF STANDARD CHARACTERS WITHOUT CLAIM TO ANY PARTICULAR FONT, STYLE, SIZE, OR COLOR.

FOR REAL ESTATE CONSULTING, NAMELY, BUILDING INSPECTION SERVICES IN THE COURSE OF CONSTRUCTION OF RESIDENTIAL PROPERTY THAT IS SUBJECT TO COMPLIANCE WITH FEDERAL, STATE AND LOCAL GOVERNMENT RULES AND REGULATIONS; REAL ESTATE CONSULTING, NAMELY, ENVIRONMENTAL REMEDIATION, NAMELY, WASTE REMOVAL FOR PROPERTIES SUBJECT TO COMPLIANCE WITH FEDERAL, STATE AND LOCAL GOVERNMENT RULES AND REGULATIONS (U.S. CLS. 100, 103 AND 106).

FIRST USE 0-0-2000; IN COMMERCE 0-0-2000.

TASNEEM HUSSAIN, EXAMINING ATTORNEY

SN 77-799,930. PETRORESOURCES, INC., EDINA, MN. FILED 8-7-2009.

3V

THE MARK CONSISTS OF STANDARD CHARACTERS WITHOUT CLAIM TO ANY PARTICULAR FONT, STYLE, SIZE, OR COLOR.

FOR CLEANING AND MAINTENANCE SERVICES FOR ABOVE GROUND AND UNDERGROUND FUEL STORAGE TANKS AND OTHER FUEL STORAGE ENVIRONMENTS, NAMELY, EQUIPMENT, IMPLEMENTS, AND VEHICLES (U.S. CLS. 100, 103 AND 106).

FIRST USE 3-8-2010; IN COMMERCE 3-8-2010.

FONG HSU, EXAMINING ATTORNEY

CLASS 37—(Continued).

SN 77-830,896. SOUTHERN INDUSTRIAL TIRE & TRACK, INC., HIALEAH, FL. FILED 9-21-2009.



NO CLAIM IS MADE TO THE EXCLUSIVE RIGHT TO USE "TIRE", APART FROM THE MARK AS SHOWN. THE STIPPLING IS FOR SHADING PURPOSES ONLY. THE MARK CONSISTS OF A ROUND RING WITH THE WORDS "PIT-STOP TIRE" IN THE RING AND 2 CROSSED CHECKERED RACING FLAGS.

FOR INSTALLATION OF TIRES (U.S. CLS. 100, 103 AND 106).

HEATHER THOMPSON, EXAMINING ATTORNEY

CLASS 37—(Continued).

SN 77-875,429. MASSEY SERVICES, INC., ORLANDO, FL. FILED 11-18-2009.



OWNER OF U.S. REG. NOS. 2,766,126 AND 3,193,876. NO CLAIM IS MADE TO THE EXCLUSIVE RIGHT TO USE "SERVICES INC. PEST PREVENTION", APART FROM THE MARK AS SHOWN.

THE MARK CONSISTS OF THE WORD "MASSEY" IN STYLIZED CAPITAL LETTERS ABOVE A RECTANGULAR BOX CONTAINING THE WORDS "SERVICES INC." IN SMALLER, STYLIZED CAPITAL LETTERS, ALL ABOVE THE WORDS "PEST PREVENTION" IN STYLIZED UPPER AND LOWER CASE LETTERS.

SEC. 2(F).

FOR RESIDENTIAL AND COMMERCIAL PEST PREVENTION AND TERMITE PROTECTION SERVICES (U.S. CLS. 100, 103 AND 106).

FIRST USE 9-1-2006; IN COMMERCE 9-1-2006.

KAREN K. BUSH, EXAMINING ATTORNEY

SN 77-894,570. ARCHITECTURE FOR CHARITY, BROWNSVILLE, TX. FILED 12-16-2009.



NO CLAIM IS MADE TO THE EXCLUSIVE RIGHT TO USE "ARCHITECTURE FOR CHARITY", APART FROM THE MARK AS SHOWN.

THE MARK CONSISTS OF AN ABSTRACT DESIGN OF A PARENT AND CHILD. THE PARENT FIGURE IS ROUNDED IN A CIRCULAR FORM. AN ARCH IS OVER THE TOP OF THE PARENT AND CHILD DESIGN REPRESENTING SHELTER OVER THEM. IN ESSENCE, THE PARENT AND CHILD FIGURE REPRESENTS AN ABSTRACT "A" (FOR "ARCHITECTURE") AND THE ARCH REPRESENTS AN ABSTRACT "C" (FOR "CHARITY"). THE WORD "ARCHITECTURE" IS WRITTEN AT THE BOTTOM RIGHT SIDE OF THE ARCH. THE WORDS "FOR CHARITY" ARE WRITTEN UNDER THE WORD "ARCHITECTURE".

FOR BUILDING CONSTRUCTION AND REPAIR (U.S. CLS. 100, 103 AND 106).

FIRST USE 7-1-2009; IN COMMERCE 7-1-2009.

INGA ERVIN, EXAMINING ATTORNEY

SN 77-857,515. REED ELSEVIER INC., NEWTON, MA. FILED 10-26-2009.

MANU-SPEC

THE MARK CONSISTS OF STANDARD CHARACTERS WITHOUT CLAIM TO ANY PARTICULAR FONT, STYLE, SIZE, OR COLOR.

FOR PROVIDING INFORMATION IN THE FIELD OF BUILDING CONSTRUCTION MATERIALS SPECIFICATION FOR THE BUILDING AND CONSTRUCTION INDUSTRY (U.S. CLS. 100, 103 AND 106).

FIRST USE 5-0-1998; IN COMMERCE 5-0-1998.

SALLY SHIH, EXAMINING ATTORNEY

CLASS 37—(Continued).

SN 77-894,622. MASSEY SERVICES, INC., ORLANDO, FL. FILED 12-16-2009.



OWNER OF U.S. REG. NOS. 2,766,126 AND 3,193,876.
NO CLAIM IS MADE TO THE EXCLUSIVE RIGHT TO USE "SERVICES INC. TERMITE PROTECTION", APART FROM THE MARK AS SHOWN.

THE MARK CONSISTS OF THE STYLIZED WORDS "MASSEY SERVICES INC." WITH THE WORD "MASSEY" IN ENLARGED CAPITAL LETTERS ABOVE A RECTANGULAR BOX CONTAINING THE STYLIZED WORDS "SERVICES INC." IN SMALLER CAPITAL LETTERS, ALL ABOVE THE STYLIZED WORDS "TERMITE PROTECTION" IN UPPER AND LOWER CASE LETTERS.

SEC. 2(F).
FOR RESIDENTIAL AND COMMERCIAL TERMITE PROTECTION SERVICES (U.S. CLS. 100, 103 AND 106).
FIRST USE 11-1-2006; IN COMMERCE 11-1-2006.
KAREN K. BUSH, EXAMINING ATTORNEY

SN 77-895,343. CONVERGINT TECHNOLOGIES, LLC, SCHAUMBURG, IL. FILED 12-17-2009.

ICARE

THE MARK CONSISTS OF STANDARD CHARACTERS WITHOUT CLAIM TO ANY PARTICULAR FONT, STYLE, SIZE, OR COLOR.

FOR PROVIDING AN INTERNET WEBSITE FOR ONLINE TRACKING AND MONITORING OF INFORMATION ABOUT INSTALLATION, MAINTENANCE AND REPAIR OF BUILDING MANAGEMENT SYSTEMS, NAMELY, HEATING, VENTILATING AND AIR CONDITIONING SYSTEMS, FIRE ALARMS AND SECURITY SYSTEMS (U.S. CLS. 100, 103 AND 106).
YAT SYE, LEE, EXAMINING ATTORNEY

CLASS 37—(Continued).

SN 77-895,344. CONVERGINT TECHNOLOGIES, LLC, SCHAUMBURG, IL. FILED 12-17-2009.



THE MARK CONSISTS OF AN ELONGATED "I" BEFORE THE WORD "CARE".

FOR PROVIDING AN INTERNET WEBSITE FOR ONLINE TRACKING AND MONITORING OF INFORMATION ABOUT INSTALLATION, MAINTENANCE AND REPAIR OF BUILDING MANAGEMENT SYSTEMS, NAMELY, HEATING, VENTILATING AND AIR CONDITIONING SYSTEMS, FIRE ALARMS AND SECURITY SYSTEMS (U.S. CLS. 100, 103 AND 106).
YAT SYE, LEE, EXAMINING ATTORNEY

SN 77-895,345. CONVERGINT TECHNOLOGIES, LLC, SCHAUMBURG, IL. FILED 12-17-2009.

**SERVICE EXCELLENCE, IT'S
IN OUR DNA**

THE MARK CONSISTS OF STANDARD CHARACTERS WITHOUT CLAIM TO ANY PARTICULAR FONT, STYLE, SIZE, OR COLOR.

NO CLAIM IS MADE TO THE EXCLUSIVE RIGHT TO USE "SERVICE EXCELLENCE", APART FROM THE MARK AS SHOWN.
FOR PROVIDING AN INTERNET WEBSITE FOR ONLINE TRACKING AND MONITORING OF INFORMATION ABOUT INSTALLATION, MAINTENANCE AND REPAIR OF BUILDING MANAGEMENT SYSTEMS, NAMELY, HEATING, VENTILATING AND AIR CONDITIONING SYSTEMS, FIRE ALARMS AND SECURITY SYSTEMS (U.S. CLS. 100, 103 AND 106).
YAT SYE, LEE, EXAMINING ATTORNEY

SN 77-908,398. KENNE BELL, INC., RANCHO CUCAMONGA, CA. FILED 1-9-2010.

Get Screwed

THE MARK CONSISTS OF STANDARD CHARACTERS WITHOUT CLAIM TO ANY PARTICULAR FONT, STYLE, SIZE, OR COLOR.

FOR AUTOMOTIVE UPGRADE SERVICES, NAMELY, SUPERCHARGING, TURBOCHARGING AND PERFORMANCE UPGRADES OF AUTOMOBILES (U.S. CLS. 100, 103 AND 106).
FIRST USE 10-1-2004; IN COMMERCE 10-1-2004.
KIMBERLY PERRY, EXAMINING ATTORNEY

CLASS 37—(Continued).

SN 77-911,637. BLINSON SERVICE COMPANY, INC., RA-LEIGH, NC. FILED 1-14-2010.



THE COLOR(S) BLACK, DARK GREEN, GREEN, LIGHT GREEN, ORANGE, LIGHT ORANGE, BLOND, TAN, BLUE, WHITE, BROWN, BEIGE AND RED IS/ARE CLAIMED AS A FEATURE OF THE MARK.

THE MARK CONSISTS OF THE WORD "ENVIROMAN", WITH "ENVIRO" IN LIGHT GREEN, "MAN" IN ORANGE WITH A STYLIZED ARROW DESIGN FOR THE LETTERS "I" AND "R", WITH SPACES AROUND IT IN WHITE AND OUTLINED IN DARK GREEN. ABOVE THIS IS A DESIGN OF A MALE SUPER HERO WITH TAN SKIN, BLOND HAIR, BLUE EYES, BROWN AND BEIGE EYEBROWS, AND WHITE TEETH. WHITE ALSO APPEARS IN THE WHITES OF HIS EYES. HIS PUPILS ARE BLACK. HIS CAPE IS RED. HIS SHIRT IS ORANGE WITH A DESIGN ON THE CHEST IN DARK GREEN, GREEN, LIGHT GREEN AND WHITE. THE SUPER HERO IS OUTLINED IN BEIGE, WITH BROWN SHADOWS AND LIGHT ORANGE HIGHLIGHTS ON HIS SHIRT. THE GLOVES ARE DARK GREEN, GREEN AND LIGHT GREEN. BEHIND THE SUPER HERO IS A CIRCLE THAT FADES FROM LIGHT GREEN ON THE LEFT TO GREEN ON THE RIGHT. THIS IS SURROUNDED BY WHITE OUTLINING AND THEN DARK GREEN OUTLINING.

FOR HVAC INSTALLATION AND REPAIR SERVICES, CRAWL SPACE SEALING SERVICES (U.S. CLS. 100, 103 AND 106).

FIRST USE 10-7-2009; IN COMMERCE 10-7-2009.
FRED CARL, EXAMINING ATTORNEY

SN 77-918,005. NAPLES GLASS & ALUMINUM, INC., NAPLES, FL. FILED 1-22-2010.

NAPLES GLASS & ALUMINUM

THE MARK CONSISTS OF STANDARD CHARACTERS WITHOUT CLAIM TO ANY PARTICULAR FONT, STYLE, SIZE, OR COLOR.

NO CLAIM IS MADE TO THE EXCLUSIVE RIGHT TO USE "GLASS & ALUMINUM", APART FROM THE MARK AS SHOWN.

SEC. 2(F) AS TO "NAPLES".
FOR INSTALLATION OF DOORS AND WINDOWS (U.S. CLS. 100, 103 AND 106).

FIRST USE 6-0-1996; IN COMMERCE 6-0-1996.
JORDAN BAKER, EXAMINING ATTORNEY

CLASS 37—(Continued).

SN 77-920,027. BLACK DAWG FRANCHISE GROUP, LLC, GOFFSTOWN, NH. FILED 1-26-2010.

"Your Driveway's Best Friend!"

THE MARK CONSISTS OF STANDARD CHARACTERS WITHOUT CLAIM TO ANY PARTICULAR FONT, STYLE, SIZE, OR COLOR.

OWNER OF U.S. REG. NO. 3,245,570.

FOR ASPHALT REPAIR, MAINTENANCE, SEALING AND PARKING LOT STRIPING (U.S. CLS. 100, 103 AND 106).

FIRST USE 8-15-2005; IN COMMERCE 8-15-2005.
AARON BRODSKY, EXAMINING ATTORNEY

SN 77-920,043. BLACK DAWG FRANCHISE GROUP, LLC, GOFFSTOWN, NH. FILED 1-26-2010.

"Your Parking Lot's Best Friend!"

THE MARK CONSISTS OF STANDARD CHARACTERS WITHOUT CLAIM TO ANY PARTICULAR FONT, STYLE, SIZE, OR COLOR.

OWNER OF U.S. REG. NO. 3,245,570.

FOR PAVEMENT MARKING SERVICES, PAVEMENT SEALING, AND PAINTING IN THE FIELD OF PARKING LOT STRIPING (U.S. CLS. 100, 103 AND 106).

FIRST USE 6-1-2006; IN COMMERCE 6-1-2006.
AARON BRODSKY, EXAMINING ATTORNEY

SN 77-922,413. MECHANICAL DYNAMICS AND ANALYSIS, LTD., LATHAM, NY. FILED 1-28-2010.

WINDINGEN

THE MARK CONSISTS OF STANDARD CHARACTERS WITHOUT CLAIM TO ANY PARTICULAR FONT, STYLE, SIZE, OR COLOR.

FOR REPAIR AND MAINTENANCE OF WIND MILLS, WIND TURBINES AND WIND POWER PLANTS (U.S. CLS. 100, 103 AND 106).

DAVID MURRAY, EXAMINING ATTORNEY

CLASS 37—(Continued).

SN 77-922,760. PACIFIC CRANE MAINTENANCE COMPANY, L.P., LONG BEACH, CA. FILED 1-28-2010.

PACIFIC CRANE MAINTENANCE
COMPANY

THE MARK CONSISTS OF STANDARD CHARACTERS WITHOUT CLAIM TO ANY PARTICULAR FONT, STYLE, SIZE, OR COLOR.

OWNER OF U.S. REG. NO. 2,367,032.

NO CLAIM IS MADE TO THE EXCLUSIVE RIGHT TO USE "CRANE MAINTENANCE COMPANY", APART FROM THE MARK AS SHOWN.

FOR CARGO CONTAINER CRANE AND TRUCK CHASSIS MAINTENANCE (U.S. CLS. 100, 103 AND 106). FIRST USE 0-0-1991; IN COMMERCE 0-0-1993.

WILLIAM P. SHANAHAN, EXAMINING ATTORNEY

SN 77-924,757. SUNSPOT SOLAR ENERGY SYSTEMS, LLC, LAS CRUCES, NM. FILED 2-1-2010.

Sunspot

THE MARK CONSISTS OF STANDARD CHARACTERS WITHOUT CLAIM TO ANY PARTICULAR FONT, STYLE, SIZE, OR COLOR.

FOR INSTALLATION AND MAINTENANCE OF PHOTOVOLTAIC SYSTEMS (U.S. CLS. 100, 103 AND 106). FIRST USE 3-1-2009; IN COMMERCE 3-1-2009.

FLORENTINA BLANDU, EXAMINING ATTORNEY

SN 77-925,683. HAHN, LAURE, DISPUTANTA, VA. FILED 2-2-2010.



NO CLAIM IS MADE TO THE EXCLUSIVE RIGHT TO USE "CRAWL SPACE SPECIALISTS", APART FROM THE MARK AS SHOWN.

THE COLOR(S) RED, WHITE, BEIGE AND BLACK IS/ARE CLAIMED AS A FEATURE OF THE MARK.

THE MARK CONSISTS OF THE WORDING "CRAWL SPACE SPECIALISTS" IN WHITE WITH A BEIGE MAN PEEKING OVER A RED BOARD WITH WHITE AND BLACK EYES. ALL THE ABOVE ON A WHITE BACKGROUND AND ALL OUTLINED IN BLACK.

FOR REPAIR OF HOME AND BUSINESS CRAWL SPACE AREAS (U.S. CLS. 100, 103 AND 106).

LOURDES AYALA, EXAMINING ATTORNEY

CLASS 37—(Continued).

SN 77-925,908. BASILIUS, INC., TOLEDO, OH. FILED 2-2-2010.



OWNER OF U.S. REG. NO. 2,379,382.

THE MARK CONSISTS OF STYLIZED "B" FEATURING HORIZONTAL LINES THAT EXTEND OUTWARD HALF-WAY FROM THE RIGHT SIDE OF "B", CREATING A TRACER EFFECT OF THE "B". BELOW THE STYLIZED "B" IS THE WORD "BASILIUS".

FOR CUSTOM MANUFACTURING OF PLASTIC MOLDED PRODUCTS FOR OTHERS, NAMELY, MACHINING, TOOLING AND INJECTION MOLDING TO THE ORDER AND SPECIFICATION OF OTHERS (U.S. CLS. 100, 103 AND 106).

FIRST USE 12-0-2001; IN COMMERCE 12-0-2001.

HANNO RITTNER, EXAMINING ATTORNEY

SN 77-925,940. GASKET PRO, LLC, CRESTWOOD, KY. FILED 2-2-2010.



NO CLAIM IS MADE TO THE EXCLUSIVE RIGHT TO USE "GASKET" - "PRO", APART FROM THE MARK AS SHOWN.

THE COLOR(S) BLACK, GREY, BLUE, GREEN, YELLOW, RED IS/ARE CLAIMED AS A FEATURE OF THE MARK.

THE MARK CONSISTS OF FOUR GRAY REFRIGERATORS WITH BLACK OUTLINING. THE FRONT RIGHT REFRIGERATOR IS DEPICTED WITH GLASS DOORS AND HAS BLUE, GREEN, YELLOW, AND RED BOTTLES INSIDE. THE STYLIZED WORDING "GASKET" - "PRO" APPEARS IN BLACK BENEATH THE DESIGN.

FOR REPAIR AND REPLACEMENT SERVICES OF GASKETS USED IN REFRIGERATION UNITS (U.S. CLS. 100, 103 AND 106).

FIRST USE 3-31-2009; IN COMMERCE 3-31-2009.

JENNIFER MARTIN, EXAMINING ATTORNEY

CLASS 37—(Continued).

SN 77-926,584. EZ-SERVE, INC., ORLANDO, FL. FILED 2-3-2010.

RIM WAND

THE MARK CONSISTS OF STANDARD CHARACTERS WITHOUT CLAIM TO ANY PARTICULAR FONT, STYLE, SIZE, OR COLOR.

NO CLAIM IS MADE TO THE EXCLUSIVE RIGHT TO USE "RIM", APART FROM THE MARK AS SHOWN.

FOR AUTOMOBILE CLEANING; AUTOMOBILE CLEANING AND CAR WASHING; AVIATION ENGINE CLEANING SERVICES; BATHTUB AND BATH BOILER CLEANING; CAR CLEANING; CLEANING OF BUILDINGS; CLEANING OF EXTERNAL SURFACES OF BUILDINGS; CLEANING OF INDUSTRIAL PREMISES; CLEANING OF RESIDENTIAL HOUSES; VEHICLE CLEANING; WINDOW CLEANING (U.S. CLS. 100, 103 AND 106).

ANDREA BUTLER, EXAMINING ATTORNEY

SN 77-926,939. GOLDEN STATE COLLISION CENTERS, INC., LOOMIS, CA. FILED 2-3-2010.



NO CLAIM IS MADE TO THE EXCLUSIVE RIGHT TO USE "VANDALISM REPAIR EXPRESS", APART FROM THE MARK AS SHOWN.

THE COLOR(S) BLUE, RED, BLACK, GRAY, PEACH, PURPLE, AND WHITE IS/ARE CLAIMED AS A FEATURE OF THE MARK.

THE MARK CONSISTS OF THE STYLIZED WORDING "VANDALISM REPAIR XPRESS" SET TO THE LEFT OF A STYLIZED DEPICTION OF A THIEF WEARING A MASK, WITH TWO HORIZONTAL LINES DEPICTING MOVEMENT SET TO THE LEFT OF THE DEPICTION OF THE THIEF, AND THREE BEADS OF SWEAT PLACED AROUND THE HEAD OF THE THIEF. THE COLOR BLUE APPEARS IN THE WORDING "VANDALISM REPAIR", IN THE SHADING IN THE BEADS OF SWEAT, AND IN THE DARKEST AREAS OF THE TWO HORIZONTAL LINES SET TO THE LEFT OF THE DEPICTION OF THE THIEF; THE COLOR RED APPEARS IN THE WORDING "XPRESS" AND IN THE LIGHTEST AREAS OF THE TWO HORIZONTAL LINES SET TO THE LEFT OF THE DEPICTION OF THE THIEF; THE COLOR BLACK APPEARS IN THE DARKER AREAS OF THE THIEF'S CLOTHING, MASK, SHOES, AND HAT, IN THE DARKER AREAS OF THE THIEF'S EYES, IN THE OUTLINE OF THE BEADS OF SWEAT, IN THE SHADING IN THE THIEF'S MOUTH, IN THE OUTLINE OF, AND DETAIL LINES ON, THE THIEF'S FACE, AND IN THE OUTLINE OF, AND DETAIL LINES ON, THE THIEF'S HANDS; THE COLOR GRAY APPEARS IN THE LIGHTER AREAS OF THE THIEF'S CLOTHING, MASK, SHOES, AND HAT, AND IN THE THIEF'S BEARD; THE COLOR PEACH APPEARS IN THE SHADING IN THE THIEF'S FACE AND HANDS; THE COLOR WHITE APPEARS IN THE LIGHTER AREAS OF THE THIEF'S EYES; THE COLOR PURPLE APPEARS IN THE SECOND DARKEST AREAS OF THE TWO HORIZONTAL LINES SET TO THE LEFT OF THE DEPICTION OF THE THIEF.

FOR VEHICLE REPAIR SERVICES (U.S. CLS. 100, 103 AND 106).

FIRST USE 1-27-2010; IN COMMERCE 1-27-2010.
MICHAEL GAAFAR, EXAMINING ATTORNEY

CLASS 37—(Continued).

SN 77-927,912. GUARDIAN HOME IMPROVEMENT, LLC, BALTIMORE, MD. FILED 2-4-2010.

HEY SIDING GUY

THE MARK CONSISTS OF STANDARD CHARACTERS WITHOUT CLAIM TO ANY PARTICULAR FONT, STYLE, SIZE, OR COLOR.

FOR INSTALLATION OF SIDING (U.S. CLS. 100, 103 AND 106).

FIRST USE 4-1-2009; IN COMMERCE 4-1-2009.

REBECCA EISINGER, EXAMINING ATTORNEY

SN 77-927,944. STA AUTO ON THE GO LLC, DBA AUTO ON THE GO, OAKLAND, CA. FILED 2-4-2010.

Auto On The Go

THE MARK CONSISTS OF STANDARD CHARACTERS WITHOUT CLAIM TO ANY PARTICULAR FONT, STYLE, SIZE, OR COLOR.

NO CLAIM IS MADE TO THE EXCLUSIVE RIGHT TO USE "AUTO", APART FROM THE MARK AS SHOWN.

FOR AUTOMOBILE REPAIR AND MAINTENANCE; CAR REPAIR AND MAINTENANCE; MOTOR VEHICLE MAINTENANCE AND REPAIR; REPAIR OR MAINTENANCE OF AUTOMOBILES; VEHICLE MAINTENANCE AND REPAIR; VEHICLE MAINTENANCE CONSULTATION; VEHICLE REPAIR SERVICES (U.S. CLS. 100, 103 AND 106).

FIRST USE 5-1-2009; IN COMMERCE 6-1-2009.

MARK T. MULLEN, EXAMINING ATTORNEY

SN 77-929,826. FLANNERY TODD DAVID, DBA CLIMATE ENGINEERING, DENVER, CO. FILED 2-6-2010.

**saving the planet one
building at a time**

THE MARK CONSISTS OF STANDARD CHARACTERS WITHOUT CLAIM TO ANY PARTICULAR FONT, STYLE, SIZE, OR COLOR.

FOR HVAC CONTRACTOR SERVICES (U.S. CLS. 100, 103 AND 106).

FIRST USE 12-1-2008; IN COMMERCE 12-30-2008.

WILLIAM BRECKENFELD, EXAMINING ATTORNEY

CLASS 37—(Continued).

SN 77-930,080. BETTER RENOVATION, INC., ATLANTA, GA. FILED 2-8-2010.

Better Renovation, Inc.
"Clients say we are the
best. We simply say we
are BETTER."

THE MARK CONSISTS OF STANDARD CHARACTERS WITHOUT CLAIM TO ANY PARTICULAR FONT, STYLE, SIZE, OR COLOR.

NO CLAIM IS MADE TO THE EXCLUSIVE RIGHT TO USE "RENOVATION, INC.", APART FROM THE MARK AS SHOWN.

FOR RENOVATION AND RESTORATION OF BUILDINGS AND APARTMENTS (U.S. CLS. 100, 103 AND 106).
JENNIFER MARTIN, EXAMINING ATTORNEY

SN 77-930,225. CRAIG COLUZZI, DBA CORTEX HOOD CLEANING, GREAT NECK, NY. FILED 2-8-2010.

Cortex Hood Cleaning

THE MARK CONSISTS OF STANDARD CHARACTERS WITHOUT CLAIM TO ANY PARTICULAR FONT, STYLE, SIZE, OR COLOR.

NO CLAIM IS MADE TO THE EXCLUSIVE RIGHT TO USE "HOOD CLEANING", APART FROM THE MARK AS SHOWN.

FOR CLEANING SERVICES FOR COMMERCIAL ROOFTOP GREASE CONTAINMENT SYSTEM COMPRISING AN EXHAUST FAN, GREASE DEFLECTOR, AND FILTER FOR TRAPPING GREASE VENTED FROM ROOFTOP EXHAUST FANS FOR COOKING AREAS WITHIN THE BUILDING (U.S. CLS. 100, 103 AND 106).
PAUL E. FAHRENKOPF, EXAMINING ATTORNEY

SN 77-931,680. HRYCKO, RUSSELL AND HRYCKO, JUNE, DANBURY, CT. FILED 2-9-2010.

Ecolibrium

THE MARK CONSISTS OF STANDARD CHARACTERS WITHOUT CLAIM TO ANY PARTICULAR FONT, STYLE, SIZE, OR COLOR.

FOR CLEANING OF BUILDINGS AND RESIDENTIAL HOUSES (U.S. CLS. 100, 103 AND 106).
ANDREA HACK, EXAMINING ATTORNEY

CLASS 37—(Continued).

SN 77-932,643. RYLAND TANIGUCHI, SEATTLE, WA. FILED 2-10-2010.

Ecoseptic

THE MARK CONSISTS OF STANDARD CHARACTERS WITHOUT CLAIM TO ANY PARTICULAR FONT, STYLE, SIZE, OR COLOR.

FOR BIO-HAZARD BIOLOGICAL CLEAN-UP SERVICES; CLEANING OF BUILDING EXTERIOR SURFACES; CLEANING OF BUILDINGS; CLEANING OF EXTERNAL SURFACES OF BUILDINGS; CLEANING OF GREASE TRAPS; CLEANING OF ILLEGAL CLANDESTINE DRUG LAB SITES; CLEANING OF INDUSTRIAL PREMISES; CLEANING OF RESIDENTIAL HOUSES; CLEANING OF WELLS; CONSULTING SERVICES FOR THE CONSTRUCTION OF WATER TREATMENT AND PURIFICATION PLANTS, SOLID WASTE TREATMENT PLANTS AND OTHER MUNICIPAL INFRASTRUCTURE FACILITIES; DRAIN AND SEWER CLEANING AND ROOTER SERVICES; DRAIN CLEANING SERVICES; DRILLING AND PUMPING OF OIL; ENVIRONMENTAL REMEDIATION SERVICES, NAMELY, WASTE DISPOSAL; HAZARDOUS WASTE DISPOSAL SERVICES; INSTALLING SEPTIC FIELDS; INSTALLING SEPTIC TANKS; MAINTAINING SEPTIC SYSTEMS; MEDICAL WASTE DISPOSAL; MEDICAL WASTE, BLOOD AND BODILY FLUID CLEANING AND DISPOSAL SERVICES; MEDICAL WASTE, BLOOD AND BODILY FLUID DISINFECTION SERVICES; OIL AND GAS INDUSTRIAL MACHINE CLEANING SERVICES; OIL PUMPING AND EXTRACTION; ON-SITE SERVICING OF PORTABLE TOILETS IN THE NATURE OF SEWAGE REMOVAL; PET WASTE REMOVAL SERVICES; PHYSICAL CLEAN-UP OF EXPLORATION AND DRILLING PROJECT LOCATIONS TO RESTORE THEM TO THEIR ORIGINAL CONDITION; PUMP REPAIR; PUMP REPAIR AND MAINTENANCE; PUMP REPAIR OR MAINTENANCE; PUMP REPAIRING; PUMPING CRUDE OIL; PUMPING SEPTIC TANKS; REAL ESTATE PROPERTY CLEANING, REPAIR AND MAINTENANCE SERVICES; REPAIR AND MAINTENANCE OF FEED OR BOOSTER PUMPS; REPAIR OR MAINTENANCE OF STORAGE TANKS; SEPTIC TANK CLEANING; SEPTIC TANK PUMPING AND CLEANING; SOLID WASTE LANDFILL SERVICES; STORAGE TANK CLEANING; TRASH COLLECTION; WASTE DISPOSAL FOR OTHERS; WASTE OIL COLLECTION FOR RECYCLING (U.S. CLS. 100, 103 AND 106).

TRACY WHITTAKER-BROWN, EXAMINING ATTORNEY

SN 78-937,768. ELECTRIC TODAY INC, TAMPA, FL. FILED 7-26-2006.

Service Today or You Won't
Pay!

THE MARK CONSISTS OF STANDARD CHARACTERS WITHOUT CLAIM TO ANY PARTICULAR FONT, STYLE, SIZE, OR COLOR.

FOR ELECTRICAL CONTRACTING (U.S. CLS. 100, 103 AND 106).

FIRST USE 3-17-2006; IN COMMERCE 3-17-2006.
SAIMA MAKHDOOM, EXAMINING ATTORNEY

CLASS 38—COMMUNICATION

SN 77-089,981. XINHUA FINANCE MEDIA LIMITED, GEORGE TOWN, CAYMAN ISLANDS, FILED 1-24-2007.



PRIORITY CLAIMED UNDER SEC. 44(D) ON HONG KONG APPLICATION NO. 300799787, FILED 1-18-2007, REG. NO. 300799787, DATED 1-18-2007, EXPIRES 1-17-2017.

OWNER OF U.S. REG. NOS. 3,119,085, 3,180,457 AND OTHERS.

NO CLAIM IS MADE TO THE EXCLUSIVE RIGHT TO USE "FINANCE MEDIA", APART FROM THE MARK AS SHOWN.

THE COLOR(S) BLACK, ORANGE AND SILVER IS/ARE CLAIMED AS A FEATURE OF THE MARK.

THE MARK CONSISTS OF A CHINESE CHARACTER APPEARING IN THE COLORS SILVER AND ORANGE, THE WORDS "XINHUA FINANCE" IN A LOWER CASE, STYLIZED FONT IN THE COLOR BLACK, AND THE WORD "MEDIA", ALSO IN A LOWER CASE, STYLIZED FONT APPEARING IN THE COLOR ORANGE.

THE ENGLISH TRANSLATION OF "XINHUA" IN THE MARK IS NEW CHINA.

THE NON-LATIN CHARACTER IN THE MARK TRANSLITERATE TO "XIN", AND THIS MEANS NEW IN ENGLISH.

FOR TELECOMMUNICATION SERVICES, NAMELY, PROVIDING ACCESS TO TELECOMMUNICATION NETWORKS; TELEVISION BROADCASTING; CABLE TELEVISION BROADCASTING; SATELLITE TELEVISION BROADCASTING; RADIO BROADCASTING (U.S. CLS. 100, 101 AND 104).

NAKIA HENRY, EXAMINING ATTORNEY

SN 77-554,044. TWENTIETH CENTURY FOX FILM CORPORATION, LOS ANGELES, CA. FILED 8-22-2008.

FSN PLUS

THE MARK CONSISTS OF STANDARD CHARACTERS WITHOUT CLAIM TO ANY PARTICULAR FONT, STYLE, SIZE, OR COLOR.

OWNER OF U.S. REG. NOS. 3,195,420, 3,527,584 AND OTHERS.

FOR TELEVISION TRANSMISSION SERVICES (U.S. CLS. 100, 101 AND 104).

FIRST USE 4-30-2007; IN COMMERCE 4-30-2007.

BARBARA RUTLAND, EXAMINING ATTORNEY

CLASS 38—(Continued).

SN 77-578,802. INTRINSIC SOLUTIONS, L.P., SEABROOK, TX. FILED 9-25-2008.



NO CLAIM IS MADE TO THE EXCLUSIVE RIGHT TO USE "INTRINSIC SOLUTIONS", APART FROM THE MARK AS SHOWN.

THE MARK CONSISTS OF THE WORDING "INTRINSIC SOLUTIONS" WITH A DESIGN OF SOUND WAVES.

FOR LEASING OF INTRINSICALLY SAFE TELECOMMUNICATION EQUIPMENT (U.S. CLS. 100, 101 AND 104).

FIRST USE 6-30-2007; IN COMMERCE 6-30-2007.

EVELYN BRADLEY, EXAMINING ATTORNEY

SN 77-636,862. QWEST COMMUNICATIONS INTERNATIONAL INC., DENVER, CO. FILED 12-19-2008.

IT'S YOUR QWEST

THE MARK CONSISTS OF STANDARD CHARACTERS WITHOUT CLAIM TO ANY PARTICULAR FONT, STYLE, SIZE, OR COLOR.

OWNER OF U.S. REG. NOS. 2,210,992, 3,385,279 AND OTHERS.

FOR TELECOMMUNICATIONS SERVICES, NAMELY, TRANSMISSION OF VOICE, DATA, AUDIO, VIDEO, MESSAGES, IMAGES, TELEVISION CONTENT AND SOUND, LEASING AND RENTAL OF TELECOMMUNICATIONS EQUIPMENT, TELECOMMUNICATIONS CONSULTING SERVICES, PROVIDING ON-LINE CHAT ROOMS, ELECTRONIC BULLETIN BOARDS AND FORMS FOR TRANSMISSION OF MESSAGES AMONG USERS IN THE FIELD OF GENERAL INTEREST (U.S. CLS. 100, 101 AND 104).

PAUL MORENO, EXAMINING ATTORNEY

SN 77-671,320. TELIGENCE (CANADA) LTD., VANCOUVER, CANADA, FILED 2-16-2009.

BIG GAY KISS

THE MARK CONSISTS OF STANDARD CHARACTERS WITHOUT CLAIM TO ANY PARTICULAR FONT, STYLE, SIZE, OR COLOR.

FOR TELECOMMUNICATIONS SERVICES, NAMELY, ELECTRONIC VOICE MESSAGING SERVICES, NAMELY, THE RECORDING AND SUBSEQUENT TRANSMISSION OF VOICE MESSAGES BY TELEPHONE, WIRELESS COMMUNICATIONS DEVICES, COMPUTERS, MEDIA PLAYERS AND DIGITAL STORAGE DEVICES; WIRELESS ELECTRONIC TRANSMISSION OF VOICE SIGNALS, DATA, AND INFORMATION (U.S. CLS. 100, 101 AND 104).

LESLIE RICHARDS, EXAMINING ATTORNEY

CLASS 38—(Continued).

SN 77-717,120. GARCIA-MILA PUJOL, PAU, OLESA DE MONTESERRAT, SPAIN, FILED 4-20-2009.

EYEOS

THE MARK CONSISTS OF STANDARD CHARACTERS WITHOUT CLAIM TO ANY PARTICULAR FONT, STYLE, SIZE, OR COLOR.

OWNER OF SPAIN REG. NO. 2837522, DATED 1-15-2009, EXPIRES 7-15-2018.

THE WORDING "EYEOS" HAS NO MEANING IN A FOREIGN LANGUAGE.

FOR TELECOMMUNICATION SERVICES, NAMELY, TRANSMISSION OF VOICE, DATA, GRAPHICS, IMAGES, AUDIO AND VIDEO BY MEANS OF TELECOMMUNICATIONS NETWORKS, WIRELESS COMMUNICATION NETWORKS, AND THE INTERNET; ELECTRONIC TRANSMISSION OF DATA AND DOCUMENTS VIA COMPUTER TERMINALS AND ELECTRONIC DEVICES; PROVIDING TELECOMMUNICATION CONNECTIONS TO THE INTERNET OR DATABASES; PROVISION OF ACCESS TO DATA OR DOCUMENTS STORED ELECTRONICALLY IN CENTRAL FILES FOR REMOTE CONSULTATION; TRANSMISSION AND RECEPTION OF DATABASE INFORMATION VIA THE TELECOMMUNICATION NETWORK (U.S. CLS. 100, 101 AND 104).

DAVID ELTON, EXAMINING ATTORNEY

CLASS 38—(Continued).

SN 77-741,263. NEXTERA COMMUNICATIONS, LLC, BAXTER, MN. FILED 5-20-2009.

Nextera Networks

SN 77-737,408. JAMBORIE, S.L., BARCELONA, SPAIN, FILED 5-14-2009.

ruituk

PRIORITY CLAIMED UNDER SEC. 44(D) ON ERPNCMNTY TM OFC APPLICATION NO. 8268484, FILED 4-30-2009, REG. NO. 8268484, DATED 10-11-2009, EXPIRES 10-11-2019.

THE COLOR(S) LIGHT BLUE, DARK BLUE, GREY IS/ARE CLAIMED AS A FEATURE OF THE MARK.

THE MARK CONSISTS OF THE WORD "RUITUK" IN STYLIZED LETTERS, WITH THE LETTERS "RUI" APPEARING IN GREY, THE LETTERS "T" AND "K" APPEARING IN LIGHT BLUE AND THE SECOND "U" APPEARING IN DARK BLUE.

THE WORDING "RUITUK" HAS NO MEANING IN A FOREIGN LANGUAGE.

FOR TELECOMMUNICATION ACCESS SERVICES; BROADCASTING AND TRANSMISSION OF INFORMATION VIA ELECTRONIC COMMUNICATIONS NETWORKS OR THE INTERNET; PROVIDING ACCESS TO THE INTERNET AND OTHER TELECOMMUNICATIONS NETWORKS; PROVIDING ACCESS TO A GLOBAL COMPUTER NETWORK; BROADCASTING SERVICES, NAMELY, TRANSMISSION OF ADVERTISING PROGRAMS AND MEDIA ADVERTISING COMMUNICATIONS VIA DIGITAL COMMUNICATIONS NETWORKS; ELECTRONIC MAIL; COMMUNICATIONS VIA COMPUTER TERMINALS; TRANSMISSION OF COMPUTER AIDED MESSAGES; INTERNET SERVICE PROVIDER SERVICES; TELEVISION BROADCASTING; RADIO BROADCASTING (U.S. CLS. 100, 101 AND 104).

LESLIE RICHARDS, EXAMINING ATTORNEY

THE MARK CONSISTS OF STANDARD CHARACTERS WITHOUT CLAIM TO ANY PARTICULAR FONT, STYLE, SIZE, OR COLOR.

NO CLAIM IS MADE TO THE EXCLUSIVE RIGHT TO USE "NETWORKS", APART FROM THE MARK AS SHOWN.

FOR TELECOMMUNICATION SERVICES, NAMELY, TRANSMISSION OF VOICE, DATA, GRAPHICS, IMAGES, AUDIO AND VIDEO BY MEANS OF A DIGITAL TELECOMMUNICATIONS NETWORK, AND THE INTERNET; VOICE OVER INTERNET PROTOCOL TELEPHONE SERVICE; TELECOMMUNICATION SERVICES, NAMELY, PROVIDING BROADBAND INTERNET ACCESS BY MEANS OF A DIGITAL WIRED AND WIRELESS BROADBAND COMMUNICATIONS NETWORK; BROADBAND COMMUNICATION SERVICES, NAMELY, TRANSMISSION OF VOICE, DATA, AUDIO, GRAPHICS AND VIDEO VIA A DIGITAL TELECOMMUNICATIONS NETWORK; TELECOMMUNICATION SERVICES, NAMELY, LOCAL AND LONG DISTANCE TELEPHONE SERVICE; PROVIDING TELEPHONE FEATURES, NAMELY, A DEDICATED TOLL-FREE NUMBER, VIRTUAL PHONE NUMBERS, VOICEMAIL, UNIFIED CALL MESSAGING, CONFERENCING, FAX CAPABILITIES, DETAILED CALL REPORTS, WEB PORTAL, CALL WAITING, CALLER ID, CALL FORWARDING, AND AUTO ATTENDANT; TELECOMMUNICATION SERVICES, NAMELY, PROVIDING HOSTED VOICE, DATA AND NETWORK SERVICES; TELECOMMUNICATIONS SERVICES, NAMELY, PROVIDING EMAIL AND INTERNET ACCESS SERVICES; PROVIDING THIRD PARTY USERS WITH ACCESS TO TELECOMMUNICATIONS INFRASTRUCTURE, NAMELY, ACCESS TO A DIGITAL TELECOMMUNICATIONS NETWORK (U.S. CLS. 100, 101 AND 104).

FIRST USE 5-5-2004; IN COMMERCE 5-5-2004.

CHRISTINE MARTIN, EXAMINING ATTORNEY

CLASS 38—(Continued).

SN 77-741,315. NEXTERA WIRELESS, LLC, BAXTER, MN. FILED 5-20-2009.

Nextera Wireless

THE MARK CONSISTS OF STANDARD CHARACTERS WITHOUT CLAIM TO ANY PARTICULAR FONT, STYLE, SIZE, OR COLOR.

NO CLAIM IS MADE TO THE EXCLUSIVE RIGHT TO USE "WIRELESS", APART FROM THE MARK AS SHOWN.

FOR TELECOMMUNICATION SERVICES, NAMELY, TRANSMISSION OF VOICE, DATA, GRAPHICS, IMAGES, AUDIO AND VIDEO BY MEANS OF A DIGITAL TELECOMMUNICATIONS NETWORK, AND THE INTERNET; VOICE OVER INTERNET PROTOCOL TELEPHONE SERVICE; TELECOMMUNICATION SERVICES, NAMELY, PROVIDING BROADBAND INTERNET ACCESS BY MEANS OF A DIGITAL WIRED AND WIRELESS BROADBAND COMMUNICATIONS NETWORK; BROADBAND COMMUNICATION SERVICES, NAMELY, TRANSMISSION OF VOICE, DATA, AUDIO, GRAPHICS AND VIDEO VIA A DIGITAL TELECOMMUNICATIONS NETWORK; TELECOMMUNICATION SERVICES, NAMELY, LOCAL AND LONG DISTANCE TELEPHONE SERVICE; PROVIDING TELEPHONE FEATURES, NAMELY, A DEDICATED TOLL-FREE NUMBER, VIRTUAL PHONE NUMBERS, VOICEMAIL, UNIFIED CALL MESSAGING, CONFERENCING, FAX CAPABILITIES, DETAILED CALL REPORTS, WEB PORTAL, CALL WAITING, CALLER ID, CALL FORWARDING, AND AUTO ATTENDANT; TELECOMMUNICATION SERVICES, NAMELY, PROVIDING HOSTED VOICE, DATA AND NETWORK SERVICES; TELECOMMUNICATIONS SERVICES, NAMELY, PROVIDING EMAIL AND INTERNET ACCESS SERVICES; PROVIDING THIRD PARTY USERS WITH ACCESS TO TELECOMMUNICATIONS INFRASTRUCTURE, NAMELY, ACCESS TO A DIGITAL TELECOMMUNICATIONS NETWORK (U.S. CLS. 100, 101 AND 104).

FIRST USE 5-5-2004; IN COMMERCE 5-5-2004.
CHRISTINE MARTIN, EXAMINING ATTORNEY

CLASS 38—(Continued).

SN 77-745,610. NEXTERA COMMUNICATIONS, LLC, BAXTER, MN. FILED 5-27-2009.



NO CLAIM IS MADE TO THE EXCLUSIVE RIGHT TO USE "NETWORKS", APART FROM THE MARK AS SHOWN.

THE COLOR(S) GREEN, GREY AND WHITE IS/ARE CLAIMED AS A FEATURE OF THE MARK.

THE MARK CONSISTS OF THE COLOR GREEN APPEARS IN THE STYLIZED "E" AND IN THE TERM "NEXTERA", THE COLOR GREY APPEARS IN THE STYLIZED "E" AND THE TERM "NETWORKS", THE COLOR WHITE APPEARS AS THE BACKGROUND.

FOR TELECOMMUNICATION SERVICES, NAMELY, TRANSMISSION OF VOICE, DATA, GRAPHICS, IMAGES, AUDIO AND VIDEO BY MEANS OF A DIGITAL TELECOMMUNICATIONS NETWORK, AND THE INTERNET; VOICE OVER INTERNET PROTOCOL TELEPHONE SERVICE; TELECOMMUNICATION SERVICES, NAMELY, PROVIDING BROADBAND INTERNET ACCESS BY MEANS OF A DIGITAL WIRED AND WIRELESS BROADBAND COMMUNICATIONS NETWORK; BROADBAND COMMUNICATION SERVICES, NAMELY, TRANSMISSION OF VOICE, DATA, AUDIO, GRAPHICS AND VIDEO VIA A DIGITAL TELECOMMUNICATIONS NETWORK; TELECOMMUNICATION SERVICES, NAMELY, LOCAL AND LONG DISTANCE TELEPHONE SERVICE; PROVIDING TELEPHONE FEATURES, NAMELY, A DEDICATED TOLL-FREE NUMBER, VIRTUAL PHONE NUMBERS, VOICEMAIL, UNIFIED CALL MESSAGING, CONFERENCING, FAX CAPABILITIES, DETAILED CALL REPORTS, WEB PORTAL, CALL WAITING, CALLER ID, CALL FORWARDING, AND AUTO ATTENDANT; TELECOMMUNICATION SERVICES, NAMELY, PROVIDING HOSTED VOICE, DATA AND NETWORK SERVICES; TELECOMMUNICATIONS SERVICES, NAMELY, PROVIDING EMAIL AND INTERNET ACCESS SERVICES; PROVIDING THIRD PARTY USERS WITH ACCESS TO TELECOMMUNICATIONS INFRASTRUCTURE, NAMELY, ACCESS TO A DIGITAL TELECOMMUNICATIONS NETWORK (U.S. CLS. 100, 101 AND 104).

FIRST USE 5-5-2004; IN COMMERCE 5-5-2004.
CHRISTINE MARTIN, EXAMINING ATTORNEY

CLASS 38—(Continued).

SN 77-745,675. NEXTERA WIRELESS, LLC, BAXTER, MN. FILED 5-27-2009.



NO CLAIM IS MADE TO THE EXCLUSIVE RIGHT TO USE "WIRELESS", APART FROM THE MARK AS SHOWN. THE COLOR(S) GREEN, GREY AND WHITE IS/ARE CLAIMED AS A FEATURE OF THE MARK.

THE MARK CONSISTS OF THE COLOR GREEN APPEARS IN THE STYLIZED "E" AND THE TERM "NEXTERA". THE COLOR GREY APPEARS IN THE STYLIZED "E" AND THE TERM "WIRELESS", THE COLOR WHITE APPEARS AS THE BACKGROUND.

FOR TELECOMMUNICATION SERVICES, NAMELY, TRANSMISSION OF VOICE, DATA, GRAPHICS, IMAGES, AUDIO AND VIDEO BY MEANS OF A DIGITAL TELECOMMUNICATIONS NETWORK, AND THE INTERNET; VOICE OVER INTERNET PROTOCOL TELEPHONE SERVICE; TELECOMMUNICATION SERVICES, NAMELY, PROVIDING BROADBAND INTERNET ACCESS BY MEANS OF A DIGITAL WIRED AND WIRELESS BROADBAND COMMUNICATIONS NETWORK; BROADBAND COMMUNICATION SERVICES, NAMELY, TRANSMISSION OF VOICE, DATA, AUDIO, GRAPHICS AND VIDEO VIA A DIGITAL TELECOMMUNICATIONS NETWORK; TELECOMMUNICATION SERVICES, NAMELY, LOCAL AND LONG DISTANCE TELEPHONE SERVICE; PROVIDING TELEPHONE FEATURES, NAMELY, A DEDICATED TOLL-FREE NUMBER, VIRTUAL PHONE NUMBERS, VOICEMAIL, UNIFIED CALL MESSAGING, CONFERENCING, FAX CAPABILITIES, DETAILED CALL REPORTS, WEB PORTAL, CALL WAITING, CALLER ID, CALL FORWARDING, AND AUTO ATTENDANT; TELECOMMUNICATION SERVICES, NAMELY, PROVIDING HOSTED VOICE, DATA AND NETWORK SERVICES; TELECOMMUNICATIONS SERVICES, NAMELY, PROVIDING EMAIL AND INTERNET ACCESS SERVICES; PROVIDING THIRD PARTY USERS WITH ACCESS TO TELECOMMUNICATIONS INFRASTRUCTURE, NAMELY, ACCESS TO A DIGITAL TELECOMMUNICATIONS NETWORK (U.S. CLS. 100, 101 AND 104).

FIRST USE 5-5-2004; IN COMMERCE 5-5-2004.
CHRISTINE MARTIN, EXAMINING ATTORNEY

SN 77-759,507. RAYCOM TV BROADCASTING, INC., MONTGOMERY, AL. FILED 6-15-2009.

WDAM

THE MARK CONSISTS OF STANDARD CHARACTERS WITHOUT CLAIM TO ANY PARTICULAR FONT, STYLE, SIZE, OR COLOR.

FOR BROADCASTING OF TELEVISION PROGRAMMES (U.S. CLS. 100, 101 AND 104).
FIRST USE 9-1-1959; IN COMMERCE 9-1-1959.
YAT SYE, LEE, EXAMINING ATTORNEY

CLASS 38—(Continued).

SN 77-773,797. PROFESSIONAL BOWLERS ASSOCIATION LLC, SEATTLE, WA. FILED 7-2-2009.

XTRA FRAME

THE MARK CONSISTS OF STANDARD CHARACTERS WITHOUT CLAIM TO ANY PARTICULAR FONT, STYLE, SIZE, OR COLOR.

FOR SUBSCRIPTION BROADCASTING SERVICES AND WEBCASTING SERVICES, NAMELY, BROADCASTING AND/OR LIVE STREAMING OF BOWLING RELATED VIDEO FOOTAGE AND RADIO SHOWS OVER THE INTERNET (U.S. CLS. 100, 101 AND 104).

FIRST USE 11-0-2007; IN COMMERCE 11-0-2007.
SUSAN RICHARDS, EXAMINING ATTORNEY

SN 77-782,536. CBS RADIO INC., NEW YORK, NY. FILED 7-16-2009.

HFS

THE MARK CONSISTS OF STANDARD CHARACTERS WITHOUT CLAIM TO ANY PARTICULAR FONT, STYLE, SIZE, OR COLOR.

OWNER OF U.S. REG. NO. 2,741,929.
FOR RADIO BROADCASTING SERVICES AND BROADCASTING SERVICES, NAMELY, STREAMING OF AUDIO MATERIAL VIA THE GLOBAL COMMUNICATION NETWORK (U.S. CLS. 100, 101 AND 104).

FIRST USE 2-20-2002; IN COMMERCE 2-20-2002.
TEJBIR SINGH, EXAMINING ATTORNEY

SN 77-787,630. TELE-TOWN HALL, LLC, WASHINGTON, DC. FILED 7-23-2009.



TELE-TOWN HALL
LLC

NO CLAIM IS MADE TO THE EXCLUSIVE RIGHT TO USE "TELE"- "TOWN HALL" AND "LLC", APART FROM THE MARK AS SHOWN.

THE COLOR(S) BLUE AND RED IS/ARE CLAIMED AS A FEATURE OF THE MARK.

THE MARK CONSISTS OF THREE, BLUE CONCENTRIC CIRCLES IN THE FORM OF A BULL'S-EYE TARGET, WITH THE RIGHT QUADRANT OF TWO OF THE OUTER CIRCLES BEING OPEN, AND THE TWO OUTER CIRCLES FILLED WITH ARCUATE RED LINES WHICH PARTIALLY COMPLETE THE TWO BROKEN BLUE CIRCLES, AND A THIRD PARTIAL RED ARCUATE LINE WHICH EXTENDS

CLASS 38—(Continued).

THE RED ARCUATE LINES OUTWARD FROM THE OUTER EDGE OF THE THIRD CONCENTRIC CIRCLE, AND PROVIDES THE APPEARANCE OF A RED SOUND SYMBOL. UNDERNEATH THE CIRCLES ARE THE WORDS "TELE TOWN HALL" IN ALL UPPERCASE, RED LETTERS. A SMALL BLUE DOT SEPARATES THE WORDS "TELE" AND "TOWN". THERE IS A BLUE LINE UNDERNEATH THE WORDS "TELE TOWN HALL", AND THE LETTERS "LLC", IN BLUE ARE LOCATED UNDER THE BLUE LINE ON THE RIGHT SIDE.

FOR INTERNET TELEPHONY SERVICES; TELEPHONE CONFERENCING SERVICES (U.S. CLS. 100, 101 AND 104).

FIRST USE 5-18-2009; IN COMMERCE 5-18-2009.
KAPIL BHANOT, EXAMINING ATTORNEY

SN 77-798,652. HUMANA INC., LOUISVILLE, KY. FILED 8-6-2009.

HG4H

THE MARK CONSISTS OF STANDARD CHARACTERS WITHOUT CLAIM TO ANY PARTICULAR FONT, STYLE, SIZE, OR COLOR.

FOR PROVIDING ON-LINE CHAT ROOMS, ON-LINE ELECTRONIC BULLETIN BOARDS AND ON-LINE DISCUSSION FORUMS FOR TRANSMISSION OF MESSAGES AMONG USERS IN THE FIELDS OF WEIGHT LOSS, DIETING, HEALTH, WELLNESS, NUTRITION AND PHYSICAL FITNESS (U.S. CLS. 100, 101 AND 104).
HELENE LIWINSKI, EXAMINING ATTORNEY

SN 77-798,880. COMPUTER TELEPHONY SOLUTIONS, INC., DBA OAISYS, TEMPE, AZ. FILED 8-6-2009.

MOBILE RECALL

THE MARK CONSISTS OF STANDARD CHARACTERS WITHOUT CLAIM TO ANY PARTICULAR FONT, STYLE, SIZE, OR COLOR.

NO CLAIM IS MADE TO THE EXCLUSIVE RIGHT TO USE "MOBILE", APART FROM THE MARK AS SHOWN.

FOR TELECOMMUNICATIONS SERVICES, NAMELY, PROVIDING THE RETRIEVAL OF RECORDED CALLS FROM A SERVER THROUGH A MOBILE DEVICE (U.S. CLS. 100, 101 AND 104).

FIRST USE 6-18-2009; IN COMMERCE 6-18-2009.
ANDREA HACK, EXAMINING ATTORNEY

CLASS 38—(Continued).

SN 77-799,603. WELLMONICS, LLC, MERRIAM, KS. FILED 8-7-2009.

IN KEY

THE MARK CONSISTS OF STANDARD CHARACTERS WITHOUT CLAIM TO ANY PARTICULAR FONT, STYLE, SIZE, OR COLOR.

FOR PROVIDING ON-LINE FORUMS FOR TRANSMISSION OF MESSAGES AMONG COMPUTER USERS THAT ARE MEMBER PRACTITIONERS AND PRODUCT PROVIDERS IN THE FIELD OF HEALTH AND WELLNESS FOR THE PURPOSE OF NETWORKING AND PROMOTION (U.S. CLS. 100, 101 AND 104).

FRED MANDIR, EXAMINING ATTORNEY

SN 77-803,825. THE FOOD PROJECT, INC., LINCOLN, MA. FILED 8-13-2009.

REAL FOOD CHALLENGE

THE MARK CONSISTS OF STANDARD CHARACTERS WITHOUT CLAIM TO ANY PARTICULAR FONT, STYLE, SIZE, OR COLOR.

NO CLAIM IS MADE TO THE EXCLUSIVE RIGHT TO USE "REAL FOOD", APART FROM THE MARK AS SHOWN.

FOR PROVIDING ON-LINE LISTSERVICES FOR TRANSMISSION OF MESSAGES AMONG COMPUTER USERS IN THE FIELD OF FARM-TO-CAFETERIA FOOD AND AGRICULTURAL PROGRAMS, GARDENING, FAIR TRADE, ORGANIC AND SUSTAINABLE FOOD PRACTICES, FARM WORKER'S RIGHTS, RELATIONSHIPS WITH LOCAL FARMERS, AND REGIONAL AND LOCAL PROGRAMS RELATED TO SAME (U.S. CLS. 100, 101 AND 104).

FIRST USE 7-22-2009; IN COMMERCE 7-22-2009.
LINDA POWELL, EXAMINING ATTORNEY

SN 77-871,205. LUCASEY, CHRIS, OAKLAND, CA. FILED 11-12-2009.

THE PALACE

THE MARK CONSISTS OF STANDARD CHARACTERS WITHOUT CLAIM TO ANY PARTICULAR FONT, STYLE, SIZE, OR COLOR.

FOR PROVIDING MULTIPLE USE ACCESS TO GLOBAL COMPUTER INFORMATION NETWORKS FOR THE TRANSFER AND DISSEMINATION OF A WIDE RANGE OF INFORMATION; PROVIDING AN ON-LINE COMPUTER DATABASE IN THE FIELD OF ON-LINE CHAT ROOMS AND TELECOMMUNICATIONS (U.S. CLS. 100, 101 AND 104).

FIRST USE 9-1-1998; IN COMMERCE 9-1-1998.
GEOFFREY FOSDICK, EXAMINING ATTORNEY

CLASS 38—(Continued).

SN 77-888,601. VANDERLINDEN, KIM, AMHERST, NY.
FILED 12-8-2009.

HOUSEWIFE CONFSSIONALS

THE MARK CONSISTS OF STANDARD CHARACTERS WITHOUT CLAIM TO ANY PARTICULAR FONT, STYLE, SIZE, OR COLOR.

NO CLAIM IS MADE TO THE EXCLUSIVE RIGHT TO USE "HOUSEWIFE", APART FROM THE MARK AS SHOWN.

FOR PROVIDING ON-LINE FORUMS FOR TRANSMISSION OF MESSAGES AMONG COMPUTER USERS (U.S. CLS. 100, 101 AND 104).

FIRST USE 10-1-2009; IN COMMERCE 11-23-2009.

JACQUELINE A. LAVINE, EXAMINING ATTORNEY

CLASS 38—(Continued).

SN 77-899,402. CBS MAXPREPS INC., CAMERON PARK, CA.
FILED 12-22-2009.

MAXPREPS TV

THE MARK CONSISTS OF STANDARD CHARACTERS WITHOUT CLAIM TO ANY PARTICULAR FONT, STYLE, SIZE, OR COLOR.

OWNER OF U.S. REG. NOS. 3,233,098, 3,237,495 AND OTHERS.

NO CLAIM IS MADE TO THE EXCLUSIVE RIGHT TO USE "TV", APART FROM THE MARK AS SHOWN.

FOR BROADCASTING SERVICES, NAMELY, THE ELECTRONIC AND INTERACTIVE TRANSMISSION OF STREAMING DIGITAL AUDIO, VOICE DATA IMAGES, SIGNALS, VIDEO, GRAPHICS, TEXT AND DATA THROUGH THE MEDIA OF TELEVISION, CABLE, SATELLITE, RADIO, TELEPHONE AND BROADBAND SYSTEMS, AND VIA THE INTERNET AND PORTABLE AND WIRELESS COMMUNICATION DEVICES (U.S. CLS. 100, 101 AND 104).

DOMINIC J. FERRAIUOLO, EXAMINING ATTORNEY

SN 77-895,506. PROCON, INC., KNOXVILLE, TN. FILED 12-17-2009.



OWNER OF U.S. REG. NOS. 3,487,073 AND 3,494,645.
THE COLOR(S) RED AND BLACK IS/ARE CLAIMED AS A FEATURE OF THE MARK.

THE MARK CONSISTS OF THE WORD "SATTRACK" IN STYLIZED BLOCK LETTERS, WHEREIN THE LETTERS "SAT" ARE IN RED AND THE LETTERS "TRACK" ARE IN BLACK, AND THREE CONCENTRIC RED ARCS EMANATING OUTWARD FROM THE UPPER RIGHT PORTION OF THE LETTER "K".

FOR SUBSCRIPTION BASED SERVICES PROVIDED OVER A GLOBAL COMPUTER NETWORK FOR ACCESSING A WEB PAGE AND TRACKING THE LOCATION OF A WIRELESS COMMUNICATION DEVICE, WHERE THE LOCATION OF THE WIRELESS COMMUNICATION DEVICE IS INDICATED ON A MAP DISPLAYED ON THE WEB PAGE, FOR PROVIDING ASSISTANCE TO A USER OF THE WIRELESS DEVICE BASED ON REQUESTS COMMUNICATED BY THE USER TO THE SERVICE PROVIDER, AND FOR CONTROLLING FUNCTIONS OF THE VEHICLE IN WHICH THE WIRELESS DEVICE IS INSTALLED VIA WIRELESS COMMUNICATION (U.S. CLS. 100, 101 AND 104).

KARANENDRA S. CHHINA, EXAMINING ATTORNEY

SN 77-918,415. IGN ENTERTAINMENT, INC., BRISBANE, CA. FILED 1-22-2010.



THE MARK CONSISTS OF THE LETTERS "IGN" TO THE RIGHT OF A DESIGN WHICH CONSISTS OF A FOUR-POINTED STAR OVER A CIRCLE.

FOR PROVIDING ON-LINE ELECTRONIC BULLETIN BOARDS FOR TRANSMISSION OF MESSAGES AMONG USERS IN THE FIELD OF GENERAL INTEREST, VIDEO GAMES AND COMPUTER GAMES, MOTION PICTURE FILM, TELEVISION AND COMIC BOOKS; PROVIDING MULTIPLE-USER ACCESS TO A GLOBAL COMPUTER INFORMATION NETWORK FOR THE TRANSFER AND DISSEMINATION OF A WIDE RANGE OF INFORMATION; PROVIDING MULTIPLE-USER ACCESS TO A GLOBAL COMPUTER NETWORK FOR ACCESSING THIRD PARTY AND PROPRIETARY WEBSITES; DIGITAL TRANSMISSION OF DATA, IMAGES AND MESSAGES (U.S. CLS. 100, 101 AND 104).

FIRST USE 12-8-2009; IN COMMERCE 12-8-2009.

LEIGH LOWRY, EXAMINING ATTORNEY

CLASS 38—(Continued).

SN 77-923,416. THE STAYWELL COMPANY, LLC, YARDLEY, PA. FILED 1-29-2010.

**LIFEMASTERS SUPPORTED
SELFCARE**

THE MARK CONSISTS OF STANDARD CHARACTERS WITHOUT CLAIM TO ANY PARTICULAR FONT, STYLE, SIZE, OR COLOR.

OWNER OF U.S. REG. NOS. 1,998,449, 2,929,517 AND OTHERS.

NO CLAIM IS MADE TO THE EXCLUSIVE RIGHT TO USE "SUPPORTED SELFCARE", APART FROM THE MARK AS SHOWN.

FOR ELECTRONIC TRANSMISSION OF MESSAGES AND DATA FOR A PERSONAL HEALTH NETWORK (U.S. CLS. 100, 101 AND 104).

LYDIA BELZER, EXAMINING ATTORNEY

SN 77-923,480. SMALLWORLD COMMUNICATIONS LLC, SOUTHGATE, MI. FILED 1-29-2010.

SOOMYA

THE MARK CONSISTS OF STANDARD CHARACTERS WITHOUT CLAIM TO ANY PARTICULAR FONT, STYLE, SIZE, OR COLOR.

FOR VIDEOCONFERENCING, VIDEO MESSAGING AND VIDEO-NETWORKING SERVICES, NAMELY, EXCHANGE AND SHARING OF VIDEO MESSAGES THROUGH A CENTRAL COMPUTER SERVER THAT RECEIVES AND DISTRIBUTES VIDEO COMMUNICATION REQUESTS AND RESPONSES, ALL FOR USE WITH MOBILE PHONES AND PERSONAL COMPUTERS (U.S. CLS. 100, 101 AND 104).

ANDREA SAUNDERS, EXAMINING ATTORNEY

CLASS 38—(Continued).

SN 77-924,906. ROXANA ADLESH, CASTAIC, CA. FILED 2-1-2010.

PINT SIZE CHEFS

THE MARK CONSISTS OF STANDARD CHARACTERS WITHOUT CLAIM TO ANY PARTICULAR FONT, STYLE, SIZE, OR COLOR.

NO CLAIM IS MADE TO THE EXCLUSIVE RIGHT TO USE "CHEFS", APART FROM THE MARK AS SHOWN.

FOR AUDIO AND VIDEO BROADCASTING SERVICES OVER THE INTERNET; BROADCASTING OF RADIO AND TELEVISION PROGRAMMES; BROADCASTING OF VIDEO AND AUDIO PROGRAMMING OVER THE INTERNET; BROADCASTING PROGRAMS VIA A GLOBAL COMPUTER NETWORK; CABLE TELEVISION BROADCASTING; CABLE TELEVISION TRANSMISSION; COMMUNICATIONS BY MOBILE PHONES; COMMUNICATIONS SERVICES, NAMELY, TRANSMITTING STREAMED SOUND AND AUDIOVISUAL RECORDINGS VIA THE INTERNET; ELECTRONIC DATA TRANSMISSION; ELECTRONIC TRANSMISSION AND STREAMING OF DIGITAL MEDIA CONTENT FOR OTHERS VIA GLOBAL AND LOCAL COMPUTER NETWORKS; ELECTRONIC TRANSMISSION OF VOICE, DATA AND IMAGES BY TELEVISION AND VIDEO BROADCASTING; INTERNET BROADCASTING SERVICES; INTERNET RADIO BROADCASTING SERVICES; MOBILE MEDIA SERVICES IN THE NATURE OF ELECTRONIC TRANSMISSION OF ENTERTAINMENT MEDIA CONTENT; RADIO AND TELEVISION PROGRAMME BROADCASTING; SATELLITE TELEVISION BROADCASTING; SATELLITE, CABLE, NETWORK TRANSMISSION OF SOUNDS, IMAGES, SIGNALS AND DATA; SOUND AND PICTURE TRANSMISSION VIA SATELLITE; STREAMING OF AUDIO MATERIAL ON THE INTERNET; STREAMING OF AUDIO, VISUAL AND AUDIOVISUAL MATERIAL VIA A GLOBAL COMPUTER NETWORK; STREAMING OF VIDEO MATERIAL ON THE INTERNET; TELECOMMUNICATION SERVICES, NAMELY, TRANSMISSION OF PODCASTS; TELECOMMUNICATION SERVICES, NAMELY, TRANSMISSION OF VOICE, DATA, GRAPHICS, IMAGES, AUDIO AND VIDEO BY MEANS OF TELECOMMUNICATIONS NETWORKS, WIRELESS COMMUNICATION NETWORKS, AND THE INTERNET; TELEVISION BROADCASTING (U.S. CLS. 100, 101 AND 104).

KIMBERLY PERRY, EXAMINING ATTORNEY

SN 77-926,548. BROWN SUSANNE, SAN RAFAEL, CA. FILED 2-3-2010.

SMELL LIKE BUTT

THE MARK CONSISTS OF STANDARD CHARACTERS WITHOUT CLAIM TO ANY PARTICULAR FONT, STYLE, SIZE, OR COLOR.

FOR COMMUNICATIONS SERVICES, NAMELY, PROVIDING INTERNET FORUM FOR PERSONAL OPINIONS (U.S. CLS. 100, 101 AND 104).

JOHN HWANG, EXAMINING ATTORNEY

CLASS 38—(Continued).

SN 77-927,143. YANKEE TELECOM, INC., WEARE, NH. FILED 2-3-2010.



OWNER OF U.S. REG. NOS. 2,800,223 AND 2,842,857.
 NO CLAIM IS MADE TO THE EXCLUSIVE RIGHT TO USE "GRANITE STATE COMMUNICATIONS", APART FROM THE MARK AS SHOWN.
 THE MARK CONSISTS OF THREE INTERLOCKING SQUARES LOCATED ABOVE THE WORDS "GRANITE STATE COMMUNICATIONS".
 FOR TELECOMMUNICATION SERVICES, NAMELY, LOCAL AND LONG DISTANCE TRANSMISSION OF VOICE, DATA, GRAPHICS AND VIDEO BY MEANS OF BROADBAND OPTICAL OR WIRELESS NETWORKS (U.S. CLS. 100, 101 AND 104).
 FIRST USE 9-30-2009; IN COMMERCE 9-30-2009.
 COLLEEN KEARNEY, EXAMINING ATTORNEY

SN 77-928,157. GOSPEL MUSIC CHANNEL, LLC, ATLANTA, GA. FILED 2-4-2010.

Always Uplifting

THE MARK CONSISTS OF STANDARD CHARACTERS WITHOUT CLAIM TO ANY PARTICULAR FONT, STYLE, SIZE, OR COLOR.
 FOR BROADCASTING OF TELEVISION PROGRAMMES; BROADCASTING OF VIDEO AND AUDIO PROGRAMMING OVER THE INTERNET; CABLE TELEVISION BROADCASTING; SATELLITE TELEVISION BROADCASTING; TELEVISION BROADCASTING (U.S. CLS. 100, 101 AND 104).
 CAROLINE WOOD, EXAMINING ATTORNEY

SN 77-929,263. CIVIGUARD TECHNOLOGIES INC., WHITE PLAINS, NY. FILED 2-5-2010.

CIVIGUARD

THE MARK CONSISTS OF STANDARD CHARACTERS WITHOUT CLAIM TO ANY PARTICULAR FONT, STYLE, SIZE, OR COLOR.
 FOR TELECOMMUNICATIONS SERVICES, SPECIFICALLY ELECTRONIC TRANSMISSION OF VOICE, DATA, AND IMAGES RELATED TO EMERGENCY RESPONSE, EMERGENCY NOTIFICATION, AND DISASTER RESPONSE, INCLUDING VOICE, TEXT, AND IMAGE MESSAGING THROUGH A WIRELESS COMMUNICATIONS NETWORK (U.S. CLS. 100, 101 AND 104).
 FIRST USE 9-7-2009; IN COMMERCE 9-7-2009.
 JOHN E. MICHOS, EXAMINING ATTORNEY

CLASS 38—(Continued).

SN 77-929,301. CIVIGUARD TECHNOLOGIES INC., WHITE PLAINS, NY. FILED 2-5-2010.

CIVICAST

THE MARK CONSISTS OF STANDARD CHARACTERS WITHOUT CLAIM TO ANY PARTICULAR FONT, STYLE, SIZE, OR COLOR.
 FOR TELECOMMUNICATIONS SERVICES, SPECIFICALLY ELECTRONIC TRANSMISSION OF VOICE, DATA, AND IMAGES RELATED TO EMERGENCY RESPONSE, EMERGENCY NOTIFICATION, AND DISASTER RESPONSE, INCLUDING VOICE, TEXT, AND IMAGE MESSAGING THROUGH A WIRELESS NETWORK (U.S. CLS. 100, 101 AND 104).
 FIRST USE 9-7-2009; IN COMMERCE 9-7-2009.
 JOHN E. MICHOS, EXAMINING ATTORNEY

SN 77-930,045. BROWN SUSANNE, SAN RAFAEL, CA. FILED 2-8-2010.

SMELLS LIKE BUTT

THE MARK CONSISTS OF STANDARD CHARACTERS WITHOUT CLAIM TO ANY PARTICULAR FONT, STYLE, SIZE, OR COLOR.
 FOR COMMUNICATIONS SERVICES, NAMELY, TELECOMMUNICATIONS (U.S. CLS. 100, 101 AND 104).
 JOHN HWANG, EXAMINING ATTORNEY

SN 77-930,335. VITELITY, LLC, ENGLEWOOD, CO. FILED 2-8-2010.

VITELITY

THE MARK CONSISTS OF STANDARD CHARACTERS WITHOUT CLAIM TO ANY PARTICULAR FONT, STYLE, SIZE, OR COLOR.
 FOR VOICE OVER INTERNET PROTOCOL (VOIP) SERVICES (U.S. CLS. 100, 101 AND 104).
 FIRST USE 5-15-2006; IN COMMERCE 7-16-2006.
 FRANK LATTUCA, EXAMINING ATTORNEY

CLASS 38—(Continued).

SN 78-954,590. SLIDE, INC., SAN FRANCISCO, CA. FILED 8-17-2006.

SLIDE.COM

THE MARK CONSISTS OF STANDARD CHARACTERS WITHOUT CLAIM TO ANY PARTICULAR FONT, STYLE, SIZE, OR COLOR.

OWNER OF U.S. REG. NOS. 3,169,728, 3,673,049 AND OTHERS.

SEC. 2(F).

FOR PROVIDING AND MAINTAINING ELECTRONIC MAIL SERVICES; ELECTRONIC TRANSMISSION OF DATA AND DOCUMENTS AMONG USERS OF COMPUTERS, NAMELY, PROVIDING A MEANS FOR A GROUP OF TWO OR MORE USERS TO COMMUNICATE, TRANSFER, AND SHARE TEXTUAL AND GRAPHIC CONTENT OVER A GLOBAL COMPUTER NETWORK; AND PROVIDING MULTIPLE-USER ACCESS TO A GLOBAL COMPUTER INFORMATION NETWORK, NAMELY, ACCESS TO PROPRIETARY AND PUBLICLY AVAILABLE COLLECTIONS OF INFORMATION OVER A GLOBAL COMPUTER NETWORK (U.S. CLS. 100, 101 AND 104).

KRISTIN DAHLING, EXAMINING ATTORNEY

CLASS 39—TRANSPORTATION AND STORAGE

SN 76-671,888. DOLPHIN LIMOUSINE SERVICE, INC., HOLLYWOOD, FL. FILED 1-26-2007.



NO CLAIM IS MADE TO THE EXCLUSIVE RIGHT TO USE "LIMOUSINE SERVICE", APART FROM THE MARK AS SHOWN.

THE COLOR(S) TURQUOISE BLUE, PINK AND BLACK IS/ARE CLAIMED AS A FEATURE OF THE MARK.

THE MARK CONSISTS OF A DESIGN ELEMENT OF A PINK CIRCLE, WITHIN WHICH IS A TURQUOISE BLUE DOLPHIN; BOTH CIRCLE AND DOLPHIN CONTAIN BLACK BORDERS OR OUTLINES. THE WORDS "DOLPHIN LIMOUSINE SERVICE", IN BLACK, APPEAR NEAR THE DESIGN ELEMENT.

FOR CHAUFFEUR TRANSPORTATION SERVICES USING LIMOUSINES, TOWN CARS, VANS, AND BUSES (U.S. CLS. 100 AND 105).

FIRST USE 3-1-1987; IN COMMERCE 3-1-1987.

HENRY S. ZAK, EXAMINING ATTORNEY

CLASS 39—(Continued).

SN 76-694,527. REGIONAL PUBLIC TRANSPORTATION AUTHORITY, PHOENIX, AZ. FILED 11-28-2008.

VALLEY METRO LINK

THE MARK CONSISTS OF STANDARD CHARACTERS WITHOUT CLAIM TO ANY PARTICULAR FONT, STYLE, SIZE, OR COLOR.

OWNER OF U.S. REG. NO. 1,868,631.

NO CLAIM IS MADE TO THE EXCLUSIVE RIGHT TO USE "METRO LINK", APART FROM THE MARK AS SHOWN.

FOR TRANSPORTATION OF PASSENGERS OR GOODS BY BUS (U.S. CLS. 100 AND 105).

DAVID ELTON, EXAMINING ATTORNEY

SN 77-321,138. BRAZILIAN TRAVEL SERVICE LTD., NEW YORK, NY. FILED 11-5-2007.

BRAZILIAN TRAVEL SERVICE

THE MARK CONSISTS OF STANDARD CHARACTERS WITHOUT CLAIM TO ANY PARTICULAR FONT, STYLE, SIZE, OR COLOR.

NO CLAIM IS MADE TO THE EXCLUSIVE RIGHT TO USE "TRAVEL SERVICE", APART FROM THE MARK AS SHOWN.

SEC. 2(F).

FOR TRAVEL AGENCY SERVICES, NAMELY, OBTAINING RESERVATIONS AND BOOKINGS FOR TRANSPORTATION FOR OTHERS; ARRANGING AND ORGANIZING VACATIONS AND TOURS FOR OTHERS; TRAVEL AND TOURIST INFORMATION SERVICES; TRAVEL AND TOUR TICKET RESERVATION SERVICE; PROVIDING AN ON-LINE COMPUTER DATABASE IN THE FIELD OF TRAVEL INFORMATION SERVICES (U.S. CLS. 100 AND 105).

FIRST USE 4-0-1981; IN COMMERCE 4-0-1981.

DEIRDRE ROBERTSON, EXAMINING ATTORNEY

SN 77-623,093. ZIPTREK ECOTOURS INC., WHISTLER, CANADA, FILED 11-28-2008.

ECO-EXHILARATION

THE MARK CONSISTS OF STANDARD CHARACTERS WITHOUT CLAIM TO ANY PARTICULAR FONT, STYLE, SIZE, OR COLOR.

PRIORITY CLAIMED UNDER SEC. 44(D) ON CANADA APPLICATION NO. 1397401, FILED 5-29-2008, REG. NO. TMA760,047, DATED 2-23-2010, EXPIRES 2-23-2025.

FOR ARRANGING, ORGANIZING, AND CONDUCTING GUIDED OUTDOOR TRIPS, OUTDOOR EXPEDITIONS, OUTDOOR EXCURSIONS, AERIAL OUTDOOR EXPEDITIONS AND EXCURSIONS AND TRAVEL TOURS (U.S. CLS. 100 AND 105).

JANICE KIM, EXAMINING ATTORNEY

CLASS 39—(Continued).

SN 77-810,859. TAYLOR ROBINETTE, WESTMINSTER, MD. FILED 8-23-2009.



NO CLAIM IS MADE TO THE EXCLUSIVE RIGHT TO USE "GREEN LIMOUSINE", APART FROM THE MARK AS SHOWN.

THE COLOR(S) GREEN AND BLACK IS/ARE CLAIMED AS A FEATURE OF THE MARK.

THE MARK CONSISTS OF A GREEN HORIZONTAL LEAF DESIGN THAT FEATURES A GREEN LETTER "G", ALL OVER THE WORDS "GREENLIMOUSINE", WHEREIN "GREEN" IS THE COLOR GREEN AND "LIMOUSINE" IS BLACK. ON THE THIRD AND LOWEST LINE OF THE MARK THE GREEN-COLORED SLOGAN "GOING GREEN NEVER LOOKED SO GOOD..."

FOR ENVIRONMENTALLY FRIENDLY LIMOUSINE SERVICES (U.S. CLS. 100 AND 105).

FIRST USE 8-1-2009; IN COMMERCE 8-1-2009. TRACY WHITTAKER-BROWN, EXAMINING ATTORNEY

CLASS 39—(Continued).

SN 77-867,745. ANOTHER ATTIC, LTD., AMARILLO, TX. FILED 11-8-2009.



OWNER OF U.S. REG. NO. 2,143,221. NO CLAIM IS MADE TO THE EXCLUSIVE RIGHT TO USE "SELF-STORAGE", APART FROM THE MARK AS SHOWN.

THE MARK CONSISTS OF AN ILLUSTRATION OF A CHIPMUNK CARRYING A CARDBOARD MOVING BOX THAT IS OPEN AT THE TOP AND OVER FLOWING WITH ACORNS. ON THE BOX IS THE WORDING "ANOTHER ATTIC SELF-STORAGE" WITH THE DESIGN OF A BOX AND ROCKING CHAIR.

FOR MINI-WAREHOUSE STORAGE SERVICES (U.S. CLS. 100 AND 105). DAVID I, EXAMINING ATTORNEY

SN 77-815,074. GREGSON, BOE, SHERIDAN, WY. FILED 8-28-2009.

NeverEndingMemory.com

THE MARK CONSISTS OF STANDARD CHARACTERS WITHOUT CLAIM TO ANY PARTICULAR FONT, STYLE, SIZE, OR COLOR.

FOR PROVIDING A WEBSITE FOR ELECTRONIC DATA STORAGE OF DIGITAL AUDIO RECORDINGS, PHOTOGRAPHS AND VIDEOS OF A SPECIFIC EVENT OR EVENTS, ALONG WITH DESCRIPTIONS OF, AND COMMENTS ABOUT, THE FILES (U.S. CLS. 100 AND 105).

KATHERINE CHANG, EXAMINING ATTORNEY

SN 77-905,001. ARRINGTON, STEPHEN, LITTLETON, CO. FILED 1-5-2010.

Landmark Tours

THE MARK CONSISTS OF STANDARD CHARACTERS WITHOUT CLAIM TO ANY PARTICULAR FONT, STYLE, SIZE, OR COLOR.

NO CLAIM IS MADE TO THE EXCLUSIVE RIGHT TO USE "TOURS". APART FROM THE MARK AS SHOWN.

FOR TRAVEL AGENCY SERVICES, NAMELY, MAKING RESERVATIONS AND BOOKINGS FOR TRANSPORTATION; TOUR CONDUCTING (U.S. CLS. 100 AND 105).

GEOFFREY FOSDICK, EXAMINING ATTORNEY

CLASS 39—(Continued).

SN 77-906,858. LDK LOGISTICS LLC, DBA LDK LOGISTICS, DENVER, CO. FILED 1-7-2010.

Think Outside the Dock

THE MARK CONSISTS OF STANDARD CHARACTERS WITHOUT CLAIM TO ANY PARTICULAR FONT, STYLE, SIZE, OR COLOR.

FOR NON-DOCK DELIVERY OF GOODS (U.S. CLS. 100 AND 105).

FIRST USE 2-1-2009; IN COMMERCE 2-1-2009.

NORA BUCHANAN WILL, EXAMINING ATTORNEY

SN 77-916,662. EXCEPTIONAL SERVICES GROUP, L.L.C., DBA EXCEPTIONAL VACATIONS, COCONUT CREEK, FL. FILED 1-21-2010.

EXCEPTIONAL VACATIONS

THE MARK CONSISTS OF STANDARD CHARACTERS WITHOUT CLAIM TO ANY PARTICULAR FONT, STYLE, SIZE, OR COLOR.

NO CLAIM IS MADE TO THE EXCLUSIVE RIGHT TO USE "VACATIONS", APART FROM THE MARK AS SHOWN.

FOR ARRANGING OF TOURS; TRAVEL AGENCY SERVICES, NAMELY, MAKING RESERVATIONS AND BOOKINGS FOR TRANSPORTATION (U.S. CLS. 100 AND 105).

FIRST USE 12-30-2002; IN COMMERCE 12-30-2002.

CHARISMA HAMPTON, EXAMINING ATTORNEY

SN 77-927,107. MOANA PA'AKAI, INC., DBA HAWAIIAN TUG & BARGE, HONOLULU, HI. FILED 2-3-2010.

HTB

THE MARK CONSISTS OF STANDARD CHARACTERS WITHOUT CLAIM TO ANY PARTICULAR FONT, STYLE, SIZE, OR COLOR.

OWNER OF U.S. REG. NO. 2,410,731.

FOR BARGE TRANSPORT; FREIGHT TRANSPORTATION BY MARINE VESSEL; MARINE TOWING; MARINE TRANSPORT; TRANSPORT AND DELIVERY OF GOODS; TRANSPORT AND STORAGE OF GOODS; TRANSPORT BY MARINE VESSEL; TRANSPORT OF GOODS (U.S. CLS. 100 AND 105).

FIRST USE 12-1-1961; IN COMMERCE 12-1-1961.

RUSS HERMAN, EXAMINING ATTORNEY

CLASS 39—(Continued).

SN 77-927,152. BRAZILIAN TRAVEL SERVICES LTD., NEW YORK, NY. FILED 2-3-2010.

CLICKANDFLY.COM

THE MARK CONSISTS OF STANDARD CHARACTERS WITHOUT CLAIM TO ANY PARTICULAR FONT, STYLE, SIZE, OR COLOR.

FOR TRAVEL AGENCY SERVICES, NAMELY, MAKING RESERVATIONS AND BOOKINGS FOR TRANSPORTATION AND TRAVEL VIA TELEPHONE AND A GLOBAL COMPUTER NETWORK (U.S. CLS. 100 AND 105).

FIRST USE 8-9-2005; IN COMMERCE 8-9-2005.

DAVID ELTON, EXAMINING ATTORNEY

SN 77-927,653. PETRICHOR VINEYARDS, INC. SANTA ROSA, CA. FILED 2-4-2010.

DRIVEN SOLAR

THE MARK CONSISTS OF STANDARD CHARACTERS WITHOUT CLAIM TO ANY PARTICULAR FONT, STYLE, SIZE, OR COLOR.

FOR TRANSPORTATION AND STORAGE SERVICES, NAMELY, PROVIDING TRANSPORT OF GOODS (U.S. CLS. 100 AND 105).

HELENE LIWINSKI, EXAMINING ATTORNEY

SN 77-927,818. GOWAITER, INC., TALLAHASSEE, FL. FILED 2-4-2010.

GOWAITER

THE MARK CONSISTS OF STANDARD CHARACTERS WITHOUT CLAIM TO ANY PARTICULAR FONT, STYLE, SIZE, OR COLOR.

FOR FOOD DELIVERY SERVICES FROM RESTAURANTS TO CUSTOMERS (U.S. CLS. 100 AND 105).

SHANNON TWOHIG, EXAMINING ATTORNEY

CLASS 39—(Continued).

SN 77-929,023. CHARLES W. HOWARD, BROAD CHANNEL, NY. FILED 2-5-2010.

PORTASHED

THE MARK CONSISTS OF STANDARD CHARACTERS WITHOUT CLAIM TO ANY PARTICULAR FONT, STYLE, SIZE, OR COLOR.
 FOR RENTAL OF MOVABLE STORAGE CONTAINERS (U.S. CLS. 100 AND 105).
 FIRST USE 7-31-2008; IN COMMERCE 7-31-2008.
 CAROLYN CATALDO, EXAMINING ATTORNEY

CLASS 39—(Continued).

SN 77-931,658. PAN AM WORLD AIRWAYS, INC., DOVER, NH. FILED 2-9-2010.



SN 77-930,022. NOORANI, MUJEEB A., DBA NOORANI INTERNATIONAL, SHAWNEE MISSION, KS. FILED 2-7-2010.

CruiseKokomo.com

THE MARK CONSISTS OF STANDARD CHARACTERS WITHOUT CLAIM TO ANY PARTICULAR FONT, STYLE, SIZE, OR COLOR.
 FOR PROVIDING LINKS TO WEB SITES OF OTHERS FEATURING TRAVEL (U.S. CLS. 100 AND 105).
 JAMES LOVELACE, EXAMINING ATTORNEY

OWNER OF U.S. REG. NOS. 3,171,134 AND 3,171,135.
 THE MARK CONSISTS OF THE OUTLINE OF A GLOBE WITH THE WORDS "PAN AM" ACROSS IT.
 FOR AIR TRANSPORTATION OF PASSENGERS AND FREIGHT (U.S. CLS. 100 AND 105).
 TEJBIR SINGH, EXAMINING ATTORNEY

SN 77-931,794. ADAM TRAVEL SERVICES, INC., BOSTON, MA. FILED 2-9-2010.

SN 77-930,720. FLYING CROWN FOUNDATION, DALLAS, TX. FILED 2-8-2010.

FLYING CROWN FOUNDATION

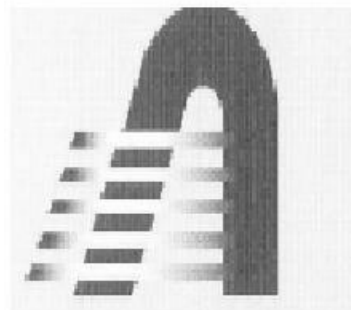

THE MARK CONSISTS OF STANDARD CHARACTERS WITHOUT CLAIM TO ANY PARTICULAR FONT, STYLE, SIZE, OR COLOR.
 NO CLAIM IS MADE TO THE EXCLUSIVE RIGHT TO USE "FOUNDATION", APART FROM THE MARK AS SHOWN.
 FOR CHARITABLE SERVICES, NAMELY, PROVIDING AIR TRANSPORTATION SERVICES TO PROVIDE ACCESS TO MEDICAL CARE SERVICES (U.S. CLS. 100 AND 105).
 MICHAEL SOUDERS, EXAMINING ATTORNEY

THE MARK CONSISTS OF A STYLIZED LETTER "A" WITH FIVE HORIZONTAL STRIPES ACROSS THE "A".
 FOR TRAVEL AGENCY SERVICES, NAMELY, MAKING RESERVATIONS AND BOOKINGS FOR TRANSPORTATION (U.S. CLS. 100 AND 105).
 FIRST USE 11-27-1996; IN COMMERCE 11-27-1996.
 ERIN FALK, EXAMINING ATTORNEY

CLASS 39—(Continued).

SN 77-932,418. KOLB & ROMACK, LLC, DBA CAPTAIN CLUTTER, CHARLOTTE, NC. FILED 2-10-2010.



THE COLOR(S) GOLD, BROWN IS/ARE CLAIMED AS A FEATURE OF THE MARK.

THE MARK CONSISTS OF GOLD BARS ON THE LEFT HAND SIDE OF THE LOGO WHICH ARE OUTLINED FOR EFFECT AND THE WORDS "CAPTAIN CLUTTER" TO THE RIGHT OF THE BARS IN CHOCOLATE BROWN USING A STENCIL TYPE FONT.

FOR JUNK REMOVAL; JUNK, TRASH AND DEBRIS REMOVAL (U.S. CLS. 100 AND 105).

FIRST USE 7-15-2009; IN COMMERCE 7-15-2009.
KATHY DE JONGE, EXAMINING ATTORNEY

CLASS 39—(Continued).

SN 77-951,786. U-HAUL INTERNATIONAL, INC., PHOENIX, AZ. FILED 3-5-2010.

COLLEGEBOXES

THE MARK CONSISTS OF STANDARD CHARACTERS WITHOUT CLAIM TO ANY PARTICULAR FONT, STYLE, SIZE, OR COLOR.

OWNER OF U.S. REG. NO. 3,008,773.
FOR TRANSPORTATION OF GOODS BY TRUCK, FURNITURE MOVING, AND STORAGE SERVICES IN GENERAL (U.S. CLS. 100 AND 105).

FIRST USE 12-31-2000; IN COMMERCE 12-31-2000.
LOURDES AYALA, EXAMINING ATTORNEY

SN 77-934,060. FINEST FLOWERS, INC., NORTH BABYLON, NY. FILED 2-11-2010.



NO CLAIM IS MADE TO THE EXCLUSIVE RIGHT TO USE "PACKNSHIP EXPRESS .COM", APART FROM THE MARK AS SHOWN.

THE MARK CONSISTS OF DESIGNS AND THE WORDING "PACKNSHIP EXPRESS .COM". THE DESIGN FEATURES A BOX WITH A POSTAGE STAMP. LINES TO THE LEFT OF THE BOX INDICATE MOVEMENT. BELOW THE DESIGN, THE WORDING "PACKNSHIP EXPRESS" APPEARS ABOVE A THIN RECTANGULAR UNDERLINE, WITH THE SECOND "P" SEPARATING THE UNDERLINE BAR IN TWO SECTIONS. THE WORDING ".COM" APPEARS WITHIN THE END OF THE UNDERLINE BAR.

FOR PACKING ARTICLES FOR TRANSPORTATION; PARCEL SHIPPING SERVICES (U.S. CLS. 100 AND 105).
CORY BOONE, EXAMINING ATTORNEY

SN 77-951,826. U-HAUL INTERNATIONAL, INC., PHOENIX, AZ. FILED 3-5-2010.

COLLEGEBOXES.COM

THE MARK CONSISTS OF STANDARD CHARACTERS WITHOUT CLAIM TO ANY PARTICULAR FONT, STYLE, SIZE, OR COLOR.

OWNER OF U.S. REG. NO. 3,008,773.
FOR TRANSPORTATION OF GOODS BY TRUCK, FURNITURE MOVING, AND STORAGE SERVICES IN GENERAL (U.S. CLS. 100 AND 105).

LOURDES AYALA, EXAMINING ATTORNEY

SN 77-941,366. SKYDANCE DESIGN LLC, OKLAHOMA CITY, OK. FILED 2-22-2010.

SKYDANCE BRIDGE

THE MARK CONSISTS OF STANDARD CHARACTERS WITHOUT CLAIM TO ANY PARTICULAR FONT, STYLE, SIZE, OR COLOR.

NO CLAIM IS MADE TO THE EXCLUSIVE RIGHT TO USE "BRIDGE", APART FROM THE MARK AS SHOWN.

FOR BRIDGE OPERATION (U.S. CLS. 100 AND 105).
KAPIL BHANOT, EXAMINING ATTORNEY

SN 77-951,854. U-HAUL INTERNATIONAL, INC., PHOENIX, AZ. FILED 3-5-2010.

COLLEGEBOX

THE MARK CONSISTS OF STANDARD CHARACTERS WITHOUT CLAIM TO ANY PARTICULAR FONT, STYLE, SIZE, OR COLOR.

OWNER OF U.S. REG. NO. 3,008,773.
FOR TRANSPORTATION OF GOODS BY TRUCK, FURNITURE MOVING, AND STORAGE SERVICES IN GENERAL (U.S. CLS. 100 AND 105).

LOURDES AYALA, EXAMINING ATTORNEY

CLASS 39—(Continued).

SN 79-075,075. JETPRESSO SA, SWITZERLAND, FILED 9-15-2009.

JETPRESSO

THE MARK CONSISTS OF STANDARD CHARACTERS WITHOUT CLAIM TO ANY PARTICULAR FONT, STYLE, SIZE, OR COLOR.

PRIORITY DATE OF 5-15-2009 IS CLAIMED.

OWNER OF INTERNATIONAL REGISTRATION 1019134 DATED 9-15-2009, EXPIRES 9-15-2019.

FOR AIR TRANSPORT; TRANSPORT OF PASSENGERS; AIR FREIGHTING, NAMELY, AIR FREIGHT SHIPPING SERVICES; ARRANGING OF TOURS, NAMELY, AIR TRANSPORT RESERVATION SERVICE; DELIVERY OF PACKAGES AND MESSAGE DELIVERY BY AIR TRANSPORT (U.S. CLS. 100 AND 105).

SUE LAWRENCE, EXAMINING ATTORNEY

CLASS 40—MATERIAL TREATMENT

SN 77-524,184. HAZAN, SHIMSHON, BOCA RATON, FL. FILED 7-16-2008.

---ShredEZ---

THE MARK CONSISTS OF STANDARD CHARACTERS WITHOUT CLAIM TO ANY PARTICULAR FONT, STYLE, SIZE, OR COLOR.

FOR RECYCLING SERVICES; SHREDDING OF DOCUMENTS, COMPACT DISCS, CREDIT CARDS, PAINTINGS, ARTWORK, HANDBAGS AND CLOTHING (U.S. CLS. 100, 103 AND 106).

KIM SAITO, EXAMINING ATTORNEY

SN 77-589,015. WIND QUARRY, LLC, MONTROSE, CO. FILED 10-9-2008.



NO CLAIM IS MADE TO THE EXCLUSIVE RIGHT TO USE "WIND" AND "LLC", APART FROM THE MARK AS SHOWN.

THE COLOR(S) GREEN AND BLUE IS/ARE CLAIMED AS A FEATURE OF THE MARK.

THE MARK CONSISTS OF A GREEN SWIRLING STYLIZED "Q" AND THE STYLIZED BLUE WORDS "WIND QUARRY LLC".

FOR GENERATION OF POWER (U.S. CLS. 100, 103 AND 106).

FIRST USE 8-1-2008; IN COMMERCE 8-14-2008.

CHRISTOPHER BUONGIORNO, EXAMINING ATTORNEY

CLASS 40—(Continued).

SN 77-663,656. COMPLEX2SIMPLE, INC., BREWSTER, MA. FILED 2-4-2009.

Solar Garden

THE MARK CONSISTS OF STANDARD CHARACTERS WITHOUT CLAIM TO ANY PARTICULAR FONT, STYLE, SIZE, OR COLOR.

NO CLAIM IS MADE TO THE EXCLUSIVE RIGHT TO USE "SOLAR", APART FROM THE MARK AS SHOWN.

FOR GENERATION OF ENERGY (U.S. CLS. 100, 103 AND 106).

MARK PILARO, EXAMINING ATTORNEY

SN 77-665,466. DEDICATED COMPUTING LLC, WAUKESHA, WI. FILED 2-6-2009.



OWNER OF U.S. REG. NO. 3,633,514.

THE MARK CONSISTS OF THE LETTERING "CC", WITH THE FIRST "C" APPEARING BACKWARD AND THE SECOND "C" APPEARING FRONTWARD, FOLLOWED BY THE WORDING "DEDICATED COMPUTING" WITH "DEDICATED" APPEARING ABOVE "COMPUTING", WITH ONE HORIZONTAL LINE APPEARING ABOVE "CC" AND "DEDICATED", AND ONE HORIZONTAL LINE APPEARING BELOW "COMPUTING".

SEC. 2(F).

FOR MANUFACTURING OF HIGH-END, SPECIALIZED COMPUTER HARDWARE FOR USE WITH PROPRIETARY SOFTWARE APPLICATIONS FOR OTHERS (U.S. CLS. 100, 103 AND 106).

FIRST USE 3-30-2003; IN COMMERCE 3-30-2003.

KRISTIN CARLSON, EXAMINING ATTORNEY

CLASS 40—(Continued).

SN 77-796,709. CLIMAX ENGINEERED MATERIALS, LLC, PHOENIX, AZ. FILED 8-4-2009.



THE MARK CONSISTS OF A TRIANGLE WITH THE LETTER "P" CENTERED ON IT, THE BOTTOM RIGHT CORNER OF THE TRIANGLE CONTAINING A "C", WITH THE LETTERS "PK" TO THE RIGHT OF THE "C".

FOR CUSTOM MANUFACTURE AND FABRICATION OF PARTS FOR THE AUTOMOTIVE, AEROSPACE AND DEFENSE INDUSTRIES, CELLULAR TELEPHONES, DENTAL INSTRUMENTS, ELECTRONIC HEAT SINKS AND HERMETIC PACKAGES, ELECTRICAL CONNECTOR HARDWARE, INDUSTRIAL TOOLS, FIBER OPTIC CONNECTORS, FLUID SPRAY SYSTEMS, HARD DISK DRIVES, PHARMACEUTICAL DEVICES, POWER HAND-TOOLS, SURGICAL INSTRUMENTS AND SPORTING EQUIPMENT, MADE BY USING METAL INJECTION MOLDING OR POWDER INJECTION MOLDING (U.S. CLS. 100, 103 AND 106).

FIRST USE 3-2-2009; IN COMMERCE 3-2-2009.
MICHAEL WIENER, EXAMINING ATTORNEY

SN 77-797,915. QUALITY ASSURED ENTERPRISES, INC., HOPKINS, MN. FILED 8-5-2009.

Quality Assured

OWNER OF U.S. REG. NO. 1,866,050.
THE MARK CONSISTS OF THE WORDS "QUALITY ASSURED" IN A STYLIZED FORM.
SEC. 2(F).

FOR CUSTOM PRINTING OF LABELING AND PACKAGING TO THE ORDER OF OTHERS (U.S. CLS. 100, 103 AND 106).

ALYSSA STEEL, EXAMINING ATTORNEY

SN 77-834,464. CRYSTAL CLEAR MEDIA GROUP, LLC, INDIANAPOLIS, IN. FILED 9-24-2009.

CRYSTAL CLEAR

THE MARK CONSISTS OF STANDARD CHARACTERS WITHOUT CLAIM TO ANY PARTICULAR FONT, STYLE, SIZE, OR COLOR.

OWNER OF U.S. REG. NOS. 2,718,211 AND 2,786,991.
SEC. 2(F).

FOR DUPLICATION OF AUDIO TAPES, CDS AND DVDS; CUSTOM MANUFACTURE OF PHONOGRAPHS (U.S. CLS. 100, 103 AND 106).

FIRST USE 1-1-2001; IN COMMERCE 1-1-2001.
LINDA M. KING, EXAMINING ATTORNEY

CLASS 40—(Continued).

SN 77-846,213. BIOSERV ENVIRONMENTAL INC, CATONSVILLE, MD. FILED 10-11-2009.



NO CLAIM IS MADE TO THE EXCLUSIVE RIGHT TO USE ENVIRONMENTAL, APART FROM THE MARK AS SHOWN.

THE COLOR(S) RED, GREEN, AND BLACK IS/ARE CLAIMED AS A FEATURE OF THE MARK.

THE MARK CONSISTS OF THE STYLIZED TERM "BIOSERV" ABOVE THE STYLIZED TERM "ENVIRONMENTAL" ENCLOSED IN AN INCOMPLETE OVAL COMPRISED OF THREE CURVED BANDS: THE COLOR RED APPEARS IN THE CURVED BAND ON THE LEFT SIDE; THE COLOR GREEN APPEARS IN THE CURVED BAND ON THE RIGHT SIDE; THE COLOR BLACK APPEARS IN THE CURVED BAND ON THE BOTTOM AND IN THE WORDING "BIOSERV ENVIRONMENTAL".

FOR MOLD REMEDIATION SERVICES (U.S. CLS. 100, 103 AND 106).

FIRST USE 1-1-2009; IN COMMERCE 3-5-2009.
MYRIAH HABEEB, EXAMINING ATTORNEY

SN 77-862,771. QUEST RECYCLING, LLC, FRISCO, TX. FILED 11-2-2009.

GREENER GARAGE

THE MARK CONSISTS OF STANDARD CHARACTERS WITHOUT CLAIM TO ANY PARTICULAR FONT, STYLE, SIZE, OR COLOR.

FOR PROVIDING A WEBSITE FEATURING INFORMATION FOR CONSUMERS IN THE FIELD OF RECYCLING OF CHEMICALS, NAMELY, INFORMATION ON HOW TO PROPERLY DISPOSE OF OR RECYCLE HOUSEHOLD CHEMICALS SUCH AS AUTOMOTIVE PRODUCTS, PAINTS, CLEANERS, POOL CHEMICALS, AND PESTICIDES (U.S. CLS. 100, 103 AND 106).

AISHA SALEM, EXAMINING ATTORNEY

SN 77-864,407. MD ORTHOTIC & PROSTHETIC LABORATORY, PC, BROOKFIELD, IL. FILED 11-3-2009.

MD LABS

THE MARK CONSISTS OF STANDARD CHARACTERS WITHOUT CLAIM TO ANY PARTICULAR FONT, STYLE, SIZE, OR COLOR.

NO CLAIM IS MADE TO THE EXCLUSIVE RIGHT TO USE "LABS", APART FROM THE MARK AS SHOWN.

FOR CUSTOM MANUFACTURE OF ORTHOTIC AND PROSTHETIC DEVICES (U.S. CLS. 100, 103 AND 106).

FIRST USE 2-28-2001; IN COMMERCE 2-28-2001.
PATRICIA EVANKO, EXAMINING ATTORNEY

CLASS 40—(Continued).

SN 77-874,591. DELTANA ENTERPRISES, INC., MIAMI, FL.
FILED 11-17-2009.

DELTANA

THE MARK CONSISTS OF STANDARD CHARACTERS WITHOUT CLAIM TO ANY PARTICULAR FONT, STYLE, SIZE, OR COLOR.

FOR CUSTOM MANUFACTURE OF ARCHITECTURAL HARDWARE PRODUCTS (U.S. CLS. 100, 103 AND 106).

FIRST USE 1-1-1977; IN COMMERCE 1-1-1977.
ALICIA COLLINS, EXAMINING ATTORNEY

CLASS 40—(Continued).

SN 77-883,908. VENKO TROPHIES & AWARDS, INC.,
MIAMI, FL. FILED 12-2-2009.



The logo features a stylized 'V' with a horizontal bar across its middle, followed by the word 'VENKO' in a bold, sans-serif font, and the word 'trophies' in a smaller, lowercase, sans-serif font below it.

NO CLAIM IS MADE TO THE EXCLUSIVE RIGHT TO USE "TROPHIES", APART FROM THE MARK AS SHOWN.

THE MARK CONSISTS OF THE WORDS "VENKO TROPHIES" WITH THE "V" IN "VENKO" IN STYLIZED FORM HAVING A "V" DISPOSED PARTIALLY WITHIN THE OPEN SPACE BETWEEN THE LEFT AND RIGHT SIDES OF ANOTHER "V".

THE ENGLISH TRANSLATION OF THE ESPERANTO WORD "VENKO" IN THE MARK IS "VICTORY".

FOR CUSTOM MANUFACTURE OF TROPHIES, STATUES, AWARDS, MEDALS AND FIGURES (U.S. CLS. 100, 103 AND 106).

ELLEN BURNS, EXAMINING ATTORNEY

SN 77-915,251. HOBRATH, JEFFREY, LEONARDTOWN,
MD. FILED 1-19-2010.

King of Tees

THE MARK CONSISTS OF STANDARD CHARACTERS WITHOUT CLAIM TO ANY PARTICULAR FONT, STYLE, SIZE, OR COLOR.

NO CLAIM IS MADE TO THE EXCLUSIVE RIGHT TO USE "TEES", APART FROM THE MARK AS SHOWN.

FOR IMPRINTING MESSAGES ON WEARING APPAREL, ACCESSORIES AND MUGS (U.S. CLS. 100, 103 AND 106).

KIMBERLY PERRY, EXAMINING ATTORNEY

SN 77-875,882. ACCURATE PRINTING & GRAPHICS, INC.,
HUNTSVILLE, AL. FILED 11-18-2009.

Accurate Printing & Graphics

THE MARK CONSISTS OF STANDARD CHARACTERS WITHOUT CLAIM TO ANY PARTICULAR FONT, STYLE, SIZE, OR COLOR.

NO CLAIM IS MADE TO THE EXCLUSIVE RIGHT TO USE "PRINTING & GRAPHICS", APART FROM THE MARK AS SHOWN.

SEC. 2(F).

FOR BINDERY SERVICES FOR OTHERS, NAMELY, COLLATING, FOLDING, STAPLING, PERFORATING, CUTTING AND BINDING OF PRINTED, PHOTOCOPIED AND TYPEWRITTEN MATERIALS; CUSTOMIZED PRINTING OF COMPANY NAMES AND LOGOS FOR PROMOTIONAL AND ADVERTISING PURPOSES ON THE GOODS OF OTHERS; DESIGN PRINTING FOR OTHERS; IMPRINTING MESSAGES ON T-SHIRTS; IMPRINTING MESSAGES ON WEARING APPAREL, ACCESSORIES AND MUGS; INKJET PRINTING SERVICES; LENTICULAR PRINTING SERVICES; LETTERPRESS PRINTING; LITHOGRAPHIC PRINTING; OFFSET PRINTING; PATTERN PRINTING; PRINTING; PRINTING OF ADVERTISING BROCHURES FOR OTHERS; PRINTING OF ADVERTISING MATTER; SCREEN PRINTING; SILK SCREEN PRINTING; STATIONERY PRINTING SERVICES; VINYL PRINTING AND PLOT- TING SERVICES (U.S. CLS. 100, 103 AND 106).

FIRST USE 11-3-2003; IN COMMERCE 11-3-2003.
MATTHEW KLINE, EXAMINING ATTORNEY

SN 77-918,315. LINCOLN INDUSTRIES, INC., LINCOLN, NE.
FILED 1-22-2010.

NeverBlue

THE MARK CONSISTS OF STANDARD CHARACTERS WITHOUT CLAIM TO ANY PARTICULAR FONT, STYLE, SIZE, OR COLOR.

FOR MATERIAL PROCESSING, NAMELY, APPLYING A FINISH TO MAINTAIN THE HIGH LUSTER AND BRIGHT APPEARANCE OF CHROME USED IN HIGH TEMPERATURE APPLICATIONS (U.S. CLS. 100, 103 AND 106).

FIRST USE 1-4-2010; IN COMMERCE 1-4-2010.

DOMINIC J. FERRAIUOLO, EXAMINING ATTORNEY

CLASS 40—(Continued).

SN 77-926,267. PHYCAL LLC, HIGHLAND HEIGHTS, OH. FILED 2-2-2010.

HETEROBOOST

THE MARK CONSISTS OF STANDARD CHARACTERS WITHOUT CLAIM TO ANY PARTICULAR FONT, STYLE, SIZE, OR COLOR.

FOR PRODUCTION OF BIOFUELS FOR OTHERS (U.S. CLS. 100, 103 AND 106).
SHAILA SETTLES, EXAMINING ATTORNEY

SN 77-926,527. KAWAR, IBRAHIM, OLNEY, MD. FILED 2-3-2010.

LEAFGOBBLER

THE MARK CONSISTS OF STANDARD CHARACTERS WITHOUT CLAIM TO ANY PARTICULAR FONT, STYLE, SIZE, OR COLOR.

FOR MATERIAL TREATMENT SERVICES, NAMELY, PROVIDING LEAF COLLECTION, BAGGING AND YARD WASTE CONTAINER SYSTEM SERVICE TO FACILITATES AND SIMPLIFIES THE COLLECTION AND BAGGING OF TREE LEAVES, YARD WASTE DEBRIS, LEFT OVER GRASS, SHRUBS, BUSHES AND TRIMS FOR CONSUMERS, HOME OWNERS, LANDSCAPERS, SMALL BUSINESS, FARMERS (U.S. CLS. 100, 103 AND 106).

JACQUELINE A. LAVINE, EXAMINING ATTORNEY

SN 77-926,689. GARE BEAR T'S, INC., MERRIVILLE, IN. FILED 2-3-2010.

GARE BEAR T's

THE MARK CONSISTS OF STANDARD CHARACTERS WITHOUT CLAIM TO ANY PARTICULAR FONT, STYLE, SIZE, OR COLOR.

NO CLAIM IS MADE TO THE EXCLUSIVE RIGHT TO USE "T'S", APART FROM THE MARK AS SHOWN.

FOR EMBROIDERING; IMPRINTING MESSAGES ON T-SHIRTS; IMPRINTING MESSAGES ON WEARING APPAREL, ACCESSORIES AND MUGS; T-SHIRT EMBROIDERING SERVICES (U.S. CLS. 100, 103 AND 106).
JESSICA A. POWERS, EXAMINING ATTORNEY

CLASS 40—(Continued).

SN 77-927,274. PICTAGE, INC., TORRANCE, CA. FILED 2-3-2010.

**EMPOWERING PHOTOGRAPHERS.
ENABLING SUCCESS.**

THE MARK CONSISTS OF STANDARD CHARACTERS WITHOUT CLAIM TO ANY PARTICULAR FONT, STYLE, SIZE, OR COLOR.

NO CLAIM IS MADE TO THE EXCLUSIVE RIGHT TO USE "PHOTOGRAPHERS", APART FROM THE MARK AS SHOWN.

FOR CREATION OF CUSTOM PORTRAITS AND PAINTINGS BASED ON PHOTOGRAPHS, SNAPSHOTS OR IMAGES PROVIDED BY THE CUSTOMER; PHOTOGRAPHIC PRINTING (U.S. CLS. 100, 103 AND 106).
LYDIA BELZER, EXAMINING ATTORNEY

SN 77-928,281. CHEYENNE COFFEE COMPANY LLC, WHEATLAND, WY. FILED 2-4-2010.



NO CLAIM IS MADE TO THE EXCLUSIVE RIGHT TO USE "CHEYENNE COFFEE COMPANY", APART FROM THE MARK AS SHOWN.

THE COLOR(S) BROWN IS/ARE CLAIMED AS A FEATURE OF THE MARK.

THE MARK CONSISTS OF A BROWN OUTLINE OF A TRANSPARENT HORSESHOE WITH DARKER BROWN SHADING ALONG THE INSIDE TO CREATE THE APPEARANCE OF A COFFEE CUP WITH A FILLED BROWN OVAL AT THE TOP OF THE HORSESHOE AND LIGHT BROWN STEAM IS CURLING FROM THE BROWN OVAL AT THE TOP OF THE HORSESHOE. THE WORDS "CHEYENNE COFFEE COMPANY" APPEAR IN A BROWN ARC ACROSS THE FRONT OF THE GRAPHIC.

FOR COFFEE ROASTING AND PROCESSING (U.S. CLS. 100, 103 AND 106).

FIRST USE 2-1-2010; IN COMMERCE 2-1-2010.
ALYSSA STEEL, EXAMINING ATTORNEY

SN 77-928,478. BIO CYCLE INDUSTRIES LLC, TIBURON, CA. FILED 2-4-2010.

BCI

THE MARK CONSISTS OF STANDARD CHARACTERS WITHOUT CLAIM TO ANY PARTICULAR FONT, STYLE, SIZE, OR COLOR.

FOR CHEMICAL RECYCLING PLANT SERVICES; RECYCLING OF CHEMICALS (U.S. CLS. 100, 103 AND 106).

ELI HELLMAN, EXAMINING ATTORNEY

CLASS 40—(Continued).

SN 77-929,673. APTWATER, INC., PLEASANT HILL, CA. FILED 2-5-2010.



THE MARK CONSISTS OF A CHEMICAL STRUCTURE OF THREE CONNECTED CIRCLES INSIDE AN IMAGE OF A WATER DROP WHICH IS NEXT TO THE STYLIZED WORD "APTWATER".

FOR WATER TREATMENT AND PURIFICATION; TREATMENT OF WASTE WATER; RENTAL AND LEASE OF WATER TREATMENT EQUIPMENT; ENVIRONMENTAL REMEDIATION SERVICES, NAMELY, SOIL, WASTE AND/OR WATER TREATMENT SERVICES (U.S. CLS. 100, 103 AND 106).

FIRST USE 11-0-2009; IN COMMERCE 11-0-2009. PRISCILLA MILTON, EXAMINING ATTORNEY

CLASS 40—(Continued).

SN 77-958,557. RYLAND TANIGUCHI, SEATTLE, WA. FILED 3-14-2010.



THE MARK CONSISTS OF STANDARD CHARACTERS WITHOUT CLAIM TO ANY PARTICULAR FONT, STYLE, SIZE, OR COLOR.

FOR BIOLOGICAL WASTE WATER TREATMENT SERVICES; CONTINUOUS BIOLOGICAL WATER TREATMENT SERVICES; ENVIRONMENTAL REMEDIATION SERVICES, NAMELY, SOIL, WASTE AND/OR WATER TREATMENT SERVICES; RENTAL OF WATER AND AIR PURIFICATION EQUIPMENT; RENTAL OF WATER FILTERS; RENTAL OF WATER FILTRATION UNITS FOR COMMERCIAL USE; RENTAL OF WATER PURIFYING APPARATUS; RENTAL OF WATER TREATMENT EQUIPMENT; SUSTAINABLE ON-SITE WATER RECYCLING AND WASTEWATER TREATMENT SERVICES; TREATMENT OF WASTE WATER; TREATMENT OF WATER USED IN NUCLEAR REACTORS; WASTE WATER REPROCESSING; WASTE WATER TREATMENT SERVICES; WASTE WATER TREATMENT SERVICES FOR INDUSTRIAL PURPOSES; WATER DEMINERALIZATION; WATER FILTRATION AND CONDITIONING SERVICES; WATER RECYCLING AND DESALINATION SERVICES; WATER TREATING; WATER TREATMENT AND PURIFICATION; WATER TREATMENT SERVICES (U.S. CLS. 100, 103 AND 106).

TRACY WHITTAKER-BROWN, EXAMINING ATTORNEY

SN 77-944,095. LINCOLN INDUSTRIES, INC., LINCOLN, NE. FILED 2-24-2010.



NO CLAIM IS MADE TO THE EXCLUSIVE RIGHT TO USE "POWERED BY" OR "TECHNOLOGY", APART FROM THE MARK AS SHOWN.

THE COLOR(S) GRAY IS/ARE CLAIMED AS A FEATURE OF THE MARK.

THE MARK CONSISTS OF THE WORD "NEVERBLUE" WHICH APPEARS IN A LARGE FONT WITH THE LETTERS "N" AND "B" IN CAPITAL LETTERS AND THE REST OF THE WORD IN SMALL LETTERS. OVER THE LETTERS "EVER" AND BETWEEN THE LETTERS "N" AND "B" IN THE WORD "NEVERBLUE" ARE THE WORDS "POWERED BY" IN SMALL CAPS. BELOW THE WORD "NEVERBLUE", BEGINNING AT THE FIRST "E" AND ENDING AT THE LAST "E" IS THE WORD "TECHNOLOGY" IN CAPITAL LETTERS WITH ONE SPACE BETWEEN EACH LETTER. ALL WORDS ARE IN THE COLOR GRAY.

FOR MATERIAL PROCESSING, NAMELY, APPLYING A FINISH TO MAINTAIN THE HIGH LUSTER AND BRIGHT APPEARANCE OF CHROME USED IN HIGH TEMPERATURE APPLICATIONS (U.S. CLS. 100, 103 AND 106).

FIRST USE 1-4-2010; IN COMMERCE 1-4-2010. DOMINIC J. FERRAIUOLO, EXAMINING ATTORNEY

SN 79-073,593. TECNOAL SRL, ITALY, FILED 8-12-2009.



THE MARK CONSISTS OF STANDARD CHARACTERS WITHOUT CLAIM TO ANY PARTICULAR FONT, STYLE, SIZE, OR COLOR.

PRIORITY DATE OF 4-30-2009 IS CLAIMED. OWNER OF INTERNATIONAL REGISTRATION 1015252 DATED 8-12-2009, EXPIRES 8-12-2019.

FOR METAL TREATING, NAMELY, METAL WORKING AND FINISHING, OXIDATION OF METALLIC MATERIAL, ANODIZING OF METALLIC SECTIONS, AND ANODIZING OF ALUMINIUM SHEETS (U.S. CLS. 100, 103 AND 106).

MEGHAN REINHART, EXAMINING ATTORNEY

CLASS 41—EDUCATION AND ENTERTAINMENT

SN 76-698,396. UNIVISION COMMUNICATIONS INC., LOS ANGELES, CA. FILED 7-13-2009.

ESTRELLAS EN CONCIERTO

THE MARK CONSISTS OF STANDARD CHARACTERS WITHOUT CLAIM TO ANY PARTICULAR FONT, STYLE, SIZE, OR COLOR.

NO CLAIM IS MADE TO THE EXCLUSIVE RIGHT TO USE "CONCIERTO", APART FROM THE MARK AS SHOWN.

THE ENGLISH TRANSLATION OF "ESTRELLAS EN CONCIERTO" IS STARS IN CONCERT.

FOR RADIO PROGRAMMING SERVICES, NAMELY, AN ONGOING RADIO PROGRAM FEATURING RECORDED MUSIC (U.S. CLS. 100, 101 AND 107).

FIRST USE 6-30-1993; IN COMMERCE 6-30-1993.
SANI KHOURI, EXAMINING ATTORNEY

SN 76-700,069. ROBERT GOTTFRIED, WEST HARTFORD, CT. FILED 10-26-2009.

ROB THE DRUMMER

THE MARK CONSISTS OF STANDARD CHARACTERS WITHOUT CLAIM TO ANY PARTICULAR FONT, STYLE, SIZE, OR COLOR.

NO CLAIM IS MADE TO THE EXCLUSIVE RIGHT TO USE "DRUMMER", APART FROM THE MARK AS SHOWN.

FOR ENTERTAINMENT SERVICES, NAMELY, LIVE MUSICAL PERFORMANCES DIRECTED TO CHILDREN (U.S. CLS. 100, 101 AND 107).

FIRST USE 1-1-1976; IN COMMERCE 5-1-1980.
ANN E. SAPPENFIELD, EXAMINING ATTORNEY

SN 76-701,081. SAPELO, LLC, EUGENE, OR. FILED 1-4-2010.

NATUREFIND

THE MARK CONSISTS OF STANDARD CHARACTERS WITHOUT CLAIM TO ANY PARTICULAR FONT, STYLE, SIZE, OR COLOR.

FOR ONLINE OR MOBILE INFORMATION SERVICE, NAMELY, PROVIDING INFORMATION ABOUT RECREATIONAL LOCATIONS, ACTIVITIES AND EVENTS WHERE YOU CAN EXPERIENCE NATURE (U.S. CLS. 100, 101 AND 107).

FIRST USE 7-1-2001; IN COMMERCE 7-1-2001.
BARBARA BROWN, EXAMINING ATTORNEY

CLASS 41—(Continued).

SN 77-023,056. ENERGY SPORTS AND FITNESS INTERNATIONAL, LLC, LEXINGTON, KY. FILED 10-17-2006.



NO CLAIM IS MADE TO THE EXCLUSIVE RIGHT TO USE "SPORTS & FITNESS", APART FROM THE MARK AS SHOWN.

THE MARK CONSISTS OF A CURSIVE LOWER CASE LETTER "E" WITH TWO TRAILING MARKS ABOVE THE LINE OF THE "E" AT THE LEFT SIDE ENDING WITHIN THE LOOP OF THE LETTER AND THE CAPITALIZED WORD "ENERGY" UNDERNEATH THE LETTER "E" AND THE CAPITALIZED WORDS "SPORTS & FITNESS" CENTERED BENEATH THE WORD "ENERGY".

FOR PHYSICAL FITNESS CONDITIONING CLASSES; PHYSICAL FITNESS CONSULTATION; PHYSICAL FITNESS INSTRUCTION; PROVIDING FITNESS AND EXERCISE FACILITIES (U.S. CLS. 100, 101 AND 107).

DAWN FELDMAN, EXAMINING ATTORNEY

SN 77-465,405. ONLY MAKE BELIEVE, INC., NEW YORK, NY. FILED 5-5-2008.



THE MARK CONSISTS OF A TRUNK WITH THE LETTERS "OMB" DISPLAYED ON IT IN STYLIZED LETTERING. TWO THEATRICAL MASKS ARE DISPLAYED COMING OUT OF THE TRUNK.

FOR CHARITABLE SERVICES, NAMELY, PLANNING, CONDUCTING AND PROVIDING THEATRICAL WORKSHOPS TO CHILDREN; CHILDREN'S ENTERTAINMENT IN THE NATURE OF PLAYS, SHOWS, PERFORMANCES AND THEATER; PLANNING, DIRECTION AND PRESENTATION OF PLAYS, SHOWS, PERFORMANCES AND THEATER FOR CHILDREN; EDUCATION SERVICES, NAMELY, TEACHING IN THE FIELD OF PLAYS, SHOWS, PERFORMANCES AND THEATER FOR CHILDREN (U.S. CLS. 100, 101 AND 107).

FIRST USE 7-20-2001; IN COMMERCE 7-20-2001.
NAKIA HENRY, EXAMINING ATTORNEY

CLASS 41—(Continued).

SN 77-480,598. PUSSYCAT DOLLS, LLC, SANTA MONICA, CA. FILED 5-21-2008.



THE MARK CONSISTS OF THE WORDS "PUSSYCAT DOLLS" WITHIN A HEART, WITH THE WORD "PUSSYCAT" PLACED ON A BANNER DISPLAYED ACROSS THE UPPER PART OF THE HEART, THE WORD "DOLLS" DISPLAYED ON THE HEART UNDER THE BANNER AND AN ORNAMENTAL DESIGN ON THE TOP OF THE HEART.

FOR PRODUCTION OF TELEVISION AND RADIO PROGRAMS; DISTRIBUTION OF TELEVISION AND RADIO PROGRAMS FOR OTHERS; PRODUCTION AND PUBLISHING OF MUSIC; PROVIDING ONLINE ENTERTAINMENT, NAMELY, NON-DOWNLOADABLE SOUND AND VIDEO RECORDINGS IN THE FIELD OF MUSIC AND MUSIC BASED ENTERTAINMENT; ENTERTAINMENT SERVICES, NAMELY, PROVIDING ONLINE NON-DOWNLOADABLE PRERECORDED MUSICAL SOUND AND VIDEO RECORDINGS VIA A GLOBAL COMPUTER NETWORK; FAN CLUBS; DEVELOPMENT AND DISSEMINATION OF EDUCATIONAL MATERIALS OF OTHERS IN THE FIELD OF MUSIC AND ENTERTAINMENT; RADIO ENTERTAINMENT PRODUCTION AND DISTRIBUTION; AUDIO AND SOUND RECORDING AND PRODUCTION; RECORD PRODUCTION; VIDEOTAPE PRODUCTION; PRODUCTION OF MOTION PICTURE FILMS; DISTRIBUTION OF MOTION PICTURE FILMS; TELEVISION PROGRAM SYNDICATION; ENTERTAINMENT IN THE NATURE OF ONGOING TELEVISION PROGRAMS IN THE FIELD OF MUSIC AND MUSIC-RELATED ENTERTAINMENT; ENTERTAINMENT, NAMELY, A CONTINUING MUSIC AND MUSIC-RELATED ENTERTAINMENT SHOW DISTRIBUTED OVER TELEVISION, SATELLITE, AUDIO, AND VIDEO MEDIA; PUBLICATION OF BOOKS AND MAGAZINES; ENTERTAINMENT IN THE NATURE OF ONGOING RADIO PROGRAMS IN THE FIELD OF MUSIC; ENTERTAINMENT IN THE NATURE OF LIVE CONCERTS AND PERFORMANCES BY MUSICAL ARTISTS AND GROUPS; ENTERTAINMENT SERVICES, NAMELY, PERSONAL APPEARANCES BY MUSICAL GROUPS, MUSICAL ARTISTS AND CELEBRITIES; ENTERTAINMENT SERVICES IN THE NATURE OF PERFORMANCES RENDERED BY MUSICAL ARTISTS THROUGH THE MEDIUM OF TELEVISION, RADIO, AND ONLINE NON-DOWNLOADABLE AUDIO AND VIDEO RECORDINGS; ENTERTAINMENT SERVICES, NAMELY, PERFORMANCES BY MUSICAL ARTISTS RENDERED LIVE AND RECORDED FOR FUTURE DISTRIBUTION; EDUCATIONAL AND ENTERTAINMENT SERVICES, NAMELY, PRODUCTION AND PRESENTATION OF TELEVISION SHOWS, SPORTS EVENTS, FASHION SHOWS, GAME SHOWS, MUSIC SHOWS, AWARD SHOWS AND COMEDY SHOWS BEFORE LIVE AUDIENCES WHICH ARE ALL BROADCAST LIVE OR TAPED FOR LATER BROADCAST. ENTERTAINMENT SERVICES, NAMELY, PROVIDING

CLASS 41—(Continued).

A WEB SITE FEATURING NON-DOWNLOADABLE MUSICAL PERFORMANCES, MUSICAL VIDEOS, RELATED FILM CLIPS, PHOTOGRAPHS, AND OTHER MULTIMEDIA MATERIALS; ENTERTAINMENT SERVICES, NAMELY, PROVIDING ON-LINE REVIEWS OF MUSIC, MUSICAL ARTISTS AND MUSIC VIDEOS; ENTERTAINMENT SERVICES, NAMELY, PROVIDING PRERECORDED NON-DOWNLOADABLE MUSIC, INFORMATION IN THE FIELD OF MUSIC, AND COMMENTARY AND ARTICLES ABOUT MUSIC, ALL ON-LINE VIA A GLOBAL COMPUTER NETWORK; ENTERTAINMENT SERVICES NAMELY, LIVE, TELEVISED AND MOVIE APPEARANCES BY A PROFESSIONAL ENTERTAINER; CONDUCTING ENTERTAINMENT EXHIBITIONS IN THE NATURE OF MUSIC FESTIVALS; ENTERTAINMENT SERVICES, NAMELY, CONDUCTING EXHIBITIONS IN THE FIELD OF MUSIC AND THE ARTS; ORGANIZING EXHIBITIONS FOR ENTERTAINMENT PURPOSES FEATURING MUSIC AND THE ARTS; AND PUBLISHING OF WEB MAGAZINES (U.S. CLS. 100, 101 AND 107).

ANN E. SAPPENFIELD, EXAMINING ATTORNEY

SN 77-523,564. LOGICAL KINETICS LLC, NEW YORK, NY. FILED 7-16-2008.

LOGIC

THE MARK CONSISTS OF STANDARD CHARACTERS WITHOUT CLAIM TO ANY PARTICULAR FONT, STYLE, SIZE, OR COLOR.

FOR PROVIDING ASSISTANCE, PERSONAL TRAINING AND PHYSICAL FITNESS CONSULTATION TO INDIVIDUALS TO HELP THEM MAKE PHYSICAL FITNESS, STRENGTH, CONDITIONING, AND EXERCISE IMPROVEMENT IN THEIR DAILY LIVING (U.S. CLS. 100, 101 AND 107).

JOHN E. MICHOS, EXAMINING ATTORNEY

SN 77-604,443. ALEXANDRA MARIA ROSSI, KEY BISCAYNE, FL. FILED 10-30-2008.

LA DOLCE VITA

THE MARK CONSISTS OF STANDARD CHARACTERS WITHOUT CLAIM TO ANY PARTICULAR FONT, STYLE, SIZE, OR COLOR.

FOR CABLE TELEVISION PROGRAMMING; DIRECTION OF MAKING RADIO OR TELEVISION PROGRAMS; DISTRIBUTION OF TELEVISION PROGRAMMING TO CABLE TELEVISION SYSTEMS; DISTRIBUTION OF TELEVISION PROGRAMS FOR OTHERS; EDUCATIONAL SERVICES, NAMELY, CONDUCTING INFORMAL PROGRAMS IN THE FIELDS OF TRAVEL AND EDUCATION AND LIFE, USING ONLINE ACTIVITIES AND INTERACTIVE EXHIBITS, AND PRINTABLE MATERIALS DISTRIBUTED THEREWITH; ENTERTAINMENT IN THE NATURE OF ONGOING TELEVISION PROGRAMS IN THE FIELD OF EDUCATIONAL AND TRAVEL AND LIFE; ENTERTAINMENT SERVICES IN THE NATURE OF AN ONGOING REALITY BASED TELEVISION PROGRAM; ENTERTAINMENT SERVICES IN THE NATURE OF AN ONGOING IPTV (INTERNET PROTOCOL TELEVISION), TELEVI-

CLASS 41—(Continued).

SION PROGRAMMING SEGMENTS IN THE FIELD OF POSITIVE PSYCHOLOGY, PERSONAL RELATIONSHIPS, THE ART AND SCIENCE OF HAPPINESS; ENTERTAINMENT SERVICES, NAMELY, A MULTIMEDIA PROGRAM SERIES FEATURING COMEDY, ACTION AND ADVENTURE DISTRIBUTED VIA VARIOUS PLATFORMS ACROSS MULTIPLE FORMS OF TRANSMISSION MEDIA; ENTERTAINMENT SERVICES, NAMELY, PROVIDING A RADIO PROGRAM IN THE FIELD OF TRAVEL AND LIFE VIA A GLOBAL COMPUTER NETWORK; ENTERTAINMENT SERVICES, NAMELY, PROVIDING A TELEVISION PROGRAM IN THE FIELD OF EDUCATION, TRAVEL AND LIFE VIA A GLOBAL COMPUTER NETWORK; PRODUCTION AND DISTRIBUTION OF RADIO PROGRAMS; PRODUCTION OF CABLE TELEVISION PROGRAMS; PRODUCTION OF CLOSED CAPTION TELEVISION PROGRAMS; PRODUCTION OF DVDS, VIDEOTAPES AND TELEVISION PROGRAMS FEATURING EDUCATION AND TRAVEL AND LIFE; PRODUCTION OF RADIO AND TELEVISION PROGRAMS; PRODUCTION OF RADIO OR TELEVISION PROGRAMS; PRODUCTION OF RADIO PROGRAMS; PRODUCTION OF TELEVISION PROGRAMS; PROGRAMMING ON A GLOBAL COMPUTER NETWORK; RADIO PROGRAM SYNDICATION; TELEVISION AND RADIO PROGRAMMING; TELEVISION PROGRAM SYNDICATION; TELEVISION PROGRAMMING; TELEVISION SCHEDULING (U.S. CLS. 100, 101 AND 107).

FIRST USE 6-1-2008; IN COMMERCE 6-1-2008.
WENDY JUN, EXAMINING ATTORNEY

CLASS 41—(Continued).

SN 77-622,055. GOUAULT-KUCZER, SEBASTIEN, LOS ANGELES, CA. FILED 11-25-2008.

KAMAG

THE MARK CONSISTS OF STANDARD CHARACTERS WITHOUT CLAIM TO ANY PARTICULAR FONT, STYLE, SIZE, OR COLOR.

THE ENGLISH TRANSLATION OF "KAMAG" IN THE MARK IS RELATIVE.

FOR MARTIAL ARTS INSTRUCTION; PHYSICAL FITNESS INSTRUCTION (U.S. CLS. 100, 101 AND 107).
SEAN CROWLEY, EXAMINING ATTORNEY

SN 77-614,900. TAKE-TWO INTERACTIVE SOFTWARE, INC., NEW YORK, NY. FILED 11-14-2008.



OWNER OF U.S. REG. NOS. 2,391,635, 3,351,855 AND OTHERS.

THE MARK CONSISTS OF A STYLIZED "R" WITH A STAR ON THE RIGHT.

FOR ENTERTAINMENT SERVICES, NAMELY, PROVIDING ONLINE GAMES, PROVIDING A WEBSITE FEATURING COMPUTER GAMES AND VIDEO GAMES, AND NEWS, INFORMATION, TIPS, HINTS, CONTESTS, COMPUTER INTERFACE THEMES, ENHANCEMENTS, AUDIO-VISUAL CONTENT, MUSIC, FILMS, VIDEOS, TELEVISION PROGRAMS, ANIMATED SERIES, AND OTHER MULTIMEDIA MATERIALS IN THE FIELD OF COMPUTER GAMES AND VIDEO GAMES; PROVIDING INFORMATION, NEWS AND COMMENTARY IN THE FIELD OF COMPUTER GAMES AND VIDEO GAMES (U.S. CLS. 100, 101 AND 107).

FIRST USE 4-30-1999; IN COMMERCE 4-30-1999.
MARCIE MILONE, EXAMINING ATTORNEY

SN 77-637,460. BROWN, RALANDRIA, HOUSTON, TX. FILED 12-21-2008.

LOVELY MONAY

THE MARK CONSISTS OF STANDARD CHARACTERS WITHOUT CLAIM TO ANY PARTICULAR FONT, STYLE, SIZE, OR COLOR.

THE NAME SHOWN IN THE MARK IDENTIFIES RALANDRIA BROWN, WHOSE CONSENT TO REGISTER IS MADE OF RECORD.

FOR ENTERTAINMENT IN THE NATURE OF PROVIDING A WEBSITE FEATURING MUSICAL ENTERTAINMENT BY A MUSICAL ARTIST; ENTERTAINMENT SERVICES IN THE NATURE OF LIVE MUSICAL PERFORMANCES; ENTERTAINMENT SERVICES, NAMELY, PROVIDING A WEB SITE FEATURING MUSICAL PERFORMANCES, MUSICAL VIDEOS, RELATED FILM CLIPS, PHOTOGRAPHS, AND OTHER MULTIMEDIA MATERIALS FEATURING MUSIC AND MUSICAL ARTISTS; ENTERTAINMENT SERVICES, NAMELY, PROVIDING WEBCASTS IN THE FIELD OF MUSIC; ENTERTAINMENT, NAMELY, LIVE MUSIC CONCERTS; ENTERTAINMENT, NAMELY, PRODUCTION OF MUSIC (U.S. CLS. 100, 101 AND 107).

FIRST USE 0-0-2007; IN COMMERCE 0-0-2007.
ANDREW LEASER, EXAMINING ATTORNEY

CLASS 41—(Continued).

SN 77-651,076. NEEWOLLAH, INC., INDEPENDENCE, KS. FILED 1-16-2009.

NEEWOLLAH

THE MARK CONSISTS OF STANDARD CHARACTERS WITHOUT CLAIM TO ANY PARTICULAR FONT, STYLE, SIZE, OR COLOR.

FOR ORGANIZING COMMUNITY FESTIVALS FEATURING A VARIETY OF ACTIVITIES, NAMELY, ART EXHIBITIONS, HERITAGE MARKETS, ETHNIC DANCES, AND THE LIKE; ORGANIZING COMMUNITY SPORTING AND CULTURAL EVENTS; SPECIAL EVENT PLANNING (U.S. CLS. 100, 101 AND 107).

FIRST USE 7-15-1919; IN COMMERCE 10-15-1919.
LAURA HAMMEL, EXAMINING ATTORNEY

SN 77-656,652. HISTORICAL MINIATURES GAMING SOCIETY, INC., BEL AIR, MD. FILED 1-26-2009.

COLD WARS

THE MARK CONSISTS OF STANDARD CHARACTERS WITHOUT CLAIM TO ANY PARTICULAR FONT, STYLE, SIZE, OR COLOR.

FOR EDUCATIONAL AND ENTERTAINMENT SERVICES, NAMELY, ARRANGING, ORGANIZING AND CONDUCTING CONFERENCES AND CONVENTIONS IN THE FIELD OF HISTORICAL RESEARCH, WAR GAMES AND BOARD GAMES; EDUCATIONAL AND ENTERTAINMENT SERVICES, NAMELY, PROVIDING FACILITIES FOR CONFERRING AND CONDUCTING HISTORICAL RESEARCH AND PLAYING WAR GAMES AND BOARD GAMES; EDUCATIONAL AND ENTERTAINMENT SERVICES, NAMELY, PROVIDING A WEB SITE FEATURING HISTORICAL RESEARCH AND INFORMATION ON WAR GAMES AND BOARD GAMES (U.S. CLS. 100, 101 AND 107).

KELLY TRUSILO, EXAMINING ATTORNEY

SN 77-656,872. THE HAROLD E. LEMAY MUSEUM, TACOMA, WA. FILED 1-26-2009.

CLUB AUTO

THE MARK CONSISTS OF STANDARD CHARACTERS WITHOUT CLAIM TO ANY PARTICULAR FONT, STYLE, SIZE, OR COLOR.

NO CLAIM IS MADE TO THE EXCLUSIVE RIGHT TO USE "AUTO", APART FROM THE MARK AS SHOWN.

FOR MUSEUM SERVICES FEATURING A MEMBERSHIP PROGRAM (U.S. CLS. 100, 101 AND 107).

FIRST USE 1-1-2005; IN COMMERCE 1-1-2005.
DANIEL CAPSHAW, EXAMINING ATTORNEY

CLASS 41—(Continued).

SN 77-657,975. OHIGO, INC., FITCHBURG, WI. FILED 1-27-2009.

MUSICSTREAKER

THE MARK CONSISTS OF STANDARD CHARACTERS WITHOUT CLAIM TO ANY PARTICULAR FONT, STYLE, SIZE, OR COLOR.

FOR PROVIDING A WEBSITE FEATURING INTERACTIVE INFORMATION RELATING TO MUSIC (U.S. CLS. 100, 101 AND 107).

FIRST USE 11-30-2007; IN COMMERCE 12-19-2008.
BARBARA GAYNOR, EXAMINING ATTORNEY

SN 77-659,318. 5 STAR ATHLETICS, LLC, MECHANICSVILLE, MD. FILED 1-29-2009.



NO CLAIM IS MADE TO THE EXCLUSIVE RIGHT TO USE "ATHLETICS", APART FROM THE MARK AS SHOWN.

THE MARK CONSISTS OF THE WORDING "5 STAR ATHLETICS" WITH FIVE STAR FIGURES FORMING AN INCOMPLETE CIRCLE AROUND THE "5" ALL CONTAINED WITHIN A RECTANGLE.

FOR (BASED ON USE IN COMMERCE) INSTRUCTION IN THE FIELD OF FASTPITCH SOFTBALL; PROFESSIONAL COACHING SERVICES IN THE FIELD OF FASTPITCH SOFTBALL; SOFTBALL CAMPS; SPORT CAMPS; SUMMER CAMPS (BASED ON INTENT TO USE) AMATEUR YOUTH SPORTS SERVICES, NAMELY, ORGANIZING AND PROVIDING YOUTH SPORTS ACTIVITIES; OPERATION OF SPORTS CAMPS (U.S. CLS. 100, 101 AND 107).

FIRST USE 5-0-2004; IN COMMERCE 8-0-2004.
MEGHAN REINHART, EXAMINING ATTORNEY

CLASS 41—(Continued).

SN 77-666,493. SCRIPPS NETWORKS, LLC, KNOXVILLE, TN. FILED 2-9-2009.

REAL ESTATE INTERVENTION

THE MARK CONSISTS OF STANDARD CHARACTERS WITHOUT CLAIM TO ANY PARTICULAR FONT, STYLE, SIZE, OR COLOR.

NO CLAIM IS MADE TO THE EXCLUSIVE RIGHT TO USE "REAL ESTATE", APART FROM THE MARK AS SHOWN.

FOR EDUCATIONAL AND ENTERTAINMENT SERVICES, NAMELY, A CONTINUING PROGRAM ABOUT HOME BUYING AND HOME SELLING, ACCESSIBLE BY RADIO, TELEVISION, CABLE, FIBER OPTIC NETWORKS, WIRELESS NETWORKS, SATELLITE, AUDIO VIDEO, AND COMPUTER NETWORKS (U.S. CLS. 100, 101 AND 107).

TEJBIR SINGH, EXAMINING ATTORNEY

SN 77-666,563. M.A. MORTENSON COMPANY, MINNEAPOLIS, MN. FILED 2-9-2009.

DISCOVER RENEWABLES

THE MARK CONSISTS OF STANDARD CHARACTERS WITHOUT CLAIM TO ANY PARTICULAR FONT, STYLE, SIZE, OR COLOR.

NO CLAIM IS MADE TO THE EXCLUSIVE RIGHT TO USE "RENEWABLES", APART FROM THE MARK AS SHOWN.

FOR EDUCATIONAL SERVICES, NAMELY, CONDUCTING PROGRAMS FEATURING EDUCATIONAL INFORMATION IN THE FIELD OF SUSTAINABLE AND RENEWABLE ENERGY CONSTRUCTION ACCESSIBLE VIA A WEBSITE, AND DISTRIBUTION OF COURSE MATERIALS THEREWITH (U.S. CLS. 100, 101 AND 107).

FIRST USE 8-21-2008; IN COMMERCE 8-21-2008.
HOWARD B. LEVINE, EXAMINING ATTORNEY

SN 77-671,589. MULTI MEDIA PRODUCTIONS, LLC, BLUE BELL, PA. FILED 2-16-2009.

A Taste of History

THE MARK CONSISTS OF STANDARD CHARACTERS WITHOUT CLAIM TO ANY PARTICULAR FONT, STYLE, SIZE, OR COLOR.

FOR ENTERTAINMENT SERVICES IN THE NATURE OF AN ONGOING TELEVISION SERIES IN THE FIELD OF HISTORIC COOKING (U.S. CLS. 100, 101 AND 107).

FIRST USE 1-9-2009; IN COMMERCE 2-7-2009.
AMY ALFIERI, EXAMINING ATTORNEY

CLASS 41—(Continued).

SN 77-677,388. FINE LIVING NETWORK, LLC, KNOXVILLE, TN. FILED 2-24-2009.

BARTENDER WARS

THE MARK CONSISTS OF STANDARD CHARACTERS WITHOUT CLAIM TO ANY PARTICULAR FONT, STYLE, SIZE, OR COLOR.

NO CLAIM IS MADE TO THE EXCLUSIVE RIGHT TO USE "BARTENDER", APART FROM THE MARK AS SHOWN.

FOR EDUCATIONAL AND ENTERTAINMENT SERVICES, NAMELY, A CONTINUING PROGRAM ABOUT SERVING FOOD AND BEVERAGES, ACCESSIBLE BY RADIO, TELEVISION, CABLE, FIBER OPTIC NETWORKS, WIRELESS NETWORKS, SATELLITE, AUDIO VIDEO, AND COMPUTER NETWORKS (U.S. CLS. 100, 101 AND 107).

ASMAT KHAN, EXAMINING ATTORNEY

SN 77-686,318. VANS, INC., CYPRESS, CA. FILED 3-9-2009.

TRIPLE CROWN

THE MARK CONSISTS OF STANDARD CHARACTERS WITHOUT CLAIM TO ANY PARTICULAR FONT, STYLE, SIZE, OR COLOR.

OWNER OF U.S. REG. NOS. 2,023,608, 2,245,145 AND OTHERS.

FOR ENTERTAINMENT SERVICES, NAMELY, ORGANIZING AND CONDUCTING INTERNATIONAL COMPETITIONS IN THE FIELD OF OCEAN SPORTS (U.S. CLS. 100, 101 AND 107).

FIRST USE 12-1-1981; IN COMMERCE 12-1-1981.
MICHAEL ENGEL, EXAMINING ATTORNEY

CLASS 41—(Continued).

SN 77-687,985. ANDERSON, JESSE WILLIAM 2, DBA TEDRIOT, WARREN, MI. FILED 3-11-2009.

TEDRIOT

THE MARK CONSISTS OF STANDARD CHARACTERS WITHOUT CLAIM TO ANY PARTICULAR FONT, STYLE, SIZE, OR COLOR.

THE NAME "TEDRIOT" IDENTIFIES THE PSEUDONYM OF "JESSE WILLIAM ANDERSON II" A LIVING INDIVIDUAL WHOSE CONSENT IS OF RECORD.

FOR ENTERTAINMENT IN THE NATURE OF AN ONGOING SPECIAL, VARIETY, NEWS IN THE NATURE OF CURRENT EVENTS, MUSIC AND COMEDY SHOW FEATURING LIVE AND RECORDED AUDIO AND VISUAL PERFORMANCES IN THE NATURE OF REFLECTIONS ON THE TRAGEDY AND COMEDY OF EARTHLY EXISTENCE AND UNIVERSAL KNOWLEDGE BROADCAST OVER TELEVISION, SATELLITE, AUDIO, AND VIDEO MEDIA (U.S. CLS. 100, 101 AND 107).

JULIE GUTTADAURO, EXAMINING ATTORNEY

CLASS 41—(Continued).

SN 77-744,196. BONNIER ACTIVE MEDIA, INC., FORMERLY TIME4 MEDIA, INC., WINTER PARK, FL. FILED 5-26-2009.

Transworld SKATEBoarding Awards

THE MARK CONSISTS OF STANDARD CHARACTERS WITHOUT CLAIM TO ANY PARTICULAR FONT, STYLE, SIZE, OR COLOR.

OWNER OF U.S. REG. NOS. 1,544,400, 2,382,801 AND 2,395,477.

NO CLAIM IS MADE TO THE EXCLUSIVE RIGHT TO USE "SKATEBOARDING AWARDS", APART FROM THE MARK AS SHOWN.

FOR ENTERTAINMENT SERVICES, NAMELY, AN ANNUAL AWARD PROGRAM FOR PRESENTATION OF AWARDS IN RECOGNITION OF DISTINGUISHED ACHIEVEMENT IN THE FIELD OF SKATEBOARDING; EDUCATIONAL SERVICES, NAMELY, PROVIDING INCENTIVES TO PERSONS TO DEMONSTRATE EXCELLENCE IN THE FIELD OF SKATEBOARDING THROUGH THE ISSUANCE OF AWARDS (U.S. CLS. 100, 101 AND 107).

FIRST USE 2-0-1998; IN COMMERCE 6-0-1998.

VIVIAN MICZNIK FIRST, EXAMINING ATTORNEY

SN 77-741,605. DOUBLE DOG SPORTS & ENTERTAINMENT, LLC, INDEPENDENCE, MO. FILED 5-20-2009.

HORSE N AROUND HOOPS

THE MARK CONSISTS OF STANDARD CHARACTERS WITHOUT CLAIM TO ANY PARTICULAR FONT, STYLE, SIZE, OR COLOR.

NO CLAIM IS MADE TO THE EXCLUSIVE RIGHT TO USE "HOOPS", APART FROM THE MARK AS SHOWN.

FOR ENTERTAINMENT SERVICES, NAMELY, ORGANIZING BASKETBALL TOURNAMENTS AND EXHIBITION GAMES, AND SPECIAL EVENTS; PROGRAMS, SEGMENTS AND SHOWS, NAMELY, AN ONGOING REALITY BASED TELEVISION PROGRAM, FEATURING COMPETITIONS, CONTESTS, SPORTS EVENTS AND COMEDY DELIVERED BY TELEVISION, RADIO, SATELLITE, THE INTERNET OR LIVE (U.S. CLS. 100, 101 AND 107).

SEAN CROWLEY, EXAMINING ATTORNEY

SN 77-753,258. DATASSURANT INC., RESTON, VA. FILED 6-5-2009.

EASYSAQ

THE MARK CONSISTS OF STANDARD CHARACTERS WITHOUT CLAIM TO ANY PARTICULAR FONT, STYLE, SIZE, OR COLOR.

FOR EDUCATIONAL SERVICES, NAMELY, CONDUCTING ONLINE AND OFFLINE TRAINING IN THE FIELD OF PAYMENT CARD SECURITY AND PAYMENT DATA SECURITY; EDUCATIONAL SERVICES, NAMELY, CONDUCTING ONLINE AND OFFLINE TRAINING IN THE FIELD OF APPLICATION SECURITY, SCANNING AND COMPLIANCE IN THE FIELD OF PAYMENT CARD SECURITY AND PAYMENT DATA SECURITY; AND CONDUCTING TRAINING WORKSHOPS, ON-LINE SEMINARS, SEMINARS AND TRAINING CONFERENCES IN THE FIELD OF PAYMENT CARD SECURITY AND PAYMENT DATA SECURITY, AND DISTRIBUTION OF TRAINING MATERIAL IN CONNECTION THEREWITH (U.S. CLS. 100, 101 AND 107).

FIRST USE 1-28-2009; IN COMMERCE 1-28-2009.

ALEXANDER L. POWERS, EXAMINING ATTORNEY

CLASS 41—(Continued).

SN 77-761,001. NANCY SHEPHERD, LUBBOCK, TX. FILED 6-16-2009.

GLOBAL FUSION Educational
Resources

THE MARK CONSISTS OF STANDARD CHARACTERS WITHOUT CLAIM TO ANY PARTICULAR FONT, STYLE, SIZE, OR COLOR.

NO CLAIM IS MADE TO THE EXCLUSIVE RIGHT TO USE "GLOBAL" OR "EDUCATIONAL RESOURCES", APART FROM THE MARK AS SHOWN.

FOR ACADEMIC ENRICHMENT PROGRAMS IN THE FIELDS OF FAMILY AND CONSUMER SCIENCES USING INTERACTIVE LEARNING AND HANDS ON LEARNING METHODS, SUCH AS TRAVELING TRUNKS; ARRANGEMENT OF TRAINING COURSES IN TEACHING INSTITUTES; CONDUCTING EDUCATIONAL EXHIBITIONS IN THE NATURE OF INTERACTIVE LEARNING TRAVELING TRUNK DISPLAYS AT TEACHER CONFERENCES, NOT FOR COMMERCIAL OR ADVERTISING PURPOSES; DEVELOPING EDUCATIONAL MANUALS FOR OTHERS IN THE FIELD OF FAMILY AND CONSUMER SCIENCE AND VARIOUS MEANS OF INTERACTIVE LEARNING; EDUCATION INFORMATION; EDUCATION SERVICES IN THE NATURE OF COURSES AT THE UNIVERSITY LEVEL; EDUCATIONAL SERVICES, NAMELY, DEVELOPING CURRICULUM FOR OTHERS IN THE FIELD OF FAMILY AND CONSUMER SCIENCES (U.S. CLS. 100, 101 AND 107).

FIRST USE 4-29-2009; IN COMMERCE 4-29-2009.

CHARLOTTE CORWIN, EXAMINING ATTORNEY

CLASS 41—(Continued).

SN 77-764,552. ALVAREZ, ESTEBAN GUERRERO, TA LA TRAMPA DE CHICAGO, MILWAKEE, WI. FILED 6-20-2009.



NO CLAIM IS MADE TO THE EXCLUSIVE RIGHT TO USE "DE CHICAGO", APART FROM THE MARK AS SHOWN.

THE COLOR(S) YELLOW, BLACK AND RED. IS/ARE CLAIMED AS A FEATURE OF THE MARK.

THE MARK CONSISTS OF A BEAR CLAW TRAPPED IN A TRAP TRYING TO ESCAPE THRU A WALL, SHOWING ONLY THE CLAW, WITH THE WORDING "LA TRAMPA DE CHICAGO" UNDERNEATH THE BEAR CLAW. THE WORDING AND BEAR CLAW ARE A BLEND OF YELLOW, MOSTLY ON TOP, AND RED, MOSTLY ON THE BOTTOM, ALL OUTLINED IN BLACK. THE AREA WHERE THE BEAR CLAW IS RIPPING THROUGH THE WALL IS BLACK.

THE ENGLISH TRANSLATION OF "LA TRAMPA DE CHICAGO" IN THE MARK IS THE TRAP OF CHICAGO.

FOR ENTERTAINMENT SERVICES IN THE NATURE OF LIVE MUSICAL PERFORMANCES; ENTERTAINMENT, NAMELY, LIVE MUSIC CONCERTS; ENTERTAINMENT, NAMELY, LIVE PERFORMANCES BY A MUSICAL BAND; MULTIMEDIA ENTERTAINMENT SERVICES IN THE NATURE OF RECORDING, PRODUCTION AND POST-PRODUCTION SERVICES IN THE FIELDS OF MUSIC, VIDEO, AND FILMS; PRESENTATION OF MUSICAL PERFORMANCE; PROVISION OF INFORMATION RELATING TO LIVE PERFORMANCES, ROAD SHOWS, LIVE STAGE EVENTS, THEATRICAL PERFORMANCES, LIVE MUSIC CONCERTS AND AUDIENCE PARTICIPATION IN SUCH EVENTS (U.S. CLS. 100, 101 AND 107).

GINA FINK, EXAMINING ATTORNEY

CLASS 41—(Continued).

SN 77-766,375. BEMA MEDIA LLC, SHERMAN, TX. FILED 6-23-2009.



THE MARK CONSISTS OF THE WORD "KNECT" WITH AN ELECTRICAL PLUG DESIGN IMBEDDED IN THE LETTER "T".

FOR ENTERTAINMENT SERVICES, NAMELY, PRODUCTION OF AUDIO AND AUDIO-VISUAL RECORDINGS FEATURING MUSIC AND ENTERTAINMENT; PROVIDING INFORMATION RELATING TO MUSIC AND MUSIC ENTERTAINMENT ONLINE FROM A GLOBAL COMPUTER NETWORK; PROVIDING NON-DOWNLOADABLE PRE-RECORDED MUSIC AND MUSICAL ENTERTAINMENT PERFORMANCES ONLINE FROM A GLOBAL COMPUTER NETWORK; RECORDING STUDIO SERVICES; MUSIC PRODUCTION SERVICES; MUSIC PUBLISHING SERVICES; ORGANIZING LIVE MUSICAL EVENTS; RECORDING STUDIO SERVICES, NAMELY, DEVELOPMENT OF RECORDINGS OF OTHERS IN THE NATURE OF CONSULTATION AND ADVICE REGARDING MUSICAL SELECTIONS AND ARRANGEMENTS FOR SOUND RECORDINGS AND LIVE PERFORMANCES; PROVIDING A WEBSITE FEATURING NON-DOWNLOADABLE MUSICAL PERFORMANCES, MUSICAL VIDEOS, AND PHOTOGRAPHS FEATURING MUSICAL ARTISTS (U.S. CLS. 100, 101 AND 107).

SHAILA SETTLES, EXAMINING ATTORNEY

SN 77-767,872. CBS BROADCASTING INC., NEW YORK, NY. FILED 6-25-2009.



THE MARK CONSISTS OF STANDARD CHARACTERS WITHOUT CLAIM TO ANY PARTICULAR FONT, STYLE, SIZE, OR COLOR.

FOR PROVIDING ON-LINE CONTENT AND INFORMATION IN THE FIELD OF CURRENT EVENTS RENDERED VIA THE INTERNET, PORTABLE AND WIRELESS COMMUNICATION DEVICES (U.S. CLS. 100, 101 AND 107).

FIRST USE 6-15-2009; IN COMMERCE 6-15-2009.
JANICE L. MCMORROW, EXAMINING ATTORNEY

CLASS 41—(Continued).

SN 77-769,259. STREETAUTHORITY, LLC, AUSTIN, TX. FILED 6-26-2009.



THE MARK CONSISTS OF STANDARD CHARACTERS WITHOUT CLAIM TO ANY PARTICULAR FONT, STYLE, SIZE, OR COLOR.

FOR PROVIDING NEWSLETTERS IN THE FIELD OF INVESTING VIA E-MAIL; PROVIDING ON-LINE NEWSLETTERS IN THE FIELD OF INVESTING (U.S. CLS. 100, 101 AND 107).

FIRST USE 9-3-2002; IN COMMERCE 9-3-2002.
MARK SHINER, EXAMINING ATTORNEY

SN 77-771,089. AMERICAN ACADEMY OF PHYSICIAN ASSISTANTS, ALEXANDRIA, VA. FILED 6-30-2009.



THE MARK CONSISTS OF THE WORD "IMPACT" IN LARGE BLOCK-STYLE CAPITAL LETTERS. THE "I", "M", "C" AND "T" ARE BLACK, AND THE "P" AND "A" ARE WHITE WITH BLACK OUTLINE.

FOR ARRANGING AND CONDUCTING ANNUAL EDUCATIONAL CONFERENCES FOR PHYSICIAN ASSISTANTS IN THE FIELDS OF ASSISTING DOCTORS AND EMERGENCY ROOM DOCTORS, BILLING PATIENTS, PRESCRIBING MEDICINES AND COUNSELING OTHERS (U.S. CLS. 100, 101 AND 107).

FIRST USE 6-1-2008; IN COMMERCE 6-1-2008.
SHAUNIA CARLYLE, EXAMINING ATTORNEY

SN 77-776,210. JENELLE M. ERICKSON, BOONTON, NJ. FILED 7-8-2009.



THE MARK CONSISTS OF STANDARD CHARACTERS WITHOUT CLAIM TO ANY PARTICULAR FONT, STYLE, SIZE, OR COLOR.

NO CLAIM IS MADE TO THE EXCLUSIVE RIGHT TO USE "READING", APART FROM THE MARK AS SHOWN.

FOR EDUCATIONAL SERVICES, NAMELY, CONDUCTING CLASSES, SEMINARS, CONFERENCES, AND WORKSHOPS IN THE FIELDS OF EARLY CHILDHOOD LANGUAGE AND LITERACY INSTRUCTION (U.S. CLS. 100, 101 AND 107).

FIRST USE 7-1-2009; IN COMMERCE 7-1-2009.
VERNA BETH RIRIE, EXAMINING ATTORNEY

CLASS 41—(Continued).

SN 77-777,474. XENITH, LLC, LOWELL, MA. FILED 7-9-2009.

XENITH ENLIGHTENED WARRIOR

THE MARK CONSISTS OF STANDARD CHARACTERS WITHOUT CLAIM TO ANY PARTICULAR FONT, STYLE, SIZE, OR COLOR.

FOR EDUCATIONAL SERVICES, NAMELY, PROVIDING PROGRAMS AND MOTIVATIONAL SPEAKING IN THE FIELD OF FOOTBALL (U.S. CLS. 100, 101 AND 107).
JACLYN KIDWELL WALKER, EXAMINING ATTORNEY

SN 77-777,790. RIVERA, LUIS, SANFORD, FL. FILED 7-9-2009.

CARS AND CAFÉ

THE MARK CONSISTS OF STANDARD CHARACTERS WITHOUT CLAIM TO ANY PARTICULAR FONT, STYLE, SIZE, OR COLOR.

FOR ARRANGING AND CONDUCTING AUTOMOBILE EXHIBITIONS FOR NON-COMMERCIAL PURPOSES (U.S. CLS. 100, 101 AND 107).

FIRST USE 5-31-2008; IN COMMERCE 5-31-2008.
DAVID C. REIHNER, EXAMINING ATTORNEY

SN 77-778,931. WILLIAMS, MARY EILEEN, LAFAYETTE, CA. FILED 7-10-2009.

**FEISTY SIDE OF FIFTY /
BABY BOOMER WOMEN**

THE MARK CONSISTS OF STANDARD CHARACTERS WITHOUT CLAIM TO ANY PARTICULAR FONT, STYLE, SIZE, OR COLOR.

NO CLAIM IS MADE TO THE EXCLUSIVE RIGHT TO USE "BABY BOOMER WOMEN", APART FROM THE MARK AS SHOWN.

FOR ENTERTAINMENT SERVICES, NAMELY, PROVIDING A RADIO PROGRAM IN THE FIELD OF ISSUES FOR WOMAN OVER FIFTY VIA A GLOBAL COMPUTER NETWORK; ON-LINE JOURNALS, NAMELY, BLOGS FEATURING ISSUES FOR WOMAN OVER FIFTY (U.S. CLS. 100, 101 AND 107).
MARC LEIPZIG, EXAMINING ATTORNEY

CLASS 41—(Continued).

SN 77-779,007. HANSEN, REBECCA RUTH, JAMAICA PLAIN, MA. FILED 7-11-2009.

Ecofoodie

THE MARK CONSISTS OF STANDARD CHARACTERS WITHOUT CLAIM TO ANY PARTICULAR FONT, STYLE, SIZE, OR COLOR.

FOR PUBLICATION AND EDITING OF PRINTED MATTER; WRITING OF ARTICLES FOR JOURNALS OTHER THAN FOR ADVERTISING OR PUBLICITY; WRITING OF ARTICLES FOR PROFESSIONAL JOURNALS OTHER THAN FOR ADVERTISING OR PUBLICITY; WRITTEN TEXT EDITING (U.S. CLS. 100, 101 AND 107).

MICHAEL LITZAU, EXAMINING ATTORNEY

SN 77-779,117. CHASSIN, THEA D., BRIARCLIFF MANOR, NY. FILED 7-12-2009.

Bald? So What!

THE MARK CONSISTS OF STANDARD CHARACTERS WITHOUT CLAIM TO ANY PARTICULAR FONT, STYLE, SIZE, OR COLOR.

FOR EDUCATIONAL SERVICES, NAMELY, PROVIDING SEMINARS AND WORKSHOPS ON THE SUBJECT MATTER OF INCREASED PERSONAL UNDERSTANDING AND PUBLIC AWARENESS OF BALDNESS DUE TO MEDICAL CONDITIONS; EDUCATIONAL SERVICES, NAMELY, PROVIDING SEMINARS AND WORKSHOPS REGARDING COSMETIC OPTIONS FOR BALDNESS, NAMELY, WIGS, MAKE-UP, AND OTHER HAIR REPLACEMENT SOLUTIONS FOR IMPROVING PHYSICAL APPEARANCE; PROVIDING EDUCATIONAL SERVICES IN THE NATURE OF PROVIDING SEMINARS AND WORKSHOPS FEATURING TREATMENT OPTIONS RELATING TO BALDNESS (U.S. CLS. 100, 101 AND 107).
THOMAS MANOR, EXAMINING ATTORNEY

CLASS 41—(Continued).

SN 77-779,119. CHASSIN, THEA D., BRIARCLIFF MANOR, NY. FILED 7-12-2009.

National Bald Out

THE MARK CONSISTS OF STANDARD CHARACTERS WITHOUT CLAIM TO ANY PARTICULAR FONT, STYLE, SIZE, OR COLOR.

NO CLAIM IS MADE TO THE EXCLUSIVE RIGHT TO USE "NATIONAL", APART FROM THE MARK AS SHOWN.

FOR EDUCATIONAL SERVICES, NAMELY, PROVIDING SEMINARS AND WORKSHOPS ON THE SUBJECT MATTER OF INCREASED PERSONAL UNDERSTANDING AND PUBLIC AWARENESS OF BALDNESS DUE TO MEDICAL CONDITIONS; EDUCATIONAL SERVICES, NAMELY, PROVIDING SEMINARS AND WORKSHOPS REGARDING COSMETIC OPTIONS FOR BALDNESS, NAMELY, WIGS, MAKE-UP, AND OTHER HAIR REPLACEMENT SOLUTIONS FOR IMPROVING PHYSICAL APPEARANCE; PROVIDING EDUCATIONAL SERVICES IN THE NATURE OF PROVIDING SEMINARS AND WORKSHOPS FEATURING TREATMENT OPTIONS RELATING TO BALDNESS (U.S. CLS. 100, 101 AND 107).

THOMAS MANOR, EXAMINING ATTORNEY

CLASS 41—(Continued).

SN 77-780,721. WORLDWIDE CHURCH OF GOD (AUSTRALIA) LTD., VARSITY LAKES, AUSTRALIA, FILED 7-14-2009.

AMBASSADOR COLLEGE OF CHRISTIAN MINISTRY

THE MARK CONSISTS OF STANDARD CHARACTERS WITHOUT CLAIM TO ANY PARTICULAR FONT, STYLE, SIZE, OR COLOR.

NO CLAIM IS MADE TO THE EXCLUSIVE RIGHT TO USE "COLLEGE OF CHRISTIAN MINISTRY", APART FROM THE MARK AS SHOWN.

FOR PROVIDING EDUCATIONAL SERVICES, NAMELY, PROVIDING EDUCATIONAL COURSES AND CONDUCTING SEMINARS AND CONFERENCE PRESENTATIONS IN THE FIELD OF CHRISTIANITY AND RELIGION TO EQUIP MEN AND WOMEN FOR CHRISTIAN MINISTRY (U.S. CLS. 100, 101 AND 107).

FIRST USE 5-9-2003; IN COMMERCE 5-9-2003.
REBECCA SMITH, EXAMINING ATTORNEY

SN 77-779,824. O'NEILL, PAUL M., DBA ELEVENTH HOUR PRODUCTIONS, LLC, PHOENIX, AZ. FILED 7-13-2009.

BullyBuffer

THE MARK CONSISTS OF STANDARD CHARACTERS WITHOUT CLAIM TO ANY PARTICULAR FONT, STYLE, SIZE, OR COLOR.

FOR ONLINE JOURNALS, NAMELY, BLOGS, FEATURING PERSONAL STORIES ABOUT STUDENTS' AND TEENAGERS' EXPERIENCES IN THE FACE OF BULLYING (U.S. CLS. 100, 101 AND 107).

FIRST USE 6-11-2009; IN COMMERCE 6-11-2009.
CORY BOONE, EXAMINING ATTORNEY

SN 77-782,533. CBS RADIO INC., NEW YORK, NY. FILED 7-16-2009.

HFS

THE MARK CONSISTS OF STANDARD CHARACTERS WITHOUT CLAIM TO ANY PARTICULAR FONT, STYLE, SIZE, OR COLOR.

OWNER OF U.S. REG. NO. 2,741,929.
FOR ENTERTAINMENT SERVICES, NAMELY, RADIO PROGRAMMING SERVICES (U.S. CLS. 100, 101 AND 107).

FIRST USE 2-20-2002; IN COMMERCE 2-20-2002.
TEJBIR SINGH, EXAMINING ATTORNEY

CLASS 41—(Continued).

SN 77-782,919. THE FOOD PROJECT, INC., LINCOLN, MA. FILED 7-16-2009.

REAL FOOD CHALLENGE

THE MARK CONSISTS OF STANDARD CHARACTERS WITHOUT CLAIM TO ANY PARTICULAR FONT, STYLE, SIZE, OR COLOR.

NO CLAIM IS MADE TO THE EXCLUSIVE RIGHT TO USE "REAL FOOD", APART FROM THE MARK AS SHOWN.

FOR EDUCATIONAL SERVICES, NAMELY, ORGANIZING, DEVELOPING, AND CONDUCTING TRAINING PROGRAMS, SUMMITS, SEMINARS, AND CONFERENCES IN THE FIELDS OF FARM-TO-CAFETERIA FOOD AND AGRICULTURAL PROGRAMS, GARDENING, FAIR TRADE, ORGANIC AND SUSTAINABLE FOOD PRACTICES, FARM WORKERS' RIGHTS, RELATIONSHIPS WITH LOCAL FARMERS, ALL PERTAINING TO REGIONAL AND LOCAL PROGRAMS, AND DISTRIBUTION OF TRAINING MATERIALS IN CONNECTION THEREWITH (U.S. CLS. 100, 101 AND 107).

FIRST USE 10-25-2007; IN COMMERCE 10-25-2007.
LINDA POWELL, EXAMINING ATTORNEY

SN 77-783,116. SYLER, RENE, CHAPPAQUA, NY. FILED 7-16-2009.

PERFECTLY IMPERFECT

THE MARK CONSISTS OF STANDARD CHARACTERS WITHOUT CLAIM TO ANY PARTICULAR FONT, STYLE, SIZE, OR COLOR.

OWNER OF U.S. REG. NOS. 3,509,686 AND 3,599,208.

FOR EDUCATIONAL SERVICES, NAMELY, ARRANGING AND CONDUCTING CLASSES, EDUCATIONAL CONFERENCES, RETREATS, SEMINARS AND WORKSHOPS FEATURING TOPICS OF INTEREST TO WOMEN IN THE FIELDS OF PARENTING, FAMILY, WOMANHOOD AND LIFESTYLE, AND DISTRIBUTING COURSE MATERIALS IN CONNECTION THEREWITH; ENTERTAINMENT SERVICES, NAMELY, LIVE SPEAKING PERFORMANCES AND SPEAKING ENGAGEMENTS FEATURING TOPICS OF INTEREST TO WOMEN IN THE FIELDS OF PARENTING, FAMILY, WOMANHOOD AND LIFESTYLE; PRODUCTION OF RADIO AND TELEVISION PROGRAMMING; VIDEOTAPES PRODUCTION (U.S. CLS. 100, 101 AND 107).

CYNTHIA TRIPI, EXAMINING ATTORNEY

CLASS 41—(Continued).

SN 77-783,915. PARTNERS FOR DIGITAL EQUALITY, INC., ATLANTA, GA. FILED 7-17-2009.



NO CLAIM IS MADE TO THE EXCLUSIVE RIGHT TO USE "DIGITAL EQUALITY", APART FROM THE MARK AS SHOWN.

THE MARK CONSISTS OF FANCIFUL LETTERS "PDE" INSIDE A SHADED RECTANGLE TO THE LEFT OF AN OUTLINE OF ANOTHER RECTANGLE WITH THE WORDING "PARTNERS FOR DIGITAL EQUALITY" IN BLOCK LETTER FORM.

FOR EDUCATIONAL SERVICES, NAMELY, CONDUCTING EDUCATIONAL PROGRAMS IN THE FIELD OF BROADBAND AND DIGITAL COMMUNICATION TECHNOLOGIES FOR UNDERSERVED AND UNSERVED COMMUNITIES (U.S. CLS. 100, 101 AND 107).

KAPIL BHANOT, EXAMINING ATTORNEY

SN 77-783,922. PARTNERS FOR DIGITAL EQUALITY, INC., ATLANTA, GA. FILED 7-17-2009.

PARTNERS FOR DIGITAL EQUALITY

THE MARK CONSISTS OF STANDARD CHARACTERS WITHOUT CLAIM TO ANY PARTICULAR FONT, STYLE, SIZE, OR COLOR.

NO CLAIM IS MADE TO THE EXCLUSIVE RIGHT TO USE "DIGITAL EQUALITY", APART FROM THE MARK AS SHOWN.

FOR EDUCATIONAL SERVICES, NAMELY, CONDUCTING EDUCATIONAL PROGRAMS IN THE FIELD OF BROADBAND AND DIGITAL COMMUNICATION TECHNOLOGIES FOR UNDERSERVED AND UNSERVED COMMUNITIES (U.S. CLS. 100, 101 AND 107).

KAPIL BHANOT, EXAMINING ATTORNEY

SN 77-784,572. AIN, BRYAN, HAIKU, HI. FILED 7-20-2009.

THE KIDD

THE MARK CONSISTS OF STANDARD CHARACTERS WITHOUT CLAIM TO ANY PARTICULAR FONT, STYLE, SIZE, OR COLOR.

FOR DISC JOCKEY, HOSTING AND MASTER OF CEREMONY SERVICES FEATURING AUDIO VISUAL ENTERTAINMENT AND PRE-MIXED MUSIC AND PLAY LISTS OF PRE-RECORDED SELECTIONS, FOR PARTIES AND SPECIAL EVENTS (U.S. CLS. 100, 101 AND 107).

FIRST USE 1-15-1987; IN COMMERCE 1-15-1987.

JEFF DEFORD, EXAMINING ATTORNEY

CLASS 41—(Continued).

SN 77-785,982. HUMANEX ACADEMY, LLC, COLUMBIA, MD. FILED 7-21-2009.

HUMANEX ACADEMY

THE MARK CONSISTS OF STANDARD CHARACTERS WITHOUT CLAIM TO ANY PARTICULAR FONT, STYLE, SIZE, OR COLOR.

NO CLAIM IS MADE TO THE EXCLUSIVE RIGHT TO USE "ACADEMY", APART FROM THE MARK AS SHOWN. FOR PROVIDING COURSES OF INSTRUCTION AT THE SECONDARY LEVEL (U.S. CLS. 100, 101 AND 107).

FIRST USE 0-0-1983; IN COMMERCE 0-0-1983.
SAIMA MAKHDOOM, EXAMINING ATTORNEY

CLASS 41—(Continued).

SN 77-787,232. THE CHILDREN'S MUSEUM OF HOUSTON, HOUSTON, TX. FILED 7-22-2009.

PLAYGROUND FOR YOUR MIND!

THE MARK CONSISTS OF STANDARD CHARACTERS WITHOUT CLAIM TO ANY PARTICULAR FONT, STYLE, SIZE, OR COLOR.

FOR EDUCATIONAL AND ENTERTAINMENT SERVICES IN THE NATURE OF A CHILDREN'S MUSEUM FEATURING CULTURAL EXHIBITS, HANDS-ON PLAY AND LEARNING ACTIVITIES; EDUCATIONAL SERVICES, NAMELY, PROVIDING CLASSES, EXHIBITS, HANDS-ON LEARNING PROGRAMS AND SEMINARS, AND PUBLISHING OF BOOKS AND PROVIDING ELECTRONIC NEWSLETTERS VIA E-MAIL, PROVIDING FACILITIES FOR EDUCATIONAL SERVICES, NAMELY, CONDUCTING EDUCATIONAL TRAINING IN THE NATURE OF ON-LINE EXHIBITIONS, DISPLAYS, AND INTERACTIVE EXHIBITS, AND PROVIDING RECREATIONAL FACILITIES FOR CHILDREN AND THEIR FAMILIES IN THE NATURE OF PLAY AREAS, ALL PERTAINING TO CHILDREN'S EDUCATION, ALL IN THE SUBJECTS OF SCIENCE, TECHNOLOGY, HISTORY, CULTURE, HEALTH AND HUMAN DEVELOPMENT, AND CREATIVE ARTS; ON-LINE EDUCATIONAL SERVICES, NAMELY, PROVIDING CLASSES, EXHIBITS, LEARNING PROGRAMS AND SEMINARS, AND PUBLICATION OF AUDIO-VISUAL MATERIALS, NAMELY, TEXT AND GRAPHIC WORKS OF OTHERS ON CD, DVD OR ON-LINE, ALL PERTAINING TO CHILDREN'S EDUCATION, ALL IN THE SUBJECTS OF SCIENCE, TECHNOLOGY, HISTORY, CULTURE, HEALTH AND HUMAN DEVELOPMENT, AND CREATIVE ARTS (U.S. CLS. 100, 101 AND 107).

FIRST USE 6-1-2008; IN COMMERCE 6-1-2008.
RONALD DELGIZZI, EXAMINING ATTORNEY

SN 77-786,419. UNITED FOOTBALL LEAGUE, LLC, NEW YORK, NY. FILED 7-21-2009.

LOCOS

THE MARK CONSISTS OF STANDARD CHARACTERS WITHOUT CLAIM TO ANY PARTICULAR FONT, STYLE, SIZE, OR COLOR.

FOR ENTERTAINMENT SERVICES IN THE FORM OF PROFESSIONAL FOOTBALL GAMES AND EXHIBITIONS (U.S. CLS. 100, 101 AND 107).

JILL C. ALT, EXAMINING ATTORNEY

SN 77-789,194. JONES, ANGILLA L, TA THE SCHOOLHOUSE, INC., ATLANTA, GA. FILED 7-24-2009.



NO CLAIM IS MADE TO THE EXCLUSIVE RIGHT TO USE "SCHOOLHOUSE PRESCHOOL ACADEMY EST. 2010", APART FROM THE MARK AS SHOWN.

THE STIPPLING IS A FEATURE OF THE MARK. THE COLOR(S) BLUE IS/ARE CLAIMED AS A FEATURE OF THE MARK.

THE MARK CONSISTS OF A STYLIZED LETTER "S"

CLASS 41—(Continued).

WITHIN A SHIELD DESIGN. WITHIN THE SHIELD IS A SINGLE LINED BORDER. BELOW THE "S" IS A DESIGN OF AN OPEN BOOK. AT THE BASE OF EACH SIDE OF THE SHIELD IS A STYLIZED LINE ABOVE A SINGLE STRAIGHT LINE. CENTERED BELOW THE SHIELD DESIGN IS THE STACKED LETTERING "THE SCHOOLHOUSE" AND "PRESCHOOL ACADEMY AND EST. 2010". THERE IS A SINGLE STRAIGHT LINE EXTENDING FROM THE CENTER OF THE WORDING "EST. 2010". THE MARK APPEARS IN THE COLOR BLUE.

FOR EDUCATIONAL SERVICES, NAMELY, PROVIDING DAILY COURSE OF INSTRUCTION, AND COURSES FOR PRE- SCHOOL, ELEMENTARY AND SECONDARY LEVEL STUDENTS; SEMINARS, TRAINING AND WORKSHOPS IN THE FIELD OF EDUCATIONAL TECHNIQUES AND CHILDHOOD DEVELOPMENT; EDUCATIONAL CONSULTING SERVICES IN THE FIELD OF TEACHING METHODOLOGIES, CURRICULUM, AND SCHOOL OPERATIONS FOR K-12 STUDENTS AND PUBLICATION OF BOOKS, NEWSLETTERS, INSTRUCTIONAL MATERIALS, STUDY GUIDES, TEACHING CURRICULUM GUIDES, NOTE PADS AND DAY CAMP SERVICES (U.S. CLS. 100, 101 AND 107).

PAULA MAHONEY, EXAMINING ATTORNEY

SN 77-789,344. THE NATIONAL TIMES CORPORATION, BOYNTON BEACH, FL. FILED 7-24-2009.



NO CLAIM IS MADE TO THE EXCLUSIVE RIGHT TO USE "NATIONAL", APART FROM THE MARK AS SHOWN. THE COLOR(S) BLUE AND RED IS/ARE CLAIMED AS A FEATURE OF THE MARK.

THE MARK CONSISTS OF THE STYLIZED WORDING "THE NATIONAL TIMES" IN BLUE, WITH SIX RED STARS SEPARATING THE WORDS "NATIONAL" AND "TIMES".

FOR PROVIDING ON-LINE MAGAZINES IN THE FIELD OF NEWS AND CURRENT EVENTS; PROVIDING ON-LINE NON-DOWNLOADABLE NEWSPAPERS (U.S. CLS. 100, 101 AND 107).

FIRST USE 3-0-2009; IN COMMERCE 3-0-2009.

JANICE KIM, EXAMINING ATTORNEY

SN 77-790,012. GITOMER, JEFFREY H., CHARLOTTE, NC. FILED 7-27-2009.

NATIONAL SALESMAN'S CRUSADE

THE MARK CONSISTS OF STANDARD CHARACTERS WITHOUT CLAIM TO ANY PARTICULAR FONT, STYLE, SIZE, OR COLOR.

NO CLAIM IS MADE TO THE EXCLUSIVE RIGHT TO USE "NATIONAL SALESMAN'S", APART FROM THE MARK AS SHOWN.

FOR EDUCATIONAL SERVICES, NAMELY, PROVIDING LIVE AND ON-LINE SEMINARS, CLASSES AND WORKSHOPS IN THE FIELD OF SALES TRAINING, SELLING TECHNIQUES, SELLING SKILLS, PEOPLE SKILLS, AND CUSTOMER SERVICE SKILLS AND TECHNIQUES, AND PRINTED MATERIALS DISTRIBUTED THEREWITH (U.S. CLS. 100, 101 AND 107).

INGA ERVIN, EXAMINING ATTORNEY

CLASS 41—(Continued).

SN 77-790,905. THE CURIOUS KIDS' MUSEUM, ST. JOSEPH, MI. FILED 7-28-2009.

curious kids'

THE MARK CONSISTS OF STANDARD CHARACTERS WITHOUT CLAIM TO ANY PARTICULAR FONT, STYLE, SIZE, OR COLOR.

NO CLAIM IS MADE TO THE EXCLUSIVE RIGHT TO USE "KIDS", APART FROM THE MARK AS SHOWN.

FOR MUSEUMS (U.S. CLS. 100, 101 AND 107).

FIRST USE 10-31-1989; IN COMMERCE 10-31-1989.

SHAUNIA CARLYLE, EXAMINING ATTORNEY

SN 77-791,479. SOLUTIONS HOUSE, INC., TARPON SPRINGS, FL. FILED 7-28-2009.



THE COLOR(S) RED AND BLACK IS/ARE CLAIMED AS A FEATURE OF THE MARK.

THE MARK CONSISTS OF A DESIGN OF A BLACK HOUSE IN FRONT OF A RED SEMI-CIRCLE.

FOR EDUCATIONAL TRAINING CONSULTING SERVICES, NAMELY, DESIGNING AND DEVELOPING CUSTOMIZED TRAINING SYSTEMS AND LEARNING METHODOLOGIES FOR BUSINESSES DEALING WITH BUSINESS ACUMEN, SALES TRAINING, BUSINESS LEADERSHIP, ORGANIZATIONAL DEVELOPMENT, BUSINESS COMMUNICATION, AND BUSINESS STRATEGIC PLANNING (U.S. CLS. 100, 101 AND 107).

FIRST USE 9-1-2008; IN COMMERCE 9-1-2008.

KIMBERLY FRYE, EXAMINING ATTORNEY

CLASS 41—(Continued).

SN 77-791,484. WIZARD SEAFOODS, INC., FALL CITY, WA.
FILED 7-28-2009.

CRAB WIZARD

THE MARK CONSISTS OF STANDARD CHARACTERS WITHOUT CLAIM TO ANY PARTICULAR FONT, STYLE, SIZE, OR COLOR.

NO CLAIM IS MADE TO THE EXCLUSIVE RIGHT TO USE "CRAB", APART FROM THE MARK AS SHOWN.

FOR CONDUCTING ENTERTAINMENT EXHIBITIONS IN THE NATURE OF COOKING DEMONSTRATIONS; EDUCATIONAL AND ENTERTAINMENT SERVICES, NAMELY, A CONTINUING PROGRAM ABOUT COOKING ACCESSIBLE BY RADIO, TELEVISION, SATELLITE, AUDIO, VIDEO AND COMPUTER NETWORKS; ENTERTAINMENT AND EDUCATION SERVICES IN THE NATURE OF A SERIES OF SHORT SHOWS FEATURING COOKING DISTRIBUTED TO MOBILE HANDSETS, WHICH MAY INCLUDE VIDEO, TEXT, PHOTOS, ILLUSTRATIONS OR HYPERTEXT; ENTERTAINMENT AND EDUCATIONAL SERVICES, NAMELY, THE PRESENTATION OF SEMINARS, LECTURES, WORKSHOPS AND PANEL DISCUSSIONS, AND ONGOING TELEVISION AND RADIO TALK SHOWS ALL IN THE FIELD OF PUBLIC INTEREST CONCERNING COOKING; ENTERTAINMENT IN THE NATURE OF AN ON-GOING SPECIAL VARIETY, NEWS, MUSIC OR COMEDY SHOW FEATURING COOKING BROADCAST OVER TELEVISION, SATELLITE, AUDIO, AND VIDEO MEDIA; ENTERTAINMENT IN THE NATURE OF LIVE PERFORMANCES BY SEAFOOD CHEFS; ENTERTAINMENT IN THE NATURE OF ON-GOING TELEVISION PROGRAMS IN THE FIELD OF COOKING; ENTERTAINMENT SERVICES, NAMELY, ARRANGING AND CONDUCTING OF COMPETITIONS FOR COOKING; ENTERTAINMENT SERVICES, NAMELY, PROVIDING A RADIO PROGRAM IN THE FIELD OF COOKING VIA A GLOBAL COMPUTER NETWORK; ENTERTAINMENT SERVICES, NAMELY, PROVIDING A TELEVISION PROGRAM IN THE FIELD OF COOKING VIA A GLOBAL COMPUTER NETWORK; ENTERTAINMENT SERVICES, NAMELY, PROVIDING A WEB SITE FEATURING PHOTOGRAPHIC, AUDIO, VIDEO AND PROSE PRESENTATIONS FEATURING COOKING; ENTERTAINMENT SERVICES, NAMELY, PROVIDING AN ON-GOING RADIO PROGRAM IN THE FIELD OF COOKING; ENTERTAINMENT SERVICES, NAMELY, PROVIDING VIDEO PODCASTS IN THE FIELD OF COOKING; ENTERTAINMENT SERVICES, NAMELY, PROVIDING WEBCASTS IN THE FIELD OF COOKING (U.S. CLS. 100, 101 AND 107).

KATINA MISTER, EXAMINING ATTORNEY

CLASS 41—(Continued).

SN 77-791,524. SOLUTIONS HOUSE, INC., TARPON SPRINGS, FL. FILED 7-28-2009.

SOLUTIONS HOUSE

THE MARK CONSISTS OF STANDARD CHARACTERS WITHOUT CLAIM TO ANY PARTICULAR FONT, STYLE, SIZE, OR COLOR.

FOR EDUCATIONAL TRAINING CONSULTING SERVICES, NAMELY, DESIGNING AND DEVELOPING CUSTOMIZED TRAINING SYSTEMS AND LEARNING METHODOLOGIES FOR BUSINESSES DEALING WITH BUSINESS ACUMEN, SALES TRAINING, BUSINESS LEADERSHIP, ORGANIZATIONAL DEVELOPMENT, BUSINESS COMMUNICATION, AND BUSINESS STRATEGIC PLANNING (U.S. CLS. 100, 101 AND 107).

FIRST USE 2-12-2002; IN COMMERCE 2-12-2002.
KIMBERLY FRYE, EXAMINING ATTORNEY

SN 77-791,676. DOG BEACH FILMS, LLC, SCOTTDALE, AZ.
FILED 7-28-2009.

DOG BEACH

THE MARK CONSISTS OF STANDARD CHARACTERS WITHOUT CLAIM TO ANY PARTICULAR FONT, STYLE, SIZE, OR COLOR.

FOR PRODUCTION AND DISTRIBUTION OF MOTION PICTURES, TELEVISION PROGRAMS; PRODUCTION OF DVD AND VIDEO RECORDINGS FEATURING FILMS, TELEVISION PROGRAMS, DOCUMENTARIES, CONCERTS AND SPORTING EVENTS; RECORD PRODUCTION; AUDIO RECORDING AND PRODUCTION; PRODUCING MUSICAL AUDIO AND VIDEOTAPE RECORDINGS FOR OTHERS; MUSIC PUBLISHING SERVICES; ENTERTAINMENT, NAMELY, PRODUCTION OF LIVE MUSICAL, THEATRICAL AND COMEDY PERFORMANCES (U.S. CLS. 100, 101 AND 107).

B. PARADEWELAI, EXAMINING ATTORNEY

CLASS 41—(Continued).

SN 77-792,418. NEW KINGDOM, INC., DBA SUE DEVITT BEAUTY, NEW YORK, NY. FILED 7-29-2009.

CLASS 41—(Continued).

SN 77-792,564. YESHIVA UNIVERSITY, NEW YORK, NY. FILED 7-29-2009.



BEAUTY ON LOCATION

THE MARK CONSISTS OF STANDARD CHARACTERS WITHOUT CLAIM TO ANY PARTICULAR FONT, STYLE, SIZE, OR COLOR.

FOR ENTERTAINMENT SERVICES, NAMELY, PROVIDING PRODUCTION OF AUDIO VISUAL VIDEO CLIPS AND POD CASTS, ALL IN THE FIELD OF TRAVEL AND TRAVEL-DESTINATION SPOTS AS RELATED TO SKIN CARE, MAKEUP, COSMETICS, BEAUTY, PROVIDED THROUGH TELEVISION, INTERNET OR OTHER DIGITAL MEANS; ENTERTAINMENT SERVICES, NAMELY, PROVIDING NON-DOWNLOADABLE AUDIO VISUAL VIDEO CLIPS AND POD CASTS, ALL IN THE FIELD OF TRAVEL AND TRAVEL-DESTINATION SPOTS AS RELATED TO SKIN CARE, MAKEUP, COSMETICS, BEAUTY, PROVIDED THROUGH TELEVISION, INTERNET OR OTHER DIGITAL MEANS (U.S. CLS. 100, 101 AND 107).

FIRST USE 2-0-2009; IN COMMERCE 2-0-2009.
ALICE BENMAMAN, EXAMINING ATTORNEY

OWNER OF U.S. REG. NO. 2,842,255.

NO CLAIM IS MADE TO THE EXCLUSIVE RIGHT TO USE "UNIVERSITY", APART FROM THE MARK AS SHOWN.

THE NAME RABBI ISAAC ELCHANAN DOES NOT IDENTIFY A LIVING INDIVIDUAL.

THE MARK CONSISTS OF THE ENGLISH WORDS "YESHIVA UNIVERSITY", A SHIELD DESIGN, A SCROLL DESIGN REPRESENTING THE TORAH, AND HEBREW WORDING WHICH TRANSLATES TO RABBI ISAAC ELCHANAN "YESHIVA" (ACROSS THE TOP OF THE SHIELD) AND TORAH AND KNOWLEDGE (IN THE CENTER OF THE SCROLL DESIGN).

THE MARK CONTAINS HEBREW WORDING WHICH TRANSLATES TO RABBI ISAAC ELCHANAN "YESHIVA" (ACROSS THE TOP) AND TORAH AND KNOWLEDGE IN THE CENTER. THE NON-LATIN HEBREW CHARACTERS IN THE MARK TRANSLITERATE TO TORAH, UHMA DAH AND YESHIVAT R YITZHAK ELCHANAN.

THE NON-LATIN HEBREW CHARACTERS IN THE MARK TRANSLITERATE TO TORAH, UHMA DAH AND YESHIVAT R YITZHAK ELCHANAN.

SEC. 2(F) AS TO "YESHIVA".

FOR EDUCATIONAL SERVICES, NAMELY, PROVIDING COURSES OF INSTRUCTION AT THE HIGH SCHOOL AND POSTGRADUATE LEVELS AND DISTRIBUTING COURSE MATERIAL IN CONNECTION THEREWITH; PROVIDING ONLINE SEMINARS OF INSTRUCTION AT THE HIGH SCHOOL, UNDERGRADUATE, GRADUATE, POSTGRADUATE AND PROFESSIONAL LEVELS; LIBRARIES; ONLINE ACADEMIC LIBRARY SERVICES; ENTERTAINMENT SERVICES, NAMELY, ORGANIZING, PROMOTING AND CONDUCTING ATHLETIC CONTESTS AND EXHIBITIONS, LECTURES, CONCERTS AND THEATER PRODUCTIONS (U.S. CLS. 100, 101 AND 107).

FIRST USE 12-31-1945; IN COMMERCE 12-31-1945.
GINA HAYES, EXAMINING ATTORNEY

CLASS 41—(Continued).

SN 77-794,341. GIANT IMPACT, LLC, DULUTH, GA. FILED 7-31-2009.

THRIVE

THE MARK CONSISTS OF STANDARD CHARACTERS WITHOUT CLAIM TO ANY PARTICULAR FONT, STYLE, SIZE, OR COLOR.

OWNER OF U.S. REG. NOS. 2,744,880 AND 3,123,928.
FOR EDUCATION SERVICES, NAMELY, CONDUCTING CLASSES, SEMINARS, CONFERENCES, WORKSHOPS AND PROGRAMS IN THE FIELD OF RELIGION (U.S. CLS. 100, 101 AND 107).
BRIAN NEVILLE, EXAMINING ATTORNEY

SN 77-795,114. NATURAL TV CORPORATION, SANTA BARBARA, CA. FILED 8-2-2009.

The Natural Channel

THE MARK CONSISTS OF STANDARD CHARACTERS WITHOUT CLAIM TO ANY PARTICULAR FONT, STYLE, SIZE, OR COLOR.

OWNER OF U.S. REG. NOS. 3,505,090 AND 3,694,862.
NO CLAIM IS MADE TO THE EXCLUSIVE RIGHT TO USE "CHANNEL", APART FROM THE MARK AS SHOWN.
FOR EDUCATION AND ENTERTAINMENT SERVICES, NAMELY, PROVIDING A WEB SITE FEATURING VIDEOS, TELEVISION PROGRAMS, ARTICLES AND PRESENTATIONS FEATURING MUSICAL PERFORMANCES, FITNESS AND FOOD; PROVIDING A WEBSITE FEATURING ENTERTAINMENT INFORMATION; PROVIDING CURRENT EVENT NEWS AND INFORMATION VIA A GLOBAL COMPUTER NETWORK; ENTERTAINMENT SERVICES IN THE NATURE OF DEVELOPMENT, CREATION AND PRODUCTION OF MULTIMEDIA ENTERTAINMENT CONTENT; ENTERTAINMENT SERVICES, NAMELY, MULTIMEDIA PRODUCTION SERVICES; ENTERTAINMENT SERVICES IN THE NATURE OF CREATION, DEVELOPMENT, AND PRODUCTION OF TELEVISION PROGRAMMING; EDUCATION AND ENTERTAINMENT SERVICES, NAMELY, PROVIDING A WEB SITE FEATURING LINKS TO VIDEOS, TELEVISION PROGRAMS, ARTICLES AND PRESENTATIONS FEATURING NEWS IN THE FIELD OF CURRENT EVENTS, MUSICAL PERFORMANCES, FITNESS AND FOOD; PRODUCTION OF DVDS FEATURING TELEVISION PROGRAMS IN THE FIELD OF MUSICAL PERFORMANCES, FITNESS AND FOOD; PRODUCTION OF DVDS FEATURING AUDIO-VIDEO PROGRAMS FEATURING MUSICAL PERFORMANCES, FITNESS AND FOOD; PRODUCTION OF MEDIA PRESENTATIONS FEATURING MUSICAL PERFORMANCES, FITNESS AND FOOD; PRODUCTION OF MEDIA PRESENTATIONS FEATURING AUDIO-VIDEO PROGRAMS FEATURING MUSICAL PERFORMANCES, FITNESS AND FOOD; PRODUCTION OF MEDIA PRESENTATIONS FEATURING TELEVISION PROGRAMS FEATURING MUSICAL PERFORMANCES, FITNESS AND FOOD; PRODUCTION OF TELEVISION PROGRAMS (U.S. CLS. 100, 101 AND 107).

FIRST USE 8-2-2009; IN COMMERCE 8-2-2009.
ELLEN BURNS, EXAMINING ATTORNEY

CLASS 41—(Continued).

SN 77-796,450. RESEARCH SPECIALISTS, LLC, BOCA RATON, FL. FILED 8-4-2009.



NO CLAIM IS MADE TO THE EXCLUSIVE RIGHT TO USE "RESEARCH SPECIALISTS, LLC", APART FROM THE MARK AS SHOWN.

THE COLOR(S) RED AND GRAY IS/ARE CLAIMED AS A FEATURE OF THE MARK.

THE MARK CONSISTS OF A RED CROSS SECTION OF AN APPLE OUTLINE SILHOUETTE WITH A GRAY LEAF CONNECTED TO THE CROSS-SECTIONAL SILHOUETTE OF AN OPEN BOOK WITH RED PAGES AND GRAY COVER, WITH THE SILHOUETTES FOR THE APPLE AND BOOK PARTIALLY AROUND THE WORDS, "RESEARCH SPECIALISTS, LLC" IN GRAY.

FOR EDUCATIONAL RESEARCH; EDUCATIONAL RESEARCH SERVICES VIA INTERNET (U.S. CLS. 100, 101 AND 107).

ROBIN MITTLER, EXAMINING ATTORNEY

SN 77-797,665. PROSTHETIC DESIGN, INC., CLAYTON, OH. FILED 8-5-2009.



OWNER OF U.S. REG. NOS. 2,268,203 AND 3,198,276.
NO CLAIM IS MADE TO THE EXCLUSIVE RIGHT TO USE "PROSTHETIC DESIGN, INC.", APART FROM THE MARK AS SHOWN.

THE MARK CONSISTS OF THE WORDS "PDI PROSTHETIC DESIGN, INC." IN FRONT OF A CHECKERED FLAG.
FOR TRAINING SERVICES IN THE FIELD OF PROSTHETIC DEVICE FABRICATION (U.S. CLS. 100, 101 AND 107).

FIRST USE 0-0-2002; IN COMMERCE 0-0-2002.
ELISSA GARBER KON, EXAMINING ATTORNEY

CLASS 41—(Continued).

SN 77-798,013. BOB & PHIL SHOW, INC., SAN RAFAEL, CA. FILED 8-5-2009.

THE FURTHUR FESTIVAL

THE MARK CONSISTS OF STANDARD CHARACTERS WITHOUT CLAIM TO ANY PARTICULAR FONT, STYLE, SIZE, OR COLOR.

NO CLAIM IS MADE TO THE EXCLUSIVE RIGHT TO USE "FESTIVAL", APART FROM THE MARK AS SHOWN.

FOR ENTERTAINMENT, NAMELY, LIVE PERFORMANCES BY MUSICAL BANDS; ARRANGING AND CONDUCTING ROCK CONCERTS; ARRANGING AND CONDUCTING FESTIVALS FEATURING MUSICAL GROUPS, ROCK MUSIC, AND BOOTHS THAT DISTRIBUTE ARTS AND CRAFTS ITEMS (U.S. CLS. 100, 101 AND 107).

MIDGE BUTLER, EXAMINING ATTORNEY

SN 77-798,332. WOMEN IN FEDERAL LAW ENFORCEMENT, INC., ARLINGTON, VA. FILED 8-6-2009.

WOMEN IN FEDERAL LAW ENFORCEMENT

THE MARK CONSISTS OF STANDARD CHARACTERS WITHOUT CLAIM TO ANY PARTICULAR FONT, STYLE, SIZE, OR COLOR.

OWNER OF U.S. REG. NOS. 2,679,195, 3,374,841 AND 3,374,846.

SEC. 2(F).

FOR EDUCATIONAL SERVICES, NAMELY, CONDUCTING TRAINING CONFERENCES IN THE FIELD OF LAW ENFORCEMENT (U.S. CLS. 100, 101 AND 107).

FIRST USE 4-4-2001; IN COMMERCE 4-4-2001.

ANDREA HACK, EXAMINING ATTORNEY

SN 77-798,466. BORJA, PERRY, FRESNO, CA. FILED 8-6-2009.

Startunez

THE MARK CONSISTS OF STANDARD CHARACTERS WITHOUT CLAIM TO ANY PARTICULAR FONT, STYLE, SIZE, OR COLOR.

FOR MUSIC PRODUCTION SERVICES (U.S. CLS. 100, 101 AND 107).

SETH A. RAPPAPORT, EXAMINING ATTORNEY

CLASS 41—(Continued).

SN 77-800,105. GLORY DAYS FANTASY, LLC, DBA YESTERYEAR FANTASY SPORTS, BELLINGHAM, WA. FILED 8-7-2009.



NO CLAIM IS MADE TO THE EXCLUSIVE RIGHT TO USE "FANTASY SPORTS", APART FROM THE MARK AS SHOWN.

THE MARK CONSISTS OF A DIAMOND HAVING BLACK AND WHITE STRIPES WITH SPECKS, WHITE SHOOTING STARS OUTLINED IN BLACK, A FOOTBALL AND THE WORDS "YESTERYEAR FANTASY SPORTS".

FOR ENTERTAINMENT SERVICES, NAMELY, PROVIDING AN ONLINE COMPUTER GAME AND ONLINE FANTASY GAME; ONLINE ENTERTAINMENT IN THE NATURE OF A FANTASY SPORTS LEAGUE; AND, PROVIDING A WEB BASED SYSTEM AND ONLINE PORTAL FOR CUSTOMERS TO PARTICIPATE IN ONLINE GAMING AND OPERATION AND COORDINATION OF GAME TOURNAMENTS (U.S. CLS. 100, 101 AND 107).

MATTHEW KLINE, EXAMINING ATTORNEY

SN 77-800,168. GLORY DAYS FANTASY, LLC, DBA YESTERYEAR FANTASY SPORTS, BELLINGHAM, WA. FILED 8-7-2009.



NO CLAIM IS MADE TO THE EXCLUSIVE RIGHT TO USE "FANTASY SPORTS", APART FROM THE MARK AS SHOWN.

THE MARK CONSISTS OF A DIAMOND HAVING BLACK AND WHITE STRIPES WITH SPECKS, WHITE SHOOTING STARS OUTLINED IN BLACK AND THE WORDS "YESTERYEAR FANTASY SPORTS".

FOR ENTERTAINMENT SERVICES, NAMELY, PROVIDING AN ONLINE COMPUTER GAME AND ONLINE FANTASY GAME; ONLINE ENTERTAINMENT IN THE NATURE OF A FANTASY SPORTS LEAGUE; AND, PROVIDING A WEB BASED SYSTEM AND ONLINE PORTAL FOR CUSTOMERS TO PARTICIPATE IN ONLINE GAMING AND OPERATION AND COORDINATION OF GAME TOURNAMENTS (U.S. CLS. 100, 101 AND 107).

MATTHEW KLINE, EXAMINING ATTORNEY

CLASS 41—(Continued).

SN 77-800,301. REJINO, KEITH G., DBA DREAMSCAPE IMAGES, ALTA LOMA, CA. FILED 8-8-2009.

Dreamscape Images

THE MARK CONSISTS OF STANDARD CHARACTERS WITHOUT CLAIM TO ANY PARTICULAR FONT, STYLE, SIZE, OR COLOR.

NO CLAIM IS MADE TO THE EXCLUSIVE RIGHT TO USE "IMAGES", APART FROM THE MARK AS SHOWN. FOR PHOTOGRAPHY SERVICES (U.S. CLS. 100, 101 AND 107).

FIRST USE 11-30-2008; IN COMMERCE 11-30-2008. MATTHEW KLINE, EXAMINING ATTORNEY

SN 77-803,455. NEW LINE PRODUCTIONS, INC., LOS ANGELES, CA. FILED 8-12-2009.

WATERTOWER MUSIC

THE MARK CONSISTS OF STANDARD CHARACTERS WITHOUT CLAIM TO ANY PARTICULAR FONT, STYLE, SIZE, OR COLOR.

NO CLAIM IS MADE TO THE EXCLUSIVE RIGHT TO USE "MUSIC". APART FROM THE MARK AS SHOWN.

FOR ENTERTAINMENT SERVICES IN THE NATURE OF LIVE-ACTION, COMEDY, DRAMA, ANIMATED, AND REALITY TELEVISION SERIES; PRODUCTION OF LIVE-ACTION, COMEDY, DRAMA, ANIMATED AND REALITY TELEVISION SERIES; DISTRIBUTION AND DISPLAY OF LIVE-ACTION, COMEDY, DRAMA AND ANIMATED MOTION PICTURE THEATRICAL FILMS; PRODUCTION OF LIVE-ACTION, COMEDY, DRAMA AND ANIMATED MOTION PICTURE THEATRICAL FILMS; THEATRICAL PERFORMANCES BOTH ANIMATED AND LIVE ACTION; INTERNET SERVICES PROVIDING INFORMATION VIA AN ELECTRONIC GLOBAL COMPUTER NETWORK IN THE FIELD OF ENTERTAINMENT RELATING SPECIFICALLY TO MOVIES, AND TELEVISION; PROVIDING NEWS ABOUT CURRENT EVENTS AND ENTERTAINMENT, AND INFORMATION RELATED TO EDUCATION AND CULTURAL EVENTS, VIA A GLOBAL COMPUTER NETWORK; AND PROVIDING INFORMATION FOR AND ACTUAL ENTERTAINMENT VIA AN ELECTRONIC GLOBAL COMMUNICATIONS NETWORK IN THE NATURE OF LIVE-ACTION, COMEDY, DRAMA AND ANIMATED PROGRAMS AND PRODUCTION OF LIVE-ACTION, COMEDY, DRAMA AND ANIMATED MOTION PICTURE FILMS FOR DISTRIBUTION VIA A GLOBAL COMPUTER NETWORK; SOUND RECORDING SERVICES, NAMELY, PRODUCTION OF SOUND AND AUDIOVISUAL RECORDINGS IN THE FIELD OF MUSIC AND MUSICAL BASED ENTERTAINMENT;

CLASS 41—(Continued).

PROVIDING ONLINE ENTERTAINMENT FEATURING A GLOBAL COMPUTER NETWORK FEATURING INFORMATION ON MUSICAL ARTISTS, TOURS OF MUSICAL ARTISTS, SOUND RECORDINGS, POPULAR CULTURE AND EVENTS AND MUSICAL BASED ENTERTAINMENT; DISTRIBUTION OF DIGITAL PROGRAMS, NAMELY, ONLINE RADIO AND TELEVISION PROGRAMS, MUSIC PUBLISHING SERVICES; ENTERTAINMENT, NAMELY, LIVE MUSICAL CONCERTS; NON-DOWNLOADABLE RING TONES, PRE-RECORDED MUSIC, VIDEOS AND GRAPHICS PRESENTED TO MOBILE COMMUNICATIONS NETWORKS; MUSIC VIDEO PRODUCTION; PROVIDING AN INTERNET WEBSITE PORTAL IN THE FIELD OF MUSIC; PROVIDING NON-DOWNLOADABLE PLAYBACK OF MUSIC VIA GLOBAL COMMUNICATION NETWORKS; MULTIMEDIA ENTERTAINMENT SERVICES IN THE NATURE OF RECORDING, PRODUCTION AND POST-PRODUCTION SERVICES IN THE FIELDS OF MUSIC, VIDEO AND FILMS (U.S. CLS. 100, 101 AND 107).

APRIL HESIK, EXAMINING ATTORNEY

SN 77-804,764. NORTH BAY CHILDREN'S CENTER, NOVATO, CA. FILED 8-14-2009.

GARDEN OF EATIN'

THE MARK CONSISTS OF STANDARD CHARACTERS WITHOUT CLAIM TO ANY PARTICULAR FONT, STYLE, SIZE, OR COLOR.

FOR EDUCATIONAL SERVICES, NAMELY, PROVIDING CLASSES IN THE FIELDS OF GROWING, HARVESTING, AND CONSUMING FRESH FRUITS AND VEGETABLES; EDUCATIONAL SERVICES, NAMELY, WORKSHOPS AND ONGOING TRAINING IN THE FIELD OF NUTRITION; AND PHYSICAL FITNESS INSTRUCTION (U.S. CLS. 100, 101 AND 107).

FIRST USE 6-1-2004; IN COMMERCE 9-15-2006. ESTHER BELENKER, EXAMINING ATTORNEY

SN 77-806,633. COMMSCOPE, INC. OF NORTH CAROLINA, HICKORY, NC. FILED 8-18-2009.

COMMSCOPE CONNECTS

THE MARK CONSISTS OF STANDARD CHARACTERS WITHOUT CLAIM TO ANY PARTICULAR FONT, STYLE, SIZE, OR COLOR.

OWNER OF U.S. REG. NOS. 898,651, 1,865,198 AND 3,418,814.

FOR PROVIDING EDUCATION AND TRAINING PROGRAMS IN THE NATURE OF COURSES, WORKSHOPS, CLASSES, SEMINARS, AND CONFERENCES IN THE FIELD OF COMMUNICATIONS INFRASTRUCTURE SYSTEM DESIGN, SELECTION, PERFORMANCE, INSTALLATION AND MAINTENANCE (U.S. CLS. 100, 101 AND 107).

AMEEN IMAM, EXAMINING ATTORNEY

CLASS 41—(Continued).

SN 77-807,085. LIFEFORCE, LLC, BURR RIDGE, IL. FILED 8-18-2009.

JIM PETERIK'S LIFEFORCE

THE MARK CONSISTS OF STANDARD CHARACTERS WITHOUT CLAIM TO ANY PARTICULAR FONT, STYLE, SIZE, OR COLOR.

THE NAME(S), PORTRAIT(S), AND/OR SIGNATURE(S) SHOWN IN THE MARK IDENTIFIES "JIM PETERIK", WHOSE CONSENT(S) TO REGISTER IS MADE OF RECORD.

FOR ENTERTAINMENT SERVICES IN THE NATURE OF LIVE MUSICAL PERFORMANCES (U.S. CLS. 100, 101 AND 107).

MARY CRAWFORD, EXAMINING ATTORNEY

SN 77-811,649. JONES, RODNEY, NORRISTOWN, PA. FILED 8-24-2009.

PHOTOTYPEZ

THE MARK CONSISTS OF STANDARD CHARACTERS WITHOUT CLAIM TO ANY PARTICULAR FONT, STYLE, SIZE, OR COLOR.

FOR PHOTOGRAPHY SERVICES (U.S. CLS. 100, 101 AND 107).

FIRST USE 10-0-2007; IN COMMERCE 3-0-2008.

COLLEEN KEARNEY, EXAMINING ATTORNEY

SN 77-813,680. NOWPUBLIC, INC., VANCOUVER, CANADA, FILED 8-26-2009.

NowPublic

THE MARK CONSISTS OF STANDARD CHARACTERS WITHOUT CLAIM TO ANY PARTICULAR FONT, STYLE, SIZE, OR COLOR.

FOR ONLINE NEWS AGENCY SERVICE FOR THE GATHERING AND DISSEMINATION OF NEWS FEATURING CITIZEN JOURNALISM (U.S. CLS. 100, 101 AND 107).

FIRST USE 5-15-2008; IN COMMERCE 5-15-2008.

KATHERINE CHANG, EXAMINING ATTORNEY

CLASS 41—(Continued).

SN 77-813,683. NOWPUBLIC, INC., VANCOUVER, CANADA, FILED 8-26-2009.

Crowd Powered Media

THE MARK CONSISTS OF STANDARD CHARACTERS WITHOUT CLAIM TO ANY PARTICULAR FONT, STYLE, SIZE, OR COLOR.

NO CLAIM IS MADE TO THE EXCLUSIVE RIGHT TO USE "MEDIA", APART FROM THE MARK AS SHOWN.

FOR ONLINE NEWS AGENCY SERVICE FOR THE GATHERING AND DISSEMINATION OF NEWS FEATURING CITIZEN JOURNALISM (U.S. CLS. 100, 101 AND 107).

FIRST USE 5-15-2008; IN COMMERCE 5-15-2008.

KATHERINE CHANG, EXAMINING ATTORNEY

SN 77-815,457. SAM CHWAT, NEW YORK, NY. FILED 8-28-2009.



NO CLAIM IS MADE TO THE EXCLUSIVE RIGHT TO USE "SPEECH CENTER", APART FROM THE MARK AS SHOWN.

THE NAME "SAM CHWAT" IDENTIFIES A LIVING INDIVIDUAL WHOSE CONSENT IS OF RECORD.

THE MARK CONSISTS OF THE STYLIZED LETTERS "SCSC" TO THE LEFT OF THE STACKED TERMS "THE", "SAM CHWAT", "SPEECH CENTER".

FOR REGIONAL AND FOREIGN ACCENT ELIMINATION TRAINING; ACCENT ACQUISITION TRAINING; ARTICULATION IMPROVEMENT TRAINING; PROFESSIONAL SPEECH TRAINING; VOICE IMPROVEMENT TRAINING FOR PUBLIC SPEAKING; TRAINING IN BODY LANGUAGE, EYE CONTACT, SPEECH ORGANIZATION AND CONSTRUCTION, SPEECH FORMATTING, OUTLINE PREPARATION, AND THE TECHNICAL ASPECTS AND NON-VERBAL ASPECTS OF PUBLIC SPEAKING AND PUBLIC SPEECH DELIVERY (U.S. CLS. 100, 101 AND 107).

FIRST USE 0-0-2008; IN COMMERCE 0-0-2008.

PAULA MAHONEY, EXAMINING ATTORNEY

SN 77-817,210. COMMUNITY BRIDGES, INC., SILVER SPRING, MD. FILED 9-1-2009.



THE COLOR(S) YELLOW, PURPLE, WHITE AND ORANGE IS/ARE CLAIMED AS A FEATURE OF THE MARK.

THE MARK CONSISTS OF A RECTANGLE DIVIDED INTO THREE SECTIONS. THE TOP SECTION IS YELLOW, THE MIDDLE SECTION IS ORANGE, AND THE BOTTOM SECTION IS PURPLE. THE RECTANGLE IS BACK-

CLASS 41—(Continued).

GROUND FOR THE DESIGN OF TWO GIRLS SHOWN IN WHITE SILHOUETTE. ONE GIRL IS IN PANTS AND THE OTHER IS IN A DRESS. BOTH GIRLS HAVE THEIR ARMS EXTENDED TOWARDS TWO WHITE BUTTERFLIES. ABOVE THE RECTANGLE IS AN ORANGE BUTTERFLY. TO THE RIGHT OF THE RECTANGLE IS THE WORDING "COMMUNITY BRIDGES" IN LARGE PURPLE LETTERS, WITH A YELLOW BUTTERFLY ABOVE THE LETTER "I" IN "COMMUNITY", AND THE WORDING "EMPOWERING GIRLS, BUILDING LEADERS FOR THE COMMUNITY" IN SMALLER PURPLE LETTERS.

FOR EDUCATIONAL SERVICES, NAMELY, PROVIDING WORKSHOPS, CLASSES AND SEMINARS IN THE FIELDS OF MULTICULTURAL EMPOWERMENT AND LEADERSHIP DEVELOPMENT (U.S. CLS. 100, 101 AND 107).

FIRST USE 1-1-1997; IN COMMERCE 1-1-1997.
KIMBERLY FRYE, EXAMINING ATTORNEY

CLASS 41—(Continued).

VICES, NAMELY, THE PRESENTATION OF SEMINARS, LECTURES, WORKSHOPS AND PANEL DISCUSSIONS, AND ONGOING TELEVISION AND RADIO TALK SHOWS ALL IN THE FIELD OF PUBLIC INTEREST CONCERNING HUMAN SEXUALITY, SEXOLOGY, WOMEN'S OVERALL HEALTH, WOMEN'S STUDIES, FEMALE/WOMEN'S EMPOWERMENT, AND SEXUAL POLICY; ENTERTAINMENT SERVICES, NAMELY, PROVIDING A WEBSITE AT WHICH THE GENERAL PUBLIC CAN RECEIVE ADVICE FROM AN INDIVIDUAL CONCERNING RELATIONSHIPS, SUCH ADVICE BEING FOR ENTERTAINMENT PURPOSES ONLY; MULTIMEDIA PUBLISHING OF BOOKS, MAGAZINES, JOURNALS, SOFTWARE, GAMES, MUSIC, AND ELECTRONIC PUBLICATIONS; PUBLICATION OF BOOKS, OF MAGAZINES, OF JOURNALS, OF NEWSPAPERS, OF PERIODICALS, OF CATALOGS, OF BROCHURES; WRITING OF ARTICLES FOR JOURNALS OTHER THAN FOR ADVERTISING OR PUBLICITY; WRITING OF TEXTS OTHER THAN PUBLICITY TEXTS (U.S. CLS. 100, 101 AND 107).

FIRST USE 0-0-2008; IN COMMERCE 0-0-2008.
TRICIA SONNEBORN, EXAMINING ATTORNEY

SN 77-819,125. USKUP, DILARA KADRIYE, DBA PINK PAPER PRODUCTIONS LLC, SOUTHFIELD, MI. FILED 9-3-2009.

SN 77-821,298. COBRO MOTORSPORTS LLC, CARSON CITY, NV. FILED 9-7-2009.



Pink Paper Productions LLC
Discovering the [pink] element

NO CLAIM IS MADE TO THE EXCLUSIVE RIGHT TO USE "PRODUCTIONS LLC", APART FROM THE MARK AS SHOWN.

THE MARK CONSISTS OF AN UPPERCASE CAPITAL LETTER "P" WITH A NUMBER "3" IN SUBSCRIPT SURROUNDED BY 2 BOXES, THE OUTER BEING LARGER THAN THE INNER BOX; THE WORDING "PINK PAPER PRODUCTIONS LLC" AND "DISCOVERING THE [PINK] ELEMENT" APPEAR UNDER THE "P3" LOGO.

FOR CONTINUING PUBLIC SERVICE PROGRAMS IN THE FIELD OF HUMAN SEXUALITY, SEXOLOGY, WOMEN'S OVERALL HEALTH, WOMEN'S STUDIES, FEMALE/WOMEN'S EMPOWERMENT, AND SEXUAL POLICY PRODUCED AND DISTRIBUTED OVER TELEVISION, SATELLITE, FILM, AUDIO, VIDEO, INTERNET, AND 3-D VIRTUAL REALITY MEDIA; EDUCATIONAL AND ENTERTAINMENT SERVICES, NAMELY, PROVIDING MOTIVATIONAL SPEAKING SERVICES IN THE FIELD OF HUMAN SEXUALITY, SEXOLOGY, WOMEN'S OVERALL HEALTH, WOMEN'S STUDIES, FEMALE/WOMEN'S EMPOWERMENT, AND SEXUAL POLICY; ELECTRONIC PUBLISHING SERVICES, NAMELY, PUBLICATION OF TEXT AND GRAPHIC WORKS OF OTHERS ON CD, DVD, ON-LINE FEATURING HUMAN SEXUALITY, SEXOLOGY, WOMEN'S OVERALL HEALTH, WOMEN'S STUDIES, FEMALE/WOMEN'S EMPOWERMENT, AND SEXUAL POLICY; ENTERTAINMENT AND EDUCATIONAL SER-

Pop the habit

THE MARK CONSISTS OF STANDARD CHARACTERS WITHOUT CLAIM TO ANY PARTICULAR FONT, STYLE, SIZE, OR COLOR.

FOR CONTINUING PUBLIC SERVICE PROGRAMS IN THE FIELD OF ANTI-SMOKING PRODUCED AND DISTRIBUTED OVER TELEVISION, SATELLITE, FILM, AUDIO, VIDEO, INTERNET, AND 3-D VIRTUAL REALITY MEDIA (U.S. CLS. 100, 101 AND 107).

FIRST USE 9-4-2009; IN COMMERCE 9-7-2009.
BILL DAWE, EXAMINING ATTORNEY

SN 77-824,638. MAJOR LEAGUE BASEBALL PROPERTIES, INC., NEW YORK, NY. FILED 9-11-2009.

ALL-TIME GAMES

THE MARK CONSISTS OF STANDARD CHARACTERS WITHOUT CLAIM TO ANY PARTICULAR FONT, STYLE, SIZE, OR COLOR.

NO CLAIM IS MADE TO THE EXCLUSIVE RIGHT TO USE "GAMES", APART FROM THE MARK AS SHOWN.

FOR ENTERTAINMENT SERVICES, NAMELY, ONGOING TELEVISION SERIES PROVIDING INFORMATION IN THE FIELD OF SPORTS AND ENTERTAINMENT AND FEATURING SPORTS GAMES AND COMPETITIONS VIA BROADCAST MEDIA (U.S. CLS. 100, 101 AND 107).

FIRST USE 1-22-2009; IN COMMERCE 1-22-2009.
KARANENDRA S. CHHINA, EXAMINING ATTORNEY

CLASS 41—(Continued).

SN 77-826,288. INSTITUTE FOR SACRED ACTIVISM, OAK PARK, IL. AND HARVEY, ANDREW, OAK PARK, IL. FILED 9-14-2009.



NO CLAIM IS MADE TO THE EXCLUSIVE RIGHT TO USE "INSTITUTE FOR" AND "ACTIVISM", APART FROM THE MARK AS SHOWN.

THE COLOR(S) RED, BLACK, YELLOW AND TAN IS/ARE CLAIMED AS A FEATURE OF THE MARK.

THE MARK CONSISTS OF THE WORDS "INSTITUTE FOR" IN RED LETTERS ABOVE THE WORDING "SACRED ACTIVISM" IN LARGER BLACK LETTERS WITH A SERIES OF TAN AND YELLOW CIRCLES, VARYING IN SIZE, FORMING A SWIRL TO THE RIGHT OF THE WORDS "INSTITUTE FOR SACRED ACTIVISM".

FOR WORKSHOPS AND SEMINARS IN THE FIELD OF PERSONAL SPIRITUAL GROWTH AND ACTIVISM TOGETHER WITH THE DISTRIBUTION OF PRINTED AND ELECTRONIC MATERIALS IN CONNECTION THEREWITH (U.S. CLS. 100, 101 AND 107).

FIRST USE 12-15-2008; IN COMMERCE 1-15-2009.

CHRISTINE COOPER, EXAMINING ATTORNEY

CLASS 41—(Continued).

SN 77-826,941. AMERICAN CASINO AND ENTERTAINMENT PROPERTIES, LLC, LAS VEGAS, NV. FILED 9-15-2009.

ACEPLAY

THE MARK CONSISTS OF STANDARD CHARACTERS WITHOUT CLAIM TO ANY PARTICULAR FONT, STYLE, SIZE, OR COLOR.

FOR CASINO AND GAMING SERVICES FEATURING A FREQUENT CUSTOMER REWARD PROGRAM SERVICE WHICH ALLOWS PARTICIPANTS TO EARN DISCOUNTS, FREE GIFTS AND COMPLEMENTARY ADMISSION TO ENTERTAINMENT AND EDUCATIONAL EVENTS; ENTERTAINMENT SERVICES, NAMELY, CONDUCTING SPECIAL EVENTS FEATURING CASINO AND GAMING CONTESTS AND TOURNAMENTS, ONLINE COMPUTER GAMES AND SWEEPSTAKES (U.S. CLS. 100, 101 AND 107).

SALLY SHIH, EXAMINING ATTORNEY

SN 77-826,910. REDEEMER CITYNET, NEW YORK, NY. FILED 9-15-2009.

LOVE YOUR CITY TO LIFE

THE MARK CONSISTS OF STANDARD CHARACTERS WITHOUT CLAIM TO ANY PARTICULAR FONT, STYLE, SIZE, OR COLOR.

FOR AUDIO RECORDING AND PRODUCTION; DEVELOPMENT AND DISSEMINATION OF EDUCATIONAL MATERIALS OF OTHERS IN THE FIELD OF CHURCH PLANTING, URBAN RENEWAL AND RELIGIOUS INSTRUCTION; PROVIDING ONLINE PUBLICATIONS IN THE NATURE OF E-BOOKS, BLOGS, MANUALS, ARTICLES, AND PAPERS, ALL IN THE FIELD OF CHURCH PLANTING, URBAN RENEWAL AND RELIGIOUS INSTRUCTION; EDUCATIONAL SERVICES, NAMELY, DEVELOPING, ARRANGING, AND CONDUCTING EDUCATIONAL CONFERENCES, SEMINARS, WORKSHOPS AND PROGRAMS AND PROVIDING COURSES OF INSTRUCTION IN THE FIELD OF CHURCH PLANTING, URBAN RENEWAL AND RELIGIOUS INSTRUCTION, AND DISTRIBUTION OF COURSE MATERIAL IN CONNECTION THEREWITH; PROVIDING PODCASTS IN THE FIELD OF CHURCH PLANTING, URBAN RENEWAL AND RELIGIOUS INSTRUCTION; FILM AND VIDEO PRODUCTION; PROVIDING A WEBSITE THAT FEATURES INFORMAL INSTRUCTION ON CHURCH PLANTING, URBAN RENEWAL AND RELIGIOUS INSTRUCTION (U.S. CLS. 100, 101 AND 107).

GISELLE AGOSTO, EXAMINING ATTORNEY

SN 77-829,327. COHERENCE LLC, DBA COHERENCE, ALLEN, TX. FILED 9-17-2009.



THE COLOR(S) RED IS/ARE CLAIMED AS A FEATURE OF THE MARK.

THE MARK CONSISTS OF THREE SLOW RED WAVES WITH FASTER WAVES ON THEIR SURFACE, POSITIONED HORIZONTALLY, SIGNIFYING THE ACTION OF THE BLOOD WHEN BREATHING COHERENTLY, THE SLOWER WAVE BEING THE RESPIRATORY COMPONENT AND THE FASTER WAVE, THE HEART BEAT.

FOR EDUCATIONAL SERVICES, NAMELY, PROVIDING WORKSHOPS AND SEMINARS IN THE FIELDS OF BREATHING FOR OPTIMAL CIRCULATION AND AUTONOMIC NERVOUS SYSTEM BALANCE (U.S. CLS. 100, 101 AND 107).

NAKIA HENRY, EXAMINING ATTORNEY

CLASS 41—(Continued).

SN 77-835,368. BLUE RIDGE SALVAGE COMPANY, INC., FLINT HILL, VA. FILED 9-25-2009.

Cartoon Friendly Since 1977
TREETOPS-Tattler

NO CLAIM IS MADE TO THE EXCLUSIVE RIGHT TO USE "SINCE 1977", APART FROM THE MARK AS SHOWN.

THE MARK CONSISTS OF THE WORDS "THE TREETOPS-TATTLER" IN STYLIZED LETTERS WITH THE WORD "THE" APPEARING WITHIN THE LETTER "O" IN "TREETOPS" AND THE WORDS "CARTOON FRIENDLY SINCE 1977" APPEARING ABOVE.

FOR ON-LINE PUBLICATION IN THE FORM OF A NEWSPAPER CONTAINING COMIC STRIPS, EDITORIAL CARTOONS, ENTERTAINING ARTICLES, STORIES (U.S. CLS. 100, 101 AND 107).

FIRST USE 9-14-2009; IN COMMERCE 9-14-2009.
 BRIAN NEVILLE, EXAMINING ATTORNEY

SN 77-835,628. VIERECK, CHARLES, VISTA, CA. FILED 9-25-2009.

My Music Jungle

THE MARK CONSISTS OF STANDARD CHARACTERS WITHOUT CLAIM TO ANY PARTICULAR FONT, STYLE, SIZE, OR COLOR.

NO CLAIM IS MADE TO THE EXCLUSIVE RIGHT TO USE "MUSIC", APART FROM THE MARK AS SHOWN.

FOR PROVIDING A WEBSITE FEATURING INFORMATION ON MUSICAL BANDS (U.S. CLS. 100, 101 AND 107).

FIRST USE 10-3-2007; IN COMMERCE 10-3-2007.
 DEZMONA MIZELLE, EXAMINING ATTORNEY

SN 77-842,761. BBI, INC., COLORADO SPRINGS, CO. FILED 10-6-2009.

**BBI BARNETT
 BICYCLE
 INSTITUTE**

OWNER OF U.S. REG. NOS. 3,471,049 AND 3,479,612.
 NO CLAIM IS MADE TO THE EXCLUSIVE RIGHT TO USE "BICYCLE INSTITUTE", APART FROM THE MARK AS SHOWN.

THE MARK CONSISTS OF THE LETTERS "BBI" OUTLINED, WITH THE WORDS "BARNETT" AND "BICYCLE" AND "INSTITUTE" APPEARING ADJACENT TO THE LETTER "I", IN THREE ROWS CONSISTING OF ONE WORD EACH.

FOR EDUCATIONAL SERVICES, NAMELY, CONDUCTING CLASSES IN THE FIELD OF BICYCLE MECHANICS AND DISTRIBUTION OF TRAINING MATERIAL IN CONNECTION THEREWITH (U.S. CLS. 100, 101 AND 107).

FIRST USE 8-24-1998; IN COMMERCE 8-24-1998.
 MARC LEIPZIG, EXAMINING ATTORNEY

CLASS 41—(Continued).

SN 77-843,958. FELECIA WRIGHT, DBA DESTINED TO PRAISE, CHARLOTTE, NC. AND ALEXANDRIA SULLIVAN, DBA DESTINED TO PRAISE, CHARLOTTE, NC. AND LEDESSA BROWN, DBA DESTINED TO PRAISE, CHARLOTTE, NC. AND BRIANNA SULLIVAN, DBA DESTINED TO PRAISE, CHARLOTTE, NC. AND MARCUS GRAHAM, DBA DESTINED TO PRAISE, CHARLOTTE, NC. AND VINCENT KELLY, DBA DESTINED TO PRAISE, CHARLOTTE, NC. AND TYRONNE BELLE, DBA DESTINED TO PRAISE, CHARLOTTE, NC. AND JAHMEL BELLE-CHAMPION, DBA DESTINED TO PRAISE, CHARLOTTE, NC. AND EMMANUEL SIMPSON, DBA DESTINED TO PRAISE, CHARLOTTE, NC. FILED 10-7-2009.

Destined 2 Praise

THE MARK CONSISTS OF STANDARD CHARACTERS WITHOUT CLAIM TO ANY PARTICULAR FONT, STYLE, SIZE, OR COLOR.

FOR ENTERTAINMENT IN THE NATURE OF LIVE PERFORMANCES BY GOSPEL GROUP (U.S. CLS. 100, 101 AND 107).

FIRST USE 1-1-2008; IN COMMERCE 6-25-2009.
 REGINA DRUMMOND, EXAMINING ATTORNEY

SN 77-847,906. KABBALAH CENTRE INTERNATIONAL, INC., LOS ANGELES, CA. FILED 10-13-2009.

 **THE KABBALAH CENTRE**
 learn transform connect

OWNER OF U.S. REG. NOS. 2,709,764, 2,885,664 AND OTHERS.

THE COLOR(S) GRAY, AQUA BLUE AND MAROON IS/ARE CLAIMED AS A FEATURE OF THE MARK.

THE MARK CONSISTS OF A SERIES OF DOTS CONNECTED BY LINES FORMING AN AQUA BLUE GEOMETRIC DESIGN, WITH A SMALL STYLIZED GRAY LION DESIGN TO ITS LEFT, AND TO ITS RIGHT THE WORDS "THE KABBALAH CENTRE" IN MAROON ABOVE THE WORDS "LEARN TRANSFORM CONNECT" IN GRAY.

SEC. 2(F) AS TO "THE KABBALAH CENTRE".
 FOR EDUCATIONAL SERVICES, NAMELY, PROVIDING SEMINARS AND COURSES ON RELIGION AND SPIRITUALITY (U.S. CLS. 100, 101 AND 107).

FIRST USE 3-11-2008; IN COMMERCE 3-11-2008.
 COLLEEN KEARNEY, EXAMINING ATTORNEY

CLASS 41—(Continued).

SN 77-848,021. PATRICK M. LYONS, NICHOLAS J. STANKUS, MICHAEL P. NOONAN, JERRIT RYNDAK, DBA SAFE HAVEN, OAK FOREST, IL. FILED 10-13-2009.

Safe Haven

THE MARK CONSISTS OF STANDARD CHARACTERS WITHOUT CLAIM TO ANY PARTICULAR FONT, STYLE, SIZE, OR COLOR.

FOR ENTERTAINMENT SERVICES RENDERED BY A MUSICAL GROUP (U.S. CLS. 100, 101 AND 107).

TRACY WHITTAKER-BROWN, EXAMINING ATTORNEY

SN 77-850,734. NATIONAL INSTITUTE FOR EDUCATIONAL PLANNING, INC., DBA COLLEGE PREVIEW, NEWPORT BEACH, CA. FILED 10-16-2009.



NO CLAIM IS MADE TO THE EXCLUSIVE RIGHT TO USE "COLLEGE", APART FROM THE MARK AS SHOWN.

THE MARK CONSISTS OF THE WORD "COLLEGE" CENTERED ABOVE THE WORD "PREVIEW" BOTH IN UPPERCASE STYLIZED FONT. TO THE LEFT OF THE WORDS IS A DRAWING CONSISTING OF A RECTANGULAR BACKGROUND THE LEFT HALF OF WHICH IS LIGHTER THAN THE RIGHT. IN FRONT OF THE RECTANGLE IS A DRAWING CONSISTING OF A PILLAR AND TWO CIRCLES AT THE UPPER LEFT AND RIGHT OF THE PILLAR.

SEC. 2(F) AS TO "COLLEGE PREVIEW".

FOR ADMISSION CONSULTING SERVICES, NAMELY, CONSULTING IN THE FIELD OF COLLEGE ADMISSIONS, SPECIFICALLY, COLLEGE SELECTION, COMPLETING ADMISSIONS APPLICATIONS, AND PREPARATION FOR COLLEGE ADMISSION INTERVIEWS (U.S. CLS. 100, 101 AND 107).

FIRST USE 8-0-1990; IN COMMERCE 8-0-1990.

DORITT L. CARROLL, EXAMINING ATTORNEY

SN 77-857,495. TOPOINTC.COM, INC., BAKERSFIELD, CA. FILED 10-26-2009.

TO POINT C

THE MARK CONSISTS OF STANDARD CHARACTERS WITHOUT CLAIM TO ANY PARTICULAR FONT, STYLE, SIZE, OR COLOR.

FOR EDUCATIONAL SERVICES, NAMELY, PROVIDING AN ONLINE PORTAL FOR EDUCATORS TO POST CLASSES, SEMINARS AND WORKSHOPS FOR A VARIETY OF PROFESSIONS; PROVIDING A DATABASE TO TRACK EDUCATIONAL COURSES AND REQUIREMENTS FOR MAINTAINING INDIVIDUAL PROFESSIONAL LICENSURE AND CERTIFICATION AND TO REPORT EDUCATION-RELATED DEADLINES (U.S. CLS. 100, 101 AND 107).

FIRST USE 10-26-2009; IN COMMERCE 10-26-2009.

REBECCA POVARCHUK, EXAMINING ATTORNEY

CLASS 41—(Continued).

SN 77-860,697. THE SAUL ZAENTZ COMPANY, BERKELEY, CA. FILED 10-29-2009.

M-E MIDDLE-EARTH

THE MARK CONSISTS OF STANDARD CHARACTERS WITHOUT CLAIM TO ANY PARTICULAR FONT, STYLE, SIZE, OR COLOR.

OWNER OF U.S. REG. NOS. 3,109,215, 3,728,901 AND OTHERS.

FOR CONDUCTING COMPETITIONS FOR COMPUTER GAME AND VIDEO GAME PLAYERS; ARRANGING FOR TICKET RESERVATIONS FOR MOVIES; ARRANGING AND CONDUCTING COMPETITIONS FOR INTERACTIVE GAME PLAYERS, VIDEO GAMERS AND COMPUTER GAME PLAYERS; ORGANIZING AND CONDUCTING FESTIVALS FEATURING INTERACTIVE ONLINE COMPUTER GAMES VIA THE WORLDWIDE WEB IN THE FIELD OF FANTASY; CONDUCTING ENTERTAINMENT EXHIBITIONS FEATURING COMPUTER GAME PROGRAMS AND ENTERTAINMENT EXHIBITIONS FEATURING FILMS OR PORTIONS THEREOF AND ONLINE INTERACTIVE GAMES; ENTERTAINMENT SERVICES IN THE NATURE OF PROVIDING INTERACTIVE ONLINE COMPUTER GAMES VIA THE WORLDWIDE WEB; ENTERTAINMENT SERVICES IN THE NATURE OF COMPETITIONS IN THE FIELD OF ENTERTAINMENT TRIVIA; FAN CLUB SERVICES; PROVIDING MULTIPLAYER INTERACTIVE GAMES OVER THE WORLDWIDE WEB; ORGANIZING ONLINE COMPUTER EVENTS, NAMELY, ENTERTAINMENT PROGRAMS FEATURING LIVE PERFORMANCES BY ENTERTAINMENT PERSONALITIES AND PEOPLE PORTRAYING FICTIONAL CHARACTERS; ORGANIZING ONLINE COMMUNITY EVENTS, NAMELY, COMPUTER EVENTS FEATURING COMPUTER GAME PROGRAMS AND ENTERTAINMENT EXHIBITIONS FEATURING FILMS; ORGANIZING SPORTING AND CULTURAL ACTIVITIES; PROVIDING A COMPUTER GAME THAT MAY BE ACCESSED NETWORK-WIDE BY NETWORK USERS; ENTERTAINMENT, NAMELY, PROVIDING A WEB SITE FEATURING ON-LINE COMPUTER GAMES AND INFORMATION ABOUT MOVIES; PROVIDING A WEB SITE FEATURING PHOTOGRAPHS OF FANTASY AND FICTIONAL CHARACTERS AND LOCATIONS; ENTERTAINMENT, NAMELY, PROVIDING AN INTERACTIVE COMPUTER GAME THAT MAY BE ACCESSED NETWORK-WIDE BY NETWORK USERS; ENTERTAINMENT, NAMELY, PROVIDING COMPUTER GAME PROGRAMS VIA AN ELECTRONIC NETWORK; ENTERTAINMENT, NAMELY, PROVIDING COMPUTER GAME PROGRAMS VIA MOBILE TELEPHONES; ENTERTAINMENT, NAMELY, PROVIDING ENTERTAINMENT IN THE NATURE OF AN AMUSEMENT RIDE; ENTERTAINMENT SERVICES, NAMELY, PROVIDING A WEB SITE FEATURING FILM CLIPS OF MOVIES, INTERVIEWS AND FANTASY GAMES; ENTERTAINMENT SERVICES, NAMELY, PROVIDING ENTERTAINMENT PROGRAMS, NAMELY, ANIMATED CARTOONS VIA MOBILE TELEPHONES; ENTERTAINMENT SERVICES, NAMELY, IN THE NATURE OF PROGRAMS PROVIDING INFORMATION AND COMMENTARY ABOUT FANTASY FILMS, VIDEO GAMES AND COMPUTER GAMES DISTRIBUTED OVER ELECTRONIC MEDIA, NAMELY, THE INTERNET AND VIA MOBILE TELEPHONES; ENTERTAINMENT SERVICES, NAMELY, PROVIDING FILM CLIPS OF MOVIES, INTERVIEWS AND FANTASY GAMES VIA MOBILE TELEPHONES; PROVIDING INFORMATION IN THE FIELD OF MOTION PICTURE FILMS VIA A GLOBAL COMPUTER NETWORK; PROVIDING ARTICLES ABOUT VIDEO GAMES AND COMPUTER GAMES, ALL ON-LINE VIA GLOBAL COMPUTER NETWORK; ENTERTAINMENT SERVICES, NAMELY, PROVIDING INTERACTIVE COMPUTER GAMES OVER AN ELECTRONIC NETWORK; ENTERTAINMENT SERVICES, NAMELY, PROVIDING INTERACTIVE MULTIPLAYER COMPUTER GAMES OVER AN ELECTRONIC NETWORK;

CLASS 41—(Continued).

ENTERTAINMENT SERVICES, NAMELY, PROVIDING ON-LINE COMPUTER GAMES; ENTERTAINMENT SERVICES, NAMELY, PROVIDING PHOTOGRAPHS AND VIDEO CLIPS OF FANTASY AND FICTIONAL CHARACTERS AND LOCATIONS, MOVIES, FANTASY GAMES AND/OR INTERVIEWS VIA MOBILE TELEPHONES; ENTERTAINMENT SERVICES, NAMELY, PROVIDING PRE-RECORDED NON-DOWNLOADABLE MUSIC VIA GLOBAL COMPUTER NETWORK; ENTERTAINMENT SERVICES, NAMELY, PROVIDING TRAINING IN THE FIELD OF PLAYING ONLINE COMPUTER GAMES; PROVIDING TRAINING COURSES, NAMELY, PROVIDING TRAINING COURSES, SEMINARS AND WORKSHOPS IN THE MASTERY OF ONLINE COMPUTER GAMES AND WORKSHOPS IN THE FIELD OF COMPUTER GAMES; RENTAL OF COMPUTER GAME PROGRAMS; RENTAL OF COMPUTER GAME SOFTWARE; RENTAL OF VIDEO GAME PROGRAMS; RENTAL OF VIDEO GAME SOFTWARE (U.S. CLS. 100, 101 AND 107).

LEIGH CAROLINE CASE, EXAMINING ATTORNEY

SN 77-861,845. LUIS F. MEDINA, BURLINGTON, MA. FILED 10-30-2009.

MATEO MEDINA

THE MARK CONSISTS OF STANDARD CHARACTERS WITHOUT CLAIM TO ANY PARTICULAR FONT, STYLE, SIZE, OR COLOR.

THE NAME "MATEO MEDINA" IDENTIFIES A LIVING INDIVIDUAL WHOSE CONSENT IS OF RECORD.

FOR ENTERTAINMENT SERVICES, NAMELY, LIVE DANCE AND MUSICAL PERFORMANCES (U.S. CLS. 100, 101 AND 107).

FIRST USE 7-16-2009; IN COMMERCE 7-16-2009.
LINDA M. KING, EXAMINING ATTORNEY

SN 77-863,060. CAL POLY ORFALEA COLLEGE OF BUSINESS, SAN LUIS OBISPO, CA. FILED 11-2-2009.

**THE BRIGHTEST MINDS MAKE
THE BEST COMPANY.**

THE MARK CONSISTS OF STANDARD CHARACTERS WITHOUT CLAIM TO ANY PARTICULAR FONT, STYLE, SIZE, OR COLOR.

FOR EDUCATIONAL SERVICES, NAMELY, PROVIDING UNDERGRADUATE AND GRADUATE DEGREE PROGRAMS AT THE COLLEGE LEVEL IN THE NATURE OF TEACHING, TRAINING, TUTORING AND COURSES OF INSTRUCTION AT THE UNDERGRADUATE AND GRADUATE LEVEL (U.S. CLS. 100, 101 AND 107).

FIRST USE 9-1-2005; IN COMMERCE 9-1-2005.
ANDREA K. NADELMAN, EXAMINING ATTORNEY

CLASS 41—(Continued).

SN 77-864,340. BIZWORLD FOUNDATION, SAN FRANCISCO, CA. FILED 11-3-2009.

BIZWORLD

THE MARK CONSISTS OF STANDARD CHARACTERS WITHOUT CLAIM TO ANY PARTICULAR FONT, STYLE, SIZE, OR COLOR.

OWNER OF U.S. REG. NO. 2,385,392.

FOR EDUCATIONAL SERVICES, NAMELY, DEVELOPING CURRICULUM FOR OTHERS IN THE FIELDS OF ENTREPRENEURSHIP, BUSINESS, MANAGEMENT, MARKETING, AND FINANCE (U.S. CLS. 100, 101 AND 107).

FIRST USE 5-30-1997; IN COMMERCE 1-1-1998.

STEPHANIE ALI, EXAMINING ATTORNEY

SN 77-864,764. STANDOFF STUDIOS, LLC, LINCOLNTON, GA. FILED 11-4-2009.



THE COLOR(S) BLUE, YELLOW, LIGHT GRAY, MEDIUM GRAY, AND WHITE IS/ARE CLAIMED AS A FEATURE OF THE MARK.

THE MARK CONSISTS OF THE WORDING "THE CATCH" SET TO THE RIGHT OF A STYLIZED DEPICTION OF MARLIN, WITH A STYLIZED DEPICTION OF A FISHING LINE INCORPORATING A LURE AND HOOK AT THE END OF THE LINE SET HORIZONTALLY BELOW THE WORDING "THE CATCH" AND SUPERIMPOSED OVER A PORTION OF THE TAIL OF THE MARLIN, WITH GROUPINGS OF BUBBLES SET AT BOTH THE RIGHT AND LEFT ENDS OF THE MARK; THE COLOR BLUE APPEARS IN THE WORDING "THE CATCH", IN THE DARKEST AREAS OF THE STYLIZED DEPICTION OF THE FISHING LINE, IN THE LURE, IN THE HOOK, IN THE DARKEST AREAS OF THE BUBBLES, AND IN THE DARKEST AREAS OF THE

CLASS 41—(Continued).

MARLIN; THE COLOR YELLOW APPEARS IN THE LIGHTEST AREAS OF THE STYLIZED DEPICTION OF THE FISHING LINE AND IN THE FOURTH LIGHTEST AREAS OF THE MARLIN; THE COLOR LIGHT GRAY APPEARS IN THE SECOND LIGHTEST AREAS OF THE MARLIN AND IN THE SECOND DARKEST AREAS OF THE BUBBLES; THE COLOR MEDIUM GRAY APPEARS IN THE THIRD LIGHTEST AREAS OF THE MARLIN; THE COLOR WHITE APPEARS IN THE LIGHTEST AREAS OF THE MARLIN AND THE LIGHTEST AREAS OF THE BUBBLES.

FOR ENTERTAINMENT IN THE NATURE OF ONGOING TELEVISION PROGRAMS IN THE FIELD OF FISHING; ENTERTAINMENT IN THE NATURE OF VISUAL AND AUDIO PERFORMANCES, AND MUSICAL, VARIETY, NEWS AND COMEDY SHOWS; ENTERTAINMENT SERVICES IN THE NATURE OF AN ONGOING REALITY BASED TELEVISION PROGRAM; ENTERTAINMENT SERVICES IN THE NATURE OF DEVELOPMENT, CREATION, PRODUCTION AND POST-PRODUCTION SERVICES OF MULTIMEDIA CONTENT; ENTERTAINMENT SERVICES, NAMELY, FIREWORKS DISPLAYS; AND ENTERTAINMENT SERVICES, NAMELY, PROVIDING ON-LINE COMPUTER GAMES (U.S. CLS. 100, 101 AND 107).

FIRST USE 4-30-2008; IN COMMERCE 4-30-2008.
MICHAEL GAAFAR, EXAMINING ATTORNEY

CLASS 41—(Continued).

SN 77-878,966. ST. LOUIS ASSOCIATION OF LEGAL ASSISTANTS, ST. LOUIS, MO. FILED 11-23-2009.



OWNER OF U.S. REG. NO. 3,126,733.
NO CLAIM IS MADE TO THE EXCLUSIVE RIGHT TO USE "ST. LOUIS PARALEGAL ASSOCIATION" AND "SERVING LEGAL COMMUNITIES SINCE 1976", APART FROM THE MARK AS SHOWN.

THE MARK CONSISTS OF THE WORDS "SERVING LEGAL COMMUNITIES SINCE 1976" WITHIN AN ARCH DESIGN WITH THE SCALES OF JUSTICE IN THE CENTER ABOVE TWO HORIZONTAL LINES CONTAINING THE WORDS "ST. LOUIS PARALEGAL ASSOCIATION" LISTED BELOW.

FOR EDUCATIONAL SERVICES, NAMELY, PROVIDING CONTINUING EDUCATIONAL PROGRAMS IN THE NATURE OF SEMINARS AND WORKSHOPS IN THE FIELD OF LEGAL EDUCATION FOR LEGAL ASSISTANTS (U.S. CLS. 100, 101 AND 107).

FIRST USE 11-20-2009; IN COMMERCE 11-20-2009.
NAPOLEON SHARMA, EXAMINING ATTORNEY

SN 77-873,934. BALLEEN, GARY, WOODLAND HILLS, CA.
FILED 11-17-2009.

The New Three Tenors

THE MARK CONSISTS OF STANDARD CHARACTERS WITHOUT CLAIM TO ANY PARTICULAR FONT, STYLE, SIZE, OR COLOR.

NO CLAIM IS MADE TO THE EXCLUSIVE RIGHT TO USE "THREE TENORS", APART FROM THE MARK AS SHOWN.

FOR ENTERTAINMENT, NAMELY, PRODUCTION OF A TELEVISION SHOW FEATURING MUSIC (U.S. CLS. 100, 101 AND 107).

MEGHAN REINHART, EXAMINING ATTORNEY

SN 77-882,521. FOSS SWIM SCHOOL, INC., EDEN PRAIRIE, MN. FILED 11-30-2009.

YOU DON'T HAVE TO SWIM WITH US TO PARTY WITH US

THE MARK CONSISTS OF STANDARD CHARACTERS WITHOUT CLAIM TO ANY PARTICULAR FONT, STYLE, SIZE, OR COLOR.

FOR SWIMMING INSTRUCTION (U.S. CLS. 100, 101 AND 107).

FIRST USE 2-1-2008; IN COMMERCE 2-1-2008.
ANDREA HACK, EXAMINING ATTORNEY

CLASS 41—(Continued).

SN 77-883,216. SHELDON, CHRISTIE, OAK VIEW, CA. FILED 12-1-2009.

CHRISTIE SHELDON

THE MARK CONSISTS OF STANDARD CHARACTERS WITHOUT CLAIM TO ANY PARTICULAR FONT, STYLE, SIZE, OR COLOR.

THE NAME(S), PORTRAIT(S), AND/OR SIGNATURE(S) SHOWN IN THE MARK IDENTIFIES A LIVING INDIVIDUAL, WHOSE CONSENT(S) TO REGISTER IS MADE OF RECORD.

FOR ENTERTAINMENT SERVICES, NAMELY, PROVIDING ON-GOING TELEVISION PROGRAMS IN THE FIELD OF INTUITIVE CONSULTATIONS; ENTERTAINMENT SERVICES, NAMELY, PROVIDING AN ON-GOING RADIO PROGRAM IN THE FIELD OF INTUITIVE CONSULTATIONS (U.S. CLS. 100, 101 AND 107).

FIRST USE 8-10-2009; IN COMMERCE 8-10-2009.
WANDA KAY PRICE, EXAMINING ATTORNEY

CLASS 41—(Continued).

SN 77-883,949. HONDA MOTOR CO., LTD., TOKYO, JAPAN, FILED 12-2-2009.

ADVANTAGE 24

THE MARK CONSISTS OF STANDARD CHARACTERS WITHOUT CLAIM TO ANY PARTICULAR FONT, STYLE, SIZE, OR COLOR.

NO CLAIM IS MADE TO THE EXCLUSIVE RIGHT TO USE "24", APART FROM THE MARK AS SHOWN.

FOR EDUCATION SERVICES, NAMELY, PROVIDING ON-LINE CLASSES IN THE FIELD OF REPAIR, SERVICE MANAGEMENT, AND MAINTENANCE PRACTICES AND PROCEDURES FOR MOTOR VEHICLES (U.S. CLS. 100, 101 AND 107).

FIRST USE 4-28-2009; IN COMMERCE 4-28-2009.
MIDGE BUTLER, EXAMINING ATTORNEY

SN 77-884,315. KALABOKES, KATHRYN A, DBA DREAM A LITTLE DREAM EVENTS, SAN FRANCISCO, CA. FILED 12-2-2009.

Dream A Little Dream Events

THE MARK CONSISTS OF STANDARD CHARACTERS WITHOUT CLAIM TO ANY PARTICULAR FONT, STYLE, SIZE, OR COLOR.

NO CLAIM IS MADE TO THE EXCLUSIVE RIGHT TO USE "EVENTS", APART FROM THE MARK AS SHOWN.

FOR SPECIAL EVENT, PARTY AND WEDDING PLANNING AND COORDINATION SERVICES (U.S. CLS. 100, 101 AND 107).

TARA PATE, EXAMINING ATTORNEY

SN 77-883,794. MARISELA LA GRAVE, LONG ISLAND CITY, NY. FILED 12-1-2009.

MAGNETIC LABORATORIUM

SN 77-884,760. DOUBLE DOWN, INC., LAS VEGAS, NV. FILED 12-2-2009.

SHUT UP AND DRINK

THE MARK CONSISTS OF STANDARD CHARACTERS WITHOUT CLAIM TO ANY PARTICULAR FONT, STYLE, SIZE, OR COLOR.

FOR ENTERTAINMENT IN THE NATURE OF LIVE VISUAL AND AUDIO PERFORMANCES, NAMELY, LIVE MUSICAL, LIVE DANCE, LIVE VARIETY, VIDEO, FILM, MULTI-MEDIA, AND THEATRICAL SHOWS FEATURING VIDEOS, FILMS AND MULTI-MEDIA CONTENT; ENTERTAINMENT IN THE NATURE OF DANCE PERFORMANCES; ENTERTAINMENT SERVICES, NAMELY, PROVIDING ONLINE ELECTRONIC GAMES (U.S. CLS. 100, 101 AND 107).

SOPHIA S. KIM, EXAMINING ATTORNEY

THE MARK CONSISTS OF STANDARD CHARACTERS WITHOUT CLAIM TO ANY PARTICULAR FONT, STYLE, SIZE, OR COLOR.

FOR ENTERTAINMENT IN THE NATURE OF CASINO SERVICES AND LIVE PERFORMANCES BY MUSICIANS AND MUSICAL GROUPS (U.S. CLS. 100, 101 AND 107).

FIRST USE 3-8-2006; IN COMMERCE 3-8-2006.
ERIN FALK, EXAMINING ATTORNEY

CLASS 41—(Continued).

SN 77-884,912. TODOROO INC., FORMERLY GRACEFUL TOOLS, INC., PALO ALTO, CA. FILED 12-2-2009.

Roo

THE MARK CONSISTS OF STANDARD CHARACTERS WITHOUT CLAIM TO ANY PARTICULAR FONT, STYLE, SIZE, OR COLOR.

FOR PROVIDING ONLINE INTERACTIVE PERSONAL AND PROFESSIONAL COACHING, MENTORING, INSTRUCTION AND EDUCATION IN THE NATURE OF CLASSES, SEMINARS, WORKSHOPS, CONFERENCES AND STEP BY STEP INSTRUCTIONS IN THE FIELDS OF TASK MANAGEMENT, PERSONAL ORGANIZATION, ROMANTIC RELATIONSHIPS, FINANCIAL MANAGEMENT, AND PERSONAL FITNESS, AVAILABLE THROUGH THE INTERNET FOR USE ON COMPUTERS, LAPTOPS, TELEPHONES, MOBILE PHONES, OR OTHER MOBILE ELECTRONIC DEVICES (U.S. CLS. 100, 101 AND 107).

FIRST USE 3-10-2009; IN COMMERCE 8-31-2009.
JAY BESCH, EXAMINING ATTORNEY

SN 77-885,150. HEROES LIKE US, RANCHO SANTA FE, CA. FILED 12-3-2009.

Heroes Like Us

THE MARK CONSISTS OF STANDARD CHARACTERS WITHOUT CLAIM TO ANY PARTICULAR FONT, STYLE, SIZE, OR COLOR.

FOR PROVIDING A WEB SITE FEATURING INFORMATION FOR GAY YOUTH AND THEIR FAMILIES IN THE FIELD OF CURRENT EVENTS RELATING TO THE GAY COMMUNITY AND CURRENT EVENTS RELATING TO THE GAY, LESBIAN, BISEXUAL AND TRANSGENDER COMMUNITY (U.S. CLS. 100, 101 AND 107).

WARREN L. OLANDRIA, EXAMINING ATTORNEY

CLASS 41—(Continued).

SN 77-886,554. AKITA, INC., WILMINGTON, DE. FILED 12-4-2009.

CHARTIS

THE MARK CONSISTS OF STANDARD CHARACTERS WITHOUT CLAIM TO ANY PARTICULAR FONT, STYLE, SIZE, OR COLOR.

FOR PROVIDING EDUCATIONAL SERVICES, NAMELY, ON-LINE TRAINING COURSES AND WORKSHOPS IN THE FIELD OF INSURANCE AND RISK MANAGEMENT; EDUCATIONAL SERVICES, NAMELY, CONDUCTING CLASSES, SEMINARS, CONFERENCES AND WORKSHOPS IN THE FIELD OF EQUIPMENT SAFETY AND WORKPLACE HAZARDS (U.S. CLS. 100, 101 AND 107).

FIRST USE 7-27-2009; IN COMMERCE 7-27-2009.
MAUREEN DALL, EXAMINING ATTORNEY

SN 77-887,404. POLOGA, FRIENDSWOOD, TX. FILED 12-7-2009.



NO CLAIM IS MADE TO THE EXCLUSIVE RIGHT TO USE "COMPANY", APART FROM THE MARK AS SHOWN.

THE MARK CONSISTS OF THE STYLIZED TEXT "THE POLOGA COMPANY" WITH A POLE AND A FEMALE HANGING UPSIDE DOWN. THE LOTUS FLOWER IS THE BASE OF THE POLE.

FOR DANCE INSTRUCTION; PHYSICAL FITNESS INSTRUCTION; YOGA INSTRUCTION (U.S. CLS. 100, 101 AND 107).

LINDA MICKLEBURGH, EXAMINING ATTORNEY

SN 77-887,490. DIRECT RESPONSE CORPORATION, MERIDEN, CT. FILED 12-7-2009.

TOTY

Teacher ^{of} the Year Award

NO CLAIM IS MADE TO THE EXCLUSIVE RIGHT TO USE "TOTY TEACHER OF THE YEAR AWARD", APART FROM THE MARK AS SHOWN.

THE MARK CONSISTS OF THE WORD "TOTY" WITH AN APPLE SUPERIMPOSED IN THE LETTER "O" IN "TOTY" AND THE WORDS "TEACHER OF THE YEAR AWARD" UNDERLINED.

FOR PROVIDING RECOGNITION BY THE WAY OF AWARDS TO DEMONSTRATE EXCELLENCE IN THE FIELD OF EDUCATION (U.S. CLS. 100, 101 AND 107).

FIRST USE 1-23-2008; IN COMMERCE 1-23-2008.
STEVEN PEREZ, EXAMINING ATTORNEY

CLASS 41—(Continued).

SN 77-888,095. HAAS, DEREK, BEVERLY HILLS, CA. FILED 12-7-2009.

CLASS 41—(Continued).

SN 77-888,467. INSTITUTE OF CERTIFIED RECORDS MANAGERS, NORTH SYRACUSE, NY. FILED 12-8-2009.

POPCORN FICTION



THE MARK CONSISTS OF STANDARD CHARACTERS WITHOUT CLAIM TO ANY PARTICULAR FONT, STYLE, SIZE, OR COLOR.

NO CLAIM IS MADE TO THE EXCLUSIVE RIGHT TO USE "FICTION", APART FROM THE MARK AS SHOWN.

FOR ENTERTAINMENT SERVICES, NAMELY, PROVIDING A WEBSITE FEATURING WORKS OF FICTION, EXCERPTS FROM WORKS OF FICTION, ENTERTAINMENT INFORMATION ABOUT WORKS OF FICTION, REVIEWS AND COMMENTARY ABOUT WORKS OF FICTION, THE AFOREMENTIONED SERVICES RELATING TO FICTIONAL WORKS OF SCIENCE FICTION, CRIME, HORROR, SUSPENSE, MYSTERY, ROMANCE, AND ACTION-ADVENTURE; PROVIDING ON-LINE ENTERTAINMENT NEWS AND GENERAL ENTERTAINMENT INFORMATION ABOUT WORKS OF FICTION VIA THE INTERNET; PROVIDING ELECTRONIC ON-LINE NON-DOWNLOADABLE PUBLICATIONS, NAMELY, LITERARY MAGAZINES RELATING TO FICTIONAL WORKS OF SCIENCE FICTION, CRIME, HORROR, SUSPENSE, MYSTERY, ROMANCE, AND ACTION-ADVENTURE, READERS' COMMENTS RELATING THERETO, AND AUTHORS' REVIEWS (U.S. CLS. 100, 101 AND 107).

FIRST USE 7-24-2009; IN COMMERCE 7-24-2009.

ELI HELLMAN, EXAMINING ATTORNEY

OWNER OF U.S. REG. NO. 2,908,363.

NO CLAIM IS MADE TO THE EXCLUSIVE RIGHT TO USE "INSTITUTE OF CERTIFIED RECORDS MANAGERS", APART FROM THE MARK AS SHOWN.

THE COLOR(S) GREEN, PINK, PURPLE AND BLUE IS/ARE CLAIMED AS A FEATURE OF THE MARK.

THE MARK CONSISTS OF THE ACRONYM "ICRM" IN THE COLOR BLUE TO THE RIGHT OF AN ABSTRACT DESIGN ELEMENT CONSISTING OF THREE OVERLAPPING RECTANGULAR SHAPES, ONE RECTANGLE IN PURPLE, ONE RECTANGLE IN GREEN, AND ONE RECTANGLE IN PINK. THE TERM "INSTITUTE OF CERTIFIED RECORDS MANAGERS" IS WRITTEN IN GREEN UNDER THE ACRONYM "ICRM".

FOR EDUCATIONAL SERVICES, NAMELY, PROVIDING WORKSHOPS, SEMINARS, CLASSES, AND TESTING IN THE FIELDS OF RECORDS AND INFORMATION MANAGEMENT (U.S. CLS. 100, 101 AND 107).

TARA PATE, EXAMINING ATTORNEY

CLASS 41—(Continued).

SN 77-888,744. INSTITUTE OF CERTIFIED RECORDS MANAGERS, NORTH SYRACUSE, NY. FILED 12-8-2009.



OWNER OF U.S. REG. NO. 2,908,363.
NO CLAIM IS MADE TO THE EXCLUSIVE RIGHT TO USE "INSTITUTE OF CERTIFIED RECORDS MANAGERS", APART FROM THE MARK AS SHOWN.

THE MARK CONSISTS OF THE ACRONYM "ICRM" TO THE RIGHT OF AN ABSTRACT DESIGN ELEMENT CONSISTING OF THREE OVERLAPPING RECTANGULAR SHAPES. THE TERM "INSTITUTE OF CERTIFIED RECORDS MANAGERS" IS WRITTEN UNDER THE ACRONYM "ICRM".

FOR EDUCATIONAL SERVICES, NAMELY, CONDUCTING WORKSHOPS, SEMINARS, CLASSES, AND TESTING IN THE FIELD OF RECORDS AND INFORMATION MANAGEMENT (U.S. CLS. 100, 101 AND 107).
TARA PATE, EXAMINING ATTORNEY

SN 77-889,098. SILENT CAL PRODUCTIONS, LLC, BURLINGAME, CA. FILED 12-8-2009.

RICOCHET

THE MARK CONSISTS OF STANDARD CHARACTERS WITHOUT CLAIM TO ANY PARTICULAR FONT, STYLE, SIZE, OR COLOR.

FOR PROVIDING INFORMATION, NEWS AND COMMENTARY IN THE FIELD OF CURRENT EVENTS, POPULAR ENTERTAINMENT AND SPORTS; PROVIDING INFORMATION IN THE FIELD OF CURRENT EVENTS, POPULAR ENTERTAINMENT, RECREATION, LEISURE ACTIVITIES, EDUCATION AND SPORTS; PROVIDING AN INTERNET WEBSITE FEATURING INFORMATION IN THE FIELD OF CURRENT EVENTS, POPULAR ENTERTAINMENT, RECREATION, LEISURE ACTIVITIES, EDUCATION AND SPORTS; PROVIDING ON-LINE JOURNALS, NAMELY, BLOGS FEATURING INFORMATION, NEWS AND COMMENTARY IN THE FIELD OF CURRENT EVENTS, INCLUDING POLITICS, POPULAR ENTERTAINMENT, SPORTS, RECREATION, LEISURE ACTIVITIES AND EDUCATION; MEETING AND SEMINAR ARRANGING (U.S. CLS. 100, 101 AND 107).

NELSON SNYDER, EXAMINING ATTORNEY

CLASS 41—(Continued).

SN 77-890,430. UNIVERSITY OF SANTA MONICA, SANTA MONICA, CA. FILED 12-10-2009.

COMMUNICATING THE PRINCIPLES AND PRACTICES OF SPIRITUAL PSYCHOLOGY WORLDWIDE

THE MARK CONSISTS OF STANDARD CHARACTERS WITHOUT CLAIM TO ANY PARTICULAR FONT, STYLE, SIZE, OR COLOR.

FOR ORGANIZING AND CONDUCTING SEMINARS AND WORKSHOPS TO HELP OTHERS DEVELOP PERSONAL GROWTH, INTERPERSONAL RELATIONSHIPS AND PERSONAL EXPRESSION; DISTRIBUTING COURSE MATERIALS IN CONNECTION WITH SEMINARS AND WORKSHOPS; EDUCATION SERVICES, NAMELY, CONDUCTING TRAINING CLASSES AND COURSES RELATING TO PERSONAL GROWTH, INTERPERSONAL RELATIONSHIPS AND PERSONAL EXPRESSION; ORGANIZING AND CONDUCTING SEMINARS, WORKSHOPS, AND COURSES RELATING TO SPIRITUAL PSYCHOLOGY, PERSONAL GROWTH, INTERPERSONAL RELATIONSHIPS AND PERSONAL EXPRESSION LEADING TO MASTER OF ARTS DEGREES IN SPIRITUAL PSYCHOLOGY AND MASTERS OF ARTS DEGREES IN SPIRITUAL PSYCHOLOGY WITH AN EMPHASIS IN CONSCIOUSNESS, HEALTH AND HEALING; EDUCATION INFORMATION SERVICES; ONLINE EDUCATION SERVICES, NAMELY, CONDUCTING TRAINING CLASSES AND COURSES RELATING TO PERSONAL GROWTH, INTERPERSONAL RELATIONSHIPS AND PERSONAL EXPRESSION; CONDUCTING LIVE AND ONLINE WORKSHOPS, SEMINARS AND CLASSES IN THE FIELDS OF SPIRITUAL PSYCHOLOGY, PERSONAL GROWTH, INTERPERSONAL RELATIONSHIPS AND PERSONAL EXPRESSION LEADING TO MASTER OF ARTS DEGREES IN SPIRITUAL PSYCHOLOGY AND MASTER OF ARTS DEGREES IN SPIRITUAL PSYCHOLOGY WITH AN EMPHASIS IN CONSCIOUSNESS, HEALTH AND HEALING; PROVIDING A WEBSITE FEATURING INFORMATION ABOUT EDUCATION; EDUCATION SERVICES, NAMELY, PROVIDING LIVE AND ONLINE CLASSES, WORKSHOPS AND SEMINARS IN THE FIELDS OF PERSONAL GROWTH, INTERPERSONAL RELATIONSHIPS, PERSONAL EXPRESSION AND SPIRITUAL PSYCHOLOGY (U.S. CLS. 100, 101 AND 107).

WENDY GOODMAN, EXAMINING ATTORNEY

CLASS 41—(Continued).

SN 77-891,373. CALKIN, ROBERT, NORTH HOLLYWOOD, CA. FILED 12-11-2009.



NO CLAIM IS MADE TO THE EXCLUSIVE RIGHT TO USE "CANNABIS CAREER INSTITUTE", APART FROM THE MARK AS SHOWN.

THE MARK CONSISTS OF THE STYLIZED WORDING "C.C.I.", WHICH IS UNDERLINED. THE STYLIZED WORDING "CANNABIS CAREER INSTITUTE" APPEARS BELOW THE WORDING "C.C.I." AND IS ALSO UNDERLINED. THE LETTER "I" IN "CCI" APPEARS IN SMALLER CASE. A DESIGN OF A CANNABIS LEAF REPRESENTS THE DOT IN THE LETTER "I" IN "CCI."

FOR EDUCATIONAL SERVICES, NAMELY, CONDUCTING COURSES AND SEMINARS IN THE FIELD OF MARIJUANA LAW AND DISTRIBUTION OF COURSE MATERIAL IN CONNECTION THEREWITH (U.S. CLS. 100, 101 AND 107).

FIRST USE 3-20-2009; IN COMMERCE 5-18-2009.
CIMMERIAN COLEMAN, EXAMINING ATTORNEY

CLASS 41—(Continued).

SN 77-896,354. BOYLE, REBEKAH, DBA MOONWISHES, PAIA, HI. FILED 12-18-2009.



SN 77-894,357. NEW MEXICO TECHNICAL RESEARCH FOUNDATION, SOCORRO, NM. FILED 12-16-2009.

Advancing the Science of Security

THE MARK CONSISTS OF STANDARD CHARACTERS WITHOUT CLAIM TO ANY PARTICULAR FONT, STYLE, SIZE, OR COLOR.

FOR EDUCATIONAL SERVICES, NAMELY, PROVIDING REALITY-BASED TESTING AND TRAINING IN THE FIELD OF THE SCIENCE OF PHYSICAL SECURITY (U.S. CLS. 100, 101 AND 107).

FIRST USE 2-15-2010; IN COMMERCE 2-15-2010.
DAVID TOOLEY, EXAMINING ATTORNEY

THE MARK CONSISTS OF "MOONWISHES IS A GATHERING OF ARTISTS, CHILDREN AND CATS LIVING BETWEEN TWO WORLDS IN A FRAGILE FOREST REGION" BENEATH THE DESIGN OF A MYTHOLOGICAL MERMAID ANGEL HOLDING A BIRD SURROUNDED BY A FULL MOON.

FOR MULTIMEDIA PUBLISHING OF BOOKS, MAGAZINES, JOURNALS, SOFTWARE, GAMES, MUSIC, AND ELECTRONIC PUBLICATIONS (U.S. CLS. 100, 101 AND 107).

FIRST USE 12-10-1999; IN COMMERCE 12-10-2009.
WENDY GOODMAN, EXAMINING ATTORNEY

CLASS 41—(Continued).

SN 77-897,000. MAJOR LEAGUE LACROSSE LLC, BOSTON, MA. FILED 12-18-2009.



OWNER OF U.S. REG. NOS. 3,280,830, 3,353,771 AND OTHERS.

THE MARK CONSISTS OF THE STYLIZED AND OUTLINED WORD "OUTLAWS" WITH A ROPE DESIGN AROUND THE LETTER "O" AND THE LETTER "S" AND THE DESIGN OF A STEER HORN ENCIRCLED WITH BARBED WIRE IN THE MIDDLE OF THE WORD "OUTLAWS" AND WITH THE STYLIZED AND RECTANGULAR OUTLINED WORD "NATION" APPEARING BELOW "OUTLAWS".

FOR ENTERTAINMENT IN THE NATURE OF LACROSSE GAMES, COMPETITIONS AND TOURNAMENTS; ENTERTAINMENT, NAMELY, PARTICIPATION IN LACROSSE GAMES AND COMPETITIONS; CONDUCTING ENTERTAINMENT EXHIBITIONS IN THE NATURE OF LACROSSE GAMES AND COMPETITIONS; ORGANIZING EXHIBITIONS FOR THE SPORT OF LACROSSE; PROVIDING FACILITIES FOR LACROSSE TOURNAMENTS; ARRANGING AND CONDUCTING ATHLETIC COMPETITIONS; ENTERTAINMENT IN THE NATURE ON-GOING TELEVISION PROGRAMS IN THE FIELD OF SPORTING EVENTS; ENTERTAINMENT, NAMELY, A CONTINUING SPORTS EVENT SHOW DISTRIBUTED OVER TELEVISION, SATELLITE, AUDIO AND VIDEO MEDIA; ENTERTAINMENT SERVICES, NAMELY, PROVIDING A TELEVISION PROGRAM FEATURING SPORTING EVENTS VIA A GLOBAL COMPUTER NETWORK; PROVIDING AN ON-LINE COMPUTER DATABASE IN THE FIELD OF LACROSSE; ENTERTAINMENT SERVICES, NAMELY, PROVIDING A WEB SITE FEATURING INFORMATION PERTAINING TO LACROSSE GOODS AND SERVICES (U.S. CLS. 100, 101 AND 107).

KELLEY WELLS, EXAMINING ATTORNEY

CLASS 41—(Continued).

SN 77-897,031. MAJOR LEAGUE LACROSSE LLC, BOSTON, MA. FILED 12-18-2009.



OWNER OF U.S. REG. NOS. 3,280,830, 3,353,771 AND OTHERS.

NO CLAIM IS MADE TO THE EXCLUSIVE RIGHT TO USE "LACROSSE", APART FROM THE MARK AS SHOWN.

THE MARK CONSISTS OF THE STYLIZED LETTER "O" WITH THE DESIGN OF A STEER HORN ENCIRCLED WITH BARBED WIRE ACROSS THE MIDDLE OF THE LETTER "O" AND THE STYLIZED WORD "OUTLAWS" APPEARING BELOW THE LETTER "O" AND THE STYLIZED WORD "LACROSSE" SET FORTH BELOW "OUTLAWS".

FOR ENTERTAINMENT IN THE NATURE OF LACROSSE GAMES, COMPETITIONS AND TOURNAMENTS; ENTERTAINMENT, NAMELY, PARTICIPATION IN LACROSSE GAMES AND COMPETITIONS; CONDUCTING ENTERTAINMENT EXHIBITIONS IN THE NATURE OF LACROSSE GAMES AND COMPETITIONS; ORGANIZING EXHIBITIONS FOR THE SPORT OF LACROSSE; PROVIDING FACILITIES FOR LACROSSE TOURNAMENTS; ARRANGING AND CONDUCTING ATHLETIC COMPETITIONS; ENTERTAINMENT IN THE NATURE ON-GOING TELEVISION PROGRAMS IN THE FIELD OF SPORTING EVENTS; ENTERTAINMENT, NAMELY, A CONTINUING SPORTS EVENT SHOW DISTRIBUTED OVER TELEVISION, SATELLITE, AUDIO AND VIDEO MEDIA; ENTERTAINMENT SERVICES, NAMELY, PROVIDING A TELEVISION PROGRAM FEATURING SPORTING EVENTS VIA A GLOBAL COMPUTER NETWORK; PROVIDING AN ON-LINE COMPUTER DATABASE IN THE FIELD OF LACROSSE; ENTERTAINMENT SERVICES, NAMELY, PROVIDING A WEB SITE FEATURING INFORMATION PERTAINING TO LACROSSE GOODS AND SERVICES (U.S. CLS. 100, 101 AND 107).

KELLEY WELLS, EXAMINING ATTORNEY

CLASS 41—(Continued).

SN 77-897,093. MAJOR LEAGUE LACROSSE LLC, BOSTON, MA. FILED 12-18-2009.



OWNER OF U.S. REG. NOS. 3,280,830, 3,353,771 AND OTHERS.

NO CLAIM IS MADE TO THE EXCLUSIVE RIGHT TO USE "LACROSSE", APART FROM THE MARK AS SHOWN.

THE MARK CONSISTS OF THE STYLIZED LETTER "B" WITH A STYLIZED DESIGN OF BARBED WIRE WRAPPER AROUND THE CROSS LINE IN THE LETTER "B" WITH THE STYLIZED WORD "BANDITS" APPEARING BELOW THE LETTER "B" AND THE STYLIZED WORD "LACROSSE" SET FORTH UNDER "BANDITS".

FOR ENTERTAINMENT IN THE NATURE OF LACROSSE GAMES, COMPETITIONS AND TOURNAMENTS; ENTERTAINMENT, NAMELY, PARTICIPATION IN LACROSSE GAMES AND COMPETITIONS; CONDUCTING ENTERTAINMENT EXHIBITIONS IN THE NATURE OF LACROSSE GAMES AND COMPETITIONS; ORGANIZING EXHIBITIONS FOR THE SPORT OF LACROSSE; PROVIDING FACILITIES FOR LACROSSE TOURNAMENTS; ARRANGING AND CONDUCTING ATHLETIC COMPETITIONS; ENTERTAINMENT IN THE NATURE ON-GOING TELEVISION PROGRAMS IN THE FIELD OF SPORTING EVENTS; ENTERTAINMENT, NAMELY, A CONTINUING SPORTS EVENT SHOW DISTRIBUTED OVER TELEVISION, SATELLITE, AUDIO AND VIDEO MEDIA; ENTERTAINMENT SERVICES, NAMELY, PROVIDING A TELEVISION PROGRAM FEATURING SPORTING EVENTS VIA A GLOBAL COMPUTER NETWORK; PROVIDING AN ON-LINE COMPUTER DATABASE IN THE FIELD OF LACROSSE; ENTERTAINMENT SERVICES, NAMELY, PROVIDING A WEB SITE FEATURING INFORMATION PERTAINING TO LACROSSE GOODS AND SERVICES (U.S. CLS. 100, 101 AND 107).
KELLEY WELLS, EXAMINING ATTORNEY

CLASS 41—(Continued).

SN 77-897,178. MAJOR LEAGUE LACROSSE LLC, BOSTON, MA. FILED 12-18-2009.



OWNER OF U.S. REG. NOS. 3,352,853, 3,482,291 AND OTHERS.

NO CLAIM IS MADE TO THE EXCLUSIVE RIGHT TO USE "JUNIOR", APART FROM THE MARK AS SHOWN.

THE MARK CONSISTS OF THE VERBIAGE "JUNIOR LIZARDS" WITH A FANCIFUL DEPICTION OF A LIZARD WRAPPED AROUND THE "L" IN THE WORD "LIZARDS".

FOR ENTERTAINMENT IN THE NATURE OF LACROSSE GAMES, COMPETITIONS AND TOURNAMENTS; ENTERTAINMENT, NAMELY, PARTICIPATION IN LACROSSE GAMES AND COMPETITIONS; CONDUCTING ENTERTAINMENT EXHIBITIONS IN THE NATURE OF LACROSSE GAMES AND COMPETITIONS; ORGANIZING EXHIBITIONS FOR THE SPORT OF LACROSSE; PROVIDING FACILITIES FOR LACROSSE TOURNAMENTS; ARRANGING AND CONDUCTING ATHLETIC COMPETITIONS; ENTERTAINMENT IN THE NATURE ON-GOING TELEVISION PROGRAMS IN THE FIELD OF SPORTING EVENTS; ENTERTAINMENT, NAMELY, A CONTINUING SPORTS EVENT SHOW DISTRIBUTED OVER TELEVISION, SATELLITE, AUDIO AND VIDEO MEDIA; ENTERTAINMENT SERVICES, NAMELY, PROVIDING A TELEVISION PROGRAM FEATURING SPORTING EVENTS VIA A GLOBAL COMPUTER NETWORK; PROVIDING AN ON-LINE COMPUTER DATABASE IN THE FIELD OF LACROSSE; ENTERTAINMENT SERVICES, NAMELY, PROVIDING A WEB SITE FEATURING INFORMATION PERTAINING TO LACROSSE GOODS AND SERVICES (U.S. CLS. 100, 101 AND 107).
KELLEY WELLS, EXAMINING ATTORNEY

SN 77-897,204. SHELTON HANK WILLIAMS III, CHICAGO, IL. FILED 12-18-2009.

HANK III

THE MARK CONSISTS OF STANDARD CHARACTERS WITHOUT CLAIM TO ANY PARTICULAR FONT, STYLE, SIZE, OR COLOR.

THE NAME(S), PORTRAIT(S), AND/OR SIGNATURE(S) SHOWN IN THE MARK IDENTIFIES SHELTON HANK WILLIAMS III, WHOSE CONSENT(S) TO REGISTER IS MADE OF RECORD.

FOR ENTERTAINMENT SERVICES IN THE NATURE OF LIVE MUSICAL PERFORMANCES (U.S. CLS. 100, 101 AND 107).

FIRST USE 1-1-1997; IN COMMERCE 9-7-1999.
JUSTINE D. PARKER, EXAMINING ATTORNEY

CLASS 41—(Continued).

SN 77-897,240. MAJOR LEAGUE LACROSSE LLC, BOSTON, MA. FILED 12-18-2009.



OWNER OF U.S. REG. NOS. 3,352,853, 3,482,291 AND OTHERS.

NO CLAIM IS MADE TO THE EXCLUSIVE RIGHT TO USE "JUNIOR", APART FROM THE MARK AS SHOWN.

THE MARK CONSISTS OF THE VERBIAGE "JUNIOR L" WITH A FANCIFUL DEPICTION OF A LIZARD WRAPPED AROUND THE "L".

FOR ENTERTAINMENT IN THE NATURE OF LACROSSE GAMES, COMPETITIONS AND TOURNAMENTS; ENTERTAINMENT, NAMELY, PARTICIPATION IN LACROSSE GAMES AND COMPETITIONS; CONDUCTING ENTERTAINMENT EXHIBITIONS IN THE NATURE OF LACROSSE GAMES AND COMPETITIONS; ORGANIZING EXHIBITIONS FOR THE SPORT OF LACROSSE; PROVIDING FACILITIES FOR LACROSSE TOURNAMENTS; ARRANGING AND CONDUCTING ATHLETIC COMPETITIONS; ENTERTAINMENT IN THE NATURE ON-GOING TELEVISION PROGRAMS IN THE FIELD OF SPORTING EVENTS; ENTERTAINMENT, NAMELY, A CONTINUING SPORTS EVENT SHOW DISTRIBUTED OVER TELEVISION, SATELLITE, AUDIO AND VIDEO MEDIA; ENTERTAINMENT SERVICES, NAMELY, PROVIDING A TELEVISION PROGRAM FEATURING SPORTING EVENTS VIA A GLOBAL COMPUTER NETWORK; PROVIDING AN ON-LINE COMPUTER DATABASE IN THE FIELD OF LACROSSE; ENTERTAINMENT SERVICES, NAMELY, PROVIDING A WEB SITE FEATURING INFORMATION PERTAINING TO LACROSSE GOODS AND SERVICES (U.S. CLS. 100, 101 AND 107).

KELLEY WELLS, EXAMINING ATTORNEY

CLASS 41—(Continued).

SN 77-897,787. ASHAYRE PRODUCTIONS, LAS VEGAS, NV. FILED 12-21-2009.



NO CLAIM IS MADE TO THE EXCLUSIVE RIGHT TO USE "PRODUCTIONS", APART FROM THE MARK AS SHOWN.

THE MARK CONSISTS OF A HEAD IMAGE WITH BEAK OF THE MYTHOLOGICAL BIRD, THE PHOENIX, AND A GRAPHICAL ARTS DEPICTION OF ITS WINGS IN THE APPEARANCE OF BARS. TWO WING BARS ARE HORIZONTAL ON TOP OF THE MARK AND ARE STRAIGHT CUT ON THE LEFT SIDE OF THE MARK AND ARE SLANTED CUT TOWARD THE LEFT ON THE RIGHT SIDE OF THE MARK. THREE WING BARS ARE SLANTED LEFT VERTICAL AND ARE MAKING UP THE REMAINDER OF THE MARK. THERE ARE A TOTAL OF FIVE WING BARS. THERE IS A SHORT DOUBLE LINE WITH A LINE IN BETWEEN WHICH BEGINS AT THE LEFT UNDERSIDE OF THE TOP HORIZONTAL WING BAR AND ABOVE THE SECOND HORIZONTAL WING BAR WHICH IS THEN ENDING AT THE CENTER OF THE "S" OF THE WORD "ASH". THERE IS A SINGLE LINE WHICH ENDS AT THE END OF THE "Y" IN "AYRE" UNDER THE SECOND HORIZONTAL WING BAR. "ASHAYRE PRODUCTIONS" IS IN STYLIZED FONT AT THE TOP AND MIDDLE OF THE MARK. "VISIONS MADE REAL" IS IN STYLIZED FONT AT THE BOTTOM OF THE MARK.

FOR (BASED ON USE IN COMMERCE) AUDIO AND VIDEO RECORDING SERVICES; AUDIO RECORDING AND PRODUCTION; DIGITAL VIDEO, AUDIO, AND MULTIMEDIA PUBLISHING SERVICES; ENTERTAINMENT SERVICES, NAMELY, PRODUCTION OF SPECIAL EFFECTS INCLUDING MODEL-MAKING SERVICES, COMPUTER-GENERATED IMAGERY AND COMPUTER-GENERATED GRAPHICS FOR THE PRODUCTION OF MOTION PICTURES, VIDEOS, AND MOVIE TRAILERS; FILM AND VIDEO PRODUCTION; MOTION PICTURE FILM PRODUCTION; MOTION PICTURE SONG PRODUCTION; MUSIC PRODUCTION SERVICES; POST-PRODUCTION EDITING SERVICES IN THE FIELD OF MUSIC, VIDEOS AND FILM; PRODUCTION AND DISTRIBUTION OF MOTION PICTURES; PRODUCTION OF VISUAL EFFECTS FOR VIDEOS, DVDS, TELEVISION AND FOR INTERNET WEB SITES; VIDEO EDITING; VIDEO MASTERING SERVICES (BASED ON INTENT TO USE) MUSIC PUBLISHING SERVICES; MUSIC VIDEO PRODUCTION; PHOTOGRAPHIC AND VIDEO SERVICES, NAMELY, PHOTOGRAPHIC AND VIDEO CAPTURE; PUBLISHING OF BOOKS, E-BOOKS, AUDIO BOOKS, MUSIC AND ILLUSTRATIONS (U.S. CLS. 100, 101 AND 107).

FIRST USE 10-9-2009; IN COMMERCE 10-9-2009.

KATHLEEN M. VANSTON, EXAMINING ATTORNEY

CLASS 41—(Continued).

SN 77-898,610. FINK PRODUCTIONS, INC., PHILADELPHIA, PA. FILED 12-21-2009.

e planet

THE MARK CONSISTS OF STANDARD CHARACTERS WITHOUT CLAIM TO ANY PARTICULAR FONT, STYLE, SIZE, OR COLOR.

NO CLAIM IS MADE TO THE EXCLUSIVE RIGHT TO USE "PLANET", APART FROM THE MARK AS SHOWN.

FOR ENTERTAINMENT AND EDUCATION SERVICES, NAMELY, CREATING PROGRAMS ABOUT ENVIRONMENTAL TOPICS AND ISSUES TO BE BROADCAST THROUGH VIDEO, TELEVISION, AND WEBCASTS (U.S. CLS. 100, 101 AND 107).

DORITT L. CARROLL, EXAMINING ATTORNEY

SN 77-898,727. C BUTCHER & ASSOCIATES, LLC, WASHINGTON, DC. FILED 12-21-2009.

The School of Life DC

THE MARK CONSISTS OF STANDARD CHARACTERS WITHOUT CLAIM TO ANY PARTICULAR FONT, STYLE, SIZE, OR COLOR.

NO CLAIM IS MADE TO THE EXCLUSIVE RIGHT TO USE "SCHOOL" AND "DC", APART FROM THE MARK AS SHOWN.

FOR EDUCATION SERVICES, NAMELY, PROVIDING COACHING, MENTORING, CLASSES, WORKSHOPS, AND RETREATS IN THE FIELD OF RELATIONSHIPS, HEALTH, YOGA AND DAILY LIVING (U.S. CLS. 100, 101 AND 107).

FIRST USE 12-15-2009; IN COMMERCE 12-15-2009.

EUGENIA MARTIN, EXAMINING ATTORNEY

SN 77-899,882. UNIVERSITY OF MIAMI, CORAL GABLES, FL. FILED 12-23-2009.

YOUR LIFE IS LARGER THAN A
CLASSROOM YOUR EDUCATION
SHOULD BE TOO.

THE MARK CONSISTS OF STANDARD CHARACTERS WITHOUT CLAIM TO ANY PARTICULAR FONT, STYLE, SIZE, OR COLOR.

FOR EDUCATIONAL SERVICES, NAMELY, PROVIDING ON-LINE COURSES OF EDUCATION AT THE HIGH-SCHOOL LEVEL (U.S. CLS. 100, 101 AND 107).

FIRST USE 11-30-2008; IN COMMERCE 11-30-2008.

DAVID TAYLOR, EXAMINING ATTORNEY

CLASS 41—(Continued).

SN 77-900,676. FRAME LOGIC DIGITAL LLC, DBA FRAME LOGIC DIGITAL, BROOKLYN, NY. FILED 12-23-2009.



THE MARK CONSISTS OF FILM FRAMES MORPHING INTO A DIGITAL SIGNAL.

FOR (BASED ON USE IN COMMERCE) FILM AND VIDEO PRODUCTION CONSULTING SERVICES; MEDIA PRODUCTION SERVICES, NAMELY, VIDEO AND FILM PRODUCTION; TELEVISION, VIDEO AND MOVIE FILMING SERVICES (BASED ON INTENT TO USE) FILM AND VIDEO PRODUCTION; FILM AND VIDEO TAPE FILM PRODUCTION; FILM MASTERING SERVICES; MOTION PICTURE FILM PRODUCTION; POST-PRODUCTION EDITING SERVICES IN THE FIELD OF MUSIC, VIDEOS AND FILM; PROVIDING INFORMATION AND ARTICLES IN THE FIELD OF FILM, FILMMAKING, AND ENTERTAINMENT VIA A GLOBAL COMPUTER NETWORK (U.S. CLS. 100, 101 AND 107).

FIRST USE 10-17-2008; IN COMMERCE 11-22-2008.

TRACY FLETCHER, EXAMINING ATTORNEY

SN 77-901,086. TANTRA, INC., PARKER, CO. FILED 12-26-2009.

MUSIC VOYAGER

THE MARK CONSISTS OF STANDARD CHARACTERS WITHOUT CLAIM TO ANY PARTICULAR FONT, STYLE, SIZE, OR COLOR.

NO CLAIM IS MADE TO THE EXCLUSIVE RIGHT TO USE "MUSIC", APART FROM THE MARK AS SHOWN.

FOR ENTERTAINMENT SERVICES IN THE NATURE OF MUSIC AND TRAVEL SHOW BROADCAST OVER TELEVISION, INTERNET, SATELLITE, AUDIO, AND VIDEO MEDIA; PROVIDING A WEBSITE FEATURING INFORMATION IN THE FIELD OF MUSIC, MUSICAL PERFORMANCES, INTERVIEWS WITH MUSIC ARTISTS, MUSICAL VIDEOS, PHOTOGRAPHS, PRE-RECORDED MUSIC, COMMENTARY AND ARTICLES ABOUT MUSIC; PRODUCTION OF MUSIC AND TRAVEL RELATED TELEVISION SHOWS, CABLE TELEVISION PROGRAMS, RADIO PROGRAMS, WEBCASTS, WEBISODES, FILMS AND MUSICAL PERFORMANCES; ENTERTAINMENT, NAMELY, LIVE MUSIC CONCERTS BY A MUSICAL ARTIST, MUSICAL BAND OR MUSICAL GROUP; ENTERTAINMENT IN THE NATURE OF VISUAL AND AUDIO PERFORMANCES BY A MUSICAL ARTIST, MUSICAL GROUP AND MUSICAL BAND; ENTERTAINMENT, NAMELY, PERSONAL APPEARANCES BY A TELEVISION STAR, MOVIE STAR, MUSIC ARTIST, COMEDIAN OR RADIO PERSONALITY; ENTERTAINMENT IN THE NATURE OF TRAVELING TOURS FEATURING MUSIC; DISTRIBUTION OF MUSIC, AUDIO AND VIDEO RECORDINGS FOR BROADCAST (U.S. CLS. 100, 101 AND 107).

FIRST USE 11-11-2009; IN COMMERCE 11-11-2009.

CHARLES L. JENKINS, EXAMINING ATTORNEY

CLASS 41—(Continued).

SN 77-901,376. TEAM OF 16, WICHITA, KS. FILED 12-28-2009.



NO CLAIM IS MADE TO THE EXCLUSIVE RIGHT TO USE "TEAM OF 16", APART FROM THE MARK AS SHOWN. THE MARK CONSISTS OF THE WORDING "T16 TEAM OF 16", WITH THE WORDING "T16" APPEARING INSIDE AN INCOMPLETE OVAL SHAPE AND A STYLIZED BASKETBALL APPEARING IN THE "6" IN "T16". THE "T" AND THE "6" IN THE "T16" LOGO APPEAR IN THE FOREGROUND, WHILE THE "1" APPEARS IN THE BACKGROUND.

FOR ENTERTAINMENT SERVICES, NAMELY, PROVIDING AN ON-LINE COMPUTER GAME (U.S. CLS. 100, 101 AND 107).

SEAN CROWLEY, EXAMINING ATTORNEY

SN 77-901,541. CARR, STEPHANIE Y, DBA MIND BELLY & SOUL, DETROIT, MI. FILED 12-28-2009.



THE COLOR(S) PROCESS BLUE, BLACK, RED, WHITE AND YELLOW IS/ARE CLAIMED AS A FEATURE OF THE MARK.

THE MARK CONSISTS OF AN ABSTRACT WOMAN IN BLACK WITH HANDS UP, A YELLOW DOT ON THE HEAD AND BELLY BUTTON, A RED HEART, AND BELLY DANCE BELT WITH RED AND WHITE STRANDS WITH YELLOW COINS ON BLUE BAR WITH THE WORDS "MIND" (IN BLUE), "BELLY" (IN BLACK), "&" (IN YELLOW), AND "SOUL" (IN RED) ON SIDE IN CURLED SCRIPT.

FOR EDUCATION SERVICES, NAMELY, PROVIDING LIVE AND ON-LINE CLASSES, SEMINARS, WORKSHOPS, CONFERENCES IN THE FIELD OF BELLY DANCE AND DANCE FUSION (U.S. CLS. 100, 101 AND 107).

FIRST USE 12-21-2006; IN COMMERCE 1-7-2007.
JASON TURNER, EXAMINING ATTORNEY

CLASS 41—(Continued).

SN 77-902,132. THE MASTER'S SOCIETY, LLC, AIKEN, SC. FILED 12-29-2009.



NO CLAIM IS MADE TO THE EXCLUSIVE RIGHT TO USE "SOCIETY", APART FROM THE MARK AS SHOWN.

THE MARK CONSISTS OF A CIRCLE WITH TEXT AND IMAGERY. THE TEXT INSIDE THE BORDER OF THE CIRCLE READS "CUPIDITAS ACTIO MISERICORDIA" AS WELL AS LEAVES. THE IMAGE INSIDE THE CIRCLE IS A SHIELD SPLIT INTO FOUR SECTIONS. THE TOP LEFT SECTION CONTAINS A BOOK, THE TOP RIGHT SECTION CONTAINS A CAP, THE BOTTOM LEFT SECTION CONTAINS A SYMBOL OF FIRE, AND THE BOTTOM RIGHT SECTION CONTAINS A COURTHOUSE FIGURE. NEXT TO THE ICON IS THE TEXT "MASTER'S SOCIETY CONIUNCTIS VIRIBUS".

FOR PROVIDING AN ACADEMIC HONOR SOCIETY IN WHICH STUDENTS ARE ADMITTED IN RECOGNITION OF ACADEMIC ACHIEVEMENT (U.S. CLS. 100, 101 AND 107).

EMILY CARLSEN, EXAMINING ATTORNEY

SN 77-903,973. SKY RIVER HELICOPTERS, LLC, BERNARDSVILLE, NJ. FILED 1-2-2010.

Sky River

THE MARK CONSISTS OF STANDARD CHARACTERS WITHOUT CLAIM TO ANY PARTICULAR FONT, STYLE, SIZE, OR COLOR.

FOR AIRPLANE FLIGHT INSTRUCTION; ENTERTAINMENT SERVICES, NAMELY, HELICOPTER RIDES AND TOURS (U.S. CLS. 100, 101 AND 107).

FIRST USE 1-13-2010; IN COMMERCE 1-13-2010.
KATINA MISTER, EXAMINING ATTORNEY

SN 77-904,429. TAVANA MEDIA LLC, WHITEFISH, MT. FILED 1-4-2010.

KITE CARTEL

THE MARK CONSISTS OF STANDARD CHARACTERS WITHOUT CLAIM TO ANY PARTICULAR FONT, STYLE, SIZE, OR COLOR.

FOR ENTERTAINMENT SERVICES, MULTIMEDIA PRODUCTION SERVICES OF MULTIMEDIA CONTENT FOR DISTRIBUTION VIA AN ENTERTAINMENT WEBSITE (U.S. CLS. 100, 101 AND 107).

SANJEEV VOHRA, EXAMINING ATTORNEY

CLASS 41—(Continued).

SN 77-905,095. THE AMERICAN BOARD OF RADIOLOGY, TUCSON, AZ. FILED 1-5-2010.



OWNER OF U.S. REG. NOS. 2,183,466, 2,197,104 AND 3,647,299.

NO CLAIM IS MADE TO THE EXCLUSIVE RIGHT TO USE "BOARD OF RADIOLOGY", "EXCELLENCE" "PROFESSIONALISM", "PUBLIC TRUST" AND "EST. 1934", APART FROM THE MARK AS SHOWN.

THE MARK CONSISTS OF THE STYLIZED, UPPERCASE LETTERS, "ABR", BELOW WHICH, ON SEPARATE LINES, ARE THE WORDS, IN STYLIZED, UPPERCASE LETTERS, "THE" AND "AMERICAN" AND, UNDERSCORED ON THE LAST LINE, "BOARD OF RADIOLOGY". BENEATH THE UNDERSCORE ARE THE WORDS IN SMALLER, STYLIZED, UPPERCASE LETTERS, EACH SEPARATED BY A BULLET POINT, "EXCELLENCE" AND "PROFESSIONALISM" AND "PUBLIC TRUST" AND "EST. 1934".

SEC. 2(F) AS TO "AMERICAN BOARD OF RADIOLOGY". FOR ORGANIZING AND CONDUCTING EDUCATIONAL MEDICAL EXAMINATIONS IN THE FIELD OF RADIOLOGY (U.S. CLS. 100, 101 AND 107).

CORY BOONE, EXAMINING ATTORNEY

CLASS 41—(Continued).

SN 77-907,465. TARGETSAFETY.COM, INC., SAN DIEGO, CA. FILED 1-7-2010.

TARGETSAFETY

THE MARK CONSISTS OF STANDARD CHARACTERS WITHOUT CLAIM TO ANY PARTICULAR FONT, STYLE, SIZE, OR COLOR.

FOR EDUCATIONAL SERVICES, NAMELY, CONDUCTING ON-LINE TRAINING AND WEB-BASED RISK MANAGEMENT TRAINING TO PUBLIC ENTITIES AND PRIVATE ENTERPRISES FEATURING BOTH GENERAL AND CUSTOMIZED, SAFETY PROGRAMS, COMPLIANCE TASK MANAGEMENT, DOCUMENT DISTRIBUTION AND MANAGEMENT, AND SELF-ASSESSMENT, AND DISTRIBUTION OF COURSE MATERIALS IN CONNECTION THEREWITH; PROVIDING INDUSTRY CERTIFICATION AND CONTINUING EDUCATION COURSES IN THE FIELD OF RISK MANAGEMENT; DRIVER SAFETY TRAINING (U.S. CLS. 100, 101 AND 107).

FIRST USE 12-8-2005; IN COMMERCE 12-8-2005.
CURTIS FRENCH, EXAMINING ATTORNEY

SN 77-906,912. GIRL SCOUTS OF GREATER CHICAGO AND NORTHWEST INDIANA, INC., CHICAGO, IL. FILED 1-7-2010.

WORLD'S STRONGEST GIRL

THE MARK CONSISTS OF STANDARD CHARACTERS WITHOUT CLAIM TO ANY PARTICULAR FONT, STYLE, SIZE, OR COLOR.

NO CLAIM IS MADE TO THE EXCLUSIVE RIGHT TO USE "GIRL", APART FROM THE MARK AS SHOWN.

FOR EDUCATIONAL SERVICES, NAMELY, CONDUCTING PROGRAMS AND ACTIVITIES FOR GIRLS AND YOUNG WOMEN TO PROMOTE SOCIAL, PHYSICAL AND INTELLECTUAL GROWTH AND DEVELOPMENT; PROVIDING A WEBSITE FEATURING EDUCATION AND ENTERTAINMENT FOR GIRLS AND YOUNG WOMEN (U.S. CLS. 100, 101 AND 107).

SHAUNIA CARLYLE, EXAMINING ATTORNEY

SN 77-908,624. SHAWN PRIDE, LOS ANGELES, CA. FILED 1-11-2010.

BIKINI RIOT

THE MARK CONSISTS OF STANDARD CHARACTERS WITHOUT CLAIM TO ANY PARTICULAR FONT, STYLE, SIZE, OR COLOR.

NO CLAIM IS MADE TO THE EXCLUSIVE RIGHT TO USE "BIKINI", APART FROM THE MARK AS SHOWN.

FOR ENTERTAINMENT SERVICES, NAMELY, PROVIDING A WEB SITE FEATURING NONDOWNLOADABLE ADULT-THEMED PHOTOGRAPHS AND VIDEOS (U.S. CLS. 100, 101 AND 107).

FIRST USE 7-1-2001; IN COMMERCE 7-1-2001.

REBECCA POVARCHUK, EXAMINING ATTORNEY

CLASS 41—(Continued).

SN 77-909,555. LINDSAY M. HOFFMAN, AKA JAK HUDSON, LOS ANGELES, CA. AND HOLLY N. LINGLE, LOS ANGELES, CA. FILED 1-11-2010.

UNKNOWN

THE MARK CONSISTS OF STANDARD CHARACTERS WITHOUT CLAIM TO ANY PARTICULAR FONT, STYLE, SIZE, OR COLOR.

FOR ENTERTAINMENT IN THE NATURE OF VISUAL AND AUDIO PERFORMANCES, NAMELY, MUSICAL BAND, ROCK GROUP, GYMNASTIC, DANCE, AND BALLET PERFORMANCES; ENTERTAINMENT SERVICES IN THE NATURE OF LIVE MUSICAL PERFORMANCES (U.S. CLS. 100, 101 AND 107).

TIMOTHY FINNEGAN, EXAMINING ATTORNEY

SN 77-910,527. SACHIKO BROWN, BRONX, NY. FILED 1-12-2010.

Genkistep

THE MARK CONSISTS OF STANDARD CHARACTERS WITHOUT CLAIM TO ANY PARTICULAR FONT, STYLE, SIZE, OR COLOR.

THE ENGLISH TRANSLATION OF "GENKI" IN THE MARK IS "VIGOR" OR "CHEERFUL." HOWEVER, THE WORDING "GENKISTEP" HAS NO MEANING IN A FOREIGN LANGUAGE.

FOR ENTERTAINMENT SERVICES IN THE NATURE OF RECORDING, PRODUCTION AND POST-PRODUCTION SERVICES IN THE FIELDS OF MUSIC; PRODUCTION OF SOUND AND MUSIC VIDEO RECORDINGS; ENTERTAINMENT SERVICES, NAMELY, PROVIDING INFORMATION ABOUT A RECORDING ARTIST VIA AN ONLINE NETWORK (U.S. CLS. 100, 101 AND 107).

MARCIE MILONE, EXAMINING ATTORNEY

SN 77-911,837. ARDIS CREATIVE SERVICE PARTNERS, INC., FORT LAUDERDALE, FL. FILED 1-14-2010.

Jersey Local Living

THE MARK CONSISTS OF STANDARD CHARACTERS WITHOUT CLAIM TO ANY PARTICULAR FONT, STYLE, SIZE, OR COLOR.

NO CLAIM IS MADE TO THE EXCLUSIVE RIGHT TO USE "JERSEY", APART FROM THE MARK AS SHOWN.

FOR MAGAZINE PUBLISHING; ONLINE ELECTRONIC PUBLISHING OF BOOKS AND PERIODICALS (U.S. CLS. 100, 101 AND 107).

FIRST USE 6-6-2009; IN COMMERCE 7-16-2009.

JORDAN BAKER, EXAMINING ATTORNEY

CLASS 41—(Continued).

SN 77-913,253. BOSTON EDUCATIONAL SERVICES LLC, RESEDA, CA. FILED 1-15-2010.



THE MARK CONSISTS OF THE STYLIZED PRINT FONT OF "ITEP" WITHIN AN OVAL.

FOR PREPARING, ADMINISTERING, AND SCORING STANDARDIZED TESTS (U.S. CLS. 100, 101 AND 107).

FIRST USE 1-31-2007; IN COMMERCE 1-31-2007.

DOMINIC J. FERRAIUOLO, EXAMINING ATTORNEY

SN 77-913,819. VAZQUEZ RICK, PORT READING, NJ. FILED 1-18-2010.

THE PIZZA DELIVERY MILLIONAIRE

THE MARK CONSISTS OF STANDARD CHARACTERS WITHOUT CLAIM TO ANY PARTICULAR FONT, STYLE, SIZE, OR COLOR.

FOR EDUCATIONAL AND ENTERTAINMENT SERVICES, NAMELY, PROVIDING CLASSES, SEMINARS AND WORKSHOPS IN THE FIELD OF INVESTING MONEY ON REAL ESTATE; PROVIDING KNOWLEDGE THROUGH MOTIVATIONAL SPEAKING SERVICES IN THE FIELD OF PERSONAL FINANCES FOR CONSUMERS; PROVIDING TRAINING IN THE FIELD OF PERSONAL FINANCES FOR CONSUMERS (U.S. CLS. 100, 101 AND 107).

FIRST USE 11-15-2007; IN COMMERCE 2-1-2009.

KATHY DE JONGE, EXAMINING ATTORNEY

SN 77-914,129. WALDRON ENTERPRISES, LLC, ESCONDI-DO, CA. FILED 1-18-2010.

CRUISIN' GRAND

THE MARK CONSISTS OF STANDARD CHARACTERS WITHOUT CLAIM TO ANY PARTICULAR FONT, STYLE, SIZE, OR COLOR.

NO CLAIM IS MADE TO THE EXCLUSIVE RIGHT TO USE "CRUISIN'", APART FROM THE MARK AS SHOWN.

FOR CONDUCTING ENTERTAINMENT EXHIBITIONS FEATURING MANUFACTURED VEHICLES, HOTRODS, RACE CARS AND VINTAGE AUTOMOBILES (U.S. CLS. 100, 101 AND 107).

FIRST USE 4-1-2000; IN COMMERCE 4-1-2000.

MICHELE SWAIN, EXAMINING ATTORNEY

CLASS 41—(Continued).

SN 77-917,395. LEMBERT ENTERPRISES, LLC, RESTON, VA. FILED 1-21-2010.



NO CLAIM IS MADE TO THE EXCLUSIVE RIGHT TO USE "AMERICANLATINO.COM", APART FROM THE MARK AS SHOWN.

THE MARK CONSISTS OF THE WORDING "AMERICANLATINO.COM" WITH TWO CURVED BANDS EXTENDING DOWNWARD FROM THE "DOT" IN ".COM" THEN UPWARD, SUPERIMPOSED OVER THE LETTER COMBINATION "ANL" IN "AMERICANLATINO".

FOR ONLINE PUBLICATION, NAMELY, MAGAZINES, NEWSLETTERS AND JOURNALS/BLOGS REPORTING ON ISSUES OF KEEN INTEREST TO THE US HISPANIC AND LATINO POPULATION SECTOR, ALL RELATING TO GENERAL NEWS, POLITICS, ARTS AND ENTERTAINMENT, EDUCATION, IDENTITY, SPORTS, TRAVEL, BUSINESS AND TECHNOLOGY, FOOD AND WINE, CULTURAL EVENTS, IMMIGRATION, BUSINESS DIRECTORIES, EMPLOYMENT, REAL ESTATE, MOTOR VEHICLES AND CLASSIFIED ADVERTISING (U.S. CLS. 100, 101 AND 107).

FIRST USE 1-5-2000; IN COMMERCE 5-1-2007.

GENE MACIOL, EXAMINING ATTORNEY

CLASS 41—(Continued).

SN 77-918,097. THE SUTER COMPANY, INC., SYCAMORE, IL. FILED 1-22-2010.

A LEADER'S VOYAGE

THE MARK CONSISTS OF STANDARD CHARACTERS WITHOUT CLAIM TO ANY PARTICULAR FONT, STYLE, SIZE, OR COLOR.

NO CLAIM IS MADE TO THE EXCLUSIVE RIGHT TO USE "LEADER'S", APART FROM THE MARK AS SHOWN.

FOR MANAGEMENT AND LEADERSHIP TRAINING, CONDUCTING SEMINARS IN THE FIELD OF LEADERSHIP, AND DISTRIBUTING PRINTED COURSE MATERIALS IN CONNECTION THEREWITH (U.S. CLS. 100, 101 AND 107).

MELISSA VALLILLO, EXAMINING ATTORNEY

SN 77-917,767. ORANGE COUNTY SCHOLASTIC ACADEMY, IRVINE, CA. FILED 1-22-2010.



NO CLAIM IS MADE TO THE EXCLUSIVE RIGHT TO USE "ORANGE COUNTY" AND "SCHOLASTIC ACADEMY", APART FROM THE MARK AS SHOWN.

THE MARK CONSISTS OF TWO INTERSECTING LINES, PERPENDICULAR LINES WITH THE LETTER "O" INSIDE A CIRCLE, THE LETTER "C" INSIDE A PENTAGON, THE LETTER "S" INSIDE A SQUARE, AND THE LETTER "A" INSIDE A TRIANGLE. EACH LETTER IS IN A DIFFERENT QUADRANT OF THE INTERSECTING LINES. THERE IS A FIGURE REACHING UP TO A STAR ON THE LEFT SIDE OF DESIGN WITH A BACKSLASH. THE STYLIZED TEXT "ORANGE COUNTY" IS WRITTEN JUST UNDER THE STAR AT THE TOP OF THE LOGO. THE STYLIZED TEXT "SCHOLASTIC ACADEMY" IS AT THE BOTTOM OF LOGO.

FOR EDUCATIONAL SERVICES, NAMELY, PROVIDING TUTORING, HOME SCHOOLING, AFTERSCHOOL AND SUMMER CLASSES IN THE FIELDS OF MATH, FOREIGN LANGUAGE, MUSIC, READING, WRITING, AND ART (U.S. CLS. 100, 101 AND 107).

FIRST USE 1-3-2009; IN COMMERCE 5-1-2009.

JOSETTE BEVERLY, EXAMINING ATTORNEY

SN 77-919,651. IVANOV, KALIN HRISTOV, BROOKLYN, NY. FILED 1-25-2010.

The Forte String Quartet

THE MARK CONSISTS OF STANDARD CHARACTERS WITHOUT CLAIM TO ANY PARTICULAR FONT, STYLE, SIZE, OR COLOR.

NO CLAIM IS MADE TO THE EXCLUSIVE RIGHT TO USE "STRING QUARTET", APART FROM THE MARK AS SHOWN.

FOR EDUCATION SERVICES, NAMELY, PROVIDING RESIDENCIES, CLASSES, SEMINARS, WORKSHOPS IN THE FIELDS OF MUSIC, INSTRUMENTAL MUSIC, AND CHAMBER MUSIC; ENTERTAINMENT SERVICES IN THE NATURE OF LIVE MUSICAL PERFORMANCES; ENTERTAINMENT, NAMELY, LIVE MUSIC CONCERTS (U.S. CLS. 100, 101 AND 107).

FIRST USE 9-0-1990; IN COMMERCE 10-0-1990.

SEAN CROWLEY, EXAMINING ATTORNEY

CLASS 41—(Continued).

SN 77-919,837. IVANOV, KALIN HRISTOV, BROOKLYN, NY. FILED 1-25-2010.

New York Empire Trio

THE MARK CONSISTS OF STANDARD CHARACTERS WITHOUT CLAIM TO ANY PARTICULAR FONT, STYLE, SIZE, OR COLOR.

NO CLAIM IS MADE TO THE EXCLUSIVE RIGHT TO USE "NEW YORK" OR "TRIO", APART FROM THE MARK AS SHOWN.

FOR EDUCATION SERVICES, NAMELY, PROVIDING RESIDENCIES, CLASSES, SEMINARS, WORKSHOPS IN THE FIELDS OF MUSIC, INSTRUMENTAL MUSIC, AND CHAMBER MUSIC; ENTERTAINMENT SERVICES IN THE NATURE OF LIVE MUSICAL PERFORMANCES; ENTERTAINMENT, NAMELY, LIVE MUSIC CONCERTS (U.S. CLS. 100, 101 AND 107).

FIRST USE 10-0-1997; IN COMMERCE 1-29-1998.
SEAN CROWLEY, EXAMINING ATTORNEY

SN 77-920,085. POTLUCK INTERNATIONAL, LLC, DBA DEPARTMENT OF MOTIVATED VEHICLES, OAKLAND, CA. FILED 1-26-2010.



NO CLAIM IS MADE TO THE EXCLUSIVE RIGHT TO USE "30 DAY", APART FROM THE MARK AS SHOWN.

THE COLOR(S) RED, DARK GRAY, LIGHT GRAY, BLACK, AND WHITE IS/ARE CLAIMED AS A FEATURE OF THE MARK.

THE MARK CONSISTS OF A LIGHT GRAY BOX ON THE LEFT WITH A RED "X" ACROSS THE EDGES AND THROUGH THE MIDDLE OF THE BOX; A DARK GRAY "30" IS IN THE MIDDLE OF THE LIGHT GRAY BOX; TO THE RIGHT OF THE BOX ARE THE WORDS, IN ALL CAPITAL LETTERS, "DAY DO IT" IN BLACK; UNDERNEATH THE BLACK WORDS IS THE WORD, IN ALL CAPITAL LETTERS, "MOVEMENT". THE BOX THAT CONTAINS THE NUMBER "30" APPEARS IN WHITE. THE WORD "MOVEMENT" APPEARS IN RED.

FOR CONDUCTING WORKSHOPS AND SEMINARS IN PERSONAL AWARENESS; CONDUCTING WORKSHOPS AND SEMINARS IN SELF AWARENESS; CONDUCTING WORKSHOPS AND SEMINARS IN PERSONAL DEVELOPMENT; EDUCATIONAL AND ENTERTAINMENT SERVICES, NAMELY, PROVIDING MOTIVATIONAL AND EDUCATIONAL SPEAKERS IN THE FIELD OF SELF- AND PERSONAL IMPROVEMENT; EDUCATIONAL SERVICES, NAMELY, CONDUCTING SEMINARS, LECTURES, TELESEMINARS, TELECLASSES, AND WORKSHOPS IN PERSONAL AWARENESS (U.S. CLS. 100, 101 AND 107).

FIRST USE 1-1-2010; IN COMMERCE 1-1-2010.
DORITT L. CARROLL, EXAMINING ATTORNEY

CLASS 41—(Continued).

SN 77-920,559. ALL UNDER ONE ROOF SPORTS, LLC, SPARKS, NV. FILED 1-26-2010.

All Under One Roof

THE MARK CONSISTS OF STANDARD CHARACTERS WITHOUT CLAIM TO ANY PARTICULAR FONT, STYLE, SIZE, OR COLOR.

FOR ENTERTAINMENT IN THE NATURE OF BASKETBALL, VOLLEYBALL, FUTSAL, CHEERLEADING, WRESTLING AND MARTIAL ARTS TOURNAMENTS (U.S. CLS. 100, 101 AND 107).

FIRST USE 12-1-2003; IN COMMERCE 12-1-2003.
KYLE PEETE, EXAMINING ATTORNEY

SN 77-921,158. A.R.B.C.O NETWORKS, MAHOPAC, NY. FILED 1-27-2010.



NO CLAIM IS MADE TO THE EXCLUSIVE RIGHT TO USE "NETWORKS", APART FROM THE MARK AS SHOWN.

THE MARK CONSISTS OF THE STYLIZED TEXT "A.R.B.C.O NETWORKS".

FOR FILM AND VIDEO PRODUCTION; MUSIC PRODUCTION SERVICES; MUSIC PUBLISHING SERVICES; RECORDING STUDIO SERVICES (U.S. CLS. 100, 101 AND 107).

JANICE L. MCMORROW, EXAMINING ATTORNEY

SN 77-921,166. I DEAF NEWS, AUSTIN, TX. FILED 1-27-2010.



NO CLAIM IS MADE TO THE EXCLUSIVE RIGHT TO USE "I DEAF NEWS", APART FROM THE MARK AS SHOWN.

THE MARK CONSISTS OF A SMALL EYE, WITH PUPIL, INSIDE THE DOT ON TOP OF THE LOWER CASE "I" IN THE TITLE, "I DEAF NEWS".

FOR PROVIDING A WEB SITE FEATURING CURRENT EVENTS NEWS AND INFORMATION FOR THE DEAF AND HARD OF HEARING (HOH) COMMUNITY THROUGHOUT THE WORLD (U.S. CLS. 100, 101 AND 107).

FIRST USE 11-12-2009; IN COMMERCE 12-8-2009.
JANICE L. MCMORROW, EXAMINING ATTORNEY

CLASS 41—(Continued).

SN 77-921,205. NATIONAL CHERRY BLOSSOM FESTIVAL, INC., WASHINGTON, DC. FILED 1-27-2010.



OWNER OF U.S. REG. NOS. 1,942,102, 3,593,757 AND OTHERS.

NO CLAIM IS MADE TO THE EXCLUSIVE RIGHT TO USE "CHERRY BLOSSOM FESTIVAL", APART FROM THE MARK AS SHOWN.

THE COLOR(S) PINK, WHITE AND BLACK IS/ARE CLAIMED AS A FEATURE OF THE MARK.

THE MARK CONSISTS OF A STYLIZED DESIGN OF TWO CHERRY BLOSSOM FLOWERS AND THE STYLIZED WORDS "NATIONAL CHERRY BLOSSOM FESTIVAL". THE COLOR BLACK APPEARS IN THE OUTLINE OF THE FLOWERS AND THE WORDING "NATIONAL" AND "FESTIVAL". THE COLOR PINK APPEARS IN THE INTERIOR COLOR OF THE FIRST FLOWER AND THE INTERIOR LINES OF THE SECOND FLOWER AND IN THE WORDING "CHERRY BLOSSOM". THE COLOR WHITE APPEARS IN THE INTERIOR LINES OF THE FIRST FLOWER AND IN THE INTERIOR COLOR OF THE SECOND FLOWER.

SEC. 2(F) AS TO "NATIONAL CHERRY BLOSSOM FESTIVAL".

FOR ENTERTAINMENT AND EDUCATIONAL SERVICES, NAMELY, ORGANIZING AND PRESENTING AN ANNUAL ECOLOGICAL AND CULTURAL CELEBRATION THAT FEATURES ARBOREAL EVENTS AND EXHIBITS, LIVE MUSIC AND DANCE ENTERTAINMENT, FOOD TASTINGS, SPORTING EVENTS, A PARADE AND THE LIKE (U.S. CLS. 100, 101 AND 107).

FIRST USE 12-7-2009; IN COMMERCE 12-7-2009.

JOHN SCHUYLER YARD, EXAMINING ATTORNEY

CLASS 41—(Continued).

SN 77-921,469. WEINTRAUB, ADAM SCOTT, TULSA, OK. FILED 1-27-2010.



NO CLAIM IS MADE TO THE EXCLUSIVE RIGHT TO USE "ATTORNEY", APART FROM THE MARK AS SHOWN.

THE NAME(S), PORTRAIT(S), AND/OR SIGNATURE(S) SHOWN IN THE MARK IDENTIFIES ADAM SCOTT WEINTRAUB, WHOSE CONSENT(S) TO REGISTER IS MADE OF RECORD.

THE MARK CONSISTS OF THE WORDING "ATTORNEY ADAM WHAT'S YOUR PROBLEM?", WHEREIN THE IMAGE OF AN INDIVIDUAL IS LEANED AGAINST THE LETTER "A" OF THE WORD "ATTORNEY" AND THE REFLECTION OF THE INDIVIDUAL IS POSITIONED PERPENDICULAR TO THE INDIVIDUAL'S IMAGE.

FOR ENTERTAINMENT SERVICES, NAMELY, PROVIDING AN ON-GOING RADIO PROGRAM FEATURING PROFESSIONAL LEGAL ADVICE IN RESPONSE TO ON-AIR QUESTIONS DEALING WITH REAL LIFE LEGAL ISSUES (U.S. CLS. 100, 101 AND 107).

FIRST USE 1-17-2010; IN COMMERCE 1-17-2010.

RUSS HERMAN, EXAMINING ATTORNEY

SN 77-921,823. HONEST CONCERTS INC., LOS ANGELES, CA. FILED 1-27-2010.

HONEST CONCERTS

THE MARK CONSISTS OF STANDARD CHARACTERS WITHOUT CLAIM TO ANY PARTICULAR FONT, STYLE, SIZE, OR COLOR.

NO CLAIM IS MADE TO THE EXCLUSIVE RIGHT TO USE "CONCERTS", APART FROM THE MARK AS SHOWN.

FOR ARRANGING, ORGANIZING AND CONDUCTING MUSIC FESTIVALS, CONCERTS AND MUSIC TOURS; AND PROVIDING A WEB SITE ON A GLOBAL COMPUTER NETWORK FEATURING INFORMATION ON MUSIC AND ENTERTAINMENT (U.S. CLS. 100, 101 AND 107).

KEVIN CORWIN, EXAMINING ATTORNEY

CLASS 41—(Continued).

SN 77-922,106. PACIFIC CAPITAL MANAGEMENT GROUP, LLC, SACRAMENTO, CA. FILED 1-28-2010.



NO CLAIM IS MADE TO THE EXCLUSIVE RIGHT TO USE "POSITIVE AND PROACTIVE EDUCATION PROGRAMS SINCE 1994", APART FROM THE MARK AS SHOWN.

THE MARK CONSISTS OF A SHADOW OF TWO STUDENTS BACK-TO-BACK, SITTING ON THE GROUND EXAMINING MATERIALS IN FRONT OF THE LETTERS "T" AND "E" (THE "T" OVERLAPS THE "E"), OVER THE LARGER WORDS, "TARGET: EXCELLENCE". THE SMALLER WORDS, "POSITIVE AND PROACTIVE EDUCATION PROGRAMS SINCE 1994", ARE RIGHT JUSTIFIED UNDER THE ELEMENTS PREVIOUSLY MENTIONED.

FOR CONDUCTING AFTER-SCHOOL TUTORING PROGRAMS; EDUCATION SERVICES, NAMELY, PROVIDING MENTORING, TUTORING, CLASSES, SEMINARS AND WORKSHOPS IN THE FIELD OF READING, WRITING, ARITHMETIC, PROPER NUTRITION, COLLEGE LEVEL COURSES AND CAREER DEVELOPMENT, TIME MANAGEMENT, STUDY SKILLS AND MANNERS; EDUCATION SERVICES, NAMELY, PROVIDING TUTORING IN THE FIELDS OF READING, WRITING, ARITHMETIC, PROPER NUTRITION, COLLEGE LEVEL COURSES AND CAREER DEVELOPMENT, TIME MANAGEMENT, STUDY SKILLS AND MANNERS (U.S. CLS. 100, 101 AND 107).

FIRST USE 1-15-1994; IN COMMERCE 1-15-1994.
REBECCA GILBERT, EXAMINING ATTORNEY

SN 77-923,399. BLACK, JASON THOMAS, CONNEAUT LAKE, PA. FILED 1-29-2010.

BLACKONIAN

THE MARK CONSISTS OF STANDARD CHARACTERS WITHOUT CLAIM TO ANY PARTICULAR FONT, STYLE, SIZE, OR COLOR.

FOR EDUCATION SERVICES, NAMELY, PROVIDING IN-PERSON AND ON-LINE CLASSES, SEMINARS, WORKSHOPS IN THE FIELD OF PHYSICS AND COURSE MATERIALS DISTRIBUTED IN CONNECTION THEREWITH; ENTERTAINMENT SERVICES, NAMELY, AN ONGOING TELEVISION SERIES CONCERNING PHYSICS (U.S. CLS. 100, 101 AND 107).

KATHLEEN M. VANSTON, EXAMINING ATTORNEY

CLASS 41—(Continued).

SN 77-923,443. ARTIX ENTERTAINMENT, LLC, LAND O' LAKES, FL. FILED 1-29-2010.

BattleOn! Games

THE MARK CONSISTS OF STANDARD CHARACTERS WITHOUT CLAIM TO ANY PARTICULAR FONT, STYLE, SIZE, OR COLOR.

OWNER OF U.S. REG. NO. 3,273,707.

NO CLAIM IS MADE TO THE EXCLUSIVE RIGHT TO USE "GAMES", APART FROM THE MARK AS SHOWN.

FOR ENTERTAINMENT SERVICES, NAMELY, PROVIDING ONLINE, REAL-TIME COMPUTER GAMES FOR OTHERS OVER GLOBAL AND LOCAL AREA COMPUTER NETWORKS (U.S. CLS. 100, 101 AND 107).

FIRST USE 1-1-2010; IN COMMERCE 1-1-2010.

AMEEN IMAM, EXAMINING ATTORNEY

SN 77-923,496. SIOUX, TRACEE, DBA THE GIRL REVOLUTION, PITTSBURG, TX. FILED 1-29-2010.

The Girl Revolution

THE MARK CONSISTS OF STANDARD CHARACTERS WITHOUT CLAIM TO ANY PARTICULAR FONT, STYLE, SIZE, OR COLOR.

FOR ON-LINE JOURNALS, NAMELY, BLOGS FEATURING ISSUES CONCERNING GIRLS (U.S. CLS. 100, 101 AND 107).

FIRST USE 10-1-2008; IN COMMERCE 1-9-2009.

GRETCHEN ULRICH, EXAMINING ATTORNEY

SN 77-923,501. ARTIX ENTERTAINMENT, LLC, LAND O' LAKES, FL. FILED 1-29-2010.

EpicDuel

THE MARK CONSISTS OF STANDARD CHARACTERS WITHOUT CLAIM TO ANY PARTICULAR FONT, STYLE, SIZE, OR COLOR.

FOR ENTERTAINMENT SERVICES, NAMELY, PROVIDING ONLINE, REAL-TIME COMPUTER GAMES FOR OTHERS OVER GLOBAL AND LOCAL AREA COMPUTER NETWORKS (U.S. CLS. 100, 101 AND 107).

FIRST USE 1-25-2007; IN COMMERCE 1-25-2007.

AMEEN IMAM, EXAMINING ATTORNEY

CLASS 41—(Continued).

SN 77-923,512. CENTRAL AMUSEMENT INTERNATIONAL, LLC, BOONTON, NJ. FILED 1-29-2010.



NO CLAIM IS MADE TO THE EXCLUSIVE RIGHT TO USE "PARK" AND "CONEY ISLAND NY", APART FROM THE MARK AS SHOWN.

THE COLOR(S) RED, NAVY BLUE, YELLOW, GRAY, BLACK, WHITE, COLUMBIA BLUE IS/ARE CLAIMED AS A FEATURE OF THE MARK.

THE MARK CONSISTS OF A RED BANNER WRAPPED AROUND A GRADIENT NAVY BLUE OVAL SHAPE. A WHITE WITH GRAY STROKES WORD "LUNA PARK" IS SITTING ON TOP THE RED BANNER. UPPER TOP OF THE RED BANNER IS A SILHOUETTE OF AMUSEMENT RIDES AND BELOW THE RED BANNER ARE THE WORDS "CONEY ISLAND NY" WRITTEN IN YELLOW. THE WORD "AT" IS IN YELLOW ON THE RED BACKGROUND ABOVE THE FORMER LISTED WORDING. THERE IS GRAY STAR LOCATED ON TOP OF THE "K" ON THE WORD "PARK".

FOR AMUSEMENT PARKS (U.S. CLS. 100, 101 AND 107).

KYLE PEETE, EXAMINING ATTORNEY

CLASS 41—(Continued).

SN 77-923,597. JON DAVIS COMPANIES INC., DALALS, TX. FILED 1-29-2010.

Red Fusion

THE MARK CONSISTS OF STANDARD CHARACTERS WITHOUT CLAIM TO ANY PARTICULAR FONT, STYLE, SIZE, OR COLOR.

FOR EDUCATIONAL SERVICES, NAMELY, CONDUCTING TRAINING PROGRAMS IN THE FIELD OF HVAC AND DISTRIBUTION OF TRAINING MATERIAL IN CONNECTION THEREWITH (U.S. CLS. 100, 101 AND 107).

FIRST USE 9-1-2007; IN COMMERCE 9-13-2007.
BRIDGETT SMITH, EXAMINING ATTORNEY

SN 77-923,612. LAKE ERIE COLLEGE, PAINESVILLE, OH. FILED 1-29-2010.

SN 77-923,562. FISCH, DEBORAH, SEBASTOPOL, CA. FILED 1-29-2010.

Chilimundo



THE MARK CONSISTS OF STANDARD CHARACTERS WITHOUT CLAIM TO ANY PARTICULAR FONT, STYLE, SIZE, OR COLOR.

THE ENGLISH TRANSLATION OF "CHILIMUNDO" IN THE MARK IS "CHILI WORLD".

FOR LANGUAGE INSTRUCTION; LANGUAGE SCHOOLS FEATURING SPANISH (U.S. CLS. 100, 101 AND 107).

FONG HSU, EXAMINING ATTORNEY

THE MARK CONSISTS OF A CARTOON FUNNEL CLOUD WITH FACIAL FEATURES AND MUSCULAR ARMS SET AGAINST A LIGHTNING BOLT AND A CLOUD.

FOR EDUCATING AT UNIVERSITY OR COLLEGES; ENCOURAGING INTERCOLLEGIATE ATHLETIC PROGRAMS BY ORGANIZING AND CONDUCTING EDUCATIONAL PROGRAMS AND ACTIVITIES FOR INTERCOLLEGIATE ATHLETES AND ALUMNI; ENTERTAINMENT IN THE NATURE OF COMPETITIONS IN THE FIELD OF ATHLETICS (U.S. CLS. 100, 101 AND 107).

FIRST USE 1-1-2008; IN COMMERCE 1-1-2008.
MARK PILARO, EXAMINING ATTORNEY

CLASS 41—(Continued).

SN 77-923,989. EMOTIONCAM, PLAYA DEL REY, CA. FILED 1-29-2010.

eMotionCam

THE MARK CONSISTS OF STANDARD CHARACTERS WITHOUT CLAIM TO ANY PARTICULAR FONT, STYLE, SIZE, OR COLOR.

FOR RENTAL OF VIDEO CAMERAS (U.S. CLS. 100, 101 AND 107).

FIRST USE 12-1-2009; IN COMMERCE 12-1-2009.
DAWN HAN, EXAMINING ATTORNEY

CLASS 41—(Continued).

SN 77-924,732. BUCK KNOB PUBLISHERS LLC, LOOGOOTEE, IN. FILED 2-1-2010.

LIVE TO HUNT - HUNT TO LIVE HUNTING FITNESS MAGAZINE

THE MARK CONSISTS OF STANDARD CHARACTERS WITHOUT CLAIM TO ANY PARTICULAR FONT, STYLE, SIZE, OR COLOR.

NO CLAIM IS MADE TO THE EXCLUSIVE RIGHT TO USE "HUNTING FITNESS MAGAZINE", APART FROM THE MARK AS SHOWN.

FOR PROVIDING ON-LINE MAGAZINES IN THE FIELD OF HUNTING FITNESS (U.S. CLS. 100, 101 AND 107).

SAMUEL E. SHARPER JR., EXAMINING ATTORNEY

SN 77-924,002. BOHEMIAN COMPANIES, LLC, FORT COLLINS, CO. FILED 1-29-2010.

BOHEMIAN NIGHTS

THE MARK CONSISTS OF STANDARD CHARACTERS WITHOUT CLAIM TO ANY PARTICULAR FONT, STYLE, SIZE, OR COLOR.

FOR LIVE MUSIC CONCERTS (U.S. CLS. 100, 101 AND 107).

FIRST USE 6-30-2005; IN COMMERCE 6-30-2005.
CHERYL CLAYTON, EXAMINING ATTORNEY

SN 77-924,793. E5 GLOBAL MEDIA, LLC, NEW YORK, NY. FILED 2-1-2010.

BOOK OF RECORD

THE MARK CONSISTS OF STANDARD CHARACTERS WITHOUT CLAIM TO ANY PARTICULAR FONT, STYLE, SIZE, OR COLOR.

FOR ON-LINE PUBLICATION OF PERIODICALS IN THE FIELD OF MUSIC AND ENTERTAINMENT (U.S. CLS. 100, 101 AND 107).

DOMINIC J. FERRAIUOLO, EXAMINING ATTORNEY

SN 77-924,674. SPORTS REPORTING TECHNOLOGIES LLC, AKRON, OH. FILED 2-1-2010.

SPORTSINK

THE MARK CONSISTS OF STANDARD CHARACTERS WITHOUT CLAIM TO ANY PARTICULAR FONT, STYLE, SIZE, OR COLOR.

FOR PROVIDING INFORMATION IN THE FIELD OF HIGH SCHOOL SPORTS VIA THE INTERNET (U.S. CLS. 100, 101 AND 107).

AMY C. KEAN, EXAMINING ATTORNEY

SN 77-924,851. SARLE, JAMES, DBA THE BROOKLYN BRIDGE BAND, HUNTINGTON, NY. FILED 2-1-2010.

the BROOKLYN BRIDGE band

THE MARK CONSISTS OF STANDARD CHARACTERS WITHOUT CLAIM TO ANY PARTICULAR FONT, STYLE, SIZE, OR COLOR.

NO CLAIM IS MADE TO THE EXCLUSIVE RIGHT TO USE "BAND", APART FROM THE MARK AS SHOWN.

FOR ENTERTAINMENT, NAMELY, LIVE PERFORMANCES BY A MUSICAL BAND (U.S. CLS. 100, 101 AND 107).

CHRISTINE COOPER, EXAMINING ATTORNEY

CLASS 41—(Continued).

SN 77-924,999. LOOKBOOK MUSIC LLC, DBA LOOKBOOK, MINNEAPOLIS, MN. FILED 2-1-2010.

Lookbook

THE MARK CONSISTS OF STANDARD CHARACTERS WITHOUT CLAIM TO ANY PARTICULAR FONT, STYLE, SIZE, OR COLOR.

FOR ENTERTAINMENT SERVICES, NAMELY, LIVE PERFORMANCES BY A MUSICAL GROUP, PRODUCTION OF MUSIC RECORDINGS, AND SHOWS AND VIDEOS FEATURING MUSICAL PERFORMANCES, MUSIC SHOWS AND EVENTS BEFORE LIVE AUDIENCES WHICH ARE BROADCAST LIVE OR TAPED FOR LATER BROADCAST OR DISTRIBUTED VIA AN ON-LINE GLOBAL COMPUTER NETWORK; PROVIDING INFORMATION ABOUT THE MUSICAL GROUP, ITS MUSICAL RECORDINGS, ITS MUSIC AND OTHER ENTERTAINMENT SUBJECTS VIA AN ON-LINE GLOBAL COMPUTER NETWORK (U.S. CLS. 100, 101 AND 107).

FIRST USE 2-10-2008; IN COMMERCE 2-10-2008.
GIANCARLO CASTRO, EXAMINING ATTORNEY

SN 77-925,000. CHAMPIONSHIP MARTIAL ARTS, INC., ORLANDO, FL. FILED 2-1-2010.



OWNER OF U.S. REG. NOS. 3,609,958 AND 3,609,959.
NO CLAIM IS MADE TO THE EXCLUSIVE RIGHT TO USE "FIT", APART FROM THE MARK AS SHOWN.

THE MARK CONSISTS OF THE WORDS "CAGE FIT" IN STYLIZED FONT, WITH SOME FADING AND SCRATCHES, WITH A CHAIN-LINKED FENCE DESIGN IN THE FOREGROUND.

FOR PROVIDING PHYSICAL FITNESS, EXERCISE AND STRENGTH AND CONDITIONING TRAINING CONSULTATION, INSTRUCTION AND FACILITIES (U.S. CLS. 100, 101 AND 107).

GIANCARLO CASTRO, EXAMINING ATTORNEY

CLASS 41—(Continued).

SN 77-925,207. POWERHOUSE ENTERTAINMENT, HOUSTON, TX. FILED 2-1-2010.

True Legacy Entertainment

THE MARK CONSISTS OF STANDARD CHARACTERS WITHOUT CLAIM TO ANY PARTICULAR FONT, STYLE, SIZE, OR COLOR.

NO CLAIM IS MADE TO THE EXCLUSIVE RIGHT TO USE "ENTERTAINMENT", APART FROM THE MARK AS SHOWN.

FOR MULTIMEDIA ENTERTAINMENT SERVICES IN THE NATURE OF RECORDING, PRODUCTION AND POST-PRODUCTION SERVICES IN THE FIELDS OF MUSIC, VIDEO, AND FILMS (U.S. CLS. 100, 101 AND 107).

ELLEN BURNS, EXAMINING ATTORNEY

SN 77-925,265. BANK OF MANHATTAN, EL SEGUNDO, CA. FILED 2-1-2010.

Celebration of Entrepreneurship

THE MARK CONSISTS OF STANDARD CHARACTERS WITHOUT CLAIM TO ANY PARTICULAR FONT, STYLE, SIZE, OR COLOR.

NO CLAIM IS MADE TO THE EXCLUSIVE RIGHT TO USE "ENTREPRENEURSHIP", APART FROM THE MARK AS SHOWN.

FOR PROVIDING RECOGNITION AND INCENTIVES BY THE WAY OF AWARDS TO DEMONSTRATE EXCELLENCE IN THE FIELD OF ENTREPRENEURSHIP (U.S. CLS. 100, 101 AND 107).

FIRST USE 7-0-2008; IN COMMERCE 7-0-2008.
APRIL HESIK, EXAMINING ATTORNEY

SN 77-925,354. MURPHY, MARK WILLIAM, CLEVELAND, QUEENSLAND, AUSTRALIA, FILED 2-1-2010.

Skite

THE MARK CONSISTS OF THE STYLIZED WORDING "SKITE".

THE WORDING "SKITE" HAS NO MEANING IN A FOREIGN LANGUAGE.

FOR PROVIDING A DATABASE OF INFORMATION IN THE FIELDS OF ENTERTAINMENT, EDUCATION, RECREATIONAL FISHING AND FISHING TOURNAMENTS, SPORTS, THE ORGANIZATION OF COMMUNITY SPORTING AND CULTURAL ACTIVITIES (U.S. CLS. 100, 101 AND 107).

ELISSA GARBER KON, EXAMINING ATTORNEY

CLASS 41—(Continued).

SN 77-925,441. ESPINDLE LEARNING, AKA LEARN THAT UNLIMITED, SEBASTOPOL, CA. FILED 2-1-2010.

LEARN THAT WORD

THE MARK CONSISTS OF STANDARD CHARACTERS WITHOUT CLAIM TO ANY PARTICULAR FONT, STYLE, SIZE, OR COLOR.

FOR EDUCATION SERVICES, NAMELY, ONE-ON-ONE MENTORING IN THE FIELDS OF ACADEMIC SUBJECTS FOR K-12, COLLEGE, AND GRADUATE LEVEL LEARNING, NAMELY, TUTORING IN THE FIELDS OF VOCABULARY, SPELLING, ENGLISH AND OTHER LANGUAGES, SCIENCE, HISTORY, LEGAL STUDIES, AND MEDICAL STUDIES (U.S. CLS. 100, 101 AND 107).

FIRST USE 12-10-2009; IN COMMERCE 2-1-2010.
LYDIA BELZER, EXAMINING ATTORNEY

SN 77-925,453. OGDEN PUBLICATIONS, INC., TOPEKA, KS. FILED 2-1-2010.

MOTHER EARTH NEWS FAIR

THE MARK CONSISTS OF STANDARD CHARACTERS WITHOUT CLAIM TO ANY PARTICULAR FONT, STYLE, SIZE, OR COLOR.

OWNER OF U.S. REG. NO. 973,432.

NO CLAIM IS MADE TO THE EXCLUSIVE RIGHT TO USE "NEWS FAIR", APART FROM THE MARK AS SHOWN.

FOR ENTERTAINMENT SERVICES AND EDUCATIONAL SERVICES, NAMELY, CONDUCTING A FAIR FEATURING ARTS, CRAFTS, LIVE MUSICAL PERFORMANCES, AND PRESENTATION OF SPEAKERS AND DISCUSSIONS ON TOPICS INCLUDING SUSTAINABLE LIVING, RENEWABLE ENERGY, ORGANIC GARDENING, AND NATURAL FOODS AND HEALTH (U.S. CLS. 100, 101 AND 107).

JOHN E. MICHOS, EXAMINING ATTORNEY

SN 77-925,523. ATLANTIC RESEARCH PARTNERS, LLC, JACKSONVILLE, FL. FILED 2-2-2010.

Power of Coaching

THE MARK CONSISTS OF STANDARD CHARACTERS WITHOUT CLAIM TO ANY PARTICULAR FONT, STYLE, SIZE, OR COLOR.

NO CLAIM IS MADE TO THE EXCLUSIVE RIGHT TO USE "COACHING", APART FROM THE MARK AS SHOWN.

FOR EDUCATION SERVICES, NAMELY, PROVIDING LIVE AND ON-LINE TEACHER COACHING FOR SCHOOL LEADERS IN THE FIELD OF PREK-12 EDUCATION FOR THE PURPOSE OF IMPROVING TEACHING EFFECTIVENESS.; EDUCATION SERVICES, NAMELY, PROVIDING MENTORING, TUTORING, CLASSES, SEMINARS AND WORKSHOPS IN THE FIELD OF TEACHER COACHING FOR SCHOOL LEADERS (U.S. CLS. 100, 101 AND 107).

FIRST USE 7-1-2007; IN COMMERCE 7-1-2007.
MARGERY A. TIERNEY, EXAMINING ATTORNEY

CLASS 41—(Continued).

SN 77-925,526. SCIENCE WITH ME! LLC, PRINCETON, NJ. FILED 2-2-2010.

Science with Me!

THE MARK CONSISTS OF STANDARD CHARACTERS WITHOUT CLAIM TO ANY PARTICULAR FONT, STYLE, SIZE, OR COLOR.

OWNER OF U.S. REG. NOS. 2,811,859 AND 2,980,827.

NO CLAIM IS MADE TO THE EXCLUSIVE RIGHT TO USE "SCIENCE", APART FROM THE MARK AS SHOWN.

FOR EDUCATIONAL SERVICES, NAMELY, PROVIDING A WEBSITE DESIGNED TO TEACH SCIENCE AND SCIENTIFIC PRINCIPLES (U.S. CLS. 100, 101 AND 107).

FIRST USE 1-8-2003; IN COMMERCE 2-4-2003.

SUSAN LESLIE DUBOIS, EXAMINING ATTORNEY

SN 77-925,529. ATLANTIC RESEARCH PARTNERS, LLC, JACKSONVILLE, FL. FILED 2-2-2010.

Power of Instructional Design

THE MARK CONSISTS OF STANDARD CHARACTERS WITHOUT CLAIM TO ANY PARTICULAR FONT, STYLE, SIZE, OR COLOR.

NO CLAIM IS MADE TO THE EXCLUSIVE RIGHT TO USE "INSTRUCTIONAL DESIGN", APART FROM THE MARK AS SHOWN.

FOR EDUCATIONAL SERVICES, NAMELY, CONDUCTING SEMINARS, TRAINING AND INSTRUCTION IN THE FIELD OF PREK-12 INSTRUCTIONAL DESIGN FOR EDUCATORS AND DISTRIBUTION OF TRAINING MATERIAL IN CONNECTION THEREWITH; EDUCATIONAL SERVICES, NAMELY, DEVELOPING CURRICULUM FOR EDUCATORS (U.S. CLS. 100, 101 AND 107).

FIRST USE 7-1-2007; IN COMMERCE 7-1-2007.
MARGERY A. TIERNEY, EXAMINING ATTORNEY

CLASS 41—(Continued).

SN 77-925,552. OAK HILLS FELLOWSHIP, INC., BEMIDJI, MN. FILED 2-2-2010.

Camp Oak Hills

THE MARK CONSISTS OF STANDARD CHARACTERS WITHOUT CLAIM TO ANY PARTICULAR FONT, STYLE, SIZE, OR COLOR.

NO CLAIM IS MADE TO THE EXCLUSIVE RIGHT TO USE "CAMP", APART FROM THE MARK AS SHOWN.

FOR CHARITABLE SERVICES, NAMELY, SENDING UNDERPRIVILEGED CHILDREN TO ONE OF SEVERAL CAMPS AROUND THE UNITED STATES WHICH ACCEPT THESE CHILDREN AT DISCOUNTED RATES FOR ONE OR MORE WEEKS; DAY CAMP SERVICES; HOLIDAY CAMP SERVICES; OPERATION OF SPORTS CAMPS; RECREATIONAL CAMPS; SUMMER CAMPS (U.S. CLS. 100, 101 AND 107).

FIRST USE 0-0-1927; IN COMMERCE 0-0-1927.
TAMARA FRAZIER, EXAMINING ATTORNEY

SN 77-925,579. CARGILL COCOA & CHOCOLATE, INC., LITITZ, PA. FILED 2-2-2010.



NO CLAIM IS MADE TO THE EXCLUSIVE RIGHT TO USE "THE CHOCOLATIER'S WORKSHOP", APART FROM THE MARK AS SHOWN.

THE MARK CONSISTS OF THE WORDS "THE CHOCOLATIER'S" ABOVE THREE CHOCOLATE CANDIES, A ROUND CANDY, A HEAR SHAPED CANDY AND A CANDY WITH SPRINKLES. THE WORD "WORKSHOP" IS ALONGSIDE THE CANDIES.

FOR WORKSHOPS AND SEMINARS IN THE FIELD OF CONFECTIONS (U.S. CLS. 100, 101 AND 107).

FIRST USE 11-10-2008; IN COMMERCE 11-10-2008.
ANNE E. GUSTASON, EXAMINING ATTORNEY

SN 77-925,600. MANNI, ANISSA, D, CONCORD, NC. FILED 2-2-2010.

Color Me Science

THE MARK CONSISTS OF STANDARD CHARACTERS WITHOUT CLAIM TO ANY PARTICULAR FONT, STYLE, SIZE, OR COLOR.

FOR EDUCATION SERVICES, NAMELY, PROVIDING WORKSHOPS AND CAMPS IN THE FIELD OF SCIENCE (U.S. CLS. 100, 101 AND 107).

BARBARA RUTLAND, EXAMINING ATTORNEY

CLASS 41—(Continued).

SN 77-925,626. ESSENTIAL MINDS, S.L., BARCELONA, SPAIN, FILED 2-2-2010.

KI-KIDS

THE MARK CONSISTS OF STANDARD CHARACTERS WITHOUT CLAIM TO ANY PARTICULAR FONT, STYLE, SIZE, OR COLOR.

OWNER OF U.S. REG. NOS. 3,131,841, 3,264,343 AND OTHERS.

FOR ENTERTAINMENT IN THE NATURE OF A CHILDREN'S TELEVISION SERIES; ENTERTAINMENT SERVICES IN THE NATURE OF ON-GOING TELEVISION PROGRAMS IN THE FIELD OF CHILDREN'S ENTERTAINMENT; ENTERTAINMENT IN THE NATURE OF ON-GOING EDUCATIONAL TELEVISION PROGRAMS IN THE FIELD OF SECOND LANGUAGE SKILLS, INTRODUCTIONS TO PROFESSIONS, VALUES AND EMOTIONS; ENTERTAINMENT IN THE NATURE OF THEATER PRODUCTIONS; ENTERTAINMENT IN THE NATURE OF VISUAL AND AUDIO PERFORMANCES, AND MUSICAL SHOWS; ENTERTAINMENT IN THE NATURE OF LIVE PERFORMANCES BY ENTERTAINMENT AND EDUCATION PROFESSIONALS FOR TEACHING SECOND LANGUAGE SKILLS, PROFESSIONS, VALUES AND EMOTIONS; ENTERTAINMENT NAMELY, PRODUCTION OF TELEVISION SHOWS, PLAYS AND THEATERS; EDUCATIONAL SERVICES, NAMELY, PROVIDING CLASSES, SEMINARS AND WORKSHOPS IN THE FIELD OF SECOND LANGUAGE SKILLS, INTRODUCTIONS TO PROFESSIONS, VALUES AND EMOTIONS; INFORMATION ABOUT EDUCATION; ENTERTAINMENT AND EDUCATION SERVICES, NAMELY, PROVIDING AN INTERACTIVE WEB SITE FEATURING ANIMATION, MUSIC, LIVE ACTION, AND OTHER MULTIMEDIA MATERIALS IN THE FIELDS OF SECOND LANGUAGE SKILLS, PROFESSIONS, VALUES AND EMOTIONS (U.S. CLS. 100, 101 AND 107).

CORY BOONE, EXAMINING ATTORNEY

SN 77-925,673. STRAIT, DAVID, CORONA, CA. FILED 2-2-2010.



NO CLAIM IS MADE TO THE EXCLUSIVE RIGHT TO USE "ACADEMY" AND "P.I. TRAINING", APART FROM THE MARK AS SHOWN.

THE COLOR(S) BLACK AND SILVER IS/ARE CLAIMED AS A FEATURE OF THE MARK.

THE MARK CONSISTS OF A BLACK RECTANGLE CONTAINING THE STYLIZED SILVER WORDING "DOUBLE O ACADEMY REAL P.I. TRAINING" WITH A SILVER LIGHT RAY APPEARING TO THE LEFT OF THE "O".

FOR TRAINING SERVICES IN THE FIELD OF PRIVATE INVESTIGATION TECHNIQUES, EQUIPMENT AND SKILLS (U.S. CLS. 100, 101 AND 107).

AMY KERTGATE, EXAMINING ATTORNEY

CLASS 41—(Continued).

SN 77-925,697. DREAMTOWN INC., LOS ANGELES, CA. FILED 2-2-2010.

MARIJUANA MILLIONAIRE

THE MARK CONSISTS OF STANDARD CHARACTERS WITHOUT CLAIM TO ANY PARTICULAR FONT, STYLE, SIZE, OR COLOR.

FOR MULTIMEDIA ENTERTAINMENT SERVICES IN THE NATURE OF RECORDING, PRODUCTION AND POST-PRODUCTION SERVICES IN THE FIELDS OF MUSIC, VIDEO, AND FILMS (U.S. CLS. 100, 101 AND 107).

KIM SAITO, EXAMINING ATTORNEY

SN 77-925,816. M HOLDINGS, LLC, HENDERSON, NV. FILED 2-2-2010.

LIBIDO LOCO

THE MARK CONSISTS OF STANDARD CHARACTERS WITHOUT CLAIM TO ANY PARTICULAR FONT, STYLE, SIZE, OR COLOR.

FOR ENTERTAINMENT IN THE NATURE OF CASINO SERVICES; NIGHT CLUBS (U.S. CLS. 100, 101 AND 107).

FIRST USE 1-16-2010; IN COMMERCE 1-16-2010.
ANDREW LEASER, EXAMINING ATTORNEY

SN 77-925,920. RE MENTOR, INC., ROCKLAND, MA. FILED 2-2-2010.

CREATIVE SUCCESS ALLIANCE

THE MARK CONSISTS OF STANDARD CHARACTERS WITHOUT CLAIM TO ANY PARTICULAR FONT, STYLE, SIZE, OR COLOR.

NO CLAIM IS MADE TO THE EXCLUSIVE RIGHT TO USE "ALLIANCE", APART FROM THE MARK AS SHOWN.

FOR EDUCATIONAL SERVICES, NAMELY, PROVIDING SEMINARS IN THE FIELDS OF REAL ESTATE INVESTING AND THE DISTRIBUTION OF COURSE MATERIALS IN CONNECTION THEREWITH (U.S. CLS. 100, 101 AND 107).

FIRST USE 12-15-2009; IN COMMERCE 12-15-2009.
HANNO RITTNER, EXAMINING ATTORNEY

CLASS 41—(Continued).

SN 77-925,926. CLOCKWORK IP, LLC, SARASOTA, FL. FILED 2-2-2010.

FOCUS ON YOUR FUTURE

THE MARK CONSISTS OF STANDARD CHARACTERS WITHOUT CLAIM TO ANY PARTICULAR FONT, STYLE, SIZE, OR COLOR.

OWNER OF U.S. REG. NOS. 2,965,386 AND 3,087,054.
FOR EDUCATIONAL SERVICES, NAMELY, CONDUCTING WEB BASED CLASSES, CONFERENCES AND SEMINARS ON THE SUBJECT OF OPERATING INDEPENDENT BUSINESSES IN THE HEATING, ELECTRICAL, PLUMBING, ROOFING, VENTILATION AND AIR CONDITIONING INDUSTRIES. FOR CONTRACTORS, TRADE ASSOCIATION MEMBERS, MANUFACTURERS AND DISTRIBUTORS; DISTRIBUTION OF COURSE WORKBOOKS IN CONNECTION THEREWITH (U.S. CLS. 100, 101 AND 107).

DAVID COLLIER, EXAMINING ATTORNEY

SN 77-925,963. STEVO DESIGN INC., MIAMI BEACH, FL. FILED 2-2-2010.

AL DeMARCO

THE MARK CONSISTS OF STANDARD CHARACTERS WITHOUT CLAIM TO ANY PARTICULAR FONT, STYLE, SIZE, OR COLOR.

THE NAME "AL DEMARCO" IDENTIFIES A LIVING INDIVIDUAL WHOSE CONSENT IS OF RECORD.

FOR HANDICAPPING FOR SPORTING EVENTS (U.S. CLS. 100, 101 AND 107).

FIRST USE 3-1-2005; IN COMMERCE 3-1-2005.
RONALD MCMORROW, EXAMINING ATTORNEY

SN 77-926,046. ABREU, CRISTOBAL, NEW YORK, NY. FILED 2-2-2010.

HUFFLESHUFFLE

THE MARK CONSISTS OF STANDARD CHARACTERS WITHOUT CLAIM TO ANY PARTICULAR FONT, STYLE, SIZE, OR COLOR.

FOR PROVIDING INSTRUCTIONAL INFORMATION ON POKER; PROVIDING ON-LINE POKER GAMES (U.S. CLS. 100, 101 AND 107).

KELLY BOULTON, EXAMINING ATTORNEY

CLASS 41—(Continued).

SN 77-926,082. SALMONS, CATHERINE A., DBA TANGO-FLOW! WORKOUT FOR TANGO DANCERS, POULTNEY, VT. FILED 2-2-2010.

Cathy Salmons' TangoFlow! Workout for Tango Dancers

THE MARK CONSISTS OF STANDARD CHARACTERS WITHOUT CLAIM TO ANY PARTICULAR FONT, STYLE, SIZE, OR COLOR.

NO CLAIM IS MADE TO THE EXCLUSIVE RIGHT TO USE "WORKOUT FOR TANGO DANCERS", APART FROM THE MARK AS SHOWN.

THE NAME "CATHY SALMONS" IDENTIFIES A LIVING INDIVIDUAL WHOSE CONSENT IS OF RECORD.

FOR DANCE EVENTS; DANCE INSTRUCTION; DANCE STUDIOS; EDUCATION SERVICES, NAMELY, PROVIDING CLASSES AND INSTRUCTION IN THE FIELD OF DANCE; EDUCATIONAL SERVICES, NAMELY, DEVELOPING AND CONDUCTING WORKSHOPS, WORKSHOPS, PRESENTATIONS, RETREATS, AND PERSONAL TRAINING IN RIGHT-BRAIN FITNESS; ENTERTAINMENT AND EDUCATION SERVICES IN THE NATURE OF LIVE DANCE AND MUSICAL PERFORMANCES; ENTERTAINMENT IN THE NATURE OF DANCE PERFORMANCES; ORGANIZATION OF DANCING EVENTS; PROVIDING A WEBSITE FEATURING ONLINE SPORTS TRAINING AND TRAINING ADVICE AND THE RECORDING OF TRAINING AND WORKOUTS; TRAINING OF DANCE INSTRUCTORS (U.S. CLS. 100, 101 AND 107).

FIRST USE 9-15-2009; IN COMMERCE 9-15-2009.

VIVIAN MICZNIK FIRST, EXAMINING ATTORNEY

SN 77-926,123. NATURALLY SLIM, INC., GARLAND, TX. FILED 2-2-2010.

IT'S NOT WHAT YOU EAT, BUT WHEN AND HOW

THE MARK CONSISTS OF STANDARD CHARACTERS WITHOUT CLAIM TO ANY PARTICULAR FONT, STYLE, SIZE, OR COLOR.

FOR EDUCATIONAL SERVICES, NAMELY, CONDUCTING CLASSES AND SEMINARS IN THE FIELD OF NUTRITION AND WEIGHT MANAGEMENT AND DISTRIBUTING COURSE MATERIALS THEREWITH (U.S. CLS. 100, 101 AND 107).

LAURIE KAUFMAN, EXAMINING ATTORNEY

CLASS 41—(Continued).

SN 77-926,280. LOGICEASE SOLUTIONS INC., BURLINGAME, CA. FILED 2-2-2010.

LendingEase

THE MARK CONSISTS OF STANDARD CHARACTERS WITHOUT CLAIM TO ANY PARTICULAR FONT, STYLE, SIZE, OR COLOR.

FOR PROVIDING ONLINE TRAINING AND ONLINE COURSES IN THE FIELDS OF FINANCE AND LENDING (U.S. CLS. 100, 101 AND 107).

FIRST USE 1-4-2010; IN COMMERCE 1-4-2010.

MICHAEL KEATING, EXAMINING ATTORNEY

SN 77-926,320. ADULT SOURCE MEDIA, INC., DBA TOTAL HENTAI, CHATSWORTH, CA. FILED 2-2-2010.



NO CLAIM IS MADE TO THE EXCLUSIVE RIGHT TO USE "HENTAI", APART FROM THE MARK AS SHOWN.

THE MARK CONSISTS OF THE WORD "TOTAL" ABOVE THE WORD "HENTAI", BOTH IN OUTLINED STYLIZED FONT.

THE ENGLISH TRANSLATION OF "HENTAI" IN THE MARK IS SEXUALLY EXPLICIT OR PORNOGRAPHIC COMICS AND ANIMATION.

FOR ENTERTAINMENT SERVICES, NAMELY, AN ON-GOING SERIES FEATURING ADULT THEME ANIMATION PROVIDED THROUGH SATELLITE BROADCAST, CABLE TELEVISION, ON-LINE STREAMING MEDIA, MEDIA VIEWABLE OR DOWNLOADABLE FROM WEBSITES OF OTHERS, VIDEO PODCASTS, MEDIA FOR MOBILE PHONES; ENTERTAINMENT SERVICES, NAMELY, PROVIDING A WEBSITE FEATURING NON-DOWNLOADABLE ADULT THEME ART, DRAWINGS, ANIMATION, AND MOVIES (U.S. CLS. 100, 101 AND 107).

FIRST USE 6-0-2007; IN COMMERCE 6-0-2007.

KAREN K. BUSH, EXAMINING ATTORNEY

CLASS 41—(Continued).

SN 77-926,453. RED CHEESE INC., BRISBANE, CA. FILED 2-2-2010.

RED CHEESE

THE MARK CONSISTS OF STANDARD CHARACTERS WITHOUT CLAIM TO ANY PARTICULAR FONT, STYLE, SIZE, OR COLOR.

FOR RENTAL OF PORTABLE PHOTOGRAPHY AND/OR VIDEOGRAPHY BOOTHS FOR TAKING OF PICTURES AND VIDEOS (U.S. CLS. 100, 101 AND 107).

FIRST USE 0-0-2000; IN COMMERCE 0-0-2000.

THEODORE MCBRIDE, EXAMINING ATTORNEY

SN 77-926,499. SCOREBIG, INC., BOSTON, MA. FILED 2-3-2010.



THE COLOR(S) BLACK, WHITE AND RED IS/ARE CLAIMED AS A FEATURE OF THE MARK.

THE MARK CONSISTS OF THE STYLIZED TERM "SCOREBIG", WITH THE WORD "SCORE" IN BLACK, AND THE WORD "BIG" IN WHITE LOCATED OVER THE IMAGE OF A RED TICKET.

FOR ENTERTAINMENT TICKET AGENCY SERVICES; ON-LINE ENTERTAINMENT TICKET AGENCY SERVICES; TICKET AGENCY SERVICES FOR ENTERTAINMENT EVENTS (U.S. CLS. 100, 101 AND 107).

WILLIAM P. SHANAHAN, EXAMINING ATTORNEY

SN 77-926,642. SIMPLE LEADERSHIP STRATEGIES, LLC, FORT WORTH, TX. FILED 2-3-2010.



NO CLAIM IS MADE TO THE EXCLUSIVE RIGHT TO USE "LEADERSHIP STRATEGIES TRAINING MANAGERS DEVELOPING LEADERS", APART FROM THE MARK AS SHOWN.

THE COLOR(S) GREEN, BLUE, WHITE, BLACK AND GOLD IS/ARE CLAIMED AS A FEATURE OF THE MARK.

THE MARK CONSISTS OF THE WORDS "SIMPLE LEADERSHIP STRATEGIES" IN WHITE, WITH A BLACK SHADOW, AGAINST A MULTICOLOR BACKGROUND MORPHING FROM BLUE ON THE LEFT TO GOLD ON THE RIGHT AND HAVING SOLID GREEN BACKGROUNDS ABOVE AND BELOW THE MORPHED BACKGROUND; AND THE WORDS "TRAINING MANAGERS DEVELOPING LEADERS" IN WHITE, WITH A BLACK SHADOW ATOP THE SOLID GREEN BACKGROUND AT THE BOTTOM.

FOR EDUCATION AND TRAINING SERVICES, NAMELY, DEVELOPING AND FACILITATING LEADERSHIP DEVELOPMENT PROGRAMS (U.S. CLS. 100, 101 AND 107).

ADA HAN, EXAMINING ATTORNEY

CLASS 41—(Continued).

SN 77-926,713. NATIONAL NETWORK OF DIGITAL SCHOOLS MANAGEMENT FOUNDATION, BEAVER, PA. FILED 2-3-2010.

MEET ME AT THE GREAT TREE

THE MARK CONSISTS OF STANDARD CHARACTERS WITHOUT CLAIM TO ANY PARTICULAR FONT, STYLE, SIZE, OR COLOR.

FOR EDUCATIONAL SERVICES RENDERED THROUGH THE MEDIUM OF TELEVISION, NAMELY, A CHILDREN'S PROGRAM (U.S. CLS. 100, 101 AND 107).

FIRST USE 1-11-2010; IN COMMERCE 1-11-2010.

JANICE L. MCMORROW, EXAMINING ATTORNEY

SN 77-926,728. ARIEFF, RACHEL, BARCELONA, SPAIN, FILED 2-3-2010.



OWNER OF SPAIN REG. NO. 2.722.610, DATED 2-23-2007, EXPIRES 7-14-2016.

THE MARK CONSISTS OF "ANTI-KARAOKE" IN STYLIZED LETTERING WITH A RECTANGLE BACKGROUND.

FOR ENTERTAINMENT IN THE NATURE OF LIVE MUSIC CONCERTS, LIVE DANCE, MUSICAL PERFORMANCES, THEATRICAL AND MUSICAL FLOOR SHOWS PROVIDED AT DISCOTHEQUES, NIGHTCLUBS AND PERFORMANCE VENUES (U.S. CLS. 100, 101 AND 107).

KAPIL BHANOT, EXAMINING ATTORNEY

SN 77-926,799. JASTER, LAURA WADE, DENVER, CO. FILED 2-3-2010.

SPIRAL

THE MARK CONSISTS OF STANDARD CHARACTERS WITHOUT CLAIM TO ANY PARTICULAR FONT, STYLE, SIZE, OR COLOR.

FOR YOGA INSTRUCTION (U.S. CLS. 100, 101 AND 107).

FIRST USE 5-29-2009; IN COMMERCE 10-24-2009.

ANNE MADDEN, EXAMINING ATTORNEY

CLASS 41—(Continued).

SN 77-926,837. LICENSE BRANDING, LLC, SAN ANTONIO, TX. FILED 2-3-2010.

ARMANDO MONTELONGO SEMINARS

THE MARK CONSISTS OF STANDARD CHARACTERS WITHOUT CLAIM TO ANY PARTICULAR FONT, STYLE, SIZE, OR COLOR.

NO CLAIM IS MADE TO THE EXCLUSIVE RIGHT TO USE "SEMINARS", APART FROM THE MARK AS SHOWN. THE NAME "ARMANDO MONTELONGO" IDENTIFIES A LIVING INDIVIDUAL WHOSE CONSENT IS OF RECORD.

FOR CONDUCTING WORKSHOPS AND SEMINARS IN THE FIELDS OF PURCHASING HOMES, SELLING HOMES, OBTAINING FINANCING, FINANCING REMODELING, PURCHASING HOMES FOR RESALE, OBTAINING CONTRACTOR AND SUBCONTRACTOR AGREEMENTS, HOME REPAIRS, WEALTH BUILDING, HOME FORECLOSURE, PURCHASING AND SELLING OF REAL ESTATE TAX LIENS (U.S. CLS. 100, 101 AND 107).

SOPHIA S. KIM, EXAMINING ATTORNEY

CLASS 41—(Continued).

SN 77-926,911. BARFIELD, ELURIEL, BROOKLYN, NY. AND BARFIELD, ALFA ANDERSON, BROOKLYN, NY. FILED 2-3-2010.

KEEP ON SMILIN PRODUCTIONS

THE MARK CONSISTS OF STANDARD CHARACTERS WITHOUT CLAIM TO ANY PARTICULAR FONT, STYLE, SIZE, OR COLOR.

NO CLAIM IS MADE TO THE EXCLUSIVE RIGHT TO USE "PRODUCTIONS", APART FROM THE MARK AS SHOWN.

FOR ARRANGING, ORGANIZING, CONDUCTING, AND HOSTING SOCIAL ENTERTAINMENT EVENTS; ENTERTAINMENT SERVICES IN THE NATURE OF LIVE MUSICAL PERFORMANCES; ENTERTAINMENT SERVICES, NAMELY, PERSONAL APPEARANCES BY A RECORDING/PERFORMING ARTIST; MULTIMEDIA ENTERTAINMENT SERVICES IN THE NATURE OF RECORDING, PRODUCTION AND POST-PRODUCTION SERVICES IN THE FIELDS OF MUSIC, VIDEO, AND FILMS (U.S. CLS. 100, 101 AND 107).

FIRST USE 6-1-2005; IN COMMERCE 6-1-2005.
MARK SHINER, EXAMINING ATTORNEY

SN 77-926,869. POWELL, MARSHA L, MARINA DEL REY, CA. FILED 2-3-2010.

migigs

THE MARK CONSISTS OF STANDARD CHARACTERS WITHOUT CLAIM TO ANY PARTICULAR FONT, STYLE, SIZE, OR COLOR.

FOR PROVIDING AN INTERNET WEBSITE PORTAL IN THE FIELD OF ENTERTAINMENT, CULTURAL AND SPORTING EVENTS (U.S. CLS. 100, 101 AND 107).

REBECCA SMITH, EXAMINING ATTORNEY

SN 77-927,171. YF HOLDINGS, INC., ST. PETERSBURG, FL. FILED 2-3-2010.

GREEN IS OUR COLOR

THE MARK CONSISTS OF STANDARD CHARACTERS WITHOUT CLAIM TO ANY PARTICULAR FONT, STYLE, SIZE, OR COLOR.

FOR HEALTH CLUB SERVICES, NAMELY, PROVIDING INSTRUCTION, FACILITIES, AND EQUIPMENT IN THE FIELD OF PHYSICAL EXERCISE (U.S. CLS. 100, 101 AND 107).

FIRST USE 9-19-2008; IN COMMERCE 9-19-2008.
THOMAS MANOR, EXAMINING ATTORNEY

CLASS 41—(Continued).

SN 77-927,178. NATIONAL ASSOCIATION OF SECONDARY SCHOOL PRINCIPALS, INC., RESTON, VA. FILED 2-3-2010.



OWNER OF U.S. REG. NOS. 2,204,972, 2,575,782 AND OTHERS.

NO CLAIM IS MADE TO THE EXCLUSIVE RIGHT TO USE "HONOR SOCIETY", APART FROM THE MARK AS SHOWN.

THE MARK CONSISTS OF A STYLIZED TORCH INSIDE TWO CONJOINED, TRAPEZOIDAL SHAPES, WITH THE LETTERS "CS" TO THE LEFT, THE LETTERS "LS" TO THE RIGHT, AND WORDS "NATIONAL" AND "HONOR SOCIETY" ABOVE.

SEC. 2(F) AS TO "NATIONAL HONOR SOCIETY".

FOR EDUCATIONAL SERVICES, NAMELY, PROVIDING INCENTIVES TO STUDENTS, FACULTY AND SCHOOL ADMINISTRATORS TO DEMONSTRATE EXCELLENCE IN THE FIELD OF SOCIAL STUDIES, LANGUAGE, MATHEMATICS, SCIENCE AND/OR OTHER TRADITIONAL OR CORE ACADEMIC DISCIPLINES THAT ARE COMMONLY TAUGHT IN HIGH SCHOOLS, THROUGH THE ISSUANCE OF AWARDS (U.S. CLS. 100, 101 AND 107).

FIRST USE 7-1-2009; IN COMMERCE 7-1-2009.

TIMOTHY FINNEGAN, EXAMINING ATTORNEY

CLASS 41—(Continued).

SN 77-927,221. NATIONAL ASSOCIATION OF SECONDARY SCHOOL PRINCIPALS, INC., RESTON, VA. FILED 2-3-2010.



OWNER OF U.S. REG. NOS. 2,232,187, 2,297,510 AND OTHERS.

NO CLAIM IS MADE TO THE EXCLUSIVE RIGHT TO USE "JUNIOR HONOR SOCIETY", APART FROM THE MARK AS SHOWN.

THE MARK CONSISTS OF A STYLIZED TORCH CONTAINING THE WORDS "NATIONAL JUNIOR" ON A DARK BACKGROUND, AND "HONOR SOCIETY" ON A LIGHT BACKGROUND.

SEC. 2(F) AS TO "NATIONAL JUNIOR HONOR SOCIETY".

FOR EDUCATIONAL SERVICES, NAMELY, PROVIDING INCENTIVES TO STUDENTS, FACULTY AND SCHOOL ADMINISTRATORS TO DEMONSTRATE EXCELLENCE IN THE FIELD OF SOCIAL STUDIES, LANGUAGE, MATHEMATICS, SCIENCE AND/OR OTHER TRADITIONAL OR CORE ACADEMIC DISCIPLINES THAT ARE COMMONLY TAUGHT IN MIDDLE LEVEL SCHOOLS, THROUGH THE ISSUANCE OF AWARDS (U.S. CLS. 100, 101 AND 107).

FIRST USE 7-1-2009; IN COMMERCE 7-1-2009.

TIMOTHY FINNEGAN, EXAMINING ATTORNEY

SN 77-927,240. FUNNBIZ.COM, LLC, MISSOULA, MT. FILED 2-3-2010.



THE MARK CONSISTS OF STANDARD CHARACTERS WITHOUT CLAIM TO ANY PARTICULAR FONT, STYLE, SIZE, OR COLOR.

FOR ON-LINE ENTERTAINMENT TICKET AGENCY SERVICES (U.S. CLS. 100, 101 AND 107).

FIRST USE 1-17-2005; IN COMMERCE 2-21-2006.

SHAUNIA CARLYLE, EXAMINING ATTORNEY

CLASS 41—(Continued).

SN 77-927,263. JSERRA CATHOLIC HIGH SCHOOL, SAN JUAN CAPISTRANO, CA. FILED 2-3-2010.



NO CLAIM IS MADE TO THE EXCLUSIVE RIGHT TO USE "CATHOLIC HIGH SCHOOL EST. 2003", APART FROM THE MARK AS SHOWN.

THE COLOR(S) GOLD, CRIMSON, WHITE AND BLACK IS/ARE CLAIMED AS A FEATURE OF THE MARK.

THE MARK CONSISTS OF A CREST OUTLINED IN GOLD WITH A CRIMSON AND BLACK INTERIOR BACKGROUND. THE INTERIOR OF THE SHIELD IS BROKEN INTO FOUR QUADRANTS, TWO WITH A CRIMSON BACKGROUND AND TWO WITH A BLACK BACKGROUND. INSIDE THE SHIELD ARE THE WORDS "SIEMPRE" ON THE LEFT UPPER QUADRANT AND "ADELANTE" ON THE RIGHT UPPER QUADRANT IN WHITE LETTERS. TO THE RIGHT OF "SIEMPRE" IS A GOLDEN LION. IN THE QUADRANT BENEATH THE GOLDEN LION IS A CIRCULAR PATTERN OF WHITE BIRDS. IN THE CENTER OF THE CIRCULAR PATTERN OF WHITE BIRDS IS A GOLDEN CIRCLE WITH THE LETTERS "J" AND "S" IN BLACK. TO THE LEFT OF "ADELANTE" IS A WHITE TREE WITH GOLDEN FRUIT. IN THE QUADRANT BELOW THE WHITE TREE IS A BLACK AND WHITE TOWER CONTAINING THREE GOLD BELLS AND A GOLD CROSS. IN THE CENTER OF THE SHIELD IS A GOLD LAMP. ABOVE THE SHIELD IS A GOLD FLEUR-DE-LIS CROSS. BELOW THE SHIELD ARE THE WORDS "EST. 2003" IN BLACK TOGETHER WITH A WHITE AND BLACK BANNER CONTAINING THE WORDS "JSERRA CATHOLIC HIGH SCHOOL" IN BLACK.

THE ENGLISH TRANSLATION OF "SIEMPRE ADELANTE" IS "ALWAYS FORWARD".

FOR EDUCATIONAL SERVICES, NAMELY, PROVIDING AND CONDUCTING COURSES, CLASSES, SEMINARS AND WORKSHOPS IN THE FIELDS OF SECONDARY SCHOOL EDUCATION, AND DISTRIBUTING COURSE MATERIALS IN CONJUNCTION THEREWITH; PROVIDING COURSES OF INSTRUCTION AT THE SECONDARY SCHOOL LEVEL; ENTERTAINMENT SERVICES, NAMELY, ARRANGING AND CONDUCTING ATHLETIC AND CULTURAL EVENTS AND COMPETITIONS, ARRANGING AND CONDUCTING EXTRACURRICULAR ACTIVITIES IN THE NATURE OF CONDUCTING AFTER-SCHOOL TUTORING PROGRAMS AND PROVIDING EDUCATIONAL AND EXTRACURRICULAR RELIGIOUS, JOURNALISTIC, ACADEMIC, SPORTS, AND DRAMATIC ARTS PROGRAMS, AND PROVIDING ENTERTAINMENT IN THE NATURE OF LIVE MUSICAL PERFORMANCES, DANCE PERFORMANCES, THEATRICAL PERFORMANCES, AND DRAMATIC PERFORMANCES (U.S. CLS. 100, 101 AND 107).

FIRST USE 4-8-1999; IN COMMERCE 4-8-1999.
ANDREA BUTLER, EXAMINING ATTORNEY

CLASS 41—(Continued).

SN 77-927,468. JENNIFER HOWARD, DBA HILTON HEAD SOCIAL CLUB, HILTON HEAD ISLAND, SC. FILED 2-3-2010.



NO CLAIM IS MADE TO THE EXCLUSIVE RIGHT TO USE "HILTON HEAD SOCIAL CLUB", APART FROM THE MARK AS SHOWN.

THE COLOR(S) BLUE, YELLOW AND BLACK IS/ARE CLAIMED AS A FEATURE OF THE MARK.

THE MARK CONSISTS OF THE WORDING "HILTON HEAD SOCIAL CLUB" IN YELLOW WITH A BLACK SHADOW ADJACENT TO EACH LETTER, TO THE RIGHT OF A DESIGN OF A BLUE DOLPHIN, OUTLINED IN BLACK, WITH A YELLOW HALO OVER ITS HEAD AND A SWIRL DESIGN OF BLUE WATER BENEATH THE DOLPHIN.

FOR SOCIAL CLUB SERVICES, NAMELY, ARRANGING, ORGANIZING, AND HOSTING SOCIAL EVENTS, GET-TOGETHERS, AND PARTIES FOR CLUB MEMBERS (U.S. CLS. 100, 101 AND 107).

FIRST USE 7-29-2009; IN COMMERCE 7-29-2009.
LAURA KOVALSKY, EXAMINING ATTORNEY

SN 77-927,493. MACALINO, JC, SAN RAMON, CA. FILED 2-3-2010.

Artistry That Rocks

THE MARK CONSISTS OF STANDARD CHARACTERS WITHOUT CLAIM TO ANY PARTICULAR FONT, STYLE, SIZE, OR COLOR.

FOR PHOTOGRAPHY SERVICES (U.S. CLS. 100, 101 AND 107).

FIRST USE 7-1-2009; IN COMMERCE 7-1-2009.
MATTHEW PAPPAS, EXAMINING ATTORNEY

CLASS 41—(Continued).

SN 77-927,500. JSERRA CATHOLIC HIGH SCHOOL, SAN JUAN CAPISTRANO, CA. FILED 2-3-2010.



THE COLOR(S) GOLD, CRIMSON AND BLACK IS/ARE CLAIMED AS A FEATURE OF THE MARK.

THE MARK CONSISTS OF A LION'S HEAD IN BLACK WITH THE CRIMSON AND GOLD LETTERS "J" AND "S".

FOR ENTERTAINMENT SERVICES, NAMELY, ARRANGING AND CONDUCTING ATHLETIC AND CULTURAL EVENTS AND COMPETITIONS, ARRANGING AND CONDUCTING EXTRACURRICULAR ACTIVITIES IN THE NATURE OF CONDUCTING AFTER-SCHOOL TUTORING PROGRAMS AND PROVIDING EDUCATIONAL AND EXTRACURRICULAR RELIGIOUS, JOURNALISTIC, ACADEMIC, SPORTS, AND DRAMATIC ARTS PROGRAMS, AND PROVIDING LIVE MUSICAL PERFORMANCES, DANCE PERFORMANCES, THEATRICAL PERFORMANCES, AND DRAMATIC PERFORMANCES (U.S. CLS. 100, 101 AND 107).

FIRST USE 12-7-2003; IN COMMERCE 12-7-2003.
ANDREA BUTLER, EXAMINING ATTORNEY

CLASS 41—(Continued).

SN 77-927,579. ATHANASIOU, GEORGE, SOUTH SAN FRANCISCO, CA. FILED 2-3-2010.

ATHAN PRODUCTIONS

SN 77-927,542. BAILEY, KATHLEEN, NEW YORK, NY. FILED 2-3-2010.

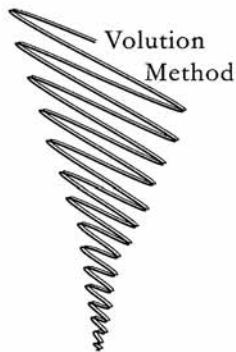

NO CLAIM IS MADE TO THE EXCLUSIVE RIGHT TO USE "METHOD", APART FROM THE MARK AS SHOWN.

THE MARK CONSISTS OF A "V" SHAPED SPIRAL WITH A SHADOWED SPIRAL BEHIND WITH "VOLUTION" AT THE TOP RIGHT CORNER OF THE SPIRAL AND "METHOD" BELOW "VOLUTION" AND RIGHT-JUSTIFIED.

FOR PHYSICAL FITNESS TRAINING SERVICES (U.S. CLS. 100, 101 AND 107).
FIRST USE 2-7-2009; IN COMMERCE 2-7-2009.
JAMES LOVELACE, EXAMINING ATTORNEY

THE MARK CONSISTS OF STANDARD CHARACTERS WITHOUT CLAIM TO ANY PARTICULAR FONT, STYLE, SIZE, OR COLOR.

NO CLAIM IS MADE TO THE EXCLUSIVE RIGHT TO USE "PRODUCTIONS", APART FROM THE MARK AS SHOWN.

FOR ENTERTAINMENT IN THE NATURE OF THEATER PRODUCTIONS; ENTERTAINMENT SERVICES IN THE NATURE OF CREATION, DEVELOPMENT, AND PRODUCTION OF TELEVISION PROGRAMMING; ENTERTAINMENT SERVICES IN THE NATURE OF DEVELOPMENT, CREATION, PRODUCTION AND POST-PRODUCTION SERVICES OF MULTIMEDIA CONTENT; FILM AND VIDEO FILM PRODUCTION; MOTION PICTURE FILM PRODUCTION; PRODUCTION AND DISTRIBUTION OF INDEPENDENT MOTION PICTURES; PRODUCTION AND DISTRIBUTION OF MOTION PICTURES; PRODUCTION AND DISTRIBUTION OF TELEVISION SHOWS AND MOVIES; PRODUCTION OF DVDS, VIDEOTAPES AND TELEVISION PROGRAMS FEATURING FICTIONAL STORIES (U.S. CLS. 100, 101 AND 107).

FIRST USE 4-1-2008; IN COMMERCE 4-1-2008.
CHRISTOPHER BUONGIORNO, EXAMINING ATTORNEY

CLASS 41—(Continued).

SN 77-927,613. DAVID K. YI, CENTREVILLE, VA. FILED 2-3-2010.



NO CLAIM IS MADE TO THE EXCLUSIVE RIGHT TO USE "LAW METHODS", APART FROM THE MARK AS SHOWN.

THE MARK CONSISTS OF THE WORDS "LAW METHODS", MOSTLY ENCIRCLED BY THREE CRESCENT SHAPES.

FOR ANALYZING EDUCATIONAL TESTS SCORES AND DATA FOR OTHERS; EDUCATION SERVICES, NAMELY, ONE-ON-ONE MENTORING IN THE FIELD OF HIGHER EDUCATION PREPARATION AND ADMISSIONS; EDUCATION SERVICES, NAMELY, PROVIDING TUTORIAL SESSIONS IN THE FIELD(S) OF HIGHER EDUCATION PREPARATION AND ADMISSIONS; EDUCATIONAL COUNSELING SERVICES TO ASSIST STUDENTS IN PLANNING AND PREPARING FOR FURTHER EDUCATION; EDUCATIONAL SERVICES, NAMELY, CONDUCTING CLASSES, SEMINARS, CONFERENCES, AND WORKSHOPS IN THE FIELD OF HIGHER EDUCATION PREPARATION AND ADMISSIONS AND DISTRIBUTION OF PRINTED MATERIALS IN CONNECTION THEREWITH IN HARD COPY OR ELECTRONIC FORMAT ON THE SAME TOPICS; EDUCATIONAL TESTING; INFORMATION ON EDUCATION; PROVIDING A WEB SITE THAT FEATURES INFORMATION ABOUT ONLINE HIGHER EDUCATION RESOURCES; PROVIDING INFORMATION ON-LINE RELATING TO EDUCATIONAL OPPORTUNITIES; PROVISION OF INFORMATION RELATING TO EDUCATIONAL SERVICES (U.S. CLS. 100, 101 AND 107).

FIRST USE 11-23-2009; IN COMMERCE 11-23-2009.
BRENDAN MCCAULEY, EXAMINING ATTORNEY

CLASS 41—(Continued).

SN 77-927,621. GEIGLEY, GINA LYNETTE, PEARL CITY, HI. AND LAWRENCE, TONEE MARIE, DENVER, CO. FILED 2-4-2010.



NO CLAIM IS MADE TO THE EXCLUSIVE RIGHT TO USE "BOUDOIR", APART FROM THE MARK AS SHOWN. THE COLOR(S) RED, WHITE, BLUE AND GREY IS/ARE CLAIMED AS A FEATURE OF THE MARK.

THE MARK CONSISTS OF THE DESIGN OF STYLIZED RED FLAMES AROUND A WHITE HEART ABOVE THE WORDING "HOMEFIRES" IN BLUE STYLIZED FONT AND "BOUDOIR" IN GREY STYLIZED FONT.

FOR PHOTOGRAPHY; PHOTOGRAPHY SERVICES; PORTRAIT PHOTOGRAPHY (U.S. CLS. 100, 101 AND 107).

FIRST USE 1-29-2010; IN COMMERCE 1-29-2010.
JAMES MACFARLANE, EXAMINING ATTORNEY

SN 77-927,642. UNG, LAM, SUNNYVALE, CA. FILED 2-4-2010.



THE MARK CONSISTS OF THE WORD "MERKAKIS" WITH A STYLIZED MONKEY REPRESENTING THE LETTER "K" AND A STYLIZED BANANA REPRESENTING A CEDILLA BELOW THE "K".

FOR EDITING OR RECORDING OF SOUNDS AND IMAGES; MOVIE STUDIOS; MULTIMEDIA PUBLISHING OF BOOKS, MAGAZINES, JOURNALS, SOFTWARE, GAMES, MUSIC, AND ELECTRONIC PUBLICATIONS; PRODUCTION AND DISTRIBUTION OF MOTION PICTURES; PRODUCTION AND DISTRIBUTION OF TELEVISION SHOWS AND MOVIES; PRODUCTION OF VIDEO AND COMPUTER GAME SOFTWARE; PUBLISHING OF BOOKS, E-BOOKS, AUDIO BOOKS, MUSIC AND ILLUSTRATIONS (U.S. CLS. 100, 101 AND 107).

JOHN DALIER, EXAMINING ATTORNEY

CLASS 41—(Continued).

SN 77-927,770. CLARK, CHARLES K., HARLINGEN, TX. FILED 2-4-2010.

GREENGHOST

THE MARK CONSISTS OF STANDARD CHARACTERS WITHOUT CLAIM TO ANY PARTICULAR FONT, STYLE, SIZE, OR COLOR.

OWNER OF U.S. REG. NOS. 3,150,035, 3,418,376 AND 3,548,383.

FOR ENTERTAINMENT SERVICES, NAMELY, A CONTINUING VARIETY AND COMEDY SHOW BROADCAST OVER TELEVISION, SATELLITE, THE INTERNET, AND AUDIO AND VIDEO MEDIA; ENTERTAINMENT SERVICES, NAMELY THE PROVISION OF CONTINUING PROGRAMS, SEGMENTS, MOVIES AND MOTION PICTURE THEATRICAL FILMS FEATURING COMEDY AND LIVE ACTION DELIVERED BY TELEVISION, SATELLITE, THE INTERNET, AND AUDIO AND VIDEO MEDIA (U.S. CLS. 100, 101 AND 107).

BRIAN NEVILLE, EXAMINING ATTORNEY

SN 77-927,852. NATIONAL NOTARY ASSOCIATION, CHATSWORTH, CA. FILED 2-4-2010.

NOTARY BULLETIN

THE MARK CONSISTS OF STANDARD CHARACTERS WITHOUT CLAIM TO ANY PARTICULAR FONT, STYLE, SIZE, OR COLOR.

OWNER OF U.S. REG. NO. 2,315,926.

NO CLAIM IS MADE TO THE EXCLUSIVE RIGHT TO USE "BULLETIN", APART FROM THE MARK AS SHOWN. SEC. 2(F).

FOR PROVIDING ON-LINE NEWSLETTERS IN THE FIELD OF NOTARY SERVICES (U.S. CLS. 100, 101 AND 107).

FIRST USE 6-30-2009; IN COMMERCE 6-30-2009.
NICHOLAS ALTREE, EXAMINING ATTORNEY

SN 77-927,937. SINGLE ACTION SHOOTING SOCIETY, INC., EDGEWOOD, NM. FILED 2-4-2010.

Wild Bunch Action Shooting

THE MARK CONSISTS OF STANDARD CHARACTERS WITHOUT CLAIM TO ANY PARTICULAR FONT, STYLE, SIZE, OR COLOR.

NO CLAIM IS MADE TO THE EXCLUSIVE RIGHT TO USE "ACTION SHOOTING", APART FROM THE MARK AS SHOWN.

FOR ORGANIZING SPORTING EVENTS, NAMELY, SHOOTING COMPETITIONS (U.S. CLS. 100, 101 AND 107).

FIRST USE 5-1-2008; IN COMMERCE 5-1-2008.
LINDA LAVACHE, EXAMINING ATTORNEY

CLASS 41—(Continued).

SN 77-927,945. SINGLE ACTION SHOOTING SOCIETY, INC., EDGEWOOD, NM. FILED 2-4-2010.

Wild Bunch

THE MARK CONSISTS OF STANDARD CHARACTERS WITHOUT CLAIM TO ANY PARTICULAR FONT, STYLE, SIZE, OR COLOR.

FOR ORGANIZING SPORTING EVENTS, NAMELY, SHOOTING COMPETITIONS (U.S. CLS. 100, 101 AND 107).

FIRST USE 5-1-2008; IN COMMERCE 5-1-2008.
LINDA LAVACHE, EXAMINING ATTORNEY

SN 77-927,946. ENDGAME ENTERPRISES, LLC, WESTMINSTER, CO. FILED 2-4-2010.

RILEY

THE MARK CONSISTS OF STANDARD CHARACTERS WITHOUT CLAIM TO ANY PARTICULAR FONT, STYLE, SIZE, OR COLOR.

FOR EDUCATIONAL AND ENTERTAINMENT SERVICES, NAMELY, A CONTINUING PROGRAM ABOUT ANIMAL AWARENESS, RELATIONSHIPS, HISTORY, LIFE, LITERATURE, PHILOSOPHY, POLITICS, PSYCHOLOGY, SCIENCE AND TECHNOLOGY, HUMOR, AND POLITICAL AND SOCIAL SATIRE ACCESSIBLE BY RADIO, TELEVISION, SATELLITE, AUDIO, VIDEO AND COMPUTER NETWORKS; PROVIDING ON-LINE PUBLICATIONS IN THE NATURE OF COMIC STRIPS, BLOGS, AUDIO AND VIDEO CONTENT, BOOKS, MAGAZINES, PAMPHLETS, NEWSPAPERS IN THE FIELD OF ANIMAL AWARENESS, RELATIONSHIPS, HISTORY, LIFE, LITERATURE, PHILOSOPHY, POLITICS, PSYCHOLOGY, SCIENCE AND TECHNOLOGY, HUMOR, AND POLITICAL AND SOCIAL SATIRE (U.S. CLS. 100, 101 AND 107).

HOWARD SMIGA, EXAMINING ATTORNEY

SN 77-928,013. BREAST HEALTH AND HEALING FOUNDATION, BELLEVILLE, NJ. FILED 2-4-2010.

OPENMEDSPACE

THE MARK CONSISTS OF STANDARD CHARACTERS WITHOUT CLAIM TO ANY PARTICULAR FONT, STYLE, SIZE, OR COLOR.

FOR CONDUCTING SEMINARS IN THE FIELD OF ONCOLOGY, NAMELY, BREAST CANCER RESEARCH (U.S. CLS. 100, 101 AND 107).

LESLIE RICHARDS, EXAMINING ATTORNEY

CLASS 41—(Continued).

SN 77-928,065. AUDIONAMIX INC, NEW YORK, NY. FILED 2-4-2010.

ADX

THE MARK CONSISTS OF STANDARD CHARACTERS WITHOUT CLAIM TO ANY PARTICULAR FONT, STYLE, SIZE, OR COLOR.

FOR AUDIO RECORDING AND PRODUCTION; FILM MASTERING SERVICES; RECORD MASTER PRODUCTION; RECORD MASTERING; VIDEO MASTERING SERVICES (U.S. CLS. 100, 101 AND 107).

FIRST USE 11-0-2009; IN COMMERCE 11-0-2009.
AMY KERTGATE, EXAMINING ATTORNEY

CLASS 41—(Continued).

SN 77-928,168. GOSPEL MUSIC CHANNEL, LLC, ATLANTA, GA. FILED 2-4-2010.

Always Uplifting

THE MARK CONSISTS OF STANDARD CHARACTERS WITHOUT CLAIM TO ANY PARTICULAR FONT, STYLE, SIZE, OR COLOR.

FOR ENTERTAINMENT IN THE NATURE OF ONGOING TELEVISION AND VIDEO PROGRAMS FEATURING MUSIC, MUSICAL PERFORMANCES, BIOGRAPHIES, NEWS, AND GENERAL INTEREST CONTENT; ENTERTAINMENT SERVICES, NAMELY, PROVIDING ONGOING TELEVISION PROGRAMS IN THE FIELD OF MUSIC, MUSICAL PERFORMANCES, BIOGRAPHIES, NEWS, AND GENERAL INTEREST CONTENT VIA A GLOBAL COMPUTER NETWORK; ENTERTAINMENT SERVICES, NAMELY, THE PROVISION OF CONTINUING TELEVISION PROGRAMS AND MOVIES FEATURING MUSIC, MUSICAL PERFORMANCES, BIOGRAPHIES, NEWS, AND GENERAL INTEREST CONTENT DELIVERED BY TELEVISION, CABLE TELEVISION, SATELLITE TELEVISION AND THE INTERNET; PRODUCTION AND DISTRIBUTION OF TELEVISION SHOWS AND MOVIES (U.S. CLS. 100, 101 AND 107).

CAROLINE WOOD, EXAMINING ATTORNEY

SN 77-928,098. WILLIAMS, TOM, LONGMONT, CO. FILED 2-4-2010.

LEAPINS

THE MARK CONSISTS OF STANDARD CHARACTERS WITHOUT CLAIM TO ANY PARTICULAR FONT, STYLE, SIZE, OR COLOR.

FOR EDUCATION SERVICES, NAMELY, PROVIDING LIVE AND ON-LINE CLASSES, SEMINARS AND WORKSHOPS IN THE FIELD OF SALES AND MARKETING, PERSONAL DEVELOPMENT, MOTIVATION, BUSINESS NETWORKING AND MORTGAGES AND FINANCE (U.S. CLS. 100, 101 AND 107).

FIRST USE 12-12-1993; IN COMMERCE 12-12-1993.
SANI KHOURI, EXAMINING ATTORNEY

SN 77-928,205. FRESTYL INC., TOLLAND, CT. FILED 2-4-2010.

FRESTYL

THE MARK CONSISTS OF STANDARD CHARACTERS WITHOUT CLAIM TO ANY PARTICULAR FONT, STYLE, SIZE, OR COLOR.

FOR ENTERTAINMENT INFORMATION; PROVIDING A WEB SITE WHERE USERS CAN POST RATINGS, REVIEWS AND RECOMMENDATIONS ON EVENTS AND ACTIVITIES IN THE FIELD OF ENTERTAINMENT AND EDUCATION; PROVIDING AN INTERNET WEBSITE PORTAL IN THE FIELD OF ENTERTAINMENT, CULTURAL AND SPORTING EVENTS; PROVIDING AN INTERNET WEBSITE PORTAL IN THE FIELD OF MUSIC; PROVISION OF INFORMATION RELATING TO MUSIC (U.S. CLS. 100, 101 AND 107).

DAWN FELDMAN, EXAMINING ATTORNEY

CLASS 41—(Continued).

SN 77-928,235. GAME SHOW NETWORK, LLC, SANTA MONICA, CA. FILED 2-4-2010.

CASINOVILLE

THE MARK CONSISTS OF STANDARD CHARACTERS WITHOUT CLAIM TO ANY PARTICULAR FONT, STYLE, SIZE, OR COLOR.

FOR ONLINE, INTERACTIVE COMPUTER GAMES AND MOBILE GAMES IN THE FORM OF NON-DOWNLOADABLE SOFTWARE ACCESSED THROUGH SOCIAL NETWORKING SITES PLAYED ON MOBILE PHONES, PDAS AND OTHER TYPES OF HAND-HELD DEVICES, GAMING DEVICES, PERSONAL COMPUTERS AND CONSOLES; ENTERTAINMENT SERVICES, NAMELY, PROVIDING ONLINE COMPUTER GAMES (U.S. CLS. 100, 101 AND 107).

DAVID COLLIER, EXAMINING ATTORNEY

SN 77-928,497. STOKES, ERIKA R., COVINGTON, GA. FILED 2-4-2010.

Absolute

THE MARK CONSISTS OF STANDARD CHARACTERS WITHOUT CLAIM TO ANY PARTICULAR FONT, STYLE, SIZE, OR COLOR.

FOR ENTERTAINMENT SERVICES IN THE NATURE OF LIVE MUSICAL PERFORMANCES; ENTERTAINMENT, NAMELY, LIVE PERFORMANCES BY A MUSICAL BAND; MUSIC COMPOSITION FOR OTHERS; MUSIC PUBLISHING SERVICES; MUSIC SELECTION SERVICES FOR USE IN TELEVISION, FILM, RADIO AND VIDEO GAMES; MUSIC VIDEO PRODUCTION; PRODUCTION OF SOUND AND MUSIC VIDEO RECORDINGS; PUBLISHING OF BOOKS, E-BOOKS, AUDIO BOOKS, MUSIC AND ILLUSTRATIONS (U.S. CLS. 100, 101 AND 107).

KELLY TRUSILO, EXAMINING ATTORNEY

SN 77-928,552. ANDERSON, CINDY, ARDMORE, OK. AND JAMES, ANTHONY, ARDMORE, OK. FILED 2-4-2010.

DUSTY MCPLAQUETOOTH

THE MARK CONSISTS OF STANDARD CHARACTERS WITHOUT CLAIM TO ANY PARTICULAR FONT, STYLE, SIZE, OR COLOR.

FOR ENTERTAINMENT IN THE NATURE OF ONGOING TELEVISION PROGRAMS IN THE FIELD OF A CARTOON (U.S. CLS. 100, 101 AND 107).

MARK SHINER, EXAMINING ATTORNEY

CLASS 41—(Continued).

SN 77-928,553. WHITE, BLAYNE, GAINESVILLE, GA. FILED 2-4-2010.

Rhinestone Road

THE MARK CONSISTS OF STANDARD CHARACTERS WITHOUT CLAIM TO ANY PARTICULAR FONT, STYLE, SIZE, OR COLOR.

NO CLAIM IS MADE TO THE EXCLUSIVE RIGHT TO USE "ROAD", APART FROM THE MARK AS SHOWN.

FOR ON-LINE JOURNALS, NAMELY, BLOGS FEATURING ARTICLES AND INFORMATION IN THE FIELD OF TRAVEL, SCRAPBOOKING, AND ARTISTS AND PHOTOGRAPHERS (U.S. CLS. 100, 101 AND 107).

FIRST USE 8-16-2009; IN COMMERCE 8-18-2009.

ELLEN PERKINS, EXAMINING ATTORNEY

SN 77-928,559. SFERE, INC., UNION CITY, NJ. FILED 2-4-2010.

MISS NOIZE

THE MARK CONSISTS OF STANDARD CHARACTERS WITHOUT CLAIM TO ANY PARTICULAR FONT, STYLE, SIZE, OR COLOR.

FOR ENTERTAINMENT AND EDUCATION SERVICES IN THE NATURE OF LIVE DANCE AND MUSICAL PERFORMANCES; ENTERTAINMENT SERVICES IN THE NATURE OF LIVE MUSICAL PERFORMANCES; ENTERTAINMENT SERVICES, NAMELY, LIVE, TELEVISED AND MOVIE APPEARANCES BY A PROFESSIONAL ENTERTAINER; ENTERTAINMENT SERVICES, NAMELY, WRESTLING EXHIBITS AND PERFORMANCES BY A PROFESSIONAL WRESTLER AND ENTERTAINER (U.S. CLS. 100, 101 AND 107).

FIRST USE 12-15-2009; IN COMMERCE 12-15-2009.

ZACHARY BELLO, EXAMINING ATTORNEY

CLASS 41—(Continued).

SN 77-928,586. TIMPERT, KRISTINE, WARREN, NJ. FILED 2-4-2010.



NO CLAIM IS MADE TO THE EXCLUSIVE RIGHT TO USE "PUBLISHING", APART FROM THE MARK AS SHOWN.

THE MARK CONSISTS OF THE STYLIZED WORDING "IF BABIES PUBLISHING" UNDERNEATH AN IMAGE OF A BABY WEARING A DIAPER AND A CAPE HOLDING A BALL OVER HIS HEAD.

FOR BOOK PUBLISHING (U.S. CLS. 100, 101 AND 107).
NICHOLAS ALTREE, EXAMINING ATTORNEY

SN 77-928,595. BECK, KAREN JIN, N. HOLLYWOOD, CA. FILED 2-4-2010.

DJ SHY

THE MARK CONSISTS OF STANDARD CHARACTERS WITHOUT CLAIM TO ANY PARTICULAR FONT, STYLE, SIZE, OR COLOR.

NO CLAIM IS MADE TO THE EXCLUSIVE RIGHT TO USE "DJ", APART FROM THE MARK AS SHOWN.

THE NAME SHOWN IN THE MARK IDENTIFIES KAREN JIN BECK, WHOSE CONSENT TO REGISTER IS MADE OF RECORD.

FOR DISC JOCKEYS FOR PARTIES AND SPECIAL EVENTS; ENTERTAINMENT SERVICES, NAMELY, THE PROVISION OF CONTINUING SHOWS AND SEGMENTS FEATURING MUSIC DELIVERED BY RADIO (U.S. CLS. 100, 101 AND 107).

FIRST USE 2-8-2006; IN COMMERCE 2-8-2006.
KATHERINE E. HALMEN, EXAMINING ATTORNEY

CLASS 41—(Continued).

SN 77-928,608. DARYL L. MACKEY, ALEXANDRIA, VA. FILED 2-4-2010.

Teamesteem

THE MARK CONSISTS OF STANDARD CHARACTERS WITHOUT CLAIM TO ANY PARTICULAR FONT, STYLE, SIZE, OR COLOR.

FOR EDUCATION SERVICES, NAMELY, PROVIDING CLASSES, TRAINING, PROFESSIONAL MOTIVATIONAL SPEECHES, SEMINARS, WORKSHOPS IN THE FIELD OF MARKETING (U.S. CLS. 100, 101 AND 107).

FIRST USE 3-28-2002; IN COMMERCE 6-1-2002.
MICHAEL WEBSTER, EXAMINING ATTORNEY

SN 77-928,701. LIGON, MARC, D., TUCSON, AZ. FILED 2-5-2010.

BARZENTONE

THE MARK CONSISTS OF STANDARD CHARACTERS WITHOUT CLAIM TO ANY PARTICULAR FONT, STYLE, SIZE, OR COLOR.

FOR MULTIMEDIA ENTERTAINMENT SERVICES IN THE NATURE OF DEVELOPMENT, PRODUCTION AND POST-PRODUCTION SERVICES IN THE FIELDS OF VIDEO AND FILMS (U.S. CLS. 100, 101 AND 107).

FIRST USE 4-15-1990; IN COMMERCE 4-15-1990.
ELLEN PERKINS, EXAMINING ATTORNEY

SN 77-928,756. TOD, ALISTAIR F, SYDNEY, AUSTRALIA, FILED 2-5-2010.

Bookisode

THE MARK CONSISTS OF STANDARD CHARACTERS WITHOUT CLAIM TO ANY PARTICULAR FONT, STYLE, SIZE, OR COLOR.

FOR BOOK PUBLISHING; ONLINE ELECTRONIC PUBLISHING OF BOOKS AND PERIODICALS; PUBLICATION OF BOOKS; PUBLICATION OF BOOKS, OF MAGAZINES, OF JOURNALS, OF NEWSPAPERS, OF PERIODICALS, OF CATALOGS, OF BROCHURES; PUBLISHING OF BOOKS, E-BOOKS, AUDIO BOOKS, MUSIC AND ILLUSTRATIONS; PUBLISHING OF ELECTRONIC PUBLICATIONS (U.S. CLS. 100, 101 AND 107).

JEFFERY COWARD, EXAMINING ATTORNEY

CLASS 41—(Continued).

SN 77-928,772. GAIA INTERACTIVE INC., SAN JOSE, CA.
FILED 2-5-2010.

SCRUBBLES

THE MARK CONSISTS OF STANDARD CHARACTERS WITHOUT CLAIM TO ANY PARTICULAR FONT, STYLE, SIZE, OR COLOR.

FOR ENTERTAINMENT SERVICES, NAMELY, PROVIDING ON-LINE COMPUTER GAMES (U.S. CLS. 100, 101 AND 107).

RON FAIRBANKS, EXAMINING ATTORNEY

SN 77-928,774. GAIA INTERACTIVE INC., SAN JOSE, CA.
FILED 2-5-2010.

OCEAN PARTY

THE MARK CONSISTS OF STANDARD CHARACTERS WITHOUT CLAIM TO ANY PARTICULAR FONT, STYLE, SIZE, OR COLOR.

FOR ENTERTAINMENT SERVICES, NAMELY, PROVIDING ON-LINE COMPUTER GAMES (U.S. CLS. 100, 101 AND 107).

RON FAIRBANKS, EXAMINING ATTORNEY

SN 77-928,796. DEVINCENT, MARC, POWELL, OH. FILED 2-5-2010.



THE MARK CONSISTS OF THE LETTER "L" WITH A HEART.

FOR CUSTOM WRITING SERVICES (U.S. CLS. 100, 101 AND 107).

FIRST USE 1-1-2010; IN COMMERCE 2-4-2010.
KATHY DE JONGE, EXAMINING ATTORNEY

CLASS 41—(Continued).

SN 77-928,813. LITTLE AIRPLANE PRODUCTIONS, INC.,
NEW YORK, NY. FILED 2-5-2010.

SMALL POTATOES

THE MARK CONSISTS OF STANDARD CHARACTERS WITHOUT CLAIM TO ANY PARTICULAR FONT, STYLE, SIZE, OR COLOR.

FOR ENTERTAINMENT SERVICES IN THE NATURE OF A CHILDREN'S TELEVISION SERIES (U.S. CLS. 100, 101 AND 107).

KEVIN DINALLO, EXAMINING ATTORNEY

SN 77-928,816. RICCI, JONATHAN MICHAEL, WAYLAND, MA. FILED 2-5-2010.

LANSDOWNE

THE MARK CONSISTS OF STANDARD CHARACTERS WITHOUT CLAIM TO ANY PARTICULAR FONT, STYLE, SIZE, OR COLOR.

FOR ENTERTAINMENT SERVICES IN THE NATURE OF LIVE MUSICAL PERFORMANCES (U.S. CLS. 100, 101 AND 107).

FIRST USE 1-27-2006; IN COMMERCE 1-27-2006.

KEVIN DINALLO, EXAMINING ATTORNEY

SN 77-928,872. REEL WINGS DECOY CO. INC., FARGO, ND.
AND PATTERNMASER CHOKES, BLACK EARTH, WI.
FILED 2-5-2010.

Waterfowl Obsession

THE MARK CONSISTS OF STANDARD CHARACTERS WITHOUT CLAIM TO ANY PARTICULAR FONT, STYLE, SIZE, OR COLOR.

NO CLAIM IS MADE TO THE EXCLUSIVE RIGHT TO USE "WATERFOWL", APART FROM THE MARK AS SHOWN.

FOR ENTERTAINMENT SERVICES IN THE NATURE OF CREATION, DEVELOPMENT, AND PRODUCTION OF TELEVISION PROGRAMMING (U.S. CLS. 100, 101 AND 107).

MICHAEL WEBSTER, EXAMINING ATTORNEY

CLASS 41—(Continued).

SN 77-929,006. ROSEN HOTELS AND RESORTS, INC., ORLANDO, FL. FILED 2-5-2010.

**W.O.W. FACTOR PROGRAM
"WORK OUT FOR WELLNESS"**

THE MARK CONSISTS OF STANDARD CHARACTERS WITHOUT CLAIM TO ANY PARTICULAR FONT, STYLE, SIZE, OR COLOR.

NO CLAIM IS MADE TO THE EXCLUSIVE RIGHT TO USE "PROGRAM" AND "WORKOUT FOR WELLNESS", APART FROM THE MARK AS SHOWN.

FOR PHYSICAL FITNESS TRAINING SERVICES; PROVIDING FITNESS AND EXERCISE FACILITIES; PHYSICAL FITNESS CONDITIONING CLASSES; PHYSICAL FITNESS CONSULTATION; AND EDUCATIONAL SERVICES, NAMELY, DEVELOPING AND CONDUCTING WORKOUTS, WORKSHOPS, PRESENTATIONS, CLASSES AND PERSONAL TRAINING IN THE FIELDS OF FITNESS AND NUTRITION (U.S. CLS. 100, 101 AND 107).

LEIGH CAROLINE CASE, EXAMINING ATTORNEY

SN 77-929,070. CLARK, CHARLES K., HARLINGEN, TX. FILED 2-5-2010.

GreenGhost & MexSÍcan

THE MARK CONSISTS OF STANDARD CHARACTERS WITHOUT CLAIM TO ANY PARTICULAR FONT, STYLE, SIZE, OR COLOR.

OWNER OF U.S. REG. NOS. 3,150,035, 3,418,376 AND 3,548,383.

FOR ENTERTAINMENT SERVICES, NAMELY, THE PROVISION OF CONTINUING PROGRAMS, SEGMENTS, MOVIES AND MOTION PICTURE THEATRICAL FILMS FEATURING COMEDY AND LIVE ACTION (U.S. CLS. 100, 101 AND 107).

BRIAN NEVILLE, EXAMINING ATTORNEY

CLASS 41—(Continued).

SN 77-929,115. SHOWTIME NETWORKS INC., NEW YORK, NY. FILED 2-5-2010.

THE REAL L WORD

THE MARK CONSISTS OF STANDARD CHARACTERS WITHOUT CLAIM TO ANY PARTICULAR FONT, STYLE, SIZE, OR COLOR.

OWNER OF U.S. REG. NOS. 2,883,277 AND 3,276,350. FOR ENTERTAINMENT SERVICES, NAMELY, AN ONGOING REALITY BASED TELEVISION SERIES RENDERED THROUGH THE MEDIA OF TELEVISION, CABLE, SATELLITE, TELEPHONE AND BROADBAND SYSTEMS, AND VIA THE INTERNET, PORTABLE AND WIRELESS COMMUNICATION DEVICES; AND PROVIDING INFORMATION IN THE FIELD OF ENTERTAINMENT FEATURING INFORMATION ON REALITY BASED TELEVISION RENDERED VIA THE INTERNET, PORTABLE AND WIRELESS COMMUNICATION DEVICES (U.S. CLS. 100, 101 AND 107).

JACLYN KIDWELL WALKER, EXAMINING ATTORNEY

SN 77-929,129. MB PUBLISHING, INC., EMERYVILLE, CA. FILED 2-5-2010.

eduArts

THE MARK CONSISTS OF STANDARD CHARACTERS WITHOUT CLAIM TO ANY PARTICULAR FONT, STYLE, SIZE, OR COLOR.

FOR PUBLISHING OF BOOKS AND ELECTRONIC PUBLICATIONS; EDUCATIONAL SERVICES, NAMELY, CONDUCTING CLASSES, SEMINARS, CONFERENCES AND WORKSHOPS IN THE FIELD OF DRAWING AND ILLUSTRATION (U.S. CLS. 100, 101 AND 107).

FIRST USE 11-0-2009; IN COMMERCE 11-0-2009.

LEIGH CAROLINE CASE, EXAMINING ATTORNEY

SN 77-929,137. RUIZ, EDUARDO, DBA NINTH OF GREEN, LANCASTER, PA. FILED 2-5-2010.

ninth of green

THE MARK CONSISTS OF STANDARD CHARACTERS WITHOUT CLAIM TO ANY PARTICULAR FONT, STYLE, SIZE, OR COLOR.

FOR ENTERTAINMENT SERVICES IN THE NATURE OF LIVE MUSICAL PERFORMANCES (U.S. CLS. 100, 101 AND 107).

MICHAEL ENGEL, EXAMINING ATTORNEY

CLASS 41—(Continued).

SN 77-929,293. MURAWSKI, MICHAEL A II, BARRINGTON, IL. FILED 2-5-2010.

SCENEHUB

THE MARK CONSISTS OF STANDARD CHARACTERS WITHOUT CLAIM TO ANY PARTICULAR FONT, STYLE, SIZE, OR COLOR.

FOR PROVIDING AN INTERNET WEBSITE PORTAL FEATURING LINKS TO MUSICAL ARTIST WEBSITES AND MUSIC PERFORMANCE TICKET INFORMATION (U.S. CLS. 100, 101 AND 107).

FIRST USE 2-3-2010; IN COMMERCE 2-3-2010.
IRA J. GOODSaid, EXAMINING ATTORNEY

SN 77-929,343. MEMOIR JOURNAL, SAUSALITO, CA. FILED 2-5-2010.

Memoir (and)

THE MARK CONSISTS OF STANDARD CHARACTERS WITHOUT CLAIM TO ANY PARTICULAR FONT, STYLE, SIZE, OR COLOR.

NO CLAIM IS MADE TO THE EXCLUSIVE RIGHT TO USE "MEMOIR", APART FROM THE MARK AS SHOWN.

FOR MULTIMEDIA PUBLISHING OF BOOKS, MAGAZINES, JOURNALS, SOFTWARE, GAMES, MUSIC, AND ELECTRONIC PUBLICATIONS; PUBLICATION OF BOOKS, MAGAZINES, ALMANACS AND JOURNALS (U.S. CLS. 100, 101 AND 107).

FIRST USE 1-1-2007; IN COMMERCE 4-19-2007.
INGRID C. EULIN, EXAMINING ATTORNEY

CLASS 41—(Continued).

SN 77-929,418. THE SALES LEADERSHIP FORUM, ALPHARETTA, GA. FILED 2-5-2010.



NO CLAIM IS MADE TO THE EXCLUSIVE RIGHT TO USE "THE SALES LEADERSHIP FORUM", APART FROM THE MARK AS SHOWN.

THE COLOR(S) WHITE AND BLUE IS/ARE CLAIMED AS A FEATURE OF THE MARK.

THE MARK CONSISTS OF "THE SALES LEADERSHIP FORUM" APPEARING IN WHITE TEXT ON A DARK BLUE BACKGROUND WITH THE TAGLINE "DRIVING PROFITABLE GROWTH" IN DARK BLUE TEXT ON A WHITE BACKGROUND. ENTIRE IMAGE MAKES A BOX.

FOR BUSINESS EDUCATION AND TRAINING SERVICES, NAMELY, DEVELOPING, AND FACILITATING CUSTOMIZED IN-COMPANY LEADERSHIP AND EXECUTIVE DEVELOPMENT PROGRAMS, PROVIDING EXECUTIVE COACHING SERVICES, AND PROVIDING PUBLIC AND IN-COMPANY KEYNOTE PRESENTATIONS TO BUSINESS LEADERS (U.S. CLS. 100, 101 AND 107).

FIRST USE 12-1-2007; IN COMMERCE 12-1-2007.
ANNE E. GUSTASON, EXAMINING ATTORNEY

SN 77-929,551. UP TO SOMETHING PARTNERS, LLC, DALLAS, TX. FILED 2-5-2010.

UP TO SOMETHING

THE MARK CONSISTS OF STANDARD CHARACTERS WITHOUT CLAIM TO ANY PARTICULAR FONT, STYLE, SIZE, OR COLOR.

FOR EDUCATIONAL SERVICES, NAMELY, CONDUCTING CLASSES, SEMINARS, CONFERENCES, WORKSHOPS IN THE FIELD OF MOTIVATION, SELF-IMPROVEMENT AND BUSINESS EDUCATION AND DISTRIBUTING INSTRUCTIONAL MATERIALS IN CONNECTION THEREWITH (U.S. CLS. 100, 101 AND 107).

FIRST USE 4-16-2009; IN COMMERCE 4-16-2009.
H. M. FISHER, EXAMINING ATTORNEY

CLASS 41—(Continued).

SN 77-929,649. GIBBS, SCOTT, ROME, GA. FILED 2-5-2010.

VeloTV

THE MARK CONSISTS OF STANDARD CHARACTERS WITHOUT CLAIM TO ANY PARTICULAR FONT, STYLE, SIZE, OR COLOR.

FOR ENTERTAINMENT SERVICES, NAMELY, PROVIDING A WEB SITE FEATURING PHOTOGRAPHIC, AUDIO, VIDEO AND PROSE PRESENTATIONS FEATURING CYCLING ; EDUCATIONAL AND ENTERTAINMENT SERVICES, NAMELY, PROVIDING A WEBSITE FEATURING NEWS AND INFORMATION IN THE FIELD OF CYCLING (U.S. CLS. 100, 101 AND 107).
EDWARD FENNESSY, EXAMINING ATTORNEY

CLASS 41—(Continued).

SN 77-929,766. WORLD TRIATHLON CORPORATION, TAMPA, FL. FILED 2-6-2010.

lavamagazineonline.com

THE MARK CONSISTS OF STANDARD CHARACTERS WITHOUT CLAIM TO ANY PARTICULAR FONT, STYLE, SIZE, OR COLOR.

FOR PROVIDING ON-LINE MAGAZINES FEATURING SWIMMING, BIKING, RUNNING AND TRIATHLONS (U.S. CLS. 100, 101 AND 107).
JUDITH HELFMAN, EXAMINING ATTORNEY

SN 77-929,683. GREENSTEIN, M A, PASADENA, CA. FILED 2-5-2010.

BODIES IN SPACE

THE MARK CONSISTS OF STANDARD CHARACTERS WITHOUT CLAIM TO ANY PARTICULAR FONT, STYLE, SIZE, OR COLOR.

FOR EDUCATION SERVICES, NAMELY, PROVIDING LIVE AND ON-LINE CLASSES, SEMINARS, COACHING, INFORMATION, WORKSHOPS IN THE FIELD OF NEURO-SOMATICS, NEUROTECHNOLOGY AND BRAIN/MIND/BODY FITNESS (U.S. CLS. 100, 101 AND 107).
FIRST USE 10-1-2006; IN COMMERCE 10-1-2008.
WANDA KAY PRICE, EXAMINING ATTORNEY

SN 77-929,796. THE CLEVER APPLE, INC., FRANKLIN, NC. FILED 2-6-2010.

The Clever Apple

THE MARK CONSISTS OF STANDARD CHARACTERS WITHOUT CLAIM TO ANY PARTICULAR FONT, STYLE, SIZE, OR COLOR.

FOR CONDUCTING AFTER-SCHOOL TUTORING PROGRAMS (U.S. CLS. 100, 101 AND 107).
ARETHA SOMERVILLE, EXAMINING ATTORNEY

SN 77-929,763. WORLD TRIATHLON CORPORATION, TAMPA, FL. FILED 2-6-2010.

lava-mag.com

THE MARK CONSISTS OF STANDARD CHARACTERS WITHOUT CLAIM TO ANY PARTICULAR FONT, STYLE, SIZE, OR COLOR.

FOR PROVIDING ON-LINE MAGAZINES FEATURING SWIMMING, BIKING, RUNNING AND TRIATHLONS (U.S. CLS. 100, 101 AND 107).
JUDITH HELFMAN, EXAMINING ATTORNEY

SN 77-929,830. FRAWG STOMP LLC, VIRGINIA BEACH, VA. FILED 2-6-2010.

FRAWGSTOMP

THE MARK CONSISTS OF STANDARD CHARACTERS WITHOUT CLAIM TO ANY PARTICULAR FONT, STYLE, SIZE, OR COLOR.

FOR ORGANIZING SPORTING EVENTS, NAMELY, ORGANIZING AND CONDUCTING URBAN RACES THAT COMBINE TECHNOLOGY, PHYSICAL FITNESS, AND COMPETITION (U.S. CLS. 100, 101 AND 107).
FIRST USE 1-15-2010; IN COMMERCE 1-15-2010.
SANJEEV VOHRA, EXAMINING ATTORNEY

CLASS 41—(Continued).

SN 77-929,870. ELISE, DISHAN, DBA DI FOR YOUR BODY & HUMAN AT EASE, MASPETH, NY. FILED 2-6-2010.

Introversion

THE MARK CONSISTS OF STANDARD CHARACTERS WITHOUT CLAIM TO ANY PARTICULAR FONT, STYLE, SIZE, OR COLOR.

FOR PERSONAL TRAINING SERVICES, NAMELY, STRENGTH AND CONDITIONING TRAINING (U.S. CLS. 100, 101 AND 107).

FIRST USE 10-9-2008; IN COMMERCE 10-9-2008.
KAELE KUNG, EXAMINING ATTORNEY

SN 77-929,916. INCLUSION, INC., GOLDEN VALLEY, MN. FILED 2-7-2010.

INCLUSION IS A BUSINESS STRATEGY

THE MARK CONSISTS OF STANDARD CHARACTERS WITHOUT CLAIM TO ANY PARTICULAR FONT, STYLE, SIZE, OR COLOR.

FOR EDUCATION SERVICES, NAMELY, PROVIDING WORKSHOPS AND SEMINARS IN THE FIELD OF BUSINESS (U.S. CLS. 100, 101 AND 107).

FIRST USE 11-15-2009; IN COMMERCE 11-15-2009.
JENNIFER DIXON, EXAMINING ATTORNEY

SN 77-929,961. MAXVICTOR, VIVACE, FORMERLY MOTAMED, KATAYOON, NEW YORK, NY. FILED 2-7-2010.

Pay Freedom Forward

THE MARK CONSISTS OF STANDARD CHARACTERS WITHOUT CLAIM TO ANY PARTICULAR FONT, STYLE, SIZE, OR COLOR.

FOR BUSINESS EDUCATION AND TRAINING SERVICES, NAMELY, DEVELOPING, AND FACILITATING CUSTOMIZED IN-COMPANY LEADERSHIP AND EXECUTIVE DEVELOPMENT PROGRAMS, PROVIDING EXECUTIVE COACHING SERVICES, AND PROVIDING PUBLIC AND IN-COMPANY KEYNOTE PRESENTATIONS TO BUSINESS LEADERS; CHARITABLE SERVICES, NAMELY, MENTORING DISADVANTAGED GIRLS IN THE FIELD OF PERSONAL GROWTH, DEVELOPMENT, EMPOWERMENT AND MOTIVATION; CHARITABLE SERVICES, NAMELY, PROVIDING BOOKS TO PEOPLE; CHARITABLE SERVICES, NAMELY, PROVIDING TRAINING IN THE FIELD OF PERSONAL GROWTH, DEVELOPMENT, EMPOWERMENT AND MOTIVATION; EDUCATION SERVICES, NAMELY, MENTORING IN THE FIELD OF PERSONAL GROWTH, DEVELOPMENT, EMPOWERMENT AND MOTIVATION; EDUCATION SERVICES, NAMELY, PROVIDING LIVE AND ON-LINE SEMINARS, WORKSHOPS, PRESENTATIONS, CLASSES IN THE FIELD OF

CLASS 41—(Continued).

ALL ASPECTS OF BUSINESS AND PERSONAL GROWTH, DEVELOPMENT, EMPOWERMENT AND MOTIVATION; EDUCATION SERVICES, NAMELY, PROVIDING MENTORING, TUTORING, CLASSES, SEMINARS AND WORKSHOPS IN THE FIELD OF ALL ASPECTS OF BUSINESS AND PERSONAL GROWTH, DEVELOPMENT, EMPOWERMENT AND MOTIVATION; EDUCATION SERVICES, NAMELY, PROVIDING ON-LINE SEMINARS, WORKSHOPS, PRESENTATIONS, CLASSES, IN THE FIELD OF ALL ASPECTS OF BUSINESS AND PERSONAL GROWTH, DEVELOPMENT, EMPOWERMENT AND MOTIVATION; EDUCATION SERVICES, NAMELY, PROVIDING SEMINARS, WORKSHOPS, PRESENTATIONS, CLASSES, IN THE FIELD OF ALL ASPECTS OF BUSINESS AND PERSONAL GROWTH, DEVELOPMENT, EMPOWERMENT AND MOTIVATION; EDUCATIONAL AND ENTERTAINMENT SERVICES, NAMELY, PROVIDING MOTIVATIONAL AND EDUCATIONAL SPEAKERS; EDUCATIONAL AND ENTERTAINMENT SERVICES, NAMELY, PROVIDING MOTIVATIONAL AND EDUCATIONAL SPEAKERS IN THE FIELD OF SELF- AND PERSONAL IMPROVEMENT; EDUCATIONAL AND ENTERTAINMENT SERVICES, NAMELY, PROVIDING MOTIVATIONAL SPEAKING SERVICES IN THE FIELD OF ALL ASPECTS OF BUSINESS AND PERSONAL GROWTH, DEVELOPMENT, EMPOWERMENT AND MOTIVATION; EDUCATIONAL SERVICES, NAMELY, CONDUCTING INFORMAL ON-LINE PROGRAMS IN THE FIELDS OF ALL ASPECTS OF BUSINESS AND PERSONAL GROWTH, DEVELOPMENT, EMPOWERMENT AND MOTIVATION, AND PRINTABLE MATERIALS DISTRIBUTED THEREWITH; EDUCATIONAL SERVICES, NAMELY, CONDUCTING INFORMAL PROGRAMS IN THE FIELDS OF ALL ASPECTS OF BUSINESS AND PERSONAL GROWTH, DEVELOPMENT, EMPOWERMENT AND MOTIVATION, USING ON-LINE ACTIVITIES AND INTERACTIVE EXHIBITS, AND PRINTABLE MATERIALS DISTRIBUTED THEREWITH; EDUCATIONAL SERVICES, NAMELY, CONDUCTING ON LINE AND TELEPHONIC INSTRUCTION AND COURSES IN THE FIELD ALL ASPECTS OF BUSINESS AND PERSONAL GROWTH, DEVELOPMENT, EMPOWERMENT AND MOTIVATION; EDUCATIONAL SERVICES, NAMELY, CONDUCTING PROGRAMS IN THE FIELD OF ALL ASPECTS OF BUSINESS AND PERSONAL GROWTH, DEVELOPMENT, EMPOWERMENT AND MOTIVATION; EDUCATIONAL SERVICES, NAMELY, CONDUCTING SEMINARS, LECTURES, TELESEMINARS, TELECLASSES, AND WORKSHOPS IN PERSONAL AWARENESS; EDUCATIONAL SERVICES, NAMELY, PROVIDING ON-LINE SEMINARS, WORKSHOPS, PRESENTATIONS, CLASSES IN THE FIELD OF ALL ASPECTS OF BUSINESS AND PERSONAL GROWTH, DEVELOPMENT, EMPOWERMENT AND MOTIVATION; EDUCATIONAL SERVICES, NAMELY, PROVIDING SEMINARS, WORKSHOPS, PRESENTATIONS, CLASSES IN THE FIELDS OF ALL ASPECTS OF BUSINESS AND PERSONAL GROWTH, DEVELOPMENT, EMPOWERMENT AND MOTIVATION; LIFE COACHING SERVICES IN THE FIELD OF ALL ASPECTS OF BUSINESS AND PERSONAL GROWTH, DEVELOPMENT, EMPOWERMENT AND MOTIVATION; PERSONAL COACHING SERVICES IN THE FIELD OF ALL ASPECTS OF BUSINESS AND PERSONAL GROWTH, DEVELOPMENT, EMPOWERMENT AND MOTIVATION; PROFESSIONAL COACHING SERVICES IN THE FIELD OF ALL ASPECTS OF BUSINESS AND PERSONAL GROWTH, DEVELOPMENT, EMPOWERMENT AND MOTIVATION; TRAINING SERVICES IN THE FIELD OF ALL ASPECTS OF BUSINESS AND PERSONAL GROWTH, DEVELOPMENT, EMPOWERMENT AND MOTIVATION (U.S. CLS. 100, 101 AND 107).

FIRST USE 9-9-2005; IN COMMERCE 9-9-2005.
SETH A. RAPPAPORT, EXAMINING ATTORNEY

CLASS 41—(Continued).

SN 77-930,017. JOHNSON, JEFFREY S, TYLER, TX. FILED 2-7-2010.



NO CLAIM IS MADE TO THE EXCLUSIVE RIGHT TO USE "GAME SHOW", APART FROM THE MARK AS SHOWN.

THE MARK CONSISTS OF THE WORDS "GAME SHOW MASTERS" WITH EACH LETTER OF EACH WORD CONTAINED IN A BLOCK, WITH EACH BLOCK HAVING ROUNDED CORNERS AND A DROP SHADOW ON THE RIGHT SIDE AND BOTTOM, WITH THREE HORIZONTAL ROWS OF SEVEN BLOCKS STACKED VERTICALLY, WITH THE LETTERS OF THE WORD "GAME" DISPLAYED IN THE FIRST HORIZONTAL ROW OF BLOCKS, WITH THREE EMPTY BLOCKS TO THE RIGHT OF THE BLOCK CONTAINING THE LETTER "E", WITH THE LETTERS OF THE WORD "SHOW" DISPLAYED IN THE SECOND HORIZONTAL ROW OF BLOCKS, WITH THREE EMPTY BLOCKS TO THE RIGHT OF THE BLOCK CONTAINING THE LETTER "W", AND WITH THE LETTERS OF THE WORD "MASTERS" DISPLAYED IN THE THIRD HORIZONTAL ROW OF BLOCKS.

FOR BUSINESS TRAINING; ENTERTAINMENT AND EDUCATIONAL SERVICES, NAMELY, THE PRESENTATION OF SEMINARS, LECTURES, WORKSHOPS AND PANEL DISCUSSIONS, AND ONGOING TELEVISION AND RADIO TALK SHOWS ALL IN THE FIELD OF PUBLIC INTEREST CONCERNING PERSONAL AND PROFESSIONAL DEVELOPMENT; ENTERTAINMENT SERVICES, NAMELY, PRODUCTION AND DISTRIBUTION OF A GAME SHOW; PRESENTATION OF LIVE SHOW PERFORMANCES (U.S. CLS. 100, 101 AND 107).

FIRST USE 12-3-2009; IN COMMERCE 12-11-2009.
JAMES LOVELACE, EXAMINING ATTORNEY

SN 77-930,018. PSYCH-TECH INC., RIVERDALE, NY. FILED 2-7-2010.

EMPATHYworks

THE MARK CONSISTS OF STANDARD CHARACTERS WITHOUT CLAIM TO ANY PARTICULAR FONT, STYLE, SIZE, OR COLOR.

FOR INTERACTIVE ON-LINE TRAINING SERVICES IN THE FIELD OF PERSONAL GROWTH AND RELATIONSHIP ENHANCEMENT (U.S. CLS. 100, 101 AND 107).

JAMES LOVELACE, EXAMINING ATTORNEY

CLASS 41—(Continued).

SN 77-930,019. DALLAS BAR ASSOCIATION COMMUNITY SERVICE FUND, DALLAS, TX. FILED 2-7-2010.



THE MARK CONSISTS OF A STYLIZED "E" WITH A GRADUATION CAP ON THE TOP PORTION OF THE "E" AND COMPUTER MOUSE EXTENDING FROM ONE END OF THE "E".

FOR CHARITABLE SERVICES, NAMELY, DEVELOPING AND PROVIDING MENTORING RELATIONSHIPS VIA E-MAIL TO PRIMARY EDUCATION STUDENTS TO ENCOURAGE STAYING IN SCHOOL AND ATTENDING HIGHER EDUCATION INSTITUTIONS (U.S. CLS. 100, 101 AND 107).

FIRST USE 9-30-2006; IN COMMERCE 9-30-2006.
JAMES LOVELACE, EXAMINING ATTORNEY

SN 77-930,021. PSYCH-TECH INC., RIVERDALE, NY. FILED 2-7-2010.

EMPATHway

THE MARK CONSISTS OF STANDARD CHARACTERS WITHOUT CLAIM TO ANY PARTICULAR FONT, STYLE, SIZE, OR COLOR.

FOR INTERACTIVE ON-LINE TRAINING SERVICES IN THE FIELD OF PERSONAL GROWTH AND RELATIONSHIP ENHANCEMENT (U.S. CLS. 100, 101 AND 107).

JAMES LOVELACE, EXAMINING ATTORNEY

SN 77-930,023. PSYCH-TECH INC., RIVERDALE, NY. FILED 2-7-2010.

WE SPACE

THE MARK CONSISTS OF STANDARD CHARACTERS WITHOUT CLAIM TO ANY PARTICULAR FONT, STYLE, SIZE, OR COLOR.

FOR INTERACTIVE ON-LINE TRAINING SERVICES IN THE FIELD OF PERSONAL GROWTH AND RELATIONSHIP ENHANCEMENT (U.S. CLS. 100, 101 AND 107).

JAMES LOVELACE, EXAMINING ATTORNEY

CLASS 41—(Continued).

SN 77-930,123. WILLIAMS, RODERICK, DBA EW CAKE DESIGNS, LITTLE ROCK, CA. FILED 2-8-2010.

**EW Cake Designs "The Cake
Craftier"**

THE MARK CONSISTS OF STANDARD CHARACTERS WITHOUT CLAIM TO ANY PARTICULAR FONT, STYLE, SIZE, OR COLOR.

NO CLAIM IS MADE TO THE EXCLUSIVE RIGHT TO USE "CAKE DESIGNS" AND "CAKE", APART FROM THE MARK AS SHOWN.

FOR TRAINING SERVICES IN THE FIELD OF CAKE DECORATING (U.S. CLS. 100, 101 AND 107).

FIRST USE 8-29-2009; IN COMMERCE 8-29-2009.
RONALD MCMORROW, EXAMINING ATTORNEY

CLASS 41—(Continued).

SN 77-930,258. THREE KINGS LLC, MILFORD, CT. FILED 2-8-2010.

KING FOR A DAY

THE MARK CONSISTS OF STANDARD CHARACTERS WITHOUT CLAIM TO ANY PARTICULAR FONT, STYLE, SIZE, OR COLOR.

FOR ENTERTAINMENT, NAMELY, LIVE PERFORMANCES BY A MUSICAL BAND (U.S. CLS. 100, 101 AND 107).

FIRST USE 12-1-2005; IN COMMERCE 1-7-2006.
DORITT L. CARROLL, EXAMINING ATTORNEY

SN 77-930,286. DEFINE, LLC, HOUSTON, TX. FILED 2-8-2010.

DEFINE YOUR BALANCE

THE MARK CONSISTS OF STANDARD CHARACTERS WITHOUT CLAIM TO ANY PARTICULAR FONT, STYLE, SIZE, OR COLOR.

FOR PROVIDING FITNESS AND EXERCISE FACILITIES; PROVIDING ASSISTANCE AND PERSONAL TRAINING, PHYSICAL FITNESS CONSULTATION TO INDIVIDUALS TO HELP THEM MAKE PHYSICAL FITNESS, STRENGTH, CONDITIONING, AND EXERCISE IMPROVEMENT IN THEIR DAILY LIVING; PROVIDING INFORMATION IN THE FIELD OF PHYSICAL EXERCISE; PROVIDING FITNESS CLASSES, NAMELY, YOGA AND PILATES (U.S. CLS. 100, 101 AND 107).
APRIL HESIK, EXAMINING ATTORNEY

SN 77-930,230. WORLD WRESTLING ENTERTAINMENT, INC., STAMFORD, CT. FILED 2-8-2010.



THE MARK CONSISTS OF TWO STACKED "W" LETTERS WITH A SCAR UNDERNEATH SITTING ON TOP OF THE LETTERS "NXT" APPEARING VERTICALLY.

FOR ENTERTAINMENT SERVICES, NAMELY, THE PRODUCTION AND EXHIBITION OF PROFESSIONAL WRESTLING EVENTS RENDERED LIVE AND THROUGH THE MEDIA OF TELEVISION; PROVIDING WRESTLING NEWS AND INFORMATION VIA A GLOBAL COMPUTER NETWORK (U.S. CLS. 100, 101 AND 107).

JOHN HWANG, EXAMINING ATTORNEY

SN 77-930,336. ERICH, ROBERT, WILLITS, CA. FILED 2-8-2010.

STAGE OFF

THE MARK CONSISTS OF STANDARD CHARACTERS WITHOUT CLAIM TO ANY PARTICULAR FONT, STYLE, SIZE, OR COLOR.

FOR PROVIDING A WEBSITE WHICH ALLOWS USERS TO ENTER CONTESTS ONLINE WITH THEIR OWN VIDEOS, AUDIOS, ARTWORK, IMAGES, AND TEXT, AND WHICH ALLOWS OTHER USERS TO VIEW AND/OR LISTEN TO THE ENTRIES AND VOTE TO SELECT CONTEST WINNERS (U.S. CLS. 100, 101 AND 107).

WENDY JUN, EXAMINING ATTORNEY

CLASS 41—(Continued).

SN 77-930,384. THE LEARNING MANAGEMENT INSTITUTE, WINCHESTER, MA. FILED 2-8-2010.

LMI

THE MARK CONSISTS OF STANDARD CHARACTERS WITHOUT CLAIM TO ANY PARTICULAR FONT, STYLE, SIZE, OR COLOR.

FOR EDUCATION SERVICES, NAMELY, PROVIDING CLASSES, SEMINARS, AND WORKSHOPS IN THE FIELD OF LEARNING MANAGEMENT (U.S. CLS. 100, 101 AND 107).

JENNIFER MARTIN, EXAMINING ATTORNEY

CLASS 41—(Continued).

SN 77-930,423. MAD ROMANCE MUSIC, INC., HOLLYWOOD, FL. FILED 2-8-2010.

MAD ROMANCE

THE MARK CONSISTS OF STANDARD CHARACTERS WITHOUT CLAIM TO ANY PARTICULAR FONT, STYLE, SIZE, OR COLOR.

FOR ENTERTAINMENT IN THE NATURE OF A VOCAL GROUP (U.S. CLS. 100, 101 AND 107).

FIRST USE 10-0-1983; IN COMMERCE 4-0-2004.
MICHAEL KEATING, EXAMINING ATTORNEY

SN 77-930,386. CHERRY, BRANDON, MILWAUKEE, WI. FILED 2-8-2010.

INDIEMUSICLOUNGE.COM

THE MARK CONSISTS OF STANDARD CHARACTERS WITHOUT CLAIM TO ANY PARTICULAR FONT, STYLE, SIZE, OR COLOR.

FOR ENTERTAINMENT AND EDUCATIONAL SERVICES, NAMELY, PROVIDING ADVICE AND INFORMATION FOR MUSIC, VIDEO AND FILM CONCEPT AND SCRIPT DEVELOPMENT (U.S. CLS. 100, 101 AND 107).

APRIL HESIK, EXAMINING ATTORNEY

SN 77-930,454. ANITA GOODESIGN, INC., CHARLOTTE, NC. FILED 2-8-2010.

ANITA GOODESIGN

THE MARK CONSISTS OF STANDARD CHARACTERS WITHOUT CLAIM TO ANY PARTICULAR FONT, STYLE, SIZE, OR COLOR.

THE NAME(S), PORTRAIT(S), AND/OR SIGNATURE(S) SHOWN IN THE MARK DOES NOT IDENTIFY A PARTICULAR LIVING INDIVIDUAL.

FOR EDUCATION SERVICES, NAMELY, PROVIDING SEMINARS IN THE FIELD OF EMBROIDERY, SEWING AND QUILTING (U.S. CLS. 100, 101 AND 107).
LESLEY LAMOTHE, EXAMINING ATTORNEY

SN 77-930,401. INSURMARK, INC., HOUSTON, TX. FILED 2-8-2010.

15 MINUTE SPOTLIGHT

THE MARK CONSISTS OF STANDARD CHARACTERS WITHOUT CLAIM TO ANY PARTICULAR FONT, STYLE, SIZE, OR COLOR.

NO CLAIM IS MADE TO THE EXCLUSIVE RIGHT TO USE "15 MINUTE", APART FROM THE MARK AS SHOWN.

FOR TRAINING SERVICES, NAMELY, ONLINE PRESENTATIONS DIRECTED TO A NATIONWIDE NETWORK OF INSURANCE AGENTS AND FINANCIAL SERVICES PROFESSIONALS ON PRODUCTS AND TOPICS RELATING TO THE INSURANCE INDUSTRY (U.S. CLS. 100, 101 AND 107).

H. M. FISHER, EXAMINING ATTORNEY

SN 77-930,524. STEVENS, KIA, TAMPA, FL. FILED 2-8-2010.

AWESOME KONG

THE MARK CONSISTS OF STANDARD CHARACTERS WITHOUT CLAIM TO ANY PARTICULAR FONT, STYLE, SIZE, OR COLOR.

FOR ENTERTAINMENT SERVICES, NAMELY, WRESTLING EXHIBITS AND PERFORMANCES BY A PROFESSIONAL WRESTLER AND ENTERTAINER (U.S. CLS. 100, 101 AND 107).

FIRST USE 1-1-2007; IN COMMERCE 1-1-2007.
SETH A. RAPPAPORT, EXAMINING ATTORNEY

CLASS 41—(Continued).

SN 77-930,601. THE ECLECTIC COLLECTIVE, LLC,
BRIGHTON, MA. FILED 2-8-2010.

BAD RABBITS

THE MARK CONSISTS OF STANDARD CHARACTERS WITHOUT CLAIM TO ANY PARTICULAR FONT, STYLE, SIZE, OR COLOR.

FOR ENTERTAINMENT IN THE NATURE OF LIVE PERFORMANCES BY A MUSICIAN OR MUSICIANS; ENTERTAINMENT SERVICES, NAMELY, PROVIDING A WEB SITE FEATURING NON-DOWNLOADABLE MUSICAL PERFORMANCES, MUSICAL VIDEOS, RELATED FILM CLIPS, PHOTOGRAPHS, AND OTHER MULTIMEDIA MATERIALS FEATURING MUSIC (U.S. CLS. 100, 101 AND 107).

FIRST USE 10-31-2007; IN COMMERCE 10-31-2007.
KATHERINE E. HALMEN, EXAMINING ATTORNEY

SN 77-930,666. THE ARTREACH FOUNDATION, ATLANTA,
GA. FILED 2-8-2010.

ArtReach Model

THE MARK CONSISTS OF STANDARD CHARACTERS WITHOUT CLAIM TO ANY PARTICULAR FONT, STYLE, SIZE, OR COLOR.

OWNER OF U.S. REG. NOS. 2,723,503 AND 2,734,037.
NO CLAIM IS MADE TO THE EXCLUSIVE RIGHT TO USE "MODEL", APART FROM THE MARK AS SHOWN.
FOR EDUCATIONAL SERVICES, NAMELY, CONDUCTING, ORGANIZING AND DEVELOPING SEMINARS AND WORKSHOPS IN THE FIELD OF CREATIVE PROBLEM-SOLVING AND EXPRESSIVE ACTIVITIES FOR INDIVIDUALS WHO HAVE BEEN EMOTIONALLY TRAUMATIZED (U.S. CLS. 100, 101 AND 107).

FIRST USE 1-1-2005; IN COMMERCE 1-1-2005.
PATRICIA EVANKO, EXAMINING ATTORNEY

SN 77-930,693. WIEGAND, ERICH HAROLD, DBA E-RICH
MUSIC, VALDOSTA, GA. FILED 2-8-2010.



NO CLAIM IS MADE TO THE EXCLUSIVE RIGHT TO USE "MUSIC", APART FROM THE MARK AS SHOWN.

THE STIPPLING IS A FEATURE OF THE MARK.
THE MARK CONSISTS OF THE WORD "E-RICH" IN A STYLIZED FONT. THERE IS A SOLID LINE UNDERNEATH THE WORD "E-RICH" WITH THE WORD "MUSIC" BENEATH THE LINE IN ALL CAPITAL LETTERS.

FOR MUSIC PRODUCTION SERVICES (U.S. CLS. 100, 101 AND 107).
ANDREA HACK, EXAMINING ATTORNEY

CLASS 41—(Continued).

SN 77-930,775. ROSENBERG MANAGEMENT CORP., DBA
THE PANDORA'S BOX, NEW YORK, NY. FILED 2-8-2010.

THE PANDORA'S BOX

THE MARK CONSISTS OF STANDARD CHARACTERS WITHOUT CLAIM TO ANY PARTICULAR FONT, STYLE, SIZE, OR COLOR.

FOR PROVIDING A WEB SITE THAT FEATURES INFORMAL INSTRUCTION ON DATING, ATTRACTION, SEDUCTION AND HOW MEN CAN LEARN TO HAVE MORE SUCCESS IN MEETING WOMEN (U.S. CLS. 100, 101 AND 107).

FIRST USE 1-31-2010; IN COMMERCE 1-31-2010.
KATHERINE CONNOLLY, EXAMINING ATTORNEY

SN 77-930,811. WILKINS, CONSUELO, SAINT LOUIS, MO.
FILED 2-8-2010.

**Take off YOUR glasses so you
can see the BIG PICTURE**

THE MARK CONSISTS OF STANDARD CHARACTERS WITHOUT CLAIM TO ANY PARTICULAR FONT, STYLE, SIZE, OR COLOR.

FOR EDUCATION SERVICES, NAMELY, PROVIDING CLASSES, SEMINARS, WORKSHOPS IN THE FIELD OF CUSTOMIZED LEADERSHIP; EDUCATIONAL AND ENTERTAINMENT SERVICES, NAMELY, PROVIDING MOTIVATIONAL SPEAKING SERVICES IN THE FIELD OF CUSTOMIZED LEADERSHIP; TRAINING SERVICES IN THE FIELD OF BRAINSTORMING (U.S. CLS. 100, 101 AND 107).

APRIL ROACH, EXAMINING ATTORNEY

CLASS 41—(Continued).SN 77-930,862. MIKE VALLELY, LONG BEACH, CA. FILED
2-8-2010.**CLASS 41—(Continued).**SN 77-930,867. MIKE VALLELY, LONG BEACH, CA. FILED
2-8-2010.**MIKE V****BY THE SWORD**

THE MARK CONSISTS OF STANDARD CHARACTERS WITHOUT CLAIM TO ANY PARTICULAR FONT, STYLE, SIZE, OR COLOR.

THE NAME "MIKE V" IDENTIFIES A LIVING INDIVIDUAL WHOSE CONSENT IS OF RECORD.

FOR ENTERTAINMENT SERVICES IN THE NATURE OF SKATEBOARDING EXHIBITIONS; PROVIDING WORKSHOPS AND SEMINARS IN THE FIELD OF SKATEBOARDING; PRODUCTION AND DISTRIBUTION OF MOTION PICTURE FILMS AND TELEVISION SHOWS; PRODUCTION OF AUDIO AND VIDEO RECORDINGS AND COMPUTER GAME SOFTWARE; ENTERTAINMENT IN THE NATURE OF ART EXHIBITIONS OF STILL PHOTOGRAPHS AND FILM; ENTERTAINMENT IN THE NATURE OF SPORTING EVENTS, NAMELY, SKATEBOARDING, SNOWBOARDING, BMX BIKING AND SURFING; PUBLICATION OF BOOKS; ENTERTAINMENT IN THE NATURE OF ONGOING TELEVISION PROGRAMS AND INTERACTIVE TELEVISION PROGRAMMING IN THE FIELDS OF SPORTS, GAME SHOWS AND REALITY BASED TELEVISION PROGRAMS; PROVIDING AN ON-LINE COMPUTER GAME; PROVIDING A WEBSITE FEATURING NEWS AND INFORMATION IN THE FIELDS OF SPORTS AND MUSIC; PROVIDING A WEBSITE FEATURING INFORMATION ON A MUSICAL ARTIST AND SUCH ARTIST'S MUSIC, SOUND AND VIDEO RECORDINGS, PICTURES, NEWS, SPECIAL PROJECTS, TOURS, PERSONAL APPEARANCES, AND MUSIC PERFORMANCE TICKET INFORMATION; ENTERTAINMENT SERVICES, NAMELY, LIVE SINGING PERFORMANCES BY AN INDIVIDUAL; ENTERTAINMENT IN THE NATURE OF A MUSICAL GROUP (U.S. CLS. 100, 101 AND 107).

SUSAN STIGLITZ, EXAMINING ATTORNEY

THE MARK CONSISTS OF STANDARD CHARACTERS WITHOUT CLAIM TO ANY PARTICULAR FONT, STYLE, SIZE, OR COLOR.

FOR ENTERTAINMENT SERVICES IN THE NATURE OF SKATEBOARDING EXHIBITIONS; PROVIDING WORKSHOPS AND SEMINARS IN THE FIELD OF SKATEBOARDING; PRODUCTION AND DISTRIBUTION OF MOTION PICTURE FILMS AND TELEVISION SHOWS; PRODUCTION OF AUDIO AND VIDEO RECORDINGS AND COMPUTER GAME SOFTWARE; ENTERTAINMENT IN THE NATURE OF ART EXHIBITIONS OF STILL PHOTOGRAPHS AND FILM; ENTERTAINMENT IN THE NATURE OF SPORTING EVENTS, NAMELY, SKATEBOARDING, SNOWBOARDING, BMX BIKING AND SURFING; PUBLICATION OF BOOKS; ENTERTAINMENT IN THE NATURE OF ONGOING TELEVISION PROGRAMS AND INTERACTIVE TELEVISION PROGRAMMING IN THE FIELDS OF SPORTS, GAME SHOWS AND REALITY BASED TELEVISION PROGRAMS; PROVIDING AN ON-LINE COMPUTER GAME; PROVIDING A WEBSITE FEATURING NEWS AND INFORMATION IN THE FIELDS OF SPORTS AND MUSIC; PROVIDING A WEBSITE FEATURING INFORMATION ON A MUSICAL ARTIST AND SUCH ARTIST'S MUSIC, SOUND AND VIDEO RECORDINGS, PICTURES, NEWS, SPECIAL PROJECTS, TOURS, PERSONAL APPEARANCES, AND MUSIC PERFORMANCE TICKET INFORMATION; ENTERTAINMENT SERVICES, NAMELY, LIVE SINGING PERFORMANCES BY AN INDIVIDUAL; ENTERTAINMENT IN THE NATURE OF A MUSICAL GROUP (U.S. CLS. 100, 101 AND 107).

SUSAN STIGLITZ, EXAMINING ATTORNEY

CLASS 41—(Continued).

SN 77-930,871. MIKE VALLELY, LONG BEACH, CA. FILED 2-8-2010.

MIKE VALLELY

THE MARK CONSISTS OF STANDARD CHARACTERS WITHOUT CLAIM TO ANY PARTICULAR FONT, STYLE, SIZE, OR COLOR.

THE NAME "MIKE VALLELY" IDENTIFIES A LIVING INDIVIDUAL WHOSE CONSENT IS OF RECORD.

FOR ENTERTAINMENT SERVICES IN THE NATURE OF SKATEBOARDING EXHIBITIONS; PROVIDING WORKSHOPS AND SEMINARS IN THE FIELD OF SKATEBOARDING; PRODUCTION AND DISTRIBUTION OF MOTION PICTURE FILMS AND TELEVISION SHOWS; PRODUCTION OF AUDIO AND VIDEO RECORDINGS AND COMPUTER GAME SOFTWARE; ENTERTAINMENT IN THE NATURE OF ART EXHIBITIONS OF STILL PHOTOGRAPHS AND FILM; ENTERTAINMENT IN THE NATURE OF SPORTING EVENTS, NAMELY, SKATEBOARDING, SNOWBOARDING, BMX BIKING AND SURFING; PUBLICATION OF BOOKS; ENTERTAINMENT IN THE NATURE OF ONGOING TELEVISION PROGRAMS AND INTERACTIVE TELEVISION PROGRAMMING IN THE FIELDS OF SPORTS, GAME SHOWS AND REALITY BASED TELEVISION PROGRAMS; PROVIDING AN ON-LINE COMPUTER GAME; PROVIDING A WEBSITE FEATURING NEWS AND INFORMATION IN THE FIELDS OF SPORTS AND MUSIC; PROVIDING A WEBSITE FEATURING INFORMATION ON A MUSICAL ARTIST AND SUCH ARTIST'S MUSIC, SOUND AND VIDEO RECORDINGS, PICTURES, NEWS, SPECIAL PROJECTS, TOURS, PERSONAL APPEARANCES, AND MUSIC PERFORMANCE TICKET INFORMATION; ENTERTAINMENT SERVICES, NAMELY, LIVE SINGING PERFORMANCES BY AN INDIVIDUAL; ENTERTAINMENT IN THE NATURE OF A MUSICAL GROUP (U.S. CLS. 100, 101 AND 107).

SUSAN STIGLITZ, EXAMINING ATTORNEY

SN 77-930,889. ZOOSK, INC., SAN FRANCISCO, CA. FILED 2-8-2010.

ZOOSK

THE MARK CONSISTS OF STANDARD CHARACTERS WITHOUT CLAIM TO ANY PARTICULAR FONT, STYLE, SIZE, OR COLOR.

FOR DANCE CLUB SERVICES; NIGHT CLUBS (U.S. CLS. 100, 101 AND 107).

GINA HAYES, EXAMINING ATTORNEY

CLASS 41—(Continued).

SN 77-930,914. WHATIFSPORTS.COM, INC., CINCINNATI, OH. FILED 2-8-2010.

WHATIFSPORTS

THE MARK CONSISTS OF STANDARD CHARACTERS WITHOUT CLAIM TO ANY PARTICULAR FONT, STYLE, SIZE, OR COLOR.

FOR ENTERTAINMENT SERVICES, NAMELY, PROVIDING ON-LINE COMPUTER SPORTS SIMULATION GAMES (U.S. CLS. 100, 101 AND 107).

FIRST USE 3-1-2000; IN COMMERCE 3-1-2000.

JEFF DEFORD, EXAMINING ATTORNEY

SN 77-930,985. EURICH, CURT, KEMP, TX. FILED 2-8-2010.



NO CLAIM IS MADE TO THE EXCLUSIVE RIGHT TO USE "GRADE YOUR PLAYERS GRADE YOUR GAMES", APART FROM THE MARK AS SHOWN.

THE MARK CONSISTS OF THE STYLIZED WORDING "GAMEGRADE GRADE YOUR PLAYERS GRADE YOUR GAMES" TO THE RIGHT OF A DESIGN OF TWO INTERLOCKING OVAL LETTER "G"'S SITTING ON A HORIZONTAL LINE.

FOR PROVIDING A WEBSITE FOR ENTERTAINMENT PURPOSES WHERE ATHLETES AND COACHES CAN GRADE THEIR INDIVIDUAL AND TEAM PERFORMANCES FOR ANY SPORT DURING THE SPORTS SEASON (U.S. CLS. 100, 101 AND 107).

ELLEN B. AWRICH, EXAMINING ATTORNEY

SN 77-931,028. THE REAL ESTATE LEARNING GROUP, LLC, PORTLAND, ME. FILED 2-8-2010.



NO CLAIM IS MADE TO THE EXCLUSIVE RIGHT TO USE "REAL ESTATE", APART FROM THE MARK AS SHOWN.

THE MARK CONSISTS OF THE WORDING "REAL ESTATE SALES ADVANTAGE" IN A STYLIZED FONT AND A DESIGN THAT CONSISTS OF A SILHOUETTE OF A HOUSE, A RECTANGLE AND AN OVAL-SHAPED SHADOW. "REAL ESTATE" APPEARS IN THE HOUSE, "SALES" APPEARS IN THE SHADOW AND "ADVANTAGE" APPEARS IN THE RECTANGLE.

FOR EDUCATIONAL SERVICES, NAMELY, CONDUCTING WORKSHOPS AND PROGRAMS IN THE FIELD OF REAL ESTATE (U.S. CLS. 100, 101 AND 107).

RENEE MCCRAY, EXAMINING ATTORNEY

CLASS 41—(Continued).

SN 77-931,049. LEVERING JR., CHARLES B., PHILADELPHIA, PA. FILED 2-8-2010.

GuruDaddy

THE MARK CONSISTS OF STANDARD CHARACTERS WITHOUT CLAIM TO ANY PARTICULAR FONT, STYLE, SIZE, OR COLOR.

FOR ENTERTAINMENT SERVICES, NAMELY, PROVIDING A WEB SITE FEATURING PHOTOGRAPHIC, AUDIO, VIDEO AND PROSE PRESENTATIONS FEATURING COMEDY, JOKES AND ENTERTAINMENT CONTENT (U.S. CLS. 100, 101 AND 107).
SANI KHOURI, EXAMINING ATTORNEY

CLASS 41—(Continued).

SN 77-931,185. WEBTERPRET, INC., MERION, PA. FILED 2-9-2010.

THE WORLD JUST GOT SMALLER

THE MARK CONSISTS OF STANDARD CHARACTERS WITHOUT CLAIM TO ANY PARTICULAR FONT, STYLE, SIZE, OR COLOR.

FOR LANGUAGE INTERPRETATION (U.S. CLS. 100, 101 AND 107).
GIANCARLO CASTRO, EXAMINING ATTORNEY

SN 77-931,137. BAKER, BRAD, NEWARK, NY. FILED 2-9-2010.

TORMENT THE VEIN

THE MARK CONSISTS OF STANDARD CHARACTERS WITHOUT CLAIM TO ANY PARTICULAR FONT, STYLE, SIZE, OR COLOR.

FOR ENTERTAINMENT SERVICES IN THE NATURE OF LIVE MUSICAL PERFORMANCES; ENTERTAINMENT, NAMELY, LIVE PERFORMANCES BY ROCK GROUPS (U.S. CLS. 100, 101 AND 107).
FIRST USE 5-0-2005; IN COMMERCE 5-0-2005.
AMY HELLA, EXAMINING ATTORNEY

SN 77-931,186. WEBTERPRET, INC., MERION, PA. FILED 2-9-2010.

WEBTERPRET

SN 77-931,182. BARNES, TERRENCE, MANNING, SC. FILED 2-9-2010.

21 SOLJAZ

THE MARK CONSISTS OF STANDARD CHARACTERS WITHOUT CLAIM TO ANY PARTICULAR FONT, STYLE, SIZE, OR COLOR.

FOR ENTERTAINMENT IN THE NATURE OF A LIVE MUSIC GROUP (U.S. CLS. 100, 101 AND 107).
GIANCARLO CASTRO, EXAMINING ATTORNEY

THE MARK CONSISTS OF STANDARD CHARACTERS WITHOUT CLAIM TO ANY PARTICULAR FONT, STYLE, SIZE, OR COLOR.

FOR LANGUAGE INTERPRETATION (U.S. CLS. 100, 101 AND 107).
GIANCARLO CASTRO, EXAMINING ATTORNEY

CLASS 41—(Continued).

SN 77-931,291. FUNKYTOWN PARTIES, LLC, AKA FUNKY-TOWN, WAXHAW, NC. FILED 2-9-2010.



NO CLAIM IS MADE TO THE EXCLUSIVE RIGHT TO USE "PARTIES", APART FROM THE MARK AS SHOWN.

THE COLOR(S) PURPLE, GREEN, BLUE, ORANGE IS/ARE CLAIMED AS A FEATURE OF THE MARK.

THE MARK CONSISTS OF THE WORDING "FUNKYTOWN PARTIES" WITH PURPLE GRAFFITI FONT FOR "FUNKYTOWN" AND "PARTIES" IN ORANGE, ALL ON GREEN DIMENSIONAL SHADOWS AND BLUE PAINT SPLATTER BACKGROUND. THE COLOR BLACK REPRESENTS BACKGROUND, OUTLINING, SHADING AND/OR TRANSPARENT AREAS AND ARE NOT PART OF THE MARK.

FOR ACADEMIC ENRICHMENT PROGRAMS IN THE FIELD(S) OF SCIENCE; ARRANGING AND CONDUCTING SPECIAL EVENTS; ARRANGING, ORGANIZING, CONDUCTING AND HOSTING BIRTHDAY PARTIES; CONDUCTING WORKSHOPS AND SEMINARS IN MUSIC, DANCE, FITNESS, ACTING, PHOTOGRAPHY, DJ MIXING, DANCING, ETIQUETTE, ART, LANGUAGE, DESIGN; DAY CAMP SERVICES; EDUCATION SERVICES, NAMELY, PROVIDING CLASSES AND INSTRUCTION IN THE FIELD OF DANCE; EDUCATION SERVICES, NAMELY, PROVIDING MENTORING, TUTORING, CLASSES, SEMINARS AND WORKSHOPS IN THE FIELD OF MUSIC, DANCE, FITNESS, ACTING, PHOTOGRAPHY, DJ MIXING, DANCING, ETIQUETTE, ART, LANGUAGE, DESIGN; EDUCATION SERVICES, NAMELY, PROVIDING INSTRUCTION IN THE FIELD OF MUSIC, DANCE, FITNESS, ACTING, PHOTOGRAPHY, DJ MIXING, DANCING, ETIQUETTE, ART, LANGUAGE, DESIGN; ENTERTAINMENT SERVICES, NAMELY, CONDUCTING PARTIES; HOLIDAY CAMP SERVICES; PARTY PLANNING; PARTY PLANNING CONSULTATION; PROVIDING CHILDREN'S PARTY CENTERS FOR THE PURPOSE OF ENTERTAINING CHILDREN AND CELEBRATING BIRTHDAYS; RECREATIONAL CAMPS; SOCIAL CLUB SERVICES, NAMELY, ARRANGING, ORGANIZING, AND HOSTING SOCIAL EVENTS, GET-TOGETHERS, AND PARTIES FOR CLUB MEMBERS; SUMMER CAMPS (U.S. CLS. 100, 101 AND 107).

FIRST USE 1-1-2010; IN COMMERCE 2-1-2010.

PRISCILLA MILTON, EXAMINING ATTORNEY

SN 77-931,328. MILLER, MACKENZIE, SEATTLE, WA. AND WEISS, MARYSIA, SANTA MONICA, CA. FILED 2-9-2010.

HOT AND HEALTHY

THE MARK CONSISTS OF STANDARD CHARACTERS WITHOUT CLAIM TO ANY PARTICULAR FONT, STYLE, SIZE, OR COLOR.

NO CLAIM IS MADE TO THE EXCLUSIVE RIGHT TO USE "HEALTHY", APART FROM THE MARK AS SHOWN.

FOR ON-LINE JOURNALS, NAMELY, BLOGS FEATURING HEALTHY LIFESTYLE ARTICLES AND PHOTOS (U.S. CLS. 100, 101 AND 107).

DAVID MURRAY, EXAMINING ATTORNEY

CLASS 41—(Continued).

SN 77-931,482. EVENTCOUTURE, ATLANTA, GA. FILED 2-9-2010.

EventCouture

THE MARK CONSISTS OF STANDARD CHARACTERS WITHOUT CLAIM TO ANY PARTICULAR FONT, STYLE, SIZE, OR COLOR.

FOR ARRANGING AND CONDUCTING SPECIAL EVENTS; ARRANGING, ORGANIZING, CONDUCTING, AND HOSTING SOCIAL ENTERTAINMENT EVENTS; PARTY PLANNING CONSULTATION; SPECIAL EVENT, PARTY AND WEDDING PLANNING AND COORDINATION SERVICES; SPECIAL EVENT, PARTY AND WEDDING PLANNING CONSULTATION SERVICES (U.S. CLS. 100, 101 AND 107).

FIRST USE 9-0-2004; IN COMMERCE 1-0-2005.

ANDREA HACK, EXAMINING ATTORNEY

SN 77-931,505. UNIVERSITY OF SANTA MONICA, SANTA MONICA, CA. FILED 2-9-2010.

THE INNER UNIVERSITY

THE MARK CONSISTS OF STANDARD CHARACTERS WITHOUT CLAIM TO ANY PARTICULAR FONT, STYLE, SIZE, OR COLOR.

NO CLAIM IS MADE TO THE EXCLUSIVE RIGHT TO USE "UNIVERSITY", APART FROM THE MARK AS SHOWN.

FOR ORGANIZING AND CONDUCTING SEMINARS AND WORKSHOPS TO HELP OTHERS DEVELOP PERSONAL GROWTH, INTERPERSONAL RELATIONSHIPS AND PERSONAL EXPRESSION; DISTRIBUTING COURSE MATERIALS IN CONNECTION WITH SEMINARS AND WORKSHOPS; EDUCATION SERVICES, NAMELY, CONDUCTING TRAINING CLASSES AND COURSES RELATING TO PERSONAL GROWTH, INTERPERSONAL RELATIONSHIPS AND PERSONAL EXPRESSION; ORGANIZING AND CONDUCTING SEMINARS, WORKSHOPS, AND COURSES RELATING TO SPIRITUAL PSYCHOLOGY, PERSONAL GROWTH, INTERPERSONAL RELATIONSHIPS AND PERSONAL EXPRESSION LEADING TO MASTER OF ARTS DEGREES IN SPIRITUAL PSYCHOLOGY AND MASTERS OF ARTS DEGREES IN SPIRITUAL PSYCHOLOGY

CLASS 41—(Continued).

WITH AN EMPHASIS IN CONSCIOUSNESS, HEALTH AND HEALING; EDUCATION INFORMATION SERVICES; ONLINE EDUCATION SERVICES, NAMELY, CONDUCTING TRAINING CLASSES AND COURSES RELATING TO PERSONAL GROWTH, INTERPERSONAL RELATIONSHIPS AND PERSONAL EXPRESSION; CONDUCTING LIVE AND ONLINE WORKSHOPS, SEMINARS AND CLASSES IN THE FIELDS OF SPIRITUAL PSYCHOLOGY, PERSONAL GROWTH, INTERPERSONAL RELATIONSHIPS AND PERSONAL EXPRESSION LEADING TO MASTER OF ARTS DEGREES IN SPIRITUAL PSYCHOLOGY AND MASTER OF ARTS DEGREES IN SPIRITUAL PSYCHOLOGY WITH AN EMPHASIS IN CONSCIOUSNESS, HEALTH AND HEALING; PROVIDING A WEBSITE FEATURING INFORMATION ABOUT EDUCATION; EDUCATION SERVICES, NAMELY, PROVIDING LIVE AND ONLINE CLASSES, WORKSHOPS AND SEMINARS IN THE FIELDS OF PERSONAL GROWTH, INTERPERSONAL RELATIONSHIPS, PERSONAL EXPRESSION AND SPIRITUAL PSYCHOLOGY (U.S. CLS. 100, 101 AND 107).
WENDY GOODMAN, EXAMINING ATTORNEY

SN 77-931,512. ADULT SOURCE MEDIA, INC., CHATSWORTH, CA. FILED 2-9-2010.

ADULT SOURCE MEDIA

THE MARK CONSISTS OF THE WORDS "ADULT SOURCE MEDIA" IN STYLIZED FONT.
SEC. 2(F).

FOR ENTERTAINMENT, NAMELY, PRODUCTION OF ADULT VIDEOS AND ANIMATION.; MULTIMEDIA ENTERTAINMENT SERVICES IN THE NATURE OF DEVELOPMENT, PRODUCTION AND POST-PRODUCTION SERVICES IN THE FIELDS OF VIDEO AND FILMS (U.S. CLS. 100, 101 AND 107).

FIRST USE 6-0-2003; IN COMMERCE 6-0-2003.
KAREN K. BUSH, EXAMINING ATTORNEY

SN 77-931,614. CHELSEA ELIZABETH PHOTOGRAPHY, NEWBURY PARK, CA. FILED 2-9-2010.

**CHELSEA ELIZABETH
PHOTOGRAPHY**

THE MARK CONSISTS OF STANDARD CHARACTERS WITHOUT CLAIM TO ANY PARTICULAR FONT, STYLE, SIZE, OR COLOR.

NO CLAIM IS MADE TO THE EXCLUSIVE RIGHT TO USE "PHOTOGRAPHY", APART FROM THE MARK AS SHOWN.

THE NAME "CHELSEA ELIZABETH" IDENTIFIES A LIVING INDIVIDUAL WHOSE CONSENT IS OF RECORD.
FOR PHOTOGRAPHY SERVICES (U.S. CLS. 100, 101 AND 107).

FIRST USE 1-1-2007; IN COMMERCE 1-1-2007.
SUSAN STIGLITZ, EXAMINING ATTORNEY

CLASS 41—(Continued).

SN 77-931,687. HEALTH COMMUNICATIONS, INC., DEERFIELD BEACH, FL. FILED 2-9-2010.

VOWS

THE MARK CONSISTS OF STANDARD CHARACTERS WITHOUT CLAIM TO ANY PARTICULAR FONT, STYLE, SIZE, OR COLOR.

FOR ENTERTAINMENT SERVICES IN THE NATURE OF AN ON-GOING REALITY BASED TELEVISION PROGRAM (U.S. CLS. 100, 101 AND 107).

DOUGLAS LEE, EXAMINING ATTORNEY

SN 77-931,741. MISTRETTE, JACQUES-YVES, PARIS, FRANCE, FILED 2-9-2010.

HUMANYWORLD

THE MARK CONSISTS OF STANDARD CHARACTERS WITHOUT CLAIM TO ANY PARTICULAR FONT, STYLE, SIZE, OR COLOR.

FOR AUDIO RECORDING AND PRODUCTION; FILM AND VIDEO PRODUCTION (U.S. CLS. 100, 101 AND 107).

DAVID I. EXAMINING ATTORNEY

SN 77-931,845. HEALTH COMMUNICATIONS, INC., DEERFIELD BEACH, FL. FILED 2-9-2010.

**VOWS LIFE...
ROMANTICIZED**

THE MARK CONSISTS OF STANDARD CHARACTERS WITHOUT CLAIM TO ANY PARTICULAR FONT, STYLE, SIZE, OR COLOR.

FOR ENTERTAINMENT SERVICES IN THE NATURE OF AN ON-GOING REALITY BASED TELEVISION PROGRAM (U.S. CLS. 100, 101 AND 107).

DOUGLAS LEE, EXAMINING ATTORNEY

CLASS 41—(Continued).

SN 77-932,053. BOLAND, TOM, SANTA BARBARA, CA. FILED 2-9-2010.



THE MARK CONSISTS OF THE STYLIZED TEXT "AFNA".

FOR EDUCATIONAL SERVICES, NAMELY, PROVIDING COURSES OF INSTRUCTION TO INDIVIDUALS TO BECOME PHYSICAL FITNESS AND NUTRITION TRAINERS (U.S. CLS. 100, 101 AND 107).

FIRST USE 1-22-2010; IN COMMERCE 1-22-2010.
DAVID C. REIHNER, EXAMINING ATTORNEY

SN 77-932,056. ALTAMIRANO, GUSTAVO, MONTEBLO, CA. FILED 2-9-2010.

Hoy Si Papa

THE MARK CONSISTS OF STANDARD CHARACTERS WITHOUT CLAIM TO ANY PARTICULAR FONT, STYLE, SIZE, OR COLOR.

THE ENGLISH TRANSLATION OF "HOY SI PAPA" IN THE MARK IS "TODAY YES DAD".

FOR ARRANGING AND CONDUCTING SPECIAL EVENTS; SPECIAL EVENT PLANNING (U.S. CLS. 100, 101 AND 107).

SARA THOMAS, EXAMINING ATTORNEY

SN 77-932,147. TWENTIETH CENTURY FOX FILM CORPORATION, LOS ANGELES, CA. FILED 2-9-2010.

BREAKOUT KINGS

THE MARK CONSISTS OF STANDARD CHARACTERS WITHOUT CLAIM TO ANY PARTICULAR FONT, STYLE, SIZE, OR COLOR.

FOR ENTERTAINMENT SERVICES IN THE NATURE OF A TELEVISION SERIES FEATURING DRAMA; PROVIDING ON-LINE INFORMATION IN THE FIELD OF TELEVISION AND VIDEO ENTERTAINMENT FEATURING DRAMA VIA THE INTERNET; ENTERTAINMENT SERVICES IN THE NATURE OF NON-DOWNLOADABLE VIDEOS AND IMAGES FEATURING TELEVISION SHOWS AND ENTERTAINMENT TRANSMITTED VIA THE INTERNET AND WIRELESS COMMUNICATION NETWORKS; ON-LINE JOURNALS, NAMELY, BLOGS FEATURING PERSONAL OPINIONS IN THE FIELD OF GENERAL INTEREST AND DRAMA (U.S. CLS. 100, 101 AND 107).

THEODORE MCBRIDE, EXAMINING ATTORNEY

CLASS 41—(Continued).

SN 77-932,159. NISSE, STEVEN F, EWING, NJ. FILED 2-9-2010.



NO CLAIM IS MADE TO THE EXCLUSIVE RIGHT TO USE "DIVAS", APART FROM THE MARK AS SHOWN.

THE MARK CONSISTS OF THE WORDING "DIVAS" WHEREIN A STYLIZED SHOWGIRL HEADDRESS IS PLACED ATOP THE LETTER "I". DIRECTLY BELOW THE WORD "DIVAS" IS A BAR CONTAINING THE WORDS "IN A MAN'S WORLD".

FOR ENTERTAINMENT IN THE NATURE OF LIVE PERFORMANCES BY CELEBRITY AND FEMALE IMPERSONATORS AND DANCERS (U.S. CLS. 100, 101 AND 107).

FIRST USE 10-20-2009; IN COMMERCE 10-20-2009.
KIM MONINGHOFF, EXAMINING ATTORNEY

SN 77-932,177. BENTON, STEVE L, PARKER, AZ. FILED 2-9-2010.

TALES FROM THE TOUR

THE MARK CONSISTS OF STANDARD CHARACTERS WITHOUT CLAIM TO ANY PARTICULAR FONT, STYLE, SIZE, OR COLOR.

FOR ENTERTAINMENT SERVICES IN THE NATURE OF CREATION, DEVELOPMENT, AND PRODUCTION OF TELEVISION PROGRAMMING; PRODUCTION OF RADIO AND TELEVISION PROGRAMS; PROVIDING A WEBSITE FEATURING INFORMATION ON GOLF AND GOLF INSTRUCTION (U.S. CLS. 100, 101 AND 107).

IRA J. GOODSaid, EXAMINING ATTORNEY

SN 77-932,293. GOLDSTEIN, IRA, RALEIGH, NC. AND GOLDSTEIN, DAVID, RALEIGH, NC. FILED 2-10-2010.

THE SPLATTER

THE MARK CONSISTS OF STANDARD CHARACTERS WITHOUT CLAIM TO ANY PARTICULAR FONT, STYLE, SIZE, OR COLOR.

FOR ON-LINE JOURNALS, NAMELY, BLOGS FEATURING COMMENTARY AND INFORMATION RELATED TO ART AND ART RELATED TOPICS NAMELY, ART CREATION, ART EVENTS, CONTESTS AND WORKSHOPS (U.S. CLS. 100, 101 AND 107).

FIRST USE 2-10-2010; IN COMMERCE 2-10-2010.
LESLIE RICHARDS, EXAMINING ATTORNEY

CLASS 41—(Continued).

SN 77-932,602. LUU, JACQUELINE, CHINO, CA. FILED 2-10-2010.

Merigroup

THE MARK CONSISTS OF STANDARD CHARACTERS WITHOUT CLAIM TO ANY PARTICULAR FONT, STYLE, SIZE, OR COLOR.

FOR EDUCATION SERVICES, NAMELY, PROVIDING TUTORING IN THE FIELDS OF MATHEMATICS, LANGUAGE ARTS, SOCIAL SCIENCES, SCIENCES, TEST PREPARATIONS AND COLLEGE APPLICATIONS (U.S. CLS. 100, 101 AND 107).

FIRST USE 9-18-2006; IN COMMERCE 9-18-2006.
KEVON CHISOLM, EXAMINING ATTORNEY

SN 77-932,620. JOHN SPENCER ELLIS ENTERPRISES, INC., RANCHO SANTA MARGARITA, CA. FILED 2-10-2010.

TACTIX

THE MARK CONSISTS OF STANDARD CHARACTERS WITHOUT CLAIM TO ANY PARTICULAR FONT, STYLE, SIZE, OR COLOR.

FOR MARTIAL ARTS INSTRUCTION; PROVIDING A WEB SITE FEATURING NON-DOWNLOADABLE INSTRUCTIONAL VIDEOS IN THE FIELD OF MARTIAL ARTS (U.S. CLS. 100, 101 AND 107).

FIRST USE 2-1-2010; IN COMMERCE 2-1-2010.
DAVID H. STINE, EXAMINING ATTORNEY

SN 77-932,662. GROWTHMINE, LLC, EULESS, TX. FILED 2-10-2010.

GROWTHMINE

THE MARK CONSISTS OF STANDARD CHARACTERS WITHOUT CLAIM TO ANY PARTICULAR FONT, STYLE, SIZE, OR COLOR.

FOR EDUCATIONAL AND TRAINING SERVICES, NAMELY, CONDUCTING CLASSES AND SEMINARS IN THE FIELD OF BUSINESS MANAGEMENT (U.S. CLS. 100, 101 AND 107).

JENNY PARK, EXAMINING ATTORNEY

CLASS 41—(Continued).

SN 77-932,762. ASCENDI GROUP, INC., MIAMI, FL. FILED 2-10-2010.

Ascendi

THE MARK CONSISTS OF STANDARD CHARACTERS WITHOUT CLAIM TO ANY PARTICULAR FONT, STYLE, SIZE, OR COLOR.

THE ENGLISH TRANSLATION OF "ASCENDI" IN THE MARK IS YOU RISE.

FOR EDUCATION SERVICES, NAMELY, PROVIDING SEMINARS, WORKSHOPS IN THE FIELDS OF COMMUNICATION SKILLS, INTERPERSONAL SKILLS, LEADERSHIP SKILLS, CUSTOMER RELATIONS, STRESS MANAGEMENT, TEAMWORK, TIME MANAGEMENT AND ORGANIZATIONAL AND WORKPLACE PERFORMANCE; PERSONAL, PROFESSIONAL, LIFE AND GROUP PERFORMANCE COACHING IN THE FIELD OF COMMUNICATION SKILLS, INTERPERSONAL SKILLS, LEADERSHIP SKILLS, CUSTOMER RELATIONS, STRESS MANAGEMENT, TEAMWORK, TIME MANAGEMENT AND ORGANIZATIONAL AND WORKPLACE PERFORMANCE (U.S. CLS. 100, 101 AND 107).

FIRST USE 1-16-2004; IN COMMERCE 1-16-2004.
CHRIS WELLS, EXAMINING ATTORNEY

SN 77-932,818. STARS AVENUE PRODUCTIONS, INC., LOS ANGELES, CA. FILED 2-10-2010.

FAST TRACK TO FAME

THE MARK CONSISTS OF STANDARD CHARACTERS WITHOUT CLAIM TO ANY PARTICULAR FONT, STYLE, SIZE, OR COLOR.

FOR ENTERTAINMENT SERVICES IN THE NATURE OF AN ONGOING TELEVISION TALENT SHOWS; PROVIDING ON-LINE INFORMATION IN THE FIELD OF TELEVISION AND VIDEO ENTERTAINMENT FEATURING TALENT SHOWS AND ENTERTAINMENT VIA THE INTERNET; ENTERTAINMENT SERVICES IN THE NATURE OF NON-DOWNLOADABLE VIDEOS AND IMAGES FEATURING TELEVISION SHOWS AND ENTERTAINMENT TRANSMITTED VIA THE INTERNET AND WIRELESS COMMUNICATION NETWORKS; ENTERTAINMENT SERVICES IN THE NATURE OF ORGANIZING, ARRANGING AND CONDUCTING TALENT SHOWS (U.S. CLS. 100, 101 AND 107).

KELLEY WELLS, EXAMINING ATTORNEY

CLASS 41—(Continued).

SN 77-932,842. STUDIO JENKINS WORKS LLC, PALM SPRINGS, CA. FILED 2-10-2010.

fotohunks

THE MARK CONSISTS OF STANDARD CHARACTERS WITHOUT CLAIM TO ANY PARTICULAR FONT, STYLE, SIZE, OR COLOR.

FOR ENTERTAINMENT SERVICES, NAMELY, PROVIDING A WEB SITE FEATURING NON-DOWNLOADABLE ADULT-THEMED PHOTOGRAPHS AND VIDEOS (U.S. CLS. 100, 101 AND 107).

ALYSSA STEEL, EXAMINING ATTORNEY

SN 77-933,000. THE COMMUNITY COLLEGE FOUNDATION, SACRAMENTO, CA. FILED 2-10-2010.

MIND FLEX TUTORING

THE MARK CONSISTS OF STANDARD CHARACTERS WITHOUT CLAIM TO ANY PARTICULAR FONT, STYLE, SIZE, OR COLOR.

NO CLAIM IS MADE TO THE EXCLUSIVE RIGHT TO USE "TUTORING", APART FROM THE MARK AS SHOWN.

FOR EDUCATION SERVICES, NAMELY, PROVIDING TUTORING IN THE FIELD OF MATHEMATICS, SCIENCE, LANGUAGE ARTS, HOMEWORK HELP, ACT PREP, SAT PREP, CALIFORNIA HIGH SCHOOL EXIT EXAM (CASHEE) AND GENERAL EDUCATION DIPLOMA (GED) TEST PREP (U.S. CLS. 100, 101 AND 107).

REBECCA SMITH, EXAMINING ATTORNEY

SN 77-933,079. ALUMNI ATHLETICS USA, LLC, SANTA ROSA, CA. FILED 2-10-2010.

Get Back in the Game!

THE MARK CONSISTS OF STANDARD CHARACTERS WITHOUT CLAIM TO ANY PARTICULAR FONT, STYLE, SIZE, OR COLOR.

FOR ENTERTAINMENT IN THE NATURE OF FOOTBALL GAMES (U.S. CLS. 100, 101 AND 107).

FIRST USE 6-1-2009; IN COMMERCE 7-1-2009.
ZACHARY BELLO, EXAMINING ATTORNEY

CLASS 41—(Continued).

SN 77-933,080. J'LA CHIC PRODUCTIONS, HERCULES, CA. FILED 2-10-2010.

J'La Chic

THE MARK CONSISTS OF THE STYLIZED, UNDERLINED TEXT "J'LA CHIC".

FOR ENTERTAINMENT, NAMELY, PRODUCTION OF PLAYS, CONCERTS, MAGIC SHOWS, COMEDY SHOWS, CABARET DINNER SHOWS ; SPECIAL EVENT PLANNING ; ENTERTAINMENT AND EDUCATION SERVICES IN THE NATURE OF LIVE DANCE AND MUSICAL PERFORMANCES ; ARRANGING, ORGANIZING, CONDUCTING, AND HOSTING SPECIAL ENTERTAINMENT EVENTS (U.S. CLS. 100, 101 AND 107).

FIRST USE 12-31-2003; IN COMMERCE 12-31-2003.

ZACHARY BELLO, EXAMINING ATTORNEY

SN 77-933,094. ASCENDI GROUP, INC., MIAMI, FL. FILED 2-10-2010.

RISE ABOVE. GROW BEYOND.

THE MARK CONSISTS OF STANDARD CHARACTERS WITHOUT CLAIM TO ANY PARTICULAR FONT, STYLE, SIZE, OR COLOR.

FOR EDUCATION SERVICES, NAMELY, PROVIDING SEMINARS, WORKSHOPS IN THE FIELDS OF COMMUNICATION SKILLS, INTERPERSONAL SKILLS, LEADERSHIP SKILLS, CUSTOMER RELATIONS, STRESS MANAGEMENT, TEAMWORK, TIME MANAGEMENT AND ORGANIZATIONAL AND WORKPLACE PERFORMANCE; PERSONAL, PROFESSIONAL, LIFE AND GROUP PERFORMANCE COACHING IN THE FIELD OF COMMUNICATION SKILLS, INTERPERSONAL SKILLS, LEADERSHIP SKILLS, CUSTOMER RELATIONS, STRESS MANAGEMENT, TEAMWORK, TIME MANAGEMENT AND ORGANIZATIONAL AND WORKPLACE PERFORMANCE (U.S. CLS. 100, 101 AND 107).

FIRST USE 3-1-2008; IN COMMERCE 3-1-2008.

CHRIS WELLS, EXAMINING ATTORNEY

CLASS 41—(Continued).

SN 77-933,127. ANGELA BROWNE-MILLER, AKA DOCTOR ANGELA, TIBURON, CA. FILED 2-10-2010.

Dr. Angela

THE MARK CONSISTS OF STANDARD CHARACTERS WITHOUT CLAIM TO ANY PARTICULAR FONT, STYLE, SIZE, OR COLOR.

OWNER OF U.S. REG. NO. 3,579,692.

FOR CONDUCTING WORKSHOPS AND SEMINARS IN SELF AWARENESS; CONTINUING EDUCATION SERVICES, NAMELY, PROVIDING LIVE AND ON-LINE CONTINUING PROFESSIONAL EDUCATION SEMINARS IN THE LEGAL, MEDICAL, ACCOUNTING, AND REAL ESTATE FIELDS (U.S. CLS. 100, 101 AND 107).

FIRST USE 1-1-1985; IN COMMERCE 1-1-1990.
KATHERINE CHANG, EXAMINING ATTORNEY

SN 77-933,203. HEALTH COMMUNICATIONS, INC., DEERFIELD BEACH, FL. FILED 2-11-2010.



THE MARK CONSISTS OF THE WORD "VOWS" IN STYLIZED LETTERING WITH TWO INTERLOCKING RINGS FORMING THE LETTER "O", UNDERNEATH WHICH IS THE WORDING "LIFE . . . ROMANTICIZED".

FOR ENTERTAINMENT SERVICES IN THE NATURE OF AN ON-GOING REALITY BASED TELEVISION PROGRAM (U.S. CLS. 100, 101 AND 107).
DOUGLAS LEE, EXAMINING ATTORNEY

SN 77-935,025. NAMCO BANDAI GAMES INC., TOKYO, JAPAN, FILED 2-12-2010.



THE COLOR(S) DARK BLUE, BLUE, PURPLE, MAGENTA, RED, WHITE AND BLACK IS/ARE CLAIMED AS A FEATURE OF THE MARK.

THE MARK CONSISTS OF THE FOLLOWING: THE WORDS "TIME CRISIS" IN A STYLIZED FONT, WITH THE WORDS "2ND STRIKE" APPEARING BELOW IN SMALLER TYPE. THE LETTERS ARE OUTLINED IN BLACK AND WHITE. THE COLOR RED APPEARS IN THE LETTERS IN "2ND STRIKE". THE COLORS DARK BLUE, BLUE, PURPLE, AND MAGENTA APPEAR IN THE

CLASS 41—(Continued).

LETTERS IN "TIME CRISIS". THE "T" IN "TIME" AND THE "C" IN "CRISIS" APPEAR IN DARK BLUE. THE DARK BLUE BLENDS INTO THE BLUE APPEARING IN THE "I" AND "M" IN "TIME" AND IN THE "R" AND "I" AND PART OF THE "S" IN "CRISIS". THE BLUE BLENDS INTO THE PURPLE APPEARING IN THE "M" IN "TIME" AND IN THE "S" AND "I" IN "CRISIS". THE PURPLE BLENDS INTO THE MAGENTA APPEARING IN THE "E" IN "TIME" AND IN THE "I" AND "S" IN "CRISIS". THE TERMS "TIME CRISIS" AND "2ND STRIKE" OVERLAP 2 SERIES OF ANGLED DOUBLED LINES. THE DOUBLED LINES ARE DARK BLUE BLENDING TO BLUE BLENDING INTO MAGENTA BLENDING INTO RED MOVING LEFT TO RIGHT AND BORDERED IN BLACK.

FOR ENTERTAINMENT, NAMELY, PROVIDING A COMPUTER GAME THAT MAY BE ACCESSED NETWORK-WIDE BY NETWORK USERS VIA MOBILE PHONES AND COMPUTERS; PROVIDING COMPUTER GAMES VIA NETWORK BETWEEN COMMUNICATIONS NETWORKS AND COMPUTERS (U.S. CLS. 100, 101 AND 107).

MARK T. MULLEN, EXAMINING ATTORNEY

SN 77-935,653. UNDER THE RADAR PRODUCTIONS, INC., PLYMOUTH, MI. FILED 2-15-2010.

UTR: Under the Radar Michigan

THE MARK CONSISTS OF STANDARD CHARACTERS WITHOUT CLAIM TO ANY PARTICULAR FONT, STYLE, SIZE, OR COLOR.

NO CLAIM IS MADE TO THE EXCLUSIVE RIGHT TO USE "MICHIGAN", APART FROM THE MARK AS SHOWN.

FOR ENTERTAINMENT IN THE NATURE OF A TELEVISION SERIES FEATURING TRAVEL AND EDUCATION RENDERED THROUGH THE MEDIA OF TELEVISION, CABLE, SATELLITE AND BROADBAND SYSTEMS, AND VIA THE INTERNET AS WELL AS PORTABLE AND WIRELESS COMMUNICATION DEVICES; PRODUCTION OF A TRAVEL AND EDUCATIONAL TELEVISION SERIES (U.S. CLS. 100, 101 AND 107).

FIRST USE 2-15-2010; IN COMMERCE 2-15-2010.
JAY FLOWERS, EXAMINING ATTORNEY

SN 77-937,505. GAME SHOW NETWORK, LLC, SANTA MONICA, CA. FILED 2-17-2010.

DUMBVILLE

THE MARK CONSISTS OF STANDARD CHARACTERS WITHOUT CLAIM TO ANY PARTICULAR FONT, STYLE, SIZE, OR COLOR.

FOR ONLINE, INTERACTIVE COMPUTER GAMES AND MOBILE GAMES IN THE FORM OF NON-DOWNLOADABLE SOFTWARE ACCESSED THROUGH SOCIAL NETWORKING SITES PLAYED ON MOBILE PHONES, PDAS AND OTHER TYPES OF HAND-HELD DEVICES, GAMING DEVICES, PERSONAL COMPUTERS AND CONSOLES; ENTERTAINMENT SERVICES, NAMELY, PROVIDING ONLINE COMPUTER GAMES (U.S. CLS. 100, 101 AND 107).

FIRST USE 2-12-2010; IN COMMERCE 2-12-2010.
DAVID COLLIER, EXAMINING ATTORNEY

CLASS 41—(Continued).

SN 77-937,535. WILKINS, CONSUELO, SAINT LOUIS, MO. FILED 2-17-2010.

**GPS Your Life: Navigating
Change with Goals,
Persistence and Strategy**

THE MARK CONSISTS OF STANDARD CHARACTERS WITHOUT CLAIM TO ANY PARTICULAR FONT, STYLE, SIZE, OR COLOR.

FOR EDUCATION SERVICES, NAMELY, PROVIDING CLASSES, SEMINARS, WORKSHOPS IN THE FIELD OF CUSTOMIZED LEADERSHIP; EDUCATIONAL AND ENTERTAINMENT SERVICES, NAMELY, PROVIDING MOTIVATIONAL SPEAKING SERVICES IN THE FIELD OF CUSTOMIZED LEADERSHIP; TRAINING SERVICES IN THE FIELD OF BRAINSTORMING (U.S. CLS. 100, 101 AND 107).

APRIL ROACH, EXAMINING ATTORNEY

SN 77-937,789. E5 GLOBAL MEDIA, LLC, NEW YORK, NY. FILED 2-17-2010.

THE LIVE FEED

THE MARK CONSISTS OF STANDARD CHARACTERS WITHOUT CLAIM TO ANY PARTICULAR FONT, STYLE, SIZE, OR COLOR.

FOR ON-LINE JOURNALS, NAMELY, BLOGS FEATURING INFORMATION IN THE FIELD OF ENTERTAINMENT (U.S. CLS. 100, 101 AND 107).

FIRST USE 4-24-2008; IN COMMERCE 4-24-2008.
DOMINIC J. FERRAIUOLO, EXAMINING ATTORNEY

SN 77-939,687. ATI PROPERTIES, INC., ALBANY, OR. FILED 2-19-2010.

CORROSION SOLUTIONS

THE MARK CONSISTS OF STANDARD CHARACTERS WITHOUT CLAIM TO ANY PARTICULAR FONT, STYLE, SIZE, OR COLOR.

OWNER OF U.S. REG. NOS. 2,515,953 AND 2,543,003.
SEC. 2(F).

FOR PROVIDING EDUCATIONAL INFORMATION THROUGH PRESENTATIONS, WORKSHOPS AND SEMINARS TO CUSTOMERS AND POTENTIAL CUSTOMERS FOR SELECTING AND PURCHASING SPECIALTY MATERIALS, NAMELY, METAL ALLOYS AND REFRACTORY ALLOYS, SUITABLE TO MEET THE CUSTOMER'S CERTAIN CORROSION ENVIRONMENT APPLICATIONS, AND DISTRIBUTING PUBLICATIONS AND SOFTWARE IN CONNECTION THEREWITH (U.S. CLS. 100, 101 AND 107).

FIRST USE 4-0-1999; IN COMMERCE 4-0-1999.
KEVIN DINALLO, EXAMINING ATTORNEY

CLASS 41—(Continued).

SN 77-940,852. WORLD WRESTLING ENTERTAINMENT, INC., STAMFORD, CT. FILED 2-21-2010.

WWE NXT

THE MARK CONSISTS OF STANDARD CHARACTERS WITHOUT CLAIM TO ANY PARTICULAR FONT, STYLE, SIZE, OR COLOR.

FOR ENTERTAINMENT SERVICES IN THE NATURE OF AN ON-GOING REALITY BASED TELEVISION PROGRAM (U.S. CLS. 100, 101 AND 107).

JOHN HWANG, EXAMINING ATTORNEY

SN 77-940,853. WORLD WRESTLING ENTERTAINMENT, INC., STAMFORD, CT. FILED 2-21-2010.



THE MARK CONSISTS OF TWO STACKED "W" LETTERS WITH A SCAR UNDERNEATH SITTING ON TOP OF THE LETTERS "NXT" APPEARING VERTICALLY.

FOR ENTERTAINMENT SERVICES IN THE NATURE OF AN ON-GOING REALITY BASED TELEVISION PROGRAM (U.S. CLS. 100, 101 AND 107).

JOHN HWANG, EXAMINING ATTORNEY

SN 77-940,880. WORLD WRESTLING ENTERTAINMENT, INC., STAMFORD, CT. FILED 2-21-2010.

A-LIST

THE MARK CONSISTS OF STANDARD CHARACTERS WITHOUT CLAIM TO ANY PARTICULAR FONT, STYLE, SIZE, OR COLOR.

FOR ENTERTAINMENT SERVICES, NAMELY, WRESTLING EXHIBITIONS AND PERFORMANCES BY A PROFESSIONAL WRESTLER AND ENTERTAINER; ENTERTAINMENT SERVICES, NAMELY, WRESTLING COMPETITOR ON AN ON-GOING REALITY BASED TELEVISION PROGRAM; PROVIDING WRESTLING NEWS AND INFORMATION VIA A GLOBAL COMPUTER NETWORK (U.S. CLS. 100, 101 AND 107).

JOHN HWANG, EXAMINING ATTORNEY

CLASS 41—(Continued).

SN 77-942,449. STARS AVENUE PRODUCTIONS, INC., LOS ANGELES, CA. FILED 2-23-2010.



THE MARK CONSISTS OF THE STYLIZED WORDS "FAST TRACK", "TO" AND "FAME" IN THREE LINES, WHICH ARE OUTLINED WITH LIGHT RAYS EMANATING FROM THE WORDING AND SEVEN FIVE-POINT STARS APPEARING AROUND THE WORDING.

FOR ENTERTAINMENT SERVICES IN THE NATURE OF AN ONGOING TELEVISION TALENT SHOWS; PROVIDING ON-LINE INFORMATION IN THE FIELD OF TELEVISION AND VIDEO ENTERTAINMENT FEATURING TALENT SHOWS AND ENTERTAINMENT VIA THE INTERNET; ENTERTAINMENT SERVICES IN THE NATURE OF NON-DOWNLOADABLE VIDEOS AND IMAGES FEATURING TELEVISION SHOWS AND ENTERTAINMENT TRANSMITTED VIA THE INTERNET AND WIRELESS COMMUNICATION NETWORKS; ENTERTAINMENT SERVICES IN THE NATURE OF ORGANIZING, ARRANGING AND CONDUCTING TALENT SHOWS (U.S. CLS. 100, 101 AND 107).

KELLEY WELLS, EXAMINING ATTORNEY

SN 77-943,148. SIEBERS, DEBBIE, LOS ANGELES, CA. FILED 2-23-2010.

Body Insurance

THE MARK CONSISTS OF STANDARD CHARACTERS WITHOUT CLAIM TO ANY PARTICULAR FONT, STYLE, SIZE, OR COLOR.

NO CLAIM IS MADE TO THE EXCLUSIVE RIGHT TO USE "BODY", APART FROM THE MARK AS SHOWN.

FOR PROVIDING INFORMATION ON PHYSICAL EXERCISE (U.S. CLS. 100, 101 AND 107).

DOMINIC FATHY, EXAMINING ATTORNEY

CLASS 41—(Continued).

SN 77-943,258. WORLD WRESTLING ENTERTAINMENT, INC., STAMFORD, CT. FILED 2-24-2010.

NXT ROOKIE

THE MARK CONSISTS OF STANDARD CHARACTERS WITHOUT CLAIM TO ANY PARTICULAR FONT, STYLE, SIZE, OR COLOR.

FOR ENTERTAINMENT SERVICES, NAMELY, WRESTLING EXHIBITIONS AND PERFORMANCES BY A PROFESSIONAL WRESTLER AND ENTERTAINER; ENTERTAINMENT SERVICES, NAMELY, WRESTLING COMPETITOR ON AN ON-GOING REALITY BASED TELEVISION PROGRAM; PROVIDING WRESTLING NEWS AND INFORMATION VIA A GLOBAL COMPUTER NETWORK (U.S. CLS. 100, 101 AND 107).

JOHN HWANG, EXAMINING ATTORNEY

SN 77-944,974. WORLD WRESTLING ENTERTAINMENT, INC., STAMFORD, CT. FILED 2-25-2010.

FATAL FOUR WAY

THE MARK CONSISTS OF STANDARD CHARACTERS WITHOUT CLAIM TO ANY PARTICULAR FONT, STYLE, SIZE, OR COLOR.

FOR ENTERTAINMENT SERVICES, NAMELY, THE PRODUCTION AND EXHIBITION OF PROFESSIONAL WRESTLING EVENTS RENDERED LIVE AND THROUGH THE MEDIA OF TELEVISION; PROVIDING WRESTLING NEWS AND INFORMATION VIA A GLOBAL COMPUTER NETWORK (U.S. CLS. 100, 101 AND 107).

JOHN HWANG, EXAMINING ATTORNEY

SN 77-944,977. L. PERRIGO COMPANY, ALLEGAN, MI. FILED 2-25-2010.

ORx

THE MARK CONSISTS OF STANDARD CHARACTERS WITHOUT CLAIM TO ANY PARTICULAR FONT, STYLE, SIZE, OR COLOR.

FOR EDUCATION SERVICES, NAMELY, A PROGRAM TO PROMOTE THE USE OF OVER-COUNTER DRUGS (U.S. CLS. 100, 101 AND 107).

FIRST USE 4-30-2008; IN COMMERCE 4-30-2008.

IRA J. GOODSaid, EXAMINING ATTORNEY

CLASS 41—(Continued).

SN 77-945,057. WORLD TRIATHLON CORPORATION, TAMPA, FL. FILED 2-25-2010.



THE MARK CONSISTS OF THE WORD "LAVA" IN STYLIZED LETTERING IN THE FORM OF BLOCK LETTERS AND BROKEN HORIZONTAL LINES THROUGH THE TOP PORTION OF THE LAST "A" IN THE WORD. SHADOWING APPEARS BELOW, BETWEEN AND ON THE SIDES OF THE LETTERS TO CREATE A RAISED EFFECT TO THE MARK.

FOR PROVIDING ON-LINE MAGAZINES FEATURING SWIMMING, BIKING, RUNNING AND TRIATHLONS (U.S. CLS. 100, 101 AND 107).

JUDITH HELFMAN, EXAMINING ATTORNEY

SN 77-945,506. WORLD WRESTLING ENTERTAINMENT, INC., STAMFORD, CT. FILED 2-25-2010.

OVER THE LIMIT

THE MARK CONSISTS OF STANDARD CHARACTERS WITHOUT CLAIM TO ANY PARTICULAR FONT, STYLE, SIZE, OR COLOR.

FOR ENTERTAINMENT SERVICES, NAMELY, THE PRODUCTION AND EXHIBITION OF PROFESSIONAL WRESTLING EVENTS RENDERED LIVE AND THROUGH THE MEDIA OF TELEVISION; PROVIDING WRESTLING NEWS AND INFORMATION VIA A GLOBAL COMPUTER NETWORK (U.S. CLS. 100, 101 AND 107).

JOHN HWANG, EXAMINING ATTORNEY

SN 77-945,515. WORLD WRESTLING ENTERTAINMENT, INC., STAMFORD, CT. FILED 2-25-2010.

MONEY IN THE BANK

THE MARK CONSISTS OF STANDARD CHARACTERS WITHOUT CLAIM TO ANY PARTICULAR FONT, STYLE, SIZE, OR COLOR.

OWNER OF U.S. REG. NO. 3,532,434.

FOR ENTERTAINMENT SERVICES, NAMELY, THE PRODUCTION AND EXHIBITION OF PROFESSIONAL WRESTLING EVENTS RENDERED LIVE AND THROUGH THE MEDIA OF TELEVISION; PROVIDING WRESTLING NEWS AND INFORMATION VIA A GLOBAL COMPUTER NETWORK (U.S. CLS. 100, 101 AND 107).

JOHN HWANG, EXAMINING ATTORNEY

CLASS 41—(Continued).

SN 77-949,203. AMERICAN SPORTING GOODS CORPORATION, ALISO VIEJO, CA. FILED 3-3-2010.



THE MARK CONSISTS OF STANDARD CHARACTERS WITHOUT CLAIM TO ANY PARTICULAR FONT, STYLE, SIZE, OR COLOR.

OWNER OF U.S. REG. NOS. 1,202,827, 3,581,438 AND OTHERS.

FOR ORGANIZING SPORTING EVENTS, NAMELY, TRIATHLONS AND RUNNING RACE EVENTS; ORGANIZING COMMUNITY SPORTING AND CULTURAL EVENTS (U.S. CLS. 100, 101 AND 107).

FIRST USE 0-0-1987; IN COMMERCE 0-0-1987.

TEJBIR SINGH, EXAMINING ATTORNEY

SN 77-958,915. NATIONAL NURSING CENTER CONSORTIUM, INC., PHILADELPHIA, PA. FILED 3-15-2010.

I RUN THIS CITY

THE MARK CONSISTS OF STANDARD CHARACTERS WITHOUT CLAIM TO ANY PARTICULAR FONT, STYLE, SIZE, OR COLOR.

FOR CHARITABLE SERVICES, NAMELY, INSTRUCTION AND MENTORING FOR HIGH-RISK STUDENTS IN THE FIELD OF PREPARATION FOR AND PARTICIPATION IN DISTANCE RUNNING COMPETITIONS (U.S. CLS. 100, 101 AND 107).

FIRST USE 5-0-2008; IN COMMERCE 5-0-2008.

MICHAEL ENGEL, EXAMINING ATTORNEY

SN 77-958,978. INCLUSION, INC., GOLDEN VALLEY, MN. FILED 3-15-2010.

SHOULDN'T INCLUSION BE FOR EVERYONE?

THE MARK CONSISTS OF STANDARD CHARACTERS WITHOUT CLAIM TO ANY PARTICULAR FONT, STYLE, SIZE, OR COLOR.

FOR EDUCATIONAL SERVICES, NAMELY, CONDUCTING WORKSHOPS AND TRAINING CLASSES IN THE FIELD OF DIVERSITY AND DISTRIBUTION OF TRAINING MATERIAL IN CONNECTION THEREWITH (U.S. CLS. 100, 101 AND 107).

FIRST USE 10-31-2009; IN COMMERCE 10-31-2009.

JENNIFER DIXON, EXAMINING ATTORNEY

CLASS 41—(Continued).

SN 77-960,271. VANS, INC., CYPRESS, CA. FILED 3-16-2010.

DOWNTOWN SHOWDOWN

THE MARK CONSISTS OF STANDARD CHARACTERS WITHOUT CLAIM TO ANY PARTICULAR FONT, STYLE, SIZE, OR COLOR.

FOR ENTERTAINMENT SERVICES, NAMELY, ORGANIZING AND CONDUCTING COMPETITIONS IN THE FIELD OF SKATEBOARDING (U.S. CLS. 100, 101 AND 107).

FIRST USE 9-1-2005; IN COMMERCE 9-1-2005.
DEZMONA MIZELLE, EXAMINING ATTORNEY

CLASS 41—(Continued).

SN 77-963,847. ENDGAME ENTERPRISES, LLC, WESTMINSTER, CO. FILED 3-19-2010.

SPOTLIGHT ON THE SWIRL

THE MARK CONSISTS OF STANDARD CHARACTERS WITHOUT CLAIM TO ANY PARTICULAR FONT, STYLE, SIZE, OR COLOR.

FOR ON-LINE PUBLICATION OF A BLOG IN THE FIELDS OF CURRENT NEWS AND EVENTS (U.S. CLS. 100, 101 AND 107).

FIRST USE 10-31-2009; IN COMMERCE 10-31-2009.
HOWARD SMIGA, EXAMINING ATTORNEY

SN 77-961,486. DEVINCENT, MARC, POWELL, OH. FILED 3-17-2010.

**Share the Story. Celebrate
a Life.**

THE MARK CONSISTS OF STANDARD CHARACTERS WITHOUT CLAIM TO ANY PARTICULAR FONT, STYLE, SIZE, OR COLOR.

FOR CUSTOM WRITING SERVICES (U.S. CLS. 100, 101 AND 107).

FIRST USE 3-1-2010; IN COMMERCE 3-17-2010.
KATHY DE JONGE, EXAMINING ATTORNEY

SN 77-966,162. GAME SHOW NETWORK, LLC, SANTA MONICA, CA. FILED 3-23-2010.

BAGGAGE

THE MARK CONSISTS OF STANDARD CHARACTERS WITHOUT CLAIM TO ANY PARTICULAR FONT, STYLE, SIZE, OR COLOR.

FOR ENTERTAINMENT SERVICES, NAMELY, AN ONGOING TELEVISION SHOW IN THE NATURE OF A DATING GAME SHOW; PROVIDING ONLINE COMPUTER GAMES (U.S. CLS. 100, 101 AND 107).

DAVID COLLIER, EXAMINING ATTORNEY

SN 77-963,843. ENDGAME ENTERPRISES, LLC, WESTMINSTER, CO. FILED 3-19-2010.

IN THE HEADLIGHTS

THE MARK CONSISTS OF STANDARD CHARACTERS WITHOUT CLAIM TO ANY PARTICULAR FONT, STYLE, SIZE, OR COLOR.

FOR ON-LINE PUBLICATION OF COMICS AND BLOGS IN THE FIELDS OF ANIMAL AWARENESS, RELATIONSHIPS, HISTORY, LIFE, LITERATURE, PHILOSOPHY, POLITICS, PSYCHOLOGY, SCIENCE AND TECHNOLOGY, HUMOR, AND POLITICAL AND SOCIAL SATIRE (U.S. CLS. 100, 101 AND 107).

FIRST USE 2-21-2010; IN COMMERCE 2-21-2010.
HOWARD SMIGA, EXAMINING ATTORNEY

SN 77-966,963. XM SATELLITE RADIO INC., WASHINGTON, DC. FILED 3-24-2010.

THE BLEND

THE MARK CONSISTS OF STANDARD CHARACTERS WITHOUT CLAIM TO ANY PARTICULAR FONT, STYLE, SIZE, OR COLOR.

FOR ENTERTAINMENT SERVICES, NAMELY, PROVIDING AUDIO PROGRAMS FEATURING MUSIC, TALK, NEWS AND DATA VIA SATELLITE AND VIA A GLOBAL COMMUNICATION NETWORK (U.S. CLS. 100, 101 AND 107).

FIRST USE 1-7-2004; IN COMMERCE 1-7-2004.
MICHAEL WEBSTER, EXAMINING ATTORNEY

CLASS 41—(Continued).

SN 77-970,099. FREMANTLE MEDIA NORTH AMERICA, INC., BURBANK, CA. FILED 3-26-2010.

DOWNFALL

THE MARK CONSISTS OF STANDARD CHARACTERS WITHOUT CLAIM TO ANY PARTICULAR FONT, STYLE, SIZE, OR COLOR.

FOR ENTERTAINMENT SERVICES IN THE NATURE OF A CONTINUING TELEVISION GAME SHOW; ENTERTAINMENT SERVICES, NAMELY, PROVIDING AN ON-LINE COMPUTER GAME; ENTERTAINMENT SERVICES, NAMELY, PROVIDING DIGITIZED PRINT AND VISUAL INFORMATION ABOUT A TELEVISION SERIES VIA A GLOBAL COMPUTER NETWORK; ENTERTAINMENT SERVICES IN THE NATURE OF A SWEEPSTAKES; ENTERTAINMENT SERVICES IN THE NATURE OF AN AMUSEMENT PARK ATTRACTION, NAMELY, A THEMED AREA (U.S. CLS. 100, 101 AND 107).

AMEEN IMAM, EXAMINING ATTORNEY

SN 77-979,104. PERFORMANCE AUDIO, LLC, AKA PERFORMANCE AUDIO, SALT LAKE CITY, UT. FILED 7-9-2009.



NO CLAIM IS MADE TO THE EXCLUSIVE RIGHT TO USE "AUDIO", APART FROM THE MARK AS SHOWN.

THE MARK CONSISTS OF DIAMOND SHAPE INTERSECTED ON A 45 DEGREE ANGLE WITH A WAVY LINE IN THE SHAPE OF A SINE WAVE TO THE LEFT OF THE WORDING "PERFORMANCE AUDIO" WITH A STYLIZED "A" IN EACH WORD THAT LACKS THE HORIZONTAL BRIDGE.

FOR AUDIO AND VIDEO RECORDING SERVICES; AUDIO RECORDING AND PRODUCTION; RENTAL OF AUDIO EQUIPMENT; RENTAL SERVICES FOR AUDIO AND VIDEO EQUIPMENT (U.S. CLS. 100, 101 AND 107).

FIRST USE 4-24-2007; IN COMMERCE 4-24-2007.

ASMAT KHAN, EXAMINING ATTORNEY

CLASS 41—(Continued).

SN 78-630,872. CLARK, CHARLES K., HARLINGEN, TX. FILED 5-16-2005.

ORALE! CHARLIE

THE MARK CONSISTS OF STANDARD CHARACTERS WITHOUT CLAIM TO ANY PARTICULAR FONT, STYLE, SIZE, OR COLOR.

THE FOREIGN WORDING IN THE MARK TRANSLATES INTO ENGLISH AS "LET'S GO".

FOR ENTERTAINMENT, NAMELY, A CONTINUING VARIETY AND COMEDY SHOW BROADCAST OVER TELEVISION, SATELLITE, AND AUDIO AND VIDEO MEDIA (U.S. CLS. 100, 101 AND 107).

FIRST USE 8-15-2004; IN COMMERCE 8-15-2004.

MARTHA FROMM, EXAMINING ATTORNEY

SN 78-922,986. 360 PICTURES LLC, BEVERLY HILLS, CA. FILED 7-5-2006.

360 PICTURES

THE MARK CONSISTS OF STANDARD CHARACTERS WITHOUT CLAIM TO ANY PARTICULAR FONT, STYLE, SIZE, OR COLOR.

NO CLAIM IS MADE TO THE EXCLUSIVE RIGHT TO USE "PICTURES", APART FROM THE MARK AS SHOWN, FOR PRODUCTION AND DISTRIBUTION OF MOTION PICTURES (U.S. CLS. 100, 101 AND 107).

FIRST USE 5-0-2005; IN COMMERCE 5-0-2005.

JASON TURNER, EXAMINING ATTORNEY

SN 78-942,449. MICHAEL J. PETER, FT. LAUDERDALE, FL. FILED 8-1-2006.

PLATINUM LIVE

THE MARK CONSISTS OF STANDARD CHARACTERS WITHOUT CLAIM TO ANY PARTICULAR FONT, STYLE, SIZE, OR COLOR.

NO CLAIM IS MADE TO THE EXCLUSIVE RIGHT TO USE "LIVE", APART FROM THE MARK AS SHOWN.

FOR ENTERTAINMENT SERVICES, NAMELY, ADULT ENTERTAINMENT SERVICES FEATURING LIVE DANCING AND MUSIC (U.S. CLS. 100, 101 AND 107).

CURTIS FRENCH, EXAMINING ATTORNEY

CLASS 41—(Continued).

SN 79-070,901. ROLAND LIEBSCHER-BRACHT, SPAIN,
FILED 1-22-2009.

CLASS 41—(Continued).

SN 85-004,959. MIRIAM E FRANCO, PC, PHOENIXVILLE,
PA. FILED 4-2-2010.

BEAUTIFUL CONFIDENCE AT
YOUR CORE

LnB

THE MARK CONSISTS OF STANDARD CHARACTERS WITHOUT CLAIM TO ANY PARTICULAR FONT, STYLE, SIZE, OR COLOR.

FOR EDUCATIONAL SERVICES, NAMELY, CONDUCTING TRAINING COURSES, CLASSES, SEMINARS, CONFERENCES, AND WORKSHOPS IN THE FIELD OF STRESS REDUCTION AND GUIDED IMAGERY SERVICES AND PERSONAL AND PROFESSIONAL DEVELOPMENT, MOTIVATIONAL IMPROVEMENTS, AND SELF-IMAGE IMPROVEMENT AND THE DISTRIBUTION OF COURSE AND TRAINING MATERIALS IN CONNECTION THEREWITH (U.S. CLS. 100, 101 AND 107).

LINDA ORNDORFF, EXAMINING ATTORNEY

PRIORITY DATE OF 9-2-2008 IS CLAIMED.
OWNER OF INTERNATIONAL REGISTRATION 1007667
DATED 1-22-2009, EXPIRES 1-22-2019.

FOR SERVICES RELATING TO EDUCATION, TRAINING, RECREATION, ENTERTAINMENT, LEISURE, CULTURE AND SPORTS, NAMELY, ARRANGING EXHIBITIONS, PROFESSIONAL WORKSHOPS, AND TRAINING COURSES, DISTRIBUTED THROUGH TELEVISION, SATELLITE, FILM, AUDIO, VIDEO, INTERNET, 3-D VIRTUAL REALITY MEDIA, NEWSPAPERS, MAGAZINES, BOOKS, ELECTRONIC BOOKS, WEB PAGES AND DVD, IN THE FIELD OF HEALTH PREVENTION AND THERAPIES AGAINST PHYSICAL PAIN; EDITING OF CULTURAL AND COMMERCIAL VIDEO CLIPS, RADIO AND TELEVISION PROGRAMMES, CINEMATOGRAPHIC FILMS, VIDEOTAPES AND DVDS; DEVELOPING CURRICULUM FOR COURSES, SEMINARS, CONFERENCES, CONGRESSES AND SYMPOSIUMS IN THE FIELD OF HEALTH PREVENTION AND THERAPIES AGAINST PHYSICAL PAIN; ARRANGING AND CONDUCTING OF INSTRUCTIONAL EXHIBITIONS, COURSES, SEMINARS, CONFERENCES, CONVENTIONS AND SYMPOSIUMS IN THE FIELDS OF HEALTH, SPORTS AND NUTRITION; CONDUCTING OF PROFESSIONAL TRAINING COURSES AND SEMINARS FOR MOVEMENT THERAPISTS, DOCTORS AND OTHER THERAPISTS, TO CONVEY KNOWLEDGE RELATING TO GYMNASTICS AND SPORTING ACTIVITIES, PAIN MANAGEMENT THERAPY, NUTRITION AND LIFESTYLE AND RELATING TO MENTAL HYGIENE, MEDITATION, MIND THERAPY AND EXERCISES; AND DISSEMINATION OF PRINTED EDUCATIONAL MATERIALS IN CONNECTION THEREWITH IN THE FIELD OF HEALTH, SPORTS AND NUTRITION; BOOK EDITING AND PUBLISHING OF BOOKS AND TEXTS, PUBLISHING OF BOOKS AND TEXTS NOT FOR ADVERTISING; ELECTRONIC PUBLISHING OF BOOKS, NEWSPAPERS, CATALOGUES, GUIDES, MAGAZINES AND PERIODICALS ON-LINE; THE FOREGOING FOR OTHER THAN PUBLICITY PURPOSES; EDITING AND PRODUCTION OF SOUND RECORDINGS IN ELECTRONIC FORMAT (U.S. CLS. 100, 101 AND 107).

LIEF MARTIN, EXAMINING ATTORNEY

SN 85-017,040. HEALTH COMMUNICATIONS, INC., DEERFIELD BEACH, FL. FILED 4-19-2010.

True Vows
LIFE . . . ROMANTICIZED

THE MARK CONSISTS OF THE WORDS "TRUE VOWS" IN STYLIZED LETTERING WITH TWO INTERLOCKING RINGS FORMING THE LETTER "O". UNDERNEATH WHICH IS THE WORDING "LIFE . . . ROMANTICIZED" IN STYLIZED LETTERING.

FOR ENTERTAINMENT SERVICES IN THE NATURE OF AN ON-GOING REALITY BASED TELEVISION PROGRAM (U.S. CLS. 100, 101 AND 107).

DOUGLAS LEE, EXAMINING ATTORNEY

CLASS 41—(Continued).

SN 85-023,116. NAVAJO NATION GAMING ENTERPRISE, CHURCH ROCK, NM. FILED 4-26-2010.

NAVAJO GOLF

THE MARK CONSISTS OF STANDARD CHARACTERS WITHOUT CLAIM TO ANY PARTICULAR FONT, STYLE, SIZE, OR COLOR.

OWNER OF U.S. REG. NOS. 3,721,178 AND 3,721,180.

NO CLAIM IS MADE TO THE EXCLUSIVE RIGHT TO USE "GOLF", APART FROM THE MARK AS SHOWN.

FOR PROVIDING RENTAL OF GOLF EQUIPMENT; PROVIDING NEWS AND INFORMATION ON THE SPORT OF GOLF; PROVIDING GOLF FACILITIES; GOLF INSTRUCTION; GOLF DRIVING RANGE SERVICES; GOLF CLUB SERVICES (U.S. CLS. 100, 101 AND 107).

KATHLEEN M. VANSTON, EXAMINING ATTORNEY

CLASS 42—SCIENTIFIC AND COMPUTER SERVICES

SN 76-701,040. TWEEDSCORP, LLC, DBA DIFFERENT DRUMMER VENTURES, EVANSVILLE, IN. FILED 12-29-2009.

MORE THAN MYTH

THE MARK CONSISTS OF STANDARD CHARACTERS WITHOUT CLAIM TO ANY PARTICULAR FONT, STYLE, SIZE, OR COLOR.

FOR PROVIDING A WEB SITE FEATURING TEMPORARY USE OF NON-DOWNLOADABLE SOFTWARE ALLOWING WEB SITE USERS TO UPLOAD, POST AND DISPLAY ONLINE LITERARY WORKS, NAMELY, PERSONAL STORIES WITH OTHERS FOR ENTERTAINMENT PURPOSES (U.S. CLS. 100 AND 101).

FIRST USE 6-1-2009; IN COMMERCE 3-31-2010.
BERNICE MIDDLETON, EXAMINING ATTORNEY

SN 76-979,068. EADS SPACE TRANSPORTATION GMBH, D-28199 BREMEN, FED REP GERMANY, FILED 4-19-2004.

SICBRAZE

THE MARK CONSISTS OF STANDARD CHARACTERS WITHOUT CLAIM TO ANY PARTICULAR FONT, STYLE, SIZE, OR COLOR.

PRIORITY CLAIMED UNDER SEC. 44(D) ON FED REP GERMANY APPLICATION NO. 003637782, FILED 1-30-2004, REG. NO. 003637782, DATED 5-4-2005, EXPIRES 1-30-2014.

FOR COMPUTER SOFTWARE DESIGN FOR OTHERS, COMPUTER PROGRAMMING FOR OTHERS, AND SOFTWARE MAINTENANCE (U.S. CLS. 100 AND 101).

MARK SPARACINO, EXAMINING ATTORNEY

CLASS 42—(Continued).

SN 76-979,069. EADS SPACE TRANSPORTATION GMBH, D-28199 BREMEN, FED REP GERMANY, FILED 6-18-2004.

SICARBON

THE MARK CONSISTS OF STANDARD CHARACTERS WITHOUT CLAIM TO ANY PARTICULAR FONT, STYLE, SIZE, OR COLOR.

PRIORITY CLAIMED UNDER SEC. 44(D) ON FED REP GERMANY APPLICATION NO. 003796828, FILED 4-27-2004, REG. NO. 003796828, DATED 7-6-2005, EXPIRES 4-27-2014.

FOR COMPUTER SOFTWARE DESIGN FOR OTHERS, COMPUTER PROGRAMMING FOR OTHERS, AND SOFTWARE MAINTENANCE (U.S. CLS. 100 AND 101).

MARK SPARACINO, EXAMINING ATTORNEY

SN 77-259,470. GENERAL COUNCIL OF THE ASSEMBLIES OF GOD, THE, DBA GOSPEL PUBLISHING HOUSE, SPRINGFIELD, MO. FILED 8-20-2007.



THE MARK CONSISTS OF THE LETTERS "GPH" WITH FLAMES ABOVE THE LETTER "P".

FOR ONLINE COMPUTER SERVICES, NAMELY, CREATING AN ON-LINE COMMUNITY FOR REGISTERED USERS TO PARTICIPATE IN COMPETITIONS, SHOWCASE THEIR SKILLS, GET FEEDBACK FROM THEIR PEERS, FORM VIRTUAL COMMUNITIES, ENGAGE IN SOCIAL NETWORKING AND IMPROVE THEIR TALENT, ALL IN THE FIELD OF RELIGION (U.S. CLS. 100 AND 101).

FIRST USE 10-3-2004; IN COMMERCE 11-8-2004.
TRICIA SONNEBORN, EXAMINING ATTORNEY

CLASS 42—(Continued).

SN 77-653,727. STRESS ENGINEERING SERVICES, INC., HOUSTON, TX. FILED 1-21-2009.

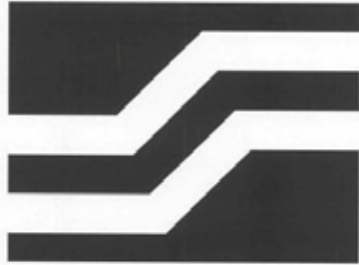

OWNER OF U.S. REG. NO. 2,275,638.
THE MARK CONSISTS OF A STYLIZED LETTER "S" WITHIN A SHADED BOX.

FOR STRUCTURAL AND MECHANICAL DESIGN FOR OTHERS RELATED TO INDUSTRIAL PLANTS, PETROLEUM DRILLING AND PRODUCTION EQUIPMENT, AND CONSUMER PRODUCTS; STRESS ANALYSIS OF PLASTICS AND METALS FOR THE PURPOSE OF DETERMINING IF A PARTICULAR PART OR DEVICE IS OF SOUND DESIGN; PREDICTIVE ENGINEERING; FAILURE ANALYSIS OF PLASTICS AND METALS; INSTRUMENT DESIGN FOR OTHERS FOR MEASURING AND CONTROLLING PROCESSES IN INDUSTRIAL PLANTS AND THE PERFORMANCE OF CONSUMER PRODUCTS; ANALYSIS OF HEAT TRANSFER AND FLUID MECHANICS IN THE OIL AND GAS PRODUCING AND PIPELINE INDUSTRIES AND CHEMICAL PLANTS AND REFINERIES; PACKAGING DESIGN FOR OTHERS (U.S. CLS. 100 AND 101).

FIRST USE 1-1-1985; IN COMMERCE 1-1-1985.
MARY ROSSMAN, EXAMINING ATTORNEY

CLASS 42—(Continued).

SN 77-667,860. GLOBAL SOUNDINGS, LLC, SCARBOROUGH, ME. FILED 2-11-2009.

SOUNDBASEGS

THE MARK CONSISTS OF STANDARD CHARACTERS WITHOUT CLAIM TO ANY PARTICULAR FONT, STYLE, SIZE, OR COLOR.

FOR PROVIDING TEMPORARY USE OF ON-LINE NON-DOWNLOADABLE SOFTWARE FOR USE IN TRACKING AND MANAGING INTERNET MARKETING CAMPAIGNS (U.S. CLS. 100 AND 101).

FIRST USE 1-31-2009; IN COMMERCE 1-31-2009.
WILLIAM VERHOSEK, EXAMINING ATTORNEY

SN 77-675,743. U.S. BUREAU OF THE CENSUS, WASHINGTON, DC. FILED 2-23-2009.

SN 77-667,858. GLOBAL SOUNDINGS, LLC, SCARBOROUGH, ME. FILED 2-11-2009.

SOUNDWAVEGS

OnTheMap

THE MARK CONSISTS OF STANDARD CHARACTERS WITHOUT CLAIM TO ANY PARTICULAR FONT, STYLE, SIZE, OR COLOR.

FOR PROVIDING TEMPORARY USE OF ON-LINE NON-DOWNLOADABLE SOFTWARE FOR USE IN TRACKING AND MANAGING INTERNET MARKETING CAMPAIGNS (U.S. CLS. 100 AND 101).

FIRST USE 1-31-2009; IN COMMERCE 1-31-2009.
WILLIAM VERHOSEK, EXAMINING ATTORNEY

THE MARK CONSISTS OF STANDARD CHARACTERS WITHOUT CLAIM TO ANY PARTICULAR FONT, STYLE, SIZE, OR COLOR.

FOR SOFTWARE FOR THE ANALYSIS AND DISPLAY OF JOB AND WORKER DATA PRODUCED BY THE U.S. BUREAU OF THE CENSUS AND ITS PARTNERS, AND THE CREATION OF MAPS AND REPORTS (U.S. CLS. 100 AND 101).

FIRST USE 6-22-2005; IN COMMERCE 6-22-2005.
INGRID C. EULIN, EXAMINING ATTORNEY

CLASS 42—(Continued).

SN 77-689,047. MCCARTY, DARREN, ROCHESTER, NY.
FILED 3-11-2009.

bubbabrain

THE MARK CONSISTS OF STANDARD CHARACTERS WITHOUT CLAIM TO ANY PARTICULAR FONT, STYLE, SIZE, OR COLOR.

FOR NON-DOWNLOADABLE EDUCATIONAL SOFTWARE FEATURING INSTRUCTION IN BIOLOGY, CHEMISTRY, SCIENCE, PHYSICS, MATH, HISTORY, SCHOLASTIC APTITUDE TEST, EUROPEAN HISTORY, UNITED STATES HISTORY, SOCIAL STUDIES, FAMILY AND CONSUMER SCIENCE, HEALTH, WORLD HISTORY, PSYCHOLOGY, THEORY OF KNOWLEDGE, HUMAN GEOGRAPHY, BUSINESS, TECHNOLOGY, LITERATURE, PHYSIOLOGY, FINE ARTS, GOVERNMENT, MUSIC, GEOGRAPHY, DRAMA, THEATRE, COMPUTER SCIENCE, ARABIC, CHINESE, MANDARIN, DANISH, DUTCH, ENGLISH, FRENCH, GERMAN, GREEK, HEBREW, HINDI, INDONESIAN, ITALIAN, JAPANESE, KOREAN, LATIN, PERSIAN, POLISH, PORTUGUESE, RUSSIAN, SPANISH, SWAHILI, SWEDISH, TAGALOG, THAI, TURKISH, VIETNAMESE, WELSH (U.S. CLS. 100 AND 101).

FIRST USE 7-17-2007; IN COMMERCE 8-25-2008.
ANDREA BUTLER, EXAMINING ATTORNEY

CLASS 42—(Continued).

SN 77-725,465. PROCLOGIC, LLC., STUDIO CITY, CA.
FILED 4-29-2009.

THE SCIENCE OF ACCELERATION

THE MARK CONSISTS OF STANDARD CHARACTERS WITHOUT CLAIM TO ANY PARTICULAR FONT, STYLE, SIZE, OR COLOR.

FOR DATA CONVERSION OF COMPUTER NETWORK DATA OR INFORMATION, NAMELY, INTEGRATING THIRD PARTY WEB CONTENT, STREAMING MEDIA AND COMPUTER APPLICATIONS FOR DELIVERY FROM A CONTENT DELIVERY NETWORK; PROVIDING GLOBAL TRAFFIC MANAGEMENT SERVICES TO CONTENT PROVIDERS WHO OPERATE MIRRORING WEB SITES, NAMELY, TRACKING CHANGING CONDITIONS ON THE INTERNET AND DIRECTING USERS TO THE DISTRIBUTED SITES THAT ARE OPTIMAL FOR THEM; COMPUTER SERVICES, NAMELY, PROVIDING WEB SITE TRAFFIC MONITORING AND REPORTING SERVICES; PROVIDING ON-LINE CUSTOMER TECHNICAL SUPPORT FEATURING REPORTING TOOLS, PERSONALIZED TECHNICAL SUPPORT AND TROUBLESHOOTING, AND TECHNOLOGY INFORMATION AND NEWS ABOUT THE COMPUTER INDUSTRY; APPLICATION SERVICE PROVIDER PROVIDING COMPUTERIZED DIGITAL RIGHTS MANAGEMENT, NAMELY, SOFTWARE FOR PROTECTING THE COPYRIGHTS OF DIGITAL CONTENT THAT IS DISTRIBUTED ONLINE (U.S. CLS. 100 AND 101).

FIRST USE 2-1-2009; IN COMMERCE 4-1-2009.
BRIAN NEVILLE, EXAMINING ATTORNEY

SN 77-736,704. SIERRA BRAVO CORPORATION, BLOOMINGTON, MN. FILED 5-14-2009.

SN 77-705,787. CANJAR, SAN RAMON, CA. FILED 4-2-2009.



SkyPie
Let's get social.

THE MARK CONSISTS OF THE STYLIZED WORDS "SKYPIE LET'S GET SOCIAL". TO THE LEFT OF THE STYLIZED WORDS IS AN IMAGE OF A PIE WEDGE WITH TEN CIRCLES ON IT THAT RESEMBLE BERRIES.

FOR PROVIDING A NON-DOWNLOADABLE WEB-BASED SOFTWARE PLATFORM COMPRISED PRIMARILY OF NON-DOWNLOADABLE COMPUTER SOFTWARE IN THE FIELD OF CONSUMER-TO-BUSINESS COMMERCE FOR CONSUMERS TO ENTER, MANAGE AND MODIFY THEIR CONSUMER PREFERENCE INFORMATION FOR USE BY MERCHANTS TO CREATE AND MANAGE OFFERS FOR DELIVERY TO CONSUMERS (U.S. CLS. 100 AND 101).

FIRST USE 1-5-2009; IN COMMERCE 1-22-2009.
LAURIE MAYES, EXAMINING ATTORNEY



NO CLAIM IS MADE TO THE EXCLUSIVE RIGHT TO USE "INTERACTIVE LABS", APART FROM THE MARK AS SHOWN.

THE MARK CONSISTS OF A LIGHT GREEN AND GREEN SHIRT POCKET DESIGN OUTLINED IN BLACK HOLDING A GRAY PEN OUTLINED IN BLACK WITH A WHITE, STYLIZED LETTER "N" OUTLINED IN BLACK ON THE FRONT OF THE POCKET DESIGN; TO THE RIGHT OF THIS DESIGN IS THE WORD "NERDERY" IN BLACK STYLIZED FONT; BELOW IT SITS A BLACK LINE WITH A SMALL BLACK FULLY SHADED CIRCLE AT EACH END; AND BENEATH THIS LINE SITS THE WORDING "INTERACTIVE LABS" IN BLACK STYLIZED FONT. THE MARK IN ITS ENTIRETY IS PRESENTED ON A TRANSPARENT BACKGROUND.

FOR HOSTING WEB SITES FOR OTHERS; PROVIDING GLOBAL COMPUTER NETWORK CONTENT DEVELOPMENT FOR OTHERS, NAMELY, CUSTOM WEB SITE DEVELOPMENT SERVICES (U.S. CLS. 100 AND 101).

FIRST USE 5-1-2009, THE MARK WAS FIRST USED ANYWHERE IN A DIFFERENT FORM OTHER THAN THAT SOUGHT TO BE REGISTERED AT LEAST AS EARLY AS 09/01/2008; IN COMMERCE 5-1-2009, THE MARK WAS FIRST USED IN COMMERCE IN A DIFFERENT FORM OTHER THAN THAT SOUGHT TO BE REGISTERED AT LEAST AS EARLY AS 09/01/2008.

GRETCHEN ULRICH, EXAMINING ATTORNEY

CLASS 42—(Continued).

SN 77-738,279. WOLFRAM ALPHA LLC, CHAMPAIGN, IL. FILED 5-15-2009.

ALPHA

THE MARK CONSISTS OF STANDARD CHARACTERS WITHOUT CLAIM TO ANY PARTICULAR FONT, STYLE, SIZE, OR COLOR.

FOR COMPUTER SERVICES, NAMELY, PROVIDING SEARCH ENGINES FOR OBTAINING DATA ON A GLOBAL COMPUTER NETWORK; ONLINE NON-DOWNLOADABLE SOFTWARE USED TO PROVIDE INFORMATION FROM SEARCHABLE INDEXES AND DATABASES OF INFORMATION (U.S. CLS. 100 AND 101).

FIRST USE 5-15-2009; IN COMMERCE 5-15-2009.
PAM WILLIS, EXAMINING ATTORNEY

CLASS 42—(Continued).

SN 77-758,061. JOHNSONITE INC., CHAGRIN FALLS, OH. FILED 6-12-2009.

COLORMATCH

THE MARK CONSISTS OF STANDARD CHARACTERS WITHOUT CLAIM TO ANY PARTICULAR FONT, STYLE, SIZE, OR COLOR.

OWNER OF U.S. REG. NO. 1,978,623.
SEC. 2(F).

FOR COLOR ANALYSIS FOR PURPOSES OF INTERIOR DESIGN REGARDING THE SELECTION OF FLOORING, WALL BASES, STAIR TREADS AND HOME IMPROVEMENT ACCESSORIES FOR FLOORING, WALL BASES AND STAIR TREADS; PAINT MATCHING, NAMELY, COLOR ANALYSIS TO DETERMINE PROPER PAINT MIXTURE FOR MATCHING COLORS FOR INTERIOR DECORATING PURPOSES REGARDING THE SELECTION OF FLOORING, WALL BASES, STAIR TREADS AND HOME IMPROVEMENT ACCESSORIES FOR FLOORING, WALL BASES AND STAIR TREADS (U.S. CLS. 100 AND 101).

FIRST USE 9-1-1995; IN COMMERCE 9-1-1995.
DAVID YONTEF, EXAMINING ATTORNEY

SN 77-749,757. IVOCLAR VIVADENT, INC., AMHERST, NY. FILED 6-2-2009.

PODIUM

THE MARK CONSISTS OF STANDARD CHARACTERS WITHOUT CLAIM TO ANY PARTICULAR FONT, STYLE, SIZE, OR COLOR.

FOR PROVIDING A WEBSITE THAT ENABLES USERS TO DEVELOP PRESENTATIONS IN THE FIELD OF DENTAL TECHNOLOGY WHICH FEATURES COLLECTED AND ORGANIZED TECHNICAL PRESENTATIONS, PICTURES AND SCIENTIFIC DATA RELATING TO MATERIALS AND INSTRUMENTS USED IN DENTISTRY AND DENTAL TECHNOLOGY THAT USERS ARE ALLOWED TO DOWNLOAD (U.S. CLS. 100 AND 101).

FIRST USE 1-31-2009; IN COMMERCE 1-31-2009.
BARBARA BROWN, EXAMINING ATTORNEY

SN 77-763,681. ROBL, ERIKA A, DBA PENNY LANE DESIGN STUDIOS, MERRILL, WI. FILED 6-19-2009.

NO CLAIM IS MADE TO THE EXCLUSIVE RIGHT TO USE "DESIGN STUDIOS", APART FROM THE MARK AS SHOWN.

THE MARK CONSISTS OF THE STYLIZED LETTER "P" CONNECTED TO THE STYLIZED LETTER "L" WITH THE WORDS "PENNYLANE" AND "DESIGNSTUDIOS" SEPARATED BY A VERTICAL LINE.

FOR GRAPHIC DESIGN SERVICES (U.S. CLS. 100 AND 101).
AMY ALFIERI, EXAMINING ATTORNEY

CLASS 42—(Continued).

SN 77-767,572. CAVOLO, CARMEN, CAVE CREEK, AZ. FILED 6-24-2009.

Mygraduationplan.com

THE MARK CONSISTS OF STANDARD CHARACTERS WITHOUT CLAIM TO ANY PARTICULAR FONT, STYLE, SIZE, OR COLOR.

FOR APPLICATION SERVICE PROVIDER (ASP) FEATURING SOFTWARE FOR USE THAT ASSISTS STUDENTS AND THEIR GUARDIANS IN PLANNING GRADUATION PLANS AND STUDENTS WITH DISABILITIES AND THEIR GUARDIANS TO PLAN TRANSITION PLANS (U.S. CLS. 100 AND 101).

FIRST USE 9-1-2008; IN COMMERCE 3-1-2009.

C. DIONNE CLYBURN, EXAMINING ATTORNEY

SN 77-767,967. ELBIT SYSTEMS OF AMERICA, LLC, FORT WORTH, TX. FILED 6-25-2009.

SUPPORTING A NATION OF
HEROES

THE MARK CONSISTS OF STANDARD CHARACTERS WITHOUT CLAIM TO ANY PARTICULAR FONT, STYLE, SIZE, OR COLOR.

FOR DESIGN AND DEVELOPMENT OF MILITARY AIRCRAFT AVIONICS SYSTEMS COMPRISED OF SOFTWARE AND HARDWARE, NAMELY, ALTIMETERS, AIR DATA INSTRUMENTS, FLIGHT DATA RECORDERS, FLIGHT DISPLAYS, AND CABIN PRESSURIZATION DETECTORS; DESIGN AND DEVELOPMENT OF MILITARY AIRCRAFT EQUIPMENT, NAMELY, ENHANCED VISION EQUIPMENT IN THE NATURE OF VISION SENSORS THAT PENETRATES THROUGH REDUCED VISIBILITY CONDITIONS AND PROVIDE AN IMAGE TO THE PILOT IN AIRCRAFT TAKE-OFF AND LANDING; DESIGN AND DEVELOPMENT OF MILITARY AIRCRAFT EQUIPMENT, NAMELY, ELECTRO-OPTIC VISUALIZATION DEVICES FOR PROVIDING ENHANCED VISION SENSORS FOR USE IN LOW VISIBILITY CONDITIONS (U.S. CLS. 100 AND 101).

WENDY JUN, EXAMINING ATTORNEY

CLASS 42—(Continued).

SN 77-774,734. BEHAVIORAL SERVICES OF TENNESSEE, INC., CORDOVA, TN. FILED 7-6-2009.



NO CLAIM IS MADE TO THE EXCLUSIVE RIGHT TO USE "PORTAL", APART FROM THE MARK AS SHOWN.

THE COLOR(S) RED, BLACK, PURPLE, AND LIGHT GREEN IS/ARE CLAIMED AS A FEATURE OF THE MARK.

THE MARK CONSISTS OF A CIRCLE WITH FOUR ALTERNATING RINGS OF LIGHT GREEN AND BLACK, HORIZONTALLY BISECTING THE CIRCLE TO THE OUTERMOST RING IS A WIDE BLACK BAND WITH THE WORDING "BSTN PORTAL" SUPERIMPOSED IN LIGHT GREEN THEREON. ABOVE AND BELOW THE WORDING, WITHIN THE BLACK BAND, APPEAR THIN HORIZONTAL LINES IN LIGHT GREEN. A BROKEN HORIZONTAL LINE IN LIGHT GREEN APPEARS JUST BELOW THE WORDING, EXTENDING TOWARD THE CENTER OF THE CIRCLE FROM THE LEFT AND RIGHT. THE INTERIOR OF THE CIRCLE CONSISTS OF ELEVEN ALTERNATING VERTICAL STRIPES OF RED AND PURPLE.

FOR PROVIDING TEMPORARY USE OF NON-DOWNLOADABLE BUSINESS COMPUTER SOFTWARE FOR THERAPIST NETWORKING, NAMELY, FOR THE INTEGRATION OF RECORDING, MONITORING AND ANALYSIS OF RESIDENTIAL AND CLINICAL SERVICES RELATED TO THERAPY TREATMENTS, EMPLOYEE ACTIVITIES, EMPLOYEE TRAINING, EMPLOYEE RECRUITMENT AND HIRING, EMPLOYEE SCHEDULING, AND PAYROLL ACTIVITIES (U.S. CLS. 100 AND 101).

FIRST USE 4-29-2009; IN COMMERCE 4-29-2009.

JERI J. FICKES, EXAMINING ATTORNEY

SN 77-774,739. BEHAVIORAL SERVICES OF TENNESSEE, INC., CORDOVA, TN. FILED 7-6-2009.

BSTN PORTAL

THE MARK CONSISTS OF STANDARD CHARACTERS WITHOUT CLAIM TO ANY PARTICULAR FONT, STYLE, SIZE, OR COLOR.

NO CLAIM IS MADE TO THE EXCLUSIVE RIGHT TO USE "PORTAL", APART FROM THE MARK AS SHOWN.

FOR PROVIDING TEMPORARY USE OF NON-DOWNLOADABLE BUSINESS COMPUTER SOFTWARE FOR THERAPIST NETWORKING, NAMELY, FOR THE INTEGRATION OF RECORDING, MONITORING AND ANALYSIS OF RESIDENTIAL AND CLINICAL SERVICES RELATED TO THERAPY TREATMENTS, EMPLOYEE ACTIVITIES, EMPLOYEE TRAINING, EMPLOYEE RECRUITMENT AND HIRING, EMPLOYEE SCHEDULING, AND PAYROLL ACTIVITIES (U.S. CLS. 100 AND 101).

FIRST USE 4-29-2009; IN COMMERCE 4-29-2009.

JERI J. FICKES, EXAMINING ATTORNEY

CLASS 42—(Continued).

SN 77-778,077. MONK MEDIA, LLC, MARINA DEL REY, CA. FILED 7-9-2009.

CLASS 42—(Continued).

SN 77-779,080. KOSS CORPORATION, MILWAUKEE, WI. FILED 7-11-2009.



MYKOSS

THE MARK CONSISTS OF THE WORDING "MONKMEDIA" TO THE RIGHT OF A DESIGN ELEMENT CONSISTING OF A SHADED CIRCLE WITH TWO VERTICALLY FORMATTED SINGLE LINE CIRCLES APPEARING WITHIN THE SHADED CIRCLE AND WITH THE LOWER SINGLE LINE CIRCLE APPEARING IN A STYLIZED INCOMPLETE SQUARE.

FOR COMPUTER SERVICES, NAMELY, CREATING AN ON-LINE COMMUNITY FOR REGISTERED USERS TO PARTICIPATE IN DISCUSSIONS, GET FEEDBACK FROM THEIR PEERS, FORM VIRTUAL COMMUNITIES, AND ENGAGE IN SOCIAL NETWORKING FEATURING SOCIAL MEDIA AND TOPICS ON JEWELRY AND FASHION ACCESSORIES (U.S. CLS. 100 AND 101).

KAREN SEVERSON, EXAMINING ATTORNEY

THE MARK CONSISTS OF STANDARD CHARACTERS WITHOUT CLAIM TO ANY PARTICULAR FONT, STYLE, SIZE, OR COLOR.

OWNER OF U.S. REG. NOS. 976,692, 1,602,016 AND OTHERS.

FOR ON-LINE DEVICE MANAGEMENT SERVICES THAT ALLOW USERS TO REMOTELY MANAGE THE INFORMATION ON AND CONFIGURE THE PREFERENCES OF VIDEO DEVICES THROUGH A GLOBAL COMPUTER NETWORK; ON-LINE DEVICE MANAGEMENT SERVICES THAT ALLOW USERS TO REMOTELY MANAGE THE INFORMATION ON AND CONFIGURE THE PREFERENCES OF AUDIO DEVICES THROUGH A GLOBAL COMPUTER NETWORK (U.S. CLS. 100 AND 101).

ANDREW LEASER, EXAMINING ATTORNEY

SN 77-778,766. SARGENTO FOODS, INC., PLYMOUTH, WI. FILED 7-10-2009.

SN 77-781,689. INTERLINK ASSOCIATES, LLC, PRINCETON, NJ. FILED 7-15-2009.

IDEA CENTER

INTERLINK BIOTECHNOLOGIES

THE MARK CONSISTS OF STANDARD CHARACTERS WITHOUT CLAIM TO ANY PARTICULAR FONT, STYLE, SIZE, OR COLOR.

FOR DEVELOPMENT SERVICES FOR OTHERS IN THE FIELD OF FOOD PRODUCTS, NAMELY, CUSTOMIZED FOOD INGREDIENT, MEALS, MIXES, APPETIZERS, BEVERAGES, AND SNACK FOOD DEVELOPMENT SERVICES FOR RETAILERS, RESTAURANTS AND FOOD DISTRIBUTORS, INCLUDING BUT NOT LIMITED TO PRE-PACKAGED, FROZEN AND REFRIGERATED MEALS, SAUCES, MIXES, SNACKS, BLENDED BEVERAGES, APPETIZERS, FLAVORINGS, INGREDIENTS, AND SOUPS (U.S. CLS. 100 AND 101).

WANDA KAY PRICE, EXAMINING ATTORNEY

THE MARK CONSISTS OF STANDARD CHARACTERS WITHOUT CLAIM TO ANY PARTICULAR FONT, STYLE, SIZE, OR COLOR.

NO CLAIM IS MADE TO THE EXCLUSIVE RIGHT TO USE "BIOTECHNOLOGIES", APART FROM THE MARK AS SHOWN.

FOR RESEARCH AND DEVELOPMENT AND CONSULTATION RELATED THERETO IN THE FIELD OF BIOTECHNOLOGY (U.S. CLS. 100 AND 101).

FIRST USE 1-15-2004; IN COMMERCE 2-23-2004.
AARON BRODSKY, EXAMINING ATTORNEY

CLASS 42—(Continued).

SN 77-783,424. IRON EAGLE TECHNOLOGIES, INC., ELK HORN, IA. FILED 7-17-2009.

**IRON EAGLE TECHNOLOGIES,
INC.**

THE MARK CONSISTS OF STANDARD CHARACTERS WITHOUT CLAIM TO ANY PARTICULAR FONT, STYLE, SIZE, OR COLOR.

NO CLAIM IS MADE TO THE EXCLUSIVE RIGHT TO USE "TECHNOLOGIES, INC.", APART FROM THE MARK AS SHOWN.

FOR ENVIRONMENTAL SERVICES, NAMELY, TECHNICAL CONSULTATION RELATED TO DESIGNING AND TESTING OF ENERGY PRODUCTS FOR OTHERS, STRUCTURAL ENGINEERING DESIGN SERVICES, AND TECHNICAL PLANNING OF SOLAR PHOTOVOLTAIC INSTALLATIONS, SOLAR THERMAL INSTALLATIONS AND WIND TURBINE INSTALLATIONS, ALL IN THE FIELDS OF WIND ENERGY AND SOLAR ENERGY (U.S. CLS. 100 AND 101).

BRIAN CALLAGHAN, EXAMINING ATTORNEY

SN 77-783,744. FEATHER, ROBIN, BAYSIDE, NY. FILED 7-17-2009.

GotItGetItGood

THE MARK CONSISTS OF STANDARD CHARACTERS WITHOUT CLAIM TO ANY PARTICULAR FONT, STYLE, SIZE, OR COLOR.

FOR COMPUTER SERVICES, NAMELY, PROVIDING SEARCH ENGINES FOR OBTAINING DATA ON A GLOBAL COMPUTER NETWORK (U.S. CLS. 100 AND 101).

KATHERINE M. DUBRAY, EXAMINING ATTORNEY

CLASS 42—(Continued).

SN 77-783,866. DAVIS HOLDINGS OF NORTH CAROLINA, DBA C. A. SHORT COMPANY, CHARLOTTE, NC. FILED 7-17-2009.

C.A. SHORT ONDEMAND

THE MARK CONSISTS OF STANDARD CHARACTERS WITHOUT CLAIM TO ANY PARTICULAR FONT, STYLE, SIZE, OR COLOR.

NO CLAIM IS MADE TO THE EXCLUSIVE RIGHT TO USE "ONDEMAND", APART FROM THE MARK AS SHOWN.

THE NAME "C.A. SHORT" DOES NOT IDENTIFY A LIVING INDIVIDUAL.

FOR PROVIDING A WEB SITE FEATURING TECHNOLOGY THAT ENABLES COMPANIES AND ORGANIZATIONS TO ADMINISTER AND MANAGE EMPLOYEE INCENTIVE AWARD PROGRAMS AND TO PROMOTE EMPLOYEE PRODUCTIVITY, PERFORMANCE, RECOGNITION AND MORALE (U.S. CLS. 100 AND 101).

FIRST USE 6-1-2009; IN COMMERCE 6-1-2009.

KATINA MISTER, EXAMINING ATTORNEY

SN 77-785,814. CENDYN CORPORATION, BOCA RATON, FL. FILED 7-21-2009.

eStatability

THE MARK CONSISTS OF STANDARD CHARACTERS WITHOUT CLAIM TO ANY PARTICULAR FONT, STYLE, SIZE, OR COLOR.

OWNER OF U.S. REG. NO. 2,433,527.

FOR PROVIDING ON-LINE NON-DOWNLOADABLE SOFTWARE FOR DATABASE MANAGEMENT OF STATISTICAL DATA BY THE HOSPITALITY INDUSTRY (U.S. CLS. 100 AND 101).

CHRISTINE MARTIN, EXAMINING ATTORNEY

SN 77-792,027. COLLECTORS PROOF INC., ORCHARD PARK, NY. FILED 7-29-2009.

CP BADGE

THE MARK CONSISTS OF STANDARD CHARACTERS WITHOUT CLAIM TO ANY PARTICULAR FONT, STYLE, SIZE, OR COLOR.

FOR PROVIDING A UNIQUE IDENTIFIER IN THE FORM OF AN ALPHA-NUMERIC CODE FOR LINKING A COLLECTIBLE ITEM TO INFORMATION ABOUT THE COLLECTIBLE ITEM AS PART OF A COLLECTIBLE ITEM REGISTRY (U.S. CLS. 100 AND 101).

JACQUELINE A. LAVINE, EXAMINING ATTORNEY

CLASS 42—(Continued).

SN 77-797,325. PAYMENT TRANSACTION SERVICES, INC., WALTHAM, MA. FILED 8-5-2009.

CLASS 42—(Continued).

SN 77-800,887. AMERICAN ACADEMY HOLDINGS, LLC, SALT LAKE CITY, UT. FILED 8-10-2009.

CAPTURE CODA

THE MARK CONSISTS OF STANDARD CHARACTERS WITHOUT CLAIM TO ANY PARTICULAR FONT, STYLE, SIZE, OR COLOR.

FOR DESIGN AND DEVELOPMENT OF COMPUTER SOFTWARE; COMPUTER PROGRAMMING SERVICES; ALL OF THE FOREGOING IN CONNECTION WITH DISCOUNT, GIFT AND LOYALTY REWARDS CARD PROGRAMS (U.S. CLS. 100 AND 101).

JEAN IM, EXAMINING ATTORNEY



SN 77-797,692. WIRED HOODS, LLC, BRONXVILLE, NY. FILED 8-5-2009.

WIRED STICKS

THE MARK CONSISTS OF STANDARD CHARACTERS WITHOUT CLAIM TO ANY PARTICULAR FONT, STYLE, SIZE, OR COLOR.

NO CLAIM IS MADE TO THE EXCLUSIVE RIGHT TO USE "WIRED", APART FROM THE MARK AS SHOWN.

FOR DESIGN, DEPLOYMENT AND MANAGEMENT OF WIRELESS NETWORKS FOR OTHERS IN ECONOMICALLY DISTRESSED NEIGHBORHOODS (U.S. CLS. 100 AND 101).

ERNEST SHOSHO, EXAMINING ATTORNEY



SN 77-799,645. KOCHANOWSKI, CECILIA, CROTON ON HUDSON, NY. FILED 8-7-2009.

LocaSutra

THE MARK CONSISTS OF STANDARD CHARACTERS WITHOUT CLAIM TO ANY PARTICULAR FONT, STYLE, SIZE, OR COLOR.

THE WORDING "LOCASUTRA" HAS NO MEANING IN A FOREIGN LANGUAGE.

FOR HOSTING AN ONLINE WEBSITE FEATURING ARTICLES AND RECIPES ABOUT LOCAL FOODS (U.S. CLS. 100 AND 101).

BRIAN PINO, EXAMINING ATTORNEY

CMAP

THE MARK CONSISTS OF STANDARD CHARACTERS WITHOUT CLAIM TO ANY PARTICULAR FONT, STYLE, SIZE, OR COLOR.

FOR TESTING, ANALYSIS AND EVALUATION OF THE MEDICAL CODING SERVICES OF OTHERS FOR THE PURPOSE OF CERTIFICATION (U.S. CLS. 100 AND 101).

JASON BLAIR, EXAMINING ATTORNEY



SN 77-801,585. HEARTLAND PAYMENT SYSTEMS, INC., PRINCETON, NJ. FILED 8-11-2009.

HEARTLAND

THE MARK CONSISTS OF STANDARD CHARACTERS WITHOUT CLAIM TO ANY PARTICULAR FONT, STYLE, SIZE, OR COLOR.

OWNER OF U.S. REG. NOS. 2,742,163, 3,315,693 AND OTHERS.

FOR DATA ENCRYPTION SERVICES IN THE FIELD OF PAYMENT CARD PROCESSING; PROVIDING TEMPORARY ONLINE NON-DOWNLOADABLE COMPUTER SOFTWARE FOR USE IN ACCESSING ONLINE CREDIT, DEBIT, BANK CARD, SMART CARD AND PAYMENT CARD TRANSACTION PROCESSING SERVICES; COMPUTER SERVICES, NAMELY, PROVIDING TEMPORARY USE OF NON-DOWNLOADABLE COMPUTER SOFTWARE FOR PROVIDING A WEB-BASED SCHOOL MANAGEMENT SYSTEM AND ONLINE PORTAL FOR PROVIDING FINANCIAL MANAGEMENT, ADMISSIONS MANAGEMENT, EDUCATION MANAGEMENT AND RECORDS MANAGEMENT (U.S. CLS. 100 AND 101).

CURTIS FRENCH, EXAMINING ATTORNEY

CLASS 42—(Continued).

SN 77-804,638. THE PRUDENTIAL INSURANCE COMPANY OF AMERICA, NEWARK, NJ. FILED 8-14-2009.

ONLINE SELLER ADVANTAGE

THE MARK CONSISTS OF STANDARD CHARACTERS WITHOUT CLAIM TO ANY PARTICULAR FONT, STYLE, SIZE, OR COLOR.

NO CLAIM IS MADE TO THE EXCLUSIVE RIGHT TO USE "ONLINE SELLER", APART FROM THE MARK AS SHOWN.

FOR PROVIDING ON-LINE NON-DOWNLOADABLE SOFTWARE FOR HOME SELLER USERS WITH RESIDENTIAL PROPERTY LISTED FOR SALE TO RECEIVE DAILY INFORMATION ON REAL ESTATE MARKET ACTIVITY PERTAINING TO THE SALE OF THE RESIDENCE (U.S. CLS. 100 AND 101).

FIRST USE 10-31-2006; IN COMMERCE 10-31-2006.
JEFF DEFORD, EXAMINING ATTORNEY

SN 77-806,483. DOCTATIONS, INC., GARDEN CITY, NY. FILED 8-17-2009.

DOCTATIONS - AN EMR WITH THE NETWORK BUILT-IN

THE MARK CONSISTS OF STANDARD CHARACTERS WITHOUT CLAIM TO ANY PARTICULAR FONT, STYLE, SIZE, OR COLOR.

OWNER OF U.S. REG. NOS. 3,445,650 AND 3,671,836.

FOR APPLICATION SERVICE PROVIDER (ASP) FEATURING SOFTWARE USED TO CONDUCT COMMUNICATIONS BETWEEN PATIENTS AND MEDICAL PERSONNEL, FOR ACCESSING MEDICAL INFORMATION AND RECORDS, FOR TRANSACTING HEALTHCARE ONLINE FOR DOCTORS AND PATIENTS, FOR USE IN THE MANAGEMENT OF HEALTHCARE PRACTICES AND ELECTRONIC MEDICAL RECORDS VIA THE INTERNET, AND FOR ALLOWING DOCTORS AND HEALTHCARE PROFESSIONALS TO CREATE ONLINE NETWORKS, GROUPS AND COMMUNITIES FOR VARIOUS PURPOSES; AND ON-LINE NON-DOWNLOADABLE SOFTWARE USED TO CONDUCT COMMUNICATIONS BETWEEN PATIENTS AND MEDICAL PERSONNEL, FOR ACCESSING MEDICAL INFORMATION AND RECORDS, FOR TRANSACTING HEALTHCARE ONLINE FOR DOCTORS AND PATIENTS, FOR USE IN THE MANAGEMENT OF HEALTHCARE PRACTICES AND ELECTRONIC MEDICAL RECORDS VIA THE INTERNET, AND FOR ALLOWING DOCTORS AND HEALTHCARE PROFESSIONALS TO CREATE ONLINE NETWORKS, GROUPS AND COMMUNITIES FOR VARIOUS PURPOSES (U.S. CLS. 100 AND 101).

DAVID C. REIHNER, EXAMINING ATTORNEY

CLASS 42—(Continued).

SN 77-806,486. DOCTATIONS, INC., GARDEN CITY, NY. FILED 8-17-2009.

DOCTATIONS - AN EMR WITH THE NETWORK INSIDE

THE MARK CONSISTS OF STANDARD CHARACTERS WITHOUT CLAIM TO ANY PARTICULAR FONT, STYLE, SIZE, OR COLOR.

OWNER OF U.S. REG. NOS. 3,445,650 AND 3,671,836.

FOR APPLICATION SERVICE PROVIDER (ASP) FEATURING SOFTWARE USED TO CONDUCT COMMUNICATIONS BETWEEN PATIENTS AND MEDICAL PERSONNEL, FOR ACCESSING MEDICAL INFORMATION AND RECORDS, FOR TRANSACTING HEALTHCARE ONLINE FOR DOCTORS AND PATIENTS, FOR USE IN THE MANAGEMENT OF HEALTHCARE PRACTICES AND ELECTRONIC MEDICAL RECORDS VIA THE INTERNET, AND FOR ALLOWING DOCTORS AND HEALTHCARE PROFESSIONALS TO CREATE ONLINE NETWORKS, GROUPS AND COMMUNITIES FOR VARIOUS PURPOSES; AND ON-LINE NON-DOWNLOADABLE SOFTWARE USED TO CONDUCT COMMUNICATIONS BETWEEN PATIENTS AND MEDICAL PERSONNEL, FOR ACCESSING MEDICAL INFORMATION AND RECORDS, FOR TRANSACTING HEALTHCARE ONLINE FOR DOCTORS AND PATIENTS, FOR USE IN THE MANAGEMENT OF HEALTHCARE PRACTICES AND ELECTRONIC MEDICAL RECORDS VIA THE INTERNET, AND FOR ALLOWING DOCTORS AND HEALTHCARE PROFESSIONALS TO CREATE ONLINE NETWORKS, GROUPS AND COMMUNITIES FOR VARIOUS PURPOSES (U.S. CLS. 100 AND 101).

DAVID C. REIHNER, EXAMINING ATTORNEY

SN 77-807,186. CENTER FOR CREATIVE LEADERSHIP, GREENSBORO, NC. FILED 8-18-2009.

360 By Design

THE MARK CONSISTS OF STANDARD CHARACTERS WITHOUT CLAIM TO ANY PARTICULAR FONT, STYLE, SIZE, OR COLOR.

OWNER OF U.S. REG. NO. 2,782,106.

FOR PROVIDING TEMPORARY USE OF ON-LINE NON-DOWNLOADABLE SOFTWARE FOR USE BY OTHERS IN CONDUCTING LEADERSHIP TESTING AND ASSESSMENT AND RETRIEVING TESTING AND ASSESSMENT REPORTS FOR PURPOSES OF DETERMINING EMPLOYMENT SKILLS AND DEVELOPING INDIVIDUAL MANAGERS AND EXECUTIVES (U.S. CLS. 100 AND 101).

FIRST USE 1-1-2006; IN COMMERCE 1-1-2006.
MARTHA FROMM, EXAMINING ATTORNEY

CLASS 42—(Continued).

SN 77-812,393. QUIST VALUATION, INC., BOULDER, CO.
FILED 8-25-2009.

QVAL

THE MARK CONSISTS OF STANDARD CHARACTERS WITHOUT CLAIM TO ANY PARTICULAR FONT, STYLE, SIZE, OR COLOR.

FOR PROVIDING TEMPORARY USE OF ONLINE NON-DOWNLOADABLE SOFTWARE FOR DATA MANAGEMENT FOR OTHERS IN THE FIELDS OF BUSINESS AND FINANCIAL VALUATION, ACCOUNTING, BALANCE SHEET AND TAXATION MANAGEMENT, AND BUSINESS PLANNING (U.S. CLS. 100 AND 101).

FIRST USE 8-30-2007; IN COMMERCE 12-21-2007.

SHAILA SETTLES, EXAMINING ATTORNEY

SN 77-812,713. DOCTATIONS, INC., GARDEN CITY, NY.
FILED 8-25-2009.



NO CLAIM IS MADE TO THE EXCLUSIVE RIGHT TO USE "CLOUD BASED HEALTHCARE IT", "SILOED EMR" AND PROHIBITION SYMBOL, APART FROM THE MARK AS SHOWN.

THE MARK CONSISTS OF THE IMAGE OF A CLOUD WITH THE WORDING "CLOUD BASED HEALTHCARE IT" WITH THE CHECK-MARK TO THE LEFT OF THE WORDING, THE FOREGOING APPEARING ABOVE THE IMAGE OF A PROHIBITION SYMBOL OVER THE WORDS "SILOED EMR".

FOR APPLICATION SERVICE PROVIDER (ASP) FEATURING SOFTWARE USED TO CONDUCT COMMUNICATIONS BETWEEN PATIENTS AND MEDICAL PERSONNEL, FOR ACCESSING MEDICAL INFORMATION AND RECORDS, FOR TRANSACTING HEALTHCARE ONLINE FOR DOCTORS AND PATIENTS, FOR USE IN THE MANAGEMENT OF HEALTHCARE PRACTICES AND ELECTRONIC MEDICAL RECORDS VIA THE INTERNET, AND FOR ALLOWING DOCTORS AND HEALTHCARE PROFESSIONALS TO CREATE ONLINE NETWORKS, GROUPS AND COMMUNITIES FOR VARIOUS PURPOSES; AND ON-LINE NON-DOWNLOADABLE SOFTWARE USED TO CONDUCT COMMUNICATIONS BETWEEN PATIENTS AND MEDICAL PERSONNEL, FOR ACCESSING MEDICAL INFORMATION AND RECORDS, FOR TRANSACTING HEALTHCARE ON-LINE FOR DOCTORS AND PATIENTS, FOR USE IN THE MANAGEMENT OF HEALTHCARE PRACTICES AND ELECTRONIC MEDICAL RECORDS VIA THE INTERNET, AND FOR ALLOWING DOCTORS AND HEALTHCARE PROFESSIONALS TO CREATE ONLINE NETWORKS, GROUPS AND COMMUNITIES FOR VARIOUS PURPOSES (U.S. CLS. 100 AND 101).

DAVID C. REIHNER, EXAMINING ATTORNEY

CLASS 42—(Continued).

SN 77-814,097. BOSTWICK LABORATORIES, INC., GLEN ALLEN, VA. FILED 8-27-2009.

AIP LABORATORIES

THE MARK CONSISTS OF STANDARD CHARACTERS WITHOUT CLAIM TO ANY PARTICULAR FONT, STYLE, SIZE, OR COLOR.

NO CLAIM IS MADE TO THE EXCLUSIVE RIGHT TO USE "LABORATORIES", APART FROM THE MARK AS SHOWN.

FOR MEDICAL AND SCIENTIFIC RESEARCH IN THE FIELD OF PATHOLOGY (U.S. CLS. 100 AND 101).

KEVON CHISOLM, EXAMINING ATTORNEY

SN 77-826,371. GORKAVCHUK, ANTON, MEDINA, OH.
FILED 9-15-2009.

NIFTY-NERD

THE MARK CONSISTS OF STANDARD CHARACTERS WITHOUT CLAIM TO ANY PARTICULAR FONT, STYLE, SIZE, OR COLOR.

FOR COMPUTER CONSULTATION (U.S. CLS. 100 AND 101).

FIRST USE 4-0-2009; IN COMMERCE 4-0-2009.

WILLIAM P. SHANAHAN, EXAMINING ATTORNEY

CLASS 42—(Continued).

SN 77-830,649. DOCTATIONS, INC., GARDEN CITY, NY.
FILED 9-21-2009.

OPTIMUM HEALTHCARE

THE MARK CONSISTS OF STANDARD CHARACTERS WITHOUT CLAIM TO ANY PARTICULAR FONT, STYLE, SIZE, OR COLOR.

NO CLAIM IS MADE TO THE EXCLUSIVE RIGHT TO USE "HEALTHCARE", APART FROM THE MARK AS SHOWN.

FOR APPLICATION SERVICE PROVIDER (ASP) FEATURING SOFTWARE USED TO CONDUCT COMMUNICATIONS BETWEEN PATIENTS AND MEDICAL PERSONNEL, FOR ACCESSING MEDICAL INFORMATION AND RECORDS, FOR TRANSACTING HEALTHCARE ONLINE FOR DOCTORS AND PATIENTS, FOR USE IN THE MANAGEMENT OF HEALTHCARE PRACTICES AND ELECTRONIC MEDICAL RECORDS VIA THE INTERNET, AND FOR ALLOWING DOCTORS AND HEALTHCARE PROFESSIONALS TO CREATE ONLINE NETWORKS, GROUPS AND COMMUNITIES FOR VARIOUS PURPOSES; ON-LINE NON-DOWNLOADABLE SOFTWARE USED TO CONDUCT COMMUNICATIONS BETWEEN PATIENTS AND MEDICAL PERSONNEL, FOR ACCESSING MEDICAL INFORMATION AND RECORDS, FOR TRANSACTING HEALTHCARE ONLINE FOR DOCTORS AND PATIENTS, FOR USE IN THE MANAGEMENT OF HEALTHCARE PRACTICES AND ELECTRONIC MEDICAL RECORDS VIA THE INTERNET, AND FOR ALLOWING DOCTORS AND HEALTHCARE PROFESSIONALS TO CREATE ONLINE NETWORKS, GROUPS AND COMMUNITIES FOR VARIOUS PURPOSES; AND CLOUD COMPUTING FEATURING SOFTWARE USED TO CONDUCT COMMUNICATIONS BETWEEN PATIENTS AND MEDICAL PERSONNEL, FOR ACCESSING MEDICAL INFORMATION AND RECORDS, FOR TRANSACTING HEALTHCARE ONLINE FOR DOCTORS AND PATIENTS, FOR USE IN THE MANAGEMENT OF HEALTHCARE PRACTICES AND ELECTRONIC MEDICAL RECORDS VIA THE INTERNET, AND FOR ALLOWING DOCTORS AND HEALTHCARE PROFESSIONALS TO CREATE ONLINE NETWORKS, GROUPS AND COMMUNITIES FOR VARIOUS PURPOSES (U.S. CLS. 100 AND 101).

DAVID C. REIHNER, EXAMINING ATTORNEY

SN 77-834,253. THERASTAT DATA CORP., MATTHEWS, NC.
FILED 9-24-2009.

MDSMax

THE MARK CONSISTS OF STANDARD CHARACTERS WITHOUT CLAIM TO ANY PARTICULAR FONT, STYLE, SIZE, OR COLOR.

FOR COMPUTER SERVICES, NAMELY, PROVIDING A WEB-BASED SOFTWARE APPLICATION FOR USE IN NURSING HOMES TO RECORD DAILY CARE GIVEN TO PATIENTS (U.S. CLS. 100 AND 101).

HEATHER BIDDULPH, EXAMINING ATTORNEY

CLASS 42—(Continued).

SN 77-835,513. CASDEX, INC., THOUSAND OAKS, CA.
FILED 9-25-2009.

pebble

THE MARK CONSISTS OF STANDARD CHARACTERS WITHOUT CLAIM TO ANY PARTICULAR FONT, STYLE, SIZE, OR COLOR.

FOR BACK-UP SERVICES FOR COMPUTER HARD DRIVE DATA; CLOUD COMPUTING FEATURING SOFTWARE FOR USE IN DATA STORAGE; COMPUTER SERVICES, NAMELY, INTERACTIVE HOSTING SERVICES WHICH ALLOW THE USER TO PUBLISH AND SHARE THEIR OWN CONTENT AND IMAGES ONLINE; COMPUTER SERVICES, NAMELY, REDIRECTING ELECTRONIC MAIL TO CHANGED PERSONAL ELECTRONIC ADDRESS; DATA WAREHOUSING; REMOTE COMPUTER BACKUP SERVICES; REMOTE ONLINE BACKUP OF COMPUTER DATA (U.S. CLS. 100 AND 101).

JASON TURNER, EXAMINING ATTORNEY

SN 77-838,750. HARVEST TECHNOLOGY GROUP, INC.,
ALPHARETTA, GA. FILED 9-30-2009.

content360°

THE MARK CONSISTS OF STANDARD CHARACTERS WITHOUT CLAIM TO ANY PARTICULAR FONT, STYLE, SIZE, OR COLOR.

FOR INFORMATION TECHNOLOGY CONSULTING SERVICES, NAMELY, CONSULTING, DESIGN, AND COMPUTER PROGRAMMING IN THE AREAS OF ENTERPRISE CONTENT MANAGEMENT (U.S. CLS. 100 AND 101).

FIRST USE 3-11-2003; IN COMMERCE 4-1-2003.

TEJBIR SINGH, EXAMINING ATTORNEY

SN 77-852,081. DAIKIN INDUSTRIES, LTD., KITA-KU
OSAKA, JAPAN, FILED 10-19-2009.

D-NET

THE MARK CONSISTS OF STANDARD CHARACTERS WITHOUT CLAIM TO ANY PARTICULAR FONT, STYLE, SIZE, OR COLOR.

FOR REMOTE MONITORING SERVICES FOR HEATING, VENTILATION, AND AIR CONDITIONING SYSTEMS THAT PROVIDES ENHANCED MAINTENANCE AND SERVICE OFFERINGS DIRECTLY TO END-USERS (U.S. CLS. 100 AND 101).

FIRST USE 8-10-2009; IN COMMERCE 8-10-2009.

PAUL F. GAST, EXAMINING ATTORNEY

CLASS 42—(Continued).

SN 77-853,114. COLLECTIVE MEDIA, INC., NEW YORK, NY.
FILED 10-20-2009.

AUDIENCE HD

THE MARK CONSISTS OF STANDARD CHARACTERS WITHOUT CLAIM TO ANY PARTICULAR FONT, STYLE, SIZE, OR COLOR.

FOR PROVIDING TEMPORARY USE OF ONLINE, NON-DOWNLOADABLE COMPUTER SOFTWARE TO COLLECT ANALYZE AND CLASSIFY BEHAVIORAL, DEMOGRAPHIC, CONTEXTUAL AND CUSTOMIZED WEB USER TARGETING DATA FOR ADVERTISERS AND PROVIDE CUSTOM REPORTS IN CONNECTION THEREWITH (U.S. CLS. 100 AND 101).

NAAKWAMA ANKRAH, EXAMINING ATTORNEY

CLASS 42—(Continued).

SN 77-867,626. ABOUT-ONE LLC, DBA ABOUTONE, MALVERN, PA. FILED 11-7-2009.



THE COLOR(S) YELLOW, PINK, BROWN, BLUE, LILAC, BLACK, GREEN, RED, MAROON AND GRAY IS/ARE CLAIMED AS A FEATURE OF THE MARK.

THE MARK CONSISTS OF A CIRCLE WITH THE FOLLOWING COLORS: YELLOW, PINK, BROWN, BLUE, LILAC, BLACK, GREEN, RED, MAROON; AND THE WORDS "ABOUTONE" IN BLACK AND THE WORDS "YOUR LIFE, ORGANIZED." IN GRAY.

FOR SOFTWARE AS A SERVICE (SAAS) SERVICES FEATURING SOFTWARE IN THE FIELD OF PERSONAL INFORMATION ORGANIZATION (U.S. CLS. 100 AND 101).

FIRST USE 11-1-2009; IN COMMERCE 11-1-2009.
BRIAN NEVILLE, EXAMINING ATTORNEY

SN 77-855,098. BIODIAGNOSTICS INC., RIVER FALLS, WI.
FILED 10-22-2009.

BONAFIDE BDI

THE MARK CONSISTS OF STANDARD CHARACTERS WITHOUT CLAIM TO ANY PARTICULAR FONT, STYLE, SIZE, OR COLOR.

FOR TESTING SERVICES, NAMELY, SEED TESTING SERVICES IN THE AGRICULTURAL INDUSTRY (U.S. CLS. 100 AND 101).

FIRST USE 6-5-2009; IN COMMERCE 6-5-2009.
HOWARD SMIGA, EXAMINING ATTORNEY

SN 77-872,620. DIGITAL EDGE VENTURES INC, DBA DIGITAL EDGE, STATEN ISLAND, NY. FILED 11-13-2009.



THE MARK CONSISTS OF THE STYLIZED WORDS "DIGITALEGE". AN IMAGE OF A ABSTRACT CIRCULAR DESIGN AROUND THE TEXT.

FOR ADVISORY SERVICES IN THE FIELD OF PRODUCT DEVELOPMENT AND QUALITY IMPROVEMENT OF SOFTWARE; APPLICATION SERVICE PROVIDER (ASP), NAMELY, HOSTING COMPUTER SOFTWARE APPLICATIONS OF OTHERS; APPLICATION SERVICE PROVIDER FEATURING SOFTWARE FOR PROVIDING AN ON-LINE DATABASE IN THE FIELD OF TRANSACTION PROCESSING TO UPLOAD TRANSACTIONAL DATA, PROVIDE STATISTICAL ANALYSIS, AND PRODUCE NOTIFICATIONS AND REPORTS; APPLICATION SERVICE PROVIDER, NAMELY, PROVIDING, HOSTING, MANAGING, DEVELOPING, AND MAINTAINING APPLICATIONS, SOFTWARE, WEB SITES, AND DATABASES IN THE FIELDS OF PERSONAL PRODUCTIVITY, WIRELESS COMMUNICATION, MOBILE INFORMATION ACCESS, AND REMOTE DATA MANAGEMENT FOR WIRELESS DELIVERY OF CONTENT TO HANDHELD COMPUTERS, LAPTOPS AND MOBILE ELECTRONIC DEVICES; APPLICATION SERVICE PROVIDER, NAMELY, PROVIDING, HOSTING, MANAGING, DEVELOPING, RESEARCHING, ANALYZING, REPORTING, AND MAINTAINING APPLICATIONS, SOFTWARE, WEB SITES, AND DATABASES OF OTHERS IN THE FIELDS OF HEALTHCARE, BENEFITS PROGRAMS, EMPLOYEE PRODUCTIVITY, AND RISK MANAGEMENT; APPLICATION SERVICE PROVIDER, NAMELY, PROVIDING, HOSTING, MANAGING, DEVELOPING, RESEARCHING, TRACKING, ANALYZING, REPORTING, AND MAINTAINING APPLICATIONS, SOFTWARE, WEB SITES, AND DATABASES OF OTHERS IN THE FIELDS OF ADVERTISING AND MARKETING; APPLICATION SERVICE PROVIDER FEATURING APPLICATION PROGRAMMING INTERFACE (API) SOFTWARE FOR USE IN BUILDING SOFTWARE APPLICATIONS; APPLICATION SERVICE PROVIDER FEATURING APPLICATION PROGRAM-

SN 77-855,135. BIODIAGNOSTICS INC., RIVER FALLS, WI.
FILED 10-22-2009.

PURE PRG

THE MARK CONSISTS OF STANDARD CHARACTERS WITHOUT CLAIM TO ANY PARTICULAR FONT, STYLE, SIZE, OR COLOR.

NO CLAIM IS MADE TO THE EXCLUSIVE RIGHT TO USE "PURE", APART FROM THE MARK AS SHOWN.

FOR TESTING SERVICES, NAMELY, SEED TESTING SERVICES TO DETECT THE PRESENCE OF RYE GRASS (U.S. CLS. 100 AND 101).

FIRST USE 6-5-2009; IN COMMERCE 6-5-2009.
HOWARD SMIGA, EXAMINING ATTORNEY

CLASS 42—(Continued).

MING INTERFACE (API) SOFTWARE FOR ALLOWING DATA RETRIEVAL, UPLOAD, ACCESS AND MANAGEMENT; BACK-UP SERVICES FOR COMPUTER HARD DRIVE DATA; BUSINESS TECHNOLOGY SOFTWARE CONSULTATION SERVICES; COMPUTER CODE CONVERSION FOR OTHERS; COMPUTER COMPATIBILITY SERVICES, NAMELY, DATA MAPPING; COMPUTER CONSULTATION; COMPUTER CONSULTATION IN THE FIELD OF COMPUTER SECURITY; COMPUTER CO-LOCATION SERVICES, NAMELY, PROVIDING FACILITIES FOR THE LOCATION OF COMPUTER SERVERS WITH THE EQUIPMENT OF OTHERS; COMPUTER DIAGNOSTIC SERVICES; COMPUTER DISASTER RECOVERY PLANNING; COMPUTER PROGRAMMING AND MAINTENANCE OF COMPUTER PROGRAMS; COMPUTER PROGRAMMING AND RENTAL OF COMPUTER PROGRAMS; COMPUTER PROGRAMMING AND SOFTWARE DESIGN; COMPUTER PROGRAMMING CONSULTANCY; COMPUTER PROGRAMMING SERVICES FOR OTHERS IN THE FIELD OF SOFTWARE CONFIGURATION MANAGEMENT; COMPUTER PROJECT MANAGEMENT SERVICES; COMPUTER PROJECT MANAGEMENT SERVICES IN THE FIELD OF TELECOMMUNICATIONS; COMPUTER SECURITY CONSULTANCY; COMPUTER SECURITY SERVICE, NAMELY, RESTRICTING ACCESS TO AND BY COMPUTER NETWORKS TO AND OF UNDESIRED WEB SITES, MEDIA AND INDIVIDUALS AND FACILITIES; COMPUTER SERVICE, ACTING AS AN APPLICATION SERVICE PROVIDER IN THE FIELD OF KNOWLEDGE MANAGEMENT TO HOST COMPUTER APPLICATION SOFTWARE FOR CREATING SEARCHABLE DATABASES OF INFORMATION AND DATA TO ALLOW USERS TO PERFORM, ON-LINE, THE COLLECTING AND ANALYZING OF DIFFERENT TYPES OF OPINION SURVEYS; COMPUTER SERVICE, NAMELY, ACTING AS AN APPLICATION SERVICE PROVIDER IN THE FIELD OF KNOWLEDGE MANAGEMENT TO HOST COMPUTER APPLICATION SOFTWARE FOR CREATING SEARCHABLE DATABASES OF INFORMATION AND DATA; COMPUTER SERVICE, NAMELY, ACTING AS AN APPLICATION SERVICE PROVIDER IN THE FIELD OF KNOWLEDGE MANAGEMENT TO HOST COMPUTER APPLICATION SOFTWARE FOR SEARCHING AND RETRIEVING INFORMATION FROM DATABASES AND COMPUTER NETWORKS; COMPUTER SERVICE, NAMELY, ACTING AS AN APPLICATION SERVICE PROVIDER IN THE FIELD OF KNOWLEDGE MANAGEMENT TO HOST COMPUTER APPLICATION SOFTWARE FOR THE COLLECTION, EDITING, ORGANIZING, MODIFYING, BOOK MARKING, TRANSMISSION, STORAGE AND SHARING OF DATA AND INFORMATION; COMPUTER SERVICES IN THE NATURE OF CUSTOMIZED WEB PAGES FEATURING USER-DEFINED INFORMATION, PERSONAL PROFILES AND INFORMATION; COMPUTER SERVICES, NAMELY, CREATING AND MAINTAINING WEB SITES FOR OTHERS; COMPUTER SERVICES, NAMELY, DATA RECOVERY SERVICES; COMPUTER SERVICES, NAMELY, DESIGNING AND IMPLEMENTING NETWORK WEB PAGES FOR OTHERS; COMPUTER SERVICES, NAMELY, DESIGNING AND IMPLEMENTING WEB SITES FOR OTHERS; COMPUTER SERVICES, NAMELY, CREATING INDEXES OF INFORMATION, SITES AND OTHER RESOURCES AVAILABLE ON COMPUTER NETWORKS; COMPUTER SERVICES, NAMELY, MANAGING WEB SITES FOR OTHERS; COMPUTER SERVICES, NAMELY, REDIRECTING ELECTRONIC MAIL TO CHANGED PERSONAL ELECTRONIC ADDRESS; COMPUTER SERVICES, NAMELY, FILTERING OF UNWANTED E-MAILS; COMPUTER SERVICES, NAMELY, MONITORING THE WEB SITES OF OTHERS TO IMPROVE SCALABILITY AND PERFORMANCE OF WEB SITES OF OTHERS; COMPUTER SERVICES, NAMELY, MONITORING AND REPORTING ON THE PERFORMANCE, AVAILABILITY, AND ERRORS OF WEB SITES OF OTHERS; COMPUTER SERVICES, NAMELY, MONITORING, TESTING, ANALYZING, AND REPORTING ON THE INTERNET TRAFFIC CONTROL AND CONTENT CONTROL OF THE WEB SITES OF OTHERS; COMPUTER SERVICES, NAMELY, REMOTE AND ON-SITE MANAGEMENT OF ELECTRONIC MESSAGING SYSTEMS AND APPLICATIONS FOR OTHERS; COMPUTER SERVICES, NAMELY, CREATING AN ON-LINE COMMUNITY FOR REGISTERED USERS TO PARTICIPATE IN COMPETITIONS, SHOWCASE THEIR SKILLS, GET

CLASS 42—(Continued).

FEEDBACK FROM THEIR PEERS, FORM VIRTUAL COMMUNITIES, ENGAGE IN SOCIAL NETWORKING AND IMPROVE THEIR TALENT; COMPUTER SERVICES, NAMELY, COMPUTER SYSTEM ADMINISTRATION FOR OTHERS; COMPUTER SERVICES, NAMELY, HOSTING AND MAINTAINING AN ON-LINE WEB SITE FOR OTHERS TO FUND RAISE, SELL GOODS, TRANSACT FINANCIAL AND OTHER INFORMATION; COMPUTER SERVICES, NAMELY, REMOTE MANAGEMENT OF COMPUTER APPLICATIONS FOR OTHERS; COMPUTER SERVICES, NAMELY, DIGITAL FORMATTING AND COMPRESSION OF MUSIC AND IMAGES, NAMELY, PROCESSING OF DIGITAL MUSIC AND VIDEO IMAGES INTO DOWNLOADABLE PRODUCTS; COMPUTER SERVICES, NAMELY, INTERACTIVE HOSTING SERVICES WHICH ALLOW THE USER TO PUBLISH AND SHARE THEIR OWN CONTENT AND IMAGES ON-LINE; COMPUTER SERVICES, NAMELY, HOSTING AN INTERACTIVE WEB SITE THAT ALLOWS FAMILIES TO RECORD AND DISPLAY FAMILY PROFILES, RELATIONSHIPS, INTERESTS, AUDIO AND VIDEO CONTENT; COMPUTER SERVICES, NAMELY, CREATING AN ON-LINE COMMUNITY FOR REGISTERED USERS TO PARTICIPATE IN DISCUSSIONS, GET FEEDBACK FROM THEIR PEERS, FORM VIRTUAL COMMUNITIES, AND ENGAGE IN SOCIAL NETWORKING; COMPUTER SERVICES, NAMELY, SEARCH ENGINE OPTIMIZATION; COMPUTER SERVICES, NAMELY, PROVIDING AN INTERACTIVE WEB SITE THAT ALLOWS USERS TO COLLECT, STORE, MANAGE, DELIVER AND SHOWCASE ELECTRONIC AND PAPER-BASED CONTENT; COMPUTER SERVICES, NAMELY, PROVIDING A WEB-BASED SYSTEM AND ONLINE PORTAL FOR CUSTOMERS TO REMOTELY MANAGE, ADMINISTER, MODIFY AND CONTROL THEIR END USER COMPUTER DEVICES, DATA AND SOFTWARE APPLICATIONS; COMPUTER SERVICES, NAMELY, REMOTE AND ON-SITE MANAGEMENT OF THE INFORMATION TECHNOLOGY (IT) SYSTEMS OF OTHERS; COMPUTER SITE DESIGN; COMPUTER SOFTWARE CONSULTATION; COMPUTER SOFTWARE CONSULTANCY; COMPUTER SOFTWARE CONSULTING; COMPUTER SOFTWARE DESIGN FOR OTHERS; COMPUTER SOFTWARE DEVELOPMENT; COMPUTER SOFTWARE DESIGN, COMPUTER PROGRAMMING, OR MAINTENANCE OF COMPUTER SOFTWARE; COMPUTER SOFTWARE DESIGN; COMPUTER SOFTWARE DEVELOPMENT AND COMPUTER PROGRAMMING DEVELOPMENT FOR OTHERS; COMPUTER SOFTWARE INSTALLATION AND MAINTENANCE; COMPUTER SYSTEM DESIGN SERVICES; COMPUTER SYSTEMS ANALYSIS; COMPUTER SYSTEMS INTEGRATION SERVICES; CONSULTANCY IN THE FIELD OF SOFTWARE DESIGN; CONSULTANCY WITH REGARD TO WEB PAGE DESIGN; CONSULTING IN THE FIELD OF TELECOMMUNICATIONS TECHNOLOGY; CONSULTING IN THE FIELD OF INFORMATION TECHNOLOGY; CONSULTING IN THE FIELD OF IT PROJECT MANAGEMENT; CONSULTING IN THE FIELD OF VIRTUALIZATION TECHNOLOGIES FOR ENTERPRISES AND BUSINESSES; CONSULTING IN THE FIELD OF CONFIGURATION MANAGEMENT FOR COMPUTER HARDWARE AND SOFTWARE; CONSULTING SERVICES IN THE FIELD OF DESIGN, SELECTION, IMPLEMENTATION AND USE OF COMPUTER HARDWARE AND SOFTWARE SYSTEMS FOR OTHERS; CONSULTING SERVICES IN THE FIELD OF COMPUTER-BASED INFORMATION SYSTEMS FOR BUSINESSES; CONSULTING SERVICES IN THE FIELD OF IDENTIFICATION, SUPPORT, AND IMPLEMENTATION OF COMPUTER-BASED INFORMATION SYSTEMS FOR BUSINESSES; CONSULTING SERVICES IN THE FIELD OF HOSTING COMPUTER SOFTWARE APPLICATIONS; CREATING AND DESIGNING WEB PAGES FOR OTHERS; CREATING AND MAINTAINING BLOGS FOR OTHERS; CREATING AND MAINTAINING WEBLOGS FOR OTHERS; CREATING OF COMPUTER PROGRAMS; CREATING OR MAINTAINING WEB SITES FOR OTHERS; CREATING, DESIGNING AND MAINTAINING WEB SITES; CREATING, MAINTAINING, AND MODERNIZING COMPUTER SOFTWARE; CREATION AND MAINTENANCE OF WEB SITES FOR OTHERS; CREATION AND PROVISION OF WEB PAGES TO AND FOR THIRD PARTIES; CUSTOMIZATION OF COMPUTER HARDWARE AND SOFTWARE; CUSTOMIZED SOFTWARE DEVELOPMENT SERVICES; DATA AUTOMATION AND COLLECTION SERVICE USING

CLASS 42—(Continued).

PROPRIETARY SOFTWARE TO EVALUATE, ANALYZE AND COLLECT SERVICE DATA; DATA MIGRATION SERVICES; DATA MINING; DATA WAREHOUSING; DATABASE DESIGN AND DEVELOPMENT; DESIGN AND DEVELOPMENT OF NETWORKS; DESIGN AND DEVELOPMENT OF ON-LINE COMPUTER SOFTWARE SYSTEMS; DESIGN AND DEVELOPMENT OF COMPUTER HARDWARE AND SOFTWARE; DESIGN AND DEVELOPMENT OF COMPUTER HARDWARE; DESIGN AND DEVELOPMENT OF COMPUTER SOFTWARE; DESIGN AND DEVELOPMENT OF WIRELESS COMPUTER NETWORKS; DESIGN AND DEVELOPMENT OF VISUALIZATION TECHNOLOGIES FOR ADVERTISEMENT OF REAL-ESTATE, COMMERCIAL PRODUCT AND BUSINESS OF OTHERS; DESIGN AND DEVELOPMENT OF COMPUTERS AND PROGRAMS FOR COMPUTERS; DESIGN AND MAINTENANCE OF COMPUTER SITES FOR THIRD PARTIES; DESIGN OF COMPUTER HARDWARE, INTEGRATED CIRCUITS, COMMUNICATIONS HARDWARE AND SOFTWARE AND COMPUTER NETWORKS FOR OTHERS; DESIGN OF HOME PAGES; DESIGN OF HOME PAGES, COMPUTER SOFTWARE AND WEB SITES; DESIGN OF HOME PAGES AND WEB SITES; DESIGN OF HOMEPAGES AND WEBSITES; DESIGN, CREATION, HOSTING AND MAINTENANCE OF INTERNET SITES FOR THIRD PARTIES; DESIGN, CREATION, HOSTING, MAINTENANCE OF WEBSITES FOR OTHERS; DESIGN, DEPLOYMENT AND MANAGEMENT OF WIRELESS NETWORKS FOR OTHERS; DESIGN, DEVELOPMENT AND IMPLEMENTATION OF SOFTWARE; DESIGN, DEVELOPMENT AND CONSULTING SERVICES IN THE FIELD OF SOFTWARE FOR CONTENT MANAGEMENT; DESIGN, DEVELOPMENT, AND CONSULTING SERVICES IN THE FIELD OF HOME AND WORKPLACE AUTOMATION HARDWARE AND SOFTWARE; DESIGN, MAINTENANCE, DEVELOPMENT AND UPDATING OF COMPUTER SOFTWARE; DESIGNING AND DEVELOPING WEB PAGES ON THE INTERNET; DESIGNING WEBSITES FOR ADVERTISING PURPOSES; DEVELOPING AND UPDATING COMPUTER SOFTWARE; DEVELOPING COMPUTER SOFTWARE; DEVELOPING OF DRIVER AND OPERATING SYSTEM SOFTWARE; DEVELOPMENT AND CREATION OF COMPUTER PROGRAMMES FOR DATA PROCESSING; DEVELOPMENT OF CUSTOMIZED SOFTWARE FOR OTHERS FOR USE IN RISK ASSESSMENT, INFORMATION SECURITY, BUSINESS ANALYSIS, AUDIT AND AUDIT PLANNING, AND SALES MANAGEMENT; DEVELOPMENT OF DATA PROCESSING PROGRAMS BY ORDER OF THIRD PARTIES; DEVELOPMENT, DESIGN AND UPDATING OF HOME PAGES; DEVELOPMENT, UPDATING AND MAINTENANCE OF SOFTWARE AND DATA BASES; DISPLAYING THE WEB SITES AND IMAGES OF OTHERS ON A COMPUTER SERVER; DOCUMENT DATA TRANSFER FROM ONE COMPUTER FORMAT TO ANOTHER; HOMEPAGE AND WEB PAGE DESIGN; HOSTING AN ONLINE COMMUNITY WEBSITE FEATURING SHARED COMMUNICATIONS BETWEEN COMMUNITY MEMBERS INTERESTED IN PERSONAL AND SMALL BUSINESS COMPUTER INFORMATION SECURITY; HOSTING OF DIGITAL CONTENT ON THE INTERNET; HOSTING OF WEB SITES; HOSTING THE WEB SITES OF OTHERS ON A COMPUTER SERVER FOR A GLOBAL COMPUTER NETWORK; HOSTING THE WEB SITES OF OTHERS; INFORMATION TECHNOLOGY CONSULTATION; INSTALLATION AND MAINTENANCE OF COMPUTER SOFTWARE; INSTALLATION AND MAINTENANCE OF INTERNET ACCESS SOFTWARE; INSTALLATION OF COMPUTER SOFTWARE; INSTALLATION, MAINTENANCE AND REPAIR OF COMPUTER SOFTWARE; INSTALLATION, REPAIR AND MAINTENANCE OF COMPUTER SOFTWARE; INSTALLING COMPUTER PROGRAMS; INTEGRATION OF COMPUTER SYSTEMS AND NETWORKS; IT CONSULTING SERVICES; IT INTEGRATION SERVICES; MAINTENANCE AND UPDATING OF COMPUTER SOFTWARE; MAINTENANCE AND UPGRADING OF COMPUTER SOFTWARE; MAINTENANCE OF COMPUTER SOFTWARE; MAINTENANCE OF COMPUTER SOFTWARE USED FOR OPERATING FILLING APPARATUS AND MACHINES; MAINTENANCE OF COMPUTER SOFTWARE RELATING TO COMPUTER SECURITY AND PREVENTION OF COMPUTER RISKS; MAINTENANCE OF ON-LINE DATABASES FOR OTHERS; MAINTENANCE OF SOFTWARE FOR INTERNET ACCESS; MAINTENANCE OF

CLASS 42—(Continued).

WEBSITES AND HOSTING ON-LINE WEB FACILITIES FOR OTHERS; MANAGING WEB SITES FOR OTHERS; ON-LINE BATCH COMPUTER SERVICES; ON-LINE SYSTEM MANAGEMENT SERVICES THAT ALLOW USERS TO REMOTELY VIEW, MONITOR, PROGRAM, OPERATE AND CONTROL LARGE AND SMALL APPLIANCES, ELECTRICAL SYSTEMS AND SECURITY SYSTEMS IN HOMES, OFFICES AND VEHICLES; ON-LINE WEB SITE THAT ENABLES THE MANAGEMENT OF PRINT SYSTEMS OF OTHERS BY PROVIDING TECHNICAL MAINTENANCE AND PERFORMANCE REPORTS BASED ON DATA PROVIDED BY USERS; PROFESSIONAL COMPUTER SERVICES, NAMELY, NETWORK ANALYSIS, LAN/WAN DESIGN, WIRELESS ENGINEERING, VIRTUALIZATION AND COMPUTER PROJECT MANAGEMENT; PROGRAMMING OF COMPUTER SOFTWARE FOR OTHERS; PROGRAMMING OF MULTIMEDIA APPLICATIONS; PROVIDING A SECURE, WEB-BASED SERVICE ENABLING INDIVIDUALS TO REMOTELY CREATE AND MANAGE THEIR OWN ACCOUNTS SO THAT WHATEVER PRIVATE CONTENT THEY UPLOAD NOW CAN BE ENCRYPTED, THEN DELIVERED TO THEIR INTENDED RECIPIENTS, AT THE TIME AND IN THE MANNER REQUESTED; PROVIDING A SECURED-ACCESS WEBSITE THAT GIVES REGISTERED INTERNET NETWORKED INSTITUTIONS THE ABILITY TO UPLOAD, VIEW, COPY, PRINT, DOWNLOAD AND SHARE DOCUMENTS AND IMAGES FOR THE PURPOSES OF CONDUCTING CONSUMER-DRIVEN TRANSACTIONS; PROVIDING A WEB SITE THAT FEATURES INFORMATION ON COMPUTER TECHNOLOGY AND PROGRAMMING; PROVIDING COMPUTER PROGRAMMING SERVICES TO CUSTOMERS THAT ENABLES THEM TO PROVIDE VIDEO AND AUDIO CONTENT ON THEIR WEB SITES; PROVIDING COMPUTER PROGRAMMING SERVICES TO CUSTOMERS THAT ENABLES THE CUSTOMER'S WEBSITE TO PROCESS NATURAL LANGUAGE QUERIES; RECONSTRUCTION OF DATABASES FOR OTHERS; REMOTE COMPUTER BACKUP SERVICES; REMOTE COMPUTER NETWORK TECHNICAL MONITORING AND SOFTWARE MAINTENANCE SERVICES; REMOTE ONLINE BACKUP OF COMPUTER DATA; RENTAL OF A DATABASE SERVER TO THIRD PARTIES; RENTAL OF COMPUTER HARDWARE; RENTAL OF COMPUTER SOFTWARE, DATA PROCESSING EQUIPMENT AND COMPUTER PERIPHERAL DEVICES; RENTAL OF WEB SERVERS; REPAIR OF SOFTWARE; SOFTWARE DEVELOPMENT FOR OTHERS IN THE FIELD OF SOFTWARE CONFIGURATION MANAGEMENT; TECHNICAL SUPPORT SERVICES, NAMELY, TROUBLESHOOTING IN THE NATURE OF DIAGNOSING COMPUTER HARDWARE AND SOFTWARE PROBLEMS; TECHNICAL SUPPORT SERVICES, NAMELY, TROUBLESHOOTING OF INDUSTRIAL PROCESS CONTROL COMPUTER SOFTWARE PROBLEMS; TECHNICAL SUPPORT SERVICES, NAMELY, TROUBLESHOOTING OF COMPUTER SOFTWARE PROBLEMS; TECHNICAL SUPPORT, NAMELY, MONITORING OF NETWORK SYSTEMS; TECHNICAL SUPPORT, NAMELY, PROVIDING BACK-UP COMPUTER PROGRAMS AND FACILITIES; UPDATING AND DESIGN OF COMPUTER SOFTWARE; UPDATING AND MAINTENANCE OF COMPUTER SOFTWARE; UPDATING AND RENTAL OF SOFTWARE FOR DATA PROCESSING; UPDATING OF COMPUTER SOFTWARE FOR OTHERS; UPDATING OF COMPUTER PROGRAMS FOR THIRD PARTIES; UPDATING OF COMPUTER SOFTWARE RELATING TO COMPUTER SECURITY AND PREVENTION OF COMPUTER RISKS; UPDATING WEBSITES FOR OTHERS; WEB SITE DESIGN; WEB SITE DEVELOPMENT FOR OTHERS; WEB SITE HOSTING SERVICES; WEBSITE DEVELOPMENT FOR OTHERS; WEBSITE USABILITY TESTING SERVICES; WRITING AND UPDATING COMPUTER SOFTWARE; WRITING OF DATA PROCESSING PROGRAMS (U.S. CLS. 100 AND 101).

FIRST USE 2-14-2002; IN COMMERCE 2-14-2002.
LAURIE KAUFMAN, EXAMINING ATTORNEY

CLASS 42—(Continued).

SN 77-872,628. RALLY COMMUNICATIONS, LLC, DBA RALLY CONGRESS, ARLINGTON, VA. FILED 11-13-2009.



NO CLAIM IS MADE TO THE EXCLUSIVE RIGHT TO USE "RALLY CONGRESS", APART FROM THE MARK AS SHOWN.

THE COLOR(S) GRAY AND DARK NAVY BLUE IS/ARE CLAIMED AS A FEATURE OF THE MARK.

THE MARK CONSISTS OF THE WORDS "RALLY CONGRESS" IN GRAY, AND IN BETWEEN THE WORDS IS A STYLIZED PENNANT/FLAG IN DARK NAVY BLUE.

FOR SOFTWARE AS A SERVICE (SAAS) SERVICES FEATURING SOFTWARE IN THE FIELD OF CREATING, MANAGING AND DISTRIBUTING ONLINE PETITIONS, CREATING AND MANAGING CHARITABLE FUND RAISING CAMPAIGNS, DATABASE MANAGEMENT, EMAIL-MARKETING, AND WEB-CONTENT MANAGEMENT IN THE FIELD OF POLITICAL ADVOCACY (U.S. CLS. 100 AND 101).

FIRST USE 3-17-2006; IN COMMERCE 3-17-2006.
KATHY DE JONGE, EXAMINING ATTORNEY

SN 77-887,886. IO DATA CENTERS, LLC, PHOENIX, AZ. FILED 12-7-2009.

I/O ON DEMAND

THE MARK CONSISTS OF STANDARD CHARACTERS WITHOUT CLAIM TO ANY PARTICULAR FONT, STYLE, SIZE, OR COLOR.

OWNER OF U.S. REG. NO. 3,414,361.

NO CLAIM IS MADE TO THE EXCLUSIVE RIGHT TO USE "ON DEMAND", APART FROM THE MARK AS SHOWN.

FOR PROVIDING ONLINE SERVICES, NAMELY, HOSTING AND MANAGEMENT OF COMPUTER HARDWARE, COMPUTER OPERATING SYSTEMS AND COMPUTER APPLICATIONS INFRASTRUCTURES (U.S. CLS. 100 AND 101).

FIRST USE 4-1-2010; IN COMMERCE 4-1-2010.
JULIE VEPPUMTHARA, EXAMINING ATTORNEY

CLASS 42—(Continued).

SN 77-893,357. PLAYDOM, INC., MOUNTAIN VIEW, CA. FILED 12-15-2009.

SORORITY LIFE

THE MARK CONSISTS OF STANDARD CHARACTERS WITHOUT CLAIM TO ANY PARTICULAR FONT, STYLE, SIZE, OR COLOR.

FOR COMPUTER SERVICES, NAMELY, CREATING AN ON-LINE COMMUNITY FOR REGISTERED USERS TO PARTICIPATE IN AND HOLD COMPETITIONS, SHOWCASE THEIR SKILLS, IMPROVE THEIR TALENT, PARTICIPATE IN INCENTIVE AWARD PROGRAMS, GET FEEDBACK FROM THEIR PEERS, FORM VIRTUAL COMMUNITIES; PROVIDING NON-DOWNLOADABLE SOFTWARE FOR TRADE, BUY AND SELL VIRTUAL GOODS, CONDUCT VIRTUAL TOURS, FACILITATE INTERACTION AMONG USERS, RANK USERS, ENGAGE IN SOCIAL NETWORKING, AND PARTICIPATE IN ON-LINE DISCUSSION BOARDS; PROVIDING TEMPORARY USE OF NON-DOWNLOADABLE SOFTWARE TO ENABLE VIEWING, PREVIEWING, SHARING, MANIPULATING, PLAYING, BLOGGING, AND PROVIDING COMPUTER GAMES, ENABLING ENHANCEMENTS FOR COMPUTER GAMES, ONLINE GAMES, AND GAME APPLICATIONS AND FOR PROVIDING INFORMATION RELATING TO COMPUTER GAMES AND GAME ENHANCEMENTS VIA GLOBAL COMPUTER NETWORKS AND ELECTRONIC COMMUNICATION NETWORKS FOR USE IN CONNECTION WITH COMPUTERS, MOBILE COMPUTERS, MEDIA PLAYERS, CELLULAR PHONES, WIRELESS DEVICES AND PORTABLE AND HANDHELD DIGITAL ELECTRONIC DEVICES; PROVIDING TEMPORARY USE OF NON-DOWNLOADABLE COMPUTER OPERATING SOFTWARE FOR COMPUTER GAMES, PROVIDING TEMPORARY USE OF NON-DOWNLOADABLE SOFTWARE FOR ENHANCEMENTS FOR COMPUTER GAMES, PROVIDING TEMPORARY USE OF NON-DOWNLOADABLE COMPUTER OPERATING SOFTWARE FOR ONLINE GAMES, AND GAME APPLICATIONS VIA GLOBAL COMPUTER NETWORKS AND ELECTRONIC COMMUNICATION NETWORKS FOR USE IN CONNECTION WITH COMPUTERS, MOBILE COMPUTERS, MEDIA PLAYERS, CELLULAR PHONES, WIRELESS DEVICES AND PORTABLE AND HANDHELD DIGITAL ELECTRONIC DEVICES (U.S. CLS. 100 AND 101).

FIRST USE 11-5-2008; IN COMMERCE 11-5-2008.
GINA HAYES, EXAMINING ATTORNEY

SN 77-893,653. COMPUWARE CORPORATION, DETROIT, MI. FILED 12-15-2009.

IDcipher

THE MARK CONSISTS OF STANDARD CHARACTERS WITHOUT CLAIM TO ANY PARTICULAR FONT, STYLE, SIZE, OR COLOR.

FOR PROVIDING NON-DOWNLOADABLE SOFTWARE, NAMELY, A SECURITY AUTHENTICATION SYSTEM FOR DESKTOP COMPUTERS (U.S. CLS. 100 AND 101).

FIRST USE 8-20-2009; IN COMMERCE 9-2-2009.
NAAKWAMA ANKRAH, EXAMINING ATTORNEY

CLASS 42—(Continued).

SN 77-896,421. KFORCE INC., TAMPA, FL. FILED 12-18-2009.

KGS

THE MARK CONSISTS OF STANDARD CHARACTERS WITHOUT CLAIM TO ANY PARTICULAR FONT, STYLE, SIZE, OR COLOR.

OWNER OF U.S. REG. NOS. 3,685,767, 3,711,498 AND 3,722,308.

FOR COMPUTER SERVICES, NAMELY, NETWORK DESIGN AND SOFTWARE DEVELOPMENT; COMPUTER TECHNOLOGY SUPPORT SERVICES, NAMELY, COMPUTER SYSTEMS AND SOFTWARE APPLICATION DEPLOYMENT, MANAGEMENT, AND HELP DESK SERVICES; RESEARCH AND DEVELOPMENT OF NEW PRODUCTS AND COMPUTER SOFTWARE TECHNOLOGIES; CONTINGENCY PLANNING FOR INFORMATION SYSTEMS; TECHNOLOGY PLANNING AND CONSULTING IN THE FIELDS OF SECURITY AND DEFENSE (U.S. CLS. 100 AND 101).

FIRST USE 3-13-2006; IN COMMERCE 3-13-2006.
HEATHER THOMPSON, EXAMINING ATTORNEY

CLASS 42—(Continued).

SN 77-898,825. 5 MINUTES, LTD., NEW YORK, NY. FILED 12-22-2009.

VIDEOSEED

THE MARK CONSISTS OF STANDARD CHARACTERS WITHOUT CLAIM TO ANY PARTICULAR FONT, STYLE, SIZE, OR COLOR.

FOR PROVIDING A WEBSITE FEATURING TECHNOLOGY THAT PROCESSES VIDEO CONTENT, NAMELY, ASSIGNS METADATA, ORGANIZES METADATA, AND CATEGORIZES THE VIDEO CONTENT; COMPUTER SOFTWARE SERVICES, NAMELY, DESIGNING, PROGRAMMING AND PROVIDING ONLINE NONDOWNLOADABLE SOFTWARE IN THE NATURE OF ONLINE WIDGETS FOR THE DISPLAY OF VIDEO CONTENT; PROVIDING ONLINE NONDOWNLOADABLE SOFTWARE FOR STREAMING VIDEOS; PROVIDING ONLINE NONDOWNLOADABLE SOFTWARE IN THE NATURE OF AN ONLINE VIDEO PLAYER (U.S. CLS. 100 AND 101).

FIRST USE 10-30-2008; IN COMMERCE 10-30-2008.
REBECCA EISINGER, EXAMINING ATTORNEY

SN 77-901,662. ZIGMO, LLC, RICHMOND, VA. FILED 12-28-2009.

ZIGMO

THE MARK CONSISTS OF STANDARD CHARACTERS WITHOUT CLAIM TO ANY PARTICULAR FONT, STYLE, SIZE, OR COLOR.

FOR INSTALLATION, MAINTENANCE, AND REPAIR OF COMPUTER SOFTWARE IN THE FIELD OF MULTIMEDIA, DATA COMMUNICATIONS, COMPUTING, SECURITY SYSTEMS, HOME AUTOMATION, AUTOMOTIVE ELECTRONICS, AND APPLIANCES; TECHNICAL COMPUTER CONSULTATION IN THE FIELDS OF COMPUTER HARDWARE DESIGN, SELECTION, DIAGNOSTICS, IMPLEMENTATION, PROGRAMMING, DATA CONVERSION, AND UPDATING OF COMPUTER HARDWARE AND SOFTWARE; TECHNOLOGICAL CONSULTATION IN THE TECHNOLOGICAL FIELD OF CONSUMER ELECTRONICS, NAMELY, MULTIMEDIA CONSUMER ELECTRONICS, DATA COMMUNICATIONS CONSUMER ELECTRONICS, COMPUTER HARDWARE SYSTEMS, ELECTRONIC SECURITY SYSTEMS, HOME AUTOMATION ELECTRONIC DEVICES, AUTOMOTIVE ELECTRONIC DEVICES, AND HOME APPLIANCES (U.S. CLS. 100 AND 101).

HEATHER BIDDULPH, EXAMINING ATTORNEY

SN 77-898,022. BERGMANN ASSOCIATES INC., ROCHESTER, NY. FILED 12-21-2009.

BERGMANN ASSOCIATES

THE MARK CONSISTS OF STANDARD CHARACTERS WITHOUT CLAIM TO ANY PARTICULAR FONT, STYLE, SIZE, OR COLOR.

NO CLAIM IS MADE TO THE EXCLUSIVE RIGHT TO USE "ASSOCIATES", APART FROM THE MARK AS SHOWN.

SEC. 2(F).
FOR ARCHITECTURAL AND ENGINEERING SERVICES (U.S. CLS. 100 AND 101).
FIRST USE 0-0-1999; IN COMMERCE 0-0-1999.
LAKEISHA LEWIS, EXAMINING ATTORNEY

CLASS 42—(Continued).

SN 77-904,902. DIGITAL MUSE, LLC, MOULTONBOROUGH, NH. FILED 1-5-2010.

DIGITAL MUSE

THE MARK CONSISTS OF STANDARD CHARACTERS WITHOUT CLAIM TO ANY PARTICULAR FONT, STYLE, SIZE, OR COLOR.

NO CLAIM IS MADE TO THE EXCLUSIVE RIGHT TO USE "DIGITAL", APART FROM THE MARK AS SHOWN. FOR COMPUTER SOFTWARE CONSULTING, DESIGN AND DEVELOPMENT (U.S. CLS. 100 AND 101).

FIRST USE 12-20-2009; IN COMMERCE 12-20-2009.
HELENE LIWINSKI, EXAMINING ATTORNEY

SN 77-907,786. PONDERA BIOTECHNOLOGIES LLC, POWNALL, ME. FILED 1-8-2010.

PONDERA

THE MARK CONSISTS OF STANDARD CHARACTERS WITHOUT CLAIM TO ANY PARTICULAR FONT, STYLE, SIZE, OR COLOR.

FOR DEVELOPMENT OF PHARMACEUTICAL PREPARATIONS AND MEDICINES; PHARMACEUTICAL RESEARCH AND DEVELOPMENT (U.S. CLS. 100 AND 101).

NATALIE POLZER, EXAMINING ATTORNEY

SN 77-908,544. 911MYWEB, LLC., CORAL GABLES, FL. FILED 1-10-2010.

911MYWEB.COM

THE MARK CONSISTS OF STANDARD CHARACTERS WITHOUT CLAIM TO ANY PARTICULAR FONT, STYLE, SIZE, OR COLOR.

FOR APPLICATION SERVICE PROVIDER, NAMELY, HOSTING, MANAGING, DEVELOPING AND MAINTAINING APPLICATIONS, SOFTWARE, WEBSITES AND DATABASES, IN THE FIELD OF, WORLDWIDE WEB DEVELOPMENT AND INTERNET DESIGNS (U.S. CLS. 100 AND 101).

FIRST USE 9-19-2007; IN COMMERCE 9-19-2007.
JAY FLOWERS, EXAMINING ATTORNEY

CLASS 42—(Continued).

SN 77-912,379. BARROW, TERESA, FORT SMITH, AR. FILED 1-14-2010.

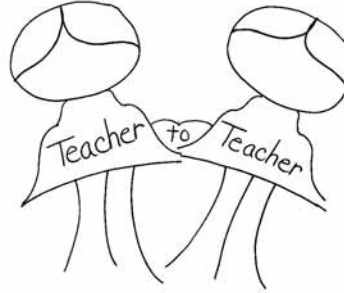

NO CLAIM IS MADE TO THE EXCLUSIVE RIGHT TO USE "TEACHER", APART FROM THE MARK AS SHOWN. THE MARK CONSISTS OF TWO TEACHERS FACING EACH OTHER; HANDS EXTENDED TOWARDS EACH OTHER AND THE STYLIZED TEXT "TEACHER TO TEACHER".

FOR COMPUTER SERVICES, NAMELY, CREATING AN ON-LINE COMMUNITY FOR REGISTERED USERS TO PARTICIPATE IN DISCUSSIONS, GET FEEDBACK FROM THEIR PEERS, FORM VIRTUAL COMMUNITIES, AND ENGAGE IN SOCIAL NETWORKING FEATURING INFORMATION RELEVANT TO TEACHERS AND THE EDUCATION COMMUNITY, SUCH AS ADVICE, TIPS, SHARING IDEAS, AND/OR BEST PRACTICES IN THEIR CLASSROOMS WITH ONE ANOTHER (U.S. CLS. 100 AND 101).

KATHERINE M. DUBRAY, EXAMINING ATTORNEY

SN 77-912,523. VMCS INC., NEW YORK, NY. FILED 1-15-2010.

ENERGY INSIDE

THE MARK CONSISTS OF STANDARD CHARACTERS WITHOUT CLAIM TO ANY PARTICULAR FONT, STYLE, SIZE, OR COLOR.

FOR DESIGN AND IMPLEMENTATION OF WEB BASED AND MOBILE BASED SOFTWARE TO PROMOTE MENTAL WELLBEING, THE SCIENCE OF EMOTION AND THE USE OF APPLIED PSYCHOLOGY PRINCIPLES (U.S. CLS. 100 AND 101).

FIRST USE 9-1-2009; IN COMMERCE 9-1-2009.
MAYUR VAGHANI, EXAMINING ATTORNEY

CLASS 42—(Continued).

SN 77-912,581. VMCS INC., NEW YORK, NY. FILED 1-15-2010.

PEPFLY

THE MARK CONSISTS OF STANDARD CHARACTERS WITHOUT CLAIM TO ANY PARTICULAR FONT, STYLE, SIZE, OR COLOR.

FOR PROVIDING TEMPORARY USE OF A NON-DOWNLOADABLE WEB BASED AND MOBILE BASED INTERACTIVE SOFTWARE PROGRAM FOR DELIVERING CONTENT AND MEDIA TO THE USER UPON INPUT RECEIVED FROM THE USER (U.S. CLS. 100 AND 101).

FIRST USE 9-1-2009; IN COMMERCE 9-1-2009.
MAYUR VAGHANI, EXAMINING ATTORNEY

SN 77-914,618. LACODA, LLC, PHILADELPHIA, PA. FILED 1-19-2010.

LACODA

THE MARK CONSISTS OF STANDARD CHARACTERS WITHOUT CLAIM TO ANY PARTICULAR FONT, STYLE, SIZE, OR COLOR.

THE WORDING "LACODA" HAS NO MEANING IN A FOREIGN LANGUAGE.

FOR SOFTWARE AS A SERVICE (SAAS) SERVICES FEATURING LOAN MANAGEMENT SOFTWARE (U.S. CLS. 100 AND 101).

MYRIAH HABEEB, EXAMINING ATTORNEY

SN 77-917,766. MIROMATRIX MEDICAL INC., EDEN PRAIRIE, MN. FILED 1-22-2010.

MIROMATRIX

THE MARK CONSISTS OF STANDARD CHARACTERS WITHOUT CLAIM TO ANY PARTICULAR FONT, STYLE, SIZE, OR COLOR.

FOR MEDICAL AND SCIENTIFIC RESEARCH; PRODUCT DEVELOPMENT SERVICES IN THE FIELDS OF BIOTECHNOLOGY, PHARMACEUTICALS, AND MEDICAL DEVICES (U.S. CLS. 100 AND 101).

JORDAN BAKER, EXAMINING ATTORNEY

CLASS 42—(Continued).

SN 77-918,384. CONNECTWISE.COM, INC., TAMPA, FL. FILED 1-22-2010.



THE COLOR(S) BLACK, BLUE AND GRAY IS/ARE CLAIMED AS A FEATURE OF THE MARK.

THE MARK CONSISTS OF A BLUE REPRESENTATION OF AN OWL'S HEAD ABOVE THE LETTERS "CONNECT-WISE". THE LETTERS ARE BLACK, THE PLUS SIGN REPRESENTING THE LETTER "T" IS BLUE, THE WORDS "IT'S BUSINESS OPERATING SYSTEM" ARE BELOW IN GRAY.

FOR PROVIDING ON-LINE SOFTWARE FOR USE IN BUSINESS AUTOMATION, CLIENT RELATIONSHIP MANAGEMENT, INVOICE AUTOMATION AND SALES AUTOMATION (U.S. CLS. 100 AND 101).

FIRST USE 12-0-2009; IN COMMERCE 12-0-2009.
WON TEAK OH, EXAMINING ATTORNEY

SN 77-918,938. WEBER, RONALD GENE, OWASSO, OK. FILED 1-25-2010.



NO CLAIM IS MADE TO THE EXCLUSIVE RIGHT TO USE "INNOVATIONS", APART FROM THE MARK AS SHOWN.

THE MARK CONSISTS OF THE WORDING "RGW INNOVATIONS" IN STYLIZED FONT.

FOR DEVELOPMENT OF NEW TECHNOLOGY FOR OTHERS IN THE FIELD OF MARINE ELECTRONICS (U.S. CLS. 100 AND 101).

MICHAEL GAFFAR, EXAMINING ATTORNEY

SN 77-919,122. ANDREWS, DANIEL, CAMARILLO, CA. FILED 1-25-2010.

EPIC WAR

THE MARK CONSISTS OF STANDARD CHARACTERS WITHOUT CLAIM TO ANY PARTICULAR FONT, STYLE, SIZE, OR COLOR.

FOR FILE SHARING SERVICES, NAMELY, PROVIDING A WEBSITE FEATURING TECHNOLOGY ENABLING USERS TO UPLOAD AND DOWNLOAD ELECTRONIC FILES (U.S. CLS. 100 AND 101).

FIRST USE 11-20-2004; IN COMMERCE 1-0-2006.
JANICE KIM, EXAMINING ATTORNEY

CLASS 42—(Continued).

SN 77-919,340. TRANSPORTATION INSIGHT LLC, HICKORY, NC. FILED 1-25-2010.

InsightTMS

THE MARK CONSISTS OF STANDARD CHARACTERS WITHOUT CLAIM TO ANY PARTICULAR FONT, STYLE, SIZE, OR COLOR.

OWNER OF U.S. REG. NOS. 2,965,006, 3,486,481 AND OTHERS.

FOR PROVIDING TEMPORARY USE OF ON-LINE NONDOWNLOADABLE SOFTWARE FOR USE IN MANAGING FREIGHT AND TRANSPORTATION BY CORPORATIONS (U.S. CLS. 100 AND 101).

FIRST USE 1-18-2010; IN COMMERCE 1-18-2010.
PRISCILLA MILTON, EXAMINING ATTORNEY

SN 77-922,340. GLEN A. BUTCHER, WABASH, IN. FILED 1-28-2010.



NO CLAIM IS MADE TO THE EXCLUSIVE RIGHT TO USE ".COM", APART FROM THE MARK AS SHOWN.

THE MARK CONSISTS OF A DEERHEAD SKULL AND ANTLERS WITH THE WORDS "FLAT DEERHEADS" AND ".COM" PLACED ABOVE EACH OTHER IN BETWEEN THE ANTLERS.

FOR PROVIDING A WEBSITE FEATURING TECHNOLOGY THAT ENABLES USERS TO UPLOAD PHOTOGRAPHS AND PURCHASE CUSTOM PRINTED WALL GRAPHICS, PORTRAITS, POSTCARDS, GREETING CARDS AND BANNERS (U.S. CLS. 100 AND 101).

LINDA ORNDORFF, EXAMINING ATTORNEY

SN 77-922,923. INFLECTION LLC, PALO ALTO, CA. FILED 1-28-2010.

PeopleSearchPro.com

THE MARK CONSISTS OF STANDARD CHARACTERS WITHOUT CLAIM TO ANY PARTICULAR FONT, STYLE, SIZE, OR COLOR.

OWNER OF U.S. REG. NO. 3,480,094.

FOR COMPUTER SERVICES, NAMELY, PROVIDING SEARCH ENGINES FOR OBTAINING DATA ON A GLOBAL COMPUTER NETWORK (U.S. CLS. 100 AND 101).

FIRST USE 7-2-2009; IN COMMERCE 7-2-2009.
DORITT L. CARROLL, EXAMINING ATTORNEY

CLASS 42—(Continued).

SN 77-923,128. CURTISS-WRIGHT FLOW CONTROL CORPORATION, FALLS CHURCH, VA. FILED 1-29-2010.

ENGINEERING TRANSFORMATION.

THE MARK CONSISTS OF STANDARD CHARACTERS WITHOUT CLAIM TO ANY PARTICULAR FONT, STYLE, SIZE, OR COLOR.

NO CLAIM IS MADE TO THE EXCLUSIVE RIGHT TO USE "ENGINEERING", APART FROM THE MARK AS SHOWN.

FOR ENGINEERING SERVICES IN THE FIELD OF COMMERCIAL POWER, GAS PROCESSING, OIL PROCESSING, PETROLEUM PROCESSING AND DEFENSE INDUSTRIES (U.S. CLS. 100 AND 101).

JAMES GRIFFIN, EXAMINING ATTORNEY

SN 77-923,891. BRADDOCK HOLDINGS COMPANY, LLC, DENVER, CO. FILED 1-29-2010.

Crystal Logic

THE MARK CONSISTS OF STANDARD CHARACTERS WITHOUT CLAIM TO ANY PARTICULAR FONT, STYLE, SIZE, OR COLOR.

FOR SOFTWARE AS A SERVICE (SAAS) FEATURING GRAPHIC INTERFACE SOFTWARE USED TO ACCESS SERVICES THAT PROVIDE RESIDENTIAL LOAN-LEVEL DATA AND RELATED INFORMATION AS WELL AS ANALYTICAL SERVICES RELATING TO RESIDENTIAL MORTGAGES, ALL TO THE FINANCIAL AND REAL ESTATE COMMUNITIES, INCLUDING MORTGAGE ORIGINATORS, SERVICERS, SECURITIES ISSUERS AND INVESTORS, RATING AGENCIES, GOVERNMENT AGENCIES, AND INSURERS (U.S. CLS. 100 AND 101).

FIRST USE 1-21-2010; IN COMMERCE 1-26-2010.
AMY HELLA, EXAMINING ATTORNEY

CLASS 42—(Continued).

SN 77-924,390. KINDWAVE LLC MICHIGAN, MANITOU BEACH, MI. FILED 1-31-2010.

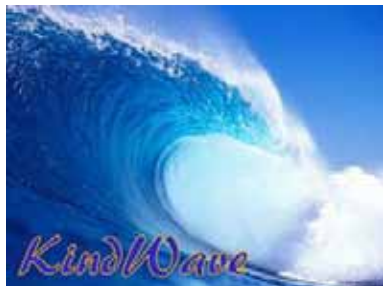

THE COLOR(S) BLUE, WHITE AND GOLD IS/ARE CLAIMED AS A FEATURE OF THE MARK.

THE MARK CONSISTS OF THE WORDING "KIND-WAVE" IN BLUE WITH GOLD OUTLINE AND THE DESIGN OF A WAVE IN BLUE AND WHITE AND A BLUE SKY.

FOR CUSTOM DESIGN OF APPAREL BASED ON PERSONAL SELECTIONS MADE BY THE CUSTOMER (U.S. CLS. 100 AND 101).

DANIEL CAPSHAW, EXAMINING ATTORNEY

SN 77-924,468. RODRIGUEZ, JOSE ANTONIO, DBA ITECH, CAGUAS, PUERTO RICO, FILED 1-31-2010.



THE MARK CONSISTS OF THE LETTER "I" AND THE CAPITAL LETTER "T" MERGED AS SINGLE SYMBOL OF ITECH.

FOR COMPUTER NETWORK DESIGN FOR OTHERS; COMPUTER PROGRAMMING; COMPUTER PROGRAMMING AND COMPUTER SYSTEM ANALYSIS; COMPUTER PROGRAMMING AND MAINTENANCE OF COMPUTER PROGRAMS; COMPUTER PROGRAMMING AND SOFTWARE DESIGN; COMPUTER PROGRAMMING SERVICES; COMPUTER SERVICES, NAMELY, CREATING AND MAINTAINING WEB SITES FOR OTHERS; COMPUTER SERVICES, NAMELY, DESIGNING AND IMPLEMENTING NETWORK WEB PAGES FOR OTHERS; COMPUTER SERVICES, NAMELY, DESIGNING AND IMPLEMENTING WEB SITES FOR OTHERS; COMPUTER SERVICES, NAMELY, MANAGING WEB SITES FOR OTHERS; COMPUTER SERVICES, NAMELY, MONITORING AND REPORTING ON THE PERFORMANCE, AVAILABILITY, AND ERRORS OF WEB SITES OF OTHERS; COMPUTER SERVICES, NAMELY, MONITORING THE WEB SITES OF OTHERS TO IMPROVE SCALABILITY AND PERFORMANCE OF WEB SITES OF OTHERS; COMPUTER SERVICES, NAMELY, MONITORING, TESTING, ANALYZING, AND REPORTING ON THE INTERNET TRAFFIC CONTROL AND CONTENT CONTROL OF THE WEB SITES OF OTHERS; COMPUTER SERVICES, NAMELY, REMOTE AND ON-SITE MANAGEMENT OF THE INFORMATION TECHNOLOGY (IT) SYSTEMS OF OTHERS; COMPUTER TECHNICAL SUPPORT SERVICES, NAMELY, 24/7 SERVICE DESK/HELP DESK SERVICES FOR IT INFRASTRUCTURE, OPERATING SYSTEMS, DATABASE SYSTEMS, AND WEB APPLICA-

CLASS 42—(Continued).

TIONS.; COMPUTER TECHNOLOGY SUPPORT SERVICES, NAMELY, HELP DESK SERVICES; CUSTOMIZED SOFTWARE DEVELOPMENT SERVICES; DRESS DESIGNING; FOOTWEAR DESIGN SERVICES; GRAPHIC DESIGN SERVICES; GRAPHIC ILLUSTRATION SERVICES FOR OTHERS; IT CONSULTING SERVICES; PROFESSIONAL COMPUTER SERVICES, NAMELY, NETWORK ANALYSIS, LAN/WAN DESIGN, WIRELESS ENGINEERING, VIRTUALIZATION AND COMPUTER PROJECT MANAGEMENT; PROGRAMMING OF COMPUTER SOFTWARE FOR OTHERS; PROVIDING GRAPHIC AND MULTIMEDIA DESIGN SERVICES FOR THE PURPOSE OF PROMOTING THE GOODS AND SERVICES OF OTHERS; RECOVERY OF COMPUTER DATA; REMOTE COMPUTER BACKUP SERVICES; REMOTE COMPUTER NETWORK TECHNICAL MONITORING AND SOFTWARE MAINTENANCE SERVICES; WEB SITE DESIGN; WEB SITE DEVELOPMENT FOR OTHERS; WEBSITE DESIGN AND DEVELOPMENT FOR OTHERS; WEBSITE DEVELOPMENT FOR OTHERS (U.S. CLS. 100 AND 101).

MARILYN IZZI, EXAMINING ATTORNEY

SN 77-924,948. DATAJOOP LLC, CHESTER, VA. FILED 2-1-2010.

DataJoop

THE MARK CONSISTS OF STANDARD CHARACTERS WITHOUT CLAIM TO ANY PARTICULAR FONT, STYLE, SIZE, OR COLOR.

FOR HOSTING AN ONLINE COMMUNITY WEBSITE FEATURING SHARED COMMUNICATIONS BETWEEN COMMUNITY MEMBERS FOR SHARING, TRANSFERRING, STORING AND ACCESSING INFORMATION AND DATA OF VARIOUS KINDS AND FORMATS (U.S. CLS. 100 AND 101).

KAPIL BHANOT, EXAMINING ATTORNEY

SN 77-925,392. INTRIGMA INC., STONY BROOK, NY. FILED 2-1-2010.

AM-SCHEDULER

THE MARK CONSISTS OF STANDARD CHARACTERS WITHOUT CLAIM TO ANY PARTICULAR FONT, STYLE, SIZE, OR COLOR.

FOR APPLICATION SERVICE PROVIDER (ASP) FEATURING SOFTWARE FOR USE AS SCHEDULING IN THE FIELD OF MEDICAL STAFFS, PHYSICIANS, AND NURSES (U.S. CLS. 100 AND 101).

FIRST USE 1-1-2008; IN COMMERCE 9-1-2008.

MARIA-VICTORIA SUAREZ, EXAMINING ATTORNEY

CLASS 42—(Continued).

SN 77-925,458. KNACK TECHNOLOGIES LLC, AUGUSTA, GA. FILED 2-1-2010.

Knack Technologies

THE MARK CONSISTS OF STANDARD CHARACTERS WITHOUT CLAIM TO ANY PARTICULAR FONT, STYLE, SIZE, OR COLOR.

NO CLAIM IS MADE TO THE EXCLUSIVE RIGHT TO USE "TECHNOLOGIES", APART FROM THE MARK AS SHOWN.

FOR COMPUTER PROGRAMMING AND COMPUTER SYSTEM ANALYSIS; COMPUTER PROGRAMMING AND SOFTWARE DESIGN; COMPUTER PROGRAMMING CONSULTANCY; COMPUTER PROGRAMMING SERVICES FOR OTHERS IN THE FIELD OF SOFTWARE CONFIGURATION MANAGEMENT; COMPUTER SOFTWARE DESIGN, COMPUTER PROGRAMMING, OR MAINTENANCE OF COMPUTER SOFTWARE; COMPUTER SOFTWARE DEVELOPMENT AND COMPUTER PROGRAMMING DEVELOPMENT FOR OTHERS; COMPUTER TECHNICAL SUPPORT SERVICES, NAMELY, 24/7 SERVICE DESK/HELP DESK SERVICES FOR IT INFRASTRUCTURE, OPERATING SYSTEMS, DATABASE SYSTEMS, AND WEB APPLICATIONS; CREATING OF COMPUTER PROGRAMS; DATA CONVERSION OF COMPUTER PROGRAM DATA OR INFORMATION; INSTALLING COMPUTER PROGRAMS; MONITORING THE COMPUTER SYSTEMS OF OTHERS FOR TECHNICAL PURPOSES AND PROVIDING BACK-UP COMPUTER PROGRAMS AND FACILITIES; REPAIR OF DAMAGED COMPUTER PROGRAMS; TECHNICAL SUPPORT, NAMELY, PROVIDING BACK-UP COMPUTER PROGRAMS AND FACILITIES; UPDATING OF COMPUTER PROGRAMS FOR THIRD PARTIES (U.S. CLS. 100 AND 101).

FIRST USE 2-26-2001; IN COMMERCE 2-26-2001.
JOHN E. MICHOS, EXAMINING ATTORNEY

SN 77-925,789. INSEQUENCE, INC., HERNDON, VA. FILED 2-2-2010.

MAPSINDEED

THE MARK CONSISTS OF STANDARD CHARACTERS WITHOUT CLAIM TO ANY PARTICULAR FONT, STYLE, SIZE, OR COLOR.

FOR PROVIDING AN ON-LINE SEARCHABLE WEBSITE DATABASE FEATURING GEOSPATIAL AND/OR GEOGRAPHICAL DATA AND INFORMATION, NAMELY, MAPS, LAND RECORDS AND GOVERNMENTAL RECORDS IN CONNECTION THEREWITH (U.S. CLS. 100 AND 101).

CARRIE GENOVESE, EXAMINING ATTORNEY

CLASS 42—(Continued).

SN 77-925,809. THOMPSON, DALLAS WAYNE, NIPOMO, CA. FILED 2-2-2010.

Eyes Wide Shut: An Enigma

THE MARK CONSISTS OF STANDARD CHARACTERS WITHOUT CLAIM TO ANY PARTICULAR FONT, STYLE, SIZE, OR COLOR.

FOR PROVIDING A WEB SITE THAT GIVES COMPUTER USERS THE ABILITY TO UPLOAD AND SHARE USER-GENERATED VIDEOS, ESSAYS AND ARTICLES ON A WIDE VARIETY OF TOPICS AND SUBJECTS (U.S. CLS. 100 AND 101).

ANDREW LEASER, EXAMINING ATTORNEY

SN 77-926,040. AXIOM CONSULTING GROUP, INC., WALNUT CREEK, CA. FILED 2-2-2010.

BIG ENOUGH TO DO IT ALL. SMALL ENOUGH TO DO IT WELL.

THE MARK CONSISTS OF STANDARD CHARACTERS WITHOUT CLAIM TO ANY PARTICULAR FONT, STYLE, SIZE, OR COLOR.

FOR IT CONSULTING SERVICES (U.S. CLS. 100 AND 101).

KELLY BOULTON, EXAMINING ATTORNEY

SN 77-926,042. HENDERSON ENGINEERS, AKA CONCEPT 520, A HENDERSON ENGINEERS DIVISION, LENEXA, KS. FILED 2-2-2010.



OWNER OF U.S. REG. NOS. 2,405,734, 3,691,771 AND OTHERS.

NO CLAIM IS MADE TO THE EXCLUSIVE RIGHT TO USE "CONCEPT" AND "ENGINEERS INC", APART FROM THE MARK AS SHOWN.

THE COLOR(S) GREEN, BLACK, AND WHITE IS/ARE CLAIMED AS A FEATURE OF THE MARK.

THE MARK CONSISTS OF A SQUARE WITH BLADES OF GRASS COMING UP FROM THE BOTTOM TO THE TOP. THE BOTTOM OF THE SQUARE IS IN BLACK. THE OUTLINE OF THE BLADES OF GRASS IS IN WHITE AND ABOVE THE BLADES OF GRASS IS GREEN. THE WORDS "CONCEPT 520 HENDERSON ENGINEERS INC" IS TO THE RIGHT OF THE SQUARE/BLADES OF GRASS. "CONCEPT" AND "HENDERSON ENGINEERS INC" ARE BLACK AND "520" IS GREEN. "CONCEPT 520" IS TYPED ABOVE THE WORDS "HENDERSON ENGINEERS INC".

FOR ENGINEERING SERVICES, NAMELY, ENGINEERING FOR THE SUSTAINABLE BUILDING SOLUTIONS (U.S. CLS. 100 AND 101).

FIRST USE 9-1-2009; IN COMMERCE 9-1-2009.
KELLY BOULTON, EXAMINING ATTORNEY

CLASS 42—(Continued).

SN 77-926,197. RELATIONAL INSIGHTS, INC., WAYNE, NJ. FILED 2-2-2010.

AUTISMOMS

THE MARK CONSISTS OF STANDARD CHARACTERS WITHOUT CLAIM TO ANY PARTICULAR FONT, STYLE, SIZE, OR COLOR.

FOR HOSTING AN ONLINE WEBSITE FEATURING INFORMATION AND RESOURCES FOR PARENTS OF AUTISTIC CHILDREN (U.S. CLS. 100 AND 101).
MICHAEL WEBSTER, EXAMINING ATTORNEY

CLASS 42—(Continued).

SN 77-926,261. SCHEDULICITY, INC., BOZEMAN, MT. FILED 2-2-2010.

FINALLY, A BETTER WAY TO SCHEDULE

THE MARK CONSISTS OF STANDARD CHARACTERS WITHOUT CLAIM TO ANY PARTICULAR FONT, STYLE, SIZE, OR COLOR.

NO CLAIM IS MADE TO THE EXCLUSIVE RIGHT TO USE "SCHEDULE", APART FROM THE MARK AS SHOWN.
FOR PROVIDING A WEB SITE FEATURING TEMPORARY USE OF NON-DOWNLOADABLE SOFTWARE ALLOWING WEB SITE USERS TO LOCATE SERVICE PROVIDERS AND MANAGE APPOINTMENTS; PROVIDING A WEB SITE FEATURING TEMPORARY USE OF NON-DOWNLOADABLE SOFTWARE TOOLS ALLOWING WEB SITE USERS TO MANAGE ONLINE MARKETING, PROMOTIONS, CLIENT MANAGEMENT AND APPOINTMENTS (U.S. CLS. 100 AND 101).

FIRST USE 1-28-2010; IN COMMERCE 1-28-2010.
PAM WILLIS, EXAMINING ATTORNEY

SN 77-926,210. C & L STVDIO, INC., ORLANDO, FL. FILED 2-2-2010.



INTERIOR DECORATING FOR A DAY

NO CLAIM IS MADE TO THE EXCLUSIVE RIGHT TO USE "INTERIOR DECORATING", APART FROM THE MARK AS SHOWN.

THE MARK CONSISTS OF A CIRCLE WITH A BACKWARDS "D" AN "I" AND A "D" INSIDE THE CIRCLE AND "INTERIOR DECORATING FOR A DAY" UNDER THE CIRCLE.

FOR INTERIOR DESIGN SERVICES (U.S. CLS. 100 AND 101).
FIRST USE 5-28-2009; IN COMMERCE 5-28-2009.
REBECCA EISINGER, EXAMINING ATTORNEY

SN 77-926,491. PRIVATE LABEL EXECUTIVE GIFTS, INC., CAMPBELL, CA. FILED 2-3-2010.

GIFTMOTO

THE MARK CONSISTS OF STANDARD CHARACTERS WITHOUT CLAIM TO ANY PARTICULAR FONT, STYLE, SIZE, OR COLOR.

FOR PROVIDING TEMPORARY USE OF ON-LINE NON-DOWNLOADABLE SOFTWARE FOR USE BY BUSINESSES IN CREATING CUSTOMIZABLE MERCHANDISE AND PROMOTIONAL PRODUCTS FOR THEIR CUSTOMERS, NAMELY, CUSTOM CANDY TINS BEARING THE BUSINESSES' NAMES, LOGOS AND TRADEMARKS (U.S. CLS. 100 AND 101).

FIRST USE 4-15-2009; IN COMMERCE 4-15-2009.
ANNE MADDEN, EXAMINING ATTORNEY

CLASS 42—(Continued).

SN 77-926,511. ALEMOZAFAR, ALI R., SAN FRANCISCO, CA. FILED 2-3-2010.

Basic Products

THE MARK CONSISTS OF STANDARD CHARACTERS WITHOUT CLAIM TO ANY PARTICULAR FONT, STYLE, SIZE, OR COLOR.

NO CLAIM IS MADE TO THE EXCLUSIVE RIGHT TO USE "PRODUCTS", APART FROM THE MARK AS SHOWN. FOR DESIGN AND TESTING FOR NEW PRODUCT DEVELOPMENT; DESIGN AND TESTING OF NEW PRODUCTS FOR OTHERS; PRODUCT DEVELOPMENT; PRODUCT DEVELOPMENT AND ENGINEERING SERVICES FOR OTHERS; PRODUCT DEVELOPMENT CONSULTATION; PRODUCT DEVELOPMENT FOR OTHERS; PRODUCT RESEARCH; PRODUCT RESEARCH AND DEVELOPMENT (U.S. CLS. 100 AND 101).

KEVON CHISOLM, EXAMINING ATTORNEY

SN 77-926,638. ROGUE TECHNOLOGIES, INC., PEORIA, IL. FILED 2-3-2010.



NO CLAIM IS MADE TO THE EXCLUSIVE RIGHT TO USE "TECHNOLOGIES", APART FROM THE MARK AS SHOWN.

THE MARK CONSISTS OF A STYLIZED ICON CONSISTING OF A CIRCLE DESIGN AND FIVE HORIZONTAL LINES OF VARIOUS LENGTHS TO THE LEFT OF THE WORDS "ROGUE TECHNOLOGIES".

FOR DEVELOPMENT AND IMPLEMENTATION OF SOFTWARE, HARDWARE AND TECHNOLOGY SOLUTIONS FOR THE PURPOSE OF PRODUCTIZATION OF ELECTRONIC COMPONENTS AND ELECTRONIC SYSTEMS (U.S. CLS. 100 AND 101).

MIDGE BUTLER, EXAMINING ATTORNEY

SN 77-926,690. MCELHINEY, PATRICK RUSSELL, BARRINGTON, NH. FILED 2-3-2010.

MCE123

THE MARK CONSISTS OF STANDARD CHARACTERS WITHOUT CLAIM TO ANY PARTICULAR FONT, STYLE, SIZE, OR COLOR.

FOR DESIGN, CREATION, HOSTING, MAINTENANCE OF WEBSITES FOR OTHERS (U.S. CLS. 100 AND 101).

FIRST USE 9-29-2002; IN COMMERCE 9-29-2002.
JESSICA A. POWERS, EXAMINING ATTORNEY

CLASS 42—(Continued).

SN 77-926,789. BROTHERS FOREVER, LLC, MILBRAE, CA. FILED 2-3-2010.

Sherlock Hounds

THE MARK CONSISTS OF STANDARD CHARACTERS WITHOUT CLAIM TO ANY PARTICULAR FONT, STYLE, SIZE, OR COLOR.

FOR INSPECTIONS OF HOMES, HOTELS, MOTELS, DORMITORIES, CRUISE SHIPS, AND AIRLINES FOR MOLD AND BED BUGS (U.S. CLS. 100 AND 101).

PRISCILLA MILTON, EXAMINING ATTORNEY

SN 77-926,840. AFFILIATE ALLIANCE, INC., SALT LAKE CITY, UT. FILED 2-3-2010.

JOUNCE

THE MARK CONSISTS OF STANDARD CHARACTERS WITHOUT CLAIM TO ANY PARTICULAR FONT, STYLE, SIZE, OR COLOR.

FOR COMPUTER SERVICES, NAMELY, PROVIDING SEARCH ENGINES FOR OBTAINING DATA ON A GLOBAL COMPUTER NETWORK; PROVIDING A WEBSITE FEATURING A MEDIA AGGREGATOR AND SEARCH ENGINE FOR INTERNET CONTENT (U.S. CLS. 100 AND 101).

SOPHIA S. KIM, EXAMINING ATTORNEY

SN 77-926,950. AMERICAN HUMAN DEVELOPMENT REPORT, INC., BROOKLYN, NY. FILED 2-3-2010.

WELL-O-METER

THE MARK CONSISTS OF STANDARD CHARACTERS WITHOUT CLAIM TO ANY PARTICULAR FONT, STYLE, SIZE, OR COLOR.

FOR PROVIDING TEMPORARY USE OF ONLINE NON-DOWNLOADABLE COMPUTER SOFTWARE FOR CONDUCTING SURVEYS, AND OTHER FEEDBACK AND DATA COLLECTION ACTIVITIES VIA COMPUTER AND COMMUNICATION NETWORKS; PROVIDING TEMPORARY USE OF ONLINE NON-DOWNLOADABLE COMPUTER SOFTWARE FOR THE ADMINISTRATION, COLLECTION, REPORTING, ANALYSIS AND PRESENTATION OF SURVEY INFORMATION GATHERED VIA COMPUTER AND COMMUNICATION NETWORKS; PROVIDING TEMPORARY USE OF ONLINE NON-DOWNLOADABLE COMPUTER SOFTWARE FOR CONDUCTING SURVEYS IN THE AREA OF HUMAN WELL-BEING AND DEVELOPMENT, PROVIDING DATA TO USERS BASED ON ANALYSIS OF SURVEY RESULTS (U.S. CLS. 100 AND 101).

FIRST USE 7-0-2008; IN COMMERCE 7-0-2008.
RENEE MCCRAY, EXAMINING ATTORNEY

CLASS 42—(Continued).

SN 77-926,960. INTERNATIONAL DATA GROUP, INC., FRAMINGHAM, MA. FILED 2-3-2010.

TECHDISPENSER

THE MARK CONSISTS OF STANDARD CHARACTERS WITHOUT CLAIM TO ANY PARTICULAR FONT, STYLE, SIZE, OR COLOR.

FOR PROVIDING A WEBSITE WHERE USERS CAN DESIGN CUSTOMIZED NEWSLETTERS (U.S. CLS. 100 AND 101).

JASON BLAIR, EXAMINING ATTORNEY

CLASS 42—(Continued).

SN 77-927,140. IMPERIUM, LLC, WESTPORT, CT. FILED 2-3-2010.

VERITY

THE MARK CONSISTS OF STANDARD CHARACTERS WITHOUT CLAIM TO ANY PARTICULAR FONT, STYLE, SIZE, OR COLOR.

FOR APPLICATION SERVICE PROVIDER FEATURING AN APPLICATION PROGRAMMING INTERFACE (API) THAT ALLOWS USERS TO ACCESS A WEB SERVICE FOR PURPOSES OF VALIDATING NAMES AND ADDRESSES OF INDIVIDUAL RESPONDENTS FOR MARKET RESEARCH SURVEYS (U.S. CLS. 100 AND 101).

FIRST USE 2-22-2010; IN COMMERCE 2-22-2010.
COLLEEN KEARNEY, EXAMINING ATTORNEY

SN 77-927,190. BROTHERS FOREVER, LLC, MILLBRAE, CA. FILED 2-3-2010.

SN 77-927,081. YOUNG AUDIENCES, INC., NEW YORK, NY. FILED 2-3-2010.



THE COLOR(S) YELLOW AND BLUE IS/ARE CLAIMED AS A FEATURE OF THE MARK.

THE MARK CONSISTS OF A YELLOW SUN AND ITS RAYS TO THE LEFT OF THE WORDS "YOUNG AUDIENCES" IN BLUE AND THE WORDS "ARTS FOR LEARNING" IN YELLOW.

FOR COMPUTER SERVICES, NAMELY, HOSTING DIGITAL CONTENT ON THE INTERNET; PROVIDING CUSTOMIZED ONLINE WEB PAGES FEATURING USER-DEFINED INFORMATION VIA SEARCH ENGINES AND ONLINE WEB LINKS TO OTHER WEB LOCATIONS AND WEBSITES FEATURING INFORMATION ON COMMUNITY, REGIONAL, NATIONAL, SUBJECT MATTER SPECIFIC AND ORGANIZATION BASED CULTURAL AND EDUCATIONAL PROGRAMS, PRESENTED BY ARTISTS, TEACHERS, AND CULTURAL INSTITUTIONS; AND COMPUTER SERVICES, NAMELY, PROVIDING SEARCH ENGINES FOR OBTAINING DATA ON COMMUNITY, REGIONAL, NATIONAL SUBJECT MATTER SPECIFIC AND ORGANIZATION BASED CULTURAL AND EDUCATION INFORMATION AND PROGRAMS PRESENTED BY ARTISTS TEACHERS, AND CULTURAL INSTITUTIONS VIA THE GLOBAL COMPUTER NETWORK (U.S. CLS. 100 AND 101).

FIRST USE 4-24-2006; IN COMMERCE 4-24-2006.
KEVON CHISOLM, EXAMINING ATTORNEY

scenttek

THE MARK CONSISTS OF THE STYLIZED TEXT "SCENTTEK" WITH A FACE BETWEEN THE "T"'S.

FOR INSPECTIONS OF HOMES, HOTELS, MOTELS, DORMITORIES, CRUISE SHIPS, AND AIRLINES FOR MOLD AND BED BUGS (U.S. CLS. 100 AND 101).

PRISCILLA MILTON, EXAMINING ATTORNEY

SN 77-927,206. SOUTH49 SOLUTIONS, INC., STERLING, VA. FILED 2-3-2010.

FRESHER DATA, BETTER DECISIONS

THE MARK CONSISTS OF STANDARD CHARACTERS WITHOUT CLAIM TO ANY PARTICULAR FONT, STYLE, SIZE, OR COLOR.

FOR PROVIDING TEMPORARY USE OF ON-LINE NON-DOWNLOADABLE SOFTWARE THAT PROVIDES REAL-TIME, INTEGRATED BUSINESS MANAGEMENT AND WORK FORCE MANAGEMENT INTELLIGENCE BY COMBINING INFORMATION FROM VARIOUS DATABASES AND PRESENTING IT IN AN EASY-TO-UNDERSTAND USER INTERFACE (U.S. CLS. 100 AND 101).

FIRST USE 1-0-2010; IN COMMERCE 1-0-2010.
JACLYN KIDWELL WALKER, EXAMINING ATTORNEY

CLASS 42—(Continued).

SN 77-927,326. MINDJET LLC, SAN FRANCISCO, CA. FILED 2-3-2010.

MINDJET CATALYST

THE MARK CONSISTS OF STANDARD CHARACTERS WITHOUT CLAIM TO ANY PARTICULAR FONT, STYLE, SIZE, OR COLOR.

OWNER OF U.S. REG. NOS. 2,733,790, 3,336,231 AND OTHERS.

FOR PROVIDING TEMPORARY USE OF NON-DOWNLOADABLE SOFTWARE IN THE NATURE OF VISUAL THINKING TOOLS THAT ENABLE USERS TO DEVELOP AND PRACTICE IDEAS AND CONCEPTS IN THE FIELD OF MIND MAPPING; PROVIDING TEMPORARY USE OF NON-DOWNLOADABLE SOFTWARE FOR CREATING COLLABORATIVE ONLINE WORKSPACES ENABLING USERS TO STORE AND RETRIEVE ELECTRONIC DOCUMENTS AND COMMUNICATE VIA ONLINE SYSTEMS (U.S. CLS. 100 AND 101).

FIRST USE 10-6-2009; IN COMMERCE 10-6-2009.
PATRICIA EVANKO, EXAMINING ATTORNEY

SN 77-927,544. INFINITY SALES GROUP, LLC, DELRAY BEACH, FL. FILED 2-3-2010.

ISGOE

THE MARK CONSISTS OF STANDARD CHARACTERS WITHOUT CLAIM TO ANY PARTICULAR FONT, STYLE, SIZE, OR COLOR.

FOR APPLICATION SERVICE PROVIDER (ASP) FEATURING SOFTWARE FOR USE IN CUSTOMER RELATIONSHIP MANAGEMENT, ONLINE RETAILER ORDER ENTRY AND SALES REPORTING (U.S. CLS. 100 AND 101).

FIRST USE 9-1-2009; IN COMMERCE 9-1-2009.
JAMES LOVELACE, EXAMINING ATTORNEY

SN 77-927,573. NASCREATIVE, INC, FAIRFAX, VA. FILED 2-3-2010.

NASDM

THE MARK CONSISTS OF STANDARD CHARACTERS WITHOUT CLAIM TO ANY PARTICULAR FONT, STYLE, SIZE, OR COLOR.

FOR APPLICATION SERVICE PROVIDER (ASP) FEATURING SOFTWARE FOR USE IN AUTO DEALERSHIP MANAGEMENT AND MARKETING (U.S. CLS. 100 AND 101).

FIRST USE 1-1-2002; IN COMMERCE 1-1-2004.
MICHAEL ENGEL, EXAMINING ATTORNEY

CLASS 42—(Continued).

SN 77-927,706. THE FAIRBANKS INSTITUTE FOR HEALTHY COMMUNITIES, INC., INDIANAPOLIS, IN. FILED 2-4-2010.

INBANK

THE MARK CONSISTS OF STANDARD CHARACTERS WITHOUT CLAIM TO ANY PARTICULAR FONT, STYLE, SIZE, OR COLOR.

FOR MEDICAL RESEARCH SERVICES; OPERATING AND MAINTAINING A BIOREPOSITORY FOR MEDICAL AND SCIENTIFIC RESEARCH PURPOSES (U.S. CLS. 100 AND 101).

LINDSEY RUBIN, EXAMINING ATTORNEY

SN 77-927,821. VOICES HEARD MEDIA, INC., KNOXVILLE, TN. FILED 2-4-2010.

VOICESHEARD MEDIA, INC.

THE MARK CONSISTS OF STANDARD CHARACTERS WITHOUT CLAIM TO ANY PARTICULAR FONT, STYLE, SIZE, OR COLOR.

NO CLAIM IS MADE TO THE EXCLUSIVE RIGHT TO USE "MEDIA, INC.", APART FROM THE MARK AS SHOWN.

FOR PROVIDING TEMPORARY USE OF NON-DOWNLOADABLE COMPUTER SOFTWARE FOR GRAPHICAL USER INTERFACE; PROVIDING TEMPORARY USE OF NON-DOWNLOADABLE COMPUTER SOFTWARE FOR DISTILLING QUESTIONS, RESPONSES, VOTES OR OTHER USER SUBMISSIONS INTO A SMALLER REPRESENTATIVE NUMBER QUESTIONS, RESPONSES, VOTES OR OTHER USER SUBMISSIONS THAT REPRESENT THE USERS AS A WHOLE; PROVIDING TEMPORARY USE OF NON-DOWNLOADABLE COMPUTER SOFTWARE FOR ALLOWING DATA RETRIEVAL, UPLOAD, ACCESS AND MANAGEMENT OF SOCIAL NETWORKS; PROVIDING TEMPORARY USE OF NON-DOWNLOADABLE COMPUTER SOFTWARE USED FOR POLLING, SOCIAL MEDIA LINKING, AND NATURAL LANGUAGE CONVERSION AND COMPILATION OF THE RESULTS OF SUCH CONVERSION (U.S. CLS. 100 AND 101).

FIRST USE 5-1-2007; IN COMMERCE 5-1-2007.
SUE LAWRENCE, EXAMINING ATTORNEY

CLASS 42—(Continued).

SN 77-927,831. VOICES HEARD MEDIA, INC., KNOXVILLE, TN. FILED 2-4-2010.

VOICESHEARD MEDIA

THE MARK CONSISTS OF STANDARD CHARACTERS WITHOUT CLAIM TO ANY PARTICULAR FONT, STYLE, SIZE, OR COLOR.

NO CLAIM IS MADE TO THE EXCLUSIVE RIGHT TO USE "MEDIA", APART FROM THE MARK AS SHOWN.

FOR PROVIDING TEMPORARY USE OF NON-DOWNLOADABLE COMPUTER SOFTWARE FOR GRAPHICAL USER INTERFACE; PROVIDING TEMPORARY USE OF NON-DOWNLOADABLE COMPUTER SOFTWARE FOR DISTILLING QUESTIONS, RESPONSES, VOTES OR OTHER USER SUBMISSIONS INTO A SMALLER REPRESENTATIVE NUMBER QUESTIONS, RESPONSES, VOTES OR OTHER USER SUBMISSIONS THAT REPRESENT THE USERS AS A WHOLE; PROVIDING TEMPORARY USE OF NON-DOWNLOADABLE COMPUTER SOFTWARE FOR ALLOWING DATA RETRIEVAL, UPLOAD, ACCESS AND MANAGEMENT OF SOCIAL NETWORKS; PROVIDING TEMPORARY USE OF NON-DOWNLOADABLE COMPUTER SOFTWARE USED FOR POLLING, SOCIAL MEDIA LINKING, AND NATURAL LANGUAGE CONVERSION AND COMPILATION OF THE RESULTS OF SUCH CONVERSION (U.S. CLS. 100 AND 101).

FIRST USE 5-1-2007; IN COMMERCE 5-1-2007.
SUE LAWRENCE, EXAMINING ATTORNEY

SN 77-927,972. CALL A SPOTTER, LLC, MANHEIM, PA. FILED 2-4-2010.

Call A Spotter

THE MARK CONSISTS OF STANDARD CHARACTERS WITHOUT CLAIM TO ANY PARTICULAR FONT, STYLE, SIZE, OR COLOR.

FOR INSPECTION SERVICES FOR NEW AND USED VEHICLES FOR PERSONS BUYING OR SELLING THEIR VEHICLES (U.S. CLS. 100 AND 101).

DOUGLAS LEE, EXAMINING ATTORNEY

CLASS 42—(Continued).

SN 77-927,994. LANDNET CORPORATION, LOVELAND, CO. FILED 2-4-2010.

Lite GIS

THE MARK CONSISTS OF STANDARD CHARACTERS WITHOUT CLAIM TO ANY PARTICULAR FONT, STYLE, SIZE, OR COLOR.

NO CLAIM IS MADE TO THE EXCLUSIVE RIGHT TO USE "GIS", APART FROM THE MARK AS SHOWN.

FOR CARTOGRAPHY AND MAPPING (U.S. CLS. 100 AND 101).

FIRST USE 2-1-2007; IN COMMERCE 1-14-2009.
ELLEN PERKINS, EXAMINING ATTORNEY

SN 77-928,332. 2POINT5, LLC, TUCKER, GA. FILED 2-4-2010.

2point5

THE MARK CONSISTS OF STANDARD CHARACTERS WITHOUT CLAIM TO ANY PARTICULAR FONT, STYLE, SIZE, OR COLOR.

FOR RESEARCH AND DEVELOPMENT OF NEW PRODUCTS (U.S. CLS. 100 AND 101).

FIRST USE 10-20-2006; IN COMMERCE 10-20-2006.
FLORENTINA BLANDU, EXAMINING ATTORNEY

SN 77-928,636. FOSHAN CITY NANHAI JINHEMING INVESTMENT CO., LTD., FOSHAN, GUANGDONG, CHINA, FILED 2-4-2010.



THE MARK CONSISTS OF THE STYLIZED ALPHABET "X" AND DEVICES RESEMBLING 2 INCOMPLETE "X"'S AT THE BACK.

FOR AUTHENTICATING WORKS OF ART; CHEMICAL ANALYSIS; CREATING OR MAINTAINING WEB SITES FOR OTHERS; DESIGN OF INTERIOR DECOR; DRESS DESIGNING; INDUSTRIAL DESIGN; PACKAGING DESIGN; QUALITY CONTROL FOR OTHERS; RESEARCH AND DEVELOPMENT FOR NEW PRODUCTS FOR OTHERS; TEXTILE TESTING (U.S. CLS. 100 AND 101).

TINA L. SNAPP, EXAMINING ATTORNEY

CLASS 42—(Continued).

SN 77-928,768. IMAKENEWS, INC., WALTHAM, MA. FILED 2-5-2010.

PARTY PULSE

THE MARK CONSISTS OF STANDARD CHARACTERS WITHOUT CLAIM TO ANY PARTICULAR FONT, STYLE, SIZE, OR COLOR.

FOR PROVIDING TEMPORARY USE OF ON-LINE NON-DOWNLOADABLE SOFTWARE FOR CREATING AND TRANSMITTING WEB-BASED MARKETING AND ADVERTISING FOR USE BY THE DIRECT SELLING INDUSTRY VIA A GLOBAL COMPUTER NETWORK (U.S. CLS. 100 AND 101).

FIRST USE 1-17-2006; IN COMMERCE 1-17-2006.
MATTHEW EINSTEIN, EXAMINING ATTORNEY

SN 77-928,773. CASSETICA SOFTWARE, INC., CHICAGO, IL. FILED 2-5-2010.

POCKETGRAPES

THE MARK CONSISTS OF STANDARD CHARACTERS WITHOUT CLAIM TO ANY PARTICULAR FONT, STYLE, SIZE, OR COLOR.

FOR COMPUTER SERVICES, NAMELY, HOSTING AND MAINTAINING AN ON-LINE WEB SITE FOR OTHERS TO MAINTAIN AND ORGANIZE INFORMATION ON WINES (U.S. CLS. 100 AND 101).

KEVIN DINALLO, EXAMINING ATTORNEY

SN 77-929,109. QUALITY INNOVATIVE SYSTEMS, INC., PARAGOULD, AR. FILED 2-5-2010.

UBSREADY

THE MARK CONSISTS OF STANDARD CHARACTERS WITHOUT CLAIM TO ANY PARTICULAR FONT, STYLE, SIZE, OR COLOR.

FOR CONSULTING SERVICES IN THE FIELD OF INTEGRATION, IMPLEMENTATION AND SUPPORT OF COMPUTER-BASED SOFTWARE SYSTEMS FOR UTILITY BILLING COMPANIES (U.S. CLS. 100 AND 101).

SANI KHOURI, EXAMINING ATTORNEY

CLASS 42—(Continued).

SN 77-929,141. PUBSHIFT, LLC, ANAHEIM, CA. FILED 2-5-2010.

Pubshift

THE MARK CONSISTS OF STANDARD CHARACTERS WITHOUT CLAIM TO ANY PARTICULAR FONT, STYLE, SIZE, OR COLOR.

FOR PROVIDING AN INTERACTIVE WEBSITE FEATURING TECHNOLOGY THAT ALLOWS USERS TO UPLOAD, DOWNLOAD, SHARE AND SELL CUSTOM AND BRANDED DIGITAL PUBLICATIONS (U.S. CLS. 100 AND 101).

JACLYN KIDWELL WALKER, EXAMINING ATTORNEY

SN 77-929,624. C INNOVATION, INC., SANDY, UT. FILED 2-5-2010.

ZANGLE

THE MARK CONSISTS OF STANDARD CHARACTERS WITHOUT CLAIM TO ANY PARTICULAR FONT, STYLE, SIZE, OR COLOR.

THE WORDING "ZANGLE" HAS NO MEANING IN A FOREIGN LANGUAGE.

FOR APPLICATION SERVICE PROVIDER, NAMELY, PROVIDING, HOSTING, MANAGING, DEVELOPING, RESEARCHING, ANALYZING, REPORTING, AND MAINTAINING APPLICATIONS, SOFTWARE AND THE WEB SITES OF OTHERS IN THE FIELDS OF CURRICULUM MANAGEMENT AND STUDENT INFORMATION SYSTEMS (U.S. CLS. 100 AND 101).

FIRST USE 10-31-2008; IN COMMERCE 10-31-2008.
LINDA ESTRADA, EXAMINING ATTORNEY

SN 77-930,073. DAYVIEWER LTD., MIDDLESEX, UNITED KINGDOM, FILED 2-8-2010.

DAYVIEWER

THE MARK CONSISTS OF STANDARD CHARACTERS WITHOUT CLAIM TO ANY PARTICULAR FONT, STYLE, SIZE, OR COLOR.

FOR PROVIDING A WEB SITE FEATURING TEMPORARY USE OF NON-DOWNLOADABLE SOFTWARE FOR USE IN CONTACT MANAGEMENT AND DATABASE MANAGEMENT; PROVIDING A WEB SITE FEATURING TEMPORARY USE OF NON-DOWNLOADABLE SOFTWARE THAT ENABLES USERS TO COMMUNICATE WITH EACH OTHER VIA ELECTRONIC MAIL AND INSTANT MESSAGING; PROVIDING A WEB SITE FEATURING TEMPORARY USE OF NON-DOWNLOADABLE SOFTWARE THAT ENABLES USERS TO PLAN SPECIAL EVENTS (U.S. CLS. 100 AND 101).

RENEE MCCRAY, EXAMINING ATTORNEY

CLASS 42—(Continued).

SN 77-930,170. DOUGLAS BIO RESEARCH LLC, ST. LOUIS, MO. FILED 2-8-2010.

CREATING SCIENCE TODAY...
DESIGNING A HEALTHIER
TOMORROW

THE MARK CONSISTS OF STANDARD CHARACTERS WITHOUT CLAIM TO ANY PARTICULAR FONT, STYLE, SIZE, OR COLOR.

FOR MEDICAL AND SCIENTIFIC RESEARCH IN THE FIELD OF HEALTH CARE AND AGRICULTURAL PRODUCTS (U.S. CLS. 100 AND 101).

ROBIN MITTLER, EXAMINING ATTORNEY

SN 77-930,337. BAYSTONE MEDIA, INC., JERICHO, NY. FILED 2-8-2010.

Baystone Media

THE MARK CONSISTS OF STANDARD CHARACTERS WITHOUT CLAIM TO ANY PARTICULAR FONT, STYLE, SIZE, OR COLOR.

NO CLAIM IS MADE TO THE EXCLUSIVE RIGHT TO USE "MEDIA", APART FROM THE MARK AS SHOWN.

FOR COMPUTER SERVICES, NAMELY, SEARCH ENGINE OPTIMIZATION; DESIGN OF HOME PAGES AND WEB SITES; GRAPHIC DESIGN SERVICES (U.S. CLS. 100 AND 101).

FIRST USE 1-1-2000; IN COMMERCE 1-1-2005.
APRIL ROACH, EXAMINING ATTORNEY

SN 77-930,362. PROCYON PHARMACEUTICALS, INC., PENDLETON, IN. FILED 2-8-2010.

Nexcyon

THE MARK CONSISTS OF STANDARD CHARACTERS WITHOUT CLAIM TO ANY PARTICULAR FONT, STYLE, SIZE, OR COLOR.

FOR PHARMACEUTICAL DRUG DEVELOPMENT SERVICES FOR ANIMALS (U.S. CLS. 100 AND 101).

AMY ALFIERI, EXAMINING ATTORNEY

CLASS 42—(Continued).

SN 77-930,395. PROCYON PHARMACEUTICALS, INC., PENDLETON, IN. FILED 2-8-2010.

Novocyon

THE MARK CONSISTS OF STANDARD CHARACTERS WITHOUT CLAIM TO ANY PARTICULAR FONT, STYLE, SIZE, OR COLOR.

FOR PHARMACEUTICAL DRUG DEVELOPMENT SERVICES FOR ANIMALS (U.S. CLS. 100 AND 101).

AMY ALFIERI, EXAMINING ATTORNEY

SN 77-930,522. TRUSTED FEDERAL SYSTEMS, INC., POTOMAC, MD. FILED 2-8-2010.

TRUSTED

THE MARK CONSISTS OF STANDARD CHARACTERS WITHOUT CLAIM TO ANY PARTICULAR FONT, STYLE, SIZE, OR COLOR.

FOR TECHNICAL CONSULTING SERVICES IN THE FIELDS OF DATACENTER ARCHITECTURE, PUBLIC AND PRIVATE CLOUD COMPUTING SOLUTIONS, AND EVALUATION AND IMPLEMENTATION OF INTERNET TECHNOLOGY AND SERVICES (U.S. CLS. 100 AND 101).

TEJBIR SINGH, EXAMINING ATTORNEY

SN 77-930,672. FORMACOAT, LLC, SAVAGE, MN. FILED 2-8-2010.

FORMACOAT

THE MARK CONSISTS OF STANDARD CHARACTERS WITHOUT CLAIM TO ANY PARTICULAR FONT, STYLE, SIZE, OR COLOR.

OWNER OF U.S. REG. NOS. 2,932,444, 3,563,505 AND 3,780,040.

FOR RESEARCH AND DEVELOPMENT OF NEW MEDICAL PRODUCTS FOR USE IN THE HUMAN BODY (U.S. CLS. 100 AND 101).

FIRST USE 11-30-2003; IN COMMERCE 11-30-2003.
JULIE WATSON, EXAMINING ATTORNEY

CLASS 42—(Continued).

SN 77-930,673. QUORUM ARCHITECTS, INC., MILWAUKEE, WI. FILED 2-8-2010.



NO CLAIM IS MADE TO THE EXCLUSIVE RIGHT TO USE THE RECYCLING SYMBOL, APART FROM THE MARK AS SHOWN.

THE MARK CONSISTS OF "WE RECYCLE BUILDINGS" SAYING WITH BUILDINGS AND RECYCLING SYMBOL.

FOR ARCHITECTURAL AND ENGINEERING SERVICES; ARCHITECTURAL CONSULTANCY; ARCHITECTURAL CONSULTATION; ARCHITECTURAL DESIGN; ARCHITECTURAL RESEARCH; CONSULTING IN THE FIELDS OF ENGINEERING AND ARCHITECTURE; CONSULTING SERVICES IN THE FIELD OF ARCHITECTURAL DESIGN (U.S. CLS. 100 AND 101).
TEJBIR SINGH, EXAMINING ATTORNEY

SN 77-930,695. KRISTIN KILMER DESIGN, INC., CULVER CITY, CA. FILED 2-8-2010.

Eco Modern Luxury

THE MARK CONSISTS OF STANDARD CHARACTERS WITHOUT CLAIM TO ANY PARTICULAR FONT, STYLE, SIZE, OR COLOR.

NO CLAIM IS MADE TO THE EXCLUSIVE RIGHT TO USE "ECO", APART FROM THE MARK AS SHOWN.

FOR INTERIOR DESIGN SERVICES (U.S. CLS. 100 AND 101).

ANNE E. GUSTASON, EXAMINING ATTORNEY

CLASS 42—(Continued).

SN 77-930,949. NUTRICATE CORPORATION, SANTA BARBARA, CA. FILED 2-8-2010.

NUTRICATE

THE MARK CONSISTS OF STANDARD CHARACTERS WITHOUT CLAIM TO ANY PARTICULAR FONT, STYLE, SIZE, OR COLOR.

OWNER OF U.S. REG. NO. 3,220,054.

FOR COMPUTER SERVICE, NAMELY, ACTING AS AN APPLICATION SERVICE PROVIDER IN THE FIELD OF KNOWLEDGE MANAGEMENT TO HOST COMPUTER APPLICATION SOFTWARE FOR CREATING SEARCHABLE DATABASES OF INFORMATION AND DATA; COMPUTER SERVICES, NAMELY, ACTING AS AN APPLICATION SERVICE PROVIDER IN THE HOSPITALITY FIELD TO HOST COMPUTER APPLICATION SOFTWARE THAT ALLOWS FOOD PREPARATION ESTABLISHMENTS TO PRINT INDIVIDUALIZED NUTRITION INFORMATION, TAILORED EDUCATION, AND TARGETED MARKETING COMMUNICATIONS ON CASH REGISTER RECEIPTS (U.S. CLS. 100 AND 101).

FIRST USE 12-5-2006; IN COMMERCE 12-5-2006.

ANDREA SAUNDERS, EXAMINING ATTORNEY

SN 77-930,963. HUTCHINS, BRIAN, SUNNYVALE, CA. FILED 2-8-2010.

Say Mmm

THE MARK CONSISTS OF STANDARD CHARACTERS WITHOUT CLAIM TO ANY PARTICULAR FONT, STYLE, SIZE, OR COLOR.

FOR COMPUTER SERVICES, NAMELY, PROVIDING A WEB SITE FEATURING TECHNOLOGY THAT ENABLES INTERNET USERS TO POST AND SHARE INFORMATION AND PHOTOGRAPHS REGARDING MEAL PLANNING, COOKING, DINING AND EATING (U.S. CLS. 100 AND 101).

FIRST USE 4-7-2009; IN COMMERCE 4-7-2009.

DOUGLAS LEE, EXAMINING ATTORNEY

CLASS 42—(Continued).

SN 77-931,298. BLEKKO, INC., REDWOOD CITY, CA. FILED 2-9-2010.

SLASHTAG

THE MARK CONSISTS OF STANDARD CHARACTERS WITHOUT CLAIM TO ANY PARTICULAR FONT, STYLE, SIZE, OR COLOR.

FOR SEARCH ENGINE SERVICES, NAMELY, PROVIDING SEARCH ENGINES ON THE INTERNET; COMPUTER SERVICES, NAMELY, CREATING INDEXES OF INFORMATION, SITES AND OTHER RESOURCES AVAILABLE ON COMPUTER NETWORKS AND COMMUNICATIONS NETWORKS (U.S. CLS. 100 AND 101).

CYNTHIA SLOAN, EXAMINING ATTORNEY

SN 77-931,406. BLOOMFIRE, LLC, VICKSBURG, MI. FILED 2-9-2010.

Bloomfire

THE MARK CONSISTS OF STANDARD CHARACTERS WITHOUT CLAIM TO ANY PARTICULAR FONT, STYLE, SIZE, OR COLOR.

FOR HOSTING AN ON-LINE COMMUNITY WEB SITE FEATURING PRIVATE OR PUBLIC SPACES WHERE MEMBERS CAN TEACH AND LEARN FROM EACH OTHER (U.S. CLS. 100 AND 101).

FIRST USE 10-11-2009; IN COMMERCE 10-11-2009.
ROBIN MITTLER, EXAMINING ATTORNEY

SN 77-931,592. CURRY, ANDREW, LOS ANGELES, CA. FILED 2-9-2010.

Split

THE MARK CONSISTS OF STANDARD CHARACTERS WITHOUT CLAIM TO ANY PARTICULAR FONT, STYLE, SIZE, OR COLOR.

FOR APPLICATION SERVICE PROVIDER, NAMELY, PROVIDING, HOSTING, MANAGING, DEVELOPING, AND MAINTAINING APPLICATIONS, SOFTWARE, WEB SITES, AND DATABASES IN THE FIELDS OF PERSONAL PRODUCTIVITY, WIRELESS COMMUNICATION, MOBILE INFORMATION ACCESS, AND REMOTE DATA MANAGEMENT FOR WIRELESS DELIVERY OF CONTENT TO HANDHELD COMPUTERS, LAPTOPS AND MOBILE ELECTRONIC DEVICES (U.S. CLS. 100 AND 101).

FIRST USE 10-25-2009; IN COMMERCE 10-25-2009.
LAURA KOVALSKY, EXAMINING ATTORNEY

CLASS 42—(Continued).

SN 77-931,640. SERENO, ANGELINA, SAN DIEGO, CA. FILED 2-9-2010.



THE MARK CONSISTS OF THE IMAGE OF A CUBE SHOWING TWO SIDES EACH SIDE OF WHICH IS DIVIDED INTO NINE SOLID SQUARES.

FOR DESIGN OF HOMEPAGES AND WEBSITES; GRAPHIC ART DESIGN; GRAPHIC DESIGN SERVICES; PLANNING, DESIGN, DEVELOPMENT, MAINTENANCE AND OPTIMIZATION OF ONLINE WEBSITES FOR THIRD PARTIES; WEBSITE DESIGN AND DEVELOPMENT FOR OTHERS (U.S. CLS. 100 AND 101).

FIRST USE 8-1-2006; IN COMMERCE 8-1-2006.
LANA PHAM, EXAMINING ATTORNEY

SN 77-931,722. ANIMATED EQUITY, LLC, SEATTLE, WA. FILED 2-9-2010.

JOTPAL

THE MARK CONSISTS OF STANDARD CHARACTERS WITHOUT CLAIM TO ANY PARTICULAR FONT, STYLE, SIZE, OR COLOR.

FOR PROVIDING ON-LINE NON-DOWNLOADABLE SOFTWARE FOR BUSINESS PLANNING (U.S. CLS. 100 AND 101).

ANDREA HACK, EXAMINING ATTORNEY

SN 77-931,838. GRAPHIENT, LLC, NEW YORK, NY. FILED 2-9-2010.

GRAPHIENT

THE MARK CONSISTS OF STANDARD CHARACTERS WITHOUT CLAIM TO ANY PARTICULAR FONT, STYLE, SIZE, OR COLOR.

FOR COMPUTER SOFTWARE DEVELOPMENT (U.S. CLS. 100 AND 101).

FIRST USE 9-18-2008; IN COMMERCE 9-18-2008.
TOBY BULLOFF, EXAMINING ATTORNEY

CLASS 42—(Continued).

SN 77-932,047. WHITENET, LLC, CHESAPEAKE BEACH, MD. FILED 2-9-2010.

FUBRUB

THE MARK CONSISTS OF STANDARD CHARACTERS WITHOUT CLAIM TO ANY PARTICULAR FONT, STYLE, SIZE, OR COLOR.

FOR COMPUTER SERVICES, NAMELY, CREATING AN ON-LINE COMMUNITY FOR REGISTERED USERS TO PARTICIPATE IN DISCUSSIONS, GET FEEDBACK FROM THEIR PEERS, FORM VIRTUAL COMMUNITIES, AND ENGAGE IN SOCIAL NETWORKING FEATURING MOBILE COMPUTING (U.S. CLS. 100 AND 101).

ALEX KEAM, EXAMINING ATTORNEY

SN 77-932,848. GATHERWORKS, INC., AMHERST, NH. FILED 2-10-2010.

SupportPlace

THE MARK CONSISTS OF STANDARD CHARACTERS WITHOUT CLAIM TO ANY PARTICULAR FONT, STYLE, SIZE, OR COLOR.

FOR PROVIDING TEMPORARY USE OF NON-DOWNLOADABLE SOFTWARE FOR HELP DESKS, ALLOWING USERS TO INTERACT WITH AND PROVIDE SUPPORT TO ITS CONSUMERS OVER THE INTERNET (U.S. CLS. 100 AND 101).

JANET LEE, EXAMINING ATTORNEY

SN 77-935,226. ALLSTATE INSURANCE COMPANY, NORTHBROOK, IL. FILED 2-13-2010.

**MY INSURANCE PERSONALITY
BY ALLSTATE**

THE MARK CONSISTS OF STANDARD CHARACTERS WITHOUT CLAIM TO ANY PARTICULAR FONT, STYLE, SIZE, OR COLOR.

OWNER OF U.S. REG. NOS. 717,683, 840,187 AND OTHERS.
FOR PROVIDING ON-LINE NON-DOWNLOADABLE SOFTWARE FOR THE ASSESSMENT OF INSURANCE COVERAGE (U.S. CLS. 100 AND 101).

MICHAEL SOUDERS, EXAMINING ATTORNEY

CLASS 42—(Continued).

SN 77-935,632. MONSANTO TECHNOLOGY LLC, ST. LOUIS, MO. FILED 2-15-2010.

VECTRAN

THE MARK CONSISTS OF STANDARD CHARACTERS WITHOUT CLAIM TO ANY PARTICULAR FONT, STYLE, SIZE, OR COLOR.

FOR DEVELOPMENT OF NEW TECHNOLOGY FOR OTHERS IN THE FIELD OF BIOTECHNOLOGY (U.S. CLS. 100 AND 101).

FIRST USE 7-31-2007; IN COMMERCE 7-31-2007.

EMILY CARLSEN, EXAMINING ATTORNEY

SN 77-938,815. BRISTOL-MYERS SQUIBB COMPANY, NEW YORK, NY. FILED 2-18-2010.

**ENTEBe Study of ENtecavir
plus TEnofovir In Patients
with Chronic Hepatitis B
[Who FailEd Previous
Treatment]**

THE MARK CONSISTS OF STANDARD CHARACTERS WITHOUT CLAIM TO ANY PARTICULAR FONT, STYLE, SIZE, OR COLOR.

NO CLAIM IS MADE TO THE EXCLUSIVE RIGHT TO USE "STUDY OF ENTECAVIR PLUS TENOFOVIR IN PATIENTS WITH CHRONIC HEPATITIS B [WHO FAILED PREVIOUS TREATMENT]", APART FROM THE MARK AS SHOWN.

FOR MEDICAL AND SCIENTIFIC RESEARCH, NAMELY, CONDUCTING CLINICAL TRIALS RELATING TO PHARMACEUTICAL PREPARATIONS FOR HUMAN USE (U.S. CLS. 100 AND 101).

SUSAN STIGLITZ, EXAMINING ATTORNEY

SN 77-939,157. GEOPALZ, LLC, BOULDER, CO. FILED 2-18-2010.

GEOPALZ

THE MARK CONSISTS OF STANDARD CHARACTERS WITHOUT CLAIM TO ANY PARTICULAR FONT, STYLE, SIZE, OR COLOR.

FOR COMPUTER SERVICES, NAMELY, HOSTING AND MAINTAINING A WEBSITE FOR UPLOADING DATA FROM ACTIVITY TRACKING DEVICES AND PROVIDING PRIZES AND INCENTIVES FOR REACHING ACTIVITY MILESTONES (U.S. CLS. 100 AND 101).

ELI HELLMAN, EXAMINING ATTORNEY

CLASS 42—(Continued).

SN 77-939,165. GEOPALZ, LLC, BOULDER, CO. FILED 2-18-2010.



THE MARK CONSISTS OF THE WORD "GEOPALZ" WITH A HEART BETWEEN "GEO" AND "PALZ" AND AN IMAGE OF A FIGURE WALKING IN THE TOP RIGHT CORNER.

FOR COMPUTER SERVICES, NAMELY, HOSTING AND MAINTAINING A WEBSITE FOR UPLOADING DATA FROM ACTIVITY TRACKING DEVICES AND PROVIDING PRIZES AND INCENTIVES FOR REACHING ACTIVITY MILESTONES (U.S. CLS. 100 AND 101).
ELI HELLMAN, EXAMINING ATTORNEY

SN 77-943,848. SANOFI-AVENTIS, PARIS 75013, FRANCE, FILED 2-24-2010.

PALLAS

THE MARK CONSISTS OF STANDARD CHARACTERS WITHOUT CLAIM TO ANY PARTICULAR FONT, STYLE, SIZE, OR COLOR.

FOR MEDICAL AND SCIENTIFIC RESEARCH, NAMELY, CONDUCTING CLINICAL TRIALS IN THE CARDIOVASCULAR FIELD (U.S. CLS. 100 AND 101).
WARREN L. OLANDRIA, EXAMINING ATTORNEY

SN 77-949,492. ARES TRADING S.A., AUBONNE CH1170, SWITZERLAND, FILED 3-3-2010.

PERFORMS

THE MARK CONSISTS OF STANDARD CHARACTERS WITHOUT CLAIM TO ANY PARTICULAR FONT, STYLE, SIZE, OR COLOR.

FOR MEDICAL AND SCIENTIFIC RESEARCH, NAMELY, CONDUCTING CLINICAL TRIALS (U.S. CLS. 100 AND 101).
ALICE BENMAMAN, EXAMINING ATTORNEY

CLASS 42—(Continued).

SN 77-949,771. NEARVERSE INC., HUNTINGDON VALLEY, PA. FILED 3-3-2010.

LOKAST

THE MARK CONSISTS OF STANDARD CHARACTERS WITHOUT CLAIM TO ANY PARTICULAR FONT, STYLE, SIZE, OR COLOR.

FOR COMPUTER SERVICES, NAMELY, CREATING AN ON-LINE COMMUNITY FOR REGISTERED USERS TO PARTICIPATE IN DISCUSSIONS, GET FEEDBACK FROM THEIR PEERS, FORM VIRTUAL COMMUNITIES, TRANSFER MEDIA, CONSUME MEDIA, AND ENGAGE IN SOCIAL NETWORKING FEATURING GAMES, GROUPS, VIDEO, PHOTOS, BLOGS, FORUMS, AND POLLS (U.S. CLS. 100 AND 101).
LINDSEY RUBIN, EXAMINING ATTORNEY

SN 77-952,901. INTERMOUNTAIN HEALTH CARE, INC., SALT LAKE CITY, UT. FILED 3-8-2010.

OURFAMILYHEALTH

THE MARK CONSISTS OF STANDARD CHARACTERS WITHOUT CLAIM TO ANY PARTICULAR FONT, STYLE, SIZE, OR COLOR.

FOR COMPUTER SERVICES, NAMELY, PROVIDING A WEB-BASED SYSTEM AND ONLINE PORTAL FEATURING ONLINE NON-DOWNLOADABLE SOFTWARE THAT ENABLES USERS TO CREATE A FAMILY PEDIGREE AND ASSIGN MEDICAL PROBLEMS OR DISEASES FOR EACH RELATIVE FOR THE PURPOSE OF CALCULATING FAMILIAL OR GENETIC DISEASE RISK AND TO SHARE THIS INFORMATION WITH HEALTHCARE PROVIDERS, FAMILY MEMBERS AND OTHERS (U.S. CLS. 100 AND 101).
DAVID MILLER, EXAMINING ATTORNEY

SN 77-953,066. FOX RIVER EXECUTION TECHNOLOGY, LLC, GENEVA, IL. FILED 3-8-2010.

FOX BLASTER

THE MARK CONSISTS OF STANDARD CHARACTERS WITHOUT CLAIM TO ANY PARTICULAR FONT, STYLE, SIZE, OR COLOR.

FOR PROVIDING TEMPORARY USE OF A NON-DOWNLOADABLE APPLICATION PLATFORM THAT AVAILS ITSELF OF ALGORITHMS, PROCESSES, AND SOFTWARE LOGIC TO ACHIEVE THE BEST EXECUTION STRATEGY OF CUSTOMER EQUITY TRADES WHERE URGENCY AND DISCRETION ARE THE PRIMARY CONSIDERATIONS (U.S. CLS. 100 AND 101).
KATHLEEN M. VANSTON, EXAMINING ATTORNEY

CLASS 42—(Continued).

SN 77-957,606. THOMAS PUBLISHING COMPANY, NEW YORK, NY. FILED 3-12-2010.

CATALOG EXPLORER

THE MARK CONSISTS OF STANDARD CHARACTERS WITHOUT CLAIM TO ANY PARTICULAR FONT, STYLE, SIZE, OR COLOR.

NO CLAIM IS MADE TO THE EXCLUSIVE RIGHT TO USE "CATALOG", APART FROM THE MARK AS SHOWN.

FOR DEVELOPING AND HOSTING THE PRODUCT CATALOG WEB SITES OF MANUFACTURERS ON THE INTERNET (U.S. CLS. 100 AND 101).

ANNE E. GUSTASON, EXAMINING ATTORNEY

SN 77-957,787. AMERICAN EXPRESS MARKETING & DEVELOPMENT CORP., NEW YORK, NY. FILED 3-12-2010.

SEARCH4

THE MARK CONSISTS OF STANDARD CHARACTERS WITHOUT CLAIM TO ANY PARTICULAR FONT, STYLE, SIZE, OR COLOR.

FOR COMPUTER SERVICES, NAMELY, SEARCH ENGINE OPTIMIZATION (U.S. CLS. 100 AND 101).

JAY FLOWERS, EXAMINING ATTORNEY

SN 77-958,868. NEW TECH GLOBAL VENTURES, LLC, HOUSTON, TX. FILED 3-15-2010.

FracPros

THE MARK CONSISTS OF STANDARD CHARACTERS WITHOUT CLAIM TO ANY PARTICULAR FONT, STYLE, SIZE, OR COLOR.

FOR ENGINEERING SERVICES, NAMELY, ENGINEERING FOR THE OIL AND GAS INDUSTRY (U.S. CLS. 100 AND 101).

INGA ERVIN, EXAMINING ATTORNEY

CLASS 42—(Continued).

SN 78-954,596. SLIDE, INC., SAN FRANCISCO, CA. FILED 8-17-2006.

SLIDE.COM

THE MARK CONSISTS OF STANDARD CHARACTERS WITHOUT CLAIM TO ANY PARTICULAR FONT, STYLE, SIZE, OR COLOR.

OWNER OF U.S. REG. NOS. 3,169,728, 3,673,049 AND OTHERS.

SEC. 2(F).

FOR HOSTING OF DIGITAL CONTENT ON THE INTERNET FOR OTHERS, NAMELY, PROVIDING A MEANS FOR USERS TO CREATE, STORE, AND PROVIDE ACCESS TO CUSTOMIZED ONLINE INFORMATION ON A GLOBAL COMPUTER NETWORK; DATA MINING APPLICATION SERVICE PROVIDER FEATURING SOFTWARE FOR EXTRACTING, DATA MINING, AND CREATING INDEXES OF SELECTED INFORMATION FROM ONLINE COMMUNICATIONS, WEB SITES, DATABASES, INDICES, AND OTHER CONTENT, FOR USERS, AVAILABLE ON A GLOBAL COMPUTER NETWORK (U.S. CLS. 100 AND 101).

KRISTIN DAHLING, EXAMINING ATTORNEY

SN 85-003,306. SIGNATURE GENOMIC LABORATORIES, LLC, SPOKANE, WA. FILED 3-31-2010.

TURNING COMPLEXITY INTO MEANING

THE MARK CONSISTS OF STANDARD CHARACTERS WITHOUT CLAIM TO ANY PARTICULAR FONT, STYLE, SIZE, OR COLOR.

FOR MEDICAL LABORATORIES; MEDICAL RESEARCH; PROVIDING INFORMATION AT THE SPECIFIC REQUEST OF END-USERS BY MEANS OF TELEPHONE OR GLOBAL COMPUTER NETWORKS; SOFTWARE AUTHORING (U.S. CLS. 100 AND 101).

FIRST USE 9-29-2009; IN COMMERCE 9-29-2009.

DAVID YONTEF, EXAMINING ATTORNEY

CLASS 43—HOTEL AND RESTAURANT SERVICES

SN 77-533,092. BARONE'S, INC., VALLEY GLEN, CA. FILED 7-28-2008.

Barone's Restaurant

THE MARK CONSISTS OF STANDARD CHARACTERS WITHOUT CLAIM TO ANY PARTICULAR FONT, STYLE, SIZE, OR COLOR.

NO CLAIM IS MADE TO THE EXCLUSIVE RIGHT TO USE "RESTAURANT", APART FROM THE MARK AS SHOWN.

SEC. 2(F).

FOR RESTAURANT (U.S. CLS. 100 AND 101).

FIRST USE 11-1-1945; IN COMMERCE 11-1-1945.

MEGHAN REINHART, EXAMINING ATTORNEY

SN 77-533,207. BARONE'S, INC., VALLEY GLEN, CA. FILED 7-29-2008.

Barone's Famous Italian

THE MARK CONSISTS OF STANDARD CHARACTERS WITHOUT CLAIM TO ANY PARTICULAR FONT, STYLE, SIZE, OR COLOR.

NO CLAIM IS MADE TO THE EXCLUSIVE RIGHT TO USE "ITALIAN", APART FROM THE MARK AS SHOWN.

SEC. 2(F).

FOR RESTAURANT (U.S. CLS. 100 AND 101).

FIRST USE 11-1-1945; IN COMMERCE 11-1-1945.

MEGHAN REINHART, EXAMINING ATTORNEY

SN 77-539,244. SHANE MIXON, ATLANTA, GA. AND KATHY CUSHING, ATLANTA, GA. FILED 8-5-2008.



THE COLOR(S) BROWN, WHITE, AND ORANGE IS/ARE CLAIMED AS A FEATURE OF THE MARK.

THE MARK CONSISTS OF A BROWN BACKGROUND, "SABA" IN WHITE LETTERING UNDERLINED WITH AN ORANGE BLOCK, AND FOUR ORANGE, INVERTED "S" TO THE IMMEDIATE LEFT OF THE WORD "SABA".

FOR RESTAURANT; RESTAURANT AND BAR SERVICES; RESTAURANT AND CATERING SERVICES (U.S. CLS. 100 AND 101).

FIRST USE 12-27-2007; IN COMMERCE 12-27-2007.

AISHA CLARKE, EXAMINING ATTORNEY

CLASS 43—(Continued).

SN 77-591,217. LINGER CAFE & LOUNGE, BROOKLYN, NY. FILED 10-13-2008.

Linger, a Localvore's lounge

THE MARK CONSISTS OF STANDARD CHARACTERS WITHOUT CLAIM TO ANY PARTICULAR FONT, STYLE, SIZE, OR COLOR.

NO CLAIM IS MADE TO THE EXCLUSIVE RIGHT TO USE "A LOCALVORE'S LOUNGE", APART FROM THE MARK AS SHOWN.

FOR CAFE (U.S. CLS. 100 AND 101).

MARK RADEMACHER, EXAMINING ATTORNEY

SN 77-724,224. RUIZ, ANTONIO, T., LA PORTE, TX. FILED 4-28-2009.



NO CLAIM IS MADE TO THE EXCLUSIVE RIGHT TO USE "BARBECUE & STEAK HOUSE", APART FROM THE MARK AS SHOWN.

THE MARK CONSISTS OF TWO CONCENTRIC RECTANGLES SURROUNDING TWO STYLIZED CARICATURES OF THE HEAD OF A LONGHORN AND A RECTANGLE WITH A CURVED UPPER LINE THAT ENCLOSES THE WORDING "TONY'S BARBECUE STEAK HOUSE" AND DISTINCTIVE DESIGNS.

FOR BAR AND RESTAURANT SERVICES (U.S. CLS. 100 AND 101).

FIRST USE 5-10-1999. THE MARK WAS FIRST USED ANYWHERE IN A DIFFERENT FORM OTHER THAN THAT SOUGHT TO BE REGISTERED AT LEAST AS EARLY AS 05/10/1999.; IN COMMERCE 5-10-1999, THE MARK WAS FIRST USED IN COMMERCE IN A DIFFERENT FORM OTHER THAN THAT SOUGHT TO BE REGISTERED AT LEAST AS EARLY AS 05/10/1999..

ANDREA BUTLER, EXAMINING ATTORNEY

SN 77-733,956. STEWART, MICHAEL, PETALUMA, CA. AND STEWART, SUSAN, PETALUMA, CA. FILED 5-11-2009.



NO CLAIM IS MADE TO THE EXCLUSIVE RIGHT TO USE "BAR-B-QUE & GRILL", APART FROM THE MARK AS SHOWN.

THE COLOR(S) TAN, RED, YELLOW, ORANGE, BLACK AND WHITE IS/ARE CLAIMED AS A FEATURE OF THE MARK.

THE MARK CONSISTS OF THE WORDS "ROAD HOG" WITH A DESIGN OF A PIG'S HEAD IN BETWEEN THESE WORDS, WITH THE WORDS "ROAD HOG" IN THE COLORS YELLOW AND ORANGE OUTLINED IN THE

CLASS 43—(Continued).

COLOR BLACK WITH THE PIG HEAD DESIGN IN THE COLOR TAN OUTLINED IN THE COLOR BLACK WITH A RED TONGUE WITH WHITE LINES, EYES IN THE COLORS WHITE AND BLACK AND HAT AND GLASSES IN THE COLOR BLACK; BELOW THE PIG HEAD DESIGN IS A WHITE ROAD DESIGN WITH LINES OR DIVIDERS IN THE COLOR BLACK; THE WORDS "BAR-B-QUE" ARE IN THE COLOR ORANGE OUTLINED IN THE COLOR BLACK, WITH AN ORANGE STAR INSIDE THE "A" IN "BAR"; AND THE WORDS "& GRILL" IN THE COLOR YELLOW OUTLINED WITH BLACK.

FOR MOBILE CAFE SERVICES FOR PROVIDING FOOD AND DRINK; RESTAURANT SERVICES FEATURING BARBEQUED FOOD ITEMS (U.S. CLS. 100 AND 101).

FIRST USE 3-12-2008; IN COMMERCE 3-12-2008.
BARBARA RUTLAND, EXAMINING ATTORNEY

SN 77-771,227. JIF, INC., DBA PIAZZANO'S, LANSING, MI.
FILED 6-30-2009.

Piazzano's Where Good Friends Meet

THE MARK CONSISTS OF STANDARD CHARACTERS WITHOUT CLAIM TO ANY PARTICULAR FONT, STYLE, SIZE, OR COLOR.

FOR RESTAURANT SERVICES, INCLUDING SIT-DOWN SERVICE OF FOOD AND TAKE-OUT RESTAURANT SERVICES (U.S. CLS. 100 AND 101).

FIRST USE 11-26-1996; IN COMMERCE 11-26-1996.
ASMAT KHAN, EXAMINING ATTORNEY

SN 77-779,339. BOI NA BRAZA, INC., GRAPEVINE, TX.
FILED 7-13-2009.

BOI NA BRAZA

THE MARK CONSISTS OF STANDARD CHARACTERS WITHOUT CLAIM TO ANY PARTICULAR FONT, STYLE, SIZE, OR COLOR.

OWNER SEEKS REGISTRATION OF THE MARK IN CONNECTION WITH "RESTAURANT AND BAR SERVICES" FOR THE ENTIRE UNITED STATES, EXCEPT FOR THE STATE OF NEW JERSEY. OWNER IS USING THE MARK IN ADVERTISING, INCLUDING PRINT, TELEVISION, RADIO, AND WEB-RELATED MEDIA, IN CONNECTION WITH OWNER'S BUSINESS. TERRA SUL CORP. (THE "EXCEPTED USER"), LOCATED AT 70 ADAMS STREET, STORE NO. 4, NEWARK, NEW JERSEY 07105, CLAIMS TO HAVE USED THE MARK CHURRASCARIA BOI NA BRAZA IN THE STATE OF NEW JERSEY SINCE 1996 BY MEANS OF ADVERTISING FOR A RESTAURANT. THE EXCEPTED USER HAS FILED APPLICATIONS SERIAL NOS. 77813335 AND 77813416. OWNER'S DATE OF FIRST USE IN COMMERCE IS PRIOR TO THE FILING DATE OF ANY APPLICATION FILED BY THE EXCEPTED USER (37 CFR SECTION 2.99(E)).

OWNER OF U.S. REG. NO. 2,666,968.

THE ENGLISH TRANSLATION OF THE MARK IS "STEER OVER EMBERS".

FOR RESTAURANT AND BAR SERVICES (U.S. CLS. 100 AND 101).

FIRST USE 7-19-1999; IN COMMERCE 9-11-2000.
MARC LEIPZIG, EXAMINING ATTORNEY

CLASS 43—(Continued).

SN 77-780,236. VICTOR R. PISANO, RICHMOND HILL, GA.
FILED 7-14-2009.

LOW COUNTRY ITALIAN

THE MARK CONSISTS OF STANDARD CHARACTERS WITHOUT CLAIM TO ANY PARTICULAR FONT, STYLE, SIZE, OR COLOR.

NO CLAIM IS MADE TO THE EXCLUSIVE RIGHT TO USE "ITALIAN", APART FROM THE MARK AS SHOWN. FOR RESTAURANT AND CAFE SERVICES (U.S. CLS. 100 AND 101).

MIDGE BUTLER, EXAMINING ATTORNEY

SN 77-787,056. CERVECERIA MODELO, S.A. DE C. V.,
COLONIA ANAHUAC, C.P., MEXICO, FILED 7-22-2009.

CORONA CANTINA

THE MARK CONSISTS OF STANDARD CHARACTERS WITHOUT CLAIM TO ANY PARTICULAR FONT, STYLE, SIZE, OR COLOR.

OWNER OF U.S. REG. NOS. 1,681,366, 2,896,806 AND OTHERS.

NO CLAIM IS MADE TO THE EXCLUSIVE RIGHT TO USE "CANTINA", APART FROM THE MARK AS SHOWN.

THE ENGLISH TRANSLATION OF "CORONA" IN THE MARK IS CROWN.

FOR PROVIDING OF FOOD AND DRINK (U.S. CLS. 100 AND 101).

MARLENE BELL, EXAMINING ATTORNEY

SN 77-798,059. BURDSALL, BRADLEY J., LAS VEGAS, NV.
FILED 8-5-2009.

EGGS-ACTLY WHAT YOU WANT

THE MARK CONSISTS OF STANDARD CHARACTERS WITHOUT CLAIM TO ANY PARTICULAR FONT, STYLE, SIZE, OR COLOR.

OWNER OF U.S. REG. NOS. 2,972,785, 3,132,146 AND 3,578,910.

FOR RESTAURANT SERVICES (U.S. CLS. 100 AND 101).

FIRST USE 1-31-1999; IN COMMERCE 1-31-1999.
MICHAEL GAFFAR, EXAMINING ATTORNEY

CLASS 43—(Continued).

SN 77-814,939. OMILAMI, ELIZABETH, LITHONIA, GA. FILED 8-28-2009.



NO CLAIM IS MADE TO THE EXCLUSIVE RIGHT TO USE "FEED THE HUNGRY & HOMELESS", APART FROM THE MARK AS SHOWN.

THE MARK CONSISTS OF A CIRCLE WITH TWO SILHOUETTES OF PEOPLE. ON THE RIGHT THERE IS A KNIFE AND SPOON WITH FORK ON THE LEFT SIDE. BELOW THERE IS A LINE WITH THE STYLIZED TEXT "HOSEA FEED THE HUNGRY & HOMELESS".

FOR CHARITABLE SERVICES, NAMELY, PROVIDING TEMPORARY SHELTER FOR THE HOMELESS; SUPPLYING MEALS TO THE HOMELESS OR UNDER-PRIVILEGED (U.S. CLS. 100 AND 101).

FIRST USE 11-0-1970; IN COMMERCE 11-0-1970.
BRIAN NEVILLE, EXAMINING ATTORNEY

CLASS 43—(Continued).

SN 77-827,959. J & A ROSA, INC, MARIETTA, GA. FILED 9-16-2009.



NO CLAIM IS MADE TO THE EXCLUSIVE RIGHT TO USE "PIZZA", APART FROM THE MARK AS SHOWN.

THE STIPPLING IS FOR SHADING PURPOSES ONLY.

THE MARK CONSISTS OF 3 MAIN SITES FOUND IN NEW YORK CITY WITH A SASH ACROSS A 2 TIERED BORDER CIRCLE. ACROSS THE CIRCLE THERE IS A SASH WITH THE STYLIZED TEXT "ROSA'S PIZZA". WITHIN THE CIRCLE ON THE LEFT SIDE THERE IS A DRAWING OF THE BROOKLYN BRIDGE AND ON THE RIGHT SIDE THERE IS A DRAWING OF THE EMPIRE STATES BUILDING. AT THE FOREFRONT OF THE PICTURE THERE IS AN IMAGE OF THE STATUE OF LIBERTY. THE LADY'S LIBERTY'S TORCH TOUCHES THE TOP OF THE CIRCLE AND EXTENDS BEYOND THE CIRCLE. SHE IS HOLDING A BOOK WITH THE STYLIZED TEXT "I ROSAS". A HEART APPEAR IN THE MIDDLE OF "I" AND "ROSAS".

FOR RESTAURANT SERVICES (U.S. CLS. 100 AND 101).

FIRST USE 10-20-2007; IN COMMERCE 10-20-2007.
KEVON CHISOLM, EXAMINING ATTORNEY

SN 77-825,435. CONSTANCE, INC, BETHESDA, MD. FILED 9-12-2009.



NO CLAIM IS MADE TO THE EXCLUSIVE RIGHT TO USE "BAGELRY", APART FROM THE MARK AS SHOWN.

THE COLOR(S) RED, BLACK, YELLOW, WHITE, AND BROWN IS/ARE CLAIMED AS A FEATURE OF THE MARK.

THE MARK CONSISTS OF A POLYGON MADE UP OF RED AND BLACK BRICKS OUTLINED IN YELLOW AND BLACK, WHERE THE WORDS "THE GEORGETOWN" ARE WRITTEN IN YELLOW ON A RED AND BLACK BANNER ABOVE A WHITE POLYGON CONTAINING BROWN AND BLACK BAGELS ABOVE THE WORD "BAGELRY" WRITTEN IN YELLOW AND OUTLINED IN BLACK.

FOR RESTAURANT AND CATERING SERVICES; RESTAURANT SERVICES, NAMELY, PROVIDING OF FOOD AND BEVERAGES FOR CONSUMPTION ON AND OFF THE PREMISES (U.S. CLS. 100 AND 101).

FIRST USE 9-12-2009; IN COMMERCE 9-12-2009.
KATHERINE M. DUBRAY, EXAMINING ATTORNEY

SN 77-833,005. HANNAH INTERNATIONAL FOODS, INC., SEABROOK, NH. FILED 9-23-2009.

HOMMUS FACTORY

THE MARK CONSISTS OF STANDARD CHARACTERS WITHOUT CLAIM TO ANY PARTICULAR FONT, STYLE, SIZE, OR COLOR.

OWNER OF U.S. REG. NO. 3,142,242.
NO CLAIM IS MADE TO THE EXCLUSIVE RIGHT TO USE "HOMMUS", APART FROM THE MARK AS SHOWN.

FOR RESTAURANT SERVICES (U.S. CLS. 100 AND 101).

MYRIAH HABEEB, EXAMINING ATTORNEY

CLASS 43—(Continued).

SN 77-854,391. SHAKEY'S USA, INC., ALHAMBRA, CA. FILED 10-21-2009.



OWNER OF U.S. REG. NOS. 721,138, 1,008,087 AND OTHERS.

NO CLAIM IS MADE TO THE EXCLUSIVE RIGHT TO USE "PIZZA PARLOR" AND "PUBLIC HOUSE", APART FROM THE MARK AS SHOWN.

THE MARK CONSISTS OF A CHEF NEXT TO THE STYLIZED WORDS "SHAKEY'S PIZZA PARLOR YE PUBLIC HOUSE".

FOR RESTAURANT SERVICES (U.S. CLS. 100 AND 101).

FIRST USE 0-0-1964; IN COMMERCE 0-0-1964.

REGINA DRUMMOND, EXAMINING ATTORNEY

CLASS 43—(Continued).

SN 77-865,539. LUTHERAN SOCIAL SERVICES OF METROPOLITAN NEW YORK, NEW YORK, NY. FILED 11-5-2009.



THE MARK CONSISTS OF A GRAPHIC OF FOUR BRACKETS FORMING A STYLIZED CROSS WITH A BRACKET IN EACH CORNER. THE CROSS GRAPHIC IS SURROUNDED BY A CIRCULAR BORDER.

FOR HOUSING SERVICES, NAMELY, PROVIDING RESIDENTIAL HOUSING IN THE NATURE OF TEMPORARY HOUSING ACCOMMODATIONS FOR ADULTS AND CHILDREN AT RISK (U.S. CLS. 100 AND 101).

FIRST USE 2-0-1992; IN COMMERCE 2-0-1992.

ALYSSA STEEL, EXAMINING ATTORNEY

SN 77-861,347. BLT MANAGEMENT LLC, NEW YORK, NY. FILED 10-30-2009.

SN 77-868,365. THIRTY EIGHT STREET, INC., CORAL SPRINGS, FL. FILED 11-9-2009.

CASA NONNA

THE MARK CONSISTS OF STANDARD CHARACTERS WITHOUT CLAIM TO ANY PARTICULAR FONT, STYLE, SIZE, OR COLOR.

THE ENGLISH TRANSLATION OF THE WORD "CASA NONNA" IN THE MARK IS "HOUSE OF THE GRANDMOTHER".

FOR RESTAURANT SERVICES (U.S. CLS. 100 AND 101).

JAY FLOWERS, EXAMINING ATTORNEY

VALUE INN WORLDWIDE

THE MARK CONSISTS OF STANDARD CHARACTERS WITHOUT CLAIM TO ANY PARTICULAR FONT, STYLE, SIZE, OR COLOR.

OWNER OF U.S. REG. NOS. 972,568, 3,735,284 AND OTHERS.

NO CLAIM IS MADE TO THE EXCLUSIVE RIGHT TO USE "INN" AND "WORLDWIDE", APART FROM THE MARK AS SHOWN.

FOR HOTEL AND MOTEL SERVICES (U.S. CLS. 100 AND 101).

FIRST USE 2-5-2009; IN COMMERCE 2-5-2009.

PAUL E. FAHRENKOPF, EXAMINING ATTORNEY

CLASS 43—(Continued).

SN 77-884,734. DOUBLE DOWN, INC., LAS VEGAS, NV.
FILED 12-2-2009.

SHUT UP AND DRINK

THE MARK CONSISTS OF STANDARD CHARACTERS
WITHOUT CLAIM TO ANY PARTICULAR FONT, STYLE,
SIZE, OR COLOR.

FOR BAR AND RESTAURANT SERVICES (U.S. CLS.
100 AND 101).

FIRST USE 3-8-2006; IN COMMERCE 3-8-2006.
ERIN FALK, EXAMINING ATTORNEY

SN 77-885,265. RIMON, RONEN, JERUSALEM, ISRAEL,
AND RIMON, YAHAV, JERUSALEM, ISRAEL, FILED
12-3-2009.

RIMON

THE MARK CONSISTS OF STANDARD CHARACTERS
WITHOUT CLAIM TO ANY PARTICULAR FONT, STYLE,
SIZE, OR COLOR.

OWNER OF ISRAEL REG. NO. 203510, DATED 1-27-2009,
EXPIRES 8-30-2017.

OWNER OF U.S. REG. NO. 3,597,043.
THE ENGLISH TRANSLATION OF "RIMON" IN THE
MARK IS "POMEGRANATE".

FOR CAFES, RESTAURANTS, SELF-SERVICE RES-
TAURANTS, CAFETERIAS, SNACK BARS, CANTEENS,
PUBS; PROVIDING OF FOOD AND DRINK; CATERING
SERVICES; HOSPITALITY SERVICES, NAMELY, THE
PROVISION OF FOOD AND DRINK (U.S. CLS. 100 AND
101).

ANDREA HACK, EXAMINING ATTORNEY

CLASS 43—(Continued).

SN 77-888,639. SWEET FISH SUSHI BAR, INC., PLAYA
VISTA, CA. FILED 12-8-2009.



NO CLAIM IS MADE TO THE EXCLUSIVE RIGHT TO
USE "FISH" AND "SUSHI BAR", APART FROM THE MARK
AS SHOWN.

THE COLOR(S) WHITE, RED AND BLACK IS/ARE
CLAIMED AS A FEATURE OF THE MARK.

THE MARK CONSISTS OF THE STYLIZED WORDS
"SWEET FISH SUSHI BAR". "SUSHI BAR" IS IN WHITE,
"SWEET" IS IN RED, AND "FISH" IS IN BLACK.

FOR RESTAURANT (U.S. CLS. 100 AND 101).
DOMINICK J. SALEMI, EXAMINING ATTORNEY

SN 77-894,676. KRAMARZ VENTURES, INC., BELMONT,
MI. FILED 12-16-2009.

THE DAM DOGS

THE MARK CONSISTS OF STANDARD CHARACTERS
WITHOUT CLAIM TO ANY PARTICULAR FONT, STYLE,
SIZE, OR COLOR.

NO CLAIM IS MADE TO THE EXCLUSIVE RIGHT TO
USE "DOGS", APART FROM THE MARK AS SHOWN.

FOR RESTAURANT SERVICES, NAMELY, THE PRE-
PARATION AND SERVING OF SPECIALTY HOT DOGS
(U.S. CLS. 100 AND 101).

FIRST USE 5-31-2002; IN COMMERCE 5-31-2002.
GEORGE LORENZO, EXAMINING ATTORNEY

CLASS 43—(Continued).

SN 77-895,125. U.S. VETS, LOS ANGELES, CA. FILED 12-16-2009.



NO CLAIM IS MADE TO THE EXCLUSIVE RIGHT TO USE "U.S. VETS", APART FROM THE MARK AS SHOWN.

THE MARK CONSISTS OF A PARTIAL STAR WITH THE STYLIZED TEXT "U.S. VETS" AND THREE STRIPES ON THE RIGHT.

FOR CHARITABLE SERVICES, NAMELY, PROVIDING TEMPORARY HOUSING TO U.S. VETERANS AND THEIR FAMILIES (U.S. CLS. 100 AND 101).

FIRST USE 6-0-1999; IN COMMERCE 6-0-1999.
JAMES A. RAUEN, EXAMINING ATTORNEY

CLASS 43—(Continued).

SN 77-901,773. GENERAL LAND HOLDINGS, S.A., APARTADO POSTAL, PANAMA, FILED 12-28-2009.

SN 77-896,287. DIANE C. HARDER WINE MARKETING, INC., REDONDO BEACH, CA. FILED 12-17-2009.

Liquid Edu

THE MARK CONSISTS OF STANDARD CHARACTERS WITHOUT CLAIM TO ANY PARTICULAR FONT, STYLE, SIZE, OR COLOR.

FOR PROVIDING A WEBSITE THAT FEATURES A SERIES OF NON-DOWNLOADABLE EDUCATIONAL VIDEOS WITH THE INTENTION OF EDUCATING CONSUMERS ABOUT ATTRIBUTES OF ALCOHOLIC BEVERAGES SPECIFICALLY FOCUSING ON WINE, BEER AND SPIRITS (U.S. CLS. 100 AND 101).

FIRST USE 9-1-2009; IN COMMERCE 9-10-2009.
KAELIE KUNG, EXAMINING ATTORNEY



SN 77-901,748. GENERAL LAND HOLDINGS, S.A., PANAMA APARTADOPOSTAL, PANAMA, FILED 12-28-2009.

Cabo Blanco Fishing Clubs

THE MARK CONSISTS OF STANDARD CHARACTERS WITHOUT CLAIM TO ANY PARTICULAR FONT, STYLE, SIZE, OR COLOR.

NO CLAIM IS MADE TO THE EXCLUSIVE RIGHT TO USE "FISHING CLUBS", APART FROM THE MARK AS SHOWN.

THE ENGLISH TRANSLATION OF "CABO BLANCO" IN THE MARK IS WHITE CAPE.

FOR PROVIDE A WEBSITE FOR MAKING RESERVATIONS AND BOOKING OF ECO-LODGING; RESORT HOTELS (U.S. CLS. 100 AND 101).

KRISTIN DAHLING, EXAMINING ATTORNEY

NO CLAIM IS MADE TO THE EXCLUSIVE RIGHT TO USE "FISHING CLUBS", APART FROM THE MARK AS SHOWN.

THE MARK CONSISTS OF A RENDERING OF THREE FISH FACING TO THE LEFT SURROUNDED BY TWO CIRCLES AND THE WORDS "CABO BLANCO FISHING CLUBS".

THE ENGLISH TRANSLATION OF "CABO BLANCO" IN THE MARK IS WHITE CAPE.

FOR PROVIDE A WEBSITE FOR MAKING RESERVATIONS AND BOOKING OF ECO-LODGING; RESORT HOTELS (U.S. CLS. 100 AND 101).

KRISTIN DAHLING, EXAMINING ATTORNEY

CLASS 43—(Continued).

SN 77-911,167. KYOCHON F&B CO., LTD., GYEONGSANG-BUK-DO, REPUBLIC OF KOREA, FILED 1-13-2010.



OWNER OF U.S. REG. NOS. 3,458,945 AND 3,468,821.
NO CLAIM IS MADE TO THE EXCLUSIVE RIGHT TO USE "CHICKEN", APART FROM THE MARK AS SHOWN.
THE COLOR(S) BLACK, BROWN, WHITE, RED, YELLOW, BEIGE IS/ARE CLAIMED AS A FEATURE OF THE MARK.

THE MARK CONSISTS OF THE WORDS "KYOCHON CHICKEN" IN STYLIZED LETTERS IN BLACK APPEARING ON A FOOD CARTON IN WHITE, BLACK, RED, YELLOW APPEARING ON TOP OF A FANCIFUL CAR IN BEIGE WITH BROWN WINGS, BROWN AND BLACK TIRES, A MOUTH IN WHITE, EYES IN BROWN AND BLACK WITH A WHITE BACKGROUND AND RED, BLACK AND BROWN RIBBON.

THE ENGLISH TRANSLATION OF "KYOCHON" IN THE MARK IS "A VILLAGE WITH A KOREAN TRADITIONAL LOCAL SCHOOL".

FOR TOURIST RESTAURANTS, TEA ROOMS, RESTAURANTS, BUFFET RESTAURANTS, WESTERN STYLE RESTAURANTS, SELF-SERVICE RESTAURANTS, CAFES, CAFETERIAS, CANTEN SERVICES, SNACK-BARS (U.S. CLS. 100 AND 101).

FIRST USE 12-23-2009; IN COMMERCE 12-23-2009.
SETH A. RAPPAPORT, EXAMINING ATTORNEY

SN 77-914,889. MEJO LLC, NEW YORK, NY. FILED 1-19-2010.

SOCARRAT BAR DE VINOS

THE MARK CONSISTS OF STANDARD CHARACTERS WITHOUT CLAIM TO ANY PARTICULAR FONT, STYLE, SIZE, OR COLOR.

OWNER OF U.S. REG. NOS. 3,760,136 AND 3,762,409.

NO CLAIM IS MADE TO THE EXCLUSIVE RIGHT TO USE "BAR DE VINOS", APART FROM THE MARK AS SHOWN.

THE ENGLISH TRANSLATION OF THE WORD "SOCARRAT" IN THE MARK IS "CARAMELIZED CRUST OF RICE THAT SOMETIMES STICKS TO THE BOTTOM OF THE PAN".

THE ENGLISH TRANSLATION OF THE WORD "BAR DE VINOS" IN THE MARK IS "WINE BAR".

FOR RESTAURANT AND WINE AND BEER BAR SERVICES (U.S. CLS. 100 AND 101).

FIRST USE 12-13-2009; IN COMMERCE 12-13-2009.
AMEEN IMAM, EXAMINING ATTORNEY

CLASS 43—(Continued).

SN 77-917,267. TROPICANA LAS VEGAS, INC., LAS VEGAS, NV. FILED 1-21-2010.

**SOUTH
BEACH**
CAFÉ & DELI

NO CLAIM IS MADE TO THE EXCLUSIVE RIGHT TO USE "CAFÉ & DELI", APART FROM THE MARK AS SHOWN.

THE MARK CONSISTS OF THE WORD "SOUTH" APPEARING ABOVE THE WORD "BEACH", WHICH IS PLACED ABOVE THE PHRASE "CAFÉ & DELI". THE "O" IN "SOUTH" IS FORMED OF CONCENTRIC CIRCLES.

FOR CAFE AND RESTAURANT SERVICES; CARRY-OUT RESTAURANTS; DELICATESSENS (U.S. CLS. 100 AND 101).

AARON BRODSKY, EXAMINING ATTORNEY

SN 77-917,775. SHADY LLC, DBA SHADY GATORS, ELDON, MO. FILED 1-22-2010.

Shady Gators

THE MARK CONSISTS OF STANDARD CHARACTERS WITHOUT CLAIM TO ANY PARTICULAR FONT, STYLE, SIZE, OR COLOR.

FOR BAR AND RESTAURANT SERVICES FEATURING LIVE MUSIC (U.S. CLS. 100 AND 101).

FIRST USE 3-1-2003; IN COMMERCE 3-1-2003.
JOHN WILKE, EXAMINING ATTORNEY

SN 77-922,754. TROPICANA LAS VEGAS, INC., LAS VEGAS, NV. FILED 1-28-2010.

BISCAYNE
STEAK • SEA • WINE

NO CLAIM IS MADE TO THE EXCLUSIVE RIGHT TO USE "STEAK", "SEA" OR "WINE", APART FROM THE MARK AS SHOWN.

THE MARK CONSISTS OF THE WORD "BISCAYNE" APPEARING ABOVE THE PHRASE "STEAK", "SEA", "WINE", WITH A STAR-LIKE SYMBOL PLACED IN BETWEEN THE WORDS "STEAK" AND "SEA" AND AGAIN BETWEEN THE WORDS "SEA" AND "WINE".

FOR PROVISION OF FOOD AND DRINK IN RESTAURANTS; RESTAURANT AND BAR SERVICES (U.S. CLS. 100 AND 101).

AARON BRODSKY, EXAMINING ATTORNEY

CLASS 43—(Continued).

SN 77-923,945. FLORES, JORGE, CHICAGO, IL. FILED 1-29-2010.



THE MARK CONSISTS OF A CIRCLE WITH A TREE IN THE MIDDLE AND CURVED LINES AT THE BOTTOM. THE STYLIZED TEXT "CASSAVA" IS TO THE RIGHT OF THE DESIGN.

FOR RESTAURANT (U.S. CLS. 100 AND 101).
KIM SAITO, EXAMINING ATTORNEY

CLASS 43—(Continued).

SN 77-924,967. HYNES FINE DINING, LLC, BOSTON, MA. FILED 2-1-2010.

TOWNE STOVE & SPIRITS

THE MARK CONSISTS OF STANDARD CHARACTERS WITHOUT CLAIM TO ANY PARTICULAR FONT, STYLE, SIZE, OR COLOR.

NO CLAIM IS MADE TO THE EXCLUSIVE RIGHT TO USE "SPIRITS", APART FROM THE MARK AS SHOWN. FOR RESTAURANT AND BAR SERVICES (U.S. CLS. 100 AND 101).

SUSAN LESLIE DUBOIS, EXAMINING ATTORNEY

SN 77-924,704. CM TRADEMARK HOLDINGS, INC., FORT LAUDERDALE, FL. FILED 2-1-2010.

**MARTORANO'S
ITALIAN-AMERICAN KITCHEN**

THE MARK CONSISTS OF STANDARD CHARACTERS WITHOUT CLAIM TO ANY PARTICULAR FONT, STYLE, SIZE, OR COLOR.

OWNER OF U.S. REG. NOS. 3,279,213 AND 3,289,724.

NO CLAIM IS MADE TO THE EXCLUSIVE RIGHT TO USE "ITALIAN-AMERICAN KITCHEN", APART FROM THE MARK AS SHOWN.

FOR DINE-IN AND TAKE-OUT RESTAURANT SERVICES (U.S. CLS. 100 AND 101).

KIM MONINGHOFF, EXAMINING ATTORNEY

SN 77-925,170. KEYSTONE PARTNERS LLC, GREENVILLE, SC. FILED 2-1-2010.

THE PEACOCK HOTEL

THE MARK CONSISTS OF STANDARD CHARACTERS WITHOUT CLAIM TO ANY PARTICULAR FONT, STYLE, SIZE, OR COLOR.

NO CLAIM IS MADE TO THE EXCLUSIVE RIGHT TO USE "HOTEL", APART FROM THE MARK AS SHOWN.

FOR HOTEL SERVICES (U.S. CLS. 100 AND 101).

WARREN L. OLANDRIA, EXAMINING ATTORNEY

SN 77-924,928. MAGIC BRANDS, LLC, AUSTIN, TX. FILED 2-1-2010.

BETTER FOR YOU

THE MARK CONSISTS OF STANDARD CHARACTERS WITHOUT CLAIM TO ANY PARTICULAR FONT, STYLE, SIZE, OR COLOR.

FOR RESTAURANT SERVICES (U.S. CLS. 100 AND 101).

FIRST USE 1-0-2008; IN COMMERCE 1-0-2008.
BRENDAN REGAN, EXAMINING ATTORNEY

SN 77-925,194. HBD RESTAURANTS, LLC, FORMERLY HUGEE'S RESTAURANTS, LLC, CHARLESTON, SC. FILED 2-1-2010.

HUBEE D'S TENDERS & WINGS

THE MARK CONSISTS OF STANDARD CHARACTERS WITHOUT CLAIM TO ANY PARTICULAR FONT, STYLE, SIZE, OR COLOR.

NO CLAIM IS MADE TO THE EXCLUSIVE RIGHT TO USE "TENDERS & WINGS", APART FROM THE MARK AS SHOWN.

FOR RESTAURANT SERVICES (U.S. CLS. 100 AND 101).

DOMINICK J. SALEMI, EXAMINING ATTORNEY

CLASS 43—(Continued).

SN 77-925,289. LUCKY ROBATA GRILL, INC., CALABASAS HILLS, CA. FILED 2-1-2010.



NO CLAIM IS MADE TO THE EXCLUSIVE RIGHT TO USE "ROBATA GRILL", APART FROM THE MARK AS SHOWN.

THE COLOR(S) BLACK, RED, ORANGE, GREY AND WHITE IS/ARE CLAIMED AS A FEATURE OF THE MARK.

THE MARK CONSISTS OF THE WORD "LUCKY" IN BLACK LETTERING, AND BELOW THAT THE WORDS "ROBATA GRILL" IN RED LETTERING; BEHIND THE WORD "LUCKY" ARE RED AND ORANGE FLAMES; THROUGH THE WORD "LUCKY" IS A GREY SKEWER; AS PART OF THE LETTER "U" IN "LUCKY" IS A WHITE JAPANESE CHARACTER; AND THE TRANSLITERATION OF THE CHARACTER IS "KICHI" WHICH MEANS "GOOD LUCK".

THE ENGLISH TRANSLATION OF "ROBATA" IN THE MARK IS CHARCOAL GRILL.

THE NON-LATIN CHARACTERS IN THE MARK TRANSLITERATE TO KICHI AND THIS MEANS GOOD LUCK IN ENGLISH.

FOR RESTAURANT SERVICES AND CARRY-OUT FOOD SERVICES (U.S. CLS. 100 AND 101).

STEPHEN AQUILA, EXAMINING ATTORNEY

SN 77-925,688. GEAH INC., ROCKVILLE, MD. FILED 2-2-2010.

Addie's

THE MARK CONSISTS OF STANDARD CHARACTERS WITHOUT CLAIM TO ANY PARTICULAR FONT, STYLE, SIZE, OR COLOR.

FOR RESTAURANT SERVICES (U.S. CLS. 100 AND 101).

FIRST USE 12-10-1996; IN COMMERCE 12-10-1996.
BRIAN PINO, EXAMINING ATTORNEY

CLASS 43—(Continued).

SN 77-925,785. M HOLDINGS, LLC, HENDERSON, NV. FILED 2-2-2010.



THE MARK CONSISTS OF THE STYLIZED WORDS "LIBIDO LOCO" WHICH ARE SEPARATED BY THE SILHOUETTES OF A WOMAN AND MAN DANCING WHICH IS SUPERIMPOSED OVER A SPLATTER.

FOR BAR AND COCKTAIL LOUNGE SERVICES (U.S. CLS. 100 AND 101).

FIRST USE 1-16-2010; IN COMMERCE 1-16-2010.
ANDREW LEASER, EXAMINING ATTORNEY

SN 77-925,892. DAVIS, WENDY CAROL-HAYES, DBA CONE-A-COPIA, JACKSON, MI. FILED 2-2-2010.

CONE-A-COPIA

THE MARK CONSISTS OF STANDARD CHARACTERS WITHOUT CLAIM TO ANY PARTICULAR FONT, STYLE, SIZE, OR COLOR.

FOR PREPARATION OF FOOD AND BEVERAGES (U.S. CLS. 100 AND 101).

JUSTINE D. PARKER, EXAMINING ATTORNEY

SN 77-926,029. LEGAL SEA FOODS, INC., BOSTON, MA. FILED 2-2-2010.

LEGAL'S SEAFOOD AND MEAT

THE MARK CONSISTS OF STANDARD CHARACTERS WITHOUT CLAIM TO ANY PARTICULAR FONT, STYLE, SIZE, OR COLOR.

OWNER OF U.S. REG. NOS. 1,060,132, 2,003,409 AND OTHERS.

NO CLAIM IS MADE TO THE EXCLUSIVE RIGHT TO USE "SEAFOOD AND MEAT", APART FROM THE MARK AS SHOWN.

FOR RESTAURANT SERVICES (U.S. CLS. 100 AND 101).

KELLY BOULTON, EXAMINING ATTORNEY

CLASS 43—(Continued).

SN 77-926,034. LEGAL SEA FOODS, INC., BOSTON, MA.
FILED 2-2-2010.

LEGAL'S MARKETPLACE

THE MARK CONSISTS OF STANDARD CHARACTERS WITHOUT CLAIM TO ANY PARTICULAR FONT, STYLE, SIZE, OR COLOR.

OWNER OF U.S. REG. NOS. 1,060,132, 2,003,409 AND OTHERS.

NO CLAIM IS MADE TO THE EXCLUSIVE RIGHT TO USE "MARKETPLACE", APART FROM THE MARK AS SHOWN.

FOR RESTAURANT SERVICES (U.S. CLS. 100 AND 101).

KELLY BOULTON, EXAMINING ATTORNEY

SN 77-926,523. FALLOON JR, ROGER, PHILADELPHIA, PA.
FILED 2-3-2010.

BURGERTIME

THE MARK CONSISTS OF STANDARD CHARACTERS WITHOUT CLAIM TO ANY PARTICULAR FONT, STYLE, SIZE, OR COLOR.

FOR RESTAURANT AND HOTEL SERVICES, NAMELY, SERVICES FOR PROVIDING FOOD AND DRINK, TEMPORARY ACCOMMODATIONS FOR CONSUMERS (U.S. CLS. 100 AND 101).

MICHAEL ENGEL, EXAMINING ATTORNEY

SN 77-926,810. ROBERT G. HISAOKA, MCLEAN, VA. FILED
2-3-2010.



NO CLAIM IS MADE TO THE EXCLUSIVE RIGHT TO USE "LOADED CHICAGO-STYLE HOTDOGS", APART FROM THE MARK AS SHOWN.

THE MARK CONSISTS OF THE STYLIZED WORD "CHIDOGO'S" WITH A STAR DOTTING THE "I" SET AGAINST A STYLIZED HOTDOG, ALL ABOVE THE WORDING "LOADED-CHICAGO-STYLE HOTDOGS".

THE WORDING "CHIDOGO'S" HAS NO MEANING IN A FOREIGN LANGUAGE.

FOR RESTAURANT SERVICES (U.S. CLS. 100 AND 101).

NORA BUCHANAN WILL, EXAMINING ATTORNEY

CLASS 43—(Continued).

SN 77-927,377. STREAM MARKETPLACE LLC, VERNON, CA. FILED 2-3-2010.

WHAT'S IT?

THE MARK CONSISTS OF STANDARD CHARACTERS WITHOUT CLAIM TO ANY PARTICULAR FONT, STYLE, SIZE, OR COLOR.

FOR RESTAURANT, CATERING, PREPARATION OF FOOD AND BEVERAGE; PREPARATION OF FOOD AND BEVERAGE FOR TAKE-OUT (U.S. CLS. 100 AND 101).

BRENDAN MCCAULEY, EXAMINING ATTORNEY

SN 77-927,393. STREAM MARKETPLACE, LLC, VERNON, CA. FILED 2-3-2010.

WATZ IT?

THE MARK CONSISTS OF STANDARD CHARACTERS WITHOUT CLAIM TO ANY PARTICULAR FONT, STYLE, SIZE, OR COLOR.

FOR RESTAURANT, CATERING, PREPARATION OF FOOD AND BEVERAGE; PREPARATION OF FOOD AND BEVERAGE FOR TAKE-OUT (U.S. CLS. 100 AND 101).

BRENDAN MCCAULEY, EXAMINING ATTORNEY

SN 77-927,418. STREAM MARKETPLACE, LLC, VERNON, CA. FILED 2-3-2010.

PEOPLE'S STREET FOOD

THE MARK CONSISTS OF STANDARD CHARACTERS WITHOUT CLAIM TO ANY PARTICULAR FONT, STYLE, SIZE, OR COLOR.

NO CLAIM IS MADE TO THE EXCLUSIVE RIGHT TO USE "STREET FOOD", APART FROM THE MARK AS SHOWN.

FOR RESTAURANT, CATERING, PREPARATION OF FOOD AND BEVERAGE; PREPARATION OF FOOD AND BEVERAGE FOR TAKE-OUT (U.S. CLS. 100 AND 101).

BRENDAN MCCAULEY, EXAMINING ATTORNEY

CLASS 43—(Continued).

SN 77-927,559. PRAIRIE PIZZA, MURDO, SD. FILED 2-3-2010.



NO CLAIM IS MADE TO THE EXCLUSIVE RIGHT TO USE "PIZZA", APART FROM THE MARK AS SHOWN.

THE MARK CONSISTS OF THE WORDING "PRAIRIE PIZZA" AND THE DESIGN OF A LONGHORN BULL HOLDING UP A PIZZA WITH ONE LEG, WITH SOME OF THE FOREGOING INSIDE OF A RECTANGLE.

FOR RESTAURANT SERVICES (U.S. CLS. 100 AND 101).

FIRST USE 4-0-2009; IN COMMERCE 4-0-2009.
MARGARET POWER, EXAMINING ATTORNEY

SN 77-928,006. FRIENDSCOOK INC., BELMONT, CA. FILED 2-4-2010.

Cook Bytes

THE MARK CONSISTS OF STANDARD CHARACTERS WITHOUT CLAIM TO ANY PARTICULAR FONT, STYLE, SIZE, OR COLOR.

NO CLAIM IS MADE TO THE EXCLUSIVE RIGHT TO USE "COOK", APART FROM THE MARK AS SHOWN.

FOR PROVIDING AN ONLINE COMPUTER DATABASE TO CONSUMERS CONCERNING RECIPES, INGREDIENTS AND COOKING INFORMATION (U.S. CLS. 100 AND 101).

AMEEN IMAM, EXAMINING ATTORNEY

CLASS 43—(Continued).

SN 77-928,044. FRIENDSCOOK INC., BELMONT, CA. FILED 2-4-2010.

Social Kitchen

THE MARK CONSISTS OF STANDARD CHARACTERS WITHOUT CLAIM TO ANY PARTICULAR FONT, STYLE, SIZE, OR COLOR.

FOR PROVIDING AN ONLINE COMPUTER DATABASE TO CONSUMERS CONCERNING RECIPES, INGREDIENTS AND COOKING INFORMATION (U.S. CLS. 100 AND 101).

AMEEN IMAM, EXAMINING ATTORNEY

SN 77-928,092. PARK LANE HOTEL, INC., NEW YORK, NY. FILED 2-4-2010.

THE PARK ROOM

THE MARK CONSISTS OF STANDARD CHARACTERS WITHOUT CLAIM TO ANY PARTICULAR FONT, STYLE, SIZE, OR COLOR.

NO CLAIM IS MADE TO THE EXCLUSIVE RIGHT TO USE "ROOM", APART FROM THE MARK AS SHOWN.

FOR RESTAURANT, BAR AND CATERING SERVICES, AND PROVIDING FACILITIES FOR BANQUETS (U.S. CLS. 100 AND 101).

FIRST USE 6-1-1972; IN COMMERCE 6-1-1972.
KATHERINE CHANG, EXAMINING ATTORNEY

SN 77-928,366. CHOICE FOODSERVICES, INC., DBA CHILDREN'S CHOICE, SAN RAMON, CA. FILED 2-4-2010.

CHOICELUNCH

THE MARK CONSISTS OF STANDARD CHARACTERS WITHOUT CLAIM TO ANY PARTICULAR FONT, STYLE, SIZE, OR COLOR.

FOR PROVIDING CATERING FOR SCHOOL CAFETERIAS AND OTHER FACILITIES; CATERING (U.S. CLS. 100 AND 101).

TRICIA SONNEBORN, EXAMINING ATTORNEY

CLASS 43—(Continued).

SN 77-928,446. SPRIRITED VENTURES 11, INC., DBA THE VARNISH, LOS ANGELES, CA. FILED 2-4-2010.



The Varnish

THE MARK CONSISTS OF A DRAWING OF A DRINKING GLASS CENTERED ABOVE THE WORDS "THE VARNISH" IN STYLIZED FONT.

FOR BAR AND COCKTAIL LOUNGE SERVICES; RESTAURANT SERVICES (U.S. CLS. 100 AND 101). FIRST USE 2-0-2009; IN COMMERCE 2-0-2009. TRACY CROSS, EXAMINING ATTORNEY

SN 77-928,489. PARASOLE IP, LLC, EDINA, MN. FILED 2-4-2010.

MOZZAMIA

THE MARK CONSISTS OF STANDARD CHARACTERS WITHOUT CLAIM TO ANY PARTICULAR FONT, STYLE, SIZE, OR COLOR.

FOR RESTAURANT AND BAR SERVICES (U.S. CLS. 100 AND 101). DORITT L. CARROLL, EXAMINING ATTORNEY

SN 77-928,537. GKRS1 LLC, STUDIO CITY, CA. FILED 2-4-2010.

THE OTHER DOOR

THE MARK CONSISTS OF STANDARD CHARACTERS WITHOUT CLAIM TO ANY PARTICULAR FONT, STYLE, SIZE, OR COLOR.

FOR BAR AND RESTAURANT SERVICES (U.S. CLS. 100 AND 101). CURTIS FRENCH, EXAMINING ATTORNEY

CLASS 43—(Continued).

SN 77-928,808. BRAT & TOTS, INC., WICHITA, KS. FILED 2-5-2010.

LINKHÄUS

THE MARK CONSISTS OF STANDARD CHARACTERS WITHOUT CLAIM TO ANY PARTICULAR FONT, STYLE, SIZE, OR COLOR.

THE ENGLISH TRANSLATION OF THE WORD "HÄUS" IN THE MARK IS HOUSES.

FOR CAFE AND RESTAURANT SERVICES (U.S. CLS. 100 AND 101).

JOHN WILKE, EXAMINING ATTORNEY

SN 77-928,961. ALVAREZ, GEORGE, CORAL GABLES, FL. FILED 2-5-2010.

BeachScapeCancun.com

THE MARK CONSISTS OF STANDARD CHARACTERS WITHOUT CLAIM TO ANY PARTICULAR FONT, STYLE, SIZE, OR COLOR.

FOR TRAVEL SERVICES, NAMELY, MAKING RESERVATIONS AND BOOKINGS FOR TEMPORARY LODGING; MAKING HOTEL AND LODGING RESERVATIONS FOR INDIVIDUALS AND GROUPS VIA A GLOBAL COMPUTER NETWORK (U.S. CLS. 100 AND 101).

FIRST USE 4-19-2009; IN COMMERCE 4-19-2009.

JUSTINE D. PARKER, EXAMINING ATTORNEY

SN 77-928,970. ALVAREZ, GEORGE, CORAL GABLES, FL. FILED 2-5-2010.

ExcellenceResortPuntaCana.com

THE MARK CONSISTS OF STANDARD CHARACTERS WITHOUT CLAIM TO ANY PARTICULAR FONT, STYLE, SIZE, OR COLOR.

FOR TRAVEL SERVICES, NAMELY, MAKING RESERVATIONS AND BOOKINGS FOR TEMPORARY LODGING; MAKING HOTEL AND LODGING RESERVATIONS FOR INDIVIDUALS AND GROUPS VIA A GLOBAL COMPUTER NETWORK (U.S. CLS. 100 AND 101).

FIRST USE 9-20-2007; IN COMMERCE 9-20-2007.

JUSTINE D. PARKER, EXAMINING ATTORNEY

CLASS 43—(Continued).

SN 77-928,973. ALVAREZ, GEORGE, CORAL GABLES, FL. FILED 2-5-2010.

MajesticElegancePuntaCana.com

THE MARK CONSISTS OF STANDARD CHARACTERS WITHOUT CLAIM TO ANY PARTICULAR FONT, STYLE, SIZE, OR COLOR.

FOR TRAVEL SERVICES, NAMELY, MAKING RESERVATIONS AND BOOKINGS FOR TEMPORARY LODGING; MAKING HOTEL AND LODGING RESERVATIONS FOR INDIVIDUALS AND GROUPS VIA A GLOBAL COMPUTER NETWORK (U.S. CLS. 100 AND 101).

FIRST USE 2-24-2007; IN COMMERCE 2-24-2007. JUSTINE D. PARKER, EXAMINING ATTORNEY



SN 77-928,979. STREAM MARKETPLACE, LLC, VERNON, CA. FILED 2-5-2010.

LIFE TASTE HAPPINESS

THE MARK CONSISTS OF STANDARD CHARACTERS WITHOUT CLAIM TO ANY PARTICULAR FONT, STYLE, SIZE, OR COLOR.

FOR RESTAURANT, CATERING, PREPARATION OF FOOD AND BEVERAGE; PREPARATION OF FOOD AND BEVERAGE FOR TAKE-OUT (U.S. CLS. 100 AND 101).

FIRST USE 7-17-2009; IN COMMERCE 7-17-2009. BRENDAN MCCAULEY, EXAMINING ATTORNEY



SN 77-929,269. SHAPIRO, ROBERT, NEW YORK, NY. FILED 2-5-2010.

PEI MUSSEL KITCHEN

THE MARK CONSISTS OF STANDARD CHARACTERS WITHOUT CLAIM TO ANY PARTICULAR FONT, STYLE, SIZE, OR COLOR.

NO CLAIM IS MADE TO THE EXCLUSIVE RIGHT TO USE "MUSSEL KITCHEN", APART FROM THE MARK AS SHOWN.

FOR RESTAURANT AND BAR SERVICES (U.S. CLS. 100 AND 101).

KATHERINE E. HALMEN, EXAMINING ATTORNEY

CLASS 43—(Continued).

SN 77-929,352. SO ALL MAY EAT, INC., DBA SAME CAFÉ, DENVER, CO. FILED 2-5-2010.

SAME CAFÉ

THE MARK CONSISTS OF STANDARD CHARACTERS WITHOUT CLAIM TO ANY PARTICULAR FONT, STYLE, SIZE, OR COLOR.

NO CLAIM IS MADE TO THE EXCLUSIVE RIGHT TO USE "CAFE", APART FROM THE MARK AS SHOWN.

FOR RESTAURANT AND CAFE SERVICES (U.S. CLS. 100 AND 101).

FIRST USE 10-20-2006; IN COMMERCE 10-20-2006. KELLEY WELLS, EXAMINING ATTORNEY



SN 77-930,065. WAFFLE CABIN, RUTLAND, VT. FILED 2-8-2010.

WAFFOLOGY

THE MARK CONSISTS OF STANDARD CHARACTERS WITHOUT CLAIM TO ANY PARTICULAR FONT, STYLE, SIZE, OR COLOR.

FOR RESTAURANT SERVICES, NAMELY, SERVICES FOR PROVIDING FOOD AND DRINK (U.S. CLS. 100 AND 101).

FIRST USE 7-1-2009; IN COMMERCE 7-1-2009. MICHAEL GAAFAR, EXAMINING ATTORNEY



SN 77-930,510. ZACK'S INC., ALBANY, GA. FILED 2-8-2010.

BARE BULB

THE MARK CONSISTS OF STANDARD CHARACTERS WITHOUT CLAIM TO ANY PARTICULAR FONT, STYLE, SIZE, OR COLOR.

FOR COFFEE SHOPS (U.S. CLS. 100 AND 101). CURTIS FRENCH, EXAMINING ATTORNEY

CLASS 43—(Continued).

SN 77-930,892. ZOOSK, INC., SAN FRANCISCO, CA. FILED 2-8-2010.

ZOOSK

THE MARK CONSISTS OF STANDARD CHARACTERS WITHOUT CLAIM TO ANY PARTICULAR FONT, STYLE, SIZE, OR COLOR.

FOR BAR AND COCKTAIL LOUNGE SERVICES; BAR AND RESTAURANT SERVICES (U.S. CLS. 100 AND 101).
GINA HAYES, EXAMINING ATTORNEY

SN 77-930,989. RANGE RESTAURANT GROUP, LLC, DBA CITY RANGE, GREENVILLE, SC. FILED 2-8-2010.



THE MARK CONSISTS OF ANIMAL LOOKING OVER ITS SHOULDER.

FOR BAR AND RESTAURANT SERVICES (U.S. CLS. 100 AND 101).
FIRST USE 11-30-1998; IN COMMERCE 11-30-1998.
KIMBERLY PERRY, EXAMINING ATTORNEY

SN 77-931,331. THE MELTING POT RESTAURANTS, INC., TAMPA, FL. FILED 2-9-2010.

BURGER 21

THE MARK CONSISTS OF STANDARD CHARACTERS WITHOUT CLAIM TO ANY PARTICULAR FONT, STYLE, SIZE, OR COLOR.

NO CLAIM IS MADE TO THE EXCLUSIVE RIGHT TO USE "BURGER", APART FROM THE MARK AS SHOWN.
FOR RESTAURANT SERVICES (U.S. CLS. 100 AND 101).
TRACY WHITTAKER-BROWN, EXAMINING ATTORNEY

CLASS 43—(Continued).

SN 77-931,341. THE MELTING POT RESTAURANTS, INC., TAMPA, FL. FILED 2-9-2010.

B 21

THE MARK CONSISTS OF STANDARD CHARACTERS WITHOUT CLAIM TO ANY PARTICULAR FONT, STYLE, SIZE, OR COLOR.

FOR RESTAURANT SERVICES (U.S. CLS. 100 AND 101).
TRACY WHITTAKER-BROWN, EXAMINING ATTORNEY

SN 77-931,468. NEELY, DANA DEANNE, SEATTLE, WA. FILED 2-9-2010.

Girls Gone BBQ

THE MARK CONSISTS OF STANDARD CHARACTERS WITHOUT CLAIM TO ANY PARTICULAR FONT, STYLE, SIZE, OR COLOR.

NO CLAIM IS MADE TO THE EXCLUSIVE RIGHT TO USE "BBQ", APART FROM THE MARK AS SHOWN.
FOR RESTAURANT AND CATERING SERVICES (U.S. CLS. 100 AND 101).
MICHAEL WEBSTER, EXAMINING ATTORNEY

SN 77-931,538. KALEIDOSCOPE, LLC, DBA KALEIDOSCOPE PIZZERIA & PUB, MEDFORD, OR. FILED 2-9-2010.

KALEIDOSCOPE

THE MARK CONSISTS OF STANDARD CHARACTERS WITHOUT CLAIM TO ANY PARTICULAR FONT, STYLE, SIZE, OR COLOR.

FOR BAR AND RESTAURANT SERVICES (U.S. CLS. 100 AND 101).
FIRST USE 9-24-2001; IN COMMERCE 9-24-2001.
GEORGE LORENZO, EXAMINING ATTORNEY

CLASS 43—(Continued).

SN 77-931,621. MEALPITA LLC, PEARLAND, TX. FILED 2-9-2010.

MealPita

THE MARK CONSISTS OF STANDARD CHARACTERS WITHOUT CLAIM TO ANY PARTICULAR FONT, STYLE, SIZE, OR COLOR.

FOR PROVIDING A WEB SITE FEATURING A SEARCHABLE COLLECTION OF ALCOHOLIC AND NON-ALCOHOLIC COCKTAIL RECIPES; PROVIDING AN ONLINE COMPUTER DATABASE TO CONSUMERS CONCERNING RECIPES, INGREDIENTS AND COOKING INFORMATION; SUBSCRIBER-BASED MEAL PLANNING SERVICES IN DIGITAL FORM, ACCESSIBLE THROUGH THE INTERNET (U.S. CLS. 100 AND 101).

ANDREA K. NADELMAN, EXAMINING ATTORNEY

CLASS 43—(Continued).

SN 77-931,843. RITA'S WATER ICE FRANCHISE COMPANY, LLC, TREVOSE, PA. FILED 2-9-2010.



OWNER OF U.S. REG. NOS. 2,614,810, 3,521,972 AND OTHERS.

NO CLAIM IS MADE TO THE EXCLUSIVE RIGHT TO USE "CUSTARD", "ICE" AND "CATERING", APART FROM THE MARK AS SHOWN.

THE NAME(S), PORTRAIT(S), AND/OR SIGNATURE(S) SHOWN IN THE MARK DOES NOT IDENTIFY A PARTICULAR LIVING INDIVIDUAL.

THE COLOR(S) RED, GREEN, WHITE AND BLUE IS/ARE CLAIMED AS A FEATURE OF THE MARK.

THE MARK CONSISTS OF THE WORD "RITA'S" APPEARING IN WHITE ON A GREEN BANNER, WITH THE WORDING "ICE CUSTARD HAPPINESS," IN WHITE, APPEARING BENEATH; ALL OVER A CIRCLE OUTLINED IN BLUE WITH WHITE AND RED VERTICAL STRIPES, WITH THE WORDS "COOL CATERING" APPEARING IN WHITE, OUTLINED IN BLUE ON A RED RECTANGULAR BACKGROUND OUTLINED IN BLUE.

FOR CATERING (U.S. CLS. 100 AND 101).
FIRST USE 3-5-2009; IN COMMERCE 3-5-2009.
MIDGE BUTLER, EXAMINING ATTORNEY

SN 77-931,668. TASTY YOGURT CORPORATION, TAMPA, FL. FILED 2-9-2010.



NO CLAIM IS MADE TO THE EXCLUSIVE RIGHT TO USE "FROZEN YOGURT AND TEA BAR", APART FROM THE MARK AS SHOWN.

THE MARK CONSISTS OF A SPLASH WITH CIRCLES AND A PALM TREE IN PLACE OF THE "I". THE STYLIZED TEXT "GREEN ISLAND FROZEN YOGURT 'N' TEA BAR" APPEARS.

FOR RESTAURANT SERVICES; SELF-SERVICE RESTAURANTS (U.S. CLS. 100 AND 101).

MICHAEL SOUDERS, EXAMINING ATTORNEY

SN 77-932,160. PICKEL, RICHARD, D, SAN FRANCISCO, CA. FILED 2-9-2010.

Party Central

THE MARK CONSISTS OF STANDARD CHARACTERS WITHOUT CLAIM TO ANY PARTICULAR FONT, STYLE, SIZE, OR COLOR.

FOR BAR AND RESTAURANT SERVICES (U.S. CLS. 100 AND 101).

JANICE L. MCMORROW, EXAMINING ATTORNEY

CLASS 43—(Continued).

SN 77-932,447. TACO SHACK DOWNTOWN, INC., AUSTIN, TX. FILED 2-10-2010.

TACO SHACK

OWNER OF U.S. REG. NO. 3,725,431.
NO CLAIM IS MADE TO THE EXCLUSIVE RIGHT TO USE "TACO", APART FROM THE MARK AS SHOWN.

THE MARK CONSISTS OF STYLIZED WORDS "TACO SHACK".

FOR FAST-FOOD RESTAURANTS; RESTAURANT; RESTAURANT SERVICES; RESTAURANT SERVICES FEATURING TEX-MEX FOOD; RESTAURANT SERVICES, INCLUDING SIT-DOWN SERVICE OF FOOD AND TAKE-OUT RESTAURANT SERVICES; RESTAURANT SERVICES, NAMELY, PROVIDING OF FOOD AND BEVERAGES FOR CONSUMPTION ON AND OFF THE PREMISES; RESTAURANTS; TAKE-OUT RESTAURANT SERVICES (U.S. CLS. 100 AND 101).

FIRST USE 3-16-1996; IN COMMERCE 3-16-1996.

KATHY DE JONGE, EXAMINING ATTORNEY

SN 77-932,750. FULLERTON, DAVID A, PROVIDENCE, RI. FILED 2-10-2010.

GARDENER'S

THE MARK CONSISTS OF STANDARD CHARACTERS WITHOUT CLAIM TO ANY PARTICULAR FONT, STYLE, SIZE, OR COLOR.

FOR RESTAURANT SERVICES (U.S. CLS. 100 AND 101).

FIRST USE 2-10-2010; IN COMMERCE 2-10-2010.

DORITT L. CARROLL, EXAMINING ATTORNEY

SN 77-932,784. ANDREW JOHNSTONE, SAN FRANCISCO, CA. FILED 2-10-2010.

The Little Chihuahua

THE MARK CONSISTS OF STANDARD CHARACTERS WITHOUT CLAIM TO ANY PARTICULAR FONT, STYLE, SIZE, OR COLOR.

FOR RESTAURANT SERVICES (U.S. CLS. 100 AND 101).

FIRST USE 1-1-2007; IN COMMERCE 1-1-2007.

JOHN WILKE, EXAMINING ATTORNEY

CLASS 43—(Continued).

SN 77-934,565. CHECKERS DRIVE-IN RESTAURANTS, INC., TAMPA, FL. FILED 2-12-2010.

DEVOUR THE NIGHT

THE MARK CONSISTS OF STANDARD CHARACTERS WITHOUT CLAIM TO ANY PARTICULAR FONT, STYLE, SIZE, OR COLOR.

FOR RESTAURANT SERVICES (U.S. CLS. 100 AND 101).

SIMON TENG, EXAMINING ATTORNEY

SN 77-935,634. PARASOLE IP, LLC, EDINA, MN. FILED 2-15-2010.

MOZZA MIA

THE MARK CONSISTS OF STANDARD CHARACTERS WITHOUT CLAIM TO ANY PARTICULAR FONT, STYLE, SIZE, OR COLOR.

FOR RESTAURANT AND BAR SERVICES (U.S. CLS. 100 AND 101).

DORITT L. CARROLL, EXAMINING ATTORNEY

SN 77-937,037. PITA KING, INC., ASTORIA, NY. FILED 2-16-2010.

PITA PAN

THE MARK CONSISTS OF STANDARD CHARACTERS WITHOUT CLAIM TO ANY PARTICULAR FONT, STYLE, SIZE, OR COLOR.

OWNER OF U.S. REG. NOS. 3,611,351 AND 3,630,835.

NO CLAIM IS MADE TO THE EXCLUSIVE RIGHT TO USE "PITA", APART FROM THE MARK AS SHOWN.

FOR CAFE RESTAURANTS; CARRY-OUT RESTAURANTS; DELICATESSENS; AND FAST FOOD RESTAURANTS (U.S. CLS. 100 AND 101).

FIRST USE 6-30-2007; IN COMMERCE 6-30-2007.

CYNTHIA SLOAN, EXAMINING ATTORNEY

CLASS 43—(Continued).

SN 77-949,196. ALVAREZ, GEORGE, CORAL GABLES, FL. FILED 3-3-2010.

BavaroCaribeBeach.com

THE MARK CONSISTS OF STANDARD CHARACTERS WITHOUT CLAIM TO ANY PARTICULAR FONT, STYLE, SIZE, OR COLOR.

FOR TRAVEL SERVICES, NAMELY, MAKING RESERVATIONS AND BOOKINGS FOR TEMPORARY LODGING; MAKING HOTEL AND LODGING RESERVATIONS FOR INDIVIDUALS AND GROUPS VIA A GLOBAL COMPUTER NETWORK (U.S. CLS. 100 AND 101).

FIRST USE 10-26-2006; IN COMMERCE 10-26-2006.
JUSTINE D. PARKER, EXAMINING ATTORNEY

SN 77-951,933. ALVAREZ, GEORGE, CORAL GABLES, FL. FILED 3-5-2010.

ReefPlayacarResort.com

THE MARK CONSISTS OF STANDARD CHARACTERS WITHOUT CLAIM TO ANY PARTICULAR FONT, STYLE, SIZE, OR COLOR.

FOR TRAVEL SERVICES, NAMELY, MAKING RESERVATIONS AND BOOKINGS FOR TEMPORARY LODGING; MAKING HOTEL AND LODGING RESERVATIONS FOR INDIVIDUALS AND GROUPS VIA A GLOBAL COMPUTER NETWORK (U.S. CLS. 100 AND 101).

FIRST USE 8-19-2005; IN COMMERCE 8-19-2005.
JUSTINE D. PARKER, EXAMINING ATTORNEY

SN 85-003,502. AMERITEL INNS, INC., BOISE, ID. FILED 3-31-2010.

AMERITEL INN

THE MARK CONSISTS OF STANDARD CHARACTERS WITHOUT CLAIM TO ANY PARTICULAR FONT, STYLE, SIZE, OR COLOR.

NO CLAIM IS MADE TO THE EXCLUSIVE RIGHT TO USE "INN", APART FROM THE MARK AS SHOWN. FOR HOTEL AND MOTEL SERVICES (U.S. CLS. 100 AND 101).

FIRST USE 5-15-1991; IN COMMERCE 5-15-1991.
MATTHEW MCDOWELL, EXAMINING ATTORNEY

CLASS 44—MEDICAL, BEAUTY AND AGRICULTURAL SERVICES

SN 76-694,558. VITAL DATA TECHNOLOGY, LLC, NEWPORT BEACH, CA. FILED 11-28-2008.



THE COLOR(S) RED, GRAY AND WHITE IS/ARE CLAIMED AS A FEATURE OF THE MARK.

THE MARK CONSISTS OF A GREEK CROSS IN GRAY, WHITE AND RED, WITH GRAY AS THE SHADOW AND WITH ARROWS FORMING A CIRCLE IN RED AND GRAY AS THE SHADOW.

FOR MEDICAL ASSISTANCE SERVICES IN THE NATURE OF MEDICAL INFORMATION PROVIDED TO MEDICAL PROFESSIONALS FROM REMOTE LOCATIONS VIA THE INTERNET AND GLOBAL COMPUTER NETWORKS THROUGH THE USE OF ARCHIVED MEDICAL IMAGES AND A DATA STORAGE AND RETRIEVAL SYSTEM; MAINTAINING PERSONAL MEDICAL HISTORY RECORDS AND FILES; PROVIDING MEDICAL INFORMATION; 24-HOUR RESPONSE CENTER WHICH PROVIDES MEDICAL INFORMATION TO EMERGENCY MEDICAL PERSONNEL AND ALLOWS MEMBERS TO UPDATE THEIR MEDICAL/PERSONAL FILES; PROVIDING AN INTERNET WEB SITE FEATURING MEDICAL INFORMATION FOR MEDICAL PROFESSIONALS AND MEDICAL PATIENTS THAT ALLOWS FOR THE EXCHANGE OF MEDICAL INFORMATION FROM REMOTE LOCATIONS USING DEVICES THAT FEED MEDICAL INFORMATION TO THE WEB SITE THAT IS THEN PROCESSED AND CAN BE ACCESSED IN REAL-TIME BY USERS (U.S. CLS. 100 AND 101).

FIRST USE 4-2-2005; IN COMMERCE 4-2-2005.
MICHAEL WIENER, EXAMINING ATTORNEY

SN 76-695,768. WAKE N BAKE, LLC, ALLENTOWN, PA. FILED 2-12-2009.

WAKE N BAKE
COFFEE-TAN
NO PROBLEM MAN

NO CLAIM IS MADE TO THE EXCLUSIVE RIGHT TO USE "COFFEE-TAN", APART FROM THE MARK AS SHOWN.

FOR TANNING SALONS (U.S. CLS. 100 AND 101).
FIRST USE 10-6-2008; IN COMMERCE 10-6-2008.
TRACY FLETCHER, EXAMINING ATTORNEY

CLASS 44—(Continued).

SN 76-700,945. BANKPLUS, RIDGELAND, MS. FILED 12-22-2009.



FOR PROVIDING ASSISTANCE, FITNESS EVALUATION AND CONSULTATION TO CORPORATE CLIENTS TO HELP THEIR EMPLOYEES MAKE HEALTH, WELLNESS AND NUTRITIONAL CHANGES IN THEIR DAILY LIVING TO IMPROVE HEALTH (U.S. CLS. 100 AND 101).
FIRST USE 8-31-2006; IN COMMERCE 8-31-2006.
JAMES MACFARLANE, EXAMINING ATTORNEY

SN 77-230,211. AESTHETICALLY WRIGHT I, L.P., PLANO, TX. FILED 7-16-2007.

SKIN M.D. AND BEYOND

THE MARK CONSISTS OF STANDARD CHARACTERS WITHOUT CLAIM TO ANY PARTICULAR FONT, STYLE, SIZE, OR COLOR.

NO CLAIM IS MADE TO THE EXCLUSIVE RIGHT TO USE "SKIN M.D." APART FROM THE MARK AS SHOWN.

FOR MEDICAL SERVICES, NAMELY, LASER HAIR REMOVAL, LASER VEIN REMOVAL, SCLEROTHERAPY AND MICRODERMABRASION; SKIN CARE SERVICES, NAMELY, BOTULINUM TOXIN TYPE A, HYALURONIC ACID, AND COLLAGEN INJECTIONS; COSMETIC SURGERY, PLASTIC SURGERY, COSMETIC DENTISTRY, DENTAL SURGERY; COSMETIC SKIN AND HAIR CARE SERVICES, NAMELY, CHEMICAL PEELS, ACNE TREATMENTS, MICRODERMABRASION TREATMENTS, BOTULINUM TOXIN TYPE A, HYALURONIC ACID, AND COLLAGEN INJECTIONS, LASER PROCEDURES FOR THE REMOVAL OF WRINKLES, CAPILLARIES, RED SPOTS, BROWN SPOTS, AGE SPOTS, SPIDER VEINS, FACIAL AND BODY HAIR, LASER PROCEDURES FOR STIMULATING COLLAGEN PRODUCTION, EVENING SKIN TONE AND SKIN RESURFACING; RENDERING CONSULTATION AND ADVISORY SERVICES IN CONNECTION WITH SKIN CARE, HAIR CARE AND DENTAL SERVICES; BEAUTY SALON SERVICES; HEALTH SPA SERVICES, NAMELY, MASSAGE SERVICES AND COSMETIC BODY CARE SERVICES; COSMETIC MEDICAL AND SURGICAL SERVICES AND MEDICAL SERVICES FOR COSMETIC PURPOSES; COSMETIC SURGERY; COSMETIC DENTISTRY AND CONSULTING SERVICES RELATING TO THE SAME; PROVIDING INFORMATION IN THE FIELD OF FACIAL AESTHETIC AND ANTI-OBESITY SURGERY, COSMETIC SURGERY, PLASTIC SURGERY, MICRODERMABRASION, LASER TREATMENTS IN THE NATURE OF SCLEROTHERAPY AND HAIR REMOVAL, AND TREATMENT OF FATTY DEPOSITS USING ULTRASOUND; MEDICAL DIAGNOSTIC SERVICES, NAMELY, PROVIDING ULTRASOUND SCREENING AND DIAGNOSIS, MEASUREMENT OF SKIN AND HAIR CONDITION; MEDICAL SERVICES FOR SKIN TREATMENT, NAMELY, DERMATOLOGY CLINIC AND SKIN HEALTH RESTORATION MEDICAL PROCEDURES FOR PHYSICIAN- OR NURSE-PRACTITIONER-ADMINISTERED OR DIRECTED EXFOLIATION OF SKIN AND ASSOCIATED PROCEDURES FOR POST-EXFO-

CLASS 44—(Continued).

LIATION TREATMENT; HYGIENIC AND BEAUTY SERVICES FOR SKIN, NAMELY, TREATMENT, HEALTH RESTORATION, CARE THERAPY, TIMED APPLICATION OF GELS, CLEANSERS, LIGHTENERS, EXFOLIANTS, BLENDEES, TONERS AND CREAMS; SKIN CARE SALON; SKIN MASSAGE THERAPY; HEALTH SPA SERVICES FOR BODY AND SKIN TREATMENTS, NAMELY, MASSAGES, APPLICATIONS OF LOTIONS AND COMPOSITIONS INCLUDING SKIN LIGHTENERS, SKIN MASKS, ANTIOXIDANT TREATMENTS, SKIN PEELS, PREOPERATIVE SKIN CARE, POST-OPERATIVE CAMOUFLAGE MAKE-UP, DEEP CLEANSING FACIAL TREATMENTS, MANICURES, PEDICURES, FACE AND BODY WAXING, HAIR DESIGN, COLOR, PERMS AND FULL BODY MASSAGE, FACIALS; BEAUTY SALON SERVICES FOR PROVIDING HAIR CARE, HAIR COLORING, MANICURES, PEDICURES, AND MAKEUP; MEDICAL SERVICES, NAMELY, INJECTION OF MEDICAL INJECTABLES FOR COSMETIC CONDITIONS AND DISEASES (U.S. CLS. 100 AND 101).

MARTHA FROMM, EXAMINING ATTORNEY

SN 77-637,428. IDEAL IMAGE DEVELOPMENT, INC., DBA IDEAL IMAGE, TAMPA, FL. FILED 12-20-2008.

(800) BE-IDEAL

THE MARK CONSISTS OF STANDARD CHARACTERS WITHOUT CLAIM TO ANY PARTICULAR FONT, STYLE, SIZE, OR COLOR.

OWNER OF U.S. REG. NOS. 2,829,610, 2,966,922 AND 3,065,163.

FOR COSMETIC ENHANCEMENT SERVICES, NAMELY, REMOVAL OF HAIR, VEINS, BROWN SPOTS, WRINKLES, ACNE AND SKIN BLEMISHES, AND LASER HAIR AND VEIN REMOVAL (U.S. CLS. 100 AND 101).

FIRST USE 1-1-2002; IN COMMERCE 1-1-2002.

JULIE GUTTADAURO, EXAMINING ATTORNEY

SN 77-663,620. TAYLOR, SONJA, COVINGTON, LA. FILED 2-4-2009.

Cherokee Arabians

THE MARK CONSISTS OF STANDARD CHARACTERS WITHOUT CLAIM TO ANY PARTICULAR FONT, STYLE, SIZE, OR COLOR.

NO CLAIM IS MADE TO THE EXCLUSIVE RIGHT TO USE "ARABIANS", APART FROM THE MARK AS SHOWN. SEC. 2(F).

FOR BREEDING AND STUD SERVICES FOR HORSES (U.S. CLS. 100 AND 101).

FIRST USE 1-1-2000; IN COMMERCE 1-1-2000.

KATHLEEN M. VANSTON, EXAMINING ATTORNEY

CLASS 44—(Continued).

SN 77-688,363. ZOOM CARE, P.C., HILLSBORO, OR. FILED 3-11-2009.

ZOOMCARE

THE MARK CONSISTS OF STANDARD CHARACTERS WITHOUT CLAIM TO ANY PARTICULAR FONT, STYLE, SIZE, OR COLOR.

FOR MEDICAL AND HEALTH CARE SERVICES, NAMELY, MEDICAL CLINIC SERVICES, WALK-IN MEDICAL CLINIC SERVICES, NON-EMERGENCY MEDICAL DIAGNOSTICS, TREATMENT, HEALTH MAINTENANCE, HEALTH CARE INFORMATION AND CONSULTING SERVICES, MEDICAL TESTING SERVICES, PREVENTIVE HEALTH CARE AND FOLLOW UP SERVICES, MEDICAL AND PHARMACEUTICAL CONSULTATION SERVICES, PHYSIOTHERAPY SERVICES, MENTAL HEALTH CARE SERVICES, DIAGNOSIS AND TREATMENT OF DISEASE, PROVIDING HEALTH CARE INFORMATION VIA TELEPHONE AND THE INTERNET, HOME HEALTH CARE SERVICES, MOBILE HEALTH CARE CENTERS, AND PROVIDING HEALTH CARE INFORMATION AND CONSULTANT SERVICES IN CONNECTION WITH AFORESAID SERVICES (U.S. CLS. 100 AND 101).

FIRST USE 5-15-2006; IN COMMERCE 5-15-2006.
KATHERINE STOIDES, EXAMINING ATTORNEY

CLASS 44—(Continued).

SN 77-737,257. COMPANION MANAGEMENT SERVICES LLC, BALLSTON LAKE, NY. FILED 5-14-2009.



NO CLAIM IS MADE TO THE EXCLUSIVE RIGHT TO USE "MRI", APART FROM THE MARK AS SHOWN.

THE COLOR(S) BEIGE, DARK GREEN, AND DARK RED IS/ARE CLAIMED AS A FEATURE OF THE MARK.

THE MARK CONSISTS OF A DRAWING OF A DOG AND A CAT FROM BEHIND. UNDER THE DRAWING IS THE WORDING "COMPANION MRI". "COMPANION" HAS A CAPITAL "C" AND "MRI" IS IN A BLOCK FONT IN CAPITAL LETTERS. THE DOG AND CAT ARE COLORED BEIGE IN A MANNER TO APPEAR AS BEIGE BRUSH STROKES. THE LETTERING "COMPANION" IS DARK GREEN. THE OUTLINE OF THE DOG AND CAT IS DARK GREEN. THE LETTERING "MRI" IS DARK RED.

FOR OPERATING MAGNETIC RESONANCE IMAGING (MRI) SYSTEMS FOR VETERINARY USE (U.S. CLS. 100 AND 101).

FIRST USE 3-31-2006; IN COMMERCE 1-31-2007.
KYLE PEETE, EXAMINING ATTORNEY

SN 77-779,807. JDLL, LLC, DBA LOVELY LASHES, COSTA MESA, CA. FILED 7-13-2009.



SN 77-696,527. ANIMAL EMERGENCY OF MCHENRY COUNTY, CRYSTAL LAKE, IL. FILED S.R. 3-23-2009; AM. P.R. 10-23-2009.

PAWS~ABILITIES

THE MARK CONSISTS OF STANDARD CHARACTERS WITHOUT CLAIM TO ANY PARTICULAR FONT, STYLE, SIZE, OR COLOR.

FOR PHYSICAL THERAPY EVALUATION, IDENTIFICATION, AND MANAGEMENT OF MOVEMENT DYSFUNCTION TO RESTORE, MAINTAIN, AND PROMOTE OPTIMAL PHYSICAL FUNCTION PREVENTING THE ONSET, SYMPTOMS AND PROGRESSION OF IMPAIRMENTS, FUNCTIONAL LIMITATIONS, AND DISABILITIES RESULTING FROM DISEASE, DISORDERS, CONDITIONS, OR INJURIES (U.S. CLS. 100 AND 101).

FIRST USE 6-1-2006; IN COMMERCE 6-1-2006.
RONALD DELGIZZI, EXAMINING ATTORNEY

NO CLAIM IS MADE TO THE EXCLUSIVE RIGHT TO USE "LASHES", APART FROM THE MARK AS SHOWN.

THE COLOR(S) PINK, WHITE, BLUE AND BLACK IS/ARE CLAIMED AS A FEATURE OF THE MARK.

THE MARK CONSISTS OF A DESIGN OF A WOMAN WITH HAIR COVERING ONE EYE. THE HAIR FLOWS TO THE RIGHT AND ALONG THE TOP EDGE OF THE HAIR IS A DESIGN FEATURING PINK HEARTS OUTLINED IN WHITE IN VARIOUS SIZES AND WHITE HEARTS OUTLINED IN PINK IN VARIOUS SIZES. ALONG THE BOTTOM EDGE OF THE HAIR IS A PINK AREA. THE WOMAN'S FACE, HAIR AND EARRING ARE WHITE, HER LIPS ARE PINK AND THE EYE IS BLUE ON A WHITE BACKGROUND WITH BLACK LASHES. THE NOSE IS BLACK. THE WORDS "LOVELY LASHES" ARE IN PINK STYLIZED FONT AT THE BOTTOM LEFT OF THE MARK. THE LETTER "O" IN "LOVELY" IS REPLACED WITH A PINK HEART.

FOR BEAUTY SALONS; BEAUTY SPA SERVICES, NAMELY, COSMETIC BODY CARE (U.S. CLS. 100 AND 101).

FIRST USE 9-1-2008; IN COMMERCE 9-1-2008.
KATHLEEN M. VANSTON, EXAMINING ATTORNEY

CLASS 44—(Continued).

SN 77-779,845. MOBILPT, INC., FOUNTAIN VALLEY, CA.
FILED 7-13-2009.

MobilPT

THE MARK CONSISTS OF STANDARD CHARACTERS WITHOUT CLAIM TO ANY PARTICULAR FONT, STYLE, SIZE, OR COLOR.

FOR PROVIDING A WEB SITE FEATURING MEDICAL INFORMATION (U.S. CLS. 100 AND 101).
FIRST USE 10-29-2004; IN COMMERCE 6-1-2009.
BRENDAN REGAN, EXAMINING ATTORNEY

SN 77-782,451. MIDWEST DENTAL HOLDING COMPANY, INC., MONDOVI, WI. FILED 7-16-2009.



MOUNTAIN DENTAL

NO CLAIM IS MADE TO THE EXCLUSIVE RIGHT TO USE "DENTAL", APART FROM THE MARK AS SHOWN.

THE MARK CONSISTS OF A STYLIZED LETTER "D" DISSECTED BY A FLOWING LETTER "M" WITH THE TERM "MOUNTAIN DENTAL" BELOW.

FOR DENTISTRY SERVICES, SPECIFICALLY EXCLUDING THE CUSTOM MANUFACTURE OF PRODUCTS FOR OTHERS (U.S. CLS. 100 AND 101).
KHANH LE, EXAMINING ATTORNEY

SN 77-786,461. ALLIANCE FOR PATIENT MEDICATION SAFETY, RICHMOND, VA. FILED 7-21-2009.

APMS

THE MARK CONSISTS OF STANDARD CHARACTERS WITHOUT CLAIM TO ANY PARTICULAR FONT, STYLE, SIZE, OR COLOR.

FOR MEDICAL CONSULTING AND EVALUATION SERVICES IN THE FIELD OF MEDICATION ERRORS, MEDICATION USE AND PATIENT CARE; PROVIDING A WEB SITE FEATURING INFORMATION REGARDING REDUCING MEDICATION ERRORS, IMPROVING MEDICATION USE, AND ENHANCING PATIENT CARE (U.S. CLS. 100 AND 101).

FIRST USE 8-0-2008; IN COMMERCE 8-0-2008.
AMEEN IMAM, EXAMINING ATTORNEY

CLASS 44—(Continued).

SN 77-787,249. MEDSTAR HEALTH, INC., COLUMBIA, MD.
FILED 7-22-2009.

MEDSTAR CONNECT

THE MARK CONSISTS OF STANDARD CHARACTERS WITHOUT CLAIM TO ANY PARTICULAR FONT, STYLE, SIZE, OR COLOR.

OWNER OF U.S. REG. NOS. 1,327,545, 2,828,750 AND 3,009,989.

FOR ELECTRONIC HEALTH RECORD SERVICES, NAMELY, MAINTAINING PATIENT MEDICAL RECORDS AND FILES AND PROVIDING THOSE RECORDS TO OTHERS VIA A WEBSITE (U.S. CLS. 100 AND 101).

DAVID MILLER, EXAMINING ATTORNEY

SN 77-789,782. LIGHTEN UP SYSTEMS, LLC, PHOENIX, AZ.
FILED 7-26-2009.



NO CLAIM IS MADE TO THE EXCLUSIVE RIGHT TO USE "SYSTEMS", APART FROM THE MARK AS SHOWN.

THE COLOR(S) BLUE AND WHITE IS/ARE CLAIMED AS A FEATURE OF THE MARK.

THE MARK CONSISTS OF ON A WHITE BACKGROUND, STYLIZED GRADED INTENSITY BLUE FONTS OF WORDS "LIGHTEN UP" WITH THE LIGHT BLUE IMAGE OF A FEATHER DOTTING THE "I" IN THE WORD "LIGHTEN". GRADED INTENSITY LINES TRAVEL ABOVE AND BELOW THE WORDS "LIGHTEN UP". TO THE RIGHT OF THE IMAGE CURVING BLUE LINES DEPICT MALE AND FEMALE SILHOUETTES. ACROSS THE LOWER PART OF THE SILHOUETTES, LIGHT BLUE ITALICIZED LETTERS DEPICT THE WORD "SYSTEMS".

FOR CONSULTING TO INDIVIDUALS AND COMMUNITIES ENGAGED IN GROUP WEIGHT LOSS PROGRAMS; PROVIDING INFORMATION ON MAINTAINING A HEALTHY LIFESTYLE AND LOSING WEIGHT; PROVIDING WEIGHT LOSS PROGRAM SERVICES; WEIGHT REDUCTION DIET PLANNING AND SUPERVISION (U.S. CLS. 100 AND 101).

FIRST USE 8-1-2008; IN COMMERCE 9-1-2008.
JAY FLOWERS, EXAMINING ATTORNEY

CLASS 44—(Continued).

SN 77-796,980. MY MEDICAL MEMORY, LLC, MESA, AZ. FILED 8-4-2009.

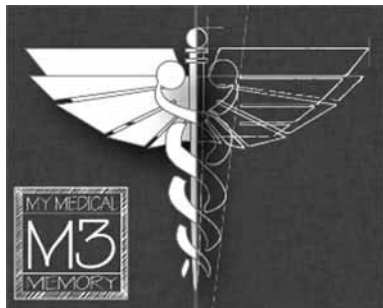

OWNER OF U.S. REG. NO. 3,693,706.
 NO CLAIM IS MADE TO THE EXCLUSIVE RIGHT TO USE "MEDICAL", APART FROM THE MARK AS SHOWN.
 THE MARK CONSISTS OF THE WORDING "MY MEDICAL MEMORY M3" INSIDE OF A BOX AT THE BOTTOM LEFT-HAND SIDE OF THE MARK AND A CADUCEUS IN THE MIDDLE OF THE MARK THAT IS SOLID ON ONE SIDE AND OUTLINED ON THE OTHER SIDE, ALL ON A SQUARE BACKGROUND.
 FOR MEDICAL INFORMATION SERVICES (U.S. CLS. 100 AND 101).
 FIRST USE 6-30-2008; IN COMMERCE 6-30-2008.
 JUSTINE D. PARKER, EXAMINING ATTORNEY

SN 77-811,366. BOSTAN COMPANY LLC, BOSTON, MA. FILED 8-24-2009.

Bostan

THE MARK CONSISTS OF STANDARD CHARACTERS WITHOUT CLAIM TO ANY PARTICULAR FONT, STYLE, SIZE, OR COLOR.
 FOR TANNING SALONS (U.S. CLS. 100 AND 101).
 FIRST USE 7-14-2008; IN COMMERCE 9-2-2009.
 KATHRYN COWARD, EXAMINING ATTORNEY

SN 77-813,435. ACCURATE HOME CARE, LLC, ELK RIVER, MN. FILED 8-26-2009.

ACCURATE HOME CARE

THE MARK CONSISTS OF STANDARD CHARACTERS WITHOUT CLAIM TO ANY PARTICULAR FONT, STYLE, SIZE, OR COLOR.
 NO CLAIM IS MADE TO THE EXCLUSIVE RIGHT TO USE "HOME CARE", APART FROM THE MARK AS SHOWN.
 FOR HOME HEALTH CARE SERVICES (U.S. CLS. 100 AND 101).
 FIRST USE 1-1-2002; IN COMMERCE 1-1-2002.
 MARK SPARACINO, EXAMINING ATTORNEY

CLASS 44—(Continued).

SN 77-814,447. BOSTWICK LABORATORIES, INC., GLEN ALLEN, VA. FILED 8-27-2009.

AIP LABORATORIES

THE MARK CONSISTS OF STANDARD CHARACTERS WITHOUT CLAIM TO ANY PARTICULAR FONT, STYLE, SIZE, OR COLOR.
 NO CLAIM IS MADE TO THE EXCLUSIVE RIGHT TO USE "LABORATORIES", APART FROM THE MARK AS SHOWN.
 FOR HEALTHCARE AND MEDICAL SERVICES, NAMELY, ANATOMICAL AND CLINICAL PATHOLOGY SERVICES (U.S. CLS. 100 AND 101).
 KEVON CHISOLM, EXAMINING ATTORNEY

SN 77-815,327. UHS OF DELAWARE, INC., KING OF PRUSSIA, PA. FILED 8-28-2009.



NO CLAIM IS MADE TO THE EXCLUSIVE RIGHT TO USE "URGENT CARE", APART FROM THE MARK AS SHOWN.
 THE MARK CONSISTS OF TWO HANDS ON EITHER SIDE OF A HEART, ALL WITHIN A CROSS SIGN WITH THE WORDS "URGENT CARE" POSITIONED TO THE RIGHT THEREOF.
 FOR MEDICAL AND HEALTHCARE SERVICES; URGENT MEDICAL CARE SERVICES (U.S. CLS. 100 AND 101).
 MAYUR VAGHANI, EXAMINING ATTORNEY

SN 77-818,039. NOVA ORTHOPAEDICS & SPORTS MEDICINE CENTER, P.C., VIENNA, VA. FILED 9-2-2009.



NO CLAIM IS MADE TO THE EXCLUSIVE RIGHT TO USE "NOVA ORTHOPAEDICS & SPORTS MEDICINE CENTER" AND THE CADUCEUS DESIGN, APART FROM THE MARK AS SHOWN.
 THE COLOR(S) BURGUNDY, NAVY BLUE, GOLD AND BROWN IS/ARE CLAIMED AS A FEATURE OF THE MARK.
 THE MARK CONSISTS OF THE BLUE WORDING "NOVA ORTHOPAEDICS & SPORTS MEDICINE CENTER" AND A DESIGN TO ITS LEFT CONSISTING OF GOLD AND BROWN IVY LEAVES AT THE BOTTOM AND A GOLD AND BROWN CREST AND CADUCEUS AT THE CENTER

CLASS 44—(Continued).

OF A SHIELD SUBDIVIDING IT INTO FOUR QUADRANTS, THE TOP LEFT OF WHICH CONTAINS THE GOLD WORDING "NOVA" AGAINST A BURGUNDY BACKGROUND; THE TOP RIGHT CONTAINS THE GOLD WORDING "OSMC" AGAINST A BLUE NAVY BACKGROUND; THE BOTTOM LEFT CONTAINS THE GOLD DESIGN OF A RUNNING PERSON AGAINST A BLUE NAVY BACKGROUND; AND THE BOTTOM RIGHT IS A GOLD TREE DESIGN AGAINST A BURGUNDY BACKGROUND.

FOR PHYSICIAN SERVICES (U.S. CLS. 100 AND 101).
FIRST USE 6-23-2006; IN COMMERCE 8-1-2009.
DAWN HAN, EXAMINING ATTORNEY

SN 77-826,419. ALLONE HEALTH GROUP, INC., WILKES-BARRE, NJ. FILED 9-15-2009.

**ANY PROBLEM. ANYTIME.
ANYWHERE.**

THE MARK CONSISTS OF STANDARD CHARACTERS WITHOUT CLAIM TO ANY PARTICULAR FONT, STYLE, SIZE, OR COLOR.

FOR COLLEGE STUDENT HEALTH CARE COUNSELING IN THE NATURE OF PROVIDING INFORMATION AND COUNSELING IN THE FIELD OF HEALTH, MENTAL HEALTH, AND WELLNESS (U.S. CLS. 100 AND 101).

RENEE SERVANCE, EXAMINING ATTORNEY

SN 77-826,466. ALLONE HEALTH GROUP, INC., WILKES-BARRE, NJ. FILED 9-15-2009.

TALK ONE-2-ONE

THE MARK CONSISTS OF STANDARD CHARACTERS WITHOUT CLAIM TO ANY PARTICULAR FONT, STYLE, SIZE, OR COLOR.

FOR COLLEGE STUDENT HEALTH CARE COUNSELING IN THE NATURE OF PROVIDING INFORMATION AND COUNSELING IN THE FIELD OF HEALTH, MENTAL HEALTH, AND WELLNESS (U.S. CLS. 100 AND 101).

RENEE SERVANCE, EXAMINING ATTORNEY

CLASS 44—(Continued).

SN 77-826,499. ALLONE HEALTH GROUP, INC., WILKES-BARRE, NJ. FILED 9-15-2009.

THE MARK CONSISTS OF THE WORD "TALK" POSITIONED ABOVE THE WORD "ONEZONE" WITH TWO DIVERGING, SHAPED LINES DISPLAYED TO THE RIGHT OF THE LETTER "K" IN "TALK".

FOR COLLEGE STUDENT HEALTH CARE COUNSELING IN THE NATURE OF PROVIDING INFORMATION AND COUNSELING IN THE FIELD OF HEALTH, MENTAL HEALTH, AND WELLNESS (U.S. CLS. 100 AND 101).

RENEE SERVANCE, EXAMINING ATTORNEY

SN 77-827,185. SNOWLINE HOSPICE, DIAMOND SPRINGS, CA. FILED 9-15-2009.

**Healing All Together -
Snowline Hospice's Place
for Grieving Children and
Teens & Their Families**

THE MARK CONSISTS OF STANDARD CHARACTERS WITHOUT CLAIM TO ANY PARTICULAR FONT, STYLE, SIZE, OR COLOR.

OWNER OF U.S. REG. NO. 3,487,890.

FOR HOSPICE SERVICE (U.S. CLS. 100 AND 101).
ALEXANDER L. POWERS, EXAMINING ATTORNEY

SN 77-830,730. HOME HEALTH CONNECTION, INC., BETHESDA, MD. FILED 9-21-2009.

**HOME HEALTH CONNECTION,
INC.**

THE MARK CONSISTS OF STANDARD CHARACTERS WITHOUT CLAIM TO ANY PARTICULAR FONT, STYLE, SIZE, OR COLOR.

NO CLAIM IS MADE TO THE EXCLUSIVE RIGHT TO USE "HOME HEALTH" AND "INC.", APART FROM THE MARK AS SHOWN.

FOR HEALTH CARE SERVICES, NAMELY, PRIVATE DUTY NURSING FOR CHILDREN AND ADULTS, INCLUDING SKILLED NURSING CARE AND CLINICAL NURSING SERVICES, REHABILITATION SERVICES, AND HOME HEALTH AIDES SERVICES (U.S. CLS. 100 AND 101).

FIRST USE 12-22-1992; IN COMMERCE 12-22-1992.

LINDA ORNDORFF, EXAMINING ATTORNEY

CLASS 44—(Continued).

SN 77-836,500. AN OASIS OF HEALING, PLC, MESA, AZ. FILED 9-28-2009.

gotlifekeepit.com

THE MARK CONSISTS OF STANDARD CHARACTERS WITHOUT CLAIM TO ANY PARTICULAR FONT, STYLE, SIZE, OR COLOR.
FOR MEDICAL SERVICES, NAMELY, ALTERNATIVE MEDICAL TREATMENT FOR CANCER (U.S. CLS. 100 AND 101).
SUSAN STIGLITZ, EXAMINING ATTORNEY

CLASS 44—(Continued).

SN 77-849,368. URBAN ORGANICS LANDSCAPING, LLC, TUCSON, AZ. FILED 10-15-2009.



THE MARK CONSISTS OF INTERLACED RECTANGLES. FOR LANDSCAPING DESIGN AND LANDSCAPE INSTALLATION SERVICES (U.S. CLS. 100 AND 101).
SHAUNIA CARLYLE, EXAMINING ATTORNEY

SN 77-836,506. AN OASIS OF HEALING, PLC, MESA, AZ. FILED 9-28-2009.

Got life? Keep it!

THE MARK CONSISTS OF STANDARD CHARACTERS WITHOUT CLAIM TO ANY PARTICULAR FONT, STYLE, SIZE, OR COLOR.
FOR MEDICAL SERVICES, NAMELY, ALTERNATIVE MEDICAL TREATMENT FOR CANCER (U.S. CLS. 100 AND 101).
SUSAN STIGLITZ, EXAMINING ATTORNEY

SN 77-850,532. ROSALES, LARRY, SANTA MONICA, CA. FILED 10-16-2009.

SN 77-838,072. IMAGINE PEDIATRIC THERAPY, OWASSO, OK. FILED 9-30-2009.

Imagine
Pediatric Therapy

NO CLAIM IS MADE TO THE EXCLUSIVE RIGHT TO USE "PEDIATRIC THERAPY", APART FROM THE MARK AS SHOWN.
THE MARK CONSISTS OF THE STYLIZED TEXT "IMAGINE PEDIATRIC THERAPY".
FOR OCCUPATIONAL, PHYSICAL, AND SPEECH THERAPY SERVICES FOR THE PEDIATRIC COMMUNITY; COUNSELING SERVICES FOR THE PARENTS/GUARDIANS OF THE PEDIATRIC PATIENTS IN THE FIELDS OF HEALTH, NUTRITION AND LIFESTYLE WELLNESS (U.S. CLS. 100 AND 101).
FIRST USE 7-15-2007; IN COMMERCE 7-15-2007.
SOPHIA S. KIM, EXAMINING ATTORNEY



OWNER OF U.S. REG. NO. 3,723,607.
NO CLAIM IS MADE TO THE EXCLUSIVE RIGHT TO USE "FOOD & NUTRITION", APART FROM THE MARK AS SHOWN.
THE MARK CONSISTS OF A CIRCLE MEANT TO LOOK LIKE A PLATE WITH THE WORDS "EAT CHIC" IN A STYLIZED FONT IN THE CENTER AND "FOOD & NUTRITION" IN A SEMI CIRCLE BELOW IT.
FOR MEDICAL SERVICES, NAMELY, PROVIDING FOOD NUTRITION, WELLNESS, AND HEALTH-RELATED CONSULTING (U.S. CLS. 100 AND 101).
DORITT L. CARROLL, EXAMINING ATTORNEY

CLASS 44—(Continued).

SN 77-851,998. CHRISTOPHER REEVE FOUNDATION, A NEW JERSEY NONPROFIT CORPORATION, SHORT HILLS, NJ. FILED 10-19-2009.

CHRISTOPHER & DANA REEVE
FOUNDATION PARALYSIS
RESOURCE CENTER

THE MARK CONSISTS OF STANDARD CHARACTERS WITHOUT CLAIM TO ANY PARTICULAR FONT, STYLE, SIZE, OR COLOR.

OWNER OF U.S. REG. NOS. 2,830,482 AND 3,417,015. NO CLAIM IS MADE TO THE EXCLUSIVE RIGHT TO USE "PARALYSIS RESOURCE CENTER", APART FROM THE MARK AS SHOWN.

THE NAME(S), PORTRAIT(S), AND/OR SIGNATURE(S) SHOWN IN THE MARK DOES NOT IDENTIFY A PARTICULAR LIVING INDIVIDUAL.

FOR PROVIDING REFERRAL INFORMATION AND GENERAL INFORMATION IN THE FIELDS OF HOME HEALTH CARE, PHYSICAL THERAPY, AND OCCUPATIONAL THERAPY FOR THE PHYSICALLY CHALLENGED (U.S. CLS. 100 AND 101).

FIRST USE 9-1-2008; IN COMMERCE 9-1-2008.
DOMINIC J. FERRAIUOLO, EXAMINING ATTORNEY

SN 77-852,173. PHARMAVITE LLC, MISSION HILLS, CA. FILED 10-19-2009.

VITAMINID.COM

THE MARK CONSISTS OF STANDARD CHARACTERS WITHOUT CLAIM TO ANY PARTICULAR FONT, STYLE, SIZE, OR COLOR.

FOR DIETARY AND NUTRITIONAL GUIDANCE; PROVIDING HEALTHY LIFESTYLE AND NUTRITION SERVICES, NAMELY, PERSONAL ASSESSMENTS AND COUNSELING; PROVIDING INFORMATION AND ADVICE ABOUT VITAMINS, MINERALS AND DIETARY SUPPLEMENTS; PROVIDING ASSISTANCE, NUTRITIONAL FITNESS EVALUATION, AND CONSULTATION TO INDIVIDUALS TO HELP THEM MAKE HEALTH, WELLNESS, AND NUTRITIONAL CHANGES TO THEIR DAILY LIVING TO IMPROVE THEIR HEALTH; PROVIDING A WEBSITE FEATURING INFORMATION AND ADVICE IN THE FIELDS OF DIETARY SUPPLEMENTS, NUTRITION, HEALTH, AND LIFESTYLE WELLNESS; DIETARY SUPPLEMENT, WELLNESS, NUTRITION, AND HEALTH-RELATED CONSULTATION SERVICES (U.S. CLS. 100 AND 101).

FIRST USE 9-1-2009; IN COMMERCE 9-1-2009.
SUSAN RICHARDS, EXAMINING ATTORNEY

CLASS 44—(Continued).

SN 77-852,183. PHARMAVITE LLC, MISSION HILLS, CA. FILED 10-19-2009.

NATURE MADE VITAMINID

THE MARK CONSISTS OF STANDARD CHARACTERS WITHOUT CLAIM TO ANY PARTICULAR FONT, STYLE, SIZE, OR COLOR.

OWNER OF U.S. REG. NOS. 1,963,505, 2,592,200 AND 3,648,644.

FOR DIETARY AND NUTRITIONAL GUIDANCE; PROVIDING HEALTHY LIFESTYLE AND NUTRITION SERVICES, NAMELY, PERSONAL ASSESSMENTS AND COUNSELING; PROVIDING INFORMATION AND ADVICE ABOUT VITAMINS, MINERALS AND DIETARY SUPPLEMENTS; PROVIDING ASSISTANCE, NUTRITIONAL FITNESS EVALUATION, AND CONSULTATION TO INDIVIDUALS TO HELP THEM MAKE HEALTH, WELLNESS, AND NUTRITIONAL CHANGES TO THEIR DAILY LIVING TO IMPROVE THEIR HEALTH; PROVIDING A WEBSITE FEATURING INFORMATION AND ADVICE IN THE FIELDS OF DIETARY SUPPLEMENTS, NUTRITION, HEALTH, AND LIFESTYLE WELLNESS; DIETARY SUPPLEMENT, WELLNESS, NUTRITION, AND HEALTH-RELATED CONSULTATION SERVICES (U.S. CLS. 100 AND 101).

FIRST USE 9-1-2009; IN COMMERCE 9-1-2009.
SUSAN RICHARDS, EXAMINING ATTORNEY

SN 77-852,195. PHARMAVITE LLC, MISSION HILLS, CA. FILED 10-19-2009.

VITAMINID

THE MARK CONSISTS OF STANDARD CHARACTERS WITHOUT CLAIM TO ANY PARTICULAR FONT, STYLE, SIZE, OR COLOR.

FOR DIETARY AND NUTRITIONAL GUIDANCE; PROVIDING HEALTHY LIFESTYLE AND NUTRITION SERVICES, NAMELY, PERSONAL ASSESSMENTS AND COUNSELING; PROVIDING INFORMATION AND ADVICE ABOUT VITAMINS, MINERALS AND DIETARY SUPPLEMENTS; PROVIDING ASSISTANCE, NUTRITIONAL FITNESS EVALUATION, AND CONSULTATION TO INDIVIDUALS TO HELP THEM MAKE HEALTH, WELLNESS, AND NUTRITIONAL CHANGES TO THEIR DAILY LIVING TO IMPROVE THEIR HEALTH; PROVIDING A WEBSITE FEATURING INFORMATION AND ADVICE IN THE FIELDS OF DIETARY SUPPLEMENTS, NUTRITION, HEALTH, AND LIFESTYLE WELLNESS; DIETARY SUPPLEMENT, WELLNESS, NUTRITION, AND HEALTH-RELATED CONSULTATION SERVICES (U.S. CLS. 100 AND 101).

FIRST USE 9-1-2009; IN COMMERCE 9-1-2009.
SUSAN RICHARDS, EXAMINING ATTORNEY

CLASS 44—(Continued).

SN 77-852,218. PHARMAVITE LLC, MISSION HILLS, CA. FILED 10-19-2009.



THE MARK CONSISTS OF A THREE LEAF DESIGN FOLLOWED BY "VITAMINID.COM".
 FOR DIETARY AND NUTRITIONAL GUIDANCE; PROVIDING HEALTHY LIFESTYLE AND NUTRITION SERVICES, NAMELY, PERSONAL ASSESSMENTS AND COUNSELING; PROVIDING INFORMATION AND ADVICE ABOUT VITAMINS, MINERALS AND DIETARY SUPPLEMENTS; PROVIDING ASSISTANCE, NUTRITIONAL FITNESS EVALUATION, AND CONSULTATION TO INDIVIDUALS TO HELP THEM MAKE HEALTH, WELLNESS, AND NUTRITIONAL CHANGES TO THEIR DAILY LIVING TO IMPROVE THEIR HEALTH; PROVIDING A WEBSITE FEATURING INFORMATION AND ADVICE IN THE FIELDS OF DIETARY SUPPLEMENTS, NUTRITION, HEALTH, AND LIFESTYLE WELLNESS; DIETARY SUPPLEMENT, WELLNESS, NUTRITION, AND HEALTH-RELATED CONSULTATION SERVICES (U.S. CLS. 100 AND 101).
 FIRST USE 9-1-2009; IN COMMERCE 9-1-2009.
 SUSAN RICHARDS, EXAMINING ATTORNEY

SN 77-852,238. PHARMAVITE LLC, MISSION HILLS, CA. FILED 10-19-2009.



THE MARK CONSISTS OF A THREE LEAF DESIGN.
 FOR DIETARY AND NUTRITIONAL GUIDANCE; PROVIDING HEALTHY LIFESTYLE AND NUTRITION SERVICES, NAMELY, PERSONAL ASSESSMENTS AND COUNSELING; PROVIDING INFORMATION AND ADVICE ABOUT VITAMINS, MINERALS AND DIETARY SUPPLEMENTS; PROVIDING ASSISTANCE, NUTRITIONAL FITNESS EVALUATION, AND CONSULTATION TO INDIVIDUALS TO HELP THEM MAKE HEALTH, WELLNESS, AND NUTRITIONAL CHANGES TO THEIR DAILY LIVING TO IMPROVE THEIR HEALTH; PROVIDING A WEBSITE FEATURING INFORMATION AND ADVICE IN THE FIELDS OF DIETARY SUPPLEMENTS, NUTRITION, HEALTH, AND LIFESTYLE WELLNESS; DIETARY SUPPLEMENT, WELLNESS, NUTRITION, AND HEALTH-RELATED CONSULTATION SERVICES (U.S. CLS. 100 AND 101).
 FIRST USE 9-1-2009; IN COMMERCE 9-1-2009.
 SUSAN RICHARDS, EXAMINING ATTORNEY

CLASS 44—(Continued).

SN 77-853,310. WISER TOGETHER, INC., WASHINGTON, DC. FILED 10-20-2009.



THE MARK CONSISTS OF THE STYLIZED TEXT "WISER TOGETHER".
 FOR PROVIDING AN ON-LINE SEARCHABLE DATABASE FEATURING HEALTH-RELATED INFORMATION IN THE FIELD OF PREGNANCY PROVIDED BY PEERS AND EXPERTS (U.S. CLS. 100 AND 101).
 FIRST USE 3-10-2008; IN COMMERCE 4-10-2009.
 KRISTINA MORRIS, EXAMINING ATTORNEY

SN 77-854,085. UNITED BIOLOGICS, LLC, SPRING BRANCH, TX. FILED 10-21-2009.



NO CLAIM IS MADE TO THE EXCLUSIVE RIGHT TO USE "ALLERGY LABS" AND "TESTING", APART FROM THE MARK AS SHOWN.
 THE MARK CONSISTS OF THE WORD "UNITED" APPEARING ABOVE THE WORDING "ALLERGYLABS" WITH A STEM DESIGN STARTING BENEATH AND BETWEEN THE LETTERS "R" AND "G" ENDING IN A DOUBLE LEAF DESIGN SLIGHTLY OVERLAPPING THE LETTER "S" FROM BENEATH AND THE WORDING "TESTING FOR A BETTER QUALITY OF LIFE." AT THE BOTTOM OF THE DESIGN.
 FOR MEDICAL TESTING SERVICES, NAMELY, ALLERGY TESTING AND ANALYSIS (U.S. CLS. 100 AND 101).
 FIRST USE 4-2-2009; IN COMMERCE 4-2-2009.
 KIMBERLY PERRY, EXAMINING ATTORNEY

CLASS 44—(Continued).

SN 77-855,374. BAYLOR HEALTH CARE SYSTEM, DALLAS, TX. FILED 10-22-2009.

HealthSource

THE MARK CONSISTS OF STANDARD CHARACTERS WITHOUT CLAIM TO ANY PARTICULAR FONT, STYLE, SIZE, OR COLOR.

FOR PROVIDING MEDICAL INFORMATION VIA AN INTERACTIVE WEBSITE CONTAINING ARTICLES AND AUDIO, VIDEO AND VISUAL MEDICAL CONTENT (U.S. CLS. 100 AND 101).

FIRST USE 8-0-2009; IN COMMERCE 8-0-2009.

MARTHA SANTOMARTINO, EXAMINING ATTORNEY

SN 77-862,463. IMPLANT AND PERIODONTAL THERAPY, TAMPA, FL. FILED 11-2-2009.

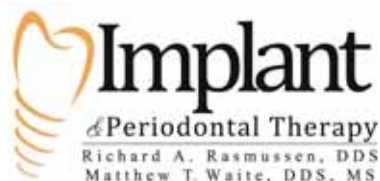

NO CLAIM IS MADE TO THE EXCLUSIVE RIGHT TO USE "IMPLANT & PERIODONTAL THERAPY RICHARD A. RASMUSSEN, DDS MATTHEW T. WAITE, DDS, MS", APART FROM THE MARK AS SHOWN.

THE NAME "MATTHEW WAITE" IDENTIFIES A LIVING INDIVIDUAL WHOSE CONSENT IS OF RECORD.

THE COLOR(S) YELLOW AND BLACK IS/ARE CLAIMED AS A FEATURE OF THE MARK.

THE MARK CONSISTS OF YELLOW CROWN ON "IMPLANT" AND BLACK LETTERING FOR WORDS AS "IMPLANT".

FOR DENTIST SERVICES (U.S. CLS. 100 AND 101).
MATTHEW KLINE, EXAMINING ATTORNEY

SN 77-863,988. BOSTWICK LABORATORIES, INC., GLEN ALLEN, VA. FILED 11-3-2009.

ABSOLUTE MATCH

THE MARK CONSISTS OF STANDARD CHARACTERS WITHOUT CLAIM TO ANY PARTICULAR FONT, STYLE, SIZE, OR COLOR.

NO CLAIM IS MADE TO THE EXCLUSIVE RIGHT TO USE "MATCH", APART FROM THE MARK AS SHOWN.

FOR DNA MATCHING SERVICES, NAMELY, BIOPSY IDENTIFICATION FOR MEDICAL PURPOSES (U.S. CLS. 100 AND 101).

FIRST USE 11-2-2009; IN COMMERCE 11-2-2009.
FRANK LATTUCA, EXAMINING ATTORNEY

CLASS 44—(Continued).

SN 77-865,049. SCHROEDER, TERRY, A, WESTLAKE VILLAGE, CA. AND SCHROEDER, LORI, A, WESTLAKE VILLAGE, CA. FILED 11-4-2009.

Live in Alignment

FOR CHIROPRACTIC SERVICES (U.S. CLS. 100 AND 101).

FIRST USE 6-12-2008; IN COMMERCE 6-12-2008.
MICHAEL LITZAU, EXAMINING ATTORNEY

SN 77-872,416. INDEPENDENT HEALTH ASSOCIATION, INC., WILLIAMSVILLE, NY. FILED 11-13-2009.

INDEPENDENT HEALTH'S EMPOWER

THE MARK CONSISTS OF STANDARD CHARACTERS WITHOUT CLAIM TO ANY PARTICULAR FONT, STYLE, SIZE, OR COLOR.

OWNER OF U.S. REG. NOS. 2,938,669, 3,196,351 AND OTHERS.

NO CLAIM IS MADE TO THE EXCLUSIVE RIGHT TO USE "HEALTH'S", APART FROM THE MARK AS SHOWN. FOR PREFERRED PROVIDER ORGANIZATION HEALTH BENEFIT PLAN WITH PREMIUM REDUCTIONS WITH REGULAR WELLNESS CARE AND ASSESSMENT (U.S. CLS. 100 AND 101).

WARREN L. OLANDRIA, EXAMINING ATTORNEY

SN 77-875,884. TREASURE ISLAND, LLC, LAS VEGAS, NV. FILED 11-18-2009.

OLEKSANDRA SPA & SALON

THE MARK CONSISTS OF STANDARD CHARACTERS WITHOUT CLAIM TO ANY PARTICULAR FONT, STYLE, SIZE, OR COLOR.

NO CLAIM IS MADE TO THE EXCLUSIVE RIGHT TO USE "SPA & SALON", APART FROM THE MARK AS SHOWN.

THE NAME(S), PORTRAIT(S), AND/OR SIGNATURE(S) SHOWN IN THE MARK IDENTIFIES OLEKSANDRA NIKOLAYENKO, A LIVING INDIVIDUAL, WHOSE CONSENT TO REGISTER IS MADE OF RECORD.

FOR COSMETICIAN SERVICES: DAY SPA SERVICES, NAMELY, NAIL CARE, MANICURES, PEDICURES AND NAIL ENHANCEMENTS; HAIR SALON SERVICES; HEALTH SPA SERVICES FOR HEALTH AND WELLNESS OF THE BODY AND SPIRIT, NAMELY, PROVIDING MASSAGE, FACIAL AND BODY TREATMENT SERVICES, COSMETIC BODY CARE SERVICES (U.S. CLS. 100 AND 101).

FIRST USE 11-2-2009; IN COMMERCE 11-2-2009.
BARBARA GAYNOR, EXAMINING ATTORNEY

CLASS 44—(Continued).

SN 77-878,545. NORTH CAROLINA FARM BUREAU FEDERATION, INC., RALEIGH, NC. FILED 11-23-2009.

Healthy Living for a Lifetime

THE MARK CONSISTS OF STANDARD CHARACTERS WITHOUT CLAIM TO ANY PARTICULAR FONT, STYLE, SIZE, OR COLOR.

FOR HEALTH SCREENING SERVICES (U.S. CLS. 100 AND 101).

DAVID C. REIHNER, EXAMINING ATTORNEY

SN 77-878,847. DKUMAR, LLC, DBA ATLANTA HAND SPECIALIST, SMYRNA, GA. FILED 11-23-2009.



NO CLAIM IS MADE TO THE EXCLUSIVE RIGHT TO USE "ATLANTA HAND SPECIALIST", APART FROM THE MARK AS SHOWN.

THE COLOR(S) PURPLE (PANTONE 257C) AND GRAY (PANTONE COOL GRAY 7C) IS/ARE CLAIMED AS A FEATURE OF THE MARK.

THE MARK CONSISTS OF THE SILVER/GRAY COLOR APPEARS ON THE HAND (INSIDE THE "A") AND THE SWOOSH SYMBOL THAT FOLLOWS UNDERNEATH THE NAME. THE PURPLE COLOR IS USED ON "ATLANTA HAND SPECIALIST".

FOR MEDICAL CLINICS; MEDICAL CONSULTATIONS; MEDICAL DIAGNOSTIC TESTING, MONITORING AND REPORTING SERVICES; MEDICAL RADIOLOGY SERVICES; MEDICAL SERVICES IN THE FIELD OF HAND AND UPPER EXTREMITY; MEDICAL, PHYSICAL REHABILITATION AND PHYSICAL THERAPY SERVICES; PHYSICAL THERAPY EVALUATION AND TREATMENT OF HAND AND UPPER EXTREMITY; PHYSICAL THERAPY EVALUATION, IDENTIFICATION, AND MANAGEMENT OF MOVEMENT DYSFUNCTION TO RESTORE, MAINTAIN, AND PROMOTE OPTIMAL PHYSICAL FUNCTION PREVENTING THE ONSET, SYMPTOMS AND PROGRESSION OF IMPAIRMENTS, FUNCTIONAL LIMITATIONS, AND DISABILITIES RESULTING FROM DISEASE, DISORDERS, CONDITIONS, OR INJURIES; PROVIDING INFORMATION IN THE FIELD OF UPPER EXTREMITY AMPUTATION; PROVIDING INFORMATION, ADVICE AND DATA ON MEDICAL IMAGING; SURGERY; TREATMENT TO JOINT-DISLOCATION, SPRAIN, BONE-FRACTURE OR THE LIKE (JUDO-SEIFUKU) (U.S. CLS. 100 AND 101).

FIRST USE 11-12-2009; IN COMMERCE 11-12-2009.
KAELIE KUNG, EXAMINING ATTORNEY

CLASS 44—(Continued).

SN 77-884,150. WISE, CRAIG L., PENFIELD, PA. FILED 12-2-2009.

JOHNSTON'S NURSERY

THE MARK CONSISTS OF STANDARD CHARACTERS WITHOUT CLAIM TO ANY PARTICULAR FONT, STYLE, SIZE, OR COLOR.

NO CLAIM IS MADE TO THE EXCLUSIVE RIGHT TO USE "NURSERY", APART FROM THE MARK AS SHOWN. SEC. 2(F).

FOR LANDSCAPE DESIGN (U.S. CLS. 100 AND 101).

FIRST USE 4-1-1999; IN COMMERCE 5-1-1999.

GINA HAYES, EXAMINING ATTORNEY

SN 77-885,474. EIGER HEALTH PARTNERS, LLC, AMAGANSETT, NY. FILED 12-3-2009.

EIGER

THE MARK CONSISTS OF STANDARD CHARACTERS WITHOUT CLAIM TO ANY PARTICULAR FONT, STYLE, SIZE, OR COLOR.

FOR DIAGNOSIS AND TREATMENT OF CANCER AND AUTO-IMMUNE DISEASES (U.S. CLS. 100 AND 101).

MARIA-VICTORIA SUAREZ, EXAMINING ATTORNEY

SN 77-886,257. WOOD, DENISE, TWAIN HARTE, CA. FILED 12-4-2009.



THE MARK CONSISTS OF THE LETTERS "L" IN THE TEXT "ALLERGY" REPLACED WITH DANDELIONS ABOVE GRASS, "ADVANCED" ABOVE THE LETTERS "ERGY" OF "ALLERGY", AND "SOLUTIONS" ACROSS THE GRASS.

FOR ACUPRESSURE SERVICES, NAMELY, A NON-INVASIVE IDENTIFICATION AND TREATMENT OF SYMPTOMS ASSOCIATED WITH ALLERGIES AND SENSITIVITIES (U.S. CLS. 100 AND 101).

FIRST USE 10-0-2009; IN COMMERCE 10-0-2009.
MATTHEW EINSTEIN, EXAMINING ATTORNEY

CLASS 44—(Continued).

SN 77-889,448. ADVANTAGE HEALTH SOLUTIONS, INC. SM, INDIANAPOLIS, IN. FILED 12-9-2009.

Care-ADVANTAGE...
An Integrated Approach to Population Health Management

NO CLAIM IS MADE TO THE EXCLUSIVE RIGHT TO USE "HEALTH MANAGEMENT", APART FROM THE MARK AS SHOWN.

THE COLOR(S) GREEN IS/ARE CLAIMED AS A FEATURE OF THE MARK.

THE MARK CONSISTS OF THE LITERAL ELEMENT "CARE-ADVANTAGE...AN INTEGRATED APPROACH TO POPULATION HEALTH MANAGEMENT" REPRESENTED IN STYLIZED FONT WHEREIN "CARE" APPEARS IN ITALICS IN UPPER AND LOWER CASE LETTERS AND IS FOLLOWED BY A HYPHEN CONNECTING IT TO THE WORD "ADVANTAGE" APPEARING IN UPPER CASE LETTERS AND WHICH IS FOLLOWED BY THREE PERIODS, THE WORDS AND PUNCTUATION ALL APPEARING IN THE COLOR GREEN. BENEATH THE WORDS "CARE-ADVANTAGE..." APPEARS THE PHRASE "AN INTEGRATED APPROACH TO POPULATION HEALTH MANAGEMENT" IN THE COLOR GREEN WHERE THE WORDS ARE LOWERCASE.

FOR CONSULTING IN THE FIELD OF HEALTH AND WELLNESS TO BRING ABOUT PERSONAL HAPPINESS; CONSULTING SERVICES IN THE FIELD OF MENTAL HEALTH AND WELLNESS; COUNSELING SERVICES IN THE FIELDS OF HEALTH, HERBALISM, AND LIFESTYLE WELLNESS; COUNSELING SERVICES IN THE FIELDS OF HEALTH, NUTRITION AND LIFESTYLE WELLNESS; HEALTH ASSESSMENT SERVICES, NAMELY, PROVIDING METABOLIC ASSESSMENT PROFILES (MAP) TO CLIENTS OBTAINED BY USING A PORTABLE METABOLIC MEASUREMENT SYSTEM IN THE NATURE OF A UNIQUE, HEART-RATE BASED OVERVIEW OF THEIR OWN METABOLISM IN ORDER TO ASSIST IN REACHING WEIGHT LOSS, SPORTS PERFORMANCE, HEALTH, FITNESS, AND WELLNESS-RELATED GOALS; HEALTH CARE SERVICES, NAMELY, DISEASE MANAGEMENT PROGRAMS; HEALTH CARE SERVICES, NAMELY, WELLNESS PROGRAMS; PROVIDING A WEB SITE FEATURING INFORMATION IN THE FIELD OF MENTAL HEALTH AND WELLNESS; PROVIDING A WEBSITE FEATURING CONTENT REGARDING HEALTHY LIVING AND LIFESTYLE WELLNESS; PROVIDING ASSISTANCE, FITNESS EVALUATION AND CONSULTATION TO CORPORATE CLIENTS TO HELP THEIR EMPLOYEES MAKE HEALTH, WELLNESS AND NUTRITIONAL CHANGES IN THEIR DAILY LIVING TO IMPROVE HEALTH; PROVIDING ASSISTANCE, FITNESS EVALUATION AND CONSULTATION TO INDIVIDUALS TO HELP THEM MAKE HEALTH, WELLNESS AND NUTRITIONAL CHANGES IN THEIR DAILY LIVING TO IMPROVE HEALTH; PROVIDING WELLNESS SERVICES, NAMELY, PERSONAL ASSESSMENTS, PERSONALIZED ROUTINES, MAINTENANCE SCHEDULES, AND COUNSELING; WELLNESS AND HEALTH-RELATED CONSULTING SERVICES (U.S. CLS. 100 AND 101).

FIRST USE 3-1-2007; IN COMMERCE 3-1-2007.
RONALD DELGIZZI, EXAMINING ATTORNEY

CLASS 44—(Continued).

SN 77-890,823. LEVINE, SUZANNE, DBA INSTITUTE BEAUTE, NEW YORK, NY. FILED 12-10-2009.

pillows for your feet

THE MARK CONSISTS OF STANDARD CHARACTERS WITHOUT CLAIM TO ANY PARTICULAR FONT, STYLE, SIZE, OR COLOR.

NO CLAIM IS MADE TO THE EXCLUSIVE RIGHT TO USE "FEET", APART FROM THE MARK AS SHOWN.

FOR MEDICAL SERVICES, NAMELY, PODIATRIC AND COSMETIC FOOT CARE SERVICES (U.S. CLS. 100 AND 101).

FIRST USE 0-0-2003; IN COMMERCE 0-0-2005.
MICHAEL WIENER, EXAMINING ATTORNEY

SN 77-896,780. SCENAR HEALTH USA LLC, LAS VEGAS, NV. FILED 12-18-2009.

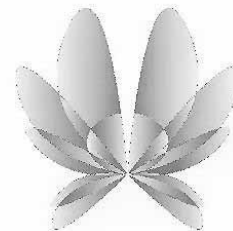

NOTOXIN
HOLISTIC THERAPY

NO CLAIM IS MADE TO THE EXCLUSIVE RIGHT TO USE "HOLISTIC THERAPY", APART FROM THE MARK AS SHOWN.

THE MARK CONSISTS OF A FLOWER ABOVE THE WORDS "NOTOXIN HOLISTIC THERAPY".

FOR PROVIDING IN-PERSON HOLISTIC HEALTH CARE SERVICES AND A INTERACTIVE HOLISTIC WEB SITE FEATURING HEALTH INFORMATION AND PATIENT INITIATED, PATIENT AUTHORIZED, FEE-FOR-SERVICE, HOLISTIC APPROACH DISTANCE HEALING SESSIONS BASED ON THE PATIENT'S SPECIFIC SET OF SYMPTOMS, MEDICAL PROFILE AND MEDICAL RECORD ANALYSIS AND PATIENT BENEFIT INFORMATION CONCERNING ORGANIC AND HOLISTIC PRODUCTS AND SERVICES (U.S. CLS. 100 AND 101).

DORITT L. CARROLL, EXAMINING ATTORNEY

CLASS 44—(Continued).

SN 77-899,119. CLASSIC RESIDENCE MANAGEMENT LIMITED PARTNERSHIP, CHICAGO, IL. FILED 12-22-2009.

VI

THE MARK CONSISTS OF STANDARD CHARACTERS WITHOUT CLAIM TO ANY PARTICULAR FONT, STYLE, SIZE, OR COLOR.

FOR NURSING HOMES; PROVIDING HEALTHCARE CONSULTING SERVICES TO SENIOR SERVICE PROVIDERS IN THE FIELD OF SENIOR HOUSING, SENIOR COMMUNITIES, ASSISTED LIVING, AND LONG-TERM CARE FACILITIES (U.S. CLS. 100 AND 101).

AISHA CLARKE, EXAMINING ATTORNEY

CLASS 44—(Continued).

SN 77-899,169. CLASSIC RESIDENCE MANAGEMENT LIMITED PARTNERSHIP, CHICAGO, IL. FILED 12-22-2009.



THE MARK CONSISTS OF THE LETTERS "VI" IN STYLIZED LETTERING WITH A FLOWER FORMING THE DOT OVER THE LETTER "I".

FOR NURSING HOMES; PROVIDING HEALTHCARE CONSULTING SERVICES TO SENIOR SERVICE PROVIDERS IN THE FIELD OF SENIOR HOUSING, SENIOR COMMUNITIES, ASSISTED LIVING, AND LONG-TERM CARE FACILITIES (U.S. CLS. 100 AND 101).

AISHA CLARKE, EXAMINING ATTORNEY

SN 77-904,003. DAVIS, NATASHA L., DBA TRIMZ ON A WHIM LLC, INDIANAPOLIS, IN. FILED 1-3-2010.

SN 77-899,138. CLASSIC RESIDENCE MANAGEMENT LIMITED PARTNERSHIP, CHICAGO, IL. FILED 12-22-2009.

VI LIVING



THE MARK CONSISTS OF STANDARD CHARACTERS WITHOUT CLAIM TO ANY PARTICULAR FONT, STYLE, SIZE, OR COLOR.

NO CLAIM IS MADE TO THE EXCLUSIVE RIGHT TO USE "LIVING", APART FROM THE MARK AS SHOWN.

FOR NURSING HOMES; PROVIDING HEALTHCARE CONSULTING SERVICES TO SENIOR SERVICE PROVIDERS IN THE FIELD OF SENIOR HOUSING, SENIOR COMMUNITIES, ASSISTED LIVING, AND LONG-TERM CARE FACILITIES (U.S. CLS. 100 AND 101).

AISHA CLARKE, EXAMINING ATTORNEY

THE COLOR(S) BLUE, YELLOW, WHITE, BROWN, GREY, AND BLACK IS/ARE CLAIMED AS A FEATURE OF THE MARK.

THE MARK CONSISTS OF A YELLOW SMILEY FACE WITH WHITE AROUND BOTH BLUE EYES THAT HAVE BLACK CENTERS WITH WHITE, WHITE TEETH, A BLACK ARM WITH A WHITE HAND HOLDING A GREY BLOW DRYER THAT HAS THE COLOR BLACK ON ONE END THE SMILEY FACE IS DRYING HIS BROWN HAIR.

FOR BEAUTY SALONS (U.S. CLS. 100 AND 101). FIRST USE 4-16-2009; IN COMMERCE 4-16-2009. RAMONA ORTIGA, EXAMINING ATTORNEY

CLASS 44—(Continued).

SN 77-905,592. ENT AND ALLERGY ASSOCIATES, LLP, TARRYTOWN, NY. FILED 1-5-2010.

ENT AND ALLERGY ASSOCIATES

THE MARK CONSISTS OF STANDARD CHARACTERS WITHOUT CLAIM TO ANY PARTICULAR FONT, STYLE, SIZE, OR COLOR.

NO CLAIM IS MADE TO THE EXCLUSIVE RIGHT TO USE "ENT AND ALLERGY", APART FROM THE MARK AS SHOWN.

SEC. 2(F).

FOR MEDICAL SERVICES (U.S. CLS. 100 AND 101).

FIRST USE 6-22-1999; IN COMMERCE 6-22-1999.

HANNO RITTNER, EXAMINING ATTORNEY

SN 77-906,677. WESTERN WISCONSIN MEDICAL ASSOCIATES, S.C., RIVER FALLS, WI. FILED 1-7-2010.

RIVERS CANCER CENTER

THE MARK CONSISTS OF STANDARD CHARACTERS WITHOUT CLAIM TO ANY PARTICULAR FONT, STYLE, SIZE, OR COLOR.

NO CLAIM IS MADE TO THE EXCLUSIVE RIGHT TO USE "CANCER CENTER", APART FROM THE MARK AS SHOWN.

FOR MEDICAL CLINICS; MEDICAL SERVICES IN THE FIELD OF CANCER DIAGNOSIS AND TREATMENT (U.S. CLS. 100 AND 101).

KIM SAITO, EXAMINING ATTORNEY

SN 77-914,663. DT SCIMED, LLC, TOWSON, MD. FILED 1-19-2010.

BIO-PROTECTION

THE MARK CONSISTS OF STANDARD CHARACTERS WITHOUT CLAIM TO ANY PARTICULAR FONT, STYLE, SIZE, OR COLOR.

FOR SURGICAL SERVICES INVOLVING TREATING TISSUE WITH NEUROTOXINS (U.S. CLS. 100 AND 101).

JAMES GRIFFIN, EXAMINING ATTORNEY

CLASS 44—(Continued).

SN 77-916,709. DANIEL RONEL, M.D., P.C., SANTA FE, NM. FILED 1-21-2010.

The Whole Being Plan

THE MARK CONSISTS OF STANDARD CHARACTERS WITHOUT CLAIM TO ANY PARTICULAR FONT, STYLE, SIZE, OR COLOR.

NO CLAIM IS MADE TO THE EXCLUSIVE RIGHT TO USE "PLAN", APART FROM THE MARK AS SHOWN.

FOR PLASTIC SURGERY SERVICES THAT INTEGRATE TRADITIONAL WESTERN MEDICAL PRACTICES WITH HOLISTIC THERAPIES (U.S. CLS. 100 AND 101).

FIRST USE 1-14-2010; IN COMMERCE 1-14-2010.

LOURDES AYALA, EXAMINING ATTORNEY

SN 77-920,074. KLEINERT, KUTZ AND ASSOCIATES HAND CARE CENTER, PLLC, DBA KLEINERT, KUTZ HAND CARE CENTER, LOUISVILLE, KY. FILED 1-26-2010.



KLEINERT KUTZ

THE STIPPLING IS FOR SHADING PURPOSES ONLY. THE MARK CONSISTS OF THE WORDS "KLEINERT KUTZ" DISPLAYED IN CONNECTION WITH A DESIGN OF TWO HANDS HOLDING A GLOBE.

FOR PERFORMING SURGICAL AND NON-SURGICAL MEDICAL PROCEDURES DIRECTED TO THE UPPER BODY EXTREMITIES (U.S. CLS. 100 AND 101).

FIRST USE 9-18-1992; IN COMMERCE 9-18-1992.

TINA L. SNAPP, EXAMINING ATTORNEY

SN 77-920,075. KLEINERT, KUTZ AND ASSOCIATES HAND CARE CENTER, PLLC, DBA KLEINERT, KUTZ HAND CARE CENTER, LOUISVILLE, KY. FILED 1-26-2010.

KLEINERT KUTZ

THE MARK CONSISTS OF STANDARD CHARACTERS WITHOUT CLAIM TO ANY PARTICULAR FONT, STYLE, SIZE, OR COLOR.

FOR PERFORMING SURGICAL AND NON-SURGICAL MEDICAL PROCEDURES DIRECTED TO THE UPPER BODY EXTREMITIES (U.S. CLS. 100 AND 101).

FIRST USE 12-31-1964; IN COMMERCE 12-31-1964.

TINA L. SNAPP, EXAMINING ATTORNEY

CLASS 44—(Continued).

SN 77-923,328, DOROTHY NARVAEZ-WOODS DDS, INC.,
DBA PLISSÉ, LA JOLLA, CA. FILED 1-29-2010.



THE MARK CONSISTS OF FOUR LARGE DIAMONDS AND THE STYLIZED WORD "PLISSÉ" CENTERED OVER THE DIAMONDS WITH AN ACUTE ACCENT MARK OVER THE "É". THE LETTER "P" IN "PLISSÉ" HAS A SMALL DIAMOND IN THE CIRCULAR STRUCTURE OF THE "P". THE BACKGROUND RECTANGLE IS FOR CONTRAST PURPOSES ONLY AND IS NOT CLAIMED AS A FEATURE OF THE MARK.

THE ENGLISH TRANSLATION OF THE WORD "PLISSÉ" IN THE MARK IS "PUCKER".

FOR DENTIST SERVICES, HEALTH SPA SERVICES, NAMELY, COSMETIC BODY, FACE AND MOUTH CARE SERVICES (U.S. CLS. 100 AND 101).

FIRST USE 1-1-2010; IN COMMERCE 1-1-2010.

JERI J. FICKES, EXAMINING ATTORNEY

CLASS 44—(Continued).

SN 77-925,476, EMELINA BALTAZAR, PASADENA, CA.
FILED 2-2-2010.

Speech Within Reach

THE MARK CONSISTS OF STANDARD CHARACTERS WITHOUT CLAIM TO ANY PARTICULAR FONT, STYLE, SIZE, OR COLOR.

NO CLAIM IS MADE TO THE EXCLUSIVE RIGHT TO USE "SPEECH", APART FROM THE MARK AS SHOWN.

FOR SPEECH AND HEARING THERAPY; SPEECH PATHOLOGY THERAPY SERVICES; SPEECH THERAPY (U.S. CLS. 100 AND 101).

KRISTINA MORRIS, EXAMINING ATTORNEY

SN 77-924,265, TRANSWORLD PSYCHOSOCIAL, INC., NEW
YORK, NY. FILED 1-30-2010.

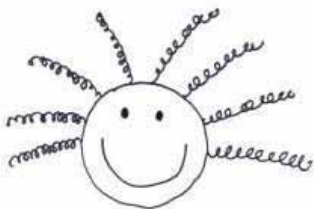

THE MARK CONSISTS OF THE ARTISTIC RENDITION OF A SMILING FACE WITH CURLY HAIR.

FOR PSYCHOLOGICAL COUNSELING (U.S. CLS. 100 AND 101).

FIRST USE 10-1-2008; IN COMMERCE 10-1-2008.

BRENDAN REGAN, EXAMINING ATTORNEY

SN 77-925,542, SMITH, BAILEY L., DBA MOSCOW HEALTH
AND WELLNESS CENTER, MOSCOW, ID. FILED 2-2-2010.



SN 77-925,234, QUALITY CARE PHYSICAL THERAPY, P.C.,
DBA QCPT WELLNESS CLUB, NEW YORK, NY. FILED 2-
1-2010.

QCPT Wellness Club

THE MARK CONSISTS OF STANDARD CHARACTERS WITHOUT CLAIM TO ANY PARTICULAR FONT, STYLE, SIZE, OR COLOR.

NO CLAIM IS MADE TO THE EXCLUSIVE RIGHT TO USE "WELLNESS", APART FROM THE MARK AS SHOWN.

FOR PHYSICAL THERAPY (U.S. CLS. 100 AND 101).

FIRST USE 6-1-2009; IN COMMERCE 6-1-2009.

LINDA POWELL, EXAMINING ATTORNEY

NO CLAIM IS MADE TO THE EXCLUSIVE RIGHT TO USE "MOSCOW HEALTH AND WELLNESS CENTER", APART FROM THE MARK AS SHOWN.

THE COLOR(S) GREEN, BROWN, YELLOW, PURPLE, WHITE, RED, AND BLUE IS/ARE CLAIMED AS A FEATURE OF THE MARK.

THE MARK CONSISTS OF HILLS AND WALKWAYS IN VARYING SHADES OF GREEN, A BROWN HOUSE WITH RED TRIM, GREEN DOOR AND GREEN ROOF, A BROWN BIRDHOUSE, BROWN TREES WITH GREEN LEAVES, YELLOW BIRD, PURPLE, WHITE AND YELLOW FLOWERS, RED AND WHITE BUTTERFLIES, AND BLUE CLOUDS WITH THE WORDING "MOSCOW" IN BLACK AND THE WORDING "HEALTH AND WELLNESS CENTER" IN RED.

FOR CHIROPRACTIC SERVICES (U.S. CLS. 100 AND 101).

SUSAN STIGLITZ, EXAMINING ATTORNEY

CLASS 44—(Continued).

SN 77-925,648. MÖLNLYCKE HEALTH CARE AB, 40252 GÖTEBORG, SWEDEN, FILED 2-2-2010.

THE PRESSURE'S ON

THE MARK CONSISTS OF STANDARD CHARACTERS WITHOUT CLAIM TO ANY PARTICULAR FONT, STYLE, SIZE, OR COLOR.

FOR PROVIDING MEDICAL INFORMATION, CONSULTANCY AND ADVISORY SERVICES INCLUDING PROVIDING MEDICAL INFORMATION IN THE FIELD OF THE TREATMENT OF PRESSURE ULCERS; PROVIDING A WEB SITE FEATURING MEDICAL INFORMATION (U.S. CLS. 100 AND 101).

FIRST USE 6-0-2008; IN COMMERCE 6-0-2008.
CAROLINE WOOD, EXAMINING ATTORNEY

SN 77-925,891. LUCIANO SZTULMAN M.D., INC., PROVIDENCE, RI. FILED 2-2-2010.

BEAUTY IS POWER

THE MARK CONSISTS OF STANDARD CHARACTERS WITHOUT CLAIM TO ANY PARTICULAR FONT, STYLE, SIZE, OR COLOR.

FOR LASER AND INTENSE PULSE LIGHT SKIN ENHANCEMENT PROCEDURES (U.S. CLS. 100 AND 101).

FIRST USE 1-26-2010; IN COMMERCE 1-26-2010.
JUSTINE D. PARKER, EXAMINING ATTORNEY

SN 77-926,720. PINELES, MIRIAM, FLUSHING, NY. FILED 2-3-2010.

**Conscious Health and
Wellness**

THE MARK CONSISTS OF STANDARD CHARACTERS WITHOUT CLAIM TO ANY PARTICULAR FONT, STYLE, SIZE, OR COLOR.

NO CLAIM IS MADE TO THE EXCLUSIVE RIGHT TO USE "HEALTH AND WELLNESS", APART FROM THE MARK AS SHOWN.

FOR ACUPUNCTURE SERVICES (U.S. CLS. 100 AND 101).

FIRST USE 8-1-2009; IN COMMERCE 9-1-2009.
JANICE L. MCMORROW, EXAMINING ATTORNEY

CLASS 44—(Continued).

SN 77-926,915. LEIDIGH, TANA, ORLANDO, FL. FILED 2-3-2010.

We make your eyes beautiful

THE MARK CONSISTS OF STANDARD CHARACTERS WITHOUT CLAIM TO ANY PARTICULAR FONT, STYLE, SIZE, OR COLOR.

FOR OPHTHALMOLOGY SERVICES; OPTOMETRY SERVICES (U.S. CLS. 100 AND 101).

FIRST USE 12-15-2009; IN COMMERCE 12-15-2009.
DANIEL CAPSHAW, EXAMINING ATTORNEY

SN 77-926,917. SIGNATURE GENOMIC LABORATORIES, LLC, SPOKANE, WA. FILED 2-3-2010.



OWNER OF U.S. REG. NOS. 2,987,462, 2,989,304 AND OTHERS.

NO CLAIM IS MADE TO THE EXCLUSIVE RIGHT TO USE "GENOMICS", APART FROM THE MARK AS SHOWN.

THE MARK CONSISTS OF THE WORDS "SIGNATURE GENOMICS" IN STYLIZED FONT ALONGSIDE A STYLIZED RENDERING OF TWENTY-FIVE CIRCLES COMPLETELY SHADED AND ARRANGED IN THE FORM OF A FIVE-BY-FIVE GRID ALL EXCEPT FOR THE ONE CIRCLE LOCATED IN THE SECOND ROW FROM THE TOP AND THE FOURTH COLUMN FROM THE LEFT OF THE GRID, WHICH IS ONLY PARTIALLY SHADED.

FOR GENETIC TESTING FOR MEDICAL PURPOSES; MEDICAL IMAGING SERVICES; MEDICAL SERVICES; MEDICAL TESTING FOR DIAGNOSTIC OR TREATMENT PURPOSES (U.S. CLS. 100 AND 101).

FIRST USE 8-31-2009; IN COMMERCE 8-31-2009.
DAVID YONTEF, EXAMINING ATTORNEY

SN 77-926,924. THE INSTITUTE FOR TRANSFUSION MEDICINE, PITTSBURGH, PA. FILED 2-3-2010.

**SAVE LIVES IT'S IN YOUR
BLOOD**

THE MARK CONSISTS OF STANDARD CHARACTERS WITHOUT CLAIM TO ANY PARTICULAR FONT, STYLE, SIZE, OR COLOR.

FOR BLOOD BANK SERVICES; COLLECTION AND PRESERVATION OF HUMAN BLOOD (U.S. CLS. 100 AND 101).

FIRST USE 10-3-2009; IN COMMERCE 10-3-2009.
BARNEY CHARLON, EXAMINING ATTORNEY

CLASS 44—(Continued).

SN 77-927,192. ROBERT KAISER, NEW YORK, NY. FILED 2-3-2010.

Penn Station Chiropractic

THE MARK CONSISTS OF STANDARD CHARACTERS WITHOUT CLAIM TO ANY PARTICULAR FONT, STYLE, SIZE, OR COLOR.

NO CLAIM IS MADE TO THE EXCLUSIVE RIGHT TO USE "CHIROPRACTIC", APART FROM THE MARK AS SHOWN.

FOR CHIROPRACTIC SERVICES (U.S. CLS. 100 AND 101).

FIRST USE 9-1-2003; IN COMMERCE 9-1-2003.
PRISCILLA MILTON, EXAMINING ATTORNEY

SN 77-927,278. COMBIMATRIX MOLECULAR DIAGNOSTICS, INC., IRVINE, CA. FILED 2-3-2010.

HER17ARRAY

THE MARK CONSISTS OF STANDARD CHARACTERS WITHOUT CLAIM TO ANY PARTICULAR FONT, STYLE, SIZE, OR COLOR.

FOR MOLECULAR DIAGNOSTIC TESTING, NAMELY, GENETIC TESTING FOR MEDICAL PURPOSES (U.S. CLS. 100 AND 101).

DOUGLAS LEE, EXAMINING ATTORNEY

SN 77-927,287. COMBIMATRIX MOLECULAR DIAGNOSTICS, INC., IRVINE, CA. FILED 2-3-2010.

HEMEARRAY

THE MARK CONSISTS OF STANDARD CHARACTERS WITHOUT CLAIM TO ANY PARTICULAR FONT, STYLE, SIZE, OR COLOR.

FOR MOLECULAR DIAGNOSTIC TESTING, NAMELY, GENETIC TESTING FOR MEDICAL PURPOSES (U.S. CLS. 100 AND 101).

DOUGLAS LEE, EXAMINING ATTORNEY

CLASS 44—(Continued).

SN 77-927,432. CHAIYAPAT, INC., DBA RAKSA, CULVER CITY, CA. FILED 2-3-2010.



THE MARK CONSISTS OF THE WORDING "RAKSA" IN STYLIZED FONT, TO THE RIGHT OF THE WORDING IS A THREE LEAFED FLOWER ABOVE AN ELEPHANT.

THE ENGLISH TRANSLATION OF "RAKSA" IS "TO HEAL" OR "TAKE CARE".

FOR SERVICES FOR HEALTH AND WELLNESS OF THE BODY AND SPIRIT, NAMELY, PROVIDING ACUPUNCTURE, REIKI, SHAMANIC HEALING, CRANIAL SACRAL THERAPY, HYPNOSIS, AYURVEDA, YOGA THERAPY, MASSAGE, FACIALS, AND REFLEXOLOGY; PROVIDING CUSTOMIZED, INTEGRATED HEALING PLANS FOR HEALTH AND WELLNESS OF THE MIND AND BODY TAKING INTO CONSIDERATION PHYSICAL, EMOTIONAL AND ENERGETIC STATES (U.S. CLS. 100 AND 101).

FIRST USE 6-0-2009; IN COMMERCE 6-0-2009.
JEAN IM, EXAMINING ATTORNEY

SN 77-927,701. BE WELL COMMUNICATION, LLC, ANN ARBOR, MI. FILED 2-4-2010.

**Personal Video Guidance
(PVG)**

THE MARK CONSISTS OF STANDARD CHARACTERS WITHOUT CLAIM TO ANY PARTICULAR FONT, STYLE, SIZE, OR COLOR.

NO CLAIM IS MADE TO THE EXCLUSIVE RIGHT TO USE "PERSONAL VIDEO GUIDANCE", APART FROM THE MARK AS SHOWN.

FOR WEB-BASED HEALTHCARE SERVICES FEATURING RECORDED VIDEO AND DATA TO ENABLE PROFESSIONALS TO INSTRUCT AND PROVIDE ONGOING FEEDBACK TO CLIENTS (U.S. CLS. 100 AND 101).

MICHAEL GAAFAR, EXAMINING ATTORNEY

CLASS 44—(Continued).

SN 77-927,840. AISHA'S SALON & SPA, INC., DBA AISHA'S SALON & SPA, HOUSTON, TX. FILED 2-4-2010.

AISHA'S SALON & SPA

THE MARK CONSISTS OF STANDARD CHARACTERS WITHOUT CLAIM TO ANY PARTICULAR FONT, STYLE, SIZE, OR COLOR.

NO CLAIM IS MADE TO THE EXCLUSIVE RIGHT TO USE "SALON & SPA", APART FROM THE MARK AS SHOWN.

FOR SALON AND SPA SERVICES, NAMELY, BEAUTY SALON SERVICES AND FACIAL TREATMENT SERVICES; HEALTH SPA SERVICES, NAMELY, COSMETIC BODY CARE SERVICES (U.S. CLS. 100 AND 101).

FIRST USE 9-30-2004; IN COMMERCE 9-30-2004.
KATHY DE JONGE, EXAMINING ATTORNEY

CLASS 44—(Continued).

SN 77-928,130. CALMAR PAIN RELIEF, LLC, NORTH PROVIDENCE, RI. FILED 2-4-2010.

CALMAR

THE MARK CONSISTS OF STANDARD CHARACTERS WITHOUT CLAIM TO ANY PARTICULAR FONT, STYLE, SIZE, OR COLOR.

FOR PAIN MANAGEMENT THERAPY AND TREATMENT SERVICES, NAMELY, NON-INVASIVE, NON-NARCOTIC, RAPID TREATMENT OF SEVERE, CHRONIC, HIGH-INTENSITY ONCOLOGIC, AND NEUROPATHIC PAIN, RESISTANT TO MORPHINE AND OTHER DRUGS (U.S. CLS. 100 AND 101).

HOWARD B. LEVINE, EXAMINING ATTORNEY

SN 77-927,903. LEWIS, YVONNE, DALLAS, TX. FILED 2-4-2010.



THE MARK CONSISTS OF A SEMICIRCLE WITH THE LETTERS "G" AND "D", DIVIDED INTO TWO, ONE REPRESENTING NIGHT AND THE OTHER REPRESENTING DAY. BELOW THERE IS THE STYLIZED TEXT "GREAT DAYS".

FOR HEALTH CARE SERVICES, NAMELY, WELLNESS PROGRAMS (U.S. CLS. 100 AND 101).

MARK T. MULLEN, EXAMINING ATTORNEY

SN 77-928,298. CHRISTIAN, JEFF, CHAGRIN FALLS, OH. FILED 2-4-2010.

RECOVERY THAT WORKS

THE MARK CONSISTS OF STANDARD CHARACTERS WITHOUT CLAIM TO ANY PARTICULAR FONT, STYLE, SIZE, OR COLOR.

FOR ADDICTION TREATMENT SERVICES; REHABILITATION OF ALCOHOL ADDICTED PATIENTS (U.S. CLS. 100 AND 101).

FIRST USE 6-1-2009; IN COMMERCE 11-1-2009.
DORITT L. CARROLL, EXAMINING ATTORNEY

SN 77-927,918. OMP, INC., LONG BEACH, CA. FILED 2-4-2010.

NU-DERM

THE MARK CONSISTS OF STANDARD CHARACTERS WITHOUT CLAIM TO ANY PARTICULAR FONT, STYLE, SIZE, OR COLOR.

OWNER OF U.S. REG. NOS. 2,155,067 AND 2,838,572.
FOR COSMETIC SKIN CARE SERVICES; MEDICAL SKIN CARE SERVICES; SKIN CARE SALONS; HYGIENIC AND BEAUTY CARE; SKIN CARE TREATMENT AND THERAPY SERVICES, NAMELY, APPLICATION OF GELS, CREAMS, SERUMS, TONERS, CLEANSERS, LIGHTENERS, EXFOLIANTS, BLENDERS, BLEACHING AGENTS, CORRECTORS, AND COSMETIC PEELS (U.S. CLS. 100 AND 101).

KAPIL BHANOT, EXAMINING ATTORNEY

SN 77-928,421. CHARLES W. HOWARD, BROAD CHANNEL, NY. FILED 2-4-2010.

AEROHEAD

THE MARK CONSISTS OF STANDARD CHARACTERS WITHOUT CLAIM TO ANY PARTICULAR FONT, STYLE, SIZE, OR COLOR.

FOR PROVIDING TOILET SERVICES FOR INDIVIDUALS THROUGH THE USE OF PORTABLE TOILETS; PROVIDING TOILET SERVICES TO INDIVIDUALS THROUGH THE USE OF PORTABLE TOILETS ON A TRUCK; RENTAL OF PORTABLE TOILETS (U.S. CLS. 100 AND 101).

FIRST USE 8-31-2008; IN COMMERCE 8-31-2008.
CAROLYN CATALDO, EXAMINING ATTORNEY

CLASS 44—(Continued).

SN 77-928,498. RICHARD J. CARON FOUNDATION, WERNERSVILLE, PA. FILED 2-4-2010.



THE MARK CONSISTS OF THE LETTER "C" WITH THE OPENING FACING TO THE BOTTOM RIGHT AND AN INTERLOCKING LETTER "C" WITH THE OPENING FACING TO THE TOP LEFT.

FOR HEALTH CARE SERVICES, NAMELY, COUNSELING, CONSULTATION, MEDICAL EVALUATIONS AND THE PROVISION OF RESIDENTIAL AND OUTPATIENT CARE FACILITIES TO ASSIST INDIVIDUALS AND FAMILIES WITH CHEMICAL DEPENDENCIES (U.S. CLS. 100 AND 101).

FIRST USE 4-1-2006; IN COMMERCE 4-1-2006.
KELLY CHOE, EXAMINING ATTORNEY

SN 77-928,540. RICHARD J. CARON FOUNDATION, WERNERSVILLE, PA. FILED 2-4-2010.

BREAKTHROUGH AT CARON

THE MARK CONSISTS OF STANDARD CHARACTERS WITHOUT CLAIM TO ANY PARTICULAR FONT, STYLE, SIZE, OR COLOR.

OWNER OF U.S. REG. NOS. 2,486,951, 3,674,608 AND OTHERS.

FOR HEALTH CARE SERVICES, NAMELY, GROUP THERAPY TO ASSIST INDIVIDUALS WITH PERSONAL AND FAMILY RELATIONSHIPS (U.S. CLS. 100 AND 101).

FIRST USE 4-1-2009; IN COMMERCE 4-1-2009.
KELLY CHOE, EXAMINING ATTORNEY

SN 77-928,891. SALERNO, ALEXANDER G., NEWARK, NJ. FILED 2-5-2010.

UHIP

THE MARK CONSISTS OF STANDARD CHARACTERS WITHOUT CLAIM TO ANY PARTICULAR FONT, STYLE, SIZE, OR COLOR.

FOR MEDICAL SERVICES (U.S. CLS. 100 AND 101).
FIRST USE 1-1-2008; IN COMMERCE 12-1-2009.
BARNEY CHARLON, EXAMINING ATTORNEY

CLASS 44—(Continued).

SN 77-929,213. CALMAR PAIN RELIEF, LLC, NORTH PROVIDENCE, RI. FILED 2-5-2010.



THE MARK CONSISTS OF THE TERM "CALMARX" WRITTEN WITH THE "X" DROPPED BELOW THE "R" IN THE FORM OF THE SYMBOL FOR THE TERM PRESCRIPTION.

FOR PAIN MANAGEMENT THERAPY AND TREATMENT SERVICES, NAMELY, NON-INVASIVE, NON-NARCOTIC, RAPID TREATMENT OF SEVERE, CHRONIC, HIGH-INTENSITY ONCOLOGIC, AND NEUROPATHIC PAIN, RESISTANT TO MORPHINE AND OTHER DRUGS (U.S. CLS. 100 AND 101).

FIRST USE 10-0-2009; IN COMMERCE 10-0-2009.
HOWARD B. LEVINE, EXAMINING ATTORNEY

SN 77-929,280. HEALTH PROMOTION SPECIALISTS, LLC, COLUMBIA, SC. FILED 2-5-2010.

HPS

THE MARK CONSISTS OF STANDARD CHARACTERS WITHOUT CLAIM TO ANY PARTICULAR FONT, STYLE, SIZE, OR COLOR.

FOR DENTIST SERVICES (U.S. CLS. 100 AND 101).
FIRST USE 1-31-2001; IN COMMERCE 1-31-2001.
JAMES GRIFFIN, EXAMINING ATTORNEY

SN 77-929,316. CLEAR PASSAGE THERAPIES, INC., DBA CLEAR PASSAGE PHYSICAL THERAPY, GAINESVILLE, FL. FILED 2-5-2010.

CLEAR PASSAGE PHYSICAL THERAPY

THE MARK CONSISTS OF STANDARD CHARACTERS WITHOUT CLAIM TO ANY PARTICULAR FONT, STYLE, SIZE, OR COLOR.

OWNER OF U.S. REG. NO. 2,468,161.
NO CLAIM IS MADE TO THE EXCLUSIVE RIGHT TO USE "PHYSICAL THERAPY", APART FROM THE MARK AS SHOWN.

FOR PHYSICAL THERAPY (U.S. CLS. 100 AND 101).
MARK T. MULLEN, EXAMINING ATTORNEY

CLASS 44—(Continued).

SN 77-929,320. HEALTH PROMOTION SPECIALISTS, LLC, COLUMBIA, SC. FILED 2-5-2010.

PROMOTING HEALTH WITH A
SMILE

THE MARK CONSISTS OF STANDARD CHARACTERS WITHOUT CLAIM TO ANY PARTICULAR FONT, STYLE, SIZE, OR COLOR.
FOR DENTIST SERVICES (U.S. CLS. 100 AND 101).
FIRST USE 1-31-2001; IN COMMERCE 1-31-2001.
JAMES GRIFFIN, EXAMINING ATTORNEY

SN 77-929,523. LUSK, SAMANTHA, DBA HY GENIE, HOUSTON, TX. FILED 2-5-2010.

Hy Genie

THE MARK CONSISTS OF STANDARD CHARACTERS WITHOUT CLAIM TO ANY PARTICULAR FONT, STYLE, SIZE, OR COLOR.
FOR HYGIENIC AND BEAUTY CARE (U.S. CLS. 100 AND 101).
JENNIFER MARTIN, EXAMINING ATTORNEY

SN 77-930,265. BYKOFSKY, SONYA S., LENOX, MA. FILED 2-8-2010.

A TOUCHING EXPERIENCE

THE MARK CONSISTS OF STANDARD CHARACTERS WITHOUT CLAIM TO ANY PARTICULAR FONT, STYLE, SIZE, OR COLOR.
FOR MASSAGE THERAPY SERVICES (U.S. CLS. 100 AND 101).
FIRST USE 5-30-2004; IN COMMERCE 5-30-2004.
APRIL ROACH, EXAMINING ATTORNEY

CLASS 44—(Continued).

SN 77-931,295. GARY L. GRIMM, D.D.S., GIG HARBOR, WA. FILED 2-9-2010.

 Innovative Smiles

THE MARK CONSISTS OF THE STYLIZED LETTERS AND WORDS "INNOVATIVE SMILES IS". THE LETTERS "IS" IS INSIDE AN IMAGE OF A CIRCLE.
FOR DENTIST SERVICES; DENTISTRY (U.S. CLS. 100 AND 101).
FIRST USE 5-16-2005; IN COMMERCE 5-16-2005.
FRED MANDIR, EXAMINING ATTORNEY

SN 77-931,380. BEHAVIORAL HEALTH OF THE PALM BEACHES, INC., NORTH PALM BEACH, FL. FILED 2-9-2010.

A HERO'S JOURNEY

THE MARK CONSISTS OF STANDARD CHARACTERS WITHOUT CLAIM TO ANY PARTICULAR FONT, STYLE, SIZE, OR COLOR.
FOR PROVIDING OUT-PATIENT THERAPEUTIC TREATMENT FOR THE TRAUMATIC EFFECTS THAT ADDICTION HAS CAUSED IN THE LIFE OF A PERSON IMPACTED BY THE DISEASE OF ADDICTION (U.S. CLS. 100 AND 101).
FIRST USE 1-25-2009; IN COMMERCE 1-25-2009.
ROBIN CHOSID, EXAMINING ATTORNEY

SN 77-967,200. HCR HEALTHCARE, LLC, TOLEDO, OH. FILED 3-24-2010.

The
 PARC

THE MARK CONSISTS OF THE WORDS "THE PARC" WHERE THE "A" IN "PARC" IS A TREE; THERE IS AN UNDERLINE BELOW THE WORD "PARC".
FOR HEALTH CARE; SKILLED NURSING CARE; TRANSITIONAL HEALTH CARE; PHYSICAL, SPEECH, AND OCCUPATIONAL REHABILITATION THERAPY (U.S. CLS. 100 AND 101).
LOURDES AYALA, EXAMINING ATTORNEY

CLASS 44—(Continued).

SN 77-967,207. HCR HEALTHCARE, LLC, TOLEDO, OH. FILED 3-24-2010.

THE PARC

THE MARK CONSISTS OF STANDARD CHARACTERS WITHOUT CLAIM TO ANY PARTICULAR FONT, STYLE, SIZE, OR COLOR.

FOR HEALTH CARE; SKILLED NURSING CARE; TRANSITIONAL HEALTH CARE; PHYSICAL, SPEECH, AND OCCUPATIONAL REHABILITATION THERAPY (U.S. CLS. 100 AND 101).

LOURDES AYALA, EXAMINING ATTORNEY

CLASS 44—(Continued).

SN 85-006,752. COMBIMATRIX MOLECULAR DIAGNOSTICS, INC., IRVINE, CA. FILED 4-5-2010.

SUMARRAY

THE MARK CONSISTS OF STANDARD CHARACTERS WITHOUT CLAIM TO ANY PARTICULAR FONT, STYLE, SIZE, OR COLOR.

FOR MOLECULAR DIAGNOSTIC TESTING, NAMELY, GENETIC TESTING FOR MEDICAL PURPOSES (U.S. CLS. 100 AND 101).

DOUGLAS LEE, EXAMINING ATTORNEY

SN 78-797,295. RIGHT AT HOME, INC., OMAHA, NE. FILED 1-23-2006.

**INTRODUCE SOMEONE YOU CARE
ABOUT TO SOMEONE YOU TRUST**

THE MARK CONSISTS OF STANDARD CHARACTERS WITHOUT CLAIM TO ANY PARTICULAR FONT, STYLE, SIZE, OR COLOR.

FOR HOME HEALTH CARE SERVICES (U.S. CLS. 100 AND 101).

FIRST USE 12-7-2005; IN COMMERCE 12-7-2005.

KATHERINE E. HALMEN, EXAMINING ATTORNEY

CLASS 45—PERSONAL AND LEGAL SERVICES

SN 77-659,590. MERIDIAN HEALTH SYSTEM, INC., NEPTUNE, NJ. FILED 1-29-2009.



THE COLOR(S) YELLOW, LIGHT ORANGE, DARK ORANGE, BLUE, AND BLACK IS/ARE CLAIMED AS A FEATURE OF THE MARK.

THE MARK CONSISTS OF THE WORD "PAWSITIVE" IN BLOCK PRINT WITH THE TOPS OF EACH OF THE LETTERS BEGINNING AS THE COLOR YELLOW AND FADING TO A LIGHT ORANGE IN THE MIDDLE OF EACH LETTER AND THEN FADING TO A DARKER ORANGE AT THE BOTTOM OF THE LETTERS. THE WORD "PAWSITIVE" IS OUTLINED IN A PALE BLUE COLOR WHICH IS OUTLINED WITH A THIN, BLACK LINE. ABOVE THE "E" IN "PAWSITIVE" IS A DEPICTION OF A YELLOW PAW PRINT OUTLINED WITH A THIN, BLACK LINE. BELOW THE "W" IN "PAWSITIVE" IS THE WORD "ACTION!" IN BLOCK PRINT WITH THE TOPS OF EACH OF THE LETTERS BEGINNING AS THE COLOR YELLOW AND FADING TO A LIGHT ORANGE IN THE MIDDLE OF EACH LETTER AND THEN FADING TO A DARKER ORANGE AT THE BOTTOM OF THE LETTERS. THE WORD "ACTION!" IS OUTLINED IN A PALE BLUE COLOR WHICH IS OUTLINED WITH A THIN, BLACK LINE.

FOR PROVIDING INFORMATION IN THE FIELDS OF CHILDREN'S SAFETY WITHOUT THE USE OF LIVE ANIMALS (U.S. CLS. 100 AND 101).

FIRST USE 9-22-2008; IN COMMERCE 9-22-2008.

JAMES A. RAUEN, EXAMINING ATTORNEY

SN 85-003,328. SIGNATURE GENOMIC LABORATORIES, LLC, SPOKANE, WA. FILED 3-31-2010.

**TURNING COMPLEXITY INTO
MEANING**

THE MARK CONSISTS OF STANDARD CHARACTERS WITHOUT CLAIM TO ANY PARTICULAR FONT, STYLE, SIZE, OR COLOR.

FOR GENETIC TESTING FOR MEDICAL PURPOSES; MEDICAL IMAGING SERVICES; MEDICAL SERVICES; MEDICAL TESTING FOR DIAGNOSTIC OR TREATMENT PURPOSES (U.S. CLS. 100 AND 101).

FIRST USE 9-29-2009; IN COMMERCE 9-29-2009.

DAVID YONTEF, EXAMINING ATTORNEY

CLASS 45—(Continued).

SN 77-660,832. INTERTEK GROUP, PLC., LONDON, UNITED KINGDOM, FILED 1-31-2009.



NO CLAIM IS MADE TO THE EXCLUSIVE RIGHT TO USE "GLOBAL SECURITY VERIFICATION", APART FROM THE MARK AS SHOWN.

THE COLOR(S) BLUE, RED, LIGHT GRAY, GRAY AND BLACK IS/ARE CLAIMED AS A FEATURE OF THE MARK.

THE MARK CONSISTS OF BLUE-COLORED LETTERS "GSV" HAVING A LIGHT-GRAY SHADOW EFFECT, FOLLOWED BY THE WORDS "GLOBAL SECURITY VERIFICATION" IN BLACK, AND RED- AND GRAY-COLORED SWIRLS SURROUNDING THE "G" IN "GSV".

FOR SECURITY INSPECTION SERVICES FOR OTHERS, NAMELY, INSPECTION, ASSESSMENT AND CERTIFICATION SERVICES FOR OTHERS, NAMELY, INSPECTIONS, ASSESSMENTS AND CERTIFICATIONS OF WAREHOUSES AND MANUFACTURING FACILITIES FOR COMPLIANCE WITH A COMPREHENSIVE SUPPLY CHAIN SECURITY VERIFICATION PROCEDURE, TO DETERMINE WHETHER APPROPRIATE MINIMUM SECURITY MEASURES, AS PUBLISHED BY THE U.S. BUREAU OF CUSTOMS AND BORDER PROTECTION, ARE IMPLEMENTED AND MAINTAINED; ADVISORY AND CONSULTING SERVICES RELATING THERETO, NAMELY, PROVIDING INFORMATION AND ADVICE VIA THE INTERNET RELATING TO INSPECTIONS, ASSESSMENTS AND CERTIFICATIONS OF WAREHOUSES AND MANUFACTURING FACILITIES FOR COMPLIANCE WITH A COMPREHENSIVE SUPPLY CHAIN SECURITY VERIFICATION PROCEDURE, TO DETERMINE WHETHER APPROPRIATE MINIMUM SECURITY MEASURES, AS PUBLISHED BY THE U.S. BUREAU OF CUSTOMS AND BORDER PROTECTION, ARE IMPLEMENTED AND MAINTAINED (U.S. CLS. 100 AND 101).

APRIL HESIK, EXAMINING ATTORNEY

SN 77-692,621. MCCALVIN, DAVID, MISSOURI CITY, TX. FILED 3-17-2009.



NO CLAIM IS MADE TO THE EXCLUSIVE RIGHT TO USE "ENTERPRISES", APART FROM THE MARK AS SHOWN.

THE STIPPLING IS FOR SHADING PURPOSES ONLY.

THE MARK CONSISTS OF TWO CONCENTRIC CIRCLES WITH THE STYLIZED TEXT "MCCALVIN ENTERPRISES" SUPERIMPOSED ON TOP OF THE CIRCLES. THE DOT IN THE "I" IN "ENTERPRISES" IS A BOLT HEAD. BETWEEN THE TWO CONCENTRIC CIRCLES IS A SERIES OF BOLT HEADS AROUND THE CIRCUMFERENCE.

FOR TECHNICAL CONSULTING SERVICES IN THE FIELD OF OIL AND GAS INDUSTRY REGULATIONS (U.S. CLS. 100 AND 101).

FIRST USE 2-1-2009; IN COMMERCE 2-1-2009.

LINDA ORNDORFF, EXAMINING ATTORNEY

CLASS 45—(Continued).

SN 77-712,137. SANGHA, PAVAN S, BURNABY, CANADA, FILED 4-12-2009.

guvano

THE MARK CONSISTS OF STANDARD CHARACTERS WITHOUT CLAIM TO ANY PARTICULAR FONT, STYLE, SIZE, OR COLOR.

THE WORDING "GUVANO" HAS NO MEANING IN A FOREIGN LANGUAGE.

FOR PROVISION OF A WEB SITE FEATURING INFORMATION ON FASHION (U.S. CLS. 100 AND 101). FIRST USE 1-25-2005; IN COMMERCE 1-25-2005.

THOMAS MANOR, EXAMINING ATTORNEY

SN 77-715,789. SEA TOW SERVICES INTERNATIONAL, INC., SOUTHOLD, NY. FILED 4-16-2009.

SEA SECURITY

OWNER OF U.S. REG. NOS. 3,200,506, 3,449,588 AND OTHERS.

NO CLAIM IS MADE TO THE EXCLUSIVE RIGHT TO USE "SEA SECURITY", APART FROM THE MARK AS SHOWN.

THE MARK CONSISTS OF THE TWO WORDS "SEA SECURITY" WITH TWO QUADRILATERALS THAT ARE COMPLETELY SHADED PLACED IN BETWEEN THE TWO WORDS.

FOR MARITIME PROTECTION AND SAFETY SERVICES, NAMELY, SURVEILLANCE AND CIVIL PROTECTION FEATURING INCIDENT REPORTING AND MAINTENANCE OF PROTECTION AND SAFETY ZONES FOR INDIVIDUALS, VESSELS, SHIPS, BRIDGES, PORTS AND OTHER PHYSICAL STRUCTURES (U.S. CLS. 100 AND 101).

DOUGLAS LEE, EXAMINING ATTORNEY

SN 77-764,825. RIVERA, VICTOR ON-TIME SECURITY SERVICES INC., BRONX, NY. FILED 6-22-2009.



NO CLAIM IS MADE TO THE EXCLUSIVE RIGHT TO USE "SECURITY SERVICE, INC." AND "SECURITY", APART FROM THE MARK AS SHOWN.

THE COLOR(S) GREY, GOLD, BLACK IS/ARE CLAIMED AS A FEATURE OF THE MARK.

THE MARK CONSISTS OF AN EAGLE FACING RIGHT

CLASS 45—(Continued).

WITH ITS WINGS SPANNED OUT CLENCHING A FLASHLIGHT. THE EAGLE IS GREY AND TWO INCHES HIGH BY THREE INCHES WIDE. THE EAGLE'S BEAK, FLASHLIGHT, STARS, AND LINING ARE GOLD. THE EAGLE'S TALONS AND BACKGROUND ARE BLACK. THERE ARE TWO BANNERS ON THE TOP AND BOTTOM OF THE MARK THAT ARE GREY WITH BLACK LETTERING. THE TOP READS "ON-TIME SECURITY" AND THE BOTTOM READS "SERVICES INC." THE WORD "SECURITY" APPEARS ACROSS THE BOTTOM OF THE DRAWING. THERE ARE FOUR FIVE POINTED GOLD STARS: ONE ON THE EAGLE'S EYE AND ONE ON IN THE MIDDLE OF THE TOP BANNER AND ONE STAR ON TOP OF EACH WING.

FOR SECURITY GUARD SERVICES (U.S. CLS. 100 AND 101).

FIRST USE 4-15-2008; IN COMMERCE 2-15-2009.
CHRIS WELLS, EXAMINING ATTORNEY

SN 77-780,801. FAERBER, KARL G., MARIETTA, GA. FILED 7-14-2009.

VIOALERT

THE MARK CONSISTS OF STANDARD CHARACTERS WITHOUT CLAIM TO ANY PARTICULAR FONT, STYLE, SIZE, OR COLOR.

FOR DIGITAL VIDEO MONITORING, NAMELY, MONITORING TRAFFIC VIOLATIONS WITH DIGITAL VIDEO CAMERAS (U.S. CLS. 100 AND 101).

FIRST USE 5-1-2006; IN COMMERCE 1-1-2007.
MATTHEW PAPPAS, EXAMINING ATTORNEY

SN 77-782,350. BE & ASSOCIATES, LLC, WEST DES MOINES, IA. FILED 7-16-2009.



THE MARK CONSISTS OF THE LETTERS "B" AND "E" INTERTWINED WITH A "BEE-LIKE" DESIGN OF BETWEEN THE LETTERS "B" AND "E" AND A DOT AFTER THE LETTER "E" WITH THE WORDS "EMPOWERING ME TO BE A STRONGER WE".

FOR SOCIAL NETWORKING SERVICES, NAMELY, HELPING TO BRING WOMEN TOGETHER TO CONNECT, SHARE AND SUPPORT ONE ANOTHER (U.S. CLS. 100 AND 101).

FIRST USE 6-0-2009; IN COMMERCE 6-0-2009.
ALEX KEAM, EXAMINING ATTORNEY

CLASS 45—(Continued).

SN 77-783,103. ACTIVE SINGLES, LLC, DBA ELITE MATCHMAKING, LOS ANGELES, CA. FILED 7-16-2009.

ELITE MATCHMAKING

THE MARK CONSISTS OF STANDARD CHARACTERS WITHOUT CLAIM TO ANY PARTICULAR FONT, STYLE, SIZE, OR COLOR.

NO CLAIM IS MADE TO THE EXCLUSIVE RIGHT TO USE "MATCHMAKING", APART FROM THE MARK AS SHOWN.

FOR DATING SERVICES; MARRIAGE PARTNER INTRODUCTION OR DATING SERVICES; SOCIAL INTRODUCTION AGENCIES (U.S. CLS. 100 AND 101).

RONALD DELGIZZI, EXAMINING ATTORNEY

SN 77-796,163. IVERIFY.US INC., CHARLOTTE, NC. FILED 8-4-2009.

I-MANAGE

THE MARK CONSISTS OF STANDARD CHARACTERS WITHOUT CLAIM TO ANY PARTICULAR FONT, STYLE, SIZE, OR COLOR.

FOR SECURITY SERVICES, NAMELY, PROTECTING PEOPLE, PROPERTY AND ASSETS FOR BUSINESSES AND GOVERNMENTAL AGENCIES BY PROVIDING SECURITY ASSESSMENTS, DEVELOPING AND IMPLEMENTING CUSTOMIZED BUSINESS SOLUTIONS FOR IMPROVING SECURITY AND PREVENTING CRIMINAL ACTIVITY, PROVIDING AUDIO AND VIDEO MONITORING OF PREMISES, PROVIDING DISCREET MONITORING OF EMPLOYEES OF BUSINESSES AND GOVERNMENTAL AGENCIES FOR BUSINESS PURPOSES, ALARM RESPONSE AND VERIFICATION SERVICES, NAMELY, PROVIDING ANNOUNCED MONITORING OF PREMISES ALERTING PERSONS ON THE PREMISES OF THE MONITORING, RESPONDING TO ALARM ACTIVATIONS, AND DETERMINING THE CAUSE OF ALARM ACTIVATIONS; SECURITY SERVICES, NAMELY, PROVIDING REAL-TIME VOICE INTERACTION WITH PERSONS ON THE PREMISES VIA SPEAKERS AND MICROPHONES, CONDUCTING VISUAL OPERATIONAL AUDITS OF PREMISES, AND ESCORTING EMPLOYEES WALKING TO AND FROM THEIR VEHICLES BY CONDUCTING AUDIO AND VIDEO MONITORING OF THE EMPLOYEES AND PROVIDING SIMULTANEOUS VOICE INTERACTION WITH SAID EMPLOYEES (U.S. CLS. 100 AND 101).

FIRST USE 6-1-2009; IN COMMERCE 6-1-2009.
SUE LAWRENCE, EXAMINING ATTORNEY

CLASS 45—(Continued).

SN 77-796,808. IVERIFY.US INC., CHARLOTTE, NC. FILED 8-4-2009.

CLASS 45—(Continued).

SN 77-796,896. IVERIFY.US INC., CHARLOTTE, NC. FILED 8-4-2009.

I-PATROL

I-GUARD

THE MARK CONSISTS OF STANDARD CHARACTERS WITHOUT CLAIM TO ANY PARTICULAR FONT, STYLE, SIZE, OR COLOR.

FOR SECURITY SERVICES, NAMELY, PROTECTING PEOPLE, PROPERTY AND ASSETS FOR BUSINESSES AND GOVERNMENTAL AGENCIES BY PROVIDING SECURITY ASSESSMENTS, DEVELOPING AND IMPLEMENTING CUSTOMIZED BUSINESS SOLUTIONS FOR IMPROVING SECURITY AND PREVENTING CRIMINAL ACTIVITY, PROVIDING AUDIO AND VIDEO MONITORING OF PREMISES, PROVIDING DISCREET MONITORING OF EMPLOYEES OF BUSINESSES AND GOVERNMENTAL AGENCIES FOR SECURITY PURPOSES, ALARM RESPONSE AND VERIFICATION SERVICES, NAMELY, PROVIDING ANNOUNCED MONITORING OF PREMISES ALERTING PERSONS ON THE PREMISES OF THE MONITORING, RESPONDING TO ALARM ACTIVATIONS, AND DETERMINING THE CAUSE OF ALARM ACTIVATIONS; SECURITY SERVICES, NAMELY, PROVIDING REAL-TIME VOICE INTERACTION WITH PERSONS ON THE PREMISES VIA SPEAKERS AND MICROPHONES, CONDUCTING VISUAL OPERATIONAL AUDITS OF PREMISES, AND ESCORTING EMPLOYEES WALKING TO AND FROM THEIR VEHICLES BY CONDUCTING AUDIO AND VIDEO MONITORING OF THE EMPLOYEES AND PROVIDING SIMULTANEOUS VOICE INTERACTION WITH SAID EMPLOYEES (U.S. CLS. 100 AND 101).

FIRST USE 1-1-2009; IN COMMERCE 1-1-2009.
SUE LAWRENCE, EXAMINING ATTORNEY

THE MARK CONSISTS OF STANDARD CHARACTERS WITHOUT CLAIM TO ANY PARTICULAR FONT, STYLE, SIZE, OR COLOR.

FOR SECURITY SERVICES, NAMELY, PROTECTING PEOPLE, PROPERTY AND ASSETS FOR BUSINESSES AND GOVERNMENTAL AGENCIES BY PROVIDING SECURITY ASSESSMENTS, DEVELOPING AND IMPLEMENTING CUSTOMIZED BUSINESS SOLUTIONS FOR IMPROVING SECURITY AND PREVENTING CRIMINAL ACTIVITY, PROVIDING AUDIO AND VIDEO MONITORING OF PREMISES, PROVIDING DISCREET MONITORING OF EMPLOYEES OF BUSINESSES AND GOVERNMENTAL AGENCIES FOR SECURITY PURPOSES, ALARM RESPONSE AND VERIFICATION SERVICES, NAMELY, PROVIDING ANNOUNCED MONITORING OF PREMISES ALERTING PERSONS ON THE PREMISES OF THE MONITORING, RESPONDING TO ALARM ACTIVATIONS, AND DETERMINING THE CAUSE OF ALARM ACTIVATIONS; SECURITY SERVICES, NAMELY, PROVIDING REAL-TIME VOICE INTERACTION WITH PERSONS ON THE PREMISES VIA SPEAKERS AND MICROPHONES, CONDUCTING VISUAL OPERATIONAL AUDITS OF PREMISES, AND ESCORTING EMPLOYEES WALKING TO AND FROM THEIR VEHICLES BY CONDUCTING AUDIO AND VIDEO MONITORING OF THE EMPLOYEES AND PROVIDING SIMULTANEOUS VOICE INTERACTION WITH SAID EMPLOYEES (U.S. CLS. 100 AND 101).

FIRST USE 1-1-2009; IN COMMERCE 1-1-2009.
SUE LAWRENCE, EXAMINING ATTORNEY

CLASS 45—(Continued).

SN 77-796,908. IVERIFY.US INC., CHARLOTTE, NC. FILED 8-4-2009.

I-PROTECT

THE MARK CONSISTS OF STANDARD CHARACTERS WITHOUT CLAIM TO ANY PARTICULAR FONT, STYLE, SIZE, OR COLOR.

FOR SECURITY SERVICES, NAMELY, PROTECTING PEOPLE, PROPERTY AND ASSETS FOR BUSINESSES AND GOVERNMENTAL AGENCIES BY PROVIDING SECURITY ASSESSMENTS, DEVELOPING AND IMPLEMENTING CUSTOMIZED BUSINESS SOLUTIONS FOR IMPROVING SECURITY AND PREVENTING CRIMINAL ACTIVITY, PROVIDING AUDIO AND VIDEO MONITORING OF PREMISES, PROVIDING DISCREET MONITORING OF EMPLOYEES OF BUSINESSES AND GOVERNMENTAL AGENCIES FOR SECURITY PURPOSES, ALARM RESPONSE AND VERIFICATION SERVICES, NAMELY, PROVIDING ANNOUNCED MONITORING OF PREMISES ALERTING PERSONS ON THE PREMISES OF THE MONITORING, RESPONDING TO ALARM ACTIVATIONS, AND DETERMINING THE CAUSE OF ALARM ACTIVATIONS; SECURITY SERVICES, NAMELY, PROVIDING REAL-TIME VOICE INTERACTION WITH PERSONS ON THE PREMISES VIA SPEAKERS AND MICROPHONES, CONDUCTING VISUAL OPERATIONAL AUDITS OF PREMISES, AND ESCORTING EMPLOYEES WALKING TO AND FROM THEIR VEHICLES BY CONDUCTING AUDIO AND VIDEO MONITORING OF THE EMPLOYEES AND PROVIDING SIMULTANEOUS VOICE INTERACTION WITH SAID EMPLOYEES (U.S. CLS. 100 AND 101).

FIRST USE 1-1-2009; IN COMMERCE 1-1-2009.
SUE LAWRENCE, EXAMINING ATTORNEY

CLASS 45—(Continued).

SN 77-807,559. INTERSECTIONS INC., CHANTILLY, VA. FILED 8-18-2009.



NO CLAIM IS MADE TO THE EXCLUSIVE RIGHT TO USE "BUSINESS SERVICES", APART FROM THE MARK AS SHOWN.

THE MARK CONSISTS OF A DESIGN COMPRISED OF TWO INTERLOCKING RINGS, THE WORDS "NETENFORCERS" TO THE RIGHT OF THE DESIGN, AND THE WORDS "INTERSECTIONS BUSINESS SERVICES" UNDERNEATH.

FOR BRAND MONITORING AND BUSINESS REPUTATION MONITORING SERVICES, NAMELY, MONITORING THE INTERNET FOR USE, MISUSE, AND UNAUTHORIZED SALE OF PRODUCTS, BRAND NAMES, PRODUCT NAMES, PRODUCT SKUS AND OTHER PRODUCT IDENTIFIERS, DOMAIN NAME MONITORING FOR ABUSE AND CYBER SQUATTING, AND COUNTERFEIT AND GRAY MARKET PRODUCT OFFERS; BRAND MANAGEMENT ONLINE, NAMELY, PREPARING AND SENDING NOTICES OF MISUSE TO AND REGARDING UNAUTHORIZED DISTRIBUTORS; INTELLECTUAL PROPERTY PROTECTION SERVICES, NAMELY, INTERNET SURVEILLANCE AND MONITORING TO DETECT POSSIBLE INFRINGEMENT, DOMAIN NAME ABUSE AND CYBER SQUATTING, COUNTERFEIT AND GRAY MARKET PRODUCTS; PURCHASING OF COUNTERFEIT AND GRAY MARKET GOODS OFFERED BY OTHERS, IN ORDER TO INVESTIGATE FRAUD AND POTENTIAL BRAND ABUSES (U.S. CLS. 100 AND 101).

FIRST USE 1-0-2008; IN COMMERCE 1-0-2008.
DOMINIC FATHY, EXAMINING ATTORNEY

SN 77-827,634. MIES, LORENE, MURRIETA, CA. FILED 9-16-2009.

THEBANKRUPTCYMINUTE.COM

THE MARK CONSISTS OF STANDARD CHARACTERS WITHOUT CLAIM TO ANY PARTICULAR FONT, STYLE, SIZE, OR COLOR.

FOR ATTORNEY SERVICES (U.S. CLS. 100 AND 101).
FIRST USE 7-27-2009; IN COMMERCE 7-27-2009.
CHARISMA HAMPTON, EXAMINING ATTORNEY

CLASS 45—(Continued).

SN 77-838,593. APUNIX, INC., SAN DIEGO, CA. FILED 9-30-2009.



NO CLAIM IS MADE TO THE EXCLUSIVE RIGHT TO USE "ENTERPRISE VISITOR MANAGEMENT", APART FROM THE MARK AS SHOWN.

THE COLOR(S) SHADED WHITE, GRAY, AND BLUE IS/ARE CLAIMED AS A FEATURE OF THE MARK.

THE MARK CONSISTS OF THE TEXT "ENTERPRISE VISITOR MANAGEMENT" IN WHITE AND GRAY WITH A STYLIZED BLUE ORBIT SURROUNDING.

FOR SECURITY CONSULTANCY, NAMELY, PROVIDING WEB BASED MANAGEMENT OF, TRACKING OF AND REPORTING ON PRE- OR SELF-REGISTERED VISITORS TO BUILDINGS (U.S. CLS. 100 AND 101).

TINA MAI, EXAMINING ATTORNEY

CLASS 45—(Continued).

SN 77-845,948. ASSOCIATED BANC-CORP, GREEN BAY, WI. FILED 10-9-2009.



OWNER OF U.S. REG. NO. 3,564,620.

NO CLAIM IS MADE TO THE EXCLUSIVE RIGHT TO USE "OOBA", APART FROM THE MARK AS SHOWN.

THE MARK CONSISTS OF THE LETTERS "OOBA" ON THE FIRST LINE, WITH THE SECOND "O" DEPICTED AS A PADLOCK STYLE DESIGN, USING A TREE STYLE DESIGN AS THE INSIDE OF THE "O"; FOLLOWED BY THE WORDS "FUNNY NAME. SERIOUS SECURITY." DIRECTLY CENTERED UNDERNEATH.

FOR ONLINE BANKING SECURITY SERVICES, NAMELY, PROVIDING USER AUTHENTICATION SERVICES IN ONLINE BANKING TRANSACTIONS, AND PROVIDING WEBSITES FEATURING INFORMATION ABOUT ONLINE BANKING SECURITY IN THE NATURE OF USER AUTHENTICATION (U.S. CLS. 100 AND 101).

FIRST USE 9-22-2009; IN COMMERCE 9-22-2009.

CHRISIE B. KING, EXAMINING ATTORNEY

SN 77-838,691. APUNIX, INC., SAN DIEGO, CA. FILED 9-30-2009.



NO CLAIM IS MADE TO THE EXCLUSIVE RIGHT TO USE "ENTERPRISE INCIDENT REPORTING", APART FROM THE MARK AS SHOWN.

THE COLOR(S) WHITE, GRAY, AND BLUE IS/ARE CLAIMED AS A FEATURE OF THE MARK.

THE MARK CONSISTS OF THE TEXT "ENTERPRISE INCIDENT REPORTING" IN WHITE AND GRAY WITH A STYLIZED BLUE ORBIT SURROUNDING.

FOR SECURITY CONSULTANCY, NAMELY, PROVIDING WEB BASED REPORTING AND TRACKING OF SECURITY INCIDENTS FOR OTHERS (U.S. CLS. 100 AND 101).

TINA MAI, EXAMINING ATTORNEY

SN 77-891,470. LEASON ELLIS LLP, WHITE PLAINS, NY. FILED 12-11-2009.



THE COLOR(S) GREEN, RED AND BLUE IS/ARE CLAIMED AS A FEATURE OF THE MARK.

THE MARK CONSISTS OF THE STYLIZED DESIGN OF A TREE INCLUDING A SMALL ROUND HOLE. AN APPLE APPEARS NEARLY BENEATH THE HOLE AND ABOVE THE RIGHT EDGE OF THE SHADOW UNDER THE TREE. THE COLOR GREEN IS LOCATED IN THE TREE DESIGN, THE COLOR RED IS LOCATED IN THE APPLE DESIGN, AND THE COLOR BLUE IS LOCATED IN THE SHADOW DESIGN AND ON THE WORDING "LEASON ELLIS", WHICH APPEARS BENEATH THE DESIGN ELEMENTS.

FOR LEGAL SERVICES (U.S. CLS. 100 AND 101).

FIRST USE 11-9-2009; IN COMMERCE 11-9-2009.

KAELIE KUNG, EXAMINING ATTORNEY

CLASS 45—(Continued).

SN 77-893,680. PLAYDOM, INC., MOUNTAIN VIEW, CA.
FILED 12-15-2009.

SORORITY LIFE

THE MARK CONSISTS OF STANDARD CHARACTERS WITHOUT CLAIM TO ANY PARTICULAR FONT, STYLE, SIZE, OR COLOR.

FOR ON-LINE SOCIAL NETWORKING SERVICES (U.S. CLS. 100 AND 101).

FIRST USE 11-5-2008; IN COMMERCE 11-5-2008.
GINA HAYES, EXAMINING ATTORNEY

SN 77-894,224. EVALID8 CORPORATION, ELLICOTT CITY, MD. FILED 12-15-2009.

TRUSTEDRA

THE MARK CONSISTS OF STANDARD CHARACTERS WITHOUT CLAIM TO ANY PARTICULAR FONT, STYLE, SIZE, OR COLOR.

FOR REVIEWING STANDARDS AND PRACTICES TO ASSURE COMPLIANCE WITH REQUIRED CORPORATE DIGITAL CREDENTIALS, DIGITAL IDENTITIES AND PRIVACY POLICIES; REVIEWING STANDARDS AND PRACTICES TO ASSURE COMPLIANCE WITH REQUIRED DIGITAL CREDENTIALS, DIGITAL IDENTITIES AND PRIVACY POLICIES IN ACCORDANCE WITH GOVERNMENTAL REGULATIONS (U.S. CLS. 100 AND 101).

FIRST USE 1-30-2009; IN COMMERCE 8-30-2009.
LAURA KOVALSKY, EXAMINING ATTORNEY

SN 77-901,356. MAILRIDER LLC, GRANITE BAY, CA.
FILED 12-28-2009.



OWNER OF U.S. REG. NO. 3,705,173.
THE STIPPLING IS FOR SHADING PURPOSES ONLY.
THE MARK CONSISTS OF A STAMP DESIGN WITH A HORSE INSIDE AND THE STYLIZED TEXT "MAILRIDER TURNS YOUR EMAIL INTO REAL MAIL".

FOR PROVIDING ADMINISTRATIVE AND PERSONAL ASSISTANT SERVICES IN THE NATURE OF HAND WRITING LETTERS FOR OTHERS, WHICH LETTERS CAN BE DICTATED VIA TEXT, E-MAIL, OR VOICE (U.S. CLS. 100 AND 101).

FIRST USE 7-7-2009; IN COMMERCE 7-7-2009.
TAMARA FRAZIER, EXAMINING ATTORNEY

CLASS 45—(Continued).

SN 77-913,843. JAMES D KUMMER, CINCINNATI, OH.
FILED 1-18-2010.

Cincy Senior Corner

THE MARK CONSISTS OF STANDARD CHARACTERS WITHOUT CLAIM TO ANY PARTICULAR FONT, STYLE, SIZE, OR COLOR.

NO CLAIM IS MADE TO THE EXCLUSIVE RIGHT TO USE "CINCY SENIOR", APART FROM THE MARK AS SHOWN.

FOR IN-HOME SUPPORT SERVICES TO SENIOR PERSONS, NAMELY, GERIATRIC CARE MANAGEMENT SERVICES AND PERSONAL AFFAIRS MANAGEMENT SERVICES IN THE NATURE OF THE COORDINATION OF NECESSARY SERVICES AND CARE FOR OLDER INDIVIDUALS (U.S. CLS. 100 AND 101).

FIRST USE 1-1-2010; IN COMMERCE 1-1-2010.
ELISSA GARBER KON, EXAMINING ATTORNEY

SN 77-921,185. ETERNA, LLC, EL PASO, TX. FILED 1-27-2010.

SHARED SORROWS

THE MARK CONSISTS OF STANDARD CHARACTERS WITHOUT CLAIM TO ANY PARTICULAR FONT, STYLE, SIZE, OR COLOR.

FOR FUNERAL ARRANGEMENT SERVICES; GRIEF COUNSELING; ORGANIZING MEETINGS OF BE-REAVED FAMILIES TO COMMEMORATE THE DEATH OF LOVED ONES; FUNERAL SERVICES; WRITING PRIVATE EVENT ANNOUNCEMENTS FOR OTHERS, NAMELY, OBITUARIES AND NOTIFICATIONS OF FUNERALS AND SIMILAR EVENTS (U.S. CLS. 100 AND 101).

FIRST USE 6-1-2008; IN COMMERCE 6-1-2008.
CORY BOONE, EXAMINING ATTORNEY

SN 77-921,267. LEGENDARY ROMANCE LLC, EDMOND, OK. FILED 1-27-2010.

LEGENDARY ROMANCE

THE MARK CONSISTS OF STANDARD CHARACTERS WITHOUT CLAIM TO ANY PARTICULAR FONT, STYLE, SIZE, OR COLOR.

NO CLAIM IS MADE TO THE EXCLUSIVE RIGHT TO USE "ROMANCE", APART FROM THE MARK AS SHOWN. FOR INTERNET BASED SOCIAL NETWORKING, INTRODUCTION, AND DATING SERVICES (U.S. CLS. 100 AND 101).

FIRST USE 1-1-2010; IN COMMERCE 1-1-2010.
TIMOTHY FINNEGAN, EXAMINING ATTORNEY

CLASS 45—(Continued).

SN 77-922,108. THE GREAT NEWS NETWORK, INC., DEN-
TON, TX. FILED 1-28-2010.



NO CLAIM IS MADE TO THE EXCLUSIVE RIGHT TO
USE "PRAYER", APART FROM THE MARK AS SHOWN.
THE COLOR(S) YELLOW, RED, WHITE AND BLACK IS/
ARE CLAIMED AS A FEATURE OF THE MARK.

THE MARK CONSISTS OF A RED, BLACK AND WHITE
STOP SIGN WITH THE ELEMENT "STOP" WITHIN IT, IN
BLACK AND YELLOW ABOVE THE STOP SIGN IS THE
ELEMENT "PRAYER".

FOR CHRISTIAN MINISTRY SERVICES (U.S. CLS. 100
AND 101).

FIRST USE 10-8-2009; IN COMMERCE 10-8-2009.
JANICE L. MCMORROW, EXAMINING ATTORNEY

SN 77-923,535. OMNIANGLE TECHNOLOGIES, LLC, WES-
TON, FL. FILED 1-29-2010.

Omniangle

THE MARK CONSISTS OF STANDARD CHARACTERS
WITHOUT CLAIM TO ANY PARTICULAR FONT, STYLE,
SIZE, OR COLOR.

FOR ANALYSIS SERVICES IN THE FIELD OF IN-
FORMATION SECURITY ON THE INTERNET,
NAMELY, REVIEWING STANDARDS AND PRACTICES
TO ASSURE COMPLIANCE WITH STATE AND FEDER-
AL REGULATIONS AND PROVIDING SECURITY AS-
SESSMENTS OF INFORMATION SYSTEMS TO DETECT
TACTICS USED TO COMPROMISE PERSONALLY
IDENTIFIABLE INFORMATION AND BILLING INFOR-
MATION OF CONSUMERS (U.S. CLS. 100 AND 101).

FIRST USE 5-29-2009; IN COMMERCE 5-29-2009.
MARY CRAWFORD, EXAMINING ATTORNEY

CLASS 45—(Continued).

SN 77-923,779. SWAN, ALEXANDER M., ROCKY HILL, NJ.
FILED 1-29-2010.

ALEXANDER SWAN

THE MARK CONSISTS OF STANDARD CHARACTERS
WITHOUT CLAIM TO ANY PARTICULAR FONT, STYLE,
SIZE, OR COLOR.

THE NAME "ALEXANDER SWAN" IDENTIFIES A LIV-
ING INDIVIDUAL WHOSE CONSENT IS OF RECORD.

FOR PERSONAL FASHION CONSULTING SERVICES
(U.S. CLS. 100 AND 101).

SUSAN LESLIE DUBOIS, EXAMINING ATTORNEY

SN 77-925,647. INGENIX, INC., EDEN PRAIRIE, MN. FILED
2-2-2010.

IT'S PERSONAL

THE MARK CONSISTS OF STANDARD CHARACTERS
WITHOUT CLAIM TO ANY PARTICULAR FONT, STYLE,
SIZE, OR COLOR.

FOR CONSULTING SERVICES IN THE FIELD OF
HEALTHCARE DATA PRIVACY AND SECURITY (U.S.
CLS. 100 AND 101).

CAROLINE WOOD, EXAMINING ATTORNEY

SN 77-926,369. SHARP, TYLER VAUGHN, PROVO, UT.
FILED 2-2-2010.

Fashion Genome Project

THE MARK CONSISTS OF STANDARD CHARACTERS
WITHOUT CLAIM TO ANY PARTICULAR FONT, STYLE,
SIZE, OR COLOR.

NO CLAIM IS MADE TO THE EXCLUSIVE RIGHT TO
USE "FASHION" AND "PROJECT", APART FROM THE
MARK AS SHOWN.

FOR PROVIDING INFORMATION AND REVIEWS IN
THE FIELD OF FASHION OVER A GLOBAL COMPU-
TER NETWORK; PERSONAL FASHION CONSULTA-
TION SERVICES, NAMELY, PROFILING A
CUSTOMER'S FASHION TASTES BASED UPON THE
CUSTOMER'S BODY DIMENSIONS, DESIRED FIT, SE-
LECTION OF APPAREL PIECES, SELECTION OF FASH-
ION ACCESSORIES, AND SELECTION OF SHOES
SHOWN OVER A GLOBAL COMPUTER NETWORK
AND RECOMMENDING OTHER FASHION PIECES,
ACCESSORIES, AND SHOES TO THE CUSTOMER
BASED ON SUCH SELECTIONS (U.S. CLS. 100 AND 101).

DAWN FELDMAN, EXAMINING ATTORNEY

CLASS 45—(Continued).

SN 77-926,619. BAUER, JR., HOWARD GIBBS, HOUSTON, TX. FILED 2-3-2010.

VELOCIDATA

THE MARK CONSISTS OF STANDARD CHARACTERS WITHOUT CLAIM TO ANY PARTICULAR FONT, STYLE, SIZE, OR COLOR.

FOR LITIGATION CONSULTANCY (U.S. CLS. 100 AND 101).

FIRST USE 2-3-2010; IN COMMERCE 2-3-2010.
JENNIFER DIXON, EXAMINING ATTORNEY

SN 77-927,033. ISRAEL, VAN KOOY & DAYS, LLC, BROOKLINE, MA. FILED 2-3-2010.

Your Family Matters Law Firm

THE MARK CONSISTS OF STANDARD CHARACTERS WITHOUT CLAIM TO ANY PARTICULAR FONT, STYLE, SIZE, OR COLOR.

NO CLAIM IS MADE TO THE EXCLUSIVE RIGHT TO USE "LAW FIRM", APART FROM THE MARK AS SHOWN.

FOR LEGAL SERVICES (U.S. CLS. 100 AND 101).

FIRST USE 11-19-2009; IN COMMERCE 1-4-2010.
VIVIAN MICZNIK FIRST, EXAMINING ATTORNEY

SN 77-927,054. ADIB NASLE, POWAY, CA. FILED 2-3-2010.

XENDEE

THE MARK CONSISTS OF STANDARD CHARACTERS WITHOUT CLAIM TO ANY PARTICULAR FONT, STYLE, SIZE, OR COLOR.

FOR INTERNET-BASED SOCIAL NETWORKING SERVICES (U.S. CLS. 100 AND 101).

ARETHA SOMERVILLE, EXAMINING ATTORNEY

CLASS 45—(Continued).

SN 77-927,084. ADIB NASLE, POWAY, CA. FILED 2-3-2010.

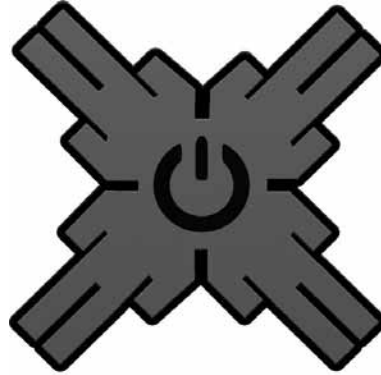

THE MARK CONSISTS OF A STYLIZED LOGO OF PEOPLE PUTTING THEIR HEADS TOGETHER AND COLLABORATING. A SINGLE HEAD WITH A POWER THERE IS THE INTERNATIONAL POWER ON/OFF ICON IN THE CENTER WHERE THE HEADS COME TOGETHER.

FOR ON-LINE SOCIAL NETWORKING SERVICES (U.S. CLS. 100 AND 101).

ARETHA SOMERVILLE, EXAMINING ATTORNEY

SN 77-927,824. FUTUREMEDIA, LLC, NEW YORK, NY. FILED 2-4-2010.

IFATE

THE MARK CONSISTS OF STANDARD CHARACTERS WITHOUT CLAIM TO ANY PARTICULAR FONT, STYLE, SIZE, OR COLOR.

FOR ASTROLOGICAL FORECASTING (U.S. CLS. 100 AND 101).

FIRST USE 11-30-2007; IN COMMERCE 11-30-2007.

ANNE E. GUSTASON, EXAMINING ATTORNEY

CLASS 45—(Continued).

SN 77-927,948. SKIPSHARKS, NAPERVILLE, IL. FILED 2-4-2010.



NO CLAIM IS MADE TO THE EXCLUSIVE RIGHT TO USE "SKIP", APART FROM THE MARK AS SHOWN.

THE MARK CONSISTS OF A SHARK WITH THE STYLIZED TEXT "SKIP SHARKS".

FOR SKIP TRACING SERVICES (U.S. CLS. 100 AND 101).

RUSS HERMAN, EXAMINING ATTORNEY

CLASS 45—(Continued).

SN 77-928,253. ILOSTIFOUND, LLC, SCOTTSDALE, AZ. FILED 2-4-2010.

!LOSTIFOUND

THE MARK CONSISTS OF STANDARD CHARACTERS WITHOUT CLAIM TO ANY PARTICULAR FONT, STYLE, SIZE, OR COLOR.

FOR PROVIDING A WEBSITE FEATURING INFORMATION ABOUT LOST AND FOUND GOODS (U.S. CLS. 100 AND 101).

FIRST USE 12-16-2009; IN COMMERCE 12-16-2009.
MIDGE BUTLER, EXAMINING ATTORNEY

SN 77-928,287. OPPOSITESCONNECT.COM, SLINGERLANDS, NY. FILED 2-4-2010.



FOR INTERNET BASED SOCIAL NETWORKING, INTRODUCTION, AND DATING SERVICES (U.S. CLS. 100 AND 101).

MARIA-VICTORIA SUAREZ, EXAMINING ATTORNEY

SN 77-928,042. FRANCIS, RONALD, NEW YORK, NY. FILED 2-4-2010.



SN 77-928,429. NORTH AMERICAN LUTHERAN CHURCH, A MINNESOTA NONPROFIT CORPORATION, NEW BRIGHTON, MN. FILED 2-4-2010.

NALC

THE MARK CONSISTS OF THE SCALES OF JUSTICE WHERE THE VERTICAL SUPPORT OF THE SCALES CONSISTS OF A HAMMER, AND THERE IS A SHADOW BEHIND THE HAMMER.

FOR ATTORNEY SERVICES (U.S. CLS. 100 AND 101).
FIRST USE 6-20-2008; IN COMMERCE 6-20-2008.
SARA THOMAS, EXAMINING ATTORNEY

THE MARK CONSISTS OF STANDARD CHARACTERS WITHOUT CLAIM TO ANY PARTICULAR FONT, STYLE, SIZE, OR COLOR.

FOR EVANGELISTIC AND MINISTERIAL SERVICES (U.S. CLS. 100 AND 101).
EDWARD FENNESSY, EXAMINING ATTORNEY

CLASS 45—(Continued).

SN 77-928,457. BARTON ENTERPRISES, INC., DBA FINE-LINE PACKAGING, CARROLLTON, TX. FILED 2-4-2010.



NO CLAIM IS MADE TO THE EXCLUSIVE RIGHT TO USE "COLOR & WRAP", APART FROM THE MARK AS SHOWN.

THE COLOR(S) PINK, GREEN, ORANGE, BLUE, YELLOW, PURPLE, BLACK IS/ARE CLAIMED AS A FEATURE OF THE MARK.

THE MARK CONSISTS OF A DESIGN OF HORIZONTAL LINES OF LAYERED COLORS IN THE FOLLOWING ORDER: PINK ON THE TOP FOLLOWED BY GREEN AND THEN ORANGE AND THEN BLUE, THEN YELLOW. PURPLE IS ON THE BOTTOM. THESE LINES OF COLOR SIT BEHIND THE BLACK WORDING "COLOR & WRAP".

FOR GIFT WRAPPING (U.S. CLS. 100 AND 101).
FRED MANDIR, EXAMINING ATTORNEY

SN 77-928,486. BIGGPEOPLE.COM, INC, EDGEWATER, NJ. FILED 2-4-2010.

BIGGPEOPLE.COM

THE MARK CONSISTS OF STANDARD CHARACTERS WITHOUT CLAIM TO ANY PARTICULAR FONT, STYLE, SIZE, OR COLOR.

FOR INTERNET-BASED DATING, SOCIAL INTRODUCTION AND SOCIAL NETWORKING SERVICES (U.S. CLS. 100 AND 101).

APRIL HESIK, EXAMINING ATTORNEY

SN 77-929,113. BARNES & THORNBURG LLP, INDIANAPOLIS, IN. FILED 2-5-2010.

B&T

THE MARK CONSISTS OF STANDARD CHARACTERS WITHOUT CLAIM TO ANY PARTICULAR FONT, STYLE, SIZE, OR COLOR.

FOR LEGAL SERVICES (U.S. CLS. 100 AND 101).
ERNEST SHOSHO, EXAMINING ATTORNEY

CLASS 45—(Continued).

SN 77-929,342. THE SPAHN LAW FIRM, PLLC, SAN ANTONIO, TX. FILED 2-5-2010.

Lawyers You Like

THE MARK CONSISTS OF STANDARD CHARACTERS WITHOUT CLAIM TO ANY PARTICULAR FONT, STYLE, SIZE, OR COLOR.

FOR ATTORNEY SERVICES (U.S. CLS. 100 AND 101).
FIRST USE 7-1-2009; IN COMMERCE 7-1-2009.
MICHAEL SOUDERS, EXAMINING ATTORNEY

SN 77-929,706. ASVAR, CHRISTOPHER A, WOODLAND HILLS., CA. FILED 2-5-2010.

ICON LAW GROUP

THE MARK CONSISTS OF STANDARD CHARACTERS WITHOUT CLAIM TO ANY PARTICULAR FONT, STYLE, SIZE, OR COLOR.

NO CLAIM IS MADE TO THE EXCLUSIVE RIGHT TO USE "LAW GROUP", APART FROM THE MARK AS SHOWN.

FOR LEGAL SERVICES (U.S. CLS. 100 AND 101).
FIRST USE 6-1-2009; IN COMMERCE 6-1-2009.
FRED MANDIR, EXAMINING ATTORNEY

SN 77-929,866. BGS WEB, LLC, ALEXANDRIA, VA. FILED 2-6-2010.

geezer

THE MARK CONSISTS OF STANDARD CHARACTERS WITHOUT CLAIM TO ANY PARTICULAR FONT, STYLE, SIZE, OR COLOR.

FOR INTERNET BASED SOCIAL NETWORKING, INTRODUCTION, AND DATING SERVICES (U.S. CLS. 100 AND 101).

KAELIE KUNG, EXAMINING ATTORNEY

CLASS 45—(Continued).

SN 77-930,149. KESTON, JOSEPH, BROOKLYN, NY. FILED 2-8-2010.



THE COLOR(S) BLUE AND WHITE IS/ARE CLAIMED AS A FEATURE OF THE MARK.

THE MARK CONSISTS OF THE WORD "PINSWAP" IN BLUE WITH A WHITE LETTER "P" IN THE MIDDLE OF A BLUE RECTANGLE.

FOR ON-LINE SOCIAL NETWORKING SERVICES (U.S. CLS. 100 AND 101).

GIANCARLO CASTRO, EXAMINING ATTORNEY

SN 77-930,338. TOB, LLC, LAS VEGAS, NV. FILED 2-8-2010.



NO CLAIM IS MADE TO THE EXCLUSIVE RIGHT TO USE "SOCIAL", APART FROM THE MARK AS SHOWN.

THE MARK CONSISTS OF THE "I" IN BOTH "SOCIAL" AND "STIR" RESEMBLING A PERSON. THE PERSON FIGURES HAVE TWO OVERLAPPING TALKING CLOUDS.

FOR DATING SERVICES, NAMELY, PROVIDING AN ON-LINE COMPUTER DATABASE FEATURING SINGLE PEOPLE INTERESTED IN MEETING OTHER SINGLE PEOPLE; INTERNET BASED SOCIAL NETWORKING, INTRODUCTION, AND DATING SERVICES (U.S. CLS. 100 AND 101).

REBECCA GILBERT, EXAMINING ATTORNEY

SN 77-930,605. TOB, LLC, LAS VEGAS, NV. FILED 2-8-2010.

Social Stir

THE MARK CONSISTS OF STANDARD CHARACTERS WITHOUT CLAIM TO ANY PARTICULAR FONT, STYLE, SIZE, OR COLOR.

NO CLAIM IS MADE TO THE EXCLUSIVE RIGHT TO USE "SOCIAL", APART FROM THE MARK AS SHOWN.

FOR DATING SERVICES, NAMELY, PROVIDING AN ON-LINE COMPUTER DATABASE FEATURING SINGLE PEOPLE INTERESTED IN MEETING OTHER SINGLE PEOPLE; INTERNET BASED SOCIAL NETWORKING, INTRODUCTION, AND DATING SERVICES (U.S. CLS. 100 AND 101).

REBECCA GILBERT, EXAMINING ATTORNEY

CLASS 45—(Continued).

SN 77-930,610. TOB, LLC, LAS VEGAS, NV. FILED 2-8-2010.

SocialStir

THE MARK CONSISTS OF STANDARD CHARACTERS WITHOUT CLAIM TO ANY PARTICULAR FONT, STYLE, SIZE, OR COLOR.

FOR DATING SERVICES, NAMELY, PROVIDING AN ON-LINE COMPUTER DATABASE FEATURING SINGLE PEOPLE INTERESTED IN MEETING OTHER SINGLE PEOPLE; INTERNET BASED SOCIAL NETWORKING, INTRODUCTION, AND DATING SERVICES (U.S. CLS. 100 AND 101).

REBECCA GILBERT, EXAMINING ATTORNEY

SN 77-930,691. IPC INTERNATIONAL CORPORATION, BANNOCKBURN, IL. FILED 2-8-2010.

The Leader in Protecting People and Places

THE MARK CONSISTS OF STANDARD CHARACTERS WITHOUT CLAIM TO ANY PARTICULAR FONT, STYLE, SIZE, OR COLOR.

FOR SECURITY GUARD SERVICES (U.S. CLS. 100 AND 101).

JENNIFER MARTIN, EXAMINING ATTORNEY

SN 77-930,705. AAA PETSITTING SERVICES, LLC, LONDONDERRY, NH. FILED 2-8-2010.

AAA PET SITTING SERVICES

THE MARK CONSISTS OF STANDARD CHARACTERS WITHOUT CLAIM TO ANY PARTICULAR FONT, STYLE, SIZE, OR COLOR.

NO CLAIM IS MADE TO THE EXCLUSIVE RIGHT TO USE "PET SITTING SERVICES", APART FROM THE MARK AS SHOWN.

FOR PET SITTING (U.S. CLS. 100 AND 101).

FIRST USE 7-8-2004; IN COMMERCE 7-8-2004.

KIMBERLY FRYE, EXAMINING ATTORNEY

CLASS 45—(Continued).

SN 77-930,960. TOB, LLC, LAS VEGAS, NV. FILED 2-8-2010.

SocialStir.com

THE MARK CONSISTS OF STANDARD CHARACTERS WITHOUT CLAIM TO ANY PARTICULAR FONT, STYLE, SIZE, OR COLOR.
 FOR DATING SERVICES, NAMELY, PROVIDING AN ON-LINE COMPUTER DATABASE FEATURING SINGLE PEOPLE INTERESTED IN MEETING OTHER SINGLE PEOPLE; INTERNET BASED SOCIAL NETWORKING, INTRODUCTION, AND DATING SERVICES (U.S. CLS. 100 AND 101).
 REBECCA GILBERT, EXAMINING ATTORNEY

SN 77-931,307. DENICE A. GIERACH, DBA THE GIERACH LAW FIRM, NAPERVILLE, IL. FILED 2-9-2010.

THE LIFELESSONS PROGRAM

THE MARK CONSISTS OF STANDARD CHARACTERS WITHOUT CLAIM TO ANY PARTICULAR FONT, STYLE, SIZE, OR COLOR.
 NO CLAIM IS MADE TO THE EXCLUSIVE RIGHT TO USE "PROGRAM", APART FROM THE MARK AS SHOWN.
 FOR INTERVIEWING INDIVIDUALS FOR THE PURPOSE OF PRESERVING THEIR PERSONAL HISTORIES (U.S. CLS. 100 AND 101).
 FIRST USE 11-11-2009; IN COMMERCE 11-11-2009.
 FRANK LATTUCA, EXAMINING ATTORNEY

SN 77-931,613. PACE LAW, P.C., DBA PACE LAW, ATLANTA, GA. FILED 2-9-2010.

PACE LAW

THE MARK CONSISTS OF STANDARD CHARACTERS WITHOUT CLAIM TO ANY PARTICULAR FONT, STYLE, SIZE, OR COLOR.
 NO CLAIM IS MADE TO THE EXCLUSIVE RIGHT TO USE "LAW", APART FROM THE MARK AS SHOWN.
 FOR LEGAL SERVICES (U.S. CLS. 100 AND 101).
 FIRST USE 12-29-2008; IN COMMERCE 12-29-2008.
 ANTHONY RINKER, EXAMINING ATTORNEY

CLASS 45—(Continued).

SN 77-931,623. ARRINGTON, WALTER J., NORTH CANTON, OH. FILED 2-9-2010.

EVANGELINK

THE MARK CONSISTS OF STANDARD CHARACTERS WITHOUT CLAIM TO ANY PARTICULAR FONT, STYLE, SIZE, OR COLOR.
 FOR CHRISTIAN MINISTRY SERVICES (U.S. CLS. 100 AND 101).
 ANDREA K. NADELMAN, EXAMINING ATTORNEY

SN 77-932,947. INTERMOUNTAIN HEALTH CARE, INC., SALT LAKE CITY, UT. FILED 2-10-2010.



OWNER OF U.S. REG. NOS. 3,343,353 AND 3,429,581.
 THE MARK CONSISTS OF THE WORDS "ANGEL WATCH" ADJACENT TO A DOVE DESIGN.
 FOR BEREAVEMENT AND GRIEF CONSULTING, NAMELY, PROVIDING SPIRITUAL AND EMOTIONAL SUPPORT SERVICES FOR PATIENTS AND FAMILY MEMBERS OF A PREGNANT WOMAN WITH A FETUS WHICH HAS A LIFE-LIMITING DIAGNOSIS (U.S. CLS. 100 AND 101).
 FIRST USE 1-31-2006; IN COMMERCE 1-31-2006.
 DAVID MILLER, EXAMINING ATTORNEY

SN 77-933,013. DIMASCIO, KIMBERLY, NEW YORK, NY. FILED 2-10-2010.

rock.roll.rule.love

THE MARK CONSISTS OF STANDARD CHARACTERS WITHOUT CLAIM TO ANY PARTICULAR FONT, STYLE, SIZE, OR COLOR.
 FOR PROVIDING A SOCIAL NETWORKING WEBSITE FOR ENTERTAINMENT PURPOSES (U.S. CLS. 100 AND 101).
 ALYSSA STEEL, EXAMINING ATTORNEY

CLASS 45—(Continued).

SN 77-946,381. SARRAF, NATASHA, LOS ANGELES, CA.
FILED 2-26-2010.

CLASS 45—(Continued).

SN 85-008,422. IPC INTERNATIONAL CORPORATION,
BANNOCKBURN, IL. FILED 4-7-2010.

SPEAK OUTSIDE THE BOX

IPC's InSite

THE MARK CONSISTS OF STANDARD CHARACTERS
WITHOUT CLAIM TO ANY PARTICULAR FONT, STYLE,
SIZE, OR COLOR.

FOR ON-LINE SOCIAL NETWORKING SERVICES
(U.S. CLS. 100 AND 101).
ALEX KEAM, EXAMINING ATTORNEY

THE MARK CONSISTS OF STANDARD CHARACTERS
WITHOUT CLAIM TO ANY PARTICULAR FONT, STYLE,
SIZE, OR COLOR.

FOR SECURITY GUARD SERVICES (U.S. CLS. 100
AND 101).
JENNIFER MARTIN, EXAMINING ATTORNEY

* * * * *

SECTION 3.—PRIOR UNITED STATES CLASSIFICATION

APPLICATION IN MORE THAN ONE CLASS

SN 77-548,004. CARBON TRUST FOOTPRINTING COMPANY LIMITED, LONDON, UNITED KINGDOM, FILED 8-15-2008.

working with
the Carbon Trust



PRIORITY CLAIMED UNDER SEC. 44(D) ON UNITED KINGDOM APPLICATION NO. 2488986, FILED 5-31-2008, REG. NO. 2488986, DATED 5-31-2008, EXPIRES 5-31-2018.

THE MARK CONSISTS OF THE WORDS "WORKING WITH THE CARBON TRUST" AND THE IMAGE OF A FOOTPRINT.

THE CERTIFICATION MARK, AS INTENDED TO BE USED BY AUTHORIZED PERSONS, IS INTENDED TO CERTIFY THAT THE PRODUCT OR SERVICE HAS BEEN AUDITED TO MEASURE CARBON DIOXIDE AND OTHER ENVIRONMENTALLY-HARMFUL EMISSIONS DURING ITS MANUFACTURE, DISTRIBUTION, USE AND DISPOSAL, AND THAT THE MANUFACTURER OR SERVICE PROVIDER HAS COMMITTED TO REDUCE EMISSIONS.

CLASS A—GOODS

FOR CHEMICALS USED IN INDUSTRY, SCIENCE AND PHOTOGRAPHY AS WELL AS IN AGRICULTURE, HORTICULTURE AND FORESTRY; UNPROCESSED ARTIFICIAL RESINS; UNPROCESSED PLASTICS; MANURES; FIRE EXTINGUISHING COMPOSITIONS; TEMPERING AND SOLDERING PREPARATIONS; CHEMICAL SUBSTANCES FOR PRESERVING FOODSTUFFS; TANNING SUBSTANCES; ADHESIVES USED IN THE INDUSTRY; PAINTS; VARNISHES; LACQUERS; PRESERVATIVES AGAINST RUST AND AGAINST DETERIORATION OF WOOD; COLORANTS; MORDENTS; RAW NATURAL RESINS; METALS IN FOIL AND POWDER FORM FOR PAINTERS, DECORATORS, PRINTERS AND ARTISTS; BLEACHING PREPARATIONS AND OTHER SUBSTANCES FOR LAUNDRY USE; CLEANING, POLISHING, SCOURING AND ABRASIVE PREPARATIONS; SOAPS; PERFUMERY; ESSENTIAL OILS; COSMETICS; HAIR LOTIONS; DENTIFRICES; INDUSTRIAL OILS AND GREASES; LUBRICANTS; DUST ABSORBING, WETTING AND BINDING COMPOSITIONS; FUELS INCLUDING MOTOR SPIRIT AND ILLUMINANTS; CANDLES AND WICKS FOR LIGHTING; PHARMACEUTICAL AND VETERINARY PREPARATIONS; SANITARY PREPARATIONS FOR MEDICAL PURPOSES; DIETETIC SUBSTANCES ADAPTED FOR MEDICAL USE; FOOD FOR BABIES; PLASTERS; MATERIAL FOR DRESSINGS; MATERIAL FOR STOPPING TEETH; DENTAL WAX; DISINFECTANTS; PREPARATIONS FOR DESTROYING VERMIN; FUNGICIDES; HERBICIDES; COMMON METALS AND THEIR ALLOYS; METAL BUILDING MATERIALS; TRANSPORTABLE BUILDINGS OF METAL; MATERI-

ALS OF METAL FOR RAILWAY TRACKS; NON-ELECTRIC CABLES AND WIRES OF COMMON METAL; IRONMONGERY; SMALL ITEMS OF METAL HARDWARE; PIPES AND TUBES OF METAL; SAFES; GOODS OF COMMON METAL NOT INCLUDED IN OTHER CLASSES; ORES; MACHINES FOR AGRICULTURAL PURPOSES; MACHINES FOR HOUSEHOLD PURPOSES; MACHINES FOR INDUSTRIAL PURPOSES; MACHINE TOOLS; MOTORS AND ENGINES EXCEPT FOR LAND VEHICLES; MACHINE COUPLING AND TRANSMISSION COMPONENTS EXCEPT FOR LAND VEHICLES; AGRICULTURAL IMPLEMENTS OTHER THAN HAND-OPERATED; INCUBATORS FOR EGGS; HAND-OPERATED HAND TOOLS AND IMPLEMENTS; CUTLERY; SIDEARMS; RAZORS; SCIENTIFIC, NAUTICAL, SURVEYING, PHOTOGRAPHIC, CINEMATOGRAPHIC, OPTICAL, WEIGHING, MEASURING, SIGNALING, CHECKING AND SUPERVISION, LIFE-SAVING AND TEACHING APPARATUS AND INSTRUMENTS; APPARATUS AND INSTRUMENTS FOR CONDUCTING, SWITCHING, TRANSFORMING, ACCUMULATING, REGULATING OR CONTROLLING ELECTRICITY; APPARATUS FOR RECORDING, TRANSMISSION OR REPRODUCTION OF SOUND OR IMAGES MAGNETIC DATA CARRIERS, RECORDING DISCS; AUTOMATIC VENDING MACHINE AND MECHANISMS FOR COIN-OPERATED APPARATUS; CASH REGISTERS; CALCULATING MACHINES DATA PROCESSING EQUIPMENT AND COMPUTERS; FIRE-EXTINGUISHING APPARATUS; SURGICAL, MEDICAL, DENTAL AND VETERINARY APPARATUS AND INSTRUMENTS; ARTIFICIAL LIMBS, EYES AND TEETH; ORTHOPEDIC ARTICLES; SUTURE MATERIALS; APPARATUS FOR LIGHTING, HEATING, STEAM GENERATING, COOKING, REFRIGERATING, DRYING, VENTILATING, WATER SUPPLY AND SANITARY PURPOSES; VEHICLES; APPARATUS FOR LOCOMOTION BY LAND, AIR OR WATER; FIREARMS; AMMUNITION AND PROJECTILES; EXPLOSIVES; FIREWORKS; PRECIOUS METALS AND THEIR ALLOY CHEMICALS USED IN INDUSTRY, SCIENCE AND PHOTOGRAPHY AS WELL AS IN AGRICULTURE, HORTICULTURE AND FORESTRY; UNPROCESSED ARTIFICIAL RESINS; UNPROCESSED PLASTICS; MANURES; FIRE EXTINGUISHING COMPOSITIONS; TEMPERING AND SOLDERING PREPARATIONS; CHEMICAL SUBSTANCES FOR PRESERVING FOODSTUFFS; TANNING SUBSTANCES; ADHESIVES USED IN THE INDUSTRY; PAINTS; VARNISHES; LACQUERS; PRESERVATIVES AGAINST RUST AND AGAINST DETERIORATION OF WOOD; COLORANTS; MORDENTS; RAW NATURAL RESINS; METALS IN FOIL AND POWDER FORM FOR PAINTERS, DECORATORS, PRINTERS AND ARTISTS; BLEACHING PREPARATIONS AND OTHER SUBSTANCES FOR LAUNDRY USE; CLEANING, POLISHING, SCOURING AND ABRASIVE PREPARATIONS; SOAPS; PERFUMERY; ESSENTIAL OILS; COSMETICS; HAIR LOTIONS; DENTIFRICES; INDUSTRIAL OILS AND GREASES; LUBRICANTS; DUST ABSORBING, WETTING AND BINDING COMPOSITIONS; FUELS INCLUDING MOTOR SPIRIT AND ILLUMINANTS; CANDLES AND WICKS FOR LIGHTING; PHARMACEUTICAL AND VETERINARY PREPARATIONS; SANITARY PREPARATIONS FOR MEDICAL PURPOSES; DIETETIC SUBSTANCES ADAPTED FOR MEDICAL USE; FOOD FOR BABIES; PLASTERS; MATERIAL FOR DRESSINGS; MATERIAL FOR STOPPING TEETH; DENTAL WAX; DISINFECTANTS; PREPARATIONS FOR DESTROYING VERMIN; FUNGICIDES; HERBICIDES; COMMON METALS AND THEIR ALLOYS; METAL BUILDING MATERIALS; TRANSPORTABLE BUILDINGS OF METAL; MATERIALS OF METAL FOR RAILWAY TRACKS; NON-ELECTRIC CABLES AND WIRES OF COMMON METAL; IRONMONGERY; SMALL ITEMS OF METAL HARDWARE; PIPES AND TUBES OF METAL; SAFES; GOODS OF COMMON METAL NOT INCLUDED IN OTHER

CLASSES; ORES; MACHINES FOR AGRICULTURAL PURPOSES; MACHINES FOR HOUSEHOLD PURPOSES; MACHINES FOR INDUSTRIAL PURPOSES; MACHINE TOOLS; MOTORS AND ENGINES EXCEPT FOR LAND VEHICLES; MACHINE COUPLING AND TRANSMISSION COMPONENTS EXCEPT FOR LAND VEHICLES; AGRICULTURAL IMPLEMENTS OTHER THAN HAND-OPERATED; INCUBATORS FOR EGGS; HAND-OPERATED HAND TOOLS AND IMPLEMENTS; CUTLERY; SIDE ARMS; RAZORS; SCIENTIFIC, NAUTICAL, SURVEYING, PHOTOGRAPHIC, CINEMATOGRAPHIC, OPTICAL, WEIGHING, MEASURING, SIGNALING, CHECKING AND SUPERVISION, LIFE-SAVING AND TEACHING APPARATUS AND INSTRUMENTS; APPARATUS AND INSTRUMENTS FOR CONDUCTING, SWITCHING, TRANSFORMING, ACCUMULATING, REGULATING OR CONTROLLING ELECTRICITY; APPARATUS FOR RECORDING, TRANSMISSION OR REPRODUCTION OF SOUND OR IMAGES MAGNETIC DATA CARRIERS, RECORDING DISCS; AUTOMATIC VENDING MACHINE AND MECHANISMS FOR COIN-OPERATED APPARATUS; CASH REGISTERS; CALCULATING MACHINES DATA PROCESSING EQUIPMENT AND COMPUTERS; FIRE-EXTINGUISHING APPARATUS; SURGICAL, MEDICAL, DENTAL AND VETERINARY APPARATUS AND INSTRUMENTS; ARTIFICIAL LIMBS, EYES AND TEETH; ORTHOPEDIC ARTICLES; SUTURE MATERIALS; APPARATUS FOR LIGHTING, HEATING, STEAM GENERATING, COOKING, REFRIGERATING, DRYING, VENTILATING, WATER SUPPLY AND SANITARY PURPOSES; VEHICLES; APPARATUS FOR LOCOMOTION BY LAND, AIR OR WATER; FIRE-ARMS; AMMUNITION AND PROJECTILES; EXPLOSIVES; FIREWORKS; PRECIOUS METALS AND THEIR ALLOYS; JEWELLERY; PRECIOUS STONES; HOROLOGICAL AND CHRONOMETRIC INSTRUMENTS; MUSICAL INSTRUMENTS; PAPER, CARDBOARD AND GOODS MADE FROM THESE MATERIALS, NOT INCLUDED IN OTHER CLASSES; PRINTED MATTER; BOOK BINDING MATERIAL; PHOTOGRAPHS; STATIONERY; ADHESIVES FOR STATIONERY OR HOUSEHOLD PURPOSES; ARTISTS MATERIALS; PAINT BRUSHES; TYPEWRITERS AND OFFICE REQUISITES EXCEPT FURNITURE' INSTRUCTIONAL AND TEACHING MATERIAL EXCEPT APPARATUS; PLASTIC MATERIALS FOR PACKAGING NOT INCLUDED IN OTHER CLASSES; PRINTERS' TYPE; PRINTING BLOCKS; RUBBER, GUTTA-PERCHA, GUM, ASBESTOS, MICA AND GOODS MADE FROM THESE MATERIALS AND NOT INCLUDED IN OTHER CLASSES; PLASTICS IN EXTRUDED FORM FOR USE IN MANUFACTURE; PACKING, STOPPING AND INSULATING MATERIALS; FLEXIBLE PIPES, NOT OF METAL; LEATHER AND IMITATIONS OF LEATHER, AND GOODS MADE OF THESE MATERIALS AND NOT INCLUDED IN OTHER CLASSES; ANIMAL SKINS, HIDES; TRUNKS AND TRAVELING BAGS; UMBRELLAS, PARASOLS AND WALKING STICKS; WHIPS, HARNESS AND SADDLERY; NON-METALLIC BUILDING MATERIALS; NON-METALLIC RIGID PIPES FOR BUILDING; ASPHALT, PITCH AND BITUMEN; NON-METALLIC TRANSPORTABLE BUILDINGS; MONUMENTS, NOT OF METAL; FURNITURE; MIRRORS; PICTURE FRAMES; GOODS NOT INCLUDED IN OTHER CLASSES OF WOOD, CORK, REED, CANE, WICKER, HORN, BONE, IVORY, WHALEBONE, SHELL, AMBER, MOTHER-OF-PEARL, MEERSCHAUM AND SUBSTITUTES FOR ALL THESE MATERIALS, OR OF PLASTICS; HOUSEHOLD OR KITCHEN UTENSILS AND CONTAINERS; COMBS AND SPONGES; BRUSHES EXCEPT PAINT BRUSHES; BRUSH-MAKING MATERIALS; ARTICLES FOR CLEANING PURPOSES; STEEL WOOL; UN-WORKED OR SEMI-WORKED GLASS EXCEPT GLASS USED IN BUILDING; GLASSWARE, PORCELAIN AND EARTHENWARE NOT INCLUDED IN OTHER CLASSES; ROPES, STRING, NETS, TENTS, AWNINGS, TARPULINS, SAILS AND BAGS NOT INCLUDED IN OTHER CLASSES; PADDING AND STUFFING MATERIALS EXCEPT OF RUBBER OR PLASTICS; RAW FIBROUS TEXTILE MATERIALS; YARNS AND THREADS, FOR TEXTILE USE; TEXTILES AND TEXTILE GOODS, NOT INCLUDED IN OTHER CLASSES; BED AND TABLE COVERS; CLOTHING; FOOTWEAR; HEADGEAR; LACE AND EMBROIDERY; RIBBONS AND BRAIDS; BUTTONS, HOOKS AND EYES; PINS AND NEEDLES; ARTIFICIAL FLOWERS; CARPETS, RUGS, MATS AND MATTING; LINOLEUM AND OTHER MATERIALS FOR COVERING EXISTING FLOORS; NON-TEXTILE WALL HANGINGS; GAMES

AND PLAYTHINGS; GYMNAS TIC AND SPORTING ARTICLES NOT INCLUDED IN OTHER CLASSES; DECORATIONS FOR CHRISTMAS TREES; MEAT, FISH, POULTRY AND GAME; MEAT EXTRACTS; PRESERVED, DRIED AND COOKED FRUITS AND VEGETABLES; JELLIES, JAMS, FRUIT SAUCES; EGGS, MILK AND MILK PRODUCTS; EDIBLE OILS AND FATS; COFFEE, TEA, COCOA, SUGAR, RICE, TAPIOCA, SAGO, ARTIFICIAL COFFEE; FLOUR AND PREPARATIONS MADE FROM CEREALS; BREAD; PASTRY AND CONFECTIONERY; ICES; HONEY, TREACLE; YEAST, BAKING-POWDER; SALT, MUSTARD; VINEGAR; CONDIMENTS, NAMELY, SAUCES; SPICES; ICE; AGRICULTURAL, HORTICULTURAL AND FORESTRY PRODUCTS AND GRAINS NOT INCLUDED IN OTHER CLASSES; LIVE ANIMALS; FRESH FRUITS AND VEGETABLES; SEEDS; NATURAL PLANTS AND FLOWERS; FOODSTUFFS FOR ANIMALS; MALT; BEERS; MINERAL AND AERATED WATERS AND OTHER NON-ALCOHOLIC DRINKS; FRUIT DRINKS AND FRUIT JUICES; SYRUPS AND OTHER PREPARATIONS FOR MAKING BEVERAGES; ALCOHOLIC BEVERAGES; TOBACCO; SMOKERS' ARTICLES IN THE NATURE OF CIGARS, CIGARETTES, AND ASHTRAY; MATCHES; JEWELLERY; PRECIOUS STONES; HOROLOGICAL AND CHRONOMETRIC INSTRUMENTS; MUSICAL INSTRUMENTS; PAPER, CARDBOARD AND GOODS MADE FROM THESE MATERIALS, NOT INCLUDED IN OTHER CLASSES; PRINTED MATTER; BOOK BINDING MATERIAL; PHOTOGRAPHS; STATIONERY; ADHESIVES FOR STATIONERY OR HOUSEHOLD PURPOSES; ARTISTS MATERIALS; PAINT BRUSHES; TYPEWRITERS AND OFFICE REQUISITES EXCEPT FURNITURE' INSTRUCTIONAL AND TEACHING MATERIAL EXCEPT APPARATUS; PLASTIC MATERIALS FOR PACKAGING NOT INCLUDED IN OTHER CLASSES; PRINTERS' TYPE; PRINTING BLOCKS; RUBBER, GUTTA-PERCHA, GUM, ASBESTOS, MICA AND GOODS MADE FROM THESE MATERIALS AND NOT INCLUDED IN OTHER CLASSES; PLASTICS IN EXTRUDED FORM FOR USE IN MANUFACTURE; PACKING, STOPPING AND INSULATING MATERIALS; FLEXIBLE PIPES, NOT OF METAL; LEATHER AND IMITATIONS OF LEATHER, AND GOODS MADE OF THESE MATERIALS AND NOT INCLUDED IN OTHER CLASSES; ANIMAL SKINS, HIDES; TRUNKS AND TRAVELING BAGS; UMBRELLAS, PARASOLS AND WALKING STICKS; WHIPS, HARNESS AND SADDLERY; NON-METALLIC BUILDING MATERIALS; NON-METALLIC RIGID PIPES FOR BUILDING; ASPHALT, PITCH AND BITUMEN; NON-METALLIC TRANSPORTABLE BUILDINGS; MONUMENTS, NOT OF METAL; FURNITURE; MIRRORS; PICTURE FRAMES; GOODS NOT INCLUDED IN OTHER CLASSES OF WOOD, CORK, REED, CANE, WICKER, HORN, BONE, IVORY, WHALEBONE, SHELL, AMBER, MOTHER-OF-PEARL, MEERSCHAUM AND SUBSTITUTES FOR ALL THESE MATERIALS, OR OF PLASTICS; HOUSEHOLD OR KITCHEN UTENSILS AND CONTAINERS; COMBS AND SPONGES; BRUSHES EXCEPT PAINT BRUSHES; BRUSH-MAKING MATERIALS; ARTICLES FOR CLEANING PURPOSES; STEEL WOOL; UN-WORKED OR SEMI-WORKED GLASS EXCEPT GLASS USED IN BUILDING; GLASSWARE, PORCELAIN AND EARTHENWARE NOT INCLUDED IN OTHER CLASSES; ROPES, STRING, NETS, TENTS, AWNINGS, TARPULINS, SAILS AND BAGS NOT INCLUDED IN OTHER CLASSES; PADDING AND STUFFING MATERIALS EXCEPT OF RUBBER OR PLASTICS; RAW FIBROUS TEXTILE MATERIALS; YARNS AND THREADS, FOR TEXTILE USE; TEXTILES AND TEXTILE GOODS, NOT INCLUDED IN OTHER CLASSES; BED AND TABLE COVERS; CLOTHING; FOOTWEAR; HEADGEAR; LACE AND EMBROIDERY; RIBBONS AND BRAIDS; BUTTONS, HOOKS AND EYES; PINS AND NEEDLES; ARTIFICIAL FLOWERS; CARPETS, RUGS, MATS AND MATTING; LINOLEUM AND OTHER MATERIALS FOR COVERING EXISTING FLOORS; NON-TEXTILE WALL HANGINGS; GAMES AND PLAYTHINGS; GYMNAS TIC AND SPORTING ARTICLES NOT INCLUDED IN OTHER CLASSES; DECORATIONS FOR CHRISTMAS TREES; MEAT, FISH, POULTRY AND GAME; MEAT EXTRACTS; PRESERVED, DRIED AND COOKED FRUITS AND VEGETABLES; JELLIES, JAMS, FRUIT SAUCES; EGGS, MILK AND MILK PRODUCTS; EDIBLE OILS AND FATS; COFFEE, TEA, COCOA, SUGAR, RICE, TAPIOCA, SAGO, ARTIFICIAL COFFEE; FLOUR AND PREPARATIONS MADE FROM CEREALS; BREAD; PASTRY AND

CONFECTIONERY; ICES; HONEY, TREACLE; YEAST, BAKING-POWDER; SALT, MUSTARD; VINEGAR; CONDIMENTS, NAMELY, SAUCES; SPICES; ICE; AGRICULTURAL, HORTICULTURAL AND FORESTRY PRODUCTS AND GRAINS NOT INCLUDED IN OTHER CLASSES; LIVE ANIMALS; FRESH FRUITS AND VEGETABLES; SEEDS; NATURAL PLANTS AND FLOWERS; FOODSTUFFS FOR ANIMALS; MALT; BEERS; MINERAL AND AERATED WATERS AND OTHER NON-ALCOHOLIC DRINKS; FRUIT DRINKS AND FRUIT JUICES; SYRUPS AND OTHER PREPARATIONS FOR MAKING BEVERAGES; ALCOHOLIC BEVERAGES; TOBACCO; SMOKERS' ARTICLES IN THE NATURE OF CIGARS, CIGARETTES, AND ASHTRAY; MATCHES.

CLASS B—SERVICES

FOR ADVERTISING; BUSINESS MANAGEMENT; BUSINESS ADMINISTRATION; OFFICE FUNCTIONS; INSURANCE; FINANCIAL AFFAIRS; MONETARY AFFAIRS; REAL ESTATE AFFAIRS; BUILDING CONSTRUCTION; REPAIR OF BUILDINGS; INSTALLATION SERVICES; TELECOMMUNICATIONS; TRANSPORT; PACKAGING AND STORAGE OF GOODS; TRAVEL ARRANGEMENT; TREATMENT OF MATERIALS; EDUCATION; PROVIDING OF TRAINING; ENTERTAINMENT; SPORTING AND CULTURAL ACTIVITIES; SCIENTIFIC AND TECHNOLOGICAL SERVICES AND RESEARCH AND DESIGN RELATING THERETO; INDUSTRIAL ANALYSIS AND RESEARCH SERVICES; DESIGN AND DEVELOPMENT OF COMPUTER HARDWARE AND SOFTWARE; SERVICES FOR PROVIDING FOOD AND DRINK; TEMPORARY ACCOMMODATION; MEDICAL SERVICES; VETERINARY SERVICES; HYGIENIC AND BEAUTY CARE FOR HUMAN BEINGS OR ANIMALS; AGRICULTURE, HORTICULTURE AND FORESTRY SERVICES; LEGAL SERVICES; SECURITY SERVICES FOR THE PROTECTION OF PROPERTY AND INDIVIDUALS; AIRCRAFT SAFETY AND AIRCRAFT SECURITY SERVICES; CHARITABLE SERVICES; CONSULTANCY SERVICES RELATING TO HEALTH AND SAFETY; CREMATION SERVICES; HOUSEKEEPING SERVICES; PRISON SERVICES; SOCIAL WORK SERVICES; UNDERTAKERS SERVICES.

TINA BROWN, EXAMINING ATTORNEY

SN 77-670,252. KLINGENBERG, KATRIN, URBANA, IL. AND KERNAGIS, JAMES MICHAEL, URBANA, IL. FILED 2-13-2009.



THE MARK CONSISTS OF THE LETTERS "P" AND "H" IN A FIVE-SIDED POLYGON WITH A CIRCLE ADJACENT. THE CERTIFICATION MARK, AS INTENDED TO BE USED BY AUTHORIZED PERSONS, IS INTENDED TO CERTIFY THAT THE GOODS AND SERVICES PROVIDED HAVE BEEN EVALUATED AND MEET THE STANDARDS FOR ENERGY EFFICIENCY SET BY THE CERTIFIER.

CLASS A—GOODS

FOR BUILDING COMPONENTS FOR AIRTIGHT BUILDINGS, NAMELY, FOUNDATIONS, FLOORS, WALLS, CEILINGS, ROOFS, VENTILATORS, INSULATION, DOORS AND WINDOWS HAVING HIGH THERMAL PERFORMANCE AND ENERGY EFFICIENCY.

CLASS B—SERVICES

FOR CONSULTING SERVICES IN THE FIELD OF ENERGY EFFICIENT BUILDING CONSTRUCTION, TRAINING SERVICES IN THE FIELD OF PLANNING ENERGY EFFICIENT BUILDING STRUCTURES AND ARCHITECTURAL DESIGN AND CONSTRUCTION SERVICES FOR ENERGY EFFICIENT BUILDING STRUCTURES.

DOMINIC J. FERRAIUOLO, EXAMINING ATTORNEY

* * * * *

SECTION 4.—PRIOR UNITED STATES CLASSIFICATION

APPLICATION IN ONE CLASS

COLLECTIVE MEMBERSHIP MARKS

CLASS 200—COLLECTIVE MEMBERSHIP
SN 77-738,795. WORLD RINGSLINGER FEDERATION LLC,
KAPOLEI, HI. FILED 5-16-2009.

SN 77-816,195. THE HONOR SOCIETY OF PHI KAPPA PHI,
BATON ROUGE, LA. FILED 8-31-2009.

RINGSLINGER



THE MARK CONSISTS OF STANDARD CHARACTERS
WITHOUT CLAIM TO ANY PARTICULAR FONT, STYLE,
SIZE, OR COLOR.
FOR INDICATING MEMBERSHIP IN AN ASSOCIA-
TION OF SPINNING-RINGS GAME PLAYERS.
SUSAN RICHARDS, EXAMINING ATTORNEY

THE COLOR(S) BLUE, GOLD AND WHITE IS/ARE
CLAIMED AS A FEATURE OF THE MARK.
THE MARK CONSISTS OF A BADGE-TYPE EMBLEM
WITH EIGHT POINTS WITH A BLUE AND GOLD BORDER
SURROUNDING A BLUE AND WHITE GLOBE WITH A
BLUE BANNER WITH THE GREEK LETTERS PHI KAPPA
AND PHI IN WHITE.
FOR INDICATING MEMBERSHIP IN NATIONAL
ACADEMIC HONOR SOCIETY.
FIRST USE 0-0-1915; IN COMMERCE 0-0-1915.
TRACY FLETCHER, EXAMINING ATTORNEY

SN 77-777,835. THE HONOR SOCIETY OF PHI KAPPA PHI,
BATON ROUGE, LA. FILED 7-9-2009.

SN 77-817,189. GENSEN, MARY E, CAMERON, WI. AND
GENSEN, REAGAN L, CAMERON, WI. FILED 9-1-2009.

PHI KAPPA PHI



THE MARK CONSISTS OF STANDARD CHARACTERS
WITHOUT CLAIM TO ANY PARTICULAR FONT, STYLE,
SIZE, OR COLOR.
FOR TO INDICATE MEMBERSHIP IN NATIONAL
ACADEMIC HONOR SOCIETY.
FIRST USE 6-12-1900; IN COMMERCE 6-12-1900.
TRACY FLETCHER, EXAMINING ATTORNEY

THE COLOR(S) BLACK, GREEN, WHITE IS/ARE
CLAIMED AS A FEATURE OF THE MARK.

THE MARK CONSISTS OF A STYLIZED VEHICLE CONTAINING DOG AND PERSON APPEARING IN BLACK WITH A WHITE WINDSHIELD AND WHITE TAIL LIGHTS, ON TOP A GREEN HIGHWAY ROAD WITH A WHITE BROKEN CENTER LINE WITH THE WORDING "HIWAY DOG" WRITTEN ALONG THE BOTTOM IN BLACK LETTERS.

FOR TO INDICATE MEMBERSHIP IN AN ORGANIZATION FOR BUSINESSES AND RETAIL STORES FOR THE PURPOSE OF INDICATING TO THE PUBLIC VARYING DEGREES OF PET HOSPITALITY FOR THEIR ESTABLISHMENT.

FIRST USE 1-20-2009; IN COMMERCE 1-20-2009.
CYNTHIA SLOAN, EXAMINING ATTORNEY

SN 77-928,248. LEATRICE M. HOLMES, UPPER MARLBORO, MD. FILED 2-4-2010.



THE MARK CONSISTS OF THE WORDS "MIRROR IMAGE" IN STYLIZED FONT ABOVE A STYLIZED DESIGN OF A FEMALE HOLDING A MOTORCYCLE IN EACH OF HER HANDS LOOKING AT HERSELF IN MIRROR.

FOR INDICATING MEMBERSHIP IN A MOTORCYCLE CLUB.

FIRST USE 11-11-2009; IN COMMERCE 12-3-2009.
KIM MONINGHOFF, EXAMINING ATTORNEY

SN 77-909,386. THE COCKTAIL CLASS WOODEN BOAT RACING ASSOCIATION, KING OF PRUSSIA, PA. FILED 1-11-2010.

CERTIFICATION MARKS

CLASS A—GOODS

SN 77-752,471. OPTIMUM HEALTH INSTITUTE, INC., LEMON GROVE, CA. FILED 6-4-2009.



THE MARK CONSISTS OF A DRAWING OF A GLASS CONTAINING CUBES, STIRRER, AND FIZZING BEVERAGE ON A COASTER WITHIN TWO CONCENTRIC STYLIZED LETTER "C"'S.

FOR INDICATING MEMBERSHIP IN AN ASSOCIATION OF SMALL WOODEN BOAT RACERS.

FIRST USE 5-31-2008; IN COMMERCE 5-31-2008.
JEAN IM, EXAMINING ATTORNEY



NO CLAIM IS MADE TO THE EXCLUSIVE RIGHT TO USE "SEAL OF APPROVAL" AND "HEALTH INSTITUTE" AND "SINCE 1976", APART FROM THE MARK AS SHOWN.

THE COLOR(S) BLACK, ORANGE, GREEN AND WHITE IS/ARE CLAIMED AS A FEATURE OF THE MARK.

THE MARK CONSISTS OF A CIRCLE WHEREIN THE INNER CIRCLE HAS THE WORDS "OPTIMUM HEALTH INSTITUTE" IN BLACK LETTERS AGAINST A LIGHT GREEN BACKGROUND. THE "O" OF THE WORD "OPTIMUM" IS IN AN ORANGE CIRCLE WITH WHEATGRASS IN GREEN. THE OUTER CIRCLE HAS A BLACK BACKGROUND WITH THE WORDS "SEAL OF APPROVAL" AT THE TOP IN WHITE LETTERING AND THE WORD AND NUMBERS "SINCE 1976" AT THE BOTTOM IN WHITE LETTERING. ON THE SIDES OF THE OUTER CIRCLE AND BETWEEN THE WORDS "SEAL OF APPROVAL" AND "SINCE 1976" ARE TWO WHITE ARCS.

THE CERTIFICATION MARK, AS INTENDED TO BE USED BY PERSONS AUTHORIZED BY THE CERTIFIER, IS INTENDED TO CERTIFY THAT THE GOODS TO WHICH THE CERTIFICATION MARK IS AFFIXED HAVE PASSED THE CERTIFICATION STANDARDS SET BY THE CERTIFYING ORGANIZATION REGARDING THE INGREDIENTS LISTED IN THE COSMETIC PRODUCTS IN FACT

COMING FROM THE COUNTRY OF ORIGIN WHERE THE INGREDIENTS ARE LISTED AS HAVING ORIGINATED FROM AND IF THE INGREDIENTS ARE CLAIMED TO BE CERTIFIED ORGANIC, THAT THE MANUFACTURER HAS RECEIVED SUPPORTING DOCUMENTS FROM THE SOURCE OF THE INGREDIENTS SUPPORTING THE STATEMENT THAT THE INGREDIENTS ARE CERTIFIED ORGANIC AND THAT A COPY OF THIS DOCUMENTATION HAS BEEN PROVIDED TO THE CERTIFYING INSTITUTE, THAT THE MANUFACTURING FACILITIES IN WHICH THE COSMETIC PRODUCTS HAVE BEEN PRODUCED HAVE PROVIDED TO THE CERTIFYING INSTITUTE DOCUMENTS CONFIRMING THAT THE MANUFACTURING FACILITIES ARE IN ACCORDANCE WITH THE STANDARDS OF THE CERTIFYING INSTITUTE FOR THE MANUFACTURER OF THE NON-MEDICATED COSMETIC PRODUCTS TO THE EXTENT POSSIBLE, AND THAT THE PACKAGING IN WHICH THE COSMETIC PRODUCTS ARE SOLD ARE ECO-FRIENDLY AND MADE OF RECYCLED MATERIALS.

FOR COSMETICS.
JEFF DEFORD, EXAMINING ATTORNEY

SN 77-824,416. INTERLOCKING CONCRETE PAVEMENT INSTITUTE, WASHINGTON, DC. FILED 9-11-2009.



SN 77-755,699. NATURAL VERIFIERS, LLC, TUCSON, AZ. FILED 6-9-2009.



NO CLAIM IS MADE TO THE EXCLUSIVE RIGHT TO USE "NATURAL VERIFIERS", APART FROM THE MARK AS SHOWN.

THE COLOR(S) BLACK AND GREEN IS/ARE CLAIMED AS A FEATURE OF THE MARK.

THE MARK CONSISTS OF A STYLIZED GREEN LEAF DEPICTED ABOVE A GREEN LINE. THE STYLIZED WORDING "NATURAL VERIFIERS" APPEARS IN THE COLOR BLACK AND IS DEPICTED BELOW THE GREEN LINE. A GREEN LEAF SERVES AS A DOT ABOVE THE FIRST "I" IN THE WORDING "VERIFIERS".

THE CERTIFICATION MARK, AS USED OR INTENDED TO BE USED BY PERSONS AUTHORIZED BY THE CERTIFIER, CERTIFIES THAT THE GOODS PROVIDED ARE COMPLETELY NATURAL OR, IN THE CASE OF SOME CHEMICALS, THAT THEY CONTAIN NO ANIMAL BY PRODUCTS.

FOR FOODS, INGREDIENTS OF FOODS, PRODUCE AND CHEMICALS.
DARRYL SPRUILL, EXAMINING ATTORNEY

OWNER OF U.S. REG. NOS. 2,325,209 AND 3,180,280.

NO CLAIM IS MADE TO THE EXCLUSIVE RIGHT TO USE "INSTALLATEUR CERTIFIÉ", "INTERLOCKING CONCRETE PAVEMENT INSTITUTE" AND "NIVEAU 1", APART FROM THE MARK AS SHOWN.

THE MARK CONSISTS OF A CIRCULAR SEAL WITH THE WORDS "INSTALLATEUR CERTIFIÉ" ENCIRCLING THE SEAL AND A BANNER CROSSING THE SEAL HORIZONTALLY READING "ICPI INTERLOCKING CONCRETE PAVEMENT INSTITUTE" TO THE LEFT OF AN IRREGULAR DIAMOND-SHAPED DESIGN FORMED FROM IRREGULARLY SHAPED INTERLOCKING BLOCKS. THE WORDING "NIVEAU 1" APPEARS BENEATH THE BANNER AND ABOVE THE TERM "CERTIFIÉ".

THE ENGLISH TRANSLATION OF "INSTALLATEUR CERTIFIÉ NIVEAU 1" IN THE MARK IS "CERTIFIED INSTALLER LEVEL 1".

THE CERTIFICATION MARK, AS USED BY AUTHORIZED PERSONS, CERTIFIES THAT THE INDIVIDUAL HAS COMPLETED AN ICPI ADMINISTERED CONCRETE PAVEMENT INSTALLER PROGRAM AND ACHIEVED A PASSING GRADE ON THE CERTIFIED PAVEMENT INSTALLER EXAMINATION ADMINISTERED BY THE ICPI.

FOR INTERLOCKING CONCRETE PAVEMENT INSTALLATION SERVICES.

FIRST USE 2-12-2008, THE MARK WAS FIRST USED ANYWHERE IN A DIFFERENT FORM OTHER THAN THAT SOUGHT TO BE REGISTERED AT LEAST AS EARLY AS 08/08/2003; IN COMMERCE 2-12-2008, THE MARK WAS FIRST USED IN COMMERCE IN A DIFFERENT FORM OTHER THAN THAT SOUGHT TO BE REGISTERED AT LEAST AS EARLY AS 08/08/2003.

NELSON SNYDER, EXAMINING ATTORNEY

SN 77-854,100. WIREDTRUST, INC., WYCKOFF, NJ. FILED 10-21-2009.



NO CLAIM IS MADE TO THE EXCLUSIVE RIGHT TO USE "SAFE.COM", APART FROM THE MARK AS SHOWN.

THE MARK CONSISTS OF A RECTANGULAR BOX, WITH ROUNDED CORNERS, MADE OF TWO ARROWS POINTING COUNTERCLOCKWISE, ON THE BOTTOM, TO THE RIGHT OF THE ARROWHEAD, APPEARS ".COM". INSIDE THE BOX, TO THE LEFT, THERE IS A PADLOCK WITH A KEYHOLE, NEXT TO THE TOP OF THE PADLOCK IS THE WORD "SOCIALLY". IN LARGER LETTERS, BELOW, IS THE WORD "SAFE".

THE CERTIFICATION MARK CERTIFIES THAT THE INTERNET WEBSITES AND INTERACTIVE TECHNOLOGIES, NAMELY MOBILE TECHNOLOGIES AND DIGITAL NETWORKS, OF THOSE CERTIFIED ADHERE TO CERTIFIER'S BEST PRACTICES PROGRAM REQUIREMENTS FOR SAFETY AND RISK MANAGEMENT.

FOR INTERNET WEBSITES AND TECHNOLOGIES, NAMELY, MOBILE TECHNOLOGIES AND DIGITAL NETWORKS.

FIRST USE 5-1-2009; IN COMMERCE 8-1-2009.
WILLIAM VERHOSEK, EXAMINING ATTORNEY

WILLIAM VERHOSEK, EXAMINING ATTORNEY

SN 77-927,837. SOCIETY OF AMERICAN FORESTERS, BETHESDA, MD. FILED 2-4-2010.

SN 77-854,133. WIREDTRUST, INC., VERONA, NJ. FILED 10-21-2009.



NO CLAIM IS MADE TO THE EXCLUSIVE RIGHT TO USE "SAFE", APART FROM THE MARK AS SHOWN.

THE MARK CONSISTS OF A RECTANGULAR BOX WITH ROUNDED CORNERS MADE OF TWO ARROWS POINTING COUNTERCLOCKWISE, ON THE BOTTOM, TO THE RIGHT OF THE ARROWHEAD, APPEAR STYLIZED FIGURES OF A GIRL AND A BOY. INSIDE THE BOX, TO THE LEFT, THERE IS A PADLOCK WITH A KEYHOLE. NEXT TO THE TOP OF THE PADLOCK IS THE WORD "SOCIALLY". IN LARGER LETTERS, BELOW, IS THE WORD "SAFE".

THE CERTIFICATION MARK CERTIFIES THAT THE INTERNET WEBSITES AND INTERACTIVE TECHNOLOGIES, NAMELY MOBILE TECHNOLOGIES AND DIGITAL NETWORKS, OF THOSE CERTIFIED ADHERE TO CERTIFIER'S BEST PRACTICES FOR CHILDREN'S AUDIENCES PROGRAM REQUIREMENTS FOR SAFETY AND RISK MANAGEMENT.

FOR INTERNET WEBSITES AND TECHNOLOGIES, NAMELY, MOBILE TECHNOLOGIES AND DIGITAL NETWORKS.

FIRST USE 5-1-2009; IN COMMERCE 8-1-2009.



OWNER OF U.S. REG. NOS. 1,280,986, 2,859,568 AND OTHERS.

NO CLAIM IS MADE TO THE EXCLUSIVE RIGHT TO USE "FORESTER", APART FROM THE MARK AS SHOWN.

THE MARK CONSISTS OF THE WORDS "SOCIETY OF AMERICAN FORESTERS CERTIFIED FORESTER PROVEN PROFESSIONALS. ADVICE YOU CAN TRUST." WITHIN A RECTANGLE, THE TOP OF WHICH IS CURVED, AND LAYERED, TO DEPICT A HILLSIDE LANDSCAPE, UPON WHICH THE OUTLINE OF TWO TREES APPEAR. THE GRAY DISPLAYED IN THE MARK IS FOR SHADING PURPOSES ONLY, TO SHOW DIMENSION.

THE CERTIFICATION MARK, AS USED BY AUTHORIZED PERSONS, CERTIFIES THAT THOSE CERTIFIED HAVE SATISFIED REQUIREMENTS ESTABLISHED BY THE CERTIFIER TO ENSURE NATIONWIDE UNIFORMITY IN ACADEMIC PREPARATION, PROFESSIONAL EXPERIENCE, ADHERENCE TO STANDARDS OF PROFESSIONAL PRACTICE, AND COMMITMENT TO CONTINUING EDUCATION FOR PROFESSIONALS ENGAGED IN FORESTRY, AND HAVE PASSED THE CERTIFIER'S EXAMINATION TO VERIFY THE SAME.

SEC. 2(F) AS TO "SOCIETY OF AMERICAN FORESTERS" AND "CERTIFIED FORESTER".
FOR FORESTRY SERVICES.

FIRST USE 10-1-2008; IN COMMERCE 10-1-2008.
KATHY DE JONGE, EXAMINING ATTORNEY

* * * * *

TRADEMARK REGISTRATIONS ISSUED

PRINCIPAL REGISTER

SECTION 1.— INTERNATIONAL CLASSIFICATION

The short titles associated below with the international class numbers are terms designed merely for quick identification and are not an official part of the international classification. The full names of international classes are given in section 6.1 of the trademark rules of practice.

The designation "U.S. Cl." appearing in this section refers to the U.S. class in effect prior to Sep. 1, 1973 rather than the international class which applies to applications filed on or after that date. For adoption of international classification see notice in the OFFICIAL GAZETTE of Jun. 26, 1973 (911 O.G. TM 210).

CLASS 1—CHEMICALS

- 3,805,124. **RONA AND DESIGN**. RONA INC., MULTIPLE CLASS, (INT. CLS. 1, 2, 3, 4, 5, 6, 7, 8, 9, 11, 12, 13, 16, 17, 19, 20, 21, 22, 24, 27, 28, 31 AND 35), (U.S. CLS. 1, 2, 4, 5, 6, 7, 9, 10, 11, 12, 13, 14, 15, 16, 18, 19, 20, 21, 22, 23, 25, 26, 28, 29, 30, 31, 32, 33, 34, 35, 36, 37, 38, 40, 42, 44, 46, 50, 51, 52, 100, 101 AND 102). SN 75-840,856. PUB. 4-6-2010. FILED 11-4-1999.
- 3,805,281. **XTENDLIFE (STANDARD CHARACTER)**. LE-SAFFRE ET COMPAGNIE, MULTIPLE CLASS, (INT. CLS. 1 AND 5), (U.S. CLS. 1, 5, 6, 10, 18, 26, 44, 46, 51 AND 52). SN 77-486,208. PUB. 10-20-2009. FILED 5-29-2008.
- 3,805,328. **RG AND DESIGN**. UNIVERSAL PRODUCTORA, S.A. DE C.V., MULTIPLE CLASS, (INT. CLS. 1 AND 5), (U.S. CLS. 1, 5, 6, 10, 18, 26, 44, 46, 51 AND 52). SN 77-555,186. PUB. 4-6-2010. FILED 8-25-2008.
- 3,805,370. **ARCTURUS (STANDARD CHARACTER)**. MDS ANALYTICAL TECHNOLOGIES (US) INC., MULTIPLE CLASS, (INT. CLS. 1 AND 9), (U.S. CLS. 1, 5, 6, 10, 21, 23, 26, 36, 38 AND 46). SN 77-589,229. PUB. 4-6-2010. FILED 10-9-2008.
- 3,805,394. **COLLARGUARD SAFE AND AFFORDABLE SHIRT COLLAR PROTECTION AND DESIGN**. COLLAR GUARD LTD., MULTIPLE CLASS, (INT. CLS. 1 AND 16), (U.S. CLS. 1, 2, 5, 6, 10, 22, 23, 26, 29, 37, 38, 46 AND 50). SN 77-615,591. PUB. 4-6-2010. FILED 11-17-2008.
- 3,805,441. **SAGAMORE LIQUID-MELT (STANDARD CHARACTER)**. B.E.T. TRUCKING, INC., DBA SAGAMORE SOILS, (U.S. CLS. 1, 5, 6, 10, 26 AND 46). SN 77-650,389. PUB. 4-6-2010. FILED 1-15-2009.
- 3,805,497. **AKEMI (STANDARD CHARACTER)**. AKEMI CHEMISCH TECHNISCHE SPEZIALFABRIK GMBH, MULTIPLE CLASS, (INT. CLS. 1, 3, 17 AND 19), (U.S. CLS. 1, 4, 5, 6, 10, 12, 13, 26, 33, 35, 46, 50, 51 AND 52). SN 77-700,095. PUB. 4-6-2010. FILED 3-26-2009.
- 3,805,617. **W AND DESIGN**. WELDINGHOUSE, INC., MULTIPLE CLASS, (INT. CLS. 1 AND 40), (U.S. CLS. 1, 5, 6, 10, 26, 46, 100, 103 AND 106). SN 77-731,906. PUB. 4-6-2010. FILED 5-7-2009.
- 3,805,719. **PRINCIPLE COATINGS AND DESIGN**. PRINCIPLE COATINGS INC., MULTIPLE CLASS, (INT. CLS. 1, 2, 17 AND 19), (U.S. CLS. 1, 5, 6, 10, 11, 12, 13, 16, 26, 33, 35, 46 AND 50). SN 77-751,575. PUB. 4-6-2010. FILED 6-3-2009.
- 3,805,830. **EASY-FILL (STANDARD CHARACTER)**. W.M. BARR & COMPANY, INC., MULTIPLE CLASS, (INT. CLS. 1 AND 5), (U.S. CLS. 1, 5, 6, 10, 18, 26, 44, 46, 51 AND 52). SN 77-780,510. PUB. 4-6-2010. FILED 7-14-2009.
- 3,805,831. **EASY-FILL AND DESIGN**. W.M. BARR & COMPANY, INC., MULTIPLE CLASS, (INT. CLS. 1 AND 5), (U.S. CLS. 1, 5, 6, 10, 18, 26, 44, 46, 51 AND 52). SN 77-780,515. PUB. 4-6-2010. FILED 7-14-2009.
- 3,805,874. **SOLUTIONS THAT STICK (STANDARD CHARACTER)**. Q'SO, INCORPORATED, (U.S. CLS. 1, 5, 6, 10, 26 AND 46). SN 77-791,760. PUB. 4-6-2010. FILED 7-28-2009.
- 3,805,905. **NUCLEOLAR-ID (STANDARD CHARACTER)**. ENZO LIFE SCIENCES, INC., (U.S. CLS. 1, 5, 6, 10, 26 AND 46). SN 77-797,219. PUB. 4-6-2010. FILED 8-5-2009.
- 3,806,118. **GEOGLYCOL (STANDARD CHARACTER)**. DYNALENE, INC., (U.S. CLS. 1, 5, 6, 10, 26 AND 46). SN 77-836,916. PUB. 4-6-2010. FILED 9-29-2009.
- 3,806,149. **HYDEAWAY (STYLIZED)**. DECON LABORATORIES, INC., (U.S. CLS. 1, 5, 6, 10, 26 AND 46). SN 77-840,065. PUB. 4-6-2010. FILED 10-2-2009.
- 3,806,177. **BOA TAPE (STANDARD CHARACTER)**. ECOLO+, LLC, (U.S. CLS. 1, 5, 6, 10, 26 AND 46). SN 77-844,213. PUB. 4-6-2010. FILED 10-8-2009.
- 3,806,202. **P AND DESIGN**. PERSTORP AKTIEBOLAG, (U.S. CLS. 1, 5, 6, 10, 26 AND 46). SN 77-846,597. PUB. 4-6-2010. FILED 10-12-2009.
- 3,806,226. **KLYMIT (STANDARD CHARACTER)**. ARGON TECHNOLOGIES, INC., (U.S. CLS. 1, 5, 6, 10, 26 AND 46). SN 77-848,892. PUB. 4-6-2010. FILED 10-14-2009.
- 3,806,364. **LUBRAZINC (STANDARD CHARACTER)**. PMC BIOGENIX, INC., (U.S. CLS. 1, 5, 6, 10, 26 AND 46). SN 77-856,954. PUB. 4-6-2010. FILED 10-26-2009.
- 3,806,389. **STALL SORB AND DESIGN**. THERMOCAL MINES, LLC, (U.S. CLS. 1, 5, 6, 10, 26 AND 46). SN 77-857,508. PUB. 4-6-2010. FILED 10-26-2009.
- 3,806,686. **WEIPREN (STANDARD CHARACTER)**. WEIFANG YAXING CHEMICAL CO., LTD., (U.S. CLS. 1, 5, 6, 10, 26 AND 46). SN 77-860,988. PUB. 4-6-2010. FILED 10-29-2009.
- 3,806,721. **STINK-EEZ (STANDARD CHARACTER)**. FRESHER FOOTWEAR LLC, (U.S. CLS. 1, 5, 6, 10, 26 AND 46). SN 77-861,528. PUB. 4-6-2010. FILED 10-30-2009.
- 3,806,902. **FERTIL GOLD (STANDARD CHARACTER)**. BIO HUMA NETICS, INC., (U.S. CLS. 1, 5, 6, 10, 26 AND 46). SN 77-865,323. PUB. 4-6-2010. FILED 11-4-2009.
- 3,806,948. **D-FEND (STANDARD CHARACTER)**. BIO HUMA NETICS, INC., (U.S. CLS. 1, 5, 6, 10, 26 AND 46). SN 77-873,219. PUB. 4-6-2010. FILED 11-16-2009.
- 3,806,965. **HEROMAN (STANDARD CHARACTER)**. RAYONCHI, INC., MULTIPLE CLASS, (INT. CLS. 1 AND 24), (U.S. CLS. 1, 5, 6, 10, 26, 42, 46 AND 50). SN 77-874,896. PUB. 4-6-2010. FILED 11-17-2009.
- 3,807,073. **EVT (STANDARD CHARACTER)**. EVOTEC AG, MULTIPLE CLASS, (INT. CLS. 1 AND 5), (U.S. CLS. 1, 5, 6, 10, 18, 26, 44, 46, 51 AND 52). SN 78-769,471. PUB. 9-18-2007. FILED 12-8-2005.
- 3,807,082. **MISCELLANEOUS DESIGN**. NUCASA MILLING COMPANY LIMITED, MULTIPLE CLASS, (INT. CLS. 1, 2, 3, 19, 20, 35, 37, 40 AND 42), (U.S. CLS. 1, 2, 4, 5, 6, 10, 11, 12, 13, 16, 22, 25, 26, 32, 33, 46, 50, 51, 52, 100, 101, 102, 103 AND 106). SN 78-885,168. PUB. 4-6-2010. FILED 5-16-2006.
- 3,807,112. **CHITOCLEAR AND DESIGN**. PRIMEX EHF., MULTIPLE CLASS, (INT. CLS. 1, 3 AND 5), (U.S. CLS. 1, 4, 5, 6, 10, 18, 26, 44, 46, 50, 51 AND 52). SN 79-057,582. PUB. 4-6-2010. FILED 12-11-2007.
- 3,807,129. **BASISNOTE (STYLIZED)**. BASISNOTE AG, MULTIPLE CLASS, (INT. CLS. 1, 3, 5 AND 42), (U.S. CLS. 1, 4, 5, 6, 10, 18, 26, 44, 46, 50, 51, 52, 100 AND 101). SN 79-061,795. PUB. 4-6-2010. FILED 10-20-2008.
- 3,807,149. **@RTMOLECULE (STYLIZED)**. @RTMOLECULE, MULTIPLE CLASS, (INT. CLS. 1, 5 AND 42), (U.S. CLS. 1, 5, 6, 10, 18, 26, 44, 46, 51, 52, 100 AND 101). SN 79-065,212. PUB. 4-6-2010. FILED 10-10-2008.
- 3,807,161. **BIOMITEX (STANDARD CHARACTER)**. BÜHLER PARTEC GMBH, MULTIPLE CLASS, (INT. CLS. 1 AND 25), (U.S. CLS. 1, 5, 6, 10, 22, 26, 39 AND 46). SN 79-067,280. PUB. 4-6-2010. FILED 3-13-2009.

- 3,807,185. **IKO AND DESIGN**. S & B INDUSTRIAL MINERALS GMBH, (U.S. CLS. 1, 5, 6, 10, 26 AND 46). SN 79-068,746. PUB. 4-6-2010. FILED 10-7-2008.
- 3,807,212. **PAPILLOCHECK (STANDARD CHARACTER)**. GREINER BIO-ONE GMBH, MULTIPLE CLASS, (INT. CLS. 1 AND 5), (U.S. CLS. 1, 5, 6, 10, 18, 26, 44, 46, 51 AND 52). SN 79-069,774. PUB. 4-6-2010. FILED 4-10-2009.
- 3,807,226. **VINNEX (STANDARD CHARACTER)**. WACKER CHEMIE AG, MULTIPLE CLASS, (INT. CLS. 1, 2 AND 16), (U.S. CLS. 1, 2, 5, 6, 10, 11, 16, 22, 23, 26, 29, 37, 38, 46 AND 50). SN 79-070,011. PUB. 4-6-2010. FILED 4-22-2009.
- 3,807,261. **P3E AND DESIGN**. OERLIKON TRADING AG, TRÜBBACH, MULTIPLE CLASS, (INT. CLS. 1, 7 AND 9), (U.S. CLS. 1, 5, 6, 10, 13, 19, 21, 23, 26, 31, 34, 35, 36, 38 AND 46). SN 79-071,155. PUB. 4-6-2010. FILED 2-20-2009.
- 3,807,263. **SLER AND DESIGN**. CONSIGLIO NAZIONALE DELLE RICERCHE; (CNR), MULTIPLE CLASS, (INT. CLS. 1, 10 AND 42), (U.S. CLS. 1, 5, 6, 10, 26, 39, 44, 46, 100 AND 101). SN 79-071,230. PUB. 4-6-2010. FILED 2-13-2009.
- 3,807,284. **MACHPLANER (STANDARD CHARACTER)**. NITTA HAAS INCORPORATED, MULTIPLE CLASS, (INT. CLS. 1, 3 AND 7), (U.S. CLS. 1, 4, 5, 6, 10, 13, 19, 21, 23, 26, 31, 34, 35, 46, 50, 51 AND 52). SN 79-072,290. PUB. 4-6-2010. FILED 6-11-2009.
- 3,807,297. **EOLYS POWERFLEX (STYLIZED)**. RHODIA ELECTRONICS AND CATALYSIS, (U.S. CLS. 1, 5, 6, 10, 26 AND 46). SN 79-073,107. PUB. 4-6-2010. FILED 7-28-2009.
- 3,807,305. **BEERPAP (STANDARD CHARACTER)**. ATYPO SPOL. S R.O., (U.S. CLS. 1, 5, 6, 10, 26 AND 46). SN 79-073,573. PUB. 4-6-2010. FILED 9-1-2009.
- 3,807,318. **AQVA DRY AND DESIGN**. SAES GETTERS S.P.A., MULTIPLE CLASS, (INT. CLS. 1 AND 9), (U.S. CLS. 1, 5, 6, 10, 21, 23, 26, 36, 38 AND 46). SN 79-074,263. PUB. 4-6-2010. FILED 8-12-2009.
- 3,807,322. **SUPERCHLON (STYLIZED)**. NIPPON SEISHI KABUSHIKI KAISHA, (U.S. CLS. 1, 5, 6, 10, 26 AND 46). SN 79-074,646. PUB. 4-6-2010. FILED 9-11-2009.
- 3,807,337. **BIG E (STANDARD CHARACTER)**. SHERWIN M. SERVILIA, (U.S. CLS. 1, 5, 6, 10, 26 AND 46). SN 79-075,542. PUB. 4-6-2010. FILED 9-17-2009.
- 3,807,364. **XPERSE (STANDARD CHARACTER)**. UMICORE, SOCIÉTÉ ANONYME, MULTIPLE CLASS, (INT. CLS. 1 AND 3), (U.S. CLS. 1, 4, 5, 6, 10, 26, 46, 50, 51 AND 52). SN 79-077,511. PUB. 4-6-2010. FILED 10-26-2009.

CLASS 2—PAINTS

- 3,805,124 (*See Class 1 for this trademark*).
- 3,805,183. **DECKSTONE (STANDARD CHARACTER)**. CONSOLIDATED COATINGS CORPORATION, (U.S. CLS. 6, 11 AND 16). SN 77-022,326. PUB. 8-25-2009. FILED 10-16-2006.
- 3,805,476. **PI PHOENIX INK AND DESIGN**. PHOENIX INK CORPORATION, MULTIPLE CLASS, (INT. CLS. 2 AND 37), (U.S. CLS. 6, 11, 16, 100, 103 AND 106). SN 77-682,606. PUB. 4-6-2010. FILED 3-3-2009.
- 3,805,719 (*See Class 1 for this trademark*).
- 3,806,472. **BULLFROG SNOT AND DESIGN**. PETRA PRODUCTS, INC., DBA BULLFROG SNOT, (U.S. CLS. 6, 11 AND 16). SN 77-858,645. PUB. 4-6-2010. FILED 10-27-2009.
- 3,806,667. **AQUA-LININGS (STANDARD CHARACTER)**. GUPTA, LAXMI, (U.S. CLS. 6, 11 AND 16). SN 77-860,778. PUB. 4-6-2010. FILED 10-29-2009.
- 3,806,936. **GUARDIAN (STANDARD CHARACTER)**. VALSPAR SOURCING, INC., (U.S. CLS. 6, 11 AND 16). SN 77-870,421. PUB. 4-6-2010. FILED 11-11-2009.
- 3,807,082 (*See Class 1 for this trademark*).
- 3,807,109. **XAARDOT (STANDARD CHARACTER)**. XAAR PLC, MULTIPLE CLASS, (INT. CLS. 2, 7 AND 9), (U.S. CLS. 6, 11, 13, 16, 19, 21, 23, 26, 31, 34, 35, 36 AND 38). SN 79-056,891. PUB. 4-6-2010. FILED 2-29-2008.
- 3,807,226 (*See Class 1 for this trademark*).

CLASS 3—COSMETICS AND CLEANING PREPARATIONS

- 3,805,118. **ROYCROFT R AND DESIGN**. MARGARET L. WENDT FOUNDATION HOLDINGS, INC., (U.S. CL. 4). SN 74-409,628. PUB. 10-11-1994. FILED 7-6-1993.
- 3,805,124 (*See Class 1 for this trademark*).
- 3,805,143. **BODIFRESH TOILET TISSUE MOISTURIZER (STANDARD CHARACTER)**. BODIFRESH, INC., (U.S. CLS. 1, 4, 6, 50, 51 AND 52). SN 76-697,062. PUB. 4-6-2010. FILED 4-24-2009.
- 3,805,148. **FORBIDDEN LEAF AND DESIGN**. DWIGHT, DANA L, DBA FORBIDDEN LEAF HEMP SEED OIL LOTION AND SOAP COMPANY, (U.S. CLS. 1, 4, 6, 50, 51 AND 52). SN 76-698,128. PUB. 4-6-2010. FILED 6-26-2009.
- 3,805,177. **FOOTSTEPS (STANDARD CHARACTER)**. GARCOA, INC, (U.S. CLS. 1, 4, 6, 50, 51 AND 52). SN 76-700,277. PUB. 4-6-2010. FILED 11-9-2009.
- 3,805,192. **CRYSTAL GLOSS IT (STANDARD CHARACTER)**. JAFER LIMITED, (U.S. CLS. 1, 4, 6, 50, 51 AND 52). SN 77-127,187. PUB. 4-6-2010. FILED 3-9-2007.
- 3,805,218. **HYDRA BAIN BATH AND DESIGN**. ADS INC., (U.S. CLS. 1, 4, 6, 50, 51 AND 52). SN 77-331,357. PUB. 3-2-2010. FILED 11-16-2007.
- 3,805,230. **JOAN COLLINS (STANDARD CHARACTER)**. GIBSON, JOAN HENRIETTA, MULTIPLE CLASS, (INT. CLS. 3, 9, 14, 16, 18, 25, 28, 35 AND 41), (U.S. CLS. 1, 2, 3, 4, 5, 6, 21, 22, 23, 26, 27, 28, 29, 36, 37, 38, 39, 41, 50, 51, 52, 100, 101, 102 AND 107). SN 77-364,194. PUB. 4-6-2010. FILED 1-4-2008.
- 3,805,237. **SINLICE (STANDARD CHARACTER)**. SINCLAIR PHARMACEUTICALS LIMITED, MULTIPLE CLASS, (INT. CLS. 3 AND 5), (U.S. CLS. 1, 4, 6, 18, 44, 46, 50, 51 AND 52). SN 77-390,418. PUB. 11-17-2009. FILED 2-6-2008.
- 3,805,242. **TURBOLASH (STANDARD CHARACTER)**. ESTEE LAUDER INC., (U.S. CLS. 1, 4, 6, 50, 51 AND 52). SN 77-406,244. PUB. 4-6-2010. FILED 2-26-2008.
- 3,805,293. **COMPLIANCE (STANDARD CHARACTER)**. PROFESSIONAL MEDICAL SURGICAL SUPPLY, INC., MULTIPLE CLASS, (INT. CLS. 3, 16 AND 41), (U.S. CLS. 1, 2, 4, 5, 6, 22, 23, 29, 37, 38, 50, 51, 52, 100, 101 AND 107). SN 77-492,161. PUB. 4-6-2010. FILED 6-5-2008.
- 3,805,338. **EMERALD BAY AND DESIGN**. CALIFORNIA TAN, INC., (U.S. CLS. 1, 4, 6, 50, 51 AND 52). SN 77-564,309. PUB. 4-6-2010. FILED 9-8-2008.
- 3,805,339. **HAND RELIEF (STANDARD CHARACTER)**. AVE-DA CORPORATION, (U.S. CLS. 1, 4, 6, 50, 51 AND 52). SN 77-564,779. PUB. 4-6-2010. FILED 9-8-2008.
- 3,805,340. **FOOT RELIEF (STANDARD CHARACTER)**. AVE-DA CORPORATION, (U.S. CLS. 1, 4, 6, 50, 51 AND 52). SN 77-564,818. PUB. 4-6-2010. FILED 9-8-2008.
- 3,805,412. **VOYA (STANDARD CHARACTER)**. CELTIC SEAWEED BATH PRODUCTS LTD., (U.S. CLS. 1, 4, 6, 50, 51 AND 52). SN 77-631,254. PUB. 11-3-2009. FILED 12-11-2008.
- 3,805,413. **DR NIRDOSH (STANDARD CHARACTER)**. NEETU NIRDOSH (DR), MULTIPLE CLASS, (INT. CLS. 3, 5 AND 35), (U.S. CLS. 1, 4, 6, 18, 44, 46, 50, 51, 52, 100, 101 AND 102). SN 77-632,963. PUB. 4-6-2010. FILED 12-15-2008.
- 3,805,424. **ONE SHOT (STANDARD CHARACTER)**. HORNADY MANUFACTURING COMPANY, (U.S. CLS. 1, 4, 6, 50, 51 AND 52). SN 77-637,246. PUB. 4-6-2010. FILED 12-19-2008.
- 3,805,451. **HOME SKIN LAB DR. PASTOREK INSTITUTE (STANDARD CHARACTER)**. KELLY KATE, INC., (U.S. CLS. 1, 4, 6, 50, 51 AND 52). SN 77-661,616. PUB. 4-6-2010. FILED 2-2-2009.
- 3,805,460. **MISCELLANEOUS DESIGN**. HAWLEY & HAZEL (BVI) CO., LTD., MULTIPLE CLASS, (INT. CLS. 3 AND 21), (U.S. CLS. 1, 2, 4, 6, 13, 23, 29, 30, 33, 40, 50, 51 AND 52). SN 77-672,267. PUB. 4-6-2010. FILED 2-17-2009.
- 3,805,497 (*See Class 1 for this trademark*).
- 3,805,540. **ORGANIC HAIR COMPANY, INC. AND DESIGN**. ORGANIC HAIR COMPANY, MULTIPLE CLASS, (INT. CLS. 3 AND 26), (U.S. CLS. 1, 4, 6, 37, 39, 40, 42, 50, 51 AND 52). SN 77-719,863. PUB. 4-6-2010. FILED 4-22-2009.
- 3,805,605. **RITZ CLASSIC (STYLIZED)**. RITZ HOTEL, LIMITED, THE, (U.S. CLS. 1, 4, 6, 50, 51 AND 52). SN 77-730,438. PUB. 4-6-2010. FILED 5-6-2009.
- 3,805,645. **FAST505 (STANDARD CHARACTER)**. ZEP IP HOLDING LLC, (U.S. CLS. 1, 4, 6, 50, 51 AND 52). SN 77-735,613. PUB. 4-6-2010. FILED 5-13-2009.

- 3,805,674. **FACE AND DESIGN**. HOCHMAN, MARCELO, (U.S. CLS. 1, 4, 6, 50, 51 AND 52). SN 77-742,085. PUB. 4-6-2010. FILED 5-21-2009.
- 3,805,682. **KRONOS (STANDARD CHARACTER)**. INTELLIGENT BEAUTY, LLC, DBA KRONOS, LLC, (U.S. CLS. 1, 4, 6, 50, 51 AND 52). SN 77-743,614. PUB. 4-6-2010. FILED 5-22-2009.
- 3,805,703. **MANTA RAY (STANDARD CHARACTER)**. GA MODEFINE S.A., (U.S. CLS. 1, 4, 6, 50, 51 AND 52). SN 77-747,350. PUB. 4-6-2010. FILED 5-29-2009.
- 3,805,823. **CLASSIC GLAMOUR DOLLS AND DESIGN**. ANA VERGARA, DBA CLASSIC GLAMOUR DOLLS, (U.S. CLS. 1, 4, 6, 50, 51 AND 52). SN 77-778,913. PUB. 4-6-2010. FILED 7-10-2009.
- 3,805,919. **WAX LYRICAL (STANDARD CHARACTER)**. COLONY GIFT CORPORATION LIMITED, MULTIPLE CLASS, (INT. CLS. 3, 4, 11 AND 21), (U.S. CLS. 1, 2, 4, 6, 13, 15, 21, 23, 29, 30, 31, 33, 34, 40, 50, 51 AND 52). SN 77-800,113. PUB. 4-6-2010. FILED 8-7-2009.
- 3,805,939. **DERMACOSMEDICS CORRECTIVE SKIN CARE AND DESIGN**. COSMEDICS, INC., (U.S. CLS. 1, 4, 6, 50, 51 AND 52). SN 77-805,450. PUB. 4-6-2010. FILED 8-15-2009.
- 3,806,015. **LAVISHEA AND DESIGN**. LAVISHEA LLC, (U.S. CLS. 1, 4, 6, 50, 51 AND 52). SN 77-818,935. PUB. 4-6-2010. FILED 9-2-2009.
- 3,806,038. **ERASE ANTI AGING FACE CREME (STANDARD CHARACTER)**. TOUCH ENTERPRISES, LLC, (U.S. CLS. 1, 4, 6, 50, 51 AND 52). SN 77-822,571. PUB. 4-6-2010. FILED S.R. 9-9-2009; AM. P.R. 12-17-2009.
- 3,806,104. **CARLA BULGARIA ROSES BEAUTY AND DESIGN**. ROYO-VILLANOVA IMPORT, S.L., (U.S. CLS. 1, 4, 6, 50, 51 AND 52). SN 77-835,464. PUB. 4-6-2010. FILED 9-25-2009.
- 3,806,176. **JOVEES AND DESIGN**. VELLINO, JEAN JACQUES, (U.S. CLS. 1, 4, 6, 50, 51 AND 52). SN 77-844,148. PUB. 4-6-2010. FILED 10-8-2009.
- 3,806,204. **DOTERRA ON GUARD (STANDARD CHARACTER)**. DOTERRA HOLDINGS, LLC, MULTIPLE CLASS, (INT. CLS. 3 AND 5), (U.S. CLS. 1, 4, 6, 18, 44, 46, 50, 51 AND 52). SN 77-846,891. PUB. 4-6-2010. FILED 10-12-2009.
- 3,806,461. **TEDDY'S PRIDE (STANDARD CHARACTER)**. ORAGENICS, INC., (U.S. CLS. 1, 4, 6, 50, 51 AND 52). SN 77-858,544. PUB. 4-6-2010. FILED 10-27-2009.
- 3,806,462. **WHERE ELEGANCE MATTERS (STANDARD CHARACTER)**. SUNSTREAM PACIFIC, LLC, MULTIPLE CLASS, (INT. CLS. 3 AND 18), (U.S. CLS. 1, 2, 3, 4, 6, 22, 41, 50, 51 AND 52). SN 77-858,545. PUB. 4-6-2010. FILED 10-27-2009.
- 3,806,465. **LIME CRIME (STANDARD CHARACTER)**. LBG ENTERTAINMENT, LLC, (U.S. CLS. 1, 4, 6, 50, 51 AND 52). SN 77-858,575. PUB. 4-6-2010. FILED 10-27-2009.
- 3,806,491. **DIRTY DOG (STANDARD CHARACTER)**. KIM LAUBE & COMPANY, INC., MULTIPLE CLASS, (INT. CLS. 3, 8, 11 AND 21), (U.S. CLS. 1, 2, 4, 6, 13, 21, 23, 28, 29, 30, 31, 33, 34, 40, 44, 50, 51 AND 52). SN 77-858,771. PUB. 4-6-2010. FILED 10-27-2009.
- 3,806,557. **PBIGROUP (STANDARD CHARACTER)**. PBIGROUP, INC., (U.S. CLS. 1, 4, 6, 50, 51 AND 52). SN 77-859,610. PUB. 4-6-2010. FILED 10-28-2009.
- 3,806,657. **COMMUNITY IMMUNITY (STANDARD CHARACTER)**. FLORACOPEIA, INC., (U.S. CLS. 1, 4, 6, 50, 51 AND 52). SN 77-860,636. PUB. 4-6-2010. FILED 10-29-2009.
- 3,806,673. **BRONZE ANGEL (STANDARD CHARACTER)**. LITANI, INC., (U.S. CLS. 1, 4, 6, 50, 51 AND 52). SN 77-860,831. PUB. 4-6-2010. FILED 10-29-2009.
- 3,806,674. **BRONZE KNIGHT (STANDARD CHARACTER)**. LITANI, INC., (U.S. CLS. 1, 4, 6, 50, 51 AND 52). SN 77-860,871. PUB. 4-6-2010. FILED 10-29-2009.
- 3,806,677. **SILKYTEXTURE (STANDARD CHARACTER)**. BIO-CARE LABS, INC., (U.S. CLS. 1, 4, 6, 50, 51 AND 52). SN 77-860,887. PUB. 4-6-2010. FILED 10-29-2009.
- 3,806,704. **JEUNESSE ULTIME (STANDARD CHARACTER)**. YAGODA, MICHELLE R., AND GANS, EUGENE H., (U.S. CLS. 1, 4, 6, 50, 51 AND 52). SN 77-861,287. PUB. 4-6-2010. FILED 10-30-2009.
- 3,806,747. **MIRACLE TOUCH (STANDARD CHARACTER)**. CHUNG SEOK SEO, (U.S. CLS. 1, 4, 6, 50, 51 AND 52). SN 77-861,869. PUB. 4-6-2010. FILED 10-30-2009.
- 3,806,859. **FORSLEAN (STANDARD CHARACTER)**. SABINSA CORPORATION, (U.S. CLS. 1, 4, 6, 50, 51 AND 52). SN 77-864,050. PUB. 4-6-2010. FILED 11-3-2009.
- 3,806,874. **TENNANTTRUE (STANDARD CHARACTER)**. TENNANT COMPANY, (U.S. CLS. 1, 4, 6, 50, 51 AND 52). SN 77-864,287. PUB. 4-6-2010. FILED 11-3-2009.
- 3,806,960. **FANGO BRILLANTE (STANDARD CHARACTER)**. BORGHESE TRADEMARKS, INC., (U.S. CLS. 1, 4, 6, 50, 51 AND 52). SN 77-874,237. PUB. 4-6-2010. FILED 11-3-2009.
- 3,807,080. **G AND DESIGN**. GOLDDIGGA BRANDS LIMITED, MULTIPLE CLASS, (INT. CLS. 3 AND 14), (U.S. CLS. 1, 2, 4, 6, 27, 28, 50, 51 AND 52). SN 78-874,806. PUB. 4-6-2010. FILED 5-2-2006.
- 3,807,082 (*See Class 1 for this trademark*).
- 3,807,084. **PINK TWINKLE AND DESIGN**. CLUB LIBBY LU, INC., (U.S. CLS. 1, 4, 6, 50, 51 AND 52). SN 78-906,568. PUB. 2-13-2007. FILED 6-13-2006.
- 3,807,112 (*See Class 1 for this trademark*).
- 3,807,129 (*See Class 1 for this trademark*).
- 3,807,131. **PUCCA AND DESIGN**. VOOZ CO., LTD., MULTIPLE CLASS, (INT. CLS. 3, 9, 14, 16, 18, 21, 24, 25, 28, 38 AND 41), (U.S. CLS. 1, 2, 3, 4, 5, 6, 13, 21, 22, 23, 26, 27, 28, 29, 30, 33, 36, 37, 38, 39, 40, 41, 42, 50, 51, 52, 100, 101, 104 AND 107). SN 79-062,067. PUB. 4-6-2010. FILED 7-17-2008.
- 3,807,136. **XM 99 (STANDARD CHARACTER)**. REXAM DISPENSING SYSTEMS, MULTIPLE CLASS, (INT. CLS. 3, 6, 20 AND 21), (U.S. CLS. 1, 2, 4, 6, 12, 13, 14, 22, 23, 25, 29, 30, 32, 33, 40, 50, 51 AND 52). SN 79-062,345. PUB. 4-6-2010. FILED 9-5-2008.
- 3,807,139. **BLACKISDIAMOND (STYLIZED)**. MARC DELORME, MULTIPLE CLASS, (INT. CLS. 3, 14 AND 25), (U.S. CLS. 1, 2, 4, 6, 22, 27, 28, 39, 50, 51 AND 52). SN 79-063,275. PUB. 4-6-2010. FILED 11-14-2008.
- 3,807,173. **BB BBCOS HAIR PRO COS AND DESIGN**. BBCOS S.N.C.; DI BERTOLA RAFFAELE & C., (U.S. CLS. 1, 4, 6, 50, 51 AND 52). SN 79-068,087. PUB. 4-6-2010. FILED 1-29-2009.
- 3,807,180. **MEDELA (STANDARD CHARACTER)**. MEDELA HOLDING AG, MULTIPLE CLASS, (INT. CLS. 3, 5, 9, 10, 11, 18, 21, 25, 40, 41 AND 44), (U.S. CLS. 1, 2, 3, 4, 6, 13, 18, 21, 22, 23, 26, 29, 30, 31, 33, 34, 36, 38, 39, 40, 41, 44, 46, 50, 51, 52, 100, 101, 103, 106 AND 107). SN 79-068,552. PUB. 4-6-2010. FILED 7-11-2008.
- 3,807,211. **TEX WASH (STANDARD CHARACTER)**. SCHWEIZER-EFFAX, GMBH, (U.S. CLS. 1, 4, 6, 50, 51 AND 52). SN 79-069,742. PUB. 4-6-2010. FILED 2-26-2009.
- 3,807,233. **ROSIE & SNOOTZ AND DESIGN**. SCENT A BRAND BVBA, MULTIPLE CLASS, (INT. CLS. 3, 9, 14, 16, 18, 21, 24, 25, 28 AND 41), (U.S. CLS. 1, 2, 3, 4, 5, 6, 13, 21, 22, 23, 26, 27, 28, 29, 30, 33, 36, 37, 38, 39, 40, 41, 42, 50, 51, 52, 100, 101 AND 107). SN 79-070,144. PUB. 12-1-2009. FILED 9-5-2008.
- 3,807,240. **ZP (STYLIZED)**. FIELDPOINT B.V., MULTIPLE CLASS, (INT. CLS. 3, 14, 16, 18, 24 AND 25), (U.S. CLS. 1, 2, 3, 4, 5, 6, 22, 23, 27, 28, 29, 37, 38, 39, 41, 42, 50, 51 AND 52). SN 79-070,390. PUB. 4-6-2010. FILED 1-16-2009.
- 3,807,270. **AGE KILLER (STANDARD CHARACTER)**. CGBS INTERNATIONAL S.A., (U.S. CLS. 1, 4, 6, 50, 51 AND 52). SN 79-071,782. PUB. 4-6-2010. FILED 4-23-2009.
- 3,807,271. **MULTISONIC (STANDARD CHARACTER)**. GREAT LENGTHS HAARVERTRIEBS GMBH, MULTIPLE CLASS, (INT. CLS. 3, 8, 10, 21, 26, 41 AND 44), (U.S. CLS. 1, 2, 4, 6, 13, 23, 26, 28, 29, 30, 33, 37, 39, 40, 42, 44, 50, 51, 52, 100, 101 AND 107). SN 79-071,795. PUB. 4-6-2010. FILED 11-19-2008.
- 3,807,281. **THINEERS (STANDARD CHARACTER)**. DENTAL-SERVE.NET; PROFESSIONAL SERVICES LTD., MULTIPLE CLASS, (INT. CLS. 3, 5 AND 10), (U.S. CLS. 1, 4, 6, 18, 26, 39, 44, 46, 50, 51 AND 52). SN 79-072,141. PUB. 4-6-2010. FILED 4-2-2009.
- 3,807,284 (*See Class 1 for this trademark*).
- 3,807,339. **BLACK SOUL (STANDARD CHARACTER)**. PARFUMS TED LAPIDUS, (U.S. CLS. 1, 4, 6, 50, 51 AND 52). SN 79-075,653. PUB. 4-6-2010. FILED 7-16-2009.
- 3,807,349. **REFERENCE (STANDARD CHARACTER)**. BATAN & SHARRO AB, (U.S. CLS. 1, 4, 6, 50, 51 AND 52). SN 79-075,979. PUB. 4-6-2010. FILED 10-23-2009.
- 3,807,355. **MT ROMANCE (STANDARD CHARACTER)**. MT ROMANCE AUSTRALIA PTY LTD, (U.S. CLS. 1, 4, 6, 50, 51

AND 52). SN 79-076,713. PUB. 4-6-2010. FILED 10-28-2009.
3,807,364 (*See Class 1 for this trademark*).

CLASS 4—LUBRICANTS AND FUELS

3,805,124 (*See Class 1 for this trademark*).
3,805,231. **CONIFEX (STANDARD CHARACTER)**. CONIFEX INC., MULTIPLE CLASS, (INT. CLS. 4, 19 AND 31), (U.S. CLS. 1, 6, 12, 15, 33, 46 AND 50). SN 77-367,869. PUB. 4-6-2010. FILED 1-9-2008.
3,805,232. **CONIFEX AND DESIGN**. CONIFEX INC., MULTIPLE CLASS, (INT. CLS. 4, 19 AND 31), (U.S. CLS. 1, 6, 12, 15, 33, 46 AND 50). SN 77-367,939. PUB. 4-6-2010. FILED 1-9-2008.
3,805,272. **S STENS THE PARTS COMPANY AND DESIGN**. STENS CORPORATION, MULTIPLE CLASS, (INT. CLS. 4, 7, 9 AND 12), (U.S. CLS. 1, 6, 13, 15, 19, 21, 23, 26, 31, 34, 35, 36, 38 AND 44). SN 77-482,285. PUB. 4-6-2010. FILED 5-23-2008.
3,805,273. **S STENS THE PARTS COMPANY AND DESIGN**. STENS CORPORATION, MULTIPLE CLASS, (INT. CLS. 4, 7, 9 AND 12), (U.S. CLS. 1, 6, 13, 15, 19, 21, 23, 26, 31, 34, 35, 36, 38 AND 44). SN 77-482,305. PUB. 4-6-2010. FILED 5-23-2008.
3,805,425. **ALPIQ (STANDARD CHARACTER)**. ALPIQ HOLDING LTD., MULTIPLE CLASS, (INT. CLS. 4, 7, 9, 11, 36, 37, 39, 40 AND 42), (U.S. CLS. 1, 6, 13, 15, 19, 21, 23, 26, 31, 34, 35, 36, 38, 100, 101, 102, 103, 105 AND 106). SN 77-637,420. PUB. 4-6-2010. FILED 12-20-2008.
3,805,813. **365 FUEL FLOW HILL-CHRISTIAN ENERGY SERVICES, LLC AND DESIGN**. HILL-CHRISTIAN, SHEILA R. (U.S. CLS. 1, 6 AND 15). SN 77-774,958. PUB. 4-6-2010. FILED 7-6-2009.
3,805,915. **A.J. AMATUZZIO (STYLIZED)**. AMSOIL INC., MULTIPLE CLASS, (INT. CLS. 4, 16 AND 25), (U.S. CLS. 1, 2, 5, 6, 15, 22, 23, 29, 37, 38, 39 AND 50). SN 77-798,525. PUB. 4-6-2010. FILED 8-6-2009.
3,805,919 (*See Class 3 for this trademark*).
3,806,270. **GUN BUTTER (STANDARD CHARACTER)**. TURN-EY, MARK, (U.S. CLS. 1, 6 AND 15). SN 77-852,903. PUB. 4-6-2010. FILED 10-20-2009.
3,806,532. **BURNING DESIRES (STANDARD CHARACTER)**. WICKS N MORE INC. (U.S. CLS. 1, 6 AND 15). SN 77-859,382. PUB. 4-6-2010. FILED 10-28-2009.
3,807,260. **RADIUS (STANDARD CHARACTER)**. RADIUS EINRICHTUNGSBEDARF GMBH, MULTIPLE CLASS, (INT. CLS. 4, 11, 18, 20, 21 AND 24), (U.S. CLS. 1, 2, 3, 6, 13, 15, 21, 22, 23, 25, 29, 30, 31, 32, 33, 34, 40, 41, 42 AND 50). SN 79-071,066. PUB. 4-6-2010. FILED 5-25-2009.

CLASS 5—PHARMACEUTICALS

3,805,124 (*See Class 1 for this trademark*).
3,805,128. **PALM-AID AND DESIGN**. LANTHUM PRODUCTS, LLC, MULTIPLE CLASS, (INT. CLS. 5 AND 28), (U.S. CLS. 6, 18, 22, 23, 38, 44, 46, 50, 51 AND 52). SN 76-679,146. PUB. 4-6-2010. FILED 7-5-2007.
3,805,184. **ZYNTERA (STANDARD CHARACTER)**. ALCON, INC., (U.S. CLS. 6, 18, 44, 46, 51 AND 52). SN 77-024,538. PUB. 4-6-2010. FILED 10-19-2006.
3,805,221. **T-CLAIR (STANDARD CHARACTER)**. SINCLAIR PHARMACEUTICALS LIMITED, (U.S. CLS. 6, 18, 44, 46, 51 AND 52). SN 77-339,418. PUB. 7-28-2009. FILED 11-28-2007.
3,805,237 (*See Class 3 for this trademark*).
3,805,258. **HYPER-EGG (STANDARD CHARACTER)**. J.H. HARE & ASSOCIATES, LTD., (U.S. CLS. 6, 18, 44, 46, 51 AND 52). SN 77-440,070. PUB. 4-6-2010. FILED 4-4-2008.
3,805,275. **CRALDORZA (STANDARD CHARACTER)**. ASTRAZENECA AB, (U.S. CLS. 6, 18, 44, 46, 51 AND 52). SN 77-484,111. PUB. 4-6-2010. FILED 5-27-2008.
3,805,276. **DANREZI (STANDARD CHARACTER)**. ASTRAZENECA AB, (U.S. CLS. 6, 18, 44, 46, 51 AND 52). SN 77-484,116. PUB. 4-6-2010. FILED 5-27-2008.

3,805,277. **EFLIZEE (STANDARD CHARACTER)**. ASTRAZENECA AB, (U.S. CLS. 6, 18, 44, 46, 51 AND 52). SN 77-484,124. PUB. 4-6-2010. FILED 5-27-2008.
3,805,278. **ELRESVA (STANDARD CHARACTER)**. ASTRAZENECA AB, (U.S. CLS. 6, 18, 44, 46, 51 AND 52). SN 77-484,130. PUB. 4-6-2010. FILED 5-27-2008.
3,805,281 (*See Class 1 for this trademark*).
3,805,282. **ERKORMIS (STANDARD CHARACTER)**. ASTRAZENECA AB, (U.S. CLS. 6, 18, 44, 46, 51 AND 52). SN 77-486,301. PUB. 4-6-2010. FILED 5-29-2008.
3,805,283. **GLENZURIS (STANDARD CHARACTER)**. ASTRAZENECA AB, (U.S. CLS. 6, 18, 44, 46, 51 AND 52). SN 77-486,306. PUB. 4-6-2010. FILED 5-29-2008.
3,805,284. **GLINZERVA (STANDARD CHARACTER)**. ASTRAZENECA AB, (U.S. CLS. 6, 18, 44, 46, 51 AND 52). SN 77-486,312. PUB. 4-6-2010. FILED 5-29-2008.
3,805,285. **KYFENZUR (STANDARD CHARACTER)**. ASTRAZENECA AB, (U.S. CLS. 6, 18, 44, 46, 51 AND 52). SN 77-486,882. PUB. 4-6-2010. FILED 5-30-2008.
3,805,286. **LERAMPLEX (STANDARD CHARACTER)**. ASTRAZENECA AB, (U.S. CLS. 6, 18, 44, 46, 51 AND 52). SN 77-486,884. PUB. 4-6-2010. FILED 5-30-2008.
3,805,295. **COMFORT STRETCH TECHNOLOGY (STANDARD CHARACTER)**. HISAMITSU PHARMACEUTICAL CO., INC., (U.S. CLS. 6, 18, 44, 46, 51 AND 52). SN 77-497,371. PUB. 4-6-2010. FILED 6-12-2008.
3,805,315. **IBRISAR (STANDARD CHARACTER)**. ASTRAZENECA AB, (U.S. CLS. 6, 18, 44, 46, 51 AND 52). SN 77-542,227. PUB. 4-6-2010. FILED 8-8-2008.
3,805,324. **ERITAMO (STANDARD CHARACTER)**. ASTRAZENECA AB, (U.S. CLS. 6, 18, 44, 46, 51 AND 52). SN 77-550,438. PUB. 4-6-2010. FILED 8-19-2008.
3,805,328 (*See Class 1 for this trademark*).
3,805,349. **OZITO (STANDARD CHARACTER)**. TIP TOP TIPS SARL, MULTIPLE CLASS, (INT. CLS. 5 AND 10), (U.S. CLS. 6, 18, 26, 39, 44, 46, 51 AND 52). SN 77-574,128. PUB. 2-2-2010. FILED 9-19-2008.
3,805,355. **VETS PLUS B BOMAC VETS PLUS, INC. ANIMAL HEALTH AND DESIGN**. BOMAC VETS PLUS, INC., (U.S. CLS. 6, 18, 44, 46, 51 AND 52). SN 77-581,332. PUB. 4-6-2010. FILED 9-29-2008.
3,805,404. **FLY-RITE (STANDARD CHARACTER)**. FLY-RITE LLC, MULTIPLE CLASS, (INT. CLS. 5 AND 28), (U.S. CLS. 6, 18, 22, 23, 38, 44, 46, 50, 51 AND 52). SN 77-624,507. PUB. 4-6-2010. FILED 12-2-2008.
3,805,413 (*See Class 3 for this trademark*).
3,805,434. **KAZURIX (STANDARD CHARACTER)**. GLAXOSMITHKLINE BIOLOGICALS, S.A., (U.S. CLS. 6, 18, 44, 46, 51 AND 52). SN 77-644,875. PUB. 4-6-2010. FILED 1-7-2009.
3,805,456. **ZAXIMO (STANDARD CHARACTER)**. ASTRAZENECA AB, (U.S. CLS. 6, 18, 44, 46, 51 AND 52). SN 77-670,141. PUB. 4-6-2010. FILED 2-13-2009.
3,805,475. **V V V AND DESIGN**. VALUE ADDED SCIENCE & TECHNOLOGIES, LLC, MULTIPLE CLASS, (INT. CLS. 5, 31 AND 44), (U.S. CLS. 1, 6, 18, 44, 46, 51, 52, 100 AND 101). SN 77-682,427. PUB. 4-6-2010. FILED 3-3-2009.
3,805,481. **PRESS-TO-METAL (STANDARD CHARACTER)**. JENSEN INDUSTRIES INCORPORATED, (U.S. CLS. 6, 18, 44, 46, 51 AND 52). SN 77-686,370. PUB. 4-6-2010. FILED 3-9-2009.
3,805,499. **MISCELLANEOUS DESIGN**. VITASOY INTERNATIONAL HOLDINGS LIMITED, MULTIPLE CLASS, (INT. CLS. 5, 30 AND 32), (U.S. CLS. 6, 18, 44, 45, 46, 48, 51 AND 52). SN 77-704,129. PUB. 1-12-2010. FILED 4-1-2009.
3,805,563. **DAILY DETOX (STANDARD CHARACTER)**. WELLEMENTS, LLC, (U.S. CLS. 6, 18, 44, 46, 51 AND 52). SN 77-723,884. PUB. 4-6-2010. FILED 4-28-2009.
3,805,612. **BEECH-NUT ADVANCING NUTRITION AND DESIGN**. BEECH-NUT NUTRITION CORPORATION, MULTIPLE CLASS, (INT. CLS. 5, 29, 30 AND 32), (U.S. CLS. 6, 18, 44, 45, 46, 48, 51 AND 52). SN 77-731,210. PUB. 4-6-2010. FILED 5-7-2009.
3,805,630. **HONEY, DON'T COUGH AND DESIGN**. HONEY DON'T COUGH LLC, DBA HONEY DON'T COUGH, (U.S. CLS. 6, 18, 44, 46, 51 AND 52). SN 77-734,121. PUB. 4-6-2010. FILED 5-11-2009.
3,805,631. **HONEY . . . DON'T COUGH AND DESIGN**. HONEY DON'T COUGH LLC, DBA HONEY DON'T COUGH, (U.S.

- CLS. 6, 18, 44, 46, 51 AND 52). SN 77-734,136. PUB. 4-6-2010. FILED 5-11-2009.
- 3,805,678. **MISCELLANEOUS DESIGN**. LIFENET HEALTH, MULTIPLE CLASS, (INT. CLS. 5, 37 AND 44), (U.S. CLS. 6, 18, 44, 46, 51, 52, 100, 101, 103 AND 106). SN 77-742,850. PUB. 4-6-2010. FILED 5-22-2009.
- 3,805,727. **YSTAPLIS (STANDARD CHARACTER)**. SANOFI-AVENTIS, (U.S. CLS. 6, 18, 44, 46, 51 AND 52). SN 77-754,095. PUB. 4-6-2010. FILED 6-8-2009.
- 3,805,730. **SOOTHE JOINTS (STANDARD CHARACTER)**. HERBSMITH INC., DBA HERBSMITH INC., (U.S. CLS. 6, 18, 44, 46, 51 AND 52). SN 77-754,456. PUB. 4-6-2010. FILED S.R. 6-8-2009; AM. P.R. 2-5-2010.
- 3,805,750. **LIVETHESOURCE (STANDARD CHARACTER)**. THE SOURCE VITAMIN COMPANY, INC., MULTIPLE CLASS, (INT. CLS. 5, 35 AND 41), (U.S. CLS. 6, 18, 44, 46, 51, 52, 100, 101, 102 AND 107). SN 77-759,097. PUB. 4-6-2010. FILED 6-13-2009.
- 3,805,751. **LIVETHESOURCE SCIENCE | NATURE | WELLNESS AND DESIGN**. THE SOURCE VITAMIN COMPANY, INC., MULTIPLE CLASS, (INT. CLS. 5, 35 AND 41), (U.S. CLS. 6, 18, 44, 46, 51, 52, 100, 101, 102 AND 107). SN 77-759,171. PUB. 4-6-2010. FILED 6-14-2009.
- 3,805,766. **DR. SCHULZE'S BOWEL FLUSH "SHOT" (STANDARD CHARACTER)**. AMERICAN BOTANICAL PHARMACY, (U.S. CLS. 6, 18, 44, 46, 51 AND 52). SN 77-762,909. PUB. 4-6-2010. FILED 6-18-2009.
- 3,805,812. **SELECT DEFENSE AND DESIGN**. CLASSONE ORTHODONTICS, INC., MULTIPLE CLASS, (INT. CLS. 5 AND 10), (U.S. CLS. 6, 18, 26, 39, 44, 46, 51 AND 52). SN 77-774,101. PUB. 4-6-2010. FILED 7-3-2009.
- 3,805,816. **LIHAREY (STANDARD CHARACTER)**. SANOFI-AVENTIS, (U.S. CLS. 6, 18, 44, 46, 51 AND 52). SN 77-775,938. PUB. 4-6-2010. FILED 7-7-2009.
- 3,805,818. **VISAMERIN (STANDARD CHARACTER)**. SANOFI-AVENTIS, (U.S. CLS. 6, 18, 44, 46, 51 AND 52). SN 77-777,385. PUB. 4-6-2010. FILED 7-9-2009.
- 3,805,819. **XAMARULT (STANDARD CHARACTER)**. SANOFI-AVENTIS, (U.S. CLS. 6, 18, 44, 46, 51 AND 52). SN 77-777,389. PUB. 4-6-2010. FILED 7-9-2009.
- 3,805,830 (*See Class 1 for this trademark*).
- 3,805,831 (*See Class 1 for this trademark*).
- 3,805,834. **INTERCEM AND DESIGN**. SCIENTIFIC PHARMACEUTICALS, INC., (U.S. CLS. 6, 18, 44, 46, 51 AND 52). SN 77-780,923. PUB. 4-6-2010. FILED 7-14-2009.
- 3,805,983. **XERCLEAR (STANDARD CHARACTER)**. MEDIVIR AB, (U.S. CLS. 6, 18, 44, 46, 51 AND 52). SN 77-812,821. PUB. 2-16-2010. FILED 8-26-2009.
- 3,805,990. **HERBAL HEAT (STANDARD CHARACTER)**. SOOTHING TOUCH, LLC, (U.S. CLS. 6, 18, 44, 46, 51 AND 52). SN 77-815,250. PUB. 4-6-2010. FILED S.R. 8-28-2009; AM. P.R. 1-14-2010.
- 3,805,999. **Z-HYALCOAT (STANDARD CHARACTER)**. CARL ZEISS MEDITEC AG, (U.S. CLS. 6, 18, 44, 46, 51 AND 52). SN 77-816,716. PUB. 4-6-2010. FILED 8-31-2009.
- 3,806,000. **Z-HYALIN (STANDARD CHARACTER)**. CARL ZEISS MEDITEC AG, (U.S. CLS. 6, 18, 44, 46, 51 AND 52). SN 77-816,731. PUB. 4-6-2010. FILED 8-31-2009.
- 3,806,001. **Z-HYALON (STANDARD CHARACTER)**. CARL ZEISS MEDITEC AG, (U.S. CLS. 6, 18, 44, 46, 51 AND 52). SN 77-816,739. PUB. 4-6-2010. FILED 8-31-2009.
- 3,806,002. **Z-CELCOAT (STANDARD CHARACTER)**. CARL ZEISS MEDITEC AG, (U.S. CLS. 6, 18, 44, 46, 51 AND 52). SN 77-816,754. PUB. 4-6-2010. FILED 8-31-2009.
- 3,806,005. **ANDROMACO AND DESIGN**. INDUSTRIA FARMACEUTICA ANDROMACO, S.A. DE C.V., (U.S. CLS. 6, 18, 44, 46, 51 AND 52). SN 77-817,418. PUB. 4-6-2010. FILED 9-1-2009.
- 3,806,024. **RT FLU-AN (STANDARD CHARACTER)**. CARL ZEISS MEDITEC AG, (U.S. CLS. 6, 18, 44, 46, 51 AND 52). SN 77-820,635. PUB. 4-6-2010. FILED 9-4-2009.
- 3,806,044. **PYGANIC DUST AND DESIGN**. MCLAUGHLIN GORMLEY KING COMPANY, (U.S. CLS. 6, 18, 44, 46, 51 AND 52). SN 77-823,940. PUB. 4-6-2010. FILED 9-10-2009.
- 3,806,052. **ORAXYL (STANDARD CHARACTER)**. E5 PHARMA, INC., (U.S. CLS. 6, 18, 44, 46, 51 AND 52). SN 77-824,776. PUB. 4-6-2010. FILED 9-11-2009.
- 3,806,071. **SKIDZ (STYLIZED)**. MATEO, QUEENCY D., (U.S. CLS. 6, 18, 44, 46, 51 AND 52). SN 77-827,346. PUB. 4-6-2010. FILED 9-16-2009.
- 3,806,204 (*See Class 3 for this trademark*).
- 3,806,369. **S AND DESIGN**. SYNERGY TECHNOLOGIES, INC., (U.S. CLS. 6, 18, 44, 46, 51 AND 52). SN 77-857,035. PUB. 4-6-2010. FILED 10-26-2009.
- 3,806,405. **DESINTOXICADOR TOTAL DETOX (STANDARD CHARACTER)**. SALAZAR, ESTHER MARISOL, (U.S. CLS. 6, 18, 44, 46, 51 AND 52). SN 77-857,977. PUB. 4-6-2010. FILED 10-27-2009.
- 3,806,426. **ORASOOTHE (STANDARD CHARACTER)**. MCMERLIN DENTAL PRODUCTS, LP, DBA MCMP, (U.S. CLS. 6, 18, 44, 46, 51 AND 52). SN 77-858,204. PUB. 4-6-2010. FILED 10-27-2009.
- 3,806,430. **MAKE IT YOUR FIRST DRINK OF THE NIGHT! (STANDARD CHARACTER)**. BOND LABORATORIES, INC., (U.S. CLS. 6, 18, 44, 46, 51 AND 52). SN 77-858,233. PUB. 4-6-2010. FILED 10-27-2009.
- 3,806,515. **4TH QTR SEASONAL DEFENSE (STANDARD CHARACTER)**. JAMES, LESLIE, (U.S. CLS. 6, 18, 44, 46, 51 AND 52). SN 77-859,141. PUB. 4-6-2010. FILED 10-28-2009.
- 3,806,517. **STOP PMS (STANDARD CHARACTER)**. VESCENT LABS INC., (U.S. CLS. 6, 18, 44, 46, 51 AND 52). SN 77-859,149. PUB. 4-6-2010. FILED 10-28-2009.
- 3,806,573. **1-DB[®] (STANDARD CHARACTER)**. 1ST PHORM, LLC, (U.S. CLS. 6, 18, 44, 46, 51 AND 52). SN 77-859,836. PUB. 4-6-2010. FILED 10-28-2009.
- 3,806,629. **URELLE (STANDARD CHARACTER)**. AZUR PHARMA INTERNATIONAL II LIMITED, (U.S. CLS. 6, 18, 44, 46, 51 AND 52). SN 77-860,362. PUB. 4-6-2010. FILED 10-29-2009.
- 3,806,638. **CITRI-MUNE (STANDARD CHARACTER)**. DANIEL J. STEIN, (U.S. CLS. 6, 18, 44, 46, 51 AND 52). SN 77-860,486. PUB. 4-6-2010. FILED 10-29-2009.
- 3,806,767. **POWERED BY SUPERSTARCH POWERED BY SUPERSTARCH AND DESIGN**. THE UCAN COMPANY, MULTIPLE CLASS, (INT. CLS. 5 AND 32), (U.S. CLS. 6, 18, 44, 45, 46, 48, 51 AND 52). SN 77-862,584. PUB. 4-6-2010. FILED 11-2-2009.
- 3,806,773. **PHORMULA-1 (STANDARD CHARACTER)**. 1ST PHORM, LLC, (U.S. CLS. 6, 18, 44, 46, 51 AND 52). SN 77-862,648. PUB. 4-6-2010. FILED 11-2-2009.
- 3,806,774. **LEVEL-1 (STANDARD CHARACTER)**. 1ST PHORM, LLC, (U.S. CLS. 6, 18, 44, 46, 51 AND 52). SN 77-862,670. PUB. 4-6-2010. FILED 11-2-2009.
- 3,806,779. **FLASH POINT (STANDARD CHARACTER)**. ISATORI TECHNOLOGIES, LLC, (U.S. CLS. 6, 18, 44, 46, 51 AND 52). SN 77-862,724. PUB. 4-6-2010. FILED 11-2-2009.
- 3,806,782. **ARTHMAX (STANDARD CHARACTER)**. SEAN SANGSOO LEE, (U.S. CLS. 6, 18, 44, 46, 51 AND 52). SN 77-862,751. PUB. 4-6-2010. FILED 11-2-2009.
- 3,806,784. **FREEDOMAX (STANDARD CHARACTER)**. SEAN SANGSOO LEE, (U.S. CLS. 6, 18, 44, 46, 51 AND 52). SN 77-862,797. PUB. 4-6-2010. FILED 11-2-2009.
- 3,806,787. **ARTHCARE (STANDARD CHARACTER)**. SEAN SANGSOON LEE, (U.S. CLS. 6, 18, 44, 46, 51 AND 52). SN 77-862,925. PUB. 4-6-2010. FILED 11-2-2009.
- 3,806,792. **OLAY (STANDARD CHARACTER)**. PROCTER & GAMBLE COMPANY, THE, (U.S. CLS. 6, 18, 44, 46, 51 AND 52). SN 77-863,010. PUB. 4-6-2010. FILED 11-2-2009.
- 3,806,794. **THYRO- DRIVE (STANDARD CHARACTER)**. 1ST PHORM, LLC, (U.S. CLS. 6, 18, 44, 46, 51 AND 52). SN 77-863,045. PUB. 4-6-2010. FILED 11-2-2009.
- 3,806,817. **VIREO (STANDARD CHARACTER)**. PHOENIX ENVIRONMENTAL CARE, LLC, (U.S. CLS. 6, 18, 44, 46, 51 AND 52). SN 77-863,445. PUB. 4-6-2010. FILED 11-3-2009.
- 3,806,818. **REDWING (STANDARD CHARACTER)**. PHOENIX ENVIRONMENTAL CARE, LLC, (U.S. CLS. 6, 18, 44, 46, 51 AND 52). SN 77-863,446. PUB. 4-6-2010. FILED 11-3-2009.
- 3,806,819. **KRAKEN (STANDARD CHARACTER)**. PHOENIX ENVIRONMENTAL CARE, LLC, (U.S. CLS. 6, 18, 44, 46, 51 AND 52). SN 77-863,447. PUB. 4-6-2010. FILED 11-3-2009.
- 3,806,880. **RAPID BLAST (STANDARD CHARACTER)**. THE TYLENOL COMPANY, (U.S. CLS. 6, 18, 44, 46, 51 AND 52). SN 77-864,500. PUB. 4-6-2010. FILED 11-4-2009.
- 3,806,905. **STARFIGHTER (STANDARD CHARACTER)**. PHOENIX ENVIRONMENTAL CARE, LLC, (U.S. CLS. 6, 18, 44, 46, 51 AND 52). SN 77-865,348. PUB. 4-6-2010. FILED

- 11-4-2009.
- 3,806,950. **PROUD 3 (STANDARD CHARACTER)**. BIO HUMANETICS, INC., (U.S. CLS. 6, 18, 44, 46, 51 AND 52). SN 77-873,303. PUB. 4-6-2010. FILED 11-16-2009.
- 3,806,996. **VETPERINE (STANDARD CHARACTER)**. SABINSA CORPORATION, (U.S. CLS. 6, 18, 44, 46, 51 AND 52). SN 77-881,005. PUB. 4-6-2010. FILED 11-25-2009.
- 3,807,044. **5-LOXIN (STANDARD CHARACTER)**. P.L. THOMAS & CO., INC., (U.S. CLS. 6, 18, 44, 46, 51 AND 52). SN 77-904,592. PUB. 4-6-2010. FILED 1-4-2010.
- 3,807,069. **FIBLAST (STANDARD CHARACTER)**. KAKEN PHARMACEUTICAL CO., LTD., (U.S. CLS. 6, 18, 44, 46, 51 AND 52). SN 78-746,584. PUB. 4-6-2010. FILED 11-3-2005.
- 3,807,073 (*See Class 1 for this trademark*).
- 3,807,078. **JOLESSA (STANDARD CHARACTER)**. BARR LABORATORIES, INC., (U.S. CLS. 6, 18, 44, 46, 51 AND 52). SN 78-846,866. PUB. 10-7-2008. FILED 3-27-2006.
- 3,807,079. **MISCELLANEOUS DESIGN**. SOCIETE DES PRODUITS NESTLE S.A., (U.S. CLS. 6, 18, 44, 46, 51 AND 52). SN 78-849,770. PUB. 4-6-2010. FILED 3-30-2006.
- 3,807,087. **BUZZ BOMB (STANDARD CHARACTER)**. COHEN, JEFFREY A., (U.S. CLS. 6, 18, 44, 46, 51 AND 52). SN 78-947,966. PUB. 4-6-2010. FILED 8-8-2006.
- 3,807,103. **CORMAN ORGANIC AND DESIGN**. CORMAN S.P.A., MULTIPLE CLASS, (INT. CLS. 5 AND 10), (U.S. CLS. 6, 18, 26, 39, 44, 46, 51 AND 52). SN 79-054,030. PUB. 4-6-2010. FILED 1-8-2008.
- 3,807,112 (*See Class 1 for this trademark*).
- 3,807,117. **ITRIM (STANDARD CHARACTER)**. ITRIM SVERIGE AB, MULTIPLE CLASS, (INT. CLS. 5, 30, 32, 41 AND 44), (U.S. CLS. 6, 18, 44, 45, 46, 48, 51, 52, 100, 101 AND 107). SN 79-059,505. PUB. 4-6-2010. FILED 4-7-2008.
- 3,807,129 (*See Class 1 for this trademark*).
- 3,807,132. **KURADURA (STANDARD CHARACTER)**. KUROS BIOSURGERY AG, MULTIPLE CLASS, (INT. CLS. 5 AND 10), (U.S. CLS. 6, 18, 26, 39, 44, 46, 51 AND 52). SN 79-062,235. PUB. 4-6-2010. FILED 8-15-2008.
- 3,807,138. **PHY PROOF OF QUALITY FOR MARKERS (STYLIZED)**. PHYTOLAB GMBH & CO. KG, MULTIPLE CLASS, (INT. CLS. 5, 42 AND 44), (U.S. CLS. 6, 18, 44, 46, 51, 52, 100 AND 101). SN 79-063,170. PUB. 4-6-2010. FILED 8-26-2008.
- 3,807,145. **ECOPARADISE (STANDARD CHARACTER)**. BARBARIAN CO., LTD., MULTIPLE CLASS, (INT. CLS. 5, 20, 24, 25 AND 44), (U.S. CLS. 2, 6, 13, 18, 22, 25, 32, 39, 42, 44, 46, 50, 51, 52, 100 AND 101). SN 79-063,881. PUB. 4-6-2010. FILED 9-26-2008.
- 3,807,149 (*See Class 1 for this trademark*).
- 3,807,164. **IOPAMIGITA (STANDARD CHARACTER)**. INSIGHT AGENTS GMBH, MULTIPLE CLASS, (INT. CLS. 5, 35 AND 42), (U.S. CLS. 6, 18, 44, 46, 51, 52, 100, 101 AND 102). SN 79-067,614. PUB. 4-6-2010. FILED 7-26-2008.
- 3,807,167. **NOZOHAEM (STANDARD CHARACTER)**. PHARMACURE HEALTH CARE AB, (U.S. CLS. 6, 18, 44, 46, 51 AND 52). SN 79-067,764. PUB. 4-6-2010. FILED 3-23-2009.
- 3,807,180 (*See Class 3 for this trademark*).
- 3,807,191. **AVIMOTIN (STANDARD CHARACTER)**. MEDITIGENE AG, (U.S. CLS. 6, 18, 44, 46, 51 AND 52). SN 79-068,993. PUB. 4-6-2010. FILED 4-28-2009.
- 3,807,194. **SPERMGLUE (STANDARD CHARACTER)**. VITROLIFE SWEDEN AB, (U.S. CLS. 6, 18, 44, 46, 51 AND 52). SN 79-069,136. PUB. 4-6-2010. FILED 5-7-2009.
- 3,807,212 (*See Class 1 for this trademark*).
- 3,807,214. **NOZORHIN (STANDARD CHARACTER)**. PHARMACURE HEALTH CARE AB, (U.S. CLS. 6, 18, 44, 46, 51 AND 52). SN 79-069,816. PUB. 4-6-2010. FILED 5-4-2009.
- 3,807,234. **IMMIFLEX AND DESIGN**. IMMITEC HOLDING AB, (U.S. CLS. 6, 18, 44, 46, 51 AND 52). SN 79-070,182. PUB. 4-6-2010. FILED 6-2-2009.
- 3,807,235. **ROVI (STANDARD CHARACTER)**. LABORATORIOS FARMACEUTICOS; ROVI, S.A., MULTIPLE CLASS, (INT. CLS. 5, 10 AND 42), (U.S. CLS. 6, 18, 26, 39, 44, 46, 51, 52, 100 AND 101). SN 79-070,198. PUB. 4-6-2010. FILED 2-24-2009.
- 3,807,254. **JELLYCARD (STANDARD CHARACTER)**. SKANCARD APS, MULTIPLE CLASS, (INT. CLS. 5, 10 AND 35), (U.S. CLS. 6, 18, 26, 39, 44, 46, 51, 52, 100, 101 AND 102). SN 79-070,752. PUB. 4-6-2010. FILED 5-5-2009.
- 3,807,281 (*See Class 3 for this trademark*).
- 3,807,292. **SAPAREX (STYLIZED)**. CYCLACEL LIMITED, (U.S. CLS. 6, 18, 44, 46, 51 AND 52). SN 79-072,708. PUB. 4-6-2010. FILED 8-5-2009.
- 3,807,295. **VALIO AND DESIGN**. VALIO LTD, MULTIPLE CLASS, (INT. CLS. 5, 29 AND 32), (U.S. CLS. 6, 18, 44, 45, 46, 48, 51 AND 52). SN 79-072,915. PUB. 4-6-2010. FILED 5-26-2009.
- 3,807,302. **ERAVEC (STANDARD CHARACTER)**. CLAVIS PHARMA ASA, (U.S. CLS. 6, 18, 44, 46, 51 AND 52). SN 79-073,401. PUB. 4-6-2010. FILED 7-7-2009.
- 3,807,329. **ASTRYMERY (STANDARD CHARACTER)**. SANOFI-AVENTIS, (U.S. CLS. 6, 18, 44, 46, 51 AND 52). SN 79-075,145. PUB. 4-6-2010. FILED 10-26-2009.
- 3,807,330. **VUSDOE (STANDARD CHARACTER)**. SANOFI-AVENTIS, (U.S. CLS. 6, 18, 44, 46, 51 AND 52). SN 79-075,146. PUB. 4-6-2010. FILED 10-26-2009.
- 3,807,333. **EDARBI (STANDARD CHARACTER)**. TAKEDA PHARMACEUTICAL COMPANY LIMITED, (U.S. CLS. 6, 18, 44, 46, 51 AND 52). SN 79-075,482. PUB. 4-6-2010. FILED 10-21-2009.
- 3,807,334. **ARBOTOTA (STANDARD CHARACTER)**. TAKEDA PHARMACEUTICAL COMPANY LIMITED, (U.S. CLS. 6, 18, 44, 46, 51 AND 52). SN 79-075,483. PUB. 4-6-2010. FILED 10-21-2009.
- 3,807,338. **QUALIRIS BY STAGO (STYLIZED)**. DIAGNOSTICA STAGO, MULTIPLE CLASS, (INT. CLS. 5, 38 AND 42), (U.S. CLS. 6, 18, 44, 46, 51, 52, 100, 101 AND 104). SN 79-075,563. PUB. 4-6-2010. FILED 7-8-2009.
- 3,807,342. **DENRAP (STANDARD CHARACTER)**. TAKEDA PHARMACEUTICAL COMPANY LIMITED, (U.S. CLS. 6, 18, 44, 46, 51 AND 52). SN 79-075,762. PUB. 4-6-2010. FILED 10-21-2009.
- 3,807,343. **IRAPSIF (STANDARD CHARACTER)**. TAKEDA PHARMACEUTICAL COMPANY LIMITED, (U.S. CLS. 6, 18, 44, 46, 51 AND 52). SN 79-075,829. PUB. 4-6-2010. FILED 10-21-2009.
- 3,807,344. **ZIVTOTA (STANDARD CHARACTER)**. TAKEDA PHARMACEUTICAL COMPANY LIMITED, (U.S. CLS. 6, 18, 44, 46, 51 AND 52). SN 79-075,830. PUB. 4-6-2010. FILED 10-21-2009.
- 3,807,345. **AZALMOD (STANDARD CHARACTER)**. TAKEDA PHARMACEUTICAL COMPANY LIMITED, (U.S. CLS. 6, 18, 44, 46, 51 AND 52). SN 79-075,832. PUB. 4-6-2010. FILED 10-21-2009.
- 3,807,351. **IBECTA (STANDARD CHARACTER)**. NOVARTIS AG, (U.S. CLS. 6, 18, 44, 46, 51 AND 52). SN 79-076,229. PUB. 4-6-2010. FILED 10-9-2009.
- 3,807,362. **TEDASSU (STANDARD CHARACTER)**. SANOFI-AVENTIS, (U.S. CLS. 6, 18, 44, 46, 51 AND 52). SN 79-077,486. PUB. 4-6-2010. FILED 11-24-2009.
- 3,807,363. **IGOLTI (STANDARD CHARACTER)**. SANOFI-AVENTIS, (U.S. CLS. 6, 18, 44, 46, 51 AND 52). SN 79-077,487. PUB. 4-6-2010. FILED 11-24-2009.
- 3,807,365. **BINAVEJ (STANDARD CHARACTER)**. SANOFI-AVENTIS, (U.S. CLS. 6, 18, 44, 46, 51 AND 52). SN 79-077,541. PUB. 4-6-2010. FILED 11-12-2009.
- 3,807,366. **BINAVEG (STANDARD CHARACTER)**. SANOFI-AVENTIS, (U.S. CLS. 6, 18, 44, 46, 51 AND 52). SN 79-077,683. PUB. 4-6-2010. FILED 11-12-2009.

CLASS 6—METAL GOODS

- 3,805,124 (*See Class 1 for this trademark*).
- 3,805,193. **WHATEVER IT TAKES (STANDARD CHARACTER)**. TRADE PLUS AID, MULTIPLE CLASS, (INT. CLS. 6, 14, 16, 19, 20, 21, 25 AND 36), (U.S. CLS. 1, 2, 5, 12, 13, 14, 22, 23, 25, 27, 28, 29, 30, 32, 33, 37, 38, 39, 40, 50, 100, 101 AND 102). SN 77-131,619. PUB. 4-6-2010. FILED 3-15-2007.
- 3,805,202. **AESSEAL (STANDARD CHARACTER)**. AES ENGINEERING LTD., MULTIPLE CLASS, (INT. CLS. 6, 7, 17, 37 AND 42), (U.S. CLS. 1, 2, 5, 12, 13, 14, 19, 21, 23, 25, 31, 34, 35, 50, 100, 101, 103 AND 106). SN 77-264,172. PUB. 4-6-2010. FILED 8-24-2007.
- 3,805,288. **MAGNUM (STANDARD CHARACTER)**. UNITED FARMERS OF ALBERTA CO-OPERATIVE LIMITED,

- MULTIPLE CLASS, (INT. CLS. 6, 11, 19 AND 21), (U.S. CLS. 1, 2, 12, 13, 14, 21, 23, 25, 29, 30, 31, 33, 34, 40 AND 50). SN 77-487,698. PUB. 12-15-2009. FILED 5-30-2008.
- 3,805,296. **PRO PACK QUALITY PACKAGING SOLUTION AND DESIGN**, KCH CORPORATION, (U.S. CLS. 2, 12, 13, 14, 23, 25 AND 50). SN 77-498,342. PUB. 4-6-2010. FILED 6-13-2008.
- 3,805,348. **GOOSE NECK AND DESIGN**, A. RICHARD TOOLS CO., MULTIPLE CLASS, (INT. CLS. 6, 16 AND 20), (U.S. CLS. 2, 5, 12, 13, 14, 22, 23, 25, 29, 32, 37, 38 AND 50). SN 77-573,952. PUB. 4-6-2010. FILED 9-19-2008.
- 3,805,392. **FALCON (STANDARD CHARACTER)**, SCHLAGE LOCK COMPANY, (U.S. CLS. 2, 12, 13, 14, 23, 25 AND 50). SN 77-612,642. PUB. 4-6-2010. FILED 11-12-2008.
- 3,805,478. **TILDA AND DESIGN**, FINNANGER, TONE, MULTIPLE CLASS, (INT. CLS. 6, 16, 20, 23, 24, 26 AND 28), (U.S. CLS. 2, 5, 12, 13, 14, 22, 23, 25, 29, 32, 37, 38, 39, 40, 42, 43 AND 50). SN 77-683,643. PUB. 4-6-2010. FILED 3-4-2009.
- 3,805,532. **TIMELESSCHARM (STYLIZED)**, BERENSON CORP, (U.S. CLS. 2, 12, 13, 14, 23, 25 AND 50). SN 77-717,716. PUB. 4-6-2010. FILED 4-20-2009.
- 3,805,709. **NOE AND DESIGN**, NOE-SCHALTECHNIK GEORG MEYER-KELLER GMBH + CO, MULTIPLE CLASS, (INT. CLS. 6, 19, 37 AND 42), (U.S. CLS. 1, 2, 12, 13, 14, 23, 25, 33, 50, 100, 101, 103 AND 106). SN 77-748,425. PUB. 4-6-2010. FILED 5-31-2009.
- 3,805,801. **BIRDSEYE AND DESIGN**, BRD SUPPLY, INC., MULTIPLE CLASS, (INT. CLS. 6 AND 20), (U.S. CLS. 2, 12, 13, 14, 22, 23, 25, 32 AND 50). SN 77-771,498. PUB. 4-6-2010. FILED 6-30-2009.
- 3,805,852. **INTENTIONALLY BETTER (STANDARD CHARACTER)**, EARNEST MACHINE PRODUCTS COMPANY, (U.S. CLS. 2, 12, 13, 14, 23, 25 AND 50). SN 77-784,913. PUB. 4-6-2010. FILED 7-20-2009.
- 3,805,898. **CONNECTIONS CLUB (STANDARD CHARACTER)**, CABIN CREEK, LLC, MULTIPLE CLASS, (INT. CLS. 6, 16, 26 AND 35), (U.S. CLS. 2, 5, 12, 13, 14, 22, 23, 25, 29, 37, 38, 39, 40, 42, 50, 100, 101 AND 102). SN 77-794,835. PUB. 4-6-2010. FILED 7-31-2009.
- 3,806,145. **BESTVIEW (STANDARD CHARACTER)**, BESTVIEW INTERNATIONAL COMPANY, MULTIPLE CLASS, (INT. CLS. 6, 11, 19 AND 37), (U.S. CLS. 1, 2, 12, 13, 14, 21, 23, 25, 31, 33, 34, 50, 100, 103 AND 106). SN 77-839,775. PUB. 4-6-2010. FILED 10-1-2009.
- 3,806,158. **ISOMANDREL (STANDARD CHARACTER)**, ACROLAB LTD., (U.S. CLS. 2, 12, 13, 14, 23, 25 AND 50). SN 77-842,095. PUB. 4-6-2010. FILED 10-6-2009.
- 3,806,169. **FLAME GARD (STANDARD CHARACTER)**, COMPONENT HARDWARE GROUP, INC., (U.S. CLS. 2, 12, 13, 14, 23, 25 AND 50). SN 77-843,331. PUB. 4-6-2010. FILED 10-7-2009.
- 3,806,317. **WE'VE NAILED BEING GREEN AND DESIGN**, W. H. MAZE COMPANY, (U.S. CLS. 2, 12, 13, 14, 23, 25 AND 50). SN 77-855,366. PUB. 4-6-2010. FILED 10-22-2009.
- 3,806,459. **SKY BRACKET (STANDARD CHARACTER)**, OLSON ALUMINUM CASTING, LTD, (U.S. CLS. 2, 12, 13, 14, 23, 25 AND 50). SN 77-858,524. PUB. 4-6-2010. FILED 10-27-2009.
- 3,806,676. **GUARDIANCOIL (STANDARD CHARACTER)**, CASCADE COIL DRAPERY, INC., (U.S. CLS. 2, 12, 13, 14, 23, 25 AND 50). SN 77-860,884. PUB. 4-6-2010. FILED 10-29-2009.
- 3,806,737. **SAFLOCK SYSTEM SCAFFOLD (STANDARD CHARACTER)**, SAFWAY SERVICES, LLC, MULTIPLE CLASS, (INT. CLS. 6 AND 7), (U.S. CLS. 2, 12, 13, 14, 19, 21, 23, 25, 31, 34, 35 AND 50). SN 77-861,714. PUB. 4-6-2010. FILED 10-30-2009.
- 3,806,885. **MOGG (STANDARD CHARACTER)**, MOGG CONSTRUCTIVE INC., (U.S. CLS. 2, 12, 13, 14, 23, 25 AND 50). SN 77-864,788. PUB. 4-6-2010. FILED 11-4-2009.
- 3,806,892. **JHICKEY (STYLIZED)**, JAMEY YON, (U.S. CLS. 2, 12, 13, 14, 23, 25 AND 50). SN 77-865,104. PUB. 4-6-2010. FILED 11-4-2009.
- 3,807,021. **LEAFREE AND DESIGN**, GP INDUSTRIES, LLC, (U.S. CLS. 2, 12, 13, 14, 23, 25 AND 50). SN 77-886,785. PUB. 4-6-2010. FILED 12-4-2009.
- 3,807,025. **5TH AND DESIGN**, LOCKHEED MARTIN CORPORATION, (U.S. CLS. 2, 12, 13, 14, 23, 25 AND 50). SN 77-890,166. PUB. 4-6-2010. FILED 12-10-2009.
- 3,807,046. **LEAFREE (STANDARD CHARACTER)**, GP INDUSTRIES, LLC, (U.S. CLS. 2, 12, 13, 14, 23, 25 AND 50). SN 77-917,234. PUB. 4-6-2010. FILED 1-21-2010.
- 3,807,068. **CONCIERGE AND DESIGN**, SPRINGBOARD RETAIL NETWORKS INC., MULTIPLE CLASS, (INT. CLS. 6, 9, 12, 21, 35, 36, 37, 38 AND 42), (U.S. CLS. 2, 12, 13, 14, 19, 21, 23, 25, 26, 29, 30, 31, 33, 35, 36, 38, 40, 44, 50, 100, 101, 102, 103, 104 AND 106). SN 78-742,448. PUB. 4-6-2010. FILED 10-28-2005.
- 3,807,100. **HNGJ AND DESIGN**, JIANGSU HUNING STEEL; MECHANISM CO., LTD, (U.S. CLS. 2, 12, 13, 14, 23, 25 AND 50). SN 79-051,939. PUB. 4-6-2010. FILED 3-20-2008.
- 3,807,104. **GREEMOTION (STANDARD CHARACTER)**, TESTRUT SERVICE GMBH, MULTIPLE CLASS, (INT. CLS. 6, 7, 8, 11, 12, 17, 18, 19, 20, 21, 22, 24, 26, 27 AND 31), (U.S. CLS. 1, 2, 3, 5, 7, 12, 13, 14, 19, 20, 21, 22, 23, 25, 28, 29, 30, 31, 32, 33, 34, 35, 37, 39, 40, 41, 42, 44, 46 AND 50). SN 79-054,633. PUB. 4-6-2010. FILED 11-21-2007.
- 3,807,106. **SUMEBORE (STANDARD CHARACTER)**, SULZER METCO MANAGEMENT AG, MULTIPLE CLASS, (INT. CLS. 6, 37 AND 40), (U.S. CLS. 2, 12, 13, 14, 23, 25, 50, 100, 103 AND 106). SN 79-056,070. PUB. 4-6-2010. FILED 2-27-2008.
- 3,807,116. **LASTO (STYLIZED)**, MAGEBA S.A., MULTIPLE CLASS, (INT. CLS. 6 AND 19), (U.S. CLS. 1, 2, 12, 13, 14, 23, 25, 33 AND 50). SN 79-059,366. PUB. 4-6-2010. FILED 6-20-2008.
- 3,807,122. **KITZ (STYLIZED)**, KITZ CORPORATION, MULTIPLE CLASS, (INT. CLS. 6, 7, 9, 11, 12, 17, 20 AND 37), (U.S. CLS. 1, 2, 5, 12, 13, 14, 19, 21, 22, 23, 25, 26, 31, 32, 34, 35, 36, 38, 44, 50, 100, 103 AND 106). SN 79-061,128. PUB. 4-6-2010. FILED 3-31-2008.
- 3,807,136 (*See Class 3 for this trademark*).
- 3,807,142. **NIHONSPINDLE AND DESIGN**, NIHON SPINDLE MFG. CO., LTD., MULTIPLE CLASS, (INT. CLS. 6, 7, 11 AND 19), (U.S. CLS. 1, 2, 12, 13, 14, 19, 21, 23, 25, 31, 33, 34, 35 AND 50). SN 79-063,727. PUB. 4-6-2010. FILED 9-29-2008.
- 3,807,184. **KOTT-STREAM (STANDARD CHARACTER)**, KOTTMANN GOSLA GMBH, MULTIPLE CLASS, (INT. CLS. 6, 11 AND 17), (U.S. CLS. 1, 2, 5, 12, 13, 14, 21, 23, 25, 31, 34, 35 AND 50). SN 79-068,674. PUB. 4-6-2010. FILED 4-27-2009.
- 3,807,190. **XOLUTION (STANDARD CHARACTER)**, CAP TECHNOLOGIES GMBH, MULTIPLE CLASS, (INT. CLS. 6, 20, 21 AND 42), (U.S. CLS. 2, 12, 13, 14, 22, 23, 25, 29, 30, 32, 33, 40, 50, 100 AND 101). SN 79-068,941. PUB. 4-6-2010. FILED 3-24-2009.
- 3,807,209. **FOIN (STANDARD CHARACTER)**, SPERIAN PROTECTION GLOVES; PLANCHER BAS, MULTIPLE CLASS, (INT. CLS. 6, 9, 17 AND 21), (U.S. CLS. 1, 2, 5, 12, 13, 14, 21, 23, 25, 26, 29, 30, 33, 35, 36, 38, 40 AND 50). SN 79-069,664. PUB. 4-6-2010. FILED 1-27-2009.
- 3,807,264. **VALPES (STANDARD CHARACTER)**, VALPES, MULTIPLE CLASS, (INT. CLS. 6, 7, 9 AND 20), (U.S. CLS. 2, 12, 13, 14, 19, 21, 22, 23, 25, 26, 31, 32, 34, 35, 36, 38 AND 50). SN 79-071,360. PUB. 4-6-2010. FILED 12-10-2008.
- 3,807,269. **MISCELLANEOUS DESIGN**, HETTICH MARKETING- UND VERTRIEBS; GMBH & CO. KG, MULTIPLE CLASS, (INT. CLS. 6, 20 AND 21), (U.S. CLS. 2, 12, 13, 14, 22, 23, 25, 29, 30, 32, 33, 40 AND 50). SN 79-071,696. PUB. 4-6-2010. FILED 3-11-2009.
- 3,807,285. **T TORGAR AND DESIGN**, SALTEC; EQUIPOS PARA LA CONSTRUCCION, S.A., MULTIPLE CLASS, (INT. CLS. 6, 7 AND 35), (U.S. CLS. 2, 12, 13, 14, 19, 21, 23, 25, 31, 34, 35, 50, 100, 101 AND 102). SN 79-072,452. PUB. 4-6-2010. FILED 3-31-2009.
- 3,807,325. **TJEP FASTENING SYSTEMS AND DESIGN**, UNIMERCO FASTENING A/S, MULTIPLE CLASS, (INT. CLS. 6, 7 AND 37), (U.S. CLS. 2, 12, 13, 14, 19, 21, 23, 25, 31, 34, 35, 50, 100, 103 AND 106). SN 79-074,726. PUB. 4-6-2010. FILED 9-23-2009.

CLASS 7—MACHINERY

3,805,124 (*See Class 1 for this trademark*).

3,805,144. **PETRALITE (STANDARD CHARACTER)**, CAL-

- VARY DESIGN TEAM INC., MULTIPLE CLASS, (INT. CLS. 7 AND 12), (U.S. CLS. 13, 19, 21, 23, 31, 34, 35 AND 44). SN 76-697,182. PUB. 4-6-2010. FILED 5-4-2009.
- 3,805,146. **I CONTROL SYSTEM AND DESIGN**. AUTOMOTIVE INDUSTRIAL MARKETING CORPORATION, (U.S. CLS. 13, 19, 21, 23, 31, 34 AND 35). SN 76-697,928. PUB. 4-6-2010. FILED 6-16-2009.
- 3,805,185. **MTUPLUS (STYLIZED)**. MTU AERO ENGINES GMBH, MULTIPLE CLASS, (INT. CLS. 7, 11, 16, 37, 40 AND 42), (U.S. CLS. 2, 5, 13, 19, 21, 22, 23, 29, 31, 34, 35, 37, 38, 50, 100, 101, 103 AND 106). SN 77-025,229. PUB. 4-6-2010. FILED 10-19-2006.
- 3,805,201. **STEAM STATIC (STANDARD CHARACTER)**. LG ELECTRONICS INC., MULTIPLE CLASS, (INT. CLS. 7 AND 11), (U.S. CLS. 13, 19, 21, 23, 31, 34 AND 35). SN 77-240,808. PUB. 1-19-2010. FILED 7-27-2007.
- 3,805,202 (*See Class 6 for this trademark*).
- 3,805,206. **DURATOMIC (STANDARD CHARACTER)**. SECO TOOLS AB, (U.S. CLS. 13, 19, 21, 23, 31, 34 AND 35). SN 77-287,131. PUB. 4-6-2010. FILED 9-24-2007.
- 3,805,207. **DURA-SPIN (STANDARD CHARACTER)**. ITT WATER & WASTEWATER AB, (U.S. CLS. 13, 19, 21, 23, 31, 34 AND 35). SN 77-294,671. PUB. 4-6-2010. FILED 10-3-2007.
- 3,805,272 (*See Class 4 for this trademark*).
- 3,805,273 (*See Class 4 for this trademark*).
- 3,805,345. **MARINE METAL PRODUCTS AND DESIGN**. MARINE METAL PRODUCTS CO., (U.S. CLS. 13, 19, 21, 23, 31, 34 AND 35). SN 77-572,378. PUB. 4-6-2010. FILED 9-17-2008.
- 3,805,403. **DESIGN BASED ANCHORING SYSTEM AND DESIGN**. DELAWARE CAPITAL FORMATION, INC., (U.S. CLS. 13, 19, 21, 23, 31, 34 AND 35). SN 77-624,475. PUB. 4-6-2010. FILED S.R. 12-2-2008; AM. P.R. 1-14-2010.
- 3,805,425 (*See Class 4 for this trademark*).
- 3,805,562. **FEEDMAX (STANDARD CHARACTER)**. WITTMAN ROBOT SYSTEME GMBH, (U.S. CLS. 13, 19, 21, 23, 31, 34 AND 35). SN 77-723,628. PUB. 4-6-2010. FILED 4-28-2009.
- 3,805,606. **MEBIC (STANDARD CHARACTER)**. MULTIBEAM SYSTEMS, INC. AKA MULTIBEAM CORPORATION, (U.S. CLS. 13, 19, 21, 23, 31, 34 AND 35). SN 77-730,733. PUB. 4-6-2010. FILED 5-6-2009.
- 3,805,661. **TOKIRON (STANDARD CHARACTER)**. MAXIS CORPORATION, (U.S. CLS. 13, 19, 21, 23, 31, 34 AND 35). SN 77-740,264. PUB. 4-6-2010. FILED 5-19-2009.
- 3,805,675. **OEC GRAPHICS AND DESIGN**. OEC GRAPHIC, INC., DBA OEC GRAPHICS, INC., (U.S. CLS. 13, 19, 21, 23, 31, 34 AND 35). SN 77-742,216. PUB. 4-6-2010. FILED 5-21-2009.
- 3,805,758. **BIONAIRE (STANDARD CHARACTER)**. SUNBEAM PRODUCTS, INC., DBA JARDEN CONSUMER SOLUTIONS, (U.S. CLS. 13, 19, 21, 23, 31, 34 AND 35). SN 77-760,774. PUB. 4-6-2010. FILED 6-16-2009.
- 3,805,763. **U-MARQ AND DESIGN**. U-MARQ LTD, MULTIPLE CLASS, (INT. CLS. 7 AND 9), (U.S. CLS. 13, 19, 21, 23, 26, 31, 34, 35, 36 AND 38). SN 77-761,705. PUB. 4-6-2010. FILED 6-17-2009.
- 3,805,767. **BIONAIRE AND DESIGN**. SUNBEAM PRODUCTS, INC., DBA JARDEN CONSUMER SOLUTIONS, (U.S. CLS. 13, 19, 21, 23, 31, 34 AND 35). SN 77-762,946. PUB. 4-6-2010. FILED 6-18-2009.
- 3,805,826. **STOKES (STANDARD CHARACTER)**. EDWARDS LIMITED, MULTIPLE CLASS, (INT. CLS. 7 AND 11), (U.S. CLS. 13, 19, 21, 23, 31, 34 AND 35). SN 77-779,371. PUB. 4-6-2010. FILED 7-13-2009.
- 3,806,056. **SONNAX (STANDARD CHARACTER)**. SONNAX INDUSTRIES, INC., MULTIPLE CLASS, (INT. CLS. 7 AND 12), (U.S. CLS. 13, 19, 21, 23, 31, 34, 35 AND 44). SN 77-825,746. PUB. 4-6-2010. FILED 9-14-2009.
- 3,806,098. **VAN STONE CONVEYOR (STANDARD CHARACTER)**. VAN STONE CONVEYOR INC., (U.S. CLS. 13, 19, 21, 23, 31, 34 AND 35). SN 77-834,368. PUB. 4-6-2010. FILED 9-24-2009.
- 3,806,157. **CLO2IX (STYLIZED)**. DRIPPING WET WATER, INC., (U.S. CLS. 13, 19, 21, 23, 31, 34 AND 35). SN 77-841,757. PUB. 4-6-2010. FILED 10-5-2009.
- 3,806,159. **DIAMOND DEVIL (STANDARD CHARACTER)**. PALMER BIT CO., INC., (U.S. CLS. 13, 19, 21, 23, 31, 34 AND 35). SN 77-842,157. PUB. 4-6-2010. FILED 10-6-2009.
- 3,806,343. **NEXTRAL (STANDARD CHARACTER)**. PLASMATHERM LLC, (U.S. CLS. 13, 19, 21, 23, 31, 34 AND 35). SN 77-856,218. PUB. 4-6-2010. FILED 10-23-2009.
- 3,806,376. **DUALOMIX (STANDARD CHARACTER)**. GLV FINANCE HUNGARY KFT., MULTIPLE CLASS, (INT. CLS. 7 AND 11), (U.S. CLS. 13, 19, 21, 23, 31, 34 AND 35). SN 77-857,141. PUB. 4-6-2010. FILED 10-26-2009.
- 3,806,388. **NEXLUME (STANDARD CHARACTER)**. BERNAL, GUSTAVUS, (U.S. CLS. 13, 19, 21, 23, 31, 34 AND 35). SN 77-857,492. PUB. 4-6-2010. FILED 10-26-2009.
- 3,806,416. **AMERIPUMPS (STANDARD CHARACTER)**. AMERIPUMPS, LLC, (U.S. CLS. 13, 19, 21, 23, 31, 34 AND 35). SN 77-858,132. PUB. 4-6-2010. FILED 10-27-2009.
- 3,806,510. **CYCLOPS (STANDARD CHARACTER)**. CENTER ROCK, INC., (U.S. CLS. 13, 19, 21, 23, 31, 34 AND 35). SN 77-859,018. PUB. 4-6-2010. FILED 10-28-2009.
- 3,806,511. **TALSA AND DESIGN**. TALSABELL S.A.U., (U.S. CLS. 13, 19, 21, 23, 31, 34 AND 35). SN 77-859,051. PUB. 4-6-2010. FILED 10-28-2009.
- 3,806,581. **PRO-JECTOR AND DESIGN**. HAYS, TIM, (U.S. CLS. 13, 19, 21, 23, 31, 34 AND 35). SN 77-859,858. PUB. 4-6-2010. FILED 10-28-2009.
- 3,806,596. **FEATURE AND DESIGN**. FEATURE-TEC (WUXI) FILTRATION TECHNOLOGY CO., LTD., MULTIPLE CLASS, (INT. CLS. 7 AND 11), (U.S. CLS. 13, 19, 21, 23, 31, 34 AND 35). SN 77-859,998. PUB. 4-6-2010. FILED 10-29-2009.
- 3,806,652. **PUROX (STANDARD CHARACTER)**. ESAB GROUP, INC., (U.S. CLS. 13, 19, 21, 23, 31, 34 AND 35). SN 77-860,615. PUB. 4-6-2010. FILED 10-29-2009.
- 3,806,727. **TYPICAL (STYLIZED)**. XIAN TYPICAL INDUSTRIES CO., LTD., (U.S. CLS. 13, 19, 21, 23, 31, 34 AND 35). SN 77-861,615. PUB. 4-6-2010. FILED 10-30-2009.
- 3,806,737 (*See Class 6 for this trademark*).
- 3,806,760. **TRANERGY (STANDARD CHARACTER)**. TRANERGY CORPORATION, (U.S. CLS. 13, 19, 21, 23, 31, 34 AND 35). SN 77-862,101. PUB. 4-6-2010. FILED 10-31-2009.
- 3,807,085. **WINDSTREAM (STANDARD CHARACTER)**. KERR, COLIN CHARLES, (U.S. CLS. 13, 19, 21, 23, 31, 34 AND 35). SN 78-910,768. PUB. 4-6-2010. FILED 6-18-2006.
- 3,807,090. **COM-PAK (STANDARD CHARACTER)**. CPM WOLVERINE PROCTOR, LLC, MULTIPLE CLASS, (INT. CLS. 7 AND 11), (U.S. CLS. 13, 19, 21, 23, 31, 34 AND 35). SN 79-029,043. PUB. 2-5-2008. FILED 2-8-2006.
- 3,807,104 (*See Class 6 for this trademark*).
- 3,807,109 (*See Class 2 for this trademark*).
- 3,807,118. **THE AGROVISION COMPANY (STYLIZED)**. LEMKEN GMBH & CO. KG, (U.S. CLS. 13, 19, 21, 23, 31, 34 AND 35). SN 79-059,990. PUB. 4-6-2010. FILED 8-14-2008.
- 3,807,120. **FLEXMACHINING (STANDARD CHARACTER)**. ABB AG, MULTIPLE CLASS, (INT. CLS. 7 AND 9), (U.S. CLS. 13, 19, 21, 23, 26, 31, 34, 35, 36 AND 38). SN 79-060,098. PUB. 4-6-2010. FILED 9-30-2008.
- 3,807,121. **FLEXFINISHING (STANDARD CHARACTER)**. ABB AG, MULTIPLE CLASS, (INT. CLS. 7 AND 9), (U.S. CLS. 13, 19, 21, 23, 26, 31, 34, 35, 36 AND 38). SN 79-060,821. PUB. 4-6-2010. FILED 10-8-2008.
- 3,807,122 (*See Class 6 for this trademark*).
- 3,807,126. **IPROS (STANDARD CHARACTER)**. WEBASTO AG, MULTIPLE CLASS, (INT. CLS. 7, 9, 11 AND 12), (U.S. CLS. 13, 19, 21, 23, 26, 31, 34, 35, 36, 38 AND 44). SN 79-061,461. PUB. 4-6-2010. FILED 3-10-2008.
- 3,807,142 (*See Class 6 for this trademark*).
- 3,807,148. **BERU (STANDARD CHARACTER)**. BERU AG, MULTIPLE CLASS, (INT. CLS. 7, 9 AND 11), (U.S. CLS. 13, 19, 21, 23, 26, 31, 34, 35, 36 AND 38). SN 79-064,748. PUB. 4-6-2010. FILED 2-18-2008.
- 3,807,163. **B BECK (STYLIZED)**. BECK GMBH DRUCKKONTROLLTECHNIK, MULTIPLE CLASS, (INT. CLS. 7 AND 9), (U.S. CLS. 13, 19, 21, 23, 26, 31, 34, 35, 36 AND 38). SN 79-067,347. PUB. 4-6-2010. FILED 11-27-2008.
- 3,807,175. **IZUMI (STANDARD CHARACTER)**. LIMITED LIABILITY COMPANY; "BTK TRADING LTD", MULTIPLE CLASS, (INT. CLS. 7, 9 AND 11), (U.S. CLS. 13, 19, 21, 23, 26, 31, 34, 35, 36 AND 38). SN 79-068,104. PUB. 4-6-2010. FILED 1-19-2009.
- 3,807,178. **YONGMAO (STYLIZED)**. FUSHUN YONGMAO

- CONSTRUCTION MACHINERY CO., LTD. (U.S. CLS. 13, 19, 21, 23, 31, 34 AND 35). SN 79-068,512. PUB. 4-6-2010. FILED 4-15-2009.
- 3,807,186. **SPIKE (STANDARD CHARACTER)**. FORMFIBER DENMARK APS, MULTIPLE CLASS, (INT. CLS. 7, 17 AND 22), (U.S. CLS. 1, 2, 5, 7, 12, 13, 19, 21, 22, 23, 31, 34, 35, 42 AND 50). SN 79-068,768. PUB. 4-6-2010. FILED 3-23-2009.
- 3,807,193. **EF-DRILL (STANDARD CHARACTER)**. EMUGE-WERK RICHARD GLIMPEL GMBH & CO KG FABRIK FÜR PRÄZISIONSWERKZEUGE, (U.S. CLS. 13, 19, 21, 23, 31, 34 AND 35). SN 79-069,065. PUB. 4-6-2010. FILED 4-22-2009.
- 3,807,197. **PLASSER (STYLIZED)**. FRANZ PLASSER BAHNBAUMASCHINEN-; INDUSTRIEGESELLSCHAFT MBH, MULTIPLE CLASS, (INT. CLS. 7, 12 AND 37), (U.S. CLS. 13, 19, 21, 23, 31, 34, 35, 44, 100, 103 AND 106). SN 79-069,247. PUB. 4-6-2010. FILED 2-5-2009.
- 3,807,199. **F- (STANDARD CHARACTER)**. SCHAEFFLER KG, MULTIPLE CLASS, (INT. CLS. 7 AND 12), (U.S. CLS. 13, 19, 21, 23, 31, 34, 35 AND 44). SN 79-069,368. PUB. 4-6-2010. FILED 9-16-2008.
- 3,807,229. **MISCELLANEOUS DESIGN**. GRASAR PTY LTD, MULTIPLE CLASS, (INT. CLS. 7, 37, 40, 41 AND 42), (U.S. CLS. 13, 19, 21, 23, 31, 34, 35, 100, 101, 103, 106 AND 107). SN 79-070,058. PUB. 4-6-2010. FILED 4-23-2009.
- 3,807,246. **RAYCOP AND DESIGN**. BUKANG SEMS CO., LTD., MULTIPLE CLASS, (INT. CLS. 7 AND 11), (U.S. CLS. 13, 19, 21, 23, 31, 34 AND 35). SN 79-070,510. PUB. 4-6-2010. FILED 5-1-2009.
- 3,807,261 (*See Class 1 for this trademark*).
- 3,807,264 (*See Class 6 for this trademark*).
- 3,807,283. **S3 (STYLIZED)**. INDESIT COMPANY SPA, MULTIPLE CLASS, (INT. CLS. 7, 9 AND 11), (U.S. CLS. 13, 19, 21, 23, 26, 31, 34, 35, 36 AND 38). SN 79-072,238. PUB. 4-6-2010. FILED 6-17-2009.
- 3,807,284 (*See Class 1 for this trademark*).
- 3,807,285 (*See Class 6 for this trademark*).
- 3,807,308. **CLAD BOY (STYLIZED)**. ARIE E. DE GROOT H.O.D.N. VIAVAC VACUUM LIFTING, DBA VIAVAC VACUUM LIFTING, MULTIPLE CLASS, (INT. CLS. 7 AND 37), (U.S. CLS. 13, 19, 21, 23, 31, 34, 35, 100, 103 AND 106). SN 79-073,678. PUB. 4-6-2010. FILED 8-31-2009.
- 3,807,320. **KCLASS (STYLIZED)**. BIZERBA GMBH & CO. KG, MULTIPLE CLASS, (INT. CLS. 7, 9 AND 16), (U.S. CLS. 2, 5, 13, 19, 21, 22, 23, 26, 29, 31, 34, 35, 36, 37, 38 AND 50). SN 79-074,540. PUB. 4-6-2010. FILED 7-23-2009.
- 3,807,325 (*See Class 6 for this trademark*).
- 3,807,340. **J-SERIES (STYLIZED)**. MITSUBISHI HEAVY INDUSTRIES, LTD., (U.S. CLS. 13, 19, 21, 23, 31, 34 AND 35). SN 79-075,703. PUB. 4-6-2010. FILED 10-26-2009.

CLASS 8—HAND TOOLS

- 3,805,124 (*See Class 1 for this trademark*).
- 3,805,720. **POWER JAWS (STANDARD CHARACTER)**. STREAMWORKS, INC., (U.S. CLS. 23, 28 AND 44). SN 77-751,614. PUB. 4-6-2010. FILED 6-3-2009.
- 3,806,135. **OREGON PROUD PORTLAND, OREGON AND DESIGN**. LEATHERMAN TOOL GROUP, INC., MULTIPLE CLASS, (INT. CLS. 8, 11 AND 25), (U.S. CLS. 13, 21, 22, 23, 28, 31, 34, 39 AND 44). SN 77-838,584. PUB. 4-6-2010. FILED 9-30-2009.
- 3,806,259. **PROCAULK (STANDARD CHARACTER)**. NATIONAL EXPRESS, INC., (U.S. CLS. 23, 28 AND 44). SN 77-852,018. PUB. 4-6-2010. FILED 10-19-2009.
- 3,806,491 (*See Class 3 for this trademark*).
- 3,806,561. **THE FOOD FAIRY (STANDARD CHARACTER)**. MCCLERNON, TERRI, (U.S. CLS. 23, 28 AND 44). SN 77-859,728. PUB. 4-6-2010. FILED 10-28-2009.
- 3,806,628. **LO-BLOW (STANDARD CHARACTER)**. IRIS RUBBER COMPANY INC, (U.S. CLS. 23, 28 AND 44). SN 77-860,355. PUB. 4-6-2010. FILED 10-29-2009.
- 3,807,104 (*See Class 6 for this trademark*).
- 3,807,108. **WAGYU (STANDARD CHARACTER)**. METALLWARENFABRIK MARKTOBERDORF; GMBH & CO. KG, MULTIPLE CLASS, (INT. CLS. 8, 9 AND 21), (U.S. CLS. 2,

- 13, 21, 23, 26, 28, 29, 30, 33, 36, 38, 40, 44 AND 50). SN 79-056,797. PUB. 12-29-2009. FILED 12-17-2007.
- 3,807,128. **MERKEL (STANDARD CHARACTER)**. MERKEL JAGD- UND SPORTWAFFEN GMBH, MULTIPLE CLASS, (INT. CLS. 8 AND 13), (U.S. CLS. 2, 9, 23, 28 AND 44). SN 79-061,770. PUB. 4-6-2010. FILED 9-22-2008.
- 3,807,177. **WMF (STYLIZED)**. WMF WÜRTEMBERGISCHE METALLWARENFABRIK; AKTIENGESELLSCHAFT, MULTIPLE CLASS, (INT. CLS. 8 AND 21), (U.S. CLS. 2, 13, 23, 28, 29, 30, 33, 40, 44 AND 50). SN 79-068,472. PUB. 4-6-2010. FILED 2-6-2009.
- 3,807,271 (*See Class 3 for this trademark*).

CLASS 9—ELECTRICAL AND SCIENTIFIC APPARATUS

- 3,805,124 (*See Class 1 for this trademark*).
- 3,805,125. **HALCON**. MVTEC SOFTWARE GMBH, (U.S. CLS. 21, 23, 26, 36 AND 38). SN 75-932,774. PUB. 5-15-2007. FILED 3-1-2000.
- 3,805,149. **SATA AIR TESTER (STANDARD CHARACTER)**. SATA GMBH & CO. KG, MULTIPLE CLASS, (INT. CLS. 9, 16, 20 AND 42), (U.S. CLS. 2, 5, 13, 21, 22, 23, 25, 26, 29, 32, 36, 37, 38, 50, 100 AND 101). SN 76-698,549. PUB. 4-6-2010. FILED 7-20-2009.
- 3,805,151. **ENOVA (STANDARD CHARACTER)**. AMX LLC, (U.S. CLS. 21, 23, 26, 36 AND 38). SN 76-698,685. PUB. 4-6-2010. FILED 7-29-2009.
- 3,805,163. **ME FIRST (STANDARD CHARACTER)**. OFFICE IMAGES, INC., DBA TRAINERS WAREHOUSE, (U.S. CLS. 21, 23, 26, 36 AND 38). SN 76-699,733. PUB. 4-6-2010. FILED 10-5-2009.
- 3,805,167. **WHOSON (STANDARD CHARACTER)**. PARKER SOFTWARE LIMITED, MULTIPLE CLASS, (INT. CLS. 9 AND 42), (U.S. CLS. 21, 23, 26, 36, 38, 100 AND 101). SN 76-699,967. PUB. 4-6-2010. FILED 10-21-2009.
- 3,805,171. **QTRAK (STANDARD CHARACTER)**. TRI STATE DISTRIBUTION, INC, MULTIPLE CLASS, (INT. CLS. 9 AND 35), (U.S. CLS. 21, 23, 26, 36, 38, 100, 101 AND 102). SN 76-700,166. PUB. 4-6-2010. FILED 11-2-2009.
- 3,805,175. **SNAKE GUARD AND DESIGN**. FOREVERLAST HUNTING PRODUCTS, INC., (U.S. CLS. 21, 23, 26, 36 AND 38). SN 76-700,218. PUB. 4-6-2010. FILED 11-3-2009.
- 3,805,180. **DISPLAYLINK (STANDARD CHARACTER)**. DISPLAYLINK CORP, MULTIPLE CLASS, (INT. CLS. 9 AND 42), (U.S. CLS. 21, 23, 26, 36, 38, 100 AND 101). SN 77-004,881. PUB. 4-6-2010. FILED 9-21-2006.
- 3,805,181. **HENNESSY ARTISTRY (STANDARD CHARACTER)**. SOCIETE JAS HENNESSY & CO., MULTIPLE CLASS, (INT. CLS. 9, 25, 35 AND 41), (U.S. CLS. 21, 22, 23, 26, 36, 38, 39, 100, 101, 102 AND 107). SN 77-006,846. PUB. 4-6-2010. FILED 9-25-2006.
- 3,805,186. **VIKING SOFTWARE SOLUTIONS AND DESIGN**. PHOENIX SOFTWARE INTERNATIONAL, INC., MULTIPLE CLASS, (INT. CLS. 9 AND 42), (U.S. CLS. 21, 23, 26, 36, 38, 100 AND 101). SN 77-037,926. PUB. 4-6-2010. FILED 11-6-2006.
- 3,805,195. **MOBISecure (STANDARD CHARACTER)**. DIVERSINET CORP., MULTIPLE CLASS, (INT. CLS. 9 AND 45), (U.S. CLS. 21, 23, 26, 36, 38, 100 AND 101). SN 77-182,595. PUB. 4-6-2010. FILED 5-16-2007.
- 3,805,215. **COMPUVISION (STANDARD CHARACTER)**. DAVIS VISION, INC., (U.S. CLS. 21, 23, 26, 36 AND 38). SN 77-328,343. PUB. 4-6-2010. FILED 11-13-2007.
- 3,805,224. **PIRATES & TREASURES (STANDARD CHARACTER)**. MONOSCOOP B.V., (U.S. CLS. 21, 23, 26, 36 AND 38). SN 77-352,565. PUB. 4-6-2010. FILED 12-14-2007.
- 3,805,227. **XTREME BINGO (STANDARD CHARACTER)**. MONOSCOOP, B.V., (U.S. CLS. 21, 23, 26, 36 AND 38). SN 77-360,738. PUB. 4-6-2010. FILED 12-28-2007.
- 3,805,228. **BINGO DREAM (STANDARD CHARACTER)**. MONOSCOOP, B.V., (U.S. CLS. 21, 23, 26, 36 AND 38). SN 77-360,744. PUB. 4-6-2010. FILED 12-28-2007.
- 3,805,230 (*See Class 3 for this trademark*).
- 3,805,236. **WHITE GLOVE (STANDARD CHARACTER)**. MONOSCOOP, B.V., (U.S. CLS. 21, 23, 26, 36 AND 38). SN

- 77-388,499. PUB. 4-6-2010. FILED 2-5-2008.
- 3,805,240. **STOCK MARKET CHALLENGE (STANDARD CHARACTER)**. CAUSE DIRECT EDUCATION, FORMERLY CAUSE DIRECT EDUCATION LTD., MULTIPLE CLASS, (INT. CLS. 9 AND 41), (U.S. CLS. 21, 23, 26, 36, 38, 100, 101 AND 107). SN 77-402,253. PUB. 6-30-2009. FILED 2-21-2008.
- 3,805,244. **LIVE IN A FLASH (STANDARD CHARACTER)**. ADERRA INC., DBA EDWARD DONNELLY, (U.S. CLS. 21, 23, 26, 36 AND 38). SN 77-411,108. PUB. 10-21-2008. FILED 3-3-2008.
- 3,805,256. **METACAUSE (STANDARD CHARACTER)**. METACAUSE SOLUTIONS LIMITED, MULTIPLE CLASS, (INT. CLS. 9, 16, 35, 41 AND 42), (U.S. CLS. 2, 5, 21, 22, 23, 26, 29, 36, 37, 38, 50, 100, 101, 102 AND 107). SN 77-435,518. PUB. 4-6-2010. FILED 3-31-2008.
- 3,805,259. **MYSONICTONIC (STANDARD CHARACTER)**. MYSONICTONIC, LLC, MULTIPLE CLASS, (INT. CLS. 9, 35, 38, 41 AND 42), (U.S. CLS. 21, 23, 26, 36, 38, 100, 101, 102, 104 AND 107). SN 77-446,229. PUB. 4-6-2010. FILED 4-11-2008.
- 3,805,265. **XMEDIUSFAX (STANDARD CHARACTER)**. SAGEM-INTERSTAR, INC., (U.S. CLS. 21, 23, 26, 36 AND 38). SN 77-461,126. PUB. 12-29-2009. FILED 4-29-2008.
- 3,805,269. **GEON AND DESIGN**. STRAWDOG STUDIOS LTD, (U.S. CLS. 21, 23, 26, 36 AND 38). SN 77-479,838. PUB. 1-19-2010. FILED 5-21-2008.
- 3,805,272 (*See Class 4 for this trademark*).
- 3,805,273 (*See Class 4 for this trademark*).
- 3,805,279. **CHECKED THE TEMPERATURE LATELY? (STANDARD CHARACTER)**. MIRATREK, INC., (U.S. CLS. 21, 23, 26, 36 AND 38). SN 77-484,729. PUB. 4-6-2010. FILED 5-28-2008.
- 3,805,287. **PGAP-TEL (STANDARD CHARACTER)**. PDP PROGRAM INC., MULTIPLE CLASS, (INT. CLS. 9, 41 AND 44), (U.S. CLS. 21, 23, 26, 36, 38, 100, 101 AND 107). SN 77-487,015. PUB. 4-6-2010. FILED 5-30-2008.
- 3,805,297. **LOANREACH (STANDARD CHARACTER)**. EUROCLEAR SA/NV, MULTIPLE CLASS, (INT. CLS. 9, 36 AND 38), (U.S. CLS. 21, 23, 26, 36, 38, 100, 101, 102 AND 104). SN 77-499,719. PUB. 4-6-2010. FILED 6-16-2008.
- 3,805,308. **BLACKWAVE AND DESIGN**. MONOSCOOP, B.V., (U.S. CLS. 21, 23, 26, 36 AND 38). SN 77-528,348. PUB. 4-6-2010. FILED 7-22-2008.
- 3,805,309. **ZITRO CASH (STANDARD CHARACTER)**. MONOSCOOP, B.V., (U.S. CLS. 21, 23, 26, 36 AND 38). SN 77-528,365. PUB. 4-6-2010. FILED 7-22-2008.
- 3,805,313. **THE PRICE EXPERIENCE AND DESIGN**. E.H. PRICE LIMITED, MULTIPLE CLASS, (INT. CLS. 9, 11, 37 AND 42), (U.S. CLS. 13, 21, 23, 26, 31, 34, 36, 38, 100, 101, 103 AND 106). SN 77-537,401. PUB. 4-6-2010. FILED 8-1-2008.
- 3,805,317. **TRACK IT SLEEP WALKER (STANDARD CHARACTER)**. LIFELINES LIMITED, MULTIPLE CLASS, (INT. CLS. 9 AND 10), (U.S. CLS. 21, 23, 26, 36, 38, 39 AND 44). SN 77-542,835. PUB. 4-6-2010. FILED 8-8-2008.
- 3,805,318. **VIZBYBIS2 AND DESIGN**. BUSINESS INTELLIGENCE SOLUTIONS SAFE B.V., MULTIPLE CLASS, (INT. CLS. 9 AND 35), (U.S. CLS. 21, 23, 26, 36, 38, 100, 101 AND 102). SN 77-543,555. PUB. 4-6-2010. FILED 8-11-2008.
- 3,805,321. **EGYPTIAN GOLD (STANDARD CHARACTER)**. ATRONIC INTERNATIONAL GMBH, (U.S. CLS. 21, 23, 26, 36 AND 38). SN 77-548,981. PUB. 4-6-2010. FILED 8-18-2008.
- 3,805,322. **EGYPTIAN DREAMS (STANDARD CHARACTER)**. ATRONIC INTERNATIONAL GMBH, (U.S. CLS. 21, 23, 26, 36 AND 38). SN 77-548,983. PUB. 4-6-2010. FILED 8-18-2008.
- 3,805,331. **UNISON AND DESIGN**. UNISON TECHNOLOGIES, INC., MULTIPLE CLASS, (INT. CLS. 9, 38, 39 AND 42), (U.S. CLS. 21, 23, 26, 36, 38, 100, 101, 104 AND 105). SN 77-557,872. PUB. 4-6-2010. FILED 8-28-2008.
- 3,805,344. **MAGNUM SEMICONDUCTOR AND DESIGN**. MAGNUM SEMICONDUCTOR, INC., (U.S. CLS. 21, 23, 26, 36 AND 38). SN 77-567,277. PUB. 2-10-2009. FILED 9-10-2008.
- 3,805,346. **GARNEAU AND DESIGN**. 9001-6262QUÉBEC INC., MULTIPLE CLASS, (INT. CLS. 9, 12, 18, 25 AND 28), (U.S. CLS. 1, 2, 3, 19, 21, 22, 23, 26, 31, 35, 36, 38, 39, 41, 44 AND 50). SN 77-573,357. PUB. 4-6-2010. FILED 9-18-2008.
- 3,805,347. **MISCELLANEOUS DESIGN**. 9001-6262QUÉBEC INC., MULTIPLE CLASS, (INT. CLS. 9, 12, 18, 25 AND 28), (U.S. CLS. 1, 2, 3, 19, 21, 22, 23, 26, 31, 35, 36, 38, 39, 41, 44 AND 50). SN 77-573,397. PUB. 4-6-2010. FILED 9-18-2008.
- 3,805,350. **L LEXUS AND DESIGN**. TOYOTA JIDOSHA KABUSHIKI KAISHA, TA TOYOTA MOTOR CORPORATION, MULTIPLE CLASS, (INT. CLS. 9 AND 24), (U.S. CLS. 21, 23, 26, 36, 38, 42 AND 50). SN 77-574,566. PUB. 10-13-2009. FILED 9-19-2008.
- 3,805,356. **EASY READER (STANDARD CHARACTER)**. FISHER SCIENTIFIC COMPANY L.L.C., (U.S. CLS. 21, 23, 26, 36 AND 38). SN 77-581,358. PUB. 4-6-2010. FILED 9-29-2008.
- 3,805,358. **ONENESS ACADEMY (STANDARD CHARACTER)**. FOR WORLD PEACE PTE LTD, (U.S. CLS. 21, 23, 26, 36 AND 38). SN 77-582,086. PUB. 4-6-2010. FILED 9-30-2008.
- 3,805,370 (*See Class 1 for this trademark*).
- 3,805,376. **AMBERLOUNGE (STYLIZED)**. AMBER LOUNGE LTD, MULTIPLE CLASS, (INT. CLS. 9, 25 AND 43), (U.S. CLS. 21, 22, 23, 26, 36, 38, 39, 100 AND 101). SN 77-595,186. PUB. 4-6-2010. FILED 10-17-2008.
- 3,805,380. **CRYOSTAR AND DESIGN**. LINDE, INC., (U.S. CLS. 21, 23, 26, 36 AND 38). SN 77-601,104. PUB. 4-6-2010. FILED 10-27-2008.
- 3,805,382. **PHILMONT (STANDARD CHARACTER)**. PHILMONT, INC., MULTIPLE CLASS, (INT. CLS. 9, 14, 16, 25, 26, 38 AND 41), (U.S. CLS. 2, 5, 21, 22, 23, 26, 27, 28, 29, 36, 37, 38, 39, 40, 42, 50, 100, 101, 104 AND 107). SN 77-601,331. PUB. 9-22-2009. FILED 10-27-2008.
- 3,805,383. **SNITCH (STANDARD CHARACTER)**. MENDEZ, ROQUE, AKA CHIKO MENDEZ, AND AYALA, JIMMY, (U.S. CLS. 21, 23, 26, 36 AND 38). SN 77-603,120. PUB. 4-6-2010. FILED 10-29-2008.
- 3,805,388. **THIN BLUE LINE AND DESIGN**. FIRST CHOICE ARMOR & EQUIPMENT, INC., (U.S. CLS. 21, 23, 26, 36 AND 38). SN 77-606,779. PUB. 4-6-2010. FILED 11-4-2008.
- 3,805,389. **AMBER BLUES AND DESIGN**. CLARK, JAMES, AND BRUMBERG, DAVID, MULTIPLE CLASS, (INT. CLS. 9, 25 AND 41), (U.S. CLS. 21, 22, 23, 26, 36, 38, 39, 100, 101 AND 107). SN 77-609,553. PUB. 4-6-2010. FILED 11-7-2008.
- 3,805,391. **OMNISCAN (STANDARD CHARACTER)**. OMNISOLV, INC., (U.S. CLS. 21, 23, 26, 36 AND 38). SN 77-612,490. PUB. 4-6-2010. FILED 11-12-2008.
- 3,805,400. **KICKSTART (STANDARD CHARACTER)**. APOGEE ELECTRONICS CORPORATION, (U.S. CLS. 21, 23, 26, 36 AND 38). SN 77-620,009. PUB. 4-6-2010. FILED 11-21-2008.
- 3,805,402. **MISCELLANEOUS DESIGN**. MODULOC CONTROLS LIMITED, (U.S. CLS. 21, 23, 26, 36 AND 38). SN 77-622,993. PUB. 4-6-2010. FILED 11-27-2008.
- 3,805,408. **ZOTAC (STYLIZED)**. ZOTAC INTERNATIONAL (MCO) LTD., (U.S. CLS. 21, 23, 26, 36 AND 38). SN 77-625,644. PUB. 4-6-2010. FILED 12-3-2008.
- 3,805,414. **OPTOPLEX (STANDARD CHARACTER)**. APPLIED MATERIALS GMBH & CO. KG, (U.S. CLS. 21, 23, 26, 36 AND 38). SN 77-633,179. PUB. 4-6-2010. FILED 12-15-2008.
- 3,805,425 (*See Class 4 for this trademark*).
- 3,805,430. **CCC (STYLIZED)**. CURRENT C CREATIVE, LLC, (U.S. CLS. 21, 23, 26, 36 AND 38). SN 77-642,628. PUB. 4-28-2009. FILED 1-2-2009.
- 3,805,438. **THE CITY CHURCH (STANDARD CHARACTER)**. THE CITY CHURCH, MULTIPLE CLASS, (INT. CLS. 9, 16, 41 AND 45), (U.S. CLS. 2, 5, 21, 22, 23, 26, 29, 36, 37, 38, 50, 100, 101 AND 107). SN 77-646,856. PUB. 4-6-2010. FILED 1-9-2009.
- 3,805,445. **ANTONIO DESIGN AND DESIGN**. ANTONIO PRECISE PRODUCTS MANUFACTORY LIMITED, (U.S. CLS. 21, 23, 26, 36 AND 38). SN 77-654,750. PUB. 4-6-2010. FILED 1-22-2009.
- 3,805,448. **ALLBUSINESS (STANDARD CHARACTER)**. DUN & BRADSTREET, INC., MULTIPLE CLASS, (INT. CLS. 9, 35 AND 41), (U.S. CLS. 21, 23, 26, 36, 38, 100, 101, 102 AND 107). SN 77-659,092. PUB. 4-6-2010. FILED 1-29-2009.
- 3,805,450. **ALLBUSINESS AND DESIGN**. DUN & BRADSTREET, INC., MULTIPLE CLASS, (INT. CLS. 9, 35 AND 41), (U.S. CLS. 21, 23, 26, 36, 38, 100, 101, 102 AND 107). SN 77-659,894. PUB. 4-6-2010. FILED 1-30-2009.
- 3,805,469. **PENTON (STANDARD CHARACTER)**. PENTON MEDIA, INC., MULTIPLE CLASS, (INT. CLS. 9, 16, 35, 38

- AND 41), (U.S. CLS. 2, 5, 21, 22, 23, 26, 29, 36, 37, 38, 50, 100, 101, 102, 104 AND 107). SN 77-677,909. PUB. 4-6-2010. FILED 2-25-2009.
- 3,805,473. **RING DAC (STANDARD CHARACTER)**. DATA CONVERSION SYSTEMS LIMITED, MULTIPLE CLASS, (INT. CLS. 9, 41 AND 42), (U.S. CLS. 21, 23, 26, 36, 38, 100, 101 AND 107). SN 77-679,088. PUB. 4-6-2010. FILED 2-26-2009.
- 3,805,482. **TELEONE (STANDARD CHARACTER)**. TELEONE, INC., MULTIPLE CLASS, (INT. CLS. 9, 35, 37, 38 AND 42), (U.S. CLS. 21, 23, 26, 36, 38, 100, 101, 102, 103, 104 AND 106). SN 77-686,651. PUB. 4-6-2010. FILED 3-9-2009.
- 3,805,484. **NAUTIZ X5 (STANDARD CHARACTER)**. HHCS HAND HELD COMPUTER SPECIALISTS AB, (U.S. CLS. 21, 23, 26, 36 AND 38). SN 77-688,055. PUB. 4-6-2010. FILED 3-11-2009.
- 3,805,485. **XIX VISION (STYLIZED)**. SEGURIDAD XIXVISION, C.A. (U.S. CLS. 21, 23, 26, 36 AND 38). SN 77-688,790. PUB. 4-6-2010. FILED 3-11-2009.
- 3,805,488. **W5GI MYSTERY ANTENNA (STANDARD CHARACTER)**. DUBE JR., JOSEPH A., (U.S. CLS. 21, 23, 26, 36 AND 38). SN 77-692,288. PUB. 4-6-2010. FILED 3-16-2009.
- 3,805,493. **GLEMSER (STANDARD CHARACTER)**. GLEMSER TECHNOLOGIES CORPORATION, MULTIPLE CLASS, (INT. CLS. 9, 41 AND 42), (U.S. CLS. 21, 23, 26, 36, 38, 100, 101 AND 107). SN 77-698,135. PUB. 4-6-2010. FILED 3-24-2009.
- 3,805,502. **EN CONTACTO (STANDARD CHARACTER)**. IN TOUCH MINISTRIES, INC., (U.S. CLS. 21, 23, 26, 36 AND 38). SN 77-706,135. PUB. 4-6-2010. FILED 4-3-2009.
- 3,805,505. **CLARITY (STANDARD CHARACTER)**. PIXEL POWER LTD, (U.S. CLS. 21, 23, 26, 36 AND 38). SN 77-707,521. PUB. 4-6-2010. FILED 4-6-2009.
- 3,805,518. **ECUBE (STANDARD CHARACTER)**. ECUBE SOLUTIONS, LLC, (U.S. CLS. 21, 23, 26, 36 AND 38). SN 77-713,002. PUB. 9-22-2009. FILED 4-13-2009.
- 3,805,533. **CLINICMAX (STANDARD CHARACTER)**. FOUR GATES LLC, MULTIPLE CLASS, (INT. CLS. 9 AND 42), (U.S. CLS. 21, 23, 26, 36, 38, 100 AND 101). SN 77-717,775. PUB. 4-6-2010. FILED 4-20-2009.
- 3,805,534. **INTERACTION CENTER PLATFORM (STANDARD CHARACTER)**. INTERACTIVE INTELLIGENCE, INC., (U.S. CLS. 21, 23, 26, 36 AND 38). SN 77-718,186. PUB. 4-6-2010. FILED 4-21-2009.
- 3,805,554. **APLINE (STANDARD CHARACTER)**. FUJITSU LIMITED, MULTIPLE CLASS, (INT. CLS. 9 AND 42), (U.S. CLS. 21, 23, 26, 36, 38, 100 AND 101). SN 77-722,186. PUB. 4-6-2010. FILED 4-24-2009.
- 3,805,564. **HYPERION (STANDARD CHARACTER)**. OREGON PHYSICS LLC, DBA OREGON PHYSICS, MULTIPLE CLASS, (INT. CLS. 9 AND 42), (U.S. CLS. 21, 23, 26, 36, 38, 100 AND 101). SN 77-723,963. PUB. 4-6-2010. FILED 4-28-2009.
- 3,805,578. **MUNDU RADIO AND DESIGN**. GEODESIC LIMITED., MULTIPLE CLASS, (INT. CLS. 9 AND 38), (U.S. CLS. 21, 23, 26, 36, 38, 100, 101 AND 104). SN 77-726,920. PUB. 4-6-2010. FILED 5-1-2009.
- 3,805,579. **MUNDU SMS AND DESIGN**. GEODESIC LIMITED., MULTIPLE CLASS, (INT. CLS. 9 AND 38), (U.S. CLS. 21, 23, 26, 36, 38, 100, 101 AND 104). SN 77-726,922. PUB. 4-6-2010. FILED 5-1-2009.
- 3,805,580. **MUNDU SPEAK AND DESIGN**. GEODESIC LIMITED., MULTIPLE CLASS, (INT. CLS. 9 AND 38), (U.S. CLS. 21, 23, 26, 36, 38, 100, 101 AND 104). SN 77-726,924. PUB. 4-6-2010. FILED 5-1-2009.
- 3,805,581. **MUNDU AND DESIGN**. GEODESIC LIMITED., MULTIPLE CLASS, (INT. CLS. 9 AND 38), (U.S. CLS. 21, 23, 26, 36, 38, 100, 101 AND 104). SN 77-726,925. PUB. 4-6-2010. FILED 5-1-2009.
- 3,805,582. **MUNDU MESSENGER AND DESIGN**. GEODESIC LIMITED., MULTIPLE CLASS, (INT. CLS. 9 AND 38), (U.S. CLS. 21, 23, 26, 36, 38, 100, 101 AND 104). SN 77-726,930. PUB. 4-6-2010. FILED 5-1-2009.
- 3,805,592. **SMARTA (STANDARD CHARACTER)**. SMARTA ENTERPRISES LTD, MULTIPLE CLASS, (INT. CLS. 9, 16, 35, 36, 38, 41, 42 AND 45), (U.S. CLS. 2, 5, 21, 22, 23, 26, 29, 36, 37, 38, 50, 100, 101, 102, 104 AND 107). SN 77-729,230. PUB. 4-6-2010. FILED 5-5-2009.
- 3,805,596. **THE FUTURE OF CONNECTIVITY (STANDARD CHARACTER)**. SYMWAVE, INC., (U.S. CLS. 21, 23, 26, 36 AND 38). SN 77-729,595. PUB. 4-6-2010. FILED 5-5-2009.
- 3,805,602. **ENERGY ASSISTANT (STANDARD CHARACTER)**. MUELLER, RICHARD W., (U.S. CLS. 21, 23, 26, 36 AND 38). SN 77-730,264. PUB. 4-6-2010. FILED 5-6-2009.
- 3,805,604. **PO GO AND DESIGN**. DIGITAL & WIRELESS GROUP, INC., (U.S. CLS. 21, 23, 26, 36 AND 38). SN 77-730,351. PUB. 4-6-2010. FILED 5-6-2009.
- 3,805,608. **FSIM PLUS (STANDARD CHARACTER)**. INVENSYS SYSTEMS, INC., (U.S. CLS. 21, 23, 26, 36 AND 38). SN 77-731,077. PUB. 4-6-2010. FILED 5-7-2009.
- 3,805,618. **LANDAIRSEA (STANDARD CHARACTER)**. LANDAIRSEA SYSTEMS, INC., (U.S. CLS. 21, 23, 26, 36 AND 38). SN 77-732,374. PUB. 4-6-2010. FILED 5-8-2009.
- 3,805,633. **GIMME THAT SOUND (STANDARD CHARACTER)**. GIMME THAT SOUND RECORDS, LLC, (U.S. CLS. 21, 23, 26, 36 AND 38). SN 77-734,332. PUB. 4-6-2010. FILED 5-11-2009.
- 3,805,658. **ROCKETFISH (STANDARD CHARACTER)**. BBY SOLUTIONS, INC., (U.S. CLS. 21, 23, 26, 36 AND 38). SN 77-739,240. PUB. 4-6-2010. FILED 5-18-2009.
- 3,805,664. **THERMOCHILL (STANDARD CHARACTER)**. THERMOCHILL UK, (U.S. CLS. 21, 23, 26, 36 AND 38). SN 77-740,835. PUB. 4-6-2010. FILED 5-20-2009.
- 3,805,666. **FISCH (STANDARD CHARACTER)**. RUTHERFORD, KENNETH M., DBA FISCH INSTRUMENTS, (U.S. CLS. 21, 23, 26, 36 AND 38). SN 77-741,235. PUB. 4-6-2010. FILED 5-20-2009.
- 3,805,667. **SECURED BY HANSCAN (STANDARD CHARACTER)**. HANSCAN IP B.V., (U.S. CLS. 21, 23, 26, 36 AND 38). SN 77-741,375. PUB. 4-6-2010. FILED 5-20-2009.
- 3,805,693. **CSE AND DESIGN**. CORPORATE SYSTEMS ENGINEERING, LLC, MULTIPLE CLASS, (INT. CLS. 9, 35 AND 42), (U.S. CLS. 21, 23, 26, 36, 38, 100, 101 AND 102). SN 77-744,765. PUB. 4-6-2010. FILED 5-26-2009.
- 3,805,722. **S AND DESIGN**. FREEBIT CO., LTD., MULTIPLE CLASS, (INT. CLS. 9 AND 42), (U.S. CLS. 21, 23, 26, 36, 38, 100 AND 101). SN 77-752,784. PUB. 4-6-2010. FILED 6-5-2009.
- 3,805,723. **SERVERSMAN AND DESIGN**. FREEBIT CO., LTD., MULTIPLE CLASS, (INT. CLS. 9 AND 42), (U.S. CLS. 21, 23, 26, 36, 38, 100 AND 101). SN 77-752,791. PUB. 4-6-2010. FILED 6-5-2009.
- 3,805,729. **MEL METER (STANDARD CHARACTER)**. DAS DISTRIBUTION INC., (U.S. CLS. 21, 23, 26, 36 AND 38). SN 77-754,295. PUB. 4-6-2010. FILED 6-8-2009.
- 3,805,743. **STEELTEX (STANDARD CHARACTER)**. ONGUARD INDUSTRIES, LLC, MULTIPLE CLASS, (INT. CLS. 9 AND 25), (U.S. CLS. 21, 22, 23, 26, 36, 38 AND 39). SN 77-757,904. PUB. 4-6-2010. FILED 6-11-2009.
- 3,805,747. **JOBPARTNERS PEOPLE MANAGEMENT. MADE PERSONAL. AND DESIGN**. JOBPARTNERS PLC, MULTIPLE CLASS, (INT. CLS. 9, 35 AND 38), (U.S. CLS. 21, 23, 26, 36, 38, 100, 101, 102 AND 104). SN 77-758,666. PUB. 4-6-2010. FILED 6-12-2009.
- 3,805,754. **X-ZONE (STANDARD CHARACTER)**. DRÄGER SAFETY AG & CO. KGAA, (U.S. CLS. 21, 23, 26, 36 AND 38). SN 77-760,461. PUB. 4-6-2010. FILED 6-16-2009.
- 3,805,763 (*See Class 7 for this trademark*).
- 3,805,768. **THINGFINDER (STANDARD CHARACTER)**. SAP AMERICA, INC., (U.S. CLS. 21, 23, 26, 36 AND 38). SN 77-763,390. PUB. 4-6-2010. FILED 6-18-2009.
- 3,805,786. **AMERICAN SUPERCONDUCTOR AND DESIGN**. AMERICAN SUPERCONDUCTOR CORPORATION, (U.S. CLS. 21, 23, 26, 36 AND 38). SN 77-766,815. PUB. 4-6-2010. FILED 6-24-2009.
- 3,805,804. **EAGLEETCH (STANDARD CHARACTER)**. EUROTEC USA INC., (U.S. CLS. 21, 23, 26, 36 AND 38). SN 77-772,084. PUB. 4-6-2010. FILED 7-1-2009.
- 3,805,817. **FRAGILE ALLIANCE (STANDARD CHARACTER)**. EIDOS INTERACTIVE LIMITED, (U.S. CLS. 21, 23, 26, 36 AND 38). SN 77-776,332. PUB. 4-6-2010. FILED 7-8-2009.
- 3,805,825. **REPLENISH (STANDARD CHARACTER)**. ALCON, INC., (U.S. CLS. 21, 23, 26, 36 AND 38). SN 77-779,235. PUB. 4-6-2010. FILED 7-13-2009.
- 3,805,827. **VICTORY (STYLIZED)**. AFTABEL UNLIMITED, LLC, (U.S. CLS. 21, 23, 26, 36 AND 38). SN 77-780,028. PUB. 4-6-2010. FILED 7-13-2009.

- 3,805,832. **ISLAND SPY (STANDARD CHARACTER)**. NICHOLAA DE CARTERET, MULTIPLE CLASS, (INT. CLS. 9, 16, 35, 38 AND 41), (U.S. CLS. 2, 5, 21, 22, 23, 26, 29, 36, 37, 38, 50, 100, 101, 102, 104 AND 107). SN 77-780,595. PUB. 4-6-2010. FILED 7-14-2009.
- 3,805,865. **STUNNER OF THE MONTH AND DESIGN**. SMITH, TODD WILLIAM, DBA STUNNER OF THE MONTH, (U.S. CLS. 21, 23, 26, 36 AND 38). SN 77-790,578. PUB. 4-6-2010. FILED 7-27-2009.
- 3,805,873. **RIVERGOOSE RECORDS (STANDARD CHARACTER)**. RIVERGOOSE RECORDS, LLC, MULTIPLE CLASS, (INT. CLS. 9 AND 41), (U.S. CLS. 21, 23, 26, 36, 38, 100, 101 AND 107). SN 77-791,622. PUB. 4-6-2010. FILED 7-28-2009.
- 3,805,909. **SOLABACUS (STANDARD CHARACTER)**. GRIF-FITHS, MARTYN HAVARD, (U.S. CLS. 21, 23, 26, 36 AND 38). SN 77-798,011. PUB. 4-6-2010. FILED 8-5-2009.
- 3,805,916. **EDX-GP (STANDARD CHARACTER)**. SHIMADZU CORPORATION, (U.S. CLS. 21, 23, 26, 36 AND 38). SN 77-799,276. PUB. 4-6-2010. FILED 8-7-2009.
- 3,805,917. **COMMAND ANTI-MALWARE (STANDARD CHARACTER)**. AUTHENTIUM, INC., (U.S. CLS. 21, 23, 26, 36 AND 38). SN 77-799,320. PUB. 4-6-2010. FILED 8-7-2009.
- 3,805,920. **RIETSA (STANDARD CHARACTER)**. DUCA, ELEFTERIA LO, AKA RIETSA, MULTIPLE CLASS, (INT. CLS. 9 AND 41), (U.S. CLS. 21, 23, 26, 36, 38, 100, 101 AND 107). SN 77-800,215. PUB. 4-6-2010. FILED 8-8-2009.
- 3,805,927. **HEALTHCONNECT (STANDARD CHARACTER)**. EVARIANT, (U.S. CLS. 21, 23, 26, 36 AND 38). SN 77-802,465. PUB. 4-6-2010. FILED 8-12-2009.
- 3,805,962. **KAMU (STANDARD CHARACTER)**. EVERYPLAY LTD., MULTIPLE CLASS, (INT. CLS. 9, 28 AND 41), (U.S. CLS. 21, 22, 23, 26, 36, 38, 50, 100, 101 AND 107). SN 77-809,733. PUB. 4-6-2010. FILED 8-21-2009.
- 3,805,965. **SCANLINK (STANDARD CHARACTER)**. AMBIR TECHNOLOGY, INC., (U.S. CLS. 21, 23, 26, 36 AND 38). SN 77-810,092. PUB. 4-6-2010. FILED 8-21-2009.
- 3,805,971. **MARK-A-TEXT (STANDARD CHARACTER)**. SEAVIEW SOFTWARE, INC., (U.S. CLS. 21, 23, 26, 36 AND 38). SN 77-810,797. PUB. 4-6-2010. FILED 8-23-2009.
- 3,805,973. **SURVEIL (STANDARD CHARACTER)**. HEALTH INFORMATION DESIGNS, INC., (U.S. CLS. 21, 23, 26, 36 AND 38). SN 77-811,075. PUB. 4-6-2010. FILED 8-24-2009.
- 3,805,995. **FCODER (STANDARD CHARACTER)**. FCODER GROUP, INC., MULTIPLE CLASS, (INT. CLS. 9 AND 42), (U.S. CLS. 21, 23, 26, 36, 38, 100 AND 101). SN 77-816,203. PUB. 4-6-2010. FILED 8-31-2009.
- 3,805,998. **SOUL (STANDARD CHARACTER)**. SIGNEO LIMITED, (U.S. CLS. 21, 23, 26, 36 AND 38). SN 77-816,551. PUB. 4-6-2010. FILED 8-31-2009.
- 3,806,006. **POWERBREAKFAST (STANDARD CHARACTER)**. PUNDIT PRODUCTIONS, INC., MULTIPLE CLASS, (INT. CLS. 9, 35 AND 41), (U.S. CLS. 21, 23, 26, 36, 38, 100, 101, 102 AND 107). SN 77-817,486. PUB. 4-6-2010. FILED 9-1-2009.
- 3,806,007. **POWERBREAKFAST AND DESIGN**. PUNDIT PRODUCTIONS, INC., MULTIPLE CLASS, (INT. CLS. 9, 35 AND 41), (U.S. CLS. 21, 23, 26, 36, 38, 100, 101, 102 AND 107). SN 77-817,614. PUB. 4-6-2010. FILED 9-1-2009.
- 3,806,028. **MISCELLANEOUS DESIGN**. STACORP LP, MULTIPLE CLASS, (INT. CLS. 9 AND 16), (U.S. CLS. 2, 5, 21, 22, 23, 26, 29, 36, 37, 38 AND 50). SN 77-821,460. PUB. 4-6-2010. FILED 9-8-2009.
- 3,806,032. **MIRROR'S EDGE AND DESIGN**. EA DIGITAL ILLUSIONS CE AB, (U.S. CLS. 21, 23, 26, 36 AND 38). SN 77-821,951. PUB. 2-9-2010. FILED 9-8-2009.
- 3,806,035. **EMA (STANDARD CHARACTER)**. EMA ELECTRO-MECANICA, S.A., (U.S. CLS. 21, 23, 26, 36 AND 38). SN 77-822,102. PUB. 4-6-2010. FILED 9-8-2009.
- 3,806,051. **GERM-GATE (STANDARD CHARACTER)**. BOVIE SCREEN PROCESS PRINTING CO., INC., (U.S. CLS. 21, 23, 26, 36 AND 38). SN 77-824,569. PUB. 4-6-2010. FILED 9-11-2009.
- 3,806,061. **SUJIKEN (STANDARD CHARACTER)**. HEINEMAN, GEORGE T, MULTIPLE CLASS, (INT. CLS. 9 AND 41), (U.S. CLS. 21, 23, 26, 36, 38, 100, 101 AND 107). SN 77-826,329. PUB. 4-6-2010. FILED 9-14-2009.
- 3,806,063. **BCM ADVANCED RESEARCH AND DESIGN**. BCM ADVANCED RESEARCH, MULTIPLE CLASS, (INT. CLS. 9 AND 42), (U.S. CLS. 21, 23, 26, 36, 38, 100 AND 101). SN 77-826,584. PUB. 4-6-2010. FILED 9-15-2009.
- 3,806,065. **LOVE SYSTEMS AND DESIGN**. LOVE SYSTEMS, INC., MULTIPLE CLASS, (INT. CLS. 9, 16, 35 AND 41), (U.S. CLS. 2, 5, 21, 22, 23, 26, 29, 36, 37, 38, 50, 100, 101, 102 AND 107). SN 77-826,887. PUB. 4-6-2010. FILED 9-15-2009.
- 3,806,067. **SCRAMBLE (STYLIZED)**. COLE SYSTEMS ASSOCIATES, INC., (U.S. CLS. 21, 23, 26, 36 AND 38). SN 77-827,136. PUB. 4-6-2010. FILED 9-15-2009.
- 3,806,121. **SINGER STAR AND DESIGN**. KTV EQUIPMENT, LLC, (U.S. CLS. 21, 23, 26, 36 AND 38). SN 77-837,093. PUB. 4-6-2010. FILED 9-29-2009.
- 3,806,125. **KPSI (STANDARD CHARACTER)**. PRESSURE SYSTEMS, INC., (U.S. CLS. 21, 23, 26, 36 AND 38). SN 77-837,483. PUB. 4-6-2010. FILED 9-29-2009.
- 3,806,136. **PRIUS ENERGY AND DESIGN**. PRIUS ENERGY SLU, MULTIPLE CLASS, (INT. CLS. 9, 11, 37 AND 42), (U.S. CLS. 13, 21, 23, 26, 31, 34, 36, 38, 100, 101, 103 AND 106). SN 77-838,887. PUB. 4-6-2010. FILED 10-1-2009.
- 3,806,148. **ACTIVECRAWL RSS (STANDARD CHARACTER)**. SPECTRAREP, LLC, (U.S. CLS. 21, 23, 26, 36 AND 38). SN 77-840,034. PUB. 4-6-2010. FILED 10-2-2009.
- 3,806,151. **HALO SYSTEMS AND DESIGN**. THE TECHNICAL ADVANTAGE, INC., (U.S. CLS. 21, 23, 26, 36 AND 38). SN 77-840,278. PUB. 4-6-2010. FILED 10-2-2009.
- 3,806,153. **SPM (STANDARD CHARACTER)**. MATERIALS MANAGEMENT MICROSYSTEMS, (U.S. CLS. 21, 23, 26, 36 AND 38). SN 77-840,522. PUB. 4-6-2010. FILED 10-2-2009.
- 3,806,170. **HAPPILY EVER AFTER (STANDARD CHARACTER)**. ROWLAND READING FOUNDATION, INC., MULTIPLE CLASS, (INT. CLS. 9 AND 16), (U.S. CLS. 2, 5, 21, 22, 23, 26, 29, 36, 37, 38 AND 50). SN 77-843,450. PUB. 4-6-2010. FILED 10-7-2009.
- 3,806,179. **WALKJOGRUN (STANDARD CHARACTER)**. ALMOST AWESOME INC., MULTIPLE CLASS, (INT. CLS. 9 AND 41), (U.S. CLS. 21, 23, 26, 36, 38, 100, 101 AND 107). SN 77-844,282. PUB. 4-6-2010. FILED 10-8-2009.
- 3,806,182. **AUTO VOLTAGE DETECTION AND DESIGN**. SCHUMACHER ELECTRIC CORPORATION, (U.S. CLS. 21, 23, 26, 36 AND 38). SN 77-844,783. PUB. 4-6-2010. FILED 10-8-2009.
- 3,806,200. **ULTRA VISION AND DESIGN**. RIGOL TECHNOLOGIES INC., (U.S. CLS. 21, 23, 26, 36 AND 38). SN 77-846,167. PUB. 4-6-2010. FILED 10-11-2009.
- 3,806,216. **AUDIOHOLIC MEDIA (STANDARD CHARACTER)**. TURNER, BRIANNE D., AND CHAIVARLIS, NICK, MULTIPLE CLASS, (INT. CLS. 9 AND 41), (U.S. CLS. 21, 23, 26, 36, 38, 100, 101 AND 107). SN 77-847,866. PUB. 4-6-2010. FILED 10-13-2009.
- 3,806,218. **SAW (STANDARD CHARACTER)**. LIONS GATE ENTERTAINMENT INC., AKA LIONSGATE ENTERTAINMENT INC., (U.S. CLS. 21, 23, 26, 36 AND 38). SN 77-848,059. PUB. 4-6-2010. FILED 10-13-2009.
- 3,806,220. **MDI ACHIEVE (STANDARD CHARACTER)**. MDI ACHIEVE, INC., (U.S. CLS. 21, 23, 26, 36 AND 38). SN 77-848,135. PUB. 4-6-2010. FILED 10-14-2009.
- 3,806,221. **MDI ACHIEVE AND DESIGN**. MDI ACHIEVE, INC., (U.S. CLS. 21, 23, 26, 36 AND 38). SN 77-848,169. PUB. 4-6-2010. FILED 10-14-2009.
- 3,806,222. **DEANA FAI (STANDARD CHARACTER)**. FAISON, ASHLEE D., DBA DEANA FAI, MULTIPLE CLASS, (INT. CLS. 9 AND 41), (U.S. CLS. 21, 23, 26, 36, 38, 100, 101 AND 107). SN 77-848,446. PUB. 4-6-2010. FILED 10-14-2009.
- 3,806,230. **FLYING MEAT (STANDARD CHARACTER)**. FLYING MEAT INC., (U.S. CLS. 21, 23, 26, 36 AND 38). SN 77-849,034. PUB. 4-6-2010. FILED 10-14-2009.
- 3,806,239. **RUTHLESS & TOOTHLESS AND DESIGN**. BRANDING EMPIRE, LLC, MULTIPLE CLASS, (INT. CLS. 9, 16, 25 AND 41), (U.S. CLS. 2, 5, 21, 22, 23, 26, 29, 36, 37, 38, 39, 50, 100, 101 AND 107). SN 77-850,188. PUB. 4-6-2010. FILED 10-16-2009.
- 3,806,244. **EZREVVU (STANDARD CHARACTER)**. IDEAS LLC, (U.S. CLS. 21, 23, 26, 36 AND 38). SN 77-850,422. PUB. 4-6-2010. FILED 10-16-2009.
- 3,806,285. **NANOVOLUME (STANDARD CHARACTER)**. VALCO INSTRUMENTS CO., INC., (U.S. CLS. 21, 23, 26, 36 AND 38). SN 77-854,035. PUB. 4-6-2010. FILED 10-21-2009.
- 3,806,286. **DTN HEDGE MINDER (STANDARD CHARACTER)**

- TER**, TELVENT DTN, INC., (U.S. CLS. 21, 23, 26, 36 AND 38). SN 77-854,040. PUB. 4-6-2010. FILED 10-21-2009.
- 3,806,291. **PANACIM (STANDARD CHARACTER)**, PANASONIC CORPORATION OF NORTH AMERICA, (U.S. CLS. 21, 23, 26, 36 AND 38). SN 77-854,170. PUB. 4-6-2010. FILED 10-21-2009.
- 3,806,305. **EEVER AND DESIGN**, ETRON TECHNOLOGY INC., (U.S. CLS. 21, 23, 26, 36 AND 38). SN 77-854,967. PUB. 4-6-2010. FILED 10-22-2009.
- 3,806,310. **POLICY PATROL (STANDARD CHARACTER)**, RED EARTH SOFTWARE, INC., (U.S. CLS. 21, 23, 26, 36 AND 38). SN 77-855,142. PUB. 4-6-2010. FILED 10-22-2009.
- 3,806,313. **HORIZONTAL (STANDARD CHARACTER)**, HORIZONTAL LLC, (U.S. CLS. 21, 23, 26, 36 AND 38). SN 77-855,235. PUB. 4-6-2010. FILED 10-22-2009.
- 3,806,339. **MARINE POWERSAFE AND DESIGN**, LAW, TIMOTHY DAVID, (U.S. CLS. 21, 23, 26, 36 AND 38). SN 77-855,663. PUB. 4-6-2010. FILED 10-23-2009.
- 3,806,349. **ENOUNCE (STANDARD CHARACTER)**, ENOUNCE, INCORPORATED, MULTIPLE CLASS, (INT. CLS. 9 AND 42), (U.S. CLS. 21, 23, 26, 36, 38, 100 AND 101). SN 77-856,508. PUB. 4-6-2010. FILED 10-23-2009.
- 3,806,350. **COMKIA (STANDARD CHARACTER)**, CENTRAL COMPUTERS, INC., (U.S. CLS. 21, 23, 26, 36 AND 38). SN 77-856,565. PUB. 4-6-2010. FILED 10-23-2009.
- 3,806,362. **MISCELLANEOUS DESIGN**, PANVIVA PTY LTD, (U.S. CLS. 21, 23, 26, 36 AND 38). SN 77-856,903. PUB. 4-6-2010. FILED 10-26-2009.
- 3,806,394. **DR INCREASE (STANDARD CHARACTER)**, HARRISON, BOB, MULTIPLE CLASS, (INT. CLS. 9 AND 41), (U.S. CLS. 21, 23, 26, 36, 38, 100, 101 AND 107). SN 77-857,733. PUB. 4-6-2010. FILED 10-26-2009.
- 3,806,423. **YARDTRAX (STANDARD CHARACTER)**, HARRIS, JAMES H, (U.S. CLS. 21, 23, 26, 36 AND 38). SN 77-858,191. PUB. 4-6-2010. FILED 10-27-2009.
- 3,806,424. **FONT DINER PREMIUM QUALITY RETRO FONTS AND DESIGN**, FONT DINER, INC., (U.S. CLS. 21, 23, 26, 36 AND 38). SN 77-858,194. PUB. 4-6-2010. FILED 10-27-2009.
- 3,806,431. **YOUTOUR (STANDARD CHARACTER)**, ANDERSON, DONALD O., (U.S. CLS. 21, 23, 26, 36 AND 38). SN 77-858,292. PUB. 4-6-2010. FILED 10-27-2009.
- 3,806,436. **AZTECH SUPPLIES AND DESIGN**, ACME FOAM COMPANY, DBA AZTECH SUPPLIES, MULTIPLE CLASS, (INT. CLS. 9 AND 17), (U.S. CLS. 1, 5, 12, 13, 21, 23, 26, 35, 36, 38 AND 50). SN 77-858,353. PUB. 4-6-2010. FILED 10-27-2009.
- 3,806,473. **FASTPREP (STANDARD CHARACTER)**, MP BIOMEDICALS, LLC, (U.S. CLS. 21, 23, 26, 36 AND 38). SN 77-858,648. PUB. 4-6-2010. FILED 10-27-2009.
- 3,806,478. **KICKING ASPHALT (STANDARD CHARACTER)**, BWC, INC., (U.S. CLS. 21, 23, 26, 36 AND 38). SN 77-858,712. PUB. 4-6-2010. FILED 10-27-2009.
- 3,806,483. **TRAVELCOOL! (STANDARD CHARACTER)**, BWC, INC., (U.S. CLS. 21, 23, 26, 36 AND 38). SN 77-858,736. PUB. 4-6-2010. FILED 10-27-2009.
- 3,806,494. **POWERBASE AND DESIGN**, VIDEOMARKET CORPORATION, DBA POWERBASE, (U.S. CLS. 21, 23, 26, 36 AND 38). SN 77-858,810. PUB. 4-6-2010. FILED 10-27-2009.
- 3,806,509. **TREE OF RICHES (STANDARD CHARACTER)**, ATRONIC INTERNATIONAL GMBH, (U.S. CLS. 21, 23, 26, 36 AND 38). SN 77-859,017. PUB. 4-6-2010. FILED 10-28-2009.
- 3,806,538. **THE ONE AND DESIGN**, RICHFIELD, MORRIE, (U.S. CLS. 21, 23, 26, 36 AND 38). SN 77-859,488. PUB. 4-6-2010. FILED 10-28-2009.
- 3,806,551. **VERABLOG (STANDARD CHARACTER)**, AVALWORKS, INC., (U.S. CLS. 21, 23, 26, 36 AND 38). SN 77-859,562. PUB. 4-6-2010. FILED 10-28-2009.
- 3,806,559. **THE FOOD FAIRY (STANDARD CHARACTER)**, MCCLERNON, TERRI, (U.S. CLS. 21, 23, 26, 36 AND 38). SN 77-859,684. PUB. 4-6-2010. FILED 10-28-2009.
- 3,806,560. **MICMAID (STANDARD CHARACTER)**, MANLEY LABORATORIES INCORPORATED, (U.S. CLS. 21, 23, 26, 36 AND 38). SN 77-859,727. PUB. 4-6-2010. FILED 10-28-2009.
- 3,806,564. **REFERRAL COACH INTERNATIONAL (STANDARD CHARACTER)**, WILLIAM R. CATES, INC., MULTIPLE CLASS, (INT. CLS. 9 AND 41), (U.S. CLS. 21, 23, 26, 36, 38, 100, 101 AND 107). SN 77-859,757. PUB. 4-6-2010. FILED 10-28-2009.
- 3,806,585. **SLIDEDECK (STANDARD CHARACTER)**, DIGITAL-TELEPATHY, (U.S. CLS. 21, 23, 26, 36 AND 38). SN 77-859,874. PUB. 4-6-2010. FILED 10-28-2009.
- 3,806,594. **SUPERTRAK (STANDARD CHARACTER)**, PROMISE TECHNOLOGY, INC., (U.S. CLS. 21, 23, 26, 36 AND 38). SN 77-859,995. PUB. 4-6-2010. FILED 10-29-2009.
- 3,806,595. **FASTTRAK (STANDARD CHARACTER)**, PROMISE TECHNOLOGY, INC., (U.S. CLS. 21, 23, 26, 36 AND 38). SN 77-859,997. PUB. 4-6-2010. FILED 10-29-2009.
- 3,806,615. **VERYPDF (STANDARD CHARACTER)**, XUE HENG, (U.S. CLS. 21, 23, 26, 36 AND 38). SN 77-860,167. PUB. 4-6-2010. FILED 10-29-2009.
- 3,806,627. **STATCOM (STANDARD CHARACTER)**, STATCOM, LLC, (U.S. CLS. 21, 23, 26, 36 AND 38). SN 77-860,345. PUB. 4-6-2010. FILED 10-29-2009.
- 3,806,631. **ENTRAPASS (STANDARD CHARACTER)**, TYCO SAFETY PRODUCTS CANADA LTD., (U.S. CLS. 21, 23, 26, 36 AND 38). SN 77-860,386. PUB. 4-6-2010. FILED 10-29-2009.
- 3,806,656. **SPIN-X (STANDARD CHARACTER)**, CORNING INCORPORATED, (U.S. CLS. 21, 23, 26, 36 AND 38). SN 77-860,633. PUB. 4-6-2010. FILED 10-29-2009.
- 3,806,659. **MMH (STANDARD CHARACTER)**, ROGER J. BEST, (U.S. CLS. 21, 23, 26, 36 AND 38). SN 77-860,652. PUB. 4-6-2010. FILED 10-29-2009.
- 3,806,662. **NETSCORE (STANDARD CHARACTER)**, SONUS NETWORKS, INC., (U.S. CLS. 21, 23, 26, 36 AND 38). SN 77-860,659. PUB. 4-6-2010. FILED 10-29-2009.
- 3,806,664. **GERM FREE REMOTES AND DESIGN**, GERM FREE REMOTES, LLC, (U.S. CLS. 21, 23, 26, 36 AND 38). SN 77-860,701. PUB. 4-6-2010. FILED 10-29-2009.
- 3,806,684. **AD AND DESIGN**, ADVANCED DRIVE TECHNOLOGY, (U.S. CLS. 21, 23, 26, 36 AND 38). SN 77-860,969. PUB. 4-6-2010. FILED 10-29-2009.
- 3,806,687. **FONEPAYS (STANDARD CHARACTER)**, FONEPAYS, LLC, FORMERLY JOWERS AND KING, LLC, (U.S. CLS. 21, 23, 26, 36 AND 38). SN 77-860,989. PUB. 4-6-2010. FILED 10-29-2009.
- 3,806,692. **VEDANT (STANDARD CHARACTER)**, VEDANT INCORPORATED, (U.S. CLS. 21, 23, 26, 36 AND 38). SN 77-861,066. PUB. 4-6-2010. FILED 10-30-2009.
- 3,806,693. **THE NEW SHAPE OF SOLAR (STANDARD CHARACTER)**, SOLYNDRA, INC., (U.S. CLS. 21, 23, 26, 36 AND 38). SN 77-861,078. PUB. 4-6-2010. FILED 10-30-2009.
- 3,806,696. **CHOPPAHEAD (STANDARD CHARACTER)**, GAGNE, JOSH, MULTIPLE CLASS, (INT. CLS. 9 AND 25), (U.S. CLS. 21, 22, 23, 26, 36, 38 AND 39). SN 77-861,215. PUB. 4-6-2010. FILED 10-30-2009.
- 3,806,702. **TRENDGRAPHIX AND DESIGN**, TRENDGRAPHIX, INC., (U.S. CLS. 21, 23, 26, 36 AND 38). SN 77-861,248. PUB. 4-6-2010. FILED 10-30-2009.
- 3,806,706. **WXFIX (STANDARD CHARACTER)**, ÊELIOS, INC., (U.S. CLS. 21, 23, 26, 36 AND 38). SN 77-861,317. PUB. 4-6-2010. FILED 10-30-2009.
- 3,806,719. **DAZ (STANDARD CHARACTER)**, DAVIES, PETER N.C., DBA DAZRISK, (U.S. CLS. 21, 23, 26, 36 AND 38). SN 77-861,518. PUB. 4-6-2010. FILED 10-30-2009.
- 3,806,755. **JOB SIMPLICITY (STANDARD CHARACTER)**, ZYBERTECH CONSTRUCTION SOFTWARE SERVICES LTD., (U.S. CLS. 21, 23, 26, 36 AND 38). SN 77-861,978. PUB. 4-6-2010. FILED 10-30-2009.
- 3,806,756. **WICHORUS (STANDARD CHARACTER)**, WICHORUS, INC., (U.S. CLS. 21, 23, 26, 36 AND 38). SN 77-861,998. PUB. 4-6-2010. FILED 10-30-2009.
- 3,806,762. **MITOFLEET (STANDARD CHARACTER)**, MITO CORPORATION, (U.S. CLS. 21, 23, 26, 36 AND 38). SN 77-862,453. PUB. 4-6-2010. FILED 11-2-2009.
- 3,806,775. **SERAWEK (STANDARD CHARACTER)**, PROCESS TYPE FOUNDRY LLC, (U.S. CLS. 21, 23, 26, 36 AND 38). SN 77-862,674. PUB. 4-6-2010. FILED 11-2-2009.
- 3,806,785. **STRATUM (STANDARD CHARACTER)**, PROCESS TYPE FOUNDRY LLC, (U.S. CLS. 21, 23, 26, 36 AND 38). SN 77-862,819. PUB. 4-6-2010. FILED 11-2-2009.
- 3,806,788. **WOODZEE (STANDARD CHARACTER)**, GREASE GRIP GLOVES USA, LLC, (U.S. CLS. 21, 23, 26, 36 AND 38). SN 77-862,978. PUB. 4-6-2010. FILED 11-2-2009.
- 3,806,803. **HMY HELLO MICKY AND DESIGN**, ZHANG, YAN, (U.S. CLS. 21, 23, 26, 36 AND 38). SN 77-863,203.

- PUB. 4-6-2010. FILED 11-2-2009.
- 3,806,836. **LIGHT BRITES (STANDARD CHARACTER)**. GREASE GRIP GLOVES USA, LLC, (U.S. CLS. 21, 23, 26, 36 AND 38). SN 77-863,748. PUB. 4-6-2010. FILED 11-3-2009.
- 3,806,840. **MYDRSORDERS (STANDARD CHARACTER)**. DUSHMAN, CHARLES J, (U.S. CLS. 21, 23, 26, 36 AND 38). SN 77-863,796. PUB. 4-6-2010. FILED 11-3-2009.
- 3,806,841. **SUNS (STANDARD CHARACTER)**. SUNS INTERNATIONAL, LLC, (U.S. CLS. 21, 23, 26, 36 AND 38). SN 77-863,803. PUB. 4-6-2010. FILED 11-3-2009.
- 3,806,842. **SPECTROSULFUR (STANDARD CHARACTER)**. CHEMPLEX INDUSTRIES, INC., (U.S. CLS. 21, 23, 26, 36 AND 38). SN 77-863,829. PUB. 4-6-2010. FILED 11-3-2009.
- 3,806,849. **POTTY MOUTH MUSIC (STANDARD CHARACTER)**. AMATO, JAMES, DBA AMEDIA ENTERTAINMENT LLC, (U.S. CLS. 21, 23, 26, 36 AND 38). SN 77-863,891. PUB. 4-6-2010. FILED 11-3-2009.
- 3,806,850. **WASH PILOT AND DESIGN**. AUTOPILOT CARWASH CONTROL SYSTEMS, INC., (U.S. CLS. 21, 23, 26, 36 AND 38). SN 77-863,904. PUB. 4-6-2010. FILED 11-3-2009.
- 3,806,853. **A BOY AND HIS BLOB (STANDARD CHARACTER)**. MAJESCO ENTERTAINMENT COMPANY, (U.S. CLS. 21, 23, 26, 36 AND 38). SN 77-863,945. PUB. 4-6-2010. FILED 11-3-2009.
- 3,806,855. **POTTY MOUTH MUSIC AND DESIGN**. AMATO, JAMES, (U.S. CLS. 21, 23, 26, 36 AND 38). SN 77-863,964. PUB. 4-6-2010. FILED 11-3-2009.
- 3,806,868. **RSCC (STANDARD CHARACTER)**. RSCC WIRE & CABLE, INC., (U.S. CLS. 21, 23, 26, 36 AND 38). SN 77-864,150. PUB. 4-6-2010. FILED 11-3-2009.
- 3,806,925. **PRONTO SOFTWARE AND DESIGN**. PRONTO SOFTWARE PTY LTD, MULTIPLE CLASS, (INT. CLS. 9 AND 42), (U.S. CLS. 21, 23, 26, 36, 38, 100 AND 101). SN 77-868,929. PUB. 4-6-2010. FILED 11-10-2009.
- 3,806,944. **HOTSPOT SHIELD (STANDARD CHARACTER)**. ANCHORFREE, INC., (U.S. CLS. 21, 23, 26, 36 AND 38). SN 77-871,648. PUB. 4-6-2010. FILED 11-12-2009.
- 3,806,947. **WALSHWARE (STANDARD CHARACTER)**. MICHAEL WALSH, INC., (U.S. CLS. 21, 23, 26, 36 AND 38). SN 77-872,768. PUB. 4-6-2010. FILED 11-14-2009.
- 3,806,952. **GLANCE SPEEDBOOST (STANDARD CHARACTER)**. GLANCE NETWORKS, INC., (U.S. CLS. 21, 23, 26, 36 AND 38). SN 77-873,660. PUB. 4-6-2010. FILED 11-16-2009.
- 3,806,953. **BW MONITOR (STANDARD CHARACTER)**. SHERILL-LUBINSKI CORPORATION, (U.S. CLS. 21, 23, 26, 36 AND 38). SN 77-873,740. PUB. 4-6-2010. FILED 11-16-2009.
- 3,806,982. **VIRTUARIUM (STANDARD CHARACTER)**. KABUSHIKIGAISSYA GOTO KOGAKU KENKYUJYO, (U.S. CLS. 21, 23, 26, 36 AND 38). SN 77-878,892. PUB. 4-6-2010. FILED 11-23-2009.
- 3,806,985. **A UNIVERSE UNDER THE MILLIMETER (STANDARD CHARACTER)**. ESAOTE, S.P.A., MULTIPLE CLASS, (INT. CLS. 9 AND 10), (U.S. CLS. 21, 23, 26, 36, 38, 39 AND 44). SN 77-879,438. PUB. 4-6-2010. FILED 11-24-2009.
- 3,806,987. **COMMAND MOBILE (STANDARD CHARACTER)**. TRACEN TECHNOLOGIES, INC., (U.S. CLS. 21, 23, 26, 36 AND 38). SN 77-879,664. PUB. 4-6-2010. FILED 11-24-2009.
- 3,806,989. **ITEUFEL TOWER (STANDARD CHARACTER)**. LAUTSPRECHER TEUFEL GMBH, MULTIPLE CLASS, (INT. CLS. 9, 35 AND 41), (U.S. CLS. 21, 23, 26, 36, 38, 100, 101, 102 AND 107). SN 77-879,836. PUB. 4-6-2010. FILED 11-24-2009.
- 3,806,990. **ITEUFEL MAGNUM (STANDARD CHARACTER)**. LAUTSPRECHER TEUFEL GMBH, MULTIPLE CLASS, (INT. CLS. 9 AND 35), (U.S. CLS. 21, 23, 26, 36, 38, 100, 101 AND 102). SN 77-879,943. PUB. 4-6-2010. FILED 11-24-2009.
- 3,807,003. **FLIP'S TWISTED WORLD (STANDARD CHARACTER)**. MAJESCO ENTERTAINMENT COMPANY, (U.S. CLS. 21, 23, 26, 36 AND 38). SN 77-883,688. PUB. 4-6-2010. FILED 12-1-2009.
- 3,807,008. **RAILGUIDE (STANDARD CHARACTER)**. LOCKHEED MARTIN CORPORATION, (U.S. CLS. 21, 23, 26, 36 AND 38). SN 77-884,365. PUB. 4-6-2010. FILED 12-2-2009.
- 3,807,010. **ZIP (STANDARD CHARACTER)**. DELAWARE CAPITAL FORMATION, INC., (U.S. CLS. 21, 23, 26, 36 AND 38). SN 77-884,604. PUB. 4-6-2010. FILED 12-2-2009.
- 3,807,012. **PHOENIX (STANDARD CHARACTER)**. DELAWARE CAPITAL FORMATION, INC., (U.S. CLS. 21, 23, 26, 36 AND 38). SN 77-885,139. PUB. 4-6-2010. FILED 12-3-2009.
- 3,807,024. **M (STYLIZED)**. MONSTER CABLE PRODUCTS, INC., (U.S. CLS. 21, 23, 26, 36 AND 38). SN 77-889,118. PUB. 4-6-2010. FILED 12-8-2009.
- 3,807,034. **AKM KNOW SHARE WIN (STANDARD CHARACTER)**. DEPARTMENT OF THE ARMY, MULTIPLE CLASS, (INT. CLS. 9 AND 42), (U.S. CLS. 21, 23, 26, 36, 38, 100 AND 101). SN 77-892,505. PUB. 4-6-2010. FILED 12-14-2009.
- 3,807,035. **AKM KNOW SHARE WIN AND DESIGN**. DEPARTMENT OF THE ARMY, MULTIPLE CLASS, (INT. CLS. 9 AND 42), (U.S. CLS. 21, 23, 26, 36, 38, 100 AND 101). SN 77-892,769. PUB. 4-6-2010. FILED 12-14-2009.
- 3,807,068 (*See Class 6 for this trademark*).
- 3,807,071. **I-PLAY (STYLIZED)**. OBERON MEDIA (UK) LIMITED, MULTIPLE CLASS, (INT. CLS. 9, 38 AND 41), (U.S. CLS. 21, 23, 26, 36, 38, 100, 101, 104 AND 107). SN 78-751,932. PUB. 4-6-2010. FILED 11-11-2005.
- 3,807,081. **PLAYSTATION (STANDARD CHARACTER)**. KABUSHIKI KAISHA SONY COMPUTER ENTERTAINMENT, TA SONY COMPUTER ENTERTAINMENT INC., MULTIPLE CLASS, (INT. CLS. 9 AND 36), (U.S. CLS. 21, 23, 26, 36, 38, 100, 101 AND 102). SN 78-878,591. PUB. 1-16-2007. FILED 5-8-2006.
- 3,807,083. **STOCKIFY (STANDARD CHARACTER)**. ENERGIZE FINANCIAL, INC., MULTIPLE CLASS, (INT. CLS. 9, 36 AND 41), (U.S. CLS. 21, 23, 26, 36, 38, 100, 101, 102 AND 107). SN 78-906,183. PUB. 12-22-2009. FILED 6-12-2006.
- 3,807,094. **DUKE MARKER AND DESIGN**. MARKER VÖKL (INTERNATIONAL) GMBH, MULTIPLE CLASS, (INT. CLS. 9, 25 AND 28), (U.S. CLS. 21, 22, 23, 26, 36, 38, 39 AND 50). SN 79-039,836. PUB. 4-8-2008. FILED 4-24-2007.
- 3,807,102. **MAIL FOR EXCHANGE (STYLIZED)**. NOKIA CORPORATION, (U.S. CLS. 21, 23, 26, 36 AND 38). SN 79-052,620. PUB. 4-6-2010. FILED 2-22-2008.
- 3,807,107. **PLD PRINTING-LIKE DISPLAY (STANDARD CHARACTER)**. ADVANCED DISPLAY TECHNOLOGY AG, MULTIPLE CLASS, (INT. CLS. 9, 14 AND 16), (U.S. CLS. 2, 5, 21, 22, 23, 26, 27, 28, 29, 36, 37, 38 AND 50). SN 79-056,340. PUB. 4-6-2010. FILED 4-4-2008.
- 3,807,108 (*See Class 8 for this trademark*).
- 3,807,109 (*See Class 2 for this trademark*).
- 3,807,110. **CONTACTRON (STANDARD CHARACTER)**. PHOENIX CONTACT GMBH & CO. KG, MULTIPLE CLASS, (INT. CLS. 9 AND 16), (U.S. CLS. 2, 5, 21, 22, 23, 26, 29, 36, 37, 38 AND 50). SN 79-057,079. PUB. 4-6-2010. FILED 4-23-2008.
- 3,807,113. **TEXCEL (STANDARD CHARACTER)**. FROUDE HOFMANN LIMITED, MULTIPLE CLASS, (INT. CLS. 9 AND 37), (U.S. CLS. 21, 23, 26, 36, 38, 100, 103 AND 106). SN 79-058,014. PUB. 4-6-2010. FILED 4-29-2008.
- 3,807,120 (*See Class 7 for this trademark*).
- 3,807,121 (*See Class 7 for this trademark*).
- 3,807,122 (*See Class 6 for this trademark*).
- 3,807,125. **BIG & SMALL AND DESIGN**. KINDLE ENTERTAINMENT LTD., MULTIPLE CLASS, (INT. CLS. 9, 16, 25, 28, 38 AND 41), (U.S. CLS. 2, 5, 21, 22, 23, 26, 29, 36, 37, 38, 39, 50, 100, 101, 104 AND 107). SN 79-061,445. PUB. 4-6-2010. FILED 6-27-2008.
- 3,807,126 (*See Class 7 for this trademark*).
- 3,807,127. **BACK TO FRONT (STANDARD CHARACTER)**. OPTION COMPUTERS LIMITED, MULTIPLE CLASS, (INT. CLS. 9, 35, 36, 38 AND 42), (U.S. CLS. 21, 23, 26, 36, 38, 100, 101, 102 AND 104). SN 79-061,496. PUB. 4-6-2010. FILED 9-24-2008.
- 3,807,131 (*See Class 3 for this trademark*).
- 3,807,134. **MADSEN (STANDARD CHARACTER)**. GN OTOMETRICS A/S, MULTIPLE CLASS, (INT. CLS. 9 AND 10), (U.S. CLS. 21, 23, 26, 36, 38, 39 AND 44). SN 79-062,304. PUB. 4-6-2010. FILED 6-9-2008.
- 3,807,135. **THE SECRET POLICEMAN'S BALL (STANDARD CHARACTER)**. AMNESTY INTERNATIONAL LIMITED, MULTIPLE CLASS, (INT. CLS. 9, 16, 25, 41 AND 45), (U.S. CLS. 2, 5, 21, 22, 23, 26, 29, 36, 37, 38, 39, 50, 100, 101 AND 107). SN 79-062,327. PUB. 4-6-2010. FILED 5-13-2008.
- 3,807,148 (*See Class 7 for this trademark*).
- 3,807,152. **NORTHGATEARINSO (STANDARD CHARACTER)**. NORTHGATEARINSO UK LIMITED, MULTIPLE

- CLASS, (INT. CLS. 9, 35 AND 42), (U.S. CLS. 21, 23, 26, 36, 38, 100, 101 AND 102). SN 79-066,249. PUB. 4-6-2010. FILED 10-15-2008.
- 3,807,153. **BALANCITY (STANDARD CHARACTER)**. KOELN-MESSE GMBH, MULTIPLE CLASS, (INT. CLS. 9, 14, 16, 18, 21, 25, 28, 29, 32, 35, 41 AND 42), (U.S. CLS. 1, 2, 3, 5, 13, 21, 22, 23, 26, 27, 28, 29, 30, 33, 36, 37, 38, 39, 40, 41, 45, 46, 48, 50, 100, 101, 102 AND 107). SN 79-066,295. PUB. 4-6-2010. FILED 10-21-2008.
- 3,807,154. **TOKYO KEISU (STYLIZED)**. CONTEX CORPORATION, (U.S. CLS. 21, 23, 26, 36 AND 38). SN 79-066,451. PUB. 4-6-2010. FILED 1-28-2009.
- 3,807,155. **TALENTSOFT (STANDARD CHARACTER)**. TALENTSOFT, MULTIPLE CLASS, (INT. CLS. 9, 35 AND 42), (U.S. CLS. 21, 23, 26, 36, 38, 100, 101 AND 102). SN 79-066,630. PUB. 12-29-2009. FILED 2-9-2009.
- 3,807,156. **BE.ON.ROAD (STYLIZED)**. APONIA SOFTWARE, S.R.O., (U.S. CLS. 21, 23, 26, 36 AND 38). SN 79-066,632. PUB. 4-6-2010. FILED 10-15-2008.
- 3,807,157. **PROSEGUR (STYLIZED)**. PROSEGUR, COMPAÑIA DE SEGURIDAD, S.A., MULTIPLE CLASS, (INT. CLS. 9 AND 39), (U.S. CLS. 21, 23, 26, 36, 38, 100 AND 105). SN 79-066,913. PUB. 4-6-2010. FILED 1-23-2009.
- 3,807,160. **HY-DEX (STANDARD CHARACTER)**. IMPEDIMED LIMITED, MULTIPLE CLASS, (INT. CLS. 9, 10 AND 44), (U.S. CLS. 21, 23, 26, 36, 38, 39, 44, 100 AND 101). SN 79-067,069. PUB. 12-29-2009. FILED 1-23-2009.
- 3,807,163 (*See Class 7 for this trademark*).
- 3,807,165. **VI-CLONEM AND DESIGN**. RODOLFO BIANCO GONZÁLEZ, MULTIPLE CLASS, (INT. CLS. 9, 35 AND 38), (U.S. CLS. 21, 23, 26, 36, 38, 100, 101, 102 AND 104). SN 79-067,618. PUB. 4-6-2010. FILED 1-19-2009.
- 3,807,170. **WATCHDATA AND DESIGN**. BEIJING WATCH DATA SYSTEM CO., LTD., (U.S. CLS. 21, 23, 26, 36 AND 38). SN 79-067,848. PUB. 4-6-2010. FILED 4-7-2009.
- 3,807,172. **ROLMINE (STANDARD CHARACTER)**. BETA SYSTEMS SOFTWARE AG, (U.S. CLS. 21, 23, 26, 36 AND 38). SN 79-068,079. PUB. 4-6-2010. FILED 4-28-2009.
- 3,807,174. **SYNCEVOLUTION (STANDARD CHARACTER)**. SYNCEVOLUTION; (SOCIÉTÉ À RESPONSABILITÉ LIMITÉE), MULTIPLE CLASS, (INT. CLS. 9 AND 42), (U.S. CLS. 21, 23, 26, 36, 38, 100 AND 101). SN 79-068,095. PUB. 4-6-2010. FILED 10-30-2008.
- 3,807,175 (*See Class 7 for this trademark*).
- 3,807,176. **CITIES XL (STANDARD CHARACTER)**. MONTE CRISTO MULTIMEDIA, MULTIPLE CLASS, (INT. CLS. 9 AND 41), (U.S. CLS. 21, 23, 26, 36, 38, 100, 101 AND 107). SN 79-068,389. PUB. 4-6-2010. FILED 9-5-2008.
- 3,807,180 (*See Class 3 for this trademark*).
- 3,807,196. **PAYWIZZ AND DESIGN**. GARANTI BILISIM TEKNOLOJISI; VE TICARET TÜRK ANONIM SİRKETİ, MULTIPLE CLASS, (INT. CLS. 9, 36 AND 42), (U.S. CLS. 21, 23, 26, 36, 38, 100, 101 AND 102). SN 79-069,205. PUB. 4-6-2010. FILED 2-9-2009.
- 3,807,207. **E20 (STANDARD CHARACTER)**. TANDBERG TELECOM AS, MULTIPLE CLASS, (INT. CLS. 9 AND 38), (U.S. CLS. 21, 23, 26, 36, 38, 100, 101 AND 104). SN 79-069,567. PUB. 4-6-2010. FILED 12-16-2008.
- 3,807,209 (*See Class 6 for this trademark*).
- 3,807,213. **HIPPIE LOGO (STANDARD CHARACTER)**. TOD'S S.P.A., MULTIPLE CLASS, (INT. CLS. 9, 18 AND 25), (U.S. CLS. 1, 2, 3, 21, 22, 23, 26, 36, 38, 39 AND 41). SN 79-069,795. PUB. 4-6-2010. FILED 12-10-2008.
- 3,807,215. **ROADBASE (STANDARD CHARACTER)**. CHEVIN COMPUTER SYSTEMS LTD, (U.S. CLS. 21, 23, 26, 36 AND 38). SN 79-069,819. PUB. 4-6-2010. FILED 5-13-2009.
- 3,807,217. **SIRIUS BLU (STANDARD CHARACTER)**. CANVAS S CO., LTD., (U.S. CLS. 21, 23, 26, 36 AND 38). SN 79-069,845. PUB. 4-6-2010. FILED 4-15-2009.
- 3,807,218. **CS AND DESIGN**. COAL SERVICES PTY LIMITED, MULTIPLE CLASS, (INT. CLS. 9, 41 AND 42), (U.S. CLS. 21, 23, 26, 36, 38, 100, 101 AND 107). SN 79-069,874. PUB. 4-6-2010. FILED 5-28-2009.
- 3,807,219. **CS VIRTUAL REALITY AND DESIGN**. COAL SERVICES PTY LIMITED, MULTIPLE CLASS, (INT. CLS. 9, 41 AND 42), (U.S. CLS. 21, 23, 26, 36, 38, 100, 101 AND 107). SN 79-069,875. PUB. 4-6-2010. FILED 5-28-2009.
- 3,807,220. **CS VRT AND DESIGN**. COAL SERVICES PTY LIMITED, MULTIPLE CLASS, (INT. CLS. 9, 41 AND 42), (U.S. CLS. 21, 23, 26, 36, 38, 100, 101 AND 107). SN 79-069,876. PUB. 4-6-2010. FILED 5-28-2009.
- 3,807,221. **CS CMTS AND DESIGN**. COAL SERVICES PTY LIMITED, MULTIPLE CLASS, (INT. CLS. 9, 41 AND 42), (U.S. CLS. 21, 23, 26, 36, 38, 100, 101 AND 107). SN 79-069,877. PUB. 4-6-2010. FILED 5-28-2009.
- 3,807,223. **WILD SYSTEMS (STANDARD CHARACTER)**. HPC PROJECT SA, MULTIPLE CLASS, (INT. CLS. 9, 38 AND 42), (U.S. CLS. 21, 23, 26, 36, 38, 100, 101 AND 104). SN 79-069,948. PUB. 4-6-2010. FILED 1-28-2009.
- 3,807,228. **DAKO COVERSTAINER LINK (STANDARD CHARACTER)**. DAKO DENMARK A/S, MULTIPLE CLASS, (INT. CLS. 9, 37, 41 AND 42), (U.S. CLS. 21, 23, 26, 36, 38, 100, 101, 103, 106 AND 107). SN 79-070,053. PUB. 4-6-2010. FILED 4-4-2009.
- 3,807,233 (*See Class 3 for this trademark*).
- 3,807,239. **ITEMP (STANDARD CHARACTER)**. GLOBAL ORTHOPAEDIC TECHNOLOGY PTY LTD, (U.S. CLS. 21, 23, 26, 36 AND 38). SN 79-070,332. PUB. 4-6-2010. FILED 6-11-2009.
- 3,807,249. **RIB ITWO (STANDARD CHARACTER)**. RIB SOFTWARE AG, MULTIPLE CLASS, (INT. CLS. 9, 35, 38, 41 AND 42), (U.S. CLS. 21, 23, 26, 36, 38, 100, 101, 102, 104 AND 107). SN 79-070,647. PUB. 4-6-2010. FILED 5-5-2009.
- 3,807,251. **FIRSTACCESS (STANDARD CHARACTER)**. SOCIETE GENERALE, MULTIPLE CLASS, (INT. CLS. 9, 36 AND 38), (U.S. CLS. 21, 23, 26, 36, 38, 100, 101, 102 AND 104). SN 79-070,686. PUB. 4-6-2010. FILED 4-2-2009.
- 3,807,252. **YES ITALIA AND DESIGN**. NEWCO RAI INTERNATIONAL S.P.A., MULTIPLE CLASS, (INT. CLS. 9, 16, 38 AND 41), (U.S. CLS. 2, 5, 21, 22, 23, 26, 29, 36, 37, 38, 50, 100, 101, 104 AND 107). SN 79-070,695. PUB. 4-6-2010. FILED 2-9-2009.
- 3,807,257. **OGAME (STANDARD CHARACTER)**. GAMEFORGE AG, MULTIPLE CLASS, (INT. CLS. 9, 28 AND 41), (U.S. CLS. 21, 22, 23, 26, 36, 38, 50, 100, 101 AND 107). SN 79-071,017. PUB. 4-6-2010. FILED 5-19-2009.
- 3,807,261 (*See Class 1 for this trademark*).
- 3,807,264 (*See Class 6 for this trademark*).
- 3,807,266. **SOURCEMAN (STANDARD CHARACTER)**. SOURCEMAN INTERNATIONAL PTY LTD, MULTIPLE CLASS, (INT. CLS. 9 AND 35), (U.S. CLS. 21, 23, 26, 36, 38, 100, 101 AND 102). SN 79-071,521. PUB. 4-6-2010. FILED 5-25-2009.
- 3,807,278. **KARYOGENOMICS (STANDARD CHARACTER)**. AGENCY FOR SCIENCE, TECHNOLOGY AND RESEARCH, MULTIPLE CLASS, (INT. CLS. 9, 42 AND 44), (U.S. CLS. 21, 23, 26, 36, 38, 100 AND 101). SN 79-072,118. PUB. 4-6-2010. FILED 5-22-2009.
- 3,807,283 (*See Class 7 for this trademark*).
- 3,807,289. **ROBODIS (STANDARD CHARACTER)**. ERWEKA GMBH, MULTIPLE CLASS, (INT. CLS. 9 AND 16), (U.S. CLS. 2, 5, 21, 22, 23, 26, 29, 36, 37, 38 AND 50). SN 79-072,559. PUB. 4-6-2010. FILED 10-27-2008.
- 3,807,296. **BIOCHEMFUSION (STANDARD CHARACTER)**. BIOCHEMFUSION APS, MULTIPLE CLASS, (INT. CLS. 9 AND 42), (U.S. CLS. 21, 23, 26, 36, 38, 100 AND 101). SN 79-072,955. PUB. 4-6-2010. FILED 6-24-2009.
- 3,807,307. **DICOMAR (STANDARD CHARACTER)**. LEICA CAMERA AG, (U.S. CLS. 21, 23, 26, 36 AND 38). SN 79-073,674. PUB. 4-6-2010. FILED 8-14-2009.
- 3,807,310. **LEMOPTIX (STANDARD CHARACTER)**. LEMOPTIX SA, MULTIPLE CLASS, (INT. CLS. 9 AND 42), (U.S. CLS. 21, 23, 26, 36, 38, 100 AND 101). SN 79-073,939. PUB. 4-6-2010. FILED 5-6-2009.
- 3,807,316. **DNA DIRECT NOTE ACCESS (STANDARD CHARACTER)**. CELEMONY SOFTWARE GMBH, MULTIPLE CLASS, (INT. CLS. 9 AND 42), (U.S. CLS. 21, 23, 26, 36, 38, 100 AND 101). SN 79-074,215. PUB. 4-6-2010. FILED 9-23-2009.
- 3,807,317. **YUIXX (STANDARD CHARACTER)**. 2L ALLIANCE B.V., (U.S. CLS. 21, 23, 26, 36 AND 38). SN 79-074,220. PUB. 4-6-2010. FILED 8-3-2009.
- 3,807,318 (*See Class 1 for this trademark*).
- 3,807,320 (*See Class 7 for this trademark*).
- 3,807,332. **VERFINO (STYLIZED)**. WUHAN ADMIRAL TECHNOLOGY LTD., (U.S. CLS. 21, 23, 26, 36 AND 38). SN 79-075,452. PUB. 4-6-2010. FILED 4-7-2009.

- 3,807,341. **JOINMAP (STANDARD CHARACTER)**. KYAZMA B.V., MULTIPLE CLASS, (INT. CLS. 9 AND 16), (U.S. CLS. 2, 5, 21, 22, 23, 26, 29, 36, 37, 38 AND 50). SN 79-075,705. PUB. 4-6-2010. FILED 9-25-2009.
- 3,807,352. **S7-MEC (STANDARD CHARACTER)**. SIEMENS AKTIENGESSELLSCHAFT, (U.S. CLS. 21, 23, 26, 36 AND 38). SN 79-076,384. PUB. 4-6-2010. FILED 10-26-2009.
- 3,807,353. **H HALFSTUDY AND DESIGN**. DARKHORSE CO., LTD., MULTIPLE CLASS, (INT. CLS. 9 AND 16), (U.S. CLS. 2, 5, 21, 22, 23, 26, 29, 36, 37, 38 AND 50). SN 79-076,521. PUB. 4-6-2010. FILED 9-25-2009.
- 3,807,369. **PRIMO EMPORIO AND DESIGN**. PRIMO EMPORIO S.N.C.; DI GIOVANNI PROVITERA & C., MULTIPLE CLASS, (INT. CLS. 9, 14, 18 AND 25), (U.S. CLS. 1, 2, 3, 21, 22, 23, 26, 27, 28, 36, 38, 39, 41 AND 50). SN 79-975,058. PUB. 4-6-2010. FILED 2-10-2006.

CLASS 10—MEDICAL APPARATUS

- 3,805,243. **MISCELLANEOUS DESIGN**. INDUSTRIAL TECHNOLOGY RESEARCH INSTITUTE, MULTIPLE CLASS, (INT. CLS. 10, 16, 41 AND 42), (U.S. CLS. 2, 5, 22, 23, 26, 29, 37, 38, 39, 44, 50, 100, 101 AND 107). SN 77-407,653. PUB. 4-6-2010. FILED 2-27-2008.
- 3,805,266. **TAMARACK FLEXURE JOINT (STANDARD CHARACTER)**. TAMARACK HABILITATION TECHNOLOGIES, INC., (U.S. CLS. 26, 39 AND 44). SN 77-464,669. PUB. 4-6-2010. FILED 5-2-2008.
- 3,805,267. **TAMARACK (STANDARD CHARACTER)**. TAMARACK HABILITATION TECHNOLOGIES, INC., (U.S. CLS. 26, 39 AND 44). SN 77-466,982. PUB. 4-6-2010. FILED 5-6-2008.
- 3,805,314. **FLIP (STANDARD CHARACTER)**. FLIP TECHNOLOGIES LIMITED, (U.S. CLS. 26, 39 AND 44). SN 77-541,720. PUB. 4-6-2010. FILED 8-7-2008.
- 3,805,317 (*See Class 9 for this trademark*).
- 3,805,327. **GISH (STANDARD CHARACTER)**. GISH BIOMEDICAL, INC., (U.S. CLS. 26, 39 AND 44). SN 77-553,990. PUB. 4-6-2010. FILED 8-22-2008.
- 3,805,349 (*See Class 5 for this trademark*).
- 3,805,379. **HW AND DESIGN**. HOWARD WRIGHT LIMITED, (U.S. CLS. 26, 39 AND 44). SN 77-599,154. PUB. 4-6-2010. FILED 10-23-2008.
- 3,805,390. **TRI-FLEX FLEXIBLE PARTIAL DENTURES AND DESIGN**. TRIDENT LABS, INC., DBA TRIDENT DENTAL LABORATORIES, (U.S. CLS. 26, 39 AND 44). SN 77-611,190. PUB. 4-6-2010. FILED 11-10-2008.
- 3,805,395. **VALUE COMES TO LIGHT (STANDARD CHARACTER)**. LUTRONIC, INC., (U.S. CLS. 26, 39 AND 44). SN 77-617,669. PUB. 4-6-2010. FILED 11-19-2008.
- 3,805,427. **ACCUFILTRER (STANDARD CHARACTER)**. CELLOMETRICS INC., FORMERLY 2158141 ONTARIO INC., (U.S. CLS. 26, 39 AND 44). SN 77-639,114. PUB. 4-6-2010. FILED 12-23-2008.
- 3,805,435. **BALANCE - BAR (STANDARD CHARACTER)**. KLEIN, FRANK, MULTIPLE CLASS, (INT. CLS. 10, 28 AND 41), (U.S. CLS. 22, 23, 26, 38, 39, 44, 50, 100, 101 AND 107). SN 77-644,998. PUB. 11-10-2009. FILED 1-7-2009.
- 3,805,627. **V S VTS MEDICAL SYSTEMS AND DESIGN**. VTS MEDICAL SYSTEMS, LLC, DBA VTS MEDICAL SYSTEMS, LLC, (U.S. CLS. 26, 39 AND 44). SN 77-733,475. PUB. 4-6-2010. FILED 5-11-2009.
- 3,805,799. **MEGAPEEL (STANDARD CHARACTER)**. DERMAMED INTERNATIONAL, INC., (U.S. CLS. 26, 39 AND 44). SN 77-770,916. PUB. 4-6-2010. FILED 6-30-2009.
- 3,805,812 (*See Class 5 for this trademark*).
- 3,805,875. **ASSURANCE AIR BITE BLOCK (STANDARD CHARACTER)**. ENDOCHOICE, INC., (U.S. CLS. 26, 39 AND 44). SN 77-792,115. PUB. 4-6-2010. FILED 7-29-2009.
- 3,806,085. **RIB-BACK (STANDARD CHARACTER)**. BECTON, DICKINSON AND COMPANY, (U.S. CLS. 26, 39 AND 44). SN 77-830,943. PUB. 4-6-2010. FILED 9-21-2009.
- 3,806,124. **ANKLE SHIELD AND DESIGN**. ARMOUREX, LLC, (U.S. CLS. 26, 39 AND 44). SN 77-837,423. PUB. 4-6-2010. FILED 9-29-2009.
- 3,806,155. **AF AND DESIGN**. AESTHETIC FACTORS, LLC, (U.S. CLS. 26, 39 AND 44). SN 77-841,049. PUB. 4-6-2010. FILED 10-5-2009.
- 3,806,171. **S4 ELEMENT (STANDARD CHARACTER)**. AESCULAP IMPLANT SYSTEMS, INC., (U.S. CLS. 26, 39 AND 44). SN 77-843,698. PUB. 4-6-2010. FILED 10-7-2009.
- 3,806,212. **FANG PLATE (STANDARD CHARACTER)**. EMINENT SPINE LLC, (U.S. CLS. 26, 39 AND 44). SN 77-847,441. PUB. 4-6-2010. FILED 10-13-2009.
- 3,806,246. **MYSTAR (STANDARD CHARACTER)**. SANOFI-AVENTIS, (U.S. CLS. 26, 39 AND 44). SN 77-850,738. PUB. 4-6-2010. FILED 10-16-2009.
- 3,806,247. **TRACSTAR (STANDARD CHARACTER)**. SANOFI-AVENTIS, (U.S. CLS. 26, 39 AND 44). SN 77-850,791. PUB. 4-6-2010. FILED 10-16-2009.
- 3,806,248. **STARTUS (STANDARD CHARACTER)**. SANOFI-AVENTIS, (U.S. CLS. 26, 39 AND 44). SN 77-850,792. PUB. 4-6-2010. FILED 10-16-2009.
- 3,806,340. **INFINITI MEDICAL (STANDARD CHARACTER)**. INFINITI MEDICAL, LLC, (U.S. CLS. 26, 39 AND 44). SN 77-855,987. PUB. 4-6-2010. FILED 10-23-2009.
- 3,806,403. **NEB-A-DOODLE (STANDARD CHARACTER)**. GF HEALTH PRODUCTS, INC., (U.S. CLS. 26, 39 AND 44). SN 77-857,954. PUB. 4-6-2010. FILED 10-27-2009.
- 3,806,417. **PERRY (STANDARD CHARACTER)**. ANSELL HEALTHCARE PRODUCTS LLC, (U.S. CLS. 26, 39 AND 44). SN 77-858,148. PUB. 4-6-2010. FILED 10-27-2009.
- 3,806,455. **VALUSHIELD PROTECTIVE CLOTHING AND DESIGN**. RELIABLE SAFETY SOLUTIONS, INC., FORMERLY RELIABLE SUPPLIES OF NORTH CAROLINA, INC., (U.S. CLS. 26, 39 AND 44). SN 77-858,517. PUB. 4-6-2010. FILED 10-27-2009.
- 3,806,477. **KENRICO (STANDARD CHARACTER)**. KENRICO LTD., (U.S. CLS. 26, 39 AND 44). SN 77-858,709. PUB. 4-6-2010. FILED 10-27-2009.
- 3,806,648. **MINI MASSEUSE (STYLIZED)**. MJ SPECIALTY RETAIL, LLC., (U.S. CLS. 26, 39 AND 44). SN 77-860,579. PUB. 4-6-2010. FILED 10-29-2009.
- 3,806,708. **COMFORTLAND (STANDARD CHARACTER)**. COMFORTLAND MEDICAL, INC., (U.S. CLS. 26, 39 AND 44). SN 77-861,353. PUB. 4-6-2010. FILED 10-30-2009.
- 3,806,720. **THE DELINEATOR (STANDARD CHARACTER)**. PAUL M HERTZ, (U.S. CLS. 26, 39 AND 44). SN 77-861,520. PUB. 4-6-2010. FILED 10-30-2009.
- 3,806,816. **LOTUSBIO AND DESIGN**. LOTUS BIO INC., (U.S. CLS. 26, 39 AND 44). SN 77-863,436. PUB. 4-6-2010. FILED 11-3-2009.
- 3,806,828. **AUTOSPLIT (STANDARD CHARACTER)**. DRUG DETECTION DEVICES, LTD., (U.S. CLS. 26, 39 AND 44). SN 77-863,565. PUB. 4-6-2010. FILED 11-3-2009.
- 3,806,985 (*See Class 9 for this trademark*).
- 3,807,020. **FLEXI-SEAL SIGNAL (STANDARD CHARACTER)**. CONVATEC INC., (U.S. CLS. 26, 39 AND 44). SN 77-886,267. PUB. 4-6-2010. FILED 12-4-2009.
- 3,807,103 (*See Class 5 for this trademark*).
- 3,807,132 (*See Class 5 for this trademark*).
- 3,807,134 (*See Class 9 for this trademark*).
- 3,807,160 (*See Class 9 for this trademark*).
- 3,807,168. **ART PLUS (STANDARD CHARACTER)**. OY AJAT LTD., (U.S. CLS. 26, 39 AND 44). SN 79-067,800. PUB. 4-6-2010. FILED 3-4-2009.
- 3,807,180 (*See Class 3 for this trademark*).
- 3,807,192. **PROVEN EXCELLENCE BY SIEMENS HEALTHCARE AND DESIGN**. SIEMENS AKTIENGESSELLSCHAFT, MULTIPLE CLASS, (INT. CLS. 10 AND 36), (U.S. CLS. 26, 39, 44, 100, 101 AND 102). SN 79-069,039. PUB. 4-6-2010. FILED 3-27-2009.
- 3,807,230. **SOFTCLOX AND DESIGN**. CHRISTINA MÜHLE, MULTIPLE CLASS, (INT. CLS. 10, 18 AND 25), (U.S. CLS. 1, 2, 3, 22, 26, 39, 41 AND 44). SN 79-070,094. PUB. 4-6-2010. FILED 5-21-2009.
- 3,807,235 (*See Class 5 for this trademark*).
- 3,807,236. **PARAGON (STANDARD CHARACTER)**. GLOBAL ORTHOPAEDIC TECHNOLOGY PTY LTD, (U.S. CLS. 26, 39 AND 44). SN 79-070,205. PUB. 4-6-2010. FILED 6-11-2009.
- 3,807,243. **GONG DONG AND DESIGN**. ZHEJIANG GONGDONG; MEDICAL PLASTIC FACTORY, (U.S. CLS. 26, 39 AND 44). SN 79-070,467. PUB. 4-6-2010. FILED 4-21-2009.
- 3,807,254 (*See Class 5 for this trademark*).

- 3,807,263 (*See Class 1 for this trademark.*)
 3,807,271 (*See Class 3 for this trademark.*)
 3,807,281 (*See Class 3 for this trademark.*)
 3,807,326. **HAEMOFINE (STANDARD CHARACTER)**. "HTL-STREFA" SPÓLKA AKCYJNA, MULTIPLE CLASS, (INT. CLS. 10 AND 16), (U.S. CLS. 2, 5, 22, 23, 26, 29, 37, 38, 39, 44 AND 50). SN 79-074,982. PUB. 4-6-2010. FILED 8-25-2009.
 3,807,346. **MISCELLANEOUS DESIGN**. UNITRACT SYRINGE PTY LTD, (U.S. CLS. 26, 39 AND 44). SN 79-075,971. PUB. 4-6-2010. FILED 10-30-2009.
 3,807,347. **UNILIFE (STANDARD CHARACTER)**. UNITRACT SYRINGE PTY LTD, (U.S. CLS. 26, 39 AND 44). SN 79-075,972. PUB. 4-6-2010. FILED 10-30-2009.
 3,807,358. **BTI BIOPILAR (STANDARD CHARACTER)**. BIOTECHNOLOGY INSTITUTE, S.L., (U.S. CLS. 26, 39 AND 44). SN 79-077,119. PUB. 4-6-2010. FILED 10-7-2009.
 3,807,361. **TIGR (STANDARD CHARACTER)**. NOVUS SCIENTIFIC PTE. LTD., (U.S. CLS. 26, 39 AND 44). SN 79-077,394. PUB. 4-6-2010. FILED 9-29-2009.

CLASS 11—ENVIRONMENTAL CONTROL APPARATUS

- 3,805,124 (*See Class 1 for this trademark.*)
 3,805,135. **TEMP KITCHEN AND DESIGN**. DWYER PRODUCTS CORPORATION, (U.S. CLS. 13, 21, 23, 31 AND 34). SN 76-689,713. PUB. 4-6-2010. FILED 5-16-2008.
 3,805,168. **ULTRASLIMLINE (STANDARD CHARACTER)**. SEVILLE CLASSICS, INC., (U.S. CLS. 13, 21, 23, 31 AND 34). SN 76-700,020. PUB. 4-6-2010. FILED 10-23-2009.
 3,805,185 (*See Class 7 for this trademark.*)
 3,805,201 (*See Class 7 for this trademark.*)
 3,805,288 (*See Class 6 for this trademark.*)
 3,805,300. **I AND DESIGN**. INTEX RECREATION CORP., MULTIPLE CLASS, (INT. CLS. 11, 12, 19 AND 28), (U.S. CLS. 1, 12, 13, 19, 21, 22, 23, 31, 33, 34, 35, 38, 44 AND 50). SN 77-504,047. PUB. 4-6-2010. FILED 6-20-2008.
 3,805,313 (*See Class 9 for this trademark.*)
 3,805,425 (*See Class 4 for this trademark.*)
 3,805,510. **STINGRAY (STANDARD CHARACTER)**. SAGE TECHNOLOGY, LLC., (U.S. CLS. 13, 21, 23, 31 AND 34). SN 77-709,929. PUB. 4-6-2010. FILED 4-8-2009.
 3,805,523. **DURANGO (STANDARD CHARACTER)**. VOGELZANG INTERNATIONAL CORPORATION, (U.S. CLS. 13, 21, 23, 31 AND 34). SN 77-715,178. PUB. 4-6-2010. FILED 4-16-2009.
 3,805,572. **POLARPACK (STANDARD CHARACTER)**. TEGRANT DIVERSIFIED BRANDS, INC., MULTIPLE CLASS, (INT. CLS. 11 AND 21), (U.S. CLS. 2, 13, 21, 23, 29, 30, 31, 33, 34, 40 AND 50). SN 77-725,939. PUB. 4-6-2010. FILED 4-30-2009.
 3,805,637. **MOSQUITO GENIE (STANDARD CHARACTER)**. TOM FLEMING, (U.S. CLS. 13, 21, 23, 31 AND 34). SN 77-735,115. PUB. 4-6-2010. FILED 5-12-2009.
 3,805,669. **KING COAL AND DESIGN**. KING COAL FURNACE CORPORATION, (U.S. CLS. 13, 21, 23, 31 AND 34). SN 77-741,422. PUB. 4-6-2010. FILED 5-20-2009.
 3,805,715. **TURBO 3 HIGH PERFORMANCE FLUSHING SYSTEM (STANDARD CHARACTER)**. CERAMICAS INDUSTRIALES CISA S.A., (U.S. CLS. 13, 21, 23, 31 AND 34). SN 77-750,049. PUB. 4-6-2010. FILED 6-2-2009.
 3,805,807. **RIVAL AND DESIGN**. SUNBEAM PRODUCTS, INC., DBA JARDEN CONSUMER SOLUTIONS, (U.S. CLS. 13, 21, 23, 31 AND 34). SN 77-773,027. PUB. 4-6-2010. FILED 7-2-2009.
 3,805,826 (*See Class 7 for this trademark.*)
 3,805,840. **REMAINS LIT AND DESIGN**. SEASONAL SPECIALTIES LLC, MULTIPLE CLASS, (INT. CLS. 11 AND 28), (U.S. CLS. 13, 21, 22, 23, 31, 34, 38 AND 50). SN 77-781,350. PUB. 4-6-2010. FILED 7-15-2009.
 3,805,841. **REMAINS LIT AND DESIGN**. SEASONAL SPECIALTIES LLC, MULTIPLE CLASS, (INT. CLS. 11 AND 28), (U.S. CLS. 13, 21, 22, 23, 31, 34, 38 AND 50). SN 77-781,462. PUB. 4-6-2010. FILED 7-15-2009.
 3,805,854. **VERTECH (STANDARD CHARACTER)**. SOCIETE DES PRODUITS NESTLE S.A., MULTIPLE CLASS, (INT. CLS. 11 AND 30), (U.S. CLS. 13, 21, 23, 31, 34 AND 46). SN 77-785,053. PUB. 4-6-2010. FILED 7-20-2009.
 3,805,855. **ALUCYCLE (STANDARD CHARACTER)**. SOCIETE DES PRODUITS NESTLE S.A., MULTIPLE CLASS, (INT. CLS. 11 AND 30), (U.S. CLS. 13, 21, 23, 31, 34 AND 46). SN 77-785,056. PUB. 4-6-2010. FILED 7-20-2009.
 3,805,919 (*See Class 3 for this trademark.*)
 3,805,924. **SUPREMEHEAT (STANDARD CHARACTER)**. FURNACE DESIGN TECHNOLOGY, (U.S. CLS. 13, 21, 23, 31 AND 34). SN 77-800,771. PUB. 4-6-2010. FILED 8-10-2009.
 3,806,127. **MAXX COLD AND DESIGN**. GREENFIELD WORLD TRADE, INC., (U.S. CLS. 13, 21, 23, 31 AND 34). SN 77-837,768. PUB. 4-6-2010. FILED 9-29-2009.
 3,806,135 (*See Class 8 for this trademark.*)
 3,806,136 (*See Class 9 for this trademark.*)
 3,806,145 (*See Class 6 for this trademark.*)
 3,806,201. **LUMINIS (STANDARD CHARACTER)**. LUMINIS USA, INC., (U.S. CLS. 13, 21, 23, 31 AND 34). SN 77-846,364. PUB. 4-6-2010. FILED 10-12-2009.
 3,806,376 (*See Class 7 for this trademark.*)
 3,806,387. **NEXLUME (STANDARD CHARACTER)**. BERNAL, GUSTAVUS, (U.S. CLS. 13, 21, 23, 31 AND 34). SN 77-857,490. PUB. 4-6-2010. FILED 10-26-2009.
 3,806,491 (*See Class 3 for this trademark.*)
 3,806,522. **ON POOL (STANDARD CHARACTER)**. U.B. ELECTRIC INC., (U.S. CLS. 13, 21, 23, 31 AND 34). SN 77-859,196. PUB. 4-6-2010. FILED 10-28-2009.
 3,806,578. **NATURESUN (STANDARD CHARACTER)**. ZOO MED LABORATORIES, INC., (U.S. CLS. 13, 21, 23, 31 AND 34). SN 77-859,850. PUB. 4-6-2010. FILED 10-28-2009.
 3,806,596 (*See Class 7 for this trademark.*)
 3,806,601. **ZEPHYR (STANDARD CHARACTER)**. HEXBG, LLC, (U.S. CLS. 13, 21, 23, 31 AND 34). SN 77-860,034. PUB. 4-6-2010. FILED 10-29-2009.
 3,806,670. **RAISE YOUR STANDARD OF LIGHTING! (STANDARD CHARACTER)**. HEGLUND, RYAN L, TA SILVERMERE AMERICA LLC, (U.S. CLS. 13, 21, 23, 31 AND 34). SN 77-860,797. PUB. 4-6-2010. FILED 10-29-2009.
 3,806,744. **UTILITY AND DESIGN**. HSM ENTERPRISES, INC., DBA UTILITY REFRIGERATOR, (U.S. CLS. 13, 21, 23, 31 AND 34). SN 77-861,804. PUB. 4-6-2010. FILED 10-30-2009.
 3,806,797. **U AND DESIGN**. U-LINE CORPORATION, (U.S. CLS. 13, 21, 23, 31 AND 34). SN 77-863,102. PUB. 4-6-2010. FILED 11-2-2009.
 3,806,955. **INTELLIHEAT (STANDARD CHARACTER)**. SI BARGHELAME, (U.S. CLS. 13, 21, 23, 31 AND 34). SN 77-873,946. PUB. 4-6-2010. FILED 11-17-2009.
 3,807,089. **AGA AND DESIGN**. AGA RANGEMASTER GROUP PLC, MULTIPLE CLASS, (INT. CLS. 11, 35 AND 37), (U.S. CLS. 13, 21, 23, 31, 34, 100, 101, 102, 103 AND 106). SN 78-976,829. PUB. 4-6-2010. FILED 6-8-2004.
 3,807,090 (*See Class 7 for this trademark.*)
 3,807,104 (*See Class 6 for this trademark.*)
 3,807,119. **SOFTSYSTEM (STANDARD CHARACTER)**. LIEBHERR-INTERNATIONAL AG, (U.S. CLS. 13, 21, 23, 31 AND 34). SN 79-060,047. PUB. 4-6-2010. FILED 8-21-2008.
 3,807,122 (*See Class 6 for this trademark.*)
 3,807,126 (*See Class 7 for this trademark.*)
 3,807,142 (*See Class 6 for this trademark.*)
 3,807,148 (*See Class 7 for this trademark.*)
 3,807,175 (*See Class 7 for this trademark.*)
 3,807,180 (*See Class 3 for this trademark.*)
 3,807,184 (*See Class 6 for this trademark.*)
 3,807,189. **LITREE (STYLIZED)**. HAINAN LITREE; PURIFYING TECHNOLOGY CO., LTD., (U.S. CLS. 13, 21, 23, 31 AND 34). SN 79-068,908. PUB. 4-6-2010. FILED 4-29-2009.
 3,807,195. **ALTREFORME (STYLIZED)**. FHOME S.R.L., MULTIPLE CLASS, (INT. CLS. 11, 20 AND 42), (U.S. CLS. 2, 13, 21, 22, 23, 25, 31, 32, 34, 50, 100 AND 101). SN 79-069,160. PUB. 4-6-2010. FILED 1-19-2009.
 3,807,206. **LAM AND DESIGN**. L.A.M. S.R.L., MULTIPLE CLASS, (INT. CLS. 11, 12 AND 42), (U.S. CLS. 13, 19, 21, 23, 31, 34, 35, 44, 100 AND 101). SN 79-069,549. PUB. 4-6-2010. FILED 1-29-2009.
 3,807,238. **ESTERAS (STANDARD CHARACTER)**. EMSA GMBH, MULTIPLE CLASS, (INT. CLS. 11, 19, 20 AND 21), (U.S. CLS. 1, 2, 12, 13, 21, 22, 23, 25, 29, 30, 31, 32, 33, 34,

40 AND 50). SN 79-070,324. PUB. 4-6-2010. FILED 3-3-2009.
 3,807,245. **K AND DESIGN**. KRÜGER GMBH & CO. KG, MULTIPLE CLASS, (INT. CLS. 11, 21 AND 30), (U.S. CLS. 2, 13, 21, 23, 29, 30, 31, 33, 34, 40, 46 AND 50). SN 79-070,485. PUB. 12-8-2009. FILED 3-20-2009.
 3,807,246 (*See Class 7 for this trademark*).
 3,807,255. **KOZLUSAN AND DESIGN**. SALIH KOZLU, (U.S. CLS. 13, 21, 23, 31 AND 34). SN 79-070,764. PUB. 4-6-2010. FILED 6-2-2009.
 3,807,260 (*See Class 4 for this trademark*).
 3,807,283 (*See Class 7 for this trademark*).
 3,807,348. **PERMA-FOIL (STYLIZED)**. TOYO TANSO CO., LTD., MULTIPLE CLASS, (INT. CLS. 11 AND 17), (U.S. CLS. 1, 5, 12, 13, 21, 23, 31, 34, 35 AND 50). SN 79-075,975. PUB. 4-6-2010. FILED 11-2-2009.
 3,807,357. **ZJXCAAC AND DESIGN**. ZHEJIANG CHUANGXIN; AUTO AIR CONDITIONER CO., LTD., (U.S. CLS. 13, 21, 23, 31 AND 34). SN 79-076,937. PUB. 4-6-2010. FILED 10-20-2009.

CLASS 12—VEHICLES

3,805,124 (*See Class 1 for this trademark*).
 3,805,144 (*See Class 7 for this trademark*).
 3,805,176. **BILLET-POWER (STANDARD CHARACTER)**. FLAMING RIVER INDUSTRIES, INC., (U.S. CLS. 19, 21, 23, 31, 35 AND 44). SN 76-700,228. PUB. 4-6-2010. FILED 11-4-2009.
 3,805,272 (*See Class 4 for this trademark*).
 3,805,273 (*See Class 4 for this trademark*).
 3,805,299. **ECLIPSE MEDICAL (STANDARD CHARACTER)**. ECLIPSE MEDICAL INC., MULTIPLE CLASS, (INT. CLS. 12, 35, 36 AND 37), (U.S. CLS. 19, 21, 23, 31, 35, 44, 100, 101, 102, 103 AND 106). SN 77-500,960. PUB. 2-9-2010. FILED 6-17-2008.
 3,805,300 (*See Class 11 for this trademark*).
 3,805,346 (*See Class 9 for this trademark*).
 3,805,347 (*See Class 9 for this trademark*).
 3,805,455. **NO SWEAT (STANDARD CHARACTER)**. KARBON KINETICS LIMITED, (U.S. CLS. 19, 21, 23, 31, 35 AND 44). SN 77-670,038. PUB. 4-6-2010. FILED 2-13-2009.
 3,805,629. **KIDADDLE (STANDARD CHARACTER)**. DYNAMIC BRANDS, LLC, MULTIPLE CLASS, (INT. CLS. 12 AND 18), (U.S. CLS. 1, 2, 3, 19, 21, 22, 23, 31, 35, 41 AND 44). SN 77-734,015. PUB. 4-6-2010. FILED 5-11-2009.
 3,805,649. **DEFENDER YACHT CLUB DYC AND DESIGN**. ALVAREZ, MARTIN, (U.S. CLS. 19, 21, 23, 31, 35 AND 44). SN 77-736,278. PUB. 4-6-2010. FILED 5-13-2009.
 3,806,017. **IQ SMART SOLUTIONS (STANDARD CHARACTER)**. DOMESTIC INVESTMENT GROUP, LLC, (U.S. CLS. 19, 21, 23, 31, 35 AND 44). SN 77-819,755. PUB. 4-6-2010. FILED 9-3-2009.
 3,806,018. **IQ SMART SOLUTIONS AND DESIGN**. DOMESTIC INVESTMENT GROUP, LLC, (U.S. CLS. 19, 21, 23, 31, 35 AND 44). SN 77-819,778. PUB. 4-6-2010. FILED 9-3-2009.
 3,806,056 (*See Class 7 for this trademark*).
 3,806,077. **SAFE 7 SYSTEM (STANDARD CHARACTER)**. AIRCRAFT RUBBER MANUFACTURING, INC. (U.S. CLS. 19, 21, 23, 31, 35 AND 44). SN 77-828,527. PUB. 4-6-2010. FILED 9-17-2009.
 3,806,115. **FLEXX HANDLEBARS AND DESIGN**. F.A.S.S.T. COMPANY, (U.S. CLS. 19, 21, 23, 31, 35 AND 44). SN 77-836,519. PUB. 4-6-2010. FILED 9-28-2009.
 3,806,150. **X METAL AND DESIGN**. T-REX TRUCK PRODUCTS INC., AKA T-REX GRILLES, (U.S. CLS. 19, 21, 23, 31, 35 AND 44). SN 77-840,174. PUB. 4-6-2010. FILED 10-2-2009.
 3,806,206. **KCR RACING AND DESIGN**. REINHART, LEAH E., DBA KCR RACING, AND REINHART, MATTHEW C., DBA KCR RACING, (U.S. CLS. 19, 21, 23, 31, 35 AND 44). SN 77-846,914. PUB. 4-6-2010. FILED 10-12-2009.
 3,806,235. **AMBUBUS (STANDARD CHARACTER)**. FIRST LINE TECHNOLOGY, LLC, (U.S. CLS. 19, 21, 23, 31, 35 AND 44). SN 77-849,595. PUB. 4-6-2010. FILED 10-15-2009.
 3,806,316. **BIG KID TOYS (STANDARD CHARACTER)**. E. J. WESSEL, (U.S. CLS. 19, 21, 23, 31, 35 AND 44). SN 77-

855,359. PUB. 4-6-2010. FILED 10-22-2009.
 3,806,378. **SWIFTY (STANDARD CHARACTER)**. SWIFTY-BIKES, (U.S. CLS. 19, 21, 23, 31, 35 AND 44). SN 77-857,164. PUB. 4-6-2010. FILED 10-26-2009.
 3,806,645. **TRACKBOX (STANDARD CHARACTER)**. KAIROS AUTONOMI, INC., (U.S. CLS. 19, 21, 23, 31, 35 AND 44). SN 77-860,564. PUB. 4-6-2010. FILED 10-29-2009.
 3,806,682. **X-TENDER (STYLIZED)**. X-TENDER BOATS, LLC, (U.S. CLS. 19, 21, 23, 31, 35 AND 44). SN 77-860,944. PUB. 4-6-2010. FILED 10-29-2009.
 3,806,691. **DUTCHIE AND DESIGN**. DUTCH BIKE COMPANY LTD, TA DUTCHIE, (U.S. CLS. 19, 21, 23, 31, 35 AND 44). SN 77-861,065. PUB. 4-6-2010. FILED 10-30-2009.
 3,806,827. **GMCL (STANDARD CHARACTER)**. CMN COMPONENTS INC, (U.S. CLS. 19, 21, 23, 31, 35 AND 44). SN 77-863,558. PUB. 4-6-2010. FILED 11-3-2009.
 3,806,839. **PORT DAWG (STANDARD CHARACTER)**. EAST BAY TIRE CO., (U.S. CLS. 19, 21, 23, 31, 35 AND 44). SN 77-863,772. PUB. 4-6-2010. FILED 11-3-2009.
 3,806,951. **TUNNYCRAFT (STANDARD CHARACTER)**. ROLAND H. NOEL, DBA TUNNYCRAFT INC., (U.S. CLS. 19, 21, 23, 31, 35 AND 44). SN 77-873,643. PUB. 4-6-2010. FILED 11-16-2009.
 3,806,969. **RAM (STANDARD CHARACTER)**. CHRYSLER GROUP LLC, (U.S. CLS. 19, 21, 23, 31, 35 AND 44). SN 77-875,412. PUB. 4-6-2010. FILED 11-18-2009.
 3,806,999. **G&J (STANDARD CHARACTER)**. COKER TIRE COMPANY, (U.S. CLS. 19, 21, 23, 31, 35 AND 44). SN 77-882,420. PUB. 4-6-2010. FILED 11-30-2009.
 3,807,000. **G&J AND DESIGN**. COKER TIRE COMPANY, (U.S. CLS. 19, 21, 23, 31, 35 AND 44). SN 77-882,449. PUB. 4-6-2010. FILED 11-30-2009.
 3,807,018. **STANWELD (STANDARD CHARACTER)**. COKER TIRE COMPANY, (U.S. CLS. 19, 21, 23, 31, 35 AND 44). SN 77-886,012. PUB. 4-6-2010. FILED 12-4-2009.
 3,807,068 (*See Class 6 for this trademark*).
 3,807,092. **SKIKE (STYLIZED)**. FOUR ACE INTERNATIONAL LIMITED, MULTIPLE CLASS, (INT. CLS. 12, 18, 25, 28, 29, 41 AND 44), (U.S. CLS. 1, 2, 3, 19, 21, 22, 23, 31, 35, 38, 39, 41, 44, 46, 50, 100, 101 AND 107). SN 79-038,754. PUB. 4-6-2010. FILED 4-15-2007.
 3,807,104 (*See Class 6 for this trademark*).
 3,807,122 (*See Class 6 for this trademark*).
 3,807,123. **TEKNOROT AND DESIGN**. TEKNOROT OTOMOTIV ÜRÜNLERI; SANAYI VE TICARET A.S., (U.S. CLS. 19, 21, 23, 31, 35 AND 44). SN 79-061,132. PUB. 4-6-2010. FILED 6-20-2008.
 3,807,126 (*See Class 7 for this trademark*).
 3,807,159. **PARAGOLFER (STANDARD CHARACTER)**. OTTO BOCK HEALTHCARE GMBH, (U.S. CLS. 19, 21, 23, 31, 35 AND 44). SN 79-066,956. PUB. 2-16-2010. FILED 2-23-2009.
 3,807,197 (*See Class 7 for this trademark*).
 3,807,199 (*See Class 7 for this trademark*).
 3,807,206 (*See Class 11 for this trademark*).
 3,807,231. **CIPOLLINI (STANDARD CHARACTER)**. LANDUCCI SABRINA, MULTIPLE CLASS, (INT. CLS. 12, 18 AND 25), (U.S. CLS. 1, 2, 3, 19, 21, 22, 23, 31, 35, 39, 41 AND 44). SN 79-070,100. PUB. 4-6-2010. FILED 5-8-2009.
 3,807,232. **SKYLEADER AND DESIGN**. SKYLEADER A.S., MULTIPLE CLASS, (INT. CLS. 12, 28, 37 AND 41), (U.S. CLS. 19, 21, 22, 23, 31, 35, 38, 44, 50, 100, 101, 103, 106 AND 107). SN 79-070,120. PUB. 4-6-2010. FILED 3-5-2009.
 3,807,273. **BORA (STYLIZED)**. VOLKSWAGEN AG, (U.S. CLS. 19, 21, 23, 31, 35 AND 44). SN 79-071,828. PUB. 4-6-2010. FILED 5-20-2009.
 3,807,303. **MISCELLANEOUS DESIGN**. N.ST. PATENTE UND MARKEN GMBH, MULTIPLE CLASS, (INT. CLS. 12, 35 AND 39), (U.S. CLS. 19, 21, 23, 31, 35, 44, 100, 101, 102 AND 105). SN 79-073,446. PUB. 4-6-2010. FILED 8-11-2009.

CLASS 13—FIREARMS

3,805,124 (*See Class 1 for this trademark*).
 3,805,639. **NDS (STANDARD CHARACTER)**. NODAK SPUD, LLC, (U.S. CLS. 2 AND 9). SN 77-735,209. PUB. 4-6-2010. FILED 5-12-2009.

- 3,806,421. **SOFT MARK (STANDARD CHARACTER)**. SOFT AIR USA, INC., (U.S. CLS. 2 AND 9). SN 77-858,183. PUB. 4-6-2010. FILED 10-27-2009.
- 3,806,633. **SEATCARRY (STANDARD CHARACTER)**. ATK GROUP, LLC, DBA THE SEATCARRY, (U.S. CLS. 2 AND 9). SN 77-860,412. PUB. 4-6-2010. FILED 10-29-2009.
- 3,806,843. **REC7 (STANDARD CHARACTER)**. BARRETT FIREARMS MFG., INC., (U.S. CLS. 2 AND 9). SN 77-863,834. PUB. 4-6-2010. FILED 11-3-2009.
- 3,807,015. **DROZD (STANDARD CHARACTER)**. PYRAMYD AIR LTD., (U.S. CLS. 2 AND 9). SN 77-885,805. PUB. 4-6-2010. FILED 12-3-2009.
- 3,807,128 (*See Class 8 for this trademark*).
- 3,807,328. **RIODIN (STANDARD CHARACTER)**. MAXAM-CORP HOLDING, S.L., (U.S. CLS. 2 AND 9). SN 79-074,995. PUB. 4-6-2010. FILED 10-30-2009.
- 3,807,331. **RIOSEIS (STANDARD CHARACTER)**. MAXAM-CORP HOLDING, S.L., (U.S. CLS. 2 AND 9). SN 79-075,363. PUB. 4-6-2010. FILED 10-30-2009.

CLASS 14—JEWELRY

- 3,805,162. **NISSIM (STANDARD CHARACTER)**. NISSIM, NETALI, (U.S. CLS. 2, 27, 28 AND 50). SN 76-699,668. PUB. 4-6-2010. FILED 9-28-2009.
- 3,805,193 (*See Class 6 for this trademark*).
- 3,805,230 (*See Class 3 for this trademark*).
- 3,805,294. **HOUSE OF FABERGE (STANDARD CHARACTER)**. FABERGE LIMITED, MULTIPLE CLASS, (INT. CLS. 14, 21, 35, 41, 42, 43 AND 44), (U.S. CLS. 2, 13, 23, 27, 28, 29, 30, 33, 40, 50, 100, 101, 102 AND 107). SN 77-496,864. PUB. 4-6-2010. FILED 6-11-2008.
- 3,805,382 (*See Class 9 for this trademark*).
- 3,805,393. **ZADORA TIMEPIECES (STANDARD CHARACTER)**. ZADORA TIMEPIECES, LLC, MULTIPLE CLASS, (INT. CLS. 14, 35, 40 AND 42), (U.S. CLS. 2, 27, 28, 50, 100, 101, 102, 103 AND 106). SN 77-613,033. PUB. 4-6-2010. FILED 11-12-2008.
- 3,805,433. **SWANA (STANDARD CHARACTER)**. A. DALUMI DIAMONDS LTD., (U.S. CLS. 2, 27, 28 AND 50). SN 77-642,941. PUB. 4-6-2010. FILED 1-4-2009.
- 3,805,458. **BEYA (STYLIZED)**. PS IMPORTS FL., INC., DBA BEYA, (U.S. CLS. 2, 27, 28 AND 50). SN 77-671,133. PUB. 4-6-2010. FILED 2-16-2009.
- 3,805,470. **BENNEY B AND DESIGN**. BENNEY WATCHES PLC, (U.S. CLS. 2, 27, 28 AND 50). SN 77-678,433. PUB. 4-6-2010. FILED 2-25-2009.
- 3,805,662. **DELATORI AND DESIGN**. Z LUXE GROUP, INC., (U.S. CLS. 2, 27, 28 AND 50). SN 77-740,390. PUB. 4-6-2010. FILED 5-19-2009.
- 3,805,685. **H AND DESIGN**. HERMÈS INTERNATIONAL, MULTIPLE CLASS, (INT. CLS. 14, 16, 18 AND 25), (U.S. CLS. 1, 2, 3, 5, 22, 23, 27, 28, 29, 37, 38, 39, 41 AND 50). SN 77-744,266. PUB. 4-6-2010. FILED 5-26-2009.
- 3,805,760. **CAMILLE CL LUCIE (STYLIZED)**. CAMI-RINGS, LLC, (U.S. CLS. 2, 27, 28 AND 50). SN 77-761,343. PUB. 4-6-2010. FILED 6-16-2009.
- 3,805,806. **VC AND DESIGN**. VAISHALI DIAMOND CORPORATION, (U.S. CLS. 2, 27, 28 AND 50). SN 77-772,938. PUB. 4-6-2010. FILED 7-1-2009.
- 3,805,935. **BJ (STYLIZED)**. GARY TALBERT, DBA BOY JEWELS, (U.S. CLS. 2, 27, 28 AND 50). SN 77-804,430. PUB. 4-6-2010. FILED 8-13-2009.
- 3,806,280. **MISCELLANEOUS DESIGN**. ELEGANT COLLECTION, (U.S. CLS. 2, 27, 28 AND 50). SN 77-853,567. PUB. 4-6-2010. FILED 10-21-2009.
- 3,806,329. **LIFE WITHOUT ED (STANDARD CHARACTER)**. JENNIFER LYNN SCHAEFER, (U.S. CLS. 2, 27, 28 AND 50). SN 77-855,713. PUB. 4-6-2010. FILED 10-23-2009.
- 3,806,334. **TRU BY NICOLE YACANO (STANDARD CHARACTER)**. TRU JEWELLERY, INC., (U.S. CLS. 2, 27, 28 AND 50). SN 77-855,861. PUB. 4-6-2010. FILED 10-23-2009.
- 3,806,357. **SINGLE (STANDARD CHARACTER)**. MARTIN, STEPHEN, A., (U.S. CLS. 2, 27, 28 AND 50). SN 77-856,778. PUB. 4-6-2010. FILED 10-25-2009.
- 3,806,542. **JOHN CLAYBORN DESIGNER JEWELRY (STAN-**

- DARD CHARACTER)**. CLAYBORN JR., JOHN, DBA JOHN CLAYBORN DESIGNS, (U.S. CLS. 2, 27, 28 AND 50). SN 77-859,508. PUB. 4-6-2010. FILED 10-28-2009.
- 3,806,616. **DIRTY LITTLE SECRETS (STANDARD CHARACTER)**. HIGGINS, NATALIE, (U.S. CLS. 2, 27, 28 AND 50). SN 77-860,177. PUB. 4-6-2010. FILED 10-29-2009.
- 3,806,856. **VIV & INGRID (STANDARD CHARACTER)**. VIV & INGRID, CO., DBA VIV & INGRID, (U.S. CLS. 2, 27, 28 AND 50). SN 77-863,997. PUB. 4-6-2010. FILED 11-3-2009.
- 3,806,881. **SCRAPPYTRAK (STANDARD CHARACTER)**. DE-CUIR, TIMOTHY, MULTIPLE CLASS, (INT. CLS. 14 AND 25), (U.S. CLS. 2, 22, 27, 28, 39 AND 50). SN 77-864,646. PUB. 4-6-2010. FILED 11-4-2009.
- 3,806,886. **WOOLOOT (STANDARD CHARACTER)**. WOOLLOOT INTERNATIONAL, INC., (U.S. CLS. 2, 27, 28 AND 50). SN 77-864,859. PUB. 4-6-2010. FILED 11-4-2009.
- 3,806,942. **925 FUSION (STANDARD CHARACTER)**. VALUE-VISION MEDIA, INC., (U.S. CLS. 2, 27, 28 AND 50). SN 77-871,489. PUB. 4-6-2010. FILED 11-12-2009.
- 3,807,026. **5TH AND DESIGN**. LOCKHEED MARTIN CORPORATION, (U.S. CLS. 2, 27, 28 AND 50). SN 77-890,174. PUB. 4-6-2010. FILED 12-10-2009.
- 3,807,080 (*See Class 3 for this trademark*).
- 3,807,091. **BERLIN AND DESIGN**. M.A.X. 2001 SPORTMARKETING GMBH, MULTIPLE CLASS, (INT. CLS. 14, 16, 18, 21, 24, 25, 28, 35 AND 41), (U.S. CLS. 1, 2, 3, 5, 13, 22, 23, 27, 28, 29, 30, 33, 37, 38, 39, 40, 41, 42, 50, 100, 101, 102 AND 107). SN 79-033,583. PUB. 4-6-2010. FILED 3-8-2006.
- 3,807,107 (*See Class 9 for this trademark*).
- 3,807,111. **MELA AND DESIGN**. GHAM LIMITED, MULTIPLE CLASS, (INT. CLS. 14, 18 AND 25), (U.S. CLS. 1, 2, 3, 22, 27, 28, 39, 41 AND 50). SN 79-057,099. PUB. 4-6-2010. FILED 7-8-2008.
- 3,807,131 (*See Class 3 for this trademark*).
- 3,807,137. **HEVEA (STANDARD CHARACTER)**. KOHAN CORPORATION, MULTIPLE CLASS, (INT. CLS. 14, 18, 21, 25 AND 26), (U.S. CLS. 1, 2, 3, 13, 22, 23, 27, 28, 29, 30, 33, 37, 39, 40, 41, 42 AND 50). SN 79-062,650. PUB. 4-6-2010. FILED 8-19-2008.
- 3,807,139 (*See Class 3 for this trademark*).
- 3,807,140. **4 WARDS RING DENIM AND DESIGN**. OTTO (GMBH & CO KG), MULTIPLE CLASS, (INT. CLS. 14, 18 AND 25), (U.S. CLS. 1, 2, 3, 22, 27, 28, 39, 41 AND 50). SN 79-063,342. PUB. 4-6-2010. FILED 9-15-2008.
- 3,807,153 (*See Class 9 for this trademark*).
- 3,807,222. **BALKIS (STANDARD CHARACTER)**. BALKIS SA, (U.S. CLS. 2, 27, 28 AND 50). SN 79-069,907. PUB. 4-6-2010. FILED 2-18-2009.
- 3,807,233 (*See Class 3 for this trademark*).
- 3,807,240 (*See Class 3 for this trademark*).
- 3,807,268. **FLIK FLAK CHARMING COLLECTION (STANDARD CHARACTER)**. ETA SA MANUFACTURE HORLOGÈRE SUISSE, (U.S. CLS. 2, 27, 28 AND 50). SN 79-071,604. PUB. 4-6-2010. FILED 5-5-2009.
- 3,807,272. **DEFY (STANDARD CHARACTER)**. LVMH SWISS MANUFACTURES SA, (U.S. CLS. 2, 27, 28 AND 50). SN 79-071,827. PUB. 4-6-2010. FILED 6-2-2009.
- 3,807,279. **MASTERGRAFF (STANDARD CHARACTER)**. GRAFF DIAMONDS LIMITED, (U.S. CLS. 2, 27, 28 AND 50). SN 79-072,122. PUB. 4-6-2010. FILED 6-3-2009.
- 3,807,280. **BABYGRAFF (STANDARD CHARACTER)**. GRAFF DIAMONDS LIMITED, (U.S. CLS. 2, 27, 28 AND 50). SN 79-072,123. PUB. 4-6-2010. FILED 6-3-2009.
- 3,807,298. **KHS (STANDARD CHARACTER)**. OLAF SCHMIE-MANN, MULTIPLE CLASS, (INT. CLS. 14 AND 25), (U.S. CLS. 2, 22, 27, 28, 39 AND 50). SN 79-073,184. PUB. 4-6-2010. FILED 9-1-2009.
- 3,807,335. **VAUCHER (STANDARD CHARACTER)**. VAUCHER MANUFACTURE FLEURIER S.A., (U.S. CLS. 2, 27, 28 AND 50). SN 79-075,506. PUB. 4-6-2010. FILED 10-16-2009.
- 3,807,369 (*See Class 9 for this trademark*).

CLASS 15—MUSICAL INSTRUMENTS

- 3,805,234. **HENNESSEY AND DESIGN**. THE MUSIC PEOPLE

- INC., (U.S. CLS. 2, 21 AND 36). SN 77-382,794. PUB. 1-13-2009. FILED 1-29-2008.
- 3,805,947. **O-PORT AND DESIGN**. DARE MUSIC GROUP, LLC, (U.S. CLS. 2, 21 AND 36). SN 77-806,829. PUB. 4-6-2010. FILED 8-18-2009.
- 3,806,851. **OWENS AND DESIGN**. OWENS,RICHIE,B, DBA OWENS MUSIC GROUP, (U.S. CLS. 2, 21 AND 36). SN 77-863,925. PUB. 4-6-2010. FILED 11-3-2009.
- 3,807,006. **BIG AL (STANDARD CHARACTER)**. ERNIE BALL, INC., (U.S. CLS. 2, 21 AND 36). SN 77-884,225. PUB. 4-6-2010. FILED 12-2-2009.
- 3,807,350. **NEXTBEAT (STANDARD CHARACTER)**. KABUSHIKI KAISHA WACOM; (ALSO TRADING AS WACOM CO., LTD.). (U.S. CLS. 2, 21 AND 36). SN 79-075,994. PUB. 4-6-2010. FILED 9-15-2009.
-
- CLASS 16—PAPER GOODS AND PRINTED MATTER**
- 3,805,120. **MINOR LEAGUE BASEBALL**. NATIONAL ASSOCIATION OF PROFESSIONAL BASEBALL LEAGUES, INC., MULTIPLE CLASS, (INT. CL. 16 AND U.S. CL. 200), (U.S. CLS. 2, 5, 22, 23, 29, 37, 38 AND 50). SN 74-729,676. PUB. 4-6-2010. FILED 9-15-1995.
- 3,805,124 (*See Class 1 for this trademark*).
- 3,805,132. **PROTECT-O-GUARD (STANDARD CHARACTER)**. CORNER-EDGE PRODUCTS LTD., (U.S. CLS. 2, 5, 22, 23, 29, 37, 38 AND 50). SN 76-689,114. PUB. 4-6-2010. FILED 4-29-2008.
- 3,805,133. **WRAP-O-GUARD (STANDARD CHARACTER)**. CORNER-EDGE PRODUCTS LTD., (U.S. CLS. 2, 5, 22, 23, 29, 37, 38 AND 50). SN 76-689,115. PUB. 4-6-2010. FILED 4-29-2008.
- 3,805,136. **STRAP-O-GUARD (STANDARD CHARACTER)**. CORNER-EDGE PRODUCTS LTD., (U.S. CLS. 2, 5, 22, 23, 29, 37, 38 AND 50). SN 76-690,874. PUB. 4-6-2010. FILED 6-26-2008.
- 3,805,149 (*See Class 9 for this trademark*).
- 3,805,153. **FORGE AND DESIGN**. BNP MEDIA, INC., (U.S. CLS. 2, 5, 22, 23, 29, 37, 38 AND 50). SN 76-699,003. PUB. 4-6-2010. FILED 8-17-2009.
- 3,805,164. **CLARITY (STANDARD CHARACTER)**. VERSO PAPER CORP., (U.S. CLS. 2, 5, 22, 23, 29, 37, 38 AND 50). SN 76-699,735. PUB. 4-6-2010. FILED 10-5-2009.
- 3,805,185 (*See Class 7 for this trademark*).
- 3,805,191. **PIG-E-BANK (STANDARD CHARACTER)**. PEER GIVING SOLUTIONS INC., MULTIPLE CLASS, (INT. CLS. 16, 35 AND 36), (U.S. CLS. 2, 5, 22, 23, 29, 37, 38, 50, 100, 101 AND 102). SN 77-126,417. PUB. 4-6-2010. FILED 3-9-2007.
- 3,805,193 (*See Class 6 for this trademark*).
- 3,805,199. **GREEN DAYS (STANDARD CHARACTER)**. MILES-BRAMWELL EXECUTIVE SERVICES LIMITED, MULTIPLE CLASS, (INT. CLS. 16, 41 AND 44), (U.S. CLS. 2, 5, 22, 23, 29, 37, 38, 50, 100, 101 AND 107). SN 77-235,806. PUB. 4-6-2010. FILED 7-23-2007.
- 3,805,200. **WHITE CLOUD AND DESIGN**. KRUGER PRODUCTS L.P., (U.S. CLS. 2, 5, 22, 23, 29, 37, 38 AND 50). SN 77-237,392. PUB. 8-25-2009. FILED 7-24-2007.
- 3,805,230 (*See Class 3 for this trademark*).
- 3,805,243 (*See Class 10 for this trademark*).
- 3,805,256 (*See Class 9 for this trademark*).
- 3,805,257. **RESIDENT UPDATE (STANDARD CHARACTER)**. UHLIG, LLC, (U.S. CLS. 2, 5, 22, 23, 29, 37, 38 AND 50). SN 77-438,003. PUB. 4-6-2010. FILED 4-2-2008.
- 3,805,293 (*See Class 3 for this trademark*).
- 3,805,342. **BRITE POCKETS (STANDARD CHARACTER)**. TOP NOTCH TEACHER PRODUCTS, INC., (U.S. CLS. 2, 5, 22, 23, 29, 37, 38 AND 50). SN 77-565,945. PUB. 4-6-2010. FILED 9-9-2008.
- 3,805,348 (*See Class 6 for this trademark*).
- 3,805,367. **MOBILE MINI (STANDARD CHARACTER)**. LOCAL INSIGHT MEDIA HOLDINGS, INC., (U.S. CLS. 2, 5, 22, 23, 29, 37, 38 AND 50). SN 77-587,114. PUB. 4-6-2010. FILED 10-7-2008.
- 3,805,372. **TRAILER BOATS (STANDARD CHARACTER)**. EHLERT PUBLISHING GROUP, INC., MULTIPLE CLASS, (INT. CLS. 16 AND 41), (U.S. CLS. 2, 5, 22, 23, 29, 37, 38, 50, 100, 101 AND 107). SN 77-591,787. PUB. 4-6-2010. FILED 10-13-2008.
- 3,805,382 (*See Class 9 for this trademark*).
- 3,805,394 (*See Class 1 for this trademark*).
- 3,805,397. **CLEMENTINE ART (STANDARD CHARACTER)**. CLEMENTINE ART KITS, INC., MULTIPLE CLASS, (INT. CLS. 16, 28 AND 35), (U.S. CLS. 2, 5, 22, 23, 29, 37, 38, 50, 100, 101 AND 102). SN 77-618,212. PUB. 4-6-2010. FILED 11-20-2008.
- 3,805,438 (*See Class 9 for this trademark*).
- 3,805,453. **PEEPS (STANDARD CHARACTER)**. JUST BORN, INC., (U.S. CLS. 2, 5, 22, 23, 29, 37, 38 AND 50). SN 77-663,772. PUB. 4-6-2010. FILED 2-5-2009.
- 3,805,457. **PHONCARDS AND DESIGN**. AQUARIUS PUBLISHING, MULTIPLE CLASS, (INT. CLS. 16 AND 28), (U.S. CLS. 2, 5, 22, 23, 29, 37, 38 AND 50). SN 77-670,949. PUB. 4-6-2010. FILED 2-15-2009.
- 3,805,461. **VASCULAR DISEASE FOUNDATION (STANDARD CHARACTER)**. THE VASCULAR DISEASE FOUNDATION, INC., MULTIPLE CLASS, (INT. CLS. 16, 35, 36 AND 41), (U.S. CLS. 2, 5, 22, 23, 29, 37, 38, 50, 100, 101, 102 AND 107). SN 77-672,832. PUB. 4-6-2010. FILED 2-18-2009.
- 3,805,465. **V VASCULAR DISEASE FOUNDATION AND DESIGN**. THE VASCULAR DISEASE FOUNDATION, INC., MULTIPLE CLASS, (INT. CLS. 16, 35, 36 AND 41), (U.S. CLS. 2, 5, 22, 23, 29, 37, 38, 50, 100, 101, 102 AND 107). SN 77-675,731. PUB. 4-6-2010. FILED 2-23-2009.
- 3,805,466. **VENOUS DISEASE COALITION AND DESIGN**. THE VASCULAR DISEASE FOUNDATION, INC., MULTIPLE CLASS, (INT. CLS. 16, 35, 36 AND 41), (U.S. CLS. 2, 5, 22, 23, 29, 37, 38, 50, 100, 101, 102 AND 107). SN 77-675,779. PUB. 4-6-2010. FILED 2-23-2009.
- 3,805,469 (*See Class 9 for this trademark*).
- 3,805,477. **KONIK'S TAIL (STANDARD CHARACTER)**. UNITED SPIRIT BRANDS LIMITED, MULTIPLE CLASS, (INT. CLS. 16 AND 33), (U.S. CLS. 2, 5, 22, 23, 29, 37, 38, 47, 49 AND 50). SN 77-683,051. PUB. 4-6-2010. FILED 3-4-2009.
- 3,805,478 (*See Class 6 for this trademark*).
- 3,805,480. **IPBC (STANDARD CHARACTER)**. GLOBE WHITE PAGE LIMITED, MULTIPLE CLASS, (INT. CLS. 16, 35 AND 41), (U.S. CLS. 2, 5, 22, 23, 29, 37, 38, 50, 100, 101, 102 AND 107). SN 77-684,023. PUB. 4-6-2010. FILED 3-5-2009.
- 3,805,500. **LIBERTY & LAW AND DESIGN**. INSTITUTE FOR JUSTICE, (U.S. CLS. 2, 5, 22, 23, 29, 37, 38 AND 50). SN 77-704,928. PUB. 12-29-2009. FILED 4-2-2009.
- 3,805,504. **THUMBS UP (STANDARD CHARACTER)**. HEALTH PRODUCTS, LLC, (U.S. CLS. 2, 5, 22, 23, 29, 37, 38 AND 50). SN 77-707,290. PUB. 4-6-2010. FILED 4-6-2009.
- 3,805,531. **PET HOME AND DESIGN**. PET HOME PRODUCTS, INC., (U.S. CLS. 2, 5, 22, 23, 29, 37, 38 AND 50). SN 77-717,586. PUB. 4-6-2010. FILED 4-20-2009.
- 3,805,560. **PHASE III COMMERCIALIZATION (STYLIZED)**. DAWNBREAKER, INC., (U.S. CLS. 2, 5, 22, 23, 29, 37, 38 AND 50). SN 77-723,516. PUB. 4-6-2010. FILED 4-27-2009.
- 3,805,573. **SARMENT (STANDARD CHARACTER)**. WINE-LIFE LIMITED, MULTIPLE CLASS, (INT. CLS. 16, 33, 35, 39 AND 41), (U.S. CLS. 2, 5, 22, 23, 29, 37, 38, 47, 49, 50, 100, 101, 102, 105 AND 107). SN 77-726,070. PUB. 4-6-2010. FILED 4-30-2009.
- 3,805,592 (*See Class 9 for this trademark*).
- 3,805,623. **WALL PRAISE (STANDARD CHARACTER)**. MISTY MOUNTAIN DESIGNS, DBA WALLPRAISE, (U.S. CLS. 2, 5, 22, 23, 29, 37, 38 AND 50). SN 77-733,187. PUB. 4-6-2010. FILED 5-9-2009.
- 3,805,638. **V12 RELOADER (STANDARD CHARACTER)**. SAN ANTONIO LIGHTHOUSE, (U.S. CLS. 2, 5, 22, 23, 29, 37, 38 AND 50). SN 77-735,117. PUB. 4-6-2010. FILED 5-12-2009.
- 3,805,640. **PEACING IT TOGETHER! (STANDARD CHARACTER)**. THE MOSAIC PROJECT, (U.S. CLS. 2, 5, 22, 23, 29, 37, 38 AND 50). SN 77-735,416. PUB. 4-6-2010. FILED 5-12-2009.
- 3,805,641. **THE MOSAIC PROJECT (STANDARD CHARACTER)**. THE MOSAIC PROJECT, (U.S. CLS. 2, 5, 22, 23, 29, 37, 38 AND 50). SN 77-735,437. PUB. 4-6-2010. FILED 5-12-2009.
- 3,805,663. **THE GUARDIAN SYSTEM (STANDARD CHARACTER)**. ANTHONY & MIDDLEBROOK, P.C., MULTIPLE CLASS, (INT. CLS. 16 AND 41), (U.S. CLS. 2, 5, 22, 23, 29, 37, 38, 50, 100, 101 AND 107). SN 77-740,581. PUB. 4-6-2010.

- FILED 5-19-2009.
- 3,805,679. **THE MORTGAGE PROFESSOR (STANDARD CHARACTER)**. GUTTENTAG, JACK, MULTIPLE CLASS, (INT. CLS. 16 AND 41), (U.S. CLS. 2, 5, 22, 23, 29, 37, 38, 50, 100, 101 AND 107). SN 77-742,919. PUB. 4-6-2010. FILED 5-22-2009.
- 3,805,685 (*See Class 14 for this trademark*).
- 3,805,700. **GNAR WEAR (STANDARD CHARACTER)**. VICTA, ALESSANDRO K., MULTIPLE CLASS, (INT. CLS. 16 AND 25), (U.S. CLS. 2, 5, 22, 23, 29, 37, 38, 39 AND 50). SN 77-746,333. PUB. 4-6-2010. FILED 5-28-2009.
- 3,805,701. **SURGISTRATEGIES (STANDARD CHARACTER)**. VIRGO PUBLISHING, LLC, MULTIPLE CLASS, (INT. CLS. 16 AND 35), (U.S. CLS. 2, 5, 22, 23, 29, 37, 38, 50, 100, 101 AND 102). SN 77-746,945. PUB. 4-6-2010. FILED 5-28-2009.
- 3,805,721. **CAPS CERTIFIED APARTMENT PORTFOLIO SUPERVISOR (STANDARD CHARACTER)**. NATIONAL APARTMENT ASSOCIATION, MULTIPLE CLASS, (INT. CLS. 16 AND 41), (U.S. CLS. 2, 5, 22, 23, 29, 37, 38, 50, 100, 101 AND 107). SN 77-752,501. PUB. 4-6-2010. FILED 6-4-2009.
- 3,805,780. **SPELLBINDERS (STANDARD CHARACTER)**. SPELLBINDERS, MULTIPLE CLASS, (INT. CLS. 16 AND 41), (U.S. CLS. 2, 5, 22, 23, 29, 37, 38, 50, 100, 101 AND 107). SN 77-765,248. PUB. 4-6-2010. FILED 6-22-2009.
- 3,805,782. **NAREIT (STANDARD CHARACTER)**. NATIONAL ASSOCIATION OF REAL ESTATE INVESTMENT TRUSTS, INC., MULTIPLE CLASS, (INT. CLS. 16, 18, 21, 25, 30, 35, 36, 38 AND 41 AND U.S. CL. 200), (U.S. CLS. 1, 2, 3, 5, 13, 22, 23, 29, 30, 33, 37, 38, 39, 40, 41, 46, 50, 100, 101, 102, 104 AND 107). SN 77-765,586. PUB. 4-6-2010. FILED 6-22-2009.
- 3,805,832 (*See Class 9 for this trademark*).
- 3,805,867. **WHERE STREET IQ MEETS BOOK IQ (STANDARD CHARACTER)**. KOOL AS NERDZ INC, (U.S. CLS. 2, 5, 22, 23, 29, 37, 38 AND 50). SN 77-790,703. PUB. 4-6-2010. FILED 7-27-2009.
- 3,805,872. **FRIENDLY CARDS SLAP! AND DESIGN**. MORRIS, MICHAEL, DBA FRIENDLY CARDS, AND GILLAIN-REGNEY, DOMINIQUE, DBA FRIENDLY CARDS, (U.S. CLS. 2, 5, 22, 23, 29, 37, 38 AND 50). SN 77-791,512. PUB. 4-6-2010. FILED 7-28-2009.
- 3,805,885. **THROTTLE MERCHANTS (STANDARD CHARACTER)**. PORTER, MATTHEW, (U.S. CLS. 2, 5, 22, 23, 29, 37, 38 AND 50). SN 77-793,154. PUB. 4-6-2010. FILED 7-30-2009.
- 3,805,898 (*See Class 6 for this trademark*).
- 3,805,915 (*See Class 4 for this trademark*).
- 3,805,941. **MAXSTICK INNOVATION THAT STICKS AND DESIGN**. MAX INTERNATIONAL CONVERTERS, INC., (U.S. CLS. 2, 5, 22, 23, 29, 37, 38 AND 50). SN 77-805,869. PUB. 4-6-2010. FILED 8-17-2009.
- 3,805,943. **STICK HAPPENS (STANDARD CHARACTER)**. MAX INTERNATIONAL CONVERTERS, INC., (U.S. CLS. 2, 5, 22, 23, 29, 37, 38 AND 50). SN 77-806,080. PUB. 4-6-2010. FILED 8-17-2009.
- 3,805,954. **OUTSIDE THE LENS (STANDARD CHARACTER)**. OUTSIDE THE LENS, MULTIPLE CLASS, (INT. CLS. 16 AND 41), (U.S. CLS. 2, 5, 22, 23, 29, 37, 38, 50, 100, 101 AND 107). SN 77-807,857. PUB. 4-6-2010. FILED 8-19-2009.
- 3,805,955. **OUTSIDE THE LENS AND DESIGN**. OUTSIDE THE LENS, MULTIPLE CLASS, (INT. CLS. 16 AND 41), (U.S. CLS. 2, 5, 22, 23, 29, 37, 38, 50, 100, 101 AND 107). SN 77-807,881. PUB. 4-6-2010. FILED 8-19-2009.
- 3,805,961. **CHILTON WINGFLOW PEN (STYLIZED)**. CHILTON PEN, LLC, (U.S. CLS. 2, 5, 22, 23, 29, 37, 38 AND 50). SN 77-809,696. PUB. 2-6-2010. FILED 8-21-2009.
- 3,806,025. **INSTANT GENIUS (STANDARD CHARACTER)**. BAKER & TAYLOR, INC., (U.S. CLS. 2, 5, 22, 23, 29, 37, 38 AND 50). SN 77-820,865. PUB. 4-6-2010. FILED 9-4-2009.
- 3,806,027. **DREAMHEART (STANDARD CHARACTER)**. OTOPPIO PTY LIMITED, (U.S. CLS. 2, 5, 22, 23, 29, 37, 38 AND 50). SN 77-821,449. PUB. 4-6-2010. FILED 9-8-2009.
- 3,806,028 (*See Class 9 for this trademark*).
- 3,806,031. **MIRROR'S EDGE AND DESIGN**. EA DIGITAL ILLUSIONS CE AB, (U.S. CLS. 2, 5, 22, 23, 29, 37, 38 AND 50). SN 77-821,947. PUB. 2-9-2010. FILED 9-8-2009.
- 3,806,065 (*See Class 9 for this trademark*).
- 3,806,080. **SANDSATIONAL SPARKLE (STANDARD CHARACTER)**. KEVMAR VENTURES, LLC, (U.S. CLS. 2, 5, 22, 23, 29, 37, 38 AND 50). SN 77-829,575. PUB. 4-6-2010. FILED 9-18-2009.
- 3,806,099. **ECO SNOOPERS (STANDARD CHARACTER)**. WANG, MARY, MULTIPLE CLASS, (INT. CLS. 16 AND 18), (U.S. CLS. 1, 2, 3, 5, 22, 23, 29, 37, 38, 41 AND 50). SN 77-834,465. PUB. 4-6-2010. FILED 9-24-2009.
- 3,806,101. **MACON STATE COLLEGE (STANDARD CHARACTER)**. BOARD OF REGENTS OF THE UNIVERSITY SYSTEM OF GEORGIA, MULTIPLE CLASS, (INT. CLS. 16, 18, 21, 25 AND 41), (U.S. CLS. 1, 2, 3, 5, 13, 22, 23, 29, 30, 33, 37, 38, 39, 40, 41, 50, 100, 101 AND 107). SN 77-834,739. PUB. 4-6-2010. FILED 9-25-2009.
- 3,806,108. **MISCELLANEOUS DESIGN**. WHERE TO EAT GUIDE AND ASSOCIATES LLC, MULTIPLE CLASS, (INT. CLS. 16 AND 35), (U.S. CLS. 2, 5, 22, 23, 29, 37, 38, 50, 100, 101 AND 102). SN 77-835,805. PUB. 4-6-2010. FILED 9-26-2009.
- 3,806,113. **GLORIA MEXICANA (STYLIZED)**. IBASIS, (U.S. CLS. 2, 5, 22, 23, 29, 37, 38 AND 50). SN 77-836,272. PUB. 4-6-2010. FILED 9-28-2009.
- 3,806,117. **PREPARE ENRICH (STANDARD CHARACTER)**. LIFE INNOVATIONS, INC., MULTIPLE CLASS, (INT. CLS. 16 AND 45), (U.S. CLS. 2, 5, 22, 23, 29, 37, 38, 50, 100 AND 101). SN 77-836,874. PUB. 4-6-2010. FILED 9-29-2009.
- 3,806,128. **CHILTON PEN, TWICE THE INK AND DESIGN**. CHILTON PEN, LLC, (U.S. CLS. 2, 5, 22, 23, 29, 37, 38 AND 50). SN 77-837,786. PUB. 4-6-2010. FILED 9-29-2009.
- 3,806,156. **CORPORATE EXECUTIVE BOARD AND DESIGN**. CORPORATE EXECUTIVE BOARD COMPANY, MULTIPLE CLASS, (INT. CLS. 16, 35 AND 41), (U.S. CLS. 2, 5, 22, 23, 29, 37, 38, 50, 100, 101, 102 AND 107). SN 77-841,638. PUB. 4-6-2010. FILED 10-5-2009.
- 3,806,170 (*See Class 9 for this trademark*).
- 3,806,189. **EMM! SOFT SAVE AND DESIGN**. REGALADO, MANUAL, DBA EL COWBOY, (U.S. CLS. 2, 5, 22, 23, 29, 37, 38 AND 50). SN 77-845,469. PUB. 4-6-2010. FILED 10-9-2009.
- 3,806,234. **I.ORGANIZE (STANDARD CHARACTER)**. ESSELTE CORPORATION, (U.S. CLS. 2, 5, 22, 23, 29, 37, 38 AND 50). SN 77-849,518. PUB. 4-6-2010. FILED 10-15-2009.
- 3,806,239 (*See Class 9 for this trademark*).
- 3,806,277. **GOOD DEAL MAGAZINE (STANDARD CHARACTER)**. GOOD DEAL MAGAZINE, (U.S. CLS. 2, 5, 22, 23, 29, 37, 38 AND 50). SN 77-853,295. PUB. 4-6-2010. FILED 10-20-2009.
- 3,806,278. **THE READING EDGE (STANDARD CHARACTER)**. SUCCESS FOR ALL FOUNDATION, INC., MULTIPLE CLASS, (INT. CLS. 16 AND 41), (U.S. CLS. 2, 5, 22, 23, 29, 37, 38, 50, 100, 101 AND 107). SN 77-853,460. PUB. 4-6-2010. FILED 10-21-2009.
- 3,806,288. **WORLDMARK (STANDARD CHARACTER)**. TRUSTEE OF THE D. DEAN RHOADS TRUST, THE TRUSTEE COMPRISING OF D. DEAN RHOADS, A U.S. CITIZEN, (U.S. CLS. 2, 5, 22, 23, 29, 37, 38 AND 50). SN 77-854,093. PUB. 4-6-2010. FILED 10-21-2009.
- 3,806,293. **5FORMS (STANDARD CHARACTER)**. KILGORE, KENNETH B, (U.S. CLS. 2, 5, 22, 23, 29, 37, 38 AND 50). SN 77-854,405. PUB. 4-6-2010. FILED 10-21-2009.
- 3,806,314. **FRANGELA (STANDARD CHARACTER)**. ANGELA SHELTON, AND FRANCES CALLIER, (U.S. CLS. 2, 5, 22, 23, 29, 37, 38 AND 50). SN 77-855,251. PUB. 4-6-2010. FILED 10-22-2009.
- 3,806,320. **MELODIES FOR LIFE (STANDARD CHARACTER)**. MYLES, DARNELL, MULTIPLE CLASS, (INT. CLS. 16 AND 41), (U.S. CLS. 2, 5, 22, 23, 29, 37, 38, 50, 100, 101 AND 107). SN 77-855,422. PUB. 4-6-2010. FILED 10-22-2009.
- 3,806,352. **THE UNEXPLAINED (STANDARD CHARACTER)**. YOUNIE, BRADFORD A., DBA CARNIVORE GAMES, (U.S. CLS. 2, 5, 22, 23, 29, 37, 38 AND 50). SN 77-856,578. PUB. 4-6-2010. FILED 10-23-2009.
- 3,806,398. **ALL AMERICAN GUYS (STANDARD CHARACTER)**. Z PRODUCTIONS, INC., (U.S. CLS. 2, 5, 22, 23, 29, 37, 38 AND 50). SN 77-857,887. PUB. 4-6-2010. FILED 10-26-2009.
- 3,806,413. **ON AND DESIGN**. NTVB MEDIA, (U.S. CLS. 2, 5, 22, 23, 29, 37, 38 AND 50). SN 77-858,095. PUB. 4-6-2010. FILED 10-27-2009.
- 3,806,439. **EDU-CREATION (STANDARD CHARACTER)**. EVERSHERD, JANE, AKA JANE EVERSHERD ART COL-

LECTION, (U.S. CLS. 2, 5, 22, 23, 29, 37, 38 AND 50). SN 77-858,370. PUB. 4-6-2010. FILED 10-27-2009.

3,806,495. **BOWHUNT AMERICA (STANDARD CHARACTER)**. ZEBRA PUBLISHING INC., (U.S. CLS. 2, 5, 22, 23, 29, 37, 38 AND 50). SN 77-858,814. PUB. 4-6-2010. FILED 10-27-2009.

3,806,506. **ROSEN PUBLISHING AND DESIGN**. THE ROSEN PUBLISHING GROUP INC., (U.S. CLS. 2, 5, 22, 23, 29, 37, 38 AND 50). SN 77-858,998. PUB. 4-6-2010. FILED 10-28-2009.

3,806,512. **OFF TO COLLEGE (STANDARD CHARACTER)**. DEES COMMUNICATIONS, INC., (U.S. CLS. 2, 5, 22, 23, 29, 37, 38 AND 50). SN 77-859,088. PUB. 4-6-2010. FILED 10-28-2009.

3,806,705. **BBS BASICS (STANDARD CHARACTER)**. AUBREY DANIELS INTERNATIONAL, (U.S. CLS. 2, 5, 22, 23, 29, 37, 38 AND 50). SN 77-861,288. PUB. 4-6-2010. FILED 10-30-2009.

3,806,754. **HUCKLEBERRYHAPPYBOOKS (STANDARD CHARACTER)**. MORNINGFOREST, CHRIS, (U.S. CLS. 2, 5, 22, 23, 29, 37, 38 AND 50). SN 77-861,970. PUB. 4-6-2010. FILED 10-30-2009.

3,806,860. **THE FOOD FAIRY (STANDARD CHARACTER)**. MCCLERNON, TERRI, (U.S. CLS. 2, 5, 22, 23, 29, 37, 38 AND 50). SN 77-864,053. PUB. 4-6-2010. FILED 11-3-2009.

3,806,865. **CHARDONNAY GIRLS (STANDARD CHARACTER)**. GREENWICH CARTOONS, (U.S. CLS. 2, 5, 22, 23, 29, 37, 38 AND 50). SN 77-864,141. PUB. 4-6-2010. FILED 11-3-2009.

3,806,917. **BOUNTY (STANDARD CHARACTER)**. THE PROCTER & GAMBLE COMPANY, (U.S. CLS. 2, 5, 22, 23, 29, 37, 38 AND 50). SN 77-867,882. PUB. 4-6-2010. FILED 11-9-2009.

3,806,935. **SMALL WONDERS (STANDARD CHARACTER)**. CHILDREN'S HEALTHCARE OF ATLANTA, INC., (U.S. CLS. 2, 5, 22, 23, 29, 37, 38 AND 50). SN 77-870,347. PUB. 4-6-2010. FILED 11-11-2009.

3,806,937. **MACKAYMITCHELL PHOTOPAK (STANDARD CHARACTER)**. MACKAY MITCHELL ENVELOPE COMPANY, LLC, (U.S. CLS. 2, 5, 22, 23, 29, 37, 38 AND 50). SN 77-870,854. PUB. 4-6-2010. FILED 11-12-2009.

3,806,939. **MISCELLANEOUS DESIGN**. DIRK HAYHURST, (U.S. CLS. 2, 5, 22, 23, 29, 37, 38 AND 50). SN 77-871,003. PUB. 4-6-2010. FILED 11-12-2009.

3,806,974. **ABAC (STANDARD CHARACTER)**. BOARD OF REGENTS OF THE UNIVERSITY SYSTEM OF GEORGIA, MULTIPLE CLASS, (INT. CLS. 16, 18, 21, 25 AND 41), (U.S. CLS. 1, 2, 3, 5, 13, 22, 23, 29, 30, 33, 37, 38, 39, 40, 41, 50, 100, 101 AND 107). SN 77-877,121. PUB. 4-6-2010. FILED 11-20-2009.

3,807,091 (*See Class 14 for this trademark*).

3,807,107 (*See Class 9 for this trademark*).

3,807,110 (*See Class 9 for this trademark*).

3,807,125 (*See Class 9 for this trademark*).

3,807,130. **RKW PROTRANS (STANDARD CHARACTER)**. RKW SE, MULTIPLE CLASS, (INT. CLS. 16, 17, 18, 22 AND 24), (U.S. CLS. 1, 2, 3, 5, 7, 12, 13, 19, 22, 23, 29, 35, 37, 38, 41, 42 AND 50). SN 79-062,060. PUB. 4-6-2010. FILED 7-1-2008.

3,807,131 (*See Class 3 for this trademark*).

3,807,135 (*See Class 9 for this trademark*).

3,807,153 (*See Class 9 for this trademark*).

3,807,182. **RHODIA WAY" (STYLIZED)**. RHODIA, MULTIPLE CLASS, (INT. CLS. 16, 35 AND 41), (U.S. CLS. 2, 5, 22, 23, 29, 37, 38, 50, 100, 101, 102 AND 107). SN 79-068,638. PUB. 4-6-2010. FILED 12-12-2008.

3,807,183. **SPIKED (STANDARD CHARACTER)**. MATTHEW WALTON, MULTIPLE CLASS, (INT. CLS. 16 AND 41), (U.S. CLS. 2, 5, 22, 23, 29, 37, 38, 50, 100, 101 AND 107). SN 79-068,653. PUB. 4-6-2010. FILED 5-1-2009.

3,807,203. **JAN VAN HAASTEREN (STANDARD CHARACTER)**. KONINKLIJKE JUMBO B.V., MULTIPLE CLASS, (INT. CLS. 16, 28 AND 41), (U.S. CLS. 2, 5, 22, 23, 29, 37, 38, 50, 100, 101 AND 107). SN 79-069,398. PUB. 4-6-2010. FILED 5-15-2009.

3,807,226 (*See Class 1 for this trademark*).

3,807,233 (*See Class 3 for this trademark*).

3,807,240 (*See Class 3 for this trademark*).

3,807,252 (*See Class 9 for this trademark*).

3,807,277. **MISCELLANEOUS DESIGN**. BOEHRINGER IN-

GELHEIM VETMEDICA GMBH, (U.S. CLS. 2, 5, 22, 23, 29, 37, 38 AND 50). SN 79-072,033. PUB. 4-6-2010. FILED 7-17-2009.

3,807,289 (*See Class 9 for this trademark*).

3,807,320 (*See Class 7 for this trademark*).

3,807,326 (*See Class 10 for this trademark*).

3,807,341 (*See Class 9 for this trademark*).

3,807,353 (*See Class 9 for this trademark*).

CLASS 17—RUBBER GOODS

3,805,124 (*See Class 1 for this trademark*).

3,805,202 (*See Class 6 for this trademark*).

3,805,246. **ALLIANCE EXPRESS (STANDARD CHARACTER)**. FILTRONA PLASTICS, LLC, MULTIPLE CLASS, (INT. CLS. 17, 20, 22, 35 AND 42), (U.S. CLS. 1, 2, 5, 7, 12, 13, 19, 22, 25, 32, 35, 42, 50, 100, 101 AND 102). SN 77-417,613. PUB. 4-6-2010. FILED 3-10-2008.

3,805,467. **BATTLE FOAM (STANDARD CHARACTER)**. BATTLE FOAM, LLC, MULTIPLE CLASS, (INT. CLS. 17 AND 18), (U.S. CLS. 1, 2, 3, 5, 12, 13, 22, 35, 41 AND 50). SN 77-676,475. PUB. 4-6-2010. FILED 2-23-2009.

3,805,497 (*See Class 1 for this trademark*).

3,805,538. **HYDRATITE (STANDARD CHARACTER)**. HYDRATECH ENGINEERED PRODUCTS, LLC, (U.S. CLS. 1, 5, 12, 13, 35 AND 50). SN 77-719,389. PUB. 4-6-2010. FILED 4-22-2009.

3,805,719 (*See Class 1 for this trademark*).

3,805,975. **TUDERTECHNICA AND DESIGN**. TUBIGOMMA DEREGIBUS S.R.L., (U.S. CLS. 1, 5, 12, 13, 35 AND 50). SN 77-811,262. PUB. 4-6-2010. FILED 8-24-2009.

3,806,254. **INSILTHIN (STANDARD CHARACTER)**. ARLON SILICONE TECHNOLOGIES DIVISION, (U.S. CLS. 1, 5, 12, 13, 35 AND 50). SN 77-851,398. PUB. 4-6-2010. FILED 10-19-2009.

3,806,436 (*See Class 9 for this trademark*).

3,806,444. **ULTRAPAD (STANDARD CHARACTER)**. ARLON SILICONE TECHNOLOGIES DIVISION, (U.S. CLS. 1, 5, 12, 13, 35 AND 50). SN 77-858,462. PUB. 4-6-2010. FILED 10-27-2009.

3,806,474. **FILTERLOCK (STANDARD CHARACTER)**. BUILD RIGHT PRODUCTS, LLC, (U.S. CLS. 1, 5, 12, 13, 35 AND 50). SN 77-858,676. PUB. 4-6-2010. FILED 10-27-2009.

3,806,526. **SILQUENCH (STANDARD CHARACTER)**. ARLON SILICONE TECHNOLOGIES DIVISION, (U.S. CLS. 1, 5, 12, 13, 35 AND 50). SN 77-859,240. PUB. 4-6-2010. FILED 10-28-2009.

3,806,640. **THERMAVAC XRT (STANDARD CHARACTER)**. ARLON SILICONE TECHNOLOGIES DIVISION, (U.S. CLS. 1, 5, 12, 13, 35 AND 50). SN 77-860,509. PUB. 4-6-2010. FILED 10-29-2009.

3,806,678. **NANOSTONE (STANDARD CHARACTER)**. CHUN AN LAI, (U.S. CLS. 1, 5, 12, 13, 35 AND 50). SN 77-860,901. PUB. 4-6-2010. FILED 10-29-2009.

3,806,979. **"TRADESMAN" (STANDARD CHARACTER)**. NUPUTTIE CORPORATION, (U.S. CLS. 1, 5, 12, 13, 35 AND 50). SN 77-877,483. PUB. 4-6-2010. FILED 11-20-2009.

3,807,104 (*See Class 6 for this trademark*).

3,807,122 (*See Class 6 for this trademark*).

3,807,130 (*See Class 16 for this trademark*).

3,807,184 (*See Class 6 for this trademark*).

3,807,186 (*See Class 7 for this trademark*).

3,807,209 (*See Class 6 for this trademark*).

3,807,287. **KORRATH (STANDARD CHARACTER)**. RATH AKTIENGESELLSCHAFT, MULTIPLE CLASS, (INT. CLS. 17 AND 19), (U.S. CLS. 1, 5, 12, 13, 33, 35 AND 50). SN 79-072,536. PUB. 4-6-2010. FILED 4-8-2009.

3,807,288. **CARATH (STANDARD CHARACTER)**. RATH AKTIENGESELLSCHAFT, MULTIPLE CLASS, (INT. CLS. 17 AND 19), (U.S. CLS. 1, 5, 12, 13, 33, 35 AND 50). SN 79-072,537. PUB. 4-6-2010. FILED 4-8-2009.

3,807,348 (*See Class 11 for this trademark*).

CLASS 18—LEATHER GOODS

- 3,805,126. **TORAX (STYLIZED)**. TORAY KABUSHIKI KAISHA (TORAY INDUSTRIES, INC.), MULTIPLE CLASS, (INT. CLS. 18, 22, 23, 24 AND 25), (U.S. CLS. 1, 2, 3, 7, 19, 22, 39, 41, 42, 43 AND 50). SN 76-509,745. PUB. 4-6-2010. FILED 4-28-2003.
- 3,805,165. **FABINA LOS ANGELES (STYLIZED)**. KWON, YOONJOUNG, (U.S. CLS. 1, 2, 3, 22 AND 41). SN 76-699,742. PUB. 4-6-2010. FILED 10-5-2009.
- 3,805,230 (*See Class 3 for this trademark*).
- 3,805,346 (*See Class 9 for this trademark*).
- 3,805,347 (*See Class 9 for this trademark*).
- 3,805,384. **LIBBIE Z AND DESIGN**. ZURSCHMIEDE, ELIZABETH, NEVILLE, DBA LIBBIE Z, (U.S. CLS. 1, 2, 3, 22 AND 41). SN 77-603,602. PUB. 4-6-2010. FILED 10-29-2008.
- 3,805,467 (*See Class 17 for this trademark*).
- 3,805,508. **NATIONAL WILDLIFE FEDERATION (STANDARD CHARACTER)**. NATIONAL WILDLIFE FEDERATION, MULTIPLE CLASS, (INT. CLS. 18, 21, 24 AND 25), (U.S. CLS. 1, 2, 3, 13, 22, 23, 29, 30, 33, 39, 40, 41, 42 AND 50). SN 77-709,232. PUB. 4-6-2010. FILED 4-8-2009.
- 3,805,629 (*See Class 12 for this trademark*).
- 3,805,681. **PANTOFOLA D'ORO 1886 (STYLIZED)**. PANTOFOLA D'ORO S.P.A., MULTIPLE CLASS, (INT. CLS. 18 AND 25), (U.S. CLS. 1, 2, 3, 22, 39 AND 41). SN 77-743,381. PUB. 4-6-2010. FILED 5-22-2009.
- 3,805,685 (*See Class 14 for this trademark*).
- 3,805,761. **CAMILLE LUCIE (STANDARD CHARACTER)**. CAMI-RINGS, LLC, (U.S. CLS. 1, 2, 3, 22 AND 41). SN 77-761,356. PUB. 4-6-2010. FILED 6-16-2009.
- 3,805,769. **ROCKET BETTY (STANDARD CHARACTER)**. SCOTT, MARGO, MULTIPLE CLASS, (INT. CLS. 18 AND 25), (U.S. CLS. 1, 2, 3, 22, 39 AND 41). SN 77-763,453. PUB. 11-3-2009. FILED 6-18-2009.
- 3,805,782 (*See Class 16 for this trademark*).
- 3,805,814. **VEDANTE (STANDARD CHARACTER)**. VEDANTE CORP, MULTIPLE CLASS, (INT. CLS. 18 AND 25), (U.S. CLS. 1, 2, 3, 22, 39 AND 41). SN 77-775,176. PUB. 4-6-2010. FILED 7-6-2009.
- 3,806,013. **DOLCE BY GRACE GREG (STANDARD CHARACTER)**. EASTSTAR SOLUTIONS, LTD., MULTIPLE CLASS, (INT. CLS. 18 AND 25), (U.S. CLS. 1, 2, 3, 22, 39 AND 41). SN 77-818,632. PUB. 4-6-2010. FILED 9-2-2009.
- 3,806,099 (*See Class 16 for this trademark*).
- 3,806,101 (*See Class 16 for this trademark*).
- 3,806,154. **COTS AND DESIGN**. DONGHUI INTERNATIONAL DEVELOPMENT CO.,LTD, (U.S. CLS. 1, 2, 3, 22 AND 41). SN 77-840,805. PUB. 4-6-2010. FILED 10-3-2009.
- 3,806,335. **MOOP (STANDARD CHARACTER)**. MOOP LLC, (U.S. CLS. 1, 2, 3, 22 AND 41). SN 77-855,912. PUB. 4-6-2010. FILED 10-23-2009.
- 3,806,365. **SEISUKE88 AND DESIGN**. TAKAHASHI RENSEN CO. LTD., (U.S. CLS. 1, 2, 3, 22 AND 41). SN 77-856,959. PUB. 4-6-2010. FILED 10-26-2009.
- 3,806,395. **MOJO MOXY (STANDARD CHARACTER)**. EASTSTAR SOLUTIONS LTD, MULTIPLE CLASS, (INT. CLS. 18 AND 25), (U.S. CLS. 1, 2, 3, 22, 39 AND 41). SN 77-857,737. PUB. 4-6-2010. FILED 10-26-2009.
- 3,806,453. **LIMON PIEL (STANDARD CHARACTER)**. LIMON PIEL INTERNATIONAL, LLC, (U.S. CLS. 1, 2, 3, 22 AND 41). SN 77-858,512. PUB. 4-6-2010. FILED 10-27-2009.
- 3,806,462 (*See Class 3 for this trademark*).
- 3,806,586. **SUSIE STRAUBMUELLER (STANDARD CHARACTER)**. STRAUBMUELLER, SUSIE, (U.S. CLS. 1, 2, 3, 22 AND 41). SN 77-859,879. PUB. 4-6-2010. FILED 10-28-2009.
- 3,806,608. **MISCELLANEOUS DESIGN**. THREE DOGZ, LLC, MULTIPLE CLASS, (INT. CLS. 18 AND 25), (U.S. CLS. 1, 2, 3, 22, 39 AND 41). SN 77-860,111. PUB. 4-6-2010. FILED 10-29-2009.
- 3,806,695. **MISCELLANEOUS DESIGN**. PET BISTRO, LLC, MULTIPLE CLASS, (INT. CLS. 18 AND 31), (U.S. CLS. 1, 2, 3, 22, 41 AND 46). SN 77-861,186. PUB. 4-6-2010. FILED 10-30-2009.
- 3,806,814. **FERRIS & MOR (STANDARD CHARACTER)**. FERRIS & MOR CORP., (U.S. CLS. 1, 2, 3, 22 AND 41). SN 77-863,388. PUB. 4-6-2010. FILED 11-2-2009.
- 3,806,974 (*See Class 16 for this trademark*).
- 3,807,091 (*See Class 14 for this trademark*).

- 3,807,092 (*See Class 12 for this trademark*).
- 3,807,104 (*See Class 6 for this trademark*).
- 3,807,111 (*See Class 14 for this trademark*).
- 3,807,124. **PYUA (STANDARD CHARACTER)**. PYUA GMBH, MULTIPLE CLASS, (INT. CLS. 18, 25 AND 28), (U.S. CLS. 1, 2, 3, 22, 23, 38, 39, 41 AND 50). SN 79-061,271. PUB. 4-6-2010. FILED 9-19-2008.
- 3,807,130 (*See Class 16 for this trademark*).
- 3,807,131 (*See Class 3 for this trademark*).
- 3,807,137 (*See Class 14 for this trademark*).
- 3,807,140 (*See Class 14 for this trademark*).
- 3,807,153 (*See Class 9 for this trademark*).
- 3,807,180 (*See Class 3 for this trademark*).
- 3,807,187. **LYS (STYLIZED)**. WENZHOU FANTAI CASE CO., LTD; (CHINA CORPORATION), (U.S. CLS. 1, 2, 3, 22 AND 41). SN 79-068,806. PUB. 4-6-2010. FILED 4-3-2009.
- 3,807,188. **G AND DESIGN**. CONCERIA GHERBER S.P.A., MULTIPLE CLASS, (INT. CLS. 18 AND 25), (U.S. CLS. 1, 2, 3, 22, 39 AND 41). SN 79-068,835. PUB. 4-6-2010. FILED 12-15-2008.
- 3,807,198. **FAUSTO COLATO MILANO AND DESIGN**. FAUSTO COLATO S.R.L., MULTIPLE CLASS, (INT. CLS. 18 AND 25), (U.S. CLS. 1, 2, 3, 22, 39 AND 41). SN 79-069,314. PUB. 4-6-2010. FILED 12-9-2008.
- 3,807,213 (*See Class 9 for this trademark*).
- 3,807,230 (*See Class 10 for this trademark*).
- 3,807,231 (*See Class 12 for this trademark*).
- 3,807,233 (*See Class 3 for this trademark*).
- 3,807,240 (*See Class 3 for this trademark*).
- 3,807,241. **ABLE (STANDARD CHARACTER)**. JIANGSU ABLE; TEXTILES & GARMENTS CO., LTD., MULTIPLE CLASS, (INT. CLS. 18 AND 25), (U.S. CLS. 1, 2, 3, 22, 39 AND 41). SN 79-070,403. PUB. 4-6-2010. FILED 5-19-2009.
- 3,807,250. **MISCELLANEOUS DESIGN**. PORTER CLASSIC CO., LTD., MULTIPLE CLASS, (INT. CLS. 18, 25 AND 35), (U.S. CLS. 1, 2, 3, 22, 39, 41, 100, 101 AND 102). SN 79-070,651. PUB. 4-6-2010. FILED 5-18-2009.
- 3,807,253. **CHROLEEN (STYLIZED)**. SHENZHEN NANTIANHUI; IMP. AND EXP. CO., LTD., (U.S. CLS. 1, 2, 3, 22 AND 41). SN 79-070,696. PUB. 4-6-2010. FILED 5-27-2009.
- 3,807,260 (*See Class 4 for this trademark*).
- 3,807,304. **SPA0 (STYLIZED)**. E.LAND WORLD LIMITED, (U.S. CLS. 1, 2, 3, 22 AND 41). SN 79-073,491. PUB. 4-6-2010. FILED 7-14-2009.
- 3,807,306. **LA LUYVZN AND DESIGN**. LI ZHONGKUI, (U.S. CLS. 1, 2, 3, 22 AND 41). SN 79-073,599. PUB. 4-6-2010. FILED 8-4-2009.
- 3,807,336. **SATI BIBO' (STANDARD CHARACTER)**. CARBONE SABRINA, (U.S. CLS. 1, 2, 3, 22 AND 41). SN 79-075,524. PUB. 4-6-2010. FILED 9-2-2009.
- 3,807,360. **REVERSE (STYLIZED)**. DECATHLON, (U.S. CLS. 1, 2, 3, 22 AND 41). SN 79-077,341. PUB. 4-6-2010. FILED 10-26-2009.
- 3,807,369 (*See Class 9 for this trademark*).

CLASS 19—NON-METALLIC BUILDING MATERIALS

- 3,805,124 (*See Class 1 for this trademark*).
- 3,805,193 (*See Class 6 for this trademark*).
- 3,805,231 (*See Class 4 for this trademark*).
- 3,805,232 (*See Class 4 for this trademark*).
- 3,805,288 (*See Class 6 for this trademark*).
- 3,805,300 (*See Class 11 for this trademark*).
- 3,805,301. **Q-PATCH (STANDARD CHARACTER)**. BIG RIVER INDUSTRIES, INC., (U.S. CLS. 1, 12, 33 AND 50). SN 77-507,416. PUB. 4-6-2010. FILED 6-25-2008.
- 3,805,326. **GARDEN WALLSCAPE (STANDARD CHARACTER)**. CORNERSTONE WALL SOLUTIONS INC., (U.S. CLS. 1, 12, 33 AND 50). SN 77-553,429. PUB. 4-6-2010. FILED 8-22-2008.
- 3,805,497 (*See Class 1 for this trademark*).
- 3,805,551. **REAL WOOD FLOORING MADE BETTER WITH ENVIRO-CORE (STANDARD CHARACTER)**. COLUMBIA INSURANCE COMPANY, (U.S. CLS. 1, 12, 33 AND 50). SN 77-721,851. PUB. 4-6-2010. FILED 4-24-2009.

- 3,805,555. **INSBLOK (STANDARD CHARACTER)**. A.P. GREEN INDUSTRIES, INC., (U.S. CLS. 1, 12, 33 AND 50). SN 77-722,712. PUB. 4-6-2010. FILED 4-27-2009.
- 3,805,614. **RAPID GLASS (STANDARD CHARACTER)**. BUYRITE AUTOGLASS, INC., DBA RAPID GLASS, MULTIPLE CLASS, (INT. CLS. 19 AND 21), (U.S. CLS. 1, 2, 12, 13, 23, 29, 30, 33, 40 AND 50). SN 77-731,802. PUB. 4-6-2010. FILED 5-7-2009.
- 3,805,650. **SPORTGRAINPLUS (STANDARD CHARACTER)**. CONNOR SPORT COURT INTERNATIONAL, INC., (U.S. CLS. 1, 12, 33 AND 50). SN 77-736,297. PUB. 4-6-2010. FILED 5-13-2009.
- 3,805,686. **SIMPLEMAT (STANDARD CHARACTER)**. CUSTOM BUILDING PRODUCTS, INC., (U.S. CLS. 1, 12, 33 AND 50). SN 77-744,297. PUB. 4-6-2010. FILED 5-26-2009.
- 3,805,709 (*See Class 6 for this trademark*).
- 3,805,712. **HERITAGE CEDAR (STANDARD CHARACTER)**. VARIFORM, INC., (U.S. CLS. 1, 12, 33 AND 50). SN 77-748,729. PUB. 4-6-2010. FILED 6-1-2009.
- 3,805,719 (*See Class 1 for this trademark*).
- 3,805,749. **ROCK IT (STANDARD CHARACTER)**. DIVERSIFIED COMPOSITE WORKS, INC., (U.S. CLS. 1, 12, 33 AND 50). SN 77-759,031. PUB. 4-6-2010. FILED 6-13-2009.
- 3,805,787. **PLYMOLD AND DESIGN. FOLDCRAFT CO., AKA FOLDCRAFT COMPANY, MULTIPLE CLASS, (INT. CLS. 19, 20 AND 21), (U.S. CLS. 1, 2, 12, 13, 22, 23, 25, 29, 30, 32, 33, 40 AND 50). SN 77-767,188. PUB. 4-6-2010. FILED 6-24-2009.**
- 3,805,907. **BFRICH (STANDARD CHARACTER)**. B.F. RICH CO., INC., MULTIPLE CLASS, (INT. CLS. 19 AND 40), (U.S. CLS. 1, 12, 33, 50, 100, 103 AND 106). SN 77-797,528. PUB. 4-6-2010. FILED 8-5-2009.
- 3,806,039. **QUALITY CULVERT (STANDARD CHARACTER)**. QUALITY CULVERT INCORPORATED, (U.S. CLS. 1, 12, 33 AND 50). SN 77-822,649. PUB. 4-6-2010. FILED 9-9-2009.
- 3,806,062. **NOBLE HILL (STANDARD CHARACTER)**. NU-STONE MANUFACTURING & DISTRIBUTING, LLC, (U.S. CLS. 1, 12, 33 AND 50). SN 77-826,500. PUB. 4-6-2010. FILED 9-15-2009.
- 3,806,145 (*See Class 6 for this trademark*).
- 3,806,265. **BIG BUILT . INSTALLED . GUARANTEED BEST WINDOW & DOOR COMPANY AND DESIGN. BEST WINDOW AND DOOR COMPANY, (U.S. CLS. 1, 12, 33 AND 50). SN 77-852,355. PUB. 4-6-2010. FILED 10-20-2009.**
- 3,806,289. **NARROW MODULAR PAVER BY STEPSTONE (STANDARD CHARACTER)**. STEPSTONE, INC., (U.S. CLS. 1, 12, 33 AND 50). SN 77-854,127. PUB. 4-6-2010. FILED 10-21-2009.
- 3,806,391. **GRANDURA (STANDARD CHARACTER)**. AM-CRAFT BUILDING PRODUCTS CO., INC., (U.S. CLS. 1, 12, 33 AND 50). SN 77-857,573. PUB. 4-6-2010. FILED 10-26-2009.
- 3,806,410. **GAZZOTTI AND DESIGN. GAZZOTTI SPA, (U.S. CLS. 1, 12, 33 AND 50). SN 77-858,032. PUB. 4-6-2010. FILED 10-27-2009.**
- 3,806,443. **QUARTZ FX (STANDARD CHARACTER)**. TURLEY INTERNATIONAL RESOURCE, L.L.C., (U.S. CLS. 1, 12, 33 AND 50). SN 77-858,444. PUB. 4-6-2010. FILED 10-27-2009.
- 3,806,610. **VIGORO (STANDARD CHARACTER)**. HOMER TLC, INC., (U.S. CLS. 1, 12, 33 AND 50). SN 77-860,120. PUB. 4-6-2010. FILED 10-29-2009.
- 3,806,701. **MISCELLANEOUS DESIGN. HOMERWOOD HARDWOOD FLOORING COMPANY, MULTIPLE CLASS, (INT. CLS. 19 AND 35), (U.S. CLS. 1, 12, 33, 50, 100, 101 AND 102). SN 77-861,236. PUB. 4-6-2010. FILED 10-30-2009.**
- 3,806,709. **SECURETHERM (STANDARD CHARACTER)**. ACH FOAM TECHNOLOGIES, LLC, (U.S. CLS. 1, 12, 33 AND 50). SN 77-861,372. PUB. 4-6-2010. FILED 10-30-2009.
- 3,806,726. **KONA (STANDARD CHARACTER)**. AZEK BUILDING PRODUCTS, INC., (U.S. CLS. 1, 12, 33 AND 50). SN 77-861,614. PUB. 4-6-2010. FILED 10-30-2009.
- 3,806,729. **ARBOR COLLECTION (STANDARD CHARACTER)**. AZEK BUILDING PRODUCTS, INC., (U.S. CLS. 1, 12, 33 AND 50). SN 77-861,638. PUB. 4-6-2010. FILED 10-30-2009.
- 3,806,730. **TAHOE (STANDARD CHARACTER)**. AZEK BUILDING PRODUCTS, INC., (U.S. CLS. 1, 12, 33 AND 50). SN 77-861,643. PUB. 4-6-2010. FILED 10-30-2009.
- 3,806,966. **JINNIU AND DESIGN. USPLY TRADING COMPANY, (U.S. CLS. 1, 12, 33 AND 50). SN 77-875,037. PUB. 4-6-2010. FILED 11-18-2009.**
- 3,806,977. **MICROBATCH (STANDARD CHARACTER)**. DELTA PERFORMANCE PRODUCTS, LLC, (U.S. CLS. 1, 12, 33 AND 50). SN 77-877,409. PUB. 4-6-2010. FILED 11-20-2009.
- 3,806,992. **MGOUT (STANDARD CHARACTER)**. MAGWALL LLC, (U.S. CLS. 1, 12, 33 AND 50). SN 77-880,287. PUB. 4-6-2010. FILED 11-24-2009.
- 3,807,082 (*See Class 1 for this trademark*).
- 3,807,104 (*See Class 6 for this trademark*).
- 3,807,116 (*See Class 6 for this trademark*).
- 3,807,142 (*See Class 6 for this trademark*).
- 3,807,224. **GETAC AND DESIGN. ALBERT GELI MARTI, (U.S. CLS. 1, 12, 33 AND 50). SN 79-069,958. PUB. 4-6-2010. FILED 4-29-2009.**
- 3,807,238 (*See Class 11 for this trademark*).
- 3,807,265. **RUSSIAN BIRCH AND DESIGN. ZAKRYTOE AKTSIONERNOE OBSHESTVO; "AVA COMPANY", MULTIPLE CLASS, (INT. CLS. 19, 20, 31, 35, 39 AND 40), (U.S. CLS. 1, 2, 12, 13, 22, 25, 32, 33, 46, 50, 100, 101, 102, 103, 105 AND 106). SN 79-071,449. PUB. 4-6-2010. FILED 4-15-2009.**
- 3,807,287 (*See Class 17 for this trademark*).
- 3,807,288 (*See Class 17 for this trademark*).

CLASS 20—FURNITURE AND ARTICLES NOT OTHERWISE CLASSIFIED

- 3,805,122. **ROYCROFT. MARGARET L. WENDT FOUNDATION HOLDINGS, INC., (U.S. CLS. 2, 13, 22, 25, 32 AND 50). SN 75-284,368. PUB. 7-28-1998. FILED 4-30-1997.**
- 3,805,123. **TR AND DESIGN. MARGARET L. WENDT FOUNDATION HOLDINGS, INC., (U.S. CLS. 2, 13, 22, 25, 32 AND 50). SN 75-473,994. PUB. 3-16-1999. FILED 4-24-1998.**
- 3,805,124 (*See Class 1 for this trademark*).
- 3,805,149 (*See Class 9 for this trademark*).
- 3,805,193 (*See Class 6 for this trademark*).
- 3,805,246 (*See Class 17 for this trademark*).
- 3,805,305. **FLEX-GEL (STANDARD CHARACTER)**. A.H. BEARD PTY LTD, (U.S. CLS. 2, 13, 22, 25, 32 AND 50). SN 77-519,927. PUB. 9-1-2009. FILED 7-11-2008.
- 3,805,348 (*See Class 6 for this trademark*).
- 3,805,474. **V.E.R.A.S. (STANDARD CHARACTER)**. C-U-C SIGNS, INC., AKA CAN-U-CEE SIGNS, (U.S. CLS. 2, 13, 22, 25, 32 AND 50). SN 77-679,588. PUB. 4-6-2010. FILED 2-27-2009.
- 3,805,478 (*See Class 6 for this trademark*).
- 3,805,517. **ST. NICK'S CHOICE SIMPLIFY YOUR CHRISTMAS PREFERRED BY PROFESSIONALS AND DESIGN. DYNO SEASONAL SOLUTIONS, LLC, MULTIPLE CLASS, (INT. CLS. 20 AND 22), (U.S. CLS. 1, 2, 7, 13, 19, 22, 25, 32, 42 AND 50). SN 77-712,492. PUB. 4-6-2010. FILED 4-13-2009.**
- 3,805,653. **ESBE (STANDARD CHARACTER)**. SLAM BRANDS, INC., (U.S. CLS. 2, 13, 22, 25, 32 AND 50). SN 77-738,030. PUB. 4-6-2010. FILED 5-15-2009.
- 3,805,787 (*See Class 19 for this trademark*).
- 3,805,801 (*See Class 6 for this trademark*).
- 3,806,087. **MISCELLANEOUS DESIGN. RPC CONTAINERS LIMITED, MULTIPLE CLASS, (INT. CLS. 20, 40 AND 42), (U.S. CLS. 2, 13, 22, 25, 32, 50, 100, 101, 103 AND 106). SN 77-831,052. PUB. 4-6-2010. FILED 9-21-2009.**
- 3,806,521. **PT CHAIR (STANDARD CHARACTER)**. PORTER, RONALD W., (U.S. CLS. 2, 13, 22, 25, 32 AND 50). SN 77-859,186. PUB. 4-6-2010. FILED 10-28-2009.
- 3,806,611. **VIGORO (STANDARD CHARACTER)**. HOMER TLC, INC., (U.S. CLS. 2, 13, 22, 25, 32 AND 50). SN 77-860,130. PUB. 4-6-2010. FILED 10-29-2009.
- 3,806,714. **WINELOC (STANDARD CHARACTER)**. ACH FOAM TECHNOLOGIES, LLC, (U.S. CLS. 2, 13, 22, 25, 32 AND 50). SN 77-861,428. PUB. 4-6-2010. FILED 10-30-2009.
- 3,806,725. **HENREDON (STYLIZED)**. HDM FURNITURE INDUSTRIES, INC., (U.S. CLS. 2, 13, 22, 25, 32 AND 50). SN 77-861,573. PUB. 4-6-2010. FILED 10-30-2009.
- 3,806,791. **TEA LEAF SUPREME (STANDARD CHARACTER)**.

- KEETSA, INC., (U.S. CLS. 2, 13, 22, 25, 32 AND 50). SN 77-863,003. PUB. 4-6-2010. FILED 11-2-2009.
- 3,806,796. **TEA LEAF CLASSIC (STANDARD CHARACTER)**. KEETSA, INC., (U.S. CLS. 2, 13, 22, 25, 32 AND 50). SN 77-863,090. PUB. 4-6-2010. FILED 11-2-2009.
- 3,806,875. **THE KEETSA LATEX (STANDARD CHARACTER)**. KEETSA, INC., (U.S. CLS. 2, 13, 22, 25, 32 AND 50). SN 77-864,317. PUB. 4-6-2010. FILED 11-3-2009.
- 3,806,957. **PEDICSOLUTIONS (STANDARD CHARACTER)**. QVC, INC., MULTIPLE CLASS, (INT. CLS. 20 AND 25), (U.S. CLS. 2, 13, 22, 25, 32, 39 AND 50). SN 77-874,158. PUB. 4-6-2010. FILED 11-17-2009.
- 3,807,082 (*See Class 1 for this trademark*).
- 3,807,104 (*See Class 6 for this trademark*).
- 3,807,122 (*See Class 6 for this trademark*).
- 3,807,136 (*See Class 3 for this trademark*).
- 3,807,144. **D-BODHI (STANDARD CHARACTER)**. D-BODHI PTE. LTD., (U.S. CLS. 2, 13, 22, 25, 32 AND 50). SN 79-063,784. PUB. 4-6-2010. FILED 9-5-2008.
- 3,807,145 (*See Class 5 for this trademark*).
- 3,807,190 (*See Class 6 for this trademark*).
- 3,807,195 (*See Class 11 for this trademark*).
- 3,807,238 (*See Class 11 for this trademark*).
- 3,807,260 (*See Class 4 for this trademark*).
- 3,807,264 (*See Class 6 for this trademark*).
- 3,807,265 (*See Class 19 for this trademark*).
- 3,807,269 (*See Class 6 for this trademark*).
- 3,807,321. **DREAM TUBES (STANDARD CHARACTER)**. AMANDA MICHELLE ALLERTON, MULTIPLE CLASS, (INT. CLS. 20 AND 24), (U.S. CLS. 2, 13, 22, 25, 32, 42 AND 50). SN 79-074,625. PUB. 4-6-2010. FILED 6-26-2009.
- 3,807,324. **DUSKY MOON (STANDARD CHARACTER)**. AMANDA MICHELLE ALLERTON, MULTIPLE CLASS, (INT. CLS. 20 AND 24), (U.S. CLS. 2, 13, 22, 25, 32, 42 AND 50). SN 79-074,678. PUB. 4-6-2010. FILED 8-22-2009.
- AND 50). SN 77-853,215. PUB. 4-6-2010. FILED 10-20-2009.
- 3,806,331. **LIFE WITHOUT ED (STANDARD CHARACTER)**. JENNIFER LYNN SCHAEFER, (U.S. CLS. 2, 13, 23, 29, 30, 33, 40 AND 50). SN 77-855,718. PUB. 4-6-2010. FILED 10-23-2009.
- 3,806,377. **SSS SIMPLY SAID SENTIMENTS (STYLIZED)**. MCNALLY-SCHOEN, DAWN L, DBA SIMPLY-SAID-SENTIMENTS, INC, (U.S. CLS. 2, 13, 23, 29, 30, 33, 40 AND 50). SN 77-857,145. PUB. 4-6-2010. FILED 10-26-2009.
- 3,806,467. **NOURISH THE WHOLE MIND BODY SOUL (STANDARD CHARACTER)**. GREULACH, JEANA, DBA J CLAY POTTERY, (U.S. CLS. 2, 13, 23, 29, 30, 33, 40 AND 50). SN 77-858,619. PUB. 4-6-2010. FILED 10-27-2009.
- 3,806,491 (*See Class 3 for this trademark*).
- 3,806,675. **MISCELLANEOUS DESIGN**. SHERWOOD COUNTRY CLUB, MULTIPLE CLASS, (INT. CLS. 21, 24, 25 AND 28), (U.S. CLS. 2, 13, 22, 23, 29, 30, 33, 38, 39, 40, 42 AND 50). SN 77-860,872. PUB. 4-6-2010. FILED 10-29-2009.
- 3,806,750. **LITTLE EFFORT . . . BIG RESULTS (STANDARD CHARACTER)**. CRA LABS, INC., (U.S. CLS. 2, 13, 23, 29, 30, 33, 40 AND 50). SN 77-861,919. PUB. 4-6-2010. FILED 10-30-2009.
- 3,806,809. **SCOOP (STANDARD CHARACTER)**. AHMED O. ELHADARY, (U.S. CLS. 2, 13, 23, 29, 30, 33, 40 AND 50). SN 77-863,361. PUB. 4-6-2010. FILED 11-2-2009.
- 3,806,815. **GO-COASTER (STANDARD CHARACTER)**. AXELGAARD MANUFACTURING COMPANY, LTD., (U.S. CLS. 2, 13, 23, 29, 30, 33, 40 AND 50). SN 77-863,394. PUB. 4-6-2010. FILED 11-2-2009.
- 3,806,946. **TALES AND DESIGN**. ARTILIZE WORLDWIDE CO., LTD., (U.S. CLS. 2, 13, 23, 29, 30, 33, 40 AND 50). SN 77-871,792. PUB. 4-6-2010. FILED 11-13-2009.
- 3,806,974 (*See Class 16 for this trademark*).
- 3,806,997. **PURE BAMBOO SUSTAINABLE BY NATURE AND DESIGN**. SULLIVAN, TOM, (U.S. CLS. 2, 13, 23, 29, 30, 33, 40 AND 50). SN 77-881,291. PUB. 4-6-2010. FILED 11-25-2009.
- 3,807,027. **5TH AND DESIGN**. LOCKHEED MARTIN CORPORATION, (U.S. CLS. 2, 13, 23, 29, 30, 33, 40 AND 50). SN 77-890,178. PUB. 4-6-2010. FILED 12-10-2009.
- 3,807,063. **FERRARI (STYLIZED)**. FERRARI S.P.A., MULTIPLE CLASS, (INT. CLS. 21 AND 22), (U.S. CLS. 1, 2, 7, 13, 19, 22, 23, 29, 30, 33, 40, 42 AND 50). SN 78-611,116. PUB. 4-6-2010. FILED 4-18-2005.
- 3,807,068 (*See Class 6 for this trademark*).
- 3,807,091 (*See Class 14 for this trademark*).
- 3,807,093. **MISCELLANEOUS DESIGN**. YUZHOU GREENSHIP PLASTIC CORPORATION, (U.S. CLS. 2, 13, 23, 29, 30, 33, 40 AND 50). SN 79-039,472. PUB. 4-6-2010. FILED 5-30-2007.
- 3,807,104 (*See Class 6 for this trademark*).
- 3,807,108 (*See Class 8 for this trademark*).
- 3,807,131 (*See Class 3 for this trademark*).
- 3,807,136 (*See Class 3 for this trademark*).
- 3,807,137 (*See Class 14 for this trademark*).
- 3,807,153 (*See Class 9 for this trademark*).
- 3,807,162. **GOLFBRUSH AND DESIGN**. COMPACT SPECIAL EUROPE B.V., (U.S. CLS. 2, 13, 23, 29, 30, 33, 40 AND 50). SN 79-067,308. PUB. 4-6-2010. FILED 1-12-2009.
- 3,807,177 (*See Class 8 for this trademark*).
- 3,807,180 (*See Class 3 for this trademark*).
- 3,807,190 (*See Class 6 for this trademark*).
- 3,807,201. **KID PACER (STANDARD CHARACTER)**. KONINKLIJKE PHILIPS ELECTRONICS N.V., (U.S. CLS. 2, 13, 23, 29, 30, 33, 40 AND 50). SN 79-069,395. PUB. 4-6-2010. FILED 5-5-2009.
- 3,807,202. **KID TIMER (STANDARD CHARACTER)**. KONINKLIJKE PHILIPS ELECTRONICS N.V., (U.S. CLS. 2, 13, 23, 29, 30, 33, 40 AND 50). SN 79-069,396. PUB. 4-6-2010. FILED 5-5-2009.
- 3,807,209 (*See Class 6 for this trademark*).
- 3,807,225. **REMINDER BRISTLES (STANDARD CHARACTER)**. KONINKLIJKE PHILIPS ELECTRONICS N.V., (U.S. CLS. 2, 13, 23, 29, 30, 33, 40 AND 50). SN 79-069,982. PUB. 4-6-2010. FILED 4-28-2009.
- 3,807,233 (*See Class 3 for this trademark*).
- 3,807,238 (*See Class 11 for this trademark*).
- 3,807,245 (*See Class 11 for this trademark*).
- 3,807,260 (*See Class 4 for this trademark*).

CLASS 21—HOUSEWARES AND GLASS

- 3,805,119. **T R AND DESIGN**. MARGARET L. WENDT FOUNDATION HOLDINGS, INC., (U.S. CLS. 2, 13, 23, 29, 30, 33, 40 AND 50). SN 74-706,176. PUB. 9-17-1996. FILED 7-26-1995.
- 3,805,124 (*See Class 1 for this trademark*).
- 3,805,193 (*See Class 6 for this trademark*).
- 3,805,288 (*See Class 6 for this trademark*).
- 3,805,294 (*See Class 14 for this trademark*).
- 3,805,460 (*See Class 3 for this trademark*).
- 3,805,508 (*See Class 18 for this trademark*).
- 3,805,566. **AMERICAN KITCHEN (STANDARD CHARACTER)**. REGAL WARE, INC., (U.S. CLS. 2, 13, 23, 29, 30, 33, 40 AND 50). SN 77-724,150. PUB. 4-6-2010. FILED 4-28-2009.
- 3,805,572 (*See Class 11 for this trademark*).
- 3,805,614 (*See Class 19 for this trademark*).
- 3,805,782 (*See Class 16 for this trademark*).
- 3,805,787 (*See Class 19 for this trademark*).
- 3,805,919 (*See Class 3 for this trademark*).
- 3,806,074. **GLOW GREEN (STANDARD CHARACTER)**. LETS GET LIT CANDLES, INC, (U.S. CLS. 2, 13, 23, 29, 30, 33, 40 AND 50). SN 77-828,103. PUB. 4-6-2010. FILED 9-16-2009.
- 3,806,101 (*See Class 16 for this trademark*).
- 3,806,132. **TUXWARE (STANDARD CHARACTER)**. TUXTON CHINA INC., (U.S. CLS. 2, 13, 23, 29, 30, 33, 40 AND 50). SN 77-838,322. PUB. 4-6-2010. FILED 9-30-2009.
- 3,806,161. **TREE IN A BOX THEMED TREE AND ORNAMENT KIT AND DESIGN**. DUNDEE ENTERPRISES, INC., MULTIPLE CLASS, (INT. CLS. 21, 26 AND 28), (U.S. CLS. 2, 13, 22, 23, 29, 30, 33, 37, 38, 39, 40, 42 AND 50). SN 77-842,215. PUB. 4-6-2010. FILED 10-6-2009.
- 3,806,209. **STAX (STANDARD CHARACTER)**. STAX SYSTEMS, LLC, (U.S. CLS. 2, 13, 23, 29, 30, 33, 40 AND 50). SN 77-847,026. PUB. 4-6-2010. FILED 10-12-2009.
- 3,806,242. **FFERRONE (STYLIZED)**. FFERRONE DESIGN LTD., (U.S. CLS. 2, 13, 23, 29, 30, 33, 40 AND 50). SN 77-850,330. PUB. 4-6-2010. FILED 10-16-2009.
- 3,806,274. **SMARTGARDENS (STANDARD CHARACTER)**. FUTUREGARDEN INC., (U.S. CLS. 2, 13, 23, 29, 30, 33, 40

3,807,269 (*See Class 6 for this trademark.*)
 3,807,271 (*See Class 3 for this trademark.*)

CLASS 22—CORDAGE AND FIBERS

3,805,124 (*See Class 1 for this trademark.*)
 3,805,126 (*See Class 18 for this trademark.*)
 3,805,246 (*See Class 17 for this trademark.*)
 3,805,381. **BUNGEE X (STANDARD CHARACTER)**. WINSTON PRODUCTS LLC, (U.S. CLS. 1, 2, 7, 19, 22, 42 AND 50). SN 77-601,133. PUB. 4-6-2010. FILED 10-27-2008.
 3,805,517 (*See Class 20 for this trademark.*)
 3,805,710. **SHOE POCKETS (STANDARD CHARACTER)**. DONALD L. ARMSTRONG, (U.S. CLS. 1, 2, 7, 19, 22, 42 AND 50). SN 77-748,469. PUB. 4-6-2010. FILED 5-31-2009.
 3,805,964. **SIERRA PACIFIC INDUSTRIES (STANDARD CHARACTER)**. SIERRA PACIFIC INDUSTRIES, MULTIPLE CLASS, (INT. CLS. 22 AND 31), (U.S. CLS. 1, 2, 7, 19, 22, 42, 46 AND 50). SN 77-810,022. PUB. 4-6-2010. FILED 8-21-2009.
 3,805,970. **SPI AND DESIGN**. SIERRA PACIFIC INDUSTRIES, MULTIPLE CLASS, (INT. CLS. 22 AND 31), (U.S. CLS. 1, 2, 7, 19, 22, 42, 46 AND 50). SN 77-810,388. PUB. 4-6-2010. FILED 8-21-2009.
 3,806,658. **COUNTYLINE (STANDARD CHARACTER)**. TRACTOR SUPPLY CO. OF TEXAS, LP, (U.S. CLS. 1, 2, 7, 19, 22, 42 AND 50). SN 77-860,640. PUB. 4-6-2010. FILED 10-29-2009.
 3,807,028. **5TH AND DESIGN**. LOCKHEED MARTIN CORPORATION, (U.S. CLS. 1, 2, 7, 19, 22, 42 AND 50). SN 77-890,181. PUB. 4-6-2010. FILED 12-10-2009.
 3,807,063 (*See Class 21 for this trademark.*)
 3,807,104 (*See Class 6 for this trademark.*)
 3,807,130 (*See Class 16 for this trademark.*)
 3,807,186 (*See Class 7 for this trademark.*)

CLASS 23—YARNS AND THREADS

3,805,126 (*See Class 18 for this trademark.*)
 3,805,478 (*See Class 6 for this trademark.*)
 3,805,772. **BABY'S FIRST (STANDARD CHARACTER)**. ORCHARD YARN AND THREAD COMPANY, INC., DBA LION BRAND YARN COMPANY, (U.S. CL. 43). SN 77-763,716. PUB. 4-6-2010. FILED 6-19-2009.

CLASS 24—FABRICS

3,805,124 (*See Class 1 for this trademark.*)
 3,805,126 (*See Class 18 for this trademark.*)
 3,805,350 (*See Class 9 for this trademark.*)
 3,805,478 (*See Class 6 for this trademark.*)
 3,805,508 (*See Class 18 for this trademark.*)
 3,805,795. **SHABBY TAILS (STANDARD CHARACTER)**. SANCHEZ, ANA, (U.S. CLS. 42 AND 50). SN 77-770,682. PUB. 4-6-2010. FILED 6-29-2009.
 3,806,110. **MISCELLANEOUS DESIGN**. SPANGLER, AMY K., MULTIPLE CLASS, (INT. CLS. 24, 25 AND 44), (U.S. CLS. 22, 39, 42, 50, 100 AND 101). SN 77-836,105. PUB. 4-6-2010. FILED 9-28-2009.
 3,806,119. **R AND DESIGN**. RENAISSANCE CARPET & TAPESTRIES, INC., MULTIPLE CLASS, (INT. CLS. 24 AND 27), (U.S. CLS. 19, 20, 37, 42 AND 50). SN 77-836,999. PUB. 4-6-2010. FILED 9-29-2009.
 3,806,624. **ALLERHEALTH (STANDARD CHARACTER)**. HEALTHGOODS, LLC, (U.S. CLS. 42 AND 50). SN 77-860,240. PUB. 4-6-2010. FILED 10-29-2009.
 3,806,675 (*See Class 21 for this trademark.*)
 3,806,732. **CRIBSHIELD (STANDARD CHARACTER)**. BREATHTABLEBABY, LLC, (U.S. CLS. 42 AND 50). SN 77-861,655. PUB. 4-6-2010. FILED 10-30-2009.
 3,806,735. **TABLEVOGUE (STANDARD CHARACTER)**. BIRDWELL, JANE, (U.S. CLS. 42 AND 50). SN 77-861,695. PUB. 4-

6-2010. FILED 10-30-2009.
 3,806,965 (*See Class 1 for this trademark.*)
 3,807,091 (*See Class 14 for this trademark.*)
 3,807,095. **AROSTRETCH (STANDARD CHARACTER)**. LAMBERTI S.P.A., MULTIPLE CLASS, (INT. CLS. 24, 25 AND 40), (U.S. CLS. 22, 39, 42, 50, 100, 103 AND 106). SN 79-047,168. PUB. 4-6-2010. FILED 10-16-2007.
 3,807,104 (*See Class 6 for this trademark.*)
 3,807,130 (*See Class 16 for this trademark.*)
 3,807,131 (*See Class 3 for this trademark.*)
 3,807,145 (*See Class 5 for this trademark.*)
 3,807,146. **EBRIQ (STANDARD CHARACTER)**. KURASHIKI BOSEKI KABUSHIKI KAISHA; (TRADING ALSO AS KURABO INDUSTRIES LTD.), MULTIPLE CLASS, (INT. CLS. 24 AND 25), (U.S. CLS. 22, 39, 42 AND 50). SN 79-064,273. PUB. 4-6-2010. FILED 9-12-2008.
 3,807,200. **DREAMLA AND DESIGN**. JIANGSU TONGYE INDUSTRY CO., LTD., (U.S. CLS. 42 AND 50). SN 79-069,391. PUB. 4-6-2010. FILED 5-19-2009.
 3,807,233 (*See Class 3 for this trademark.*)
 3,807,240 (*See Class 3 for this trademark.*)
 3,807,260 (*See Class 4 for this trademark.*)
 3,807,321 (*See Class 20 for this trademark.*)
 3,807,324 (*See Class 20 for this trademark.*)

CLASS 25—CLOTHING

3,805,121. **FREE SOUL**. ELDO S.R.L., (U.S. CLS. 22 AND 39). SN 75-258,761. PUB. 4-6-2010. FILED 3-17-1997.
 3,805,126 (*See Class 18 for this trademark.*)
 3,805,139. **HELL 'N BACK (STANDARD CHARACTER)**. TUCKER-ROCKY CORPORATION, INC., (U.S. CLS. 22 AND 39). SN 76-695,624. PUB. 4-6-2010. FILED 2-3-2009.
 3,805,141. **REBECCA MALONE (STANDARD CHARACTER)**. SPECIALTY RETAILERS, INC., (U.S. CLS. 22 AND 39). SN 76-697,055. PUB. 4-6-2010. FILED 4-24-2009.
 3,805,160. **DELI ALDO AND DESIGN**. CONAL INTERNATIONAL TRADING, INC., (U.S. CLS. 22 AND 39). SN 76-699,441. PUB. 4-6-2010. FILED 9-14-2009.
 3,805,181 (*See Class 9 for this trademark.*)
 3,805,182. **D (STYLIZED)**. GROUPE DYNAMITE INC., MULTIPLE CLASS, (INT. CLS. 25 AND 35), (U.S. CLS. 22, 39, 100, 101 AND 102). SN 77-015,987. PUB. 9-11-2007. FILED 10-6-2006.
 3,805,188. **MISCELLANEOUS DESIGN**. BUDDHA FOODHA INC., MULTIPLE CLASS, (INT. CLS. 25, 29, 30 AND 43), (U.S. CLS. 22, 39, 46, 100 AND 101). SN 77-088,942. PUB. 4-6-2010. FILED 1-23-2007.
 3,805,193 (*See Class 6 for this trademark.*)
 3,805,198. **GI (STANDARD CHARACTER)**. MARKET PLACE CLOTHING, INC., (U.S. CLS. 22 AND 39). SN 77-215,451. PUB. 4-6-2010. FILED 6-26-2007.
 3,805,230 (*See Class 3 for this trademark.*)
 3,805,233. **ROCK-N-ROLL GANG AND DESIGN**. ROCK N ROLL GANGSTAR, INC., MULTIPLE CLASS, (INT. CLS. 25 AND 35), (U.S. CLS. 22, 39, 100, 101 AND 102). SN 77-376,649. PUB. 4-6-2010. FILED 1-21-2008.
 3,805,241. **CHUPA CHUPS AND DESIGN**. PERFETTI VAN MELLE S.P.A., (U.S. CLS. 22 AND 39). SN 77-405,437. PUB. 1-26-2010. FILED 2-25-2008.
 3,805,253. **DRY ZONE (STANDARD CHARACTER)**. SAN MAR CORPORATION, (U.S. CLS. 22 AND 39). SN 77-428,665. PUB. 4-6-2010. FILED 3-21-2008.
 3,805,262. **TAMALEWOOD (STANDARD CHARACTER)**. TAMALEWOOD, LLC, (U.S. CLS. 22 AND 39). SN 77-456,133. PUB. 4-6-2010. FILED 4-23-2008.
 3,805,271. **NORTHERN I.O.W.A AND DESIGN**. UNIVERSITY OF NORTHERN IOWA, (U.S. CLS. 22 AND 39). SN 77-481,032. PUB. 4-6-2010. FILED 5-22-2008.
 3,805,334. **DA COACH (STANDARD CHARACTER)**. DITKA, MICHAEL K., (U.S. CLS. 22 AND 39). SN 77-561,403. PUB. 11-3-2009. FILED 9-3-2008.
 3,805,335. **BIG GAME TROPHY CLUB AND DESIGN**. LIVE OAK LICENSING GROUP, LLC, (U.S. CLS. 22 AND 39). SN 77-562,099. PUB. 4-6-2010. FILED 9-4-2008.
 3,805,346 (*See Class 9 for this trademark.*)

- 3,805,347 (*See Class 9 for this trademark.*)
- 3,805,359. **CARHARTT C AND DESIGN.** CARHARTT, INC., (U.S. CLS. 22 AND 39). SN 77-582,380. PUB. 4-6-2010. FILED 9-30-2008.
- 3,805,362. **LOVE PINK VICTORIA'S SECRET AND DESIGN.** VICTORIA'S SECRET STORES BRAND MANAGEMENT, INC., (U.S. CLS. 22 AND 39). SN 77-583,183. PUB. 4-6-2010. FILED 10-1-2008.
- 3,805,373. **MISCELLANEOUS DESIGN.** DEATH ADDERS INC., DBA MISHKA NYC, (U.S. CLS. 22 AND 39). SN 77-592,734. PUB. 4-6-2010. FILED 10-14-2008.
- 3,805,376 (*See Class 9 for this trademark.*)
- 3,805,378. **G-GA (STANDARD CHARACTER).** BUSH JR, JEROME T, DBA JONT VENTURE, (U.S. CLS. 22 AND 39). SN 77-599,081. PUB. 4-6-2010. FILED 10-23-2008.
- 3,805,382 (*See Class 9 for this trademark.*)
- 3,805,389 (*See Class 9 for this trademark.*)
- 3,805,507. **XTREME TAEKWONDO AND DESIGN.** MERRELL, JOHN, DBA XTREME TAEKWONDO, (U.S. CLS. 22 AND 39). SN 77-708,940. PUB. 4-6-2010. FILED 4-7-2009.
- 3,805,508 (*See Class 18 for this trademark.*)
- 3,805,539. **FUNKTALITY (STANDARD CHARACTER).** ORDOÑEZ, ELIZABETH, AKA ELIZABETH SKY, E.SKY, (U.S. CLS. 22 AND 39). SN 77-719,507. PUB. 4-6-2010. FILED 4-22-2009.
- 3,805,558. **H HEELYS WORLDWIDE AND DESIGN.** HEELING SPORTS LIMITED, MULTIPLE CLASS, (INT. CLS. 25 AND 28), (U.S. CLS. 22, 23, 38, 39 AND 50). SN 77-723,261. PUB. 4-6-2010. FILED 4-27-2009.
- 3,805,559. **P AND DESIGN.** PROSPER INDEPENDENT SCHOOL DISTRICT, MULTIPLE CLASS, (INT. CLS. 25 AND 41), (U.S. CLS. 22, 39, 100, 101 AND 107). SN 77-723,443. PUB. 4-6-2010. FILED 4-27-2009.
- 3,805,616. **SING & SMILE (STANDARD CHARACTER).** GLOBAL FASHIONS INC., (U.S. CLS. 22 AND 39). SN 77-731,890. PUB. 4-6-2010. FILED 5-7-2009.
- 3,805,643. **PEACING IT TOGETHER! (STANDARD CHARACTER).** THE MOSAIC PROJECT, (U.S. CLS. 22 AND 39). SN 77-735,487. PUB. 4-6-2010. FILED 5-12-2009.
- 3,805,644. **MISCELLANEOUS DESIGN.** TEE AND TEE CLOTHING, LLC, (U.S. CLS. 22 AND 39). SN 77-735,556. PUB. 4-6-2010. FILED 5-13-2009.
- 3,805,672. **PRETTY PLEASE (STANDARD CHARACTER).** HO, MAN KWONG, (U.S. CLS. 22 AND 39). SN 77-741,762. PUB. 4-6-2010. FILED 5-21-2009.
- 3,805,681 (*See Class 18 for this trademark.*)
- 3,805,685 (*See Class 14 for this trademark.*)
- 3,805,700 (*See Class 16 for this trademark.*)
- 3,805,728. **NEVER... LIE TO YOUR HAIRDRESSER (STANDARD CHARACTER).** NEVER LIE TO YOUR HAIRDRESSER, LLC, (U.S. CLS. 22 AND 39). SN 77-754,233. PUB. 4-6-2010. FILED 6-8-2009.
- 3,805,743 (*See Class 9 for this trademark.*)
- 3,805,759. **MISCELLANEOUS DESIGN.** MCDONALD CORPORATION, (U.S. CLS. 22 AND 39). SN 77-761,232. PUB. 11-3-2009. FILED 6-16-2009.
- 3,805,769 (*See Class 18 for this trademark.*)
- 3,805,777. **SPX AND DESIGN.** PO JEN PAI, (U.S. CLS. 22 AND 39). SN 77-764,428. PUB. 4-6-2010. FILED 6-19-2009.
- 3,805,782 (*See Class 16 for this trademark.*)
- 3,805,798. **SIKKAIR AND DESIGN.** SEALE, DALLYN, AND WALMSLEY, ROSS, (U.S. CLS. 22 AND 39). SN 77-770,871. PUB. 4-6-2010. FILED 6-30-2009.
- 3,805,814 (*See Class 18 for this trademark.*)
- 3,805,846. **MISCELLANEOUS DESIGN.** BLACK HAWKS HOCKEY, INC., MULTIPLE CLASS, (INT. CLS. 25 AND 41), (U.S. CLS. 22, 39, 100, 101 AND 107). SN 77-782,932. PUB. 12-29-2009. FILED 7-16-2009.
- 3,805,864. **SKITRAX (STANDARD CHARACTER).** IMPLUS FOOTCARE, LLC, (U.S. CLS. 22 AND 39). SN 77-790,362. PUB. 4-6-2010. FILED 7-27-2009.
- 3,805,888. **CLUBCORP (STANDARD CHARACTER).** CLUBCORP, INC., (U.S. CLS. 22 AND 39). SN 77-793,580. PUB. 4-6-2010. FILED 7-30-2009.
- 3,805,915 (*See Class 4 for this trademark.*)
- 3,805,922. **MONKEYBAR BUDDIES (STANDARD CHARACTER).** GINA WISSMILLER, (U.S. CLS. 22 AND 39). SN 77-800,427. PUB. 4-6-2010. FILED 8-9-2009.
- 3,805,923. **MISCELLANEOUS DESIGN.** GINA WISSMILLER, (U.S. CLS. 22 AND 39). SN 77-800,433. PUB. 4-6-2010. FILED 8-9-2009.
- 3,805,972. **CUSHIONAIRE (STANDARD CHARACTER).** NEXT STEP GROUP, INC., (U.S. CLS. 22 AND 39). SN 77-810,987. PUB. 4-6-2010. FILED 8-24-2009.
- 3,805,977. **SPRAYGROUND (STANDARD CHARACTER).** SPRAYGROUND LIMITED LIABILITY COMPANY, (U.S. CLS. 22 AND 39). SN 77-811,465. PUB. 4-6-2010. FILED 8-24-2009.
- 3,805,982. **RUGGED TRAILS (STANDARD CHARACTER).** BOB'S STORES CORP., (U.S. CLS. 22 AND 39). SN 77-812,262. PUB. 4-6-2010. FILED 8-25-2009.
- 3,805,984. **BARBARA ECLECTIC (STANDARD CHARACTER).** VILLAGE VOGUE, INC. II, MULTIPLE CLASS, (INT. CLS. 25 AND 35), (U.S. CLS. 22, 39, 100, 101 AND 102). SN 77-813,320. PUB. 4-6-2010. FILED 8-26-2009.
- 3,806,009. **WRANGLER JEANS CO. ESTABLISHED 1947 (STANDARD CHARACTER).** WRANGLER APPAREL CORP., (U.S. CLS. 22 AND 39). SN 77-818,111. PUB. 4-6-2010. FILED 9-2-2009.
- 3,806,011. **MAIN EVENTS (STANDARD CHARACTER).** NEW JERSEY SPORTS PRODUCTIONS, INC., (U.S. CLS. 22 AND 39). SN 77-818,462. PUB. 4-6-2010. FILED 9-2-2009.
- 3,806,012. **MAIN EVENTS AND DESIGN.** NEW JERSEY SPORTS PRODUCTIONS, INC., (U.S. CLS. 22 AND 39). SN 77-818,504. PUB. 4-6-2010. FILED 9-2-2009.
- 3,806,013 (*See Class 18 for this trademark.*)
- 3,806,053. **EMV (STYLIZED).** MONAVIE, LLC, (U.S. CLS. 22 AND 39). SN 77-824,839. PUB. 4-6-2010. FILED 9-11-2009.
- 3,806,054. **ARGOS (STANDARD CHARACTER).** BYRD, PAUL A., (U.S. CLS. 22 AND 39). SN 77-825,351. PUB. 4-6-2010. FILED 9-11-2009.
- 3,806,095. **CARLOS SUAREZ (STANDARD CHARACTER).** SUAREZ, CARLOS, (U.S. CLS. 22 AND 39). SN 77-833,311. PUB. 4-6-2010. FILED 9-23-2009.
- 3,806,101 (*See Class 16 for this trademark.*)
- 3,806,110 (*See Class 24 for this trademark.*)
- 3,806,135 (*See Class 8 for this trademark.*)
- 3,806,141. **COLUMBUS BLUE JACKETS AND DESIGN.** COLHOC LIMITED PARTNERSHIP, (U.S. CLS. 22 AND 39). SN 77-839,257. PUB. 4-6-2010. FILED 10-1-2009.
- 3,806,147. **MIGUEL ANTOINETTE (STYLIZED).** MANN MANN APPAREL GROUP LLC, (U.S. CLS. 22 AND 39). SN 77-839,954. PUB. 4-6-2010. FILED 10-2-2009.
- 3,806,215. **ALIEN COUTURE AND DESIGN.** CALPOP.COM, INC., (U.S. CLS. 22 AND 39). SN 77-847,746. PUB. 4-6-2010. FILED 10-13-2009.
- 3,806,239 (*See Class 9 for this trademark.*)
- 3,806,249. **VITORIA GEAR (STYLIZED).** VITORIA GEAR, (U.S. CLS. 22 AND 39). SN 77-850,805. PUB. 4-6-2010. FILED 10-16-2009.
- 3,806,262. **CARAVARI (STANDARD CHARACTER).** GRUPO BOOCHI, S.A., (U.S. CLS. 22 AND 39). SN 77-852,219. PUB. 4-6-2010. FILED 10-19-2009.
- 3,806,266. **HH HUGS AND HONIS AND DESIGN.** ODA, NATASHA K., DBA HUGS AND HONIS BY NATASHA, (U.S. CLS. 22 AND 39). SN 77-852,361. PUB. 4-6-2010. FILED 10-20-2009.
- 3,806,273. **SHAPESHIFTERZ (STANDARD CHARACTER).** FUTURE CIRCUS, INC., (U.S. CLS. 22 AND 39). SN 77-853,189. PUB. 4-6-2010. FILED 10-20-2009.
- 3,806,287. **ROLLOUT RR RACQUETBALL (STANDARD CHARACTER).** CLAY, JONATHAN, (U.S. CLS. 22 AND 39). SN 77-854,076. PUB. 4-6-2010. FILED 10-21-2009.
- 3,806,330. **LIFE WITHOUT ED (STANDARD CHARACTER).** JENNIFER LYNN SCHAEFER, (U.S. CLS. 22 AND 39). SN 77-855,715. PUB. 4-6-2010. FILED 10-23-2009.
- 3,806,344. **JU.LEE AND DESIGN.** IRIDESCENCE BRIDAL COUTURE, INC., (U.S. CLS. 22 AND 39). SN 77-856,346. PUB. 4-6-2010. FILED 10-23-2009.
- 3,806,345. **HOLY G (STANDARD CHARACTER).** HOLY G WEAR LLC, (U.S. CLS. 22 AND 39). SN 77-856,480. PUB. 4-6-2010. FILED 10-23-2009.
- 3,806,395 (*See Class 18 for this trademark.*)
- 3,806,402. **TUMMY TROUSERS (STANDARD CHARACTER).** CADEN, JODI E., (U.S. CLS. 22 AND 39). SN 77-857,951. PUB. 4-6-2010. FILED 10-27-2009.

- 3,806,428. **ZOMSTERS (STANDARD CHARACTER)**. ZOMSTERS, LLC, (U.S. CLS. 22 AND 39). SN 77-858,219. PUB. 4-6-2010. FILED 10-27-2009.
- 3,806,432. **RAT (STANDARD CHARACTER)**. MERCURY INTERNATIONAL TRADING CORPORATION, (U.S. CLS. 22 AND 39). SN 77-858,312. PUB. 4-6-2010. FILED 10-27-2009.
- 3,806,447. **SSMF (STANDARD CHARACTER)**. SUNSET STRIP BUSINESS ASSOCIATION, (U.S. CLS. 22 AND 39). SN 77-858,476. PUB. 4-6-2010. FILED 10-27-2009.
- 3,806,466. **GHIADA (STANDARD CHARACTER)**. GHIADA CORPORATION, (U.S. CLS. 22 AND 39). SN 77-858,602. PUB. 4-6-2010. FILED 10-27-2009.
- 3,806,479. **CORKYS FOOTWEAR (STANDARD CHARACTER)**. CORKYS FOOTWEAR, INC., (U.S. CLS. 22 AND 39). SN 77-858,718. PUB. 4-6-2010. FILED 10-27-2009.
- 3,806,480. **QUIET CLOTHING (STANDARD CHARACTER)**. DOUGHERTY, MAUREEN, (U.S. CLS. 22 AND 39). SN 77-858,723. PUB. 4-6-2010. FILED 10-27-2009.
- 3,806,481. **CORKYS FOOTWEAR AND DESIGN**. CORKYS FOOTWEAR, INC., (U.S. CLS. 22 AND 39). SN 77-858,724. PUB. 4-6-2010. FILED 10-27-2009.
- 3,806,486. **GREEN ZEBRA ADVENTURES (STANDARD CHARACTER)**. EPIC OFF ROAD, LLC, MULTIPLE CLASS, (INT. CLS. 25 AND 39), (U.S. CLS. 22, 39, 100 AND 105). SN 77-858,748. PUB. 4-6-2010. FILED 10-27-2009.
- 3,806,514. **HY GORGEIOUS (STANDARD CHARACTER)**. HY GORGEIOUS, LLC, MULTIPLE CLASS, (INT. CLS. 25 AND 44), (U.S. CLS. 22, 39, 100 AND 101). SN 77-859,137. PUB. 4-6-2010. FILED 10-28-2009.
- 3,806,537. **TWEEDLE BUGS (STANDARD CHARACTER)**. YOUNG DISCOVERERS, LLC, MULTIPLE CLASS, (INT. CLS. 25 AND 35), (U.S. CLS. 22, 39, 100, 101 AND 102). SN 77-859,479. PUB. 4-6-2010. FILED 10-28-2009.
- 3,806,567. **REGULAR ROB AND DESIGN**. BURNS, ROBERT, JUDE, DBA REGULAR ROB, (U.S. CLS. 22 AND 39). SN 77-859,778. PUB. 4-6-2010. FILED 10-28-2009.
- 3,806,570. **PRIVILEGED AND DESIGN**. CHOU, JENNIFER, (U.S. CLS. 22 AND 39). SN 77-859,817. PUB. 4-6-2010. FILED 10-28-2009.
- 3,806,583. **MISCELLANEOUS DESIGN**. VIX SWIMWEAR, INC., (U.S. CLS. 22 AND 39). SN 77-859,866. PUB. 4-6-2010. FILED 10-28-2009.
- 3,806,587. **V VALEVIBE AND DESIGN**. RAMSEY, RALPH, AND HENRY, WAYNE, MULTIPLE CLASS, (INT. CLS. 25 AND 41), (U.S. CLS. 22, 39, 100, 101 AND 107). SN 77-859,883. PUB. 4-6-2010. FILED 10-28-2009.
- 3,806,608 (*See Class 18 for this trademark*).
- 3,806,621. **MABEL (STANDARD CHARACTER)**. ROHANI, DANIELLE, (U.S. CLS. 22 AND 39). SN 77-860,230. PUB. 4-6-2010. FILED 10-29-2009.
- 3,806,643. **LONNIE POOLE GOLF COURSE AND DESIGN**. NORTH CAROLINA STATE UNIVERSITY, MULTIPLE CLASS, (INT. CLS. 25 AND 41), (U.S. CLS. 22, 39, 100, 101 AND 107). SN 77-860,551. PUB. 4-6-2010. FILED 10-29-2009.
- 3,806,675 (*See Class 21 for this trademark*).
- 3,806,683. **CLOTHE YOUR NEIGHBOR AS YOURSELF (STANDARD CHARACTER)**. BARNETT, JAMES, (U.S. CLS. 22 AND 39). SN 77-860,949. PUB. 4-6-2010. FILED 10-29-2009.
- 3,806,696 (*See Class 9 for this trademark*).
- 3,806,743. **KASIA DE GELAQUE (STANDARD CHARACTER)**. KASIA DE GELAQUE, INC., (U.S. CLS. 22 AND 39). SN 77-861,803. PUB. 4-6-2010. FILED 10-30-2009.
- 3,806,748. **CIRCE SNOW (STANDARD CHARACTER)**. ILIAD LICENSING LLC, (U.S. CLS. 22 AND 39). SN 77-861,901. PUB. 4-6-2010. FILED 10-30-2009.
- 3,806,751. **CIRCE SNOW AND DESIGN**. ILIAD LICENSING LLC, (U.S. CLS. 22 AND 39). SN 77-861,925. PUB. 4-6-2010. FILED 10-30-2009.
- 3,806,789. **WE TEACH (STANDARD CHARACTER)**. PROFESSIONAL NET IMAGES, LLC, (U.S. CLS. 22 AND 39). SN 77-862,982. PUB. 4-6-2010. FILED 11-2-2009.
- 3,806,837. **ENWRAPPE (STANDARD CHARACTER)**. EVELYN & COMPANY LLC, (U.S. CLS. 22 AND 39). SN 77-863,751. PUB. 4-6-2010. FILED 11-3-2009.
- 3,806,881 (*See Class 14 for this trademark*).
- 3,806,956. **VIZIPRO (STANDARD CHARACTER)**. SAUCONY, INC., (U.S. CLS. 22 AND 39). SN 77-874,149. PUB. 4-6-2010. FILED 11-17-2009.
- 3,806,957 (*See Class 20 for this trademark*).
- 3,806,974 (*See Class 16 for this trademark*).
- 3,806,980. **DEUGO (STANDARD CHARACTER)**. TODIA LTD., (U.S. CLS. 22 AND 39). SN 77-877,959. PUB. 4-6-2010. FILED 11-20-2009.
- 3,806,998. **UA UNIVERSAL GUARANTEE OF PERFORMANCE. PROTECT THIS HOUSE. AND DESIGN**. UNDER ARMOUR, INC., (U.S. CLS. 22 AND 39). SN 77-882,159. PUB. 4-6-2010. FILED 11-30-2009.
- 3,807,029. **5TH AND DESIGN**. LOCKHEED MARTIN CORPORATION, (U.S. CLS. 22 AND 39). SN 77-890,183. PUB. 4-6-2010. FILED 12-10-2009.
- 3,807,037. **GET TONED WITHOUT SETTING FOOT IN A GYM (STANDARD CHARACTER)**. SKECHERS U.S.A., INC. II, (U.S. CLS. 22 AND 39). SN 77-894,163. PUB. 4-6-2010. FILED 12-15-2009.
- 3,807,043. **CIRCE AND DESIGN**. ILIAD LICENSING LLC, (U.S. CLS. 22 AND 39). SN 77-903,127. PUB. 4-6-2010. FILED 12-30-2009.
- 3,807,067. **ULTIMO (STANDARD CHARACTER)**. MJM INTERNATIONAL LIMITED, (U.S. CLS. 22 AND 39). SN 78-735,067. PUB. 10-14-2008. FILED 10-18-2005.
- 3,807,070. **KANAKA KOA AND DESIGN**. FESKE JR., DAVID, A., (U.S. CLS. 22 AND 39). SN 78-748,100. PUB. 4-6-2010. FILED 11-7-2005.
- 3,807,075. **T'S BY TOPSHOP (STANDARD CHARACTER)**. ARCADIA GROUP BRANDS LIMITED, (U.S. CLS. 22 AND 39). SN 78-784,641. PUB. 8-12-2008. FILED 1-4-2006.
- 3,807,091 (*See Class 14 for this trademark*).
- 3,807,092 (*See Class 12 for this trademark*).
- 3,807,094 (*See Class 9 for this trademark*).
- 3,807,095 (*See Class 24 for this trademark*).
- 3,807,096. **OFFSHORE ONE OFF SHORE 1 AND DESIGN**. SARL CRW DESIGN, (U.S. CLS. 22 AND 39). SN 79-049,123. PUB. 10-20-2009. FILED 8-20-2007.
- 3,807,099. **FAVEO (STANDARD CHARACTER)**. FAVEO LIMITED, (U.S. CLS. 22 AND 39). SN 79-051,901. PUB. 4-6-2010. FILED 10-30-2007.
- 3,807,105. **VIKING AND DESIGN**. VIKING FOTTØY AS, (U.S. CLS. 22 AND 39). SN 79-054,724. PUB. 12-29-2009. FILED 4-24-2008.
- 3,807,111 (*See Class 14 for this trademark*).
- 3,807,114. **INDITEX (STANDARD CHARACTER)**. INDUSTRIA DE DISEÑO TEXTIL, S.A.; (INDITEX, S.A.), MULTIPLE CLASS, (INT. CLS. 25, 35, 39 AND 42), (U.S. CLS. 22, 39, 100, 101, 102 AND 105). SN 79-058,223. PUB. 4-6-2010. FILED 1-24-2008.
- 3,807,124 (*See Class 18 for this trademark*).
- 3,807,125 (*See Class 9 for this trademark*).
- 3,807,131 (*See Class 3 for this trademark*).
- 3,807,135 (*See Class 9 for this trademark*).
- 3,807,137 (*See Class 14 for this trademark*).
- 3,807,139 (*See Class 3 for this trademark*).
- 3,807,140 (*See Class 14 for this trademark*).
- 3,807,141. **SANO (STANDARD CHARACTER)**. MEPHISTO S.A.; (SOCIÉTÉ ANONYME À DIRECTOIRE ET; CONSEIL DE SURVEILLANCE), MULTIPLE CLASS, (INT. CLS. 25 AND 35), (U.S. CLS. 22, 39, 100, 101 AND 102). SN 79-063,436. PUB. 4-6-2010. FILED 11-27-2008.
- 3,807,145 (*See Class 5 for this trademark*).
- 3,807,146 (*See Class 24 for this trademark*).
- 3,807,153 (*See Class 9 for this trademark*).
- 3,807,161 (*See Class 1 for this trademark*).
- 3,807,180 (*See Class 3 for this trademark*).
- 3,807,188 (*See Class 18 for this trademark*).
- 3,807,198 (*See Class 18 for this trademark*).
- 3,807,204. **360 MODENA (STYLIZED)**. FERRARI S.P.A., MULTIPLE CLASS, (INT. CLS. 25 AND 28), (U.S. CLS. 22, 23, 38, 39 AND 50). SN 79-069,443. PUB. 4-6-2010. FILED 2-24-2009.
- 3,807,213 (*See Class 9 for this trademark*).
- 3,807,230 (*See Class 10 for this trademark*).
- 3,807,231 (*See Class 12 for this trademark*).
- 3,807,233 (*See Class 3 for this trademark*).
- 3,807,240 (*See Class 3 for this trademark*).
- 3,807,241 (*See Class 18 for this trademark*).

3,807,242. **MISCELLANEOUS DESIGN**. VALSTAR S.P.A., (U.S. CLS. 22 AND 39). SN 79-070,463. PUB. 4-6-2010. FILED 4-14-2009.
 3,807,250 (*See Class 18 for this trademark*).
 3,807,259. **FAKEER (STANDARD CHARACTER)**. LUXURIA, S.R.O., MULTIPLE CLASS, (INT. CLS. 25, 32 AND 33), (U.S. CLS. 22, 39, 45, 46, 47, 48 AND 49). SN 79-071,065. PUB. 4-6-2010. FILED 5-5-2009.
 3,807,282. **RELIFE (STANDARD CHARACTER)**. KARL PRATTES, (U.S. CLS. 22 AND 39). SN 79-072,159. PUB. 4-6-2010. FILED 7-1-2009.
 3,807,298 (*See Class 14 for this trademark*).
 3,807,299. **ARIGATO AND DESIGN**. PINKBUDDHA CO., LTD., (U.S. CLS. 22 AND 39). SN 79-073,251. PUB. 4-6-2010. FILED 7-31-2009.
 3,807,323. **MISCELLANEOUS DESIGN**. ZHU SONG NIAN, AND ZHU YI NIAN, (U.S. CLS. 22 AND 39). SN 79-074,661. PUB. 4-6-2010. FILED 10-7-2009.
 3,807,369 (*See Class 9 for this trademark*).

CLASS 26—FANCY GOODS

3,805,382 (*See Class 9 for this trademark*).
 3,805,478 (*See Class 6 for this trademark*).
 3,805,540 (*See Class 3 for this trademark*).
 3,805,898 (*See Class 6 for this trademark*).
 3,806,161 (*See Class 21 for this trademark*).
 3,807,104 (*See Class 6 for this trademark*).
 3,807,137 (*See Class 14 for this trademark*).
 3,807,271 (*See Class 3 for this trademark*).

CLASS 27—FLOOR COVERINGS

3,805,124 (*See Class 1 for this trademark*).
 3,806,119 (*See Class 24 for this trademark*).
 3,806,903. **RECORE (STANDARD CHARACTER)**. OMNOVA SOLUTIONS INC., (U.S. CLS. 19, 20, 37, 42 AND 50). SN 77-865,324. PUB. 4-6-2010. FILED 11-4-2009.
 3,807,104 (*See Class 6 for this trademark*).
 3,807,181. **HUAXIN AND DESIGN**. ZHENGPING HUAXIN; CARPET GROUP CO., LTD., (U.S. CLS. 19, 20, 37, 42 AND 50). SN 79-068,628. PUB. 4-6-2010. FILED 4-29-2009.

CLASS 28—TOYS AND SPORTING GOODS

3,805,124 (*See Class 1 for this trademark*).
 3,805,128 (*See Class 5 for this trademark*).
 3,805,230 (*See Class 3 for this trademark*).
 3,805,300 (*See Class 11 for this trademark*).
 3,805,329. **SRIXON LADY (STANDARD CHARACTER)**. SRI KABUSHIKI KAISHA, TA SRI SPORTS LIMITED, (U.S. CLS. 22, 23, 38 AND 50). SN 77-556,098. PUB. 4-6-2010. FILED 8-26-2008.
 3,805,346 (*See Class 9 for this trademark*).
 3,805,347 (*See Class 9 for this trademark*).
 3,805,374. **POP-UP BARRELS (STANDARD CHARACTER)**. SEVENTEENFLAT.COM, (U.S. CLS. 22, 23, 38 AND 50). SN 77-594,254. PUB. 4-6-2010. FILED 10-16-2008.
 3,805,397 (*See Class 16 for this trademark*).
 3,805,404 (*See Class 5 for this trademark*).
 3,805,435 (*See Class 10 for this trademark*).
 3,805,457 (*See Class 16 for this trademark*).
 3,805,478 (*See Class 6 for this trademark*).
 3,805,526. **LIFT ASSIST (STANDARD CHARACTER)**. SHIFERAW, TESSEMA DOSHO, (U.S. CLS. 22, 23, 38 AND 50). SN 77-716,466. PUB. 4-6-2010. FILED 4-17-2009.
 3,805,558 (*See Class 25 for this trademark*).
 3,805,840 (*See Class 11 for this trademark*).
 3,805,841 (*See Class 11 for this trademark*).
 3,805,845. **COLOR ME COOL (STANDARD CHARACTER)**. CRAFTY PRODUCTIONS, INC., (U.S. CLS. 22, 23, 38 AND

50). SN 77-782,700. PUB. 4-6-2010. FILED 7-16-2009.
 3,805,880. **MATRYOSHKA MADNESS! (STANDARD CHARACTER)**. PALMER, ANDREW C, (U.S. CLS. 22, 23, 38 AND 50). SN 77-792,518. PUB. 4-6-2010. FILED 7-29-2009.
 3,805,937. **PRETTY LITTLE PRINCESS (STANDARD CHARACTER)**. XCESSORY INTERNATIONAL LLC, (U.S. CLS. 22, 23, 38 AND 50). SN 77-805,165. PUB. 4-6-2010. FILED 8-14-2009.
 3,805,945. **S-SPORTS AND DESIGN**. BROTHER HOLDINGS CO., LTD., (U.S. CLS. 22, 23, 38 AND 50). SN 77-806,546. PUB. 4-6-2010. FILED 8-18-2009.
 3,805,962 (*See Class 9 for this trademark*).
 3,806,090. **OUR BUSINESS IS FUN! (STANDARD CHARACTER)**. ELAUT USA, INC., (U.S. CLS. 22, 23, 38 AND 50). SN 77-832,701. PUB. 4-6-2010. FILED 9-23-2009.
 3,806,161 (*See Class 21 for this trademark*).
 3,806,173. **PILOT-1 (STANDARD CHARACTER)**. HOBBY LOBBY INTERNATIONAL, INC., (U.S. CLS. 22, 23, 38 AND 50). SN 77-843,747. PUB. 4-6-2010. FILED 10-7-2009.
 3,806,380. **CLUBFACE GOLF (STANDARD CHARACTER)**. CLUBFACE GOLF LLC, (U.S. CLS. 22, 23, 38 AND 50). SN 77-857,256. PUB. 4-6-2010. FILED 10-26-2009.
 3,806,381. **THE 39 CLUES (STANDARD CHARACTER)**. SCHOLASTIC INC., (U.S. CLS. 22, 23, 38 AND 50). SN 77-857,284. PUB. 4-6-2010. FILED 10-26-2009.
 3,806,382. **THE 39 CLUES AND DESIGN**. SCHOLASTIC INC., (U.S. CLS. 22, 23, 38 AND 50). SN 77-857,296. PUB. 4-6-2010. FILED 10-26-2009.
 3,806,406. **YOGINIBINI (STANDARD CHARACTER)**. MARY KESEL WILLIS, (U.S. CLS. 22, 23, 38 AND 50). SN 77-857,987. PUB. 4-6-2010. FILED 10-27-2009.
 3,806,518. **HSPIN AND DESIGN**. HSPIN YOYO GMBH, (U.S. CLS. 22, 23, 38 AND 50). SN 77-859,157. PUB. 4-6-2010. FILED 10-28-2009.
 3,806,617. **CITY SERVICE FLEET (STANDARD CHARACTER)**. TOY STATE INDUSTRIAL LTD., (U.S. CLS. 22, 23, 38 AND 50). SN 77-860,189. PUB. 4-6-2010. FILED 10-29-2009.
 3,806,623. **PITCHER'S NIGHTMARE (STANDARD CHARACTER)**. LAUNCH PAD 39A, LLC, (U.S. CLS. 22, 23, 38 AND 50). SN 77-860,238. PUB. 4-6-2010. FILED 10-29-2009.
 3,806,651. **KETTLEBLOCK (STANDARD CHARACTER)**. POWER BLOCK, INC., (U.S. CLS. 22, 23, 38 AND 50). SN 77-860,608. PUB. 4-6-2010. FILED 10-29-2009.
 3,806,675 (*See Class 21 for this trademark*).
 3,806,694. **MONSTER HOOP (STANDARD CHARACTER)**. ALBAUM, ABBY, (U.S. CLS. 22, 23, 38 AND 50). SN 77-861,104. PUB. 4-6-2010. FILED 10-30-2009.
 3,806,712. **WOKER (STANDARD CHARACTER)**. TEORE, LISA C, DBA LCT ENTERPRISES, LLC, (U.S. CLS. 22, 23, 38 AND 50). SN 77-861,418. PUB. 4-6-2010. FILED 10-30-2009.
 3,806,745. **MR. FUZZY (STANDARD CHARACTER)**. GOLDEN SHORE INVESTMENT, DBA MR. FUZZY, (U.S. CLS. 22, 23, 38 AND 50). SN 77-861,806. PUB. 4-6-2010. FILED 10-30-2009.
 3,806,863. **SUN BUDDIES (STANDARD CHARACTER)**. BARBARA YANEY DESIGNS, INC., (U.S. CLS. 22, 23, 38 AND 50). SN 77-864,129. PUB. 4-6-2010. FILED 11-3-2009.
 3,806,897. **HIBALL (STANDARD CHARACTER)**. DONALD W. GORDON, (U.S. CLS. 22, 23, 38 AND 50). SN 77-865,240. PUB. 4-6-2010. FILED 11-4-2009.
 3,806,921. **BOODA SKINS (STANDARD CHARACTER)**. DOSKOCIL MANUFACTURING COMPANY, INC., (U.S. CLS. 22, 23, 38 AND 50). SN 77-868,012. PUB. 4-6-2010. FILED 11-9-2009.
 3,807,030. **5TH AND DESIGN**. LOCKHEED MARTIN CORPORATION, (U.S. CLS. 22, 23, 38 AND 50). SN 77-890,186. PUB. 4-6-2010. FILED 12-10-2009.
 3,807,033. **POCKET PROS AND DESIGN**. RAZOR USA LLC, (U.S. CLS. 22, 23, 38 AND 50). SN 77-891,519. PUB. 4-6-2010. FILED 12-11-2009.
 3,807,047. **VIRTUALCONSOLE (STANDARD CHARACTER)**. NINTENDO OF AMERICA INC., (U.S. CLS. 22, 23, 38 AND 50). SN 77-976,159. PUB. 1-20-2009. FILED 10-4-2006.
 3,807,048. **POST OFFICE OPOLY (STANDARD CHARACTER)**. UNITED STATES POSTAL SERVICE, (U.S. CLS. 22, 23, 38 AND 50). SN 77-976,530. PUB. 4-6-2010. FILED 7-28-2008.
 3,807,091 (*See Class 14 for this trademark*).

3,807,092 (*See Class 12 for this trademark.*)
 3,807,094 (*See Class 9 for this trademark.*)
 3,807,124 (*See Class 18 for this trademark.*)
 3,807,125 (*See Class 9 for this trademark.*)
 3,807,131 (*See Class 3 for this trademark.*)
 3,807,153 (*See Class 9 for this trademark.*)
 3,807,203 (*See Class 16 for this trademark.*)
 3,807,204 (*See Class 25 for this trademark.*)
 3,807,227. **HALLEY AND DESIGN.** WINGROUP S. COOP., (U.S. CLS. 22, 23, 38 AND 50). SN 79-070,021. PUB. 4-6-2010. FILED 4-2-2009.
 3,807,232 (*See Class 12 for this trademark.*)
 3,807,233 (*See Class 3 for this trademark.*)
 3,807,257 (*See Class 9 for this trademark.*)
 3,807,258. **GIBLI (STANDARD CHARACTER).** MASERATI S.P.A., (U.S. CLS. 22, 23, 38 AND 50). SN 79-071,031. PUB. 4-6-2010. FILED 6-16-2009.
 3,807,294. **SPARK POINT (STANDARD CHARACTER).** V M C PECHE, (U.S. CLS. 22, 23, 38 AND 50). SN 79-072,744. PUB. 4-6-2010. FILED 6-2-2009.
 3,807,312. **STARS IN THE EYES AND DESIGN.** STARS IN THE EYES SÄRL, MULTIPLE CLASS, (INT. CLS. 28, 39 AND 41), (U.S. CLS. 22, 23, 38, 50, 100, 101, 105 AND 107). SN 79-074,047. PUB. 4-6-2010. FILED 5-20-2009.
 3,807,313. **DIAMANA AND DESIGN.** MITSUBISHI RAYON CO., LTD., (U.S. CLS. 22, 23, 38 AND 50). SN 79-074,152. PUB. 4-6-2010. FILED 9-8-2009.
 3,807,314. **DIAMANA AND DESIGN.** MITSUBISHI RAYON CO., LTD., (U.S. CLS. 22, 23, 38 AND 50). SN 79-074,156. PUB. 4-6-2010. FILED 9-8-2009.
 3,807,315. **DIAMANA AND DESIGN.** MITSUBISHI RAYON CO., LTD., (U.S. CLS. 22, 23, 38 AND 50). SN 79-074,157. PUB. 4-6-2010. FILED 9-8-2009.
 3,807,327. **CYANO (STANDARD CHARACTER).** HEAD TECHNOLOGY GMBH, (U.S. CLS. 22, 23, 38 AND 50). SN 79-074,992. PUB. 4-6-2010. FILED 10-8-2009.

CLASS 29—MEATS AND PROCESSED FOODS

3,805,188 (*See Class 25 for this trademark.*)
 3,805,302. **RELLENO DOG (STANDARD CHARACTER).** BRADBURY, RHONDA, (U.S. CL. 46). SN 77-510,744. PUB. 4-6-2010. FILED 6-29-2008.
 3,805,304. **ENGINEERING THE ULTIMATE BURGER (STANDARD CHARACTER).** BURGER FUEL INTERNATIONAL LIMITED, MULTIPLE CLASS, (INT. CLS. 29, 30 AND 43), (U.S. CLS. 46, 100 AND 101). SN 77-519,887. PUB. 4-6-2010. FILED 7-11-2008.
 3,805,320. **EASY (STANDARD CHARACTER).** DEAN INTELLECTUAL PROPERTY SERVICES II, L.P., (U.S. CL. 46). SN 77-547,889. PUB. 11-25-2008. FILED 8-15-2008.
 3,805,365. **AMAZON THUNDER (STANDARD CHARACTER).** AMAZON THUNDER INC., (U.S. CL. 46). SN 77-585,736. PUB. 4-6-2010. FILED 10-4-2008.
 3,805,396. **SOUTH DAKOTA SOYBEAN PROCESSORS (STANDARD CHARACTER).** SOUTH DAKOTA SOYBEAN PROCESSORS, LLC, (U.S. CL. 46). SN 77-617,834. PUB. 4-6-2010. FILED 11-19-2008.
 3,805,462. **APRESVIN (STANDARD CHARACTER).** APRESVIN ENTERPRISES, INC., (U.S. CL. 46). SN 77-673,115. PUB. 4-6-2010. FILED 2-18-2009.
 3,805,593. **WILD WEST SHRIMP (STANDARD CHARACTER).** RARE HOSPITALITY MANAGEMENT, INC., (U.S. CL. 46). SN 77-729,394. PUB. 4-6-2010. FILED 5-5-2009.
 3,805,599. **I LOVE PRODUCE (STANDARD CHARACTER).** I LOVE PRODUCE, LLC, MULTIPLE CLASS, (INT. CLS. 29 AND 31), (U.S. CLS. 1 AND 46). SN 77-729,997. PUB. 4-6-2010. FILED 5-6-2009.
 3,805,612 (*See Class 5 for this trademark.*)
 3,805,785. **PACIFIC FRIEND (STANDARD CHARACTER).** MULSEN TRADING CO., LTD., (U.S. CL. 46). SN 77-765,947. PUB. 4-6-2010. FILED 6-23-2009.
 3,805,843. **PEANUT PATCH (STANDARD CHARACTER).** MCCALL FARMS, INC., (U.S. CL. 46). SN 77-781,797. PUB. 4-6-2010. FILED 7-15-2009.
 3,805,844. **MCCALL FARMS (STANDARD CHARACTER).**

MCCALL FARMS, INC., (U.S. CL. 46). SN 77-781,831. PUB. 4-6-2010. FILED 7-15-2009.
 3,805,877. **COUNTRY BARN AND DESIGN.** WALTON & POST, INC., MULTIPLE CLASS, (INT. CLS. 29, 30 AND 32), (U.S. CLS. 45, 46 AND 48). SN 77-792,442. PUB. 4-6-2010. FILED 7-29-2009.
 3,805,886. **COUNTRY BARN (STANDARD CHARACTER).** WALTON & POST, INC., MULTIPLE CLASS, (INT. CLS. 29, 30 AND 32), (U.S. CLS. 45, 46 AND 48). SN 77-793,408. PUB. 4-6-2010. FILED 7-30-2009.
 3,805,912. **KERLEYS (STANDARD CHARACTER).** TC OF YUMA, LLC, (U.S. CL. 46). SN 77-798,100. PUB. 3-2-2010. FILED 8-5-2009.
 3,805,933. **BAIBAOTANG BACH BAO DUONG AND DESIGN.** HOCEAN INC., MULTIPLE CLASS, (INT. CLS. 29 AND 30), (U.S. CL. 46). SN 77-804,305. PUB. 4-6-2010. FILED 8-13-2009.
 3,805,967. **HARVESTLAND AND DESIGN.** PERDUE HOLDINGS, INC., (U.S. CL. 46). SN 77-810,223. PUB. 4-6-2010. FILED 8-21-2009.
 3,806,162. **ROCKBITES (STANDARD CHARACTER).** THE CHEESECAKE FACTORY ASSETS CO. LLC, (U.S. CL. 46). SN 77-842,243. PUB. 4-6-2010. FILED 10-6-2009.
 3,806,236. **ZERILLI'S (STANDARD CHARACTER).** REQUEST FOODS, INC., MULTIPLE CLASS, (INT. CLS. 29 AND 30), (U.S. CL. 46). SN 77-849,672. PUB. 4-6-2010. FILED 10-15-2009.
 3,806,404. **TWIN COUNTY (STANDARD CHARACTER).** TWIN COUNTY DORPERS, INC., (U.S. CL. 46). SN 77-857,969. PUB. 4-6-2010. FILED 10-27-2009.
 3,806,482. **CHERRY JERKY CO. AND DESIGN.** PAUL LYONS ENTERPRISES, INC., (U.S. CL. 46). SN 77-858,730. PUB. 4-6-2010. FILED 10-27-2009.
 3,806,527. **DELTA BLUES BBQ (STANDARD CHARACTER).** DELTA BLUES BBQ, INC., (U.S. CL. 46). SN 77-859,245. PUB. 4-6-2010. FILED 10-28-2009.
 3,806,807. **PAPA SCALISE (STANDARD CHARACTER).** SCALISE BROTHERS, LLC, (U.S. CL. 46). SN 77-863,334. PUB. 4-6-2010. FILED 11-2-2009.
 3,806,958. **LIFE'S DHA AND DESIGN.** MARTEK BIOSCIENCES CORPORATION, (U.S. CL. 46). SN 77-874,223. PUB. 4-6-2010. FILED 11-17-2009.
 3,806,959. **LIFE'S DHA (STANDARD CHARACTER).** MARTEK BIOSCIENCES CORPORATION, (U.S. CL. 46). SN 77-874,225. PUB. 4-6-2010. FILED 11-17-2009.
 3,806,967. **SUNNY SLOPE (STANDARD CHARACTER).** SUNNY SLOPE FARMS, MULTIPLE CLASS, (INT. CLS. 29 AND 31), (U.S. CLS. 1 AND 46). SN 77-875,198. PUB. 4-6-2010. FILED 11-18-2009.
 3,807,092 (*See Class 12 for this trademark.*)
 3,807,097. **REYPENAER AND DESIGN.** WIJNGAARD KAAS B.V., (U.S. CL. 46). SN 79-049,258. PUB. 4-6-2010. FILED 12-20-2007.
 3,807,098. **REYPENAER V.S.O.P. AND DESIGN.** WIJNGAARD KAAS B.V., (U.S. CL. 46). SN 79-049,259. PUB. 4-6-2010. FILED 12-20-2007.
 3,807,101. **LE CROBAG EINFACH NUR GENIESSEN AND DESIGN.** LE CROBAG GMBH & CO. KG, MULTIPLE CLASS, (INT. CLS. 29, 30, 35, 41, 42 AND 43), (U.S. CLS. 46, 100, 101, 102 AND 107). SN 79-052,001. PUB. 4-6-2010. FILED 2-12-2008.
 3,807,115. **PORTO-MUIÑOS AND DESIGN.** ROSA MARÍA MIRAS ANTEL, MULTIPLE CLASS, (INT. CLS. 29, 30 AND 31), (U.S. CLS. 1 AND 46). SN 79-059,154. PUB. 4-6-2010. FILED 8-1-2008.
 3,807,153 (*See Class 9 for this trademark.*)
 3,807,169. **WASA SINCE 1919 AND DESIGN.** WASABRÖD AKTIEBOLAG, MULTIPLE CLASS, (INT. CLS. 29, 30 AND 43), (U.S. CLS. 46, 100 AND 101). SN 79-067,827. PUB. 4-6-2010. FILED 2-16-2009.
 3,807,205. **VIANDER AND DESIGN.** VIANDER S.P.A., (U.S. CL. 46). SN 79-069,446. PUB. 4-6-2010. FILED 5-21-2008.
 3,807,237. **LA PIADINERIA AND DESIGN.** GRUPPO LA PIADINERIA S.R.L., MULTIPLE CLASS, (INT. CLS. 29, 30, 35, 42 AND 43), (U.S. CLS. 46, 100, 101 AND 102). SN 79-070,296. PUB. 4-6-2010. FILED 9-29-2008.
 3,807,295 (*See Class 5 for this trademark.*)
 3,807,311. **GRILLOUMI (STYLIZED).** FONTANA FOOD AB, MULTIPLE CLASS, (INT. CLS. 29 AND 30), (U.S. CL. 46).

SN 79-074,044. PUB. 4-6-2010. FILED 8-25-2009.
 3,807,367. **LACTOLAND (STANDARD CHARACTER)**. KRÜGER GMBH & CO. KG, (U.S. CL. 46). SN 79-077,743. PUB. 4-6-2010. FILED 3-31-2009.

CLASS 30—STAPLE FOODS

3,805,137. **FA ELLEN COFFEE AND DESIGN**. E-Z MART STORES, INC., (U.S. CL. 46). SN 76-692,763. PUB. 4-6-2010. FILED 9-11-2008.
 3,805,154. **ANDRIA'S AND DESIGN**. ANDRIA'S FOOD GROUP, INC., MULTIPLE CLASS, (INT. CLS. 30 AND 43), (U.S. CLS. 46, 100 AND 101). SN 76-699,008. PUB. 4-6-2010. FILED 8-17-2009.
 3,805,188 (See Class 25 for this trademark).
 3,805,210. **CHEILJEDANG (STANDARD CHARACTER)**. CJ CHEILJEDANG CORPORATION, (U.S. CL. 46). SN 77-310,719. PUB. 4-6-2010. FILED 10-23-2007.
 3,805,212. **PRETZEL WAVES (STANDARD CHARACTER)**. FRITO-LAY NORTH AMERICA, INC., (U.S. CL. 46). SN 77-318,713. PUB. 4-6-2010. FILED 11-1-2007.
 3,805,251. **FRESHIAN (STANDARD CHARACTER)**. CJ CHEILJEDANG CORPORATION, (U.S. CL. 46). SN 77-424,611. PUB. 4-27-2010. FILED 3-18-2008.
 3,805,304 (See Class 29 for this trademark).
 3,805,429. **SUSIE'S CHOCOLATE STAMPEDE (STANDARD CHARACTER)**. SUSIES SOUTH FORTY CONFECTIONS, (U.S. CL. 46). SN 77-642,517. PUB. 11-3-2009. FILED 1-2-2009.
 3,805,464. **SUN RICE AND DESIGN**. RICEGROWERS LIMITED, (U.S. CL. 46). SN 77-673,632. PUB. 4-6-2010. FILED 2-19-2009.
 3,805,499 (See Class 5 for this trademark).
 3,805,503. **WASA BAKED SINCE 1919 AND DESIGN**. WASABROD AB, (U.S. CL. 46). SN 77-706,347. PUB. 4-6-2010. FILED 4-3-2009.
 3,805,511. **ORO (STANDARD CHARACTER)**. SABORMEX EUROPA, S.L., (U.S. CL. 46). SN 77-710,135. PUB. 4-6-2010. FILED 4-8-2009.
 3,805,553. **VITAL LIFESTYLE AND DESIGN**. BISCUITS LECLERC LTEE, AKA BISCUITS LECLERC LTD., (U.S. CL. 46). SN 77-722,073. PUB. 4-6-2010. FILED 4-24-2009.
 3,805,561. **SHIV BRAND SINCE 1947 AND DESIGN**. KRISH ENTERPRISES LLC, DBA KNR IMPORTS LLC, (U.S. CL. 46). SN 77-723,560. PUB. 4-6-2010. FILED 4-27-2009.
 3,805,612 (See Class 5 for this trademark).
 3,805,671. **FRIDA (STANDARD CHARACTER)**. EUROPASTRY, S.A., (U.S. CL. 46). SN 77-741,578. PUB. 4-6-2010. FILED 5-20-2009.
 3,805,683. **ENDLESS MOUNTAINS COFFEE (STANDARD CHARACTER)**. GRIFFITHS FAMILY FINANCIAL LTD, DBA ENDLESS MOUNTAINS COFFEE COMPANY, (U.S. CL. 46). SN 77-743,872. PUB. 4-6-2010. FILED 5-25-2009.
 3,805,707. **GENERAL'S BEST (STANDARD CHARACTER)**. TRINITY FOODS, INC., MULTIPLE CLASS, (INT. CLS. 30 AND 32), (U.S. CLS. 45, 46 AND 48). SN 77-748,012. PUB. 4-6-2010. FILED 5-29-2009.
 3,805,714. **MADE FRESH DAILY DINOBITE'S INCREDIBLE ICE CREAM AND DESIGN**. DINOBITES L.L.C., (U.S. CL. 46). SN 77-749,869. PUB. 4-6-2010. FILED 6-2-2009.
 3,805,782 (See Class 16 for this trademark).
 3,805,800. **LEAN POCKETS AND DESIGN**. SOCIETE DES PRODUITS NESTLE S.A., (U.S. CL. 46). SN 77-771,480. PUB. 4-6-2010. FILED 6-30-2009.
 3,805,854 (See Class 11 for this trademark).
 3,805,855 (See Class 11 for this trademark).
 3,805,877 (See Class 29 for this trademark).
 3,805,886 (See Class 29 for this trademark).
 3,805,892. **THEOBROMA CHOCOLAT (STANDARD CHARACTER)**. VIGNEAULT CHOCOLATIER LTEE, (U.S. CL. 46). SN 77-794,149. PUB. 4-6-2010. FILED 7-31-2009.
 3,805,928. **SGT. CAMO (STANDARD CHARACTER)**. WHITEY'S ICE CREAM, INC., (U.S. CL. 46). SN 77-802,551. PUB. 4-6-2010. FILED 8-12-2009.
 3,805,933 (See Class 29 for this trademark).
 3,805,959. **ALAMO ZESTFUL SEASONING (STANDARD CHARACTER)**. E & H DISTRIBUTING CO., (U.S. CL. 46).

SN 77-808,794. PUB. 4-6-2010. FILED 8-20-2009.
 3,806,068. **CHRIS MOUSE (STANDARD CHARACTER)**. THE SWISS COLONY, INC., MULTIPLE CLASS, (INT. CLS. 30 AND 35), (U.S. CLS. 46, 100, 101 AND 102). SN 77-827,147. PUB. 4-6-2010. FILED 9-15-2009.
 3,806,083. **HONEY LOVERS (STYLIZED)**. GIMBAL BROTHERS, INC., (U.S. CL. 46). SN 77-830,329. PUB. 4-6-2010. FILED 9-18-2009.
 3,806,105. **AWESOME OATZ AND DESIGN**. CHATFIELD, DEBRA J, DBA LUTZ NUTZ COMPANY, (U.S. CL. 46). SN 77-835,682. PUB. 4-6-2010. FILED 9-25-2009.
 3,806,109. **POWERSEED BREAD AND DESIGN**. AVB, INC., (U.S. CL. 46). SN 77-835,987. PUB. 4-6-2010. FILED 9-28-2009.
 3,806,174. **MARINELA NAPOLITANO AND DESIGN**. GRUPO BIMBO, S.A. B. DE C.V., (U.S. CL. 46). SN 77-844,063. PUB. 4-6-2010. FILED 10-8-2009.
 3,806,187. **OAT COUTURE (STANDARD CHARACTER)**. COOKIES A LA MAIN, (U.S. CL. 46). SN 77-845,083. PUB. 4-6-2010. FILED 10-9-2009.
 3,806,203. **HONIBE PURE HONEY JOY AND DESIGN**. ISLAND ABBEY FOODS, LTD., (U.S. CL. 46). SN 77-846,867. PUB. 4-6-2010. FILED 10-12-2009.
 3,806,208. **DRAGON AND DESIGN**. AMERICAN RICE, INC., (U.S. CL. 46). SN 77-846,959. PUB. 4-6-2010. FILED 10-12-2009.
 3,806,236 (See Class 29 for this trademark).
 3,806,284. **BEAR COUNTRY COOKIES (STANDARD CHARACTER)**. JOEL CLARK, (U.S. CL. 46). SN 77-854,019. PUB. 4-6-2010. FILED 10-21-2009.
 3,806,295. **FULLBLOOM BAKING COMPANY (STANDARD CHARACTER)**. FULLBLOOM BAKING COMPANY, INC., (U.S. CL. 46). SN 77-854,566. PUB. 4-6-2010. FILED 10-22-2009.
 3,806,298. **VAO VAO THE BIRTHPLACE FOR FLAVOR (STYLIZED)**. LOVA LLC, (U.S. CL. 46). SN 77-854,757. PUB. 4-6-2010. FILED 10-22-2009.
 3,806,301. **FULLBLOOM BAKING COMPANY AND DESIGN**. FULLBLOOM BAKING COMPANY, INC., (U.S. CL. 46). SN 77-854,868. PUB. 4-6-2010. FILED 10-22-2009.
 3,806,324. **VITAMAX AND DESIGN**. TASTYFOOD INDUSTRIES (S) PTE LTD, (U.S. CL. 46). SN 77-855,532. PUB. 4-6-2010. FILED 10-22-2009.
 3,806,348. **A HIGH-PROTEIN TREAT FOR A NO-CRAVE DIET (STANDARD CHARACTER)**. THE PENNY PROTEIN PLAN, LLC, (U.S. CL. 46). SN 77-856,499. PUB. 4-6-2010. FILED 10-23-2009.
 3,806,363. **THREE TABLESPOONS (STANDARD CHARACTER)**. THREE TABLESPOONS, LLC, (U.S. CL. 46). SN 77-856,951. PUB. 4-6-2010. FILED 10-26-2009.
 3,806,396. **TRUE BEANS COFFEE ROASTERS, TRUE TO THE BEAN, TRUE TO THE CUP AND DESIGN**. TRUE BEANS COFFEE ROASTERS, (U.S. CL. 46). SN 77-857,854. PUB. 4-6-2010. FILED 10-26-2009.
 3,806,419. **LYNN'S MIXING BOWL L AND DESIGN**. CONLIN, LYNN M., (U.S. CL. 46). SN 77-858,157. PUB. 4-6-2010. FILED 10-27-2009.
 3,806,437. **SAU TAO AND DESIGN**. SUN SHUN FUK FOODS COMPANY LIMITED, (U.S. CL. 46). SN 77-858,358. PUB. 4-6-2010. FILED 10-27-2009.
 3,806,546. **WONDERJUNK (STANDARD CHARACTER)**. WONDERJUNK LTD., (U.S. CL. 46). SN 77-859,535. PUB. 4-6-2010. FILED 10-28-2009.
 3,806,548. **FEDERAL IS PHILLY (STANDARD CHARACTER)**. J&J SNACK FOODS CORP., (U.S. CL. 46). SN 77-859,545. PUB. 4-6-2010. FILED 10-28-2009.
 3,806,698. **GROWNUP KIDSTUFF (STANDARD CHARACTER)**. GROWNUP KIDSTUFF, INC., (U.S. CL. 46). SN 77-861,220. PUB. 4-6-2010. FILED 10-30-2009.
 3,806,710. **MRS. FIELDS AND DESIGN**. THE MRS. FIELDS' BRAND, INC., (U.S. CL. 46). SN 77-861,375. PUB. 4-6-2010. FILED 10-30-2009.
 3,806,718. **SHAKE 'N CAKE (STANDARD CHARACTER)**. LUCAS, NANCY J., AND LUCAS, LANCE, (U.S. CL. 46). SN 77-861,498. PUB. 4-6-2010. FILED 10-30-2009.
 3,806,749. **MISCELLANEOUS DESIGN**. REINWALD BROTHERS BAKERY CORP., (U.S. CL. 46). SN 77-861,915. PUB. 4-6-2010. FILED 10-30-2009.
 3,806,777. **LOLLIBAKES (STANDARD CHARACTER)**. DI'S

KITCHEN, (U.S. CL. 46). SN 77-862,699. PUB. 4-6-2010. FILED 11-2-2009.

3,806,783. **LUCKY WHEEL AND DESIGN**. H&L WHOLESALE FOOD CORPORATION, DBA BL TRADING, (U.S. CL. 46). SN 77-862,754. PUB. 4-6-2010. FILED 11-2-2009.

3,806,802. **RAYSING AND DESIGN**. KEI SING MA, (U.S. CL. 46). SN 77-863,199. PUB. 4-6-2010. FILED 11-2-2009.

3,806,846. **MIMS (STANDARD CHARACTER)**. CSC GEORGIAN TERRACE LIMITED PARTNERSHIP, MULTIPLE CLASS, (INT. CLS. 30 AND 35), (U.S. CLS. 46, 100, 101 AND 102). SN 77-863,849. PUB. 4-6-2010. FILED 11-3-2009.

3,806,894. **DANIELLE'S DESSERTS (STANDARD CHARACTER)**. DANIELLE'S DESSERTS, LLC, MULTIPLE CLASS, (INT. CLS. 30 AND 43), (U.S. CLS. 46, 100 AND 101). SN 77-865,145. PUB. 4-6-2010. FILED 11-4-2009.

3,806,911. **BANG 90 (STANDARD CHARACTER)**. GREASE GRIP GLOVES USA, LLC, (U.S. CL. 46). SN 77-865,835. PUB. 4-6-2010. FILED 11-5-2009.

3,806,912. **BOOM 93 (STANDARD CHARACTER)**. GREASE GRIP GLOVES USA, LLC, (U.S. CL. 46). SN 77-865,879. PUB. 4-6-2010. FILED 11-5-2009.

3,806,934. **GIANT KING (STANDARD CHARACTER)**. UNILEVER SUPPLY CHAIN, INC., (U.S. CL. 46). SN 77-870,127. PUB. 4-6-2010. FILED 11-11-2009.

3,807,011. **C CHILI CLUB AND DESIGN**. MA, CHI, (U.S. CL. 46). SN 77-884,682. PUB. 4-6-2010. FILED 12-2-2009.

3,807,041. **BB (STYLIZED)**. R & A BAILEY & CO, (U.S. CL. 46). SN 77-898,057. PUB. 4-6-2010. FILED 12-21-2009.

3,807,101 (*See Class 29 for this trademark*).

3,807,115 (*See Class 29 for this trademark*).

3,807,117 (*See Class 5 for this trademark*).

3,807,133. **MISCELLANEOUS DESIGN**. NINGBO RICH HARVEST FOOD CO., LTD., (U.S. CL. 46). SN 79-062,292. PUB. 4-6-2010. FILED 6-11-2008.

3,807,143. **GOLFADE (STANDARD CHARACTER)**. O32 EHF., MULTIPLE CLASS, (INT. CLS. 30 AND 32), (U.S. CLS. 45, 46 AND 48). SN 79-063,745. PUB. 4-6-2010. FILED 7-23-2008.

3,807,169 (*See Class 29 for this trademark*).

3,807,237 (*See Class 29 for this trademark*).

3,807,245 (*See Class 11 for this trademark*).

3,807,248. **FRIA GLUTEN FREE AND DESIGN**. FRIA BRÖD AB, (U.S. CL. 46). SN 79-070,558. PUB. 4-6-2010. FILED 3-2-2009.

3,807,311 (*See Class 29 for this trademark*).

CLASS 31—NATURAL AGRICULTURAL PRODUCTS

3,805,124 (*See Class 1 for this trademark*).

3,805,194. **SOLID GOLD HOLISTIQUE BLENDZ (STANDARD CHARACTER)**. SOLID GOLD HEALTH PRODUCTS FOR PETS, INC., (U.S. CLS. 1 AND 46). SN 77-162,311. PUB. 4-6-2010. FILED 4-20-2007.

3,805,231 (*See Class 4 for this trademark*).

3,805,232 (*See Class 4 for this trademark*).

3,805,398. **SOUTH DAKOTA SOYBEAN PROCESSORS (STANDARD CHARACTER)**. SOUTH DAKOTA SOYBEAN PROCESSORS, LLC, (U.S. CLS. 1 AND 46). SN 77-618,240. PUB. 4-6-2010. FILED 11-20-2008.

3,805,444. **SUNSATION (STANDARD CHARACTER)**. ERIE JAMES LTD., (U.S. CLS. 1 AND 46). SN 77-651,960. PUB. 4-6-2010. FILED 1-19-2009.

3,805,475 (*See Class 5 for this trademark*).

3,805,520. **WATERMAN LOOMIS ORGANICS AND DESIGN**. LAND O'LAKES, INC., (U.S. CLS. 1 AND 46). SN 77-713,773. PUB. 4-6-2010. FILED 4-14-2009.

3,805,599 (*See Class 29 for this trademark*).

3,805,634. **DY RANCHES (STANDARD CHARACTER)**. YOUNTS, CHARLETON D., (U.S. CLS. 1 AND 46). SN 77-734,442. PUB. 4-6-2010. FILED 5-11-2009.

3,805,704. **SLICK PIK (STANDARD CHARACTER)**. UNIVERSITY OF NEW HAMPSHIRE, (U.S. CLS. 1 AND 46). SN 77-747,754. PUB. 4-6-2010. FILED 5-29-2009.

3,805,815. **THE DAN HINKLEY PLANT COLLECTION (STANDARD CHARACTER)**. MONROVIA NURSERY COMPANY, (U.S. CLS. 1 AND 46). SN 77-775,900. PUB. 4-6-

2010. FILED 7-7-2009.

3,805,918. **KANKAWE (STANDARD CHARACTER)**. ITD INCORPORATED, (U.S. CLS. 1 AND 46). SN 77-799,642. PUB. 4-6-2010. FILED 8-7-2009.

3,805,964 (*See Class 22 for this trademark*).

3,805,970 (*See Class 22 for this trademark*).

3,806,163. **BUCCANEER LANDSCAPE MANAGEMENT AND DESIGN**. BUCCANEER LANDSCAPE MANAGEMENT CORPORATION, MULTIPLE CLASS, (INT. CLS. 31, 37 AND 44), (U.S. CLS. 1, 46, 100, 101, 103 AND 106). SN 77-842,704. PUB. 4-6-2010. FILED 10-6-2009.

3,806,210. **BLOOMING IDIOTS (STANDARD CHARACTER)**. NANCY M RICH, DBA BLOOMING IDIOTS, (U.S. CLS. 1 AND 46). SN 77-847,111. PUB. 4-6-2010. FILED 10-12-2009.

3,806,429. **WESTWIND SEEDS (STANDARD CHARACTER)**. WESTWIND SEEDS & GARDENSCAPES LLC, (U.S. CLS. 1 AND 46). SN 77-858,227. PUB. 4-6-2010. FILED 10-27-2009.

3,806,605. **SWEET HARVEST (STANDARD CHARACTER)**. KAYLOR OF COLORADO, (U.S. CLS. 1 AND 46). SN 77-860,055. PUB. 4-6-2010. FILED 10-29-2009.

3,806,660. **E & S (STANDARD CHARACTER)**. RIO QUEEN CITRUS, INC., (U.S. CLS. 1 AND 46). SN 77-860,654. PUB. 4-6-2010. FILED 10-29-2009.

3,806,695 (*See Class 18 for this trademark*).

3,806,812. **BEIJING KING CROWN CUT BROCCOLI AND DESIGN**. STATE ST PRODUCE, INC., (U.S. CLS. 1 AND 46). SN 77-863,369. PUB. 4-6-2010. FILED 11-2-2009.

3,806,949. **SIMPLY STRAW (STANDARD CHARACTER)**. COUNTRY FARE LLC, (U.S. CLS. 1 AND 46). SN 77-873,230. PUB. 4-6-2010. FILED 11-16-2009.

3,806,967 (*See Class 29 for this trademark*).

3,807,104 (*See Class 6 for this trademark*).

3,807,115 (*See Class 29 for this trademark*).

3,807,265 (*See Class 19 for this trademark*).

3,807,319. **VIENCO (STYLIZED)**. JUNGPFANZEN GRÜNEWALD GMBH, (U.S. CLS. 1 AND 46). SN 79-074,441. PUB. 4-6-2010. FILED 8-25-2009.

CLASS 32—LIGHT BEVERAGES

3,805,138. **ISRAEL LIGHT (STANDARD CHARACTER)**. WHITFIELD, ANTHONY, (U.S. CLS. 45, 46 AND 48). SN 76-693,403. PUB. 4-6-2010. FILED 10-6-2008.

3,805,179. **COWBOY UP (STANDARD CHARACTER)**. WYOMING WEST DESIGNS II, INC., (U.S. CLS. 45, 46 AND 48). SN 76-979,049. PUB. 4-6-2010. FILED 12-19-2006.

3,805,209. **FOR PURE ENERGY DON'T WING IT WACK IT! (STANDARD CHARACTER)**. D'ANGELO BRANDS LTD., (U.S. CLS. 45, 46 AND 48). SN 77-305,186. PUB. 4-6-2010. FILED 10-16-2007.

3,805,252. **FRESHIAN (STANDARD CHARACTER)**. CJ CHEILJEDANG CORPORATION, (U.S. CLS. 45, 46 AND 48). SN 77-424,623. PUB. 4-6-2010. FILED 3-18-2008.

3,805,499 (*See Class 5 for this trademark*).

3,805,612 (*See Class 5 for this trademark*).

3,805,707 (*See Class 30 for this trademark*).

3,805,793. **DEPTH CHARGE ENERGY DRINK (STANDARD CHARACTER)**. VOTA, PAUL, (U.S. CLS. 45, 46 AND 48). SN 77-770,211. PUB. 4-6-2010. FILED 6-29-2009.

3,805,877 (*See Class 29 for this trademark*).

3,805,886 (*See Class 29 for this trademark*).

3,806,040. **ANCHOR BOCK (STANDARD CHARACTER)**. ANCHOR BREWING COMPANY, (U.S. CLS. 45, 46 AND 48). SN 77-822,713. PUB. 4-6-2010. FILED 9-9-2009.

3,806,059. **RAGE CARTEL (STANDARD CHARACTER)**. RAGE BEVERAGES INC., FORMERLY PINNACLE EXCLUSIVES INC., (U.S. CLS. 45, 46 AND 48). SN 77-826,241. PUB. 4-6-2010. FILED 9-14-2009.

3,806,060. **RAGE INFERNO (STANDARD CHARACTER)**. RAGE BEVERAGES INC., FORMERLY PINNACLE EXCLUSIVES INC., (U.S. CLS. 45, 46 AND 48). SN 77-826,251. PUB. 4-6-2010. FILED 9-14-2009.

3,806,183. **TAILGATE BEER (STANDARD CHARACTER)**. KEEGAN, TIMOTHY J, (U.S. CLS. 45, 46 AND 48). SN 77-844,852. PUB. 4-6-2010. FILED 10-8-2009.

3,806,190. **GOOD MAN DOWN (STANDARD CHARACTER)**.

- KENNETH LIVINGSTON, MULTIPLE CLASS, (INT. CLS. 32 AND 33), (U.S. CLS. 45, 46, 47, 48 AND 49). SN 77-845,485. PUB. 4-6-2010. FILED 10-9-2009.
- 3,806,258. **C2O AND DESIGN**. AGS ADVANCED GLOBAL SERVICES LLC, (U.S. CLS. 45, 46 AND 48). SN 77-851,862. PUB. 4-6-2010. FILED 10-19-2009.
- 3,806,311. **MISCELLANEOUS DESIGN**. KIRKWOOD, PETER S., (U.S. CLS. 45, 46 AND 48). SN 77-855,170. PUB. 4-6-2010. FILED 10-22-2009.
- 3,806,661. **ALIVIA (STANDARD CHARACTER)**. ALIVIA, (U.S. CLS. 45, 46 AND 48). SN 77-860,658. PUB. 4-6-2010. FILED 10-29-2009.
- 3,806,767 (*See Class 5 for this trademark*).
- 3,806,769. **GENERATION UCAN (STANDARD CHARACTER)**. THE UCAN COMPANY, (U.S. CLS. 45, 46 AND 48). SN 77-862,599. PUB. 4-6-2010. FILED 11-2-2009.
- 3,806,776. **ORANGE MAYHEM (STANDARD CHARACTER)**. ISATORI TECHNOLOGIES, LLC, (U.S. CLS. 45, 46 AND 48). SN 77-862,688. PUB. 4-6-2010. FILED 11-2-2009.
- 3,806,826. **ABSTRACT ENERGY DRINK (STANDARD CHARACTER)**. ABSTRACT INTERNATIONAL, INC., (U.S. CLS. 45, 46 AND 48). SN 77-863,536. PUB. 4-6-2010. FILED 11-3-2009.
- 3,807,117 (*See Class 5 for this trademark*).
- 3,807,143 (*See Class 30 for this trademark*).
- 3,807,153 (*See Class 9 for this trademark*).
- 3,807,210. **GIZE+ (STANDARD CHARACTER)**. CANADIAN MINERAL WATER; DEVELOPMENT S.A., MULTIPLE CLASS, (INT. CLS. 32 AND 33), (U.S. CLS. 45, 46, 47, 48 AND 49). SN 79-069,691. PUB. 4-6-2010. FILED 6-2-2009.
- 3,807,216. **GIZE (STANDARD CHARACTER)**. CANADIAN MINERAL WATER; DEVELOPMENT S.A., MULTIPLE CLASS, (INT. CLS. 32 AND 33), (U.S. CLS. 45, 46, 47, 48 AND 49). SN 79-069,827. PUB. 4-6-2010. FILED 6-2-2009.
- 3,807,247. **ACTIVE 02 TWO (STYLIZED)**. ADELHOLZENER ALPENQUELLEN GMBH, (U.S. CLS. 45, 46 AND 48). SN 79-070,520. PUB. 4-6-2010. FILED 5-29-2009.
- 3,807,259 (*See Class 25 for this trademark*).
- 3,807,290. **GEROLSTEINER DAS WASSER MIT STERN (STYLIZED)**. GEROLSTEINER BRUNNEN GMBH & CO. KG, (U.S. CLS. 45, 46 AND 48). SN 79-072,607. PUB. 4-6-2010. FILED 7-10-2009.
- 3,807,295 (*See Class 5 for this trademark*).
-
- CLASS 33—WINES AND SPIRITS**
- 3,805,196. **SOUTH AFRICAN LIFE. SOUTH AFRICAN STYLE. KWV ESTABLISHED 1918 AND DESIGN**. KWV INTELLECTUAL PROPERTIES (PTY) LIMITED, (U.S. CLS. 47 AND 49). SN 77-186,552. PUB. 4-6-2010. FILED 5-21-2007.
- 3,805,197. **WILHELM BERGMANN (STYLIZED)**. KESPELHER WINE SHIPPERS GMBH, (U.S. CLS. 47 AND 49). SN 77-203,736. PUB. 4-6-2010. FILED 6-12-2007.
- 3,805,205. **CAPTAIN (STANDARD CHARACTER)**. DIAGEO NORTH AMERICA, INC., (U.S. CLS. 47 AND 49). SN 77-283,163. PUB. 4-6-2010. FILED 9-19-2007.
- 3,805,208. **PARKER STATION (STANDARD CHARACTER)**. PARKER STATION, INC., (U.S. CLS. 47 AND 49). SN 77-304,559. PUB. 4-6-2010. FILED 10-15-2007.
- 3,805,219. **WELLBAY (STANDARD CHARACTER)**. DIAGEO SINGAPORE PTE. LTD., (U.S. CLS. 47 AND 49). SN 77-333,385. PUB. 4-6-2010. FILED 11-19-2007.
- 3,805,238. **TUSCAN MOON (STANDARD CHARACTER)**. SOCIETÀ AGRICOLA TERENCE S.R.L., (U.S. CLS. 47 AND 49). SN 77-393,447. PUB. 4-6-2010. FILED 2-11-2008.
- 3,805,290. **JACK BLUE AND DESIGN**. THE POLITICAL WINERY, LLC, (U.S. CLS. 47 AND 49). SN 77-490,954. PUB. 4-6-2010. FILED 6-4-2008.
- 3,805,291. **JACKIE O'ROUGE AND DESIGN**. THE POLITICAL WINERY, LLC, (U.S. CLS. 47 AND 49). SN 77-490,983. PUB. 4-6-2010. FILED 6-4-2008.
- 3,805,292. **ELIE BLANC AND DESIGN**. THE POLITICAL WINERY, LLC, (U.S. CLS. 47 AND 49). SN 77-491,022. PUB. 4-6-2010. FILED 6-4-2008.
- 3,805,477 (*See Class 16 for this trademark*).
- 3,805,573 (*See Class 16 for this trademark*).
- 3,805,609. **VINUVA (STANDARD CHARACTER)**. ENOITALIA S.P.A., (U.S. CLS. 47 AND 49). SN 77-731,110. PUB. 4-6-2010. FILED 5-7-2009.
- 3,805,648. **BRENNAN VINEYARDS (STANDARD CHARACTER)**. BRENNAN VINEYARDS, L.L.C., (U.S. CLS. 47 AND 49). SN 77-736,252. PUB. 4-6-2010. FILED 5-13-2009.
- 3,805,665. **KALEMBÚ (STANDARD CHARACTER)**. J&J SPIRITS, C. X A., (U.S. CLS. 47 AND 49). SN 77-740,961. PUB. 4-6-2010. FILED 5-20-2009.
- 3,805,770. **NAPA ONE AND DESIGN**. SUR LA LUNE, INC., DBA SUR LA LUNE, INC., (U.S. CLS. 47 AND 49). SN 77-763,494. PUB. 4-6-2010. FILED 6-18-2009.
- 3,805,778. **MAMALÓN AND DESIGN**. URCULLU SALINAS, ÁNGEL, (U.S. CLS. 47 AND 49). SN 77-764,431. PUB. 4-6-2010. FILED 6-19-2009.
- 3,805,913. **TANQUERAY STERLING CHARLES TANQUERAY LONDON ENGLAND T AND DESIGN**. DIAGEO BRANDS B.V., (U.S. CLS. 47 AND 49). SN 77-798,360. PUB. 4-6-2010. FILED 8-6-2009.
- 3,805,952. **JORONGO (STANDARD CHARACTER)**. TEQUILA JORONGO TRADERS LLC, (U.S. CLS. 47 AND 49). SN 77-807,626. PUB. 4-6-2010. FILED 8-19-2009.
- 3,806,190 (*See Class 32 for this trademark*).
- 3,806,196. **SOLAZ (STANDARD CHARACTER)**. GRUPO OSBORNE S.A., (U.S. CLS. 47 AND 49). SN 77-845,807. PUB. 4-6-2010. FILED 10-9-2009.
- 3,806,275. **RHINEFARM VINEYARD (STANDARD CHARACTER)**. VINEBURG LLC, (U.S. CLS. 47 AND 49). SN 77-853,222. PUB. 4-6-2010. FILED 10-20-2009.
- 3,806,292. **FOXHORN VINEYARDS AND DESIGN**. WINE GROUP LLC., THE, (U.S. CLS. 47 AND 49). SN 77-854,189. PUB. 4-6-2010. FILED 10-21-2009.
- 3,806,296. **DISZNOKÓ (STANDARD CHARACTER)**. DISZNOKÓ RT, (U.S. CLS. 47 AND 49). SN 77-854,617. PUB. 4-6-2010. FILED 10-22-2009.
- 3,806,668. **DON RICH (STANDARD CHARACTER)**. AGUILAR ALMANZA, RICARDO ANTONIO, (U.S. CLS. 47 AND 49). SN 77-860,785. PUB. 4-6-2010. FILED 10-29-2009.
- 3,806,711. **FISH HOEK (STYLIZED)**. SPRINGTREE WINE COMPANY (PTY) LIMITED, THE, (U.S. CLS. 47 AND 49). SN 77-861,397. PUB. 4-6-2010. FILED 10-30-2009.
- 3,806,804. **CULTIVATION (STANDARD CHARACTER)**. CHAPPELLET WINERY, INC., (U.S. CLS. 47 AND 49). SN 77-863,212. PUB. 4-6-2010. FILED 11-2-2009.
- 3,806,889. **VINTAGE FLIGHT (STANDARD CHARACTER)**. JUDD FAMILY VINEYARDS, L.P., (U.S. CLS. 47 AND 49). SN 77-865,031. PUB. 4-6-2010. FILED 11-4-2009.
- 3,806,899. **SEVEN LIONS WINERY (STANDARD CHARACTER)**. EVE SZU-JU CHEN, (U.S. CLS. 47 AND 49). SN 77-865,298. PUB. 4-6-2010. FILED 11-4-2009.
- 3,806,904. **MISCELLANEOUS DESIGN**. HAMBRECHT WINE GROUP, L.P., (U.S. CLS. 47 AND 49). SN 77-865,331. PUB. 4-6-2010. FILED 11-4-2009.
- 3,807,086. **MISCELLANEOUS DESIGN**. DIAGEO BRANDS B.V., (U.S. CLS. 47 AND 49). SN 78-940,055. PUB. 4-6-2010. FILED 7-28-2006.
- 3,807,147. **MORELLO DI PRILE (STANDARD CHARACTER)**. CASTELPRILE; DI FEDERICA MASCHERONI STIANTI, (U.S. CLS. 47 AND 49). SN 79-064,613. PUB. 4-6-2010. FILED 11-25-2008.
- 3,807,171. **SAMBUCA 313 TRE-UNO-TRE PALLINI AND DESIGN**. I.L.A.R. S.P.A., (U.S. CLS. 47 AND 49). SN 79-068,026. PUB. 4-6-2010. FILED 2-6-2009.
- 3,807,179. **H (STYLIZED)**. DOUBLE EAGLE BRANDS 2 N.V., (U.S. CLS. 47 AND 49). SN 79-068,545. PUB. 4-6-2010. FILED 4-27-2009.
- 3,807,210 (*See Class 32 for this trademark*).
- 3,807,216 (*See Class 32 for this trademark*).
- 3,807,244. **MISCELLANEOUS DESIGN**. YOSHIDA SHUZOTEN CO., LTD., (U.S. CLS. 47 AND 49). SN 79-070,475. PUB. 4-6-2010. FILED 5-18-2009.
- 3,807,256. **SHEEP DIP (STANDARD CHARACTER)**. SPENCERFIELD SPIRIT COMPANY LIMITED, (U.S. CLS. 47 AND 49). SN 79-071,000. PUB. 4-6-2010. FILED 5-14-2009.
- 3,807,259 (*See Class 25 for this trademark*).
- 3,807,262. **FEUDI DEL DUCA AND DESIGN**. FEMAR VINI S.R.L., (U.S. CLS. 47 AND 49). SN 79-071,183. PUB. 4-6-2010. FILED 6-5-2009.

- 3,807,276. **CHATEAU TROTANOY POMEROL (STANDARD CHARACTER)**, SOCIETE CIVILE DU CHATEAU TROTANOY, (U.S. CLS. 47 AND 49), SN 79-072,031. PUB. 4-6-2010. FILED 7-20-2009.
- 3,807,286. **CALANICA (STANDARD CHARACTER)**, DUCA DI SALAPARUTA S.P.A., (U.S. CLS. 47 AND 49), SN 79-072,528. PUB. 4-6-2010. FILED 7-29-2009.
- 3,807,293. **ALMORANO (STANDARD CHARACTER)**, CASA VINICOLA SARTORI S.P.A., (U.S. CLS. 47 AND 49), SN 79-072,738. PUB. 4-6-2010. FILED 8-7-2009.
- 3,807,359. **VIA DIAGONALIS (STANDARD CHARACTER)**, JAYR ETVART AGOPIAN, (U.S. CLS. 47 AND 49), SN 79-077,260. PUB. 4-6-2010. FILED 11-2-2009.

CLASS 34—SMOKERS' ARTICLES

- 3,805,893. **MISCELLANEOUS DESIGN**, CUBAN CIGAR BRANDS, N.V., (U.S. CLS. 2, 8, 9 AND 17), SN 77-794,156. PUB. 12-29-2009. FILED 7-31-2009.
- 3,805,956. **P AND DESIGN**, PRESIDENT TOBACCO, LLC., (U.S. CLS. 2, 8, 9 AND 17), SN 77-807,894. PUB. 4-6-2010. FILED 8-19-2009.
- 3,807,291. **ARTIST LINE (STANDARD CHARACTER)**, DAN-NEMANN AG, (U.S. CLS. 2, 8, 9 AND 17), SN 79-072,654. PUB. 4-6-2010. FILED 8-11-2009.
- 3,807,356. **SPITFIRE (STANDARD CHARACTER)**, DAVIDOFF & CIE SA, (U.S. CLS. 2, 8, 9 AND 17), SN 79-076,853. PUB. 4-6-2010. FILED 7-2-2009.

SERVICE MARKS

CLASS 35—ADVERTISING AND BUSINESS

- 3,805,124 (*See Class 1 for this trademark*).
- 3,805,131. **CW'S COFFEE COMPANY (STANDARD CHARACTER)**, WORSLEY OPERATING CORPORATION, (U.S. CLS. 100, 101 AND 102), SN 76-686,359. PUB. 4-6-2010. FILED 1-31-2008.
- 3,805,145. **AGILE.1 ONE WORLD. ONE WORKFORCE. AND DESIGN**, THE ACT 1 GROUP, INC., MULTIPLE CLASS, (INT. CLS. 35 AND 42), (U.S. CLS. 100, 101 AND 102), SN 76-697,261. PUB. 4-6-2010. FILED 5-6-2009.
- 3,805,155. **FLORIDA WIRE & RIGGING SUPPLY (STANDARD CHARACTER)**, FLORIDA WIRE & RIGGING SUPPLY, INC., (U.S. CLS. 100, 101 AND 102), SN 76-699,033. PUB. 4-6-2010. FILED 8-18-2009.
- 3,805,156. **AGENTSCAN (STANDARD CHARACTER)**, WSOL, INC., (U.S. CLS. 100, 101 AND 102), SN 76-699,041. PUB. 4-6-2010. FILED 8-18-2009.
- 3,805,157. **SERLUCA GROUP FINANCIAL CONSULTING COMPANIES AND DESIGN**, SALANDRA, URSULA, (U.S. CLS. 100, 101 AND 102), SN 76-699,227. PUB. 4-6-2010. FILED 8-28-2009.
- 3,805,171 (*See Class 9 for this trademark*).
- 3,805,173. **HEALTHY DISCOUNTS (STANDARD CHARACTER)**, HEALTHY DISCOUNTS, INC, MULTIPLE CLASS, (INT. CLS. 35 AND 43), (U.S. CLS. 100, 101 AND 102), SN 76-700,175. PUB. 4-6-2010. FILED 11-2-2009.
- 3,805,181 (*See Class 9 for this trademark*).
- 3,805,182 (*See Class 25 for this trademark*).
- 3,805,191 (*See Class 16 for this trademark*).
- 3,805,203. **I TRAVEL CCTC AND DESIGN**, CROSS COUNTRY TRAVCORPS, INC., (U.S. CLS. 100, 101 AND 102), SN 77-276,809. PUB. 4-6-2010. FILED 9-11-2007.
- 3,805,204. **TELETRACK (STANDARD CHARACTER)**, FIRST ADVANTAGE CORPORATION, MULTIPLE CLASS, (INT. CLS. 35, 36, 42 AND 45), (U.S. CLS. 100, 101 AND 102), SN 77-283,061. PUB. 4-29-2008. FILED 9-19-2007.
- 3,805,225. **HELLO WE ARE THE SLOBS STRANGE LITTLE OFFICE BEINGS OFFICE DEPOT AND DESIGN**, THE OFFICE CLUB, INC., MULTIPLE CLASS, (INT. CLS. 35 AND 42), (U.S. CLS. 100, 101 AND 102), SN 77-354,906. PUB. 4-6-2010. FILED 12-18-2007.
- 3,805,226. **ILLNESSPROTECTION.COM (STYLIZED)**, ILLNESSPROTECTION.COM INC., MULTIPLE CLASS, (INT. CLS. 35 AND 36), (U.S. CLS. 100, 101 AND 102), SN 77-357,638. PUB. 1-26-2010. FILED 12-21-2007.
- 3,805,230 (*See Class 3 for this trademark*).
- 3,805,233 (*See Class 25 for this trademark*).
- 3,805,235. **M|M MUSICMINUTES AND DESIGN**, KOK, STEVEN WILLEM, (U.S. CLS. 100, 101 AND 102), SN 77-383,152. PUB. 8-25-2009. FILED 1-29-2008.
- 3,805,246 (*See Class 17 for this trademark*).
- 3,805,248. **INSPIRUS (STANDARD CHARACTER)**, DIAMOND H RECOGNITION, LLC, MULTIPLE CLASS, (INT. CLS. 35 AND 41), (U.S. CLS. 100, 101, 102 AND 107), SN 77-420,740. PUB. 4-6-2010. FILED 3-13-2008.
- 3,805,249. **INSPIRUS (STYLIZED)**, DIAMOND H RECOGNITION, L.P., MULTIPLE CLASS, (INT. CLS. 35 AND 41), (U.S. CLS. 100, 101, 102 AND 107), SN 77-420,779. PUB. 4-6-2010. FILED 3-13-2008.
- 3,805,250. **SQUAD FITTERS AND DESIGN**, SQUADFITTEES, INC, (U.S. CLS. 100, 101 AND 102), SN 77-421,559. PUB. 4-6-2010. FILED 3-13-2008.
- 3,805,256 (*See Class 9 for this trademark*).
- 3,805,259 (*See Class 9 for this trademark*).
- 3,805,261. **IXORAA MEDIA (STANDARD CHARACTER)**, IXORAA MEDIA LLC, MULTIPLE CLASS, (INT. CLS. 35, 39 AND 41), (U.S. CLS. 100, 101, 102, 105 AND 107), SN 77-454,068. PUB. 8-11-2009. FILED 4-21-2008.
- 3,805,264. **KUDDLEBUTTKIDS (STANDARD CHARACTER)**, HURST, TRACEY L, (U.S. CLS. 100, 101 AND 102), SN 77-459,969. PUB. 4-6-2010. FILED 4-28-2008.
- 3,805,274. **ZIBE (STANDARD CHARACTER)**, LOOKSLIKE, INC., (U.S. CLS. 100, 101 AND 102), SN 77-483,405. PUB. 8-25-2009. FILED 5-26-2008.
- 3,805,294 (*See Class 14 for this trademark*).
- 3,805,298. **EQUBE INTERNATIONAL INC. (STANDARD CHARACTER)**, EQUBE TECHNOLOGY AND SOFTWARE INC., MULTIPLE CLASS, (INT. CLS. 35, 41, 42 AND 45), (U.S. CLS. 100, 101, 102 AND 107), SN 77-500,626. PUB. 1-26-2010. FILED 6-17-2008.
- 3,805,299 (*See Class 12 for this trademark*).
- 3,805,312. **MAGIC TOUCH TOYS (STANDARD CHARACTER)**, SPRINGSTEEN, STEPHEN, (U.S. CLS. 100, 101 AND 102), SN 77-535,426. PUB. 4-6-2010. FILED 7-30-2008.
- 3,805,318 (*See Class 9 for this trademark*).
- 3,805,332. **ONBOARD ADVISOR (STANDARD CHARACTER)**, LIBERTY MUTUAL INSURANCE COMPANY, MULTIPLE CLASS, (INT. CLS. 35, 41 AND 42), (U.S. CLS. 100, 101, 102 AND 107), SN 77-558,778. PUB. 4-6-2010. FILED 8-29-2008.
- 3,805,337. **MAMA+ (STANDARD CHARACTER)**, DOCTORS OF THE WORLD-USA, FORMERLY DOCTORS OF THE WORLD-USA, MULTIPLE CLASS, (INT. CLS. 35, 43, 44 AND 45), (U.S. CLS. 100, 101 AND 102), SN 77-563,704. PUB. 4-6-2010. FILED 9-5-2008.
- 3,805,357. **TRUNK CLUB YOU HAVE ARRIVED AND DESIGN**, THE TRUNK CLUB, INC., (U.S. CLS. 100, 101 AND 102), SN 77-581,681. PUB. 4-6-2010. FILED 9-29-2008.
- 3,805,364. **BAIN CRG (STANDARD CHARACTER)**, BAIN & COMPANY, (U.S. CLS. 100, 101 AND 102), SN 77-585,088. PUB. 4-6-2010. FILED 10-3-2008.
- 3,805,368. **THE MARKETING THERAPIST (STANDARD CHARACTER)**, THOMAS, LORRIE, (U.S. CLS. 100, 101 AND 102), SN 77-587,977. PUB. 4-6-2010. FILED 10-8-2008.
- 3,805,375. **FREEDOM TAX RELIEF (STANDARD CHARACTER)**, FREEDOM TAX RELIEF, LLC, MULTIPLE CLASS, (INT. CLS. 35 AND 45), (U.S. CLS. 100, 101 AND 102), SN 77-594,511. PUB. 4-6-2010. FILED 10-16-2008.
- 3,805,385. **ONTARGET (STANDARD CHARACTER)**, IGNITE MEDIA SOLUTIONS, LLC, (U.S. CLS. 100, 101 AND 102), SN 77-604,997. PUB. 4-6-2010. FILED 10-31-2008.
- 3,805,393 (*See Class 14 for this trademark*).
- 3,805,397 (*See Class 16 for this trademark*).
- 3,805,405. **SMARTPOWER LET'S GET ENERGY SMART. AND DESIGN**, SMARTPOWER, INC., DBA SMARTPOWER, MULTIPLE CLASS, (INT. CLS. 35, 39, 40 AND 41), (U.S. CLS. 100, 101, 102, 103, 105, 106 AND 107), SN 77-624,643. PUB. 4-6-2010. FILED 12-2-2008.

- 3,805,409. **PAX ARCTICA (STANDARD CHARACTER)**. SAGAX DEVELOPMENT CORP., (U.S. CLS. 100, 101 AND 102). SN 77-628,477. PUB. 4-6-2010. FILED 12-8-2008.
- 3,805,413 (*See Class 3 for this trademark*).
- 3,805,415. **ISU ONE RESPONSIBLE SOURCE (STANDARD CHARACTER)**. ISU EMPLOYER SERVICES, INC., MULTIPLE CLASS, (INT. CLS. 35, 36 AND 41), (U.S. CLS. 100, 101, 102 AND 107). SN 77-633,474. PUB. 4-6-2010. FILED 12-15-2008.
- 3,805,416. **ONE RESPONSIBLE SOURCE (STANDARD CHARACTER)**. ISU EMPLOYER SERVICES, INC., MULTIPLE CLASS, (INT. CLS. 35, 36 AND 41), (U.S. CLS. 100, 101, 102 AND 107). SN 77-633,504. PUB. 4-6-2010. FILED 12-15-2008.
- 3,805,428. **FORIS (STANDARD CHARACTER)**. FORIS AG, MULTIPLE CLASS, (INT. CLS. 35, 36, 41 AND 45), (U.S. CLS. 100, 101, 102 AND 107). SN 77-641,379. PUB. 8-25-2009. FILED 12-30-2008.
- 3,805,431. **CCC (STYLIZED)**. CURRENT C CREATIVE, LLC, (U.S. CLS. 100, 101 AND 102). SN 77-642,643. PUB. 4-28-2009. FILED 1-2-2009.
- 3,805,436. **BAYTECH SOLUTIONS A PROFESSIONAL SEARCH FIRM AND DESIGN**. TERRANSOFT, INC., (U.S. CLS. 100, 101 AND 102). SN 77-645,193. PUB. 4-6-2010. FILED 1-7-2009.
- 3,805,437. **MODICOM AND DESIGN**. TERRANSOFT, INC., (U.S. CLS. 100, 101 AND 102). SN 77-645,204. PUB. 4-6-2010. FILED 1-7-2009.
- 3,805,440. **ECO OPTIONS AND DESIGN**. HOMER TLC, INC., (U.S. CLS. 100, 101 AND 102). SN 77-647,543. PUB. 4-6-2010. FILED 1-12-2009.
- 3,805,446. **MONEYBOOKERS QUICK CHECKOUT (STANDARD CHARACTER)**. MONEYBOOKERS LTD., MULTIPLE CLASS, (INT. CLS. 35, 36 AND 38), (U.S. CLS. 100, 101, 102 AND 104). SN 77-655,642. PUB. 4-6-2010. FILED 1-23-2009.
- 3,805,447. **MONEYBOOKERS (STANDARD CHARACTER)**. MONEYBOOKERS LTD., MULTIPLE CLASS, (INT. CLS. 35, 36 AND 38), (U.S. CLS. 100, 101, 102 AND 104). SN 77-655,646. PUB. 4-6-2010. FILED 1-23-2009.
- 3,805,448 (*See Class 9 for this trademark*).
- 3,805,450 (*See Class 9 for this trademark*).
- 3,805,452. **MEDICARE SAVINGS ADVANTAGE+ (STANDARD CHARACTER)**. SOCIAL SERVICE COORDINATORS, INC., (U.S. CLS. 100, 101 AND 102). SN 77-662,474. PUB. 12-29-2009. FILED 2-3-2009.
- 3,805,454. **ENERGY ACE (STANDARD CHARACTER)**. ENERGY ACE, INC., MULTIPLE CLASS, (INT. CLS. 35, 37 AND 42), (U.S. CLS. 100, 101, 102, 103 AND 106). SN 77-666,590. PUB. 4-6-2010. FILED 2-9-2009.
- 3,805,461 (*See Class 16 for this trademark*).
- 3,805,465 (*See Class 16 for this trademark*).
- 3,805,466 (*See Class 16 for this trademark*).
- 3,805,469 (*See Class 9 for this trademark*).
- 3,805,472. **HQ AERO AND DESIGN**. HQ AERO MANAGEMENT INC., (U.S. CLS. 100, 101 AND 102). SN 77-679,026. PUB. 4-6-2010. FILED 2-26-2009.
- 3,805,480 (*See Class 16 for this trademark*).
- 3,805,482 (*See Class 9 for this trademark*).
- 3,805,487. **SUE WEAVER C.A.U.S.E. (STYLIZED)**. THE SUE WEAVER CAUSE, MULTIPLE CLASS, (INT. CLS. 35 AND 42), (U.S. CLS. 100, 101 AND 102). SN 77-690,264. PUB. 4-6-2010. FILED 3-13-2009.
- 3,805,490. **COEFFICIENT GENERATOR (STANDARD CHARACTER)**. MARKETING ANALYTICS, INC., (U.S. CLS. 100, 101 AND 102). SN 77-693,057. PUB. 4-6-2010. FILED 3-17-2009.
- 3,805,501. **CONCIERGE LOGISTICS (STANDARD CHARACTER)**. JOHN M. CRAWLEY, LLC, (U.S. CLS. 100, 101 AND 102). SN 77-705,773. PUB. 4-6-2010. FILED 4-2-2009.
- 3,805,516. **BORDER STATES GREENWAY (STANDARD CHARACTER)**. BORDER STATES INDUSTRIES, INC., (U.S. CLS. 100, 101 AND 102). SN 77-712,347. PUB. 4-6-2010. FILED 4-13-2009.
- 3,805,527. **G'DAY! PET CARE AND DESIGN**. G'DAY! PET CARE, LLC, MULTIPLE CLASS, (INT. CLS. 35, 37, 39, 44 AND 45), (U.S. CLS. 100, 101, 102, 103, 105 AND 106). SN 77-716,730. PUB. 4-6-2010. FILED 4-17-2009.
- 3,805,545. **CLICK WITH CONFIDENCE (STANDARD CHARACTER)**. TRUE ULTIMATE STANDARDS EVERYWHERE, INC., MULTIPLE CLASS, (INT. CLS. 35 AND 45), (U.S. CLS. 100, 101 AND 102). SN 77-720,960. PUB. 4-6-2010. FILED 4-23-2009.
- 3,805,557. **TANDEM INTERACTIVE (STANDARD CHARACTER)**. LARATRO, JOSEPH, (U.S. CLS. 100, 101 AND 102). SN 77-723,188. PUB. 4-6-2010. FILED 4-27-2009.
- 3,805,573 (*See Class 16 for this trademark*).
- 3,805,577. **PLANET BLUE (STANDARD CHARACTER)**. REGENTS OF THE UNIVERSITY OF MICHIGAN, (U.S. CLS. 100, 101 AND 102). SN 77-726,893. PUB. 4-6-2010. FILED 5-1-2009.
- 3,805,587. **DIGITAL SIGNAGE EXPO (STANDARD CHARACTER)**. EXPONATION, L.L.C., (U.S. CLS. 100, 101 AND 102). SN 77-728,197. PUB. 4-6-2010. FILED 5-4-2009.
- 3,805,588. **DSE (STANDARD CHARACTER)**. EXPONATION, L.L.C., (U.S. CLS. 100, 101 AND 102). SN 77-728,209. PUB. 4-6-2010. FILED 5-4-2009.
- 3,805,591. **RVU ALLIANCE (STANDARD CHARACTER)**. RVU ALLIANCE, (U.S. CLS. 100, 101 AND 102). SN 77-729,212. PUB. 4-6-2010. FILED 5-5-2009.
- 3,805,592 (*See Class 9 for this trademark*).
- 3,805,597. **WANTED LIST TELL US WHAT YOU WANT WE FIND IT FOR YOU AND DESIGN**. WINTICE GROUP, INC., (U.S. CLS. 100, 101 AND 102). SN 77-729,982. PUB. 4-6-2010. FILED 5-6-2009.
- 3,805,598. **KNEEBONE (STANDARD CHARACTER)**. KNEEBONE INC., (U.S. CLS. 100, 101 AND 102). SN 77-729,988. PUB. 4-6-2010. FILED 5-6-2009.
- 3,805,603. **ALL INTERIOR SUPPLY (STANDARD CHARACTER)**. ALL INTERIOR SUPPLY, INC., (U.S. CLS. 100, 101 AND 102). SN 77-730,319. PUB. 4-6-2010. FILED 5-6-2009.
- 3,805,610. **MISCELLANEOUS DESIGN**. CATALYST COUNCIL INC., (U.S. CLS. 100, 101 AND 102). SN 77-731,181. PUB. 4-6-2010. FILED 5-7-2009.
- 3,805,619. **NEXUS DENTISTRY A COMMUNITY OF SMILES AND DESIGN**. SHAH DENTAL CLINIC, LLC, DBA MT. VERNON MODERN DENTAL; NEXUS DENTAL; NEXUS DENTISTRY, MULTIPLE CLASS, (INT. CLS. 35 AND 44), (U.S. CLS. 100, 101 AND 102). SN 77-732,397. PUB. 4-6-2010. FILED 5-8-2009.
- 3,805,625. **UEM (STANDARD CHARACTER)**. COMPTROL TECHNOLOGIES, INC., (U.S. CLS. 100, 101 AND 102). SN 77-733,262. PUB. 4-6-2010. FILED 5-10-2009.
- 3,805,626. **MY RUBS TEAM (STANDARD CHARACTER)**. COMPTROL TECHNOLOGIES, INC., (U.S. CLS. 100, 101 AND 102). SN 77-733,269. PUB. 4-6-2010. FILED 5-10-2009.
- 3,805,628. **BEWATERWISE.COM (STANDARD CHARACTER)**. METROPOLITAN WATER DISTRICT, MULTIPLE CLASS, (INT. CLS. 35, 39 AND 44), (U.S. CLS. 100, 101, 102 AND 105). SN 77-733,706. PUB. 4-6-2010. FILED 5-11-2009.
- 3,805,632. **SPORTS55 (STANDARD CHARACTER)**. SPORTS55, (U.S. CLS. 100, 101 AND 102). SN 77-734,298. PUB. 4-6-2010. FILED 5-11-2009.
- 3,805,646. **COMPREHENSIVE PRACTICE ASSESSMENT (STANDARD CHARACTER)**. BENCO DENTAL SUPPLY COMPANY, DBA TRANSITIONS GROUP NORTH AMERICA, (U.S. CLS. 100, 101 AND 102). SN 77-736,062. PUB. 4-6-2010. FILED 5-13-2009.
- 3,805,651. **EMERGENCY COVERAGE CORPORATION OF TEAMHEALTH (STANDARD CHARACTER)**. TEAM HEALTH, INC., (U.S. CLS. 100, 101 AND 102). SN 77-737,346. PUB. 4-6-2010. FILED 5-14-2009.
- 3,805,656. **POSTEVERYWHERE (STANDARD CHARACTER)**. GRIZELLA CORPORATION, (U.S. CLS. 100, 101 AND 102). SN 77-738,645. PUB. 4-6-2010. FILED 5-15-2009.
- 3,805,657. **POST EVERYWHERE AND DESIGN**. GRIZELLA CORPORATION, (U.S. CLS. 100, 101 AND 102). SN 77-738,647. PUB. 4-6-2010. FILED 5-15-2009.
- 3,805,660. **VETTOR (STANDARD CHARACTER)**. VETTOR CORPORATION OF AMERICA, (U.S. CLS. 100, 101 AND 102). SN 77-740,181. PUB. 4-6-2010. FILED 5-19-2009.
- 3,805,676. **BEE-TLE MED (STANDARD CHARACTER)**. BEE-TLE MED, LLC, (U.S. CLS. 100, 101 AND 102). SN 77-742,242. PUB. 4-6-2010. FILED 5-21-2009.
- 3,805,677. **ALL THE WATER WITHOUT THE WORK (STANDARD CHARACTER)**. PETSMART STORE SUPPORT GROUP, INC., (U.S. CLS. 100, 101 AND 102). SN 77-

- 742,528. PUB. 4-6-2010. FILED 5-21-2009.
- 3,805,688. **TOTAL ANESTHESIA SOLUTIONS (STANDARD CHARACTER)**. TOTAL ANESTHESIA SOLUTIONS, LLC, (U.S. CLS. 100, 101 AND 102). SN 77-744,427. PUB. 4-6-2010. FILED 5-26-2009.
- 3,805,691. **DISEASE EXCHANGE (STANDARD CHARACTER)**. THE HEART EXCHANGE, LLC, (U.S. CLS. 100, 101 AND 102). SN 77-744,619. PUB. 4-6-2010. FILED 5-26-2009.
- 3,805,692. **CANCER EXCHANGE (STANDARD CHARACTER)**. THE HEART EXCHANGE, LLC, (U.S. CLS. 100, 101 AND 102). SN 77-744,638. PUB. 4-6-2010. FILED 5-26-2009.
- 3,805,693 (*See Class 9 for this trademark*).
- 3,805,694. **ALLEGIS CORPORATION AND DESIGN**. ALLEGIS CORPORATION, (U.S. CLS. 100, 101 AND 102). SN 77-745,671. PUB. 4-6-2010. FILED 5-27-2009.
- 3,805,701 (*See Class 16 for this trademark*).
- 3,805,711. **L.A.XPRESS (STYLIZED)**. RICH, JOSHUA G., DBA LAXPRESS, (U.S. CLS. 100, 101 AND 102). SN 77-748,533. PUB. 4-6-2010. FILED 5-31-2009.
- 3,805,713. **B RELAXX BX (STANDARD CHARACTER)**. BAHAM HAKAKIAN, (U.S. CLS. 100, 101 AND 102). SN 77-749,064. PUB. 4-6-2010. FILED 6-1-2009.
- 3,805,737. **PREPMD (STANDARD CHARACTER)**. PREPMD LLC, MULTIPLE CLASS, (INT. CLS. 35 AND 41), (U.S. CLS. 100, 101, 102 AND 107). SN 77-756,129. PUB. 4-6-2010. FILED 6-10-2009.
- 3,805,742. **A.R.T.I.S.T. ALLOWING RAPPERS TO INDEPENDENTLY SELL THEMSELVES (STANDARD CHARACTER)**. ORTIZ, MIGUEL, (U.S. CLS. 100, 101 AND 102). SN 77-757,843. PUB. 4-6-2010. FILED 6-11-2009.
- 3,805,745. **HERO-GEAR (STANDARD CHARACTER)**. HERO-GEAR, LLC, (U.S. CLS. 100, 101 AND 102). SN 77-758,298. PUB. 11-3-2009. FILED 6-12-2009.
- 3,805,746. **IT'S NOT ENOUGH TO DO WHAT YOU CAN DO. YOU HAVE TO DO ALL YOU CAN DO. (STANDARD CHARACTER)**. TWETI, MIRA, (U.S. CLS. 100, 101 AND 102). SN 77-758,476. PUB. 4-6-2010. FILED 6-12-2009.
- 3,805,747 (*See Class 9 for this trademark*).
- 3,805,748. **INFRASTRUCTURE ACADEMY AND DESIGN**. LOS ANGELES INFRASTRUCTURE ACADEMY, THE, MULTIPLE CLASS, (INT. CLS. 35 AND 41), (U.S. CLS. 100, 101, 102 AND 107). SN 77-758,909. PUB. 4-6-2010. FILED 6-12-2009.
- 3,805,750 (*See Class 5 for this trademark*).
- 3,805,751 (*See Class 5 for this trademark*).
- 3,805,752. **KEEP SMILING (STANDARD CHARACTER)**. JUMPIN' JACKS JAVA CORP., MULTIPLE CLASS, (INT. CLS. 35 AND 43), (U.S. CLS. 100, 101 AND 102). SN 77-759,680. PUB. 4-6-2010. FILED 6-15-2009.
- 3,805,756. **MY MUSIC TOOLS (STANDARD CHARACTER)**. PAVLENKO, ALEX, MULTIPLE CLASS, (INT. CLS. 35 AND 41), (U.S. CLS. 100, 101, 102 AND 107). SN 77-760,595. PUB. 4-6-2010. FILED 6-16-2009.
- 3,805,764. **THE APPAREL SOURCE (STANDARD CHARACTER)**. THE APPAREL SOURCE, INC., MULTIPLE CLASS, (INT. CLS. 35 AND 40), (U.S. CLS. 100, 101, 102, 103 AND 106). SN 77-762,112. PUB. 4-6-2010. FILED 6-17-2009.
- 3,805,781. **PRODUCTS THAT CARE (STANDARD CHARACTER)**. MOMENTUM 1 PRODUCTS, INC., (U.S. CLS. 100, 101 AND 102). SN 77-765,404. PUB. 4-6-2010. FILED 6-22-2009.
- 3,805,782 (*See Class 16 for this trademark*).
- 3,805,783. **FOCUS ON THE FUTURE (STANDARD CHARACTER)**. VIRGO PUBLISHING, LLC, (U.S. CLS. 100, 101 AND 102). SN 77-765,656. PUB. 4-6-2010. FILED 6-22-2009.
- 3,805,784. **NATURALLY FOR HER (STANDARD CHARACTER)**. SOOKA, INC., (U.S. CLS. 100, 101 AND 102). SN 77-765,907. PUB. 4-6-2010. FILED 6-23-2009.
- 3,805,794. **SAVE BABIES THROUGH SCREENING FOUNDATION, INC. AND DESIGN**. SAVE BABIES THROUGH SCREENING FOUNDATION, INC., (U.S. CLS. 100, 101 AND 102). SN 77-770,442. PUB. 4-6-2010. FILED 6-29-2009.
- 3,805,797. **AG AUDITGUARD AND DESIGN**. HEALTH MANAGEMENT RESOURCES, INC., (U.S. CLS. 100, 101 AND 102). SN 77-770,863. PUB. 12-29-2009. FILED 6-30-2009.
- 3,805,808. **GENERATION POWER AND DESIGN**. GENERATION POWER, LLC, MULTIPLE CLASS, (INT. CLS. 35 AND 41), (U.S. CLS. 100, 101, 102 AND 107). SN 77-773,470. PUB. 4-6-2010. FILED 7-2-2009.
- 3,805,809. **ASPENDENTAL RETHINK DENTISTRY AND DESIGN**. ASPEN DENTAL MANAGEMENT, INC, (U.S. CLS. 100, 101 AND 102). SN 77-773,566. PUB. 4-6-2010. FILED 7-2-2009.
- 3,805,810. **ASPENDENTAL RETHINK YOUR DENTAL CAREER AND DESIGN**. ASPEN DENTAL MANAGEMENT, INC, (U.S. CLS. 100, 101 AND 102). SN 77-773,610. PUB. 4-6-2010. FILED 7-2-2009.
- 3,805,820. **ENERGY GEMS OF SOUTHEAST IDAHO NUCLEAR HYDRO SOLAR WIND BIOMASS CLEAN COAL GEOTHERMAL AND DESIGN**. EASTERN IDAHO ECONOMIC DEVELOPMENT PARTNERS, INC., (U.S. CLS. 100, 101 AND 102). SN 77-777,691. PUB. 4-6-2010. FILED 7-9-2009.
- 3,805,824. **CORPORATE TRAVEL SAFETY AND DESIGN**. CORPORATE TRAVEL SAFETY, LLC, (U.S. CLS. 100, 101 AND 102). SN 77-778,915. PUB. 4-6-2010. FILED 7-10-2009.
- 3,805,828. **MLSBYYOURSELF.COM (STANDARD CHARACTER)**. PROGRESSIVE REAL ESTATE, INC., MULTIPLE CLASS, (INT. CLS. 35 AND 36), (U.S. CLS. 100, 101 AND 102). SN 77-780,136. PUB. 4-6-2010. FILED S.R. 7-13-2009; AM. P.R. 2-5-2010.
- 3,805,832 (*See Class 9 for this trademark*).
- 3,805,837. **IP ARCHITECTS, LLC. (STYLIZED)**. PIRONTI, JOHN P., (U.S. CLS. 100, 101 AND 102). SN 77-781,206. PUB. 4-6-2010. FILED 7-14-2009.
- 3,805,838. **BORDER STATES GRID SOLUTIONS (STANDARD CHARACTER)**. BORDER STATES INDUSTRIES, INC., MULTIPLE CLASS, (INT. CLS. 35 AND 39), (U.S. CLS. 100, 101, 102 AND 105). SN 77-781,302. PUB. 4-6-2010. FILED 7-15-2009.
- 3,805,850. **SOCIAL MEDIA EXPLORER (STANDARD CHARACTER)**. SOCIAL MEDIA EXPLORER LLC, (U.S. CLS. 100, 101 AND 102). SN 77-784,423. PUB. 4-6-2010. FILED 7-19-2009.
- 3,805,857. **DO JOBS ONLINE AND DESIGN**. AMERICAN OSTEOPATHIC ASSOCIATION, (U.S. CLS. 100, 101 AND 102). SN 77-785,628. PUB. 4-6-2010. FILED 7-21-2009.
- 3,805,861. **1-800-NICE SMILE (STANDARD CHARACTER)**. IZZO, JAMES, AKA DREAMFUNDER'S INC., (U.S. CLS. 100, 101 AND 102). SN 77-788,644. PUB. 4-6-2010. FILED 7-24-2009.
- 3,805,862. **GREEN ENTERPRISES, LLC AND DESIGN**. GREEN ENTERPRISES, LLC, (U.S. CLS. 100, 101 AND 102). SN 77-790,040. PUB. 4-6-2010. FILED 7-27-2009.
- 3,805,863. **BLUWIRE AND DESIGN**. BLUWIRE GROUP LLC, (U.S. CLS. 100, 101 AND 102). SN 77-790,231. PUB. 4-6-2010. FILED 7-27-2009.
- 3,805,869. **GK SCOTT (STANDARD CHARACTER)**. G.K. SCOTT, LLC, (U.S. CLS. 100, 101 AND 102). SN 77-791,120. PUB. 4-6-2010. FILED 7-28-2009.
- 3,805,870. **VHIP (STANDARD CHARACTER)**. VERISK HEALTH, INC., MULTIPLE CLASS, (INT. CLS. 35 AND 36), (U.S. CLS. 100, 101 AND 102). SN 77-791,438. PUB. 4-6-2010. FILED 7-28-2009.
- 3,805,871. **RECYCLE YOUR RIDE (STANDARD CHARACTER)**. BROWNSTONE MARKETING, LLC, (U.S. CLS. 100, 101 AND 102). SN 77-791,494. PUB. 4-6-2010. FILED 7-28-2009.
- 3,805,878. **YOU TAKE CARE OF PATIENTS...WE TAKE CARE OF THE REST! (STANDARD CHARACTER)**. PRACTICE VELOCITY, LLC, (U.S. CLS. 100, 101 AND 102). SN 77-792,451. PUB. 4-6-2010. FILED 7-29-2009.
- 3,805,879. **HEARTLAND LIFESTYLE (STANDARD CHARACTER)**. ACCESS BRAND STRATEGIES, (U.S. CLS. 100, 101 AND 102). SN 77-792,456. PUB. 12-29-2009. FILED 7-29-2009.
- 3,805,887. **SOME GIFTS COUNT MORE THAN OTHERS (STANDARD CHARACTER)**. LERNER NEW YORK, INC., (U.S. CLS. 100, 101 AND 102). SN 77-793,433. PUB. 4-6-2010. FILED 7-30-2009.
- 3,805,894. **WOODWORKING NETWORK AND DESIGN**. VANCE PUBLISHING CORPORATION, (U.S. CLS. 100, 101 AND 102). SN 77-794,677. PUB. 4-6-2010. FILED 7-31-2009.
- 3,805,895. **AVENÍU BRANDS (STANDARD CHARACTER)**. A.V. BRANDS, INC., DBA AVENÍU BRANDS, (U.S. CLS. 100, 101 AND 102). SN 77-794,698. PUB. 4-6-2010. FILED 7-

- 31-2009.
- 3,805,896. **AVENÜ BRANDS AND DESIGN**. A.V. BRANDS, INC., DBA AVENÜ BRANDS, (U.S. CLS. 100, 101 AND 102). SN 77-794,707. PUB. 4-6-2010. FILED 7-31-2009.
- 3,805,897. **FLY 4 LIFE AND DESIGN**. INTERNATIONAL ASSOCIATION OF MISSIONARY AVIATION, (U.S. CLS. 100, 101 AND 102). SN 77-794,758. PUB. 4-6-2010. FILED 7-31-2009.
- 3,805,898 (*See Class 6 for this trademark*).
- 3,805,899. **GA GRACE ADVISORY AND DESIGN**. GRACE ADVISORY M&A/CORPORATE FINANCE GMBH, MULTIPLE CLASS, (INT. CLS. 35 AND 36), (U.S. CLS. 100, 101 AND 102). SN 77-795,181. PUB. 4-6-2010. FILED 8-3-2009.
- 3,805,901. **FLYZ (STANDARD CHARACTER)**. HALLUM, INC., DBA HALLUM STORES, (U.S. CLS. 100, 101 AND 102). SN 77-795,785. PUB. 4-6-2010. FILED 8-3-2009.
- 3,805,925. **CIRCA 2008 GEORGE'S AT ALYS BEACH AND DESIGN**. HARTLEY, ANN, MULTIPLE CLASS, (INT. CLS. 35 AND 43), (U.S. CLS. 100, 101 AND 102). SN 77-801,250. PUB. 4-6-2010. FILED 8-10-2009.
- 3,805,938. **PROMOLAST AND DESIGN**. FELDMAN, J. DREW, (U.S. CLS. 100, 101 AND 102). SN 77-805,356. PUB. 4-6-2010. FILED 8-14-2009.
- 3,805,940. **FIND EVERYONE YOU'LL EVER NEED (STANDARD CHARACTER)**. SERVICE OASIS, INC., (U.S. CLS. 100, 101 AND 102). SN 77-805,731. PUB. 4-6-2010. FILED 8-17-2009.
- 3,805,942. **D DIGITAL EYE RESEARCH AND DESIGN**. DIGITAL EYE RESEARCH LLC, (U.S. CLS. 100, 101 AND 102). SN 77-805,898. PUB. 4-6-2010. FILED 8-17-2009.
- 3,805,944. **CHOOSE HELP AND DESIGN**. SCHOEL, MARTIN M., MULTIPLE CLASS, (INT. CLS. 35, 41 AND 44), (U.S. CLS. 100, 101, 102 AND 107). SN 77-806,391. PUB. 4-6-2010. FILED 8-17-2009.
- 3,805,946. **KIDDIEZ KORNER (STANDARD CHARACTER)**. BARBARA CHRISTINE JACKSON, DBA JBM SOLUTIONS, LLC, (U.S. CLS. 100, 101 AND 102). SN 77-806,651. PUB. 4-6-2010. FILED 8-18-2009.
- 3,805,950. **PROSELECT (STANDARD CHARACTER)**. PROLIANCE ENERGY LLC, (U.S. CLS. 100, 101 AND 102). SN 77-806,874. PUB. 4-6-2010. FILED 8-18-2009.
- 3,805,951. **WARM WELCOMES, MAGIC MOMENTS, AND FOND FAREWELLS (STANDARD CHARACTER)**. CLUB-CORP, INC., MULTIPLE CLASS, (INT. CLS. 35 AND 41), (U.S. CLS. 100, 101, 102 AND 107). SN 77-807,274. PUB. 4-6-2010. FILED 8-18-2009.
- 3,805,958. **MISCELLANEOUS DESIGN**. AIRLINES REPORTING CORPORATION, MULTIPLE CLASS, (INT. CLS. 35 AND 42), (U.S. CLS. 100, 101 AND 102). SN 77-808,604. PUB. 4-6-2010. FILED 8-19-2009.
- 3,805,966. **PMA (STANDARD CHARACTER)**. PRODUCE MARKETING ASSOCIATION, INC., MULTIPLE CLASS, (INT. CLS. 35 AND 41), (U.S. CLS. 100, 101, 102 AND 107). SN 77-810,183. PUB. 4-6-2010. FILED 8-21-2009.
- 3,805,969. **FRESH SUMMIT (STANDARD CHARACTER)**. PRODUCE MARKETING ASSOCIATION, INC., MULTIPLE CLASS, (INT. CLS. 35 AND 41), (U.S. CLS. 100, 101, 102 AND 107). SN 77-810,250. PUB. 4-6-2010. FILED 8-21-2009.
- 3,805,978. **12 MONTH BIZPLAN.COM THE BUSINESS PLAN THAT MOVES AND DESIGN**. ISAAC BUSINESS SERVICES LLC, (U.S. CLS. 100, 101 AND 102). SN 77-811,535. PUB. 4-6-2010. FILED 8-24-2009.
- 3,805,981. **RXCUT (STANDARD CHARACTER)**. FREEFORALL, INCORPORATED, (U.S. CLS. 100, 101 AND 102). SN 77-811,967. PUB. 4-6-2010. FILED 8-25-2009.
- 3,805,984 (*See Class 25 for this trademark*).
- 3,805,987. **PDC PHARMACY (STANDARD CHARACTER)**. PASSAVANT DEVELOPMENT CORPORATION, (U.S. CLS. 100, 101 AND 102). SN 77-814,918. PUB. 4-6-2010. FILED 8-28-2009.
- 3,805,988. **GL STAFFING SERVICES, INC. "WE WILL GET THE JOB DONE" (STYLIZED)**. GENERAL LABOR STAFFING SERVICES INC., (U.S. CLS. 100, 101 AND 102). SN 77-815,012. PUB. 4-6-2010. FILED 8-28-2009.
- 3,805,989. **BHINDI JEWELLERS (STANDARD CHARACTER)**. BHINDI K INTERNATIONAL, DBA BHINDI JEWELLERS, (U.S. CLS. 100, 101 AND 102). SN 77-815,067. PUB. 4-6-2010. FILED 8-28-2009.
- 3,805,991. **NEXT MEDICAL STAFFING (STANDARD CHARACTER)**. NEXT MEDICAL STAFFING, LLC, (U.S. CLS. 100, 101 AND 102). SN 77-815,535. PUB. 4-6-2010. FILED 8-28-2009.
- 3,805,992. **BAM ARTE Y MAS (STYLIZED)**. BORRERO ART MATERIALS (BAM) CORP., (U.S. CLS. 100, 101 AND 102). SN 77-815,587. PUB. 4-6-2010. FILED 8-28-2009.
- 3,806,006 (*See Class 9 for this trademark*).
- 3,806,007 (*See Class 9 for this trademark*).
- 3,806,010. **4 VISUAL MEDIA GROUP (STANDARD CHARACTER)**. 4 VISUAL MEDIA GROUP, INC., MULTIPLE CLASS, (INT. CLS. 35 AND 40), (U.S. CLS. 100, 101, 102, 103 AND 106). SN 77-818,398. PUB. 4-6-2010. FILED 9-2-2009.
- 3,806,014. **SCANPLANET.COM (STANDARD CHARACTER)**. MASS GROUP, INC., AKA MASS GROUP, (U.S. CLS. 100, 101 AND 102). SN 77-818,782. PUB. 4-6-2010. FILED 9-2-2009.
- 3,806,021. **MHQ VEHICLES EQUIPMENT GEAR AND DESIGN**. NATICK AUTO SALES, INC., MULTIPLE CLASS, (INT. CLS. 35 AND 37), (U.S. CLS. 100, 101, 102, 103 AND 106). SN 77-820,158. PUB. 4-6-2010. FILED 9-4-2009.
- 3,806,022. **INDIEPOWER (STANDARD CHARACTER)**. INDIEPOWER LLC, (U.S. CLS. 100, 101 AND 102). SN 77-820,308. PUB. 4-6-2010. FILED 9-4-2009.
- 3,806,041. **DEALSLIP AND DESIGN**. 58PHASES, LLC, (U.S. CLS. 100, 101 AND 102). SN 77-823,234. PUB. 4-6-2010. FILED 9-9-2009.
- 3,806,042. **COUPON GURUS AND DESIGN**. 58PHASES, LLC, (U.S. CLS. 100, 101 AND 102). SN 77-823,253. PUB. 4-6-2010. FILED 9-9-2009.
- 3,806,049. **WEGO SOLAR (STANDARD CHARACTER)**. WEGO CHEMICAL & MINERAL CORP., (U.S. CLS. 100, 101 AND 102). SN 77-824,432. PUB. 4-6-2010. FILED 9-11-2009.
- 3,806,055. **BEE BOTANICS (STANDARD CHARACTER)**. MACROSERVE PTE. LTD., (U.S. CLS. 100, 101 AND 102). SN 77-825,567. PUB. 4-6-2010. FILED 9-14-2009.
- 3,806,057. **. QUALITY . DENTAL PLAN AND DESIGN**. OPERATIONAL MANAGEMENT SERVICES, INC., (U.S. CLS. 100, 101 AND 102). SN 77-825,829. PUB. 4-6-2010. FILED 9-14-2009.
- 3,806,064. **FOUR PEAS CONSULTING AND DESIGN**. FOUR PEAS CONSULTING, LLC, (U.S. CLS. 100, 101 AND 102). SN 77-826,876. PUB. 4-6-2010. FILED 9-15-2009.
- 3,806,065 (*See Class 9 for this trademark*).
- 3,806,066. **PRIME MY CLOSET (STANDARD CHARACTER)**. PRIME RETAIL, L.P., (U.S. CLS. 100, 101 AND 102). SN 77-826,931. PUB. 4-6-2010. FILED 9-15-2009.
- 3,806,068 (*See Class 30 for this trademark*).
- 3,806,069. **PRIMEMYCLOSET AND DESIGN**. PRIME RETAIL, L.P., (U.S. CLS. 100, 101 AND 102). SN 77-827,219. PUB. 4-6-2010. FILED 9-15-2009.
- 3,806,073. **DALLASCOWBOYS.COM (STANDARD CHARACTER)**. DALLAS COWBOYS FOOTBALL CLUB, LTD., MULTIPLE CLASS, (INT. CLS. 35, 38 AND 41), (U.S. CLS. 100, 101, 102, 104 AND 107). SN 77-828,060. PUB. 4-6-2010. FILED 9-16-2009.
- 3,806,076. **MISCELLANEOUS DESIGN**. UPLANDERS WAREHOUSE LLC, DBA UPLANDERS WAREHOUSE, (U.S. CLS. 100, 101 AND 102). SN 77-828,176. PUB. 4-6-2010. FILED 9-16-2009.
- 3,806,078. **NETWORK SALESFORCE NETFORCE1 A CARLSBAD CHAMBER REFERRAL GROUP AND DESIGN**. CARLSBAD CHAMBER OF COMMERCE, (U.S. CLS. 100, 101 AND 102). SN 77-828,643. PUB. 4-6-2010. FILED 9-17-2009.
- 3,806,079. **ABOUTTHREE (STANDARD CHARACTER)**. TRUE LABEL, INC., (U.S. CLS. 100, 101 AND 102). SN 77-828,690. PUB. 4-6-2010. FILED 9-17-2009.
- 3,806,081. **SKINGIFT (STANDARD CHARACTER)**. SENSATIONAL SKIN CENTERS, PLLC, (U.S. CLS. 100, 101 AND 102). SN 77-829,637. PUB. 4-6-2010. FILED 9-18-2009.
- 3,806,091. **BUY, SELL OR FINANCE WITH AN AGENT WHO UNDERSTANDS YOU. (STANDARD CHARACTER)**. LDSAGENTS, LLC, DBA LDSAGENTS.COM, (U.S. CLS. 100, 101 AND 102). SN 77-832,988. PUB. 4-6-2010. FILED 9-23-2009.
- 3,806,097. **DRUGS AMERICA (STANDARD CHARACTER)**. MAST DRUG CO., INC., (U.S. CLS. 100, 101 AND 102). SN 77-833,888. PUB. 4-6-2010. FILED 9-24-2009.
- 3,806,100. **SUPER COUPE CLUB OF AMERICA (STANDARD**

- CHARACTER).** SUPER COUPE CLUB OF AMERICA, INC., (U.S. CLS. 100, 101 AND 102). SN 77-834,724. PUB. 4-6-2010. FILED S.R. 9-25-2009; AM. P.R. 2-1-2010.
- 3,806,103. **DYNAMIC VENDING (STANDARD CHARACTER).** DYNAMIC VENDING, INC., MULTIPLE CLASS, (INT. CLS. 35 AND 37), (U.S. CLS. 100, 101, 102, 103 AND 106). SN 77-835,315. PUB. 4-6-2010. FILED 9-25-2009.
- 3,806,106. **SUNDAY AND DESIGN.** SUNDAY LLC, MULTIPLE CLASS, (INT. CLS. 35 AND 45), (U.S. CLS. 100, 101 AND 102). SN 77-835,714. PUB. 4-6-2010. FILED 9-26-2009.
- 3,806,108 (*See Class 16 for this trademark*).
- 3,806,111. **RUNNER'S ALLEY AND DESIGN.** RUNNER'S ALLEY, LLC, (U.S. CLS. 100, 101 AND 102). SN 77-836,112. PUB. 4-6-2010. FILED 9-28-2009.
- 3,806,114. **CAL TAX GROUP AND DESIGN.** CAL TAX GROUP, INC., (U.S. CLS. 100, 101 AND 102). SN 77-836,286. PUB. 4-6-2010. FILED 9-28-2009.
- 3,806,126. **GREEN SMARTS WITH THE GREEN MAN (STANDARD CHARACTER).** MUSECO MEDIA AND EDUCATION PROJECT, (U.S. CLS. 100, 101 AND 102). SN 77-837,574. PUB. 4-6-2010. FILED 9-29-2009.
- 3,806,133. **ROD WORKS UNIQUE IRON AND HOME DECOR AND DESIGN.** ROD WORKS INC., (U.S. CLS. 100, 101 AND 102). SN 77-838,326. PUB. 4-6-2010. FILED 9-30-2009.
- 3,806,134. **LEOADVENTURES (STANDARD CHARACTER).** LEOADVENTURES, LLC, (U.S. CLS. 100, 101 AND 102). SN 77-838,377. PUB. 4-6-2010. FILED 9-30-2009.
- 3,806,137. **A A S A T AMERICAN ASSOCIATION FOR SEX ADDICTION THERAPY AND DESIGN.** AMERICAN ASSOCIATION FOR SEX ADDICTION THERAPY, (U.S. CLS. 100, 101 AND 102). SN 77-838,922. PUB. 4-6-2010. FILED 10-1-2009.
- 3,806,156 (*See Class 16 for this trademark*).
- 3,806,164. **AGCHECK (STANDARD CHARACTER).** DELL'S INSURANCE AGENCY, INC., (U.S. CLS. 100, 101 AND 102). SN 77-842,812. PUB. 4-6-2010. FILED 10-6-2009.
- 3,806,165. **HOCKEYBOSS (STYLIZED).** CARRAGINO, ROBERT, (U.S. CLS. 100, 101 AND 102). SN 77-842,919. PUB. 4-6-2010. FILED 10-6-2009.
- 3,806,168. **GEMTRESS (STANDARD CHARACTER).** ON RITE CO., INC, MULTIPLE CLASS, (INT. CLS. 35 AND 41), (U.S. CLS. 100, 101, 102 AND 107). SN 77-843,090. PUB. 4-6-2010. FILED 10-7-2009.
- 3,806,175. **THE CONGRENIENCE STORE (STANDARD CHARACTER).** NATIONAL ASSOCIATION OF CONVENIENCE STORES, (U.S. CLS. 100, 101 AND 102). SN 77-844,145. PUB. 4-6-2010. FILED 10-8-2009.
- 3,806,178. **FRAUDPREDATOR (STANDARD CHARACTER).** LPS IP HOLDING COMPANY, LLC, MULTIPLE CLASS, (INT. CLS. 35, 36 AND 45), (U.S. CLS. 100, 101 AND 102). SN 77-844,235. PUB. 4-6-2010. FILED 10-8-2009.
- 3,806,180. **WHEELHOUSE WINE CELLARS (STANDARD CHARACTER).** SONOMA WINE COMPANY, LLC, (U.S. CLS. 100, 101 AND 102). SN 77-844,321. PUB. 4-6-2010. FILED 10-8-2009.
- 3,806,184. **TEAM ACCELERATOR (STANDARD CHARACTER).** 3CIRCLE PARTNERS, LLC, MULTIPLE CLASS, (INT. CLS. 35 AND 41), (U.S. CLS. 100, 101, 102 AND 107). SN 77-844,855. PUB. 4-6-2010. FILED 10-8-2009.
- 3,806,185. **GLENDALE AZ AND DESIGN.** CITY OF GLENDALE, (U.S. CLS. 100, 101 AND 102). SN 77-844,858. PUB. 4-6-2010. FILED 10-8-2009.
- 3,806,186. **3CIRCLE PARTNERS (STANDARD CHARACTER).** 3CIRCLE PARTNERS, LLC, MULTIPLE CLASS, (INT. CLS. 35 AND 41), (U.S. CLS. 100, 101, 102 AND 107). SN 77-844,863. PUB. 4-6-2010. FILED 10-8-2009.
- 3,806,188. **JD CROSS-SEARCH (STANDARD CHARACTER).** DEERE & COMPANY, (U.S. CLS. 100, 101 AND 102). SN 77-845,135. PUB. 4-6-2010. FILED 10-9-2009.
- 3,806,191. **FASIG-TIPTON RACING CLUB (STANDARD CHARACTER).** FASIG-TIPTON RACING CLUB MANAGEMENT, LLC, MULTIPLE CLASS, (INT. CLS. 35 AND 39), (U.S. CLS. 100, 101, 102 AND 105). SN 77-845,691. PUB. 4-6-2010. FILED 10-9-2009.
- 3,806,197. **CEPTARA (STANDARD CHARACTER).** CEPTARA CORP, (U.S. CLS. 100, 101 AND 102). SN 77-845,923. PUB. 4-6-2010. FILED 10-9-2009.
- 3,806,205. **SHEET MUSIC PLUS (STANDARD CHARACTER).** SHEET MUSIC PLUS, LLC, (U.S. CLS. 100, 101 AND 102). SN 77-846,913. PUB. 4-6-2010. FILED 10-12-2009.
- 3,806,207. **SHEET MUSIC PLUS.COM AND DESIGN.** SHEET MUSIC PLUS, LLC, (U.S. CLS. 100, 101 AND 102). SN 77-846,927. PUB. 4-6-2010. FILED 10-12-2009.
- 3,806,213. **TEA PAGES (STANDARD CHARACTER).** MUNICHIELLO, KATRINA AVILA, (U.S. CLS. 100, 101 AND 102). SN 77-847,643. PUB. 4-6-2010. FILED 10-13-2009.
- 3,806,219. **COMPZONE (STANDARD CHARACTER).** VANTREO INSURANCE BROKERAGE, (U.S. CLS. 100, 101 AND 102). SN 77-848,063. PUB. 4-6-2010. FILED 10-14-2009.
- 3,806,227. **START THE CONVERSATION... (STANDARD CHARACTER).** GREEN NURTURE, LLC, (U.S. CLS. 100, 101 AND 102). SN 77-848,973. PUB. 4-6-2010. FILED 10-14-2009.
- 3,806,228. **PETGIGS (STANDARD CHARACTER).** KOHN GALE, LILA, (U.S. CLS. 100, 101 AND 102). SN 77-848,996. PUB. 4-6-2010. FILED 10-14-2009.
- 3,806,231. **OPTASK (STANDARD CHARACTER).** OPTASK INC., (U.S. CLS. 100, 101 AND 102). SN 77-849,041. PUB. 4-6-2010. FILED 10-14-2009.
- 3,806,233. **MISCELLANEOUS DESIGN.** FASIG-TIPTON RACING CLUB MANAGEMENT, LLC, MULTIPLE CLASS, (INT. CLS. 35 AND 39), (U.S. CLS. 100, 101, 102 AND 105). SN 77-849,152. PUB. 4-6-2010. FILED 10-15-2009.
- 3,806,252. **IRINGPRO (STANDARD CHARACTER).** HLADECEK LLC, (U.S. CLS. 100, 101 AND 102). SN 77-850,980. PUB. 4-6-2010. FILED 10-16-2009.
- 3,806,263. **BOOMERANG BARTER EXCHANGE (STANDARD CHARACTER).** BOOMERANG BARTER EXCHANGE, INC., (U.S. CLS. 100, 101 AND 102). SN 77-852,327. PUB. 4-6-2010. FILED 10-19-2009.
- 3,806,267. **CONSTRUCTION LOTS AND DESIGN.** WW ONE CORP., (U.S. CLS. 100, 101 AND 102). SN 77-852,467. PUB. 4-6-2010. FILED 10-20-2009.
- 3,806,271. **ISC (STANDARD CHARACTER).** INVENTORY SALES CO., (U.S. CLS. 100, 101 AND 102). SN 77-853,024. PUB. 4-6-2010. FILED 10-20-2009.
- 3,806,272. **ISC AND DESIGN.** INVENTORY SALES CO., (U.S. CLS. 100, 101 AND 102). SN 77-853,033. PUB. 4-6-2010. FILED 10-20-2009.
- 3,806,282. **SHAPESHIFTERZ.COM (STANDARD CHARACTER).** FUTURE CIRCUS, INC., (U.S. CLS. 100, 101 AND 102). SN 77-853,890. PUB. 4-6-2010. FILED 10-21-2009.
- 3,806,290. **EAGLE TAX (STANDARD CHARACTER).** EAGLE TAX SERVICES GROUP, LLC, FORMERLY EAGLE TAX SERVICES GROUP, INC., (U.S. CLS. 100, 101 AND 102). SN 77-854,143. PUB. 4-6-2010. FILED 10-21-2009.
- 3,806,294. **WMS WINDSOR MANAGEMENT SERVICES (STYLIZED).** WINDSOR CAPITAL GROUP, INC., (U.S. CLS. 100, 101 AND 102). SN 77-854,495. PUB. 4-6-2010. FILED 10-21-2009.
- 3,806,297. **S2S SHOES2SHARE.COM PROVIDING SHOES TO THOSE IN NEED AND DESIGN.** SHOES 2 SHARE, INC., AKA BAREFOOT SUNDAY, (U.S. CLS. 100, 101 AND 102). SN 77-854,753. PUB. 4-6-2010. FILED 10-22-2009.
- 3,806,299. **DICE DOJO (STANDARD CHARACTER).** CHICAGOLAND GAMES, LLC, (U.S. CLS. 100, 101 AND 102). SN 77-854,787. PUB. 4-6-2010. FILED 10-22-2009.
- 3,806,300. **YOUR ONE STOP CLOWN SHOP! (STANDARD CHARACTER).** CLOWNANTICS LLC, (U.S. CLS. 100, 101 AND 102). SN 77-854,808. PUB. 4-6-2010. FILED 10-22-2009.
- 3,806,302. **SAMPLEABILITY UPDATES (STANDARD CHARACTER).** MEDPRO SYSTEMS, LLC, (U.S. CLS. 100, 101 AND 102). SN 77-854,870. PUB. 4-6-2010. FILED 10-22-2009.
- 3,806,303. **PRACTITIONERPROXIMITYID (STANDARD CHARACTER).** MEDPRO SYSTEMS, LLC, (U.S. CLS. 100, 101 AND 102). SN 77-854,878. PUB. 4-6-2010. FILED 10-22-2009.
- 3,806,326. **EXPERIENCE WORKS (STANDARD CHARACTER).** EXPERIENCE WORKS, INC., MULTIPLE CLASS, (INT. CLS. 35 AND 41), (U.S. CLS. 100, 101, 102 AND 107). SN 77-855,640. PUB. 4-6-2010. FILED 10-23-2009.
- 3,806,327. **EXPERIENCEWORKS AND DESIGN.** EXPERIENCE WORKS, INC., MULTIPLE CLASS, (INT. CLS. 35 AND 41), (U.S. CLS. 100, 101, 102 AND 107). SN 77-855,643. PUB. 4-6-2010. FILED 10-23-2009.
- 3,806,328. **GREEN THUMB (STANDARD CHARACTER).** EX-

- PERIENCE WORKS, INC., MULTIPLE CLASS, (INT. CLS. 35 AND 41), (U.S. CLS. 100, 101, 102 AND 107). SN 77-855,644. PUB. 4-6-2010. FILED 10-23-2009.
- 3,806,332. **SOBER CAMEL (STANDARD CHARACTER)**. LONNON, CHRISTY L, DBA SOBER CAMEL, (U.S. CLS. 100, 101 AND 102). SN 77-855,723. PUB. 4-6-2010. FILED 10-23-2009.
- 3,806,338. **YOUR RETAIL SOLUTIONS PARTNER (STANDARD CHARACTER)**. STRATMAR SYSTEMS, INC., DBA STRATMAR RETAIL SERVICES, (U.S. CLS. 100, 101 AND 102). SN 77-855,947. PUB. 4-6-2010. FILED 10-23-2009.
- 3,806,353. **SUPPLIQ AND DESIGN**. SUPPLIQ, LLC, (U.S. CLS. 100, 101 AND 102). SN 77-856,585. PUB. 4-6-2010. FILED 10-23-2009.
- 3,806,356. **PRO-ACTIVE CANDIDATE (STANDARD CHARACTER)**. COENEN BROS. INC., (U.S. CLS. 100, 101 AND 102). SN 77-856,768. PUB. 4-6-2010. FILED 10-25-2009.
- 3,806,358. **COVERMYMEDS (STANDARD CHARACTER)**. COVERMYMEDS LLC, AKA COVERMYMEDS, (U.S. CLS. 100, 101 AND 102). SN 77-856,800. PUB. 4-6-2010. FILED 10-25-2009.
- 3,806,366. **CHICAGO ILLINOIS SIMPLY MAGNIFICENT AND DESIGN**. ILLINOIS DEPARTMENT OF COMMERCE AND ECONOMIC OPPORTUNITY, (U.S. CLS. 100, 101 AND 102). SN 77-856,964. PUB. 4-6-2010. FILED 10-26-2009.
- 3,806,368. **BOX BUDDY SHIPPING (STANDARD CHARACTER)**. BOX BUDDY SHIPPING LLC, (U.S. CLS. 100, 101 AND 102). SN 77-857,030. PUB. 4-6-2010. FILED 10-26-2009.
- 3,806,384. **INNOVATIVE POSITIONING (STANDARD CHARACTER)**. HOWARD ROCKETT INC., AKA HRI, (U.S. CLS. 100, 101 AND 102). SN 77-857,364. PUB. 4-6-2010. FILED 10-26-2009.
- 3,806,386. **D MOVING DALLAS' BEST MOVERS "WHEN ONLY THE VERY BEST WILL DO" AND DESIGN**. ASSOCIATED CAPITAL SERVICES INC., DBA D MOVING, (U.S. CLS. 100, 101 AND 102). SN 77-857,469. PUB. 4-6-2010. FILED 10-26-2009.
- 3,806,390. **GOD'S PIT CREW CRISIS RESPONSE TEAM AND DESIGN**. GOD'S PIT CREW, INC., (U.S. CLS. 100, 101 AND 102). SN 77-857,512. PUB. 4-6-2010. FILED 10-26-2009.
- 3,806,393. **YOUR VOTE IS YOUR VOICE (STANDARD CHARACTER)**. TANGENT MEDIA, LLC, (U.S. CLS. 100, 101 AND 102). SN 77-857,674. PUB. 4-6-2010. FILED 10-26-2009.
- 3,806,399. **HOMOACTIVE (STANDARD CHARACTER)**. R.S. THOMPSON, (U.S. CLS. 100, 101 AND 102). SN 77-857,911. PUB. 4-6-2010. FILED 10-27-2009.
- 3,806,409. **BOOMERANG BARTER EXCHANGE JOIN THE REVOLUTION AND DESIGN**. BOOMERANG BARTER EXCHANGE, INC., (U.S. CLS. 100, 101 AND 102). SN 77-858,029. PUB. 4-6-2010. FILED 10-27-2009.
- 3,806,412. **CHICALOGIC (STANDARD CHARACTER)**. CHICALOGIC INC, (U.S. CLS. 100, 101 AND 102). SN 77-858,069. PUB. 4-6-2010. FILED 10-27-2009.
- 3,806,415. **FURNITURE BUY CONSIGNMENT (STANDARD CHARACTER)**. FURNITURE BUY CONSIGNMENT, INC., (U.S. CLS. 100, 101 AND 102). SN 77-858,114. PUB. 4-6-2010. FILED 10-27-2009.
- 3,806,418. **EXPRESS TUNNEL COOL DRINKS AND DESIGN**. EXPRESS TUNNEL INC., (U.S. CLS. 100, 101 AND 102). SN 77-858,150. PUB. 4-6-2010. FILED 10-27-2009.
- 3,806,433. **LIXIVIAN (STANDARD CHARACTER)**. LIXIVIAN, INC., (U.S. CLS. 100, 101 AND 102). SN 77-858,318. PUB. 4-6-2010. FILED 10-27-2009.
- 3,806,438. **MIDDIE BUZZ AND DESIGN**. MALDONADO-MONSANTO, VIVIAN, (U.S. CLS. 100, 101 AND 102). SN 77-858,363. PUB. 4-6-2010. FILED 10-27-2009.
- 3,806,445. **A I A AND DESIGN**. ATTRACTION INDUSTRIES, INC., (U.S. CLS. 100, 101 AND 102). SN 77-858,469. PUB. 4-6-2010. FILED 10-27-2009.
- 3,806,446. **JESKE (STANDARD CHARACTER)**. THE JESKE COMPANY, INC., (U.S. CLS. 100, 101 AND 102). SN 77-858,475. PUB. 4-6-2010. FILED 10-27-2009.
- 3,806,450. **EDISON MANUFACTURERS NETWORK (STANDARD CHARACTER)**. TECHSOLVE, INC., (U.S. CLS. 100, 101 AND 102). SN 77-858,499. PUB. 4-6-2010. FILED 10-27-2009.
- 3,806,457. **EMN (STANDARD CHARACTER)**. TECHSOLVE, INC., (U.S. CLS. 100, 101 AND 102). SN 77-858,521. PUB. 4-6-2010. FILED 10-27-2009.
- 3,806,471. **CHATMETER (STANDARD CHARACTER)**. CHATMETER, (U.S. CLS. 100, 101 AND 102). SN 77-858,644. PUB. 4-6-2010. FILED 10-27-2009.
- 3,806,475. **WASHINGTON KETTLE CORN COMPANY "WE'RE NOT YOUR AVERAGE KERNEL, WE'RE BIGGER!" (STANDARD CHARACTER)**. JONES, RICHARD L., (U.S. CLS. 100, 101 AND 102). SN 77-858,689. PUB. 4-6-2010. FILED 10-27-2009.
- 3,806,476. **RUN MY GAME (STANDARD CHARACTER)**. ACAPULCO GOLD LLC, (U.S. CLS. 100, 101 AND 102). SN 77-858,703. PUB. 4-6-2010. FILED 10-27-2009.
- 3,806,484. **CARSINCONTEXT AND DESIGN**. CADORNIGA, DENNIS, AND EWING, MARK, AND SAWYER, CHRISTOPHER, (U.S. CLS. 100, 101 AND 102). SN 77-858,738. PUB. 4-6-2010. FILED 10-27-2009.
- 3,806,485. **AD SIGNALS AND DESIGN**. AD SIGNALS, INC., (U.S. CLS. 100, 101 AND 102). SN 77-858,746. PUB. 4-6-2010. FILED 10-27-2009.
- 3,806,492. **POLKA DOT POTTERY (STANDARD CHARACTER)**. GEIGER, KIMBERLY, (U.S. CLS. 100, 101 AND 102). SN 77-858,774. PUB. 4-6-2010. FILED 10-27-2009.
- 3,806,496. **LITTLE MONSTERZ AND DESIGN**. LITTLE MONSTERZ, (U.S. CLS. 100, 101 AND 102). SN 77-858,823. PUB. 4-6-2010. FILED 10-27-2009.
- 3,806,497. **GOTTUNES AND DESIGN**. GOTTUNEZ.COM, LLC, (U.S. CLS. 100, 101 AND 102). SN 77-858,843. PUB. 4-6-2010. FILED 10-27-2009.
- 3,806,503. **CAREERLISTIC (STANDARD CHARACTER)**. DEBRA DAVIS, (U.S. CLS. 100, 101 AND 102). SN 77-858,962. PUB. 4-6-2010. FILED 10-28-2009.
- 3,806,507. **SMARTMOVE AUTO (STANDARD CHARACTER)**. INTERSTATE AUTO GROUP, INC., MULTIPLE CLASS, (INT. CLS. 35 AND 36), (U.S. CLS. 100, 101 AND 102). SN 77-859,005. PUB. 4-6-2010. FILED 10-28-2009.
- 3,806,519. **ELP AND DESIGN**. LAMPO LICENSING, LLC, (U.S. CLS. 100, 101 AND 102). SN 77-859,171. PUB. 4-6-2010. FILED 10-28-2009.
- 3,806,520. **SCANSCOUT (STANDARD CHARACTER)**. SCANSCOUT, INC., (U.S. CLS. 100, 101 AND 102). SN 77-859,181. PUB. 4-6-2010. FILED 10-28-2009.
- 3,806,523. **RENT MY NOGGIN (STANDARD CHARACTER)**. BRADLEY, ROBYN, (U.S. CLS. 100, 101 AND 102). SN 77-859,199. PUB. 4-6-2010. FILED 10-28-2009.
- 3,806,525. **UNDERHEAD (STANDARD CHARACTER)**. UNDERHEAD LLC, (U.S. CLS. 100, 101 AND 102). SN 77-859,238. PUB. 4-6-2010. FILED 10-28-2009.
- 3,806,531. **RESPONSIBLE LUXURY (STANDARD CHARACTER)**. LAURA KAEHLER ARCHITECTS, L.L.C., (U.S. CLS. 100, 101 AND 102). SN 77-859,376. PUB. 4-6-2010. FILED 10-28-2009.
- 3,806,534. **NATO (STANDARD CHARACTER)**. NATIONAL ASSOCIATION OF THEATRE OWNERS, INC., (U.S. CLS. 100, 101 AND 102). SN 77-859,451. PUB. 4-6-2010. FILED 10-28-2009.
- 3,806,535. **THE CONTENT FACTOR (STANDARD CHARACTER)**. THE CONTENT FACTOR, LLC, (U.S. CLS. 100, 101 AND 102). SN 77-859,459. PUB. 4-6-2010. FILED 10-28-2009.
- 3,806,537 (*See Class 25 for this trademark*).
- 3,806,539. **THE AUTHORITY IN GOVERNMENT CONTRACTS (STANDARD CHARACTER)**. FEDERAL SCHEDULES, INC., (U.S. CLS. 100, 101 AND 102). SN 77-859,495. PUB. 4-6-2010. FILED 10-28-2009.
- 3,806,540. **ZEPHERELLA (STANDARD CHARACTER)**. ZEPHERELLA, INC., (U.S. CLS. 100, 101 AND 102). SN 77-859,505. PUB. 4-6-2010. FILED 10-28-2009.
- 3,806,543. **MYACCENT (STANDARD CHARACTER)**. ACCENT ENERGY GROUP LLC, (U.S. CLS. 100, 101 AND 102). SN 77-859,514. PUB. 4-6-2010. FILED 10-28-2009.
- 3,806,544. **NO-SURPRISE HEALTHCARE PRICING (STANDARD CHARACTER)**. ZEPHERELLA, INC., (U.S. CLS. 100, 101 AND 102). SN 77-859,517. PUB. 4-6-2010. FILED 10-28-2009.
- 3,806,545. **MYDYNOWATT (STANDARD CHARACTER)**. ACCENT ENERGY TEXAS LP, (U.S. CLS. 100, 101 AND 102). SN 77-859,518. PUB. 4-6-2010. FILED 10-28-2009.
- 3,806,549. **SALES ATHLETE EXECUTIVE SEARCH (STAN-**

- DARD CHARACTER**). AARONSON, KATHLEEN, (U.S. CLS. 100, 101 AND 102). SN 77-859,546. PUB. 4-6-2010. FILED 10-28-2009.
- 3,806,555. **NATIONALLY KNOWN, LOCALLY OWNED (STANDARD CHARACTER)**. MATTRESS FIRM, INC., (U.S. CLS. 100, 101 AND 102). SN 77-859,591. PUB. 4-6-2010. FILED 10-28-2009.
- 3,806,565. **SCHEELS RIGHT THERE WITH YOU (STYLIZED)**. SCHEELS ALL SPORTS, INC., (U.S. CLS. 100, 101 AND 102). SN 77-859,759. PUB. 4-6-2010. FILED 10-28-2009.
- 3,806,566. **PINNACLE QUALITY INSIGHT (STANDARD CHARACTER)**. PINNACLE CONSULTING, LLC, (U.S. CLS. 100, 101 AND 102). SN 77-859,763. PUB. 4-6-2010. FILED 10-28-2009.
- 3,806,568. **PINNACLE QUALITY INSIGHT AND DESIGN**. PINNACLE CONSULTING, LLC, (U.S. CLS. 100, 101 AND 102). SN 77-859,792. PUB. 4-6-2010. FILED 10-28-2009.
- 3,806,571. **CHANGING THE WAY HOSPITALS DO BUSINESS (STANDARD CHARACTER)**. TRACTMANAGER, INC., (U.S. CLS. 100, 101 AND 102). SN 77-859,819. PUB. 4-6-2010. FILED 10-28-2009.
- 3,806,580. **THE ART OF WELL BEING (STANDARD CHARACTER)**. RMF DEVELOPMENT LLC, DBA ELIVELIFE-COM, (U.S. CLS. 100, 101 AND 102). SN 77-859,856. PUB. 4-6-2010. FILED 10-28-2009.
- 3,806,588. **ITIQUES (STANDARD CHARACTER)**. LOBOI, JOHN, (U.S. CLS. 100, 101 AND 102). SN 77-859,894. PUB. 4-6-2010. FILED 10-28-2009.
- 3,806,602. **RETAILFIRST! (STANDARD CHARACTER)**. DO IT BEST CORP., (U.S. CLS. 100, 101 AND 102). SN 77-860,036. PUB. 4-6-2010. FILED 10-29-2009.
- 3,806,603. **GLAM CANDY (STANDARD CHARACTER)**. GLAM CANDY, INC., (U.S. CLS. 100, 101 AND 102). SN 77-860,043. PUB. 4-6-2010. FILED 10-29-2009.
- 3,806,604. **MIDWEST SMOKE OUT (STANDARD CHARACTER)**. DIVERSIFIED MARKETING STRATEGIES, INC., (U.S. CLS. 100, 101 AND 102). SN 77-860,054. PUB. 4-6-2010. FILED 10-29-2009.
- 3,806,613. **RECYCLE YOUR HOLIDAYS (STANDARD CHARACTER)**. RECYCLING ASSOCIATION OF MINNESOTA, MULTIPLE CLASS, (INT. CLS. 35 AND 40), (U.S. CLS. 100, 101, 102, 103 AND 106). SN 77-860,150. PUB. 4-6-2010. FILED 10-29-2009.
- 3,806,614. **MISCELLANEOUS DESIGN**. CAMPBELL, MELANIE, (U.S. CLS. 100, 101 AND 102). SN 77-860,159. PUB. 4-6-2010. FILED 10-29-2009.
- 3,806,634. **ACTIVENGAGE (STANDARD CHARACTER)**. ACTIVENGAGE, INC., (U.S. CLS. 100, 101 AND 102). SN 77-860,420. PUB. 4-6-2010. FILED 10-29-2009.
- 3,806,647. **BLUEDOORWAY (STANDARD CHARACTER)**. BLUEDOORWAY, LLC, (U.S. CLS. 100, 101 AND 102). SN 77-860,574. PUB. 4-6-2010. FILED 10-29-2009.
- 3,806,653. **SEARCHONE (STANDARD CHARACTER)**. SEARCHONE, LLC, (U.S. CLS. 100, 101 AND 102). SN 77-860,617. PUB. 4-6-2010. FILED 10-29-2009.
- 3,806,663. **BOLLINGER (STANDARD CHARACTER)**. BOLLINGER, INC., MULTIPLE CLASS, (INT. CLS. 35 AND 36), (U.S. CLS. 100, 101 AND 102). SN 77-860,700. PUB. 4-6-2010. FILED 10-29-2009.
- 3,806,665. **THEAUTSPOT.COM AND DESIGN**. POPOOLA, DELE, AND KOLTSOV, GREG, (U.S. CLS. 100, 101 AND 102). SN 77-860,706. PUB. 4-6-2010. FILED 10-29-2009.
- 3,806,666. **CLIMATE WEEK NYC AND DESIGN**. THE CLIMATE GROUP, MULTIPLE CLASS, (INT. CLS. 35 AND 36), (U.S. CLS. 100, 101 AND 102). SN 77-860,765. PUB. 4-6-2010. FILED 10-29-2009.
- 3,806,669. **OPTIMANET (STANDARD CHARACTER)**. CITI TAX SERVICES INC., (U.S. CLS. 100, 101 AND 102). SN 77-860,786. PUB. 4-6-2010. FILED 10-29-2009.
- 3,806,672. **TRINISPIRIT (STANDARD CHARACTER)**. CASCA-DOO, LLC, (U.S. CLS. 100, 101 AND 102). SN 77-860,829. PUB. 4-6-2010. FILED 10-29-2009.
- 3,806,679. **BOCCI ENGINEERING AND DESIGN**. BOCCI ENGINEERING, MULTIPLE CLASS, (INT. CLS. 35 AND 42), (U.S. CLS. 100, 101 AND 102). SN 77-860,914. PUB. 4-6-2010. FILED 10-29-2009.
- 3,806,680. **CROWDMAGNET (STYLIZED)**. STAHL, DAVID, (U.S. CLS. 100, 101 AND 102). SN 77-860,917. PUB. 4-6-2010. FILED 10-29-2009.
- 3,806,681. **CCLI (STANDARD CHARACTER)**. CHRISTIAN COPYRIGHT LICENSING INTERNATIONAL, INC., MULTIPLE CLASS, (INT. CLS. 35 AND 45), (U.S. CLS. 100, 101 AND 102). SN 77-860,923. PUB. 4-6-2010. FILED 10-29-2009.
- 3,806,685. **SOSBUZZ (STANDARD CHARACTER)**. SOSBUZZ, INC., (U.S. CLS. 100, 101 AND 102). SN 77-860,978. PUB. 4-6-2010. FILED 10-29-2009.
- 3,806,690. **ARGUMENT CLINIC (STANDARD CHARACTER)**. VALANGIMAN SESHAGIRI, MULTIPLE CLASS, (INT. CLS. 35 AND 42), (U.S. CLS. 100, 101 AND 102). SN 77-861,057. PUB. 4-6-2010. FILED 10-30-2009.
- 3,806,701 (*See Class 19 for this trademark*).
- 3,806,715. **THE NO HASSLE ALTERNATIVE TO THE MEDICAL ANSWERING SERVICE (STANDARD CHARACTER)**. ACUMANTRA SOLUTIONS, INC., (U.S. CLS. 100, 101 AND 102). SN 77-861,436. PUB. 4-6-2010. FILED 10-30-2009.
- 3,806,724. **CHBO (STANDARD CHARACTER)**. CORPORATE HOUSING BY OWNER, INC., (U.S. CLS. 100, 101 AND 102). SN 77-861,548. PUB. 4-6-2010. FILED 10-30-2009.
- 3,806,741. **OPTIMIZE YOUR PRACTICE (STANDARD CHARACTER)**. HSR GROUP, INC., DBA THE MARKETING CENTER FOR SOCIAL SECURITY LAW PRACTICES, (U.S. CLS. 100, 101 AND 102). SN 77-861,786. PUB. 4-6-2010. FILED 10-30-2009.
- 3,806,746. **IT'S THE NETWORK THAT DELIVERS (STANDARD CHARACTER)**. RADIANT LOGISTICS, INC., MULTIPLE CLASS, (INT. CLS. 35 AND 39), (U.S. CLS. 100, 101, 102 AND 105). SN 77-861,838. PUB. 4-6-2010. FILED 10-30-2009.
- 3,806,758. **IACQUIRE (STANDARD CHARACTER)**. IACQUIRE, LLC, (U.S. CLS. 100, 101 AND 102). SN 77-862,055. PUB. 4-6-2010. FILED 10-31-2009.
- 3,806,764. **RESUMIGHT! AND DESIGN**. LUSTIG, DAN A, (U.S. CLS. 100, 101 AND 102). SN 77-862,537. PUB. 4-6-2010. FILED 11-2-2009.
- 3,806,765. **JOE'S BLACKBOOK (STANDARD CHARACTER)**. JOE'S BLACKBOOK, INC., (U.S. CLS. 100, 101 AND 102). SN 77-862,542. PUB. 4-6-2010. FILED 11-2-2009.
- 3,806,778. **THE SCENT OF ATTRACTION (STANDARD CHARACTER)**. LODIX CORPORATION, (U.S. CLS. 100, 101 AND 102). SN 77-862,700. PUB. 4-6-2010. FILED 11-2-2009.
- 3,806,781. **IT'S HAPPENING ON THE HARBOR (STANDARD CHARACTER)**. THE PUNTA GORDA CHAMBER OF COMMERCE, INC., (U.S. CLS. 100, 101 AND 102). SN 77-862,736. PUB. 4-6-2010. FILED 11-2-2009.
- 3,806,786. **WAG-O-MAT SHOP (STANDARD CHARACTER)**. PET STOP SALES GROUP, LLC, (U.S. CLS. 100, 101 AND 102). SN 77-862,830. PUB. 4-6-2010. FILED 11-2-2009.
- 3,806,799. **CHAIN SEQUENCE (STANDARD CHARACTER)**. CHAIN SEQUENCE, INC., (U.S. CLS. 100, 101 AND 102). SN 77-863,130. PUB. 4-6-2010. FILED 11-2-2009.
- 3,806,806. **RECRUITING HOUND, INC. AND DESIGN**. RECRUITING HOUND, INC., (U.S. CLS. 100, 101 AND 102). SN 77-863,291. PUB. 4-6-2010. FILED 11-2-2009.
- 3,806,820. **KNOWLEDGEBOX (STANDARD CHARACTER)**. PREMIER, INC., MULTIPLE CLASS, (INT. CLS. 35, 42 AND 44), (U.S. CLS. 100, 101 AND 102). SN 77-863,467. PUB. 4-6-2010. FILED 11-3-2009.
- 3,806,825. **SANTA FEEDS AMERICA (STANDARD CHARACTER)**. CBL & ASSOCIATES MANAGEMENT, INC., (U.S. CLS. 100, 101 AND 102). SN 77-863,510. PUB. 4-6-2010. FILED 11-3-2009.
- 3,806,830. **ECOINSIGHT AND DESIGN**. ECOINSIGHT, INC., (U.S. CLS. 100, 101 AND 102). SN 77-863,644. PUB. 4-6-2010. FILED 11-3-2009.
- 3,806,846 (*See Class 30 for this trademark*).
- 3,806,848. **SO YOU CAN GET TO WHAT YOU REALLY WANT TO BE DOING. (STANDARD CHARACTER)**. LAUREN ZAHNER, (U.S. CLS. 100, 101 AND 102). SN 77-863,884. PUB. 4-6-2010. FILED 11-3-2009.
- 3,806,873. **CHRISTIAN COPYRIGHT LICENSING INTERNATIONAL (STANDARD CHARACTER)**. CHRISTIAN COPYRIGHT LICENSING INTERNATIONAL, INC., MULTIPLE CLASS, (INT. CLS. 35 AND 45), (U.S. CLS. 100, 101 AND 102). SN 77-864,227. PUB. 4-6-2010. FILED 11-3-2009.
- 3,806,876. **EVENT HORIZON 1984 (STANDARD CHARACTER)**

- TER). MICHAEL LIM, DBA EVENT HORIZON, (U.S. CLS. 100, 101 AND 102). SN 77-864,330. PUB. 4-6-2010. FILED 11-3-2009.
- 3,806,883. **RECYCLE THE RAINDROPS (STANDARD CHARACTER)**. RASKIN, CYNTHIA, (U.S. CLS. 100, 101 AND 102). SN 77-864,676. PUB. 4-6-2010. FILED 11-4-2009.
- 3,806,884. **ENERGY SAVED BY 1 AND DESIGN**. ENERGY SAVED BY 1, LLC, (U.S. CLS. 100, 101 AND 102). SN 77-864,771. PUB. 4-6-2010. FILED 11-4-2009.
- 3,806,891. **THE VILLAGE VETS (STANDARD CHARACTER)**. VILLAGE VETERINARY CENTERS, INC., DBA THE VILLAGE VETS, MULTIPLE CLASS, (INT. CLS. 35 AND 44), (U.S. CLS. 100, 101 AND 102). SN 77-865,095. PUB. 4-6-2010. FILED 11-4-2009.
- 3,806,896. **THE VILLAGE VETS MEDICINE SURGERY DENTISTRY BOARDING AND DESIGN**. VILLAGE VETERINARY CENTERS, INC., DBA THE VILLAGE VETS, MULTIPLE CLASS, (INT. CLS. 35 AND 44), (U.S. CLS. 100, 101 AND 102). SN 77-865,195. PUB. 4-6-2010. FILED 11-4-2009.
- 3,806,901. **GO DIRECT. GO GTM. (STANDARD CHARACTER)**. IT'S GREEK TO ME, INC., (U.S. CLS. 100, 101 AND 102). SN 77-865,317. PUB. 4-6-2010. FILED 11-4-2009.
- 3,806,910. **LIGHTING FIRST (STANDARD CHARACTER)**. ADAMS SALES, INC., (U.S. CLS. 100, 101 AND 102). SN 77-865,538. PUB. 4-6-2010. FILED 11-5-2009.
- 3,806,915. **MISCELLANEOUS DESIGN**. GROUSE INDUSTRIES, INC., (U.S. CLS. 100, 101 AND 102). SN 77-866,445. PUB. 4-6-2010. FILED 11-5-2009.
- 3,806,916. **SOLUSOURCE (STANDARD CHARACTER)**. THOMAS PUBLISHING COMPANY, (U.S. CLS. 100, 101 AND 102). SN 77-866,556. PUB. 4-6-2010. FILED 11-6-2009.
- 3,806,919. **HABITAT (STANDARD CHARACTER)**. HABITAT OF HUMANITY INTERNATIONAL, INC., (U.S. CLS. 100, 101 AND 102). SN 77-867,999. PUB. 4-6-2010. FILED 11-9-2009.
- 3,806,923. **OPTIMANET TAX SERVICES AND DESIGN**. CITI TAX SERVICES INC., (U.S. CLS. 100, 101 AND 102). SN 77-868,629. PUB. 4-6-2010. FILED 11-9-2009.
- 3,806,928. **VRS VIDEOREALTYSERVICE YOU DON'T PAY THE PRODUCTION FEE UNTIL IT SELLS! AND DESIGN**. GAMACHE PRODUCTIONS LLC, (U.S. CLS. 100, 101 AND 102). SN 77-869,732. PUB. 4-6-2010. FILED 11-10-2009.
- 3,806,930. **PLANET BULB (STANDARD CHARACTER)**. PLANET BULB, LLC, (U.S. CLS. 100, 101 AND 102). SN 77-869,980. PUB. 4-6-2010. FILED 11-11-2009.
- 3,806,940. **IMPACT (STANDARD CHARACTER)**. HAEMONETICS CORPORATION, (U.S. CLS. 100, 101 AND 102). SN 77-871,284. PUB. 4-6-2010. FILED 11-12-2009.
- 3,806,954. **HOPE WALKS AND DESIGN**. GLOBAL STRATEGIES FOR HIV PREVENTION, MULTIPLE CLASS, (INT. CLS. 35, 36 AND 41), (U.S. CLS. 100, 101, 102 AND 107). SN 77-873,792. PUB. 4-6-2010. FILED 11-16-2009.
- 3,806,968. **BIG GEYSER INC. (STANDARD CHARACTER)**. BIG GEYSER INC., (U.S. CLS. 100, 101 AND 102). SN 77-875,399. PUB. 4-6-2010. FILED 11-18-2009.
- 3,806,973. **SIDE BY SIDE BEFORE YOU DECIDE (STANDARD CHARACTER)**. MATTRESS FIRM, INC., (U.S. CLS. 100, 101 AND 102). SN 77-876,850. PUB. 4-6-2010. FILED 11-19-2009.
- 3,806,975. **ENTREWORKS CONSULTING (STANDARD CHARACTER)**. PAGES, ERIK, (U.S. CLS. 100, 101 AND 102). SN 77-877,222. PUB. 4-6-2010. FILED 11-20-2009.
- 3,806,976. **MW AND DESIGN**. MEDIAWHIZ HOLDINGS, INC., (U.S. CLS. 100, 101 AND 102). SN 77-877,395. PUB. 4-6-2010. FILED 11-20-2009.
- 3,806,984. **KALYAAN MARKET QUALITY INDIAN FOODS AND SPICES AND DESIGN**. KALYAAN MARKET, (U.S. CLS. 100, 101 AND 102). SN 77-879,292. PUB. 4-6-2010. FILED 11-23-2009.
- 3,806,989 (*See Class 9 for this trademark*).
- 3,806,990 (*See Class 9 for this trademark*).
- 3,806,995. **EASYPASS (STANDARD CHARACTER)**. MATTRESS FIRM, INC., MULTIPLE CLASS, (INT. CLS. 35 AND 42), (U.S. CLS. 100, 101 AND 102). SN 77-880,826. PUB. 4-6-2010. FILED 11-25-2009.
- 3,807,005. **LIFETIME STERLING (STANDARD CHARACTER)**. LIFETIME BRANDS, INC., (U.S. CLS. 100, 101 AND 102). SN 77-884,111. PUB. 4-6-2010. FILED 12-2-2009.
- 3,807,007. **CITIZENS BANK QUARTERLY CASH (STANDARD CHARACTER)**. CITIZENS FINANCIAL GROUP, INC., (U.S. CLS. 100, 101 AND 102). SN 77-884,310. PUB. 4-6-2010. FILED 12-2-2009.
- 3,807,009. **MONETIZEIT THE MEDIAWHIZ AFFILIATE NETWORK AND DESIGN**. MEDIAWHIZ HOLDINGS, INC., (U.S. CLS. 100, 101 AND 102). SN 77-884,377. PUB. 4-6-2010. FILED 12-2-2009.
- 3,807,013. **V-LOCAL (STANDARD CHARACTER)**. INTERMARK CORPORATION, (U.S. CLS. 100, 101 AND 102). SN 77-885,725. PUB. 4-6-2010. FILED 12-3-2009.
- 3,807,019. **WAG-O-MAT (STANDARD CHARACTER)**. PET STOP SALES GROUP, LLC, MULTIPLE CLASS, (INT. CLS. 35 AND 44), (U.S. CLS. 100, 101 AND 102). SN 77-886,182. PUB. 4-6-2010. FILED 12-4-2009.
- 3,807,031. **PREPARE FOR COMBAT (STANDARD CHARACTER)**. NIKE, INC., (U.S. CLS. 100, 101 AND 102). SN 77-890,982. PUB. 4-6-2010. FILED 12-10-2009.
- 3,807,045. **MARSHALLS SHOE MEGA SHOP AND DESIGN**. MARSHALLS OF NEVADA, INC., (U.S. CLS. 100, 101 AND 102). SN 77-907,190. PUB. 4-6-2010. FILED 1-7-2010.
- 3,807,049. **FREE GREEN CAN (STANDARD CHARACTER)**. FREE GREEN CAN LLC, (U.S. CLS. 100, 101 AND 102). SN 77-978,521. PUB. 4-6-2010. FILED 4-16-2009.
- 3,807,056. **SYNOVATIA ENERGETIC GROWTH STRATEGIES FOR BUSINESS AND DESIGN**. JACKIE NAGEL, INC., (U.S. CLS. 100, 101 AND 102). SN 78-268,815. PUB. 4-6-2010. FILED 6-30-2003.
- 3,807,059. **CNX MARKETLINK (STANDARD CHARACTER)**. CNW GROUP LTD., MULTIPLE CLASS, (INT. CLS. 35, 36, 38 AND 41), (U.S. CLS. 100, 101, 102, 104 AND 107). SN 78-365,768. PUB. 4-6-2010. FILED 2-10-2004.
- 3,807,065. **GLOBAL TRADE STARTS HERE (STANDARD CHARACTER)**. ALIBABA.COM LIMITED, MULTIPLE CLASS, (INT. CLS. 35, 36, 38 AND 42), (U.S. CLS. 100, 101, 102 AND 104). SN 78-649,982. PUB. 4-6-2010. FILED 6-14-2005.
- 3,807,068 (*See Class 6 for this trademark*).
- 3,807,074. **HELIOS (STANDARD CHARACTER)**. HELIOS KLINIKEN GMBH, MULTIPLE CLASS, (INT. CLS. 35, 37, 38, 39, 42, 43 AND 44), (U.S. CLS. 100, 101, 102, 103, 104, 105 AND 106). SN 78-769,593. PUB. 4-6-2010. FILED 12-8-2005.
- 3,807,082 (*See Class 1 for this trademark*).
- 3,807,089 (*See Class 11 for this trademark*).
- 3,807,091 (*See Class 14 for this trademark*).
- 3,807,101 (*See Class 29 for this trademark*).
- 3,807,114 (*See Class 25 for this trademark*).
- 3,807,127 (*See Class 9 for this trademark*).
- 3,807,141 (*See Class 25 for this trademark*).
- 3,807,150. **XT3 (STANDARD CHARACTER)**. THE TRUSTEES OF THE ROMAN CATHOLIC CHURCH FOR THE ARCHDIOCESE OF SYDNEY, MULTIPLE CLASS, (INT. CLS. 35, 38, 42 AND 45), (U.S. CLS. 100, 101, 102 AND 104). SN 79-065,489. PUB. 11-10-2009. FILED 9-29-2008.
- 3,807,151. **COMMUNIGAYTE AGENTUR FÜR GAY MARKETING & ADVERTISING AND DESIGN**. MICHAEL DRESCHER, MULTIPLE CLASS, (INT. CLS. 35 AND 41), (U.S. CLS. 100, 101, 102 AND 107). SN 79-065,721. PUB. 4-6-2010. FILED 1-13-2009.
- 3,807,152 (*See Class 9 for this trademark*).
- 3,807,153 (*See Class 9 for this trademark*).
- 3,807,155 (*See Class 9 for this trademark*).
- 3,807,158. **DBRLIVE (STYLIZED)**. SUPPONOR OY, MULTIPLE CLASS, (INT. CLS. 35, 41 AND 42), (U.S. CLS. 100, 101, 102 AND 107). SN 79-066,930. PUB. 4-6-2010. FILED 2-4-2009.
- 3,807,164 (*See Class 5 for this trademark*).
- 3,807,165 (*See Class 9 for this trademark*).
- 3,807,182 (*See Class 16 for this trademark*).
- 3,807,208. **INVITALIA AND DESIGN**. AGENZIA NAZIONALE PER L'ATTRAZIONE DEGLI INVESTIMENTI E LO SVILUPPO D'IMPRESA S.P.A., MULTIPLE CLASS, (INT. CLS. 35 AND 36), (U.S. CLS. 100, 101 AND 102). SN 79-069,597. PUB. 4-6-2010. FILED 2-24-2009.
- 3,807,237 (*See Class 29 for this trademark*).
- 3,807,249 (*See Class 9 for this trademark*).
- 3,807,250 (*See Class 18 for this trademark*).
- 3,807,254 (*See Class 5 for this trademark*).
- 3,807,265 (*See Class 19 for this trademark*).

- 3,807,266 (*See Class 9 for this trademark*).
 3,807,274. **CENTRUM JONAS INTERNACIONAL 15. AUG. 1956 JONÁSOVA METÓDA PRIRODZENEJ REGULÁCIE POCATIA AND DESIGN.** MUDR. EUGEN JONÁS, MULTIPLE CLASS, (INT. CLS. 35 AND 44), (U.S. CLS. 100, 101 AND 102). SN 79-071,863. PUB. 4-6-2010. FILED 4-16-2009.
 3,807,275. **MISCELLANEOUS DESIGN.** KABUSHIKI KAISHA; SONY COMPUTER ENTERTAINMENT; (ALSO TRADING AS; SONY COMPUTER ENTERTAINMENT INC.), MULTIPLE CLASS, (INT. CLS. 35, 41 AND 42), (U.S. CLS. 100, 101, 102 AND 107). SN 79-071,955. PUB. 4-6-2010. FILED 4-22-2009.
 3,807,285 (*See Class 6 for this trademark*).
 3,807,300. **MEGA FORTRIS AND DESIGN.** MEGA FORTRIS (MALAYSIA) SDN BHD, (U.S. CLS. 100, 101 AND 102). SN 79-073,362. PUB. 4-6-2010. FILED 5-29-2009.
 3,807,303 (*See Class 12 for this trademark*).
 3,807,309. **GODEVENT (STANDARD CHARACTER).** GODEVENT AB, (U.S. CLS. 100, 101 AND 102). SN 79-073,753. PUB. 4-6-2010. FILED 9-16-2009.

CLASS 36—INSURANCE AND FINANCIAL

- 3,805,134. **JYSKE GLOBAL ASSET MANAGEMENT AND DESIGN.** JYSKE GLOOBAL ASSET MANAGEMENT FONDSMAEGLERSELSKAB A/S, (U.S. CLS. 100, 101 AND 102). SN 76-689,225. PUB. 4-6-2010. FILED 4-30-2008.
 3,805,140. **NJRA NJRA NJRA (STYLIZED).** NEW JERSEY REDEVELOPMENT TRAINING INSTITUTE, (U.S. CLS. 100, 101 AND 102). SN 76-696,694. PUB. 4-6-2010. FILED 4-6-2009.
 3,805,191 (*See Class 16 for this trademark*).
 3,805,193 (*See Class 6 for this trademark*).
 3,805,204 (*See Class 35 for this trademark*).
 3,805,216. **CANDY & CANDY (STANDARD CHARACTER).** CANDY & CANDY LIMITED, (U.S. CLS. 100, 101 AND 102). SN 77-330,542. PUB. 4-6-2010. FILED 11-15-2007.
 3,805,226 (*See Class 35 for this trademark*).
 3,805,268. **IDAYO (STANDARD CHARACTER).** IDAYO INTERNATIONAL, INC., (U.S. CLS. 100, 101 AND 102). SN 77-479,229. PUB. 10-21-2008. FILED 5-20-2008.
 3,805,270. **MISCELLANEOUS DESIGN.** THE SHOKO CHUKIN BANK, LTD., (U.S. CLS. 100, 101 AND 102). SN 77-480,303. PUB. 4-6-2010. FILED 5-21-2008.
 3,805,289. **TRACTIS (STANDARD CHARACTER).** NEGONATION PLATFORM, S.L., MULTIPLE CLASS, (INT. CLS. 36, 38 AND 45), (U.S. CLS. 100, 101, 102 AND 104). SN 77-489,524. PUB. 1-26-2010. FILED 6-3-2008.
 3,805,297 (*See Class 9 for this trademark*).
 3,805,299 (*See Class 12 for this trademark*).
 3,805,316. **IT'S WORTH A TALK. (STANDARD CHARACTER).** CANADIAN IMPERIAL BANK OF COMMERCE, (U.S. CLS. 100, 101 AND 102). SN 77-542,615. PUB. 4-6-2010. FILED 8-8-2008.
 3,805,325. **TD RETAIL CARD SERVICES (STANDARD CHARACTER).** THE TORONTO-DOMINION BANK, (U.S. CLS. 100, 101 AND 102). SN 77-550,729. PUB. 4-6-2010. FILED 8-19-2008.
 3,805,336. **SEGUROS AZTECA MIGRANTE AND DESIGN.** SEGUROS AZTECA S.A. DE C.V., (U.S. CLS. 100, 101 AND 102). SN 77-562,387. PUB. 4-6-2010. FILED 9-4-2008.
 3,805,341. **BERKLEY LIFE SCIENCES (STANDARD CHARACTER).** W. R. BERKLEY CORPORATION, (U.S. CLS. 100, 101 AND 102). SN 77-564,948. PUB. 4-6-2010. FILED 9-8-2008.
 3,805,343. **FEMINIST MAJORITY (STANDARD CHARACTER).** FEMINIST MAJORITY FOUNDATION, MULTIPLE CLASS, (INT. CLS. 36 AND 41), (U.S. CLS. 100, 101, 102 AND 107). SN 77-566,739. PUB. 4-6-2010. FILED 9-10-2008.
 3,805,360. **SAFE STATE AND FEDERAL EMPLOYEES BENEFITS CONSULTING GROUP AND DESIGN.** STATE AND FEDERAL EMPLOYEES BENEFITS CONSULTING GROUP LLP, (U.S. CLS. 100, 101 AND 102). SN 77-582,762. PUB. 4-6-2010. FILED 9-30-2008.
 3,805,361. **EDUCARUNO (STANDARD CHARACTER).** EDUCARUNO, ASOCIACION CIVIL, (U.S. CLS. 100, 101 AND 102). SN 77-582,868. PUB. 4-6-2010. FILED 10-1-2008.
 3,805,399. **TYGRIS COMMERCIAL FINANCE AND DESIGN.** TYGRIS COMMERCIAL FINANCE GROUP, INC., (U.S. CLS. 100, 101 AND 102). SN 77-619,114. PUB. 4-6-2010. FILED 11-20-2008.
 3,805,415 (*See Class 35 for this trademark*).
 3,805,416 (*See Class 35 for this trademark*).
 3,805,425 (*See Class 4 for this trademark*).
 3,805,428 (*See Class 35 for this trademark*).
 3,805,442. **GREEN MACHINE (STANDARD CHARACTER).** THE TORONTO-DOMINION BANK, (U.S. CLS. 100, 101 AND 102). SN 77-650,564. PUB. 4-6-2010. FILED 1-15-2009.
 3,805,443. **GREEN MACHINE AND DESIGN.** THE TORONTO-DOMINION BANK, (U.S. CLS. 100, 101 AND 102). SN 77-650,584. PUB. 4-6-2010. FILED 1-15-2009.
 3,805,446 (*See Class 35 for this trademark*).
 3,805,447 (*See Class 35 for this trademark*).
 3,805,461 (*See Class 16 for this trademark*).
 3,805,465 (*See Class 16 for this trademark*).
 3,805,466 (*See Class 16 for this trademark*).
 3,805,471. **MARKET TOPOGRAPHER (STANDARD CHARACTER).** OCE INTERACTIVE LLC, (U.S. CLS. 100, 101 AND 102). SN 77-678,726. PUB. 4-6-2010. FILED 2-26-2009.
 3,805,496. **RETAILERS CASUALTY INSURANCE COMPANY AND DESIGN.** RETAILERS CASUALTY INSURANCE COMPANY, (U.S. CLS. 100, 101 AND 102). SN 77-700,008. PUB. 4-6-2010. FILED 3-26-2009.
 3,805,528. **MTL EQUITY PRODUCTS, INC. A MEMBER OF THE MUTUAL TRUST FINANCIAL GROUP (STANDARD CHARACTER).** MTL INSURANCE COMPANY, (U.S. CLS. 100, 101 AND 102). SN 77-717,154. PUB. 4-6-2010. FILED 4-20-2009.
 3,805,529. **MTL AGENCY, INC. A MEMBER OF THE MUTUAL TRUST FINANCIAL GROUP (STANDARD CHARACTER).** MTL INSURANCE COMPANY, (U.S. CLS. 100, 101 AND 102). SN 77-717,155. PUB. 4-6-2010. FILED 4-20-2009.
 3,805,547. **CHOSEN PEOPLE MINISTRIES (STANDARD CHARACTER).** CHOSEN PEOPLE MINISTRIES, INC., (U.S. CLS. 100, 101 AND 102). SN 77-721,552. PUB. 4-6-2010. FILED 4-24-2009.
 3,805,567. **MECKLENBURG BAR FOUNDATION MBF 26TH JUDICIAL DISTRICT EST 1962 AND DESIGN.** MECKLENBURG BAR FOUNDATION, (U.S. CLS. 100, 101 AND 102). SN 77-724,236. PUB. 4-6-2010. FILED 4-28-2009.
 3,805,570. **PRACTICAL MAGIC BALL (STANDARD CHARACTER).** CITY HARVEST, INC., (U.S. CLS. 100, 101 AND 102). SN 77-724,829. PUB. 4-6-2010. FILED 4-29-2009.
 3,805,576. **SASSI AND DESIGN.** THE W.H. BROWNYARD CORPORATION, (U.S. CLS. 100, 101 AND 102). SN 77-726,803. PUB. 4-6-2010. FILED 5-1-2009.
 3,805,585. **CRISTA (STANDARD CHARACTER).** CRISTA MINISTRIES, MULTIPLE CLASS, (INT. CLS. 36 AND 41), (U.S. CLS. 100, 101, 102 AND 107). SN 77-727,613. PUB. 4-6-2010. FILED 5-2-2009.
 3,805,592 (*See Class 9 for this trademark*).
 3,805,613. **ATLANTIS HEALTH PLAN BY DOCTORS. FOR NEW YORKERS. (STANDARD CHARACTER).** ATLANTIS HEALTH PLAN, INC., (U.S. CLS. 100, 101 AND 102). SN 77-731,267. PUB. 4-6-2010. FILED 5-7-2009.
 3,805,615. **TEAM CONTINUUM (STANDARD CHARACTER).** TEAM CONTINUUM, (U.S. CLS. 100, 101 AND 102). SN 77-731,874. PUB. 4-6-2010. FILED 5-7-2009.
 3,805,647. **TEAM CONTINUUM AND DESIGN.** TEAM CONTINUUM, (U.S. CLS. 100, 101 AND 102). SN 77-736,193. PUB. 4-6-2010. FILED 5-13-2009.
 3,805,684. **CG COLCHESTER GLOBAL INVESTORS AND DESIGN.** COLCHESTER GLOBAL INVESTORS LIMITED, (U.S. CLS. 100, 101 AND 102). SN 77-744,253. PUB. 4-6-2010. FILED 5-26-2009.
 3,805,689. **COLCHESTER GLOBAL INVESTORS (STANDARD CHARACTER).** COLCHESTER GLOBAL INVESTORS LIMITED, (U.S. CLS. 100, 101 AND 102). SN 77-744,524. PUB. 4-6-2010. FILED 5-26-2009.
 3,805,705. **CAROUSEL CAPITAL (STANDARD CHARACTER).** CAROUSEL CAPITAL MANAGEMENT COMPANY, LP, (U.S. CLS. 100, 101 AND 102). SN 77-747,827. PUB. 4-6-2010. FILED 5-29-2009.
 3,805,706. **MISCELLANEOUS DESIGN.** CAROUSEL CAPI-

- TAL MANAGEMENT COMPANY, LP, (U.S. CLS. 100, 101 AND 102). SN 77-747,863. PUB. 4-6-2010. FILED 5-29-2009.
- 3,805,733. **LAND VISTA (STANDARD CHARACTER)**. LAND VISTA LLC, (U.S. CLS. 100, 101 AND 102). SN 77-755,900. PUB. 4-6-2010. FILED 6-10-2009.
- 3,805,757. **CB CAPITAL PARTNERS (STANDARD CHARACTER)**. CHRISTOPHER J. BACLAWSKI ENTERPRISES, INC., (U.S. CLS. 100, 101 AND 102). SN 77-760,701. PUB. 4-6-2010. FILED 6-16-2009.
- 3,805,782 (*See Class 16 for this trademark*).
- 3,805,790. **VM AND DESIGN**. HARRIS CONSULTING, INC., DBA VANTAGE MORTGAGE GROUP, INC., (U.S. CLS. 100, 101 AND 102). SN 77-768,695. PUB. 11-10-2009. FILED 6-25-2009.
- 3,805,796. **MISCELLANEOUS DESIGN**. NAVAL AVIATION MUSEUM FOUNDATION, INC., (U.S. CLS. 100, 101 AND 102). SN 77-770,736. PUB. 4-6-2010. FILED 6-29-2009.
- 3,805,811. **EXCHANGERATES.COM AND DESIGN**. VERANDAGLOBAL.COM, INC., DBA FIRST PLACE INTERNET, INC., (U.S. CLS. 100, 101 AND 102). SN 77-773,671. PUB. 4-6-2010. FILED 7-2-2009.
- 3,805,821. **YOUR HEALTH, OUR PROMISE (STANDARD CHARACTER)**. NEIGHBORHOOD HEALTH PLAN, INC., MULTIPLE CLASS, (INT. CLS. 36 AND 44), (U.S. CLS. 100, 101 AND 102). SN 77-778,729. PUB. 4-6-2010. FILED 7-10-2009.
- 3,805,822. **MISCELLANEOUS DESIGN**. NEIGHBORHOOD HEALTH PLAN, INC., MULTIPLE CLASS, (INT. CLS. 36 AND 44), (U.S. CLS. 100, 101 AND 102). SN 77-778,738. PUB. 4-6-2010. FILED 7-10-2009.
- 3,805,828 (*See Class 35 for this trademark*).
- 3,805,829. **CONTINUE EXTEND PLUS (STANDARD CHARACTER)**. AMERICAN INTERNATIONAL GROUP, INC., (U.S. CLS. 100, 101 AND 102). SN 77-780,326. PUB. 4-6-2010. FILED 7-14-2009.
- 3,805,835. **NATIONAL PSORIASIS FOUNDATION WALK TO CURE PSORIASIS AND DESIGN**. NATIONAL PSORIASIS FOUNDATION, MULTIPLE CLASS, (INT. CLS. 36 AND 41), (U.S. CLS. 100, 101, 102 AND 107). SN 77-780,955. PUB. 4-6-2010. FILED 7-14-2009.
- 3,805,836. **NATIONAL PSORIASIS FOUNDATION WALK TO CURE PSORIASIS AND DESIGN**. NATIONAL PSORIASIS FOUNDATION, MULTIPLE CLASS, (INT. CLS. 36 AND 41), (U.S. CLS. 100, 101, 102 AND 107). SN 77-781,033. PUB. 4-6-2010. FILED 7-14-2009.
- 3,805,839. **CLARK STREET CAPITAL (STANDARD CHARACTER)**. CLARK STREET CAPITAL MANAGEMENT, LLC, (U.S. CLS. 100, 101 AND 102). SN 77-781,321. PUB. 4-6-2010. FILED 7-15-2009.
- 3,805,851. **PHOTOPHILANTHROPY (STANDARD CHARACTER)**. FARESE FAMILY FOUNDATION, THE, (U.S. CLS. 100, 101 AND 102). SN 77-784,808. PUB. 4-6-2010. FILED 7-20-2009.
- 3,805,860. **IRA ADD-VANTAGE (STANDARD CHARACTER)**. TORONTO-DOMINION BANK, THE, (U.S. CLS. 100, 101 AND 102). SN 77-787,789. PUB. 4-6-2010. FILED 7-23-2009.
- 3,805,870 (*See Class 35 for this trademark*).
- 3,805,884. **OC AND THE OWNERS CLUB AND DESIGN**. CLUBCORP, INC., (U.S. CLS. 100, 101 AND 102). SN 77-793,147. PUB. 4-6-2010. FILED 7-30-2009.
- 3,805,890. **ISOPAY (STANDARD CHARACTER)**. ISOPAY, L.L.C., (U.S. CLS. 100, 101 AND 102). SN 77-794,053. PUB. 12-29-2009. FILED 7-31-2009.
- 3,805,899 (*See Class 35 for this trademark*).
- 3,805,902. **PROPERTY ADVANCE (STANDARD CHARACTER)**. CNA FINANCIAL CORPORATION, (U.S. CLS. 100, 101 AND 102). SN 77-796,490. PUB. 4-6-2010. FILED 8-4-2009.
- 3,805,903. **CNA NETPROTECT (STANDARD CHARACTER)**. CNA FINANCIAL CORPORATION, (U.S. CLS. 100, 101 AND 102). SN 77-796,491. PUB. 4-6-2010. FILED 8-4-2009.
- 3,805,904. **EPACK EZ (STANDARD CHARACTER)**. CNA FINANCIAL CORPORATION, (U.S. CLS. 100, 101 AND 102). SN 77-796,494. PUB. 4-6-2010. FILED 8-4-2009.
- 3,805,914. **FIRST CLASS FINANCING (STANDARD CHARACTER)**. DAIMLER AG, (U.S. CLS. 100, 101 AND 102). SN 77-798,483. PUB. 4-6-2010. FILED 8-6-2009.
- 3,805,926. **NETPROTECT ESSENTIAL (STANDARD CHARACTER)**. CNA FINANCIAL CORPORATION, (U.S. CLS. 100, 101 AND 102). SN 77-801,532. PUB. 4-6-2010. FILED 8-11-2009.
- 3,805,929. **BROKER IN A BOX (STANDARD CHARACTER)**. OPTIMUS FUNDING CORPORATION, (U.S. CLS. 100, 101 AND 102). SN 77-802,612. PUB. 4-6-2010. FILED 8-12-2009.
- 3,805,980. **BETTERBORROWERS AND DESIGN**. BETTER BORROWERS, LLC, (U.S. CLS. 100, 101 AND 102). SN 77-811,775. PUB. 4-6-2010. FILED 8-25-2009.
- 3,805,985. **TRUSTFIRST FINANCIAL (STANDARD CHARACTER)**. JOHNSON, CHARLES DEAN, DBA TRUSTFIRST FINANCIAL, (U.S. CLS. 100, 101 AND 102). SN 77-814,445. PUB. 4-6-2010. FILED 8-27-2009.
- 3,805,996. **STADION AND DESIGN**. STADION MONEY MANAGEMENT, INC., (U.S. CLS. 100, 101 AND 102). SN 77-816,423. PUB. 4-6-2010. FILED 8-31-2009.
- 3,805,997. **MAXIM LIFETIME ASSET ALLOCATION SERIES (STANDARD CHARACTER)**. GREAT-WEST LIFE & ANNUITY INSURANCE COMPANY, (U.S. CLS. 100, 101 AND 102). SN 77-816,549. PUB. 4-6-2010. FILED 8-31-2009.
- 3,806,029. **COBBLESTONE HARRIS WILLIAMS AND DESIGN**. HARRIS WILLIAMS LLC, DBA HARRIS WILLIAMS & CO., (U.S. CLS. 100, 101 AND 102). SN 77-821,690. PUB. 4-6-2010. FILED 9-8-2009.
- 3,806,034. **360 AND DESIGN**. 360FUELCARD.COM LLC, DBA INTEGRITY MARKETING, (U.S. CLS. 100, 101 AND 102). SN 77-822,026. PUB. 4-6-2010. FILED 9-8-2009.
- 3,806,046. **S.USA WOMEN (STANDARD CHARACTER)**. SB LI USA MUTUAL LIFE INSURANCE COMPANY, INC., MULTIPLE CLASS, (INT. CLS. 36 AND 44), (U.S. CLS. 100, 101 AND 102). SN 77-823,996. PUB. 4-6-2010. FILED 9-10-2009.
- 3,806,048. **NOT ONE MORE CHILD! NOT ONE MORE FAMILY! (STANDARD CHARACTER)**. GOLD RUSH CURE FOUNDATION INC., (U.S. CLS. 100, 101 AND 102). SN 77-824,341. PUB. 4-6-2010. FILED 9-10-2009.
- 3,806,072. **ADIUM (STANDARD CHARACTER)**. ADIUM, LLC, (U.S. CLS. 100, 101 AND 102). SN 77-827,391. PUB. 4-6-2010. FILED 9-16-2009.
- 3,806,096. **EDWARDJONES MAKING SENSE OF INVESTING (STYLIZED)**. EDWARD D. JONES & CO. LP, (U.S. CLS. 100, 101 AND 102). SN 77-833,432. PUB. 4-6-2010. FILED 9-23-2009.
- 3,806,112. **O AND DESIGN**. LANGVA, MARC D., (U.S. CLS. 100, 101 AND 102). SN 77-836,116. PUB. 4-6-2010. FILED 9-28-2009.
- 3,806,122. **EMBRACING LIFE (STANDARD CHARACTER)**. SIMPSON SENIOR SERVICES, MULTIPLE CLASS, (INT. CLS. 36 AND 43), (U.S. CLS. 100, 101 AND 102). SN 77-837,113. PUB. 4-6-2010. FILED 9-29-2009.
- 3,806,131. **BLINGTAG (STANDARD CHARACTER)**. BLING NATION, LTD., (U.S. CLS. 100, 101 AND 102). SN 77-838,071. PUB. 4-6-2010. FILED 9-30-2009.
- 3,806,146. **LRG LEITER REALTY GROUP AND DESIGN**. LEITER REALTY GROUP, LLC, (U.S. CLS. 100, 101 AND 102). SN 77-839,776. PUB. 4-6-2010. FILED 10-1-2009.
- 3,806,172. **SAPIENT CAPITAL (STANDARD CHARACTER)**. SAPIENT CAPITAL MANAGEMENT, LLC, (U.S. CLS. 100, 101 AND 102). SN 77-843,735. PUB. 4-6-2010. FILED 10-7-2009.
- 3,806,178 (*See Class 35 for this trademark*).
- 3,806,194. **ECO STARR (STANDARD CHARACTER)**. C. V. STARR & CO., INC., (U.S. CLS. 100, 101 AND 102). SN 77-845,783. PUB. 4-6-2010. FILED 10-9-2009.
- 3,806,195. **STARR RESPONSE (STANDARD CHARACTER)**. C. V. STARR & CO., INC., (U.S. CLS. 100, 101 AND 102). SN 77-845,792. PUB. 4-6-2010. FILED 10-9-2009.
- 3,806,225. **MY MONEY MY FUTURE MY TENNESSEE 401(K) & 457 DEFERRED COMPENSATION PROGRAM AND DESIGN**. GREAT-WEST LIFE & ANNUITY INSURANCE COMPANY, (U.S. CLS. 100, 101 AND 102). SN 77-848,677. PUB. 4-6-2010. FILED 10-14-2009.
- 3,806,250. **THE CHILDREN'S HEART FOUNDATION AND DESIGN**. CHILDREN'S HEART FOUNDATION, (U.S. CLS. 100, 101 AND 102). SN 77-850,913. PUB. 4-6-2010. FILED 10-16-2009.
- 3,806,333. **BAMBOO LEASING (STANDARD CHARACTER)**. BAMBOO REALTY, INC., (U.S. CLS. 100, 101 AND 102). SN 77-855,802. PUB. 4-6-2010. FILED 10-23-2009.

- 3,806,342. **MANAGER CONNECT AND DESIGN**, MESIROW FINANCIAL HOLDINGS, INC., (U.S. CLS. 100, 101 AND 102). SN 77-856,118. PUB. 4-6-2010. FILED 10-23-2009.
- 3,806,351. **ATHLETES FOR THE EARTH (STANDARD CHARACTER)**, EARTH DAY NETWORK, INC., (U.S. CLS. 100, 101 AND 102). SN 77-856,573. PUB. 4-6-2010. FILED 10-23-2009.
- 3,806,370. **STERLING JEWELERS GOLD EXCHANGE (STANDARD CHARACTER)**, STERLING OF OHIO, INC., (U.S. CLS. 100, 101 AND 102). SN 77-857,087. PUB. 4-6-2010. FILED 10-26-2009.
- 3,806,371. **JBR GOLD EXCHANGE (STANDARD CHARACTER)**, STERLING OF OHIO, INC., (U.S. CLS. 100, 101 AND 102). SN 77-857,094. PUB. 4-6-2010. FILED 10-26-2009.
- 3,806,372. **JARED GOLD EXCHANGE (STANDARD CHARACTER)**, STERLING OF OHIO, INC., (U.S. CLS. 100, 101 AND 102). SN 77-857,098. PUB. 4-6-2010. FILED 10-26-2009.
- 3,806,401. **ARMOS (STANDARD CHARACTER)**, ARMOS VENTURES INTERNATIONAL, LLC, (U.S. CLS. 100, 101 AND 102). SN 77-857,949. PUB. 4-6-2010. FILED 10-27-2009.
- 3,806,468. **SHOWSTOPPERS AND DESIGN**, AFFINITY INSURANCE SERVICES, INC., (U.S. CLS. 100, 101 AND 102). SN 77-858,622. PUB. 4-6-2010. FILED 10-27-2009.
- 3,806,470. **TIX (STANDARD CHARACTER)**, WORLDWIDE ACCESS SOLUTIONS, INC., (U.S. CLS. 100, 101 AND 102). SN 77-858,630. PUB. 4-6-2010. FILED 10-27-2009.
- 3,806,493. **FRIENDS OF NICU AND DESIGN**, FRIENDS OF NICU, (U.S. CLS. 100, 101 AND 102). SN 77-858,805. PUB. 4-6-2010. FILED 10-27-2009.
- 3,806,507 (*See Class 35 for this trademark*).
- 3,806,553. **CAMPAIGNPRO (STANDARD CHARACTER)**, MARKEL CORPORATION, (U.S. CLS. 100, 101 AND 102). SN 77-859,574. PUB. 4-6-2010. FILED 10-28-2009.
- 3,806,558. **TOWBOAT INVITATIONAL AND DESIGN**, FOSS MARITIME COMPANY, (U.S. CLS. 100, 101 AND 102). SN 77-859,659. PUB. 4-6-2010. FILED 10-28-2009.
- 3,806,574. **ULLICO INVESTMENT ADVISORS (STANDARD CHARACTER)**, ULLICO, INC., (U.S. CLS. 100, 101 AND 102). SN 77-859,841. PUB. 4-6-2010. FILED 10-28-2009.
- 3,806,582. **THE ARMORETTES ATLANTA AND DESIGN**, THE ARMORETTES, (U.S. CLS. 100, 101 AND 102). SN 77-859,861. PUB. 4-6-2010. FILED 10-28-2009.
- 3,806,593. **CONDO SHARKS (STANDARD CHARACTER)**, CONDO SHARKS, INC., (U.S. CLS. 100, 101 AND 102). SN 77-859,994. PUB. 4-6-2010. FILED 10-29-2009.
- 3,806,630. **SKYMARK RESEARCH (STANDARD CHARACTER)**, KIRK, BEN, (U.S. CLS. 100, 101 AND 102). SN 77-860,374. PUB. 4-6-2010. FILED 10-29-2009.
- 3,806,632. **WHERE RENTERS FIND HOMES (STANDARD CHARACTER)**, MILNOR, WALKER I., (U.S. CLS. 100, 101 AND 102). SN 77-860,388. PUB. 4-6-2010. FILED 10-29-2009.
- 3,806,642. **VERYCOOLSPACE (STYLIZED)**, DRUMELLER PROPERTIES, LLC, (U.S. CLS. 100, 101 AND 102). SN 77-860,545. PUB. 4-6-2010. FILED 10-29-2009.
- 3,806,663 (*See Class 35 for this trademark*).
- 3,806,666 (*See Class 35 for this trademark*).
- 3,806,689. **NO MORE WAITING (STANDARD CHARACTER)**, NOVATION CAPITAL, LLC, (U.S. CLS. 100, 101 AND 102). SN 77-861,033. PUB. 4-6-2010. FILED 10-30-2009.
- 3,806,731. **FOUNDATION FOR LIFE. INVESTING WITH WISDOM. (STANDARD CHARACTER)**, CHARTWELL FAMILY OFFICE, LLC, (U.S. CLS. 100, 101 AND 102). SN 77-861,648. PUB. 4-6-2010. FILED 10-30-2009.
- 3,806,752. **DAMELECIA (STANDARD CHARACTER)**, DAMELECIA, INC., (U.S. CLS. 100, 101 AND 102). SN 77-861,941. PUB. 4-6-2010. FILED 10-30-2009.
- 3,806,821. **CEREDEX VALUE ADVISORS (STANDARD CHARACTER)**, SUNTRUST BANKS, INC., (U.S. CLS. 100, 101 AND 102). SN 77-863,481. PUB. 4-6-2010. FILED 11-3-2009.
- 3,806,822. **FANTASYPROTECT.COM (STANDARD CHARACTER)**, FANTASYPROTECT.COM, LLC, (U.S. CLS. 100, 101 AND 102). SN 77-863,495. PUB. 4-6-2010. FILED 11-3-2009.
- 3,806,833. **MISCELLANEOUS DESIGN**, NEW YORK YACHT CLUB, MULTIPLE CLASS, (INT. CLS. 36, 41 AND 43), (U.S. CLS. 100, 101, 102 AND 107). SN 77-863,720. PUB. 4-6-2010. FILED 11-3-2009.
- 3,806,852. **AC= (STANDARD CHARACTER)**, FUNRAISERS LLC, (U.S. CLS. 100, 101 AND 102). SN 77-863,938. PUB. 4-6-2010. FILED 11-3-2009.
- 3,806,854. **JLLCW (STANDARD CHARACTER)**, FUNRAISERS LLC, (U.S. CLS. 100, 101 AND 102). SN 77-863,959. PUB. 4-6-2010. FILED 11-3-2009.
- 3,806,867. **SCNB SUFFOLK COUNTY NATIONAL BANK AND DESIGN**, SUFFOLK COUNTY NATIONAL BANK, (U.S. CLS. 100, 101 AND 102). SN 77-864,147. PUB. 4-6-2010. FILED 11-3-2009.
- 3,806,870. **SCNB SUFFOLK COUNTY NATIONAL BANK AND DESIGN**, SUFFOLK COUNTY NATIONAL BANK, (U.S. CLS. 100, 101 AND 102). SN 77-864,183. PUB. 4-6-2010. FILED 11-3-2009.
- 3,806,879. **FIRMS (STYLIZED)**, FIRST INSURANCE COMPANY OF HAWAII, LTD., (U.S. CLS. 100, 101 AND 102). SN 77-864,402. PUB. 4-6-2010. FILED 11-3-2009.
- 3,806,898. **MISCELLANEOUS DESIGN**, THE WELLNESS COMMUNITY OF SOUTHERN CONNECTICUT, (U.S. CLS. 100, 101 AND 102). SN 77-865,291. PUB. 4-6-2010. FILED 11-4-2009.
- 3,806,914. **NOSOCOMIAL RX (STANDARD CHARACTER)**, AKITA, INC., (U.S. CLS. 100, 101 AND 102). SN 77-866,061. PUB. 4-6-2010. FILED 11-5-2009.
- 3,806,920. **HABITAT (STANDARD CHARACTER)**, HABITAT FOR HUMANITY INTERNATIONAL, INC., (U.S. CLS. 100, 101 AND 102). SN 77-868,006. PUB. 4-6-2010. FILED 11-9-2009.
- 3,806,929. **CAMPAIGNSAFE (STANDARD CHARACTER)**, MARKEL CORPORATION, (U.S. CLS. 100, 101 AND 102). SN 77-869,764. PUB. 4-6-2010. FILED 11-10-2009.
- 3,806,941. **SHARPHOME.COM (STANDARD CHARACTER)**, HY-KO PRODUCTS COMPANY, (U.S. CLS. 100, 101 AND 102). SN 77-871,337. PUB. 4-6-2010. FILED 11-12-2009.
- 3,806,945. **BRASS BALLS PAWN (STANDARD CHARACTER)**, DUNCAN, KATHLEEN, (U.S. CLS. 100, 101 AND 102). SN 77-871,660. PUB. 4-6-2010. FILED 11-12-2009.
- 3,806,954 (*See Class 35 for this trademark*).
- 3,806,971. **PNA BANK AND DESIGN**, PNA BANK, (U.S. CLS. 100, 101 AND 102). SN 77-876,738. PUB. 4-6-2010. FILED 11-19-2009.
- 3,806,972. **PNA BANK (STANDARD CHARACTER)**, PNA BANK, (U.S. CLS. 100, 101 AND 102). SN 77-876,746. PUB. 4-6-2010. FILED 11-19-2009.
- 3,806,978. **HARMONIZING THE CAPITAL OF BUSINESS AND LIFE (STANDARD CHARACTER)**, BRONFMAN, MARK C., (U.S. CLS. 100, 101 AND 102). SN 77-877,480. PUB. 4-6-2010. FILED 11-20-2009.
- 3,807,002. **DNOA (STANDARD CHARACTER)**, HEALTH CARE SERVICE CORPORATION, (U.S. CLS. 100, 101 AND 102). SN 77-883,360. PUB. 4-6-2010. FILED 12-1-2009.
- 3,807,014. **BROOKLYNLOFTS.COM AND DESIGN**, JOFFE, PAUL, (U.S. CLS. 100, 101 AND 102). SN 77-885,796. PUB. 4-6-2010. FILED 12-3-2009.
- 3,807,016. **MARGARET A. CARGILL FOUNDATION (STANDARD CHARACTER)**, MARGARET A. CARGILL FOUNDATION, (U.S. CLS. 100, 101 AND 102). SN 77-885,846. PUB. 4-6-2010. FILED 12-3-2009.
- 3,807,022. **DENTEMAX (STANDARD CHARACTER)**, HEALTH CARE SERVICE CORPORATION, (U.S. CLS. 100, 101 AND 102). SN 77-888,555. PUB. 4-6-2010. FILED 12-8-2009.
- 3,807,023. **DENTEMAX AND DESIGN**, HEALTH CARE SERVICE CORPORATION, (U.S. CLS. 100, 101 AND 102). SN 77-888,574. PUB. 4-6-2010. FILED 12-8-2009.
- 3,807,038. **GOOD RELATIONSHIPS ARE GOOD BUSINESS (STANDARD CHARACTER)**, SUFFOLK COUNTY NATIONAL BANK, (U.S. CLS. 100, 101 AND 102). SN 77-894,972. PUB. 4-6-2010. FILED 12-16-2009.
- 3,807,039. **SELLING LOUDOUN COUNTY ONE FRONT DOOR AT A TIME (STANDARD CHARACTER)**, FRONT DOOR REALTY, (U.S. CLS. 100, 101 AND 102). SN 77-895,249. PUB. 4-6-2010. FILED 12-16-2009.
- 3,807,057. **HILCO REAL ESTATE (STANDARD CHARACTER)**, HILCO TRADING, LLC, (U.S. CLS. 100, 101 AND 102). SN 78-346,059. PUB. 4-6-2010. FILED 12-29-2003.
- 3,807,058. **NORTHSTAR AND DESIGN**, CNL INCOME NORTHSTAR, LLC, MULTIPLE CLASS, (INT. CLS. 36, 37 AND 41), (U.S. CLS. 100, 101, 102, 103, 106 AND 107). SN 78-360,021. PUB. 4-6-2010. FILED 1-30-2004.

3,807,059 (*See Class 35 for this trademark.*)
 3,807,060. **LANDMARK CREDIT UNION AND DESIGN.** LANDMARK CREDIT UNION, (U.S. CLS. 100, 101 AND 102). SN 78-368,699. PUB. 4-6-2010. FILED 2-16-2004.
 3,807,062. **EUREKA GROWTH CAPITAL (STANDARD CHARACTER).** EUREKA GROWTH CAPITAL II, L.P., (U.S. CLS. 100, 101 AND 102). SN 78-606,472. PUB. 4-6-2010. FILED 4-11-2005.
 3,807,065 (*See Class 35 for this trademark.*)
 3,807,068 (*See Class 6 for this trademark.*)
 3,807,076. **HARBOR CAPITAL GROUP (STANDARD CHARACTER).** HARBOR CAPITAL GROUP, (U.S. CLS. 100, 101 AND 102). SN 78-807,733. PUB. 4-6-2010. FILED 2-6-2006.
 3,807,077. **GENFUND (STANDARD CHARACTER).** GENUITY FINANCIAL GROUP, (U.S. CLS. 100, 101 AND 102). SN 78-824,496. PUB. 4-6-2010. FILED 2-27-2006.
 3,807,081 (*See Class 9 for this trademark.*)
 3,807,083 (*See Class 9 for this trademark.*)
 3,807,088. **PRAYERS 4 PAWS (STANDARD CHARACTER).** BRAUN, WILLIAM C., (U.S. CLS. 100, 101 AND 102). SN 78-949,025. PUB. 4-6-2010. FILED 8-10-2006.
 3,807,127 (*See Class 9 for this trademark.*)
 3,807,192 (*See Class 10 for this trademark.*)
 3,807,196 (*See Class 9 for this trademark.*)
 3,807,208 (*See Class 35 for this trademark.*)
 3,807,251 (*See Class 9 for this trademark.*)
 3,807,368. **GCPI (STANDARD CHARACTER).** DEUTSCHE BÖRSE AG, (U.S. CLS. 100, 101 AND 102). SN 79-077,784. PUB. 4-6-2010. FILED 10-19-2009.

CLASS 37—CONSTRUCTION AND REPAIR

3,805,185 (*See Class 7 for this trademark.*)
 3,805,202 (*See Class 6 for this trademark.*)
 3,805,255. **JANI-LOTS (STANDARD CHARACTER).** SADOWSKI, RICHARD A, DBA JANI-LOTS, FORMERLY R.A.S. REPAIR SERVICE LLC, (U.S. CLS. 100, 103 AND 106). SN 77-433,665. PUB. 4-6-2010. FILED 3-27-2008.
 3,805,299 (*See Class 12 for this trademark.*)
 3,805,313 (*See Class 9 for this trademark.*)
 3,805,363. **A & D ENVIRONMENTAL (STANDARD CHARACTER).** A&D ENVIRONMENTAL SERVICES, INC., MULTIPLE CLASS, (INT. CLS. 37, 40 AND 42), (U.S. CLS. 100, 101, 103 AND 106). SN 77-583,845. PUB. 4-6-2010. FILED 10-2-2008.
 3,805,425 (*See Class 4 for this trademark.*)
 3,805,454 (*See Class 35 for this trademark.*)
 3,805,463. **CRAFTING THE HIGHLY EFFECTIVE HOMEOWNER (STANDARD CHARACTER).** HOMEWORKS - COLLABORATE, COACH, CONTRACT, LLC, (U.S. CLS. 100, 103 AND 106). SN 77-673,384. PUB. 4-6-2010. FILED 2-19-2009.
 3,805,468. **ATC DRIVETRAIN AND DESIGN.** ATC TECHNOLOGY CORPORATION, (U.S. CLS. 100, 103 AND 106). SN 77-677,685. PUB. 4-6-2010. FILED 2-25-2009.
 3,805,476 (*See Class 2 for this trademark.*)
 3,805,482 (*See Class 9 for this trademark.*)
 3,805,483. **V AND DESIGN.** VERDOLINI, MICHAEL D., (U.S. CLS. 100, 103 AND 106). SN 77-687,103. PUB. 4-6-2010. FILED 3-10-2009.
 3,805,522. **FAAKS SR654X AIR RIDERS AVIATION, INC. AND DESIGN.** PERONT, DERRICK, DBA AIR RIDERS AVIATION, INC., (U.S. CLS. 100, 103 AND 106). SN 77-714,335. PUB. 4-6-2010. FILED 4-15-2009.
 3,805,527 (*See Class 35 for this trademark.*)
 3,805,600. **JOE OCHOA ROOFS & EVEN MORE AND DESIGN.** JOE OCHOA ROOFING, INC. (U.S. CLS. 100, 103 AND 106). SN 77-730,143. PUB. 4-6-2010. FILED 5-6-2009.
 3,805,607. **EVERHART CONSTRUCTION (STANDARD CHARACTER).** EVERHART, ANTHONY R, (U.S. CLS. 100, 103 AND 106). SN 77-731,034. PUB. 4-6-2010. FILED 5-7-2009.
 3,805,673. **SSI SUSTAINABLE SYSTEMS INTEGRATORS AND DESIGN.** SUSTAINABLE SYSTEMS INTEGRATORS LLC, (U.S. CLS. 100, 103 AND 106). SN 77-742,040. PUB. 4-6-2010. FILED 5-21-2009.
 3,805,678 (*See Class 5 for this trademark.*)
 3,805,680. **LIFENET HEALTH SAVING LIVES. RESTORING HEALTH AND DESIGN.** LIFENET HEALTH, MULTIPLE CLASS, (INT. CLS. 37 AND 44), (U.S. CLS. 100, 101, 103 AND 106). SN 77-742,922. PUB. 4-6-2010. FILED 5-22-2009.
 3,805,697. **ADVANTACLEAN (STANDARD CHARACTER).** ADVANTACLEAN SYSTMS, INC., (U.S. CLS. 100, 103 AND 106). SN 77-746,175. PUB. 4-6-2010. FILED 5-28-2009.
 3,805,708. **VERICLEAN SERVICES NOT JUST CLEAN...VERICLEAN AND DESIGN.** VERICLEAN JANITORIAL SERVICES LLC, DBA VERICLEAN SERVICES, (U.S. CLS. 100, 103 AND 106). SN 77-748,384. PUB. 4-6-2010. FILED 5-30-2009.
 3,805,709 (*See Class 6 for this trademark.*)
 3,805,779. **HANDYMANLINK (STANDARD CHARACTER).** FLOODMAN, STEPHEN ROBERT, DBA HANDYMANLINK, (U.S. CLS. 100, 103 AND 106). SN 77-764,729. PUB. 4-6-2010. FILED 6-22-2009.
 3,805,908. **AMERICA'S FLEET SERVICE (STANDARD CHARACTER).** AMERICA'S FLEET SERVICE, INC, (U.S. CLS. 100, 103 AND 106). SN 77-797,575. PUB. 4-6-2010. FILED 8-5-2009.
 3,805,953. **STEEL CITY LANDSCAPE INC. AND DESIGN.** STEEL CITY LANDSCAPE INC., MULTIPLE CLASS, (INT. CLS. 37 AND 44), (U.S. CLS. 100, 101, 103 AND 106). SN 77-807,735. PUB. 4-6-2010. FILED 8-19-2009.
 3,806,021 (*See Class 35 for this trademark.*)
 3,806,103 (*See Class 35 for this trademark.*)
 3,806,116. **INSPECT-UR GADGET CELL PHONE AND MOBILE DEVICE REPAIR AND DESIGN.** INSPECT-UR GADGET INC., (U.S. CLS. 100, 103 AND 106). SN 77-836,690. PUB. 4-6-2010. FILED 9-28-2009.
 3,806,136 (*See Class 9 for this trademark.*)
 3,806,145 (*See Class 6 for this trademark.*)
 3,806,163 (*See Class 31 for this trademark.*)
 3,806,223. **BOH BROS. AND DESIGN.** BOH BROS. CONSTRUCTION CO., L.L.C., (U.S. CLS. 100, 103 AND 106). SN 77-848,583. PUB. 4-6-2010. FILED 10-14-2009.
 3,806,237. **SUNAIR AND DESIGN.** SUNAIR SALES CORPORATION, (U.S. CLS. 100, 103 AND 106). SN 77-849,721. PUB. 4-6-2010. FILED 10-15-2009.
 3,806,256. **CLOSETS 4 YOU AND DESIGN.** DAI, EDWARD, (U.S. CLS. 100, 103 AND 106). SN 77-851,673. PUB. 4-6-2010. FILED 10-19-2009.
 3,806,336. **ROSCOE THE BED BUG DOG (STANDARD CHARACTER).** BELL ENVIRONMENTAL SERVICES, INC., AKA BELL BED BUGS, BELL BIRD CONTROL, MULTIPLE CLASS, (INT. CLS. 37 AND 42), (U.S. CLS. 100, 101, 103 AND 106). SN 77-855,936. PUB. 4-6-2010. FILED 10-23-2009.
 3,806,408. **C AND DESIGN.** CROCKETT HOMES, INC., (U.S. CLS. 100, 103 AND 106). SN 77-858,013. PUB. 4-6-2010. FILED 10-27-2009.
 3,806,469. **IMPROVE YOUR CAR-MA (STANDARD CHARACTER).** BWC, INC., (U.S. CLS. 100, 103 AND 106). SN 77-858,623. PUB. 4-6-2010. FILED 10-27-2009.
 3,806,524. **SOUTH RIVER RESTORATION (STANDARD CHARACTER).** SOUTH RIVER RESTORATION, INC., MULTIPLE CLASS, (INT. CLS. 37 AND 40), (U.S. CLS. 100, 103 AND 106). SN 77-859,211. PUB. 4-6-2010. FILED 10-28-2009.
 3,806,554. **TRENTON MAKES (STANDARD CHARACTER).** TRENTON MAKES, LLC, (U.S. CLS. 100, 103 AND 106). SN 77-859,577. PUB. 4-6-2010. FILED 10-28-2009.
 3,806,575. **SIMPLE TO SENSATIONAL (STYLIZED).** RIVERSIDE HOME THEATER AND AUTOMATION INC., (U.S. CLS. 100, 103 AND 106). SN 77-859,842. PUB. 4-6-2010. FILED 10-28-2009.
 3,806,626. **SUMMIT HOME ENERGY SOLUTIONS GOING GREEN HAS NEVER BEEN A BETTER INVESTMENT AND DESIGN.** PEACOCK, BRADLEY, (U.S. CLS. 100, 103 AND 106). SN 77-860,265. PUB. 4-6-2010. FILED 10-29-2009.
 3,806,639. **OEHL (STANDARD CHARACTER).** OEHL PLUMBING AND HEATING, INC., (U.S. CLS. 100, 103 AND 106). SN 77-860,508. PUB. 4-6-2010. FILED 10-29-2009.
 3,806,654. **SOLAROPOLY (STANDARD CHARACTER).** SOLAROPOLY, INC., (U.S. CLS. 100, 103 AND 106). SN 77-860,624. PUB. 4-6-2010. FILED 10-29-2009.

- 3,806,707. **PUNCH WORX AND DESIGN**. LITTLE, ANTHONY, D. II, DBA PUNCH WORX, (U.S. CLS. 100, 103 AND 106). SN 77-861,330. PUB. 4-6-2010. FILED 10-30-2009.
- 3,806,722. **MISCELLANEOUS DESIGN**. AEROFRAME SERVICES, LLC, (U.S. CLS. 100, 103 AND 106). SN 77-861,533. PUB. 4-6-2010. FILED 10-30-2009.
- 3,806,742. **TSI (STANDARD CHARACTER)**. TOWER SERVICES, INC., (U.S. CLS. 100, 103 AND 106). SN 77-861,789. PUB. 4-6-2010. FILED 10-30-2009.
- 3,806,766. **CLEANAPHORIA (STANDARD CHARACTER)**. SERVICEMASTER BRANDS LLC, (U.S. CLS. 100, 103 AND 106). SN 77-862,578. PUB. 4-6-2010. FILED 11-2-2009.
- 3,806,770. **INTEGRITY WATERPROOFING (STANDARD CHARACTER)**. INTEGRITY WATERPROOFING INC., DBA INTEGRITY WATERPROOFING, (U.S. CLS. 100, 103 AND 106). SN 77-862,623. PUB. 4-6-2010. FILED 11-2-2009.
- 3,806,888. **GEO-INGENUITY (STANDARD CHARACTER)**. GEOPIER FOUNDATION COMPANY, INC., MULTIPLE CLASS, (INT. CLS. 37 AND 42), (U.S. CLS. 100, 101, 103 AND 106). SN 77-864,979. PUB. 4-6-2010. FILED 11-4-2009.
- 3,806,900. **WASHOUSE AND DESIGN**. FUHRMAN, GREGORY A., (U.S. CLS. 100, 103 AND 106). SN 77-865,311. PUB. 4-6-2010. FILED 11-4-2009.
- 3,806,922. **HABITAT (STANDARD CHARACTER)**. HABITAT FOR HUMANITY INTERNATIONAL, INC., (U.S. CLS. 100, 103 AND 106). SN 77-868,020. PUB. 4-6-2010. FILED 11-9-2009.
- 3,806,926. **KNOVATIONS (STANDARD CHARACTER)**. GASPARILLA PASS, LLC, MULTIPLE CLASS, (INT. CLS. 37 AND 42), (U.S. CLS. 100, 101, 103 AND 106). SN 77-869,060. PUB. 4-6-2010. FILED 11-10-2009.
- 3,806,964. **MASTERS ROOFING (STANDARD CHARACTER)**. ELITE SOUTHERN CONSTRUCTION, (U.S. CLS. 100, 103 AND 106). SN 77-874,838. PUB. 4-6-2010. FILED 11-17-2009.
- 3,806,986. **LHG GENERAL CONTRACTORS INC. AND DESIGN**. LHG ENTERPRISES-GENERAL CONTRACTORS, INC., DBA LHG, INC., (U.S. CLS. 100, 103 AND 106). SN 77-879,571. PUB. 4-6-2010. FILED 11-24-2009.
- 3,807,042. **PBS&J (STANDARD CHARACTER)**. PBSJ CORPORATION, THE, (U.S. CLS. 100, 103 AND 106). SN 77-902,837. PUB. 4-6-2010. FILED 12-30-2009.
- 3,807,058 (*See Class 36 for this trademark*).
- 3,807,068 (*See Class 6 for this trademark*).
- 3,807,074 (*See Class 35 for this trademark*).
- 3,807,082 (*See Class 1 for this trademark*).
- 3,807,089 (*See Class 11 for this trademark*).
- 3,807,106 (*See Class 6 for this trademark*).
- 3,807,113 (*See Class 9 for this trademark*).
- 3,807,122 (*See Class 6 for this trademark*).
- 3,807,197 (*See Class 7 for this trademark*).
- 3,807,228 (*See Class 9 for this trademark*).
- 3,807,229 (*See Class 7 for this trademark*).
- 3,807,232 (*See Class 12 for this trademark*).
- 3,807,301. **BDS VIRCON AND DESIGN**. BDS GLOBAL DETAILING PTY LIMITED, MULTIPLE CLASS, (INT. CLS. 37 AND 42), (U.S. CLS. 100, 101, 103 AND 106). SN 77-073,400. PUB. 4-6-2010. FILED 7-10-2009.
- 3,807,308 (*See Class 7 for this trademark*).
- 3,807,325 (*See Class 6 for this trademark*).
- 3,805,263. **LIVING LIFE OUT LOUD (STANDARD CHARACTER)**. WFMP-FM, LLC, (U.S. CLS. 100, 101 AND 104). SN 77-457,207. PUB. 4-6-2010. FILED 4-24-2008.
- 3,805,280. **MISCELLANEOUS DESIGN**. WIMAX FORUM, (U.S. CLS. 100, 101 AND 104). SN 77-485,689. PUB. 10-28-2008. FILED 5-29-2008.
- 3,805,289 (*See Class 36 for this trademark*).
- 3,805,297 (*See Class 9 for this trademark*).
- 3,805,307. **WATCHDOG (STANDARD CHARACTER)**. TRANSPORTATION INTERMEDIARIES ASSOCIATION, (U.S. CLS. 100, 101 AND 104). SN 77-526,402. PUB. 4-6-2010. FILED 7-18-2008.
- 3,805,331 (*See Class 9 for this trademark*).
- 3,805,382 (*See Class 9 for this trademark*).
- 3,805,426. **GET QWEST. GET NIMBLE. (STANDARD CHARACTER)**. QWEST COMMUNICATIONS INTERNATIONAL INC., (U.S. CLS. 100, 101 AND 104). SN 77-638,109. PUB. 4-6-2010. FILED 12-22-2008.
- 3,805,446 (*See Class 35 for this trademark*).
- 3,805,447 (*See Class 35 for this trademark*).
- 3,805,449. **TAYCOR (STANDARD CHARACTER)**. TAYCOR, L.L.C., MULTIPLE CLASS, (INT. CLS. 38, 42 AND 44), (U.S. CLS. 100, 101 AND 104). SN 77-659,717. PUB. 4-6-2010. FILED 1-29-2009.
- 3,805,469 (*See Class 9 for this trademark*).
- 3,805,482 (*See Class 9 for this trademark*).
- 3,805,519. **MISCELLANEOUS DESIGN**. MEEBO, INC., (U.S. CLS. 100, 101 AND 104). SN 77-713,325. PUB. 4-6-2010. FILED 4-14-2009.
- 3,805,578 (*See Class 9 for this trademark*).
- 3,805,579 (*See Class 9 for this trademark*).
- 3,805,580 (*See Class 9 for this trademark*).
- 3,805,581 (*See Class 9 for this trademark*).
- 3,805,582 (*See Class 9 for this trademark*).
- 3,805,592 (*See Class 9 for this trademark*).
- 3,805,747 (*See Class 9 for this trademark*).
- 3,805,782 (*See Class 16 for this trademark*).
- 3,805,792. **SPIRIT 105.3 (STYLIZED)**. CRISTA MINISTRIES, (U.S. CLS. 100, 101 AND 104). SN 77-769,627. PUB. 4-6-2010. FILED 6-26-2009.
- 3,805,802. **NOTI CENTRO AND DESIGN**. GRUPO RADIO CENTRO, S.A. B DE C.V., (U.S. CLS. 100, 101 AND 104). SN 77-771,516. PUB. 4-6-2010. FILED 6-30-2009.
- 3,805,832 (*See Class 9 for this trademark*).
- 3,805,891. **AT&T MOBILE TV (STANDARD CHARACTER)**. AT&T INTELLECTUAL PROPERTY II, L.P., (U.S. CLS. 100, 101 AND 104). SN 77-794,066. PUB. 4-6-2010. FILED 7-31-2009.
- 3,805,934. **IPASS (STANDARD CHARACTER)**. IPASS, INC., (U.S. CLS. 100, 101 AND 104). SN 77-804,405. PUB. 4-6-2010. FILED 8-13-2009.
- 3,806,073 (*See Class 35 for this trademark*).
- 3,806,075. **POSITIVE XCHANGE AND DESIGN**. VISION REGENERATION INC., MULTIPLE CLASS, (INT. CLS. 38 AND 45), (U.S. CLS. 100, 101 AND 104). SN 77-828,153. PUB. 4-6-2010. FILED 9-16-2009.
- 3,806,167. **GYNZY (STANDARD CHARACTER)**. GYNZY 500 BV, MULTIPLE CLASS, (INT. CLS. 38 AND 41), (U.S. CLS. 100, 101, 104 AND 107). SN 77-843,056. PUB. 4-6-2010. FILED 10-7-2009.
- 3,806,268. **FREEDOMEDGE (STANDARD CHARACTER)**. CALLCATCHERS, INC., (U.S. CLS. 100, 101 AND 104). SN 77-852,816. PUB. 4-6-2010. FILED 10-20-2009.
- 3,806,309. **FULL SERVICE NETWORK AND DESIGN**. FULL SERVICE NETWORK LP, (U.S. CLS. 100, 101 AND 104). SN 77-855,071. PUB. 4-6-2010. FILED 10-22-2009.
- 3,806,323. **LOOPT MIX (STANDARD CHARACTER)**. LOOPT, INC., MULTIPLE CLASS, (INT. CLS. 38 AND 45), (U.S. CLS. 100, 101 AND 104). SN 77-855,501. PUB. 4-6-2010. FILED 10-22-2009.
- 3,806,383. **BROADCAST CHANNELS FOR EVERYONE (STANDARD CHARACTER)**. ONNOWTV.COM BROADCASTING ASSOCIATION, (U.S. CLS. 100, 101 AND 104). SN 77-857,303. PUB. 4-6-2010. FILED 10-26-2009.
- 3,806,490. **WAVE (STANDARD CHARACTER)**. WAVEDIVISION HOLDINGS, LLC, (U.S. CLS. 100, 101 AND 104). SN 77-858,770. PUB. 4-6-2010. FILED 10-27-2009.
- 3,806,513. **CHATTERBEE (STANDARD CHARACTER)**. ALL

CLASS 38—COMMUNICATION

- 3,805,189. **MISCELLANEOUS DESIGN**. TERREMARK TRADEMARK HOLDINGS, INC., MULTIPLE CLASS, (INT. CLS. 38, 39, 42 AND 45), (U.S. CLS. 100, 101, 104 AND 105). SN 77-091,965. PUB. 4-6-2010. FILED 1-26-2007.
- 3,805,222. **MISCELLANEOUS DESIGN**. UNIVERSAL COMMUNICATIONS NETWORK, INC., DBA NEW TANG DYNASTY TELEVISION, (U.S. CLS. 100, 101 AND 104). SN 77-341,991. PUB. 4-6-2010. FILED 12-2-2007.
- 3,805,229. **BOOTY CALL (STANDARD CHARACTER)**. MOBEZE, INC., MULTIPLE CLASS, (INT. CLS. 38 AND 39), (U.S. CLS. 100, 101, 104 AND 105). SN 77-362,984. PUB. 4-6-2010. FILED 1-2-2008.
- 3,805,259 (*See Class 9 for this trademark*).

- ABOUT LEARNING PRESS, INC., (U.S. CLS. 100, 101 AND 104). SN 77-859,102. PUB. 4-6-2010. FILED 10-28-2009.
- 3,806,547. **WORLDCELL (STANDARD CHARACTER)**. WORLDCELL, INC., (U.S. CLS. 100, 101 AND 104). SN 77-859,540. PUB. 4-6-2010. FILED 10-28-2009.
- 3,806,649. **DOCSTREAM (STANDARD CHARACTER)**. BLOCKJOCKS.COM LLC, (U.S. CLS. 100, 101 AND 104). SN 77-860,584. PUB. 4-6-2010. FILED 10-29-2009.
- 3,806,834. **GET IT TOGETHER AND DESIGN**. BODAMER CONSULTING, LLC, (U.S. CLS. 100, 101 AND 104). SN 77-863,730. PUB. 4-6-2010. FILED 11-3-2009.
- 3,806,882. **DID YOU HEAR? (STANDARD CHARACTER)**. PREMIERE RADIO NETWORKS, INC., (U.S. CLS. 100, 101 AND 104). SN 77-864,672. PUB. 4-6-2010. FILED 11-4-2009.
- 3,807,001. **LA VIDA ES CORTA, TEN UNA AVENTURA. (STANDARD CHARACTER)**. AVID DATING LIFE INC., MULTIPLE CLASS, (INT. CLS. 38 AND 45), (U.S. CLS. 100, 101 AND 104). SN 77-882,459. PUB. 4-6-2010. FILED 11-30-2009.
- 3,807,017. **FAXEDGE (STANDARD CHARACTER)**. CALLCATCHERS, INC., (U.S. CLS. 100, 101 AND 104). SN 77-885,863. PUB. 4-6-2010. FILED 12-3-2009.
- 3,807,032. **ILOVETOCREATE.COM AND DESIGN**. DUNCAN ENTERPRISES, MULTIPLE CLASS, (INT. CLS. 38 AND 41), (U.S. CLS. 100, 101, 104 AND 107). SN 77-891,479. PUB. 4-6-2010. FILED 12-11-2009.
- 3,807,051. **HS GAMETIME (STANDARD CHARACTER)**. BELO INTERACTIVE, INC., MULTIPLE CLASS, (INT. CLS. 38, 41 AND 42), (U.S. CLS. 100, 101, 104 AND 107). SN 77-978,747. PUB. 4-6-2010. FILED 11-19-2007.
- 3,807,052. **HS GAME TIME (STYLIZED)**. BELO INTERACTIVE, INC., MULTIPLE CLASS, (INT. CLS. 38, 41 AND 42), (U.S. CLS. 100, 101, 104 AND 107). SN 77-978,748. PUB. 4-6-2010. FILED 1-28-2008.
- 3,807,059 (*See Class 35 for this trademark*).
- 3,807,065 (*See Class 35 for this trademark*).
- 3,807,068 (*See Class 6 for this trademark*).
- 3,807,071 (*See Class 9 for this trademark*).
- 3,807,074 (*See Class 35 for this trademark*).
- 3,807,125 (*See Class 9 for this trademark*).
- 3,807,127 (*See Class 9 for this trademark*).
- 3,807,131 (*See Class 3 for this trademark*).
- 3,807,150 (*See Class 35 for this trademark*).
- 3,807,165 (*See Class 9 for this trademark*).
- 3,807,207 (*See Class 9 for this trademark*).
- 3,807,223 (*See Class 9 for this trademark*).
- 3,807,249 (*See Class 9 for this trademark*).
- 3,807,251 (*See Class 9 for this trademark*).
- 3,807,252 (*See Class 9 for this trademark*).
- 3,807,267. **DISCINNET AND DESIGN**. DISCINNET LABS, MULTIPLE CLASS, (INT. CLS. 38, 41 AND 42), (U.S. CLS. 100, 101, 104 AND 107). SN 79-071,600. PUB. 4-6-2010. FILED 4-8-2009.
- 3,807,338 (*See Class 5 for this trademark*).
- TIONAL MEGA LOGISTIC, (U.S. CLS. 100 AND 105). SN 77-730,180. PUB. 4-6-2010. FILED 5-6-2009.
- 3,805,628 (*See Class 35 for this trademark*).
- 3,805,762. **PACKAGING PROBLEM SOLVERS (STANDARD CHARACTER)**. TRANS-PACKERS SERVICES CORP., (U.S. CLS. 100 AND 105). SN 77-761,517. PUB. 4-6-2010. FILED 6-17-2009.
- 3,805,771. **TEAM RIDEFINDERS (STANDARD CHARACTER)**. OLD DOMINION TRANSIT MANAGEMENT COMPANY, DBA GRTC TRANSIT SYSTEM, (U.S. CLS. 100 AND 105). SN 77-763,691. PUB. 4-6-2010. FILED 6-19-2009.
- 3,805,838 (*See Class 35 for this trademark*).
- 3,805,976. **FARMERS BRANCH AND DESIGN**. CITY OF FARMERS BRANCH, TEXAS, MULTIPLE CLASS, (INT. CLS. 39 AND 41), (U.S. CLS. 100, 101, 105 AND 107). SN 77-811,378. PUB. 4-6-2010. FILED 8-24-2009.
- 3,806,008. **SKIPPERATO (STANDARD CHARACTER)**. FLIPPERATO, INC., MULTIPLE CLASS, (INT. CLS. 39 AND 42), (U.S. CLS. 100, 101 AND 105). SN 77-817,679. PUB. 4-6-2010. FILED 9-1-2009.
- 3,806,102. **LEGAL VAULT AND DESIGN**. COHEN, FRED J., (U.S. CLS. 100 AND 105). SN 77-835,143. PUB. 4-6-2010. FILED 9-25-2009.
- 3,806,191 (*See Class 35 for this trademark*).
- 3,806,224. **MISCELLANEOUS DESIGN**. KEY CLUB ASSOCIATES, LP, MULTIPLE CLASS, (INT. CLS. 39, 41 AND 43), (U.S. CLS. 100, 101, 105 AND 107). SN 77-848,608. PUB. 4-6-2010. FILED 10-14-2009.
- 3,806,232. **RENT-A-DUMP (STANDARD CHARACTER)**. NEW IMAGE MAINTENANCE INC., (U.S. CLS. 100 AND 105). SN 77-849,081. PUB. 4-6-2010. FILED 10-15-2009.
- 3,806,233 (*See Class 35 for this trademark*).
- 3,806,253. **FLYTEPORT AND DESIGN**. INDUSTRIAL TELEVISION SERVICES, INC., (U.S. CLS. 100 AND 105). SN 77-851,020. PUB. 4-6-2010. FILED 10-16-2009.
- 3,806,367. **BOX BUDDY SHIPPING (STANDARD CHARACTER)**. BOX BUDDY SHIPPING LLC, (U.S. CLS. 100 AND 105). SN 77-857,026. PUB. 4-6-2010. FILED 10-26-2009.
- 3,806,379. **PAN PACIFIC JOURNEYS AND DESIGN**. PAN PACIFIC JOURNEYS INC., (U.S. CLS. 100 AND 105). SN 77-857,231. PUB. 4-6-2010. FILED 10-26-2009.
- 3,806,486 (*See Class 25 for this trademark*).
- 3,806,516. **PROFILL (STANDARD CHARACTER)**. GRACO MINNESOTA INC., (U.S. CLS. 100 AND 105). SN 77-859,145. PUB. 4-6-2010. FILED 10-28-2009.
- 3,806,563. **THE WAVE AND DESIGN**. THE WASHINGTON WAVE, LLC, DBA THE WAVE, (U.S. CLS. 100 AND 105). SN 77-859,756. PUB. 4-6-2010. FILED 10-28-2009.
- 3,806,697. **OUR JOB SUCKS...AND WE GUARANTEE IT! (STANDARD CHARACTER)**. DEVONIAN INDUSTRIES, INC., (U.S. CLS. 100 AND 105). SN 77-861,219. PUB. 4-6-2010. FILED 10-30-2009.
- 3,806,736. **PRECORP (STANDARD CHARACTER)**. POWDER RIVER ENERGY CORPORATION, (U.S. CLS. 100 AND 105). SN 77-861,705. PUB. 4-6-2010. FILED 10-30-2009.
- 3,806,740. **POWDER RIVER ENERGY CORPORATION AND DESIGN**. POWDER RIVER ENERGY CORPORATION, (U.S. CLS. 100 AND 105). SN 77-861,771. PUB. 4-6-2010. FILED 10-30-2009.
- 3,806,746 (*See Class 35 for this trademark*).
- 3,806,795. **MY FAMILY DOCUMENTS YOUR FAMILY'S ONLINE SAFETY DEPOSIT BOX AND DESIGN**. KALRA, RAJ, (U.S. CLS. 100 AND 105). SN 77-863,058. PUB. 4-6-2010. FILED 11-2-2009.
- 3,806,801. **SURTI TIENDAS ST AND DESIGN**. SURTITIENDAS, (U.S. CLS. 100 AND 105). SN 77-863,163. PUB. 4-6-2010. FILED 11-2-2009.
- 3,806,831. **NOT JUST CORPORATE SPONSORS**. FANS. (STANDARD CHARACTER). WIZARD CO., INC., (U.S. CLS. 100 AND 105). SN 77-863,676. PUB. 4-6-2010. FILED 11-3-2009.
- 3,806,877. **AURELIAN (STANDARD CHARACTER)**. PRIDE TRAVEL, (U.S. CLS. 100 AND 105). SN 77-864,343. PUB. 4-6-2010. FILED 11-3-2009.
- 3,806,913. **EXPLORE IN GRANDEUR (STANDARD CHARACTER)**. PRIDE TRAVEL, (U.S. CLS. 100 AND 105). SN 77-865,983. PUB. 4-6-2010. FILED 11-5-2009.
- 3,806,988. **CROSSROADS SAFETY MANAGEMENT AND DE-**

CLASS 39—TRANSPORTATION AND STORAGE

- 3,805,189 (*See Class 38 for this trademark*).
- 3,805,229 (*See Class 38 for this trademark*).
- 3,805,261 (*See Class 35 for this trademark*).
- 3,805,331 (*See Class 9 for this trademark*).
- 3,805,405 (*See Class 35 for this trademark*).
- 3,805,425 (*See Class 4 for this trademark*).
- 3,805,527 (*See Class 35 for this trademark*).
- 3,805,548. **CHOSEN PEOPLE MINISTRIES (STANDARD CHARACTER)**. CHOSEN PEOPLE MINISTRIES, INC., (U.S. CLS. 100 AND 105). SN 77-721,569. PUB. 4-6-2010. FILED 4-24-2009.
- 3,805,573 (*See Class 16 for this trademark*).
- 3,805,574. **WHEELCHAIR GETAWAYS (STANDARD CHARACTER)**. JDR FRANCHISES LLC, (U.S. CLS. 100 AND 105). SN 77-726,767. PUB. 4-6-2010. FILED 5-1-2009.
- 3,805,601. **ORION-LOGISTICS (STANDARD CHARACTER)**. MEGATRANS LOGISTICS, INC., DBA ORION INTERNA-

SIGN. CROSSROADS COMPLIANCE, INC., (U.S. CLS. 100 AND 105). SN 77-879,668. PUB. 4-6-2010. FILED 11-24-2009. 3,807,074 (*See Class 35 for this trademark.*)
 3,807,114 (*See Class 25 for this trademark.*)
 3,807,157 (*See Class 9 for this trademark.*)
 3,807,265 (*See Class 19 for this trademark.*)
 3,807,303 (*See Class 12 for this trademark.*)
 3,807,312 (*See Class 28 for this trademark.*)

3,807,095 (*See Class 24 for this trademark.*)
 3,807,106 (*See Class 6 for this trademark.*)
 3,807,180 (*See Class 3 for this trademark.*)
 3,807,229 (*See Class 7 for this trademark.*)
 3,807,265 (*See Class 19 for this trademark.*)
 3,807,354. **SOLAR CATCH POT (STANDARD CHARACTER)**. EHW-RESEARCH, (U.S. CLS. 100, 103 AND 106). SN 79-076,569. PUB. 4-6-2010. FILED 7-27-2009.

CLASS 40—MATERIAL TREATMENT

3,805,169. **PROTOTEK (STANDARD CHARACTER)**. PROTO-TEK SHEETMETAL FABRICATION, LLC, (U.S. CLS. 100, 103 AND 106). SN 76-700,110. PUB. 4-6-2010. FILED 10-29-2009.
 3,805,185 (*See Class 7 for this trademark.*)
 3,805,190. **MISCELLANEOUS DESIGN**. MARTINREA INTERNATIONAL INC., MULTIPLE CLASS, (INT. CLS. 40 AND 42), (U.S. CLS. 100, 101, 103 AND 106). SN 77-097,877. PUB. 10-13-2009. FILED 2-2-2007.
 3,805,363 (*See Class 37 for this trademark.*)
 3,805,393 (*See Class 14 for this trademark.*)
 3,805,405 (*See Class 35 for this trademark.*)
 3,805,419. **STAY CONNECTED (STANDARD CHARACTER)**. THUNDER BAY FASHIONS INC., AKA LES MODES THUNDER BAY INC., (U.S. CLS. 100, 103 AND 106). SN 77-634,974. PUB. 4-6-2010. FILED 12-17-2008.
 3,805,425 (*See Class 4 for this trademark.*)
 3,805,617 (*See Class 1 for this trademark.*)
 3,805,620. **NEXUS DENTAL LABORATORIES A COMMUNITY OF SMILES AND DESIGN**. SHAH DENTAL CLINIC, LLC, DBA MT. VERNON MODERN DENTAL; NEXUS DENTAL; NEXUS DENTISTRY, (U.S. CLS. 100, 103 AND 106). SN 77-732,415. PUB. 4-6-2010. FILED 5-8-2009.
 3,805,635. **EMS ENGINEERED MACHINE SYSTEMS AND DESIGN**. TWENTY TEN, LLC, (U.S. CLS. 100, 103 AND 106). SN 77-734,513. PUB. 4-6-2010. FILED 5-12-2009.
 3,805,764 (*See Class 35 for this trademark.*)
 3,805,907 (*See Class 19 for this trademark.*)
 3,806,010 (*See Class 35 for this trademark.*)
 3,806,087 (*See Class 20 for this trademark.*)
 3,806,152. **RESOURCE O&P (STANDARD CHARACTER)**. WRYMARK, INC., MULTIPLE CLASS, (INT. CLS. 40, 42 AND 44), (U.S. CLS. 100, 101, 103 AND 106). SN 77-840,500. PUB. 4-6-2010. FILED 10-2-2009.
 3,806,359. **GREAT LAKES WATERPROOFING (STANDARD CHARACTER)**. HOWLEY, JOHN P, DBA GREAT LAKES WATERPROOFING, (U.S. CLS. 100, 103 AND 106). SN 77-856,818. PUB. 4-6-2010. FILED 10-25-2009.
 3,806,434. **LIXIVIAN (STANDARD CHARACTER)**. LIXIVIAN, INC., (U.S. CLS. 100, 103 AND 106). SN 77-858,324. PUB. 4-6-2010. FILED 10-27-2009.
 3,806,452. **NUTRACEUTICAL SOLUTIONS (STANDARD CHARACTER)**. ADVANTAGE MARKETING INCORPORATED, (U.S. CLS. 100, 103 AND 106). SN 77-858,510. PUB. 4-6-2010. FILED 10-27-2009.
 3,806,524 (*See Class 37 for this trademark.*)
 3,806,613 (*See Class 35 for this trademark.*)
 3,806,620. **BOLD CITY BREWERY AND DESIGN**. BOLD CITY BREWERY, LLC, MULTIPLE CLASS, (INT. CLS. 40 AND 43), (U.S. CLS. 100, 101, 103 AND 106). SN 77-860,223. PUB. 4-6-2010. FILED 10-29-2009.
 3,806,866. **RECYCLE OR DIE (STANDARD CHARACTER)**. EXTREME RECYCLING INC., (U.S. CLS. 100, 103 AND 106). SN 77-864,143. PUB. 4-6-2010. FILED 11-3-2009.
 3,806,872. **MEWITHWINGS (STANDARD CHARACTER)**. 99WINGS, LLC, (U.S. CLS. 100, 103 AND 106). SN 77-864,226. PUB. 4-6-2010. FILED 11-3-2009.
 3,806,924. **CELEBRATE THEIR LIFE FUNERAL TEMPLATES (STYLIZED)**. CROWLEY, PATRICK S., (U.S. CLS. 100, 103 AND 106). SN 77-868,656. PUB. 4-6-2010. FILED 11-9-2009.
 3,806,991. **VINTAGE PHARMACEUTICALS, LLC (STANDARD CHARACTER)**. VINTAGE PHARMACEUTICALS, LLC, (U.S. CLS. 100, 103 AND 106). SN 77-879,984. PUB. 4-6-2010. FILED 11-24-2009.
 3,807,082 (*See Class 1 for this trademark.*)

CLASS 41—EDUCATION AND ENTERTAINMENT

3,805,130. **SCHOOL OF ROCK FESTIVAL (STANDARD CHARACTER)**. PAUL GREEN SCHOOL OF ROCK MUSIC, LLC, (U.S. CLS. 100, 101 AND 107). SN 76-682,864. PUB. 4-6-2010. FILED 10-11-2007.
 3,805,142. **INNOVATED LEARNING OUTSIDE THE BOX AND DESIGN**. PINNACLE EDUCATION, INC., (U.S. CLS. 100, 101 AND 107). SN 76-697,059. PUB. 4-6-2010. FILED 4-24-2009.
 3,805,147. **FUNKY METERS (STANDARD CHARACTER)**. FUNKY METERS, INC., (U.S. CLS. 100, 101 AND 107). SN 76-698,072. PUB. 4-6-2010. FILED 6-25-2009.
 3,805,152. **KINDERJAM (STANDARD CHARACTER)**. KINDERJAM LLC, (U.S. CLS. 100, 101 AND 107). SN 76-698,969. PUB. 4-6-2010. FILED 8-14-2009.
 3,805,158. **RE-CREATING NATURE NOT JUST ANOTHER CROWN! AND DESIGN**. FUNCTIONAL ESTHETICS DENTAL LAB, INC., (U.S. CLS. 100, 101 AND 107). SN 76-699,382. PUB. 4-6-2010. FILED 9-8-2009.
 3,805,159. **NCRS AMERICAN HERITAGE AWARD (STANDARD CHARACTER)**. NATIONAL CORVETTE RESTORERS SOCIETY, INC., (U.S. CLS. 100, 101 AND 107). SN 76-699,405. PUB. 4-6-2010. FILED 9-10-2009.
 3,805,181 (*See Class 9 for this trademark.*)
 3,805,199 (*See Class 16 for this trademark.*)
 3,805,230 (*See Class 3 for this trademark.*)
 3,805,240 (*See Class 9 for this trademark.*)
 3,805,243 (*See Class 10 for this trademark.*)
 3,805,247. **SCORPIO RISING FILMS (STANDARD CHARACTER)**. JENNIFER FONTAINE, (U.S. CLS. 100, 101 AND 107). SN 77-418,060. PUB. 4-6-2010. FILED 3-10-2008.
 3,805,248 (*See Class 35 for this trademark.*)
 3,805,249 (*See Class 35 for this trademark.*)
 3,805,254. **ENGLISH TIME LANGUAGE SCHOOLS & OVERSEAS EDUCATION AND DESIGN**. VIZYONTIME EGITIM VE DANISHMANLIK HIZMETLERI TICARET LIMITED SIRKETI, (U.S. CLS. 100, 101 AND 107). SN 77-432,191. PUB. 4-6-2010. FILED 3-26-2008.
 3,805,256 (*See Class 9 for this trademark.*)
 3,805,259 (*See Class 9 for this trademark.*)
 3,805,260. **LEAP FOR GIRLS LEADERSHIP EMPOWERMENT AND AWARENESS PROGRAM FOR GIRLS AND DESIGN**. LOVE HEALS INC., (U.S. CLS. 100, 101 AND 107). SN 77-448,832. PUB. 4-6-2010. FILED 4-15-2008.
 3,805,261 (*See Class 35 for this trademark.*)
 3,805,287 (*See Class 9 for this trademark.*)
 3,805,293 (*See Class 3 for this trademark.*)
 3,805,294 (*See Class 14 for this trademark.*)
 3,805,298 (*See Class 35 for this trademark.*)
 3,805,306. **AMBASSADORS OF COMPASSION (STANDARD CHARACTER)**. SERVANT ENTERTAINMENT, AND LIFT UP AMERICA, (U.S. CLS. 100, 101 AND 107). SN 77-522,841. PUB. 4-6-2010. FILED 7-15-2008.
 3,805,310. **MEP EBUM (STANDARD CHARACTER)**. ROD MACPHERSON AND ASSOCIATES INC., (U.S. CLS. 100, 101 AND 107). SN 77-528,970. PUB. 9-1-2009. FILED 7-23-2008.
 3,805,319. **GRAVENSTEIN REACH CREATIVE ARTS MAGNET PROGRAM (STANDARD CHARACTER)**. GRAVENSTEIN UNIFIED SCHOOL DISTRICT, DBA GUSD, (U.S. CLS. 100, 101 AND 107). SN 77-547,127. PUB. 4-6-2010. FILED 8-14-2008.
 3,805,323. **HOMEBET (STANDARD CHARACTER)**. AMTOTE INTERNATIONAL, INC., MULTIPLE CLASS, (INT. CLS. 41 AND 42), (U.S. CLS. 100, 101 AND 107). SN 77-550,176.

- PUB. 4-6-2010. FILED 8-19-2008.
- 3,805,330. **FACULTY MEMBER ICP USEA ICP INSTRUCTORS' CERTIFICATION PROGRAM AND DESIGN.** UNITED STATES EVENTING ASSOCIATION, MULTIPLE CLASS, (INT. CLS. 41 AND 42), (U.S. CLS. 100, 101 AND 107). SN 77-557,094. PUB. 4-6-2010. FILED 8-27-2008.
- 3,805,332 (*See Class 35 for this trademark.*)
- 3,805,333. **DATING IN THE DARK (STANDARD CHARACTER).** TALPA CONTENT BV, (U.S. CLS. 100, 101 AND 107). SN 77-560,310. PUB. 4-6-2010. FILED 9-2-2008.
- 3,805,343 (*See Class 36 for this trademark.*)
- 3,805,353. **PNVA PACIFIC NORTHWEST VEGETABLE ASSOCIATION AND DESIGN.** PACIFIC NORTHWEST VEGETABLE ASSOCIATION, (U.S. CLS. 100, 101 AND 107). SN 77-579,015. PUB. 4-6-2010. FILED 9-25-2008.
- 3,805,371. **MERMAID (STANDARD CHARACTER).** BY THE BEACH PRODUCTIONS, L.L.C., DBA MERMAID SERIES, (U.S. CLS. 100, 101 AND 107). SN 77-589,904. PUB. 4-6-2010. FILED 10-9-2008.
- 3,805,372 (*See Class 16 for this trademark.*)
- 3,805,382 (*See Class 9 for this trademark.*)
- 3,805,389 (*See Class 9 for this trademark.*)
- 3,805,405 (*See Class 35 for this trademark.*)
- 3,805,406. **THE BEAUTY OF EMPOWERMENT (STANDARD CHARACTER).** WARRICK, MERCEDES, (U.S. CLS. 100, 101 AND 107). SN 77-625,341. PUB. 4-6-2010. FILED 12-3-2008.
- 3,805,407. **NAFTC STUDIOS (STANDARD CHARACTER).** NORTH AMERICAN FREE TRADE CONSULTANTS INC., (U.S. CLS. 100, 101 AND 107). SN 77-625,547. PUB. 4-6-2010. FILED 12-3-2008.
- 3,805,415 (*See Class 35 for this trademark.*)
- 3,805,416 (*See Class 35 for this trademark.*)
- 3,805,417. **TEDDY ESQUIRE (STANDARD CHARACTER).** BRILLIANT LEARNING INC., (U.S. CLS. 100, 101 AND 107). SN 77-633,641. PUB. 4-6-2010. FILED 12-15-2008.
- 3,805,420. **MUSICAL TEDDY (STANDARD CHARACTER).** BRILLIANT LEARNING INC., (U.S. CLS. 100, 101 AND 107). SN 77-636,564. PUB. 4-6-2010. FILED 12-19-2008.
- 3,805,421. **TEDDSTER (STANDARD CHARACTER).** BRILLIANT LEARNING INC., (U.S. CLS. 100, 101 AND 107). SN 77-636,620. PUB. 4-6-2010. FILED 12-19-2008.
- 3,805,422. **TEDDY GREEN THUMB (STANDARD CHARACTER).** BRILLIANT LEARNING INC., (U.S. CLS. 100, 101 AND 107). SN 77-636,633. PUB. 4-6-2010. FILED 12-19-2008.
- 3,805,423. **TOOL BELT TEDDY (STANDARD CHARACTER).** BRILLIANT LEARNING INC., (U.S. CLS. 100, 101 AND 107). SN 77-636,639. PUB. 4-6-2010. FILED 12-19-2008.
- 3,805,428 (*See Class 35 for this trademark.*)
- 3,805,432. **CCC (STYLIZED).** CURRENT C CREATIVE, LLC, (U.S. CLS. 100, 101 AND 107). SN 77-642,645. PUB. 4-28-2009. FILED 1-2-2009.
- 3,805,435 (*See Class 10 for this trademark.*)
- 3,805,438 (*See Class 9 for this trademark.*)
- 3,805,448 (*See Class 9 for this trademark.*)
- 3,805,450 (*See Class 9 for this trademark.*)
- 3,805,459. **ADVANCED SCOUT (STANDARD CHARACTER).** KAPLAN, ARI DAVID, (U.S. CLS. 100, 101 AND 107). SN 77-671,546. PUB. 12-29-2009. FILED 2-16-2009.
- 3,805,461 (*See Class 16 for this trademark.*)
- 3,805,465 (*See Class 16 for this trademark.*)
- 3,805,466 (*See Class 16 for this trademark.*)
- 3,805,469 (*See Class 9 for this trademark.*)
- 3,805,473 (*See Class 9 for this trademark.*)
- 3,805,480 (*See Class 16 for this trademark.*)
- 3,805,491. **G-CODE RECORDS (STANDARD CHARACTER).** TENNISON, DEONTAE, (U.S. CLS. 100, 101 AND 107). SN 77-693,739. PUB. 4-6-2010. FILED 3-18-2009.
- 3,805,492. **MCC MAXIMS CASINO CLUB AND DESIGN.** GENTING INTERNATIONAL MANAGEMENT LIMITED, (U.S. CLS. 100, 101 AND 107). SN 77-697,841. PUB. 4-6-2010. FILED 3-24-2009.
- 3,805,493 (*See Class 9 for this trademark.*)
- 3,805,494. **CAMPUS CONNECTION (STANDARD CHARACTER).** ESPN, INC., (U.S. CLS. 100, 101 AND 107). SN 77-698,539. PUB. 4-6-2010. FILED 3-25-2009.
- 3,805,495. **SPA WEEK (STANDARD CHARACTER).** SPA WEEK MEDIA GROUP LTD., (U.S. CLS. 100, 101 AND 107). SN 77-699,431. PUB. 4-6-2010. FILED 3-25-2009.
- 3,805,498. **SPEAKING FOR RESULTS (STANDARD CHARACTER).** GEDALIAH, ROBERT, DBA GEDALIAH COMMUNICATIONS, (U.S. CLS. 100, 101 AND 107). SN 77-702,821. PUB. 4-6-2010. FILED 3-31-2009.
- 3,805,512. **PURPLE MOOSE CAMP ESTABLISHED 2005 AND DESIGN.** VICTIM RESPONSE, INC., (U.S. CLS. 100, 101 AND 107). SN 77-710,615. PUB. 4-6-2010. FILED 4-9-2009.
- 3,805,513. **MISCELLANEOUS DESIGN.** STONE CLIFF PRODUCTIONS, INC., (U.S. CLS. 100, 101 AND 107). SN 77-711,230. PUB. 4-6-2010. FILED 4-10-2009.
- 3,805,514. **PASAQUAN (STANDARD CHARACTER).** PASAQUAN PRESERVATION SOCIETY, INC., (U.S. CLS. 100, 101 AND 107). SN 77-711,410. PUB. 4-6-2010. FILED 4-10-2009.
- 3,805,521. **PAVALINE (STANDARD CHARACTER).** PAVALINE ENTERTAINMENT GROUP, DBA LVC INTERNATIONAL LLC, (U.S. CLS. 100, 101 AND 107). SN 77-714,110. PUB. 4-6-2010. FILED 4-15-2009.
- 3,805,530. **THE SIMPLE ADHD EXPERT (STANDARD CHARACTER).** GLENN, BEN, J, DBA CHALKGUY MEDIA INTERNATIONAL, INC. (U.S. CLS. 100, 101 AND 107). SN 77-717,202. PUB. 4-6-2010. FILED 4-20-2009.
- 3,805,535. **SCHOOL OF RISK CONTROL EXCELLENCE (STANDARD CHARACTER).** CNA FINANCIAL CORPORATION, (U.S. CLS. 100, 101 AND 107). SN 77-718,566. PUB. 4-6-2010. FILED 4-21-2009.
- 3,805,536. **HIGH ADVENTURE (STANDARD CHARACTER).** BOY SCOUTS OF AMERICA, (U.S. CLS. 100, 101 AND 107). SN 77-718,625. PUB. 4-6-2010. FILED 4-21-2009.
- 3,805,537. **10,000 WOMEN AND DESIGN.** GOLDMAN, SACHS & CO., (U.S. CLS. 100, 101 AND 107). SN 77-718,701. PUB. 4-6-2010. FILED 4-21-2009.
- 3,805,541. **YOUTH EXPLORING SCIENCE (STANDARD CHARACTER).** ST. LOUIS SCIENCE CENTER, (U.S. CLS. 100, 101 AND 107). SN 77-719,978. PUB. 4-6-2010. FILED 4-22-2009.
- 3,805,549. **CHOSEN PEOPLE MINISTRIES (STANDARD CHARACTER).** CHOSEN PEOPLE MINISTRIES, INC., (U.S. CLS. 100, 101 AND 107). SN 77-721,599. PUB. 4-6-2010. FILED 4-24-2009.
- 3,805,556. **QUICK-2-FIT BOOT CAMP (STANDARD CHARACTER).** DEMELLO, CINDIE, (U.S. CLS. 100, 101 AND 107). SN 77-723,034. PUB. 4-6-2010. FILED 4-27-2009.
- 3,805,559 (*See Class 25 for this trademark.*)
- 3,805,565. **MECKLENBURG COUNTY BAR MCB 26TH JUDICIAL DISTRICT EST. 1912 AND DESIGN.** MECKLENBURG COUNTY BAR, (U.S. CLS. 100, 101 AND 107). SN 77-724,137. PUB. 4-6-2010. FILED 4-28-2009.
- 3,805,571. **QL QUALITY LEADERSHIP TRAINING (STYLIZED).** DAVID BEGG ASSOCIATES USA, LLC, (U.S. CLS. 100, 101 AND 107). SN 77-725,613. PUB. 4-6-2010. FILED 4-29-2009.
- 3,805,573 (*See Class 16 for this trademark.*)
- 3,805,583. **LOS ANGELES LAKER GIRLS AND DESIGN.** THE LOS ANGELES LAKER, INC., (U.S. CLS. 100, 101 AND 107). SN 77-726,996. PUB. 4-6-2010. FILED 5-1-2009.
- 3,805,584. **10,000 WOMEN (STANDARD CHARACTER).** GOLDMAN, SACHS & CO., (U.S. CLS. 100, 101 AND 107). SN 77-727,007. PUB. 4-6-2010. FILED 5-1-2009.
- 3,805,585 (*See Class 36 for this trademark.*)
- 3,805,589. **TRANSITION UNITED STATES (STANDARD CHARACTER).** TRANSITION US, (U.S. CLS. 100, 101 AND 107). SN 77-728,247. PUB. 4-6-2010. FILED 5-4-2009.
- 3,805,590. **TRANSITION US (STANDARD CHARACTER).** TRANSITION US, (U.S. CLS. 100, 101 AND 107). SN 77-728,254. PUB. 4-6-2010. FILED 5-4-2009.
- 3,805,592 (*See Class 9 for this trademark.*)
- 3,805,611. **ADOPTION OPTIONS (STANDARD CHARACTER).** DISCOVERY COMMUNICATIONS, LLC, (U.S. CLS. 100, 101 AND 107). SN 77-731,191. PUB. 4-6-2010. FILED 5-7-2009.
- 3,805,621. **THE MOSAIC PROJECT (STANDARD CHARACTER).** THE MOSAIC PROJECT, (U.S. CLS. 100, 101 AND 107). SN 77-732,731. PUB. 4-6-2010. FILED 5-8-2009.
- 3,805,622. **UNITE EDUCATE EMPOWER (STANDARD CHARACTER).** THE MOSAIC PROJECT, (U.S. CLS. 100, 101 AND 107). SN 77-732,882. PUB. 4-6-2010. FILED 5-8-2009.

- 3,805,642. **HOOFBEATS TO HEALING (STANDARD CHARACTER)**. HOOFBEATS TO HEALING. (U.S. CLS. 100, 101 AND 107). SN 77-735,473. PUB. 4-6-2010. FILED 5-12-2009.
- 3,805,652. **DIVINE TOUCH (STANDARD CHARACTER)**. GUIDEPOSTS A CHURCH CORPORATION, (U.S. CLS. 100, 101 AND 107). SN 77-738,022. PUB. 4-6-2010. FILED 5-15-2009.
- 3,805,654. **MISCELLANEOUS DESIGN**. HWAL'BAY BA:J ENTERPRISES, INC, (U.S. CLS. 100, 101 AND 107). SN 77-738,276. PUB. 4-6-2010. FILED 5-15-2009.
- 3,805,659. **ELEGANT EVENT ENTERTAINMENT (STANDARD CHARACTER)**. ELEGANT EVENT ENTERTAINMENT, INC., (U.S. CLS. 100, 101 AND 107). SN 77-739,586. PUB. 4-6-2010. FILED 5-18-2009.
- 3,805,663 (*See Class 16 for this trademark*).
- 3,805,668. **ULTRINSIC (STANDARD CHARACTER)**. ULTRINSIC MOTIVATOR INC., (U.S. CLS. 100, 101 AND 107). SN 77-741,387. PUB. 4-6-2010. FILED 5-20-2009.
- 3,805,679 (*See Class 16 for this trademark*).
- 3,805,687. **WASEDA UNIVERSITY (STANDARD CHARACTER)**. SCHOOL JURIDICAL PERSON WASEDA UNIVERSITY, MULTIPLE CLASS, (INT. CLS. 41 AND 42), (U.S. CLS. 100, 101 AND 107). SN 77-744,393. PUB. 4-6-2010. FILED 5-26-2009.
- 3,805,690. **KNOWLEDGE ON BOARD (STANDARD CHARACTER)**. CERTAINTEEED CORPORATION, (U.S. CLS. 100, 101 AND 107). SN 77-744,538. PUB. 4-6-2010. FILED 5-26-2009.
- 3,805,716. **FRESH NEWS (STANDARD CHARACTER)**. CITY HARVEST, INC., (U.S. CLS. 100, 101 AND 107). SN 77-750,155. PUB. 4-6-2010. FILED 6-2-2009.
- 3,805,717. **CASA DE FUEGO AND DESIGN**. PICAYUNE RANCHERIA OF THE CHUKCHANSI INDIANS, (U.S. CLS. 100, 101 AND 107). SN 77-750,433. PUB. 4-6-2010. FILED 6-2-2009.
- 3,805,718. **SAFETY 1ST ZIPLINE TOUR IN THE UNITED STATES ADVENTURE ENVIRONMENT AND DESIGN**. ADVENTURE HOLDINGS LLC, (U.S. CLS. 100, 101 AND 107). SN 77-750,554. PUB. 4-6-2010. FILED 6-2-2009.
- 3,805,721 (*See Class 16 for this trademark*).
- 3,805,724. **CAPS CERTIFIED APARTMENT PORTFOLIO SUPERVISOR AND DESIGN**. NATIONAL APARTMENT ASSOCIATION, (U.S. CLS. 100, 101 AND 107). SN 77-752,863. PUB. 4-6-2010. FILED 6-5-2009.
- 3,805,726. **AHA! MOMENT (STANDARD CHARACTER)**. HARPO, INC., (U.S. CLS. 100, 101 AND 107). SN 77-753,529. PUB. 4-6-2010. FILED 6-5-2009.
- 3,805,731. **NATURAL DOG TRAINING AND DESIGN**. BEHAN, KEVIN, AND BEHAN, AGI, (U.S. CLS. 100, 101 AND 107). SN 77-755,209. PUB. 4-6-2010. FILED 6-9-2009.
- 3,805,732. **DOMINATRIX CHARM SCHOOL AND DESIGN**. TWO NICKELS INCORPORATED, (U.S. CLS. 100, 101 AND 107). SN 77-755,880. PUB. 4-6-2010. FILED 6-10-2009.
- 3,805,734. **CHFP (STANDARD CHARACTER)**. HEALTHCARE FINANCIAL MANAGEMENT ASSOCIATION, MULTIPLE CLASS, (INT. CLS. 41 AND 42), (U.S. CLS. 100, 101 AND 107). SN 77-756,076. PUB. 4-6-2010. FILED 6-10-2009.
- 3,805,735. **FHMA (STANDARD CHARACTER)**. HEALTHCARE FINANCIAL MANAGEMENT ASSOCIATION, MULTIPLE CLASS, (INT. CLS. 41 AND 42), (U.S. CLS. 100, 101 AND 107). SN 77-756,091. PUB. 4-6-2010. FILED 6-10-2009.
- 3,805,736. **CRCR (STANDARD CHARACTER)**. HEALTHCARE FINANCIAL MANAGEMENT ASSOCIATION, MULTIPLE CLASS, (INT. CLS. 41 AND 42), (U.S. CLS. 100, 101 AND 107). SN 77-756,100. PUB. 4-6-2010. FILED 6-10-2009.
- 3,805,737 (*See Class 35 for this trademark*).
- 3,805,741. **109 (STANDARD CHARACTER)**. BLOGWIRE HUNGARY SZELLEMI ALKOTAST HASZNOSITO KFT, (U.S. CLS. 100, 101 AND 107). SN 77-757,349. PUB. 4-6-2010. FILED 6-11-2009.
- 3,805,748 (*See Class 35 for this trademark*).
- 3,805,750 (*See Class 5 for this trademark*).
- 3,805,751 (*See Class 5 for this trademark*).
- 3,805,755. **ELC ROUNDTABLE (STANDARD CHARACTER)**. PACE, THOMAS A., (U.S. CLS. 100, 101 AND 107). SN 77-760,507. PUB. 4-6-2010. FILED 6-16-2009.
- 3,805,756 (*See Class 35 for this trademark*).
- 3,805,765. **ROOKIE COOKIE TOUR AND DESIGN**. PEPPER, JACK, (U.S. CLS. 100, 101 AND 107). SN 77-762,893. PUB. 4-6-2010. FILED 6-18-2009.
- 3,805,773. **PROJECT VICTORY A TIRR FOUNDATION COLLABORATION AND DESIGN**. THE INSTITUTE FOR REHABILITATION AND RESEARCH FOUNDATION, MULTIPLE CLASS, (INT. CLS. 41 AND 44), (U.S. CLS. 100, 101 AND 107). SN 77-763,839. PUB. 4-6-2010. FILED 6-19-2009.
- 3,805,775. **YOURS, TRULY. (STANDARD CHARACTER)**. KERSHAWHEALTH, MULTIPLE CLASS, (INT. CLS. 41 AND 44), (U.S. CLS. 100, 101 AND 107). SN 77-764,145. PUB. 4-6-2010. FILED 6-19-2009.
- 3,805,780 (*See Class 16 for this trademark*).
- 3,805,782 (*See Class 16 for this trademark*).
- 3,805,789. **CAT WHISPERER (STANDARD CHARACTER)**. PURRTOPIA ENTERPRISES LIMITED, AKA THE CAT BEHAVIOR CLINIC, (U.S. CLS. 100, 101 AND 107). SN 77-768,484. PUB. 4-6-2010. FILED 6-25-2009.
- 3,805,791. **MOVIN' OUT BAND (STANDARD CHARACTER)**. BOEGER, WADE P., (U.S. CLS. 100, 101 AND 107). SN 77-769,562. PUB. 4-6-2010. FILED 6-26-2009.
- 3,805,803. **REALITYUNWIND (STANDARD CHARACTER)**. RATCLIFF JESSICA A., DBA REALITYUNWIND SOCIAL MEDIA NETWORKING COMPANY, (U.S. CLS. 100, 101 AND 107). SN 77-771,868. PUB. 4-6-2010. FILED 6-30-2009.
- 3,805,808 (*See Class 35 for this trademark*).
- 3,805,832 (*See Class 9 for this trademark*).
- 3,805,833. **BACKROOM MILF (STANDARD CHARACTER)**. BBIP, LLC, (U.S. CLS. 100, 101 AND 107). SN 77-780,622. PUB. 4-6-2010. FILED 7-14-2009.
- 3,805,835 (*See Class 36 for this trademark*).
- 3,805,836 (*See Class 36 for this trademark*).
- 3,805,842. **MISCELLANEOUS DESIGN**. WAY OF LIFE COACHING, LLC, (U.S. CLS. 100, 101 AND 107). SN 77-781,796. PUB. 4-6-2010. FILED 7-15-2009.
- 3,805,846 (*See Class 25 for this trademark*).
- 3,805,853. **DAILY MONSTER (STANDARD CHARACTER)**. STEFAN G. BUCHER, (U.S. CLS. 100, 101 AND 107). SN 77-784,990. PUB. 4-6-2010. FILED 7-20-2009.
- 3,805,873 (*See Class 9 for this trademark*).
- 3,805,881. **CC AND DESIGN**. CLUBCORP, INC., (U.S. CLS. 100, 101 AND 107). SN 77-792,590. PUB. 4-6-2010. FILED 7-29-2009.
- 3,805,906. **IN THE HOTSEAT (STANDARD CHARACTER)**. ONE EYED SPARK PRODUCTIONS, INC., (U.S. CLS. 100, 101 AND 107). SN 77-797,515. PUB. 4-6-2010. FILED 8-5-2009.
- 3,805,920 (*See Class 9 for this trademark*).
- 3,805,930. **SYLVANMATHPREP.COM AND DESIGN**. SYLVAN LEARNING, INC., (U.S. CLS. 100, 101 AND 107). SN 77-803,170. PUB. 4-6-2010. FILED 8-12-2009.
- 3,805,931. **SYLVANMATHPREP (STANDARD CHARACTER)**. SYLVAN LEARNING, INC., (U.S. CLS. 100, 101 AND 107). SN 77-803,172. PUB. 4-6-2010. FILED 8-12-2009.
- 3,805,932. **SCHOOLMATHPREP.COM AND DESIGN**. SYLVAN LEARNING, INC., (U.S. CLS. 100, 101 AND 107). SN 77-803,254. PUB. 4-6-2010. FILED 8-12-2009.
- 3,805,944 (*See Class 35 for this trademark*).
- 3,805,951 (*See Class 35 for this trademark*).
- 3,805,954 (*See Class 16 for this trademark*).
- 3,805,955 (*See Class 16 for this trademark*).
- 3,805,957. **THE SELF-PORTRAIT EXPERIENCE (STANDARD CHARACTER)**. SALMERON, CRISTINA NUÑEZ, MULTIPLE CLASS, (INT. CLS. 41 AND 44), (U.S. CLS. 100, 101 AND 107). SN 77-808,265. PUB. 4-6-2010. FILED 8-19-2009.
- 3,805,960. **UNITED WORLD UNLIMITED AND DESIGN**. KRISTEN GALICH, DBA UNITED WORLD UNLIMITED, AND VICTORIA ZAKRZEWSKI, DBA UNITED WORLD UNLIMITED, (U.S. CLS. 100, 101 AND 107). SN 77-809,034. PUB. 4-6-2010. FILED 8-20-2009.
- 3,805,962 (*See Class 9 for this trademark*).
- 3,805,966 (*See Class 35 for this trademark*).
- 3,805,969 (*See Class 35 for this trademark*).
- 3,805,976 (*See Class 39 for this trademark*).
- 3,805,994. **FRESH CONNECTIONS (STANDARD CHARACTER)**. PRODUCE MARKETING ASSOCIATION, INC., (U.S. CLS. 100, 101 AND 107). SN 77-816,151. PUB. 4-6-2010. FILED 8-31-2009.

- 3,806,004. **GUITAR TRICKS (STANDARD CHARACTER)**. WEB TRICK, INCORPORATED, (U.S. CLS. 100, 101 AND 107). SN 77-817,061. PUB. 4-6-2010. FILED 9-1-2009.
- 3,806,006 (*See Class 9 for this trademark*).
- 3,806,007 (*See Class 9 for this trademark*).
- 3,806,016. **CAMP KOREY (STANDARD CHARACTER)**. CAMP KOREY, (U.S. CLS. 100, 101 AND 107). SN 77-819,585. PUB. 4-6-2010. FILED 9-3-2009.
- 3,806,019. **MAVERICK PRIZE (STANDARD CHARACTER)**. AUTRY NATIONAL CENTER OF THE AMERICAN WEST, (U.S. CLS. 100, 101 AND 107). SN 77-820,027. PUB. 4-6-2010. FILED 9-3-2009.
- 3,806,020. **GOOD TO WOW (STANDARD CHARACTER)**. SEK, KOSOL P, (U.S. CLS. 100, 101 AND 107). SN 77-820,134. PUB. 4-6-2010. FILED 9-4-2009.
- 3,806,023. **JAZZ D'ELEGANCE AND DESIGN**. JAZZ D'ELEGANCE, LLC, (U.S. CLS. 100, 101 AND 107). SN 77-820,397. PUB. 4-6-2010. FILED 9-4-2009.
- 3,806,026. **BROW PLANE (STANDARD CHARACTER)**. THE CHRISTI HARRIS COMPANIES, INC., (U.S. CLS. 100, 101 AND 107). SN 77-821,036. PUB. 4-6-2010. FILED 9-5-2009.
- 3,806,033. **MIRROR'S EDGE AND DESIGN**. EA DIGITAL ILLUSIONS CE AB, (U.S. CLS. 100, 101 AND 107). SN 77-822,010. PUB. 2-9-2010. FILED 9-8-2009.
- 3,806,037. **I RUN FOR THE PARTY (STANDARD CHARACTER)**. MARTIN, EMMIT, (U.S. CLS. 100, 101 AND 107). SN 77-822,250. PUB. 4-6-2010. FILED 9-8-2009.
- 3,806,043. **WRESTLING CONNECTION (STANDARD CHARACTER)**. NEW YORK WRESTLING CONNECTION INC., DBA NEW YORK WRESTLING CONNECTION, (U.S. CLS. 100, 101 AND 107). SN 77-823,898. PUB. 2-9-2010. FILED 9-10-2009.
- 3,806,061 (*See Class 9 for this trademark*).
- 3,806,065 (*See Class 9 for this trademark*).
- 3,806,073 (*See Class 35 for this trademark*).
- 3,806,084. **OBOW (STANDARD CHARACTER)**. ECA WORLD FITNESS ALLIANCE, (U.S. CLS. 100, 101 AND 107). SN 77-830,413. PUB. 4-6-2010. FILED 9-19-2009.
- 3,806,086. **CLEARKEYGOLF (STANDARD CHARACTER)**. CAREY G. MUMFORD, (U.S. CLS. 100, 101 AND 107). SN 77-830,980. PUB. 4-6-2010. FILED 9-21-2009.
- 3,806,089. **MISCELLANEOUS DESIGN**. BOHEMIAN CLUB, (U.S. CLS. 100, 101 AND 107). SN 77-831,931. PUB. 4-6-2010. FILED 9-22-2009.
- 3,806,092. **INTELLUM (STANDARD CHARACTER)**. INTEL-LUM, INC., MULTIPLE CLASS, (INT. CLS. 41 AND 42), (U.S. CLS. 100, 101 AND 107). SN 77-833,209. PUB. 4-6-2010. FILED 9-23-2009.
- 3,806,093. **MISCELLANEOUS DESIGN**. INTELUM, INC., MULTIPLE CLASS, (INT. CLS. 41 AND 42), (U.S. CLS. 100, 101 AND 107). SN 77-833,271. PUB. 4-6-2010. FILED 9-23-2009.
- 3,806,101 (*See Class 16 for this trademark*).
- 3,806,123. **ZOOTOO PET NEWS (STANDARD CHARACTER)**. ZOO TOO LLC, (U.S. CLS. 100, 101 AND 107). SN 77-837,364. PUB. 4-6-2010. FILED 9-29-2009.
- 3,806,142. **MISCELLANEOUS DESIGN**. RAYMOND GUER-RERO, MULTIPLE CLASS, (INT. CLS. 41 AND 43), (U.S. CLS. 100, 101 AND 107). SN 77-839,334. PUB. 4-6-2010. FILED 10-1-2009.
- 3,806,143. **CUBAN PETE'S (STANDARD CHARACTER)**. RAY-MOND GUERRERO, MULTIPLE CLASS, (INT. CLS. 41 AND 43), (U.S. CLS. 100, 101 AND 107). SN 77-839,380. PUB. 4-6-2010. FILED 10-1-2009.
- 3,806,156 (*See Class 16 for this trademark*).
- 3,806,160. **CC CERTIFIED CONTROLLER (STANDARD CHARACTER)**. INTERNATIONAL INSTITUTE OF CER-TIFIED PUBLIC ACCOUNTANTS INCORPORATED, (U.S. CLS. 100, 101 AND 107). SN 77-842,212. PUB. 4-6-2010. FILED 10-6-2009.
- 3,806,166. **PROVERBS CINEMA HEAVENLY TRUTHS**. EARTHLY STORIES (STANDARD CHARACTER). RUSS RICE, DBA SIGNATURE FUNDRAISING, INC., (U.S. CLS. 100, 101 AND 107). SN 77-843,008. PUB. 4-6-2010. FILED 10-6-2009.
- 3,806,167 (*See Class 38 for this trademark*).
- 3,806,168 (*See Class 35 for this trademark*).
- 3,806,179 (*See Class 9 for this trademark*).
- 3,806,184 (*See Class 35 for this trademark*).
- 3,806,186 (*See Class 35 for this trademark*).
- 3,806,192. **CROWN ELITE TENNIS AND DESIGN**. CROWN ELITE TENNIS LLC, (U.S. CLS. 100, 101 AND 107). SN 77-845,704. PUB. 4-6-2010. FILED 10-9-2009.
- 3,806,198. **PROVERBS CINEMA (STANDARD CHARACTER)**. RUSS RICE, DBA SIGNATURE FUNDRAISING, INC., (U.S. CLS. 100, 101 AND 107). SN 77-846,080. PUB. 4-6-2010. FILED 10-10-2009.
- 3,806,199. **HEAVENLY TRUTHS**. EARTHLY STORIES (STAN-DARD CHARACTER). RUSS RICE, DBA SIGNATURE FUNDRAISING, INC., (U.S. CLS. 100, 101 AND 107). SN 77-846,084. PUB. 4-6-2010. FILED 10-10-2009.
- 3,806,214. **GR8—SPACE (STANDARD CHARACTER)**. GREAT LAKES SERVICES, LLC, (U.S. CLS. 100, 101 AND 107). SN 77-847,699. PUB. 4-6-2010. FILED 10-13-2009.
- 3,806,216 (*See Class 9 for this trademark*).
- 3,806,217. **ASKSALLYM (STANDARD CHARACTER)**. SALLY MILLER, (U.S. CLS. 100, 101 AND 107). SN 77-847,938. PUB. 4-6-2010. FILED 10-13-2009.
- 3,806,222 (*See Class 9 for this trademark*).
- 3,806,224 (*See Class 39 for this trademark*).
- 3,806,239 (*See Class 9 for this trademark*).
- 3,806,243. **CELEBRITYBABYSCOOP (STYLIZED)**. CELEBRITY BABY SCOOP, LLC, (U.S. CLS. 100, 101 AND 107). SN 77-850,380. PUB. 4-6-2010. FILED 10-16-2009.
- 3,806,245. **FIRST PERSON VIDEO (STANDARD CHARAC-TER)**. FORD, MADELINE CELESTE, DBA CELESTE FORD, (U.S. CLS. 100, 101 AND 107). SN 77-850,490. PUB. 4-6-2010. FILED 10-16-2009.
- 3,806,251. **KORNBLUE KICKING SCHOOL AND DESIGN**. KORNBLUE KICKING SCHOOL, INC., (U.S. CLS. 100, 101 AND 107). SN 77-850,931. PUB. 4-6-2010. FILED 10-16-2009.
- 3,806,255. **TAXI LIBRE (STANDARD CHARACTER)**. AZTECA INTERNATIONAL CORPORATION, (U.S. CLS. 100, 101 AND 107). SN 77-851,484. PUB. 4-6-2010. FILED 10-19-2009.
- 3,806,261. **MARIACHI DE MI TIERRA (STANDARD CHAR-ACTER)**. BOCANEGRA, ALFREDO, (U.S. CLS. 100, 101 AND 107). SN 77-852,216. PUB. 4-6-2010. FILED 10-19-2009.
- 3,806,264. **PIANO4LIFE (STANDARD CHARACTER)**. NEL-SON, HITCH, DBA PIANO4LIFE, (U.S. CLS. 100, 101 AND 107). SN 77-852,344. PUB. 4-6-2010. FILED 10-20-2009.
- 3,806,269. **NORTH JERSEY VALKYRIES TSF ACADEMY BLUE REIGN AND DESIGN**. J & S ENTERPRISES, LLC, (U.S. CLS. 100, 101 AND 107). SN 77-852,822. PUB. 4-6-2010. FILED 10-20-2009.
- 3,806,276. **TIEMPOS FINALES TELEVISION (STANDARD CHARACTER)**. GUTIERREZ, JOSE A., DBA TIEMPOS FINALES TELEVISION, (U.S. CLS. 100, 101 AND 107). SN 77-853,254. PUB. 4-6-2010. FILED 10-20-2009.
- 3,806,278 (*See Class 16 for this trademark*).
- 3,806,281. **LO QUE LA GENTE CUENTA (STANDARD CHAR-ACTER)**. AZTECA INTERNATIONAL CORP, (U.S. CLS. 100, 101 AND 107). SN 77-853,655. PUB. 4-6-2010. FILED 10-21-2009.
- 3,806,304. **THE MIGHTY PRAGMATICS (STANDARD CHAR-ACTER)**. LAZZARA, TONY, (U.S. CLS. 100, 101 AND 107). SN 77-854,897. PUB. 4-6-2010. FILED 10-22-2009.
- 3,806,306. **TRIPLE HORN (STANDARD CHARACTER)**. EX-CLUSIVE GENETICS, LP, (U.S. CLS. 100, 101 AND 107). SN 77-854,991. PUB. 4-6-2010. FILED 10-22-2009.
- 3,806,308. **DATAWEST GROUP (STANDARD CHARACTER)**. DATAWEST GROUP, INC., (U.S. CLS. 100, 101 AND 107). SN 77-855,065. PUB. 4-6-2010. FILED 10-22-2009.
- 3,806,312. **GEARGALS (STANDARD CHARACTER)**. MISSAL LLC, DBA JILL MISSAL, (U.S. CLS. 100, 101 AND 107). SN 77-855,187. PUB. 4-6-2010. FILED 10-22-2009.
- 3,806,315. **D2M DANCE ACADEMY (STANDARD CHARAC-TER)**. D2M DANCE ACADEMY, (U.S. CLS. 100, 101 AND 107). SN 77-855,254. PUB. 4-6-2010. FILED 10-22-2009.
- 3,806,320 (*See Class 16 for this trademark*).
- 3,806,322. **LICENSE LOGIC (STANDARD CHARACTER)**. LICENSELOGIC, LLC, (U.S. CLS. 100, 101 AND 107). SN 77-855,477. PUB. 4-6-2010. FILED 10-22-2009.
- 3,806,326 (*See Class 35 for this trademark*).
- 3,806,327 (*See Class 35 for this trademark*).
- 3,806,328 (*See Class 35 for this trademark*).
- 3,806,354. **TECHNOLOGY CONVERGENCE CONFERENCE**

- AND DESIGN. TELADATA LLC, (U.S. CLS. 100, 101 AND 107). SN 77-856,688. PUB. 4-6-2010. FILED 10-24-2009.
- 3,806,361. **HIGH OCTANE AND DESIGN**. BAUMES, RAYMOND L., (U.S. CLS. 100, 101 AND 107). SN 77-856,871. PUB. 4-6-2010. FILED 10-25-2009.
- 3,806,373. **TRAIN WITH JANE AND DESIGN**. TWJ, INC., MULTIPLE CLASS, (INT. CLS. 41 AND 44), (U.S. CLS. 100, 101 AND 107). SN 77-857,105. PUB. 4-6-2010. FILED 10-26-2009.
- 3,806,374. **BACKYARD SHAKESPEARE (STANDARD CHARACTER)**. GEORGES, MARTIN, AND GEORGES, ELEANOR, (U.S. CLS. 100, 101 AND 107). SN 77-857,118. PUB. 4-6-2010. FILED 10-26-2009.
- 3,806,375. **LINGUISTIC REMEDIES (STANDARD CHARACTER)**. REMEDIES FOR READING DISABILITIES, INC., (U.S. CLS. 100, 101 AND 107). SN 77-857,137. PUB. 4-6-2010. FILED 10-26-2009.
- 3,806,385. **INTERPRET-EARS (STANDARD CHARACTER)**. INTERPRET-EARS, CORP., (U.S. CLS. 100, 101 AND 107). SN 77-857,436. PUB. 4-6-2010. FILED 10-26-2009.
- 3,806,394 (*See Class 9 for this trademark*).
- 3,806,411. **ABOVE GRADE LEVEL (STANDARD CHARACTER)**. EQUINOX LEARNING, LLC, (U.S. CLS. 100, 101 AND 107). SN 77-858,034. PUB. 4-6-2010. FILED 10-27-2009.
- 3,806,420. **THE FIREFLIES (STANDARD CHARACTER)**. GIACALONE, PAUL, (U.S. CLS. 100, 101 AND 107). SN 77-858,170. PUB. 4-6-2010. FILED 10-27-2009.
- 3,806,422. **MUSEUM OF THE MACABRE AND DESIGN**. FINK, ROBERT, AND FINK II, RICHARD, (U.S. CLS. 100, 101 AND 107). SN 77-858,190. PUB. 4-6-2010. FILED 10-27-2009.
- 3,806,425. **ZOE PRODUCTIONS (STANDARD CHARACTER)**. ZOE PRODUCTIONS, INC., (U.S. CLS. 100, 101 AND 107). SN 77-858,196. PUB. 4-6-2010. FILED 10-27-2009.
- 3,806,440. **MISCELLANEOUS DESIGN**. TOTAL LIFE COMMUNITY EDUCATIONAL FOUNDATION, INC., (U.S. CLS. 100, 101 AND 107). SN 77-858,377. PUB. 4-6-2010. FILED 10-27-2009.
- 3,806,441. **CHANGE BUILDERS (STANDARD CHARACTER)**. PEOPLE BUSINESS, INC., (U.S. CLS. 100, 101 AND 107). SN 77-858,408. PUB. 4-6-2010. FILED 10-27-2009.
- 3,806,442. **CME 2ME (STYLIZED)**. CATHOLIC HEALTH INITIATIVES COLORADO, DBA ST. ANTHONY CENTRAL HOSPITAL, (U.S. CLS. 100, 101 AND 107). SN 77-858,434. PUB. 4-6-2010. FILED 10-27-2009.
- 3,806,448. **IRON TRIBE FITNESS (STANDARD CHARACTER)**. WALDEN FORREST, (U.S. CLS. 100, 101 AND 107). SN 77-858,486. PUB. 4-6-2010. FILED 10-27-2009.
- 3,806,451. **ZUKU REVIEW AND DESIGN**. ZUKU, LLC, (U.S. CLS. 100, 101 AND 107). SN 77-858,501. PUB. 4-6-2010. FILED 10-27-2009.
- 3,806,456. **HEALTHADVANTAGE (STYLIZED)**. HAWAII PACIFIC HEALTH, MULTIPLE CLASS, (INT. CLS. 41 AND 44), (U.S. CLS. 100, 101 AND 107). SN 77-858,519. PUB. 4-6-2010. FILED 10-27-2009.
- 3,806,463. **MISCELLANEOUS DESIGN**. BANDSINTOWN, INC, (U.S. CLS. 100, 101 AND 107). SN 77-858,549. PUB. 4-6-2010. FILED 10-27-2009.
- 3,806,498. **DARE DORM (STANDARD CHARACTER)**. RKIP, LLC, (U.S. CLS. 100, 101 AND 107). SN 77-858,937. PUB. 4-6-2010. FILED 10-28-2009.
- 3,806,499. **MOLLY'S LIFE (STANDARD CHARACTER)**. RKIP, LLC, (U.S. CLS. 100, 101 AND 107). SN 77-858,947. PUB. 4-6-2010. FILED 10-28-2009.
- 3,806,500. **MUFFIA (STANDARD CHARACTER)**. RKIP, LLC, (U.S. CLS. 100, 101 AND 107). SN 77-858,949. PUB. 4-6-2010. FILED 10-28-2009.
- 3,806,501. **RKTV (STANDARD CHARACTER)**. RKIP, LLC, (U.S. CLS. 100, 101 AND 107). SN 77-858,957. PUB. 4-6-2010. FILED 10-28-2009.
- 3,806,502. **THE RED PUMPKIN (STANDARD CHARACTER)**. HANNAH GAMES, LLC, (U.S. CLS. 100, 101 AND 107). SN 77-858,959. PUB. 4-6-2010. FILED 10-28-2009.
- 3,806,508. **CHEF IT UP! AND CHEF IT UP 2 GO! "WHERE KIDS & FOOD ARE A GREAT MIX" (STANDARD CHARACTER)**. LISA TIRONE, DBA CHEF IT UP & CHEF IT UP 2 GO, (U.S. CLS. 100, 101 AND 107). SN 77-859,014. PUB. 4-6-2010. FILED 10-28-2009.
- 3,806,528. **ASTONISH COACHING (STANDARD CHARACTER)**. ASTONISH RESULTS, LP, (U.S. CLS. 100, 101 AND 107). SN 77-859,263. PUB. 4-6-2010. FILED 10-28-2009.
- 3,806,529. **MYVIDEOMYVOICE (STANDARD CHARACTER)**. MY VIDEO MY VOICE, LLC, (U.S. CLS. 100, 101 AND 107). SN 77-859,331. PUB. 4-6-2010. FILED 10-28-2009.
- 3,806,536. **CC CONTEMPORARY COCKTAILS INC. AND DESIGN**. CONTEMPORARY COCKTAILS, INC., MULTIPLE CLASS, (INT. CLS. 41 AND 43), (U.S. CLS. 100, 101 AND 107). SN 77-859,467. PUB. 4-6-2010. FILED 10-28-2009.
- 3,806,541. **THE CLIMATE RACE (STANDARD CHARACTER)**. MINNESOTA PUBLIC RADIO, (U.S. CLS. 100, 101 AND 107). SN 77-859,506. PUB. 4-6-2010. FILED 10-28-2009.
- 3,806,550. **THE 7TH LINK (STANDARD CHARACTER)**. ROMDON MUSIC GROUP, LLC, (U.S. CLS. 100, 101 AND 107). SN 77-859,561. PUB. 4-6-2010. FILED 10-28-2009.
- 3,806,556. **ST INSTITUTE (STANDARD CHARACTER)**. KAI DI, (U.S. CLS. 100, 101 AND 107). SN 77-859,603. PUB. 4-6-2010. FILED 10-28-2009.
- 3,806,564 (*See Class 9 for this trademark*).
- 3,806,587 (*See Class 25 for this trademark*).
- 3,806,589. **ANYTIME RENTALS (STANDARD CHARACTER)**. ANYTIME PRODUCTION EQUIPMENT RENTALS, INC., (U.S. CLS. 100, 101 AND 107). SN 77-859,906. PUB. 4-6-2010. FILED 10-28-2009.
- 3,806,591. **FIRST FAMILY ESSENTIALS (STANDARD CHARACTER)**. THE PAIRS FOUNDATION, INC., (U.S. CLS. 100, 101 AND 107). SN 77-859,924. PUB. 4-6-2010. FILED 10-28-2009.
- 3,806,592. **THE BAND PERRY (STANDARD CHARACTER)**. PERRY, KIMBERLY, AND PERRY, REID, AND PERRY, NEIL, (U.S. CLS. 100, 101 AND 107). SN 77-859,974. PUB. 4-6-2010. FILED 10-28-2009.
- 3,806,606. **TALENTSPARKS (STANDARD CHARACTER)**. IBIO INSTITUTE, (U.S. CLS. 100, 101 AND 107). SN 77-860,098. PUB. 4-6-2010. FILED 10-29-2009.
- 3,806,607. **MIT LGO LEADERS FOR GLOBAL OPERATIONS AND DESIGN**. MASSACHUSETTS INSTITUTE OF TECHNOLOGY, (U.S. CLS. 100, 101 AND 107). SN 77-860,101. PUB. 4-6-2010. FILED 10-29-2009.
- 3,806,609. **MISCELLANEOUS DESIGN**. RENAISSANCE NUTRITION CENTER, INC., MULTIPLE CLASS, (INT. CLS. 41 AND 44), (U.S. CLS. 100, 101 AND 107). SN 77-860,119. PUB. 4-6-2010. FILED 10-29-2009.
- 3,806,612. **CAPOKIDS (STANDARD CHARACTER)**. CAPOEIRA VOLTA AO MUNDO, INC., (U.S. CLS. 100, 101 AND 107). SN 77-860,136. PUB. 4-6-2010. FILED 10-29-2009.
- 3,806,618. **BOKTOBERFEST (STANDARD CHARACTER)**. THE BOK TOWER GARDENS FOUNDATION, INC., DBA BOK TOWER GARDENS, (U.S. CLS. 100, 101 AND 107). SN 77-860,196. PUB. 4-6-2010. FILED 10-29-2009.
- 3,806,622. **IMMINENT SUCCESS ENTERPRISES AND DESIGN**. IMMINENT SUCCESS ENTERPRISES, LLC, MULTIPLE CLASS, (INT. CLS. 41 AND 45), (U.S. CLS. 100, 101 AND 107). SN 77-860,237. PUB. 4-6-2010. FILED 10-29-2009.
- 3,806,635. **STUDIO 880 (STANDARD CHARACTER)**. LUCASEY, JOHN, (U.S. CLS. 100, 101 AND 107). SN 77-860,428. PUB. 4-6-2010. FILED 10-29-2009.
- 3,806,637. **IDEAS TO INK (STANDARD CHARACTER)**. IDEAS TO INK, LLC, (U.S. CLS. 100, 101 AND 107). SN 77-860,459. PUB. 4-6-2010. FILED 10-29-2009.
- 3,806,641. **AMERICAN DREAM (STANDARD CHARACTER)**. MCCLAINE, STEPHANIE A, (U.S. CLS. 100, 101 AND 107). SN 77-860,535. PUB. 4-6-2010. FILED 10-29-2009.
- 3,806,643 (*See Class 25 for this trademark*).
- 3,806,655. **FOTOBOT (STANDARD CHARACTER)**. GRAHAM, ARAN S, DBA FOTOBOT, (U.S. CLS. 100, 101 AND 107). SN 77-860,632. PUB. 4-6-2010. FILED 10-29-2009.
- 3,806,671. **BROCDIANT IP ALERT (STANDARD CHARACTER)**. BROCDIANT PLLC, (U.S. CLS. 100, 101 AND 107). SN 77-860,808. PUB. 4-6-2010. FILED 10-29-2009.
- 3,806,688. **ISIS THE AMAZON (STANDARD CHARACTER)**. DOG EAT DOG, LLC, (U.S. CLS. 100, 101 AND 107). SN 77-861,029. PUB. 4-6-2010. FILED 10-30-2009.
- 3,806,728. **DIW THE DANCE INSTITUTE OF WASHINGTON AND DESIGN**. DANCE INSTITUTE OF WASHINGTON, (U.S. CLS. 100, 101 AND 107). SN 77-861,630. PUB. 4-6-2010. FILED 10-30-2009.

- 3,806,733. **BLACK BEAK PRESS (STANDARD CHARACTER)**. SOPRANZI, ANTHONY D., (U.S. CLS. 100, 101 AND 107). SN 77-861,678. PUB. 4-6-2010. FILED 10-30-2009.
- 3,806,734. **DIW (STANDARD CHARACTER)**. DANCE INSTITUTE OF WASHINGTON, (U.S. CLS. 100, 101 AND 107). SN 77-861,687. PUB. 4-6-2010. FILED 10-30-2009.
- 3,806,738. **ENGLISHPOD (STANDARD CHARACTER)**. PRAXIS LANGUAGE LTD., (U.S. CLS. 100, 101 AND 107). SN 77-861,725. PUB. 4-6-2010. FILED 10-30-2009.
- 3,806,753. **M ENT W (STYLIZED)**, MAKE WAY ENTERTAINMENT LLC, (U.S. CLS. 100, 101 AND 107). SN 77-861,946. PUB. 4-6-2010. FILED 10-30-2009.
- 3,806,757. **UNSILENT NIGHT (STANDARD CHARACTER)**. KLINE, PHIL, (U.S. CLS. 100, 101 AND 107). SN 77-862,025. PUB. 4-6-2010. FILED 10-31-2009.
- 3,806,759. **HELLOPOLITICS (STANDARD CHARACTER)**. REIKO NAKAMA TOM, AKA REIKO EOH, (U.S. CLS. 100, 101 AND 107). SN 77-862,097. PUB. 4-6-2010. FILED 10-31-2009.
- 3,806,761. **CHANGING LIVES, MAKING INDIANA GREAT (STANDARD CHARACTER)**. IVY TECH COMMUNITY COLLEGE, (U.S. CLS. 100, 101 AND 107). SN 77-862,445. PUB. 4-6-2010. FILED 11-2-2009.
- 3,806,763. **WEDIDUCAN (STANDARD CHARACTER)**. WHITE HAT VENTURES, LLC, (U.S. CLS. 100, 101 AND 107). SN 77-862,487. PUB. 4-6-2010. FILED 11-2-2009.
- 3,806,768. **ANSWER PLOT AND DESIGN**. WINFIELD SOLUTIONS LLC, MULTIPLE CLASS, (INT. CLS. 41 AND 44), (U.S. CLS. 100, 101 AND 107). SN 77-862,590. PUB. 4-6-2010. FILED 11-2-2009.
- 3,806,771. **BAD MUSICALS FESTIVAL (STYLIZED)**. NY ARTISTS UNLIMITED, (U.S. CLS. 100, 101 AND 107). SN 77-862,630. PUB. 4-6-2010. FILED 11-2-2009.
- 3,806,780. **CARMEN CARTER (STANDARD CHARACTER)**. CARMEN CARTER, (U.S. CLS. 100, 101 AND 107). SN 77-862,727. PUB. 4-6-2010. FILED 11-2-2009.
- 3,806,790. **HEARTLAND U.S.A. (STANDARD CHARACTER)**. BABCO ASSOCIATES, LTD., (U.S. CLS. 100, 101 AND 107). SN 77-862,994. PUB. 4-6-2010. FILED 11-2-2009.
- 3,806,793. **GREEDWATCHER (STANDARD CHARACTER)**. HENDON, STAMFORD HILL & CO., INC., (U.S. CLS. 100, 101 AND 107). SN 77-863,035. PUB. 4-6-2010. FILED 11-2-2009.
- 3,806,800. **LAZYDAYS RV CAMPGROUND (STANDARD CHARACTER)**. LAZY DAYS' R.V. CENTER, INC., MULTIPLE CLASS, (INT. CLS. 41 AND 43), (U.S. CLS. 100, 101 AND 107). SN 77-863,161. PUB. 4-6-2010. FILED 11-2-2009.
- 3,806,833 (*See Class 36 for this trademark*).
- 3,806,835. **MCELROYHUB (STANDARD CHARACTER)**. RALPH MCELROY AND ASSOCIATES, LTD., MULTIPLE CLASS, (INT. CLS. 41 AND 42), (U.S. CLS. 100, 101 AND 107). SN 77-863,736. PUB. 4-6-2010. FILED 11-3-2009.
- 3,806,838. **B AND DESIGN**. SOPRANZI, ANTHONY D., (U.S. CLS. 100, 101 AND 107). SN 77-863,768. PUB. 4-6-2010. FILED 11-3-2009.
- 3,806,844. **24 HOUR FITNESS AND DESIGN**. 24 HOUR FITNESS USA, INC., (U.S. CLS. 100, 101 AND 107). SN 77-863,843. PUB. 4-6-2010. FILED 11-3-2009.
- 3,806,845. **BAKER HOTEL (STANDARD CHARACTER)**. BECKWORTH, CARTER, (U.S. CLS. 100, 101 AND 107). SN 77-863,846. PUB. 4-6-2010. FILED 11-3-2009.
- 3,806,858. **ALEGGUP (STANDARD CHARACTER)**. ALEGGUP, LLC, (U.S. CLS. 100, 101 AND 107). SN 77-864,015. PUB. 4-6-2010. FILED 11-3-2009.
- 3,806,861. **EARTH-LIST.COM AND DESIGN**. EARTH-LIST, LLC, AKA EARTH-LIST.COM, (U.S. CLS. 100, 101 AND 107). SN 77-864,070. PUB. 4-6-2010. FILED 11-3-2009.
- 3,806,862. **CINESPIA (STANDARD CHARACTER)**. WYATT, JOHN, (U.S. CLS. 100, 101 AND 107). SN 77-864,103. PUB. 4-6-2010. FILED 11-3-2009.
- 3,806,871. **IUON (STANDARD CHARACTER)**. ROSS, ROBERT, DR., (U.S. CLS. 100, 101 AND 107). SN 77-864,200. PUB. 4-6-2010. FILED 11-3-2009.
- 3,806,887. **C IN A CIRCLE (STANDARD CHARACTER)**. BROADCAST MUSIC, INC., (U.S. CLS. 100, 101 AND 107). SN 77-864,969. PUB. 4-6-2010. FILED 11-4-2009.
- 3,806,890. **VIBRANTSTILLNESS (STANDARD CHARACTER)**. SAMUEL JACKSON, DBA VIBRANTSTILLNESS, (U.S. CLS. 100, 101 AND 107). SN 77-865,076. PUB. 4-6-2010. FILED 11-4-2009.
- 3,806,931. **SMIRNOFF EXPERIENCE (STANDARD CHARACTER)**. DIAGEO NORTH AMERICA, INC., (U.S. CLS. 100, 101 AND 107). SN 77-870,017. PUB. 4-6-2010. FILED 11-11-2009.
- 3,806,932. **CPR COLLEGE PLANNING RELIEF AND DESIGN**. SUMMIT FINANCIAL GROUP, INC., (U.S. CLS. 100, 101 AND 107). SN 77-870,072. PUB. 4-6-2010. FILED 11-11-2009.
- 3,806,933. **GYM STATION'S FIELD DAY CAMPS (STYLIZED)**. GSF SYSTEMS, LLC, (U.S. CLS. 100, 101 AND 107). SN 77-870,116. PUB. 4-6-2010. FILED 11-11-2009.
- 3,806,954 (*See Class 35 for this trademark*).
- 3,806,970. **CGS CENTER FOR GREEN STUDIES AND DESIGN**. CENTER FOR GREEN STUDIES, INC., (U.S. CLS. 100, 101 AND 107). SN 77-875,925. PUB. 4-6-2010. FILED 11-18-2009.
- 3,806,974 (*See Class 16 for this trademark*).
- 3,806,989 (*See Class 9 for this trademark*).
- 3,807,032 (*See Class 38 for this trademark*).
- 3,807,051 (*See Class 38 for this trademark*).
- 3,807,052 (*See Class 38 for this trademark*).
- 3,807,058 (*See Class 36 for this trademark*).
- 3,807,059 (*See Class 35 for this trademark*).
- 3,807,071 (*See Class 9 for this trademark*).
- 3,807,083 (*See Class 9 for this trademark*).
- 3,807,091 (*See Class 14 for this trademark*).
- 3,807,092 (*See Class 12 for this trademark*).
- 3,807,101 (*See Class 29 for this trademark*).
- 3,807,117 (*See Class 5 for this trademark*).
- 3,807,125 (*See Class 9 for this trademark*).
- 3,807,131 (*See Class 3 for this trademark*).
- 3,807,135 (*See Class 9 for this trademark*).
- 3,807,151 (*See Class 35 for this trademark*).
- 3,807,153 (*See Class 9 for this trademark*).
- 3,807,158 (*See Class 35 for this trademark*).
- 3,807,176 (*See Class 9 for this trademark*).
- 3,807,180 (*See Class 3 for this trademark*).
- 3,807,182 (*See Class 16 for this trademark*).
- 3,807,183 (*See Class 16 for this trademark*).
- 3,807,203 (*See Class 16 for this trademark*).
- 3,807,218 (*See Class 9 for this trademark*).
- 3,807,219 (*See Class 9 for this trademark*).
- 3,807,220 (*See Class 9 for this trademark*).
- 3,807,221 (*See Class 9 for this trademark*).
- 3,807,228 (*See Class 9 for this trademark*).
- 3,807,229 (*See Class 7 for this trademark*).
- 3,807,232 (*See Class 12 for this trademark*).
- 3,807,233 (*See Class 3 for this trademark*).
- 3,807,249 (*See Class 9 for this trademark*).
- 3,807,252 (*See Class 9 for this trademark*).
- 3,807,257 (*See Class 9 for this trademark*).
- 3,807,267 (*See Class 38 for this trademark*).
- 3,807,271 (*See Class 3 for this trademark*).
- 3,807,275 (*See Class 35 for this trademark*).
- 3,807,312 (*See Class 28 for this trademark*).

CLASS 42—SCIENTIFIC AND COMPUTER SERVICES

- 3,805,145 (*See Class 35 for this trademark*).
- 3,805,149 (*See Class 9 for this trademark*).
- 3,805,167 (*See Class 9 for this trademark*).
- 3,805,170. **WORK SMARTER, TOGETHER. (STANDARD CHARACTER)**. HOTSCHEDULES.COM, INC, (U.S. CLS. 100 AND 101). SN 76-700,159. PUB. 4-6-2010. FILED 10-30-2009.
- 3,805,180 (*See Class 9 for this trademark*).
- 3,805,185 (*See Class 7 for this trademark*).
- 3,805,186 (*See Class 9 for this trademark*).
- 3,805,187. **HOLT SOUNDBOOTH (STANDARD CHARACTER)**. HMH PUBLISHERS LLC, (U.S. CLS. 100 AND 101). SN 77-046,604. PUB. 8-19-2008. FILED 11-17-2006.
- 3,805,189 (*See Class 38 for this trademark*).
- 3,805,190 (*See Class 40 for this trademark*).
- 3,805,202 (*See Class 6 for this trademark*).

- 3,805,204 (*See Class 35 for this trademark*).
- 3,805,211. **FUSION FACTOR (STANDARD CHARACTER)**. FUSION FACTOR CORPORATION, (U.S. CLS. 100 AND 101). SN 77-315,910. PUB. 4-6-2010. FILED 10-29-2007.
- 3,805,217. **CANDY & CANDY (STANDARD CHARACTER)**. CANDY & CANDY LIMITED, (U.S. CLS. 100 AND 101). SN 77-330,550. PUB. 4-6-2010. FILED 11-15-2007.
- 3,805,225 (*See Class 35 for this trademark*).
- 3,805,239. **VASCULAR BIOGENICS (STANDARD CHARACTER)**. VASCULAR BIOGENICS LTD., (U.S. CLS. 100 AND 101). SN 77-397,305. PUB. 4-6-2010. FILED 2-14-2008.
- 3,805,243 (*See Class 10 for this trademark*).
- 3,805,245. **VBL VASCULAR BIOGENICS LTD. AND DESIGN**. VASCULAR BIOGENICS LTD., (U.S. CLS. 100 AND 101). SN 77-411,204. PUB. 4-6-2010. FILED 3-3-2008.
- 3,805,246 (*See Class 17 for this trademark*).
- 3,805,256 (*See Class 9 for this trademark*).
- 3,805,259 (*See Class 9 for this trademark*).
- 3,805,294 (*See Class 14 for this trademark*).
- 3,805,298 (*See Class 35 for this trademark*).
- 3,805,303. **MOVE YOUR MEDIA (STANDARD CHARACTER)**. SOUNDBLAZE MEDIA, LLC, (U.S. CLS. 100 AND 101). SN 77-511,300. PUB. 4-6-2010. FILED 6-30-2008.
- 3,805,313 (*See Class 9 for this trademark*).
- 3,805,323 (*See Class 41 for this trademark*).
- 3,805,330 (*See Class 41 for this trademark*).
- 3,805,331 (*See Class 9 for this trademark*).
- 3,805,332 (*See Class 35 for this trademark*).
- 3,805,363 (*See Class 37 for this trademark*).
- 3,805,366. **CONNECT HERE. BE EVERYWHERE. (STANDARD CHARACTER)**. NEW CLOUD TECHNOLOGIES, LLC, (U.S. CLS. 100 AND 101). SN 77-586,557. PUB. 4-6-2010. FILED 10-6-2008.
- 3,805,377. **AUGUSTWAVE (STANDARD CHARACTER)**. AUGUSTWAVE, LLC, (U.S. CLS. 100 AND 101). SN 77-597,477. PUB. 4-6-2010. FILED 10-21-2008.
- 3,805,393 (*See Class 14 for this trademark*).
- 3,805,401. **EIGHTSHAPES AND DESIGN**. EIGHTSHAPES, LLC, (U.S. CLS. 100 AND 101). SN 77-620,425. PUB. 4-6-2010. FILED 11-24-2008.
- 3,805,425 (*See Class 4 for this trademark*).
- 3,805,439. **SITECONNECT AND DESIGN**. EVARIANT, LLC, (U.S. CLS. 100 AND 101). SN 77-647,155. PUB. 4-6-2010. FILED 1-10-2009.
- 3,805,449 (*See Class 38 for this trademark*).
- 3,805,454 (*See Class 35 for this trademark*).
- 3,805,473 (*See Class 9 for this trademark*).
- 3,805,479. **INTELLIGENT AND DESIGN**. CHERKAS SOFTWARE CONSULTANTS, INC., AKA WEBGRAPHING.COM, (U.S. CLS. 100 AND 101). SN 77-683,772. PUB. 4-6-2010. FILED 3-4-2009.
- 3,805,482 (*See Class 9 for this trademark*).
- 3,805,487 (*See Class 35 for this trademark*).
- 3,805,493 (*See Class 9 for this trademark*).
- 3,805,515. **DOCTUM AND DESIGN**. THE IONA GROUP, INC., (U.S. CLS. 100 AND 101). SN 77-711,452. PUB. 4-6-2010. FILED 4-10-2009.
- 3,805,525. **TELOS (STANDARD CHARACTER)**. TELOS CORPORATION, (U.S. CLS. 100 AND 101). SN 77-716,003. PUB. 4-6-2010. FILED 4-17-2009.
- 3,805,533 (*See Class 9 for this trademark*).
- 3,805,554 (*See Class 9 for this trademark*).
- 3,805,564 (*See Class 9 for this trademark*).
- 3,805,569. **SPIDERLABS (STANDARD CHARACTER)**. TRUSTWAVE HOLDINGS, INC, (U.S. CLS. 100 AND 101). SN 77-724,640. PUB. 4-6-2010. FILED 4-29-2009.
- 3,805,575. **IKANO THERAPEUTICS INC. ITI AND DESIGN**. IKANO THERAPEUTICS INC., (U.S. CLS. 100 AND 101). SN 77-726,784. PUB. 4-6-2010. FILED 5-1-2009.
- 3,805,592 (*See Class 9 for this trademark*).
- 3,805,594. **MMD TRADE TRACKER (STANDARD CHARACTER)**. THOMSON REUTERS (MARKETS) LLC, (U.S. CLS. 100 AND 101). SN 77-729,495. PUB. 4-6-2010. FILED 5-5-2009.
- 3,805,636. **INNKEEPER'S ADVANTAGE (STANDARD CHARACTER)**. IMPACTIV, INC., DBA INNKEEPER'S ADVANTAGE, (U.S. CLS. 100 AND 101). SN 77-734,977. PUB. 4-6-2010. FILED 5-12-2009.
- 3,805,670. **HANSCAN TOUCH THE FUTURE (STANDARD CHARACTER)**. HANSCAN IP B.V., (U.S. CLS. 100 AND 101). SN 77-741,470. PUB. 4-6-2010. FILED 5-20-2009.
- 3,805,687 (*See Class 41 for this trademark*).
- 3,805,693 (*See Class 9 for this trademark*).
- 3,805,695. **EXPRESS1040 (STANDARD CHARACTER)**. TAX-HAWK, INC., FORMERLY MY1040EZ.COM, INC., (U.S. CLS. 100 AND 101). SN 77-745,830. PUB. 4-6-2010. FILED 5-27-2009.
- 3,805,696. **FREETAXUSA (STANDARD CHARACTER)**. TAX-HAWK, INC., FORMERLY MY1040EZ.COM, INC., (U.S. CLS. 100 AND 101). SN 77-745,848. PUB. 4-6-2010. FILED 5-27-2009.
- 3,805,698. **VOICETECH AND DESIGN**. VOICE-TECH, INC., (U.S. CLS. 100 AND 101). SN 77-746,316. PUB. 4-6-2010. FILED 5-28-2009.
- 3,805,699. **VT VOICE-TECH ESSENTIAL PHARMACY TECHNOLOGY AND DESIGN**. VOICE-TECH, INC., (U.S. CLS. 100 AND 101). SN 77-746,319. PUB. 4-6-2010. FILED 5-28-2009.
- 3,805,709 (*See Class 6 for this trademark*).
- 3,805,722 (*See Class 9 for this trademark*).
- 3,805,723 (*See Class 9 for this trademark*).
- 3,805,725. **FINRA FIRM GATEWAY (STANDARD CHARACTER)**. FINANCIAL INDUSTRY REGULATORY AUTHORITY, INC., FORMERLY NATIONAL ASSOCIATION OF SECURITIES DEALERS, INC., MULTIPLE CLASS, (INT. CLS. 42 AND 45), (U.S. CLS. 100 AND 101). SN 77-753,295. PUB. 4-6-2010. FILED 6-5-2009.
- 3,805,734 (*See Class 41 for this trademark*).
- 3,805,735 (*See Class 41 for this trademark*).
- 3,805,736 (*See Class 41 for this trademark*).
- 3,805,738. **HUMAN THREADING (STANDARD CHARACTER)**. CHRISTOPHER LIAPIS, (U.S. CLS. 100 AND 101). SN 77-756,267. PUB. 4-6-2010. FILED 6-10-2009.
- 3,805,753. **KA KNOWLEDGE ARCHITECTURE AND DESIGN**. KNOWLEDGE ARCHITECTURE, (U.S. CLS. 100 AND 101). SN 77-760,345. PUB. 4-6-2010. FILED 6-15-2009.
- 3,805,788. **U AND DESIGN**. ULTRA UNLIMITED, (U.S. CLS. 100 AND 101). SN 77-767,834. PUB. 4-6-2010. FILED 6-25-2009.
- 3,805,847. **GITHUB (STANDARD CHARACTER)**. GITHUB, LLC, DBA GITHUB.COM, (U.S. CLS. 100 AND 101). SN 77-783,149. PUB. 4-6-2010. FILED 7-16-2009.
- 3,805,848. **GITHUB SOCIAL CODING (STYLIZED)**. GITHUB, LLC, DBA GITHUB.COM, (U.S. CLS. 100 AND 101). SN 77-783,171. PUB. 4-6-2010. FILED 7-16-2009.
- 3,805,849. **ROGUE SURFER AND DESIGN**. ROGUE SURFER LLC, (U.S. CLS. 100 AND 101). SN 77-784,203. PUB. 12-29-2009. FILED 7-17-2009.
- 3,805,856. **DEFINITIVE LOGIC (STANDARD CHARACTER)**. DEFINITIVE LOGIC CORPORATION, (U.S. CLS. 100 AND 101). SN 77-785,577. PUB. 4-6-2010. FILED 7-21-2009.
- 3,805,866. **VISIONSYNC (STANDARD CHARACTER)**. VISIONSYNC, INC., (U.S. CLS. 100 AND 101). SN 77-790,658. PUB. 4-6-2010. FILED 7-27-2009.
- 3,805,900. **L CUSTOMFIT YOUR COMPANY'S CUSTOMIZED WEBSITE AND DESIGN**. LEHIGH OUTFITTERS, LLC, (U.S. CLS. 100 AND 101). SN 77-795,548. PUB. 4-6-2010. FILED 8-3-2009.
- 3,805,921. **LMN SOLUTIONS (STANDARD CHARACTER)**. LMN SOLUTIONS, INC., (U.S. CLS. 100 AND 101). SN 77-800,322. PUB. 4-6-2010. FILED 8-8-2009.
- 3,805,948. **GENESEEEK (STANDARD CHARACTER)**. GENESEEEK, INC., (U.S. CLS. 100 AND 101). SN 77-806,841. PUB. 4-6-2010. FILED 8-18-2009.
- 3,805,949. **MISCELLANEOUS DESIGN**. GENESEEEK, INC., (U.S. CLS. 100 AND 101). SN 77-806,866. PUB. 4-6-2010. FILED 8-18-2009.
- 3,805,958 (*See Class 35 for this trademark*).
- 3,805,974. **INSTANTPRESENTER (STANDARD CHARACTER)**. COSNET, INC., (U.S. CLS. 100 AND 101). SN 77-811,209. PUB. 4-6-2010. FILED 8-24-2009.
- 3,805,993. **IDONATEPRO (STANDARD CHARACTER)**. LCFH VENTURES, LLC, (U.S. CLS. 100 AND 101). SN 77-815,897. PUB. 4-6-2010. FILED 8-29-2009.
- 3,805,995 (*See Class 9 for this trademark*).
- 3,806,008 (*See Class 39 for this trademark*).
- 3,806,047. **AN ANALYTICAL APPROACH TO INFORMA-**

- TION SECURITY (STANDARD CHARACTER).** NETFLOW-DATA LLC, MULTIPLE CLASS, (INT. CLS. 42 AND 45), (U.S. CLS. 100 AND 101). SN 77-824,294. PUB. 4-6-2010. FILED 9-10-2009.
- 3,806,050. **EQUISOLVE (STANDARD CHARACTER).** EQUISOLVE, LLC, (U.S. CLS. 100 AND 101). SN 77-824,565. PUB. 4-6-2010. FILED 9-11-2009.
- 3,806,063 (*See Class 9 for this trademark*).
- 3,806,070. **PAPER MERINGUE (STANDARD CHARACTER).** CALDWELL, CHRISTINA L., (U.S. CLS. 100 AND 101). SN 77-827,299. PUB. 4-6-2010. FILED 9-16-2009.
- 3,806,082. **APEX (STANDARD CHARACTER).** ZENITH ADMINISTRATORS, INC., (U.S. CLS. 100 AND 101). SN 77-830,175. PUB. 12-29-2009. FILED 9-18-2009.
- 3,806,087 (*See Class 20 for this trademark*).
- 3,806,088. **POINTCLICK TECHNOLOGIES (STANDARD CHARACTER).** POINTCLICK TECHNOLOGIES, LLC, (U.S. CLS. 100 AND 101). SN 77-831,186. PUB. 4-6-2010. FILED 9-21-2009.
- 3,806,092 (*See Class 41 for this trademark*).
- 3,806,093 (*See Class 41 for this trademark*).
- 3,806,094. **ROLLBOOK (STANDARD CHARACTER).** INTEL-LUM, INC., (U.S. CLS. 100 AND 101). SN 77-833,298. PUB. 4-6-2010. FILED 9-23-2009.
- 3,806,120. **PROVARÉ (STANDARD CHARACTER).** PROVARE TECHNOLOGY, INC., (U.S. CLS. 100 AND 101). SN 77-837,063. PUB. 4-6-2010. FILED 9-29-2009.
- 3,806,136 (*See Class 9 for this trademark*).
- 3,806,152 (*See Class 40 for this trademark*).
- 3,806,211. **SDLC 3.0 (STANDARD CHARACTER).** KENNALEY, MARK, (U.S. CLS. 100 AND 101). SN 77-847,413. PUB. 4-6-2010. FILED 10-13-2009.
- 3,806,241. **ADDRESSTWO (STYLIZED).** CARTER AND COMPANY, LLC, DBA ADDRESSTWO, (U.S. CLS. 100 AND 101). SN 77-850,300. PUB. 4-6-2010. FILED 10-16-2009.
- 3,806,257. **RMA CONSULTING GROUP AND DESIGN.** RMA CONSULTING GROUP, (U.S. CLS. 100 AND 101). SN 77-851,720. PUB. 4-6-2010. FILED 10-19-2009.
- 3,806,279. **VIRTUON (STANDARD CHARACTER).** VIRTUON, INC., (U.S. CLS. 100 AND 101). SN 77-853,554. PUB. 4-6-2010. FILED 10-21-2009.
- 3,806,283. **YOUR PATHWAY TO . . . (STANDARD CHARACTER).** IP PATHWAYS, LLC, (U.S. CLS. 100 AND 101). SN 77-853,969. PUB. 4-6-2010. FILED 10-21-2009.
- 3,806,336 (*See Class 37 for this trademark*).
- 3,806,341. **GEEYEE (STANDARD CHARACTER).** GEEYEE, INC., (U.S. CLS. 100 AND 101). SN 77-856,031. PUB. 4-6-2010. FILED 10-23-2009.
- 3,806,349 (*See Class 9 for this trademark*).
- 3,806,407. **CHART NAVIGATOR (STANDARD CHARACTER).** HEALTH RISK PARTNERS LLC, (U.S. CLS. 100 AND 101). SN 77-857,996. PUB. 4-6-2010. FILED 10-27-2009.
- 3,806,435. **LIXIVIAN (STANDARD CHARACTER).** LIXIVIAN, INC., (U.S. CLS. 100 AND 101). SN 77-858,328. PUB. 4-6-2010. FILED 10-27-2009.
- 3,806,449. **BLAST YOUR PAST (STANDARD CHARACTER).** BLAST YOUR PAST, LLC, (U.S. CLS. 100 AND 101). SN 77-858,487. PUB. 4-6-2010. FILED 10-27-2009.
- 3,806,458. **WEB OF SCIENCE (STANDARD CHARACTER).** THOMSON REUTERS (SCIENTIFIC) INC., (U.S. CLS. 100 AND 101). SN 77-858,522. PUB. 4-6-2010. FILED 10-27-2009.
- 3,806,460. **SUPPORTSUITE (STANDARD CHARACTER).** KAYAKO, INC., (U.S. CLS. 100 AND 101). SN 77-858,528. PUB. 4-6-2010. FILED 10-27-2009.
- 3,806,488. **NOVANIX (STANDARD CHARACTER).** NOVANIX, LLC., (U.S. CLS. 100 AND 101). SN 77-858,756. PUB. 4-6-2010. FILED 10-27-2009.
- 3,806,530. **CARASOLVA (STANDARD CHARACTER).** CARASOLVA, INC., (U.S. CLS. 100 AND 101). SN 77-859,344. PUB. 4-6-2010. FILED 10-28-2009.
- 3,806,562. **BKM ENGINEERING LIFE SPACES AND DESIGN.** BURDETTE, KOEHLER, MURPHY & ASSOCIATES, INC., AKA BKM, (U.S. CLS. 100 AND 101). SN 77-859,737. PUB. 4-6-2010. FILED 10-28-2009.
- 3,806,569. **DOCUMENTIT (STANDARD CHARACTER).** RADICE, DEBRA K., DBA SYNDICIT RE, (U.S. CLS. 100 AND 101). SN 77-859,803. PUB. 4-6-2010. FILED 10-28-2009.
- 3,806,572. **CHANGING THE WAY HOSPITALS DO BUSINESS (STANDARD CHARACTER).** TRACTMANAGER, INC., (U.S. CLS. 100 AND 101). SN 77-859,822. PUB. 4-6-2010. FILED 10-28-2009.
- 3,806,577. **SIGNITECTURE AND DESIGN.** SIGNITECTURE LLC, (U.S. CLS. 100 AND 101). SN 77-859,846. PUB. 4-6-2010. FILED 10-28-2009.
- 3,806,597. **SMART. SIMPLE. SYSTEMATIC. (STANDARD CHARACTER).** WOLF & COMPANY, P.C., (U.S. CLS. 100 AND 101). SN 77-860,028. PUB. 4-6-2010. FILED 10-29-2009.
- 3,806,598. **WOLFPAC (STANDARD CHARACTER).** WOLF & COMPANY, P.C., (U.S. CLS. 100 AND 101). SN 77-860,030. PUB. 4-6-2010. FILED 10-29-2009.
- 3,806,599. **WOLFPAC INTEGRATED RISK MANAGEMENT AND DESIGN.** WOLF & COMPANY, P.C., (U.S. CLS. 100 AND 101). SN 77-860,031. PUB. 4-6-2010. FILED 10-29-2009.
- 3,806,600. **MANAGE PROCESSES, MANAGE PEOPLE, MANAGE TECHNOLOGY, ENTERPRISE RISK, CUSTOMER INFORMATION RISK, REGULATORY COMPLIANCE RISK, VENDOR RISK, FINANCIAL REPORTING RISK, BUSINESS CONTINUITY RISK, OPERATIONAL RISK, INFORMATION TECHNOLOGY RISK. AND DESIGN.** WOLF & COMPANY, P.C., (U.S. CLS. 100 AND 101). SN 77-860,033. PUB. 4-6-2010. FILED 10-29-2009.
- 3,806,636. **ALLOFE (STANDARD CHARACTER).** ALLOFE SOLUTIONS, (U.S. CLS. 100 AND 101). SN 77-860,446. PUB. 4-6-2010. FILED 10-29-2009.
- 3,806,650. **CITIZING! (STANDARD CHARACTER).** CITIZENS LEAGUE, (U.S. CLS. 100 AND 101). SN 77-860,598. PUB. 4-6-2010. FILED 10-29-2009.
- 3,806,679 (*See Class 35 for this trademark*).
- 3,806,690 (*See Class 35 for this trademark*).
- 3,806,699. **SHAKING PLANET (STANDARD CHARACTER).** LENBURG, AARON, (U.S. CLS. 100 AND 101). SN 77-861,231. PUB. 4-6-2010. FILED 10-30-2009.
- 3,806,717. **OPTIMAL BLUE (STANDARD CHARACTER).** OPTIMAL BLUE, LLC, (U.S. CLS. 100 AND 101). SN 77-861,455. PUB. 4-6-2010. FILED 10-30-2009.
- 3,806,739. **ADDING DIMENSION TO YOUR BRAND (STANDARD CHARACTER).** MADETOORDER, INC., (U.S. CLS. 100 AND 101). SN 77-861,745. PUB. 4-6-2010. FILED 10-30-2009.
- 3,806,772. **AGON (STANDARD CHARACTER).** APTOCORE APS, (U.S. CLS. 100 AND 101). SN 77-862,635. PUB. 4-6-2010. FILED 11-2-2009.
- 3,806,805. **STUDY ISLAND AND DESIGN.** ARCHIPELAGO LEARNING, LLC, (U.S. CLS. 100 AND 101). SN 77-863,258. PUB. 4-6-2010. FILED 11-2-2009.
- 3,806,820 (*See Class 35 for this trademark*).
- 3,806,832. **AMUEN (STANDARD CHARACTER).** NEUMA TATTOO MACHINES CORPORATION, (U.S. CLS. 100 AND 101). SN 77-863,714. PUB. 4-6-2010. FILED 11-3-2009.
- 3,806,835 (*See Class 41 for this trademark*).
- 3,806,869. **STANCEWORKS (STANDARD CHARACTER).** BURROUGHS, MICHAEL R., (U.S. CLS. 100 AND 101). SN 77-864,156. PUB. 4-6-2010. FILED 11-3-2009.
- 3,806,888 (*See Class 37 for this trademark*).
- 3,806,893. **HIPAA BOX (STANDARD CHARACTER).** HIPAA BOX INC., (U.S. CLS. 100 AND 101). SN 77-865,126. PUB. 4-6-2010. FILED 11-4-2009.
- 3,806,895. **TOADFLY (STANDARD CHARACTER).** VARDAMAN, (U.S. CLS. 100 AND 101). SN 77-865,158. PUB. 4-6-2010. FILED 11-4-2009.
- 3,806,908. **ZIMBA (STANDARD CHARACTER).** ZIMBA, KELSY, (U.S. CLS. 100 AND 101). SN 77-865,439. PUB. 4-6-2010. FILED 11-4-2009.
- 3,806,909. **ZIMBA (STYLIZED).** ZIMBA, KELSY, (U.S. CLS. 100 AND 101). SN 77-865,443. PUB. 4-6-2010. FILED 11-4-2009.
- 3,806,925 (*See Class 9 for this trademark*).
- 3,806,926 (*See Class 37 for this trademark*).
- 3,806,938. **MISCELLANEOUS DESIGN.** VELOCITUDE, LLC, (U.S. CLS. 100 AND 101). SN 77-870,898. PUB. 4-6-2010. FILED 11-12-2009.
- 3,806,961. **TASKSTREAM ADVANCING EDUCATIONAL EXCELLENCE AND DESIGN.** TASKSTREAM, LLC, (U.S. CLS. 100 AND 101). SN 77-874,490. PUB. 4-6-2010. FILED 11-17-2009.
- 3,806,962. **TASKSTREAM (STANDARD CHARACTER).** TASK-

STREAM, LLC, (U.S. CLS. 100 AND 101). SN 77-874,678. PUB. 4-6-2010. FILED 11-17-2009.

3,806,963. **SUPPORT SMARTER (STANDARD CHARACTER)**. CITRIX ONLINE, LLC, (U.S. CLS. 100 AND 101). SN 77-874,784. PUB. 4-6-2010. FILED 11-17-2009.

3,806,981. **HOSTLEY AND DESIGN**. CRYSTONE, (U.S. CLS. 100 AND 101). SN 77-878,801. PUB. 4-6-2010. FILED 11-23-2009.

3,806,995 (*See Class 35 for this trademark*).

3,807,004. **VINTAGE PHARMACEUTICALS, LLC (STANDARD CHARACTER)**. VINTAGE PHARMACEUTICALS, LLC, (U.S. CLS. 100 AND 101). SN 77-884,070. PUB. 4-6-2010. FILED 12-2-2009.

3,807,034 (*See Class 9 for this trademark*).

3,807,035 (*See Class 9 for this trademark*).

3,807,051 (*See Class 38 for this trademark*).

3,807,052 (*See Class 38 for this trademark*).

3,807,053. **OPT-EFX (STANDARD CHARACTER)**. BATTELLE MEMORIAL INSTITUTE, (U.S. CLS. 100 AND 101). SN 77-979,611. PUB. 8-19-2008. FILED 12-18-2006.

3,807,054. **OPTIMIST (STANDARD CHARACTER)**. BATTELLE MEMORIAL INSTITUTE, (U.S. CLS. 100 AND 101). SN 77-979,639. PUB. 8-19-2008. FILED 12-20-2006.

3,807,055. **OPTIWEB (STANDARD CHARACTER)**. BATTELLE MEMORIAL INSTITUTE, (U.S. CLS. 100 AND 101). SN 77-979,640. PUB. 8-19-2008. FILED 12-20-2006.

3,807,064. **DIVIS AND DESIGN**. CHANCE-I USA CORP., (U.S. CLS. 100 AND 101). SN 78-613,796. PUB. 1-31-2006. FILED 4-21-2005.

3,807,065 (*See Class 35 for this trademark*).

3,807,068 (*See Class 6 for this trademark*).

3,807,072. **R.COM (STANDARD CHARACTER)**. MORRIS, RICHARD L JR, (U.S. CLS. 100 AND 101). SN 78-765,180. PUB. 12-9-2008. FILED 12-2-2005.

3,807,074 (*See Class 35 for this trademark*).

3,807,082 (*See Class 1 for this trademark*).

3,807,101 (*See Class 29 for this trademark*).

3,807,114 (*See Class 25 for this trademark*).

3,807,127 (*See Class 9 for this trademark*).

3,807,129 (*See Class 1 for this trademark*).

3,807,138 (*See Class 5 for this trademark*).

3,807,149 (*See Class 1 for this trademark*).

3,807,150 (*See Class 35 for this trademark*).

3,807,152 (*See Class 9 for this trademark*).

3,807,153 (*See Class 9 for this trademark*).

3,807,155 (*See Class 9 for this trademark*).

3,807,158 (*See Class 35 for this trademark*).

3,807,164 (*See Class 5 for this trademark*).

3,807,174 (*See Class 9 for this trademark*).

3,807,190 (*See Class 6 for this trademark*).

3,807,195 (*See Class 11 for this trademark*).

3,807,196 (*See Class 9 for this trademark*).

3,807,206 (*See Class 11 for this trademark*).

3,807,218 (*See Class 9 for this trademark*).

3,807,219 (*See Class 9 for this trademark*).

3,807,220 (*See Class 9 for this trademark*).

3,807,221 (*See Class 9 for this trademark*).

3,807,223 (*See Class 9 for this trademark*).

3,807,228 (*See Class 9 for this trademark*).

3,807,229 (*See Class 7 for this trademark*).

3,807,235 (*See Class 5 for this trademark*).

3,807,237 (*See Class 29 for this trademark*).

3,807,249 (*See Class 9 for this trademark*).

3,807,263 (*See Class 1 for this trademark*).

3,807,267 (*See Class 38 for this trademark*).

3,807,275 (*See Class 35 for this trademark*).

3,807,278 (*See Class 9 for this trademark*).

3,807,296 (*See Class 9 for this trademark*).

3,807,301 (*See Class 37 for this trademark*).

3,807,310 (*See Class 9 for this trademark*).

3,807,316 (*See Class 9 for this trademark*).

3,807,338 (*See Class 5 for this trademark*).

CLASS 43—HOTEL AND RESTAURANT SERVICES

3,805,129. **CARBECUE AIN'T NOTHIN LIKE IT (STYLIZED)**. KORNS, JEFFREY L., (U.S. CLS. 100 AND 101). SN 76-681,839. PUB. 4-6-2010. FILED 9-13-2007.

3,805,154 (*See Class 30 for this trademark*).

3,805,166. **MI MADRE'S AND DESIGN**. MI MADRE'S MEXICAN RESTAURANT, INC., (U.S. CLS. 100 AND 101). SN 76-699,837. PUB. 4-6-2010. FILED 10-14-2009.

3,805,173 (*See Class 35 for this trademark*).

3,805,178. **WOWCAFE (STANDARD CHARACTER)**. WOW CAFE AND WINGERY, LLC, (U.S. CLS. 100 AND 101). SN 76-700,533. PUB. 4-6-2010. FILED 11-24-2009.

3,805,188 (*See Class 25 for this trademark*).

3,805,220. **PASTA ROMA (STANDARD CHARACTER)**. KASGO, LLC, (U.S. CLS. 100 AND 101). SN 77-336,516. PUB. 4-6-2010. FILED 11-26-2007.

3,805,294 (*See Class 14 for this trademark*).

3,805,304 (*See Class 29 for this trademark*).

3,805,337 (*See Class 35 for this trademark*).

3,805,351. **STAR ISLAND CAFE AND DESIGN**. MERA MARCAS SA DE CV, (U.S. CLS. 100 AND 101). SN 77-575,366. PUB. 4-6-2010. FILED 9-22-2008.

3,805,352. **MARKET STATION AND DESIGN**. MERA MARCAS SA DE CV, (U.S. CLS. 100 AND 101). SN 77-575,469. PUB. 4-6-2010. FILED 9-22-2008.

3,805,354. **SOUTH SEAS (STANDARD CHARACTER)**. YANKEE DEVELOPMENT CORP., (U.S. CLS. 100 AND 101). SN 77-580,778. PUB. 4-6-2010. FILED 9-29-2008.

3,805,376 (*See Class 9 for this trademark*).

3,805,410. **ZÍ PANÍ BREADS CAFE (STANDARD CHARACTER)**. BRBAGELS & MORE INC., DBA ZÍ PANÍ BREADS CAFÉ, (U.S. CLS. 100 AND 101). SN 77-629,133. PUB. 4-6-2010. FILED 12-9-2008.

3,805,418. **KITCHEN ON THE STREET AND DESIGN**. KITCHEN ON THE STREET, INC, (U.S. CLS. 100 AND 101). SN 77-634,926. PUB. 4-6-2010. FILED 12-17-2008.

3,805,542. **JENNI'S NOODLE HOUSE (STANDARD CHARACTER)**. COOL BEANS INC, DBA JENNI'S NOODLE HOUSE, (U.S. CLS. 100 AND 101). SN 77-720,330. PUB. 4-6-2010. FILED 4-23-2009.

3,805,543. **JENNI'S NOODLE HOUSE AND DESIGN**. COOL BEANS INC, DBA JENNI'S NOODLE HOUSE, (U.S. CLS. 100 AND 101). SN 77-720,360. PUB. 4-6-2010. FILED 4-23-2009.

3,805,544. **NOODLES RULE! (STANDARD CHARACTER)**. COOL BEANS INC, DBA JENNI'S NOODLE HOUSE, (U.S. CLS. 100 AND 101). SN 77-720,430. PUB. 4-6-2010. FILED 4-23-2009.

3,805,546. **NOODLELISM (STANDARD CHARACTER)**. COOL BEANS INC, DBA JENNI'S NOODLE HOUSE, (U.S. CLS. 100 AND 101). SN 77-721,181. PUB. 4-6-2010. FILED 4-23-2009.

3,805,568. **MISCELLANEOUS DESIGN**. UNION SQUARE HOSPITALITY GROUP, LLC, (U.S. CLS. 100 AND 101). SN 77-724,280. PUB. 4-6-2010. FILED 4-28-2009.

3,805,586. **FRESH CUTT CARVING GRILL FRESH CUTT CARVING GRILL AND DESIGN**. FRESH CUTT, INC., (U.S. CLS. 100 AND 101). SN 77-727,722. PUB. 4-6-2010. FILED 5-2-2009.

3,805,624. **MAX N CHEESE AND DESIGN**. SUMSPOT, LLC, (U.S. CLS. 100 AND 101). SN 77-733,199. PUB. 4-6-2010. FILED 5-9-2009.

3,805,702. **NAPLES FLATBREAD & WINE BAR AND DESIGN**. NAPLES FLATBREAD ORIGINAL LLC, (U.S. CLS. 100 AND 101). SN 77-747,346. PUB. 4-6-2010. FILED 5-29-2009.

3,805,744. **MISCELLANEOUS DESIGN**. WHITEY'S RESTAURANT, INC., (U.S. CLS. 100 AND 101). SN 77-758,081. PUB. 4-6-2010. FILED 6-12-2009.

3,805,752 (*See Class 35 for this trademark*).

3,805,858. **KICKERZ (STANDARD CHARACTER)**. GIANT HAT CORPORATION, (U.S. CLS. 100 AND 101). SN 77-786,248. PUB. 4-6-2010. FILED 7-21-2009.

3,805,859. **KICKERZ AND DESIGN**. GIANT HAT CORPORATION, (U.S. CLS. 100 AND 101). SN 77-786,615. PUB. 4-6-2010. FILED 7-22-2009.

3,805,868. **CHARLEY'S (STYLIZED)**. PHEASANT MALL RESTAURANT GROUP, INC., (U.S. CLS. 100 AND 101).

- SN 77-790,816. PUB. 4-6-2010. FILED 7-28-2009.
- 3,805,876. **HOPJACKS (STANDARD CHARACTER)**. HOPJACKS, INC., (U.S. CLS. 100 AND 101). SN 77-792,285. PUB. 4-6-2010. FILED 7-29-2009.
- 3,805,883. **PLAZA CLUB HAWAII (STANDARD CHARACTER)**. CLUBCORP, INC., (U.S. CLS. 100 AND 101). SN 77-793,090. PUB. 4-6-2010. FILED 7-30-2009.
- 3,805,889. **THE PLAZA CLUB HAWAII AND DESIGN**. CLUBCORP, INC., (U.S. CLS. 100 AND 101). SN 77-793,705. PUB. 4-6-2010. FILED 7-30-2009.
- 3,805,910. **MAI'S RESTAURANT (STANDARD CHARACTER)**. TT & M MAI'S RESTAURANT, INC., (U.S. CLS. 100 AND 101). SN 77-798,056. PUB. 4-6-2010. FILED 8-5-2009.
- 3,805,911. **MAI'S RESTAURANT (STYLIZED)**. TT & M MAI'S RESTAURANT, INC., (U.S. CLS. 100 AND 101). SN 77-798,062. PUB. 4-6-2010. FILED 8-5-2009.
- 3,805,925 (*See Class 35 for this trademark*).
- 3,805,968. **TIJUANA FLATS MORNIN' MUNCHIES (STANDARD CHARACTER)**. TJF USA, LLC., (U.S. CLS. 100 AND 101). SN 77-810,231. PUB. 4-6-2010. FILED 8-21-2009.
- 3,806,030. **CHARLESTON CASA MEDINA BOGOTA AND DESIGN**. HOTELES CHARLESTON S.A., (U.S. CLS. 100 AND 101). SN 77-821,813. PUB. 4-6-2010. FILED 9-8-2009.
- 3,806,036. **CHARLESTON SANTA TERESA CARTAGENA AND DESIGN**. HOTELES CHARLESTON S.A., (U.S. CLS. 100 AND 101). SN 77-822,113. PUB. 4-6-2010. FILED 9-8-2009.
- 3,806,045. **STONE ROSE BAR & GRILL (STANDARD CHARACTER)**. GERBER GROUP LP, FORMERLY AFTER MIDNIGHT MANAGEMENT COMPANY LP, (U.S. CLS. 100 AND 101). SN 77-823,966. PUB. 4-6-2010. FILED 9-10-2009.
- 3,806,122 (*See Class 36 for this trademark*).
- 3,806,142 (*See Class 41 for this trademark*).
- 3,806,143 (*See Class 41 for this trademark*).
- 3,806,193. **DÉGAGÉ JAZZ CAFÉ (STANDARD CHARACTER)**. RWRB, LLC, (U.S. CLS. 100 AND 101). SN 77-845,750. PUB. 4-6-2010. FILED 10-9-2009.
- 3,806,224 (*See Class 39 for this trademark*).
- 3,806,238. **GREEK PEAK MOUNTAIN RESORT (STANDARD CHARACTER)**. PEAK RESORTS, INC., (U.S. CLS. 100 AND 101). SN 77-850,153. PUB. 4-6-2010. FILED 10-16-2009.
- 3,806,307. **WHISKEY GIRL (STYLIZED)**. BUFFALO JOE'S, LLC, DBA WHISKEY GIRL, (U.S. CLS. 100 AND 101). SN 77-855,043. PUB. 4-6-2010. FILED 10-22-2009.
- 3,806,318. **BERGHOFF AND DESIGN**. BERGHOFF RESTAURANT COMPANY OF DELAWARE, INC., (U.S. CLS. 100 AND 101). SN 77-855,395. PUB. 4-6-2010. FILED 10-22-2009.
- 3,806,319. **BERGHOFF CAFE (STYLIZED)**. BERGHOFF RESTAURANT COMPANY OF DELAWARE, INC., (U.S. CLS. 100 AND 101). SN 77-855,420. PUB. 4-6-2010. FILED 10-22-2009.
- 3,806,321. **BERGHOFF CAFE (STANDARD CHARACTER)**. BERGHOFF RESTAURANT COMPANY OF DELAWARE, INC., (U.S. CLS. 100 AND 101). SN 77-855,426. PUB. 4-6-2010. FILED 10-22-2009.
- 3,806,360. **DINEADVISOR (STANDARD CHARACTER)**. APPLIED MEDIA SOLUTIONS, LLC, (U.S. CLS. 100 AND 101). SN 77-856,843. PUB. 4-6-2010. FILED 10-25-2009.
- 3,806,397. **FRESHFOODS CAFE, SAVOR FRESH FLAVOR AND DESIGN**. FRESH FOODS CAFE LLC, (U.S. CLS. 100 AND 101). SN 77-857,873. PUB. 4-6-2010. FILED 10-26-2009.
- 3,806,427. **CLOVER (STANDARD CHARACTER)**. CLOVER FAST FOOD, INC., (U.S. CLS. 100 AND 101). SN 77-858,206. PUB. 4-6-2010. FILED 10-27-2009.
- 3,806,487. **GREAT TASTE DELIVERED FRESH (STANDARD CHARACTER)**. WILDFLOWER BREAD COMPANY, (U.S. CLS. 100 AND 101). SN 77-858,753. PUB. 4-6-2010. FILED 10-27-2009.
- 3,806,536 (*See Class 41 for this trademark*).
- 3,806,590. **TACO LITA (STANDARD CHARACTER)**. TACO ENTERPRISES, INC., (U.S. CLS. 100 AND 101). SN 77-859,910. PUB. 4-6-2010. FILED 10-28-2009.
- 3,806,619. **CHAP-A-NOSH (STANDARD CHARACTER)**. CHAP A NOSH OF CEDARHURST, AND CHAP A NOSH OF BROOKLYN, (U.S. CLS. 100 AND 101). SN 77-860,221. PUB. 4-6-2010. FILED 10-29-2009.
- 3,806,620 (*See Class 40 for this trademark*).
- 3,806,625. **WHAT'S IN YOUR BOX? (STANDARD CHARACTER)**. KLEIN, FRANK, (U.S. CLS. 100 AND 101). SN 77-860,242. PUB. 4-6-2010. FILED 10-29-2009.
- 3,806,646. **TARANTINO'S PIZZERIA T AND DESIGN**. RAM TRADING, LLC, (U.S. CLS. 100 AND 101). SN 77-860,566. PUB. 4-6-2010. FILED 10-29-2009.
- 3,806,703. **WAKEY WAKEY EGGS AND BAKEY (STANDARD CHARACTER)**. FIRST WATCH RESTAURANTS, INC., (U.S. CLS. 100 AND 101). SN 77-861,278. PUB. 4-6-2010. FILED 10-30-2009.
- 3,806,800 (*See Class 41 for this trademark*).
- 3,806,808. **KITCHEN TABLE (STANDARD CHARACTER)**. W2007 MVP CORPORATE, LLC, (U.S. CLS. 100 AND 101). SN 77-863,356. PUB. 4-6-2010. FILED 11-2-2009.
- 3,806,810. **KITCHEN TABLE AND DESIGN**. W2007 MVP CORPORATE, LLC, (U.S. CLS. 100 AND 101). SN 77-863,362. PUB. 4-6-2010. FILED 11-2-2009.
- 3,806,811. **16 MIX (STANDARD CHARACTER)**. W2007 MVP CORPORATE, LLC, (U.S. CLS. 100 AND 101). SN 77-863,366. PUB. 4-6-2010. FILED 11-2-2009.
- 3,806,813. **16 MIX AND DESIGN**. W2007 MVP CORPORATE, LLC, (U.S. CLS. 100 AND 101). SN 77-863,380. PUB. 4-6-2010. FILED 11-2-2009.
- 3,806,824. **MISCELLANEOUS DESIGN**. AMERICAN DAIRY QUEEN CORPORATION, (U.S. CLS. 100 AND 101). SN 77-863,506. PUB. 4-6-2010. FILED 11-3-2009.
- 3,806,829. **LIVINGSTON (STANDARD CHARACTER)**. CSC GEORGIAN TERRACE LIMITED PARTNERSHIP, (U.S. CLS. 100 AND 101). SN 77-863,582. PUB. 4-6-2010. FILED 11-3-2009.
- 3,806,833 (*See Class 36 for this trademark*).
- 3,806,857. **ALEMBIC (STANDARD CHARACTER)**. VUCUREVICH SIMONS ADVISORY GROUP, LLC, (U.S. CLS. 100 AND 101). SN 77-864,005. PUB. 4-6-2010. FILED 11-3-2009.
- 3,806,864. **THE FOOD FAIRY (STANDARD CHARACTER)**. MCCLERNON, TERRI, (U.S. CLS. 100 AND 101). SN 77-864,136. PUB. 4-6-2010. FILED 11-3-2009.
- 3,806,894 (*See Class 30 for this trademark*).
- 3,806,927. **TADA! STYLISH EVENTS NATIONWIDE AND DESIGN**. TADA! CATERING, LLC, (U.S. CLS. 100 AND 101). SN 77-869,389. PUB. 4-6-2010. FILED 11-10-2009.
- 3,806,943. **BUCATINI TRATTORIA AND DESIGN**. BUCATINI, LLC., (U.S. CLS. 100 AND 101). SN 77-871,605. PUB. 4-6-2010. FILED 11-12-2009.
- 3,806,983. **MISCELLANEOUS DESIGN**. SURF TACO COASTAL CUISINE, (U.S. CLS. 100 AND 101). SN 77-879,114. PUB. 4-6-2010. FILED 11-23-2009.
- 3,807,050. **ROUTE 66 CASINO HOTEL (STANDARD CHARACTER)**. LAGUNA DEVELOPMENT CORPORATION, (U.S. CLS. 100 AND 101). SN 77-978,738. PUB. 4-6-2010. FILED 11-9-2007.
- 3,807,066. **TEQUILA RANCH (STANDARD CHARACTER)**. HRLS LLC, (U.S. CLS. 100 AND 101). SN 78-705,095. PUB. 4-6-2010. FILED 9-1-2005.
- 3,807,074 (*See Class 35 for this trademark*).
- 3,807,101 (*See Class 29 for this trademark*).
- 3,807,166. **SPIRITO DELL'ITALIA! (STYLIZED)**. I.P. CREATIONS ENTERPRISES LIMITED, (U.S. CLS. 100 AND 101). SN 79-067,730. PUB. 4-6-2010. FILED 2-6-2009.
- 3,807,169 (*See Class 29 for this trademark*).
- 3,807,237 (*See Class 29 for this trademark*).

CLASS 44—MEDICAL, BEAUTY AND AGRICULTURAL SERVICES

- 3,805,161. **MIDWEST PHYSICIANS AND DESIGN**. C/HCA, INC., (U.S. CLS. 100 AND 101). SN 76-699,625. PUB. 4-6-2010. FILED 9-25-2009.
- 3,805,174. **MAKING HEALTHCARE HUMAN AGAIN (STANDARD CHARACTER)**. TEXAS HEALTH RESOURCES, (U.S. CLS. 100 AND 101). SN 76-700,206. PUB. 4-6-2010. FILED 11-3-2009.
- 3,805,199 (*See Class 16 for this trademark*).
- 3,805,213. **RA BEAUTY CORE (STANDARD CHARACTER)**. KIM, HYUN TAE, (U.S. CLS. 100 AND 101). SN 77-319,579. PUB. 10-14-2008. FILED 11-1-2007.
- 3,805,214. **RA BEAUTY CORE TOTAL BEAUTY SERVICE AND DESIGN**. KIM, HYUN TAE, (U.S. CLS. 100 AND 101).

- SN 77-319,599. PUB. 10-14-2008. FILED 11-1-2007.
 3,805,287 (*See Class 9 for this trademark*).
 3,805,294 (*See Class 14 for this trademark*).
 3,805,337 (*See Class 35 for this trademark*).
 3,805,369. **STRATA (STANDARD CHARACTER)**. RMJM LIMITED, (U.S. CLS. 100 AND 101). SN 77-588,495. PUB. 4-6-2010. FILED 10-8-2008.
 3,805,411. **REDIMD (STANDARD CHARACTER)**. REDIMD, LLC, (U.S. CLS. 100 AND 101). SN 77-630,821. PUB. 4-6-2010. FILED 12-11-2008.
 3,805,449 (*See Class 38 for this trademark*).
 3,805,475 (*See Class 5 for this trademark*).
 3,805,527 (*See Class 35 for this trademark*).
 3,805,595. **NEW YORK WALK & TRAIN WALKING . TRAINING . BOARDING AND DESIGN**. NEW YORK WALK & TRAIN, (U.S. CLS. 100 AND 101). SN 77-729,571. PUB. 4-6-2010. FILED 5-5-2009.
 3,805,619 (*See Class 35 for this trademark*).
 3,805,628 (*See Class 35 for this trademark*).
 3,805,678 (*See Class 5 for this trademark*).
 3,805,680 (*See Class 37 for this trademark*).
 3,805,773 (*See Class 41 for this trademark*).
 3,805,775 (*See Class 41 for this trademark*).
 3,805,805. **THE VEIN GUYS (STANDARD CHARACTER)**. DAVIS, KEITH L., (U.S. CLS. 100 AND 101). SN 77-772,571. PUB. 4-6-2010. FILED 7-1-2009.
 3,805,821 (*See Class 36 for this trademark*).
 3,805,822 (*See Class 36 for this trademark*).
 3,805,882. **EATING FOR PERFORMANCE (STANDARD CHARACTER)**. WILSON, PENNY L, DBA EATING FOR PERFORMANCE, (U.S. CLS. 100 AND 101). SN 77-792,984. PUB. 4-6-2010. FILED 7-30-2009.
 3,805,944 (*See Class 35 for this trademark*).
 3,805,953 (*See Class 37 for this trademark*).
 3,805,957 (*See Class 41 for this trademark*).
 3,805,979. **MISCELLANEOUS DESIGN**. ASHE MASSAGE CENTER, LLC, (U.S. CLS. 100 AND 101). SN 77-811,693. PUB. 4-6-2010. FILED 8-24-2009.
 3,805,986. **MISCELLANEOUS DESIGN**. PASSPORT HEALTH COMMUNICATIONS, INC., (U.S. CLS. 100 AND 101). SN 77-814,884. PUB. 4-6-2010. FILED 8-28-2009.
 3,806,003. **LIGHTERLIVING (STANDARD CHARACTER)**. BRUGMAN, MARJOLEIN, (U.S. CLS. 100 AND 101). SN 77-816,814. PUB. 4-6-2010. FILED 8-31-2009.
 3,806,046 (*See Class 36 for this trademark*).
 3,806,058. **TATTOO VANISH AND DESIGN**. TATTOO VANISH, INC., (U.S. CLS. 100 AND 101). SN 77-825,900. PUB. 4-6-2010. FILED 9-14-2009.
 3,806,110 (*See Class 24 for this trademark*).
 3,806,129. **TUCK CHIROPRACTIC (STANDARD CHARACTER)**. RAY TUCK, D.C., P.C., DBA TUCK CHIROPRACTIC CLINIC, (U.S. CLS. 100 AND 101). SN 77-837,931. PUB. 4-6-2010. FILED 9-30-2009.
 3,806,130. **TUCK CHIROPRACTIC AND DESIGN**. RAY TUCK, D.C., P.C., DBA TUCK CHIROPRACTIC CLINIC, (U.S. CLS. 100 AND 101). SN 77-837,945. PUB. 4-6-2010. FILED 9-30-2009.
 3,806,139. **SHIRE AND DESIGN**. SHIRE INTERNATIONAL LICENSING B.V., (U.S. CLS. 100 AND 101). SN 77-839,040. PUB. 4-6-2010. FILED 10-1-2009.
 3,806,144. **MINT M THE SALON AND DESIGN**. MINT SALON, LLC, (U.S. CLS. 100 AND 101). SN 77-839,403. PUB. 4-6-2010. FILED 10-1-2009.
 3,806,152 (*See Class 40 for this trademark*).
 3,806,163 (*See Class 31 for this trademark*).
 3,806,181. **F FACIAL FUSION AND DESIGN**. WATSON-NEIMY, SUSAN, (U.S. CLS. 100 AND 101). SN 77-844,358. PUB. 4-6-2010. FILED 10-8-2009.
 3,806,229. **AMERICAN/ENGLISH CHAMPION LINES LITTLE FLOWER GOLDENS AND DESIGN**. ELKINTON, HEIDI, (U.S. CLS. 100 AND 101). SN 77-849,000. PUB. 4-6-2010. FILED 10-14-2009.
 3,806,240. **FITMAP (STANDARD CHARACTER)**. FITLAB METABOLIC SERVICES, (U.S. CLS. 100 AND 101). SN 77-850,265. PUB. 4-6-2010. FILED 10-16-2009.
 3,806,260. **USA MCO (STANDARD CHARACTER)**. USA MANAGED CARE ORGANIZATION, INC., (U.S. CLS. 100 AND 101). SN 77-852,067. PUB. 4-6-2010. FILED 10-19-2009.
 3,806,325. **KYRENIA HEART CENTER (STANDARD CHARACTER)**. THE NEW YORK HOSPITAL MEDICAL CENTER OF QUEENS, (U.S. CLS. 100 AND 101). SN 77-855,594. PUB. 4-6-2010. FILED 10-22-2009.
 3,806,337. **DOGS D'RULE (STANDARD CHARACTER)**. DOGS D'RULE, (U.S. CLS. 100 AND 101). SN 77-855,938. PUB. 4-6-2010. FILED 10-23-2009.
 3,806,346. **HYBRID TUMMY TUCK (STANDARD CHARACTER)**. BRENT R.W. MOELLEKEN, (U.S. CLS. 100 AND 101). SN 77-856,482. PUB. 4-6-2010. FILED 10-23-2009.
 3,806,347. **CARE COMMONS (STANDARD CHARACTER)**. CARE COMMONS, INC., (U.S. CLS. 100 AND 101). SN 77-856,483. PUB. 4-6-2010. FILED 10-23-2009.
 3,806,373 (*See Class 41 for this trademark*).
 3,806,454. **MYHEALTHADVANTAGE (STANDARD CHARACTER)**. HAWAII PACIFIC HEALTH, (U.S. CLS. 100 AND 101). SN 77-858,515. PUB. 4-6-2010. FILED 10-27-2009.
 3,806,456 (*See Class 41 for this trademark*).
 3,806,489. **ECOLOGY-LAWN ENVIRONMENT SENSITIVE LAWN & SHRUB CARE AND DESIGN**. ECOLOGY-LAWN USA LLC, (U.S. CLS. 100 AND 101). SN 77-858,757. PUB. 4-6-2010. FILED 10-27-2009.
 3,806,504. **GOLDEN SOL (STANDARD CHARACTER)**. GOLDEN SOL, INC., (U.S. CLS. 100 AND 101). SN 77-858,964. PUB. 4-6-2010. FILED 10-28-2009.
 3,806,505. **GOLDEN SOL AND DESIGN**. GOLDEN SOL, INC., (U.S. CLS. 100 AND 101). SN 77-858,965. PUB. 4-6-2010. FILED 10-28-2009.
 3,806,514 (*See Class 25 for this trademark*).
 3,806,533. **COMPASSION AND DESIGN**. COMPASSION INTERNATIONAL, INC., MULTIPLE CLASS, (INT. CLS. 44 AND 45), (U.S. CLS. 100 AND 101). SN 77-859,428. PUB. 4-6-2010. FILED 10-28-2009.
 3,806,552. **MEDIANT HEALTH (STANDARD CHARACTER)**. MEDIANT HEALTH, INC, (U.S. CLS. 100 AND 101). SN 77-859,565. PUB. 4-6-2010. FILED 10-28-2009.
 3,806,579. **THE AFTER OWLS (STANDARD CHARACTER)**. THE AFTER OWLS PEDIATRIC CARE, PC, (U.S. CLS. 100 AND 101). SN 77-859,851. PUB. 4-6-2010. FILED 10-28-2009.
 3,806,584. **LIFE TURN HEALTHY BEGINNINGS (STANDARD CHARACTER)**. DISON, CHERYL CAROLINE, (U.S. CLS. 100 AND 101). SN 77-859,868. PUB. 4-6-2010. FILED 10-28-2009.
 3,806,609 (*See Class 41 for this trademark*).
 3,806,644. **LIBERTY REGIONAL HEART & VASCULAR CENTER A SERVICE OF LIBERTY HOSPITAL AND DESIGN**. NEW LIBERTY HOSPITAL DISTRICT OF CLAY COUNTY, (U.S. CLS. 100 AND 101). SN 77-860,557. PUB. 4-6-2010. FILED 10-29-2009.
 3,806,700. **WE'VE BEEN "EXPECTING" YOU. (STANDARD CHARACTER)**. OAKDALE OBSTETRICS AND GYNECOLOGY, (U.S. CLS. 100 AND 101). SN 77-861,235. PUB. 4-6-2010. FILED 10-30-2009.
 3,806,723. **BLOOD THE ULTIMATE RENEWABLE RESOURCE (STANDARD CHARACTER)**. MEMORIAL BLOOD CENTERS, (U.S. CLS. 100 AND 101). SN 77-861,536. PUB. 4-6-2010. FILED 10-30-2009.
 3,806,768 (*See Class 41 for this trademark*).
 3,806,798. **MSPB (STANDARD CHARACTER)**. MEDICAL SPECIALISTS OF THE PALM BEACHES, INC., (U.S. CLS. 100 AND 101). SN 77-863,129. PUB. 4-6-2010. FILED 11-2-2009.
 3,806,820 (*See Class 35 for this trademark*).
 3,806,823. **SUDS WITH LOVE (STANDARD CHARACTER)**. JENNIFER BOWERS BAHNEY, (U.S. CLS. 100 AND 101). SN 77-863,501. PUB. 4-6-2010. FILED 11-3-2009.
 3,806,891 (*See Class 35 for this trademark*).
 3,806,896 (*See Class 35 for this trademark*).
 3,806,906. **ECHOMETRICS (STANDARD CHARACTER)**. ECHOMETRICS CORPORATION, (U.S. CLS. 100 AND 101). SN 77-865,371. PUB. 4-6-2010. FILED 11-4-2009.
 3,806,907. **ECHOMETRICS AND DESIGN**. ECHOMETRICS CORPORATION, (U.S. CLS. 100 AND 101). SN 77-865,382. PUB. 4-6-2010. FILED 11-4-2009.
 3,806,918. **YOU4LIFE (STANDARD CHARACTER)**. CHILDREN'S HEALTHCARE OF ATLANTA, INC., (U.S. CLS. 100 AND 101). SN 77-867,953. PUB. 4-6-2010. FILED 11-9-

2009.
 3,806,993. **ADVANCE CHOICE DENTAL VISION & BRACES (STANDARD CHARACTER)**. ADVANCE CHOICE GROUP, LLC, (U.S. CLS. 100 AND 101). SN 77-880,373. PUB. 4-6-2010. FILED 11-24-2009.
 3,806,994. **ADVANCE CHOICE DENTAL VISION & BRACES AND DESIGN**. ADVANCE CHOICE GROUP, LLC, (U.S. CLS. 100 AND 101). SN 77-880,401. PUB. 4-6-2010. FILED 11-24-2009.
 3,807,019 (*See Class 35 for this trademark*).
 3,807,040. **MISCELLANEOUS DESIGN**. HEALTH BY DESIGN MANAGEMENT, LLP, (U.S. CLS. 100 AND 101). SN 77-895,928. PUB. 4-6-2010. FILED 12-17-2009.
 3,807,061. **GULF STATES HEALTH SERVICES AND DESIGN**. GULF STATES HEALTH SERVICES, INC., (U.S. CLS. 100 AND 101). SN 78-528,163. PUB. 3-21-2006. FILED 12-7-2004.
 3,807,074 (*See Class 35 for this trademark*).
 3,807,092 (*See Class 12 for this trademark*).
 3,807,117 (*See Class 5 for this trademark*).
 3,807,138 (*See Class 5 for this trademark*).
 3,807,145 (*See Class 5 for this trademark*).
 3,807,160 (*See Class 9 for this trademark*).
 3,807,180 (*See Class 3 for this trademark*).
 3,807,271 (*See Class 3 for this trademark*).
 3,807,274 (*See Class 35 for this trademark*).
 3,807,278 (*See Class 9 for this trademark*).
 (U.S. CLS. 100 AND 101). SN 77-738,499. PUB. 4-6-2010. FILED 5-15-2009.
 3,805,725 (*See Class 42 for this trademark*).
 3,805,963. **APRIL BEYER (STANDARD CHARACTER)**. BEYER, APRIL, (U.S. CLS. 100 AND 101). SN 77-810,004. PUB. 4-6-2010. FILED 8-21-2009.
 3,806,047 (*See Class 42 for this trademark*).
 3,806,075 (*See Class 38 for this trademark*).
 3,806,106 (*See Class 35 for this trademark*).
 3,806,107. **MISCELLANEOUS DESIGN**. JOHN W. DAVIS, (U.S. CLS. 100 AND 101). SN 77-835,772. PUB. 4-6-2010. FILED 9-26-2009.
 3,806,117 (*See Class 16 for this trademark*).
 3,806,178 (*See Class 35 for this trademark*).
 3,806,323 (*See Class 38 for this trademark*).
 3,806,355. **OPLF (STANDARD CHARACTER)**. CARL OPPE-DAHL, (U.S. CLS. 100 AND 101). SN 77-856,748. PUB. 4-6-2010. FILED 10-24-2009.
 3,806,392. **LIFEBRIDGE CHRISTIAN CHURCH AND DESIGN**. LIFEBRIDGE CHRISTIAN CHURCH, (U.S. CLS. 100 AND 101). SN 77-857,670. PUB. 4-6-2010. FILED 10-26-2009.
 3,806,400. **THE EGO TAMER (STANDARD CHARACTER)**. REJUVENATION STATION, LLC, THE, (U.S. CLS. 100 AND 101). SN 77-857,943. PUB. 4-6-2010. FILED 10-27-2009.
 3,806,414. **WINGS FOR GREAT IDEAS AND DESIGN**. KELLY, DONALD GRANT, (U.S. CLS. 100 AND 101). SN 77-858,098. PUB. 4-6-2010. FILED 10-27-2009.
 3,806,464. **FAMILY BRIDGES (STANDARD CHARACTER)**. FAMILY BRIDGES HOME CARE, INC., (U.S. CLS. 100 AND 101). SN 77-858,556. PUB. 4-6-2010. FILED 10-27-2009.
 3,806,533 (*See Class 44 for this trademark*).
 3,806,576. **GRINDR AND DESIGN**. NEARBY BUDDY FIN-DER LLC, (U.S. CLS. 100 AND 101). SN 77-859,845. PUB. 4-6-2010. FILED 10-28-2009.
 3,806,622 (*See Class 41 for this trademark*).
 3,806,681 (*See Class 35 for this trademark*).
 3,806,713. **WE WON'T TAKE NO FOR AN ANSWER (STANDARD CHARACTER)**. JAN DILS ATTORNEY AT LAW, LC, (U.S. CLS. 100 AND 101). SN 77-861,419. PUB. 4-6-2010. FILED 10-30-2009.
 3,806,716. **SHE WON'T TAKE NO FOR AN ANSWER (STANDARD CHARACTER)**. JAN DILS ATTORNEY AT LAW, LC, (U.S. CLS. 100 AND 101). SN 77-861,440. PUB. 4-6-2010. FILED 10-30-2009.
 3,806,847. **DREAMWITHME.COM (STANDARD CHARACTER)**. DREAMWITHME, L.L.C., (U.S. CLS. 100 AND 101). SN 77-863,880. PUB. 4-6-2010. FILED 11-3-2009.
 3,806,873 (*See Class 35 for this trademark*).
 3,806,878. **SELTZER CAPLAN MCMAHON VITEK (STANDARD CHARACTER)**. SELTZER CAPLAN MCMAHON VITEK, (U.S. CLS. 100 AND 101). SN 77-864,364. PUB. 4-6-2010. FILED 11-3-2009.
 3,807,001 (*See Class 38 for this trademark*).
 3,807,135 (*See Class 9 for this trademark*).
 3,807,150 (*See Class 35 for this trademark*).

* * * * *

CLASS 45—PERSONAL AND LEGAL SERVICES

- 3,805,150. **HELPING YOU DISCOVER THE POSSIBILITIES (STANDARD CHARACTER)**. CONSULTING & MEDIATION SERVICES OF TEXAS, (U.S. CLS. 100 AND 101). SN 76-698,658. PUB. 4-6-2010. FILED 7-27-2009.
 3,805,172. **GO YE INTO THE WORLD UBC ST. MATT 28:19:20 AND DESIGN**. UNITED BROTHERS FOR CHRIST, INC, (U.S. CLS. 100 AND 101). SN 76-700,173. PUB. 4-6-2010. FILED 11-2-2009.
 3,805,189 (*See Class 38 for this trademark*).
 3,805,195 (*See Class 9 for this trademark*).
 3,805,204 (*See Class 35 for this trademark*).
 3,805,289 (*See Class 36 for this trademark*).
 3,805,298 (*See Class 35 for this trademark*).
 3,805,337 (*See Class 35 for this trademark*).
 3,805,375 (*See Class 35 for this trademark*).
 3,805,386. **WE CARE AND IT SHOWS AMERICA'S COMPANION SERVICES AND DESIGN**. AMERICA'S COMPANION SERVICES, (U.S. CLS. 100 AND 101). SN 77-605,500. PUB. 8-25-2009. FILED 10-31-2008.
 3,805,428 (*See Class 35 for this trademark*).
 3,805,438 (*See Class 9 for this trademark*).
 3,805,486. **MISCELLANEOUS DESIGN**. NG FOOK FUNERAL SERVICES LLC, (U.S. CLS. 100 AND 101). SN 77-689,375. PUB. 4-6-2010. FILED 3-12-2009.
 3,805,506. **TO KNOW CHRIST AND TO MAKE HIM KNOWN (STANDARD CHARACTER)**. THE NAVIGATORS, (U.S. CLS. 100 AND 101). SN 77-707,533. PUB. 4-6-2010. FILED 4-6-2009.
 3,805,509. **BELIEVE IT. BE IT. (STANDARD CHARACTER)**. BIBIT, LLC, (U.S. CLS. 100 AND 101). SN 77-709,853. PUB. 4-6-2010. FILED 4-8-2009.
 3,805,524. **ASSISTANT CARE BY DESIGN AND DESIGN**. FIRST AMERICAN PRIME CARE, INC., (U.S. CLS. 100 AND 101). SN 77-715,522. PUB. 4-6-2010. FILED 4-16-2009.
 3,805,527 (*See Class 35 for this trademark*).
 3,805,545 (*See Class 35 for this trademark*).
 3,805,550. **CHOSEN PEOPLE MINISTRIES (STANDARD CHARACTER)**. CHOSEN PEOPLE MINISTRIES, INC., (U.S. CLS. 100 AND 101). SN 77-721,624. PUB. 4-6-2010. FILED 4-24-2009.
 3,805,552. **MISCELLANEOUS DESIGN**. CHOSEN PEOPLE MINISTRIES, INC., (U.S. CLS. 100 AND 101). SN 77-721,921. PUB. 4-6-2010. FILED 4-24-2009.
 3,805,592 (*See Class 9 for this trademark*).
 3,805,655. **PROTECT YOUR INTELLECT (STANDARD CHARACTER)**. LUCE, FORWARD, HAMILTON & SCRIPPS LLP,

SECTION 2.—PRIOR UNITED STATES CLASSIFICATION

COLLECTIVE MEMBERSHIP MARKS

CLASS 200—COLLECTIVE MEMBERSHIP

- 3,805,120 (*See Class 16 for this trademark*).
- 3,805,223. **AARSREP (STANDARD CHARACTER)**. DICKSON, RUSSELL T., SN 77-343,214. PUB. 4-6-2010. FILED 12-4-2007.
- 3,805,489. **VICIOUS CIRCLE NEW YORK MC AND DESIGN**. MASON LANCE E, SN 77-692,514. PUB. 12-29-2009. FILED 3-17-2009.
- 3,805,774. **SOLARWINDS CERTIFIED PROFESSIONAL AND DESIGN**. SOLARWINDS WORLDWIDE, LLC, SN 77-764,057. PUB. 4-6-2010. FILED 6-19-2009.
- 3,805,776. **SOLARWINDS CERTIFIED PROFESSIONAL (STANDARD CHARACTER)**. SOLARWINDS WORLDWIDE, LLC, SN 77-764,162. PUB. 4-6-2010. FILED 6-19-2009.
- 3,805,782 (*See Class 16 for this trademark*).
- 3,806,138. **CSPC (STANDARD CHARACTER)**. BROWNS CANYON CORPORATION, SN 77-838,991. PUB. 4-6-2010. FILED 10-1-2009.
- 3,806,140. **CSAM (STANDARD CHARACTER)**. BROWNS CANYON CORPORATION, SN 77-839,046. PUB. 4-6-2010. FILED 10-1-2009.
- 3,807,036. **NATO AND DESIGN**. NATIONAL ASSOCIATION OF THEATRE OWNERS, INC., SN 77-893,591. PUB. 4-6-2010. FILED 12-15-2009.

CERTIFICATION MARKS

CLASS A—GOODS

- 3,805,936. **TRI-STATE HEALTH CARE COALITION AND DESIGN**. TRI-STATE HEALTH CARE COALITION, INC., DBA TRI-STATE HEALTH CARE COALITION, SN 77-805,101. PUB. 4-6-2010. FILED 8-14-2009.

CLASS B—SERVICES

- 3,805,127. **G MED AND DESIGN**. LABORATOIRE NATIONAL DE METROLOGIE ET D'ESSAIS, SN 76-660,959. PUB. 4-6-2010. FILED 6-2-2006.
- 3,805,311. **CRRC COOL ROOF RATING COUNCIL ACCREDITED LABORATORY AND DESIGN**. COOL ROOF RATING COUNCIL, INC., SN 77-532,443. PUB. 4-6-2010. FILED 7-28-2008.
- 3,805,387. **CFLE (STANDARD CHARACTER)**. NATIONAL COUNCIL ON FAMILY RELATIONS, DBA NCFR, SN 77-606,302. PUB. 4-6-2010. FILED 11-3-2008.
- 3,805,739. **VSI CERTIFIED VINYL SIDING INSTALLER SPONSORED BY THE VINYL SIDING INSTITUTE AND DESIGN**. VINYL SIDING INSTITUTE, INC., SN 77-756,306. PUB. 4-6-2010. FILED 6-10-2009.
- 3,805,740. **VSI CERTIFIED VINYL SIDING INSTALLER COMPANY SPONSORED BY THE VINYL SIDING INSTITUTE AND DESIGN**. VINYL SIDING INSTITUTE, INC., SN 77-756,371. PUB. 4-6-2010. FILED 6-10-2009.

* * * * *

TRADEMARK REGISTRATIONS ISSUED UNDER SECTION 1(d)

The following marks have registered on the Principal Register pursuant to the intent-to-use provisions of Section 1(d) of the Trademark Act of 1946, as amended.

SECTION 1.— INTERNATIONAL CLASSIFICATION

The short titles associated below with the international class numbers are terms designed merely for quick identification and are not an official part of the international classification. The full names of international classes are given in section 6.1 of the trademark rules of practice.

The designation "U.S. Cl." appearing in this section refers to the U.S. class in effect prior to Sep. 1, 1973 rather than the international class which applies to applications filed on or after that date. For adoption of international classification see notice in the OFFICIAL GAZETTE of Jun. 26, 1973 (911 O.G. TM 210).

Application in more than one class

3,807,370. AEROBICS AND FITNESS ASSOCIATION OF AMERICA, SHERMAN OAKS, CA. SN 75-899,918. PUB. 7-31-2007, FILED 1-21-2000.

WELLNESS TRIAGE

NO CLAIM IS MADE TO THE EXCLUSIVE RIGHT TO USE "WELLNESS", APART FROM THE MARK AS SHOWN.

CLASS 41—EDUCATION AND ENTERTAINMENT

FOR PROVIDING INFORMATION AND ADVICE VIA WEBSITES ON A GLOBAL COMPUTER NETWORK ON AEROBICS, EXERCISE AND FITNESS (U.S. CLS. 100, 101 AND 107).

FIRST USE 11-19-2009; IN COMMERCE 11-19-2009.

CLASS 42—SCIENTIFIC AND COMPUTER SERVICES

FOR PROVIDING INFORMATION AND ADVICE VIA WEBSITES ON A GLOBAL COMPUTER NETWORK ON NUTRITION AND GENERAL HEALTH ISSUES (U.S. CLS. 100 AND 101).

FIRST USE 11-19-2009; IN COMMERCE 11-19-2009.

3,807,373. THE LARRY SCHWARZ COMPANY, INC., NEW YORK, NY. SN 76-645,621. PUB. 5-29-2007, FILED 8-26-2005.

THUMB WRESTLING FEDERATION

NO CLAIM IS MADE TO THE EXCLUSIVE RIGHT TO USE "THUMB WRESTLING" AS TO INTERNATIONAL CLASS 41, APART FROM THE MARK AS SHOWN.

CLASS 9—ELECTRICAL AND SCIENTIFIC APPARATUS

FOR DVDS FEATURING CHILDREN'S STORIES (U.S. CLS. 21, 23, 26, 36 AND 38).

FIRST USE 10-0-2008; IN COMMERCE 10-0-2008.

CLASS 28—TOYS AND SPORTING GOODS

FOR TOYS AND GAMES, NAMELY, ACTION FIGURES (U.S. CLS. 22, 23, 38 AND 50).

FIRST USE 12-0-2007; IN COMMERCE 12-0-2007.

CLASS 41—EDUCATION AND ENTERTAINMENT

FOR ENTERTAINMENT SERVICES, NAMELY, PRODUCTION OF TELEVISION, AND INTERNET PROGRAMS (U.S. CLS. 100, 101 AND 107).

FIRST USE 2-0-2008; IN COMMERCE 2-0-2008.

3,807,385. UTAH ASSOCIATED MUNICIPAL POWER SYSTEMS, SALT LAKE CITY, UT. SN 76-691,865. PUB. 6-23-2009, FILED 8-6-2008.



OWNER OF U.S. REG. NO. 3,597,700.

THE MARK CONSISTS OF THE WORDING "UAMPS UTAH ASSOCIATED MUNICIPAL POWER SYSTEMS SMART ENERGY" WITH A LIGHTNING BOLT BETWEEN THE LETTERS "U" AND "A" AND A STYLIZED DEPICTION OF ELECTRICITY NEXT TO THE WORDING "SMARTENERGY".

SEC. 2(F) AS TO "UTAH ASSOCIATED MUNICIPAL POWER SYSTEMS".

CLASS 35—ADVERTISING AND BUSINESS

FOR ENERGY MANAGEMENT SERVICES, NAMELY, PROVIDING A SERVICE THAT ALLOWS CUSTOMERS TO PURCHASE ENERGY, NAMELY, ELECTRICITY, NATURAL GAS AND RENEWABLE ENERGY, AT A FIXED PRICE; MANAGEMENT OF ENERGY PRODUCTION FACILITIES; PROCUREMENT, NAMELY, PURCHASING ENERGY AND ELECTRIC POWER FOR OTHERS; PROVIDING MARKETING CONSULTATION IN THE FIELD OF ENERGY AND ELECTRIC POWER (U.S. CLS. 100, 101 AND 102).

FIRST USE 4-0-2009; IN COMMERCE 4-0-2009.

3,807,395. SABERT CORPORATION., SAYREVILLE, NJ. SN 76-695,825. PUB. 7-14-2009, FILED 2-17-2009.

ENJOY

CLASS 36—INSURANCE AND FINANCIAL

FOR BROKERAGE OF ENERGY, NAMELY, GAS AND ELECTRICITY (U.S. CLS. 100, 101 AND 102).

FIRST USE 4-0-2009; IN COMMERCE 4-0-2009.

THE MARK CONSISTS OF STANDARD CHARACTERS WITHOUT CLAIM TO ANY PARTICULAR FONT, STYLE, SIZE, OR COLOR.

CLASS 40—MATERIAL TREATMENT

FOR GENERATION OF ENERGY; PRODUCTION OF ENERGY (U.S. CLS. 100, 103 AND 106).

FIRST USE 4-0-2009; IN COMMERCE 4-0-2009.

CLASS 8—HAND TOOLS

FOR PLASTIC CUTLERY, NAMELY, FORKS, SPOONS, AND KNIVES; AND CAKE CUTTERS (U.S. CLS. 23, 28 AND 44).

FIRST USE 6-0-2009; IN COMMERCE 6-0-2009.

CLASS 21—HOUSEWARES AND GLASS

FOR PLASTIC FOOD CONTAINERS OF ALL KINDS, NAMELY, SERVING TRAYS, PLATTERS, PLASTIC EATING PLATES, CUPS, BOWLS, AND LIDS RELATED THERETO, SOLD AS A UNIT FOR FOOD SERVICE; PLASTIC SERVING UTENSILS, NAMELY, SERVING FORKS, SERVING SPOONS AND SERVING TONGS; SPREADERS, NAMELY, SPATULAS (U.S. CLS. 2, 13, 23, 29, 30, 33, 40 AND 50).

FIRST USE 6-0-2009; IN COMMERCE 6-0-2009.

3,807,386. KODI KLIP CORPORATION, LEBANON, TN. SN 76-692,480. PUB. 6-23-2009, FILED 8-29-2008.

3,807,399. ADVANCE MAGAZINE PUBLISHERS INC., NEW YORK, NY. SN 76-697,107. PUB. 11-17-2009, FILED 4-27-2009.



THE DESIGN IS THE FACE OF A BEAR WITH REBAR IN ITS MOUTH.

CLASS 7—MACHINERY

FOR POWER TOOLS FOR APPLYING CLIPS FOR REINFORCING AND CONSTRUCTION BARS, NAMELY, CLIP APPLYING GUNS FOR CONCRETE APPLICATION (U.S. CLS. 13, 19, 21, 23, 31, 34 AND 35).

FIRST USE 1-1-2010; IN COMMERCE 1-1-2010.

CLASS 20—FURNITURE AND ARTICLES NOT OTHERWISE CLASSIFIED

FOR NON-METAL CLIPS FOR SECURING REINFORCEMENT BARS AND CONSTRUCTION BARS (U.S. CLS. 2, 13, 22, 25, 32 AND 50).

FIRST USE 1-1-2009; IN COMMERCE 1-1-2009.

BON APPETIT WINE SHOP

THE MARK CONSISTS OF STANDARD CHARACTERS WITHOUT CLAIM TO ANY PARTICULAR FONT, STYLE, SIZE, OR COLOR.

OWNER OF U.S. REG. NOS. 653,791, 2,773,320, AND OTHERS.

NO CLAIM IS MADE TO THE EXCLUSIVE RIGHT TO USE "WINE SHOP", APART FROM THE MARK AS SHOWN.

THE ENGLISH TRANSLATION OF "BON APPETIT" IN THE MARK IS "I WISH YOU A HEARTY APPETITE".

CLASS 35—ADVERTISING AND BUSINESS

FOR ONLINE RETAIL STORE SERVICES IN THE FIELD OF WINE AND WINE ACCESSORIES; MAIL ORDER SERVICES IN THE FIELD OF WINE AND WINE ACCESSORIES (U.S. CLS. 100, 101 AND 102).

FIRST USE 10-6-2009; IN COMMERCE 10-6-2009.

CLASS 43—HOTEL AND RESTAURANT SERVICES

FOR PROVIDING INFORMATION ABOUT WINE CHARACTERISTICS AND FOOD PREPARATION, AS WELL AS INFORMATION IN THE NATURE OF ADVICE ON WINE AND FOOD PAIRING ALL VIA AN ONLINE ELECTRONIC COMMUNICATIONS NETWORK (U.S. CLS. 100 AND 101).

FIRST USE 10-6-2009; IN COMMERCE 10-6-2009.

3,807,407. PATRIOT OUTDOORS, CLOVIS, NM. SN 77-010,222. PUB. 8-11-2009, FILED 9-29-2006.

PATRIOT OUTDOORS

THE MARK CONSISTS OF STANDARD CHARACTERS WITHOUT CLAIM TO ANY PARTICULAR FONT, STYLE, SIZE, OR COLOR.

NO CLAIM IS MADE TO THE EXCLUSIVE RIGHT TO USE "OUTDOORS", APART FROM THE MARK AS SHOWN.

CLASS 35—ADVERTISING AND BUSINESS

FOR RETAIL STORE SERVICES FEATURING SPORTING GOODS, NONE OF WHICH RELATES TO THE SPORT OF AMERICAN FOOTBALL (U.S. CLS. 100, 101 AND 102).

FIRST USE 1-29-2005; IN COMMERCE 1-29-2005.

CLASS 41—EDUCATION AND ENTERTAINMENT

FOR OUTDOOR SPORTS AND FIREARMS TRAINING SERVICES, NONE OF WHICH RELATE TO THE SPORT OF AMERICAN FOOTBALL (U.S. CLS. 100, 101 AND 107).

FIRST USE 1-29-2005; IN COMMERCE 1-29-2005.

3,807,417. ADC TELECOMMUNICATIONS, INC., EDEN PRAIRIE, MN. SN 77-049,589. PUB. 10-14-2008, FILED 11-22-2006.

ENGINEERED FOR UPTIME

THE MARK CONSISTS OF STANDARD CHARACTERS WITHOUT CLAIM TO ANY PARTICULAR FONT, STYLE, SIZE, OR COLOR.

CLASS 37—CONSTRUCTION AND REPAIR

FOR CONSULTING SERVICES IN THE FIELD OF INSTALLATION OF DATA CABLE SYSTEMS (U.S. CLS. 100, 103 AND 106).

FIRST USE 0-0-2007; IN COMMERCE 0-0-2007.

CLASS 41—EDUCATION AND ENTERTAINMENT

FOR EDUCATIONAL SERVICES, NAMELY, PROVIDING VOCATIONAL EDUCATION, PROVIDING EDUCATIONAL DEMONSTRATIONS, PROVIDING SEMINARS, PROVIDING WORKSHOPS, PROVIDING INTERACTIVE AND SELF-PACED DISTANCE LEARNING THROUGH CLASSES OVER A GLOBAL COMPUTER NETWORK, ALL IN THE FIELD OF SELECTION AND INSTALLATION OF DATA CABLE; TRAINING IN THE SELECTION AND INSTALLATION OF DATA CABLE (U.S. CLS. 100, 101 AND 107).

FIRST USE 0-0-2007; IN COMMERCE 0-0-2007.

3,807,430. MENTICE AB, GOTENBORG, SWEDEN. SN 77-073,017. PUB. 8-7-2007, FILED 12-28-2006.



THE COLOR(S) GREY AND ORANGE IS/ARE CLAIMED AS A FEATURE OF THE MARK.

THE MARK CONSISTS OF A DESIGN OF STACKED RECTANGLES OF GREY AND ORANGE, THE ORANGE RECTANGLES FORMING A CROSS.

CLASS 9—ELECTRICAL AND SCIENTIFIC APPARATUS

FOR EDUCATIONAL SOFTWARE FEATURING INSTRUCTION IN TEACHING AND PRACTICING SURGICAL PROCEDURES INCLUDING RADIOLOGY, INTERVENTIONAL, ENDOVASCULAR, ENDOSCOPIC, ARTHROSCOPIC AND CARDIOLOGY PROCEDURES AND ASSESSING SURGICAL SKILLS; VIRTUAL REALITY SOFTWARE FOR COMPUTER BASED SIMULATION FOR TEACHING AND PRACTICING SURGICAL PROCEDURES INCLUDING RADIOLOGY, INTERVENTIONAL, ENDOVASCULAR, ENDOSCOPIC, ARTHROSCOPIC AND CARDIOLOGY PROCEDURES AND ASSESSING SURGICAL SKILLS (U.S. CLS. 21, 23, 26, 36 AND 38).

FIRST USE 11-22-2002; IN COMMERCE 12-16-2002.

CLASS 41—EDUCATION AND ENTERTAINMENT

FOR ARRANGEMENT OF TRAINING COURSES IN TEACHING INSTITUTES; TRAINING IN THE USE AND OPERATION OF COMPUTER BASED SIMULATION AND VIRTUAL REALITY SYSTEM FOR TEACHING AND PRACTICING SURGICAL PROCEDURES INCLUDING RADIOLOGY, INTERVENTIONAL, ENDOVASCULAR, ENDOSCOPIC, ARTHROSCOPIC AND CARDIOLOGY PROCEDURES AND ASSESSING SURGICAL SKILLS (U.S. CLS. 100, 101 AND 107).

FIRST USE 5-31-1999; IN COMMERCE 5-31-1999.

3,807,450. GLOBAL MED TECHNOLOGIES, INC., DBA WYNDGATE TECHNOLOGIES, LAKEWOOD, CO. SN 77-134,346. PUB. 4-21-2009, FILED 3-19-2007.

ELDORADO DONOR DOC

THE MARK CONSISTS OF STANDARD CHARACTERS WITHOUT CLAIM TO ANY PARTICULAR FONT, STYLE, SIZE, OR COLOR.

NO CLAIM IS MADE TO THE EXCLUSIVE RIGHT TO USE "DONOR", APART FROM THE MARK AS SHOWN.

CLASS 9—ELECTRICAL AND SCIENTIFIC APPARATUS

FOR SOFTWARE FOR DATABASE MANAGEMENT, NAMELY, SOFTWARE FOR MONITORING THE COLLECTION AND TRANSFER OF BLOOD AND BLOOD PRODUCTS FOR TRANSFUSION (U.S. CLS. 21, 23, 26, 36 AND 38).

FIRST USE 12-26-2007; IN COMMERCE 12-26-2007.

CLASS 42—SCIENTIFIC AND COMPUTER SERVICES

FOR PROVIDING USE OF ON-LINE, NON-DOWNLOADABLE SOFTWARE FOR USE IN DATABASE MANAGEMENT, NAMELY, FOR MONITORING THE COLLECTION AND TRANSFER OF BLOOD AND BLOOD PRODUCTS FOR TRANSFUSION (U.S. CLS. 100 AND 101).

FIRST USE 12-26-2007; IN COMMERCE 12-26-2007.

3,807,454. UNVERFERTH MANUFACTURING CO., INC., KALIDA, OH. SN 77-166,633. PUB. 4-15-2008, FILED 4-26-2007.

SEED PRO

THE MARK CONSISTS OF STANDARD CHARACTERS WITHOUT CLAIM TO ANY PARTICULAR FONT, STYLE, SIZE, OR COLOR.

NO CLAIM IS MADE TO THE EXCLUSIVE RIGHT TO USE "SEED", APART FROM THE MARK AS SHOWN.

CLASS 7—MACHINERY

FOR PRODUCT USED FOR DISPENSING FIELD CROP SEED INTO FIELD CROP SEEDING EQUIPMENT, NAMELY, A COMBINATION SEED STORAGE AND DELIVERY SYSTEM COMPRISED OF UNLOADING CONVEYOR(S), UNDERCARRIAGE AND SEED HOPPER/BIN (U.S. CLS. 13, 19, 21, 23, 31, 34 AND 35).

FIRST USE 4-21-2010; IN COMMERCE 4-21-2010.

CLASS 12—VEHICLES

FOR AGRICULTURAL MACHINERY, NAMELY, A WHEELED TRAILER FOR TRANSPORTING FIELD CROP SEED TO THE FIELD (U.S. CLS. 19, 21, 23, 31, 35 AND 44).

FIRST USE 4-21-2010; IN COMMERCE 4-21-2010.

3,807,463. CAUSE TV, INC., POTOMAC, MD. SN 77-194,000. PUB. 7-7-2009, FILED 5-31-2007.

CAUSETV

THE MARK CONSISTS OF STANDARD CHARACTERS WITHOUT CLAIM TO ANY PARTICULAR FONT, STYLE, SIZE, OR COLOR.

CLASS 41—EDUCATION AND ENTERTAINMENT

FOR ENTERTAINMENT SERVICES, NAMELY, PROVIDING A WEB SITE FEATURING PHOTOGRAPHIC, VIDEO AND PROSE PRESENTATIONS FEATURING SOCIAL AND ENVIRONMENTAL ISSUES, CORPORATE RESPONSIBILITY, POLITICAL ISSUES, CITIZEN ACTION AND NON-PROFITS (U.S. CLS. 100, 101 AND 107).

FIRST USE 6-20-2008; IN COMMERCE 6-20-2008.

CLASS 42—SCIENTIFIC AND COMPUTER SERVICES

FOR COMPUTER SERVICES, NAMELY, HOSTING ON-LINE WEB FACILITIES FOR OTHERS FOR ORGANIZING AND CONDUCTING ONLINE MEETINGS, GATHERINGS AND INTERACTIVE DISCUSSIONS IN THE FIELD OF SOCIAL AND ENVIRONMENTAL ISSUES, CORPORATE RESPONSIBILITY, POLITICAL ISSUES, CITIZEN ACTION, AND NON-PROFITS; COMPUTER SERVICES, NAMELY, INTERACTIVE HOSTING SERVICES WHICH ALLOW USERS TO PUBLISH AND SHARE THEIR OWN CONTENT AND IMAGES ONLINE RELATING TO SOCIAL AND ENVIRONMENTAL ISSUES, CORPORATE RESPONSIBILITY, POLITICAL ISSUES, CITIZEN ACTION, AND NON-PROFITS; PROVIDING A WEB SITE THAT GIVES COMPUTER USERS THE ABILITY TO UPLOAD, EXCHANGE AND SHARE PHOTOS, VIDEOS AND VIDEO LOGS FEATURING SOCIAL AND ENVIRONMENTAL ISSUES, CORPORATE RESPONSIBILITY, POLITICAL ISSUES, CITIZEN ACTION AND NON-PROFITS (U.S. CLS. 100 AND 101).

FIRST USE 6-20-2008; IN COMMERCE 6-20-2008.

CLASS 45—PERSONAL AND LEGAL SERVICES

FOR ONLINE SOCIAL NETWORKING SERVICES RELATING TO SOCIAL AND ENVIRONMENTAL ISSUES, CORPORATE RESPONSIBILITY, POLITICAL ISSUES, CITIZEN ACTION, AND NON-PROFITS (U.S. CLS. 100 AND 101).

FIRST USE 6-20-2008; IN COMMERCE 6-20-2008.

3,807,464. ADITALL, LLC, NEW YORK, NY. SN 77-199,423. PUB. 7-15-2008, FILED 6-6-2007.



THE COLOR(S) GRAY, WHITE, BLACK, GREEN (YELLOWGREEN, KHAKI) IS/ARE CLAIMED AS A FEATURE OF THE MARK.

THE MARK CONSISTS OF WORD "ADITALL" IN TWO COLORS AS FOLLOWS: "AD" IN BLACK, "IT" IN GREEN (YELLOWGREEN SHADE) AND "ALL" IN BLACK. THE WORD IS LOCATED UNDERNEATH THREE FIGURES, ALL FEATURED AGAINST A WHITE BACKGROUND. THE THREE FIGURES ARE DESCRIBED AS FOLLOWS. FIRST FIGURE IS THE SMALLEST OF THE THREE. IT IS IN GRAY COLOR AND CONSISTS AND OF AN ELLIPSE WITH TWO LEGS EXTENDING DOWNWARDS THEREFROM

AND A CROWN ABOVE IT. THE ELLIPSE CONTAINS A WHITE CIRCLE WITHIN IT. WITHIN THE WHITE CIRCLE APPEARS A GRAY TRIANGLE. THE SECOND FIGURE IS THE LARGEST OF THE THREE. IT IS IN GREEN (YELLOWGREEN SHADE) COLOR AND HAS TWO LEGS EXTENDING DOWNWARDS THEREFROM AND TWO ANTENNAE EXTENDING ATOP THEREOF. THE SECOND FIGURE CONTAINS A WHITE CIRCLE WITHIN THE ELLIPSE. THE WHITE CIRCLE CONTAINS A BLACK TRIANGLE. THE THIRD FIGURE A MEDIUM SIZED ELLIPSE WITH TWO LEGS EXTENDING DOWNWARDS THEREFROM AND TWO LEG-LIKE ANTENNAE EXTENDING FROM ATOP THEREOF. THE ELLIPSE CONTAINS A WHITE CIRCLE WITHIN IT. THE WHITE CIRCLE CONTAINS A GRAY TRIANGLE.

CLASS 35—ADVERTISING AND BUSINESS

FOR ADVERTISING AGENCIES; ADVERTISING AGENCIES, NAMELY, PROMOTING THE GOODS AND SERVICES OF OTHERS; ADVERTISING AND ADVERTISEMENT SERVICES; ADVERTISING AND BUSINESS MANAGEMENT CONSULTANCY; ADVERTISING AND BUSINESS SERVICES, NAMELY, SECURING AIRTIME ON ALL FORMS OF MEDIA COMMUNICATIONS STATIONS, SYSTEMS, NETWORKS, AND SERVICES FOR THE PURPOSE OF PROMOTING THE GOODS AND SERVICES OF OTHERS; ADVERTISING AND COMMERCIAL INFORMATION SERVICES, VIA THE INTERNET; ADVERTISING AND MARKETING; ADVERTISING AND PROMOTION SERVICES AND RELATED CONSULTING; ADVERTISING AND PUBLICITY SERVICES; ADVERTISING AND PUBLICITY SERVICES, NAMELY, PROMOTING THE GOODS, SERVICES, BRAND IDENTITY AND COMMERCIAL INFORMATION AND NEWS OF THIRD PARTIES THROUGH PRINT, AUDIO, VIDEO, DIGITAL AND ON-LINE MEDIUM; ADVERTISING BY TRANSMISSION OF ON-LINE PUBLICITY FOR THIRD PARTIES THROUGH ELECTRONIC COMMUNICATIONS NETWORKS; ADVERTISING CONSULTATION; ADVERTISING PARTICULARLY SERVICES FOR THE PROMOTION OF GOODS; ADVERTISING SERVICES; ADVERTISING SERVICES OF A RADIO AND TELEVISION ADVERTISING AGENCY; ADVERTISING SERVICES, NAMELY, CREATING CORPORATE AND BRAND IDENTITY FOR OTHERS; ADVERTISING SERVICES, NAMELY, CREATING CORPORATE LOGOS FOR OTHERS; ADVERTISING SERVICES, NAMELY, PROMOTING AND MARKETING THE GOODS AND SERVICES OF OTHERS THROUGH ALL PUBLIC COMMUNICATION MEANS; ADVERTISING SERVICES, NAMELY, PROVIDING INFORMATION AS TO THE AVAILABILITY OF ADVERTISING MULTIMEDIA FOR RENT OR PURCHASE; ADVERTISING THROUGH ALL PUBLIC COMMUNICATION MEANS; ADVERTISING VIA ELECTRONIC MEDIA AND SPECIFICALLY THE INTERNET; ADVERTISING, INCLUDING PROMOTION RELATING TO THE SALE OF ARTICLES AND SERVICES FOR THIRD PARTIES BY THE TRANSMISSION OF ADVERTISING MATERIAL AND THE DISSEMINATION OF ADVERTISING MESSAGES ON COMPUTER NETWORKS; ADVERTISING, MARKETING AND PROMOTION SERVICES; AGENCIES FOR ADVERTISING TIME AND SPACE; CREATING AND UPDATING ADVERTISING MATERIAL; DESIGN OF ADVERTISING MATERIALS FOR OTHERS; DESIGN OF INTERNET ADVERTISING; DISPLAYING ADVERTISEMENTS FOR OTHERS; DISSEMINATION OF ADVERTISEMENTS AND OF ADVERTISING MATERIAL; DISSEMINATION OF ADVERTISING FOR OTHERS VIA AN ON-LINE COMMUNICATIONS NETWORK ON THE INTERNET; DISSEMINATION OF ADVERTISING FOR OTHERS VIA THE INTERNET; DISSEMINATION OF ADVERTISING MATERIAL; DISSEMINATION OF ADVERTISING MATERIAL; DISTRIBUTION AND DISSEMINATION OF ADVERTISING MATERIALS; DISTRIBUTION OF ADVERTISEMENTS AND COMMERCIAL ANNOUNCEMENTS; DISTRIBUTION OF PRODUCTS FOR ADVERTISING PURPOSES; ISSUING AND UPDATING OF ADVERTISING TEXTS; LAYOUT SERVICES FOR ADVERTISING PURPOSES; MEDIA BUYING ADVICE, NAMELY, ADVISING THE CLIENT HOW MUCH MEDIA TIME, AND AT WHAT TIMES THE CLIENT SHOULD BE PURCHASING ADVERTISING; MEDIA PLANNING, NAMELY, ADVISING THE CLIENT ON THE CORRECT TIMES AND STATIONS TO ADVERTISE BASED ON

MEDIA ANALYSIS OF THE MARKET FOR THAT MEDIA; MUSIC SELECTION SERVICES FOR USE IN ADVERTISING; ON-LINE ADVERTISING AND MARKETING SERVICES; ON-LINE ADVERTISING ON COMPUTER COMMUNICATION NETWORKS; ORGANIZING EXHIBITIONS FOR ADVERTISING MULTIMEDIA; PLACING ADVERTISEMENTS FOR OTHERS; PREPARATION AND REALIZATION OF MEDIA AND ADVERTISING PLANS AND CONCEPTS; PREPARATION OF CUSTOM ADVERTISEMENTS FOR OTHERS; PREPARATION OF CUSTOM OR NON-CUSTOM ADVERTISING FOR BUSINESSES FOR DISSEMINATION VIA THE WEB, CD OR DVD FOR OPTIONAL UPLOAD OR DOWNLOAD TO A COMPUTER; PREPARING ADVERTISEMENTS FOR OTHERS; PREPARING AND PLACING ADVERTISEMENTS FOR OTHERS; PREPARING AND PLACING OF ADVERTISEMENTS; PREPARING AUDIO-VISUAL DISPLAYS IN THE FIELD OF ADVERTISING; PREPARING AUDIO-VISUAL PRESENTATIONS FOR USE IN ADVERTISING; PROMOTING THE GOODS AND SERVICES OF OTHERS BY DISTRIBUTING ADVERTISING MATERIALS THROUGH A VARIETY OF METHODS; PROMOTING THE GOODS AND SERVICES OF OTHERS BY PREPARING AND PLACING ADVERTISEMENTS IN AN ELECTRONIC MAGAZINE ACCESSED THROUGH A GLOBAL COMPUTER NETWORK; PROMOTING, ADVERTISING AND MARKETING OF THE ON-LINE WEBSITES OF OTHERS; PROMOTION, ADVERTISING AND MARKETING OF ON-LINE WEBSITES; PROVIDING A SEARCHABLE ON-LINE ADVERTISING GUIDE FEATURING THE GOODS AND SERVICES OF OTHER ON-LINE VENDORS ON THE INTERNET; PROVIDING A WEB SITE WHICH FEATURES ADVERTISEMENTS FOR THE GOODS AND SERVICES OF OTHERS ON A GLOBAL COMPUTER NETWORK; PROVIDING ADVERTISING SERVICES USING 3D AND ANIMATION DESIGNS; PROVIDING AND RENTAL OF ADVERTISING SPACE ON THE INTERNET; PROVIDING SPACE AT A WEB SITE FOR THE ADVERTISEMENT OF THE GOODS AND SERVICES OF OTHERS; PROVISION OF ADVERTISING SPACE BY ELECTRONIC MEANS AND GLOBAL INFORMATION NETWORKS; RENTAL OF ADVERTISEMENT SPACE AND ADVERTISING MATERIAL; RENTAL OF ADVERTISING SPACE; RENTAL OF ADVERTISING SPACE ON WEB SITES; ENTERTAINMENT SERVICES, NAMELY, PROVIDING A WEBSITE FEATURING, PHOTOGRAPHIC, AUDIO, VIDEO AND PROSE PRESENTATIONS FEATURING ADVERTISING MULTIMEDIA (U.S. CLS. 100, 101 AND 102).

FIRST USE 10-23-2007; IN COMMERCE 10-23-2007.

CLASS 41—EDUCATION AND ENTERTAINMENT

FOR CONDUCTING ENTERTAINMENT EXHIBITIONS IN THE NATURE OF ADVERTISING; ENTERTAINMENT SERVICES, NAMELY, A CONTINUING PROGRAM ABOUT ADVERTISING ACCESSIBLE BY RADIO, TELEVISION, SATELLITE, AUDIO, VIDEO AND COMPUTER NETWORKS; ENTERTAINMENT SERVICES, NAMELY, ARRANGING AND CONDUCTING OF COMPETITIONS FOR ADVERTISING MULTIMEDIA; ENTERTAINMENT SERVICES, NAMELY, CONDUCTING PARTIES; ENTERTAINMENT SERVICES, NAMELY, PROVIDING A RADIO PROGRAM IN THE FIELD OF ADVERTISING MULTIMEDIA VIA A GLOBAL COMPUTER NETWORK; ENTERTAINMENT SERVICES, NAMELY, PROVIDING A WEB SITE FEATURING MUSICAL PERFORMANCES, MUSICAL VIDEOS, RELATED FILM CLIPS, PHOTOGRAPHS, AND OTHER MULTIMEDIA MATERIALS; MULTIMEDIA ENTERTAINMENT SERVICES IN THE NATURE OF RECORDING, PRODUCTION AND POST-PRODUCTION SERVICES IN THE FIELDS OF MUSIC, VIDEO, AND FILMS; MULTIMEDIA ENTERTAINMENT SOFTWARE PRODUCTION SERVICES; ORGANIZING EXHIBITIONS FOR ADVERTISING MULTIMEDIA; PROVIDING A WEB SITE WHERE USERS CAN POST RATINGS, RE-

VIEWS AND RECOMMENDATIONS ON EVENTS AND ACTIVITIES IN THE FIELD OF ENTERTAINMENT AND EDUCATION; PROVIDING INFORMATION IN THE FIELD OF ENTERTAINMENT, FEATURING ANIMATION RENDERED BY MEANS OF A GLOBAL COMPUTER NETWORK; PROVIDING INFORMATION, NEWS AND COMMENTARY IN THE FIELD OF ENTERTAINMENT; TRAINING COURSES IN STRATEGIC PLANNING RELATING TO ADVERTISING, PROMOTION, MARKETING AND BUSINESS; TRAINING IN THE FIELD OF DESIGN, ADVERTISING AND COMMUNICATION TECHNOLOGIES (U.S. CLS. 100, 101 AND 107).
FIRST USE 10-23-2007; IN COMMERCE 10-23-2007.

3,807,467. DIXIE CONSUMER PRODUCTS LLC, ATLANTA, GA. SN 77-208,266. PUB. 11-6-2007, FILED 6-18-2007.



THE MARK CONSISTS OF THE LETTER "X" IN A STYLIZED FORMAT.

3,807,466. VERISYS REGISTRARS LLC, BROOKFIELD, WI. SN 77-203,451. PUB. 10-28-2008, FILED 6-11-2007.

CLASS 16—PAPER GOODS AND PRINTED MATTER

FOR DISPOSABLE NAPKINS (U.S. CLS. 2, 5, 22, 23, 29, 37, 38 AND 50).
FIRST USE 9-4-2007; IN COMMERCE 9-4-2007.

CLASS 21—HOUSEWARES AND GLASS

FOR SERVING PLATTERS (U.S. CLS. 2, 13, 23, 29, 30, 33, 40 AND 50).
FIRST USE 10-25-2007; IN COMMERCE 10-25-2007.

VERISYS REGISTRARS

3,807,470. NATURES IMAGE, INC., LAKE FOREST, CA. SN 77-218,431. PUB. 12-29-2009, FILED 6-28-2007.

NATURES IMAGE

THE MARK CONSISTS OF STANDARD CHARACTERS WITHOUT CLAIM TO ANY PARTICULAR FONT, STYLE, SIZE, OR COLOR.

NO CLAIM IS MADE TO THE EXCLUSIVE RIGHT TO USE "REGISTRARS", APART FROM THE MARK AS SHOWN.

CLASS 35—ADVERTISING AND BUSINESS

FOR BUSINESS CONSULTING, MANAGEMENT, PLANNING AND SUPERVISION; BUSINESS INFORMATION MANAGEMENT; BUSINESS MANAGEMENT AND CONSULTATION; BUSINESS MANAGEMENT ASSISTANCE TO INDUSTRIAL OR COMMERCIAL COMPANIES; BUSINESS MANAGEMENT CONSULTANCY AND ADVISORY SERVICES; BUSINESS RECORDS MANAGEMENT; COMPUTERIZED AND CENTRAL FILE MANAGEMENT AND BUSINESS FILE MANAGEMENT; CORPORATE MANAGEMENT ASSISTANCE; PROVIDING BUSINESS MANAGEMENT INFORMATION IN CONNECTION WITH CONSULTING AND ADVISORY SERVICES IN THE FIELD OF STRATEGIC PLANNING; RECORDS MANAGEMENT SERVICES, NAMELY, DOCUMENT INDEXING FOR OTHERS; BUSINESS MANAGEMENT AND ADVICE; BUSINESS MANAGEMENT CONSULTANCY SERVICES; BUSINESS AUDITING (U.S. CLS. 100, 101 AND 102).
FIRST USE 6-28-2005; IN COMMERCE 6-28-2005.

CLASS 42—SCIENTIFIC AND COMPUTER SERVICES

FOR QUALITY CONTROL FOR OTHERS IN THE FIELD OF BUSINESS AND ACCOUNTING AUDITING (U.S. CLS. 100 AND 101).
FIRST USE 6-28-2005; IN COMMERCE 6-28-2005.

THE MARK CONSISTS OF STANDARD CHARACTERS WITHOUT CLAIM TO ANY PARTICULAR FONT, STYLE, SIZE, OR COLOR.

CLASS 37—CONSTRUCTION AND REPAIR

FOR PEST CONTROL, FUMIGATION AND VERMIN ANIMALS AND PLANT EXTERMINATION; INSTALLATION AND MAINTENANCE OF IRRIGATION SYSTEMS; SOIL EROSION CONTROL SERVICES; CONSTRUCTION, MAINTENANCE AND RENOVATION OF PROPERTY; CONSTRUCTION CONSULTANCY; INSTALLATION AND MAINTENANCE OF PLANT AND ANIMAL ABATEMENT SYSTEMS; INSTALLATION OF BOTANICAL PLANT SALVAGE SYSTEMS; ECOSYSTEM RESTORATION AND ECOSYSTEM RESTORATION SERVICES IN THE NATURE OF CONSTRUCTION SERVICES (U.S. CLS. 100, 103 AND 106).
FIRST USE 4-0-2007; IN COMMERCE 4-0-2007.

CLASS 42—SCIENTIFIC AND COMPUTER SERVICES

FOR LANDSCAPING SERVICES, NAMELY, LANDSCAPE ARCHITECTURAL DESIGN SERVICES (U.S. CLS. 100 AND 101).
FIRST USE 4-0-2007; IN COMMERCE 4-0-2007.

CLASS 44—MEDICAL, BEAUTY AND AGRICULTURAL SERVICES

FOR LANDSCAPE DESIGN; LANDSCAPE GARDENING; ECOSYSTEM RESTORATION AND ECOSYSTEM RESTORATION SERVICES IN THE NATURE OF GARDENING SERVICES (U.S. CLS. 100 AND 101).
FIRST USE 4-0-2007; IN COMMERCE 4-0-2007.

3,807,471. MITSUBISHI CABLE INDUSTRIES, LTD., TOKYO, JAPAN. SN 77-219,208. PUB. 1-6-2009, FILED 6-29-2007.

SUNELAST

THE MARK CONSISTS OF STANDARD CHARACTERS WITHOUT CLAIM TO ANY PARTICULAR FONT, STYLE, SIZE, OR COLOR.

CLASS 7—MACHINERY

FOR STRUCTURAL PARTS FOR LAND VEHICLE ENGINES AND AIRCRAFT ENGINES, NAMELY, NON-METAL GASKETS; AND STRUCTURAL PARTS FOR AIRCRAFT ENGINES, NAMELY, ENGINE AND TRANSMISSION SEALS AND O-RINGS, NAMELY, O-SHAPED SEALS (U.S. CLS. 13, 19, 21, 23, 31, 34 AND 35).
FIRST USE 11-19-1998; IN COMMERCE 2-0-2010.

CLASS 17—RUBBER GOODS

FOR NON-METAL SEALS FOR USE IN PREVENTING THE LEAKAGE OF FLUIDS; PACKING MATERIALS FOR FORMING SEALS; NON-METAL O-RINGS, NAMELY, O-SHAPED SEALS FOR USE IN PREVENTING THE LEAKAGE OF FLUIDS; GASKETS, NAMELY, PIPE GASKETS; AND RUBBER, NAMELY, RAW RUBBER AND SEMI-WORKED RUBBER (U.S. CLS. 1, 5, 12, 13, 35 AND 50).
FIRST USE 11-19-1998; IN COMMERCE 1-0-2010.

3,807,492. INERGY PROPANE, LLC, KANSAS CITY, MO. SN 77-259,255. PUB. 2-19-2008, FILED 8-20-2007.

PYROFAX GAS

THE MARK CONSISTS OF STANDARD CHARACTERS WITHOUT CLAIM TO ANY PARTICULAR FONT, STYLE, SIZE, OR COLOR.

NO CLAIM IS MADE TO THE EXCLUSIVE RIGHT TO USE "GAS", APART FROM THE MARK AS SHOWN.

CLASS 4—LUBRICANTS AND FUELS

FOR COMPRESSED GAS FOR HEATING, POWER AND LIGHTING PURPOSES (U.S. CLS. 1, 6 AND 15).
FIRST USE 10-29-2009; IN COMMERCE 10-29-2009.

CLASS 39—TRANSPORTATION AND STORAGE

FOR PROPANE DELIVERY SERVICES (U.S. CLS. 100 AND 105).
FIRST USE 10-29-2009; IN COMMERCE 10-29-2009.

3,807,498. AMBRY GENETICS, ALISO VIEJO, CA. SN 77-277,191. PUB. 4-28-2009, FILED 9-12-2007.

AMBRYPORT

THE MARK CONSISTS OF STANDARD CHARACTERS WITHOUT CLAIM TO ANY PARTICULAR FONT, STYLE, SIZE, OR COLOR.

OWNER OF U.S. REG. NOS. 2,674,217 AND 3,069,616.

CLASS 35—ADVERTISING AND BUSINESS

FOR ONLINE ORDERING SERVICES IN THE FIELD OF MEDICAL TESTING; ONLINE ORDERING SERVICES IN THE FIELD OF MEDICAL REPORTS (U.S. CLS. 100, 101 AND 102).
FIRST USE 3-31-2009; IN COMMERCE 3-31-2009.

CLASS 41—EDUCATION AND ENTERTAINMENT

FOR ONLINE PUBLISHING OF MEDICAL REPORTS FOR OTHERS (U.S. CLS. 100, 101 AND 107).
FIRST USE 3-31-2009; IN COMMERCE 3-31-2009.

CLASS 44—MEDICAL, BEAUTY AND AGRICULTURAL SERVICES

FOR ONLINE SERVICES, NAMELY, PROVIDING A WEBSITE FOR VIEWING MEDICAL REPORTS FOR USE IN MEDICAL DIAGNOSIS AND TREATMENTS; PREPARATION OF MEDICAL REPORTS FOR OTHERS WHICH CAN BE VIEWED ONLINE (U.S. CLS. 100 AND 101).
FIRST USE 3-31-2009; IN COMMERCE 3-31-2009.

3,807,504. NELSONQUICK GROUP, LLC, STILLWATER, OK. SN 77-283,685. PUB. 10-6-2009, FILED 9-19-2007.

THE LEADERSHIP BATTERY

THE MARK CONSISTS OF STANDARD CHARACTERS WITHOUT CLAIM TO ANY PARTICULAR FONT, STYLE, SIZE, OR COLOR.

NO CLAIM IS MADE TO THE EXCLUSIVE RIGHT TO USE "LEADERSHIP", APART FROM THE MARK AS SHOWN.

CLASS 35—ADVERTISING AND BUSINESS

FOR EXPERT EVALUATIONS AND REPORTS RELATING TO INDIVIDUALS AND WORK PERFORMANCE, NAMELY, PROVIDING CUSTOMIZED ASSESSMENTS IN THE FIELD OF ORGANIZATIONAL BEHAVIOR AND MANAGEMENT (U.S. CLS. 100, 101 AND 102).

FIRST USE 12-13-2007; IN COMMERCE 12-13-2007.

CLASS 41—EDUCATION AND ENTERTAINMENT

FOR PROFESSIONAL COACHING SERVICES IN THE FIELD OF ORGANIZATIONAL BEHAVIOR AND MANAGEMENT (U.S. CLS. 100, 101 AND 107).

FIRST USE 12-13-2007; IN COMMERCE 12-13-2007.

3,807,513. SONY COMPUTER ENTERTAINMENT AMERICA LLC, FOSTER CITY, CA. SN 77-304,721. PUB. 8-5-2008, FILED 10-15-2007.

SOCOM

THE MARK CONSISTS OF STANDARD CHARACTERS WITHOUT CLAIM TO ANY PARTICULAR FONT, STYLE, SIZE, OR COLOR.

THE WORD "SOCOM" HAS NO MEANING IN A FOREIGN LANGUAGE

CLASS 9—ELECTRICAL AND SCIENTIFIC APPARATUS

FOR COMPUTER GAME SOFTWARE AND VIDEO GAME SOFTWARE (U.S. CLS. 21, 23, 26, 36 AND 38).

FIRST USE 8-27-2002; IN COMMERCE 8-27-2002.

CLASS 41—EDUCATION AND ENTERTAINMENT

FOR ENTERTAINMENT, NAMELY, PROVIDING AN ONLINE COMPUTER GAME (U.S. CLS. 100, 101 AND 107).

FIRST USE 8-27-2002; IN COMMERCE 8-27-2002.

3,807,511. UNITEDHEALTH GROUP INCORPORATED, MINNETONKA, MN. SN 77-302,784. PUB. 8-19-2008, FILED 10-12-2007.

UHC-IENROLL

THE MARK CONSISTS OF STANDARD CHARACTERS WITHOUT CLAIM TO ANY PARTICULAR FONT, STYLE, SIZE, OR COLOR.

OWNER OF U.S. REG. NO. 2,645,558.

CLASS 9—ELECTRICAL AND SCIENTIFIC APPARATUS

FOR COMPUTER SOFTWARE FOR USE IN FACILITATING APPLICATION AND ENROLLMENT INTO HEALTH CARE BENEFIT PROGRAMS AND HEALTH CARE BENEFIT PLANS (U.S. CLS. 21, 23, 26, 36 AND 38).

FIRST USE 11-1-2007; IN COMMERCE 11-1-2007.

CLASS 36—INSURANCE AND FINANCIAL

FOR PROVIDING ONLINE INSURANCE SERVICES IN THE FIELD OF HEALTH CARE, NAMELY, PROVIDING SERVICES RELATED TO APPLICATION AND ENROLLMENT INTO HEALTH CARE BENEFIT PROGRAMS AND HEALTH CARE BENEFIT PLANS VIA A GLOBAL COMPUTER NETWORK (U.S. CLS. 100, 101 AND 102).

FIRST USE 11-1-2007; IN COMMERCE 11-1-2007.

CLASS 42—SCIENTIFIC AND COMPUTER SERVICES

FOR APPLICATION SERVICE PROVIDER (ASP) FEATURING COMPUTER SOFTWARE FOR USE IN FACILITATING APPLICATION AND ENROLLMENT INTO HEALTH CARE BENEFIT PROGRAMS AND HEALTH CARE BENEFIT PLANS (U.S. CLS. 100 AND 101).

FIRST USE 11-1-2007; IN COMMERCE 11-1-2007.

3,807,518. COMFORT IN A CUP, INC., GIG HARBOR, WA. SN 77-325,891. PUB. 3-11-2008, FILED 11-9-2007.

HARBOR CHAI

THE MARK CONSISTS OF STANDARD CHARACTERS WITHOUT CLAIM TO ANY PARTICULAR FONT, STYLE, SIZE, OR COLOR.

NO CLAIM IS MADE TO THE EXCLUSIVE RIGHT TO USE "CHAI", APART FROM THE MARK AS SHOWN.

CLASS 30—STAPLE FOODS

FOR CHOCOLATE; CHOCOLATE POWDER; GIFT BASKETS CONTAINING CANDY; BEVERAGES MADE OF TEA; BLACK TEA; FLAVOURINGS OF TEA; FRUIT TEAS; GREEN TEA; HERB TEA; HERBAL TEA; ICED TEA; JAPANESE GREEN TEA; MIXES IN THE NATURE OF CONCENTRATES, SYRUPS OR POWDERS USED IN THE PREPARATION OF TEA BASED BEVERAGES; TEA; TEA BAGS; TEA FOR INFUSIONS; TEA-BASED BEVERAGES WITH FRUIT FLAVORING; BEVERAGES MADE OF COFFEE; COFFEE; COFFEE BEANS; COFFEE FLAVORED SYRUP USED IN MAKING FOOD BEVERAGES; COFFEE SUBSTITUTES; GROUND COFFEE BEANS; PREPARED COFFEE AND COFFEE-BASED BEVERAGES; ROASTED COFFEE BEANS; COCOA; COCOA BEVERAGES WITH MILK; COCOA MIXES; PREPARED COCOA AND COCOA-BASED BEVERAGES (U.S. CL. 46).

FIRST USE 5-31-2008; IN COMMERCE 7-6-2008.

CLASS 35—ADVERTISING AND BUSINESS

FOR COMPUTERIZED ON-LINE ORDERING SERVICES IN THE FIELD OF TEA, COFFEE, CAPPUCCINO, MOCHA, CHOCOLATE, COCOA, TEA PRODUCTS, DESSERT ITEMS; COMPUTERIZED ON-LINE RETAIL STORE SERVICES IN THE FIELD OF TEA, COFFEE, CAPPUCCINO, MOCHA, CHOCOLATE, COCOA, TEA PRODUCTS, DESSERT ITEMS; MAIL ORDER CATALOG SERVICES FEATURING TEA, COFFEE, CAPPUCCINO, MOCHA, CHOCOLATE, COCOA, TEA PRODUCTS, DESSERT ITEMS; MAIL ORDER SERVICES FEATURING TEA, COFFEE, CAPPUCCINO, MOCHA, CHOCOLATE, COCOA, TEA PRODUCTS, DESSERT ITEMS; WHOLESALE ORDERING SERVICES IN THE FIELD OF TEA, COFFEE, CAPPUCCINO, MOCHA, CHOCOLATE, COCOA, TEA PRODUCTS, DESSERT ITEMS; WHOLESALE STORES FEATURING TEA, COFFEE, CAPPUCCINO, MOCHA, CHOCOLATE, COCOA, TEA PRODUCTS, DESSERT ITEMS (U.S. CLS. 100, 101 AND 102).

FIRST USE 5-31-2008; IN COMMERCE 7-6-2008.

3,807,520. E-GLUE SOFTWARE TECHNOLOGIES, INC., HOBOKEN, NJ. SN 77-327,675. PUB. 10-14-2008, FILED 11-12-2007.

INSPIRE EVERY INTERACTION

THE MARK CONSISTS OF STANDARD CHARACTERS WITHOUT CLAIM TO ANY PARTICULAR FONT, STYLE, SIZE, OR COLOR.

CLASS 35—ADVERTISING AND BUSINESS

FOR BUSINESS MANAGEMENT CONSULTANCY (U.S. CLS. 100, 101 AND 102).

FIRST USE 9-0-2007; IN COMMERCE 9-0-2007.

CLASS 42—SCIENTIFIC AND COMPUTER SERVICES

FOR COMPUTER SERVICES, NAMELY, PROVIDING SOFTWARE MAINTENANCE, SUPPORT, AND CUSTOMIZATIONS (U.S. CLS. 100 AND 101).

FIRST USE 9-0-2007; IN COMMERCE 9-0-2007.

3,807,535. PLAYMATES TOYS INTERNATIONAL LIMITED, TSIMSHATSUI, KOWLOON, HONG KONG. SN 77-360,014. PUB. 12-9-2008, FILED 12-27-2007.



OWNER OF U.S. REG. NOS. 1,381,554 AND 1,576,558.

NO CLAIM IS MADE TO THE EXCLUSIVE RIGHT TO USE "TOYS", APART FROM THE MARK AS SHOWN.

THE COLOR(S) BLUE, RED AND WHITE IS/ARE CLAIMED AS A FEATURE OF THE MARK.

THE MARK CONSISTS OF A RECTANGLE CONSISTING OF THE COLORS BLUE IN THE UPPER PORTION, THE COLOR RED IN THE LOWER PORTION DIVIDED BY A WHITE LINE. THE WORDS "PLAYMATES TOYS" APPEARS

IN THE COLOR WHITE, WITH THE WORD "TOYS" APPEARING IN A RED OVAL ENCIRCLED IN BLUE AND OUTLINED IN WHITE.

CLASS 16—PAPER GOODS AND PRINTED MATTER

FOR ARTS AND CRAFTS SETS COMPRISED OF CRAYONS, MARKERS, PENCILS, PAINT, SIDEWALK CHALK, SCISSORS, ERASERS, PLAYING CLAY, MODELING COMPOUND, RULERS, GLUE FOR STATIONERY USE, GLITTER GLUE, PAPER, PAINT BRUSHES, RUBBER STAMPS AND STAMP PADS, ALL OF THE ABOVE FEATURING MAKE AND PLAY ACTIVITIES; AND ROOM DECOR PRODUCTS, NAMELY, WALL AND DOOR REMOVABLE DECALS, BUT EXPRESSLY EXCLUDING SUCH GOODS IN THE FIELD OF ADULT-THEMED ENTERTAINMENT FEATURING FEMALE MODELS IN FULL OR PARTIAL NUDITY (U.S. CLS. 2, 5, 22, 23, 29, 37, 38 AND 50).

FIRST USE 7-0-2009; IN COMMERCE 7-0-2009.

CLASS 28—TOYS AND SPORTING GOODS

FOR CHILDREN'S INTERACTIVE TOYS; DOLLS AND RELATED DOLL ACCESSORIES AND PLAYSETS THEREFOR; ACTION FIGURES AND RELATED ACCESSORIES AND PLAYSETS THEREFOR; ROLE-PLAYING TOYS AND RELATED ELECTRONIC AND NON-ELECTRONIC ACCESSORIES, NAMELY, PLASTIC MASKS AND PLASTIC WEAPONS, CHILDREN'S DRESS-UP SETS FOR TOYS, NAMELY, DRESS-UP CLOTHING, COSTUMES, HATS, SHOES, HAIR PIECES, HAIR RIBBONS, HAIR BARRETTES AND JEWELRY FOR TOYS; INTERACTIVE VIRTUAL CHARACTER DOLLS AND ANIMALS AND RELATED ACCESSORIES AND PLAYSETS THEREFOR; BATTLE BOARD AND DICE GAMES AND CARD GAMES FEATURING ACTION FIGURE PLAYING PIECES AND CARDS WHICH MAY BE TRADED; PLUSH TOYS AND RELATED ACCESSORIES AND PLAYSETS, BUT EXPRESSLY EXCLUDING SUCH GOODS IN THE FIELD OF ADULT-THEMED ENTERTAINMENT FEATURING FEMALE MODELS IN FULL OR PARTIAL NUDITY (U.S. CLS. 22, 23, 38 AND 50).

FIRST USE 9-0-2008; IN COMMERCE 9-0-2008.

3,807,536. OLÉ MEXICAN FOODS, INC., NORCROSS, GA. SN 77-362,747. PUB. 5-13-2008, FILED 1-2-2008.



OWNER OF U.S. REG. NOS. 2,932,643, 3,153,309, AND OTHERS.

NO CLAIM IS MADE TO THE EXCLUSIVE RIGHT TO USE "AUTHENTIC", APART FROM THE MARK AS SHOWN.

THE COLOR(S) GREEN, WHITE, BROWN AND RED IS/ARE CLAIMED AS A FEATURE OF THE MARK.

THE MARK CONSISTS OF TWO RED CONCENTRIC CIRCLES WITH THE WORDS "LA BANDERITA" IN RED BETWEEN THE CIRCLES AT THE TOP AND THE WORD

"AUTHENTIC" IN GREEN BETWEEN THE CIRCLES AT THE BOTTOM; INSIDE THE TWO CONCENTRIC CIRCLES IS A WHITE BULL OUTLINED IN BROWN AND SUPERIMPOSED OVER A GREEN, WHITE, AND RED FLAG DESIGN.

THE FOREIGN WORDING IN THE MARK TRANSLATES INTO ENGLISH AS THE LITTLE FLAG.

CLASS 29—MEATS AND PROCESSED FOODS

FOR MEXICAN STYLE FOOD PRODUCTS, NAMELY, CHORIZO, CHEESES AND CHEESE DIPS, AND CHICHARRONES (U.S. CL. 46).

FIRST USE 6-0-1996; IN COMMERCE 6-0-1996.

CLASS 30—STAPLE FOODS

FOR MEXICAN STYLE FOOD PRODUCTS, NAMELY, TORTILLAS, TOSTADAS, GORDITAS, TORTILLA CHIPS, MEXICAN PASTRIES, MEXICAN SNACK FOODS, NAMELY, CORN CHIPS, AND SALSAS (U.S. CL. 46).

FIRST USE 1-0-1996; IN COMMERCE 1-0-1996.

3,807,537. KUHN RIKON CORPORATION, NOVATO, CA. SN 77-363,723. PUB. 12-9-2008, FILED 1-3-2008.

KINDERKITCHEN

THE MARK CONSISTS OF STANDARD CHARACTERS WITHOUT CLAIM TO ANY PARTICULAR FONT, STYLE, SIZE, OR COLOR.

CLASS 8—HAND TOOLS

FOR KITCHEN KNIVES, KITCHEN SHEARS (U.S. CLS. 23, 28 AND 44).

FIRST USE 4-30-2009; IN COMMERCE 4-30-2009.

CLASS 9—ELECTRICAL AND SCIENTIFIC APPARATUS

FOR MEASURING SPOONS (U.S. CLS. 21, 23, 26, 36 AND 38).

FIRST USE 4-30-2009; IN COMMERCE 4-30-2009.

CLASS 21—HOUSEWARES AND GLASS

FOR HOUSEHOLD UTENSILS, NAMELY, COOKING TONGS, SERVING TONGS, COOKIE CUTTERS, WHISKS, COOKING SPOONS FOR STIRRING AND MIXING, SPATULAS (U.S. CLS. 2, 13, 23, 29, 30, 33, 40 AND 50).

FIRST USE 4-30-2009; IN COMMERCE 4-30-2009.

CLASS 25—CLOTHING

FOR APRONS (U.S. CLS. 22 AND 39).

FIRST USE 4-30-2009; IN COMMERCE 4-30-2009.

3,807,539. ASYNCAST CORP., CAMPBELL, CA. SN 77-368,805. PUB. 6-3-2008, FILED 1-10-2008.

ROCKETRON

THE MARK CONSISTS OF STANDARD CHARACTERS WITHOUT CLAIM TO ANY PARTICULAR FONT, STYLE, SIZE, OR COLOR.

CLASS 9—ELECTRICAL AND SCIENTIFIC APPARATUS

FOR COMPUTER SOFTWARE FOR USE IN BROADCASTING, NARROW CASTING, AND PROVISION OF TELECOMMUNICATION ACCESS TO AUDIO, VIDEO, TEXT OR IMAGE CONTENT PROVIDED VIA MOBILE TELEPHONE AND ELECTRONIC COMMUNICATION NETWORKS; COMPUTER SOFTWARE FOR STREAMING OF AUDIO, VIDEO, TEXT OR IMAGE CONTENT OVER THE INTERNET (U.S. CLS. 21, 23, 26, 36 AND 38).

FIRST USE 2-19-2009; IN COMMERCE 2-19-2009.

CLASS 38—COMMUNICATION

FOR BROADCASTING SERVICES, NARROW CASTING SERVICES, AND PROVISION OF TELECOMMUNICATION ACCESS TO AUDIO, VIDEO, TEXT OR IMAGE CONTENT PROVIDED VIA MOBILE TELEPHONE AND ELECTRONIC COMMUNICATION NETWORKS; STREAMING OF AUDIO, VIDEO, TEXT AND IMAGE CONTENT OVER THE INTERNET (U.S. CLS. 100, 101 AND 104).

FIRST USE 7-7-2008; IN COMMERCE 7-7-2008.

3,807,545. CEPOR, LLC, SKOKIE, IL. SN 77-387,922. PUB. 12-9-2008, FILED 2-4-2008.

CONVERGENCE OF PEOPLE,
SPACE, TIME AND ENERGY

THE MARK CONSISTS OF STANDARD CHARACTERS WITHOUT CLAIM TO ANY PARTICULAR FONT, STYLE, SIZE, OR COLOR.

CLASS 9—ELECTRICAL AND SCIENTIFIC APPARATUS

FOR BUILDING AND FACILITY MANAGEMENT COMPUTER SOFTWARE AND COMPUTER HARDWARE TO CONTROL BUILDING ENVIRONMENT, ACCESS AND SECURITY SYSTEMS; BUILDING AND FACILITY SYSTEMS COMPRISING COMPUTER SOFTWARE AND COMPUTER HARDWARE FOR PICTURE, VIDEO, ALARM STATUS, SECURITY, BUILDING PLANS, WORK STATION ACCESS, OCCUPANCY, LIGHTING, HVAC, AND OTHER FACILITY INFORMATION; DOWNLOADABLE REPORTS ABOUT PROPERTIES AND BUILDINGS (U.S. CLS. 21, 23, 26, 36 AND 38).

FIRST USE 3-0-2008; IN COMMERCE 3-0-2008.

CLASS 35—ADVERTISING AND BUSINESS

FOR PROVIDING AN INTERACTIVE SITE FOR PERSONS TO LOCATE OTHER INDIVIDUALS, OFFICE SPACES, BUILDING RESOURCES, AVAILABLE MEETING ROOMS AND WORK STATIONS, EVENT SCHEDULES, FACILITY RESERVATIONS, AND TRANSPORTATION REQUESTS (U.S. CLS. 100, 101 AND 102).

FIRST USE 3-0-2008; IN COMMERCE 3-0-2008.

CLASS 38—COMMUNICATION

FOR VOICE OVER INTERNET PROTOCOL (VOIP) SERVICES, VOICE CONFERENCING SERVICES, DIGITAL CONTENT DISTRIBUTION SYSTEMS, AUDIO AND VIDEO SYSTEMS AND DIGITAL PROJECTION SERVICES AND DEVICES, NAMELY, MANAGEMENT OF AND ACCESS TO DATA AND SYSTEM INTERFACES OF AUDIO/VISUAL AND DIGITAL PROJECTOR DEVICES; EMAIL NOTIFICATION ALERTS REGARDING BUILDING FACILITIES INFORMATION, SUCH AS INDIVIDUAL LOCATION, OFFICE SPACES, BUILDING RESOURCES, AVAILABLE MEETING ROOMS AND WORK STATIONS, EVENT SCHEDULES, FACILITY RESERVATIONS AND TRANSPORTATION REQUESTS (U.S. CLS. 100, 101 AND 104).

FIRST USE 3-0-2008; IN COMMERCE 3-0-2008.

CLASS 42—SCIENTIFIC AND COMPUTER SERVICES

FOR PLANNING OF BUILDINGS AND INFRASTRUCTURE SYSTEMS FOR BUILDINGS; NETWORKING OF CONTROLS, NAMELY, WIRELESS AND WIRED LIGHTING CONTROLS, THERMOSTAT AND HEATING CONTROLS, SHUTTERS AND BLIND CONTROLS, DOOR CONTROLS, APPLIANCE CONTROLS, HOME AUDIO AND VIDEO CONTROLS; COMPUTER SERVICES, NAMELY, HOSTING INTERACTIVE PUBLIC BUILDING CALENDARS THAT ALLOW MULTIPLE PARTICIPANTS TO SHARE EVENT SCHEDULES, FACILITY RESERVATIONS, AND TRANSPORTATION REQUESTS (U.S. CLS. 100 AND 101).

FIRST USE 3-0-2008; IN COMMERCE 3-0-2008.

CLASS 45—PERSONAL AND LEGAL SERVICES

FOR CONTROL OF BUILDING ENVIRONMENTAL ACCESS AND SECURITY SYSTEMS; PROVIDING SURVEILLANCE SERVICES (U.S. CLS. 100 AND 101).

FIRST USE 3-0-2008; IN COMMERCE 3-0-2008.

CLASS 8—HAND TOOLS

FOR HAND TOOLS FOR CONCRETE WORK, NAMELY, TWISTER TOOLS FOR BAR TIES; SLAP HAMMER STAPLERS (U.S. CLS. 23, 28 AND 44).

FIRST USE 7-2-2007; IN COMMERCE 7-2-2007.

CLASS 17—RUBBER GOODS

FOR PLASTIC SHEETING FOR GENERAL CONSTRUCTION AND AGRICULTURAL USE; AIR INFILTRATION AND WEATHER BARRIER FOR USE IN BUILDING CONSTRUCTION; CONCRETE CURING BLANKETS; PNEUMATIC TOOL PARTS, NAMELY, AIR HOSES (U.S. CLS. 1, 5, 12, 13, 35 AND 50).

FIRST USE 8-9-2006; IN COMMERCE 8-9-2006.

3,807,546. PRIMESOURCE BUILDING PRODUCTS, INC., IRVING, TX. SN 77-389,812. PUB. 1-20-2009, FILED 2-6-2008.

PRIMESOURCE
BUILDING PRODUCTS INC.

NO CLAIM IS MADE TO THE EXCLUSIVE RIGHT TO USE "BUILDING PRODUCTS INC.", APART FROM THE MARK AS SHOWN.

CLASS 4—LUBRICANTS AND FUELS

FOR LUBRICATING OILS FOR TOOLS AND COMPRESSORS (U.S. CLS. 1, 6 AND 15).

FIRST USE 6-15-2008; IN COMMERCE 6-15-2008.

CLASS 20—FURNITURE AND ARTICLES NOT OTHERWISE CLASSIFIED

FOR FASTENERS, NAMELY, ROUND NON-METAL CAP FASTENERS (U.S. CLS. 2, 13, 22, 25, 32 AND 50).

FIRST USE 0-0-1996; IN COMMERCE 0-0-1996.

3,807,557. MPR REVOCABLE TRUST, LAS VEGAS, NV. SN
77-406,042. PUB. 8-11-2009, FILED 2-26-2008.



CLASS 9—ELECTRICAL AND SCIENTIFIC APPARATUS

FOR ENTERTAINMENT GAME SOFTWARE TO BE USED IN CONNECTION WITH TELEVISION GAMING SYSTEMS, PORTABLE GAMING SYSTEMS, PERSONAL COMPUTERS, GLOBAL COMPUTER NETWORK, PERSONAL DIGITAL ASSISTANTS, ELECTRONIC GAMES; BLANK CD-ROMS FOR SOUND AND VIDEO RECORDING, AND OPTICAL DISCS FEATURING MOVING PICTURES AND ANIMATED CARTOONS; VIDEO GAME DISCS; VIDEO GAME MACHINES FOR USE WITH TELEVISIONS; VIDEO GAME SOFTWARE; COMPUTER GAME PROGRAMS; COMPUTER GAME SOFTWARE; COMPUTER GAME CARTRIDGE; COMPUTER OPERATING SYSTEM SOFTWARE; MOUSE PADS; APPARATUS FOR TRANSMITTING, RECORDING, AND REPRODUCING SOUND OR IMAGES; PRERECORDED MULTIMEDIA, NAMELY, AUDIO CASSETTES, VIDEO CASSETTES, DVD VIDEOS FEATURING MOVING PICTURES AND ANIMATED CARTOONS; DVD PLAYERS; VIDEO CAMERAS; AUDIO COMPACT DISCS FEATURING RECORDINGS OF ANIMATED CARTOONS AND MUSIC; AUDIO BOOKS FEATURING DRAMATIC FICTIONAL STORIES BASED ON ANIMATED CARTOONS AND MOVING PICTURES; CELLULAR TELEPHONES; CORDLESS TELEPHONES; ELECTRONIC GAME SOFTWARE FOR CELLULAR TELEPHONES; CALCULATORS; WALKIE-TALKIES; VENDING MACHINES; ELECTRONIC BOOKS FEATURING ILLUSTRATIONS FROM ANIMATED CARTOONS AND MOVING PICTURES RECORDED ON COMPUTER MEDIA; ELECTRONIC MAGAZINES IN THE FIELD OF ENTERTAINMENT RECORDED ON COMPUTER MEDIA; ELECTRONIC NEWSLETTERS IN THE FIELD OF ENTERTAINMENT RECORDED ON COMPUTER MEDIA; ELECTRONIC CATALOGUES IN THE FIELD OF ENTERTAINMENT RECORDED ON COMPUTER MEDIA; ELECTRONIC JOURNALS IN THE FIELD OF ENTERTAINMENT RECORDED ON COMPUTER MEDIA (U.S. CLS. 21, 23, 26, 36 AND 38).

FIRST USE 4-1-2008; IN COMMERCE 4-1-2008.

CLASS 14—JEWELRY

FOR PINS; WATCHES; NON-MONETARY COLLECTIBLE COINS; JEWELRY; JEWELRY BOXES; CASES FOR WATCHES AND CLOCKS; CLOCKS; COLLECTIBLE COINS; CUFF LINKS; FIGURES OF PRECIOUS METAL; KEY CHAINS OF PRECIOUS METAL; LEATHER JEWELRY AND ACCESSORY BOXES; MEDALS AND MEDALLIONS; POCKET WATCHES; PRECIOUS METAL TROPHIES; STATUES OF PRECIOUS METAL (U.S. CLS. 2, 27, 28 AND 50).

FIRST USE 4-1-2008; IN COMMERCE 4-1-2008.

CLASS 16—PAPER GOODS AND PRINTED MATTER

FOR TRADING CARDS; PRECIOUS METAL TRADING CARDS, NAMELY, USING SILVER, BRONZE, GOLD; GREETING CARDS; BLANK CARDS; NOTE CARDS; GIFT CARDS; BUSINESS CARDS; OCCASION CARDS; STICKERS; ALBUMS FOR STICKERS; BUMPER STICKERS; STICKER BOOKS; APPLIQUES IN THE FORM OF DECALS; ADHESIVE LABELS; PRINTED PAPER LABELS; PRINTED MATTER, NAMELY, MAGAZINES IN THE FIELDS OF ENTERTAINMENT AND SPORTS; COMIC BOOKS; COMIC STRIPS; CARTOON PRINTS; NEWSPAPER CARTOONS; COLORING BOOKS; CHILDREN'S BOOKS; CHILDREN'S ACTIVITY BOOKS; NOTEBOOKS; COMPOSITION BOOKS; SCRAPBOOKS; PHOTO ALBUMS; BINDERS; STATIONERY; WRITING JOURNALS; POSTERS; PACKAGING, NAMELY, BLISTER CARDS; POSTCARDS; DESK CALENDARS; DESK PADS AND DESK TOP ORGANIZERS; BOOKMARKS; CALENDARS; PEN CASES; PENCIL CASES; LUNCH BAGS; TEMPORARY BODY TATTOOS (U.S. CLS. 2, 5, 22, 23, 29, 37, 38 AND 50).

FIRST USE 4-1-2008; IN COMMERCE 4-1-2008.

CLASS 20—FURNITURE AND ARTICLES NOT OTHERWISE CLASSIFIED

FOR FIGURINES AND STATUETTES MADE OF PLASTIC, BONE, IVORY, PLASTER, FABRIC, WAX OR WOOD; COLD CAST RESIN FIGURINES AND STATUETTES; PLAQUES MADE OF BONE, IVORY, PLASTIC, WAX, WOOD; NON-METAL KEY RINGS; PICTURE FRAMES; PARTY ORNAMENTS OF PLASTIC; PLASTIC NAME BADGES; PLASTIC NOVELTY LICENSE PLATES; PLASTIC PENNANTS; PLASTIC CAKE DECORATIONS; SLEEPING BAGS; TABLES; TOY CHESTS; WIND CHIMES; DRINKING STRAWS; BASSINETS; BEDS; BENCHES; BOOKCASES; CABINETS; CHAIRS; FURNITURE (U.S. CLS. 2, 13, 22, 25, 32 AND 50).

FIRST USE 4-1-2008; IN COMMERCE 4-1-2008.

CLASS 21—HOUSEWARES AND GLASS

FOR BEER JUGS; BEER MUGS; BEVERAGE GLASSWARE; PLASTIC WATER BOTTLES SOLD EMPTY; COFFEE CUPS, TEA CUPS AND MUGS; DRINKING FLASKS; DRINKING STEINS; PAPER AND PLASTIC CUPS; PAPER PLATES; PLASTIC COASTERS; CERAMIC FIGURINES; FIGURINES MADE OUT OF FIBERGLASS; FIGURINES MADE OUT OF CHINA; FIGURINES MADE OUT OF EARTHENWARE; FIGURINES MADE OUT OF GLASS; FIGURINES MADE OUT OF PORCELAIN; CERAMIC SCULPTURES, VASES, VESSELS, BOWLS, PLATES AND POTS; SCULPTURES MADE OF CHINA; SCULPTURES MADE OF CRYSTAL; SCULPTURES MADE OF EARTHENWARE; SCULPTURES MADE OF TERRA COTTA; SCULPTURES MADE OF GLASS; SCULPTURES MADE OF PORCELAIN; COOLING BUCKETS FOR WINE; ICE BUCKETS; CORKSCREWS; DECORATIVE CRYSTAL PRISMS; DECORATIVE CERAMIC TILES NOT FOR USE AS BUILDING MATERIALS; DECORATIVE PLATES; GARBAGE CANS; LUNCH BOXES; NON-METAL PIGGY BANKS; ORNAMENTAL GLASS SPHERES (U.S. CLS. 2, 13, 23, 29, 30, 33, 40 AND 50).

FIRST USE 4-1-2008; IN COMMERCE 4-1-2008.

CLASS 25—CLOTHING

FOR CLOTHING FOR MEN, WOMEN AND CHILDREN, NAMELY, SWEATERS, SWEATSHIRTS, SWEAT PANTS, T-SHIRTS, BLOUSES, TUNICS, HALTER TOPS, TANK TOPS, JERSEYS, UNDERSHIRTS, JACKETS; PANTS, NAMELY, JEANS, SLACKS AND TRACK PANTS; JOGGING SUITS; SHORTS; SKIRTS; SUITS; DRESSES; NIGHTGOWNS, NAMELY, NIGHT SHIRTS; ROBES, PAJAMAS AND LOUNGE WEAR; LEGGINGS; SOCKS; BOXER SHORTS; UNDERPANTS; HEAD WEAR, NAMELY, CAPS, HATS, VISORS AND HEADBANDS; GLOVES; NECKTIES; SCARVES; BELTS; FOOTWEAR, NAMELY, BOOTS, ATHLETIC SHOES, SANDALS AND SLIPPERS; SWIM WEAR, NAMELY, BATHING SUITS, BATHING TRUNKS, BEACHWEAR AND BEACH COVER-UPS (U.S. CLS. 22 AND 39).

FIRST USE 4-1-2008; IN COMMERCE 4-1-2008.

CLASS 28—TOYS AND SPORTING GOODS

FOR ACTION SKILL GAMES; AMUSEMENT GAME MACHINES; ARCADE GAMES; ARCADE-TYPE ELECTRONIC EDUCATION VIDEO GAMES; ARCADE-TYPE ELECTRONIC VIDEO GAMES; BACKGAMMON GAME SETS; BADMINTON GAME PLAYING EQUIPMENT; BASKETBALL TABLE TOP GAMES; BILLIARD GAME PLAYING EQUIPMENT; BINGO GAME PLAYING EQUIPMENT; BOARD GAMES; CARD GAMES; COIN-OPERATED VIDEO GAMES; DICE GAMES; DISPOSABLE TICKET SETS FOR PLAYING GAMES OF CHANCE; ELECTRONIC DART GAMES; ELECTRONIC EDUCATIONAL GAME MACHINES FOR CHILDREN; EQUIPMENT SOLD AS A UNIT FOR PLAYING BOARD GAMES; EQUIPMENT SOLD AS A UNIT FOR PLAYING CARD GAMES; EQUIPMENT SOLD AS A UNIT FOR PLAYING A MEMORY GAME; EQUIPMENT SOLD AS A UNIT FOR PLAYING ACTION TYPE TARGET GAMES; EXERCISE MACHINES INCORPORATING ELECTRONIC AND VIDEO GAME CONTROLLERS; FLOOR-STANDING UNITS FOR PLAYING ELECTRONIC GAMES OTHER THAN IN CONJUNCTION WITH A TELEVISION OR COMPUTER; GAME EQUIPMENT, NAMELY, CHIPS; GAME TABLES; GAMING EQUIPMENT, NAMELY, GAME WHEELS; HAND HELD UNIT FOR PLAYING ELECTRONIC GAMES; HAND HELD UNIT FOR PLAYING VIDEO GAMES; HAND-HELD GAMES WITH LIQUID CRYSTAL DISPLAYS; HORIZONTAL PINBALL MACHINE; JAPANESE CHESS; JAPANESE DICE GAMES; KARUTA PLAYING CARDS (JAPANESE CARD GAME); LCD GAME MACHINES; MANIPULATIVE GAMES; NETS FOR BALL GAMES; PADDLE BALL GAMES; PARLOR GAMES; PARTY GAMES; PINBALL-TYPE GAMES; PROMOTIONAL GAME CARDS; RING GAMES; ROLE PLAYING GAMES; STAND ALONE VIDEO GAME MACHINES; TABLETOP UNITS FOR PLAYING ELECTRONIC GAMES OTHER THAN IN CONJUNCTION WITH A TELEVISION OR COMPUTER; TOY, NAMELY, BATTERY-POWERED COMPUTER GAME WITH LCD SCREEN WHICH FEATURES ANIMATION AND SOUND EFFECTS; TRADING CARD GAMES; BABY MULTIPLE ACTIVITY TOYS; BATH TOYS; BATTERY OPERATED ACTION TOYS; CASES FOR TOY STRUCTURES; CASES FOR TOY VEHICLES; CHILDREN'S MULTIPLE ACTIVITY TOYS; CHILDREN'S WIRE CONSTRUCTION AND ART ACTIVITY TOYS; COLLECTABLE TOY FIGURES; ELECTRIC ACTION TOYS; ELECTRONIC LEARNING TOYS; ELECTRONICALLY OPERATED TOY MOTOR VEHICLES; FANTASY CHARACTER TOYS; INFANT TOYS; MECHANICAL TOYS; MINIATURE TOY HELMETS; MODELED TOY FIGURINES; MUSICAL TOYS; PLAY MATS FOR USE WITH TOY VEHICLES; PLUSH TOYS; POP UP TOYS; POSITIONAL TOY FIGURES; TOY REMOTE CONTROL CARS; TOY REMOTE CONTROL AIRPLANES; TOY REMOTE CONTROL BOATS; TOY REMOTE CONTROL ROBOTS; SAND TOYS; RUBBER CHARACTER TOYS; SQUEEZE TOYS; STACKING TOYS; STUFFED TOY ANIMALS; TOY ACTION FIGURES; TOY ANIMALS AND ACCESSORIES; TOY BOXES; TOY BUILDING BLOCKS; TOY CLOCKS AND WATCHES; TOY CONSTRUCTION SETS; TOY FURNITURE; TOY MASKS; TOY MODEL TRAIN SETS; TOY MODEL CARS; TOY STAMPS; WIND-UP TOYS; HAND-HELD UNITS FOR PLAYING ELECTRONIC GAMES; STAND ALONE VIDEO GAME MACHINES (U.S. CLS. 22, 23, 38 AND 50).

FIRST USE 4-1-2008; IN COMMERCE 4-1-2008.

FOR ON-LINE AND RETAIL STORE SERVICES FEATURING SPORTS AND ENTERTAINMENT MEMORABILIA, COLLECTIBLES, AND CLOTHING; PROVIDING ADVERTISING AND MARKETING SERVICES FOR THE PROMOTION OF MEMORABILIA, COLLECTIBLES AND CLOTHING; ORGANIZING EXHIBITIONS FOR COMMERCIAL PURPOSES; ORGANIZING AND CONDUCTING TRADE SHOWS IN THE FIELDS OF SPORTS AND ENTERTAINMENT; ARRANGING AND CONDUCTING BUSINESS CONFERENCES; ONLINE RETAIL STORE SERVICES FEATURING PRINTED MATERIAL, TOYS, AND ELECTRONIC GOODS, NAMELY, VIDEO GAMES, COMPUTER SOFTWARE, AUDIO AND VIDEO RECORDINGS; OPERATING AN ONLINE SHOPPING SITE IN THE FIELD OF ENTERTAINMENT, SPORTS, MEMORABILIA, COLLECTIBLES, TOYS AND CLOTHING (U.S. CLS. 100, 101 AND 102).

FIRST USE 4-1-2008; IN COMMERCE 4-1-2008.

CLASS 41—EDUCATION AND ENTERTAINMENT

FOR PRODUCTION, DISTRIBUTION, OF MOVIES, TELEVISION MOVIES, TELEVISION PROGRAMS, CABLE TELEVISION PROGRAMS AND RADIO SHOWS; ANIMATION PRODUCTION SERVICES; AUDIO RECORDING AND PRODUCTION; CINEMATOGRAPHIC ADAPTATION AND EDITING; DIRECTION OF MAKING RADIO OR TELEVISION PROGRAMS; EDITING OR RECORDING OF SOUNDS AND IMAGES; ENTERTAINMENT IN THE NATURE OF ON-GOING TELEVISION PROGRAMS IN THE FIELD OF CHILDREN'S ENTERTAINMENT; ENTERTAINMENT IN THE NATURE OF THEATER PRODUCTIONS; ENTERTAINMENT IN THE NATURE OF VISUAL AND AUDIO PERFORMANCES, AND MUSICAL, VARIETY, NEWS AND COMEDY SHOWS; ENTERTAINMENT SERVICES, NAMELY, PROVIDING AN ON-LINE COMPUTER GAME; PROVIDING ONLINE INFORMATION IN THE FIELD OF ENTERTAINMENT CONCERNING MOVIES, TELEVISION MOVIES, TELEVISION PROGRAMS AND CABLE TELEVISION PROGRAMMING SERVICES; ENTERTAINMENT SERVICES, NAMELY, PROVIDING A TELEVISION PROGRAM IN THE FIELD OF CHILDREN'S ENTERTAINMENT VIA A GLOBAL COMPUTER NETWORK; ENTERTAINMENT SERVICES, NAMELY, PRODUCTION AND DISTRIBUTION OF A GAME SHOW; ENTERTAINMENT SERVICES IN THE NATURE OF ON-GOING TELEVISION PROGRAMS IN THE FIELD OF CHILDREN'S ENTERTAINMENT; ENTERTAINMENT SERVICES, NAMELY, PROVIDING ON-LINE COMPUTER GAMES; FILM STUDIOS; FILM MASTERING SERVICES; FILM EDITING; FILM DISTRIBUTION; MAGAZINE PUBLISHING; MOBILE MEDIA AND ENTERTAINMENT SERVICES IN THE NATURE OF CONTENT PREPARATION, POST-PRODUCTION; MOTION PICTURE SONG PRODUCTION; MOTION PICTURE THEATERS; MOVIE STUDIOS; MULTIMEDIA ENTERTAINMENT SOFTWARE PRODUCTION SERVICES; MULTIMEDIA PUBLISHING OF BOOKS, MAGAZINES, JOURNALS, SOFTWARE, GAMES, MUSIC; PRODUCTION AND DISTRIBUTION OF MOTION PICTURES; PHOTOGRAPHIC AND VIDEO SERVICES, NAMELY, PHOTOGRAPHIC AND VIDEO CAPTURE; PRODUCTION OF VIDEO AND CREATION OF VISUAL EFFECTS FOR OTHERS FOR USE IN DVDS, TELEVISION PROGRAMS AND ON WEBSITES; PRODUCTION OF VIDEO DISCS AND TAPES; PRODUCTION OF VIDEO AND COMPUTER GAME SOFTWARE; PUBLICATION OF BOOKS, MAGAZINES, JOURNALS, NEWSPAPERS, PERIODICALS, CATALOGS AND BROCHURES (U.S. CLS. 100, 101 AND 107).

FIRST USE 4-1-2008; IN COMMERCE 4-1-2008.

CLASS 35—ADVERTISING AND BUSINESS

3,807,558. MPR REVOCABLE TRUST, LAS VEGAS, NV. SN 77-406,045. PUB. 8-4-2009, FILED 2-26-2008.



CLASS 9—ELECTRICAL AND SCIENTIFIC APPARATUS

FOR ENTERTAINMENT GAME SOFTWARE TO BE USED IN CONNECTION WITH TELEVISION GAMING SYSTEMS, PORTABLE GAMING SYSTEMS, PERSONAL COMPUTERS, GLOBAL COMPUTER NETWORK, PERSONAL DIGITAL ASSISTANTS, ELECTRONIC GAMES; BLANK CD-ROMS FOR SOUND AND VIDEO RECORDING, AND OPTICAL DISCS FEATURING MOVING PICTURES AND ANIMATED CARTOONS; VIDEO GAME DISCS; VIDEO GAME MACHINES FOR USE WITH TELEVISIONS; VIDEO GAME SOFTWARE; COMPUTER GAME PROGRAMS; COMPUTER GAME SOFTWARE; COMPUTER GAME CARTRIDGE; COMPUTER OPERATING SYSTEM SOFTWARE; MOUSE PADS; APPARATUS FOR TRANSMITTING, RECORDING, AND REPRODUCING SOUND OR IMAGES; PRERECORDED MULTIMEDIA, NAMELY, AUDIO CASSETTES, VIDEO CASSETTES, DVD VIDEOS FEATURING MOVING PICTURES AND ANIMATED CARTOONS; DVD PLAYERS; VIDEO CAMERAS; AUDIO COMPACT DISCS FEATURING RECORDINGS OF ANIMATED CARTOONS AND MUSIC; AUDIO BOOKS FEATURING DRAMATIC FICTIONAL STORIES BASED ON ANIMATED CARTOONS AND MOVING PICTURES; CELLULAR TELEPHONES; CORDLESS TELEPHONES; ELECTRONIC GAME SOFTWARE FOR CELLULAR TELEPHONES; CALCULATORS; WALKIE-TALKIES; VENDING MACHINES; ELECTRONIC BOOKS FEATURING ILLUSTRATIONS FROM ANIMATED CARTOONS AND MOVING PICTURES RECORDED ON COMPUTER MEDIA; ELECTRONIC MAGAZINES IN THE FIELD OF ENTERTAINMENT RECORDED ON COMPUTER MEDIA; ELECTRONIC NEWSLETTERS IN THE FIELD OF ENTERTAINMENT RECORDED ON COMPUTER MEDIA; ELECTRONIC CATALOGUES IN THE FIELD OF ENTERTAINMENT RECORDED ON COMPUTER MEDIA; ELECTRONIC JOURNALS IN THE FIELD OF ENTERTAINMENT RECORDED ON COMPUTER MEDIA (U.S. CLS. 21, 23, 26, 36 AND 38).

FIRST USE 4-1-2008; IN COMMERCE 4-1-2008.

CLASS 14—JEWELRY

FOR PINS; WATCHES; NON-MONETARY COLLECTIBLE COINS; JEWELRY; JEWELRY BOXES; CASES FOR WATCHES AND CLOCKS; CLOCKS; COLLECTIBLE COINS; CUFF LINKS; FIGURES OF PRECIOUS METAL; KEY CHAINS OF PRECIOUS METAL; LEATHER JEWELRY AND ACCESSORY BOXES; MEDALS AND MEDALLIONS; POCKET WATCHES; PRECIOUS METAL TROPHIES; STATUES OF PRECIOUS METAL (U.S. CLS. 2, 27, 28 AND 50).

FIRST USE 4-1-2008; IN COMMERCE 4-1-2008.

CLASS 16—PAPER GOODS AND PRINTED MATTER

FOR TRADING CARDS; PRECIOUS METAL TRADING CARDS, NAMELY, USING SILVER, BRONZE, GOLD; GREETING CARDS; BLANK CARDS; NOTE CARDS; GIFT CARDS; BUSINESS CARDS; OCCASION CARDS; STICKERS; ALBUMS FOR STICKERS; BUMPER STICKERS; STICKER BOOKS; APPLIQUES IN THE FORM OF DECALS; ADHESIVE LABELS; PRINTED PAPER LABELS; PRINTED MATTER, NAMELY, MAGAZINES IN THE FIELDS OF ENTERTAINMENT AND SPORTS; COMIC BOOKS; COMIC STRIPS; CARTOON PRINTS; NEWSPAPER CARTOONS; COLORING BOOKS; CHILDREN'S BOOKS; CHILDREN'S ACTIVITY BOOKS; NOTEBOOKS; COMPOSITION BOOKS; SCRAPBOOKS; PHOTO ALBUMS; BINDERS; STATIONERY; WRITING JOURNALS; POSTERS; PACKAGING, NAMELY, BLISTER CARDS; POSTCARDS; DESK CALENDARS; DESK PADS AND DESK TOP ORGANIZERS; BOOKMARKS; CALENDARS; PEN CASES; PENCIL CASES; LUNCH BAGS; TEMPORARY BODY TATTOOS (U.S. CLS. 2, 5, 22, 23, 29, 37, 38 AND 50).

FIRST USE 4-1-2008; IN COMMERCE 4-1-2008.

CLASS 20—FURNITURE AND ARTICLES NOT OTHERWISE CLASSIFIED

FOR FIGURINES AND STATUETTES MADE OF PLASTIC, BONE, IVORY, PLASTER, FABRIC, WAX OR WOOD; COLD CAST RESIN FIGURINES AND STATUETTES; PLAQUES MADE OF BONE, IVORY, PLASTIC, WAX, WOOD; NON-METAL KEY RINGS; PICTURE FRAMES; PARTY ORNAMENTS OF PLASTIC; PLASTIC NAME BADGES; PLASTIC NOVELTY LICENSE PLATES; PLASTIC PENNANTS; PLASTIC CAKE DECORATIONS; SLEEPING BAGS; TABLES; TOY CHESTS; WIND CHIMES; DRINKING STRAWS; BASSINETS; BEDS; BENCHES; BOOKCASES; CABINETS; CHAIRS; FURNITURE (U.S. CLS. 2, 13, 22, 25, 32 AND 50).

FIRST USE 4-1-2008; IN COMMERCE 4-1-2008.

CLASS 21—HOUSEWARES AND GLASS

FOR BEER JUGS; BEER MUGS; BEVERAGE GLASSWARE; PLASTIC WATER BOTTLES SOLD EMPTY; COFFEE CUPS, TEA CUPS AND MUGS; DRINKING FLASKS; DRINKING STEINS; PAPER AND PLASTIC CUPS; PAPER PLATES; PLASTIC COASTERS; CERAMIC FIGURINES; FIGURINES MADE OUT OF FIBERGLASS; FIGURINES MADE OUT OF CHINA; FIGURINES MADE OUT OF EARTHENWARE; FIGURINES MADE OUT OF GLASS; FIGURINES MADE OUT OF PORCELAIN; CERAMIC SCULPTURES, VASES, VESSELS, BOWLS, PLATES AND POTS; SCULPTURES MADE OF CHINA; SCULPTURES MADE OF CRYSTAL; SCULPTURES MADE OF EARTHENWARE; SCULPTURES MADE OF TERRA COTTA; SCULPTURES MADE OF GLASS; SCULPTURES MADE OF PORCELAIN; COOLING BUCKETS FOR WINE; ICE BUCKETS; CORKSCREWS; DECORATIVE CRYSTAL PRISMS; DECORATIVE CERAMIC TILES NOT FOR USE AS BUILDING MATERIALS; DECORATIVE PLATES; GARBAGE CANS; LUNCH BOXES; NON-METAL PIGGY BANKS; ORNAMENTAL GLASS SPHERES (U.S. CLS. 2, 13, 23, 29, 30, 33, 40 AND 50).

FIRST USE 4-1-2008; IN COMMERCE 4-1-2008.

CLASS 25—CLOTHING

FOR CLOTHING FOR MEN, WOMEN AND CHILDREN, NAMELY, SWEATERS, SWEATSHIRTS, SWEAT PANTS, T-SHIRTS, BLOUSES, TUNICS, HALTER TOPS, TANK TOPS, JERSEYS, UNDERSHIRTS, JACKETS; PANTS, NAMELY, JEANS, SLACKS AND TRACK PANTS; JOGGING SUITS; SHORTS; SKIRTS; SUITS; DRESSES; NIGHTGOWNS, NAMELY, NIGHT SHIRTS; ROBES, PAJAMAS AND LOUNGE WEAR; LEGGINGS; SOCKS; BOXER SHORTS; UNDERPANTS; HEAD WEAR, NAMELY, CAPS, HATS, VISORS AND HEADBANDS; GLOVES; NECKTIES; SCARVES; BELTS; FOOTWEAR, NAMELY, BOOTS, ATHLETIC SHOES, SANDALS AND SLIPPERS; SWIM WEAR, NAMELY, BATHING SUITS, BATHING TRUNKS, BEACHWEAR AND BEACH COVER-UPS (U.S. CLS. 22 AND 39).

FIRST USE 4-1-2008; IN COMMERCE 4-1-2008.

CLASS 28—TOYS AND SPORTING GOODS

FOR ACTION SKILL GAMES; AMUSEMENT GAME MACHINES; ARCADE GAMES; ARCADE-TYPE ELECTRONIC EDUCATION VIDEO GAMES; ARCADE-TYPE ELECTRONIC VIDEO GAMES; BACKGAMMON GAME SETS; BADMINTON GAME PLAYING EQUIPMENT; BASKETBALL TABLE TOP GAMES; BILLIARD GAME PLAYING EQUIPMENT; BINGO GAME PLAYING EQUIPMENT; BOARD GAMES; CARD GAMES; COIN-OPERATED VIDEO GAMES; DICE GAMES; DISPOSABLE TICKET SETS FOR PLAYING GAMES OF CHANCE; ELECTRONIC DART GAMES; ELECTRONIC EDUCATIONAL GAME MACHINES FOR CHILDREN; EQUIPMENT SOLD AS A UNIT FOR PLAYING BOARD GAMES; EQUIPMENT SOLD AS A UNIT FOR PLAYING CARD GAMES; EQUIPMENT SOLD AS A UNIT FOR PLAYING A MEMORY GAME; EQUIPMENT SOLD AS A UNIT FOR PLAYING ACTION TYPE TARGET GAMES; EXERCISE MACHINES INCORPORATING ELECTRONIC AND VIDEO GAME CONTROLLERS; FLOOR-STANDING UNITS FOR PLAYING ELECTRONIC GAMES OTHER THAN IN CONJUNCTION WITH A TELEVISION OR COMPUTER; GAME EQUIPMENT, NAMELY, CHIPS; GAME TABLES; GAMING EQUIPMENT, NAMELY, GAME WHEELS; HAND HELD UNIT FOR PLAYING ELECTRONIC GAMES; HAND HELD UNIT FOR PLAYING VIDEO GAMES; HAND-HELD GAMES WITH LIQUID CRYSTAL DISPLAYS; HORIZONTAL PINBALL MACHINE; JAPANESE CHESS; JAPANESE DICE GAMES; KARUTA PLAYING CARDS (JAPANESE CARD GAME); LCD GAME MACHINES; MANIPULATIVE GAMES; NETS FOR BALL GAMES; PADDLE BALL GAMES; PARLOR GAMES; PARTY GAMES; PINBALL-TYPE GAMES; PROMOTIONAL GAME CARDS; RING GAMES; ROLE PLAYING GAMES; STAND ALONE VIDEO GAME MACHINES; TABLETOP UNITS FOR PLAYING ELECTRONIC GAMES OTHER THAN IN CONJUNCTION WITH A TELEVISION OR COMPUTER; TOY, NAMELY, BATTERY-POWERED COMPUTER GAME WITH LCD SCREEN WHICH FEATURES ANIMATION AND SOUND EFFECTS; TRADING CARD GAMES; BABY MULTIPLE ACTIVITY TOYS; BATH TOYS; BATTERY OPERATED ACTION TOYS; CASES FOR TOY STRUCTURES; CASES FOR TOY VEHICLES; CHILDREN'S MULTIPLE ACTIVITY TOYS; CHILDREN'S WIRE CONSTRUCTION AND ART ACTIVITY TOYS; COLLECTABLE TOY FIGURES; ELECTRIC ACTION TOYS; ELECTRONIC LEARNING TOYS; ELECTRONICALLY OPERATED TOY MOTOR VEHICLES; FANTASY CHARACTER TOYS; INFANT TOYS; MECHANICAL TOYS; MINIATURE TOY HELMETS; MODELED TOY FIGURINES; MUSICAL TOYS; PLAY MATS FOR USE WITH TOY VEHICLES; PLUSH TOYS; POP UP TOYS; POSITIONAL TOY FIGURES; TOY REMOTE CONTROL CARS; TOY REMOTE CONTROL AIRPLANES; TOY REMOTE CONTROL BOATS; TOY REMOTE CONTROL ROBOTS; SAND TOYS; RUBBER CHARACTER TOYS; SQUEEZE TOYS; STACKING TOYS; STUFFED TOY ANIMALS; TOY ACTION FIGURES; TOY ANIMALS AND ACCESSORIES; TOY BOXES; TOY BUILDING BLOCKS; TOY CLOCKS AND WATCHES; TOY CONSTRUCTION SETS; TOY FURNITURE; TOY MASKS; TOY MODEL TRAIN SETS; TOY MODEL CARS; TOY STAMPS; WIND-UP TOYS; HAND-HELD UNITS FOR PLAYING ELECTRONIC GAMES; STAND ALONE VIDEO GAME MACHINES (U.S. CLS. 22, 23, 38 AND 50).

FIRST USE 4-1-2008; IN COMMERCE 4-1-2008.

FOR ON-LINE AND RETAIL STORE SERVICES FEATURING SPORTS AND ENTERTAINMENT MEMORABILIA, COLLECTIBLES, AND CLOTHING; PROVIDING ADVERTISING AND MARKETING SERVICES FOR THE PROMOTION OF MEMORABILIA, COLLECTIBLES AND CLOTHING; ORGANIZING EXHIBITIONS FOR COMMERCIAL PURPOSES; ORGANIZING AND CONDUCTING TRADE SHOWS IN THE FIELDS OF SPORTS AND ENTERTAINMENT; ARRANGING AND CONDUCTING BUSINESS CONFERENCES; ONLINE RETAIL STORE SERVICES FEATURING PRINTED MATERIAL, TOYS, AND ELECTRONIC GOODS, NAMELY, VIDEO GAMES, COMPUTER SOFTWARE, AUDIO AND VIDEO RECORDINGS; OPERATING AN ONLINE SHOPPING SITE IN THE FIELD OF ENTERTAINMENT, SPORTS, MEMORABILIA, COLLECTIBLES, TOYS AND CLOTHING (U.S. CLS. 100, 101 AND 102).

FIRST USE 4-1-2008; IN COMMERCE 4-1-2008.

CLASS 41—EDUCATION AND ENTERTAINMENT

FOR PRODUCTION, DISTRIBUTION, OF MOVIES, TELEVISION MOVIES, TELEVISION PROGRAMS, CABLE TELEVISION PROGRAMS AND RADIO SHOWS; ANIMATION PRODUCTION SERVICES; AUDIO RECORDING AND PRODUCTION; CINEMATOGRAPHIC ADAPTATION AND EDITING; DIRECTION OF MAKING RADIO OR TELEVISION PROGRAMS; EDITING OR RECORDING OF SOUNDS AND IMAGES; ENTERTAINMENT IN THE NATURE OF ON-GOING TELEVISION PROGRAMS IN THE FIELD OF CHILDREN'S ENTERTAINMENT; ENTERTAINMENT IN THE NATURE OF THEATER PRODUCTIONS; ENTERTAINMENT IN THE NATURE OF VISUAL AND AUDIO PERFORMANCES, AND MUSICAL, VARIETY, NEWS AND COMEDY SHOWS; ENTERTAINMENT SERVICES, NAMELY, PROVIDING AN ON-LINE COMPUTER GAME; PROVIDING ONLINE INFORMATION IN THE FIELD OF ENTERTAINMENT CONCERNING MOVIES, TELEVISION MOVIES, TELEVISION PROGRAMS AND CABLE TELEVISION PROGRAMMING SERVICES; ENTERTAINMENT SERVICES, NAMELY, PROVIDING A TELEVISION PROGRAM IN THE FIELD OF CHILDREN'S ENTERTAINMENT VIA A GLOBAL COMPUTER NETWORK; ENTERTAINMENT SERVICES, NAMELY, PRODUCTION AND DISTRIBUTION OF A GAME SHOW; ENTERTAINMENT SERVICES IN THE NATURE OF ON-GOING TELEVISION PROGRAMS IN THE FIELD OF CHILDREN'S ENTERTAINMENT; ENTERTAINMENT SERVICES, NAMELY, PROVIDING ON-LINE COMPUTER GAMES; FILM STUDIOS; FILM MASTERING SERVICES; FILM EDITING; FILM DISTRIBUTION; MAGAZINE PUBLISHING; MOBILE MEDIA AND ENTERTAINMENT SERVICES IN THE NATURE OF CONTENT PREPARATION, POST-PRODUCTION; MOTION PICTURE SONG PRODUCTION; MOTION PICTURE THEATERS; MOVIE STUDIOS; MULTIMEDIA ENTERTAINMENT SOFTWARE PRODUCTION SERVICES; MULTIMEDIA PUBLISHING OF BOOKS, MAGAZINES, JOURNALS, SOFTWARE, GAMES, MUSIC; PRODUCTION AND DISTRIBUTION OF MOTION PICTURES; PHOTOGRAPHIC AND VIDEO SERVICES, NAMELY, PHOTOGRAPHIC AND VIDEO CAPTURE; PRODUCTION OF VIDEO AND CREATION OF VISUAL EFFECTS FOR OTHERS FOR USE IN DVDS, TELEVISION PROGRAMS AND ON WEBSITES; PRODUCTION OF VIDEO DISCS AND TAPES; PRODUCTION OF VIDEO AND COMPUTER GAME SOFTWARE; PUBLICATION OF BOOKS, MAGAZINES, JOURNALS, NEWSPAPERS, PERIODICALS, CATALOGS AND BROCHURES (U.S. CLS. 100, 101 AND 107).

FIRST USE 4-1-2008; IN COMMERCE 4-1-2008.

CLASS 35—ADVERTISING AND BUSINESS

3,807,559. TVBG LLC, PACIFIC PALISADES, CA. SN 77-406,241. PUB. 1-27-2009, FILED 2-26-2008.

505 SOUTHWESTERN

THE MARK CONSISTS OF STANDARD CHARACTERS WITHOUT CLAIM TO ANY PARTICULAR FONT, STYLE, SIZE, OR COLOR.

OWNER OF U.S. REG. NO. 2,577,049. SEC. 2(F) "SOUTHWESTERN".

CLASS 29—MEATS AND PROCESSED FOODS

FOR PROCESSED ROASTED CHILE PEPPERS (U.S. CL. 46).
FIRST USE 8-22-2007; IN COMMERCE 8-22-2007.

CLASS 30—STAPLE FOODS

FOR CHILE SAUCES; SAUCES; SALSAS; MARINADES (U.S. CL. 46).
FIRST USE 10-19-1996; IN COMMERCE 4-4-1997.

MATERION

THE MARK CONSISTS OF STANDARD CHARACTERS WITHOUT CLAIM TO ANY PARTICULAR FONT, STYLE, SIZE, OR COLOR.

CLASS 1—CHEMICALS

FOR MATERIALS, NAMELY, INDUSTRIAL ADHESIVES FOR USE IN SPUTTERING COATINGS ONTO FLEXIBLE OR RIGID CONTINUOUS SUBSTRATES (U.S. CLS. 1, 5, 6, 10, 26 AND 46).
FIRST USE 3-15-2010; IN COMMERCE 3-15-2010.

CLASS 2—PAINTS

FOR COATINGS IN THE NATURE OF HIGH PERFORMANCE ENGINEERED MATERIALS, NAMELY, COPPER, GOLD, SILVER, PLATINUM, NICKEL, PALLADIUM, ALUMINUM, TITANIUM, CHROMIUM, INDIUM, MOLYBDENUM, SILICON, VANADIUM, NIOBIUM, TANTALUM, IRON, TIN, TUNGSTEN, CADMIUM, GALLIUM, SELENIUM, AND TELLURIUM AND ALLOYS OF TWO OR MORE OF THESE METALS AND INORGANIC COMPOUNDS, NAMELY, ALUMINUM OXIDE, SILICON OXIDE, INDIUM TIN OXIDE, AND ZINC OXIDE FOR USE IN AUTOMOTIVE ELECTRONICS, TELECOMMUNICATION AND COMPUTERS, INDUSTRIAL COMPONENTS, OPTICAL MEDIA, AEROSPACE AND DEFENSE AND MEDICAL SPECIALTIES AREAS; COATINGS IN THE NATURE OF METALS, ALLOYS OR INORGANIC COMPOUNDS FOR EXTERIOR AND INTERIOR USE ON A VARIETY OF SUBSTRATES, NAMELY, VARIOUS FLEXIBLE POLYMERIC ORGANIC SUBSTRATES, VARIOUS FLEXIBLE METAL FOILS, RIGID GLASS SHAPES, RIGID POLYMERIC SUBSTRATES, RIGID METAL SHAPES; SEALER COATINGS FOR USE IN THE AUTOMOTIVE ELECTRONICS, TELECOMMUNICATION AND COMPUTERS, INDUSTRIAL COMPONENTS, OPTICAL MEDIA, AEROSPACE AND DEFENSE AND MEDICAL SPECIALTIES AREAS (U.S. CLS. 6, 11 AND 16).

FIRST USE 3-24-2010; IN COMMERCE 3-24-2010.

3,807,567. CIM GROUP, LLC, HOLLYWOOD, CA. SN 77-414,307. PUB. 7-28-2009, FILED 3-5-2008.

CIM GROUP

THE MARK CONSISTS OF STANDARD CHARACTERS WITHOUT CLAIM TO ANY PARTICULAR FONT, STYLE, SIZE, OR COLOR.

NO CLAIM IS MADE TO THE EXCLUSIVE RIGHT TO USE "GROUP", APART FROM THE MARK AS SHOWN.

CLASS 35—ADVERTISING AND BUSINESS

FOR PREPARING FINANCIAL REPORTS FOR OTHERS (U.S. CLS. 100, 101 AND 102).
FIRST USE 4-21-1995; IN COMMERCE 9-30-1996.

CLASS 36—INSURANCE AND FINANCIAL

FOR REAL ESTATE SERVICES, NAMELY, REAL ESTATE FUND MANAGEMENT, INVESTMENT, FINANCING, LEASING, AND PROPERTY MANAGEMENT; REAL ESTATE SERVICES IN THE NATURE OF BUILDING AND INFRASTRUCTURE INVESTMENTS, NAMELY, FUND MANAGEMENT, INVESTMENT, AND FINANCING; MORTGAGE AND REAL ESTATE LOAN SERVICES, NAMELY, DEBT FUND MANAGEMENT, AND INVESTMENT IN, AND FINANCING AND MANAGEMENT OF, MORTGAGE AND DEBT INSTRUMENTS SECURED, DIRECTLY OR INDIRECTLY, BY INTERESTS IN REAL ESTATE; REAL ESTATE PRIVATE EQUITY SERVICES, NAMELY, REAL-ESTATE-RELATED EQUITY FUND MANAGEMENT, AND INVESTMENT IN, AND FINANCING AND MANAGEMENT OF, REAL-ESTATE-RELATED EQUITY INVESTMENTS; ASSET MANAGEMENT SERVICES IN CONNECTION WITH REAL ESTATE, MORTGAGES AND OTHER REAL ESTATE DEBT, AND REAL-ESTATE-RELATED EQUITY INTERESTS; FINANCIAL INVESTMENT IN THE FIELDS OF REAL ESTATE, BUILDING INFRASTRUCTURES, MORTGAGE AND OTHER REAL ESTATE DEBT, AND REAL-ESTATE-RELATED EQUITY INTERESTS; FINANCIAL MANAGEMENT OF REAL ESTATE, INFRASTRUCTURE, MORTGAGE AND OTHER REAL ESTATE DEBT AND REAL-ESTATE-RELATED EQUITY

INTERESTS; INVESTMENT SERVICES, NAMELY, INVESTMENT SERVICES IN THE FIELDS OF REAL ESTATE, BUILDING INFRASTRUCTURES, MORTGAGE AND OTHER REAL ESTATE DEBT, AND REAL ESTATE-RELATED EQUITY INTERESTS; FINANCIAL SERVICES, NAMELY, FINANCING, INVESTMENT AND INVESTMENT FUND MANAGEMENT IN THE FIELDS OF REAL ESTATE, BUILDING INFRASTRUCTURES, MORTGAGE AND OTHER REAL ESTATE DEBT, AND REAL ESTATE-RELATED EQUITY INTERESTS; ASSET MANAGEMENT, NAMELY, ASSET MANAGEMENT OF REAL ESTATE, MORTGAGE AND OTHER REAL ESTATE DEBT, AND REAL ESTATE-RELATED EQUITY INTERESTS; INVESTMENT MANAGEMENT; INVESTMENT ADVICE; FINANCIAL RISK MANAGEMENT; FINANCIAL ASSET MANAGEMENT, NAMELY, PORTFOLIO MANAGEMENT; FINANCIAL ASSET EVALUATION; INVESTMENT SERVICES, NAMELY, INVESTMENT OF FUNDS OF OTHERS AND FUND MANAGEMENT; FINANCIAL ANALYSIS; INVESTMENT ADVISORY SERVICES; FINANCIAL INVESTMENT RESEARCH; EQUITY CAPITAL INVESTMENT; FINANCIAL RESEARCH; LEASING OF BUILDING INFRASTRUCTURES; BUILDING MANAGEMENT; FINANCIAL SERVICES, NAMELY, FINANCING, INVESTMENT FUND MANAGEMENT, AND FINANCIAL ASSET MANAGEMENT FOR TRANSPORTATION INFRASTRUCTURES IN THE NATURE OF ROADS, AIRPORTS, PORTS, BRIDGES, TUNNELS, RAILWAY LINES, BUS LINES, FERRY LINES AND PARKING FACILITIES; FINANCIAL SERVICES, NAMELY, FINANCING, INVESTMENT FUND MANAGEMENT, AND FINANCIAL ASSET MANAGEMENT FOR UTILITIES INFRASTRUCTURES IN THE NATURE OF EQUIPMENT AND FACILITIES FOR THE TRANSMISSION, STORAGE AND DISTRIBUTION OF ELECTRICITY AND GAS; FINANCIAL SERVICES, NAMELY, FINANCING, INVESTMENT FUND MANAGEMENT, AND FINANCIAL ASSET MANAGEMENT FOR COMMUNICATION INFRASTRUCTURES IN THE NATURE OF BROADCAST TRANSMISSION NETWORKS, MOBILE TELEPHONY TOWERS, AND SATELLITES; FINANCIAL SERVICES, NAMELY, FINANCING, INVESTMENT FUND MANAGEMENT, AND FINANCIAL ASSET MANAGEMENT FOR WATER RESOURCES INFRASTRUCTURES IN THE NATURE OF EQUIPMENT AND FACILITIES FOR WATER TREATMENT, DISTRIBUTION, STORAGE, DESALINATION, AND RECLAMATION; FINANCIAL SERVICES, NAMELY, FINANCING, INVESTMENT FUND MANAGEMENT, AND FINANCIAL ASSET MANAGEMENT FOR ENERGY RESOURCE INFRASTRUCTURES IN THE NATURE OF EQUIPMENT AND FACILITIES FOR THE PRODUCTION, GENERATION, STORAGE AND DISTRIBUTION OF HYDROCARBONS, GAS, GEOTHERMAL, SOLAR, WIND-GENERATED, WATER-GENERATED, AND NUCLEAR ENERGY (U.S. CLS. 100, 101 AND 102). FIRST USE 4-21-1995; IN COMMERCE 9-30-1996.

CLASS 37—CONSTRUCTION AND REPAIR

FOR CONSTRUCTION MANAGEMENT; REAL ESTATE DEVELOPMENT; CONSTRUCTION AND INSTALLATION OF TRANSPORT INFRASTRUCTURES IN THE NATURE OF ROADS, AIRPORTS, BRIDGES, TUNNELS, RAILWAY LINES, AND PARKING FACILITIES; CONSTRUCTION AND INSTALLATION OF UTILITIES INFRASTRUCTURES IN THE NATURE OF FACILITIES FOR TRANSMITTING, STORING, AND DISTRIBUTING ELECTRICITY OR GAS; CONSTRUCTION AND INSTALLATION OF COMMUNICATION INFRASTRUCTURES IN THE NATURE OF BROADCAST TRANSMISSION NETWORKS, MOBILE TELEPHONY TOWERS, AND SATELLITES; CONSTRUCTION AND INSTALLATION OF WATER RESOURCE INFRASTRUCTURES IN THE NATURE OF FACILITIES FOR WATER TREATMENT, WATER DISTRIBUTION, WATER STORAGE, WATER DESALINATION, AND WATER RECLAMATION; CONSTRUCTION AND INSTALLATION OF ENERGY RESOURCE INFRASTRUCTURES IN THE NATURE OF FACILITIES FOR THE PRODUCTION, GENERATION, DISTRIBUTION, AND STORAGE OF HYDROCARBONS, GAS, GEOTHERMAL, SOLAR, WIND GENERATED, WATER GENERATED, AND NUCLEAR ENERGY (U.S. CLS. 100, 103 AND 106). FIRST USE 4-21-1995; IN COMMERCE 9-30-1996.

3,807,569. RED-WHITE VALVE CORP., LAKE FOREST, CA. SN 77-415,090. PUB. 8-5-2008, FILED 3-6-2008.

RWVC

THE MARK CONSISTS OF STANDARD CHARACTERS WITHOUT CLAIM TO ANY PARTICULAR FONT, STYLE, SIZE, OR COLOR.

OWNER OF U.S. REG. NOS. 1,769,093 AND 2,044,058.

CLASS 6—METAL GOODS

FOR MANUALLY-OPERATED METAL VALVES FOR FLUID CONTROL (U.S. CLS. 2, 12, 13, 14, 23, 25 AND 50). FIRST USE 10-23-2009; IN COMMERCE 10-23-2009.

CLASS 11—ENVIRONMENTAL CONTROL APPARATUS

FOR PLUMBING FITTINGS, NAMELY, FLUID CONTROL VALVES FOR SHOWERS AND TUBS (U.S. CLS. 13, 21, 23, 31 AND 34).

FIRST USE 1-12-2010; IN COMMERCE 1-12-2010.

3,807,570. EVERGREEN ALLIANCE GOLF LIMITED, L.P., DALLAS, TX. SN 77-415,375. PUB. 2-10-2009, FILED 3-6-2008.

EAGLE GOLF

THE MARK CONSISTS OF STANDARD CHARACTERS WITHOUT CLAIM TO ANY PARTICULAR FONT, STYLE, SIZE, OR COLOR.

NO CLAIM IS MADE TO THE EXCLUSIVE RIGHT TO USE "GOLF", APART FROM THE MARK AS SHOWN.

CLASS 35—ADVERTISING AND BUSINESS

FOR BUSINESS MANAGEMENT AND BUSINESS OPERATION OF GOLF COURSES FOR OTHERS (U.S. CLS. 100, 101 AND 102).

FIRST USE 10-31-2007; IN COMMERCE 10-31-2007.

CLASS 37—CONSTRUCTION AND REPAIR

FOR CONSTRUCTION AND MAINTENANCE OF GOLF COURSES (U.S. CLS. 100, 103 AND 106).

FIRST USE 10-31-2007; IN COMMERCE 10-31-2007.

3,807,571. WIJESIRIWARDANA, RAVINDRA, BENTONVILLE, AR. SN 77-417,803. PUB. 8-5-2008, FILED 3-10-2008.



CLASS 9—ELECTRICAL AND SCIENTIFIC APPARATUS

FOR ACCELERATION SENSORS; AN OPTICAL METROLOGY INSPECTION SYSTEM COMPRISED OF A LIGHT SOURCE, ONE OR MORE CAMERAS AND SENSORS IN COMMUNICATION WITH COMPUTER SOFTWARE AND HARDWARE; AVIONIC SENSOR SYSTEMS, NAMELY, AIRCRAFT AIRSPEED SENSORS; AVIONIC SENSOR SYSTEMS, NAMELY, AIRCRAFT ALTITUDE INDICATORS; AVIONIC SENSOR SYSTEMS, NAMELY, NAVIGATION SYSTEMS; CAMERA CONTAINING A LINEAR IMAGE SENSOR; ELECTRIC OR ELECTRONIC SENSORS FOR ENVIRONMENTAL INFORMATION MONITORING; ELECTRIC, ELECTRONIC, OR ELECTROCHEMICAL OXYGEN MONITORS AND SENSORS FOR ENVIRONMENTAL USE; ELECTRONIC DATA RELAYS FOR SENSORS; ELECTRONIC MAGNETOSTRICTIVE EQUIPMENT, NAMELY, A WAVE GENERATOR, WAVE SENSOR AND WAVE ANALYZER; ELECTRONIC MOTOR VEHICLE IGNITION TUNING KITS COMPRISED OF AN ELECTRONIC CONTROL UNIT THAT MONITORS ENGINE PERFORMANCES AND DELIVERS RE-CALCULATED SENSOR VALUES TO THE ORIGINAL ENGINE CONTROL UNIT TO INCREASE ENGINE PERFORMANCE; ELECTRONIC PLANT MOISTURE SENSOR; ELECTRONIC PROXIMITY SENSORS AND SWITCHES; ELECTRICAL SENSORS FOR MEASURING SOLAR RADIATION; ENVIRONMENTAL MONITORING SYSTEM COMPRISED OF METERS AND SENSORS THAT MEASURE PRESSURE, HUMIDITY, TEMPERATURE AND INCLUDES ALARM AND REPORTING FUNCTIONS; GAS SENSORS FOR MEASURING GAS CONCENTRATION; HAND-HELD DEVICE COMPRISED OF CHEMICAL AND HEAT SENSORS FOR THE DETECTION OF EXPLOSIVES; LEAK DETECTING DEVICE FOR WATER SUPPLIED HOME APPLIANCES CONSISTING OF WATER SENSOR, CONTROL UNIT WITH AUDIBLE ALARM AND WATER VALVES; LIQUID LEVEL SENSORS; OIL LEVEL SENSORS; POLLUTANT SENSORS; PRESSURE SENSORS; PROXIMITY SENSORS; SAFETY SENSORS, NAMELY, CARBON MONOXIDE DETECTORS, SMOKE DETECTORS, AND COMBINATION CARBON MONOXIDE AND SMOKE DETECTORS; SENSOR ACTIVATED FIRE EXTINGUISHER FOR USE IN CLOTHING DRYERS; SENSOR CARDS FOR DATA ACQUISITION; SENSOR CHIPS FOR SCIENTIFIC USE; SENSORS AND DETECTOR UNITS FOR USE IN CONTROLLING THE ACTUATION AND OPERATION OF AUTOMOTIVE SAFETY APPARATUS AND EQUIPMENT; SENSORS FOR THE DETERMINATION OF TEMPERATURES, POSITIONS AND DISTANCES; TELECOMMUNICATIONS HARDWARE AND SOFTWARE FOR MONITORING AND ALERTING REMOTE SENSOR STATUS VIA THE INTERNET; TEMPERATURE SENSORS; TEMPERATURE SENSORS USED IN THE MEDICAL FIELD TO MEASURE TEMPERATURE OF MEDICAL SOLUTIONS; TIMING SENSORS; ULTRASONIC SENSORS; VEHICLE MOUNTED GPS SENSOR FOR DETERMINING THE RATE OF MOTION FOR A VEHICLE; VEHICLE SAFETY EQUIPMENT,

NAMELY, BACK-UP SENSORS AND CAMERAS; VIBRATION SENSORS FOR INSTALLATION IN WIND MILL HOUSINGS (U.S. CLS. 21, 23, 26, 36 AND 38). FIRST USE 3-19-2008; IN COMMERCE 4-27-2010.

CLASS 10—MEDICAL APPARATUS

FOR ALARMS AND SENSORS TO BE WORN ON A PERSON WHILE EXERCISING FOR THE PURPOSE OF MONITORING HEART RATE; DIGITAL SENSOR USED FOR TAKING DIGITAL DENTAL RADIOGRAPHS; ELECTROCHEMICAL SENSORS FOR DETERMINATION OF ANALYTE CONCENTRATIONS IN FLUIDS FOR MEDICAL PURPOSES; HEALTH MONITORS COMPRISING SENSOR THAT MONITOR THE HEALTH OF THE ELDERLY OR HANDICAPPED IN THEIR OWN HOMES; MEDICAL PRODUCTS, NAMELY, BIOFEED-BACK SENSORS; PATIENT MONITORING SENSORS AND ALARMS; ELECTRIC OR ELECTRONIC SENSORS FOR MONITORING PATIENT PHYSIOLOGICAL INFORMATION (U.S. CLS. 26, 39 AND 44). FIRST USE 3-19-2008; IN COMMERCE 2-16-2010.

3,807,572. CITRIX ONLINE, LLC, SANTA BARBARA, CA. SN 77-417,892. PUB. 2-10-2009, FILED 3-10-2008.

GOTOTRAINING

THE MARK CONSISTS OF STANDARD CHARACTERS WITHOUT CLAIM TO ANY PARTICULAR FONT, STYLE, SIZE, OR COLOR.

OWNER OF U.S. REG. NOS. 3,172,020 AND 3,213,853.

CLASS 9—ELECTRICAL AND SCIENTIFIC APPARATUS

FOR COMPUTER SOFTWARE FOR TRANSMITTING DOCUMENTS, DATA, GRAPHICS, AUDIO AND/OR VIDEO OVER ELECTRONIC COMMUNICATIONS NETWORKS; COMPUTER SOFTWARE FOR WEB COLLABORATION; COMPUTER SOFTWARE FOR CREATING, OFFERING, HOSTING, AND DELIVERING ONLINE CONFERENCES, MEETINGS, DEMONSTRATIONS, PRESENTATIONS, EDUCATIONAL COURSES, AND INTERACTIVE DISCUSSIONS (U.S. CLS. 21, 23, 26, 36 AND 38).

FIRST USE 2-16-2010; IN COMMERCE 2-16-2010.

CLASS 38—COMMUNICATION

FOR TELECOMMUNICATION SERVICES, NAMELY, BROADCASTING A WIDE VARIETY OF MEETINGS, EDUCATIONAL COURSES, EVENTS AND REAL TIME INFORMATION OVER GLOBAL COMPUTER COMMUNICATIONS NETWORKS; COMPUTER AND TELECOMMUNICATIONS-RELATED SERVICES, NAMELY, FACILITATING THE SENDING AND RECEIVING OF DOCUMENTS, DATA, MESSAGES, IMAGES, VOICE AND TELEPHONY OVER GLOBAL COMPUTER COMMUNICATIONS NETWORKS; INSTANT MESSAGING SERVICES; WEB CONFERENCING SERVICES (U.S. CLS. 100, 101 AND 104).

FIRST USE 2-16-2010; IN COMMERCE 2-16-2010.

CLASS 42—SCIENTIFIC AND COMPUTER SERVICES

FOR COMPUTER SERVICES, NAMELY, HOSTING ONLINE WEB FACILITIES FOR OTHERS FOR CONDUCTING ONLINE CONFERENCES, MEETINGS, DEMONSTRATIONS, PRESENTATIONS, EDUCATIONAL COURSES, AND INTERACTIVE DISCUSSIONS (U.S. CLS. 100 AND 101).

FIRST USE 2-16-2010; IN COMMERCE 2-16-2010.

3,807,585. FKP ARCHITECTS, INC., HOUSTON, TX. SN 77-430,445. PUB. 7-21-2009, FILED 3-25-2008.



THE COLOR(S) PURPLE AND WHITE IS/ARE CLAIMED AS A FEATURE OF THE MARK.

THE MARK CONSISTS OF A GRADATION PURPLE BUTTERFLY DESIGN COMPRISED OF TWO SOLID TRIANGLES AND TWO PURPLE OUTLINED WHITE TRIANGLES.

CLASS 35—ADVERTISING AND BUSINESS

FOR PLANNING AND IMPLEMENTING MOVES OF OFFICES AND FACILITIES; BUSINESS MANAGEMENT AND ECONOMIC CONSULTING FOR OTHERS, NAMELY, PLANNING, ORGANIZING, MONITORING AND CARRYING OUT STRATEGY PLANS (U.S. CLS. 100, 101 AND 102).

FIRST USE 8-20-2007; IN COMMERCE 9-28-2007.

CLASS 42—SCIENTIFIC AND COMPUTER SERVICES

FOR PLANNING AND LAYOUT DESIGN FOR THE INTERIOR SPACE OF HEALTHCARE, SCIENCE AND EDUCATIONAL FACILITIES; COMPUTERIZED MODELING OF INTERIOR DESIGNS, PROJECT COORDINATION IN THE FIELD OF INTERIOR DESIGN (U.S. CLS. 100 AND 101).

FIRST USE 8-20-2007; IN COMMERCE 9-28-2007.

3,807,586. INTEGRITY ENTERPRISE SOLUTIONS, INC., CHANTILLY, VA. SN 77-431,137. PUB. 8-11-2009, FILED 3-25-2008.

**IT IS GOOD TO DO BUSINESS
WITH INTEGRITY**

THE MARK CONSISTS OF STANDARD CHARACTERS WITHOUT CLAIM TO ANY PARTICULAR FONT, STYLE, SIZE, OR COLOR.

CLASS 35—ADVERTISING AND BUSINESS

FOR PROVIDING BUSINESS INTELLIGENCE SERVICES; LOGISTICS MANAGEMENT IN THE FIELD OF GEOSPATIAL INTELLIGENCE, REQUIREMENTS ANALYSIS, ADVANCED DATA ANALYSIS AND DATA PRODUCTION (U.S. CLS. 100, 101 AND 102).

FIRST USE 4-27-2010; IN COMMERCE 4-27-2010.

CLASS 42—SCIENTIFIC AND COMPUTER SERVICES

FOR COMPUTER SERVICES IN THE FIELD OF GEOSPATIAL INTELLIGENCE, NAMELY, SOFTWARE APPLICATION DEVELOPMENT, COMPUTER DATABASE DEVELOPMENT SERVICES, COUNTER-TERRORISM, NAMELY, INTELLIGENCE AND OPERATIONS PLANNING AND SUPPORT, NAMELY, ANALYSIS OF INTELLIGENCE AND OPERATIONS PLANNING DATA AND PROCESSES TO DEVELOP A SOLUTION ADDRESSING INTELLIGENCE AND OPERATIONS PLANNING NEEDS; GEOSPATIAL ANALYSIS SOFTWARE DEVELOPMENT; IMAGERY ANALYSIS SOFTWARE DEVELOPMENT; OPERATIONS PLANNING AND SUPPORT FOR SOFTWARE DEVELOPMENT, NAMELY, ANALYSIS OF OPERATIONS PLANNING DATA AND PROCESSES TO DEVELOP SOFTWARE TAILORED TO OPERATIONS PLANNING AND SUPPORT NEEDS; WEBSITE DESIGN FOR OTHERS AND CONSULTING SERVICES IN CONNECTION THEREWITH FOR ALL OF THE AFOREMENTIONED SERVICES; INFORMATION TECHNOLOGY, NAMELY, INFORMATION TECHNOLOGY CONSULTATION; ENTERPRISE ARCHITECTURAL DESIGN (U.S. CLS. 100 AND 101).

FIRST USE 4-27-2010; IN COMMERCE 4-27-2010.

3,807,589. CAMPBELL, MARCIE, SHERMAN OAKS, CA. SN 77-433,786. PUB. 6-23-2009, FILED 3-27-2008.

BOW WOW BUNGALOW

THE MARK CONSISTS OF STANDARD CHARACTERS WITHOUT CLAIM TO ANY PARTICULAR FONT, STYLE, SIZE, OR COLOR.

CLASS 39—TRANSPORTATION AND STORAGE

FOR TRANSPORTATION OF DOGS BY VAN (U.S. CLS. 100 AND 105).

FIRST USE 5-0-2001; IN COMMERCE 5-0-2001.

CLASS 43—HOTEL AND RESTAURANT SERVICES

FOR DOG BOARDING SERVICES; DOG DAY CARE SERVICES (U.S. CLS. 100 AND 101).

FIRST USE 5-0-2001; IN COMMERCE 5-0-2001.

CLASS 44—MEDICAL, BEAUTY AND AGRICULTURAL SERVICES

FOR DOG GROOMING (U.S. CLS. 100 AND 101).

FIRST USE 5-0-2001; IN COMMERCE 5-0-2001.

3,807,590. CAMPBELL, MARCIE, SHERMAN OAKS, CA. SN 77-433,789. PUB. 6-23-2009, FILED 3-27-2008.



THE MARK CONSISTS OF A DOG ON A ROCKING CHAIR SMOKING A CIGAR, WITH A HOUSE AND THE WORDING "BOW WOW BUNGALOW" BEHIND THE DOG.

CLASS 39—TRANSPORTATION AND STORAGE

FOR TRANSPORTATION OF DOGS BY VAN (U.S. CLS. 100 AND 105).
FIRST USE 5-0-2001; IN COMMERCE 5-0-2001.

CLASS 43—HOTEL AND RESTAURANT SERVICES

FOR DOG BOARDING SERVICES; DOG DAY CARE SERVICES (U.S. CLS. 100 AND 101).
FIRST USE 5-0-2001; IN COMMERCE 5-0-2001.

CLASS 44—MEDICAL, BEAUTY AND AGRICULTURAL SERVICES

FOR DOG GROOMING (U.S. CLS. 100 AND 101).
FIRST USE 5-0-2001; IN COMMERCE 5-0-2001.

3,807,596. PROSTATE NET, INC., THE, HACKENSACK, NJ. SN 77-438,768. PUB. 2-10-2009, FILED 4-3-2008.

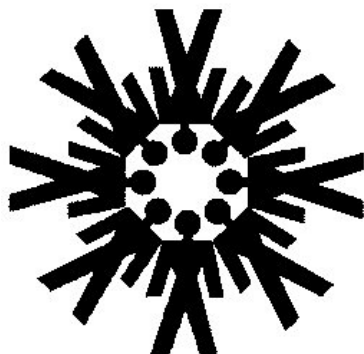

THE MARK CONSISTS OF EIGHT SIMPLE HUMAN FIGURES WITH ARMS AKIMBO AND LEGS SPREAD ARRANGED IN THE FORM OF A CIRCLE WITH SHOULDERS TOUCHING AND THE HEADS OF THE FIGURES AT THE CENTER OF THE CIRCLE.

CLASS 16—PAPER GOODS AND PRINTED MATTER

FOR PAMPHLETS AND BOOKLETS ON THE SUBJECTS OF PROSTATE CANCER AND PROSTATE CANCER TREATMENT (U.S. CLS. 2, 5, 22, 23, 29, 37, 38 AND 50).

FIRST USE 12-4-2009; IN COMMERCE 12-4-2009.

CLASS 36—INSURANCE AND FINANCIAL

FOR CHARITABLE FUNDRAISING FOR PROSTATE CANCER AND PROSTATE CANCER TREATMENT (U.S. CLS. 100, 101 AND 102).

FIRST USE 7-31-2008; IN COMMERCE 7-31-2008.

CLASS 41—EDUCATION AND ENTERTAINMENT

FOR EDUCATIONAL SERVICES RELATED TO PROSTATE CANCER AND PROSTATE CANCER TREATMENT, NAMELY, WORKSHOPS, SEMINARS, CONFERENCES, AND INTERACTIVE PRESENTATIONS, BOTH IN PERSON AND VIA THE INTERNET; AWARD PROGRAMS AND CEREMONIES FOR ACHIEVEMENTS IN MEDICINE AND PROSTATE CANCER TREATMENT (U.S. CLS. 100, 101 AND 107).

FIRST USE 10-6-2009; IN COMMERCE 10-6-2009.

3,807,597. TAILWAGGERS PET RESORT, LLC, RALEIGH, NC. SN 77-440,117. PUB. 8-26-2008, FILED 4-4-2008.

SUITE PAWS PET RESORT & SPA

THE MARK CONSISTS OF STANDARD CHARACTERS WITHOUT CLAIM TO ANY PARTICULAR FONT, STYLE, SIZE, OR COLOR.

NO CLAIM IS MADE TO THE EXCLUSIVE RIGHT TO USE "PET RESORT & SPA", APART FROM THE MARK AS SHOWN.

CLASS 35—ADVERTISING AND BUSINESS

FOR RETAIL PET STORE SERVICES (U.S. CLS. 100, 101 AND 102).

FIRST USE 10-3-2008; IN COMMERCE 10-3-2008.

CLASS 41—EDUCATION AND ENTERTAINMENT

FOR PET TRAINING SERVICES (U.S. CLS. 100, 101 AND 107).

FIRST USE 10-3-2008; IN COMMERCE 10-3-2008.

CLASS 43—HOTEL AND RESTAURANT SERVICES

FOR PET BOARDING SERVICES AND PET DAY CARE SERVICES (U.S. CLS. 100 AND 101).

FIRST USE 10-3-2008; IN COMMERCE 10-3-2008.

CLASS 44—MEDICAL, BEAUTY AND AGRICULTURAL SERVICES

FOR PET CARE SERVICES, NAMELY, DOG BATHING AND NON-MEDICATED PET GROOMING SERVICES (U.S. CLS. 100 AND 101).

FIRST USE 10-3-2008; IN COMMERCE 10-3-2008.

3,807,602. MEDI-REJUVENATION CORPORATION, TORRANCE, CA. SN 77-443,565. PUB. 9-9-2008, FILED 4-9-2008.

Skin 365

THE MARK CONSISTS OF STANDARD CHARACTERS WITHOUT CLAIM TO ANY PARTICULAR FONT, STYLE, SIZE, OR COLOR.

NO CLAIM IS MADE TO THE EXCLUSIVE RIGHT TO USE "SKIN", APART FROM THE MARK AS SHOWN.

CLASS 3—COSMETICS AND CLEANING PREPARATIONS

FOR COSMETICS; FACIAL CLEANSERS; SKIN CLEANSERS; SKIN MOISTURIZERS; BODY CREAMS; FACIAL CREAMS; BODY SCRUBS; FACIAL SCRUBS; EXFOLIANTS FOR BODY, NECK, CHEST, AND FACE; AND SUN BLOCK (U.S. CLS. 1, 4, 6, 50, 51 AND 52).
FIRST USE 3-1-2008; IN COMMERCE 3-1-2008.

CLASS 44—MEDICAL, BEAUTY AND AGRICULTURAL SERVICES

FOR MEDICAL SERVICES, NAMELY, OPHTHALMIC MUSCLE RELAXANT COSMETIC APPLICATIONS, FILLS AND PHOTOFACIALS (U.S. CLS. 100 AND 101).
FIRST USE 3-1-2008; IN COMMERCE 3-1-2008.

3,807,603. JHHA CORPORATION, NEW YORK, NY. SN 77-445,011. PUB. 9-8-2009, FILED 4-10-2008.



OWNER OF U.S. REG. NO. 2,728,327.

NO CLAIM IS MADE TO THE EXCLUSIVE RIGHT TO USE "JEWISH HOME LIFECARE", APART FROM THE MARK AS SHOWN.

THE COLOR(S) DARK GRAY, DARK RED AND DARK YELLOW IS/ARE CLAIMED AS A FEATURE OF THE MARK.

THE MARK CONSISTS OF THE WORDING "JEWISH HOME LIFECARE" APPEARING IN DARK GRAY AND TWO BLADES OF GRASS, ONE BLADE IN DARK RED AND ANOTHER IN DARK YELLOW.

CLASS 39—TRANSPORTATION AND STORAGE

FOR TRANSPORTATION OF THE ELDERLY BY VAN AND BUS (U.S. CLS. 100 AND 105).
FIRST USE 0-0-2009; IN COMMERCE 0-0-2009.

CLASS 41—EDUCATION AND ENTERTAINMENT

FOR CONDUCTING TRAINING PROGRAMS ON MEDICAL CARE AND PHARMACOLOGY FOR THE ELDERLY AND ON ETHICS RELATED TO CARE FOR THE ELDERLY; MEDICAL, NURSING AND SOCIAL SERVICES PERSONNEL TRAINING SERVICES IN THE FIELD OF GERIATRIC CARE; CONDUCTING EDUCATIONAL PROGRAMS FOR THE ELDERLY RELATED TO CARING FOR THEIR PHYSICAL AND MENTAL WELL-BEING; EDUCATIONAL RESEARCH FOR OTHERS RELATING TO ISSUES AFFECTING THE ELDERLY AND CAREGIVERS FOR THE ELDERLY (U.S. CLS. 100, 101 AND 107).

FIRST USE 0-0-2009; IN COMMERCE 0-0-2009.

CLASS 42—SCIENTIFIC AND COMPUTER SERVICES

FOR MEDICAL, PHARMACEUTICAL AND PSYCHOSOCIAL RESEARCH FOR OTHERS RELATING TO ISSUES AFFECTING THE ELDERLY AND CAREGIVERS FOR THE ELDERLY IN THE FIELDS OF THE AGING EXPERIENCE OF THE ELDERLY AND RELATING TO SERVICES FOR THE ELDERLY TO CONTRIBUTE TO THE QUALITY OF THEIR CARE AND OF THEIR LIFE AND FOR FAMILIES OF PERSONS WITH CHRONIC ILLNESS (U.S. CLS. 100 AND 101).

FIRST USE 0-0-2009; IN COMMERCE 0-0-2009.

CLASS 43—HOTEL AND RESTAURANT SERVICES

FOR PROVIDING COMMUNITY CENTERS FOR SOCIAL GATHERINGS AND MEETINGS FOR THE ELDERLY; PROVIDING SENIOR HOUSING FACILITIES FOR THE ELDERLY, NAMELY, PROVIDING INDEPENDENT LIVING FACILITIES FOR THE ELDERLY; PROVIDING ADULT DAY CARE SERVICES FOR THE ELDERLY (U.S. CLS. 100 AND 101).

FIRST USE 0-0-2009; IN COMMERCE 0-0-2009.

CLASS 44—MEDICAL, BEAUTY AND AGRICULTURAL SERVICES

FOR NUTRITION COUNSELING FOR THE ELDERLY; NURSING CARE FOR THE ELDERLY; NURSING HOMES FOR THE ELDERLY; MEDICAL SERVICES FOR THE ELDERLY; ARRANGING FOR KIDNEY DIALYSIS SERVICES; IN-HOME HEALTH CARE SERVICES, NAMELY, NURSING SERVICES, HOME HEALTH AIDE SERVICES, PROVIDING PHYSICAL AND MENTAL REHABILITATION FACILITIES, FOOD NUTRITION CONSULTATION, SPEECH THERAPY; SOCIAL REHABILITATION, NAMELY, PROVIDING OCCUPATIONAL THERAPY SERVICES CONCERNING ACTIVITIES OF DAILY LIVING (U.S. CLS. 100 AND 101).

FIRST USE 0-0-2009; IN COMMERCE 0-0-2009.

CLASS 45—PERSONAL AND LEGAL SERVICES

FOR IN-HOME SUPPORT AND SOCIAL WORK SERVICES TO SENIOR PERSONS, NAMELY, GERIATRIC CARE MANAGEMENT SERVICES AND PERSONAL AFFAIRS MANAGEMENT SERVICES IN THE NATURE OF THE COORDINATION OF NECESSARY SERVICES AND CARE FOR THE ELDERLY; CASE MANAGEMENT SERVICES, NAMELY, COORDINATION OF LEGAL, SOCIAL AND PSYCHOLOGICAL SERVICES FOR THE ELDERLY (U.S. CLS. 100 AND 101).

FIRST USE 0-0-2009; IN COMMERCE 0-0-2009.

3,807,609. LENDINGTREE, LLC, CHARLOTTE, NC. SN 77-448,144. PUB. 11-4-2008, FILED 4-15-2008.

Tree

THE MARK CONSISTS OF STANDARD CHARACTERS WITHOUT CLAIM TO ANY PARTICULAR FONT, STYLE, SIZE, OR COLOR.

CLASS 35—ADVERTISING AND BUSINESS

FOR MATCHING CONSUMERS WITH REAL ESTATE PROFESSIONALS IN THE FIELD OF REAL ESTATE SERVICES, VIA A GLOBAL COMPUTER NETWORK; MATCHING BORROWERS WITH POTENTIAL LENDERS IN THE FIELD OF CONSUMER AND MORTGAGE LENDING (U.S. CLS. 100, 101 AND 102).
FIRST USE 4-27-2009; IN COMMERCE 5-1-2009.

CLASS 36—INSURANCE AND FINANCIAL

FOR PROVIDING STUDENT LOAN FINANCING; STUDENT LOAN INFORMATION; STUDENT LOAN SERVICES; CREDIT AND LOAN SERVICES; INSURANCE BROKERAGE AND ADMINISTRATION SERVICES (U.S. CLS. 100, 101 AND 102).
FIRST USE 4-27-2009; IN COMMERCE 5-1-2009.

CLASS 41—EDUCATION AND ENTERTAINMENT

FOR PROVIDING INFORMATION ON ATTENDING COLLEGE, UNIVERSITY AND BUSINESS SCHOOL WITH AN EMPHASIS ON NEWLY ENROLLED STUDENTS (U.S. CLS. 100, 101 AND 107).
FIRST USE 4-27-2009; IN COMMERCE 5-1-2009.

3,807,615. NUTRILAB CORPORATION, ST. PETERSBURG, FL. SN 77-453,287. PUB. 9-15-2009, FILED 4-21-2008.

SWEET-INFUSED FRUITS

THE MARK CONSISTS OF STANDARD CHARACTERS WITHOUT CLAIM TO ANY PARTICULAR FONT, STYLE, SIZE, OR COLOR.

NO CLAIM IS MADE TO THE EXCLUSIVE RIGHT TO USE "FRUITS", APART FROM THE MARK AS SHOWN.

CLASS 5—PHARMACEUTICALS

FOR NUTRACEUTICALS FOR USE AS A DIETARY SUPPLEMENT; PHARMACEUTICALS FOR THE TREATMENT OF POST-SURGERY RECOVERY AND GLYCEMIC BALANCE THEREOF BY WAY OF ENHANCED DELIVERY OF ELECTROLYTES AND NUTRIENTS (U.S. CLS. 6, 18, 44, 46, 51 AND 52).
FIRST USE 5-1-2008; IN COMMERCE 5-1-2008.

CLASS 30—STAPLE FOODS

FOR LOW GLYCEMIC FOODS FOR HUMAN CONSUMPTION, NAMELY, SNACK-SIZE CAKES, COOKIES, CHEESE CRACKERS, ANIMAL CRACKERS, PUDDING, FROZEN YOGURT, CANDIES, CHOCOLATE BARS, ICE CREAM, GUMMY CANDY, CANDY FRUIT ROLLS, FROZEN CONFECTIONS (U.S. CL. 46).
FIRST USE 5-1-2008; IN COMMERCE 5-1-2008.

CLASS 32—LIGHT BEVERAGES

FOR LOW GLYCEMIC BEVERAGES, NAMELY, SPORTS DRINKS, CARBONATED SOFT DRINKS, COFFEE DRINKS, FLAVORED WATER, ENERGY DRINKS, THERMOGENIC SOFT DRINKS (U.S. CLS. 45, 46 AND 48).
FIRST USE 5-1-2008; IN COMMERCE 5-1-2008.

3,807,616. SF INVESTMENTS, INC., WILMINGTON, DE. SN 77-455,042. PUB. 8-25-2009, FILED 4-22-2008.

LEARNERS TO LEADERS

THE MARK CONSISTS OF STANDARD CHARACTERS WITHOUT CLAIM TO ANY PARTICULAR FONT, STYLE, SIZE, OR COLOR.

CLASS 36—INSURANCE AND FINANCIAL

FOR CHARITABLE SERVICES, NAMELY, PROVIDING FUNDING AND FINANCIAL SUPPORT TO EDUCATIONAL AND NUTRITIONAL PROGRAMS FOR DISADVANTAGED INDIVIDUALS (U.S. CLS. 100, 101 AND 102).
FIRST USE 12-0-2006; IN COMMERCE 12-0-2006.

CLASS 41—EDUCATION AND ENTERTAINMENT

FOR EDUCATION SERVICES, NAMELY, PROVIDING TUTORING IN THE FIELDS OF POST-SECONDARY AND HIGH SCHOOL EDUCATION, ENGLISH AS A SECOND LANGUAGE, NUTRITION, LEADERSHIP, AND CULTURE AND THE ARTS; EDUCATION SERVICES, NAMELY, PROVIDING MENTORING IN THE FIELD OF POST-SECONDARY AND HIGH SCHOOL EDUCATION, ENGLISH AS A SECOND LANGUAGE, NUTRITION, LEADERSHIP, AND CULTURE AND THE ARTS; COUNSELING IN THE FIELD OF POST-SECONDARY AND HIGH SCHOOL EDUCATION, ENGLISH AS A SECOND LANGUAGE, NUTRITION, LEADERSHIP, AND CULTURE AND THE ARTS (U.S. CLS. 100, 101 AND 107).
FIRST USE 12-0-2006; IN COMMERCE 12-0-2006.

3,807,624. THE TRAVEL CHANNEL, L.L.C., CHEVY CHASE, MD. SN 77-464,847. PUB. 6-23-2009, FILED 5-2-2008.

TRAVEL CHANNEL GO

THE MARK CONSISTS OF STANDARD CHARACTERS

WITHOUT CLAIM TO ANY PARTICULAR FONT, STYLE, SIZE, OR COLOR.

OWNER OF U.S. REG. NOS. 2,740,214 AND 2,948,169.

NO CLAIM IS MADE TO THE EXCLUSIVE RIGHT TO USE "TRAVEL CHANNEL", APART FROM THE MARK AS SHOWN.

SEC. 2(F) AS TO "TRAVEL CHANNEL".

CLASS 39—TRANSPORTATION AND STORAGE

FOR PROVIDING INFORMATION, NEWS, AND COMMENTARY IN THE FIELD OF TRAVEL AND TRAVEL INFORMATION SERVICES VIA WIRELESS AND MOBILE DEVICES AND HANDSETS (U.S. CLS. 100 AND 105).

FIRST USE 6-24-2008; IN COMMERCE 6-24-2008.

CLASS 41—EDUCATION AND ENTERTAINMENT

FOR ENTERTAINMENT SERVICES, NAMELY, A WEBSITE FEATURING NON-DOWNLOADABLE ELECTRONIC MEDIA AND MULTIMEDIA MATERIALS IN THE FORM OF VIDEOS, PICTURES, IMAGES, TEXT, PHOTOS, USER-GENERATED CONTENT, AND AUDIO MATERIALS IN THE FIELDS OF TRAVEL AND TRAVEL-RELATED TOPICS PRESENTED TO WIRELESS AND MOBILE COMMUNICATIONS DEVICES AND HANDSETS VIA A GLOBAL COMPUTER NETWORK AND WIRELESS NETWORKS (U.S. CLS. 100, 101 AND 107).

FIRST USE 6-24-2008; IN COMMERCE 6-24-2008.

3,807,640. CORE SYSTEMS (NI) LIMITED, BELFAST, NORTHERN IRELAND. SN 77-481,705. PUB. 10-13-2009, FILED 5-22-2008.

TUSA

THE MARK CONSISTS OF STANDARD CHARACTERS WITHOUT CLAIM TO ANY PARTICULAR FONT, STYLE, SIZE, OR COLOR.

CLASS 9—ELECTRICAL AND SCIENTIFIC APPARATUS

FOR COMPUTER SOFTWARE TO OPERATE AND MANAGE A DATABASE OR DATABASE(S) OF INMATE, FACILITY, AND OPERATIONAL INFORMATION FOR JAIL AND CORRECTIONAL FACILITIES; COMPUTER SOFTWARE FOR FACILITATING COMMUNICATIONS BETWEEN INMATES, RELATIVES AND OTHER OUTSIDE CONTACTS, CORRECTIONAL FACILITIES PERSONNEL, CORRECTIONAL EMPLOYEES, LAW ENFORCEMENT; COMPUTER SOFTWARE FOR ORDERING GOODS AND SERVICES FOR JAILS AND CORRECTIONAL FACILITIES; SECURITY DEVICES, NAMELY, ACCESS CARDS, ELECTRONIC CARD READERS, BIOMETRIC READERS, AND ACCESS CONTROL DEVICES, NAMELY, ELECTRONIC LOCKS; COMPUTER SOFTWARE USED FOR IDENTITY AUTHENTICATION AND ACCESS CONTROL (U.S. CLS. 21, 23, 26, 36 AND 38).

FIRST USE 6-19-2008; IN COMMERCE 6-19-2008.

CLASS 42—SCIENTIFIC AND COMPUTER SERVICES

FOR TECHNICAL SUPPORT SERVICES, NAMELY, TROUBLESHOOTING OF COMPUTER SOFTWARE PROBLEMS, AND MONITORING OF NETWORK SYSTEMS; COMPUTER CONSULTANCY AND COMPUTER PROJECT MANAGEMENT SERVICES; INSTALLATION, MAINTENANCE, INTEGRATION, AND REPAIR OF COMPUTER SOFTWARE; DATA BACK-UP SERVICES FOR COMPUTER PROGRAMS AND FACILITIES (U.S. CLS. 100 AND 101).

FIRST USE 6-19-2008; IN COMMERCE 6-19-2008.

3,807,648. LOEW'S HOTELS, INC., NEW YORK, NY. SN 77-496,365. PUB. 7-28-2009, FILED 6-11-2008.



THE MARK CONSISTS OF A GEOMETRIC DESIGN AND THE WORD "LOEWS" IN STYLIZED LETTERS.

CLASS 35—ADVERTISING AND BUSINESS

FOR BUSINESS MANAGEMENT AND ADVERTISING SERVICES IN THE FIELD OF HOTELS, RESTAURANTS, CONVENTIONS, HEALTH AND FITNESS SPAS AND RESORT HOTELS; RETAIL STORE SERVICES FEATURING RETAIL GIFTS, SOUVENIRS, GOLF EQUIPMENT, GOLF CLOTHING, ACCESSORIES FOR GOLFERS, BOOKS RELATING TO GOLF AND OTHER ARTICLES OF INTEREST TO GOLFERS, AND HEALTH AND BEAUTY SPA PRODUCTS; PROVIDING INFORMATION IN PERSON, BY MAIL, OVER THE TELEPHONE, AND VIA THE INTERNET IN THE NATURE OF DIRECTORIES OF HOTELS, RESTAURANTS, HEALTH AND FITNESS SPAS, RESORT HOTELS, RETAIL STORES AND SHOPPING MALLS FEATURING GIFTS, SOUVENIRS, GOLF ACCESSORIES, BOOKS, AND HEALTH AND BEAUTY SPA PRODUCTS, RECREATIONAL FACILITIES IN THE NATURE OF GOLF, TENNIS, EXERCISE, BOATING, SAILING, FISHING, HORSEBACK RIDING, SWIMMING AND WATER ACTIVITIES, AND ENTERTAINMENT VENUES; CONDUCTING INCENTIVE AWARD PROGRAMS TO PROMOTE THE SALE OF THE PRODUCTS AND SERVICES OF OTHERS; COPYING OF DOCUMENTS FOR OTHERS; PROVIDING SHOPPING GUIDES PROMOTING THE GOODS AND SERVICES OF OTHERS IN PERSON, BY MAIL, OVER THE TELEPHONE AND VIA THE INTERNET; TELEPHONE ANSWERING SERVICES; PROVIDING FACILITIES FOR BUSINESS MEETINGS AND BUSINESS CONFERENCES; VENDING MACHINE SERVICES IN THE NATURE OF PROVIDING VENDING MACHINES OFFERING FOOD AND BEVERAGES; ENTERTAINMENT SERVICES, NAMELY, PROVIDING INFORMATION IN PERSON, BY MAIL, OVER THE TELEPHONE, AND VIA THE INTERNET IN THE NATURE OF REVIEWS OF RETAIL STORES AND SHOPPING MALLS FEATURING GIFTS, SOUVENIRS, GOLF ACCESSORIES, BOOKS, AND HEALTH AND BEAUTY SPA PRODUCTS, AND ENTERTAINMENT VENUES; PROVIDING CONCESSION STAND SERVICES FEATURING FOOD, BEVERAGES AND SNACK FOODS (U.S. CLS. 100, 101 AND 102).

FIRST USE 1-1-2009; IN COMMERCE 1-1-2009.

CLASS 41—EDUCATION AND ENTERTAINMENT

FOR ENTERTAINMENT SERVICES, NAMELY, PROVIDING FACILITIES FOR RECREATIONAL ACTIVITIES IN THE NATURE OF GOLF, TENNIS, EXERCISE, BOATING, SAILING, FISHING, HORSEBACK RIDING, SWIMMING AND WATER ACTIVITIES; PRESENTATION OF LIVE MUSICAL AND DRAMATIC SHOW PERFORMANCES; BOOKING OF ENTERTAINMENT, NAMELY, BOOKING OF SEATS FOR SHOWS AND BOOKING OF THEATER TICKETS; ARRANGING FOR TICKET RESERVATIONS FOR CONCERTS, DANCE SHOWS, LIVE MUSICAL PERFORMANCES AND LIVE COMEDY AND DRAMATIC SHOWS; PROVIDING FITNESS FACILITIES; ENTERTAINMENT SERVICES, NAMELY, PROVIDING INFORMATION IN PERSON, BY MAIL, OVER THE TELEPHONE, AND VIA THE INTERNET IN THE NATURE OF REVIEWS OF RECREATIONAL FACILITIES IN THE NATURE OF GOLF, TENNIS, EXERCISE, BOATING, SAILING, FISHING, HORSEBACK RIDING, SWIMMING AND WATER ACTIVITIES (U.S. CLS. 100, 101 AND 107).
FIRST USE 1-1-2009; IN COMMERCE 1-1-2009.

CLASS 43—HOTEL AND RESTAURANT SERVICES

FOR PROVIDING FOOD AND DRINK SERVICES FOR GUESTS, NAMELY, RESTAURANT SERVICES; PROVIDING TEMPORARY LODGING AND ACCOMMODATIONS, NAMELY, HOTEL AND RESORT HOTEL SERVICES; CONVENTION SERVICES, NAMELY, PROVIDING CONVENTION AND BANQUET FACILITIES; MAKING HOTEL RESERVATIONS FOR OTHERS; CATERING SERVICES, BAR SERVICES; COCKTAIL LOUNGE SERVICES; RESTAURANT SERVICES, NAMELY, TAKE OUT FOOD AND BEVERAGE SERVICES; PROVIDING GENERAL PURPOSE FACILITIES FOR TRADE EXHIBITIONS; PROVIDING FACILITIES FOR FAIRS AND SOCIAL FUNCTIONS; ENTERTAINMENT SERVICES, NAMELY, PROVIDING INFORMATION IN PERSON, BY MAIL, OVER THE TELEPHONE, AND VIA THE INTERNET IN THE NATURE OF REVIEWS OF HOTELS, RESORT HOTELS AND RESTAURANTS (U.S. CLS. 100 AND 101).
FIRST USE 1-1-2009; IN COMMERCE 1-1-2009.

CLASS 44—MEDICAL, BEAUTY AND AGRICULTURAL SERVICES

FOR ENTERTAINMENT SERVICES, NAMELY, PROVIDING INFORMATION IN PERSON, BY MAIL, OVER THE TELEPHONE, AND VIA THE INTERNET IN THE NATURE OF REVIEWS OF HEALTH AND FITNESS SPAS (U.S. CLS. 100 AND 101).
FIRST USE 1-1-2009; IN COMMERCE 1-1-2009.

3,807,661. CODEGA, LLC, HOUSTON, TX. SN 77-511,347. PUB. 7-7-2009, FILED 6-30-2008.

CODEGA

THE MARK CONSISTS OF STANDARD CHARACTERS WITHOUT CLAIM TO ANY PARTICULAR FONT, STYLE, SIZE, OR COLOR.
THE WORDING "CODEGA" HAS NO MEANING IN A FOREIGN LANGUAGE.

CLASS 9—ELECTRICAL AND SCIENTIFIC APPARATUS

FOR PRE-RECORDED VIDEOTAPES, DVDS, CDS, CD-ROMS, ALL FEATURING VEHICLE SAFETY AND INSPECTION INFORMATION (U.S. CLS. 21, 23, 26, 36 AND 38).
FIRST USE 10-1-2008; IN COMMERCE 10-1-2008.

CLASS 38—COMMUNICATION

FOR STREAMING OF VIDEO MATERIAL ON THE INTERNET (U.S. CLS. 100, 101 AND 104).
FIRST USE 10-1-2008; IN COMMERCE 10-1-2008.

3,807,663. CODEGA, LLC, HOUSTON, TX. SN 77-511,371. PUB. 7-7-2009, FILED 6-30-2008.

CODEGA

THE MARK CONSISTS OF STANDARD CHARACTERS WITHOUT CLAIM TO ANY PARTICULAR FONT, STYLE, SIZE, OR COLOR.
THE WORDING "CODEGA" HAS NO MEANING IN A FOREIGN LANGUAGE.

CLASS 38—COMMUNICATION

FOR STREAMING OF VIDEO MATERIAL ON THE INTERNET; TRANSMISSION OF SOUND AND VIDEO VIA INTERACTIVE MULTIMEDIA NETWORKS (U.S. CLS. 100, 101 AND 104).
FIRST USE 10-1-2008; IN COMMERCE 10-1-2008.

CLASS 41—EDUCATION AND ENTERTAINMENT

FOR PRODUCTION SERVICES, NAMELY, PRODUCTION OF DVDS, CDS, AND VIDEOTAPES; EDUCATIONAL SERVICES, NAMELY, LIVE AND ON-LINE CLASSES, SEMINARS, CONFERENCES, WORKSHOPS IN THE FIELDS OF VEHICLE SAFETY TRAINING AND VEHICLE INSPECTIONS; ANIMATION PRODUCTION SERVICES (U.S. CLS. 100, 101 AND 107).
FIRST USE 10-1-2008; IN COMMERCE 10-1-2008.

3,807,668. BLUE MAN PRODUCTIONS, INC., NEW YORK, NY. SN 77-517,772. PUB. 1-13-2009, FILED 7-9-2008.

THE BLUE SCHOOL

THE MARK CONSISTS OF STANDARD CHARACTERS WITHOUT CLAIM TO ANY PARTICULAR FONT, STYLE, SIZE, OR COLOR.
NO CLAIM IS MADE TO THE EXCLUSIVE RIGHT TO USE "SCHOOL", APART FROM THE MARK AS SHOWN.

CLASS 16—PAPER GOODS AND PRINTED MATTER

FOR EDUCATIONAL PUBLICATIONS, NAMELY, BOOKS, WORKBOOKS, INSTRUCTIONAL MANUALS IN THE FIELDS OF LANGUAGE, SCIENCE, MATH, SOCIAL STUDIES, FINE ARTS, PERFORMING ARTS, PHYSICAL ARTS, FITNESS, TECHNOLOGY AND MEDIA LITERACY (U.S. CLS. 2, 5, 22, 23, 29, 37, 38 AND 50).
FIRST USE 8-31-2009; IN COMMERCE 8-31-2009.

CLASS 41—EDUCATION AND ENTERTAINMENT

FOR EDUCATIONAL SERVICES, NAMELY, PROVIDING CLASSES, WORKSHOPS AND DISTRIBUTION OF COURSE MATERIALS IN CONNECTION THEREWITH IN THE FIELDS OF LANGUAGE, SCIENCE, MATH, SOCIAL STUDIES, FINE ARTS, PERFORMING ARTS, PHYSICAL ARTS, FITNESS, TECHNOLOGY AND MEDIA LITERACY (U.S. CLS. 100, 101 AND 107).
FIRST USE 3-31-2009; IN COMMERCE 3-31-2009.

CLASS 41—EDUCATION AND ENTERTAINMENT

FOR PROVIDING ONLINE VIDEO GAMES FOR USE ON WIRELESS DEVICES AND COMPUTERS (U.S. CLS. 100, 101 AND 107).
FIRST USE 5-15-2009; IN COMMERCE 5-15-2009.

CLASS 42—SCIENTIFIC AND COMPUTER SERVICES

FOR PROVIDING TEMPORARY USE OF ONLINE NON-DOWNLOADABLE SOFTWARE FOR USE ON WIRELESS DEVICES AND COMPUTERS ENABLING THE UPLOADING, DOWNLOADING, CREATION AND MANIPULATION OF MEDIA FILES, NAMELY, PHOTO FILES, WALLPAPERS, AUDIO FILES AND RING TONES, VIDEO FILES, VIDEO FEEDS AND SCREENSAVERS (U.S. CLS. 100 AND 101).
FIRST USE 5-15-2008; IN COMMERCE 5-15-2008.

3,807,684. SONIC BOOM, INC., NEW YORK, NY. SN 77-534,850. PUB. 8-11-2009, FILED 7-30-2008.

SONICBOOM

THE MARK CONSISTS OF STANDARD CHARACTERS WITHOUT CLAIM TO ANY PARTICULAR FONT, STYLE, SIZE, OR COLOR.

CLASS 9—ELECTRICAL AND SCIENTIFIC APPARATUS

FOR VIDEO GAME SOFTWARE; DOWNLOADABLE RING TONES AND AUDIO FILES FOR USE WITH COMPUTERS AND WIRELESS DEVICES; DOWNLOADABLE SOFTWARE FOR USE ON WIRELESS DEVICES AND COMPUTERS ENABLING THE UPLOADING, DOWNLOADING, CREATION AND MANIPULATION OF MEDIA FILES, NAMELY, PHOTO FILES, WALLPAPERS, AUDIO FILES AND RING TONES, VIDEO FILES, VIDEO FEEDS AND SCREENSAVERS (U.S. CLS. 21, 23, 26, 36 AND 38).
FIRST USE 5-15-2008; IN COMMERCE 5-15-2008.

CLASS 35—ADVERTISING AND BUSINESS

FOR ONLINE RETAIL STORE SERVICES FEATURING DOWNLOADABLE RING TONES AND VIDEO GAMES (U.S. CLS. 100, 101 AND 102).
FIRST USE 5-15-2008; IN COMMERCE 5-15-2008.

CLASS 38—COMMUNICATION

FOR PROVIDING CHAT ROOMS, INSTANT MESSAGING, AND ELECTRONIC BULLETIN BOARDS ALLOWING USERS TO SHARE FILES AND COMMUNICATE CONCERNING THE CREATION AND MANIPULATION OF MEDIA FILES, NAMELY, PHOTO FILES, WALLPAPERS, AUDIO FILES AND RING TONES, VIDEO FILES, VIDEO FEEDS AND SCREENSAVER (U.S. CLS. 100, 101 AND 104).
FIRST USE 5-15-2008; IN COMMERCE 5-15-2008.

3,807,685. HELIX GROUP PLC, WEST MIDLANDS, UNITED KINGDOM. SN 77-535,799. PUB. 7-21-2009, FILED 7-31-2008.



OWNER OF U.S. REG. NOS. 1,618,747, 2,741,254, AND OTHERS.

THE COLOR(S) BLACK, BLUE, GOLD AND WHITE IS/ARE CLAIMED AS A FEATURE OF THE MARK.

THE MARK CONSISTS OF THE WORD "HELIX" IN YELLOW, ABOVE A CURVING YELLOW LINE. TWO YELLOW VERTICAL STRIPES ON EACH SIDE OF THE MARK. THE WORD "OXFORD" IN WHITE WITH A BLACK BORDER. TWO STYLIZED DEPICTIONS OF A RUNNER ON TOP OF A GLOBE DESIGN SURROUNDED BY A BANNER, WITH THE RUNNER BEING DEPICTED IN WHITE WITH A BLACK BORDER AND THE GLOBE FEATURING WHITE CONTINENTS, BLACK OCEANS, AND A BLACK BORDER. A BLUE BACKGROUND BEHIND ALL OF THE FOREGOING.

CLASS 9—ELECTRICAL AND SCIENTIFIC APPARATUS

FOR MEASURING AND TEACHING APPARATUS AND INSTRUMENTS, NAMELY, GRADUATED RULERS, PROTRACTORS, AND GRADUATED MEASURING SCALE RULERS; MATHEMATICAL INSTRUMENTS, NAMELY, GRADUATED RULERS, PROTRACTORS, AND GRADUATED MEASURING SCALE RULERS; SETS OF MATHEMATICAL INSTRUMENTS CONTAINING GRADUATED RULERS, PROTRACTORS, GRADUATED MEASURING SCALE RULERS, TRIANGLES, MEASURING RULES, PENCIL SHARPENERS, PENCILS, ERASERS, DIVIDERS AND STENCILS; PROTRACTORS; RULERS, NAMELY, GRADUATED RULERS AND MEASURING RULES (U.S. CLS. 21, 23, 26, 36 AND 38).
FIRST USE 6-18-2008; IN COMMERCE 6-18-2008.

CLASS 16—PAPER GOODS AND PRINTED MATTER

FOR SETS OF DRAWING INSTRUMENTS; DRAWING INSTRUMENTS; DRAWING COMPASSES; DRAFTING COMPASSES; T-SQUARES; PROTRACTORS; RULERS, NAMELY, DRAFTING RULERS, DRAWING RULERS, ERASERS; PENCILS; PENCIL SHARPENERS; STENCILS; CASES FOR SETS OF DRAWING INSTRUMENTS; PENS; STATIONERY; VELLUM PAPER; AND SET SQUARES, NAMELY, DRAWING TRIANGLES; DRAFTING AND DRAWING COMPASSES; AND CASES FOR PROTRACTORS, ERASERS, PENCILS (U.S. CLS. 2, 5, 22, 23, 29, 38 AND 50).

FIRST USE 6-18-2008; IN COMMERCE 6-18-2008.

3,807,686. BUNN-O-MATIC CORPORATION, SPRINGFIELD, IL. SN 77-536,023. PUB. 9-8-2009, FILED 7-31-2008.



THE MARK CONSISTS OF A BRANCH DESIGN CONSISTING OF THREE LEAVES AND FOUR COFFEE CHERRIES ALL INSIDE A PARTIALLY SOLID RECTANGLE AND THE WORDS "RESPECT" ABOVE AND "EARTH" BELOW THE RECTANGLE.

CLASS 7—MACHINERY

FOR ELECTRIC BEVERAGE MAKING SUBSTANCE GRINDERS, NAMELY, COFFEE GRINDERS (U.S. CLS. 13, 19, 21, 23, 31, 34 AND 35).

FIRST USE 9-0-2008; IN COMMERCE 11-0-2009.

CLASS 11—ENVIRONMENTAL CONTROL APPARATUS

FOR ELECTRIC COFFEE BREWERS, TEA BREWERS, AND ICED TEA BREWERS; HEATED AND REFRIGERATED BEVERAGE DISPENSING UNITS FOR DOMESTIC AND COMMERCIAL USE AND COMPONENTS THEREFOR; ELECTRIC MACHINES FOR PREPARING AND DISPENSING HEATED WATER; ELECTRIC DOCKING SYSTEMS COMPRISING DISPENSERS, SERVERS, WARMING STATIONS AND STANDS FOR BEVERAGE DISPENSING UNITS; REFRIGERATION EQUIPMENT, NAMELY, BEVERAGE CHILLING UNITS FOR COMMERCIAL AND DOMESTIC USE AND COMPONENTS THEREFOR; ELECTRIC MACHINES FOR PREPARING AND DISPENSING FROZEN OR SEMI-FROZEN BEVERAGES (U.S. CLS. 13, 21, 23, 31 AND 34).

FIRST USE 9-0-2008; IN COMMERCE 11-0-2009.

CLASS 21—HOUSEWARES AND GLASS

FOR BEVERAGE DISPENSING EQUIPMENT, NAMELY, NON-ELECTRIC DECANTERS, CARAFES, SERVERS, AND DISPENSERS (U.S. CLS. 2, 13, 23, 29, 30, 33, 40 AND 50).

FIRST USE 9-0-2008; IN COMMERCE 11-0-2009.

3,807,688. SUGAR FACTORY, LLC, LAS VEGAS, NV. SN 77-537,428. PUB. 2-10-2009, FILED 8-1-2008.

SUGAR FACTORY

THE MARK CONSISTS OF STANDARD CHARACTERS WITHOUT CLAIM TO ANY PARTICULAR FONT, STYLE, SIZE, OR COLOR.

NO CLAIM IS MADE TO THE EXCLUSIVE RIGHT TO USE "SUGAR ", APART FROM THE MARK AS SHOWN.

CLASS 35—ADVERTISING AND BUSINESS

FOR RETAIL STORE AND ON-LINE RETAIL STORE FEATURING CANDY, CONFECTIONS, ICE CREAM, BAKED GOODS, AND DELICATESSEN GOODS; RETAIL STORE AND ON-LINE RETAIL STORE SERVICES FEATURING CANDY, CONFECTIONS, ICE CREAM, BAKED GOODS, AND DELICATESSEN GOODS (U.S. CLS. 100, 101 AND 102).

FIRST USE 6-26-2009; IN COMMERCE 6-26-2009.

CLASS 43—HOTEL AND RESTAURANT SERVICES

FOR RESTAURANT SERVICES (U.S. CLS. 100 AND 101).

FIRST USE 2-13-2010; IN COMMERCE 2-13-2010.

3,807,690. HALL, JAY, ANNAPOLIS, MD. SN 77-538,755. PUB. 1-20-2009, FILED 8-4-2008.

GREENCOMP

THE MARK CONSISTS OF THE STYLIZED TEXT "GREENCOMP".

CLASS 9—ELECTRICAL AND SCIENTIFIC APPARATUS

FOR DOWNLOADABLE COMPUTER SOFTWARE PROGRAM USED AS A COMPARISON CALCULATOR TOOL TO COMPARE RELATIVE OVERALL PERFORMANCE OF GREEN HOME BUILDING CERTIFICATION PROGRAMS AROUND THE COUNTRY (U.S. CLS. 21, 23, 26, 36 AND 38).

FIRST USE 4-1-2010; IN COMMERCE 4-10-2010.

CLASS 42—SCIENTIFIC AND COMPUTER SERVICES

FOR PROVIDING ON-LINE NON-DOWNLOADABLE SOFTWARE USED AS A COMPARISON CALCULATOR TOOL TO COMPARE RELATIVE OVERALL PERFORMANCE OF GREEN HOME BUILDING CERTIFICATION PROGRAMS AROUND THE COUNTRY (U.S. CLS. 100 AND 101).

FIRST USE 4-1-2010; IN COMMERCE 4-10-2010.

3,807,691. WHERE WOMEN CREATE INC., OGDEN, UT. SN 77-539,066. PUB. 7-28-2009, FILED 8-5-2008.

THE SILVER SUITCASE SOCIETY

THE MARK CONSISTS OF STANDARD CHARACTERS WITHOUT CLAIM TO ANY PARTICULAR FONT, STYLE, SIZE, OR COLOR.

NO CLAIM IS MADE TO THE EXCLUSIVE RIGHT TO USE "SOCIETY", APART FROM THE MARK AS SHOWN.

CLASS 35—ADVERTISING AND BUSINESS

FOR CUSTOMER LOYALTY SERVICES AND CUSTOMER CLUB SERVICES FOR COMMERCIAL, PROMOTIONAL AND/OR ADVERTISING PURPOSES, NAMELY, PROVIDING DISCOUNTS ON PURCHASES (U.S. CLS. 100, 101 AND 102).

FIRST USE 2-0-2009; IN COMMERCE 2-0-2009.

CLASS 41—EDUCATION AND ENTERTAINMENT

FOR MEMBERSHIP CLUB SERVICES, NAMELY, PROVIDING ONLINE NEWSLETTERS IN THE FIELD OF ARTS, CRAFTS, SCRAPBOOKING, KNITTING, STAINED GLASS MAKING, AND SMALL BUSINESS DEVELOPMENT; MEMBERSHIP CLUB SERVICES, NAMELY, PROVIDING CLASSES IN THE FIELD OF ARTS, CRAFTS, SCRAPBOOKING, KNITTING, STAINED GLASS MAKING, AND SMALL BUSINESS DEVELOPMENT (U.S. CLS. 100, 101 AND 107).

FIRST USE 2-0-2009; IN COMMERCE 2-0-2009.

3,807,693. KAPOW TECHNOLOGIES HOLDINGS, INC., PALO ALTO, CA. SN 77-540,664. PUB. 2-10-2009, FILED 8-6-2008.

KAPOW TECHNOLOGIES

THE MARK CONSISTS OF STANDARD CHARACTERS WITHOUT CLAIM TO ANY PARTICULAR FONT, STYLE, SIZE, OR COLOR.

NO CLAIM IS MADE TO THE EXCLUSIVE RIGHT TO USE "TECHNOLOGIES", APART FROM THE MARK AS SHOWN.

CLASS 9—ELECTRICAL AND SCIENTIFIC APPARATUS

FOR COMPUTER SOFTWARE FOR USE IN ACCESSING, TRANSFORMING, SEARCHING, COMPILING, INDEXING, CONNECTING, COLLECTING, COMBINING, ORGANIZING AND MANIPULATING FROM MULTIPLE SOURCES DATA, MULTIMEDIA CONTENT, INFORMATION AND BUSINESS INTELLIGENCE ON THE INTERNET INTO USABLE FORM; COMPUTER SOFTWARE FOR CREATING INDEXES OF INFORMATION, WEB SITES, AND OTHER INFORMATION RESOURCES, AND INSTRUCTIONAL MANUALS, SOLD AS A UNIT (U.S. CLS. 21, 23, 26, 36 AND 38).

FIRST USE 7-31-2003; IN COMMERCE 7-31-2003.

CLASS 38—COMMUNICATION

FOR TELECOMMUNICATION SERVICES, NAMELY, RENTAL OF ACCESS TIME TO GLOBAL COMPUTER NETWORKS, AND PROVIDING ONLINE ACCESS TO DATABASES; PROVIDING MULTIPLE USER ACCESS TO PROPRIETARY COLLECTIONS OF INFORMATION BY MEANS OF GLOBAL COMPUTER INFORMATION NETWORKS (U.S. CLS. 100, 101 AND 104).

FIRST USE 11-30-2006; IN COMMERCE 11-30-2006.

CLASS 42—SCIENTIFIC AND COMPUTER SERVICES

FOR COMPUTER SOFTWARE CONSULTATION SERVICES; COMPUTER CONSULTANCY IN THE FIELDS OF DATABASES, WEB SITES AND WEB HOSTING SERVICES AND PROGRAMMING COMPUTER SERVICES, NAMELY, PROVIDING SOFTWARE INTERFACES AVAILABLE OVER A COMPUTER NETWORK IN ORDER FOR USERS TO CREATE A PERSONALIZED ON-LINE INFORMATION AND DATA RETRIEVAL AND EXTRACTION SERVICE; COMPUTER SERVICE, NAMELY, ACTING AS AN APPLICATION SERVICE PROVIDER IN THE FIELD OF KNOWLEDGE MANAGEMENT TO HOST COMPUTER APPLICATION SOFTWARE FOR THE COLLECTION, EDITING, ORGANIZING, MODIFYING, BOOK MARKING, TRANSMISSION, STORAGE AND SHARING OF DATA AND INFORMATION; DATA MINING, NAMELY, EXTRACTION AND RETRIEVAL OF INFORMATION BY MEANS OF GLOBAL COMPUTER NETWORKS; CREATING INDEXES OF INFORMATION, WEB SITES AND OTHER INFORMATION SOURCES IN CONNECTION WITH GLOBAL COMPUTER NETWORKS; PROVIDING INFORMATION AT THE SPECIFIC REQUEST OF END-USERS BY MEANS OF GLOBAL COMPUTER INFORMATION NETWORKS; PROVIDING ONLINE NON-DOWNLOADABLE COMPUTER SOFTWARE FOR USE IN SEARCHING, COMPILING, INDEXING, CONNECTING, COLLECTING, COMBINING AND ORGANIZING FROM MULTIPLE SOURCES DATA, MULTIMEDIA CONTENT, INFORMATION AND BUSINESS INTELLIGENCE ON THE INTERNET AND FOR USE IN CREATING INDEXES OF INFORMATION, WEB SITES AND OTHER INFORMATION RESOURCES (U.S. CLS. 100 AND 101).

FIRST USE 11-30-2006; IN COMMERCE 11-30-2006.

3,807,694. KAPOW TECHNOLOGIES HOLDINGS, INC., PALO ALTO, CA. SN 77-540,670. PUB. 2-10-2009, FILED 8-6-2008.



NO CLAIM IS MADE TO THE EXCLUSIVE RIGHT TO USE "TECHNOLOGIES", APART FROM THE MARK AS SHOWN.

THE COLOR(S) BLACK, GRAY AND ORANGE IS/ARE CLAIMED AS A FEATURE OF THE MARK.

THE MARK CONSISTS OF THE WORD "KAPOW" IN BLACK. BELOW THAT WORD IS A HORIZONTAL ORANGE LINE. BELOW THE ORANGE LINE IS THE WORD "TECHNOLOGIES" IN GREY. PARTIALLY OBSCURING THE LETTER "K" IN "KAPOW" IS A SQUARE OUTLINED IN GRAY WITH AN ORANGE ARROW DESIGN IN THE INTERIOR OF THE SQUARE.

CLASS 9—ELECTRICAL AND SCIENTIFIC APPARATUS

FOR COMPUTER SOFTWARE FOR USE IN ACCESSING, TRANSFORMING, SEARCHING, COMPILING, INDEXING, CONNECTING, COLLECTING, COMBINING, ORGANIZING AND MANIPULATING FROM MULTIPLE SOURCES DATA, MULTIMEDIA CONTENT, INFORMATION AND BUSINESS INTELLIGENCE ON THE INTERNET INTO USABLE FORM; COMPUTER SOFTWARE FOR CREATING INDEXES OF INFORMATION, WEB SITES, AND OTHER INFORMATION RESOURCES, AND INSTRUCTIONAL MANUALS, SOLD AS A UNIT (U.S. CLS. 21, 23, 26, 36 AND 38).

FIRST USE 7-31-2003; IN COMMERCE 7-31-2003.

CLASS 38—COMMUNICATION

FOR TELECOMMUNICATION SERVICES, NAMELY, RENTAL OF ACCESS TIME TO GLOBAL COMPUTER NETWORKS, AND PROVIDING ONLINE ACCESS TO DATABASES; PROVIDING MULTIPLE USER ACCESS TO PROPRIETARY COLLECTIONS OF INFORMATION BY MEANS OF GLOBAL COMPUTER INFORMATION NETWORKS (U.S. CLS. 100, 101 AND 104).

FIRST USE 11-30-2006; IN COMMERCE 11-30-2006.

CLASS 42—SCIENTIFIC AND COMPUTER SERVICES

FOR COMPUTER SOFTWARE CONSULTATION SERVICES; COMPUTER CONSULTANCY IN THE FIELDS OF DATABASES, WEB SITES AND WEB HOSTING SERVICES AND PROGRAMMING COMPUTER SERVICES, NAMELY, PROVIDING SOFTWARE INTERFACES AVAILABLE OVER A COMPUTER NETWORK IN ORDER FOR USERS TO CREATE A PERSONALIZED ON-LINE INFORMATION AND DATA RETRIEVAL AND EXTRACTION SERVICE; COMPUTER SERVICE, NAMELY, ACTING AS AN APPLICATION SERVICE PROVIDER IN THE FIELD OF KNOWLEDGE MANAGEMENT TO HOST COMPUTER APPLICATION SOFTWARE FOR THE COLLECTION, EDITING, ORGANIZING, MODIFYING, BOOK MARKING, TRANSMISSION, STORAGE AND SHARING OF DATA AND INFORMATION; DATA MINING, NAMELY, EXTRACTION AND RETRIEVAL OF INFORMATION BY MEANS OF GLOBAL COMPUTER NETWORKS; CREATING INDEXES OF INFORMATION, WEB SITES AND OTHER INFORMATION SOURCES IN CONNECTION WITH GLOBAL COMPUTER NETWORKS; PROVIDING INFORMATION AT THE SPECIFIC REQUEST OF END-USERS BY MEANS OF GLOBAL COMPUTER INFORMATION NETWORKS; PROVIDING ONLINE NON-DOWNLOADABLE COMPUTER SOFTWARE FOR USE IN SEARCHING, COMPILING, INDEXING, CONNECTING, COLLECTING, COMBINING AND ORGANIZING FROM MULTIPLE SOURCES DATA, MULTIMEDIA CONTENT, INFORMATION AND BUSINESS INTELLIGENCE ON THE INTERNET AND FOR USE IN CREATING INDEXES OF INFORMATION, WEB SITES AND OTHER INFORMATION RESOURCES (U.S. CLS. 100 AND 101).

FIRST USE 11-30-2006; IN COMMERCE 11-30-2006.

3,807,695. BASEBALL INVENTIONS, LLC, SCOTTSDALE, AZ. SN 77-540,719. PUB. 8-11-2009, FILED 8-6-2008.

WEAR IT LIKE A PRO

THE MARK CONSISTS OF STANDARD CHARACTERS WITHOUT CLAIM TO ANY PARTICULAR FONT, STYLE, SIZE, OR COLOR.

CLASS 17—RUBBER GOODS

FOR PLASTIC PADDING FOR IMPACT PROTECTION (U.S. CLS. 1, 5, 12, 13, 35 AND 50).

FIRST USE 2-28-2007; IN COMMERCE 2-28-2007.

CLASS 28—TOYS AND SPORTING GOODS

FOR JOCK STRAPS; ATHLETIC EQUIPMENT, NAMELY, GUARDS FOR THE GENITAL AREA; ATHLETIC PROTECTIVE PADS FOR THE GENITAL AREA; ATHLETIC SUPPORTERS; MEN'S ATHLETIC SUPPORTERS; PROTECTIVE ATHLETIC CUPS; PROTECTIVE PADDING FOR PLAYING BASEBALL, ICE HOCKEY, FOOTBALL, SOFTBALL, TENNIS, LACROSSE, FIELD HOCKEY, PAINTBALL, SOCCER, POLE CLIMBING, RODEO, JAI ALAI, CYCLING, MOTOCROSS, MOTOR-CYCLE RIDING, SKATEBOARDING, JOUSTING, ROLLER DERBY, RIGGING, ROLLER HOCKEY, CRICKET, RUGBY, AUSTRALIAN-RULES FOOTBALL, RACKET BALL, MIXED MARTIAL ARTS, CAGE FIGHTING, AND WRESTLING; SPORTS EQUIPMENT FOR BOXING, MARTIAL ARTS, AND THE LIKE, NAMELY, PROTECTIVE BRAS; ATHLETIC EQUIPMENT, NAMELY, TRAINING DEVICES TO BE WORN ON THE BODY FOR SUPPORT; STRESS RELIEF BALLS FOR HAND EXERCISE (U.S. CLS. 22, 23, 38 AND 50).

FIRST USE 2-28-2007; IN COMMERCE 2-28-2007.

CLASS 35—ADVERTISING AND BUSINESS

FOR RETAIL STORE SERVICES AND ONLINE RETAIL STORE SERVICES IN THE FIELD OF DEVICES FOR GENITAL SUPPORT AND PROTECTION FOR ATHLETIC, MILITARY, PARAMILITARY, POLICE, SECURITY, AND TACTICAL PERSONNEL, T-SHIRTS, FOOTWEAR, CLOTHING, SWIMWEAR, UNDERWEAR, BOXER BRIEFS, BRIEFS, PANTIES, LOUNGEWEAR, ATHLETIC WEAR, ATHLETIC EQUIPMENT, MILITARY WEAR, POLICE WEAR, STRESS RELIEF BALLS FOR EXERCISE (U.S. CLS. 100, 101 AND 102).

FIRST USE 2-28-2007; IN COMMERCE 2-28-2007.

3,807,698. JOHN SNELL & ASSOCIATES, INC., MONTPELIER, VT. SN 77-542,567. PUB. 6-23-2009, FILED 8-8-2008.



OWNER OF U.S. REG. NOS. 3,343,872 AND 3,365,676.
NO CLAIM IS MADE TO THE EXCLUSIVE RIGHT TO USE "GROUP", APART FROM THE MARK AS SHOWN.
THE COLOR(S) RED, WHITE, AND BLUE IS/ARE CLAIMED AS A FEATURE OF THE MARK.

THE MARK CONSISTS OF THE UNDERLINED WORDS "THE SNELL GROUP" WITH A GLOBE COMPRISED OF MERIDIANS AND WAVY LINES BETWEEN THE WORDS "THE" AND "SNELL". THE WORDS "THE" AND "GROUP" AND THE UNDERLINING ARE BLUE. THE WORD "SNELL" IS RED. THE GLOBE IS BLUE WITH WHITE MERIDIANS AND BLUE AND WHITE WAVY LINES.

CLASS 16—PAPER GOODS AND PRINTED MATTER

FOR BOOKS, NEWSLETTERS, PRINTED INSTRUCTIONAL AND TEACHING MATERIALS IN THE FIELD OF INFRARED THERMOGRAPHICS AND MOTOR CIRCUIT ANALYSIS (U.S. CLS. 2, 5, 22, 23, 29, 37, 38 AND 50).

FIRST USE 1-6-2008; IN COMMERCE 1-6-2008.

CLASS 37—CONSTRUCTION AND REPAIR

FOR RESIDENTIAL, COMMERCIAL AND INDUSTRIAL BUILDING INSPECTIONS SERVICES OF BUILDINGS DURING THE COURSE OF CONSTRUCTION USING INFRARED THERMOGRAPHY (U.S. CLS. 100, 103 AND 106).

FIRST USE 1-6-2008; IN COMMERCE 1-6-2008.

CLASS 41—EDUCATION AND ENTERTAINMENT

FOR EDUCATIONAL SERVICES, NAMELY, CONDUCTING TRAINING SEMINARS AND PROFESSIONAL CONFERENCES IN THE FIELDS OF INFRARED THERMOGRAPHY AND ELECTRIC MOTOR AND RELATED CIRCUITRY INSPECTION AND TESTING (U.S. CLS. 100, 101 AND 107).

FIRST USE 1-6-2008; IN COMMERCE 1-6-2008.

CLASS 42—SCIENTIFIC AND COMPUTER SERVICES

FOR INSPECTION AND TESTING OF MACHINES AND INSTRUMENTS USING INFRARED THERMOGRAPHY; INSPECTION AND TESTING OF ELECTRIC MOTORS AND RELATED CIRCUITRY AND CONSULTING SERVICE REGARDING THE SAME; RESIDENTIAL, COMMERCIAL AND INDUSTRIAL INSPECTION AND TESTING SERVICES OF EXISTING BUILDINGS AND EQUIPMENT USING INFRARED THERMOGRAPHY (U.S. CLS. 100 AND 101).

FIRST USE 1-6-2008; IN COMMERCE 1-6-2008.

3,807,700. SHAFER INSURANCE AGENCY, INC., KNOXVILLE, TN. SN 77-545,247. PUB. 7-21-2009, FILED 8-12-2008.

BE SAFER WITH SHAFER

THE MARK CONSISTS OF STANDARD CHARACTERS WITHOUT CLAIM TO ANY PARTICULAR FONT, STYLE, SIZE, OR COLOR.

CLASS 35—ADVERTISING AND BUSINESS

FOR INSURANCE SERVICES, NAMELY, BUSINESS RISK MANAGEMENT AND BUSINESS RISK MANAGEMENT CONSULTING (U.S. CLS. 100, 101 AND 102).

FIRST USE 7-0-1996; IN COMMERCE 7-0-1963.

CLASS 36—INSURANCE AND FINANCIAL

FOR INSURANCE SERVICES, NAMELY, INSURANCE BROKERAGE, FINANCIAL RISK MANAGEMENT, INSURANCE ADMINISTRATION, AND FINANCIAL RISK MANAGEMENT CONSULTING (U.S. CLS. 100, 101 AND 102).

FIRST USE 7-0-1963; IN COMMERCE 7-0-1963.

3,807,703. THREE MOUNTAIN HOLDING COMPANY LLC, SAN ANTONIO, TX. SN 77-546,182. PUB. 7-21-2009, FILED 8-13-2008.

THREE MOUNTAIN

THE MARK CONSISTS OF STANDARD CHARACTERS WITHOUT CLAIM TO ANY PARTICULAR FONT, STYLE, SIZE, OR COLOR.

CLASS 37—CONSTRUCTION AND REPAIR

FOR FURNITURE INSTALLATION SERVICES (U.S. CLS. 100, 103 AND 106).

FIRST USE 6-30-2009; IN COMMERCE 6-30-2009.

CLASS 39—TRANSPORTATION AND STORAGE

FOR FURNITURE DISTRIBUTION, NAMELY, TRANSPORTATION OF FURNITURE OF OTHERS BY TRUCKS (U.S. CLS. 100 AND 105).

FIRST USE 6-30-2009; IN COMMERCE 6-30-2009.

CLASS 40—MATERIAL TREATMENT

FOR CONTRACT MANUFACTURING IN THE FIELD OF FURNITURE (U.S. CLS. 100, 103 AND 106).

FIRST USE 6-30-2009; IN COMMERCE 6-30-2009.

3,807,709. DCH MANAGEMENT SERVICES INC., SOUTH AMBOY, NJ. SN 77-549,602. PUB. 1-20-2009, FILED 8-18-2008.

KEEP IT OUT OF CARS

THE MARK CONSISTS OF STANDARD CHARACTERS WITHOUT CLAIM TO ANY PARTICULAR FONT, STYLE, SIZE, OR COLOR.

CLASS 35—ADVERTISING AND BUSINESS

FOR PROMOTING PUBLIC AWARENESS OF SAFE TEEN DRIVING (U.S. CLS. 100, 101 AND 102).

FIRST USE 10-1-2008; IN COMMERCE 10-1-2008.

CLASS 41—EDUCATION AND ENTERTAINMENT

FOR EDUCATIONAL SERVICES, NAMELY, PROVIDING AUTOMOBILE ACCIDENT AVOIDANCE TRAINING AND SAFE DRIVING TRAINING TO TEENAGERS; AND EDUCATIONAL PROGRAMS, NAMELY, DRIVING SAFETY CLASSES AND SEMINARS (U.S. CLS. 100, 101 AND 107).

FIRST USE 10-1-2008; IN COMMERCE 10-1-2008.

3,807,721. BART-PLANGE, SELINA, NEW YORK, NY. SN 77-555,369. PUB. 3-3-2009, FILED 8-25-2008.



THE MARK CONSISTS OF THE WORDING "BOUDOIR D'HUITRES BD" WITH AN ORNATE DESIGN OF GEOMETRICAL SHAPES, A BIRD, AND PLANT-LIKE SHAPES IN FORMS SIMILAR TO ANTIQUE KEYS.

THE FOREIGN WORDING IN THE MARK TRANSLATES INTO ENGLISH AS "BED OF OYSTERS".

CLASS 14—JEWELRY

FOR BEADS FOR USE IN THE MANUFACTURE OF JEWELRY; BRACELETS; BROOCHES; CHARMS; COSTUME JEWELRY; DIAMOND JEWELRY; GEMSTONE JEWELRY; JEWELRY CHAINS; JEWELRY FOR ATTACHMENT TO CLOTHING; JEWELRY WATCHES; JEWELRY, NAMELY, AMULETS; JEWELRY, NAMELY, ANKLETS; JEWELRY, NAMELY, STONE PENDANTS; RINGS (U.S. CLS. 2, 27, 28 AND 50).

FIRST USE 11-1-2009; IN COMMERCE 11-1-2009.

CLASS 25—CLOTHING

FOR BELTS; EYESHADES; LEATHER BELTS; MUFFLERS; SHOULDER WRAPS; TIES; TOPS; WEARABLE GARMENTS AND CLOTHING, NAMELY, SHIRTS; WRAPS (U.S. CLS. 22 AND 39).

FIRST USE 11-1-2009; IN COMMERCE 11-1-2009.

3,807,728. MOLNLYCKE HEALTH CARE AB, GÖTEBURG, SWEDEN. SN 77-557,219. PUB. 7-14-2009, FILED 8-27-2008.

TUBIGRIP

THE MARK CONSISTS OF STANDARD CHARACTERS WITHOUT CLAIM TO ANY PARTICULAR FONT, STYLE, SIZE, OR COLOR.

OWNER OF ERPN CMNTY TM OFC REG. NO. 861633, DATED 2-18-2000, EXPIRES 6-26-2018.

CLASS 5—PHARMACEUTICALS

FOR MEDICAL AND SURGICAL BANDAGES AND MATERIALS PREPARED FOR BANDAGING (U.S. CLS. 6, 18, 44, 46, 51 AND 52).

FIRST USE 1-0-2009; IN COMMERCE 1-0-2009.

CLASS 10—MEDICAL APPARATUS

FOR TUBULAR BANDAGES FOR COMPRESSION AND SUPPORT PURPOSES (U.S. CLS. 26, 39 AND 44). FIRST USE 1-0-2009; IN COMMERCE 1-0-2009.

3,807,729. NORTHWEST KIDNEY CENTERS, SEATTLE, WA. SN 77-557,451. PUB. 7-21-2009, FILED 8-27-2008.

LIVING WELL WITH CKD

THE MARK CONSISTS OF STANDARD CHARACTERS WITHOUT CLAIM TO ANY PARTICULAR FONT, STYLE, SIZE, OR COLOR.

CLASS 9—ELECTRICAL AND SCIENTIFIC APPARATUS

FOR DOWNLOADABLE ELECTRONIC PUBLICATIONS, NAMELY, BROCHURES AND INFORMATIONAL FLYERS IN THE FIELD OF CHRONIC KIDNEY DISEASE (U.S. CLS. 21, 23, 26, 36 AND 38).

FIRST USE 2-0-2009; IN COMMERCE 2-0-2009.

CLASS 41—EDUCATION AND ENTERTAINMENT

FOR EDUCATIONAL SERVICES, NAMELY, CONDUCTING CLASSES AND SEMINARS IN THE FIELD OF CHRONIC KIDNEY DISEASE AND DISTRIBUTING COURSE MATERIALS IN CONNECTION THEREWITH; DISSEMINATION OF EDUCATIONAL MATERIALS OF OTHERS, NAMELY, BROCHURES, POSTERS, INFORMATIONAL FLYERS, AND TEACHING MATERIALS IN THE FIELD OF CHRONIC KIDNEY DISEASE TO THE PUBLIC AND HEALTHCARE PROVIDERS (U.S. CLS. 100, 101 AND 107).

FIRST USE 7-0-2007; IN COMMERCE 7-0-2007.

3,807,730. BRIGHTSTORM, INC., SAN FRANCISCO, CA. SN 77-557,476. PUB. 9-29-2009, FILED 8-27-2008.

BRIGHTSTORM

THE MARK CONSISTS OF STANDARD CHARACTERS WITHOUT CLAIM TO ANY PARTICULAR FONT, STYLE, SIZE, OR COLOR.

CLASS 9—ELECTRICAL AND SCIENTIFIC APPARATUS

FOR INTERACTIVE MULTIMEDIA COMPUTER GAME PROGRAMS; EDUCATIONAL MULTIMEDIA FILES CONTAINING TEXT RELATING TO MATH, ALGEBRA 1, ALGEBRA 2, GEOMETRY, PRE-CALCULUS, TRIGONOMETRY, READING, WRITING, SCIENCE, BIOLOGY, CHEMISTRY, PHYSICS, CALCULUS, U.S. GOVERNMENT, HISTORY, ECONOMICS, LITERATURE, COLLEGE READINESS, AND COLLEGE ENTRANCE EXAMS (U.S. CLS. 21, 23, 26, 36 AND 38).

FIRST USE 10-21-2008; IN COMMERCE 10-21-2008.

CLASS 35—ADVERTISING AND BUSINESS

FOR ONLINE RETAIL STORE SERVICES FEATURING EDUCATIONAL MATERIALS (U.S. CLS. 100, 101 AND 102).

FIRST USE 10-21-2008; IN COMMERCE 10-21-2008.

CLASS 38—COMMUNICATION

FOR PROVIDING ONLINE FORUMS FOR TRANSMISSION OF MESSAGES AMONG STUDENT, TEACHER AND TUTOR COMPUTER USERS CONCERNING EDUCATIONAL INFORMATION AND CONTENT (U.S. CLS. 100, 101 AND 104).

FIRST USE 10-21-2008; IN COMMERCE 10-21-2008.

CLASS 41—EDUCATION AND ENTERTAINMENT

FOR EDUCATIONAL SERVICES, NAMELY, PROVIDING AN ONLINE WEBSITE FEATURING VIDEO CLASSES, SEMINARS, WORKSHOPS, AND OTHER INSTRUCTIONAL PROGRAMS FOR K-12 AND COLLEGE LEVEL STUDENTS IN THE FIELDS OF MATH, ALGEBRA 1, ALGEBRA 2, GEOMETRY, PRE-CALCULUS, TRIGONOMETRY, READING, WRITING, SCIENCE, BIOLOGY, CHEMISTRY, PHYSICS, CALCULUS, U.S. GOVERNMENT, HISTORY, ECONOMICS, LITERATURE, COLLEGE READINESS, COLLEGE ENTRANCE EXAMS, AND PROVIDING ONLINE EDUCATIONAL MATERIALS AND RESOURCES IN CONNECTION THEREWITH; EDUCATIONAL SERVICES, NAMELY, PROVIDING COURSES OF INSTRUCTION FOR K-12 AND COLLEGE LEVEL STUDENTS, AND DISTRIBUTION OF COURSE MATERIAL THEREWITH; ONLINE JOURNALS, NAMELY, BLOGS FEATURING EDUCATIONAL INFORMATION AND CONTENT POSTED BY STUDENTS, TEACHERS AND TUTORS FOR EDUCATIONAL PURPOSES; EDUCATIONAL SERVICES, NAMELY, PROVIDING AN ONLINE WEBSITE THAT ENCOURAGES AND ALLOWS STUDENTS, TEACHERS AND TUTORS TO CREATE, DESIGN, UPLOAD, DOWNLOAD, POST, SHARE, SEARCH, AND DISTRIBUTE MULTIMEDIA CONTENT, PHOTOS, PICTURES, IMAGES, TEXT, INFORMATION, AND OTHER USER-GENERATED MULTIMEDIA CONTENT FOR EDUCATIONAL PURPOSES; PROVIDING ONLINE COURSES FOR HIGH SCHOOL AND COLLEGE LEARNING; DISTRIBUTING COURSE MATERIALS, NAMELY, INTERACTIVE EDUCATIONAL MULTIMEDIA CONTENT ONLINE IN THE FIELDS OF MATH, ALGEBRA 1, ALGEBRA 2, GEOMETRY, PRE-CALCULUS, TRIGONOMETRY, READING, WRITING, SCIENCE, BIOLOGY, CHEMISTRY, PHYSICS, CALCULUS, U.S. GOVERNMENT, HISTORY, ECONOMICS, LITERATURE, COLLEGE READINESS, COLLEGE ENTRANCE EXAMS, IN CONNECTION WITH ONLINE HIGH SCHOOL COURSES OF INSTRUCTION; DIGITAL VIDEO, AUDIO, AND MULTIMEDIA PUBLISHING SERVICES IN THE FIELD OF EDUCATION; ELECTRONIC PUBLISHING SERVICES, NAMELY, PUBLICATION OF TEXT AND GRAPHIC WORKS OF OTHERS ON-LINE FEATURING EDUCATIONAL CONTENT; ENTERTAINMENT SERVICES, NAMELY, PROVIDING ON-LINE COMPUTER GAMES, AND INTERACTIVE ONLINE MULTIMEDIA GAMES; ENTERTAINMENT SERVICES, NAMELY, PROVIDING ONLINE GAMING IN THE NATURE OF A WEB SITE FEATURING INTERACTIVE MULTIMEDIA COMPUTER GAMES; PROVIDING ONLINE NEWS AND INFORMATION IN THE FIELD OF EDUCATION, COURSEWORK, TUTORING, EDUCATIONAL TESTING, AND EDUCATIONAL GAMES; PROVIDING ONLINE INTERACTIVE MULTIMEDIA COMPUTER GAMES THAT MAY BE ACCESSED NETWORK-WIDE BY NETWORK USERS; ONLINE TUTORING IN THE FIELDS OF MATH, ALGEBRA 1, ALGEBRA 2, GEOMETRY, PRE-CALCULUS, TRIGONOMETRY, READING, WRITING, SCIENCE, BIOLOGY, CHEMISTRY, PHYSICS, CALCULUS, U.S. GOVERNMENT, HISTORY, ECONOMICS, LITERATURE, COLLEGE READINESS, COLLEGE ENTRANCE EXAMS, GRADUATE SCHOOL ENTRANCE EXAMS (U.S. CLS. 100, 101 AND 107).

FIRST USE 10-21-2008; IN COMMERCE 10-21-2008.

CLASS 42—SCIENTIFIC AND COMPUTER SERVICES

FOR COMPUTER SERVICES, NAMELY, CREATING AN ONLINE COMMUNITY FOR REGISTERED STUDENT, TEACHER AND TUTOR USERS TO PARTICIPATE IN DISCUSSIONS, GET FEEDBACK FROM THEIR PEERS, FORM VIRTUAL COMMUNITIES, AND ENGAGE IN SOCIAL NETWORKING FOR EDUCATIONAL PURPOSES; PROVIDING A WEBSITE THAT GIVES STUDENT, TEACHER AND TUTOR COMPUTER USERS THE ABILITY TO CREATE, DESIGN, UPLOAD, DOWNLOAD, POST, SHARE, SEARCH, AND DISTRIBUTE MULTIMEDIA CONTENT, PHOTOS, PICTURES, IMAGES, TEXT, INFORMATION, AND OTHER USER-GENERATED MULTIMEDIA CONTENT FOR EDUCATIONAL PURPOSES (U.S. CLS. 100 AND 101).

FIRST USE 10-21-2008; IN COMMERCE 10-21-2008.

3,807,738. LEVETON-JONES, BARBARA, FT. LAUDERDALE, FL. SN 77-560,123. PUB. 5-12-2009, FILED 9-2-2008.

KOOLIO KOALA CLOTHING LINE

THE MARK CONSISTS OF STANDARD CHARACTERS WITHOUT CLAIM TO ANY PARTICULAR FONT, STYLE, SIZE, OR COLOR.

NO CLAIM IS MADE TO THE EXCLUSIVE RIGHT TO USE "CLOTHING LINE", APART FROM THE MARK AS SHOWN.

CLASS 18—LEATHER GOODS

FOR BACKPACKS (U.S. CLS. 1, 2, 3, 22 AND 41).
FIRST USE 12-18-2008; IN COMMERCE 12-18-2008.

CLASS 25—CLOTHING

FOR CLOTHING, NAMELY, PANTS, SHORTS, SKIRTS, SKORTS, SHIRTS, T-SHIRTS, BLOUSES, AND SHOES FOR MEN, WOMEN AND CHILDREN (U.S. CLS. 22 AND 39).

FIRST USE 12-18-2008; IN COMMERCE 12-18-2008.

3,807,741. BAITH, DONALD W., DBA GREEN LIGHTING SOLUTIONS, BRADENTON, FL. SN 77-560,973. PUB. 1-20-2009, FILED 9-3-2008.



NO CLAIM IS MADE TO THE EXCLUSIVE RIGHT TO USE "GREEN LIGHTING", APART FROM THE MARK AS SHOWN.

THE MARK CONSISTS OF A TREE INSIDE A LIGHT

BULB AND THE WORDS "GREEN LIGHTING SOLUTIONS" OVER THE LIGHT BULB.

3,807,770. THE MONTEVERDI RESIDENCE CLUB, CINCINNATI, OH. SN 77-568,854. PUB. 7-21-2009, FILED 9-12-2008.

CLASS 11—ENVIRONMENTAL CONTROL APPARATUS

FOR LIGHTING FIXTURES (U.S. CLS. 13, 21, 23, 31 AND 34).
FIRST USE 1-30-2009; IN COMMERCE 3-27-2010.

CLASS 37—CONSTRUCTION AND REPAIR

FOR INSTALLATION OF LIGHTING FIXTURES (U.S. CLS. 100, 103 AND 106).
FIRST USE 1-30-2009; IN COMMERCE 3-27-2010.



NO CLAIM IS MADE TO THE EXCLUSIVE RIGHT TO USE "A VAL D'ORCIA", APART FROM THE MARK AS SHOWN.

THE MARK CONSISTS OF AN ARCHWAY POSITIONED OVER THE WORD "MONTEVERDI" WITH THE WORDS "A VAL D'ORCIA" APPEARING BENEATH IN LOWER CASE SCRIPT.

THE ENGLISH TRANSLATION OF "MONTEVERDI A VAL D'ORCIA" IN THE MARK IS "GREEN MOUNTAIN AT THE VALLEY OF ORCIA".

3,807,750. THE READING FOUNDATION, DBA NATIONAL CHILDREN'S READING FOUNDATION, KENNEWICK, WA. SN 77-563,624. PUB. 8-4-2009, FILED 9-5-2008.



The
Children's
Reading
Foundation

CLASS 36—INSURANCE AND FINANCIAL

FOR REAL ESTATE SERVICES, NAMELY, BROKERAGE OF MEMBERSHIPS IN PRIVATE RESIDENCE CLUBS (U.S. CLS. 100, 101 AND 102).
FIRST USE 7-1-2009; IN COMMERCE 7-1-2009.

CLASS 37—CONSTRUCTION AND REPAIR

FOR REAL ESTATE DEVELOPMENT (U.S. CLS. 100, 103 AND 106).
FIRST USE 7-1-2009; IN COMMERCE 7-1-2009.

3,807,777. ADCO PRODUCTS, INC., MICHIGAN CENTER, MI. SN 77-571,116. PUB. 7-21-2009, FILED 9-16-2008.

HelioBond

NO CLAIM IS MADE TO THE EXCLUSIVE RIGHT TO USE "THE CHILDREN'S READING FOUNDATION", APART FROM THE MARK AS SHOWN.

THE MARK CONSISTS OF A STICK FORM HUMAN ADULT READING A BOOK TO A STICK FORM HUMAN CHILD AND THE STYLIZED WORDING "THE CHILDREN'S READING FOUNDATION".

THE MARK CONSISTS OF STANDARD CHARACTERS WITHOUT CLAIM TO ANY PARTICULAR FONT, STYLE, SIZE, OR COLOR.

CLASS 16—PAPER GOODS AND PRINTED MATTER

FOR PRINTED EDUCATIONAL PUBLICATIONS, NAMELY, BOOKS, BOOKLETS, MANUALS, PAMPHLETS, BROCHURES AND ARTICLES RELATING TO READING, READING PROFICIENCY, AND TECHNIQUES FOR TEACHING READING TO CHILDREN (U.S. CLS. 2, 5, 22, 23, 29, 37, 38 AND 50).
FIRST USE 8-1-2008; IN COMMERCE 3-22-2009.

CLASS 1—CHEMICALS

FOR ADHESIVES FOR USE IN THE CONSTRUCTION AND INSTALLATION OF SOLAR MODULES AND PHOTO-VOLTAIC ASSEMBLIES (U.S. CLS. 1, 5, 6, 10, 26 AND 46).
FIRST USE 5-28-2008; IN COMMERCE 5-28-2008.

CLASS 41—EDUCATION AND ENTERTAINMENT

FOR PROVIDING EDUCATIONAL INFORMATION IN THE FIELDS OF READING, READING PROFICIENCY, AND TECHNIQUES FOR TEACHING READING TO CHILDREN (U.S. CLS. 100, 101 AND 107).
FIRST USE 8-1-2008; IN COMMERCE 3-22-2009.

CLASS 17—RUBBER GOODS

FOR ADHESIVE SEALANTS FOR USE IN THE CONSTRUCTION OF SOLAR MODULES AND PHOTO-VOLTAIC ASSEMBLIES (U.S. CLS. 1, 5, 12, 13, 35 AND 50).
FIRST USE 5-28-2008; IN COMMERCE 5-28-2008.

3,807,783. THE EXECUTIVE DEN MENS HAIRSTYLIST LLC, NEW YORK, NY. SN 77-572,347. PUB. 8-4-2009, FILED 9-17-2008.

3,807,789. DFINE, INC., SAN JOSE, CA. SN 77-574,975. PUB. 2-10-2009, FILED 9-20-2008.

REBUILDING CONFIDENCE ONE
HAIR AT A TIME

DFine

THE MARK CONSISTS OF STANDARD CHARACTERS WITHOUT CLAIM TO ANY PARTICULAR FONT, STYLE, SIZE, OR COLOR.

THE MARK CONSISTS OF STANDARD CHARACTERS WITHOUT CLAIM TO ANY PARTICULAR FONT, STYLE, SIZE, OR COLOR.

CLASS 40—MATERIAL TREATMENT

FOR CUSTOM MANUFACTURE AND FITTING OF HAIR PROSTHESES TO THE SCALP TO CORRECT HAIR LOSS (U.S. CLS. 100, 103 AND 106).
FIRST USE 9-30-2008; IN COMMERCE 9-30-2008.

CLASS 5—PHARMACEUTICALS

FOR BONE CEMENT HAVING ADJUSTABLE VISCOSITY (U.S. CLS. 6, 18, 44, 46, 51 AND 52).
FIRST USE 7-1-2004; IN COMMERCE 6-1-2008.

CLASS 42—SCIENTIFIC AND COMPUTER SERVICES

FOR CUSTOM DESIGN OF HAIR PROSTHESES TO THE SCALP TO CORRECT HAIR LOSS (U.S. CLS. 100 AND 101).
FIRST USE 9-30-2008; IN COMMERCE 9-30-2008.

CLASS 10—MEDICAL APPARATUS

FOR MEDICAL AND SURGICAL INSTRUMENTS, NAMELY, CUTTING TOOLS, OSTEOTOMES, AND STYLETTS, USED FOR CUTTING BONE; SURGICAL ACCESS DEVICES, NAMELY, CANNULAE AND INTRODUCERS; SURGICAL HYDRAULIC INJECTION APPARATUS, NAMELY, A HYDRAULIC PRESSURE SOURCE AND LINE, BONE CEMENT RESERVOIR AND BONE CEMENT INJECTOR, AND TOOLS FOR FILLING VOIDS IN BONES; SURGICAL APPARATUS, NAMELY, CONTROLLERS, HEATING ELEMENTS, AND SYSTEMS COMPRISED OF AN ENERGY SOURCE AND THERMAL EMITTER FOR CONTROLLING VISCOSITY OF ENERGY RESPONSIVE BONE CEMENT FOR USE IN SURGICAL PROCEDURES (U.S. CLS. 26, 39 AND 44).
FIRST USE 7-1-2004; IN COMMERCE 6-1-2008.

3,807,788. ECOPAY, LOS ANGELES, CA. SN 77-573,906. PUB. 2-10-2009, FILED 9-19-2008.

ecopay

THE COLOR(S) GREEN IS/ARE CLAIMED AS A FEATURE OF THE MARK.

THE MARK CONSISTS OF "ECOPAY" IN THE COLOR OF GRASS GREEN IN ALL LOWER CASE LETTERS IN THE TAHOMA FONT STYLE PRINT.

3,807,792. THE EXECUTIVE DEN MENS HAIRSTYLIST LLC, NEW YORK, NY. SN 77-576,208. PUB. 8-4-2009, FILED 9-23-2008.

 yourHAIRx
Prescription for natural looking hair.
by Joseph Paris

CLASS 36—INSURANCE AND FINANCIAL

FOR CREDIT CARD AND PAYMENT CARD SERVICES; CREDIT CARD PAYMENT PROCESSING SERVICES; CREDIT CARD TRANSACTION PROCESSING SERVICES (U.S. CLS. 100, 101 AND 102).
FIRST USE 1-10-2009; IN COMMERCE 6-1-2009.

OWNER OF U.S. REG. NO. 3,486,840.
THE NAME "JOSEPH PARIS" IDENTIFIES A LIVING INDIVIDUAL WHOSE CONSENT IS OF RECORD.

THE MARK CONSISTS OF THE WORD "YOURHAIRX" WITH THE LETTER "X" CONSISTING OF A LINE INTERSECTING THE EXTENDED RIGHT ARM OF THE LETTER "R". DIRECTLY BELOW THE WORD "YOURHAIRX" ARE THE WORDS "YOUR PRESCRIPTION FOR NATURAL LOOKING HAIR." IN SMALLER SIZE FONT. BELOW AND OFF-SET TO THE RIGHT OF THE WORDS "YOUR PRESCRIPTION FOR NATURAL LOOKING HAIR." ARE THE WORDS "BY JOSEPH PARIS". DIRECTLY TO THE LEFT OF THE WORDS "YOURHAIRX" AND "YOUR PRESCRIPTION FOR NATURAL LOOKING HAIR." IS A SWIRL-SHAPED DESIGN.

CLASS 42—SCIENTIFIC AND COMPUTER SERVICES

FOR PROVIDING A WEB-SITE FEATURING ENVIRONMENTAL INFORMATION ABOUT CLIMATE CHANGE AND BIO-DIVERSITY; PROVIDING TECHNOLOGICAL AND SCIENTIFIC INFORMATION ABOUT ENVIRONMENTALLY-CONSCIOUS AND GREEN INNOVATIONS; PROVIDING TECHNOLOGICAL INFORMATION ABOUT ENVIRONMENTALLY-CONSCIOUS AND GREEN INNOVATIONS; RESEARCH IN THE FIELD OF ENVIRONMENTAL PROTECTION (U.S. CLS. 100 AND 101).
FIRST USE 1-10-2009; IN COMMERCE 6-1-2009.

CLASS 10—MEDICAL APPARATUS

FOR HAIR PROSTHESES FOR MEDICAL HAIR LOSS (U.S. CLS. 26, 39 AND 44).
FIRST USE 9-30-2008; IN COMMERCE 9-30-2008.

CLASS 40—MATERIAL TREATMENT

FOR CUSTOM MANUFACTURE AND FITTING OF HAIR PROSTHESES TO THE SCALP TO CORRECT HAIR LOSS (U.S. CLS. 100, 103 AND 106).

FIRST USE 9-30-2008; IN COMMERCE 9-30-2008.

CLASS 42—SCIENTIFIC AND COMPUTER SERVICES

FOR CUSTOM DESIGN OF HAIR PROSTHESES TO THE SCALP TO CORRECT HAIR LOSS (U.S. CLS. 100 AND 101).

FIRST USE 9-30-2008; IN COMMERCE 9-30-2008.

3,807,796. HEALTHWON, INC., WILLIAMSVILLE, NY. SN 77-577,310. PUB. 7-21-2009, FILED 9-24-2008.

HEALTHPOWERWON

THE MARK CONSISTS OF STANDARD CHARACTERS WITHOUT CLAIM TO ANY PARTICULAR FONT, STYLE, SIZE, OR COLOR.

CLASS 35—ADVERTISING AND BUSINESS

FOR BUSINESS MARKETING SERVICES, NAMELY, PROVIDING CONSUMER MARKETING INFORMATION AND ANALYSIS OF HEALTH CARE PRICING AND HEALTH CARE PRICING AND HEALTH CARE QUALITY FOR COMMERCIAL PURPOSES VIA THE INTERNET (U.S. CLS. 100, 101 AND 102).

FIRST USE 11-1-2008; IN COMMERCE 11-1-2008.

CLASS 36—INSURANCE AND FINANCIAL

FOR FINANCIAL INFORMATION AND ADVISORY SERVICES, NAMELY, PROVIDING INFORMATION AND ANALYSIS ABOUT HEALTH SAVINGS ACCOUNTS VIA THE INTERNET (U.S. CLS. 100, 101 AND 102).

FIRST USE 11-1-2008; IN COMMERCE 11-1-2008.

3,807,800. DIMATTIA SOLD RIGHT AUCTION CO., PC, POCOMOKE, MD. SN 77-579,334. PUB. 8-4-2009, FILED 9-26-2008.

THE PAYDIRT PROGRAM

THE MARK CONSISTS OF STANDARD CHARACTERS WITHOUT CLAIM TO ANY PARTICULAR FONT, STYLE, SIZE, OR COLOR.

NO CLAIM IS MADE TO THE EXCLUSIVE RIGHT TO USE "PROGRAM", APART FROM THE MARK AS SHOWN.

CLASS 35—ADVERTISING AND BUSINESS

FOR REAL ESTATE AUCTIONS; REAL ESTATE MARKETING PROGRAM FEATURING AUCTIONS OF PROPERTIES FOR SALE SIMULTANEOUSLY WITH OTHER REAL ESTATE MARKETING SERVICES IN THE FIELDS OF RESIDENTIAL, COMMERCIAL AND AGRICULTURAL PROPERTIES (U.S. CLS. 100, 101 AND 102).

FIRST USE 11-30-2008; IN COMMERCE 11-30-2008.

CLASS 36—INSURANCE AND FINANCIAL

FOR REAL ESTATE BROKERAGE AND CONSULTANCY SERVICES; REAL ESTATE LISTING AND MULTIPLE LISTING SERVICES; PROVIDING REAL ESTATE LISTINGS AND REAL ESTATE INFORMATION VIA THE INTERNET; REAL ESTATE VALUATION (U.S. CLS. 100, 101 AND 102).

FIRST USE 11-30-2008; IN COMMERCE 11-30-2008.

3,807,801. WWP PRODUCTIONS, LLC, PLYMOUTH, MN. SN 77-579,978. PUB. 7-21-2009, FILED 9-26-2008.

Amore & Fede

THE MARK CONSISTS OF STANDARD CHARACTERS WITHOUT CLAIM TO ANY PARTICULAR FONT, STYLE, SIZE, OR COLOR.

THE ENGLISH TRANSLATION OF "AMORE" IN THE MARK IS LOVE. THE ENGLISH TRANSLATION OF "FEDE" IN THE MARK IS FAITH, BELIEF.

CLASS 14—JEWELRY

FOR JEWELRY, NAMELY, BRACELETS, NECKLACES, RINGS, EARRINGS, CUFF-LINKS, ANKLE BRACELETS, CHOKERS, TOE RINGS, BROOCHES, CHARITY BRACELETS, CHARMS, LAPEL PINS, CROSSES; WATCHES; KEY CHAINS; JEWELRY FOR THE HEAD (U.S. CLS. 2, 27, 28 AND 50).

FIRST USE 1-2-2010; IN COMMERCE 1-2-2010.

CLASS 18—LEATHER GOODS

FOR HANDBAGS; WALLETS; TOTE BAGS; BRIEF-CASES; SPORT BAGS; GYM BAGS; BACKPACKS; EVENING HANDBAGS; TRAVEL BAGS; CLUTCHES; COIN PURSES; DUFFLE BAGS; SUITCASES; OVERNIGHT BAGS; WRISTLET BAGS; UMBRELLAS (U.S. CLS. 1, 2, 3, 22 AND 41).

FIRST USE 1-2-2010; IN COMMERCE 1-2-2010.

CLASS 25—CLOTHING

FOR CLOTHING, NAMELY, LONG-SLEEVED TOPS, SHORT-SLEEVED TOPS, BLOUSES, VESTS, BLAZERS, PULLOVERS, SWEATERS, CARDIGANS, SWEAT-SHIRTS, SHIRTS, T-SHIRTS, PANTS, JEANS, CAPRI PANTS, SKIRTS, DRESSES, SHORTS, SOCKS, PAJAMAS, SUITS, JUMPSUITS, LOUNGEWEAR, SKI WEAR, JACKETS, COATS, PARKAS; UNDERCLOTHING, NAMELY, BODICES, CAMISOLES, BRASSIERES, UNDERWEAR; DRESSING GOWNS; BATHROBES; BEACH CLOTHING, NAMELY, BATHING SUITS, COVER UPS, SARONGS; SCARVES, SHAWLS; MITTENS; GLOVES; BELTS; FOOTWEAR, NAMELY, SHOES, BOOTS, SLIPPERS, ATHLETIC SHOES, SANDALS, BEACH SHOES, FLIP FLOPS; HEADWEAR, NAMELY, HATS, EAR BANDS, CAPS, BERETS (U.S. CLS. 22 AND 39).

FIRST USE 1-2-2010; IN COMMERCE 1-2-2010.

3,807,806. LF, LLC, WILMINGTON, DE. SN 77-581,898. PUB. 7-28-2009, FILED 9-30-2008.

FINISH FACTOR

THE MARK CONSISTS OF STANDARD CHARACTERS WITHOUT CLAIM TO ANY PARTICULAR FONT, STYLE, SIZE, OR COLOR.

OWNER OF U.S. REG. NO. 3,382,294.

CLASS 8—HAND TOOLS

FOR HAND TOOLS, NAMELY, UTILITY BLADES AND SCRAPER BLADES USED WITH HAND TOOLS, NAMELY, PAINT TOOLS (U.S. CLS. 23, 28 AND 44).

FIRST USE 4-0-2006; IN COMMERCE 4-0-2006.

CLASS 9—ELECTRICAL AND SCIENTIFIC APPARATUS

FOR SAFETY EQUIPMENT, NAMELY, PROTECTIVE SPRAY SOCKS IN THE NATURE OF HEAD AND NECK SOCK COVERS FOR WEARING OVER THE HEAD AND NECK FOR PROTECTION FROM SPRAYS; PROTECTIVE WORK GLOVES (U.S. CLS. 21, 23, 26, 36 AND 38).

FIRST USE 4-0-2006; IN COMMERCE 4-0-2006.

CLASS 21—HOUSEWARES AND GLASS

FOR CLEANING RAGS; COTTON WIPING CLOTHS; COTTON KNIT CLEANING CLOTHS (U.S. CLS. 2, 13, 23, 29, 30, 33, 40 AND 50).

FIRST USE 4-0-2006; IN COMMERCE 4-0-2006.

CLASS 25—CLOTHING

FOR COVERALLS; POLYPROPYLENE COVERALLS; POLYPROPYLENE SHOE GUARDS, NAMELY, SHOE COVERS (U.S. CLS. 22 AND 39).

FIRST USE 4-0-2006; IN COMMERCE 4-0-2006.

CLASS 6—METAL GOODS

FOR METAL HITCH PINS; METAL WHEEL BOLTS (U.S. CLS. 2, 12, 13, 14, 23, 25 AND 50).

FIRST USE 2-0-2007; IN COMMERCE 2-0-2007.

CLASS 7—MACHINERY

FOR POWER-OPERATED SPRAY GUN KITS COMPRISED OF POWER-OPERATED SPRAY GUNS AND POWER-OPERATED SPRAYER; POWER-OPERATED SPRAY GUNS; MECHANICAL SPREADERS; EARTH MOVING MACHINES, NAMELY, AERATORS; LAWN MOWER ACCESSORIES, NAMELY, BLADE BALANCERS; POWER WASHER ACCESSORIES, NAMELY, NOZZLES FOR POWER WASHERS, PLUGS FOR POWER WASHERS, SOCKETS FOR POWER WASHERS, WASHER TIPS; TUNE-UP KITS COMPRISED OF FUEL FILTERS, FUEL SHUT-OFFS, SPARK PLUGS; AIR FILTERS FOR MECHANICAL PURPOSES; BRUSHES BEING PARTS OF POWER WASHERS; MECHANICAL ENGINE PART FOR LAWN MOWERS, NAMELY, THROTTLE CONTROLS (U.S. CLS. 13, 19, 21, 23, 31, 34 AND 35).

FIRST USE 2-0-2007; IN COMMERCE 2-0-2007.

CLASS 8—HAND TOOLS

FOR LAWN MAINTENANCE EQUIPMENT, NAMELY, LAWN ROLLERS; HAND TOOLS, NAMELY, WRENCHES FOR SPARK PLUGS (U.S. CLS. 23, 28 AND 44).

FIRST USE 2-0-2007; IN COMMERCE 2-0-2007.

CLASS 12—VEHICLES

FOR FARM WAGONS; DUMP CARTS; TIRES; WHEELS (U.S. CLS. 19, 21, 23, 31, 35 AND 44).

FIRST USE 2-0-2007; IN COMMERCE 2-0-2007.

CLASS 17—RUBBER GOODS

FOR HOSES MADE OF RUBBER FOR POWER WASHERS (U.S. CLS. 1, 5, 12, 13, 35 AND 50).

FIRST USE 2-0-2007; IN COMMERCE 2-0-2007.

CLASS 21—HOUSEWARES AND GLASS

FOR TELESCOPING SPRAYER WANDS FOR GARDEN HOSES (U.S. CLS. 2, 13, 23, 29, 30, 33, 40 AND 50).

FIRST USE 2-0-2007; IN COMMERCE 2-0-2007.

3,807,807. LF, LLC, WILMINGTON, DE. SN 77-581,905. PUB. 7-28-2009, FILED 9-30-2008.



THE MARK CONSISTS OF THE STYLIZED LETTERS "PF" IN A SQUARE WITH THE LETTER "P" MADE TO LOOK LIKE A COG AND OVERLAPPING THE LETTER "F".

3,807,812. SOLIS BRANDS, INC., ALTAMONTE SPRINGS, FL. SN 77-583,175. PUB. 7-7-2009, FILED 10-1-2008.



OWNER OF U.S. REG. NO. 3,154,760.

THE COLOR(S) LIGHT BLUE, DARK BLUE AND WHITE IS/ARE CLAIMED AS A FEATURE OF THE MARK.

THE COLOR WHITE APPEARS WITHIN THE WORDS "SUPERC". THE COLOR DARK BLUE APPEARS WITHIN THE OUTLINE OF THE WORDS "SUPERC" AND IN THE OUTLINE OF THE QUADRILATERAL. THE COLOR LIGHT BLUE APPEARS WITHIN THE QUADRILATERAL.

SEC. 2(F) AS TO "SUPER C" .

3,807,831. CONIFER HEALTH SOLUTIONS, INC., DALLAS, TX. SN 77-594,410. PUB. 8-4-2009, FILED 10-16-2008.

CLASS 5—PHARMACEUTICALS

FOR VITAMIN, MINERAL AND HERBAL SUPPLEMENTS (U.S. CLS. 6, 18, 44, 46, 51 AND 52).
FIRST USE 1-0-2005; IN COMMERCE 1-0-2005.

CLASS 32—LIGHT BEVERAGES

FOR BEVERAGES, NAMELY, SOFT DRINKS, POWDERS USED IN THE PREPARATION OF SOFT DRINKS AND FLAVORED WATERS (U.S. CLS. 45, 46 AND 48).
FIRST USE 1-0-2005; IN COMMERCE 1-0-2005.

3,807,817. KISS NAIL PRODUCTS, INC., PORT WASHINGTON, NY. SN 77-584,925. PUB. 2-10-2009, FILED 10-3-2008.

RED BY KISS

THE MARK CONSISTS OF STANDARD CHARACTERS WITHOUT CLAIM TO ANY PARTICULAR FONT, STYLE, SIZE, OR COLOR.

OWNER OF U.S. REG. NOS. 1,759,380, 2,248,495, AND 2,616,120.

CLASS 9—ELECTRICAL AND SCIENTIFIC APPARATUS

FOR ELECTRIC FLAT IRONS; ELECTRIC HAIR CURLING IRONS (U.S. CLS. 21, 23, 26, 36 AND 38).
FIRST USE 2-18-2008; IN COMMERCE 2-18-2008.

CLASS 11—ENVIRONMENTAL CONTROL APPARATUS

FOR HAIR DRYERS (U.S. CLS. 13, 21, 23, 31 AND 34).
FIRST USE 6-11-2007; IN COMMERCE 6-11-2007.

3,807,819. PREMIERE FIBERS, INC., ANSONVILLE, NC. SN 77-585,934. PUB. 1-13-2009, FILED 10-6-2008.

ECO INNOVATION FIBER

THE MARK CONSISTS OF STANDARD CHARACTERS WITHOUT CLAIM TO ANY PARTICULAR FONT, STYLE, SIZE, OR COLOR.

NO CLAIM IS MADE TO THE EXCLUSIVE RIGHT TO USE "FIBER", APART FROM THE MARK AS SHOWN.

CLASS 22—CORDAGE AND FIBERS

FOR SYNTHETIC AND TEXTILE FIBERS (U.S. CLS. 1, 2, 7, 19, 22, 42 AND 50).
FIRST USE 3-8-2010; IN COMMERCE 3-8-2010.

CLASS 23—YARNS AND THREADS

FOR YARNS (U.S. CL. 43).
FIRST USE 3-8-2010; IN COMMERCE 3-8-2010.

CONIFER REVENUE CYCLE SOLUTIONS

THE MARK CONSISTS OF STANDARD CHARACTERS WITHOUT CLAIM TO ANY PARTICULAR FONT, STYLE, SIZE, OR COLOR.

NO CLAIM IS MADE TO THE EXCLUSIVE RIGHT TO USE "REVENUE CYCLE SOLUTIONS", APART FROM THE MARK AS SHOWN.

CLASS 35—ADVERTISING AND BUSINESS

FOR BUSINESS CONSULTING, BUSINESS MANAGEMENT AND OUTSOURCING SERVICES IN THE FIELD OF REVENUE CYCLE MANAGEMENT AND SERVICES PROVIDED IN THE FIELD OF HEALTHCARE, PROVIDED BY HOSPITALS, AMBULATORY SERVICE CENTERS, DIAGNOSTIC SERVICE CENTERS, PHYSICIAN PRACTICES AND OTHER HEALTHCARE FACILITIES; PATIENT ACCOUNT MANAGEMENT SERVICES, NAMELY, MEDICAL ACCOUNTS RECEIVABLES SERVICES; COST MANAGEMENT SERVICES FOR HEALTH CARE PROVIDERS AND FACILITIES; REVIEW OF PAYMENT ARRANGEMENTS TO HEALTHCARE PROVIDERS AND HEALTH CARE PROFESSIONAL GROUPS FROM HEALTHCARE AND NON-HEALTHCARE RELATED PAYORS (U.S. CLS. 100, 101 AND 102).
FIRST USE 11-0-2008; IN COMMERCE 11-0-2008.

CLASS 36—INSURANCE AND FINANCIAL

FOR PATIENT ACCOUNT MANAGEMENT SERVICES, NAMELY, COLLECTION OF DEBTS SERVICES; FINANCIAL CONSULTING SERVICES RELATED TO ENHANCING REVENUE CYCLE SERVICES PROVIDED IN THE FIELD OF HEALTHCARE; CLAIMS ADMINISTRATION SERVICES IN THE FIELD OF HEALTH INSURANCE; ADMINISTRATION OF PATIENT ASSISTANCE ELIGIBILITY PROGRAMS FOR HEALTH CARE BENEFITS AND CLAIMS; PROVIDING PATIENT ELIGIBILITY ASSISTANCE SERVICES, NAMELY, DETERMINING ELIGIBILITY FOR HEALTH BENEFITS AND FUNDING; ENTITLEMENT FUNDING SERVICES, NAMELY, PROVIDING GUIDANCE TO PATIENTS NECESSITATING FUNDING FOR HEALTHCARE (U.S. CLS. 100, 101 AND 102).

FIRST USE 11-0-2008; IN COMMERCE 11-0-2008.

3,807,836. FLYING HORSE COMMUNICATION, INC., BOZEMAN, MT. SN 77-596,120. PUB. 3-10-2009, FILED 10-20-2008.

FLYING HORSE COMMUNICATION

OWNER OF U.S. REG. NOS. 3,314,206 AND 3,320,933.
NO CLAIM IS MADE TO THE EXCLUSIVE RIGHT TO USE "COMMUNICATION", APART FROM THE MARK AS SHOWN.

THE MARK CONSISTS OF THE WORDS "FLYING HORSE" WITH THE "R" IN THE SHAPE OF A HORSE HEAD AND THE WORD "COMMUNICATION" UNDERNEATH THE WORDS "FLYING HORSE".

CLASS 35—ADVERTISING AND BUSINESS

FOR BUSINESS ORGANIZATION AND MANAGEMENT CONSULTING SERVICES; BUSINESS MARKETING CONSULTING SERVICES; ADVERTISING, MARKETING AND PROMOTION SERVICES; MARKET RESEARCH; PUBLIC RELATIONS; GOVERNMENT RELATIONS SERVICES, NAMELY, PROVIDING ADVICE AND ASSISTANCE TO COMMERCIAL ENTITIES RELATING TO THE ESTABLISHMENT AND MAINTENANCE OF BUSINESS AND CONTRACTUAL RELATIONSHIPS WITH FEDERAL, STATE, AND LOCAL GOVERNMENTS; BRAND CONCEPT, BRAND DEVELOPMENT, AND BRAND MANAGEMENT SERVICES FOR CLIENTS; BUSINESS MANAGEMENT, NAMELY, STRATEGIC PLANNING FOR PUBLIC AND PRIVATE SECTOR CLIENTS; BUSINESS MARKETING SERVICES IN THE FIELD OF FILMS AND TELEVISION PROGRAMS (U.S. CLS. 100, 101 AND 102).

FIRST USE 12-31-2008; IN COMMERCE 12-31-2008.

CLASS 41—EDUCATION AND ENTERTAINMENT

FOR MOTION PICTURE FILM PRODUCTION; PRODUCTION OF TELEVISION PROGRAMS FOR OTHERS; DISTRIBUTION OF FILMS AND TELEVISION PROGRAMS FOR OTHERS (U.S. CLS. 100, 101 AND 107).

FIRST USE 12-31-2008; IN COMMERCE 12-31-2008.

CLASS 42—SCIENTIFIC AND COMPUTER SERVICES

FOR DESIGN AND CREATION OF WEBSITES FOR OTHERS; GRAPHIC DESIGN SERVICES (U.S. CLS. 100 AND 101).

FIRST USE 12-31-2008; IN COMMERCE 12-31-2008.

3,807,837. CHICKADVISOR INC., TORONTO, CANADA. SN 77-596,152. PUB. 11-10-2009, FILED 10-20-2008.

CHICKADVISOR

THE MARK CONSISTS OF STANDARD CHARACTERS WITHOUT CLAIM TO ANY PARTICULAR FONT, STYLE, SIZE, OR COLOR.

PRIORITY CLAIMED UNDER SEC. 44(D) ON CANADA APPLICATION NO. 1392437, FILED 4-22-2008, REG. NO. TMA741092, DATED 5-28-2009, EXPIRES 5-28-2024.

CLASS 9—ELECTRICAL AND SCIENTIFIC APPARATUS

FOR PRE-RECORDED VIDEO TAPES CONTAINING ENTERTAINMENT, NAMELY, TELEVISION PROGRAMS FEATURING INFORMATION ON TOPICS OF GENERAL INTEREST TO WOMEN IN THE FIELDS OF BEAUTY, SHOPPING, WELLNESS AND DINING (U.S. CLS. 21, 23, 26, 36 AND 38).

FIRST USE 6-22-2007; IN COMMERCE 6-22-2007.

CLASS 35—ADVERTISING AND BUSINESS

FOR PROVIDING AN ONLINE DIRECTORY INFORMATION SERVICE FEATURING INFORMATION RELATING TO PRODUCTS AND SERVICES OF OTHERS IN THE FIELDS OF BEAUTY, WELLNESS, SHOPPING AND RESTAURANTS; PROVIDING AN ONLINE DIRECTORY INFORMATION SERVICE FEATURING INFORMATION RELATING TO VIRTUAL COMMUNITY AND SOCIAL NETWORKING IN THE FIELDS OF BEAUTY, WELLNESS, SHOPPING AND RESTAURANTS; PROVIDING LINKS TO THE WEBSITES OF MERCHANTS; OPERATION OF AN INTERNET WEBSITE OFFERING INFORMATION ON THE PRODUCTS AND SERVICES OF OTHERS IN THE FIELDS OF BEAUTY, WELLNESS, SHOPPING AND RESTAURANTS; OPERATION OF A BLOG DIRECTORY; ADVERTISING THE PRODUCTS AND SERVICES OF OTHERS OVER THE INTERNET (U.S. CLS. 100, 101 AND 102).

FIRST USE 9-2-2006; IN COMMERCE 9-2-2006.

CLASS 38—COMMUNICATION

FOR INTERACTIVE ELECTRONIC COMMUNICATION SERVICES, NAMELY, AN INTERACTIVE CHAT ROOM AND BULLETIN BOARD FEATURING ONLINE REVIEWS POSTED BY CONSUMERS, AND AN INTERACTIVE CHAT ROOM AND BULLETIN BOARD FOR THE POSTING OF INFORMATION AND EXCHANGING OF MESSAGES RELATING TO PRODUCTS AND SERVICES OF OTHERS IN THE FIELDS OF BEAUTY, WELLNESS, SHOPPING AND RESTAURANTS; INTERACTIVE ELECTRONIC COMMUNICATION SERVICES, NAMELY, AN INTERACTIVE CHAT ROOM AND BULLETIN BOARD FEATURING AN ONLINE DISCUSSION FORUM FOR CONSUMERS; VIDEO BROADCASTING SERVICES OVER THE INTERNET, NAMELY, UPLOADING, POSTING, SHOWING, DISPLAYING, TAGGING AND ELECTRONICALLY TRANSMITTING INFORMATION AND VIDEO CLIPS (U.S. CLS. 100, 101 AND 104).

FIRST USE 12-3-2006; IN COMMERCE 12-3-2006.

CLASS 41—EDUCATION AND ENTERTAINMENT

FOR CONDUCTING AND ADMINISTERING CONTESTS WHEREBY GIFT CERTIFICATES OR FREE PRODUCTS ARE PROVIDED TO CONTEST WINNERS IN EXCHANGE FOR PRODUCT REVIEWS FROM CONTEST ENTRANTS; OPERATION OF AN INTERNET BLOG, NAMELY, A BLOG FEATURING ARTICLES ON TOPICS OF GENERAL INTEREST TO WOMEN IN THE FIELDS OF BEAUTY, WELLNESS, SHOPPING AND RESTAURANTS; ENTERTAINMENT SERVICES, NAMELY, DEVELOPMENT, PRODUCTION AND DISTRIBUTION OF TELEVISION SHOWS; ARRANGING AND CONDUCTING SHOPPING EVENTS FEATURING GUIDED SHOPPING, DISCOUNTS, PROMOTIONAL GIVEAWAYS, COCKTAIL PARTIES AND/OR BEAUTY MAKEOVERS; PROVIDING INFORMATION VIA ELECTRONIC PUBLICATIONS, NAMELY, NEWSLETTERS, RELATING TO PRODUCTS AND SERVICES OF OTHERS IN THE FIELDS OF BEAUTY, WELLNESS, SHOPPING AND RESTAURANTS (U.S. CLS. 100, 101 AND 107).

FIRST USE 6-14-2006; IN COMMERCE 6-14-2006.

3,807,849. ARTIST J, LLC, GROVETOWN, GA. SN 77-602,318.
PUB. 3-17-2009, FILED 10-28-2008.

3,807,901. GUIDE DOGS OF THE DESERT, PALM SPRINGS,
CA. SN 77-641,533. PUB. 12-15-2009, FILED 12-30-2008.



NO CLAIM IS MADE TO THE EXCLUSIVE RIGHT TO USE "ARTIST" AND "ART", APART FROM THE MARK AS SHOWN.

"ARTIST J" IS NOT THE NAME OF ANY LIVING INDIVIDUAL.

THE COLOR(S) RED, WHITE AND BLUE IS/ARE CLAIMED AS A FEATURE OF THE MARK.

THE MARK CONSISTS OF A RED STAR OVER A BLUE 3/4 CIRCLE-LIKE SYMBOL WITH THE WORDS "ARTIST J", "PROFOUND ART" IN WHITE WITH A FONT STYLE OF PAPYRUS.

CLASS 16—PAPER GOODS AND PRINTED MATTER

FOR ART PICTURES; DRAWINGS (U.S. CLS. 2, 5, 22, 23, 29, 37, 38 AND 50).
FIRST USE 10-1-2008; IN COMMERCE 6-1-2009.

CLASS 25—CLOTHING

FOR ATHLETIC APPAREL, NAMELY, SHIRTS, PANTS, JACKETS, FOOTWEAR, HATS AND CAPS, ATHLETIC UNIFORMS; BERMUDA SHORTS; BOARD SHORTS; BOMBER JACKETS; BOXER SHORTS; BRIEFS; DENIM JACKETS; FLEECE SHORTS; GOLF SHIRTS; GYM SHORTS; JACKETS; LADIES' UNDERWEAR; LEATHER JACKETS; LONG JACKETS; LONG-SLEEVED SHIRTS; MEN'S AND WOMEN'S JACKETS, COATS, TROUSERS, VESTS; MOISTURE-WICKING SPORTS SHIRTS; NIGHT SHIRTS; OPEN-NECKED SHIRTS; PANTIES; PANTIES, SHORTS AND BRIEFS; POLO SHIRTS; RAIN JACKETS; REVERSIBLE JACKETS; RUGBY SHIRTS; RUGBY SHORTS; SCIENTIFIC AND TECHNOLOGICAL APPAREL, NAMELY, SHIRTS, PANTS, JACKETS, FOOTWEAR, HATS AND CAPS, UNIFORMS; SHIRTS; SHORTS; SKI JACKETS; SLEEP SHIRTS; SLEEVED OR SLEEVELESS JACKETS; SLIDING SHORTS; SPORTS JACKETS; SPORTS SHIRTS; SPORTS SHIRTS WITH SHORT SLEEVES; SWEAT JACKETS; SWEAT SHIRTS; SWEAT SHORTS; SWIMWEAR; T-SHIRTS; THONGS; TRIATHLON CLOTHING, NAMELY, TRIATHLON TIGHTS, TRIATHLON SHORTS, TRIATHLON SINGLET, TRIATHLON SHIRTS, TRIATHLON SUITS; UNDERWEAR; UNDERWEAR, NAMELY, BOY SHORTS; WALKING SHORTS; WEARABLE GARMENTS AND CLOTHING, NAMELY, SHIRTS; WIND RESISTANT JACKETS; WIND SHIRTS; WIND-JACKETS; WOMEN'S UNDERWEAR; YOGA SHIRTS (U.S. CLS. 22 AND 39).
FIRST USE 10-1-2008; IN COMMERCE 6-1-2009.

GUIDE DOG DEPOT

THE MARK CONSISTS OF STANDARD CHARACTERS WITHOUT CLAIM TO ANY PARTICULAR FONT, STYLE, SIZE, OR COLOR.

NO CLAIM IS MADE TO THE EXCLUSIVE RIGHT TO USE "GUIDE DOG" IN CLASSES 035 AND 041, APART FROM THE MARK AS SHOWN.

CLASS 25—CLOTHING

FOR CLOTHING, NAMELY, SHIRTS (U.S. CLS. 22 AND 39).
FIRST USE 4-9-2008; IN COMMERCE 4-20-2008.

CLASS 35—ADVERTISING AND BUSINESS

FOR RETAIL STORE SERVICES FEATURING PET TOYS, ACCESSORIES, FOOD, AND CLOTHING; PROMOTING THE PUBLIC AWARENESS ABOUT THE NEEDS OF BLIND AND VISUALLY IMPAIRED PERSONS (U.S. CLS. 100, 101 AND 102).
FIRST USE 9-30-2008; IN COMMERCE 9-30-2008.

CLASS 41—EDUCATION AND ENTERTAINMENT

FOR EDUCATIONAL SERVICES, NAMELY, TRAINING DOGS TO SERVE AS GUIDE DOGS FOR ASSISTING BLIND AND VISUALLY IMPAIRED PERSONS; TRAINING BLIND AND VISUALLY IMPAIRED PERSONS IN THE USE OF GUIDE DOGS; AND ARRANGING, ORGANIZING AND CONDUCTING SEMINARS, LECTURES, AND TRAINING REGARDING THE USE OF GUIDE DOGS BY BLIND AND VISUALLY IMPAIRED PERSONS (U.S. CLS. 100, 101 AND 107).
FIRST USE 4-9-2008; IN COMMERCE 4-9-2008.

3,807,905. SPARK OFF ROSE, LLC, SANTA MONICA, CA.
SN 77-644,082. PUB. 7-14-2009, FILED 1-6-2009.

SPARK OFF ROSE

THE MARK CONSISTS OF STANDARD CHARACTERS WITHOUT CLAIM TO ANY PARTICULAR FONT, STYLE, SIZE, OR COLOR.

CLASS 9—ELECTRICAL AND SCIENTIFIC APPARATUS

FOR DIGITAL MEDIA, NAMELY, DOWNLOADABLE AUDIO RECORDINGS FEATURING RECORDINGS OF LIVE STORYTELLING PERFORMANCES (U.S. CLS. 21, 23, 26, 36 AND 38).
FIRST USE 12-6-2009; IN COMMERCE 12-6-2009.

CLASS 41—EDUCATION AND ENTERTAINMENT

FOR ENTERTAINMENT SERVICES IN THE NATURE OF PRESENTING AND CONDUCTING LIVE STORYTELLING EVENTS AND EDUCATIONAL SERVICES IN THE NATURE OF CONDUCTING WORKSHOPS, CLASSES AND SEMINARS FOR THE PURPOSE OF TEACHING STORYTELLING TECHNIQUES (U.S. CLS. 100, 101 AND 107).

FIRST USE 1-12-2009; IN COMMERCE 1-12-2009.

3,807,919. MAXIM INTEGRATED PRODUCTS, INC., SUNNYVALE, CA. SN 77-648,894. PUB. 4-7-2009, FILED 1-14-2009.

INNOVATION DELIVERED

THE MARK CONSISTS OF STANDARD CHARACTERS WITHOUT CLAIM TO ANY PARTICULAR FONT, STYLE, SIZE, OR COLOR.

CLASS 9—ELECTRICAL AND SCIENTIFIC APPARATUS

FOR INTEGRATED CIRCUITS (U.S. CLS. 21, 23, 26, 36 AND 38).

FIRST USE 12-7-2009; IN COMMERCE 12-7-2009.

CLASS 35—ADVERTISING AND BUSINESS

FOR COMPUTERIZED ON-LINE ORDERING SERVICES IN THE FIELD OF SEMICONDUCTORS AND INTEGRATED CIRCUITS (U.S. CLS. 100, 101 AND 102).

FIRST USE 2-17-2009; IN COMMERCE 3-22-2009.

3,807,925. BOYMOM, LLC, DALLAS, TX. SN 77-651,713. PUB. 5-5-2009, FILED 1-17-2009.

BOYMOM

THE MARK CONSISTS OF STANDARD CHARACTERS WITHOUT CLAIM TO ANY PARTICULAR FONT, STYLE, SIZE, OR COLOR.

OWNER OF U.S. REG. NO. 3,347,486.

CLASS 14—JEWELRY

FOR JEWELRY, NAMELY, PENDANTS, NECKLACES, BRACELETS, WATCHES, CUFF LINKS, TIE PINS, BROOCHES AND RINGS (U.S. CLS. 2, 27, 28 AND 50).

FIRST USE 7-1-2006; IN COMMERCE 7-1-2009.

CLASS 16—PAPER GOODS AND PRINTED MATTER

FOR PAPER AND PRINTED MATTER, NAMELY, PHOTOGRAPHS AND STATIONERY; ADHESIVES FOR STATIONERY OR HOUSEHOLD PURPOSES; PLASTIC BAGS FOR PACKAGING; PAPER SACKS AND BAGS (U.S. CLS. 2, 5, 22, 23, 29, 37, 38 AND 50).

FIRST USE 7-1-2006; IN COMMERCE 7-1-2009.

3,807,928. T.F.H. PUBLICATIONS, INC., NEPTUNE CITY, NJ. SN 77-654,489. PUB. 5-5-2009, FILED 1-22-2009.

CHEW SOLUTIONS

THE MARK CONSISTS OF STANDARD CHARACTERS WITHOUT CLAIM TO ANY PARTICULAR FONT, STYLE, SIZE, OR COLOR.

NO CLAIM IS MADE TO THE EXCLUSIVE RIGHT TO USE "CHEW", APART FROM THE MARK AS SHOWN.

CLASS 28—TOYS AND SPORTING GOODS

FOR PET TOYS (U.S. CLS. 22, 23, 38 AND 50).

FIRST USE 3-17-2010; IN COMMERCE 3-17-2010.

CLASS 31—NATURAL AGRICULTURAL PRODUCTS

FOR EDIBLE PET CHEWS (U.S. CLS. 1 AND 46).

FIRST USE 3-17-2010; IN COMMERCE 3-17-2010.

3,807,954. HAYSE BLACK, LLC, NEW YORK, NY. SN 77-670,203. PUB. 7-21-2009, FILED 2-13-2009.

HAYSE BLACK

THE MARK CONSISTS OF STANDARD CHARACTERS WITHOUT CLAIM TO ANY PARTICULAR FONT, STYLE, SIZE, OR COLOR.

THE NAME(S), PORTRAIT(S), AND/OR SIGNATURE(S) SHOWN IN THE MARK DOES NOT IDENTIFY A PARTICULAR LIVING INDIVIDUAL.

CLASS 18—LEATHER GOODS

FOR PET LEASHES AND COLLARS (U.S. CLS. 1, 2, 3, 22 AND 41).

FIRST USE 8-25-2009; IN COMMERCE 8-25-2009.

CLASS 20—FURNITURE AND ARTICLES NOT OTHERWISE CLASSIFIED

FOR PET BEDS (U.S. CLS. 2, 13, 22, 25, 32 AND 50).

FIRST USE 8-25-2009; IN COMMERCE 8-25-2009.

CLASS 21—HOUSEWARES AND GLASS

FOR PET FOOD BOWLS (U.S. CLS. 2, 13, 23, 29, 30, 33, 40 AND 50).
FIRST USE 8-25-2009; IN COMMERCE 8-25-2009.

CLASS 28—TOYS AND SPORTING GOODS

FOR TOYS FOR DOMESTIC PETS, NAMELY, TENNIS BALLS (U.S. CLS. 22, 23, 38 AND 50).
FIRST USE 8-25-2009; IN COMMERCE 8-25-2009.

3,807,962. 7029713 CANADA INC., TORONTO, ONTARIO, CANADA. SN 77-672,059. PUB. 12-29-2009, FILED 2-17-2009.



THE MARK CONSISTS OF THE STYLIZED WORD "NAIL" FOLLOWED BY TWO OVALS DEPICTING A TARGET FOLLOWED BY THE STYLIZED WORD "IT".

CLASS 35—ADVERTISING AND BUSINESS

FOR MARKETING SERVICES, NAMELY, MARKETING CONSULTING, MARKETING PLAN DEVELOPMENT AND CONSUMER MARKETING RESEARCH; BRANDING SERVICES, NAMELY, BRAND IMAGERY CONSULTING SERVICES AND CREATING CORPORATE AND BRAND IDENTITY FOR OTHERS; ADVERTISING SERVICES; BUSINESS MANAGING CONSULTING AND BUSINESS MARKETING CONSULTING SERVICES IN THE FIELD OF MANAGEMENT AND MARKETING OF INTELLECTUAL PROPERTY ASSETS OF OTHERS, INCLUDING INVENTIONS, PATENTS, PATENT APPLICATIONS, TRADEMARKS, COPYRIGHTS AND TRADE SECRETS; PROVIDING STRATEGIC MARKET RESEARCH TO OTHERS (U.S. CLS. 100, 101 AND 102).
FIRST USE 10-6-2008; IN COMMERCE 12-14-2009.

CLASS 42—SCIENTIFIC AND COMPUTER SERVICES

FOR GRAPHIC DESIGN SERVICES; WEB SITE DESIGN SERVICES; INDUSTRIAL DESIGN SERVICES (U.S. CLS. 100 AND 101).
FIRST USE 10-6-2008; IN COMMERCE 12-14-2009.

3,807,963. CRESCENT FROG, DBA DILLON WALSH CREATIVE, WILMINGTON, VT. SN 77-673,239. PUB. 8-4-2009, FILED 2-18-2009.



NO CLAIM IS MADE TO THE EXCLUSIVE RIGHT TO USE "KILLINGTON VERMONT", APART FROM THE MARK AS SHOWN.

THE COLOR(S) GREEN, BLUE, PURPLE AND YELLOW IS/ARE CLAIMED AS A FEATURE OF THE MARK.

THE MARK CONSISTS OF A DESIGN OF A GREEN MOUNTAIN AND BLUE REFLECTED WATER, WITH A YELLOW SUN RISING BEHIND THE MOUNTAIN, AND THE WORDING "KILLINGTON VERMONT EXPLORE - DISCOVER - THRIVE" IN PURPLE.

CLASS 16—PAPER GOODS AND PRINTED MATTER

FOR PRINTED PERIODICALS IN THE FIELD OF TOURISM (U.S. CLS. 2, 5, 22, 23, 29, 37, 38 AND 50).
FIRST USE 3-5-2009; IN COMMERCE 5-25-2009.

CLASS 35—ADVERTISING AND BUSINESS

FOR CHAMBER OF COMMERCE SERVICES, NAMELY, PROMOTING BUSINESS AND TOURISM IN THE KILLINGTON, VERMONT AREA; CONVENTION AND VISITORS BUREAU SERVICES, NAMELY, PROMOTING BUSINESS AND TOURISM IN THE KILLINGTON, VERMONT AREA; CONVENTION AND VISITORS BUREAU SERVICES, NAMELY, PROMOTING BUSINESS, TOURISM AND THE HOLDING OF CONVENTIONS IN THE KILLINGTON, VERMONT AREA; CONVENTION AND VISITORS BUREAU SERVICES, NAMELY, PROMOTING CONVENTIONS AND TOURISM IN THE KILLINGTON, VERMONT AREA; CONVENTION AND VISITORS BUREAU SERVICES, NAMELY, PROMOTING TOURISM, BUSINESS AND CONVENTIONS IN AND AROUND THE KILLINGTON, VERMONT AREA; MARKETING, ADVERTISING AND PROMOTING THE GOODS AND SERVICES OF OTHERS IN THE FIELD OF TRAVEL AND TOURISM, NAMELY, PROVIDING INFORMATION VIA MAIL AND ELECTRONIC MAIL; PROMOTING RECREATION AND TOURISM IN KILLINGTON, VERMONT; PROMOTING TOURISM IN KILLINGTON, VERMONT AREA (U.S. CLS. 100, 101 AND 102).

FIRST USE 5-25-2009; IN COMMERCE 7-1-2009.

3,807,965. JOHNSON & JOHNSON, NEW BRUNSWICK, NJ. SN 77-673,439. PUB. 8-18-2009, FILED 2-19-2009.

K-Y BRAND

THE MARK CONSISTS OF STANDARD CHARACTERS WITHOUT CLAIM TO ANY PARTICULAR FONT, STYLE, SIZE, OR COLOR.

OWNER OF U.S. REG. NOS. 54,124, 2,798,877, AND OTHERS.

NO CLAIM IS MADE TO THE EXCLUSIVE RIGHT TO USE "BRAND", APART FROM THE MARK AS SHOWN.

CLASS 9—ELECTRICAL AND SCIENTIFIC APPARATUS

FOR AUDIO RECORDINGS FEATURING MUSIC (U.S. CLS. 21, 23, 26, 36 AND 38).
FIRST USE 2-5-2009; IN COMMERCE 2-5-2009.

CLASS 42—SCIENTIFIC AND COMPUTER SERVICES

FOR PROVIDING A WEBSITE ALLOWING USERS TO DOWNLOAD MUSIC (U.S. CLS. 100 AND 101).
FIRST USE 2-5-2009; IN COMMERCE 2-5-2009.

3,807,969. FITZGERALD, J. DOUGLAS, WEST BEND, WI. SN 77-674,464. PUB. 1-12-2010, FILED 2-20-2009.

THE ADVANTAGE PATHWAY

THE MARK CONSISTS OF STANDARD CHARACTERS WITHOUT CLAIM TO ANY PARTICULAR FONT, STYLE, SIZE, OR COLOR.

CLASS 36—INSURANCE AND FINANCIAL

FOR PROVIDING THE PROFESSIONAL SERVICES OF ADVISING OTHERS ON FINANCIAL MATTERS (U.S. CLS. 100, 101 AND 102).
FIRST USE 8-6-2009; IN COMMERCE 8-6-2009.

CLASS 45—PERSONAL AND LEGAL SERVICES

FOR PROVIDING THE PROFESSIONAL SERVICES OF ADVISING OTHERS ON LEGAL MATTERS (U.S. CLS. 100 AND 101).
FIRST USE 8-6-2009; IN COMMERCE 8-6-2009.

3,807,973. LOYALTYONE US, INC., WILMINGTON, DE. SN 77-675,471. PUB. 11-24-2009, FILED 2-22-2009.

wellQ

THE MARK CONSISTS OF STANDARD CHARACTERS WITHOUT CLAIM TO ANY PARTICULAR FONT, STYLE, SIZE, OR COLOR.

CLASS 35—ADVERTISING AND BUSINESS

FOR GENERATING CUSTOMIZABLE ELECTRONIC REPORTS, NAMELY, PREPARING ELECTRONIC REPORTS FOR HEALTH AND WELLNESS SERVICE PROVIDERS OF PATIENT ADHERENCE TO HEALTH AND WELLNESS PROGRAMS; GENERATING CUSTOMIZABLE PRINT REPORTS, NAMELY, PREPARING CUSTOMIZABLE PRINT REPORTS FOR HEALTH AND WELLNESS SERVICE PROVIDERS OF PATIENT ADHERENCE TO HEALTH AND WELLNESS PROGRAMS; TRACKING USAGE OF HEALTH AND WELLNESS PRODUCTS AND SERVICES FOR BUSINESS PURPOSES (U.S. CLS. 100, 101 AND 102).
FIRST USE 8-17-2009; IN COMMERCE 8-17-2009.

CLASS 38—COMMUNICATION

FOR TRANSMITTING CUSTOMIZABLE MESSAGES TO AN INDIVIDUAL OVER A MOBILE MESSAGING MEDIUM ENCOURAGING THE RECIPIENT TO ADHERE TO A PERSONAL HEALTH CARE OR WELLNESS REGIMEN (U.S. CLS. 100, 101 AND 104).
FIRST USE 8-17-2009; IN COMMERCE 8-17-2009.

CLASS 44—MEDICAL, BEAUTY AND AGRICULTURAL SERVICES

FOR PROVIDING AN INTERACTIVE WEBSITE FEATURING HEALTH AND WELLNESS INFORMATION, PERMITTING WEBSITE USERS TO REPORT INFORMATION REGARDING HEALTH AND WELLNESS ISSUES, AND MONITORING PATIENT ADHERENCE TO A HEALTH OR WELLNESS PROGRAM THROUGH THE INTERACTIVE WEBSITE (U.S. CLS. 100 AND 101).
FIRST USE 8-17-2009; IN COMMERCE 8-17-2009.

3,807,979. H. MUEHLSTEIN & CO., INC., NORWALK, CT. SN 77-677,288. PUB. 8-11-2009, FILED 2-24-2009.

ENSPEC

THE MARK CONSISTS OF STANDARD CHARACTERS WITHOUT CLAIM TO ANY PARTICULAR FONT, STYLE, SIZE, OR COLOR.

CLASS 1—CHEMICALS

FOR DRY BLENDS OF VARIOUS POLYETHYLENE RESINS SOLD IN BULK FOR GENERAL INDUSTRIAL PURPOSES, PARTICULARLY FOR MANUFACTURING INTO PIPE OR CONDUIT PRODUCTS, NAMELY, CABLE TRANSITS, TUBES, DUCTS, INSULATION, CONDUITS FOR ELECTRICAL USE, CONDUITS FOR IRRIGATION, CONDUITS FOR DRAINAGE, COUPLINGS, AND ELBOWS (U.S. CLS. 1, 5, 6, 10, 26 AND 46).
FIRST USE 6-2-2009; IN COMMERCE 6-2-2009.

CLASS 35—ADVERTISING AND BUSINESS

FOR WHOLESALE DISTRIBUTORSHIP FEATURING PLASTIC RESIN IN BULK (U.S. CLS. 100, 101 AND 102).
FIRST USE 5-3-2010; IN COMMERCE 5-3-2010.

3,807,985. SUN HARVEST FOODS, INC., SAN DIEGO, CA. SN 77-679,481. PUB. 6-30-2009, FILED 2-26-2009.

SUMMER FESTIVAL

THE MARK CONSISTS OF STANDARD CHARACTERS WITHOUT CLAIM TO ANY PARTICULAR FONT, STYLE, SIZE, OR COLOR.

CLASS 29—MEATS AND PROCESSED FOODS

FOR FROZEN FRUITS; FROZEN VEGETABLES (U.S. CL. 46).
FIRST USE 9-30-2009; IN COMMERCE 9-30-2009.

CLASS 31—NATURAL AGRICULTURAL PRODUCTS

FOR FRESH FRUIT AND VEGETABLES (U.S. CLS. 1 AND 46).
FIRST USE 9-30-2009; IN COMMERCE 9-30-2009.

3,807,986. SUN HARVEST FOODS, INC., SAN DIEGO, CA. SN 77-679,484. PUB. 6-30-2009, FILED 2-26-2009.

SUMMER FEAST

THE MARK CONSISTS OF STANDARD CHARACTERS WITHOUT CLAIM TO ANY PARTICULAR FONT, STYLE, SIZE, OR COLOR.

CLASS 29—MEATS AND PROCESSED FOODS

FOR FROZEN FRUITS; FROZEN VEGETABLES (U.S. CL. 46).
FIRST USE 9-30-2009; IN COMMERCE 9-30-2009.

CLASS 31—NATURAL AGRICULTURAL PRODUCTS

FOR FRESH FRUIT AND VEGETABLES (U.S. CLS. 1 AND 46).
FIRST USE 9-30-2009; IN COMMERCE 9-30-2009.

3,807,992. I AM BEYOND LLC, BEVERLY HILLS, CA. SN 77-681,832. PUB. 8-25-2009, FILED 3-2-2009.

BEYOND YOGA

THE MARK CONSISTS OF STANDARD CHARACTERS WITHOUT CLAIM TO ANY PARTICULAR FONT, STYLE, SIZE, OR COLOR.

OWNER OF U.S. REG. NO. 2,940,533.
NO CLAIM IS MADE TO THE EXCLUSIVE RIGHT TO USE "YOGA", APART FROM THE MARK AS SHOWN.

CLASS 18—LEATHER GOODS

FOR HANDBAGS; TOTE BAGS (U.S. CLS. 1, 2, 3, 22 AND 41).
FIRST USE 5-0-2009; IN COMMERCE 5-0-2009.

CLASS 21—HOUSEWARES AND GLASS

FOR PLASTIC WATER BOTTLES SOLD EMPTY (U.S. CLS. 2, 13, 23, 29, 30, 33, 40 AND 50).
FIRST USE 10-0-2009; IN COMMERCE 10-0-2009.

CLASS 25—CLOTHING

FOR BOTTOMS; DRESSES; HEADBANDS; JACKETS; SCARVES; TOPS; UNDERWEAR (U.S. CLS. 22 AND 39).
FIRST USE 8-0-2009; IN COMMERCE 8-0-2009.

CLASS 35—ADVERTISING AND BUSINESS

FOR ON-LINE RETAIL STORE SERVICES FEATURING CLOTHING AND YOGA ACCESSORIES (U.S. CLS. 100, 101 AND 102).
FIRST USE 0-0-2006; IN COMMERCE 0-0-2006.

CLASS 41—EDUCATION AND ENTERTAINMENT

FOR YOGA INSTRUCTION (U.S. CLS. 100, 101 AND 107).
FIRST USE 3-13-2010; IN COMMERCE 3-13-2010.

3,808,017. OESTERREICHISCHE VIALIT GESELLSCHAFT M.B.H., BRAUNAU / INN, AUSTRIA. SN 77-689,140. PUB. 8-4-2009, FILED 3-12-2009.

VIALIT

THE MARK CONSISTS OF STANDARD CHARACTERS WITHOUT CLAIM TO ANY PARTICULAR FONT, STYLE, SIZE, OR COLOR.

CLASS 1—CHEMICALS

FOR ADHESIVE MATERIALS FOR THE BUILDING INDUSTRY AND TILES; ADHESIVE PRIMERS FOR USE IN ROOFING; ADHESIVES FOR APPLYING FLOOR TILES; ADHESIVES FOR APPLYING WALL COVERINGS; ADHESIVES FOR FLOOR, CEILING AND WALL TILES; ROOFING ADHESIVES; INDUSTRIAL ADHESIVES; INDUSTRIAL ADHESIVES FOR USE IN COATING AND SEALING (U.S. CLS. 1, 5, 6, 10, 26 AND 46).
FIRST USE 7-2-2007; IN COMMERCE 7-2-2007.

CLASS 19—NON-METALLIC BUILDING MATERIALS

FOR BITUMEN; BITUMEN-ASPHALT; BITUMEN-BASED ASPHALT SEALANTS; BITUMEN-BASED DRIVEWAY SEALANTS; BITUMEN-BASED ROOFING SEALANTS; BITUMEN-BASED SEALANTS FOR ASPHALT; BITUMEN PRODUCTS, NAMELY, ASPHALT FOR CONSTRUCTION PURPOSES AND BITUMEN COATINGS FOR ASPHALT, CONCRETE, ROOFING, ROAD CONSTRUCTION AND WATERPROOFING; ASPHALT; ASPHALT COMPOSITION PAVING; ASPHALT PATCHING COMPOUND MADE OF A BITUMEN BASE; ASPHALT ROOF COATINGS; ASPHALT-BASED COATINGS AND SEALANTS FOR USE ON ROOFS, WALLS AND PAVEMENTS; ASPHALT-BASED PENETRANT, SOFTENER, AND SEALANT USED TO RECONDITION AIRPORT RUNWAYS; ASPHALT-BASED ROOFING MASTICS (U.S. CLS. 1, 12, 33 AND 50).
FIRST USE 7-2-2007; IN COMMERCE 7-2-2007.

CLASS 37—CONSTRUCTION AND REPAIR

FOR ROAD CONSTRUCTION, NAMELY, ROAD-SURFACING AND BITUMINIZING SERVICES; SEALING IN THE FIELD OF BUILDING CONSTRUCTION; CONSTRUCTION OF ROADS; REPAIR OF ROADS; ROAD PAVING AND ASPHALTING (U.S. CLS. 100, 103 AND 106).
FIRST USE 7-2-2007; IN COMMERCE 7-2-2007.

CLASS 42—SCIENTIFIC AND COMPUTER SERVICES

FOR UNDERGROUND ENGINEERING AND CIVIL ENGINEERING WORKS IN THE FIELD OF BUILDING CONSTRUCTION; CONSTRUCTION OF ROADS; REPAIR OF ROADS; ROAD PAVING AND ASPHALTING; RESEARCH AND DEVELOPMENT OF NEW PRODUCTS FOR OTHERS; RESEARCH AND DEVELOPMENT FOR OTHERS IN THE FIELDS OF ROAD CONSTRUCTION, ROAD-SURFACING, ROAD MAINTENANCE, BUILDING SEALING AND WATERPROOFING; RESEARCH AND DEVELOPMENT FOR OTHERS IN THE DESIGN OF NEW TEST METHODS FOR BITUMEN, BITUMEN EMULSIONS AND ASPHALTENE USED IN THE FIELDS OF ROAD CONSTRUCTION, ROAD-SURFACING, ROAD MAINTENANCE, BUILDING SEALING AND WATERPROOFING (U.S. CLS. 100 AND 101).
FIRST USE 7-2-2007; IN COMMERCE 7-2-2007.

3,808,018. R.L. KUNZ, INC., GREENVILLE, SC. SN 77-689,148. PUB. 8-11-2009, FILED 3-12-2009.

**ELEMENTAL CONSTRUCTION
SPECIALTIES, LLC**

THE MARK CONSISTS OF STANDARD CHARACTERS WITHOUT CLAIM TO ANY PARTICULAR FONT, STYLE, SIZE, OR COLOR.

NO CLAIM IS MADE TO THE EXCLUSIVE RIGHT TO USE "CONSTRUCTION SPECIALTIES, LLC", APART FROM THE MARK AS SHOWN.

CLASS 6—METAL GOODS

FOR DECORATIVE METAL TRIM FOR BUILDINGS FOR SALE TO ARCHITECTURAL FIRMS (U.S. CLS. 2, 12, 13, 14, 23, 25 AND 50).
FIRST USE 1-28-2010; IN COMMERCE 1-28-2010.

CLASS 11—ENVIRONMENTAL CONTROL APPARATUS

FOR LOUVERS, NAMELY, DECORATIVE LOUVERS FOR BUILDINGS FOR SALE TO ARCHITECTURAL FIRMS (U.S. CLS. 13, 21, 23, 31 AND 34).
FIRST USE 10-21-2009; IN COMMERCE 10-21-2009.

3,808,019. MACE SECURITY INTERNATIONAL, INC., BENNINGTON, VT. SN 77-689,274. PUB. 9-8-2009, FILED 3-12-2009.



OWNER OF U.S. REG. NOS. 888,911, 2,010,600, AND OTHERS.

THE MARK CONSISTS OF THE STYLIZED WORD "MACE" WITH A BOX AROUND THE "M".

CLASS 6—METAL GOODS

FOR METAL LOCKING DEVICES FOR DOORS AND WINDOWS (U.S. CLS. 2, 12, 13, 14, 23, 25 AND 50).
FIRST USE 9-25-2009; IN COMMERCE 9-25-2009.

CLASS 9—ELECTRICAL AND SCIENTIFIC APPARATUS

FOR PERSONAL SECURITY ALARMS, NAMELY, SONIC ALARMS; ELECTRONIC VIDEO SURVEILLANCE PRODUCTS, NAMELY, ELECTRONIC COMPONENTS OF SECURITY SYSTEMS (U.S. CLS. 21, 23, 26, 36 AND 38).
FIRST USE 1-18-2010; IN COMMERCE 1-18-2010.

CLASS 13—FIREARMS

FOR PERSONAL DEFENSE SPRAYS; SELF-DEFENSE PRODUCTS, NAMELY, AEROSOL CANISTERS CONTAINING A VOLATILE LIQUID PREPARATION FOR TEMPORARILY INCAPACITATING PERSONS AND ANIMALS (U.S. CLS. 2 AND 9).
FIRST USE 12-24-2009; IN COMMERCE 12-24-2009.

3,808,020. SUMMIT AUTOMATION, LLC, FENTON, MO. SN 77-689,458. PUB. 7-28-2009, FILED 3-12-2009.

INTRAFLO

THE MARK CONSISTS OF STANDARD CHARACTERS WITHOUT CLAIM TO ANY PARTICULAR FONT, STYLE, SIZE, OR COLOR.

CLASS 6—METAL GOODS

FOR STEEL BLOCKS FOR USE IN DISTRIBUTING FLUIDS FROM A SINGLE SOURCE TO MULTIPLE LUBRICATION POINTS ON VEHICLES (U.S. CLS. 2, 12, 13, 14, 23, 25 AND 50).
FIRST USE 5-0-2009; IN COMMERCE 5-0-2009.

CLASS 7—MACHINERY

FOR LUBRICATING PUMPS (U.S. CLS. 13, 19, 21, 23, 31, 34 AND 35).
FIRST USE 5-0-2009; IN COMMERCE 5-0-2009.

3,808,021. KENEXA CORPORATION, WAYNE, PA. SN 77-689,475. PUB. 9-15-2009, FILED 3-12-2009.

KENEXA PERSON-JOB FIT

THE MARK CONSISTS OF STANDARD CHARACTERS WITHOUT CLAIM TO ANY PARTICULAR FONT, STYLE, SIZE, OR COLOR.

OWNER OF U.S. REG. NOS. 2,632,896 AND 2,672,936.

NO CLAIM IS MADE TO THE EXCLUSIVE RIGHT TO USE "PERSON-JOB FIT", APART FROM THE MARK AS SHOWN.

CLASS 9—ELECTRICAL AND SCIENTIFIC APPARATUS

FOR COMPUTER SOFTWARE FOR MATCHING CANDIDATE CHARACTERISTICS TO EMPLOYMENT PREFERENCES (U.S. CLS. 21, 23, 26, 36 AND 38).

FIRST USE 6-15-2009; IN COMMERCE 6-15-2009.

CLASS 35—ADVERTISING AND BUSINESS

FOR BUSINESS SERVICES IN THE FIELD OF RECRUITMENT, NAMELY, PROVIDING APPLICANT AND JOB PROFILES FOR USE IN CANDIDATE SELECTION (U.S. CLS. 100, 101 AND 102).

FIRST USE 6-15-2009; IN COMMERCE 6-15-2009.

CLASS 35—ADVERTISING AND BUSINESS

FOR TAX PLANNING, NAMELY, ADVICE, INFORMATION AND CONSULTANCY SERVICES (U.S. CLS. 100, 101 AND 102).

FIRST USE 9-15-2006; IN COMMERCE 9-15-2006.

CLASS 36—INSURANCE AND FINANCIAL

FOR MONEY MANAGEMENT SERVICES, FINANCIAL ANALYSIS AND CONSULTATION, FINANCIAL PLANNING, INVESTMENT ADVICE AND CONSULTATION, PROVIDING INFORMATION AND CONSULTATION IN THE FIELD OF INSURANCE, ESTATE PLANNING, AND REAL ESTATE MORTGAGE AND INVESTMENT SERVICES (U.S. CLS. 100, 101 AND 102).

FIRST USE 9-15-2006; IN COMMERCE 9-15-2006.

3,808,045. GRIFFDOG RECORDS, INC., HUNTINGTON BEACH, CA. SN 77-692,274. PUB. 7-21-2009, FILED 3-16-2009.

3,808,059. AMASH IMPORTS, INC., DBA MICHIGAN INDUSTRIAL TOOLS, GRAND RAPIDS, MI. SN 77-695,910. PUB. 1-5-2010, FILED 3-20-2009.

GDR

THE MARK CONSISTS OF STANDARD CHARACTERS WITHOUT CLAIM TO ANY PARTICULAR FONT, STYLE, SIZE, OR COLOR.

CLASS 9—ELECTRICAL AND SCIENTIFIC APPARATUS

FOR MUSICAL SOUND RECORDINGS; MUSICAL VIDEO RECORDINGS; DOWNLOADABLE AUDIO AND VIDEO RECORDINGS FEATURING MUSIC AND MUSICAL ENTERTAINMENT (U.S. CLS. 21, 23, 26, 36 AND 38).

FIRST USE 0-0-1999; IN COMMERCE 0-0-1999.

CLASS 41—EDUCATION AND ENTERTAINMENT

FOR ENTERTAINMENT SERVICES, NAMELY, LIVE MUSICAL PERFORMANCES; RECORDING STUDIO SERVICES; PRODUCTION, EDITING AND DISTRIBUTION OF MUSICAL RECORDINGS AND MUSIC VIDEO RECORDINGS FOR OTHERS (U.S. CLS. 100, 101 AND 107).

FIRST USE 0-0-1999; IN COMMERCE 0-0-1999.

3,808,054. NEWFOCUS FINANCIAL GROUP, LLC, VANCOUVER, WA. SN 77-695,091. PUB. 7-21-2009, FILED 3-19-2009.

NEWFOCUS

THE MARK CONSISTS OF STANDARD CHARACTERS WITHOUT CLAIM TO ANY PARTICULAR FONT, STYLE, SIZE, OR COLOR.

TEKTON

THE MARK CONSISTS OF STANDARD CHARACTERS WITHOUT CLAIM TO ANY PARTICULAR FONT, STYLE, SIZE, OR COLOR.

CLASS 6—METAL GOODS

FOR METAL HARDWARE, NAMELY, NAILS, SCREWS, RIVETS AND UTILITY HOOKS; HAND-OPERATED METAL AIR HOSE REELS (U.S. CLS. 2, 12, 13, 14, 23, 25 AND 50).

FIRST USE 3-16-2009; IN COMMERCE 10-12-2009.

CLASS 8—HAND TOOLS

FOR HAND TOOLS, NAMELY, SOCKETS AND RATCHETS, WRENCHES, SCREWDRIVERS, PLIERS, HAMMERS, PRY BARS AND PRYING TOOLS IN THE NATURE OF CROWBARS, RIPPING BARS, WRECKING BARS AND TACK PULLERS, CUTTERS IN THE NATURE OF BOLT CUTTERS, WIRE CUTTERS, TUBE CUTTERS, DIAGONAL CUTTERS, NIPPERS AND CUTTING PLIERS, SNIPS, KNIVES, CLAMPS, GRINDING TOOLS IN THE NATURE OF MANUALLY-OPERATED GRINDSTONES AND SHARPENING STONES, VISES, HAND-OPERATED JACKS, PULLERS IN THE NATURE OF RATCHETING CABLE PULLERS AND NAIL PULLERS, HAND-OPERATED PIPE CUTTING TOOLS, SCRAPERS, WIRE STRIPPERS, FILES, HAND-OPERATED CHISELS, SAWS, PICK AND HOOK SETS COMPRISING PICKS AND HAND HOOKS, SANDING BLOCKS, TAPS AND DIES; CRAFT AND HOBBY TOOLS IN THE NATURE OF KNIVES FOR HOBBY USE, SCALPELS FOR HOBBY USE AND PAINT SCRAPERS; INSPECTION TOOLS IN THE NATURE OF TONGS AND PINNERS; PICK UP TOOLS IN THE NATURE OF MAGNETIC REACHING DEVICES FOR PICKING UP SMALL METAL OBJECTS AND NON-MAGNETIC REACHING DEVICES FOR PICKING UP OBJECTS; HAND TOOL ACCESSORIES, NAMELY, INSERT BITS FOR HAND DRILLS AND HAND DRIVERS, INSERT BIT SETS COMPRISING INSERT BITS FOR HAND DRIVERS AND ACCESSORIES FOR HAND DRIVING IN THE NATURE OF EXTENSIONS, HOLDERS AND ADAPTERS; HAND TOOL SETS, NAMELY, CHISEL SETS, CLAMP SETS, UTILITY KNIFE SETS, AND MIXED HAND TOOL SETS COMPRISING WRENCHES, SOCKETS, HAMMERS, SCREWDRIVERS, SCREWDRIVER BITS, TAPE MEASURES, AND LEVELS (U.S. CLS. 23, 28 AND 44).

FIRST USE 3-16-2009; IN COMMERCE 5-4-2009.

CLASS 17—RUBBER GOODS

FOR NON-METAL SEALS, NAMELY, RUBBER O-RINGS; RUBBER AIR HOSES; ADHESIVE TAPES FOR INDUSTRIAL OR COMMERCIAL USE (U.S. CLS. 1, 5, 12, 13, 35 AND 50).

FIRST USE 3-16-2009; IN COMMERCE 10-9-2009.

CLASS 21—HOUSEWARES AND GLASS

FOR HAND TOOLS, NAMELY, WIRE BRUSHES NOT BEING MACHINE PARTS (U.S. CLS. 2, 13, 23, 29, 30, 33, 40 AND 50).

FIRST USE 3-16-2009; IN COMMERCE 11-3-2009.

CLASS 22—CORDAGE AND FIBERS

FOR TIE DOWN STRAPS; BUNGEE CORDS; TARPAILINS; NON-METAL TIE DOWNS (U.S. CLS. 1, 2, 7, 19, 22, 42 AND 50).

FIRST USE 3-16-2009; IN COMMERCE 8-26-2009.

3,808,062. C5 ADVISORS, LLC, BIRMINGHAM, AL. SN 77-696,285. PUB. 1-5-2010, FILED 3-21-2009.

Be a Banker Again

THE MARK CONSISTS OF STANDARD CHARACTERS WITHOUT CLAIM TO ANY PARTICULAR FONT, STYLE, SIZE, OR COLOR.

CLASS 35—ADVERTISING AND BUSINESS

FOR BUSINESS MANAGEMENT CONSULTANCY AND ADVISORY SERVICES; BUSINESS MANAGEMENT CONSULTANCY SERVICES; BUSINESS MANAGEMENT CONSULTING AND ADVISORY SERVICES; MANAGEMENT AND BUSINESS CONSULTING SERVICES IN THE FIELD OF TRAINING AND RECRUITMENT; MANAGEMENT AND BUSINESS CONSULTING SERVICES IN THE FIELD OF BANKING AND FINANCIAL SERVICES; TRADE SHOW MANAGEMENT SERVICES (U.S. CLS. 100, 101 AND 102).

FIRST USE 3-1-2009; IN COMMERCE 3-1-2009.

CLASS 36—INSURANCE AND FINANCIAL

FOR BANKING; BANKING AND FINANCING SERVICES; BANKING CONSULTATION; BANKING SERVICES; BANKING SERVICES PROVIDED BY MOBILE TELEPHONE CONNECTIONS; INVESTMENT BANKING SERVICES; MERCHANT BANKING AND INVESTMENT BANKING SERVICES; SAVINGS ACCOUNT SERVICES; SAVINGS AND LOAN SERVICES; SAVINGS BANK SERVICES (U.S. CLS. 100, 101 AND 102).

FIRST USE 3-1-2009; IN COMMERCE 3-1-2009.

3,808,065. ANDREAS HEINE, PENDLETON, SC. SN 77-696,916. PUB. 8-4-2009, FILED 3-23-2009.

MFLAX

THE MARK CONSISTS OF STANDARD CHARACTERS WITHOUT CLAIM TO ANY PARTICULAR FONT, STYLE, SIZE, OR COLOR.

CLASS 24—FABRICS

FOR ELASTIC POLYESTER FABRIC FOR COVERING EXTERNAL MOTOR VEHICLE MIRRORS WHICH ARE PRINTED, EMBROIDERED, OR OTHERWISE MARKED WITH WOVEN PATTERNS, TEXT, IMAGES, PATTERNS, AND LOGOS (U.S. CLS. 42 AND 50).

FIRST USE 1-20-2010; IN COMMERCE 1-20-2010.

CLASS 35—ADVERTISING AND BUSINESS

FOR ADVERTISING AND PROMOTING THE GOODS AND SERVICES OF OTHERS VIA DISPLAY ON MOTOR VEHICLES USING LOGOS, PICTURES, AND ADVERTISING TEXTS (U.S. CLS. 100, 101 AND 102).

FIRST USE 1-20-2010; IN COMMERCE 1-20-2010.

3,808,066. CHANGYOU.COM LIMITED, GEORGE TOWN, GRAND CAYMAN, CAYMAN ISLANDS. SN 77-696,971. PUB. 7-28-2009, FILED 3-23-2009.



THE COLOR(S) ORANGE AND MAGENTA IS/ARE CLAIMED AS A FEATURE OF THE MARK.

THE MARK CONSISTS OF A DEVICE MARK, WHICH COMPRISES A DOT IN ORANGE IN THE UPPER SIDE OF THE DEVICE AND AN IRREGULAR DESIGN IN MAGENTA IN THE LOWER SIDE OF THE DEVICE.

CLASS 41—EDUCATION AND ENTERTAINMENT

FOR ENTERTAINMENT SERVICES, NAMELY, PROVIDING ON-LINE COMPUTER GAMES; PHOTOGRAPHY; VIDEOTAPE PRODUCTION; MUSIC PRODUCTION SERVICES; PRODUCTION OF RADIO AND TELEVISION PROGRAMS; PROVIDING ON-LINE NON-DOWNLOADABLE ELECTRONIC DICTIONARIES; DUBBING SERVICES; TEACHING AND TRAINING IN BUSINESS, INDUSTRY AND INFORMATION TECHNOLOGY; VOCATIONAL GUIDANCE; EDUCATION INFORMATION; ANIMAL TRAINING (U.S. CLS. 100, 101 AND 107).

FIRST USE 3-3-2009; IN COMMERCE 3-17-2009.

CLASS 42—SCIENTIFIC AND COMPUTER SERVICES

FOR DESIGNING AND MODIFYING COMPUTER PROGRAMS AND VIDEO GAMES FOR OTHERS; COMPUTER SOFTWARE DESIGN; HOSTING THE WEB SITES OF OTHERS ON A COMPUTER SERVER FOR A GLOBAL COMPUTER NETWORK; COMPUTER SERVICES, NAMELY, PROVIDING SEARCH ENGINES FOR OBTAINING DATA ON A GLOBAL COMPUTER NETWORK; CONVERSION OF DATA OR DOCUMENTS FROM PHYSICAL TO ELECTRONIC MEDIA; RENTAL OF WEB SERVERS; DESIGN AND DEVELOPMENT OF ON-LINE COMPUTER SOFTWARE SYSTEMS; INSTALLATION OF COMPUTER SOFTWARE (U.S. CLS. 100 AND 101).

FIRST USE 3-3-2009; IN COMMERCE 3-17-2009.

3,808,068. PACIFIC BUSINESS GROUP INC., SANTA FE SPRINGS, CA. SN 77-697,102. PUB. 7-21-2009, FILED 3-23-2009.

VERTEX

THE MARK CONSISTS OF STANDARD CHARACTERS WITHOUT CLAIM TO ANY PARTICULAR FONT, STYLE, SIZE, OR COLOR.

CLASS 9—ELECTRICAL AND SCIENTIFIC APPARATUS

FOR ELECTRIC IRONS AND TELEVISION SETS SOLD TO HOTELS AND MOTELS (U.S. CLS. 21, 23, 26, 36 AND 38).

FIRST USE 3-10-2009; IN COMMERCE 4-8-2009.

CLASS 11—ENVIRONMENTAL CONTROL APPARATUS

FOR AIR CONDITIONING UNITS, ELECTRIC COFFEE MAKERS, MICROWAVE OVENS FOR COOKING AND REFRIGERATORS ALL SOLD TO HOTELS AND MOTELS (U.S. CLS. 13, 21, 23, 31 AND 34).

FIRST USE 3-10-2009; IN COMMERCE 4-8-2009.

3,808,077. QUEST DIAGNOSTICS INVESTMENTS INCORPORATED, WILMINGTON, DE. SN 77-697,970. PUB. 7-21-2009, FILED 3-24-2009.

CENTERGY

THE MARK CONSISTS OF STANDARD CHARACTERS WITHOUT CLAIM TO ANY PARTICULAR FONT, STYLE, SIZE, OR COLOR.

CLASS 9—ELECTRICAL AND SCIENTIFIC APPARATUS

FOR COMPUTER SOFTWARE FOR MEDICAL RECORD-KEEPING AND FOR ACCESSING, MAINTAINING, MANAGING AND DISTRIBUTING PATIENT, MEDICAL AND OTHER HEALTHCARE INFORMATION, AND TO FACILITATE COMMUNICATIONS, CONNECTIVITY AND WORKFLOW WITH HEALTH CARE PROVIDERS, HEALTHCARE SYSTEMS AND PATIENTS (U.S. CLS. 21, 23, 26, 36 AND 38).

FIRST USE 4-4-2009; IN COMMERCE 4-4-2009.

CLASS 42—SCIENTIFIC AND COMPUTER SERVICES

FOR PROVIDING TEMPORARY USE OF ON-LINE NON-DOWNLOADABLE SOFTWARE VIA A CENTRALIZED WEB-BASED CLINICAL AND PATIENT PORTAL TO PERMIT THE SECURE ACCESS OF PATIENT INFORMATION AND TO ACCESS, MAINTAIN, MANAGE AND DISTRIBUTE PATIENT MEDICAL AND OTHER HEALTHCARE INFORMATION, AND TO FACILITATE COMMUNICATIONS, CONNECTIVITY AND WORKFLOW WITH HEALTH CARE PROVIDERS, HEALTHCARE SYSTEMS AND PATIENTS (U.S. CLS. 100 AND 101).

FIRST USE 4-4-2009; IN COMMERCE 4-4-2009.

3,808,086. CARFX, INC., OVERLAND PARK, KS. SN 77-698,963. PUB. 7-28-2009, FILED 3-25-2009.

MOTOSTEW

THE MARK CONSISTS OF STANDARD CHARACTERS WITHOUT CLAIM TO ANY PARTICULAR FONT, STYLE, SIZE, OR COLOR.

CLASS 35—ADVERTISING AND BUSINESS

FOR ONLINE RETAIL STORE SERVICES FEATURING AUTOMOBILE PARTS AND ACCESSORIES (U.S. CLS. 100, 101 AND 102).

FIRST USE 8-15-2009; IN COMMERCE 8-15-2009.

CLASS 45—PERSONAL AND LEGAL SERVICES

FOR ONLINE SOCIAL NETWORKING SERVICES (U.S. CLS. 100 AND 101).

FIRST USE 8-15-2009; IN COMMERCE 8-15-2009.

3,808,088. LOS ANGELES TIMES COMMUNICATIONS, LLC, LOS ANGELES, CA. SN 77-699,408. PUB. 7-21-2009, FILED 3-25-2009.

BRAND X

THE MARK CONSISTS OF STANDARD CHARACTERS WITHOUT CLAIM TO ANY PARTICULAR FONT, STYLE, SIZE, OR COLOR.

CLASS 16—PAPER GOODS AND PRINTED MATTER

FOR NEWSPAPERS FOR GENERAL CIRCULATION (U.S. CLS. 2, 5, 22, 23, 29, 37, 38 AND 50).
FIRST USE 4-15-2009; IN COMMERCE 4-15-2009.

CLASS 45—PERSONAL AND LEGAL SERVICES

FOR ON-LINE SOCIAL NETWORKING SERVICES (U.S. CLS. 100 AND 101).
FIRST USE 4-15-2009; IN COMMERCE 4-15-2009.

CLASS 20—FURNITURE AND ARTICLES NOT OTHERWISE CLASSIFIED

FOR CUSHIONS (U.S. CLS. 2, 13, 22, 25, 32 AND 50).
FIRST USE 4-30-2009; IN COMMERCE 4-30-2009.

CLASS 24—FABRICS

FOR COVERS FOR CUSHIONS (U.S. CLS. 42 AND 50).
FIRST USE 4-30-2009; IN COMMERCE 4-30-2009.

3,808,091. PONIEWAZ, ERICKA, SIMI VALLEY, CA. SN 77-699,784. PUB. 7-28-2009, FILED 3-26-2009.



THE MARK CONSISTS OF THE STYLIZED WORD "WICKIDZ". AN IMAGE OF A CARTOON STYLE SKULL AND TWO BONE ARMS REACHING UP.

CLASS 18—LEATHER GOODS

FOR CARRYING CASES; DIAPER BAGS; TOILETRY CASES SOLD EMPTY; TRAVEL CASES (U.S. CLS. 1, 2, 3, 22 AND 41).
FIRST USE 2-1-2009; IN COMMERCE 3-1-2009.

CLASS 24—FABRICS

FOR BURP CLOTHS; DIAPER CHANGING PADS NOT OF PAPER (U.S. CLS. 42 AND 50).
FIRST USE 2-1-2009; IN COMMERCE 3-1-2009.

CLASS 25—CLOTHING

FOR BEANIES; CLOTH BIBS; HATS; INFANT AND TODDLER ONE PIECE CLOTHING; SHIRTS (U.S. CLS. 22 AND 39).
FIRST USE 2-1-2009; IN COMMERCE 3-1-2009.

3,808,092. ATG VENTURES, LLC, POINT PLEASANT, NJ. SN 77-699,954. PUB. 7-28-2009, FILED 3-26-2009.

Slouchback

THE MARK CONSISTS OF STANDARD CHARACTERS WITHOUT CLAIM TO ANY PARTICULAR FONT, STYLE, SIZE, OR COLOR.

3,808,102. HIGHLANDS OVERRIDE, INC., PORTSMOUTH, NH. SN 77-700,815. PUB. 7-28-2009, FILED 3-27-2009.

IT PAYS TO BE IN THE LOOP

THE MARK CONSISTS OF STANDARD CHARACTERS WITHOUT CLAIM TO ANY PARTICULAR FONT, STYLE, SIZE, OR COLOR.

CLASS 35—ADVERTISING AND BUSINESS

FOR CUSTOMER LOYALTY SERVICES AND CUSTOMER CLUB SERVICES, FOR COMMERCIAL, PROMOTIONAL AND/OR ADVERTISING PURPOSES; PROVIDING INCENTIVE AWARD PROGRAMS FOR CUSTOMERS THROUGH THE ISSUANCE AND PROCESSING OF LOYALTY CARDS AND DISCOUNT CARDS FOR FREQUENT USE OF PARTICIPATING BUSINESSES; INCENTIVE AWARD PROGRAMS TO PROMOTE THE SALE OF PRODUCTS AND SERVICES OF OTHERS; CONSUMER LOYALTY SERVICES FOR COMMERCIAL, PROMOTIONAL, AND/OR ADVERTISING PURPOSES, NAMELY, ADMINISTRATION OF FREQUENT BUYER PROGRAM THAT ALLOWS MEMBERS TO REDEEM PURCHASE POINTS FOR DISCOUNTS OR AWARDS OFFERED BY THE LOYALTY PROGRAM; ADMINISTRATION OF A PROGRAM FOR ENABLING PARTICIPANTS TO OBTAIN DISCOUNTS ON GOODS AND RECEIVE IMPROVED SERVICES; SALES PROMOTION FOR OTHERS PROVIDED THROUGH THE DISTRIBUTION AND THE ADMINISTRATION OF PRIVILEGED USER CARDS; AND RETAIL STORE SERVICES IN THE FIELD OF CONVENIENCE STORE ITEMS AND FUEL FEATURING A BONUS INCENTIVE PROGRAM FOR CUSTOMERS (U.S. CLS. 100, 101 AND 102).
FIRST USE 3-0-2009; IN COMMERCE 3-0-2009.

CLASS 37—CONSTRUCTION AND REPAIR

FOR GAS REFUELING SERVICE STATION SERVICES FOR VEHICLES AND AUTOMOBILE SERVICE STATION SERVICES FEATURING A BONUS INCENTIVE PROGRAM FOR CUSTOMERS (U.S. CLS. 100, 103 AND 106).
FIRST USE 3-0-2009; IN COMMERCE 3-0-2009.

3,808,104. GML COATINGS, LLC, SARASOTA, FL. SN 77-701,244. PUB. 8-4-2009, FILED 3-27-2009.

3,808,109. PHANTOM MFG. (INT'L) LTD, ABBOTSFORD, CANADA. SN 77-702,158. PUB. 7-28-2009, FILED 3-30-2009.

GREEN MONSTER

THE MARK CONSISTS OF STANDARD CHARACTERS WITHOUT CLAIM TO ANY PARTICULAR FONT, STYLE, SIZE, OR COLOR.

NO CLAIM IS MADE TO THE EXCLUSIVE RIGHT TO USE "GREEN", APART FROM THE MARK AS SHOWN.

CLASS 2—PAINTS

FOR COATINGS IN THE NATURE OF SPRAYED MONOLITHIC MEMBRANE COATINGS (U.S. CLS. 6, 11 AND 16).

FIRST USE 7-15-2006; IN COMMERCE 7-15-2006.

CLASS 37—CONSTRUCTION AND REPAIR

FOR APPLYING PROTECTIVE COATINGS TO CONCRETE, METAL, BRICK, FIBERGLASS, STEEL, GALVANIZED AND ALUMINUM SURFACES, GEOTEXTILE FABRIC, SANITARY SEWER SYSTEM INFRASTRUCTURE, STORM WATER INFRASTRUCTURE, MANHOLES, LIFT STATIONS, LAGOONS, POND AND LANDFILL LINERS, AND INTERIOR AND EXTERIOR SURFACES OF METAL TANKS (U.S. CLS. 100, 103 AND 106).

FIRST USE 7-15-2006; IN COMMERCE 7-15-2006.

3,808,108. PHANTOM MFG. (INT'L) LTD, ABBOTSFORD, CANADA. SN 77-701,889. PUB. 7-28-2009, FILED 3-30-2009.

PHANTOM INFINITY

THE MARK CONSISTS OF STANDARD CHARACTERS WITHOUT CLAIM TO ANY PARTICULAR FONT, STYLE, SIZE, OR COLOR.

PRIORITY CLAIMED UNDER SEC. 44(D) ON CANADA APPLICATION NO. 1422538, FILED 12-19-2008.

OWNER OF U.S. REG. NOS. 1,983,857, 2,266,669, AND OTHERS.

CLASS 6—METAL GOODS

FOR METAL SCREENS, NAMELY, RETRACTABLE INSECT SCREENS AND SUNSCREENS FOR DOORS, WINDOWS, AND SKYLIGHTS (U.S. CLS. 2, 12, 13, 14, 23, 25 AND 50).

FIRST USE 3-0-2009; IN COMMERCE 3-0-2009.

CLASS 19—NON-METALLIC BUILDING MATERIALS

FOR NON-METAL SCREENS, NAMELY, RETRACTABLE INSECT SCREENS AND SUNSCREENS FOR DOORS, WINDOWS, AND SKYLIGHTS (U.S. CLS. 1, 12, 33 AND 50).

FIRST USE 3-0-2009; IN COMMERCE 3-0-2009.

PHANTOM SUREVIEW

THE MARK CONSISTS OF STANDARD CHARACTERS WITHOUT CLAIM TO ANY PARTICULAR FONT, STYLE, SIZE, OR COLOR.

PRIORITY CLAIMED UNDER SEC. 44(D) ON CANADA APPLICATION NO. 1422539, FILED 12-19-2008.

OWNER OF U.S. REG. NOS. 1,983,857, 2,266,669, AND OTHERS.

CLASS 6—METAL GOODS

FOR METAL SCREENS, NAMELY, RETRACTABLE INSECT SCREENS AND SUNSCREENS FOR DOORS, WINDOWS, AND SKYLIGHTS (U.S. CLS. 2, 12, 13, 14, 23, 25 AND 50).

FIRST USE 3-0-2008; IN COMMERCE 7-0-2009.

CLASS 19—NON-METALLIC BUILDING MATERIALS

FOR NON-METAL SCREENS, NAMELY, RETRACTABLE INSECT SCREENS AND SUNSCREENS FOR DOORS, WINDOWS, AND SKYLIGHTS (U.S. CLS. 1, 12, 33 AND 50).

FIRST USE 3-0-2008; IN COMMERCE 7-0-2009.

3,808,110. PHANTOM MFG. (INT'L) LTD, ABBOTSFORD, CANADA. SN 77-702,168. PUB. 7-28-2009, FILED 3-30-2009.

PHANTOM VANTAGE

THE MARK CONSISTS OF STANDARD CHARACTERS WITHOUT CLAIM TO ANY PARTICULAR FONT, STYLE, SIZE, OR COLOR.

PRIORITY CLAIMED UNDER SEC. 44(D) ON CANADA APPLICATION NO. 1422540, FILED 12-19-2008.

OWNER OF U.S. REG. NOS. 1,983,857, 2,266,669, AND OTHERS.

CLASS 6—METAL GOODS

FOR METAL SCREENS, NAMELY, RETRACTABLE INSECT SCREENS AND SUNSCREENS FOR DOORS, WINDOWS, AND SKYLIGHTS (U.S. CLS. 2, 12, 13, 14, 23, 25 AND 50).

FIRST USE 7-0-2009; IN COMMERCE 7-0-2009.

CLASS 19—NON-METALLIC BUILDING MATERIALS

FOR NON-METAL SCREENS, NAMELY, RETRACTABLE INSECT SCREENS AND SUNSCREENS FOR DOORS, WINDOWS, AND SKYLIGHTS (U.S. CLS. 1, 12, 33 AND 50).

FIRST USE 7-0-2009; IN COMMERCE 7-0-2009.

3,808,111. PHANTOM MFG. (INT'L) LTD, ABBOTSFORD, CANADA. SN 77-702,174. PUB. 7-28-2009, FILED 3-30-2009.

PHANTOM UNSEEN

THE MARK CONSISTS OF STANDARD CHARACTERS WITHOUT CLAIM TO ANY PARTICULAR FONT, STYLE, SIZE, OR COLOR.

PRIORITY CLAIMED UNDER SEC. 44(D) ON CANADA APPLICATION NO. 1422541, FILED 12-19-2008.

OWNER OF U.S. REG. NOS. 1,983,857, 2,266,669, AND OTHERS.

CLASS 6—METAL GOODS

FOR METAL SCREENS, NAMELY, RETRACTABLE INSECT SCREENS AND SUNSCREENS FOR DOORS, WINDOWS, AND SKYLIGHTS (U.S. CLS. 2, 12, 13, 14, 23, 25 AND 50).

FIRST USE 7-0-2009; IN COMMERCE 7-0-2009.

CLASS 19—NON-METALLIC BUILDING MATERIALS

FOR NON-METAL SCREENS, NAMELY, RETRACTABLE INSECT SCREENS AND SUNSCREENS FOR DOORS, WINDOWS, AND SKYLIGHTS (U.S. CLS. 1, 12, 33 AND 50).

FIRST USE 7-0-2009; IN COMMERCE 7-0-2009.

3,808,112. PHANTOM MFG. (INT'L) LTD, ABBOTSFORD, CANADA. SN 77-702,317. PUB. 7-28-2009, FILED 3-30-2009.

PHANTOM VIEWPOINT

THE MARK CONSISTS OF STANDARD CHARACTERS WITHOUT CLAIM TO ANY PARTICULAR FONT, STYLE, SIZE, OR COLOR.

PRIORITY CLAIMED UNDER SEC. 44(D) ON CANADA APPLICATION NO. 1423947, FILED 1-8-2009.

OWNER OF U.S. REG. NOS. 1,983,857, 2,266,669, AND OTHERS.

CLASS 6—METAL GOODS

FOR METAL SCREENS, NAMELY, RETRACTABLE INSECT SCREENS AND SUNSCREENS FOR DOORS, WINDOWS, AND SKYLIGHTS (U.S. CLS. 2, 12, 13, 14, 23, 25 AND 50).

FIRST USE 3-0-2008; IN COMMERCE 5-0-2009.

CLASS 19—NON-METALLIC BUILDING MATERIALS

FOR NON-METAL SCREENS, NAMELY, RETRACTABLE INSECT SCREENS AND SUNSCREENS FOR DOORS, WINDOWS, AND SKYLIGHTS (U.S. CLS. 1, 12, 33 AND 50).

FIRST USE 3-0-2008; IN COMMERCE 5-0-2009.

3,808,120. STATE UNIVERSITY OF NEW YORK UPSTATE MEDICAL UNIVERSITY, SYRACUSE, NY. SN 77-703,385. PUB. 8-4-2009, FILED 3-31-2009.



NO CLAIM IS MADE TO THE EXCLUSIVE RIGHT TO USE "CHILDREN'S HOSPITAL", APART FROM THE MARK AS SHOWN.

THE MARK CONSISTS OF THE WORDS "UPSTATE GOLISANO CHILDREN'S HOSPITAL", A STICK FIGURE, AND A SERIES OF ARCHED DOTS.

CLASS 41—EDUCATION AND ENTERTAINMENT

FOR EDUCATIONAL SERVICES, NAMELY, CONDUCTING CLASSES, SEMINARS, RESIDENCY, FELLOWSHIP AND INTERNSHIP TRAINING FOR DOCTORS, NURSES, TECHNICIANS IN THE MEDICAL AND HEALTHCARE FIELDS (U.S. CLS. 100, 101 AND 107).

FIRST USE 8-1-2009; IN COMMERCE 8-1-2009.

CLASS 42—SCIENTIFIC AND COMPUTER SERVICES

FOR PEDIATRIC MEDICAL RESEARCH (U.S. CLS. 100 AND 101).

FIRST USE 8-1-2009; IN COMMERCE 8-1-2009.

CLASS 44—MEDICAL, BEAUTY AND AGRICULTURAL SERVICES

FOR PEDIATRIC HOSPITAL SERVICES; HEALTHCARE SERVICES, NAMELY, INPATIENT CARE, OUTPATIENT CARE AND MEDICAL CLINICS; PROVIDING INFORMATION ON HEALTHCARE (U.S. CLS. 100 AND 101).

FIRST USE 8-1-2009; IN COMMERCE 8-1-2009.

3,808,145. LONDON LUXURY LLC, NEW ROCHELLE, NY. SN 77-706,203. PUB. 8-4-2009, FILED 4-3-2009.

GREENESSENTIALS

THE MARK CONSISTS OF STANDARD CHARACTERS WITHOUT CLAIM TO ANY PARTICULAR FONT, STYLE, SIZE, OR COLOR.

CLASS 20—FURNITURE AND ARTICLES NOT OTHERWISE CLASSIFIED

FOR PILLOWS (U.S. CLS. 2, 13, 22, 25, 32 AND 50).

FIRST USE 8-0-2009; IN COMMERCE 8-0-2009.

CLASS 24—FABRICS

FOR TOWELS (U.S. CLS. 42 AND 50).

FIRST USE 8-0-2009; IN COMMERCE 8-0-2009.

CLASS 25—CLOTHING

FOR BATHROBES (U.S. CLS. 22 AND 39),
FIRST USE 8-0-2009; IN COMMERCE 8-0-2009.

3,808,146. ROMANO & SANFILIPPO, LLC, ESCONDIDO,
CA. SN 77-706,220. PUB. 8-4-2009, FILED 4-3-2009.

HIGH DEFINITION PEOPLE

THE MARK CONSISTS OF STANDARD CHARACTERS
WITHOUT CLAIM TO ANY PARTICULAR FONT, STYLE,
SIZE, OR COLOR.

CLASS 9—ELECTRICAL AND SCIENTIFIC APPARATUS

FOR PRERECORDED ELECTRONIC MEDIA, NAMELY, AUDIO/VIDEO DISCS AND TAPES, DIGITAL RECORDING DISCS AND TAPES, COMPACT SOUND RECORDING DISCS, VIDEO DISCS AND VIDEOTAPES, ALL FEATURING INSTRUCTION, SPEECHES AND SOUND EFFECTS IN THE FIELD OF BUSINESS, COMMUNICATION, CONFLICT RESOLUTION, CULTURE, LIFESTYLE, MANAGEMENT, MOTIVATION, PERFORMANCE, PERSONAL EMPOWERMENT, PRODUCTIVITY, SALES, STRATEGIC RELATIONSHIP BUILDING AND TEAM BUILDING, STRESS AND TIME MANAGEMENT; DOWNLOADABLE PODCASTS IN THE FIELD OF BUSINESS, COMMUNICATION, CONFLICT RESOLUTION, CULTURE, LIFESTYLE, MANAGEMENT, MOTIVATION, PERFORMANCE, PERSONAL EMPOWERMENT, PRODUCTIVITY, SALES, STRATEGIC RELATIONSHIP BUILDING AND TEAM BUILDING, STRESS AND TIME MANAGEMENT (U.S. CLS. 21, 23, 26, 36 AND 38).

FIRST USE 1-10-2010; IN COMMERCE 3-16-2010.

CLASS 16—PAPER GOODS AND PRINTED MATTER

FOR PRINTED MATTER, NAMELY, A SERIES OF ARTICLES FOR PUBLICATION IN BOOKLETS, BROCHURES, CATALOGS, DIRECTORIES, MAGAZINES, MANUALS, NEWSLETTERS, NEWSPAPERS, PAMPHLETS AND PERIODICALS IN THE FIELD OF BUSINESS, COMMUNICATION, CONFLICT RESOLUTION, CULTURE, LIFESTYLE, MANAGEMENT, MOTIVATION, PERFORMANCE, PERSONAL EMPOWERMENT, PRODUCTIVITY, SALES, STRATEGIC RELATIONSHIP BUILDING AND TEAM BUILDING, STRESS AND TIME MANAGEMENT; AGENDAS; EVENT ALBUMS; BUSINESS CARDS; BOOKMARKS; CALENDARS; DESK DIARIES; PHOTOGRAPHS; PRINTED GREETING CARDS; PRINTED EDUCATIONAL, INSTRUCTIONAL AND TEACHING MATERIALS IN THE FIELD OF BUSINESS, COMMUNICATION, CONFLICT RESOLUTION, CULTURE, LIFESTYLE, MANAGEMENT, MOTIVATION, PERFORMANCE, PERSONAL EMPOWERMENT, PRODUCTIVITY, SALES, STRATEGIC RELATIONSHIP BUILDING AND TEAM BUILDING, STRESS AND TIME MANAGEMENT; PROMOTIONAL POSTCARDS AND POSTERS, SERIES OF BOOKS IN THE FIELD OF BUSINESS, COMMUNICATION, CONFLICT RESOLUTION, CULTURE, LIFESTYLE, MANAGEMENT, MOTIVATION, PERFORMANCE, PERSONAL EMPOWERMENT, PRODUCTIVITY, SALES, STRATEGIC RELATIONSHIP BUILDING AND TEAM BUILDING, STRESS AND TIME MANAGEMENT; PENS AND PENCILS (U.S. CLS. 2, 5, 22, 23, 29, 37, 38 AND 50).

FIRST USE 10-6-2009; IN COMMERCE 2-5-2010.

CLASS 35—ADVERTISING AND BUSINESS

FOR BUSINESS CONSULTATION AND ADVISORY SERVICES IN THE FIELD OF BUSINESS, COMMUNICATION, CONFLICT RESOLUTION, CULTURE, LIFESTYLE, MANAGEMENT, MOTIVATION, PERFORMANCE, PERSONAL EMPOWERMENT, PRODUCTIVITY, SALES, STRATEGIC RELATIONSHIP BUILDING AND TEAM BUILDING, STRESS AND TIME MANAGEMENT; RETAIL STORE SERVICES, WHOLESALE STORE SERVICES, ONLINE ORDERING SERVICES, TELEPHONE ORDERING SERVICES AND CATALOG ORDERING SERVICES, ALL FEATURING BOOKS AND MEDIA RECORDATIONS (U.S. CLS. 100, 101 AND 102).

FIRST USE 10-6-2009; IN COMMERCE 10-6-2009.

CLASS 38—COMMUNICATION

FOR TELECOMMUNICATIONS SERVICES, NAMELY, BROADCASTING RADIO AND TELEVISION PROGRAMS AND FILMS VIA A GLOBAL COMPUTER NETWORK AND AUDIO STREAMING SERVICES ON THE INTERNET; ELECTRONIC, ELECTRIC, AND DIGITAL TRANSMISSION OF VOICE, DATA, IMAGES, SOUND, SIGNAL AND MESSAGES; ELECTRONIC TRANSMISSION OF E-BOOKS, E-ZINES AND NEWSLETTERS VIA A GLOBAL COMPUTER NETWORK; ELECTRONIC TRANSMISSION OF GREETING CARDS AND MAILERS VIA A GLOBAL COMPUTER NETWORK; TRANSMISSION OF DATA, DOCUMENTS AND INFORMATION OVER ELECTRONIC MEDIA; WEBCASTING AND BROADCASTING SERVICES AND PROVISION OF TELECOMMUNICATION ACCESS TO AUDIO RECORDINGS PROVIDED VIA AN AUDIO-ON-DEMAND SERVICE VIA THE INTERNET; TELECOMMUNICATION SERVICES, NAMELY, TRANSMISSION OF PODCASTS (U.S. CLS. 100, 101 AND 104).

FIRST USE 2-5-2010; IN COMMERCE 2-5-2010.

CLASS 41—EDUCATION AND ENTERTAINMENT

FOR EDUCATIONAL AND INSTRUCTIONAL SERVICES, NAMELY, ARRANGING AND CONDUCTING EDUCATIONAL CONFERENCES, RETREATS, SEMINARS, PERSONAL COACHING AND WORKSHOPS IN THE FIELD OF BUSINESS, COMMUNICATION, CONFLICT RESOLUTION, CULTURE, LIFESTYLE, MANAGEMENT, MOTIVATION, PERFORMANCE, PERSONAL EMPOWERMENT, PRODUCTIVITY, SALES, STRATEGIC RELATIONSHIP BUILDING AND TEAM BUILDING, STRESS AND TIME MANAGEMENT; ENTERTAINMENT SERVICES, NAMELY, PROVIDING PODCASTS IN THE FIELD OF BUSINESS, COMMUNICATION, CONFLICT RESOLUTION, CULTURE, LIFESTYLE, MANAGEMENT, MOTIVATION, PERFORMANCE, PERSONAL EMPOWERMENT, PRODUCTIVITY, SALES, STRATEGIC RELATIONSHIP BUILDING AND TEAM BUILDING, STRESS AND TIME MANAGEMENT; LIVE SPEAKING PERFORMANCES IN THE FIELD OF BUSINESS, COMMUNICATION, CONFLICT RESOLUTION, CULTURE, LIFESTYLE, MANAGEMENT, MOTIVATION, PERFORMANCE, PERSONAL EMPOWERMENT, PRODUCTIVITY, SALES, STRATEGIC RELATIONSHIP BUILDING AND TEAM BUILDING, STRESS AND TIME MANAGEMENT; PRODUCTION OF RADIO AND TELEVISION AND FILM PROGRAMS AND PUBLICATION OF ACCOMPANYING MATERIALS IN THE FORM OF BOOKS, MAGAZINES AND NEWSLETTERS; PROVIDING COACHING SERVICES IN THE FIELD OF BUSINESS, COMMUNICATION, CONFLICT RESOLUTION, CULTURE, LIFESTYLE, MANAGEMENT, MOTIVATION, PERFORMANCE, PERSONAL EMPOWERMENT, PRODUCTIVITY, SALES, STRATEGIC RELATIONSHIP BUILDING AND TEAM BUILDING, STRESS AND TIME MANAGEMENT (U.S. CLS. 100, 101 AND 107).

FIRST USE 2-1-2009; IN COMMERCE 3-24-2009.

3,808,148. ALPHA CREATIONS, INC., HOUSTON, TX. SN 77-707,064. PUB. 8-11-2009, FILED 4-5-2009.



THE NAME "BRIAN GAVIN" IDENTIFIES A LIVING INDIVIDUAL WHOSE CONSENT IS OF RECORD.

THE MARK CONSISTS OF THE NAME "BRIAN GAVIN" WRITTEN IN A STYLIZED FONT DIVIDED BY A STYLIZED GEMSTONE OR DIAMOND WITH THE NAMES "BRIAN" AND "GAVIN" UNDERLINED.

CLASS 14—JEWELRY

FOR DIAMONDS, CUT DIAMONDS, DIAMOND JEWELRY, JEWELRY AND PRECIOUS STONES (U.S. CLS. 2, 27, 28 AND 50).

FIRST USE 2-28-2009; IN COMMERCE 2-28-2009.

CLASS 35—ADVERTISING AND BUSINESS

FOR ON-LINE RETAIL STORE SERVICES FEATURING JEWELRY, DIAMONDS, PRECIOUS AND SEMI-PRECIOUS STONES AND CUSTOM JEWELRY DESIGNS (U.S. CLS. 100, 101 AND 102).

FIRST USE 2-28-2009; IN COMMERCE 2-28-2009.

3,808,162. TIM RYAN ROUILLIER, FRANKLING, TN. SN 77-709,676. PUB. 8-11-2009, FILED 4-8-2009.

BORN TO BE A COWBOY

THE MARK CONSISTS OF STANDARD CHARACTERS WITHOUT CLAIM TO ANY PARTICULAR FONT, STYLE, SIZE, OR COLOR.

CLASS 21—HOUSEWARES AND GLASS

FOR BEVERAGE GLASSWARE; MUGS (U.S. CLS. 2, 13, 23, 29, 30, 33, 40 AND 50).

FIRST USE 4-2-2010; IN COMMERCE 4-2-2010.

CLASS 25—CLOTHING

FOR SHIRTS; SWEAT SHIRTS; T-SHIRTS (U.S. CLS. 22 AND 39).

FIRST USE 4-2-2010; IN COMMERCE 4-2-2010.

3,808,193. XYTEX INTERNATIONAL, LTD., AUGUSTA, GA. SN 77-714,315. PUB. 8-18-2009, FILED 4-15-2009.



THE MARK CONSISTS OF A FIGURE IN THE SHAPE OF AN "X".

CLASS 39—TRANSPORTATION AND STORAGE

FOR BIOMEDICAL SERVICES, NAMELY, STORAGE OF UMBILICAL CORD BLOOD AND REPRODUCTIVE TISSUES; TRANSPORT AND DELIVERY OF UMBILICAL CORD BLOOD AND REPRODUCTIVE TISSUES (U.S. CLS. 100 AND 105).

FIRST USE 1-1-2009; IN COMMERCE 1-1-2009.

CLASS 42—SCIENTIFIC AND COMPUTER SERVICES

FOR MEDICAL LABORATORY SERVICES (U.S. CLS. 100 AND 101).

FIRST USE 1-1-2009; IN COMMERCE 1-1-2009.

CLASS 44—MEDICAL, BEAUTY AND AGRICULTURAL SERVICES

FOR SPERM, OVUM, AND UMBILICAL CORD BLOOD BANKING SERVICES; COLLECTION, TESTING AND PRESERVATION OF UMBILICAL CORD BLOOD AND REPRODUCTIVE TISSUES; MEDICAL SERVICES, NAMELY, MATCHING OF UMBILICAL CORD BLOOD FOR OTHERS; DIAGNOSTIC SERVICES, NAMELY, SEMEN ANALYSIS (U.S. CLS. 100 AND 101).

FIRST USE 1-1-2009; IN COMMERCE 1-1-2009.

3,808,202. ADVANCE MAGAZINE PUBLISHERS, INC., NEW YORK, NY. SN 77-715,500. PUB. 8-18-2009, FILED 4-16-2009.



OWNER OF U.S. REG. NOS. 1,595,325, 2,340,335, AND OTHERS.

THE MARK CONSISTS OF THE WORD "BRIDES" IN A STYLIZED FORMAT.

CLASS 16—PAPER GOODS AND PRINTED MATTER

FOR GIFT BAGS, GUEST BOOKS, PAPER GIFT TAGS, STICKERS, SEALS, STORAGE BOXES, NAMELY, PAPER STORAGE BOXES AND CARDBOARD STORAGE BOXES, FILE FOLDERS, DECALS, PRINTED INVITATIONS, EVENT PROGRAMS, THANK-YOU NOTES, NOTE CARD SETS, PLACE CARDS, STATIONERY (U.S. CLS. 2, 5, 22, 23, 29, 37, 38 AND 50).

FIRST USE 1-15-2008; IN COMMERCE 1-15-2008.

CLASS 28—TOYS AND SPORTING GOODS

FOR CONFETTI (U.S. CLS. 22, 23, 38 AND 50).
FIRST USE 1-15-2008; IN COMMERCE 1-15-2008.

3,808,220. CAMELOT COMMUNICATIONS GROUP, INC., NEW YORK, NY. SN 77-719,821. PUB. 12-1-2009, FILED 4-22-2009.

WE PUT A FACE TO TECHNOLOGY

THE MARK CONSISTS OF STANDARD CHARACTERS WITHOUT CLAIM TO ANY PARTICULAR FONT, STYLE, SIZE, OR COLOR.

CLASS 37—CONSTRUCTION AND REPAIR

FOR INSTALLATION, REPAIR AND MAINTENANCE OF TELECOMMUNICATIONS NETWORKS, APPARATUS, AND INSTRUMENTS (U.S. CLS. 100, 103 AND 106).
FIRST USE 2-26-2010; IN COMMERCE 2-26-2010.

CLASS 42—SCIENTIFIC AND COMPUTER SERVICES

FOR CONSULTING IN THE FIELD OF TELECOMMUNICATIONS TECHNOLOGY; PLANNING AND DEVELOPMENT OF ELECTRONIC COMMUNICATIONS NETWORKS; TECHNICAL SUPPORT OF ELECTRONIC COMMUNICATIONS NETWORKS, NAMELY, MONITORING OF NETWORK SYSTEMS; REMOTE COMPUTER NETWORK TECHNICAL MONITORING AND SOFTWARE MAINTENANCE SERVICES; COMPUTER SERVICES, NAMELY, REMOTE AND ON-SITE MANAGEMENT OF THE INFORMATION TECHNOLOGY (IT) SYSTEMS OF OTHERS; DESIGN AND DEVELOPMENT OF NETWORKS; DESIGN, DEPLOYMENT AND MANAGEMENT OF WIRELESS NETWORKS FOR OTHERS; COMPUTER TECHNOLOGY SUPPORT SERVICES, NAMELY, HELP DESK SERVICES (U.S. CLS. 100 AND 101).

FIRST USE 2-26-2010; IN COMMERCE 2-26-2010.

3,808,237. XEROX CORPORATION, NORWALK, CT. SN 77-726,217. PUB. 7-28-2009, FILED 4-30-2009.

XEROX SERVICES ADVANTAGE

THE MARK CONSISTS OF STANDARD CHARACTERS WITHOUT CLAIM TO ANY PARTICULAR FONT, STYLE,

SIZE, OR COLOR.

OWNER OF U.S. REG. NOS. 916,047, 3,200,714, AND OTHERS.

NO CLAIM IS MADE TO THE EXCLUSIVE RIGHT TO USE "SERVICES", APART FROM THE MARK AS SHOWN.

CLASS 41—EDUCATION AND ENTERTAINMENT

FOR EDUCATION, NAMELY, TRAINING IN THE FIELD OF PRINTING AND PRINTER OPERATION (U.S. CLS. 100, 101 AND 107).

FIRST USE 10-19-2009; IN COMMERCE 10-19-2009.

CLASS 42—SCIENTIFIC AND COMPUTER SERVICES

FOR DESIGN AND DEVELOPMENT OF COMPUTER HARDWARE AND SOFTWARE IN THE FIELD OF PRINTING; TECHNOLOGICAL ADVISORY AND CONSULTING SERVICES IN PRINT MANAGEMENT AND PRINT COSTS, IN FILE CONVERSION, IN DATA STORAGE MANAGEMENT, IN COMPUTER NETWORK INTEGRATION AND MANAGEMENT (U.S. CLS. 100 AND 101).

FIRST USE 10-19-2009; IN COMMERCE 10-19-2009.

3,808,242. BRUCKMAN, DAVID B., RYE BROOK, NY. SN 77-727,776. PUB. 10-6-2009, FILED 5-3-2009.

Family Financial Confidant

THE MARK CONSISTS OF STANDARD CHARACTERS WITHOUT CLAIM TO ANY PARTICULAR FONT, STYLE, SIZE, OR COLOR.

NO CLAIM IS MADE TO THE EXCLUSIVE RIGHT TO USE "FAMILY FINANCIAL", APART FROM THE MARK AS SHOWN.

CLASS 35—ADVERTISING AND BUSINESS

FOR BUSINESS ADVICE AND INFORMATION ABOUT A CORPORATE EXECUTIVE WHOSE WEALTH AMOUNTS TO AT LEAST A BILLION DOLLARS, POUNDS, OR THE EQUIVALENT IN OTHER CURRENCY (U.S. CLS. 100, 101 AND 102).

FIRST USE 7-6-2009; IN COMMERCE 7-6-2009.

CLASS 36—INSURANCE AND FINANCIAL

FOR FINANCIAL CONSULTING SERVICES IN THE FIELD OF PLANNED GIVING FOR NON-PROFIT AND CHARITABLE ORGANIZATIONS; FINANCIAL MANAGEMENT; FINANCIAL PLANNING; FINANCIAL PLANNING CONSULTATION; FINANCIAL PLANNING FOR RETIREMENT; FINANCIAL PLANNING SERVICES, NAMELY, DEVELOPING AND MANAGING CHARITABLE GIVING PROGRAMS ON BEHALF OF WEALTHY INDIVIDUALS OR FAMILIES; FINANCIAL RISK MANAGEMENT; ADVICE RELATING TO INVESTMENTS; FINANCIAL ADVISORY AND CONSULTANCY SERVICES; FINANCIAL PLANNING AND INVESTMENT ADVISORY SERVICES; FINANCIAL PLANNING, NAMELY, THE CREATION OF PERSONALIZED STRATEGIES TO ACHIEVE FINANCIAL INDEPENDENCE; FINANCIAL PORTFOLIO ANALYSIS SERVICES; FINANCIAL PORTFOLIO MANAGEMENT; INVESTMENT ADVICE (U.S. CLS. 100, 101 AND 102).

FIRST USE 7-6-2009; IN COMMERCE 7-6-2009.

3,808,269. NORTH AMERICAN MANUFACTURING ENTERPRISES, INC., STATEN ISLAND, NY. SN 77-731,869. PUB. 9-15-2009, FILED 5-7-2009.

3,808,303. AOSOM LLC, TIGARD, OR. SN 77-745,033. PUB. 11-17-2009, FILED 5-27-2009.

MHT LIGHTING

THE MARK CONSISTS OF STANDARD CHARACTERS WITHOUT CLAIM TO ANY PARTICULAR FONT, STYLE, SIZE, OR COLOR.

NO CLAIM IS MADE TO THE EXCLUSIVE RIGHT TO USE "LIGHTING", APART FROM THE MARK AS SHOWN.

CLASS 11—ENVIRONMENTAL CONTROL APPARATUS

FOR LIGHTING FIXTURES (U.S. CLS. 13, 21, 23, 31 AND 34).

FIRST USE 2-1-2009; IN COMMERCE 2-1-2009.

CLASS 42—SCIENTIFIC AND COMPUTER SERVICES

FOR LIGHTING DESIGN AND LIGHTING DESIGN CONSULTING SERVICES (U.S. CLS. 100 AND 101).

FIRST USE 2-1-2009; IN COMMERCE 2-1-2009.



3,808,278. RAZOR USA LLC, CERRITOS, CA. SN 77-735,281. PUB. 12-8-2009, FILED 5-12-2009.

SOLE SKATE

THE MARK CONSISTS OF STANDARD CHARACTERS WITHOUT CLAIM TO ANY PARTICULAR FONT, STYLE, SIZE, OR COLOR.

NO CLAIM IS MADE TO THE EXCLUSIVE RIGHT TO USE "SKATE", APART FROM THE MARK AS SHOWN.

CLASS 12—VEHICLES

FOR SCOOTERS (U.S. CLS. 19, 21, 23, 31, 35 AND 44).
FIRST USE 7-15-2009; IN COMMERCE 8-13-2009.

CLASS 28—TOYS AND SPORTING GOODS

FOR ROLLER SKATES, TOY SCOOTERS, RIDE-ON TOYS, TOY VEHICLES (U.S. CLS. 22, 23, 38 AND 50).
FIRST USE 7-15-2009; IN COMMERCE 8-13-2009.

THE NAME(S), PORTRAIT(S), AND/OR SIGNATURE(S) SHOWN IN THE MARK DOES NOT IDENTIFY A PARTICULAR LIVING INDIVIDUAL.

THE COLOR(S) YELLOW, RED, BLACK AND BLUE IS/ARE CLAIMED AS A FEATURE OF THE MARK.

THE MARK CONSISTS OF THE WORD "AOSOM" IN SCRIPT BLACK LETTERS BELOW A STYLIZED LETTER "A". THE COLORS YELLOW, RED AND BLUE APPEAR AS THE LINES COMPRISING THE STYLIZED LETTER "A".

THE WORDING "AOSOM" HAS NO MEANING IN A FOREIGN LANGUAGE.

CLASS 9—ELECTRICAL AND SCIENTIFIC APPARATUS

FOR PROJECTION SCREENS (U.S. CLS. 21, 23, 26, 36 AND 38).

FIRST USE 10-1-2008; IN COMMERCE 10-1-2008.

CLASS 10—MEDICAL APPARATUS

FOR MASSAGE APPARATUS (U.S. CLS. 26, 39 AND 44).

FIRST USE 10-1-2008; IN COMMERCE 10-1-2008.

CLASS 20—FURNITURE AND ARTICLES NOT OTHERWISE CLASSIFIED

FOR PLAYPENS (U.S. CLS. 2, 13, 22, 25, 32 AND 50).
FIRST USE 10-1-2008; IN COMMERCE 10-1-2008.

3,808,305. CHRISTIAN BROTHERS SERVICES, ROMEOVILLE, IL. SN 77-745,620. PUB. 10-6-2009, FILED 5-27-2009.



THE MARK CONSISTS OF OVERLAPPING STAR DESIGNS WITHIN A RECTANGULAR BLOCK.

CLASS 36—INSURANCE AND FINANCIAL

FOR ADMINISTRATION AND FINANCIAL MANAGEMENT OF TRUSTS, BENEFIT PROGRAMS, RETIREMENT PLANS AND RISK MANAGEMENT PROGRAMS FOR CHARITABLE AND RELIGIOUS ORGANIZATIONS; CONSULTING IN THE FIELD OF TRUSTS, BENEFIT PROGRAMS, RETIREMENT PLANS AND RISK MANAGEMENT PROGRAMS FOR CHARITABLE AND RELIGIOUS ORGANIZATIONS (U.S. CLS. 100, 101 AND 102).

FIRST USE 8-3-2009; IN COMMERCE 8-3-2009.

CLASS 42—SCIENTIFIC AND COMPUTER SERVICES

FOR DESIGN, CREATION, HOSTING, MAINTENANCE OF WEBSITES FOR OTHERS (U.S. CLS. 100 AND 101).

FIRST USE 8-3-2009; IN COMMERCE 8-3-2009.

3,808,306. CHRISTIAN BROTHERS SERVICES, ROMEOVILLE, IL. SN 77-745,622. PUB. 10-6-2009, FILED 5-27-2009.

UNDERSTANDING PROTECTING
GUIDING

THE MARK CONSISTS OF STANDARD CHARACTERS WITHOUT CLAIM TO ANY PARTICULAR FONT, STYLE, SIZE, OR COLOR.

CLASS 36—INSURANCE AND FINANCIAL

FOR ADMINISTRATION AND FINANCIAL MANAGEMENT OF TRUSTS, BENEFIT PROGRAMS, RETIREMENT PLANS AND RISK MANAGEMENT PROGRAMS FOR CHARITABLE AND RELIGIOUS ORGANIZATIONS; CONSULTING IN THE FIELD OF TRUSTS, BENEFIT PROGRAMS, RETIREMENT PLANS AND RISK MANAGEMENT PROGRAMS FOR CHARITABLE AND RELIGIOUS ORGANIZATIONS (U.S. CLS. 100, 101 AND 102).

FIRST USE 8-3-2009; IN COMMERCE 8-3-2009.

CLASS 42—SCIENTIFIC AND COMPUTER SERVICES

FOR DESIGN, CREATION, HOSTING, MAINTENANCE OF WEBSITES FOR OTHERS (U.S. CLS. 100 AND 101).

FIRST USE 8-3-2009; IN COMMERCE 8-3-2009.

3,808,316. BROWN, DAVID H, VISTA, CA. SN 77-750,467. PUB. 12-8-2009, FILED 6-2-2009.



THE COLOR(S) BLACK, WHITE AND RED IS/ARE CLAIMED AS A FEATURE OF THE MARK.

THE MARK CONSISTS OF THE FOLLOWING: THE LETTERS "FKD" APPEARING IN RED AND OUTLINED IN BLACK AND WHITE. A CIRCULAR DESIGN COMPOSED OF STYLIZED AX BLADES APPEARING IN BLACK AND WHITE.

CLASS 18—LEATHER GOODS

FOR BAGS, NAMELY, MESSENGER BAGS, CLUTCHES, KNAPSACKS, ATHLETIC BAGS, BOOK BAGS, SATCHELS, BRIEFCASES, BACKPACKS, SUITCASES, ROLL ON AND CARRY ON BAGS (U.S. CLS. 1, 2, 3, 22 AND 41).

FIRST USE 6-1-2002; IN COMMERCE 6-1-2008.

CLASS 25—CLOTHING

FOR CLOTHING, NAMELY, ACTIVEWEAR IN THE NATURE OF SHIRTS, PANTS, T-SHIRTS, TANK TOPS, SHORTS, SWEATERS, SWEATSHIRTS, HOODED SWEATSHIRTS, JACKETS, TUNICS, SKIRTS, SKORTS, SPORTS BRAS, UNDER GARMENTS, WIND-RESISTANT JACKETS; SPORTSWEAR, IN THE NATURE OF SHIRTS, PANTS, T-SHIRTS, TANK TOPS, SHORTS, SWEATERS, SWEATSHIRTS, HOODED SWEATSHIRTS, JACKETS, TUNICS, SKIRTS, SKORTS, SPORTS BRAS, UNDER GARMENTS, WIND-RESISTANT JACKETS, SOCKS; SKATEWEAR, IN THE NATURE OF SHIRTS, PANTS, T-SHIRTS, TANK TOPS, SHORTS, SWEATERS, SWEATSHIRTS, HOODED SWEATSHIRTS, JACKETS, TUNICS, SKIRTS, SKORTS, SPORTS BRAS, UNDER GARMENTS, WIND-RESISTANT JACKETS; SKI WEAR AND OTHER CLOTHING, NAMELY, T-SHIRTS, TANK TOPS, SHIRTS, SHORTS, SWEATSHIRTS, HOODED SWEATSHIRTS, TOPS, HOODED TOPS, SWEATPANTS, OUTERWEAR, NAMELY, COATS, JACKETS AND SKI JACKETS, JACKET, SKI JACKETS, BABY TEES, PANTS, SHORTS, SWIMWEAR, BELTS, HATS; HEADGEAR, NAMELY, VISORS, BASEBALL CAPS, BEANIES, HEADBANDS; GLOVES, SHOES, FOOTWEAR, SKATEBOARD FOOTWEAR, SLIPPERS, FLIP FLOPS, SANDALS, CAPS, HEADWEAR, HATS AND ACCESSORIES IN THE NATURE OF SCARVES, BELTS, SOCKS, VISORS (U.S. CLS. 22 AND 39).

FIRST USE 1-1-1997; IN COMMERCE 1-1-1997.

CLASS 28—TOYS AND SPORTING GOODS

FOR SPORTING GOODS, NAMELY, SKATEBOARDS, SKATEBOARD DECKS, SKATEBOARD TRUCKS, SKATEBOARD WHEELS, SKATEBOARD AXELS, SKATEBOARD WHEEL ASSEMBLIES, AND PARTS AND FITTINGS FOR ANY THEREOF, SKATEBOARD BEARINGS, SKATEBOARD MOUNTING HARDWARE, SKATEBOARD GRIP TAPE, SKATEBOARD RISER PADS, SKATEBOARD NUTS AND BOLTS, SKATEBOARD BAGS, AND ACCESSORIES IN THE NATURE OF PROTECTIVE PADDING FOR SKATEBOARDING (U.S. CLS. 22, 23, 38 AND 50).

FIRST USE 2-1-1997; IN COMMERCE 2-1-1997.

CLASS 25—CLOTHING

FOR CLOTHING, NAMELY, T-SHIRTS, SHIRTS, TOPS, SWEAT SHIRTS; HEADGEAR, NAMELY, BEANIES (U.S. CLS. 22 AND 39).

FIRST USE 1-1-2010; IN COMMERCE 1-1-2010.

CLASS 35—ADVERTISING AND BUSINESS

FOR ON-LINE RETAIL STORE SERVICES FEATURING CLOTHING, CAMPING GEAR, SPORTING GOODS, SPORTSWEAR, AND HEADWEAR (U.S. CLS. 100, 101 AND 102).

FIRST USE 1-1-2010; IN COMMERCE 1-1-2010.

3,808,352. HALOGEN SOFTWARE INC., OTTAWA ONTARIO, CANADA. SN 77-762,048. PUB. 12-1-2009, FILED 6-17-2009.

HALOGEN

THE MARK CONSISTS OF STANDARD CHARACTERS WITHOUT CLAIM TO ANY PARTICULAR FONT, STYLE, SIZE, OR COLOR.

OWNER OF U.S. REG. NO. 2,623,836.

CLASS 9—ELECTRICAL AND SCIENTIFIC APPARATUS

FOR COMPUTER SOFTWARE FOR USE IN THE MANAGEMENT OF HUMAN RESOURCES AND PRINTED USER MANUALS AND PRINTED USER GUIDES SOLD AS A UNIT (U.S. CLS. 21, 23, 26, 36 AND 38).

FIRST USE 4-0-2001; IN COMMERCE 4-0-2001.

CLASS 35—ADVERTISING AND BUSINESS

FOR BUSINESS CONSULTATION SERVICES RELATED TO THE MANAGEMENT OF HUMAN RESOURCES (U.S. CLS. 100, 101 AND 102).

FIRST USE 4-0-2001; IN COMMERCE 4-0-2001.

CLASS 42—SCIENTIFIC AND COMPUTER SERVICES

FOR COMPUTER SERVICES, NAMELY, PROVIDING ON-LINE TEMPORARY USE OF HOSTED, NON-DOWNLOADABLE SOFTWARE FOR USE IN THE MANAGEMENT OF HUMAN RESOURCES (U.S. CLS. 100 AND 101).

FIRST USE 4-0-2001; IN COMMERCE 4-0-2001.

3,808,355. RANGE OF LIGHT, LLC., ROSEVILLE, CA. SN 77-764,099. PUB. 11-17-2009, FILED 6-19-2009.



THE MARK CONSISTS OF A MOUNTAIN RANGE HAVING THREE PEAKS AND WITH THE STYLIZED TEXT "RANGE OF LIGHT".

3,808,362. LIQUID WEB, INC., LANSING, MI. SN 77-767,170. PUB. 1-5-2010, FILED 6-24-2009.

STORM

THE MARK CONSISTS OF STANDARD CHARACTERS WITHOUT CLAIM TO ANY PARTICULAR FONT, STYLE, SIZE, OR COLOR.

CLASS 38—COMMUNICATION

FOR PROVIDING ACCESS TO HOSTED OPERATING SYSTEMS AND COMPUTER APPLICATIONS THROUGH THE INTERNET (U.S. CLS. 100, 101 AND 104).

FIRST USE 1-11-2010; IN COMMERCE 1-11-2010.

CLASS 42—SCIENTIFIC AND COMPUTER SERVICES

FOR COMPUTER SERVICES, NAMELY, ACTING AS AN APPLICATION SERVICES PROVIDER FOR THIRD PARTIES FEATURING REMOTE HOSTING OF OPERATING SYSTEMS AND COMPUTER APPLICATIONS; COMPUTER SERVICES, NAMELY, PROVIDING A VIRTUAL COMPUTING ENVIRONMENT ACCESSIBLE VIA THE INTERNET FOR REGISTERED USERS FOR THE PURPOSE OF COMPUTING COMPUTER SERVER CAPACITY; RENTAL OF COMPUTING AND DATA STORAGE FACILITIES OF VARIABLE CAPACITY, NAMELY, DATABASE SERVERS, TO THIRD PARTIES; SOFTWARE, NON-DOWNLOADABLE, ACCESSIBLE OVER A GLOBAL COMPUTER NETWORK, FOR MANAGING COMPUTER APPLICATIONS (U.S. CLS. 100 AND 101).

FIRST USE 1-11-2010; IN COMMERCE 1-11-2010.

3,808,367. SOSRODJOJO, SOEKIANTO SOSRODJOJO, SOEWITO SOSRODJOJO, SOEJANI SOSRODJOJO, KUNNIARTI SOSRODJOJO, SUKOWATI, KELAPAGADING, JAKARTA, INDONESIA. SN 77-769,931. PUB. 11-24-2009, FILED 6-29-2009.



OWNER OF U.S. REG. NO. 1,821,569.
NO CLAIM IS MADE TO THE EXCLUSIVE RIGHT TO USE "FRUIT TEA", APART FROM THE MARK AS SHOWN. THE COLOR(S) RED, WHITE, GREEN AND YELLOW IS/ARE CLAIMED AS A FEATURE OF THE MARK.
THE MARK CONSISTS OF "FRUIT TEA" IN RED WITH WHITE SHADING BELOW A RED CIRCLE WITH "SOSRO" IN WHITE, ALL INSIDE A POINTED CIRCULAR DESIGN OF YELLOW OUTLINED IN GREEN AND RED AND GREEN DOTS AND TRIANGLES.

CLASS 30—STAPLE FOODS

FOR TEA, TEA BASED BEVERAGES WITH FRUIT FLAVOR, BEVERAGES MADE OF TEA, READY-TO-DRINK TEA (U.S. CL. 46).
FIRST USE 7-1-2008; IN COMMERCE 7-1-2008.

CLASS 32—LIGHT BEVERAGES

FOR BEVERAGES AND NON-ALCOHOLIC DRINKS WITH TEA AND FRUIT FLAVOR; NON ALCOHOLIC BEVERAGES CONTAINING FRUIT JUICES (U.S. CLS. 45, 46 AND 48).
FIRST USE 7-1-2008; IN COMMERCE 7-1-2008.

3,808,369. SOSRODJOJO, SOEKIANTO SOSRODJOJO, SOEWITO SOSRODJOJO, SOEJANI SOSRODJOJO, KUNNIARTI SOSRODJOJO, SUKOWATI, KELAPAGADING, JAKARTA, INDONESIA. SN 77-769,955. PUB. 11-24-2009, FILED 6-29-2009.



NO CLAIM IS MADE TO THE EXCLUSIVE RIGHT TO USE "TEHBOTOL", APART FROM THE MARK AS SHOWN. THE COLOR(S) RED, WHITE AND BLACK IS/ARE CLAIMED AS A FEATURE OF THE MARK.
THE MARK CONSISTS OF THE WORD "SOSRO" IN WHITE INSIDE A RED CIRCLE ABOVE THE STYLIZED WORD "TEHBOTOL" IN WHITE OUTLINED IN BLACK.
THE ENGLISH TRANSLATION OF "TEHBOTOL" IN THE

MARK IS TEA IN A BOTTLE.

CLASS 30—STAPLE FOODS

FOR TEA, BEVERAGES MADE OF TEA, READY-TO-DRINK TEA (U.S. CL. 46).
FIRST USE 4-28-2008; IN COMMERCE 7-1-2008.

CLASS 32—LIGHT BEVERAGES

FOR BEVERAGES AND NON-ALCOHOLIC DRINKS WITH TEA FLAVOR (U.S. CLS. 45, 46 AND 48).
FIRST USE 4-28-2008; IN COMMERCE 7-1-2008.

3,808,370. SOSRODJOJO, SOEKIANTO SOSRODJOJO, SOEWITO SOSRODJOJO, SOEJANI SOSRODJOJO, KUNNIARTI SOSRODJOJO, SUKOWATI, KELAPAGADING, JAKARTA, INDONESIA. SN 77-769,963. PUB. 11-24-2009, FILED 6-29-2009.

TEH BOTOL SOSRO

THE MARK CONSISTS OF STANDARD CHARACTERS WITHOUT CLAIM TO ANY PARTICULAR FONT, STYLE, SIZE, OR COLOR.

OWNER OF U.S. REG. NO. 1,821,569.
NO CLAIM IS MADE TO THE EXCLUSIVE RIGHT TO USE "TEH BOTOL", APART FROM THE MARK AS SHOWN. THE ENGLISH TRANSLATION OF "TEH BOTOL" IN THE MARK IS TEA IN A BOTTLE.

CLASS 30—STAPLE FOODS

FOR TEA, BEVERAGES MADE OF TEA, READY-TO-DRINK TEA (U.S. CL. 46).
FIRST USE 4-28-2008; IN COMMERCE 7-1-2008.

CLASS 32—LIGHT BEVERAGES

FOR BEVERAGES AND NON-ALCOHOLIC DRINKS WITH TEA FLAVOR (U.S. CLS. 45, 46 AND 48).
FIRST USE 4-28-2008; IN COMMERCE 7-1-2008.

3,808,379. VONAGE MARKETING LLC, HOLMDEL, NJ. SN 77-772,460. PUB. 9-22-2009, FILED 7-1-2009.



OWNER OF U.S. REG. NO. 3,440,689.
THE MARK CONSISTS OF CONTINUOUS WAVE-LIKE DESIGN COMPRISED OF REPEATING DESIGNS OF A STYLIZED "V" WITH SOLID DOT.

CLASS 35—ADVERTISING AND BUSINESS

FOR ADVERTISING AND PROMOTION OF TELEPHONY COMMUNICATION SERVICES (U.S. CLS. 100, 101 AND 102).
FIRST USE 6-30-2009; IN COMMERCE 6-30-2009.

CLASS 38—COMMUNICATION

FOR TELEPHONY COMMUNICATION SERVICES (U.S. CLS. 100, 101 AND 104).
FIRST USE 6-30-2009; IN COMMERCE 6-30-2009.

3,808,385. CHANNEL V MEDIA, TA CHANNEL V BOOKS, NEW YORK, NY. SN 77-775,344. PUB. 12-1-2009, FILED 7-7-2009.

3,808,382. DOCAUTO, INC., NORCROSS, GA. SN 77-774,849. PUB. 12-1-2009, FILED 7-6-2009.

FUNCTIONALITY IS A
FUNCTION OF YOU

THE MARK CONSISTS OF STANDARD CHARACTERS WITHOUT CLAIM TO ANY PARTICULAR FONT, STYLE, SIZE, OR COLOR.

CLASS 9—ELECTRICAL AND SCIENTIFIC APPARATUS

FOR COMPUTER SOFTWARE PRODUCTS FOR EXTENDING THE CAPABILITIES OF CONTENT MANAGEMENT SYSTEMS, NAMELY, COMPUTER SOFTWARE FOR IMPORTING CONTENT INTO CONTENT MANAGEMENT SYSTEMS, COMPUTER SOFTWARE FOR EXPORTING CONTENT FROM CONTENT MANAGEMENT SYSTEMS, COMPUTER SOFTWARE FOR E-MAIL MANAGEMENT WITH CONTENT MANAGEMENT SYSTEMS, COMPUTER SOFTWARE FOR SECURITY AND METADATA MANAGEMENT WITH CONTENT MANAGEMENT SYSTEMS, COMPUTER SOFTWARE FOR DATA SYNCHRONIZATION BETWEEN CONTENT MANAGEMENT SYSTEMS AND OTHER SYSTEMS, COMPUTER SOFTWARE FOR MATTER-CENTRIC CONTENT AND STRUCTURAL MANAGEMENT WITHIN CONTENT MANAGEMENT SYSTEMS, COMPUTER SOFTWARE FOR EVENT MONITORING, NOTIFICATION, AND REPORTING WITHIN CONTENT MANAGEMENT SYSTEMS, AND COMPUTER SOFTWARE FOR CONTENT IDENTIFICATION WITHIN CONTENT MANAGEMENT SYSTEMS (U.S. CLS. 21, 23, 26, 36 AND 38).

FIRST USE 9-0-2009; IN COMMERCE 9-0-2009.

CLASS 41—EDUCATION AND ENTERTAINMENT

FOR TRAINING IN THE USE OF COMPUTER SOFTWARE FOR EXTENDING THE CAPABILITIES OF CONTENT MANAGEMENT SYSTEMS (U.S. CLS. 100, 101 AND 107).

FIRST USE 12-0-2009; IN COMMERCE 12-0-2009.

CLASS 42—SCIENTIFIC AND COMPUTER SERVICES

FOR CONSULTATION IN THE SELECTION, IMPLEMENTATION AND USE OF COMPUTER SOFTWARE FOR EXTENDING THE CAPABILITIES OF CONTENT MANAGEMENT SYSTEMS (U.S. CLS. 100 AND 101).

FIRST USE 9-0-2009; IN COMMERCE 9-0-2009.



THE MARK CONSISTS OF THREE CIRCULAR ELEMENTS, WHICH ARE PRESENTED VERTICALLY. THE FIRST IS A GEOMETRIC, BLACK LETTER 'C', THE INSIDE EDGES OF WHICH FORM A TRANSPARENT HEXAGON. THIS SITS ATOP THE LETTER 'V', WHICH IS TRANSPARENT AND SURROUNDED BY A BLACK BACKGROUND CREATING A CIRCULAR FORMAT. THE FINAL ELEMENT, WHICH SITS BELOW SECOND, IS A TRANSPARENT SILHOUETTE OF A BOOK ENCASED IN AN INCOMPLETE BLACK CIRCULAR FORMAT.

CLASS 16—PAPER GOODS AND PRINTED MATTER

FOR BOOK COVERS (U.S. CLS. 2, 5, 22, 23, 29, 37, 38 AND 50).

FIRST USE 9-1-2009; IN COMMERCE 9-1-2009.

CLASS 42—SCIENTIFIC AND COMPUTER SERVICES

FOR DESIGN OF HOMEPAGES AND WEBSITES; HOSTING AN ONLINE WEBSITE FEATURING BOOKS, AUTHORS AND COMPANY INFORMATION (U.S. CLS. 100 AND 101).

FIRST USE 9-1-2009; IN COMMERCE 9-1-2009.

3,808,391. GEO STUDIO TECHNOLOGY, BELO HORIZONTE, BRAZIL. SN 77-779,069. PUB. 12-29-2009, FILED 7-11-2009.



THE COLOR(S) BLUE AND RED IS/ARE CLAIMED AS A FEATURE OF THE MARK.

THE MARK CONSISTS OF THE WORD "TRACKMAKER" APPEARING IN BLUE AND THE DESIGN ELEMENT APPEARING IN RED.

CLASS 9—ELECTRICAL AND SCIENTIFIC APPARATUS

FOR GLOBAL POSITIONING SYSTEM (GPS) CONSISTING OF COMPUTERS, COMPUTER SOFTWARE, TRANSMITTERS, RECEIVERS, AND NETWORK INTERFACE DEVICES; VEHICLE LOCATOR AND RECOVERY DEVICE PROGRAMMED TO USE GLOBAL POSITIONING SYSTEMS (GPS) AND CELLULAR TELECOMMUNICATIONS; COMPUTER PERIPHERAL APPARATUS; TRANSPONDERS; COMPUTER SOFTWARE FOR GPS, MAPPING AND DATA TREATMENT (U.S. CLS. 21, 23, 26, 36 AND 38).

FIRST USE 1-8-2001; IN COMMERCE 1-8-2001.

CLASS 42—SCIENTIFIC AND COMPUTER SERVICES

FOR TECHNICAL DESIGN, TECHNICAL DEVELOPMENT, AND TECHNICAL CONSULTATION IN THE FIELD OF ELECTRIC AND ELECTRONIC APPARATUS, GLOBAL POSITIONING SATELLITE (GPS) BASED NAVIGATION EQUIPMENT, COMPUTER SYSTEMS AND VEHICLE TRACKING DEVICES; COMPUTER SUPPORT SERVICES, NAMELY, CONSULTATION IN THE USE AND OPERATION OF COMPUTER SOFTWARE (U.S. CLS. 100 AND 101).

FIRST USE 1-8-2001; IN COMMERCE 1-8-2001.

3,808,392. GEO STUDIO TECHNOLOGY, BELO HORIZONTE, BRAZIL. SN 77-779,070. PUB. 12-29-2009, FILED 7-11-2009.

TrackMaker

THE MARK CONSISTS OF STANDARD CHARACTERS WITHOUT CLAIM TO ANY PARTICULAR FONT, STYLE, SIZE, OR COLOR.

CLASS 9—ELECTRICAL AND SCIENTIFIC APPARATUS

FOR GLOBAL POSITIONING SYSTEM (GPS) CONSISTING OF COMPUTERS, COMPUTER SOFTWARE, TRANSMITTERS, RECEIVERS, AND NETWORK INTERFACE DEVICES; VEHICLE LOCATOR AND RECOVERY DEVICE PROGRAMMED TO USE GLOBAL POSITIONING SYSTEMS (GPS) AND CELLULAR TELECOMMUNICATIONS; COMPUTER PERIPHERAL APPARATUS; TRANSPONDERS; COMPUTER SOFTWARE FOR GPS, MAPPING AND DATA TREATMENT (U.S. CLS. 21, 23, 26, 36 AND 38).

FIRST USE 1-8-2001; IN COMMERCE 1-8-2001.

CLASS 42—SCIENTIFIC AND COMPUTER SERVICES

FOR TECHNICAL DESIGN, TECHNICAL DEVELOPMENT, AND TECHNICAL CONSULTATION IN THE FIELD OF ELECTRIC AND ELECTRONIC APPARATUS, GLOBAL POSITIONING SATELLITE (GPS) BASED NAVIGATION EQUIPMENT, COMPUTER SYSTEMS AND VEHICLE TRACKING DEVICES; COMPUTER SUPPORT SERVICES, NAMELY, CONSULTATION IN THE USE AND OPERATION OF COMPUTER SOFTWARE (U.S. CLS. 100 AND 101).

FIRST USE 1-8-2001; IN COMMERCE 1-8-2001.

3,808,421. GOMEZ, ROBERT LOUIS, GARNER, NC. SN 77-790,995. PUB. 12-22-2009, FILED 7-28-2009.

THINK STRAIGHT, TALK STRAIGHT

THE MARK CONSISTS OF STANDARD CHARACTERS WITHOUT CLAIM TO ANY PARTICULAR FONT, STYLE, SIZE, OR COLOR.

CLASS 35—ADVERTISING AND BUSINESS

FOR TAX ADVISORY SERVICES; TAX AND TAXATION PLANNING, ADVICE, INFORMATION AND CONSULTANCY SERVICES; TAX CONSULTATION; TAX PREPARATION (U.S. CLS. 100, 101 AND 102).

FIRST USE 3-1-2010; IN COMMERCE 3-1-2010.

CLASS 36—INSURANCE AND FINANCIAL

FOR FINANCIAL CONSULTING AND ADVISING IN THE FIELD OF MERGERS AND ACQUISITIONS; FINANCIAL CONSULTING SERVICES, NAMELY, EXPERT ANALYSIS IN FINANCE; INVESTMENT BANKING SERVICES; INVESTMENT CONSULTATION; VENTURE CAPITAL FUNDING SERVICES TO EMERGING AND START-UP COMPANIES (U.S. CLS. 100, 101 AND 102).

FIRST USE 3-1-2010; IN COMMERCE 3-1-2010.

3,808,472. HDLOGIX, INC., EDISON, NJ. SN 77-810,268. PUB. 1-19-2010, FILED 8-21-2009.

HDLOGIX

THE MARK CONSISTS OF STANDARD CHARACTERS WITHOUT CLAIM TO ANY PARTICULAR FONT, STYLE, SIZE, OR COLOR.

CLASS 9—ELECTRICAL AND SCIENTIFIC APPARATUS

FOR DOWNLOADABLE SOFTWARE FOR ENHANCING THE QUALITY OF DIGITAL IMAGES; MOBILE ENTERPRISE PLATFORM SOFTWARE, NAMELY, SOFTWARE THAT PROVIDES A SCALABLE FRAMEWORK CAPABLE OF SUPPORTING LARGE ENTERPRISES UTILIZING MOBILE CLIENT DEVICES; COMPUTER SOFTWARE THAT FACILITATES VIDEO AND VOICE COMMUNICATIONS BETWEEN PARTIES OVER THE INTERNET; COMPUTER TELEPHONY SOFTWARE; VIDEO MESSAGING SOFTWARE; VIDEO TRANSMISSION APPARATUS; WEB CAMERAS (U.S. CLS. 21, 23, 26, 36 AND 38).

FIRST USE 10-31-2008; IN COMMERCE 10-31-2008.

CLASS 42—SCIENTIFIC AND COMPUTER SERVICES

FOR APPLICATION SERVICE PROVIDER (ASP) FEATURING SOFTWARE FOR USE IN ENHANCING THE QUALITY OF DIGITAL IMAGES; PROVIDING ON-LINE NON-DOWNLOADABLE SOFTWARE FOR ENHANCING THE QUALITY OF DIGITAL IMAGES; COMPUTER SOFTWARE DEVELOPMENT; COMPUTER SOFTWARE DEVELOPMENT IN THE FIELD OF MOBILE APPLICATIONS; PROVIDING TEMPORARY USE OF NON-DOWNLOADABLE SOFTWARE THAT FACILITATES VIDEO AND VOICE COMMUNICATIONS BETWEEN PARTIES OVER THE INTERNET (U.S. CLS. 100 AND 101).

FIRST USE 10-31-2008; IN COMMERCE 10-31-2008.

3,808,495. CHURCH & DWIGHT CO., INC., PRINCETON, NJ. SN 77-838,361. PUB. 1-12-2010, FILED 9-30-2009.

LYSINE WITHOUT LIMITS

THE MARK CONSISTS OF STANDARD CHARACTERS WITHOUT CLAIM TO ANY PARTICULAR FONT, STYLE, SIZE, OR COLOR.

NO CLAIM IS MADE TO THE EXCLUSIVE RIGHT TO USE "LYSINE", APART FROM THE MARK AS SHOWN.

CLASS 5—PHARMACEUTICALS

FOR FEED SUPPLEMENTS FOR LIVESTOCK; NON-MEDICATED ADDITIVES FOR ANIMAL FEED FOR USE AS NUTRITIONAL SUPPLEMENTS (U.S. CLS. 6, 18, 44, 46, 51 AND 52).

FIRST USE 12-29-2009; IN COMMERCE 12-29-2009.

CLASS 31—NATURAL AGRICULTURAL PRODUCTS

FOR ANIMAL FOODSTUFFS; NUTRITIONAL ADDITIVES FOR ANIMAL FOODSTUFFS, NOT FOR MEDICAL PURPOSES (U.S. CLS. 1 AND 46).

FIRST USE 12-29-2009; IN COMMERCE 12-29-2009.

3,808,501. CONAGRA FOODS RDM, INC., OMAHA, NE. SN 77-977,746. PUB. 3-20-2007, FILED 11-7-2006.

START MAKING CHOICES

THE MARK CONSISTS OF STANDARD CHARACTERS WITHOUT CLAIM TO ANY PARTICULAR FONT, STYLE, SIZE, OR COLOR.

CLASS 29—MEATS AND PROCESSED FOODS

FOR BEEF; BEEF CUTS; PORK; PORK CUTS; POULTRY; POULTRY CUTS; SEAFOOD; FRIED CHICKEN; CHICKEN PATTIES; CHICKEN NUGGETS; CHICKEN STRIPS; CHICKEN BREASTS; MEATBALLS; EGG SUBSTITUTES; FROZEN PREPARED MEALS AND ENTREES CONSISTING PRIMARILY OF BEEF, PORK, POULTRY, SEAFOOD OR VEGETABLES; FROZEN PREPARED MEALS CONSISTING PRIMARILY OF A CHICKEN, FISH OR CORN DOG MAIN DISH TOGETHER WITH ONE OR MORE SIDE DISH, DESSERT AND/OR DIPPING SAUCE; REFRIED BEANS; PROCESSED PINTO BEANS; CANNED TOMATOES; VEGETABLE PUREE; PEANUT BUTTER; TOMATO PASTE; TOMATO PUREE (U.S. CL. 46).

FIRST USE 3-1-2008; IN COMMERCE 3-1-2008.

CLASS 30—STAPLE FOODS

FOR FROZEN PREPARED MEALS AND ENTREES CONSISTING PRIMARILY OF PASTA OR RICE; FROZEN PREPARED MEALS CONSISTING PRIMARILY OF A PASTA, CHEESEBURGER OR TACO MAIN DISH AND ONE OR MORE SIDE DISH AND/OR DESSERT; FROZEN PREPARED MEALS CONSISTING PRIMARILY OF PIZZA TOGETHER WITH ONE OR MORE SIDE DISH, DESSERT AND/OR DIPPING SAUCE; PIZZA; POT PIES; PASTA AND MEATBALLS; PASTA AND SAUCE; CANNED PASTA; LASAGNA; MACARONI AND CHEESE; RAVIOLI; TOMATO SAUCE; MICROWAVE POPCORN; UNPOPPED POPCORN (U.S. CL. 46).

FIRST USE 6-1-2008; IN COMMERCE 6-1-2008.

3,808,504. JONAS BROTHERS PROPERTIES LLC, NEW YORK, NY. SN 77-978,393. PUB. 4-14-2009, FILED 8-7-2008.

TEAM JONAS

THE MARK CONSISTS OF STANDARD CHARACTERS WITHOUT CLAIM TO ANY PARTICULAR FONT, STYLE, SIZE, OR COLOR.

CLASS 16—PAPER GOODS AND PRINTED MATTER

FOR POSTERS, STICKERS, POSTER BOOKS, PHOTOGRAPHS (U.S. CLS. 2, 5, 22, 23, 29, 37, 38 AND 50).

FIRST USE 12-0-2008; IN COMMERCE 12-0-2008.

CLASS 25—CLOTHING

FOR CLOTHING, NAMELY, TOPS (U.S. CLS. 22 AND 39).

FIRST USE 6-12-2008; IN COMMERCE 6-12-2008.

CLASS 41—EDUCATION AND ENTERTAINMENT

3,808,510. COCALO, INC., IRVINE, CA. SN 77-979,229. PUB. 1-15-2008, FILED 7-25-2007.

FOR ENTERTAINMENT SERVICES, NAMELY, PROVIDING NON-DOWNLOADABLE MUSICAL SOUND AND VIDEO RECORDINGS BY MEANS OF A GLOBAL COMPUTER NETWORK; PROVIDING INFORMATION ABOUT ENTERTAINMENT SERVICES PERFORMED BY AN ACTOR, ACTORS OR MUSICAL GROUP AND FILMS; ENTERTAINMENT INFORMATION, NAMELY, PROVIDING MUSIC, TELEVISION AND FILM INFORMATION VIA A WEBSITE; PROVIDING A WEBSITE FEATURING MUSICAL PERFORMANCES, MUSICAL VIDEOS, PHOTOGRAPHS AND OTHER MULTIMEDIA MATERIALS, AND PERSONAL INFORMATION REGARDING AN ACTOR, ACTORS OR MUSICAL GROUP AND THEIR LIVE AND RECORDED PERFORMANCES; FAN CLUB SERVICES; ENTERTAINMENT SERVICES, NAMELY, PROVIDING PODCASTS FEATURING MUSIC AND/OR INFORMATION ABOUT A MUSICAL ARTIST OR ARTISTS (U.S. CLS. 100, 101 AND 107).

FIRST USE 3-17-2008; IN COMMERCE 3-17-2008.

CO CO & COMPANY

THE MARK CONSISTS OF STANDARD CHARACTERS WITHOUT CLAIM TO ANY PARTICULAR FONT, STYLE, SIZE, OR COLOR.

NO CLAIM IS MADE TO THE EXCLUSIVE RIGHT TO USE "& COMPANY", APART FROM THE MARK AS SHOWN.

CLASS 16—PAPER GOODS AND PRINTED MATTER

FOR PICTURES, ART PICTURES, ART PRINTS, AND PHOTO ALBUMS; PERSONAL ORGANIZERS FEATURING INFANT INFORMATION (U.S. CLS. 2, 5, 22, 23, 29, 37, 38 AND 50).

FIRST USE 10-22-2009; IN COMMERCE 10-29-2009.

CLASS 24—FABRICS

FOR TEXTILE WALL HANGINGS AND FABRIC VALENCES; BEDDING, NAMELY, BED BLANKETS, BED SHEETS, DUST RUFFLES, SHAMS, DUVETS, WINDOW CURTAINS (U.S. CLS. 42 AND 50).

FIRST USE 10-22-2009; IN COMMERCE 11-9-2009.

CLASS 27—FLOOR COVERINGS

FOR DECORATIVE WALL COVERINGS, WALLPAPER AND NON-TEXTILE WALL HANGINGS; WALL COVERINGS (U.S. CLS. 19, 20, 37, 42 AND 50).

FIRST USE 10-22-2009; IN COMMERCE 10-22-2009.

CLASS 28—TOYS AND SPORTING GOODS

FOR INFANT NURSERY DECORATIONS AND ACCESSORIES, NAMELY, HANGING CRIB TOYS AND CRIB MOBILES (U.S. CLS. 22, 23, 38 AND 50).

FIRST USE 10-22-2009; IN COMMERCE 11-9-2009.

3,808,507. SENSEI, INC., BOCA RATON, FL. SN 77-978,868. PUB. 3-31-2009, FILED 11-20-2008.



THE COLOR(S) ORANGE, GREEN, AND BLUE IS/ARE CLAIMED AS A FEATURE OF THE MARK.

THE MARK CONSISTS OF AN ORANGE LOWER CASE LETTER "I" WITH A BLUE DESIGN TO THE LEFT OF THE "I" AND A GREEN DESIGN TO THE RIGHT OF THE "I.". THE COLOR BLACK IS NOT CLAIMED AS A FEATURE OF THE MARK, BUT IS MERELY THE BACKGROUND.

CLASS 38—COMMUNICATION

FOR ELECTRONIC TRANSMISSION OF MESSAGES AND DATA, NAMELY, COMMUNICATING PERSONAL BEHAVIORAL CHANGE AND PERSONAL WELLNESS MANAGEMENT INFORMATION VIA A WIRELESS MOBILE DEVICE (U.S. CLS. 100, 101 AND 104).

FIRST USE 11-0-2008; IN COMMERCE 11-0-2008.

CLASS 44—MEDICAL, BEAUTY AND AGRICULTURAL SERVICES

FOR PROVIDING WELLNESS SERVICES, NAMELY, PROVIDING PERSONAL ASSESSMENTS OF HEALTH AND WELLNESS PROGRAMS FOR INDIVIDUALS, MAINTENANCE SCHEDULES RELATING TO INDIVIDUAL BEHAVIOR AND PROVIDING PERSONALIZED ROUTINES FOR HEALTH AND WELLNESS; PROVIDING A WEBSITE FEATURING INFORMATION IN THE FIELD OF HEALTH AND WELLNESS (U.S. CLS. 100 AND 101).

FIRST USE 11-0-2008; IN COMMERCE 11-0-2008.

3,808,514. DWELL HOME FURNISHINGS LLC, NEW YORK, NY. SN 77-979,285. PUB. 7-8-2008, FILED 9-24-2007.



THE MARK CONSISTS OF FOUR DOUBLE "D"'S.

CLASS 20—FURNITURE AND ARTICLES NOT OTHERWISE CLASSIFIED

FOR DESKS, ARMOIRES AND BEDS; HOME ACCESSORIES, NAMELY, MIRRORS; AND STORAGE UNITS AND STORAGE RACKS (U.S. CLS. 2, 13, 22, 25, 32 AND 50).

FIRST USE 9-0-2008; IN COMMERCE 9-0-2008.

CLASS 24—FABRICS

FOR HAND TOWELS, TOWELS, BATH TOWELS, AND WASH CLOTHS; PLACE MATS NOT OF PAPER; CLOTH TABLE NAPKINS, TABLE LINENS, TABLE CLOTHS NOT OF PAPER, FABRIC SHOWER CURTAINS; QUILTS, BEDSPREADS (U.S. CLS. 42 AND 50).

FIRST USE 1-0-2009; IN COMMERCE 1-0-2009.

CLASS 27—FLOOR COVERINGS

FOR BATH MATS (U.S. CLS. 19, 20, 37, 42 AND 50).
FIRST USE 1-0-2009; IN COMMERCE 1-0-2009.

3,808,519. CRYOPRAXIS CRIOBIOLOGIA LTDA., RIO DE JANEIRO / RJ, BRAZIL. SN 77-979,356. PUB. 6-23-2009, FILED 2-5-2008.

CELLPRAXIS

THE MARK CONSISTS OF STANDARD CHARACTERS WITHOUT CLAIM TO ANY PARTICULAR FONT, STYLE, SIZE, OR COLOR.

CLASS 42—SCIENTIFIC AND COMPUTER SERVICES

FOR CONSULTANCY, ADVICE AND INFORMATION ABOUT THE DEVELOPMENT OF PRODUCTS (U.S. CLS. 100 AND 101).

FIRST USE 12-0-2003; IN COMMERCE 12-0-2003.

CLASS 44—MEDICAL, BEAUTY AND AGRICULTURAL SERVICES

FOR MEDICAL SERVICES, VETERINARY SERVICES, HYGIENIC AND BEAUTY CARE FOR HUMAN BEINGS AND ANIMALS (U.S. CLS. 100 AND 101).

FIRST USE 12-0-2003; IN COMMERCE 12-0-2003.

3,808,523. PH(X) GLASS, LLC, WOODSIDE, CA. SN 77-979,383. PUB. 7-22-2008, FILED 3-10-2008.

THE MARK CONSISTS OF THE LETTERS "PHX" WITH A SOLID LINE ABOVE THE LETTERS "P" AND "X" AND A SOLID LINE BELOW THE LETTERS "P" "H" AND "X" WITH PARENTHESES AROUND THE LETTER "X".

CLASS 25—CLOTHING

FOR SHIRTS; HATS; CAPS (U.S. CLS. 22 AND 39).
FIRST USE 3-10-2009; IN COMMERCE 3-10-2009.

CLASS 34—SMOKERS' ARTICLES

FOR SMOKING WATER AND GLASS PIPES (U.S. CLS. 2, 8, 9 AND 17).

FIRST USE 7-10-2003; IN COMMERCE 7-10-2003.

3,808,528. CATCHLIGHT ENERGY, LLC, SAN RAMON, CA. SN 77-979,410. PUB. 1-27-2009, FILED 2-29-2008.

CATCHLIGHT ENERGY

THE MARK CONSISTS OF STANDARD CHARACTERS WITHOUT CLAIM TO ANY PARTICULAR FONT, STYLE, SIZE, OR COLOR.

NO CLAIM IS MADE TO THE EXCLUSIVE RIGHT TO USE "ENERGY", APART FROM THE MARK AS SHOWN.

CLASS 4—LUBRICANTS AND FUELS

FOR NON-CHEMICAL BIO-ADDITIVES FOR FUELS; NON-CHEMICAL ADDITIVES FOR FUELS AND OILS (U.S. CLS. 1, 6 AND 15).

FIRST USE 12-21-2009; IN COMMERCE 12-21-2009.

CLASS 16—PAPER GOODS AND PRINTED MATTER

FOR DESK PADS (U.S. CLS. 2, 5, 22, 23, 29, 37, 38 AND 50).

FIRST USE 2-28-2010; IN COMMERCE 2-28-2010.

CLASS 18—LEATHER GOODS

FOR BAGS FOR TRAVEL; ATHLETIC BAGS (U.S. CLS. 1, 2, 3, 22 AND 41).

FIRST USE 2-28-2010; IN COMMERCE 2-28-2010.

CLASS 25—CLOTHING

FOR CLOTHING, NAMELY, T-SHIRTS, CAPS, HATS AND KNIT SHIRTS (U.S. CLS. 22 AND 39).

FIRST USE 4-1-2010; IN COMMERCE 4-1-2010.

CLASS 40—MATERIAL TREATMENT

FOR PROVIDING INFORMATION IN THE FIELDS OF ENERGY PRODUCTION AND BIOFUEL PRODUCTION (U.S. CLS. 100, 103 AND 106).

FIRST USE 8-0-2009; IN COMMERCE 8-0-2009.

3,808,529. FOXPY2 INC., COCONUT GROVE, FL. SN 77-979,413. PUB. 1-20-2009, FILED 9-25-2007.

OPEN ENGLISH

THE MARK CONSISTS OF STANDARD CHARACTERS WITHOUT CLAIM TO ANY PARTICULAR FONT, STYLE, SIZE, OR COLOR.

NO CLAIM IS MADE TO THE EXCLUSIVE RIGHT TO USE "ENGLISH", APART FROM THE MARK AS SHOWN.

CLASS 9—ELECTRICAL AND SCIENTIFIC APPARATUS

FOR DVDS, CDS, AND COMPUTER SOFTWARE FEATURING LANGUAGE AND EDUCATIONAL INSTRUCTION MATERIALS; CELLULAR TELEPHONES; HANDHELD COMPUTERS (U.S. CLS. 21, 23, 26, 36 AND 38).

FIRST USE 1-7-2008; IN COMMERCE 1-7-2008.

CLASS 41—EDUCATION AND ENTERTAINMENT

FOR LANGUAGE INSTRUCTION; EDUCATIONAL INSTRUCTION, NAMELY, CONDUCTING INFORMAL ON-LINE PROGRAMS IN LANGUAGE LEARNING AND INSTRUCTION, AND PRINTABLE MATERIALS DISTRIBUTED THEREWITH; EDUCATIONAL INSTRUCTION, NAMELY, PROVIDING COURSES OF INSTRUCTION AT THE SECONDARY AND COLLEGE LEVEL AND DISTRIBUTION OF COURSE MATERIAL IN CONNECTION THEREWITH; PROVIDING FACILITIES FOR LANGUAGE AND EDUCATIONAL INSTRUCTION; LANGUAGE LEARNING AND EDUCATIONAL TELEVISION AND RADIO PROGRAMMING, NAMELY, PROVIDING TELEVISION AND RADIO PROGRAMS IN THE FIELDS OF LANGUAGE LEARNING AND INSTRUCTION (U.S. CLS. 100, 101 AND 107).

FIRST USE 1-7-2008; IN COMMERCE 1-7-2008.

CLASS 9—ELECTRICAL AND SCIENTIFIC APPARATUS

FOR CARRYING CASES SPECIALLY ADAPTED FOR POCKET CALCULATORS AND CELLPHONES; PROTECTIVE CARRYING CASES FOR PORTABLE MUSIC PLAYERS, NAMELY, MP3 PLAYERS; COMPUTER CARRYING CASES (U.S. CLS. 21, 23, 26, 36 AND 38).

FIRST USE 4-13-2010; IN COMMERCE 4-13-2010.

CLASS 14—JEWELRY

FOR JEWELRY (U.S. CLS. 2, 27, 28 AND 50).

FIRST USE 4-13-2010; IN COMMERCE 4-13-2010.

CLASS 25—CLOTHING

FOR CLOTHING, NAMELY, T-SHIRTS (U.S. CLS. 22 AND 39).

FIRST USE 4-13-2010; IN COMMERCE 4-13-2010.

3,808,533. THE INSPIRATIONAL NETWORK, INC., INDIAN LAND, SC. SN 77-979,434. PUB. 7-7-2009, FILED 3-6-2009.



THE MARK CONSISTS OF AN IMAGE OF A FLAME OF FIRE.

CLASS 41—EDUCATION AND ENTERTAINMENT

FOR EDUCATIONAL SERVICES, NAMELY, RELIGIOUS INSTRUCTION PROMOTING CHRISTIAN VALUES; PRODUCTION OF TELEVISION PROGRAMS (U.S. CLS. 100, 101 AND 107).

FIRST USE 11-1-2008; IN COMMERCE 11-1-2008.

CLASS 45—PERSONAL AND LEGAL SERVICES

FOR RELIGIOUS AND SPIRITUAL SERVICES, NAMELY, CONDUCTING GATHERINGS AND RETREATS IN THE FIELD OF RELIGION AND CHRISTIAN MINISTRY; PROVIDING AN INTERNET WEBSITE FEATURING NEWS AND INFORMATION IN THE FIELD OF RELIGION AND CHRISTIAN MINISTRY; PROVIDING INFORMATION IN THE FIELD OF RELIGION AND CHRISTIAN MINISTRY VIA E-MAIL (U.S. CLS. 100 AND 101).

FIRST USE 11-1-2008; IN COMMERCE 11-1-2008.

3,808,530. HOEFLER, CHRISTINA, CHARDON, OH. SN 77-979,418. PUB. 1-20-2009, FILED 8-27-2008.



THE STIPLING IS FOR SHADING PURPOSES ONLY.
THE MARK CONSISTS OF AN IMAGE OF A BANNER WITH THE STYLIZED WORDS "SOUL OF THE ROSE" ON IT. ABOVE THE BANNER IS AN IMAGE OF A HEART AS BACKGROUND TO A GUITAR WITH WINGS. THE GUITAR HAS A ROSE VINE THAT WRAPS AROUND THE BODY AND HANDLE.

3,808,536. BARILLA G.E.R. FRATELLI - SOCIETÀ PER AZIONI, PARMA, ITALY. SN 77-979,461. PUB. 8-11-2009, FILED 5-4-2009.

3,808,543. GOYA FOODS, INC., SECAUCUS, NJ. SN 77-979,512. PUB. 3-4-2008, FILED 1-14-2007.

SHARE THE TABLE

THE MARK CONSISTS OF STANDARD CHARACTERS WITHOUT CLAIM TO ANY PARTICULAR FONT, STYLE, SIZE, OR COLOR.

CLASS 35—ADVERTISING AND BUSINESS

FOR PROVIDING A WEBSITE FEATURING INFORMATION ABOUT MARKETING TRENDS IN THE FOOD PRODUCT INDUSTRY (U.S. CLS. 100, 101 AND 102).
FIRST USE 9-0-2009; IN COMMERCE 9-0-2009.

CLASS 43—HOTEL AND RESTAURANT SERVICES

FOR PROVIDING A WEBSITE FEATURING RECIPES (U.S. CLS. 100 AND 101).
FIRST USE 9-0-2009; IN COMMERCE 9-0-2009.

3,808,537. BARILLA G.E.R. FRATELLI - SOCIETÀ PER AZIONI, PARMA, ITALY. SN 77-979,462. PUB. 8-11-2009, FILED 5-4-2009.

SHARE THE TABLE THE BARILLA FAMILY DINNER PROJECT

THE MARK CONSISTS OF STANDARD CHARACTERS WITHOUT CLAIM TO ANY PARTICULAR FONT, STYLE, SIZE, OR COLOR.

OWNER OF U.S. REG. NOS. 897,460, 2,964,682, AND OTHERS.

NO CLAIM IS MADE TO THE EXCLUSIVE RIGHT TO USE "FAMILY DINNER", APART FROM THE MARK AS SHOWN.

CLASS 35—ADVERTISING AND BUSINESS

FOR PROVIDING A WEBSITE FEATURING INFORMATION ABOUT MARKETING TRENDS IN THE FOOD PRODUCT INDUSTRY (U.S. CLS. 100, 101 AND 102).
FIRST USE 9-0-2009; IN COMMERCE 9-0-2009.

CLASS 43—HOTEL AND RESTAURANT SERVICES

FOR PROVIDING A WEBSITE FEATURING RECIPES (U.S. CLS. 100 AND 101).
FIRST USE 9-0-2009; IN COMMERCE 9-0-2009.

ONE WORLD ONE BRAND

THE MARK CONSISTS OF STANDARD CHARACTERS WITHOUT CLAIM TO ANY PARTICULAR FONT, STYLE, SIZE, OR COLOR.

NO CLAIM IS MADE TO THE EXCLUSIVE RIGHT TO USE "BRAND", APART FROM THE MARK AS SHOWN.

CLASS 35—ADVERTISING AND BUSINESS

FOR ARRANGING AND CONDUCTING BUSINESS CONFERENCES; ARRANGING AND CONDUCTING TRADE SHOW EXHIBITIONS IN THE FIELD OF MARKETING OF FOODS, BEVERAGES AND CONSUMERS GOODS GENERALLY; ORGANISATION AND HOLDING OF FAIRS FOR COMMERCIAL OR ADVERTISING PURPOSES; PLANNING AND CONDUCTING OF TRADE FAIRS, EXHIBITIONS AND PRESENTATIONS FOR ECONOMIC OR ADVERTISING PURPOSES; PROMOTING AND CONDUCTING TRADE SHOWS IN THE FIELD OF MARKETING AND PROMOTION OF GOODS TO THE SPANISH, HISPANIC AND LATINO CONSUMER; PROVIDING TRADE INFORMATION (U.S. CLS. 100, 101 AND 102).

FIRST USE 3-6-2007; IN COMMERCE 3-6-2007.

CLASS 41—EDUCATION AND ENTERTAINMENT

FOR ARRANGING AND CONDUCTING EDUCATIONAL CONFERENCES; ARRANGING OF EXHIBITIONS, SEMINARS AND CONFERENCES; EDUCATION SERVICES, NAMELY, PROVIDING SYMPOSIA AND WORKSHOPS IN THE FIELD OF MARKETING DEVELOPMENTS AFFECTING THE FOOD AND BEVERAGE PRODUCT INDUSTRIES; INSTRUCTION IN THE FIELD OF HISTORY, CULTURE, MUSIC AND ART RENDERED AT ART MUSEUMS, CONFERENCE CENTERS AND OVER THE WORLD WIDE WEB; ORGANIZING EXHIBITIONS FOR CULTURAL AND EDUCATIONAL PURPOSES, NAMELY, ART EXHIBITIONS AND ETHNIC FOODS AND COOKING EXHIBITIONS; ORGANIZING EXHIBITIONS IN THE FIELD OF HISPANIC CULTURE, HISPANIC COOKING AND HISPANIC TRADITION; TRAINING COURSES IN STRATEGIC PLANNING RELATING TO ADVERTISING, PROMOTION, MARKETING AND BUSINESS (U.S. CLS. 100, 101 AND 107).

FIRST USE 3-6-2007; IN COMMERCE 3-6-2007.

3,808,544. YALE UNIVERSITY, NEW HAVEN, CT. SN 77-979,516. PUB. 7-28-2009, FILED 7-31-2008.

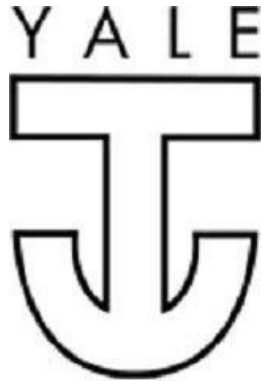

OWNER OF U.S. REG. NOS. 1,391,543, 1,391,926, AND OTHERS.

THE MARK CONSISTS OF THE WORD "YALE" APPEARING ABOVE A STYLIZED ANCHOR FORMED FROM A CAPITAL LETTER "T".

CLASS 9—ELECTRICAL AND SCIENTIFIC APPARATUS

FOR DOWNLOADABLE BOOKS AND BOOKS RECORDED ON MAGNETIC MEDIA, NAMELY, BIBLES, BIBLE DICTIONARIES, BIBLE COMMENTARIES, AND BIBLE REFERENCE BOOKS (U.S. CLS. 21, 23, 26, 36 AND 38).
FIRST USE 12-0-2007; IN COMMERCE 12-0-2007.

CLASS 16—PAPER GOODS AND PRINTED MATTER

FOR BOOKS, NAMELY, BIBLES, BIBLE DICTIONARIES, BIBLE COMMENTARIES, AND BIBLE REFERENCE BOOKS (U.S. CLS. 2, 5, 22, 23, 29, 37, 38 AND 50).
FIRST USE 12-0-2007; IN COMMERCE 12-0-2007.

3,808,545. CATCHLIGHT ENERGY, LLC, SAN RAMON, CA. SN 77-979,528. PUB. 1-27-2009, FILED 2-29-2008.



THE COLOR(S) BLUE, GREEN AND YELLOW IS/ARE CLAIMED AS A FEATURE OF THE MARK.

THE MARK CONSISTS OF TWO INTERSECTING HEXAGONS. THE COLOR YELLOW APPEARS IN THE UPPER-MOST HEXAGON, THE COLOR BLUE APPEARS IN THE LOWER HEXAGON, AND THE COLOR GREEN APPEARS IN THE OVERLAPPING SECTION OF THE TWO HEXAGONS.

CLASS 4—LUBRICANTS AND FUELS

FOR NON-CHEMICAL BIO-ADDITIVES FOR FUELS; NON-CHEMICAL ADDITIVES FOR FUELS AND OILS (U.S. CLS. 1, 6 AND 15).
FIRST USE 12-21-2009; IN COMMERCE 12-21-2009.

CLASS 18—LEATHER GOODS

FOR BAGS FOR TRAVEL; ATHLETIC BAGS (U.S. CLS. 1, 2, 3, 22 AND 41).
FIRST USE 2-28-2010; IN COMMERCE 2-28-2010.

CLASS 25—CLOTHING

FOR CLOTHING, NAMELY, T-SHIRTS, CAPS, HATS AND KNIT SHIRTS (U.S. CLS. 22 AND 39).
FIRST USE 4-1-2010; IN COMMERCE 4-1-2010.

CLASS 40—MATERIAL TREATMENT

FOR PROVIDING INFORMATION IN THE FIELDS OF ENERGY PRODUCTION AND BIOFUEL PRODUCTION (U.S. CLS. 100, 103 AND 106).
FIRST USE 8-0-2009; IN COMMERCE 8-0-2009.

3,808,546. CATCHLIGHT ENERGY, LLC, SAN RAMON, CA. SN 77-979,529. PUB. 1-27-2009, FILED 2-29-2008.



NO CLAIM IS MADE TO THE EXCLUSIVE RIGHT TO USE "ENERGY", APART FROM THE MARK AS SHOWN.

THE COLOR(S) BLUE, GREEN, YELLOW, BLACK AND WHITE IS/ARE CLAIMED AS A FEATURE OF THE MARK.

THE MARK CONSISTS OF TWO INTERSECTING HEXAGONS. THE COLOR YELLOW APPEARS IN THE UPPER-MOST HEXAGON, THE COLOR BLUE APPEARS IN THE LOWER HEXAGON, AND THE COLOR GREEN APPEARS IN THE OVERLAPPING SECTION OF THE TWO HEXAGONS. THE TERMS "CATCHLIGHT ENERGY" APPEAR IN THE COLOR BLACK TO THE LOWER LEFT OF THE DESIGN. THE LITERAL ELEMENT AND DESIGN APPEAR ON A FIELD OF WHITE.

CLASS 4—LUBRICANTS AND FUELS

FOR NON-CHEMICAL BIO-ADDITIVES FOR FUELS; NON-CHEMICAL ADDITIVES FOR FUELS AND OILS (U.S. CLS. 1, 6 AND 15).
FIRST USE 12-21-2009; IN COMMERCE 12-21-2009.

CLASS 16—PAPER GOODS AND PRINTED MATTER

FOR DESK PADS (U.S. CLS. 2, 5, 22, 23, 29, 37, 38 AND 50).
FIRST USE 2-28-2010; IN COMMERCE 2-28-2010.

CLASS 18—LEATHER GOODS

FOR BAGS FOR TRAVEL; ATHLETIC BAGS (U.S. CLS. 1, 2, 3, 22 AND 41).
FIRST USE 2-28-2010; IN COMMERCE 2-28-2010.

CLASS 25—CLOTHING

FOR CLOTHING, NAMELY, T-SHIRTS, CAPS, HATS AND KNIT SHIRTS (U.S. CLS. 22 AND 39).
FIRST USE 4-1-2010; IN COMMERCE 4-1-2010.

CLASS 40—MATERIAL TREATMENT

FOR PROVIDING INFORMATION IN THE FIELDS OF ENERGY PRODUCTION AND BIOFUEL PRODUCTION (U.S. CLS. 100, 103 AND 106).
FIRST USE 8-0-2009; IN COMMERCE 8-0-2009.

3,808,561. MOLL ANDERSON HOME, LLC, KNOXVILLE, TN. SN 78-593,179. PUB. 6-13-2006, FILED 3-23-2005.

**CHANGE YOUR HOME
CHANGE YOUR LIFE**

THE MARK CONSISTS OF STANDARD CHARACTERS WITHOUT CLAIM TO ANY PARTICULAR FONT, STYLE, SIZE, OR COLOR.

CLASS 2—PAINTS

FOR PAINT, NAMELY, INTERIOR AND EXTERIOR PAINTS, SPRAY PAINTS FOR CRAFTS, PAINT FOR ARTISTS, VARNISH AND VARNISH STAIN (U.S. CLS. 6, 11 AND 16).
FIRST USE 2-0-2008; IN COMMERCE 2-0-2008.

CLASS 24—FABRICS

FOR BED SHEETS AND TOWELS (U.S. CLS. 42 AND 50).
FIRST USE 9-0-2008; IN COMMERCE 9-0-2008.

CLASS 41—EDUCATION AND ENTERTAINMENT

FOR ONGOING TELEVISION SHOW FEATURING INTERIOR DESIGN, HOME CARE, DECORATING, GARDENING AND ENTERTAINING (U.S. CLS. 100, 101 AND 107).
FIRST USE 8-0-2007; IN COMMERCE 8-0-2007.

CLASS 42—SCIENTIFIC AND COMPUTER SERVICES

FOR PROVIDING INFORMATION ABOUT INTERIOR DESIGN AND DECORATING VIA A GLOBAL COMPUTER NETWORK (U.S. CLS. 100 AND 101).
FIRST USE 3-0-2005; IN COMMERCE 3-0-2005.

CLASS 43—HOTEL AND RESTAURANT SERVICES

FOR PROVIDING INFORMATION ABOUT ENTERTAINING, NAMELY, MENUS AND RECIPES, VIA A GLOBAL COMPUTER NETWORK (U.S. CLS. 100 AND 101).
FIRST USE 3-0-2005; IN COMMERCE 3-0-2005.

CLASS 44—MEDICAL, BEAUTY AND AGRICULTURAL SERVICES

FOR PROVIDING INFORMATION ABOUT GARDENING VIA A GLOBAL COMPUTER NETWORK (U.S. CLS. 100 AND 101).
FIRST USE 3-0-2005; IN COMMERCE 3-0-2005.

3,808,565. LIFTED RESEARCH GROUP INC., IRVINE, CA. SN 78-643,708. PUB. 1-23-2007, FILED 6-3-2005.

LIFTED RESEARCH GROUP

THE MARK CONSISTS OF STANDARD CHARACTERS WITHOUT CLAIM TO ANY PARTICULAR FONT, STYLE, SIZE, OR COLOR.

OWNER OF U.S. REG. NO. 2,513,951.

CLASS 18—LEATHER GOODS

FOR BAGS AND LUGGAGE, NAMELY, TRAVEL AND OVERNIGHT BAGS, GARMENT BAGS FOR TRAVEL, SHOE BAGS FOR TRAVEL, GYM BAGS, ATHLETIC BAGS, ALL PURPOSE SPORT BAGS, KNAPSACKS, TOTE BAGS, WRIST MOUNTED CARRY ALL BAGS, SHOULDER BAGS, MESSENGER BAGS, BACKPACKS, BOOK BAGS, WALLET, AND BILLFOLDS (U.S. CLS. 1, 2, 3, 22 AND 41).
FIRST USE 7-31-2002; IN COMMERCE 7-31-2002.

CLASS 25—CLOTHING

FOR CLOTHING, HEADWEAR, AND FOOTWEAR, NAMELY, T-SHIRTS, WOVEN SHIRTS, SPORT SHIRTS, CASUAL TOPS WITH LONG AND SHORT SLEEVES, SWEATSHIRTS, SWEATERS, VESTS, BLAZERS, SUITS, JACKETS, COATS, ANORAKS, PARKAS, JEANS, PANTS, SLACKS, SHORTS, SOCKS, BELTS, SANDALS, SWIMWEAR, SKI WEAR, SNOWBOARD WEAR, NAMELY, PANTS, BASEBALL CAPS, HATS, BEANIES (U.S. CLS. 22 AND 39).
FIRST USE 7-31-1999; IN COMMERCE 7-31-1999.

3,808,566. KABUSHIKI KAISHA NIBARIKI, TOKYO, JAPAN. SN 78-645,373. PUB. 9-19-2006, FILED 6-7-2005.

HOWL'S MOVING CASTLE

THE MARK CONSISTS OF STANDARD CHARACTERS WITHOUT CLAIM TO ANY PARTICULAR FONT, STYLE, SIZE, OR COLOR.

CLASS 9—ELECTRICAL AND SCIENTIFIC APPARATUS

FOR VIDEO COMPACT DISCS CONTAINING RECORDED MUSIC, ANIMATED CARTOONS, AND ACTION ADVENTURE MOTION PICTURE FILMS (U.S. CLS. 21, 23, 26, 36 AND 38).
FIRST USE 4-0-2006; IN COMMERCE 4-0-2006.

CLASS 16—PAPER GOODS AND PRINTED MATTER

FOR PRINTED PUBLICATIONS, NAMELY, COMIC BOOKS, COMIC MAGAZINES; GRAPHIC ART REPRODUCTIONS (U.S. CLS. 2, 5, 22, 23, 29, 37, 38 AND 50).
FIRST USE 6-0-2005; IN COMMERCE 6-0-2005.

3,808,567. AMDEGA LIMITED, CO DURHAM, ENGLAND.
SN 78-657,947. PUB. 9-29-2009, FILED 6-24-2005.

AMDEGA

THE MARK CONSISTS OF STANDARD CHARACTERS WITHOUT CLAIM TO ANY PARTICULAR FONT, STYLE, SIZE, OR COLOR.

OWNER OF UNITED KINGDOM REG. NO. 1349132, DATED 6-18-1988, EXPIRES 6-18-2015.

OWNER OF UNITED KINGDOM REG. NO. 1424224, DATED 4-28-1990, EXPIRES 4-28-2017.

OWNER OF UNITED KINGDOM REG. NO. 1312954, DATED 6-13-1987, EXPIRES 6-13-2018.

CLASS 6—METAL GOODS

FOR CONSERVATORIES, PORCHES, AND GARDEN PREFABRICATED BUILDINGS MADE FROM METAL; SELF ASSEMBLY PORCHES AND GARDEN PREFABRICATED BUILDINGS MADE FROM METAL; METAL BUILDING MATERIALS, NAMELY, METAL WINDOW FRAMES, METAL DOOR FRAMES, METAL DOORS, METAL GLAZING BARS, METAL RIDGE BEAMS, METAL EAVES BEAMS, METAL GUTTERS, METAL SEALING GASKETS, METAL DECORATIVE MOLDINGS, METAL CRESTINGS AND FINIALS, METAL SUPPORTS, METAL CONSERVATORY ROOFS; EXTERIOR WINDOW BLINDS FOR USE IN CONSERVATORIES, PORCHES, SUMMER HOUSES AND GARDEN BUILDINGS MADE FROM METAL; METAL PARTS AND FITTINGS FOR ALL OF THE ABOVE SAID GOODS, NAMELY, BRACKETS, BOLTS, NAILS, RIVETS, SCREWS, BRADS, CLAMPS, PINS, AND NUTS; METAL WINDOW BLIND HARDWARE, NAMELY, WALL BRACKETS AND SUPPORTS, FINIALS (U.S. CLS. 2, 12, 13, 14, 23, 25 AND 50).
FIRST USE 6-30-1996; IN COMMERCE 6-30-1996.

CLASS 19—NON-METALLIC BUILDING MATERIALS

FOR (BASED ON SECTION 44(E) NON-FIXED, NON-METAL STRUCTURES, NAMELY, MOVEABLE SUMMER HOUSES AND GARDEN PREFABRICATED BUILDINGS; NON-FIXED NON-METAL STRUCTURES, NAMELY, MOVEABLE SELF ASSEMBLY SUMMER HOUSES AND GARDEN PREFABRICATED BUILDINGS; NON-FIXED WOODEN STRUCTURES, NAMELY, MOVEABLE SUMMER HOUSES AND GARDEN PREFABRICATED BUILDINGS; NON-FIXED WOODEN STRUCTURES, NAMELY, MOVEABLE SELF ASSEMBLY SUMMER HOUSES AND GARDEN PREFABRICATED BUILDINGS (U.S. CLS. 1, 12, 33 AND 50).

CLASS 20—FURNITURE AND ARTICLES NOT OTHERWISE CLASSIFIED

FOR (BASED ON SECTION 44(E) FURNITURE FOR CONSERVATORIES AND GARDEN BUILDINGS (U.S. CLS. 2, 13, 22, 25, 32 AND 50).

CLASS 37—CONSTRUCTION AND REPAIR

FOR (BASED ON SECTION 44(E) CONSTRUCTING AND ERECTING CONSERVATORIES AND GARDEN BUILDINGS (U.S. CLS. 100, 103 AND 106).

CLASS 42—SCIENTIFIC AND COMPUTER SERVICES

FOR SURVEYING, PLANNING, AND DESIGNING SERVICES FOR OTHERS IN THE FIELD OF THE BUILDING OF CONSERVATORIES, PORCHES, SUMMER HOUSES, AND GARDEN BUILDINGS; INTERIOR DÉCOR DESIGN FOR OTHERS, RELATING TO THE BUILDING OF CONSERVATORIES, PORCHES, SUMMER HOUSES, AND GARDEN BUILDINGS; CONSULTANCY, INFORMATION, AND ADVISORY SERVICES IN THE FIELD OF SURVEYING, PLANNING, DESIGNING, AND INTERIOR DÉCOR DESIGN OF CONSERVATORIES, PORCHES, SUMMER HOUSES, AND GARDEN BUILDINGS (U.S. CLS. 100 AND 101).
FIRST USE 6-30-1996; IN COMMERCE 6-30-1996.

3,808,573. GREAT STUFF, INC., AUSTIN, TX. SN 78-722,800.
PUB. 12-26-2006, FILED 9-28-2005.

GREAT STUFF

THE MARK CONSISTS OF STANDARD CHARACTERS WITHOUT CLAIM TO ANY PARTICULAR FONT, STYLE, SIZE, OR COLOR.

CLASS 7—MACHINERY

FOR POWER OPERATED REELS FOR WINDING AND STORING LINEAR MATERIAL, NAMELY, HOSES AND ELECTRICAL CORD; POWER OPERATED GARDEN HOSE REELS (U.S. CLS. 13, 19, 21, 23, 31, 34 AND 35).
FIRST USE 4-28-2009; IN COMMERCE 4-28-2009.

CLASS 9—ELECTRICAL AND SCIENTIFIC APPARATUS

FOR REELS FOR ELECTRIC WIRE (U.S. CLS. 21, 23, 26, 36 AND 38).
FIRST USE 4-28-2009; IN COMMERCE 4-28-2009.

3,808,575. SEATTLE'S BEST COFFEE, LLC, SEATTLE, WA.
SN 78-725,363. PUB. 1-16-2007, FILED 10-3-2005.

SEATTLE'S BEST COFFEE

THE MARK CONSISTS OF STANDARD CHARACTERS WITHOUT CLAIM TO ANY PARTICULAR FONT, STYLE, SIZE, OR COLOR.

OWNER OF U.S. REG. NOS. 1,910,161, 2,733,884, AND OTHERS.

SEC. 2(F) AS TO "SEATTLE'S BEST".

CLASS 21—HOUSEWARES AND GLASS

FOR INSULATED COFFEE AND BEVERAGE CUPS, COLLAPSIBLE CUP CARRIERS AND CADDIES, INSULATED VACUUM BOTTLES, COFFEE CUPS, TEA CUPS AND MUGS, BEVERAGE GLASSWARE, STORAGE CANISTERS, NON-ELECTRIC DRIP COFFEE MAKERS, NON-ELECTRIC PLUNGER-STYLE COFFEE MAKERS, AND DECORATIVE STORAGE CONTAINERS FOR FOOD, NON-ELECTRIC TEA KETTLES, TEA INFUSERS NOT OF PRECIOUS METAL, TEA POTS NOT OF PRECIOUS METAL, TEA STRAINERS (U.S. CLS. 2, 13, 23, 29, 30, 33, 40 AND 50).

FIRST USE 6-13-1989; IN COMMERCE 8-2-1989.

CLASS 29—MEATS AND PROCESSED FOODS

FOR MILK, FLAVORED MILK AND MILK BASED FOOD BEVERAGES (U.S. CL. 46).

FIRST USE 6-13-1989; IN COMMERCE 8-2-1989.

CLASS 32—LIGHT BEVERAGES

FOR NON-ALCOHOLIC DRINKS, NAMELY, SOFT DRINKS, FRUIT DRINKS AND FRUIT JUICES, LIQUID AND POWDERED BEVERAGE MIXES FOR MAKING CARBONATED AND NON-CARBONATED SOFT DRINKS AND FRUIT DRINKS; FLAVORING SYRUPS FOR MAKING BEVERAGES, NAMELY, CARBONATED AND NON-CARBONATED SOFT DRINKS AND FRUIT DRINKS; FLAVORED AND UNFLAVORED BOTTLED WATERS, FRUIT JUICES, JUICE BASED BEVERAGES AND SODA BEVERAGES, NAMELY, SODA POP; FROZEN FRUIT BEVERAGES AND FROZEN FRUIT-BASED BEVERAGES (U.S. CLS. 45, 46 AND 48).

FIRST USE 6-13-1989; IN COMMERCE 8-2-1989.

3,808,578. RETAIL LICENSING COMPANY, LAS VEGAS, NV. SN 78-736,559. PUB. 2-6-2007, FILED 10-19-2005.

**CLASS 3—COSMETICS AND CLEANING PREPARATIONS**

FOR PERSONAL CARE PRODUCTS AND COSMETICS, NAMELY, NON-MEDICATED LIP BALM, HAND CREAM, SKIN CREAM, NAIL ENAMEL, BODY LOTIONS, MAKEUP, SKIN SOAP, LIQUID SOAPS FOR HANDS, FACE AND BODY, SUN SCREEN PREPARATIONS (U.S. CLS. 1, 4, 6, 50, 51 AND 52).

FIRST USE 10-4-2006; IN COMMERCE 10-4-2006.

CLASS 14—JEWELRY

FOR JEWELRY (U.S. CLS. 2, 27, 28 AND 50).
FIRST USE 11-6-2008; IN COMMERCE 11-6-2008.

CLASS 18—LEATHER GOODS

FOR ATHLETIC BAGS, CARRY-ON BAGS, BRIEF-CASES, LUGGAGE (U.S. CLS. 1, 2, 3, 22 AND 41).
FIRST USE 9-6-2006; IN COMMERCE 9-6-2006.

CLASS 35—ADVERTISING AND BUSINESS

FOR RETAIL STORE SERVICES AND ELECTRONIC RETAIL SERVICES USING A GLOBAL COMPUTER AND/OR COMMUNICATIONS NETWORK, ALL IN THE FIELD OF ATHLETIC BAGS, LUGGAGE, PERSONAL CARE PRODUCTS, CANDLES, TOYS, SPORTING GOODS, WRISTWATCHES, STATIONARY, PORTFOLIOS, NOTEPADS, CALENDARS, AND TRAVEL DIARIES, PENS, GREETING CARDS, NOTE CARDS (U.S. CLS. 100, 101 AND 102).

FIRST USE 9-6-2006; IN COMMERCE 9-6-2006.

3,808,580. TD AMERITRADE IP COMPANY, INC., OMAHA, NE. AND THE TORONTO-DOMINION BANK, TORONTO, ONTARIO, CANADA. SN 78-766,576. PUB. 8-7-2007, FILED 12-5-2005.

TD AMERITRADE

THE MARK CONSISTS OF STANDARD CHARACTERS WITHOUT CLAIM TO ANY PARTICULAR FONT, STYLE, SIZE, OR COLOR.

CLASS 9—ELECTRICAL AND SCIENTIFIC APPARATUS

FOR COMPUTER SOFTWARE RELATED TO FINANCIAL INFORMATION, INVESTMENT, AND TRADING, NAMELY, ELECTRONIC TRADING SOFTWARE, PORTFOLIO MANAGEMENT SOFTWARE; FINANCIAL ANALYTICAL SOFTWARE, FINANCIAL CONTACT MANAGEMENT SOFTWARE, FINANCIAL RISK MODELING SOFTWARE; SOFTWARE FOR PROVIDING ELECTRONIC CONNECTIVITY TO FINANCIAL EXCHANGES AND MARKETS (U.S. CLS. 21, 23, 26, 36 AND 38).

FIRST USE 4-21-2006; IN COMMERCE 4-21-2006.

CLASS 16—PAPER GOODS AND PRINTED MATTER

FOR PRINTED PUBLICATIONS, NAMELY, MAGAZINES, NEWSLETTERS, GUIDES, MANUALS, PAMPHLETS, AND BROCHURES, ALL IN THE FIELDS OF FINANCE, INVESTMENT, AND TRADING (U.S. CLS. 2, 5, 22, 23, 29, 37, 38 AND 50).

FIRST USE 4-21-2006; IN COMMERCE 4-21-2006.

CLASS 35—ADVERTISING AND BUSINESS

FOR ECONOMIC RESEARCH AND ECONOMIC RESEARCH SERVICES PROVIDED VIA A GLOBAL COMPUTER NETWORK; ECONOMIC FORECASTING AND ANALYSIS (U.S. CLS. 100, 101 AND 102).

FIRST USE 4-21-2006; IN COMMERCE 4-21-2006.

CLASS 36—INSURANCE AND FINANCIAL

FOR FINANCIAL SERVICES, NAMELY, PROVIDING SECURITIES AND INVESTMENT INFORMATION; COMMODITY TRADING FOR OTHERS (U.S. CLS. 100, 101 AND 102).

FIRST USE 4-21-2006; IN COMMERCE 4-21-2006.

CLASS 41—EDUCATION AND ENTERTAINMENT

FOR EDUCATIONAL SERVICES, NAMELY, PROVIDING CONFERENCES, WEBINARS, WEBCASTS, AND SEMINARS IN THE FIELDS OF INVESTMENT AND FINANCES (U.S. CLS. 100, 101 AND 107).

FIRST USE 4-21-2006; IN COMMERCE 4-21-2006.

3,808,588. TD AMERITRADE IP COMPANY, INC., OMAHA, NE. AND THE TORONTO-DOMINION BANK, TORONTO, ONTARIO, CANADA. SN 78-830,842. PUB. 8-7-2007, FILED 3-7-2006.



3,808,581. CTG ATHLETICS, LLC, BRONX, NY. SN 78-769,822. PUB. 4-3-2007, FILED 12-8-2005.

CONTROLLING THE GAME

THE MARK CONSISTS OF STANDARD CHARACTERS WITHOUT CLAIM TO ANY PARTICULAR FONT, STYLE, SIZE, OR COLOR.

CLASS 25—CLOTHING

FOR CLOTHING, NAMELY, T-SHIRTS, GOLF SHIRTS, TOPS, HATS, CAPS, SKULL CAPS, SWEATSHIRTS, HOODED SWEATSHIRTS, RUNNING SUITS, PANTS, SWEATBANDS, UNDERWEAR AND WRISTBANDS (U.S. CLS. 22 AND 39).

FIRST USE 11-30-2003; IN COMMERCE 11-30-2003.

CLASS 28—TOYS AND SPORTING GOODS

FOR SPORTING GOODS, NAMELY, BASEBALL BATS, BASEBALL GLOVES, BATTING GLOVES, FOOTBALL GLOVES (U.S. CLS. 22, 23, 38 AND 50).

FIRST USE 12-31-2004; IN COMMERCE 12-31-2004.

3,808,586. PAPE, PIERCE J., ATLANTA, GA. SN 78-812,551. PUB. 1-30-2007, FILED 2-10-2006.

Take The Hill

THE MARK CONSISTS OF STANDARD CHARACTERS WITHOUT CLAIM TO ANY PARTICULAR FONT, STYLE, SIZE, OR COLOR.

CLASS 25—CLOTHING

FOR CLOTHING APPAREL, NAMELY, JACKETS AND OUTER WEAR (U.S. CLS. 22 AND 39).

FIRST USE 1-15-2009; IN COMMERCE 1-15-2009.

CLASS 26—FANCY GOODS

FOR FOOTWEAR ACCESSORIES, NAMELY, SHOE LACES, BOOT LACES, ELASTIC SHOE LACES, SHOE LACES WHICH CAN BE FASTENED WITHOUT TYING, AND SHOE LACES EQUIPPED WITH LOCKING SLIDE FASTENERS TO PREVENT LACES FROM BECOMING UNTIED (U.S. CLS. 37, 39, 40, 42 AND 50).

FIRST USE 4-20-2010; IN COMMERCE 4-20-2010.

CLASS 9—ELECTRICAL AND SCIENTIFIC APPARATUS

FOR COMPUTER SOFTWARE RELATED TO FINANCIAL INFORMATION, INVESTMENT, AND TRADING, NAMELY, ELECTRONIC TRADING SOFTWARE, PORTFOLIO MANAGEMENT SOFTWARE; FINANCIAL ANALYTICAL SOFTWARE, FINANCIAL CONTACT MANAGEMENT SOFTWARE, FINANCIAL RISK MODELING SOFTWARE; SOFTWARE FOR PROVIDING ELECTRONIC CONNECTIVITY TO FINANCIAL EXCHANGES AND MARKETS (U.S. CLS. 21, 23, 26, 36 AND 38).

FIRST USE 4-21-2006; IN COMMERCE 4-21-2006.

CLASS 16—PAPER GOODS AND PRINTED MATTER

FOR PRINTED PUBLICATIONS, NAMELY, MAGAZINES, NEWSLETTERS, GUIDES, MANUALS, PAMPHLETS, AND BROCHURES, ALL IN THE FIELDS OF FINANCE, INVESTMENT, AND TRADING (U.S. CLS. 2, 5, 22, 23, 29, 37, 38 AND 50).

FIRST USE 4-21-2006; IN COMMERCE 4-21-2006.

CLASS 35—ADVERTISING AND BUSINESS

FOR ECONOMIC RESEARCH AND ECONOMIC RESEARCH SERVICES PROVIDED VIA A GLOBAL COMPUTER NETWORK; ECONOMIC FORECASTING AND ANALYSIS (U.S. CLS. 100, 101 AND 102).

FIRST USE 4-21-2006; IN COMMERCE 4-21-2006.

CLASS 36—INSURANCE AND FINANCIAL

FOR FINANCIAL SERVICES, NAMELY, PROVIDING SECURITIES AND INVESTMENT INFORMATION; COMMODITY TRADING FOR OTHERS (U.S. CLS. 100, 101 AND 102).

FIRST USE 4-21-2006; IN COMMERCE 4-21-2006.

CLASS 41—EDUCATION AND ENTERTAINMENT

FOR EDUCATIONAL SERVICES, NAMELY, PROVIDING CONFERENCES, WEBINARS, WEBCASTS, AND SEMINARS IN THE FIELDS OF INVESTMENT AND FINANCES (U.S. CLS. 100, 101 AND 107).

FIRST USE 4-21-2006; IN COMMERCE 4-21-2006.

3,808,589. TURKOWITZ, NORMAN S., NEW YORK, NY. SN 78-837,291. PUB. 2-13-2007, FILED 3-15-2006.



THE MARK CONSISTS OF STANDARD CHARACTERS WITHOUT CLAIM TO ANY PARTICULAR FONT, STYLE, SIZE, OR COLOR.

CLASS 3—COSMETICS AND CLEANING PREPARATIONS

FOR NON-MEDICATED LIP LINER, LIP GLOSS AND LIPSTICK (U.S. CLS. 1, 4, 6, 50, 51 AND 52).
FIRST USE 3-0-2008; IN COMMERCE 4-21-2009.

CLASS 5—PHARMACEUTICALS

FOR MEDICATED LIP BALM (U.S. CLS. 6, 18, 44, 46, 51 AND 52).
FIRST USE 3-0-2008; IN COMMERCE 4-21-2009.

3,808,590. DATATRAX TECHNOLOGIES INC., TORONTO, CANADA. SN 78-838,123. PUB. 9-25-2007, FILED 3-15-2006.



DataTrax

PRIORITY CLAIMED UNDER SEC. 44(D) ON CANADA APPLICATION NO. 1272053, FILED 9-15-2005, REG. NO. TMA691053, DATED 6-28-2007, EXPIRES 6-28-2022.

CLASS 35—ADVERTISING AND BUSINESS

FOR LICENSING COMPUTER SOFTWARE FOR USE BY OTHERS AT POINT OF SALE TERMINALS FOR ISSUING AND TRACKING ATTRACTION, EVENT AND TOUR TICKETS; OPERATING AND HOSTING REPORT SEVERs FOR USERS OF COMPUTER SOFTWARE, AND COMPILING DAILY, WEEKLY, AND MONTHLY REPORTS FOR TERMINAL COMPUTER SOFTWARE USERS; LICENSING OF COMPUTER SOFTWARE FOR USE BY OTHERS AT POINT OF SALE TERMINALS TO TRACK AND RECORD SALES AND RECEIPTS AND RETAIL OUTLETS; LICENSING COMPUTER SOFTWARE FOR USE BY SALES PROFESSIONALS ON HAND-HELD TERMINALS TO PROVIDE CUSTOMER ACCOUNT INFORMATION, PRODUCT INVENTORY CONTROLS, AND ORDER CONFIRMATIONS; LICENSING OF COMPUTER SOFTWARE FOR USE BY CONTRACTORS AT POINT OF SALE TERMINALS FOR QUOTING, INVOICING AND PROVIDING A FIELD ACCOUNTING SYSTEM; LICENSING OF COMPUTER SOFTWARE FOR USE BY OTHERS AT POINT OF SALE TERMINALS TO PROCESS CREDIT AND DEBIT CARD TRANSACTIONS; PREPARING FINANCIAL REPORTS FOR OTHERS (U.S. CLS. 100, 101 AND 102).
FIRST USE 5-1-2001; IN COMMERCE 5-1-2005.

CLASS 36—INSURANCE AND FINANCIAL

FOR FINANCIAL MANAGEMENT SERVICES; ACCOUNTS PAYABLE AND COMMISSIONS DEBITING SERVICES (U.S. CLS. 100, 101 AND 102).
FIRST USE 9-30-2009; IN COMMERCE 9-30-2009.

CLASS 42—SCIENTIFIC AND COMPUTER SERVICES

FOR OPERATING AND HOSTING WEB SITES ON A COMPUTER SERVER FOR USERS OF COMPUTER SOFTWARE FOR THE PURPOSE OF MANAGING THEIR PRODUCTS, AGENTS, REPORTS AND INVENTORY (U.S. CLS. 100 AND 101).
FIRST USE 5-1-2001; IN COMMERCE 5-1-2005.

3,808,591. COPELAND, MARTY, FORT WORTH, TX. SN 78-839,107. PUB. 8-28-2007, FILED 3-16-2006.

GOHIFIT!

THE MARK CONSISTS OF STANDARD CHARACTERS WITHOUT CLAIM TO ANY PARTICULAR FONT, STYLE, SIZE, OR COLOR.

CLASS 9—ELECTRICAL AND SCIENTIFIC APPARATUS

FOR PRE-RECORDED AUDIOTAPES, AUDIO DISCS, VIDEOTAPES AND VIDEO DISCS IN THE FIELD OF PHYSICAL FITNESS AND EXERCISE (U.S. CLS. 21, 23, 26, 36 AND 38).
FIRST USE 3-3-2010; IN COMMERCE 3-3-2010.

CLASS 16—PAPER GOODS AND PRINTED MATTER

FOR BOOKS, BROCHURES AND PAMPHLETS IN THE FIELD OF PHYSICAL FITNESS (U.S. CLS. 2, 5, 22, 23, 29, 37, 38 AND 50).
FIRST USE 3-3-2010; IN COMMERCE 3-3-2010.

CLASS 25—CLOTHING

FOR FITNESS APPAREL, NAMELY, MEN'S, WOMEN'S AND CHILDREN'S SHORTS, T-SHIRTS, FLEECE TOPS AND BOTTOMS, WARM UP SUITS, LEOTARDS, KNIT HATS, CAPS AND HEADWEAR (U.S. CLS. 22 AND 39).
FIRST USE 4-23-2010; IN COMMERCE 4-23-2010.

3,808,592. ADVANCED MEDICAL TECHNOLOGY ASSOCIATION, WASHINGTON, DC. SN 78-858,690. PUB. 1-22-2008, FILED 4-11-2006.



NO CLAIM IS MADE TO THE EXCLUSIVE RIGHT TO USE "MEDICAL TECHNOLOGY", APART FROM THE MARK AS SHOWN.

CLASS 16—PAPER GOODS AND PRINTED MATTER

FOR NEWSLETTERS AND BULLETINS IN THE FIELDS OF MEDICAL TECHNOLOGY RESEARCH AND DEVELOPMENT (U.S. CLS. 2, 5, 22, 23, 29, 37, 38 AND 50).

FIRST USE 6-22-2006; IN COMMERCE 6-22-2006.

CLASS 42—SCIENTIFIC AND COMPUTER SERVICES

FOR MEDICAL AND SCIENTIFIC RESEARCH AND DATA SERVICES, NAMELY, PROVIDING INFORMATION IN THE FIELD OF THE DEVELOPMENT OF NEW MEDICAL TECHNOLOGY (U.S. CLS. 100 AND 101).

FIRST USE 6-22-2006; IN COMMERCE 6-22-2006.

3,808,593. VIAGEN, INC., AUSTIN, TX. SN 78-873,872. PUB. 7-17-2007, FILED 5-1-2006.

VIAGEN

THE MARK CONSISTS OF STANDARD CHARACTERS WITHOUT CLAIM TO ANY PARTICULAR FONT, STYLE, SIZE, OR COLOR.

OWNER OF U.S. REG. NOS. 3,121,353 AND 3,127,495.

CLASS 31—NATURAL AGRICULTURAL PRODUCTS

FOR MAMMALIAN EMBRYOS; CLONED EMBRYOS OF MAMMALIAN ANIMALS; LIVE MAMMALIAN ANIMALS; CLONED LIVE MAMMALIAN ANIMALS (U.S. CLS. 1 AND 46).

FIRST USE 0-0-2006; IN COMMERCE 0-0-2006.

CLASS 44—MEDICAL, BEAUTY AND AGRICULTURAL SERVICES

FOR CLONING SERVICES IN RESPECT OF MAMMALIAN ANIMALS (U.S. CLS. 100 AND 101).

FIRST USE 10-13-2008; IN COMMERCE 10-13-2008.

3,808,594. DIETERBAKICENTERPRISES GMBH, 81829 MUNCHEN, FED REP GERMANY. SN 78-879,837. PUB. 1-22-2008, FILED 5-9-2006.



PRIORITY CLAIMED UNDER SEC. 44(D) ON ERP CMNTY TM OFC APPLICATION NO. 004734877, FILED 11-10-2005, REG. NO. 004734877, DATED 11-20-2006, EXPIRES 11-10-2015.

THE MARK CONSISTS OF A DESIGN ELEMENT REPRESENTING THE LETTERS "DB" AND A STYLIZED PERFUME BOTTLE.

CLASS 16—PAPER GOODS AND PRINTED MATTER

FOR PACKAGING MATERIAL AND OUTER PACKAGING FOR COSMETICS, NAMELY, PAPER BAGS AND POUCHES FOR PACKAGING (U.S. CLS. 2, 5, 22, 23, 29, 37, 38 AND 50).

FIRST USE 8-19-1996; IN COMMERCE 8-19-1996.

CLASS 20—FURNITURE AND ARTICLES NOT OTHERWISE CLASSIFIED

FOR NON-METAL SEALING CAPS FOR COSMETIC CONTAINERS (U.S. CLS. 2, 13, 22, 25, 32 AND 50).

FIRST USE 8-19-1996; IN COMMERCE 8-19-1996.

CLASS 21—HOUSEWARES AND GLASS

FOR PLASTIC BOTTLES FOR COSMETICS, SOLD EMPTY; GLASS CONTAINERS FOR COSMETICS, SOLD EMPTY; GLASS FLACONS FOR COSMETICS, SOLD EMPTY; GLASS BOTTLES FOR COSMETICS, SOLD EMPTY (U.S. CLS. 2, 13, 23, 29, 30, 33, 40 AND 50).

FIRST USE 8-19-1996; IN COMMERCE 8-19-1996.

CLASS 35—ADVERTISING AND BUSINESS

FOR BUSINESS CONSULTANCY WITH REGARD TO PRODUCT DESIGN AND PRODUCT MARKETING (U.S. CLS. 100, 101 AND 102).

FIRST USE 8-19-1996; IN COMMERCE 8-19-1996.

CLASS 42—SCIENTIFIC AND COMPUTER SERVICES

FOR INDUSTRIAL DESIGN SERVICES; PACKAGING DESIGN FOR OTHERS (U.S. CLS. 100 AND 101).

FIRST USE 8-19-1996; IN COMMERCE 8-19-1996.

3,808,595. ALL ENGLAND ENTERPRISES, LTD., MINNEAPOLIS, MN. SN 78-881,632. PUB. 9-11-2007, FILED 5-11-2006.

BRIT'S PUB

THE MARK CONSISTS OF STANDARD CHARACTERS WITHOUT CLAIM TO ANY PARTICULAR FONT, STYLE, SIZE, OR COLOR.

CLASS 21—HOUSEWARES AND GLASS

FOR BEVERAGE GLASSWARE AND COASTERS NOT OF PAPER AND NOT BEING TABLE LINEN MARKED AND SOLD ONLY AT RETAIL THROUGH PUBS THAT ARE LOCATED IN THE UNITED STATES AND ARE OWNED OR OPERATED BY OWNER AND/OR OWNER'S RELATED COMPANIES AND THROUGH ON-LINE WEBSITES DIRECTLY ASSOCIATED WITH THOSE PUBS (U.S. CLS. 2, 13, 23, 29, 30, 33, 40 AND 50).

FIRST USE 7-1-1996; IN COMMERCE 7-1-1996.

CLASS 25—CLOTHING

FOR SHORTS AND PANTS, JACKETS AND HEADWEAR MARKED AND SOLD ONLY AT RETAIL THROUGH PUBS THAT ARE LOCATED IN THE UNITED STATES AND ARE OWNED AND OPERATED BY OWNER AND OR OWNER'S RELATED COMPANIES AND THROUGH ON-LINE WEBSITES DIRECTLY ASSOCIATED WITH THOSE PUBS (U.S. CLS. 22 AND 39).

FIRST USE 7-1-1996; IN COMMERCE 7-1-1996.

3,808,610. KNUCKLEHEADS INC., AGOURA HILLS, CA. SN 78-919,884. PUB. 2-13-2007, FILED 6-29-2006.

KNUCKLEHEADS

THE MARK CONSISTS OF STANDARD CHARACTERS WITHOUT CLAIM TO ANY PARTICULAR FONT, STYLE, SIZE, OR COLOR.

CLASS 35—ADVERTISING AND BUSINESS

FOR FRANCHISE SERVICES, NAMELY, OFFERING TECHNICAL AND BUSINESS MANAGEMENT ASSISTANCE IN THE ESTABLISHMENT AND OPERATION OF FITNESS CENTERS (U.S. CLS. 100, 101 AND 102).
FIRST USE 10-15-2009; IN COMMERCE 10-15-2009.

CLASS 41—EDUCATION AND ENTERTAINMENT

FOR PROVIDING FACILITIES FOR EXERCISE AND PHYSICAL FITNESS TRAINING; EDUCATION SERVICES, NAMELY, PROVIDING HEALTH AND FITNESS PROGRAMS; FITNESS CENTERS PROVIDING FITNESS AND EXERCISE FACILITIES (U.S. CLS. 100, 101 AND 107).
FIRST USE 4-0-2007; IN COMMERCE 4-0-2007.

3,808,612. TANDENT VISION SCIENCE, INC., SAN FRANCISCO, CA. SN 78-934,607. PUB. 8-7-2007, FILED 7-21-2006.

TANDENT VISION SCIENCE

THE MARK CONSISTS OF STANDARD CHARACTERS WITHOUT CLAIM TO ANY PARTICULAR FONT, STYLE, SIZE, OR COLOR.

NO CLAIM IS MADE TO THE EXCLUSIVE RIGHT TO USE "VISION SCIENCE", APART FROM THE MARK AS SHOWN.

CLASS 9—ELECTRICAL AND SCIENTIFIC APPARATUS

FOR COMPUTER PROGRAMS FOR OBJECT RECOGNITION, IMAGING, AND IMAGE ANALYSIS, FOR USE IN COMPUTER VISION; COMPUTER SOFTWARE DEVELOPMENT TOOLS FOR USE IN COMPUTER VISION, IMAGING, AND IMAGE ANALYSIS (U.S. CLS. 21, 23, 26, 36 AND 38).
FIRST USE 4-20-2010; IN COMMERCE 4-20-2010.

CLASS 35—ADVERTISING AND BUSINESS

FOR BUSINESS RESEARCH IN FIELDS OF COMPUTER VISION, IMAGING, AND IMAGE ANALYSIS (U.S. CLS. 100, 101 AND 102).
FIRST USE 7-21-2006; IN COMMERCE 7-21-2006.

CLASS 42—SCIENTIFIC AND COMPUTER SERVICES

FOR CONDUCTING IMAGING ANALYSIS IN THE FIELD OF COMPUTER VISION, TECHNOLOGY RESEARCH, AND TECHNOLOGY CONSULTING (U.S. CLS. 100 AND 101).
FIRST USE 7-21-2006; IN COMMERCE 7-21-2006.

3,808,618. DORIS MAVIS LLC, MINNEAPOLIS, MN. SN 78-950,314. PUB. 7-10-2007, FILED 8-11-2006.

IT'S ALL ABOUT THE DOUGHNUTS

THE MARK CONSISTS OF STANDARD CHARACTERS WITHOUT CLAIM TO ANY PARTICULAR FONT, STYLE, SIZE, OR COLOR.

CLASS 25—CLOTHING

FOR GOLF APPAREL AND ACCESSORIES, NAMELY, HATS, CAPS, CLEATS, SHIRTS, T-SHIRTS, SWEATERS, PULLOVERS, JACKETS, RAINCOATS, SOCKS, SHOES, SPIKES, SHORTS AND PANTS (U.S. CLS. 22 AND 39).
FIRST USE 4-1-2010; IN COMMERCE 4-1-2010.

CLASS 28—TOYS AND SPORTING GOODS

FOR GOLF EQUIPMENT AND MERCHANDISE, NAMELY, GOLF CLUBS, GOLF BALLS, COVERS FOR GOLF CLUBS, DIVOT REPAIR TOOLS, GOLF ACCESSORY POUCHES, GOLF BAG COVERTS, GOLF BAIL MARKERS, GOLF BAIL RETRIEVERS, GOLF BALL SLEEVES, GOLF CLUB COVERS, GOLF CLUB GRIPS, GOLF CLUB HEADS, GOLF CLUB SHAFTS, GOLF GLOVES, IRONS, PUTTERS, PUTTER COVERS, TEE MARKERS, TEES, HAND GRIPS, HEAD COVERS, AND GOLF TOWEL CLIPS (U.S. CLS. 22, 23, 38 AND 50).
FIRST USE 4-1-2010; IN COMMERCE 4-1-2010.

3,808,621. KIKI HOLDINGS LLC, NEW YORK, NY. SN 78-978,576. PUB. 8-7-2007, FILED 12-17-2004.

KIKI DE MONTPARNASSE

THE MARK CONSISTS OF STANDARD CHARACTERS WITHOUT CLAIM TO ANY PARTICULAR FONT, STYLE, SIZE, OR COLOR.

THE NAME SHOWN IN THE MARK DOES NOT IDENTIFY A LIVING INDIVIDUAL.

CLASS 3—COSMETICS AND CLEANING PREPARATIONS

FOR COSMETICS, INCLUDING BATH OIL, BODY OILS AND CREAMS, AND MASSAGE OILS AND CREAMS; FRAGRANCES FOR PERSONAL USE; SKIN SOAP (U.S. CLS. 1, 4, 6, 50, 51 AND 52).
FIRST USE 5-13-2006; IN COMMERCE 5-13-2006.

CLASS 10—MEDICAL APPARATUS

FOR CONDOMS, PROPHYLACTICS; ADULT SEXUAL AIDS FOR SEXUAL PLAY, FANTASY AND ENHANCEMENT, NAMELY, VIBRATORS, BENWA BALLS, PERSONAL ELECTRIC VIBRATING MASSAGERS, ANAL PLUGS, KEGEL EXERCISERS, AND ARTIFICIAL PENISES IN THE NATURE OF DILDOES BEING SEXUAL AIDS (U.S. CLS. 26, 39 AND 44).
FIRST USE 5-13-2006; IN COMMERCE 5-13-2006.

CLASS 4—LUBRICANTS AND FUELS

FOR CANDLES (U.S. CLS. 1, 6 AND 15).
FIRST USE 5-13-2006; IN COMMERCE 5-13-2006.

CLASS 14—JEWELRY

FOR JEWELRY (U.S. CLS. 2, 27, 28 AND 50).
FIRST USE 5-13-2006; IN COMMERCE 5-13-2006.

CLASS 16—PAPER GOODS AND PRINTED MATTER

FOR PAPER GOODS IN THE NATURE OF ART PAPER AND DRAWING PAPER; DIARIES (U.S. CLS. 2, 5, 22, 23, 29, 37, 38 AND 50).
FIRST USE 5-13-2006; IN COMMERCE 5-13-2006.

CLASS 5—PHARMACEUTICALS

FOR SILICONE AND WATER-BASED PERSONAL LUBRICANTS (U.S. CLS. 6, 18, 44, 46, 51 AND 52).
FIRST USE 5-13-2006; IN COMMERCE 5-13-2006.

CLASS 24—FABRICS

FOR BEDDING, NAMELY, BED SHEETS AND BED SPREADS (U.S. CLS. 42 AND 50).
FIRST USE 5-13-2006; IN COMMERCE 5-13-2006.

* * * * *

SECTION 2.— INTERNATIONAL CLASSIFICATION

The short titles associated below with the international class numbers are terms designed merely for quick identification and are not an official part of the international classification. The full names of international classes are given in section 6.1 of the trademark rules of practice.

The designation "U.S. Cl." appearing in this section refers to the U.S. class in effect prior to Sep. 1, 1973 rather than the international class which applies to applications filed on or after that date. For adoption of international classification see notice in the OFFICIAL GAZETTE of Jun. 26, 1973 (911 O.G. TM 210).

Application in one class

CLASS 1—CHEMICALS

3,807,521. MOMENTIVE PERFORMANCE MATERIALS INC., ALBANY, NY. SN 77-327,688. PUB. 7-1-2008, FILED 11-12-2007.

CLASS 1—(Continued).

3,807,604. INTERNATIONAL FLORA TECHNOLOGIES, LTD., CHANDLER, AZ. SN 77-445,468. PUB. 9-15-2009, FILED 4-10-2008.

AGROSPRED

THE MARK CONSISTS OF STANDARD CHARACTERS WITHOUT CLAIM TO ANY PARTICULAR FONT, STYLE, SIZE, OR COLOR.

FOR CHEMICAL PREPARATIONS FOR USE IN AGRICULTURE, NAMELY, SILICONE SURFACTANTS, AND SILICONE SURFACTANT MIXTURES WITH NONIONIC SURFACTANTS (U.S. CLS. 1, 5, 6, 10, 26 AND 46).
FIRST USE 12-4-2009; IN COMMERCE 12-4-2009.

PHYTOSEBUM

THE MARK CONSISTS OF STANDARD CHARACTERS WITHOUT CLAIM TO ANY PARTICULAR FONT, STYLE, SIZE, OR COLOR.

FOR BOTANICAL AND BOTANICALLY-DERIVED EXTRACTS FOR USE IN THE MANUFACTURE OF PERSONAL CARE PRODUCTS, PHARMACEUTICALS, AND COSMETICS (U.S. CLS. 1, 5, 6, 10, 26 AND 46).
FIRST USE 4-10-2008; IN COMMERCE 4-10-2008.

3,807,594. HELENA HOLDING COMPANY, WILMINGTON, DE. SN 77-437,732. PUB. 8-19-2008, FILED 4-2-2008.

3,807,884. ALZCHEM TROSTBERG GMBH, TROSTBERG, FED REP GERMANY. SN 77-622,573. PUB. 4-7-2009, FILED 11-26-2008.

QUICKSHOT

THE MARK CONSISTS OF STANDARD CHARACTERS WITHOUT CLAIM TO ANY PARTICULAR FONT, STYLE, SIZE, OR COLOR.

FOR FERTILIZER USED IN AGRICULTURE (U.S. CLS. 1, 5, 6, 10, 26 AND 46).
FIRST USE 4-23-2010; IN COMMERCE 4-23-2010.

NitrAlz

THE MARK CONSISTS OF STANDARD CHARACTERS WITHOUT CLAIM TO ANY PARTICULAR FONT, STYLE, SIZE, OR COLOR.

FOR CHEMICAL PRODUCTS FOR INDUSTRIAL PURPOSES, NAMELY, AROMATIC AND ALIPHATIC NITRILES AND CYANO COMPOUNDS (U.S. CLS. 1, 5, 6, 10, 26 AND 46).
FIRST USE 3-0-2010; IN COMMERCE 3-0-2010.

CLASS 1—(Continued).

3,807,936. ZEHR, MICHAEL R., DBA MAPLE ROW MANAGEMENT, LLC, WAUSEON, OH. AND MCCLARREN, BRIAN K., DBA MAPLE ROW MANAGEMENT, LLC, DELTA, OH. SN 77-659,378. PUB. 5-19-2009, FILED 1-29-2009.

GreenYields

THE MARK CONSISTS OF STANDARD CHARACTERS WITHOUT CLAIM TO ANY PARTICULAR FONT, STYLE, SIZE, OR COLOR.

FOR PREPARATIONS FOR FORTIFYING PLANTS (U.S. CLS. 1, 5, 6, 10, 26 AND 46).
FIRST USE 3-1-2009; IN COMMERCE 3-1-2009.

3,807,943. ENVIROTECH SERVICES, INC., GREELEY, CO. SN 77-666,849. PUB. 6-2-2009, FILED 2-9-2009.

DURABLEND

THE MARK CONSISTS OF STANDARD CHARACTERS WITHOUT CLAIM TO ANY PARTICULAR FONT, STYLE, SIZE, OR COLOR.

FOR CHEMICAL PREPARATIONS AND COMPOSITIONS, NAMELY, A DUST CONTROL/STABILIZATION LIQUID FOR USE ON ROADS, PARKING LOTS, PARKS, FEEDLOTS, NURSERIES, ORCHARDS, AIRFIELDS, HELICOPTER PADS, CONSTRUCTION AREAS, QUARRIES AND MINES (U.S. CLS. 1, 5, 6, 10, 26 AND 46).
FIRST USE 2-20-2009; IN COMMERCE 5-1-2009.

3,807,994. HYDROLVE LLC, REDDING, CA. SN 77-682,675. PUB. 6-30-2009, FILED 3-3-2009.



THE COLOR(S) BLACK, BLUE, WHITE, GREY, TAN IS/ ARE CLAIMED AS A FEATURE OF THE MARK.

CLASS 1—(Continued).

THE MARK CONSISTS OF STYLIZED LETTERS "DORANITE" ENCAPSULATED IN AN OBLONG ELLIPTICAL CIRCLE CONSISTING OF A BLACK LINE AND BACK-FILLED IN TAN WITH THE BLACK "O" WITH WHITE RINGS ON BOTH THE INNER AND OUTER EDGE OF LETTER IS ENCAPSULATED IN A BLACK LINED DIAMOND BACKFILLED IN GREY WHICH TOUCHES THE "D" ON ONE SIDE AND THE "R" ON THE OTHER ALL REMAINING LETTERS ARE BLUE .

FOR COMPOST (U.S. CLS. 1, 5, 6, 10, 26 AND 46).
FIRST USE 7-24-2009; IN COMMERCE 7-24-2009.

3,808,028. EDISON WELDING INSTITUTE, INC., COLUMBUS, OH. SN 77-690,275. PUB. 7-14-2009, FILED 3-13-2009.

DEEPTIG

THE MARK CONSISTS OF STANDARD CHARACTERS WITHOUT CLAIM TO ANY PARTICULAR FONT, STYLE, SIZE, OR COLOR.

FOR METALLIC OXIDE COMPOUNDS FOR USE IN WELDING APPLICATIONS; METALLIC OXIDE COMPOUNDS IN THE FORM OF AEROSOL SPRAYS FOR USE IN WELDING APPLICATIONS (U.S. CLS. 1, 5, 6, 10, 26 AND 46).

FIRST USE 11-15-2009; IN COMMERCE 11-15-2009.

3,808,080. AVIOQ, INC., ROCKVILLE, MD. SN 77-698,150. PUB. 7-28-2009, FILED 3-24-2009.

AVIOQ

THE MARK CONSISTS OF STANDARD CHARACTERS WITHOUT CLAIM TO ANY PARTICULAR FONT, STYLE, SIZE, OR COLOR.

FOR DIAGNOSTIC PREPARATIONS FOR SCIENTIFIC OR RESEARCH USE; DIAGNOSTIC PREPARATIONS FOR CLINICAL OR MEDICAL LABORATORY USE (U.S. CLS. 1, 5, 6, 10, 26 AND 46).

FIRST USE 3-15-2010; IN COMMERCE 3-15-2010.

CLASS 1—(Continued).

3,808,128. CEDARCHEM, LLC, CEDARTOWN, GA. SN 77-704,539. PUB. 8-4-2009, FILED 4-1-2009.



THE MARK CONSISTS OF THE SILHOUETTE OF A PINE TREE WITHIN A CIRCLE.
FOR WATER CLARIFICATION AND SOLID SEPARATION CHEMICALS FOR WATER AND WASTE WATER TREATMENT (U.S. CLS. 1, 5, 6, 10, 26 AND 46).
FIRST USE 4-13-2009; IN COMMERCE 4-13-2009.

3,808,130. CEDARCHEM, LLC, CEDARTOWN, GA. SN 77-704,596. PUB. 8-4-2009, FILED 4-1-2009.

CHEMISTRY FOR CLEAN WATER

THE MARK CONSISTS OF STANDARD CHARACTERS WITHOUT CLAIM TO ANY PARTICULAR FONT, STYLE, SIZE, OR COLOR.
FOR WATER CLARIFICATION AND SOLID SEPARATION CHEMICALS FOR WATER AND WASTE WATER TREATMENT (U.S. CLS. 1, 5, 6, 10, 26 AND 46).
FIRST USE 4-13-2009; IN COMMERCE 4-13-2009.

3,808,218. DELO INDUSTRIAL ADHESIVES LLC, HAUPPAUGE, NY. SN 77-719,244. PUB. 8-25-2009, FILED 4-22-2009.

DUALBOND

THE MARK CONSISTS OF STANDARD CHARACTERS WITHOUT CLAIM TO ANY PARTICULAR FONT, STYLE, SIZE, OR COLOR.
FOR ADHESIVES FOR INDUSTRIAL USE; INDUSTRIAL ADHESIVES (U.S. CLS. 1, 5, 6, 10, 26 AND 46).
FIRST USE 7-12-2000; IN COMMERCE 7-16-2009.

CLASS 1—(Continued).

3,808,230. THOMAS J. HUMPHREY, DBA HUMPHREY BIOTIC SOLUTIONS, TULARE, CA. SN 77-724,344. PUB. 9-1-2009, FILED 4-28-2009.

BACRITE

THE MARK CONSISTS OF STANDARD CHARACTERS WITHOUT CLAIM TO ANY PARTICULAR FONT, STYLE, SIZE, OR COLOR.
FOR BACTERIA FOR WASTE WATER TREATMENT; BACTERIAL ADDITIVE FOR BREAKDOWN OF ANIMAL WASTE (U.S. CLS. 1, 5, 6, 10, 26 AND 46).
FIRST USE 11-4-2008; IN COMMERCE 1-29-2010.

3,808,291. BPSI HOLDINGS, LLC., WILMINGTON, DE. SN 77-740,016. PUB. 9-22-2009, FILED 5-19-2009.

CHROMATERIC

THE MARK CONSISTS OF STANDARD CHARACTERS WITHOUT CLAIM TO ANY PARTICULAR FONT, STYLE, SIZE, OR COLOR.
OWNER OF U.S. REG. NO. 3,316,910.
FOR EDIBLE POWDER POLYMER-CONTAINING COMPOSITIONS FOR USE IN THE MANUFACTURE OF FILM COATINGS FOR USE IN ENCAPSULATING PHARMACEUTICALS, FOOD, CONFECTIONARY AND NUTRITIONAL SUPPLEMENT PRODUCTS (U.S. CLS. 1, 5, 6, 10, 26 AND 46).
FIRST USE 4-9-2010; IN COMMERCE 4-9-2010.

3,808,402. SAFARILAND, LLC, JACKSONVILLE, FL. SN 77-784,103. PUB. 12-1-2009, FILED 7-17-2009.

LIGHTNING SPRAY

THE MARK CONSISTS OF STANDARD CHARACTERS WITHOUT CLAIM TO ANY PARTICULAR FONT, STYLE, SIZE, OR COLOR.
OWNER OF U.S. REG. NO. 2,662,010.
NO CLAIM IS MADE TO THE EXCLUSIVE RIGHT TO USE "SPRAY", APART FROM THE MARK AS SHOWN.
FOR SPRAYABLE LATENT FINGERPRINT DUSTING POWDER (U.S. CLS. 1, 5, 6, 10, 26 AND 46).
FIRST USE 6-1-2009; IN COMMERCE 6-1-2009.

CLASS 2—PAINTS

CLASS 2—(Continued).

3,808,438. PYRAMEX SAFETY PRODUCTS, LLC, COLLIERVILLE, TN. SN 77-796,804. PUB. 12-29-2009, FILED 8-4-2009.

H2X

THE MARK CONSISTS OF STANDARD CHARACTERS WITHOUT CLAIM TO ANY PARTICULAR FONT, STYLE, SIZE, OR COLOR.

FOR ANTI-FOG COATING SOLUTION DESIGNED TO ELIMINATE MOISTURE AND CONDENSATION ON EYEWEAR (U.S. CLS. 6, 11 AND 16).

FIRST USE 3-12-2010; IN COMMERCE 3-12-2010.

CLASS 3—COSMETICS AND CLEANING PREPARATIONS

3,807,393. FIT HAIR, INC., LONG BEACH, CA. SN 76-695,710. PUB. 6-30-2009, FILED 2-9-2009.

MYRRHMAID

THE MARK CONSISTS OF STANDARD CHARACTERS WITHOUT CLAIM TO ANY PARTICULAR FONT, STYLE, SIZE, OR COLOR.

FOR NON-MEDICATED HAIR CARE PREPARATIONS, NAMELY, SHAMPOOS AND CONDITIONERS (U.S. CLS. 1, 4, 6, 50, 51 AND 52).

FIRST USE 11-30-2009; IN COMMERCE 11-30-2009.

3,807,425. ESTHETIQUES SANS FRONTIERES INC., CITY OF ANJOU, QUEBEC. SN 77-066,512. PUB. 12-15-2009, FILED 12-18-2006.

EPIL LYSS

THE MARK CONSISTS OF STANDARD CHARACTERS WITHOUT CLAIM TO ANY PARTICULAR FONT, STYLE, SIZE, OR COLOR.

PRIORITY CLAIMED UNDER SEC. 44(D) ON CANADA APPLICATION NO. 1308708, FILED 7-11-2006, REG. NO. TMA744025, DATED 7-24-2009, EXPIRES 7-24-2024.

FOR DEPILATORY WAXES, GELS FOR SKIN CARE, HYDRATING GELS, BIOLOGICAL CREAMS FOR THE BODY AND DEPILATORY BIOLOGICAL CREAMS, OILS FOR THE BODY, HAND AND FEET LOTIONS WITH GERMICIDAL PROPERTIES (U.S. CLS. 1, 4, 6, 50, 51 AND 52).

FIRST USE 9-0-1990; IN COMMERCE 0-0-2003.

CLASS 3—(Continued).

3,807,426. KONSTANTINE BAKALIS, BROOKLYN, NY. SN 77-066,585. PUB. 7-17-2007, FILED 12-18-2006.

KONSTANTINE

THE MARK CONSISTS OF STANDARD CHARACTERS WITHOUT CLAIM TO ANY PARTICULAR FONT, STYLE, SIZE, OR COLOR.

FOR COLOGNE; PERFUME (U.S. CLS. 1, 4, 6, 50, 51 AND 52).

FIRST USE 4-15-2010; IN COMMERCE 4-15-2010.

3,807,448. BURWELL INDUSTRIES, INC., ENGLEWOOD, CO. SN 77-130,159. PUB. 7-31-2007, FILED 3-13-2007.

AQUARELLES

THE MARK CONSISTS OF STANDARD CHARACTERS WITHOUT CLAIM TO ANY PARTICULAR FONT, STYLE, SIZE, OR COLOR.

THE FOREIGN WORDING IN THE MARK TRANSLATES INTO ENGLISH AS "WATERCOLORS".

FOR BATH SALTS; BODY LOTION; BODY SPRAYS; BODY WASHES; BUBBLE BATH; HAND LOTIONS; PERFUME (U.S. CLS. 1, 4, 6, 50, 51 AND 52).

FIRST USE 1-5-2010; IN COMMERCE 1-5-2010.

3,807,487. WILLIAMSON, CYNTHIA, WASHINGTON, CT. SN 77-256,139. PUB. 2-12-2008, FILED 8-15-2007.

JUJU

THE MARK CONSISTS OF STANDARD CHARACTERS WITHOUT CLAIM TO ANY PARTICULAR FONT, STYLE, SIZE, OR COLOR.

FOR BODY AND BEAUTY CARE COSMETICS; COSMETIC CREAMS; COSMETIC CREAMS FOR SKIN CARE; COSMETICS; FACE CREAMS FOR COSMETIC USE; SKIN AND BODY TOPICAL LOTIONS, CREAMS AND OILS FOR COSMETIC USE; TONERS; TOPICAL SKIN SPRAYS FOR COSMETIC PURPOSES; COSMETIC SOAPS; SOAPS (U.S. CLS. 1, 4, 6, 50, 51 AND 52).

FIRST USE 1-1-2007; IN COMMERCE 5-1-2007.

CLASS 3—(Continued).

3,807,530. ACTIVE ORGANICS, LP, LEWISVILLE, TX. SN 77-348,733. PUB. 5-6-2008, FILED 12-11-2007.

ACTIPIXEL

THE MARK CONSISTS OF STANDARD CHARACTERS WITHOUT CLAIM TO ANY PARTICULAR FONT, STYLE, SIZE, OR COLOR.

FOR NON-MEDICATED SKINCARE PREPARATIONS FOR TOPICAL APPLICATION TO THE FACE AND BODY, NAMELY, CREAMS, LOTIONS, GELS, SERUMS AND SPRAYS (U.S. CLS. 1, 4, 6, 50, 51 AND 52).

FIRST USE 4-26-2010; IN COMMERCE 4-26-2010.

3,807,532. ZZY INC, MIAMI, FL. SN 77-350,296. PUB. 5-6-2008, FILED 12-12-2007.

C.E.O.

THE MARK CONSISTS OF STANDARD CHARACTERS WITHOUT CLAIM TO ANY PARTICULAR FONT, STYLE, SIZE, OR COLOR.

FOR COLOGNES, PERFUMES AND COSMETICS; EAU DE COLOGNE; EAU DE PERFUME; EAU DE TOILETTE (U.S. CLS. 1, 4, 6, 50, 51 AND 52).

FIRST USE 6-5-2009; IN COMMERCE 2-15-2010.

3,807,549. LIFETHERAPY, L.L.C., ADDISON, IL. SN 77-394,604. PUB. 7-22-2008, FILED 2-12-2008.

CHOOSE YOUR MOOD

THE MARK CONSISTS OF STANDARD CHARACTERS WITHOUT CLAIM TO ANY PARTICULAR FONT, STYLE, SIZE, OR COLOR.

FOR BODY OILS, HAND CREAMS AND SCENTED BODY CREAM (U.S. CLS. 1, 4, 6, 50, 51 AND 52).

FIRST USE 2-7-2008; IN COMMERCE 11-13-2008.

CLASS 3—(Continued).

3,807,556. JOHNSON & JOHNSON, NEW BRUNSWICK, NJ. SN 77-405,836. PUB. 1-20-2009, FILED 2-26-2008.

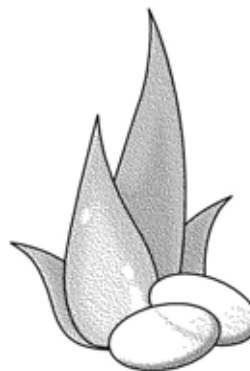

THE STIPPLING IS FOR SHADING PURPOSES ONLY. THE MARK CONSISTS OF AN ALOE PLANT AND TWO VITAMIN E CAPSULES.

FOR TOILETRIES, NAMELY, BODY LOTION (U.S. CLS. 1, 4, 6, 50, 51 AND 52).

FIRST USE 12-31-2007; IN COMMERCE 12-31-2007.

3,807,761. CHUO BUSSAN INTERNATIONAL CO., LTD., TOKYO 107-0062, JAPAN. SN 77-566,907. PUB. 7-21-2009, FILED 9-10-2008.



THE MARK CONSISTS OF THE WORDING "DEONATULLE" IN A STYLIZED FONT WITH THE LETTER "N" SET OFF IN A DISTINCT STYLIZED FONT. THE DESIGN ELEMENT CONSISTS OF A STYLIZED MOUNTAIN LANDSCAPE.

FOR ANTIPERSPIRANTS; NON-MEDICATED TOILETRIES; COSMETICS; ANTIPERSPIRANT CREAMS; COSMETIC CREAMS; ANTIPERSPIRANT LOTIONS; DEODORANTS FOR PERSONAL USE; REMEDIES FOR FOOT PERSPIRATION AND PERSPIRATION, NAMELY, ALUM STONES WITH STERILIZING PROPERTIES FOR PERSONAL COSMETIC USE (U.S. CLS. 1, 4, 6, 50, 51 AND 52).

FIRST USE 5-1-2009; IN COMMERCE 5-1-2009.

CLASS 3—(Continued).

3,807,767. CHUO BUSSAN INTERNATIONAL CO., LTD., TOKYO, JAPAN. SN 77-567,934. PUB. 7-7-2009, FILED 9-11-2008.

SARA SARA CREAM

THE MARK CONSISTS OF STANDARD CHARACTERS WITHOUT CLAIM TO ANY PARTICULAR FONT, STYLE, SIZE, OR COLOR.

NO CLAIM IS MADE TO THE EXCLUSIVE RIGHT TO USE "CREAM", APART FROM THE MARK AS SHOWN.

FOR ANTIPERSPIRANTS; NON-MEDICATED TOILETRIES; COSMETICS; ANTIPERSPIRANT CREAMS; COSMETIC CREAMS; ANTIPERSPIRANT LOTIONS; DEODORANTS FOR PERSONAL USE; REMEDIES FOR FOOT PERSPIRATION AND PERSPIRATION, NAMELY, ALUM STONES WITH STERILIZING PROPERTIES FOR PERSONAL COSMETIC USE (U.S. CLS. 1, 4, 6, 50, 51 AND 52).

FIRST USE 5-1-2009; IN COMMERCE 5-1-2009.

3,807,781. VELOWIPES, INC., VIENNA, VA. SN 77-571,697. PUB. 2-10-2009, FILED 9-17-2008.



The logo for VeloShine features the word "VeloShine" in a bold, italicized, sans-serif font. A stylized leaf or flame-like shape is positioned above the "e" in "Shine", extending to the right and curving upwards.

THE MARK CONSISTS OF "VELOSHINE" WITH A LEAF ABUTTING THE "I".

FOR CLEANERS FOR MOTORCYCLE AND BICYCLE PARTS (U.S. CLS. 1, 4, 6, 50, 51 AND 52).

FIRST USE 4-15-2010; IN COMMERCE 4-15-2010.

3,807,785. GIORGIO ARMANI S.P.A., MILAN, SWISS BRANCH MENDRISIO, MENDRISIO, SWITZERLAND. SN 77-572,531. PUB. 5-26-2009, FILED 9-17-2008.

EYE MASTER

THE MARK CONSISTS OF STANDARD CHARACTERS WITHOUT CLAIM TO ANY PARTICULAR FONT, STYLE, SIZE, OR COLOR.

PRIORITY CLAIMED UNDER SEC. 44(D) ON SWITZERLAND APPLICATION NO. 57721/2008, FILED 6-18-2008, REG. NO. 580491, DATED 12-15-2008, EXPIRES 6-18-2018.

CLASS 3—(Continued).

NO CLAIM IS MADE TO THE EXCLUSIVE RIGHT TO USE "EYE", APART FROM THE MARK AS SHOWN.

FOR COSMETICS, NAMELY, CREAMS, MILKS, LOTIONS, GELS AND POWDERS FOR THE FACE; MAKE-UP PREPARATIONS (U.S. CLS. 1, 4, 6, 50, 51 AND 52).

FIRST USE 3-0-2008; IN COMMERCE 3-0-2008.

3,807,912. COLGATE-PALMOLIVE COMPANY, NEW YORK, NY. SN 77-646,806. PUB. 3-31-2009, FILED 1-9-2009.

FABULOSO OXY

THE MARK CONSISTS OF STANDARD CHARACTERS WITHOUT CLAIM TO ANY PARTICULAR FONT, STYLE, SIZE, OR COLOR.

OWNER OF U.S. REG. NOS. 1,412,859 AND 2,898,018.

THE ENGLISH TRANSLATION OF "FABULOSO" IN THE MARK IS "FABULOUS".

FOR ALL-PURPOSE CLEANER (U.S. CLS. 1, 4, 6, 50, 51 AND 52).

FIRST USE 7-27-2009; IN COMMERCE 7-27-2009.

3,807,929. THE ESTHETICIANS GARDEN, DBA TERRA DOLCE SOAP, MIAMI SHORES, FL. SN 77-654,827. PUB. 6-9-2009, FILED 1-22-2009.



The logo for Terra Dolce features the words "TERRA DOLCE" in a bold, serif font. A small green leafy branch is positioned between the two words. Below this, the words "The Estheticians Garden" are written in a smaller, italicized, serif font.

THE COLOR(S) BLACK AND FOREST GREEN IS/ARE CLAIMED AS A FEATURE OF THE MARK.

THE MARK CONSISTS OF THE STYLIZED WORDING "TERRA DOLCE" IN BLACK. THERE IS A FOREST GREEN BRANCH WITH LEAVES BETWEEN THE TWO WORDS. BELOW THAT WORDING AND DESIGN IS A BLACK HORIZONTAL LINE. BELOW THE HORIZONTAL LINE IS THE STYLIZED WORDING "THE ESTHETICIANS GARDEN" IN THE COLOR BLACK.

THE ENGLISH TRANSLATION OF "TERRA DOLCE" IN THE MARK IS "SWEET EARTH".

FOR AROMATHERAPY BODY CARE PRODUCTS, NAMELY, BODY LOTION, NON-MEDICATED LIP BALM, SOAP, BODY SCRUB; COSMETIC CREAMS FOR SKIN CARE; COSMETIC PREPARATIONS FOR BODY CARE (U.S. CLS. 1, 4, 6, 50, 51 AND 52).

FIRST USE 1-1-2009; IN COMMERCE 4-1-2009.

CLASS 3—(Continued).

3,807,953. UNILEVER SUPPLY CHAIN, INC., CLINTON, CT. SN 77-669,988. PUB. 7-21-2009, FILED 2-13-2009.

VASELINE SHEER INFUSION

THE MARK CONSISTS OF STANDARD CHARACTERS WITHOUT CLAIM TO ANY PARTICULAR FONT, STYLE, SIZE, OR COLOR.

OWNER OF U.S. REG. NOS. 140,345, 319,120, AND OTHERS.

FOR NON-MEDICATED SKIN CARE PREPARATIONS, NAMELY, OILS, CREAMS AND LOTIONS FOR THE SKIN (U.S. CLS. 1, 4, 6, 50, 51 AND 52).

FIRST USE 8-0-2009; IN COMMERCE 8-0-2009.

CLASS 3—(Continued).

3,808,000. BARE ESSENTUALS BEAUTY, INC., SAN FRANCISCO, CA. SN 77-683,444. PUB. 6-30-2009, FILED 3-4-2009.

CLICK, LOCK, GO

THE MARK CONSISTS OF STANDARD CHARACTERS WITHOUT CLAIM TO ANY PARTICULAR FONT, STYLE, SIZE, OR COLOR.

FOR COSMETIC APPLICATORS SOLD AS AN INTEGRAL COMPONENT OF COSMETIC POWDERS FOR THE FACE, BODY, SKIN, AND EYES (U.S. CLS. 1, 4, 6, 50, 51 AND 52).

FIRST USE 9-0-2009; IN COMMERCE 9-0-2009.

3,807,968. UNILEVER SUPPLY CHAIN, INC., CLINTON, CT. SN 77-674,428. PUB. 6-2-2009, FILED 2-20-2009.

WHIPPED SOUFFLÉ

THE MARK CONSISTS OF STANDARD CHARACTERS WITHOUT CLAIM TO ANY PARTICULAR FONT, STYLE, SIZE, OR COLOR.

FOR BODY WASH (U.S. CLS. 1, 4, 6, 50, 51 AND 52).

FIRST USE 2-0-2010; IN COMMERCE 2-0-2010.

3,808,001. BARE ESSENTUALS BEAUTY, INC., SAN FRANCISCO, CA. SN 77-683,456. PUB. 6-30-2009, FILED 3-4-2009.

BABES ABOUT TOWN

THE MARK CONSISTS OF STANDARD CHARACTERS WITHOUT CLAIM TO ANY PARTICULAR FONT, STYLE, SIZE, OR COLOR.

FOR COSMETICS (U.S. CLS. 1, 4, 6, 50, 51 AND 52).

FIRST USE 10-0-2009; IN COMMERCE 10-0-2009.

3,807,991. CONOPCO, INC., ENGLEWOOD CLIFFS, NJ. SN 77-681,749. PUB. 7-21-2009, FILED 3-2-2009.

SUAVE NATURALS

THE MARK CONSISTS OF STANDARD CHARACTERS WITHOUT CLAIM TO ANY PARTICULAR FONT, STYLE, SIZE, OR COLOR.

OWNER OF U.S. REG. NOS. 2,787,388 AND 2,815,606.

NO CLAIM IS MADE TO THE EXCLUSIVE RIGHT TO USE "NATURALS", APART FROM THE MARK AS SHOWN.

FOR HAIR CARE PRODUCTS, NAMELY, SHAMPOO AND CONDITIONER (U.S. CLS. 1, 4, 6, 50, 51 AND 52).

FIRST USE 0-0-2003; IN COMMERCE 0-0-2003.

3,808,007. YIWU CITY WENDY COSMETICS CO., LTD., YIWU, ZHEJIANG, CHINA. SN 77-685,795. PUB. 7-7-2009, FILED 3-6-2009.

PHIDIAS

THE MARK CONSISTS OF THE WORD "PHIDIAS" WITH A STYLIZED "P".

FOR COSMETICS AND COSMETIC PREPARATIONS; NON-MEDICAL SKIN CARE PREPARATIONS; HAIR CARE PREPARATIONS (U.S. CLS. 1, 4, 6, 50, 51 AND 52).

FIRST USE 4-12-2009; IN COMMERCE 4-12-2009.

CLASS 3—(Continued).

3,808,058. BOOTS RETAIL HOLDINGS (USA) INC., STAMFORD, CT. SN 77-695,530. PUB. 7-28-2009, FILED 3-20-2009.

No 7 WILD VOLUME

THE MARK CONSISTS OF STANDARD CHARACTERS WITHOUT CLAIM TO ANY PARTICULAR FONT, STYLE, SIZE, OR COLOR.

OWNER OF U.S. REG. NOS. 2,929,889, 3,108,067, AND 3,160,336.

NO CLAIM IS MADE TO THE EXCLUSIVE RIGHT TO USE "VOLUME", APART FROM THE MARK AS SHOWN.

FOR COSMETICS, NAMELY, LIPSTICKS, LIP LINERS, LIP GLOSSES, LIP BALMS (U.S. CLS. 1, 4, 6, 50, 51 AND 52).

FIRST USE 7-0-2009; IN COMMERCE 3-7-2010.

3,808,085. THE EVERCARE COMPANY, ALPHARETTA, GA. SN 77-698,828. PUB. 8-25-2009, FILED 3-25-2009.

DRYEL ON THE GO

THE MARK CONSISTS OF STANDARD CHARACTERS WITHOUT CLAIM TO ANY PARTICULAR FONT, STYLE, SIZE, OR COLOR.

OWNER OF U.S. REG. NOS. 2,186,197 AND 3,615,752.

FOR STAIN REMOVERS (U.S. CLS. 1, 4, 6, 50, 51 AND 52).

FIRST USE 8-31-2009; IN COMMERCE 8-31-2009.

3,808,157. THE ERWYN GROUP, MORGANVILLE, NJ. SN 77-709,060. PUB. 8-4-2009, FILED 4-7-2009.

MY EARTH

THE MARK CONSISTS OF STANDARD CHARACTERS WITHOUT CLAIM TO ANY PARTICULAR FONT, STYLE, SIZE, OR COLOR.

FOR SHAMPOO, CONDITIONER, SHOWER GEL, BODY SOAP, BODY LOTION (U.S. CLS. 1, 4, 6, 50, 51 AND 52).

FIRST USE 4-2-2009; IN COMMERCE 11-8-2009.

CLASS 3—(Continued).

3,808,167. SOAP & GLORY LIMITED, LONDON, UNITED KINGDOM. SN 77-710,266. PUB. 7-28-2009, FILED 4-9-2009.

SCRUB 'EM AND LEAVE 'EM

THE MARK CONSISTS OF STANDARD CHARACTERS WITHOUT CLAIM TO ANY PARTICULAR FONT, STYLE, SIZE, OR COLOR.

FOR COSMETIC PREPARATIONS FOR EXFOLIATING THE SKIN, BODY SCRUBS (U.S. CLS. 1, 4, 6, 50, 51 AND 52).

FIRST USE 2-15-2010; IN COMMERCE 2-15-2010.

3,808,172. BATH & BODY WORKS BRAND MANAGEMENT, INC., REYNOLDSBURG, OH. SN 77-711,746. PUB. 8-18-2009, FILED 4-10-2009.

WINTER WHITE FRESH

THE MARK CONSISTS OF STANDARD CHARACTERS WITHOUT CLAIM TO ANY PARTICULAR FONT, STYLE, SIZE, OR COLOR.

FOR PERSONAL CARE PRODUCTS, NAMELY, BODY LOTION, BODY SPLASH, BODY WASH, BODY SHIMMER CREAM AND EAU DE TOILETTE (U.S. CLS. 1, 4, 6, 50, 51 AND 52).

FIRST USE 11-0-2009; IN COMMERCE 11-0-2009.

3,808,173. BATH & BODY WORKS BRAND MANAGEMENT, INC., REYNOLDSBURG, OH. SN 77-711,748. PUB. 8-18-2009, FILED 4-10-2009.

WINTER WHITE FLORAL

THE MARK CONSISTS OF STANDARD CHARACTERS WITHOUT CLAIM TO ANY PARTICULAR FONT, STYLE, SIZE, OR COLOR.

FOR PERSONAL CARE PRODUCTS, NAMELY, BODY LOTION, BODY SPLASH, BODY WASH, BODY SHIMMER CREAM AND EAU DE TOILETTE (U.S. CLS. 1, 4, 6, 50, 51 AND 52).

FIRST USE 11-0-2009; IN COMMERCE 11-0-2009.

CLASS 3—(Continued).

3,808,185. PROCTER & GAMBLE COMPANY, THE, CINCINNATI, OH. SN 77-713,209. PUB. 8-4-2009, FILED 4-14-2009.

FLAWLESS RENEWAL

THE MARK CONSISTS OF STANDARD CHARACTERS WITHOUT CLAIM TO ANY PARTICULAR FONT, STYLE, SIZE, OR COLOR.

OWNER OF U.S. REG. NOS. 2,762,897 AND 3,551,255. FOR ANTIPERSPIRANTS AND DEODORANTS FOR PERSONAL USE (U.S. CLS. 1, 4, 6, 50, 51 AND 52). FIRST USE 8-31-2009; IN COMMERCE 8-31-2009.

3,808,186. MOMENTUM SALES & MARKETING, INC., TAMPA, FL. SN 77-713,351. PUB. 8-11-2009, FILED 4-14-2009.

AMP YOUR SMILE

THE MARK CONSISTS OF STANDARD CHARACTERS WITHOUT CLAIM TO ANY PARTICULAR FONT, STYLE, SIZE, OR COLOR.

FOR COSMETIC TEETH WHITENING KIT (U.S. CLS. 1, 4, 6, 50, 51 AND 52). FIRST USE 4-11-2010; IN COMMERCE 4-11-2010.

3,808,255. THE GILLETTE COMPANY, BOSTON, MA. SN 77-729,460. PUB. 9-15-2009, FILED 5-5-2009.

ALL DAY CLEAN

THE MARK CONSISTS OF STANDARD CHARACTERS WITHOUT CLAIM TO ANY PARTICULAR FONT, STYLE, SIZE, OR COLOR.

NO CLAIM IS MADE TO THE EXCLUSIVE RIGHT TO USE "CLEAN", APART FROM THE MARK AS SHOWN.

FOR ANTI-PERSPIRANTS AND DEODORANTS FOR PERSONAL USE; BODY WASH (U.S. CLS. 1, 4, 6, 50, 51 AND 52).

FIRST USE 1-4-2010; IN COMMERCE 1-4-2010.

CLASS 3—(Continued).

3,808,272. TUPPERWARE PRODUCTS S.A., FRIBOURG CH-1700, SWITZERLAND. SN 77-732,221. PUB. 8-25-2009, FILED 5-8-2009.

CRYSTASH

THE MARK CONSISTS OF STANDARD CHARACTERS WITHOUT CLAIM TO ANY PARTICULAR FONT, STYLE, SIZE, OR COLOR.

FOR PERFUMERY (U.S. CLS. 1, 4, 6, 50, 51 AND 52). FIRST USE 12-3-2009; IN COMMERCE 12-3-2009.

3,808,273. DESIGNER SKIN, LLC, INDIANAPOLIS, IN. SN 77-733,864. PUB. 8-4-2009, FILED 5-11-2009.

SINFULLY BLACK

THE MARK CONSISTS OF STANDARD CHARACTERS WITHOUT CLAIM TO ANY PARTICULAR FONT, STYLE, SIZE, OR COLOR.

FOR NON-MEDICATED INDOOR AND OUTDOOR SKIN TANNING PREPARATIONS (U.S. CLS. 1, 4, 6, 50, 51 AND 52).

FIRST USE 11-1-2009; IN COMMERCE 11-1-2009.

3,808,373. LJC CUTS FOR KIDS II INC., ROSLYN HEIGHTS, NY. SN 77-770,361. PUB. 11-17-2009, FILED 6-29-2009.

Zippity Doo's

THE MARK CONSISTS OF THE WORD "ZIPPITY DOO'S" WITH A COMB REPRESENTING THE "I'S", A SCISSOR REPRESENTING THE "Y" AND TWO FACES REPRESENTING THE "O'S".

FOR HAIR CARE PRODUCTS, NAMELY, SHAMPOO, CONDITIONER, STYLING GEL, SHIELD SPRAY AND DETANGLER (U.S. CLS. 1, 4, 6, 50, 51 AND 52).

FIRST USE 7-1-2009; IN COMMERCE 7-1-2009.

CLASS 3—(Continued).

3,808,374. LJC CUTS FOR KIDS II INC., ROSLYN HEIGHTS, NY. SN 77-770,369. PUB. 11-17-2009, FILED 6-29-2009.

ZIPPITY DOO'S

THE MARK CONSISTS OF STANDARD CHARACTERS WITHOUT CLAIM TO ANY PARTICULAR FONT, STYLE, SIZE, OR COLOR.

FOR HAIR CARE PRODUCTS, NAMELY, SHAMPOO, CONDITIONER, STYLING GEL, SHIELD SPRAY AND DETANGLER (U.S. CLS. 1, 4, 6, 50, 51 AND 52).

FIRST USE 7-1-2009; IN COMMERCE 7-1-2009.

CLASS 3—(Continued).

3,808,442. WHIP-MIX CORPORATION, LOUISVILLE, KY. SN 77-798,297. PUB. 1-19-2010, FILED 8-6-2009.

GREEN ENVY

THE MARK CONSISTS OF STANDARD CHARACTERS WITHOUT CLAIM TO ANY PARTICULAR FONT, STYLE, SIZE, OR COLOR.

NO CLAIM IS MADE TO THE EXCLUSIVE RIGHT TO USE "GREEN", APART FROM THE MARK AS SHOWN.

FOR CLEANING PREPARATIONS FOR CLEANING DENTAL IMPRESSION TRAYS (U.S. CLS. 1, 4, 6, 50, 51 AND 52).

FIRST USE 3-18-2010; IN COMMERCE 3-18-2010.

3,808,433. GHCH LLC, DBA HULA PLEASURES, HONOLULU, HI. SN 77-795,079. PUB. 12-29-2009, FILED 8-2-2009.

HULA PLEASURES

THE MARK CONSISTS OF STANDARD CHARACTERS WITHOUT CLAIM TO ANY PARTICULAR FONT, STYLE, SIZE, OR COLOR.

FOR NON-MEDICATED TOILETRIES (U.S. CLS. 1, 4, 6, 50, 51 AND 52).

FIRST USE 4-1-2010; IN COMMERCE 4-1-2010.

3,808,522. L'OREAL, PARIS, FRANCE. SN 77-979,380. PUB. 9-22-2009, FILED 5-11-2009.

THE SCRUBLET

THE MARK CONSISTS OF STANDARD CHARACTERS WITHOUT CLAIM TO ANY PARTICULAR FONT, STYLE, SIZE, OR COLOR.

FOR FACIAL CLEANSING PAD SOLD AS A UNIT WITH FACIAL CLEANSER (U.S. CLS. 1, 4, 6, 50, 51 AND 52).

FIRST USE 12-0-2009; IN COMMERCE 12-0-2009.

3,808,441. INTERQUANTUM, LLC, ENCINO, CA. SN 77-798,197. PUB. 1-12-2010, FILED 8-5-2009.

**FRESH BREATH FROM THE
OUTSIDE IN**

THE MARK CONSISTS OF STANDARD CHARACTERS WITHOUT CLAIM TO ANY PARTICULAR FONT, STYLE, SIZE, OR COLOR.

NO CLAIM IS MADE TO THE EXCLUSIVE RIGHT TO USE "FRESH BREATH", APART FROM THE MARK AS SHOWN.

FOR NON-MEDICATED BREATH FRESHENING PREPARATIONS, NAMELY, BREATH FRESHENING COATED CAPSULES; BREATH FRESHENERS; BREATH MINTS (U.S. CLS. 1, 4, 6, 50, 51 AND 52).

FIRST USE 10-5-2009; IN COMMERCE 10-5-2009.

3,808,534. GUMP'S CORP., SAN FRANCISCO, CA. SN 77-979,450. PUB. 8-4-2009, FILED 11-11-2008.

BAROQUE PEARL

THE MARK CONSISTS OF STANDARD CHARACTERS WITHOUT CLAIM TO ANY PARTICULAR FONT, STYLE, SIZE, OR COLOR.

FOR COSMETICS; COSMETIC PREPARATIONS FOR BODY CARE (U.S. CLS. 1, 4, 6, 50, 51 AND 52).

FIRST USE 3-12-2009; IN COMMERCE 3-24-2009.

CLASS 3—(Continued).

3,808,540. KINESYS PHARMACEUTICAL INC., RICHMOND, CANADA. SN 77-979,478. PUB. 7-14-2009, FILED 9-18-2008.

EARTHKIND BY KINESYS

THE MARK CONSISTS OF STANDARD CHARACTERS WITHOUT CLAIM TO ANY PARTICULAR FONT, STYLE, SIZE, OR COLOR.

OWNER OF U.S. REG. NOS. 2,008,906, 2,532,817, AND 2,532,818.

FOR SKIN AND BODY CARE PRODUCTS, NAMELY, SUNSCREENS (U.S. CLS. 1, 4, 6, 50, 51 AND 52).

FIRST USE 3-31-2010; IN COMMERCE 3-31-2010.

3,808,550. MINARDI BEAUTY PRODUCTS, INC., NEW YORK, NY. SN 77-979,553. PUB. 8-11-2009, FILED 4-13-2009.

SMART LUXURY

THE MARK CONSISTS OF STANDARD CHARACTERS WITHOUT CLAIM TO ANY PARTICULAR FONT, STYLE, SIZE, OR COLOR.

FOR HAIR CARE PREPARATIONS (U.S. CLS. 1, 4, 6, 50, 51 AND 52).

FIRST USE 1-10-2009; IN COMMERCE 4-5-2009.

3,808,619. RETAIL ROYALTY COMPANY, LAS VEGAS, NV. SN 78-959,513. PUB. 8-21-2007, FILED 8-24-2006.



THE MARK CONSISTS OF A STYLIZED FLYING BIRD. FOR PERSONAL CARE PRODUCTS AND COSMETICS, NAMELY, SHAVING CREAM, FACIAL SCRUBS, SUN SCREEN PREPARATIONS (U.S. CLS. 1, 4, 6, 50, 51 AND 52).

FIRST USE 11-15-2009; IN COMMERCE 11-15-2009.

CLASS 4—LUBRICANTS AND FUELS

3,808,082. ROBERTS, CANDICE, AUSTIN, TX. SN 77-698,614. PUB. 7-21-2009, FILED 3-25-2009.

EVO LUXE

THE MARK CONSISTS OF STANDARD CHARACTERS WITHOUT CLAIM TO ANY PARTICULAR FONT, STYLE, SIZE, OR COLOR.

FOR SCENTED CANDLES (U.S. CLS. 1, 6 AND 15).

FIRST USE 1-1-2010; IN COMMERCE 2-10-2010.

CLASS 5—PHARMACEUTICALS

3,807,419. CPEX PHARMACEUTICALS, INC., EXETER, NH. SN 77-054,463. PUB. 10-9-2007, FILED 11-30-2006.

NASULIN

THE MARK CONSISTS OF STANDARD CHARACTERS WITHOUT CLAIM TO ANY PARTICULAR FONT, STYLE, SIZE, OR COLOR.

FOR PHARMACEUTICAL PREPARATIONS FOR TREATING DIABETES (U.S. CLS. 6, 18, 44, 46, 51 AND 52).

FIRST USE 2-28-2009; IN COMMERCE 2-28-2009.

3,807,428. SUNESIS PHARMACEUTICALS, INC., SOUTH SAN FRANCISCO, CA. SN 77-070,754. PUB. 7-24-2007, FILED 12-22-2006.

CELADYN

THE MARK CONSISTS OF STANDARD CHARACTERS WITHOUT CLAIM TO ANY PARTICULAR FONT, STYLE, SIZE, OR COLOR.

FOR PHARMACEUTICAL PREPARATIONS FOR THE TREATMENT OF TUMORS AND CANCER (U.S. CLS. 6, 18, 44, 46, 51 AND 52).

FIRST USE 3-15-2010; IN COMMERCE 3-15-2010.

CLASS 5—(Continued).

3,807,429. SUNESIS PHARMACEUTICALS, INC., SOUTH SAN FRANCISCO, CA. SN 77-070,805. PUB. 7-24-2007, FILED 12-22-2006.

REPLIVEL

THE MARK CONSISTS OF STANDARD CHARACTERS WITHOUT CLAIM TO ANY PARTICULAR FONT, STYLE, SIZE, OR COLOR.

FOR PHARMACEUTICAL PREPARATIONS FOR THE TREATMENT OF TUMORS AND CANCER (U.S. CLS. 6, 18, 44, 46, 51 AND 52).

FIRST USE 3-15-2010; IN COMMERCE 3-15-2010.

3,807,469. GRAYPEL, ERNEST A., ST. LOUIS, MO. SN 77-210,999. PUB. 1-22-2008, FILED 6-20-2007.

PSORILIMINATOR

THE MARK CONSISTS OF STANDARD CHARACTERS WITHOUT CLAIM TO ANY PARTICULAR FONT, STYLE, SIZE, OR COLOR.

FOR MEDICATED CAUSTIC PENCILS FOR THE ELIMINATION OF PSORIATIC LESIONS (U.S. CLS. 6, 18, 44, 46, 51 AND 52).

FIRST USE 4-27-2010; IN COMMERCE 4-27-2010.

3,807,525. BELLA BABY FOODS INC., PORT WASHINGTON, NY. SN 77-335,019. PUB. 12-9-2008, FILED 11-21-2007.

BELLA BABY

THE MARK CONSISTS OF STANDARD CHARACTERS WITHOUT CLAIM TO ANY PARTICULAR FONT, STYLE, SIZE, OR COLOR.

NO CLAIM IS MADE TO THE EXCLUSIVE RIGHT TO USE "BABY FOODS", APART FROM THE MARK AS SHOWN.

THE NAME(S), PORTRAIT(S), AND/OR SIGNATURE(S) SHOWN IN THE MARK IDENTIFIES "BELLA" O'DONNELL, WHOSE CONSENT(S) TO REGISTER IS SUBMITTED.

FOR BABY FOOD (U.S. CLS. 6, 18, 44, 46, 51 AND 52). FIRST USE 8-1-2008; IN COMMERCE 8-1-2008.

CLASS 5—(Continued).

3,807,527. BALTIMOREANIMAL MEDICINE INCORPORATED, BALTIMORE, MD. SN 77-343,093. PUB. 5-20-2008, FILED 12-3-2007.

bamvet

THE MARK CONSISTS OF STANDARD CHARACTERS WITHOUT CLAIM TO ANY PARTICULAR FONT, STYLE, SIZE, OR COLOR.

FOR DRUG DELIVERY AGENTS CONSISTING OF COMPOUNDS THAT FACILITATE DELIVERY OF A WIDE RANGE OF PHARMACEUTICALS; PHARMACEUTICAL PREPARATIONS FOR THE PREVENTION AND TREATMENT OF DISORDERS OF THE NERVOUS SYSTEM, THE IMMUNE SYSTEM, THE CARDIO-VASCULAR SYSTEM, THE METABOLIC SYSTEM, THE RESPIRATORY SYSTEM, THE MUSCULO-SKELETAL SYSTEM, THE GENITOURINARY SYSTEM, FOR THE TREATMENT OF INFLAMMATORY DISORDERS, FOR USE IN DERMATOLOGY, ONCOLOGY, HEMATOLOGY AND IN TISSUE AND ORGAN TRANSPLANTATION, IN OPHTHALMOLOGY AND FOR GASTROENTEROLOGICAL DISORDERS (U.S. CLS. 6, 18, 44, 46, 51 AND 52).

FIRST USE 3-5-2010; IN COMMERCE 3-5-2010.

3,807,547. PHENOMIX CORPORATION, SAN DIEGO, CA. SN 77-390,935. PUB. 9-16-2008, FILED 2-7-2008.

PHENOMIX

THE MARK CONSISTS OF STANDARD CHARACTERS WITHOUT CLAIM TO ANY PARTICULAR FONT, STYLE, SIZE, OR COLOR.

FOR PHARMACEUTICALS, NAMELY, PHARMACEUTICALS FOR THE TREATMENT OF METABOLIC DISORDERS, INFECTIOUS DISEASES, AND CANCER (U.S. CLS. 6, 18, 44, 46, 51 AND 52).

FIRST USE 8-25-2008; IN COMMERCE 9-3-2009.

3,807,581. JOHNSON & JOHNSON, NEW BRUNSWICK, NJ. SN 77-429,229. PUB. 8-5-2008, FILED 3-24-2008.

REAL WHITENING. REAL EASY.

THE MARK CONSISTS OF STANDARD CHARACTERS WITHOUT CLAIM TO ANY PARTICULAR FONT, STYLE, SIZE, OR COLOR.

FOR MEDICATED MOUTH RINSE (U.S. CLS. 6, 18, 44, 46, 51 AND 52).

FIRST USE 3-31-2010; IN COMMERCE 3-31-2010.

CLASS 5—(Continued).

3,807,627. SOLACE INTERNATIONAL INC., RENO, NV. SN 77-468,975. PUB. 10-7-2008, FILED 5-8-2008.

NATURAL BOOST

FIGHT OFF EVERYTHING!

THE MARK CONSISTS OF THE STYLIZED WORDS "NATURAL BOOST FIGHT OFF EVERYTHING!". FOR DIETARY SUPPLEMENTS (U.S. CLS. 6, 18, 44, 46, 51 AND 52). FIRST USE 2-1-2009; IN COMMERCE 3-1-2009.

3,807,634. PROTERA, INC., RENO, NV. SN 77-475,743. PUB. 10-14-2008, FILED 5-15-2008.

VITALACTIV

THE MARK CONSISTS OF STANDARD CHARACTERS WITHOUT CLAIM TO ANY PARTICULAR FONT, STYLE, SIZE, OR COLOR. FOR DIETARY AND NUTRITIONAL SUPPLEMENTS (U.S. CLS. 6, 18, 44, 46, 51 AND 52). FIRST USE 6-13-2008; IN COMMERCE 6-13-2008.

3,807,635. BASF SE, LUDWIGSHAFEN AM RHEIN, FED REP GERMANY. SN 77-476,677. PUB. 1-27-2009, FILED 5-16-2008.

FREQUENCY

THE MARK CONSISTS OF STANDARD CHARACTERS WITHOUT CLAIM TO ANY PARTICULAR FONT, STYLE, SIZE, OR COLOR. FOR PESTICIDES, NAMELY, HERBICIDES (U.S. CLS. 6, 18, 44, 46, 51 AND 52). FIRST USE 8-0-2009; IN COMMERCE 8-0-2009.

CLASS 5—(Continued).

3,807,696. ATLEY PHARMACEUTICALS, INC., ASHLAND, VA. SN 77-541,721. PUB. 3-31-2009, FILED 8-7-2008.

ZONATUSS

THE MARK CONSISTS OF STANDARD CHARACTERS WITHOUT CLAIM TO ANY PARTICULAR FONT, STYLE, SIZE, OR COLOR.

FOR MEDICINES, PHARMACEUTICAL PREPARATIONS FOR THE TREATMENT AND SYMPTOMATIC RELIEF OF RESPIRATORY DISEASE, COUGH AND COLDS (U.S. CLS. 6, 18, 44, 46, 51 AND 52). FIRST USE 3-3-2010; IN COMMERCE 3-3-2010.

3,807,743. ARYSTA LIFESCIENCE NORTH AMERICA, LLC, CARY, NC. SN 77-561,780. PUB. 1-20-2009, FILED 9-3-2008.

OBTAIN

THE MARK CONSISTS OF STANDARD CHARACTERS WITHOUT CLAIM TO ANY PARTICULAR FONT, STYLE, SIZE, OR COLOR.

FOR HERBICIDES FOR AGRICULTURAL USE (U.S. CLS. 6, 18, 44, 46, 51 AND 52). FIRST USE 10-0-2009; IN COMMERCE 10-0-2009.

3,807,745. MCLAUGHLIN GORMLEY KING COMPANY, MINNEAPOLIS, MN. SN 77-562,015. PUB. 1-27-2009, FILED 9-4-2008.



THE COLOR(S) ORANGE AND WHITE IS/ARE CLAIMED AS A FEATURE OF THE MARK.

CLASS 5—(Continued).

THE MARK CONSISTS OF A WHITE FLOWER ON AN ORANGE BACKGROUND.

FOR INSECTICIDES (U.S. CLS. 6, 18, 44, 46, 51 AND 52).

FIRST USE 12-22-2009; IN COMMERCE 12-22-2009.

3,807,746. MCLAUGHLIN GORMLEY KING COMPANY, MINNEAPOLIS, MN. SN 77-562,019. PUB. 1-27-2009, FILED 9-4-2008.

PIRETROS

THE MARK CONSISTS OF STANDARD CHARACTERS WITHOUT CLAIM TO ANY PARTICULAR FONT, STYLE, SIZE, OR COLOR.

FOR INSECTICIDES (U.S. CLS. 6, 18, 44, 46, 51 AND 52).

FIRST USE 12-22-2009; IN COMMERCE 12-22-2009.

3,807,804. CYTOGENIX LABORATORIES SRL, ST. MICHAEL, BARBADOS. SN 77-581,114. PUB. 7-28-2009, FILED 9-29-2008.



CYTOGENIX
LABORATORIES

NO CLAIM IS MADE TO THE EXCLUSIVE RIGHT TO USE "LABORATORIES", APART FROM THE MARK AS SHOWN.

THE MARK CONSISTS OF A SPLIT OCTAGON NEXT TO THE WORDS "CYTOGENIX LABORATORIES".

FOR DIETARY SUPPLEMENTS (U.S. CLS. 6, 18, 44, 46, 51 AND 52).

FIRST USE 7-0-2008; IN COMMERCE 7-0-2008.

3,807,805. CYTOGENIX LABORATORIES SRL, ST. MICHAEL, BARBADOS. SN 77-581,127. PUB. 7-28-2009, FILED 9-29-2008.



CYTOGENIX  **LABORATORIES**

NO CLAIM IS MADE TO THE EXCLUSIVE RIGHT TO USE "LABORATORIES", APART FROM THE MARK AS SHOWN.

THE MARK CONSISTS OF A SPLIT OCTAGON APPEARS BETWEEN THE WORDS "CYTOGENIX LABORATORIES".

FOR DIETARY SUPPLEMENTS (U.S. CLS. 6, 18, 44, 46, 51 AND 52).

FIRST USE 7-0-2008; IN COMMERCE 7-0-2008.

CLASS 5—(Continued).

3,807,827. PROMIUS PHARMA, LLC, BRIDGEWATER, NJ. SN 77-592,267. PUB. 9-22-2009, FILED 10-14-2008.

PROMIUS

THE MARK CONSISTS OF STANDARD CHARACTERS WITHOUT CLAIM TO ANY PARTICULAR FONT, STYLE, SIZE, OR COLOR.

FOR HUMAN CARDIOVASCULAR PHARMACEUTICALS (U.S. CLS. 6, 18, 44, 46, 51 AND 52).

FIRST USE 2-16-2009; IN COMMERCE 2-16-2009.

3,807,830. ARYSTA LIFESCIENCE NORTH AMERICA, LLC, CARY, NC. SN 77-593,533. PUB. 1-20-2009, FILED 10-15-2008.



Obtain

THE MARK CONSISTS OF SINGLE LEAF WITH WAVY STEM.

FOR HERBICIDES FOR AGRICULTURAL USE (U.S. CLS. 6, 18, 44, 46, 51 AND 52).

FIRST USE 10-0-2009; IN COMMERCE 10-0-2009.

3,807,845. MILLIKEN & COMPANY, SPARTANBURG, SC. SN 77-600,836. PUB. 8-11-2009, FILED 10-27-2008.

SELECTCARE

THE MARK CONSISTS OF STANDARD CHARACTERS WITHOUT CLAIM TO ANY PARTICULAR FONT, STYLE, SIZE, OR COLOR.

FOR WOUND DRESSINGS FOR USE IN HOSPITALS (U.S. CLS. 6, 18, 44, 46, 51 AND 52).

FIRST USE 4-26-2009; IN COMMERCE 4-26-2009.

CLASS 5—(Continued).

3,807,859. OSTEOTECH, INC., EATONTOWN, NJ. SN 77-092,205. PUB. 5-19-2009, FILED 11-6-2008.

MAGNIFUSE

THE MARK CONSISTS OF STANDARD CHARACTERS WITHOUT CLAIM TO ANY PARTICULAR FONT, STYLE, SIZE, OR COLOR.

FOR BIOLOGICAL IMPLANTS, NAMELY, BIO-RESORBABLE IMPLANTS COMPRISING MINERALIZED AND DEMINERALIZED BONE TISSUE; ALLOGRAFT MATERIAL, NAMELY, HUMAN TISSUE AND BONE FOR SURGICAL IMPLANTS; BIOLOGICAL IMPLANTS, NAMELY, BIO-RESORBABLE IMPLANTS COMPRISING MINERALIZED AND DEMINERALIZED BONE TISSUE SOLD AS A UNIT WITH A BIO-RESORBABLE DEVICE FOR DELIVERY OF BONE IMPLANTS FOR USE IN SURGICAL PROCEDURES; ALLOGRAFT MATERIAL, NAMELY, HUMAN TISSUE AND BONE FOR SURGICAL IMPLANTS SOLD AS A UNIT WITH A BIO-RESORBABLE DEVICE FOR DELIVERY OF BONE IMPLANTS FOR USE IN SURGICAL PROCEDURES (U.S. CLS. 6, 18, 44, 46, 51 AND 52).

FIRST USE 10-26-2009; IN COMMERCE 10-26-2009.

3,807,922. BATH SOLUTIONS, INC., BENSENVILLE, IL. SN 77-650,439. PUB. 12-1-2009, FILED 1-15-2009.

SPRITZ SCENTS

THE MARK CONSISTS OF STANDARD CHARACTERS WITHOUT CLAIM TO ANY PARTICULAR FONT, STYLE, SIZE, OR COLOR.

NO CLAIM IS MADE TO THE EXCLUSIVE RIGHT TO USE "SCENTS", APART FROM THE MARK AS SHOWN.

FOR AIR FRESHENERS (U.S. CLS. 6, 18, 44, 46, 51 AND 52).

FIRST USE 2-0-2009; IN COMMERCE 2-0-2009.

CLASS 5—(Continued).

3,807,990. TAKEFIVE DIETARY SUPPLEMENTS, LLC, DBA TAKEFIVE, LLC, SEATTLE, WA. SN 77-681,700. PUB. 1-19-2010, FILED 3-2-2009.

TAKEFIVE

THE MARK CONSISTS OF STANDARD CHARACTERS WITHOUT CLAIM TO ANY PARTICULAR FONT, STYLE, SIZE, OR COLOR.

FOR NATURAL DIETARY SUPPLEMENTS (U.S. CLS. 6, 18, 44, 46, 51 AND 52).

FIRST USE 10-22-2009; IN COMMERCE 10-22-2009.

3,808,004. EXPLOREX TECHNOLOGIES INC., MISSISSAUGA, ONTARIO, CANADA. SN 77-684,444. PUB. 9-15-2009, FILED 3-5-2009.

MuscleON

THE MARK CONSISTS OF STANDARD CHARACTERS WITHOUT CLAIM TO ANY PARTICULAR FONT, STYLE, SIZE, OR COLOR.

FOR NUTRITIONAL SUPPLEMENTS; DIETARY SUPPLEMENTS (U.S. CLS. 6, 18, 44, 46, 51 AND 52).

FIRST USE 3-0-2009; IN COMMERCE 3-0-2009.

3,808,176. MANZEN, LLC, LAS VEGAS, NV. SN 77-711,934. PUB. 8-11-2009, FILED 4-10-2009.

XY-MASS

THE MARK CONSISTS OF STANDARD CHARACTERS WITHOUT CLAIM TO ANY PARTICULAR FONT, STYLE, SIZE, OR COLOR.

FOR DIETARY AND NUTRITIONAL SUPPLEMENTS; PROTEIN SUPPLEMENTS; POWDERED NUTRITIONAL SUPPLEMENT DRINK MIX, PROTEIN SHAKES FOR USE AS A DIETARY AND NUTRITIONAL SUPPLEMENT; PROTEIN SHAKES FOR USE AS A MEAL REPLACEMENT; NUTRITIONALLY FORTIFIED BEVERAGES, DIETARY SUPPLEMENTAL DRINKS; VITAMIN FORTIFIED BEVERAGES; MEAL REPLACEMENT AND DIETARY SUPPLEMENT DRINK MIXES; NUTRITIONAL SUPPLEMENT IN THE NATURE OF A NUTRIENT-DENSE, PROTEIN-BASED DRINK MIX; MEAL REPLACEMENT DRINKS (U.S. CLS. 6, 18, 44, 46, 51 AND 52).

FIRST USE 1-8-2010; IN COMMERCE 1-8-2010.

CLASS 5—(Continued).

3,808,192. BIOSAFE SYSTEMS LLC, HARTFORD, CT. SN 77-714,300. PUB. 8-18-2009, FILED 4-15-2009.

CaproDerm

THE MARK CONSISTS OF STANDARD CHARACTERS WITHOUT CLAIM TO ANY PARTICULAR FONT, STYLE, SIZE, OR COLOR.

FOR ANTI-INFECTIVE PRODUCTS FOR VETERINARY USE; VETERINARY PREPARATIONS FOR MASTITIS IN DAIRY CATTLE (U.S. CLS. 6, 18, 44, 46, 51 AND 52).

FIRST USE 6-15-2009; IN COMMERCE 6-15-2009.

CLASS 5—(Continued).

3,808,300. DRS.SOLUTIONS, LLC, GRAND PRAIRIE, TX. SN 77-744,814. PUB. 10-6-2009, FILED 5-26-2009.

MICRODINE

THE MARK CONSISTS OF STANDARD CHARACTERS WITHOUT CLAIM TO ANY PARTICULAR FONT, STYLE, SIZE, OR COLOR.

FOR HAND-SANITIZING PREPARATIONS (U.S. CLS. 6, 18, 44, 46, 51 AND 52).

FIRST USE 5-26-2009; IN COMMERCE 5-26-2009.

3,808,228. NAIDU L.P., POMONA, CA. SN 77-723,512. PUB. 9-15-2009, FILED 4-27-2009.

BIOREP FOR LIFE

THE MARK CONSISTS OF STANDARD CHARACTERS WITHOUT CLAIM TO ANY PARTICULAR FONT, STYLE, SIZE, OR COLOR.

FOR DIETARY SUPPLEMENTS (U.S. CLS. 6, 18, 44, 46, 51 AND 52).

FIRST USE 7-25-2008; IN COMMERCE 7-25-2008.

3,808,301. DRS. SOLUTIONS, LLC, GRAND PRAIRIE, TX. SN 77-744,816. PUB. 10-6-2009, FILED 5-26-2009.

PROVODERM

THE MARK CONSISTS OF STANDARD CHARACTERS WITHOUT CLAIM TO ANY PARTICULAR FONT, STYLE, SIZE, OR COLOR.

FOR HAND-SANITIZING PREPARATIONS (U.S. CLS. 6, 18, 44, 46, 51 AND 52).

FIRST USE 5-26-2009; IN COMMERCE 5-26-2009.

3,808,271. MONAVIE, LLC, SOUTH JORDAN, UT. SN 77-732,117. PUB. 10-6-2009, FILED 5-7-2009.

MonaVie €^{mv}

OWNER OF U.S. REG. NOS. 3,106,146, 3,111,333, AND OTHERS.

THE MARK CONSISTS OF A STYLIZED "MONAVIE" AND A STYLIZED "E" WITH A STYLIZED AND SUPERSCRIPT "MV".

FOR NUTRITIONAL SUPPLEMENTS, VITAMIN AND MINERAL SUPPLEMENTS, NUTRITIONAL ADDITIVES FOR MEDICINAL PURPOSES FOR USE IN FOODS AND DIETARY SUPPLEMENTS FOR HUMAN CONSUMPTION, PLANT AND HERB EXTRACTS FOR MEDICINAL PURPOSES (U.S. CLS. 6, 18, 44, 46, 51 AND 52).

FIRST USE 6-13-2009; IN COMMERCE 6-13-2009.

3,808,315. DRS. SOLUTIONS, LLC, GRAND PRAIRIE, TX. SN 77-750,320. PUB. 10-13-2009, FILED 6-2-2009.

FOR SURGICALLY CLEAN HANDS

THE MARK CONSISTS OF STANDARD CHARACTERS WITHOUT CLAIM TO ANY PARTICULAR FONT, STYLE, SIZE, OR COLOR.

FOR HAND-SANITIZING PREPARATIONS (U.S. CLS. 6, 18, 44, 46, 51 AND 52).

FIRST USE 6-2-2009; IN COMMERCE 6-2-2009.

CLASS 5—(Continued).

3,808,328. DESIGNING HEALTH, INC., VALENCIA, CA. SN 77-755,237. PUB. 11-10-2009, FILED 6-9-2009.

WELL BLEND

THE MARK CONSISTS OF STANDARD CHARACTERS WITHOUT CLAIM TO ANY PARTICULAR FONT, STYLE, SIZE, OR COLOR.

NO CLAIM IS MADE TO THE EXCLUSIVE RIGHT TO USE "BLEND", APART FROM THE MARK AS SHOWN.

FOR DIETARY SUPPLEMENTS AND FOOD SUPPLEMENTS FOR DOMESTIC ANIMALS (U.S. CLS. 6, 18, 44, 46, 51 AND 52).

FIRST USE 7-1-2009; IN COMMERCE 7-1-2009.

CLASS 5—(Continued).

3,808,395. NEPHROCEUTICALS, LLC, DAYTON, OH. SN 77-781,301. PUB. 12-8-2009, FILED 7-15-2009.

PRORENAL VITAL

THE MARK CONSISTS OF STANDARD CHARACTERS WITHOUT CLAIM TO ANY PARTICULAR FONT, STYLE, SIZE, OR COLOR.

FOR NUTRITIONAL SUPPLEMENTS; VITAMIN AND MINERAL SUPPLEMENTS (U.S. CLS. 6, 18, 44, 46, 51 AND 52).

FIRST USE 7-21-2009; IN COMMERCE 7-21-2009.

3,808,329. EHRLICH, PETER D., PAHRUMP, NV. SN 77-755,862. PUB. 10-27-2009, FILED 6-10-2009.

MAGIC DUST

THE MARK CONSISTS OF STANDARD CHARACTERS WITHOUT CLAIM TO ANY PARTICULAR FONT, STYLE, SIZE, OR COLOR.

FOR BANDAGES FOR SKIN WOUNDS (U.S. CLS. 6, 18, 44, 46, 51 AND 52).

FIRST USE 3-19-2010; IN COMMERCE 3-19-2010.

3,808,396. RAINBOW LIGHT NUTRITIONAL SYSTEMS, INC., SANTA CRUZ, CA. SN 77-781,545. PUB. 1-26-2010, FILED 7-15-2009.

COMPLETE CALM

THE MARK CONSISTS OF STANDARD CHARACTERS WITHOUT CLAIM TO ANY PARTICULAR FONT, STYLE, SIZE, OR COLOR.

NO CLAIM IS MADE TO THE EXCLUSIVE RIGHT TO USE "COMPLETE", APART FROM THE MARK AS SHOWN.

FOR DIETARY AND NUTRITIONAL SUPPLEMENTS FOR PETS (U.S. CLS. 6, 18, 44, 46, 51 AND 52).

FIRST USE 10-5-2009; IN COMMERCE 10-5-2009.

3,808,349. DR.'S SOLUTIONS, LLC, GRAND PRAIRIE, TX. SN 77-760,873. PUB. 10-6-2009, FILED 6-16-2009.

MICRODINE

THE MARK CONSISTS OF THE WORD "MICRODINE" IN STYLIZED FONT, AND WITH THE "O" REPLACED BY AN IMAGE OF A SPIRAL/SWIRL.

FOR HAND-SANITIZING PREPARATIONS (U.S. CLS. 6, 18, 44, 46, 51 AND 52).

FIRST USE 6-16-2009; IN COMMERCE 6-16-2009.

3,808,400. SNAKE RIVER NUTRITION LLC, BOISE, ID. SN 77-783,916. PUB. 12-8-2009, FILED 7-17-2009.

NuBetaine

THE MARK CONSISTS OF STANDARD CHARACTERS WITHOUT CLAIM TO ANY PARTICULAR FONT, STYLE, SIZE, OR COLOR.

FOR NUTRITIONAL SUPPLEMENTS PARTICULARLY SUPPLEMENTS CONTAINING BETAINE, ALSO COMMONLY KNOWN AS TRIMETHYLGLYCINE, OR GLYCINE BETAINE (U.S. CLS. 6, 18, 44, 46, 51 AND 52).

FIRST USE 4-20-2010; IN COMMERCE 4-20-2010.

CLASS 5—(Continued).

3,808,403. ALOE VERA OF AMERICA, DALLAS, TX. SN 77-784,914. PUB. 12-29-2009, FILED 7-20-2009.

FOREVER CARDIOHEALTH

THE MARK CONSISTS OF STANDARD CHARACTERS WITHOUT CLAIM TO ANY PARTICULAR FONT, STYLE, SIZE, OR COLOR.

OWNER OF U.S. REG. NOS. 1,950,344 AND 2,094,053. NO CLAIM IS MADE TO THE EXCLUSIVE RIGHT TO USE "CARDIOHEALTH", APART FROM THE MARK AS SHOWN.

FOR A DIETARY SUPPLEMENT FOR CARDIOVASCULAR SUPPORT (U.S. CLS. 6, 18, 44, 46, 51 AND 52). FIRST USE 8-12-2009; IN COMMERCE 8-17-2009.

3,808,434. WELLYTAILS, INC., GUELPH, ONTARIO N1G 4W, CANADA. SN 77-795,088. PUB. 1-19-2010, FILED 8-2-2009.



THE MARK CONSISTS OF A TOP HALF OF A HALF SUN WITH SEVEN RAYS EMANATING THEREFROM AND A DOG AND A CAT PROFILE ABOVE A JAGGED LINE INSIDE. OVER A TEXT BOX WITH THE WORDS "WELLYTAILS HOLISTIC FACTORS TO IMPROVE YOUR PET COMPANION'S HEALTH".

FOR NATURAL PET HEALTH PRODUCTS, NAMELY, NUTRITIONAL SUPPLEMENTS (U.S. CLS. 6, 18, 44, 46, 51 AND 52).

FIRST USE 12-31-2009; IN COMMERCE 12-31-2009.

3,808,452. ECO-COMMAND, INC., WITTMAN, MD. SN 77-800,496. PUB. 1-5-2010, FILED 8-10-2009.

Go Flushless

THE MARK CONSISTS OF STANDARD CHARACTERS WITHOUT CLAIM TO ANY PARTICULAR FONT, STYLE, SIZE, OR COLOR.

FOR URINAL DEODORIZER SPRAY (U.S. CLS. 6, 18, 44, 46, 51 AND 52). FIRST USE 4-16-2010; IN COMMERCE 4-16-2010.

CLASS 5—(Continued).

3,808,453. ECO-COMMAND, INC., WITTMAN, MD. SN 77-800,502. PUB. 1-5-2010, FILED 8-10-2009.

It's A Whole New Bowlgame

THE MARK CONSISTS OF STANDARD CHARACTERS WITHOUT CLAIM TO ANY PARTICULAR FONT, STYLE, SIZE, OR COLOR.

FOR URINAL DEODORIZER SPRAY (U.S. CLS. 6, 18, 44, 46, 51 AND 52).

FIRST USE 4-16-2010; IN COMMERCE 4-16-2010.

3,808,464. THE COROMEGA COMPANY, INC., VISTA, CA. SN 77-804,457. PUB. 1-12-2010, FILED 8-13-2009.

MULTI-V

THE MARK CONSISTS OF STANDARD CHARACTERS WITHOUT CLAIM TO ANY PARTICULAR FONT, STYLE, SIZE, OR COLOR.

FOR DIETARY AND NUTRITIONAL SUPPLEMENTS (U.S. CLS. 6, 18, 44, 46, 51 AND 52).

FIRST USE 12-3-2009; IN COMMERCE 12-3-2009.

3,808,488. SHIRE HUMAN GENETIC THERAPIES, INC., LEXINGTON, MA. SN 77-821,564. PUB. 2-2-2010, FILED 9-8-2009.

VPRIV

THE MARK CONSISTS OF STANDARD CHARACTERS WITHOUT CLAIM TO ANY PARTICULAR FONT, STYLE, SIZE, OR COLOR.

FOR PHARMACEUTICAL PREPARATIONS FOR THE TREATMENT OF ENZYME DEFICIENCIES; PHARMACEUTICAL PREPARATIONS FOR THE TREATMENT OF GAUCHER'S DISEASE (U.S. CLS. 6, 18, 44, 46, 51 AND 52).

FIRST USE 2-27-2010; IN COMMERCE 2-27-2010.

CLASS 5—(Continued).

3,808,562. WINDMILL HEALTH PRODUCTS, LLC., WEST CALDWELL, NJ. SN 78-601,501. PUB. 7-11-2006, FILED 4-4-2005.

VITA-QUENCH

THE MARK CONSISTS OF STANDARD CHARACTERS WITHOUT CLAIM TO ANY PARTICULAR FONT, STYLE, SIZE, OR COLOR.

FOR VITAMIN ENRICHED WATER (U.S. CLS. 6, 18, 44, 46, 51 AND 52).
FIRST USE 3-31-2007; IN COMMERCE 3-31-2007.

3,808,582. WATHEN, BOYD J., LEHI, UT. SN 78-769,825. PUB. 1-22-2008, FILED 12-8-2005.

NATURE 4 U

THE MARK CONSISTS OF STANDARD CHARACTERS WITHOUT CLAIM TO ANY PARTICULAR FONT, STYLE, SIZE, OR COLOR.

FOR NUTRITIONAL SUPPLEMENT DRINKS (U.S. CLS. 6, 18, 44, 46, 51 AND 52).
FIRST USE 1-5-2010; IN COMMERCE 1-13-2010.

3,808,613. SMITH, DANIEL S., ALAMO, CA. SN 78-935,162. PUB. 9-29-2009, FILED 7-21-2006.

total amino solution

NO CLAIM IS MADE TO THE EXCLUSIVE RIGHT TO USE "AMINO", APART FROM THE MARK AS SHOWN.

FOR VITAMINS; VITAMIN SUPPLEMENTS; NUTRACEUTICALS FOR USE AS DIETARY SUPPLEMENTS; DIETARY AND NUTRITIONAL SUPPLEMENTS; FOOD SUPPLEMENTS, NAMELY, ANTI-OXIDANTS; POWDERED NUTRITIONAL SUPPLEMENTS (U.S. CLS. 6, 18, 44, 46, 51 AND 52).
FIRST USE 8-31-2006; IN COMMERCE 8-31-2006.

CLASS 6—METAL GOODS

3,807,482. ADRIAN FABRICATORS, INC., ADRIAN, MI. SN 77-251,450. PUB. 1-15-2008, FILED 8-9-2007.

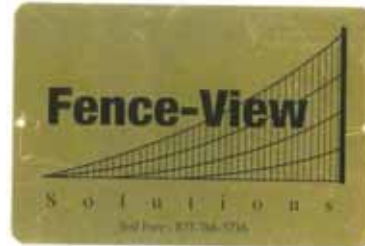

THE MARK CONSISTS OF STANDARD CHARACTERS WITHOUT CLAIM TO ANY PARTICULAR FONT, STYLE, SIZE, OR COLOR.

FOR METAL FENCES (U.S. CLS. 2, 12, 13, 14, 23, 25 AND 50).
FIRST USE 7-0-2007; IN COMMERCE 6-0-2008.

3,807,534. MENARD, INC., EAU CLAIRE, WI. SN 77-351,604. PUB. 5-6-2008, FILED 12-13-2007.

GRIP FAST

THE MARK CONSISTS OF STANDARD CHARACTERS WITHOUT CLAIM TO ANY PARTICULAR FONT, STYLE, SIZE, OR COLOR.

FOR METAL FASTENERS, NAMELY, COLLATED NAILS, BRADS, PINS, CLEATS, STAPLES AND SCREWS AND NON-COLLATED NAILS, BRADS, PINS, CLEATS, STAPLES, SCREWS, NUTS, BOLTS, WASHERS, ANCHORS, TOGGLE BOLTS, AND RIVETS (U.S. CLS. 2, 12, 13, 14, 23, 25 AND 50).
FIRST USE 4-27-2010; IN COMMERCE 4-27-2010.

3,807,714. METAL FORMS CORPORATION, MILWAUKEE, IL. SN 77-552,382. PUB. 9-29-2009, FILED 8-21-2008.

Meta Art

THE MARK CONSISTS OF STANDARD CHARACTERS WITHOUT CLAIM TO ANY PARTICULAR FONT, STYLE, SIZE, OR COLOR.

NO CLAIM IS MADE TO THE EXCLUSIVE RIGHT TO USE "ART", APART FROM THE MARK AS SHOWN.
FOR SCULPTURES OF METAL (U.S. CLS. 2, 12, 13, 14, 23, 25 AND 50).
FIRST USE 3-4-2009; IN COMMERCE 12-17-2009.

CLASS 6—(Continued).

3,807,981. OMNIMOUNT SYSTEMS, INC., PHOENIX, AZ. SN 77-678,220. PUB. 12-29-2009, FILED 2-25-2009.

OMNILITE SERIES

THE MARK CONSISTS OF STANDARD CHARACTERS WITHOUT CLAIM TO ANY PARTICULAR FONT, STYLE, SIZE, OR COLOR.

NO CLAIM IS MADE TO THE EXCLUSIVE RIGHT TO USE "SERIES", APART FROM THE MARK AS SHOWN.

FOR WALL AND CEILING MOUNTS MADE OF METAL FOR AUDIO/VISUAL EQUIPMENT IN THE NATURE OF AUDIO SPEAKERS, MICROPHONES, PERSONAL STEREOs, VIDEO PLAYERS, DVD PLAYERS, AUDIO PLAYERS, AMPLIFIERS, SOUND MIXERS, FREQUENCY TUNERS, SURROUND PROCESSORS, DIGITAL SOUND SIGNAL SYNTHESIZERS, STEREOs AND STEREO PARTS, TELEVISIONS, LIQUID CRYSTAL DISPLAY AND PLASMA MONITORS, LOUDSPEAKERS, COMPUTER PERIPHERALS, AND PROJECTORS (U.S. CLS. 2, 12, 13, 14, 23, 25 AND 50).
FIRST USE 5-5-2009; IN COMMERCE 5-5-2009.



3,808,223. NORMAN WILLIAM LIEFKE, SURREY, B.C., CANADA. SN 77-721,418. PUB. 9-1-2009, FILED 4-24-2009.

Regal ideas

THE MARK CONSISTS OF STANDARD CHARACTERS WITHOUT CLAIM TO ANY PARTICULAR FONT, STYLE, SIZE, OR COLOR.

FOR METAL FENCE PANELS; METAL FENCE POSTS; METAL FENCE RAIL CLAMPS; METAL FENCE STAYS; METAL GATES AND FENCES; METAL RAILINGS FOR FENCES (U.S. CLS. 2, 12, 13, 14, 23, 25 AND 50).

FIRST USE 8-10-2009; IN COMMERCE 8-20-2009.



3,808,229. ACCURIDE INTERNATIONAL INC., SANTA FE SPRINGS, CA. SN 77-724,215. PUB. 9-8-2009, FILED 4-28-2009.

ACTION-ASSIST

THE MARK CONSISTS OF STANDARD CHARACTERS WITHOUT CLAIM TO ANY PARTICULAR FONT, STYLE, SIZE, OR COLOR.

FOR METAL SLIDES FOR DRAWERS (U.S. CLS. 2, 12, 13, 14, 23, 25 AND 50).

FIRST USE 6-1-2009; IN COMMERCE 6-17-2009.



CLASS 7—MACHINERY

CLASS 7—(Continued).

3,807,409. SAVICORP, SANTA ANA, CA. SN 77-017,898. PUB. 2-13-2007, FILED 10-10-2006.

SAVICORP

THE MARK CONSISTS OF STANDARD CHARACTERS WITHOUT CLAIM TO ANY PARTICULAR FONT, STYLE, SIZE, OR COLOR.

FOR EMISSION REDUCTION UNITS FOR MOTORS AND ENGINES, NAMELY, PCV VALVES (U.S. CLS. 13, 19, 21, 23, 31, 34 AND 35).

FIRST USE 3-2-2008; IN COMMERCE 3-2-2008.



3,807,479. FRONTIER WIND, LLC, WEST CONSHOHOCKEN, PA. SN 77-246,754. PUB. 1-22-2008, FILED 8-3-2007.

FRONTIER WIND

THE MARK CONSISTS OF STANDARD CHARACTERS WITHOUT CLAIM TO ANY PARTICULAR FONT, STYLE, SIZE, OR COLOR.

NO CLAIM IS MADE TO THE EXCLUSIVE RIGHT TO USE "WIND", APART FROM THE MARK AS SHOWN.

FOR WIND TURBINES (U.S. CLS. 13, 19, 21, 23, 31, 34 AND 35).

FIRST USE 6-30-2007; IN COMMERCE 6-30-2007.



3,807,575. MILHOUS, MARIA M., LOOMIS, CA. SN 77-424,059. PUB. 7-29-2008, FILED 3-17-2008.

LITTLE MOE

THE MARK CONSISTS OF STANDARD CHARACTERS WITHOUT CLAIM TO ANY PARTICULAR FONT, STYLE, SIZE, OR COLOR.

FOR CARPET CLEANING MACHINES (U.S. CLS. 13, 19, 21, 23, 31, 34 AND 35).

FIRST USE 3-4-2008; IN COMMERCE 10-2-2009.

CLASS 7—(Continued).

3,807,614. ZHEJIANG RONGPENG AIR TOOLS CO., LTD, TAIZHOU CITY, ZHEJIANG, CHINA. SN 77-453,073. PUB. 8-25-2009, FILED 4-21-2008.

ROPO

FOR HAND-HELD TOOLS, OTHER THAN HAND-OPERATED, NAMELY, POWER DRILLS AND ELECTRIC HAMMERS; ELECTRIC GLUE GUNS; SPRAY GUNS FOR PAINT; COMPRESSED AIR MACHINES; HYDRAULIC HANDIWORK TOOL, NAMELY, HYDRAULIC HAMMERS AND JACKS; WIND PROMOTING HANDWORK TOOL, NAMELY, POWER DRILLS; IMPACT WRENCHES; GAS PIN GUN, NAMELY, POWER-OPERATED NAILING GUNS POWERED BY GAS; ELECTRIC PIN GUN, NAMELY, POWER-OPERATED NAILING GUNS POWERED BY ELECTRICITY; GAS HANDWORK TOOLS, NAMELY, FLOOR SANDERS AND POWER DRILLS (U.S. CLS. 13, 19, 21, 23, 31, 34 AND 35).

FIRST USE 1-1-2007; IN COMMERCE 10-1-2008.

3,807,727. GAME EQUIPMENT, L.L.C., NAPOLEONVILLE, LA. SN 77-556,950. PUB. 7-21-2009, FILED 8-27-2008.



NO CLAIM IS MADE TO THE EXCLUSIVE RIGHT TO USE "EQUIPMENT L.L.C.", APART FROM THE MARK AS SHOWN.

THE MARK CONSISTS OF IMAGE OF GLOBE WITH LITERAL ELEMENT CENTERED.

FOR AGRICULTURAL AND CONSTRUCTION OFF HIGHWAY MOBILE EQUIPMENT, NAMELY, HARVESTERS, LOADERS, PLANTERS, AND SPRAYERS (U.S. CLS. 13, 19, 21, 23, 31, 34 AND 35).

FIRST USE 9-8-2003; IN COMMERCE 9-8-2003.

CLASS 7—(Continued).

3,807,758. PRAMAC AMERICA LLC, MEDLEY, FL. SN 77-565,798. PUB. 7-21-2009, FILED 9-9-2008.

POWERSTATION

THE MARK CONSISTS OF STANDARD CHARACTERS WITHOUT CLAIM TO ANY PARTICULAR FONT, STYLE, SIZE, OR COLOR.

FOR ELECTRIC GENERATOR AND TRANSFER SWITCH SOLD AS A UNIT (U.S. CLS. 13, 19, 21, 23, 31, 34 AND 35).

FIRST USE 3-15-1998; IN COMMERCE 3-15-1998.

3,807,848. LINCOLN GLOBAL, INC., CITY OF INDUSTRY, CA. SN 77-602,141. PUB. 7-28-2009, FILED 10-28-2008.

TOMAHAWK

THE MARK CONSISTS OF STANDARD CHARACTERS WITHOUT CLAIM TO ANY PARTICULAR FONT, STYLE, SIZE, OR COLOR.

FOR PLASMA CUTTERS (U.S. CLS. 13, 19, 21, 23, 31, 34 AND 35).

FIRST USE 4-1-2009; IN COMMERCE 4-1-2009.

3,807,852. PANGBORN CORPORATION, FAIRBURN, GA. SN 77-606,161. PUB. 4-14-2009, FILED 11-3-2008.

GENESIS

THE MARK CONSISTS OF STANDARD CHARACTERS WITHOUT CLAIM TO ANY PARTICULAR FONT, STYLE, SIZE, OR COLOR.

FOR BLAST WHEELS, NAMELY, PARTICLE BLAST CLEANING MACHINES (U.S. CLS. 13, 19, 21, 23, 31, 34 AND 35).

FIRST USE 2-23-2009; IN COMMERCE 4-15-2009.

CLASS 7—(Continued).

3,807,937. PATTERSON PUMP COMPANY, TOCCOA, GA. SN 77-661,037. PUB. 8-25-2009, FILED 2-2-2009.



THE MARK CONSISTS OF THE UNDERLINED WORD "ENVIROFLO" AND A LEAF DESIGN ATTACHED TO THE UNDERLINE.

FOR WATER PUMPS FOR HYDRONIC APPLICATIONS IN HVAC SYSTEMS (U.S. CLS. 13, 19, 21, 23, 31, 34 AND 35).

FIRST USE 2-1-2009; IN COMMERCE 2-1-2009.

CLASS 7—(Continued).

3,808,016. PACIFIC EQUIPMENT SALES, INC., TRAVELERS REST, SC. SN 77-688,148. PUB. 8-4-2009, FILED 3-11-2009.



NO CLAIM IS MADE TO THE EXCLUSIVE RIGHT TO USE "EQUIPMENT", APART FROM THE MARK AS SHOWN.

THE MARK CONSISTS OF A CIRCLE THAT IS SHADED TO REPRESENT THE SUN TO THE LEFT AND PARTIALLY HIDDEN BY THE "P" OF THE STYLIZED, CURSIVE WORD "PACIFIC" WITH THE WORD "EQUIPMENT" UNDER THE CIRCLE AND THE STYLIZED, CURSIVE WORD "PACIFIC".

FOR GASOLINE GENERATORS, DIESEL GENERATORS, PRESSURE WASHERS, AIR COMPRESSORS, AND TRASH PUMPS (U.S. CLS. 13, 19, 21, 23, 31, 34 AND 35).

FIRST USE 4-0-2009; IN COMMERCE 4-0-2009.

3,807,948. NEXREV INC., PLANO, TX. SN 77-668,071. PUB. 8-11-2009, FILED 2-11-2009.

DRIVEPAK

THE MARK CONSISTS OF STANDARD CHARACTERS WITHOUT CLAIM TO ANY PARTICULAR FONT, STYLE, SIZE, OR COLOR.

FOR VARIABLE SPEED DRIVE AND PRESSURIZATION CONTROL LOGIC SOLD AS A UNIT FOR USE WITH HEATING, VENTILATING AND AIR CONDITIONING APPARATUS (U.S. CLS. 13, 19, 21, 23, 31, 34 AND 35).

FIRST USE 4-8-2009; IN COMMERCE 4-8-2009.

3,808,069. NATIONAL OPTRONICS, INC., CHARLOTTEVILLE, VA. SN 77-697,150. PUB. 6-23-2009, FILED 3-23-2009.

AXIOM

3,807,997. TAKE TWO MARKETING AND EVENTS PTY. LTD., CLOVELLY, NSW, AUSTRALIA. SN 77-683,169. PUB. 7-7-2009, FILED 3-4-2009.

Seal it save it store it

THE MARK CONSISTS OF STANDARD CHARACTERS WITHOUT CLAIM TO ANY PARTICULAR FONT, STYLE, SIZE, OR COLOR.

FOR APPARATUS FOR SEALING CONTAINERS, NAMELY, ELECTRIC OR BATTERY OPERATED BAG SEALERS; ELECTRIC OR BATTERY OPERATED HEAT SEALING MACHINES, FOR USE IN HEAT SEALING PLASTIC BAGS; PACKAGING MACHINES FOR SEALING BAGS (U.S. CLS. 13, 19, 21, 23, 31, 34 AND 35).

FIRST USE 4-0-2009; IN COMMERCE 4-0-2009.

THE MARK CONSISTS OF STANDARD CHARACTERS WITHOUT CLAIM TO ANY PARTICULAR FONT, STYLE, SIZE, OR COLOR.

FOR GENERATING MACHINES FOR EYEGLASS LENSES (U.S. CLS. 13, 19, 21, 23, 31, 34 AND 35).

FIRST USE 11-1-2009; IN COMMERCE 2-26-2010.

CLASS 7—(Continued).

3,808,097. ORECK HOLDINGS, LLC, NASHVILLE, TN. SN 77-700,269. PUB. 8-18-2009, FILED 3-26-2009.

STEAM-IT

THE MARK CONSISTS OF STANDARD CHARACTERS WITHOUT CLAIM TO ANY PARTICULAR FONT, STYLE, SIZE, OR COLOR.

FOR MULTIPURPOSE ELECTRIC STEAM CLEANING MACHINES AND PARTS AND ACCESSORIES THEREFORE, NAMELY, UPHOLSTERY AND CURTAIN CLEANING UTILITY TOOL, WINDOW SQUEEGEE, MULTIPURPOSE BRUSHES, CARPET COMB, MOP ATTACHMENT, AND CURVED FIT JET NOZZLES FOR CLEANING AND DISINFECTING ALL SURFACES (U.S. CLS. 13, 19, 21, 23, 31, 34 AND 35).

FIRST USE 5-28-2009; IN COMMERCE 5-28-2009.

3,808,170. SER-MANUKYAN FAMILY HOLDINGS, GLENDALE, CA. SN 77-711,566. PUB. 1-12-2010, FILED 4-10-2009.



The logo for "atmowater" features the word "atmowater" in a lowercase, sans-serif font. A small globe icon is positioned between the "o" and "w", with a single water drop falling from the top of the globe.

THE MARK CONSISTS OF THE STYLIZED WORDS "ATMOWATER". IN BETWEEN THE WORD "ATMO" AND "WATER" IS AN IMAGE OF A GLOBE SHAPED AS A WATER DROP.

FOR POTABLE POWER-OPERATED WATER EXTRACTING MACHINES THAT EXTRACT WATER FROM AMBIENT AIR DELIVERED THROUGH WATER DISPENSER FOR RESIDENTIAL, COMMERCIAL AND AGRICULTURAL USE (U.S. CLS. 13, 19, 21, 23, 31, 34 AND 35).

FIRST USE 1-18-2010; IN COMMERCE 1-18-2010.

3,808,217. ORECK HOLDINGS, LLC, NASHVILLE, TN. SN 77-718,953. PUB. 8-25-2009, FILED 4-21-2009.

LITTLE HERO JIFFY VAC

THE MARK CONSISTS OF STANDARD CHARACTERS WITHOUT CLAIM TO ANY PARTICULAR FONT, STYLE, SIZE, OR COLOR.

NO CLAIM IS MADE TO THE EXCLUSIVE RIGHT TO USE "VAC", APART FROM THE MARK AS SHOWN.

FOR VACUUM CLEANERS (U.S. CLS. 13, 19, 21, 23, 31, 34 AND 35).

FIRST USE 4-21-2009; IN COMMERCE 4-21-2009.

CLASS 7—(Continued).

3,808,221. AMANA TOOL CORPORATION, FARMINGDALE, NY. SN 77-719,918. PUB. 8-25-2009, FILED 4-22-2009.



The logo for "MAMBA" features the word "MAMBA" in a bold, stylized, uppercase font. A black snake is integrated into the design, with its body forming the letter "A" and its head positioned at the end of the word.

THE MARK CONSISTS OF THE WORD "MAMBA" IN STYLIZED LETTERS AND A SNAKE DESIGN.

FOR SAW BLADES FOR CIRCULAR SAWS (U.S. CLS. 13, 19, 21, 23, 31, 34 AND 35).

FIRST USE 7-0-2009; IN COMMERCE 7-0-2009.

3,808,432. NTFB COMBUSTION EQUIPMENT USA, INC., SAN MATEO, CA. SN 77-794,301. PUB. 1-12-2010, FILED 7-31-2009.



The logo for "NTFB" features the letters "NTFB" in a bold, uppercase font. A stylized flame or wave graphic is integrated into the letter "F", with yellow and red colors.

THE COLOR(S) BLACK, YELLOW AND RED IS/ARE CLAIMED AS A FEATURE OF THE MARK.

THE MARK CONSISTS OF THE FOLLOWING: THE LETTERS "NTFB" IN BLACK AND THE "F" INCLUDES A RED WAVY LINE AND A YELLOW WAVY LINE.

FOR HEATING BOILERS AND BOILER ROOM EQUIPMENT, NAMELY, HEAT PIPES TO COOL HEAT PRODUCING COMPONENTS, HEATING SYSTEMS FOR RESIDENTIAL OR COMMERCIAL BUILDINGS COMPRISED OF BOILERS, VALVES, PIPES, MANIFOLDS, CONTROL PANELS, SWITCHES AND ELECTRICAL WIRE, ALL SOLD AS A UNIT (U.S. CLS. 13, 19, 21, 23, 31, 34 AND 35).

FIRST USE 3-31-2010; IN COMMERCE 3-31-2010.

3,808,435. VITA-MIX CORPORATION, CLEVELAND, OH. SN 77-795,256. PUB. 12-29-2009, FILED 8-3-2009.

CREATIONS

THE MARK CONSISTS OF STANDARD CHARACTERS WITHOUT CLAIM TO ANY PARTICULAR FONT, STYLE, SIZE, OR COLOR.

FOR ELECTRIC FOOD BLENDERS (U.S. CLS. 13, 19, 21, 23, 31, 34 AND 35).

FIRST USE 12-0-2009; IN COMMERCE 12-0-2009.

CLASS 7—(Continued).

3,808,456. MTD PRODUCTS INC, VALLEY CITY, OH. SN 77-801,873. PUB. 1-12-2010, FILED 8-11-2009.

LOGMASTER

THE MARK CONSISTS OF STANDARD CHARACTERS WITHOUT CLAIM TO ANY PARTICULAR FONT, STYLE, SIZE, OR COLOR.

OWNER OF U.S. REG. NOS. 2,759,847 AND 2,769,897. FOR CHAINSAWS (U.S. CLS. 13, 19, 21, 23, 31, 34 AND 35). FIRST USE 4-12-2010; IN COMMERCE 4-12-2010.

CLASS 7—(Continued).

3,808,607. REEDHYCALOG, L.P., HOUSTON, TX. SN 78-919,362. PUB. 2-13-2007, FILED 6-28-2006.

SMOOTHSTEER

THE MARK CONSISTS OF STANDARD CHARACTERS WITHOUT CLAIM TO ANY PARTICULAR FONT, STYLE, SIZE, OR COLOR.

FOR DOWNHOLE DRILLING TOOLS, NAMELY, DRILL BITS FOR SUBTERRANEAN HYDROCARBON WELLS (U.S. CLS. 13, 19, 21, 23, 31, 34 AND 35). FIRST USE 11-16-2009; IN COMMERCE 11-16-2009.

3,808,473. FLINT HYDRAULICS INC., MEMPHIS, TN. SN 77-810,275. PUB. 1-19-2010, FILED 8-21-2009.



THE COLOR(S) BLUE IS/ARE CLAIMED AS A FEATURE OF THE MARK.

THE ENTIRE MARK IS DEPICTED IN BLUE. FOR HYDRAULIC CONTROLS FOR MACHINES, MOTORS AND ENGINES; HYDRAULIC PUMPS; REPLACEMENT PARTS FOR MACHINES, NAMELY, REPLACEMENT PARTS FOR TRENCH EXCAVATORS, DRAG-LINE EXCAVATORS, HOISTING MACHINES, LOCOMOTIVE CRANES, SHOVELING MACHINES, POWER SHOVELS AND LOG HANDLING MACHINES, NAMELY, CHASSIS PARTS, HYDRAULIC AND PNEUMATIC PARTS (U.S. CLS. 13, 19, 21, 23, 31, 34 AND 35). FIRST USE 4-21-2010; IN COMMERCE 4-21-2010.

3,808,608. REEDHYCALOG, L.P., HOUSTON, TX. SN 78-919,366. PUB. 2-13-2007, FILED 6-28-2006.

ROCKFORCE

THE MARK CONSISTS OF STANDARD CHARACTERS WITHOUT CLAIM TO ANY PARTICULAR FONT, STYLE, SIZE, OR COLOR.

FOR DOWNHOLE DRILLING TOOLS, NAMELY, DRILL BITS FOR SUBTERRANEAN HYDROCARBON WELLS (U.S. CLS. 13, 19, 21, 23, 31, 34 AND 35). FIRST USE 11-16-2009; IN COMMERCE 11-16-2009.

3,808,606. REEDHYCALOG, L.P., HOUSTON, TX. SN 78-918,202. PUB. 2-13-2007, FILED 6-27-2006.

SMOOTHTORQUE

THE MARK CONSISTS OF STANDARD CHARACTERS WITHOUT CLAIM TO ANY PARTICULAR FONT, STYLE, SIZE, OR COLOR.

FOR DRILL BITS FOR ROCK DRILLING AND CORE DRILLING FOR OIL AND GAS EXPLORATION (U.S. CLS. 13, 19, 21, 23, 31, 34 AND 35). FIRST USE 11-16-2009; IN COMMERCE 11-16-2009.

CLASS 8—HAND TOOLS

3,807,384. GORE, DAVID, LOUISVILLE, KY. SN 76-691,618. PUB. 2-17-2009, FILED 7-28-2008.



THE MARK CONSISTS OF THE STYLIZED TERM "GORVO".

THE TERM "GORVO" DOES NOT HAVE ANY MEANING IN A FOREIGN LANGUAGE.

FOR HAND TOOLS, NAMELY, A HAND TOOL FOR USE IN ATTACHING AND REMOVING HOSE CLAMPS (U.S. CLS. 23, 28 AND 44). FIRST USE 11-5-2008; IN COMMERCE 1-5-2009.

CLASS 8—(Continued).

3,807,647. TRIA BEAUTY, INC., PLEASANTON, CA. SN 77-496,271. PUB. 3-10-2009, FILED 6-11-2008.

TRIA BEAUTY

THE MARK CONSISTS OF STANDARD CHARACTERS WITHOUT CLAIM TO ANY PARTICULAR FONT, STYLE, SIZE, OR COLOR.

OWNER OF U.S. REG. NO. 3,360,633.

NO CLAIM IS MADE TO THE EXCLUSIVE RIGHT TO USE "BEAUTY", APART FROM THE MARK AS SHOWN.

FOR HAND HELD BATTERY OPERATED AND ELECTRICAL DEVICES FOR PERSONAL USE FOR FACIAL REJUVENATION AND TONING, SKIN CARE, AND ELIMINATING ACNE (U.S. CLS. 23, 28 AND 44).

FIRST USE 4-4-2010; IN COMMERCE 4-4-2010.

3,807,893. PLUCINSKI, COLLEEN, DBA HARVEST HOUSE QUILTING, PLAINFIELD, IL. SN 77-631,850. PUB. 10-20-2009, FILED 12-12-2008.

The WACKER seams perfect

THE MARK CONSISTS OF STANDARD CHARACTERS WITHOUT CLAIM TO ANY PARTICULAR FONT, STYLE, SIZE, OR COLOR.

FOR HAND TOOL, NAMELY, A SEWING TOOL FOR FLATTENING FOR MULTI-SEAMS FOR SEWING, QUILTING, CLOTHING CONSTRUCTION, FABRIC HOME DECOR AND FIBER CRAFTS (U.S. CLS. 23, 28 AND 44).

FIRST USE 7-1-2006; IN COMMERCE 7-1-2007.

3,807,938. TUSCAN LEVELING, INC., FAIRFIELD, IA. SN 77-661,583. PUB. 6-2-2009, FILED 2-2-2009.

Tuscan Leveling System

THE MARK CONSISTS OF STANDARD CHARACTERS WITHOUT CLAIM TO ANY PARTICULAR FONT, STYLE, SIZE, OR COLOR.

NO CLAIM IS MADE TO THE EXCLUSIVE RIGHT TO USE "LEVELING SYSTEM", APART FROM THE MARK AS SHOWN.

FOR HAND TOOLS, NAMELY, A FLATTENING DEVICE WITH A TOP AND BOTTOM PLATE CONNECTED BY A SHAFT, FOR LEVELING TILE, MARBLE, CERAMIC, ONYX AND GRANITE (U.S. CLS. 23, 28 AND 44).

FIRST USE 9-30-2007; IN COMMERCE 9-30-2007.

CLASS 8—(Continued).

3,808,002. BARBARA'S WAY LLC, GREENWICH, CT. SN 77-683,638. PUB. 8-11-2009, FILED 3-4-2009.



THE COLOR(S) PURPLE, GREEN, WHITE IS/ARE CLAIMED AS A FEATURE OF THE MARK.

THE MARK CONSISTS OF THE WORD "BARBARA'S" IN PURPLE WITH AN APOSTROPHE IN GREEN AND THE WORD "WAY" IN WHITE ON A GREEN CIRCULAR BACKGROUND.

FOR CUTTING PLIERS; DRILL BITS FOR HAND DRILLS; GARDENING SHEARS AND SCISSORS; GARDENING TOOLS, NAMELY, RAKES, CULTIVATOR; GARDENING TROWELS; HAMMERS; HAND OPERATED PLUMBING SNAKES; HAND TOOLS, NAMELY, AUGERS; HAND TOOLS, NAMELY, DRILLS; HAND TOOLS, NAMELY, FILES; HAND TOOLS, NAMELY, HAMMERS; HAND TOOLS, NAMELY, HAND TOOLS FOR SKIMMING WALL REPAIRS IN SMALL OR TIGHT AREAS WITH SPACKLE, JOINT COMPOUND, PUTTY, OR SMOOTHING VINYL LETTERING; HAND TOOLS, NAMELY, HEX KEYS WRENCHES; HAND TOOLS, NAMELY, NAIL SETS; HAND TOOLS, NAMELY, NUT DRIVERS; HAND TOOLS, NAMELY, RATCHET WRENCHES; HAND TOOLS, NAMELY, SCREWDRIVERS; HAND TOOLS, NAMELY, SOCKET SETS; HAND TOOLS, NAMELY, SOCKET WRENCHES; HAND TOOLS, NAMELY, WIRE CUTTERS; HAND TOOLS, NAMELY, WIRE NIPPERS; HAND TOOLS, NAMELY, WIRE STRIPPERS; HAND TOOLS, NAMELY, WRENCHES; HAND TOOLS, NAMELY, SLIP JOINT PLIERS; KNIVES; MANUAL DRILLS; MANUALLY OPERATED HAND TOOLS, NAMELY, KNIVES, SCISSORS, PLIERS, WRENCHES, WIRE CUTTERS, SCREWDRIVERS, SHOVELS, HAMMERS; MONKEY WRENCHES; MULTI-FUNCTION HAND TOOLS COMPRISED OF GLUE STICKS, PRECISION PLIERS, PRECISION SCREWDRIVERS, CORD TIES, INTERCHANGEABLE SCREWDRIVERS, HAND DRILLS, ADJUSTABLE WRENCHES; PEN KNIVES; PENKNIVES; PLIERS; POCKET KNIVES; POCKET SHEARS; PRUNING KNIVES; PRUNING SCISSORS; PRUNING SHEARS; PUTTY KNIVES; RAKES; SCISSORS; SCISSORS FOR HOUSEHOLD USE; SCREW WRENCHES; SCREWDRIVERS; TOOL APRONS; TOOL BELTS; TOOL HOLDERS; TOOL POUCHES FOR ATTACHMENT TO TOOL BELTS; TORQUE WRENCHES; TROWELS; UTILITY KNIVES; WIRE CUTTERS; WIRE STRIPPERS; WRENCHES; PRE-PACKAGED KITS CONTAINING SLIP JOINT PLIERS AND ASSOCIATED SMALL ITEMS FOR USE THEREWITH IN THE NATURE OF GLUE STICKS, PICTURE HOOKS, CURTAIN HANGERS, SCREWS, NUTS, NAILS, WASHERS, BOLTS, EXPANSION SHIELDS, WALL PLUGS, PLASTIC SHIELDS, TOGGLES, AND MOLLY, SOLD AS A UNIT (U.S. CLS. 23, 28 AND 44).

FIRST USE 2-15-2010; IN COMMERCE 3-29-2010.

CLASS 8—(Continued).

3,808,005. TELEBRANDS CORP., FAIRFIELD, NJ. SN 77-684,940. PUB. 11-10-2009, FILED 3-6-2009.

PEDI PISTOL

THE MARK CONSISTS OF STANDARD CHARACTERS WITHOUT CLAIM TO ANY PARTICULAR FONT, STYLE, SIZE, OR COLOR.

NO CLAIM IS MADE TO THE EXCLUSIVE RIGHT TO USE "PEDI", APART FROM THE MARK AS SHOWN. FOR BATTERY OPERATED PEDICURE INSTRUMENTS, NAMELY, ELECTRIC PEDICURE SETS AND NAIL FILES (U.S. CLS. 23, 28 AND 44).
FIRST USE 5-28-2009; IN COMMERCE 5-28-2009.



3,808,073. REVO BRAND GROUP LLC, PLYMOUTH, MN. SN 77-697,582. PUB. 7-21-2009, FILED 3-24-2009.

VISCERA

THE MARK CONSISTS OF STANDARD CHARACTERS WITHOUT CLAIM TO ANY PARTICULAR FONT, STYLE, SIZE, OR COLOR.

FOR HUNTING KNIVES (U.S. CLS. 23, 28 AND 44).
FIRST USE 1-13-2010; IN COMMERCE 1-13-2010.

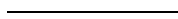

3,808,195. LIFETIME BRANDS, INC., GARDEN CITY, NY. SN 77-714,521. PUB. 8-18-2009, FILED 4-15-2009.

HEARTLAND

THE MARK CONSISTS OF STANDARD CHARACTERS WITHOUT CLAIM TO ANY PARTICULAR FONT, STYLE, SIZE, OR COLOR.

OWNER OF U.S. REG. NOS. 1,479,358 AND 1,625,851. FOR FLATWARE (U.S. CLS. 23, 28 AND 44).
FIRST USE 1-1-1982; IN COMMERCE 1-1-1982.

CLASS 8—(Continued).

3,808,210. STEVEN ERIC JOHNSON, GIBBON, NE. SN 77-716,995. PUB. 8-25-2009, FILED 4-19-2009.

ADVENTURE

THE MARK CONSISTS OF STANDARD CHARACTERS WITHOUT CLAIM TO ANY PARTICULAR FONT, STYLE, SIZE, OR COLOR.

FOR KNIVES, NAMELY, HUNTING, FISHING, POCKET, FOLDING, AND SPORTING KNIVES (U.S. CLS. 23, 28 AND 44).
FIRST USE 4-8-2010; IN COMMERCE 4-8-2010.



3,808,231. WAHL CLIPPER CORPORATION, STERLING, IL. SN 77-724,842. PUB. 9-8-2009, FILED 4-29-2009.

T-STYLER PRO

THE MARK CONSISTS OF STANDARD CHARACTERS WITHOUT CLAIM TO ANY PARTICULAR FONT, STYLE, SIZE, OR COLOR.

OWNER OF U.S. REG. NO. 3,572,580. FOR ELECTRIC HAIR TRIMMERS (U.S. CLS. 23, 28 AND 44).
FIRST USE 10-0-2009; IN COMMERCE 10-0-2009.

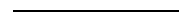

CLASS 9—ELECTRICAL AND SCIENTIFIC APPARATUS

3,807,374. GIBSON GUITAR CORP., NASHVILLE, TN. SN 76-648,382. PUB. 1-2-2007, FILED 10-13-2005.

TITAN

THE MARK CONSISTS OF STANDARD CHARACTERS WITHOUT CLAIM TO ANY PARTICULAR FONT, STYLE, SIZE, OR COLOR.

FOR ELECTRONIC SOUND AMPLIFIERS FOR MUSICAL INSTRUMENTS (U.S. CLS. 21, 23, 26, 36 AND 38).
FIRST USE 1-31-1964; IN COMMERCE 1-31-1964.

CLASS 9—(Continued).

3,807,377. BALTIC LATVIAN UNIVERSAL ELECTRONICS, LLC, WESTLAKE VILLAGE, CA. SN 76-662,360. PUB. 7-14-2009, FILED 6-29-2006.

POWERSTREAM

THE MARK CONSISTS OF STANDARD CHARACTERS WITHOUT CLAIM TO ANY PARTICULAR FONT, STYLE, SIZE, OR COLOR.

FOR TUBE MICROPHONE AMPLIFIER AND PARTS THEREOF (U.S. CLS. 21, 23, 26, 36 AND 38).
FIRST USE 9-5-2006; IN COMMERCE 10-31-2006.

3,807,391. TEXAS HEALTH RESOURCES, ARLINGTON, TX. SN 76-695,128. PUB. 6-30-2009, FILED 1-2-2009.

CARETUBE

THE MARK CONSISTS OF STANDARD CHARACTERS WITHOUT CLAIM TO ANY PARTICULAR FONT, STYLE, SIZE, OR COLOR.

FOR HEALTHCARE SOFTWARE FOR PROVIDING HEALTHCARE TRAINING INFORMATION AND FEATURING HEALTHCARE TRAINING VIDEOS WITH PHYSICIANS, EMPLOYEES, PATIENTS AND THEIR FAMILIES AND CORRESPONDING ONLINE DOWNLOADABLE MULTIMEDIA FILES FEATURING TRAINING VIDEO WITH PHYSICIANS, EMPLOYEES, PATIENTS AND THEIR FAMILIES; ONLINE DOWNLOADABLE MULTIMEDIA FILES FEATURING VIDEOS IN THE FIELD OF HEALTHCARE MANAGEMENT OFFERED OVER THE INTERNET; DOWNLOADABLE MULTIMEDIA FILES FEATURING TRAINING VIDEOS OFFERED OVER THE INTERNET FEATURING MEDICAL SERVICES INFORMATION (U.S. CLS. 21, 23, 26, 36 AND 38).

FIRST USE 5-1-2009; IN COMMERCE 10-1-2009.

3,807,397. NOUVEAU EYEWEAR, INC., CARROLLTON, TX. SN 76-696,739. PUB. 8-4-2009, FILED 4-6-2009.

ASTORIA

THE MARK CONSISTS OF STANDARD CHARACTERS WITHOUT CLAIM TO ANY PARTICULAR FONT, STYLE, SIZE, OR COLOR.

FOR OPTICAL LENSES, FRAMES AND SUNGLASSES (U.S. CLS. 21, 23, 26, 36 AND 38).
FIRST USE 12-28-2009; IN COMMERCE 12-28-2009.

CLASS 9—(Continued).

3,807,404. THE STEPHAN CO., FORT LAUDERDALE, FL. SN 76-698,989. PUB. 1-12-2010, FILED 8-14-2009.

STYLENAC

THE MARK CONSISTS OF STANDARD CHARACTERS WITHOUT CLAIM TO ANY PARTICULAR FONT, STYLE, SIZE, OR COLOR.

FOR COMBINATION ELECTRIC HAIR CURLER AND STRAIGHTENER (U.S. CLS. 21, 23, 26, 36 AND 38).
FIRST USE 2-5-2010; IN COMMERCE 2-5-2010.

3,807,405. IKON AUDIO INTERNATIONAL, INC., CHATSWORTH, CA. SN 76-979,002. PUB. 11-11-2008, FILED 4-21-2000.

MATRIX MOBILE SOUND

NO CLAIM IS MADE TO THE EXCLUSIVE RIGHT TO USE "MOBILE SOUND", APART FROM THE MARK AS SHOWN.

FOR AUTOMOBILE AUDIO COMPONENTS, NAMELY, SPEAKERS (U.S. CLS. 21, 23, 26, 36 AND 38).
FIRST USE 10-0-1999; IN COMMERCE 10-0-1999.

3,807,416. EASTMAN, ANDRE L., MODESTO, CA. SN 77-046,215. PUB. 9-11-2007, FILED 11-17-2006.

LIFE HOP

THE MARK CONSISTS OF STANDARD CHARACTERS WITHOUT CLAIM TO ANY PARTICULAR FONT, STYLE, SIZE, OR COLOR.

FOR PRE-RECORDED CDS AND DVDS TEACHING LIFE SKILLS EDUCATION THROUGH HIP HOP MUSIC (U.S. CLS. 21, 23, 26, 36 AND 38).

FIRST USE 12-27-2008; IN COMMERCE 2-5-2009.

3,807,436. IGT, RENO, NV. SN 77-089,853. PUB. 6-26-2007, FILED 1-24-2007.

SONG BIRDS

THE MARK CONSISTS OF STANDARD CHARACTERS WITHOUT CLAIM TO ANY PARTICULAR FONT, STYLE, SIZE, OR COLOR.

FOR GAMING MACHINES, NAMELY, DEVICES WHICH ACCEPT A WAGER (U.S. CLS. 21, 23, 26, 36 AND 38).

FIRST USE 12-17-2009; IN COMMERCE 12-17-2009.

CLASS 9—(Continued).

3,807,443. VIATRACK SYSTEMS, LLC, AUGUSTA, GA. SN 77-114,676. PUB. 1-12-2010, FILED 2-23-2007.

VTALK

THE MARK CONSISTS OF STANDARD CHARACTERS WITHOUT CLAIM TO ANY PARTICULAR FONT, STYLE, SIZE, OR COLOR.

FOR COMPUTER SOFTWARE FOR STORING A DATABASE OF STANDARDIZED ELECTRONIC TRANSACTIONS COMPRISING BILLING, INVOICING OR OTHERWISE CHARGING FOR MEDICAL SERVICES BY DOCTORS OR OTHER MEDICAL SERVICE PROVIDERS AND FOR PAYMENT, COMPROMISE OR SETTLEMENT FOR SUCH MEDICAL SERVICES BY INSURANCE COMPANIES, MEDICAID, MEDICARE AND/OR OTHER PUBLIC OR GOVERNMENT AGENCIES IN RESPONSE TO SUCH BILLING IN THE FIELDS OF HEALTH CARE AND INSURANCE, EXCLUDING THE FOLLOWING: COMPUTER SOFTWARE FOR USE IN PORTABLE AND HANDHELD DIGITAL ELECTRONIC DEVICES AND COMPUTER SOFTWARE FOR USE IN VOICE OVER INTERNET PROTOCOL (VOIP) COMMUNICATION (U.S. CLS. 21, 23, 26, 36 AND 38).
FIRST USE 4-0-2006; IN COMMERCE 4-0-2006.

3,807,446. AUTOPART INTERNATIONAL, INC., NORTON, MA. SN 77-119,409. PUB. 7-15-2008, FILED 3-1-2007.

Protune

THE MARK CONSISTS OF STANDARD CHARACTERS WITHOUT CLAIM TO ANY PARTICULAR FONT, STYLE, SIZE, OR COLOR.

FOR VEHICLE IGNITION PARTS, NAMELY, IGNITION SENSORS, IGNITION SWITCHES, IGNITION MODULES, IGNITION SOLENOIDS, IGNITION VOLTAGE REGULATORS, IGNITION CABLES, AND IGNITION CABLE SETS (U.S. CLS. 21, 23, 26, 36 AND 38).
FIRST USE 4-5-2010; IN COMMERCE 4-5-2010.

CLASS 9—(Continued).

3,807,447. OLYMPUS CORPORATION, TOKYO, JAPAN. SN 77-128,047. PUB. 9-11-2007, FILED 3-12-2007.

SPOT-RANGING

THE MARK CONSISTS OF STANDARD CHARACTERS WITHOUT CLAIM TO ANY PARTICULAR FONT, STYLE, SIZE, OR COLOR.

FOR INDUSTRIAL ENDOSCOPES; PARTS AND FITTINGS THEREFOR (U.S. CLS. 21, 23, 26, 36 AND 38).
FIRST USE 7-0-2005; IN COMMERCE 7-0-2005.

3,807,465. AUTOMATED MEDIA PROCESSING SOLUTIONS, INC., SAUSALITO, CA. SN 77-203,069. PUB. 6-9-2009, FILED 6-11-2007.

Ad-per-view

THE MARK CONSISTS OF STANDARD CHARACTERS WITHOUT CLAIM TO ANY PARTICULAR FONT, STYLE, SIZE, OR COLOR.

FOR COMPUTING SOFTWARE, NAMELY, COMPUTER SOFTWARE FOR PROVIDING TARGETED AND/OR PERSONALIZED MARKETING INFORMATION TO INDIVIDUALS AS PART OF A CONTENT PRESENTATION (U.S. CLS. 21, 23, 26, 36 AND 38).
FIRST USE 4-13-2009; IN COMMERCE 4-13-2009.

3,807,476. NIKON CORPORATION, TOKYO, JAPAN. SN 77-242,142. PUB. 11-27-2007, FILED 7-30-2007.



FOR LASER RANGEFINDER (U.S. CLS. 21, 23, 26, 36 AND 38).
FIRST USE 3-1-2008; IN COMMERCE 3-1-2008.

CLASS 9—(Continued).

3,807,480. BRIAN BOUCHARD, DBA CHI-STAR TECHNOLOGY, ALGONQUIN, IL. SN 77-248,183. PUB. 1-22-2008, FILED 8-6-2007.

ASSETCROSS

THE MARK CONSISTS OF STANDARD CHARACTERS WITHOUT CLAIM TO ANY PARTICULAR FONT, STYLE, SIZE, OR COLOR.

FOR SOFTWARE FOR TRANSFER OF ASSETS BETWEEN CORPORATE DEPRECIATION BOOKS (U.S. CLS. 21, 23, 26, 36 AND 38).

FIRST USE 4-15-2010; IN COMMERCE 4-15-2010.

3,807,495. ATMEL CORPORATION, SAN JOSE, CA. SN 77-268,682. PUB. 2-26-2008, FILED 8-30-2007.

XMEGA

THE MARK CONSISTS OF STANDARD CHARACTERS WITHOUT CLAIM TO ANY PARTICULAR FONT, STYLE, SIZE, OR COLOR.

FOR SEMICONDUCTOR INTEGRATED CIRCUITS, NAMELY, MICROCONTROLLER CHIPS; CIRCUIT BOARDS HAVING AT LEAST ONE MICROCONTROLLER CHIP; TOOLS, NAMELY, KITS FOR DEMONSTRATING, EVALUATING, AND SIMULATING MICROCONTROLLERS COMPRISING SOFTWARE, CIRCUIT BOARDS WITH OR WITHOUT AT LEAST ONE CHIP INCORPORATED OR EMBEDDED THEREIN, PERIPHERAL DEVICES, AND CABLES, AND COMPUTER PROGRAMS FOR DEMONSTRATING, EVALUATING, AND SIMULATING MICROCONTROLLERS (U.S. CLS. 21, 23, 26, 36 AND 38).

FIRST USE 4-0-2010; IN COMMERCE 4-0-2010.

3,807,496. IGT, RENO, NV. SN 77-274,709. PUB. 1-22-2008, FILED 9-7-2007.

CALYPSO MAGIC

THE MARK CONSISTS OF STANDARD CHARACTERS WITHOUT CLAIM TO ANY PARTICULAR FONT, STYLE, SIZE, OR COLOR.

FOR GAMING MACHINES, NAMELY, DEVICES WHICH ACCEPT A WAGER (U.S. CLS. 21, 23, 26, 36 AND 38).

FIRST USE 4-21-2010; IN COMMERCE 4-21-2010.

CLASS 9—(Continued).

3,807,508. FREEWAY EYEWEAR INC., LOS ANGELES, CA. SN 77-288,286. PUB. 2-12-2008, FILED 9-25-2007.

L.A. RAYS

THE MARK CONSISTS OF STANDARD CHARACTERS WITHOUT CLAIM TO ANY PARTICULAR FONT, STYLE, SIZE, OR COLOR.

NO CLAIM IS MADE TO THE EXCLUSIVE RIGHT TO USE "L.A.", APART FROM THE MARK AS SHOWN.

FOR EYEGLASS CASES; EYEGLASS FRAMES; EYEGLASSES; EYEWEAR (U.S. CLS. 21, 23, 26, 36 AND 38).

FIRST USE 4-3-2010; IN COMMERCE 4-3-2010.

3,807,510. MOD SYSTEMS INCORPORATED, SEATTLE, WA. SN 77-300,984. PUB. 4-15-2008, FILED 10-10-2007.

GREEN PLAY

THE MARK CONSISTS OF STANDARD CHARACTERS WITHOUT CLAIM TO ANY PARTICULAR FONT, STYLE, SIZE, OR COLOR.

FOR INTERACTIVE INFORMATIONAL AND MULTIMEDIA COMPUTER KIOSKS COMPRISING COMPUTER HARDWARE, COMPUTER OPERATING SOFTWARE AND COMPUTER PERIPHERALS FOR CONNECTING TO A GLOBAL COMPUTER NETWORK; COMPUTER MEMORY CARDS AND FLASH MEMORY CARDS; COMPUTER DISC DRIVES; COMPUTER SOFTWARE FOR RECORDING, WRITING AND COPYING SOUND, IMAGES AND DATA ON COMPACT DISCS, CD-ROM DISCS AND DVD DISCS AND OTHER OPTICAL DISCS; COMPUTER DISC DRIVES (U.S. CLS. 21, 23, 26, 36 AND 38).

FIRST USE 12-1-2009; IN COMMERCE 12-1-2009.

3,807,519. E-GLUE SOFTWARE TECHNOLOGIES, INC., HOBOKEN, NJ. SN 77-327,659. PUB. 11-11-2008, FILED 11-12-2007.

EGLUE INTERACT

THE MARK CONSISTS OF STANDARD CHARACTERS WITHOUT CLAIM TO ANY PARTICULAR FONT, STYLE, SIZE, OR COLOR.

FOR COMPUTER SOFTWARE, NAMELY, COMPUTER SOFTWARE PROVIDING REAL-TIME CUSTOMER INTERACTION MANAGEMENT APPLICATIONS (U.S. CLS. 21, 23, 26, 36 AND 38).

FIRST USE 9-0-2007; IN COMMERCE 9-0-2007.

CLASS 9—(Continued).

3,807,522. BLACKWAVE INC., ACTON, MA. SN 77-332,634. PUB. 4-7-2009, FILED 11-19-2007.

BLACKWAVE

THE MARK CONSISTS OF STANDARD CHARACTERS WITHOUT CLAIM TO ANY PARTICULAR FONT, STYLE, SIZE, OR COLOR.

FOR COMPUTER PROGRAMS FOR STORING, TRANSMITTING AND STREAMING DATA, PICTURES, SOFTWARE, MUSIC AND VIDEO FOR OTHERS VIA GLOBAL OR LOCAL COMPUTER NETWORKS; COMPUTER HARDWARE (U.S. CLS. 21, 23, 26, 36 AND 38). FIRST USE 1-10-2008; IN COMMERCE 1-10-2008.

CLASS 9—(Continued).

3,807,543. PURE ENERGY SOLUTIONS, INC., BOULDER, CO. SN 77-383,135. PUB. 6-17-2008, FILED 1-29-2008.



THE COLOR(S) ORANGE IS/ARE CLAIMED AS A FEATURE OF THE MARK.

THE MARK CONSISTS OF AN ORANGE STYLIZED GRID PATTERN OF FOUR DIAMOND SHAPED STARS THAT ARE EACH CONNECTED AT TWO ENDS FORMING A DIAMOND SHAPE WITHIN THE IMAGE.

FOR POWER SUPPLY AND DATA DELIVERY COMPUTER HARDWARE AND FIRMWARE, ELECTRICAL CONNECTORS, ELECTRICAL CONTACT PADS, AND ADAPTERS FOR DELIVERY OF ELECTRIC POWER AND/OR DATA TO PORTABLE, ELECTRICALLY POWERED AND ELECTRONIC DEVICES (U.S. CLS. 21, 23, 26, 36 AND 38).

FIRST USE 10-18-2007; IN COMMERCE 10-18-2007.

3,807,526. GARMIN INTERNATIONAL, INC., OLATHE, KS. SN 77-337,420. PUB. 4-29-2008, FILED 11-27-2007.

G950

THE MARK CONSISTS OF STANDARD CHARACTERS WITHOUT CLAIM TO ANY PARTICULAR FONT, STYLE, SIZE, OR COLOR.

FOR NAVIGATION AND COMMUNICATION SYSTEMS IN THE FIELD OF AVIONICS, NAMELY, GPS RECEIVERS, COMMUNICATION TRANSCEIVERS, TRANSPONDERS, AUDIO PANELS COMPRISING COMPUTER HARDWARE AND SOFTWARE FOR CONTROLLING TRANSMISSION AND RECEPTION OF RADIO SIGNALS, WEATHER RADAR, TERRAIN AWARENESS AND WARNING SYSTEMS (TAWS) COMPRISING COMPUTER HARDWARE AND SOFTWARE FOR DETERMINING WHEN A TERRAIN HAZARD EXISTS AND FOR OUTPUTTING CORRESPONDING ALERTS TO AN AIRCRAFT PILOT OR CREW, ATTITUDE HEADING AND REFERENCE SYSTEMS (AHRS) COMPRISING COMPUTER HARDWARE AND SOFTWARE FOR PROVIDING AIRCRAFT ATTITUDE AND HEADING INFORMATION FOR USE BY A PILOT, FLIGHT CREW OR OTHER AVIONICS, PRIMARY FLIGHT DISPLAYS (PFDS) COMPRISING COMPUTER HARDWARE AND SOFTWARE FOR DISPLAYING NAVIGATION AND FLIGHT INFORMATION AND FOR CONTROLLING AVIONICS INSTRUMENTS, AND MULTI-FUNCTION FLIGHT DISPLAYS (MFDS) COMPRISING COMPUTER HARDWARE AND SOFTWARE FOR DISPLAYING NAVIGATION AND FLIGHT INFORMATION AND FOR CONTROLLING AVIONICS INSTRUMENTS (U.S. CLS. 21, 23, 26, 36 AND 38). FIRST USE 1-0-2008; IN COMMERCE 1-0-2008.

3,807,553. CONTROL TECHNIQUES LIMITED, POWYS, UNITED KINGDOM. SN 77-404,103. PUB. 10-27-2009, FILED 2-22-2008.

DIGITAX

THE MARK CONSISTS OF STANDARD CHARACTERS WITHOUT CLAIM TO ANY PARTICULAR FONT, STYLE, SIZE, OR COLOR.

PRIORITY CLAIMED UNDER SEC. 44(D) ON ERPNTY TM OFC APPLICATION NO. 6686026, FILED 2-21-2008, REG. NO. 006686026, DATED 1-22-2009, EXPIRES 2-21-2018.

FOR ELECTRONIC SERVO MOTOR CONTROLLERS (U.S. CLS. 21, 23, 26, 36 AND 38). FIRST USE 1-0-2008; IN COMMERCE 7-7-2008.

CLASS 9—(Continued).

3,807,566. AONIX, ISSY LES MOULINEAUX, FRANCE. SN 77-413,715. PUB. 7-22-2008, FILED 3-5-2008.

TELEUSE

THE MARK CONSISTS OF STANDARD CHARACTERS WITHOUT CLAIM TO ANY PARTICULAR FONT, STYLE, SIZE, OR COLOR.

FOR COMPUTER SOFTWARE FOR PROGRAMMING AND DEVELOPING EMBEDDED SYSTEMS, AND FOR REAL TIME VIRTUAL MACHINE SOFTWARE DEVELOPMENT TOOLS THEREFOR, NAMELY, COMPUTER SOFTWARE FOR THE CREATION, ANALYSIS, DESIGN, CODING AND TESTING OF EMBEDDED SYSTEMS SOFTWARE (U.S. CLS. 21, 23, 26, 36 AND 38).

FIRST USE 12-31-1998; IN COMMERCE 12-31-1998.

CLASS 9—(Continued).

3,807,577. TEXAS SCENIC COMPANY, INC., SAN ANTONIO, TX. SN 77-425,843. PUB. 8-5-2008, FILED 3-19-2008.

DECK BOSS

THE MARK CONSISTS OF STANDARD CHARACTERS WITHOUT CLAIM TO ANY PARTICULAR FONT, STYLE, SIZE, OR COLOR.

FOR ELECTRIC MOTOR CONTROLLER (U.S. CLS. 21, 23, 26, 36 AND 38).

FIRST USE 3-0-2010; IN COMMERCE 3-0-2010.

3,807,568. ARMOUR, STEPHEN RICHARD, GRANTS PASS, OR. SN 77-414,535. PUB. 8-4-2009, FILED 3-6-2008.



NO CLAIM IS MADE TO THE EXCLUSIVE RIGHT TO USE "LIGHT IN ACTION", APART FROM THE MARK AS SHOWN.

THE COLOR(S) BLACK, WHITE, YELLOW, RED IS/ARE CLAIMED AS A FEATURE OF THE MARK.

THE MARK CONSISTS OF STYLIZED UPPERCASE LETTER "L", IN SHADES OF YELLOW WITH DIFFUSED YELLOW OUTLINE, AND WITH THE LOWER PART OF THE STYLIZED "L" SERVING AS THE UNDERLINE FOR THE LETTERS "IGHT IN ACTION" WHICH ARE YELLOW AND WITH DIFFUSED YELLOW OUTLINE, AND THE STYLIZED "L" ALSO SERVING AS THE CROSSBAR FOR THE UPPERCASE LETTER "A" IN THE WORD "ACTION" IN YELLOW WITH A DIFFUSED OUTLINE, WITH A WHITE AND YELLOW DIFFUSED SPOT ON THE RIGHT END OF THE LOWER PART OF THE "L", WITH A RED CIRCLE AND DIFFUSED RED COLOR AROUND IT, WITH ALL COLOR ELEMENTS AND LETTERS ON A BLACK BACKGROUND.

FOR DIGITAL MEDIA, NAMELY, PRE-RECORDED VIDEO CASSETTES, DIGITAL VIDEO DISCS, DIGITAL VERSATILE DISCS, DOWNLOADABLE AUDIO AND VIDEO RECORDINGS, DVDS, AND HIGH DEFINITION DIGITAL DISKS FEATURING PROGRAMS IN THE FIELD OF RELIGION (U.S. CLS. 21, 23, 26, 36 AND 38).

FIRST USE 4-7-2010; IN COMMERCE 4-7-2010.

3,807,618. ASHUR, JEFFREY, NEWTON, MA. SN 77-458,688. PUB. 3-31-2009, FILED 4-25-2008.

DaysTil

THE MARK CONSISTS OF STANDARD CHARACTERS WITHOUT CLAIM TO ANY PARTICULAR FONT, STYLE, SIZE, OR COLOR.

FOR TIMERS; DAY COUNT DOWN TIMER; ELECTRONIC DAY COUNTER IN A SINGLE OR MULTI-DIGIT FORMAT; DIGITAL TIME DISPLAY, NAMELY, AN ELECTRONIC REAL-TIME DISPLAY SHOWING DIGITS REPRESENTING THE AMOUNT OF TIME REMAINING WITH RESPECT TO AN ASSOCIATED TIMEKEEPING DEVICE; DIGITAL DAY AND TIME COUNTER; COUNT DOWN TIMER; EVENT MONITORS IN THE NATURE OF TIMERS FOR TRACKING THE NUMBER OF DAYS UNTIL AN EVENT SUCH AS TAXES DUE, SERVICE APPOINTMENT, SCHEDULED CLEANING, WARRANTY EXPIRATION, LOANED ITEMS DUE FOR RETURN, OR START OF A VACATION; ACTIVITY START MONITORS IN THE NATURE OF TIMERS FOR MONITORING A WIDE VARIETY OF ACTIVITIES INCLUDING FOR EXAMPLE PET GROOMING, FISH TANK CLEANING, POOL MAINTENANCE, PLANT CARE, PERSONAL CARE, HAIR CUT, HEALTH-CLUB WORK-OUT SCHEDULE, PERSONAL EXERCISE PROGRAMS, AND OTHER SUCH MAINTENANCE EVENTS (U.S. CLS. 21, 23, 26, 36 AND 38).

FIRST USE 4-20-2010; IN COMMERCE 4-20-2010.

CLASS 9—(Continued).

3,807,619. ALIPHCOM, SAN FRANCISCO, CA. SN 77-459,339. PUB. 2-17-2009, FILED 4-28-2008.

NOISEASSASSIN

THE MARK CONSISTS OF STANDARD CHARACTERS WITHOUT CLAIM TO ANY PARTICULAR FONT, STYLE, SIZE, OR COLOR.

FOR TELEPHONES; SPEAKERPHONES, AUDIO SPEAKERS, AND AUDIO CONTROL MODULES, NAMELY, ELECTRONIC CONTROLLERS FOR AUDIO CONTROL OF TELECOMMUNICATIONS EQUIPMENT; AND OPERATIONAL COMPUTER SOFTWARE FOR THE FOREGOING GOODS (U.S. CLS. 21, 23, 26, 36 AND 38).

FIRST USE 5-15-2008; IN COMMERCE 5-15-2008.

3,807,637. BLACKLINE GPS INC., CALGARY, CANADA. SN 77-480,667. PUB. 4-7-2009, FILED 5-21-2008.

Share Your Where

THE MARK CONSISTS OF STANDARD CHARACTERS WITHOUT CLAIM TO ANY PARTICULAR FONT, STYLE, SIZE, OR COLOR.

FOR COMPUTER HARDWARE AND SOFTWARE SYSTEM FOR TRACKING PEOPLE, OBJECTS AND PETS USING GPS DATA ON A DEVICE ON THE TRACKED PEOPLE, OBJECTS AND PETS; GLOBAL POSITIONING SYSTEM (GPS); GLOBAL POSITIONING SYSTEM (GPS) CONSISTING OF COMPUTERS, COMPUTER SOFTWARE, TRANSMITTERS, RECEIVERS, AND NETWORK INTERFACE DEVICES; VEHICLE LOCATOR AND RECOVERY DEVICE PROGRAMMED TO USE GLOBAL POSITIONING SYSTEMS (GPS) AND CELLULAR TELECOMMUNICATIONS (U.S. CLS. 21, 23, 26, 36 AND 38).

FIRST USE 8-0-2007; IN COMMERCE 8-0-2007.

CLASS 9—(Continued).

3,807,642. STMICROELECTRONICS N.V., GENEVA, SWITZERLAND. SN 77-484,747. PUB. 8-18-2009, FILED 5-28-2008.

STAC

THE MARK CONSISTS OF STANDARD CHARACTERS WITHOUT CLAIM TO ANY PARTICULAR FONT, STYLE, SIZE, OR COLOR.

FOR ELECTRONIC PACKAGES FOR POWER TRANSISTORS COMPRISED PRIMARILY OF MICROELECTRONIC CIRCUITS, SEMICONDUCTORS, ELECTRICAL CONNECTORS, CONNECTORS FOR ELECTRONIC CIRCUITS AND HEAT SINKS (U.S. CLS. 21, 23, 26, 36 AND 38).

FIRST USE 11-12-2008; IN COMMERCE 11-12-2008.

3,807,644. PRESONUS AUDIO ELECTRONICS, INC., BATON ROUGE, LA. SN 77-490,944. PUB. 7-28-2009, FILED 6-4-2008.



NO CLAIM IS MADE TO THE EXCLUSIVE RIGHT TO USE "CAPTURE", APART FROM THE MARK AS SHOWN. THE COLOR(S) BLACK AND WHITE IS/ARE CLAIMED AS A FEATURE OF THE MARK.

THE MARK CONSISTS OF A STYLIZED DEPICTION OF A RECORD BUTTON ON AUDIO EQUIPMENT TO THE LEFT OF THE WORD "CAPTURE".

FOR COMPUTER SOFTWARE FOR THE CONTROL AND OPERATION OF AUDIO RECORDING EQUIPMENT (U.S. CLS. 21, 23, 26, 36 AND 38).

FIRST USE 2-1-2009; IN COMMERCE 2-1-2009.

3,807,649. SUNGARD PUBLIC SECTOR INC., LAKE MARY, FL. SN 77-498,759. PUB. 7-21-2009, FILED 6-13-2008.

Ola

THE MARK CONSISTS OF STANDARD CHARACTERS WITHOUT CLAIM TO ANY PARTICULAR FONT, STYLE, SIZE, OR COLOR.

FOR COMPUTER SOFTWARE USED TO ADMINISTER STANDARDS-BASED ASSESSMENTS TO STUDENTS, AND TO ASSESS STUDENTS' PERFORMANCE ON STANDARDS-BASED ASSESSMENTS (U.S. CLS. 21, 23, 26, 36 AND 38).

FIRST USE 6-1-2008; IN COMMERCE 10-1-2008.

CLASS 9—(Continued).

3,807,654. COIN-MATE INC, CHICAGO, IL. SN 77-503,407.
PUB. 6-16-2009, FILED 6-19-2008.

CoinMate

THE MARK CONSISTS OF THE WORDING "COINMATE" IN STYLIZED FONT.

FOR COIN CHANGERS; COIN COUNTING OR SORTING MACHINES; COUNTERFEIT MONEY DETECTION LIGHT TO BE USED IN RETAIL STORES AND BANKS; CURRENCY COUNTING MACHINES; CURRENCY RECOGNITION MACHINES; CURRENCY SORTING MACHINES; MONEY COUNTING AND SORTING MACHINES (U.S. CLS. 21, 23, 26, 36 AND 38).

FIRST USE 10-1-2009; IN COMMERCE 10-1-2009.

3,807,670. TREK 2000 INTERNATIONAL LTD, 508769, SINGAPORE. SN 77-521,241. PUB. 2-10-2009, FILED 7-14-2008.

FLU CARD

THE MARK CONSISTS OF STANDARD CHARACTERS WITHOUT CLAIM TO ANY PARTICULAR FONT, STYLE, SIZE, OR COLOR.

NO CLAIM IS MADE TO THE EXCLUSIVE RIGHT TO USE "CARD", APART FROM THE MARK AS SHOWN.

FOR COMPUTER HARDWARE AND PERIPHERALS; COMPUTER BOARDS AND CHIPS; NETWORK CARDS; COMPUTER DISC DRIVES; COMPUTER DISCS, NAMELY, BLANK CD-ROMS AND BLANK HD-DVD DISCS; BLANK COMPUTER DISC TAPES; MEDIA, NAMELY, BLANK DVDS, BLANK AUDIO CASSETTES, AND WIRELESS EXTERNAL COMPUTER STORAGE DEVICES, NAMELY, USB FLASH DRIVE, OPTICAL PICK-UP DRIVE, OPTICAL DRIVE AND FLASH DRIVES; AND APPARATUS, ALL FOR THE ACQUISITION, RECORDING, PROCESSING, TRANSMISSION, STORAGE OR OUTPUT OF SOUND, IMAGES AND/OR DATA (U.S. CLS. 21, 23, 26, 36 AND 38).

FIRST USE 1-20-2010; IN COMMERCE 1-20-2010.

3,807,682. RAYMOND O. BATCHELOR, UNION, NJ. SN 77-533,783. PUB. 7-28-2009, FILED 7-29-2008.



THE MARK CONSISTS OF THE WORDING "PRO-PHYLE SGS" IN STYLIZED FORMAT; WITHIN THE FIRST LETTER "P", IS THE SILHOUETTE OF A MAN'S HEAD; BETWEEN "PHYLE" AND "SGS" IS THE DESIGN OF AN EYE.

FOR SUNGLASSES (U.S. CLS. 21, 23, 26, 36 AND 38).
FIRST USE 12-15-2009; IN COMMERCE 12-15-2009.

CLASS 9—(Continued).

3,807,687. HARRIS CORPORATION, MELBOURNE, FL. SN 77-536,679. PUB. 7-7-2009, FILED 8-1-2008.

GEOSTAR

THE MARK CONSISTS OF STANDARD CHARACTERS WITHOUT CLAIM TO ANY PARTICULAR FONT, STYLE, SIZE, OR COLOR.

FOR COMPUTER SOFTWARE, NAMELY, USER-INTERFACE SOFTWARE FOR INTERNET-BASED SEARCHING, RETRIEVING AND VIEWING OF GEOGRAPHIC INFORMATION AND ASSOCIATED META-DATA AND FOR PLACING ORDERS FOR GEOGRAPHIC INFORMATION PRODUCTS (U.S. CLS. 21, 23, 26, 36 AND 38).

FIRST USE 5-20-2009; IN COMMERCE 5-20-2009.

3,807,689. THE VON CORPORATION, BIRMINGHAM, AL. SN 77-538,363. PUB. 3-31-2009, FILED 8-4-2008.

SERVICE SENTRY

THE MARK CONSISTS OF STANDARD CHARACTERS WITHOUT CLAIM TO ANY PARTICULAR FONT, STYLE, SIZE, OR COLOR.

NO CLAIM IS MADE TO THE EXCLUSIVE RIGHT TO USE "SERVICE", APART FROM THE MARK AS SHOWN.

FOR GROUND FAULT INTERRUPTER, NAMELY, A CURRENT SENSING DEVICE TO BE INSTALLED BY AN ELECTRIC UTILITY COMPANY WHILE TEMPORARY EQUIPMENT IS IN PLACE TO RESTORE A SUBSCRIBER'S POWER (U.S. CLS. 21, 23, 26, 36 AND 38).

FIRST USE 8-20-2008; IN COMMERCE 8-20-2008.

3,807,724. KYNEN, LLC, SEVERNA PARK, MD. SN 77-556,913. PUB. 7-14-2009, FILED 8-27-2008.

Tact-ID

THE MARK CONSISTS OF STANDARD CHARACTERS WITHOUT CLAIM TO ANY PARTICULAR FONT, STYLE, SIZE, OR COLOR.

FOR ELECTRONIC DEVICES FOR BIOMETRIC VERIFICATION OF PERSONAL IDENTITY (U.S. CLS. 21, 23, 26, 36 AND 38).

FIRST USE 12-1-2009; IN COMMERCE 12-1-2009.

CLASS 9—(Continued).

3,807,734. DOMO RECORDS, INC., LOS ANGELES, CA. SN 77-558,870. PUB. 8-4-2009, FILED 8-29-2008.

DARUMA

THE MARK CONSISTS OF STANDARD CHARACTERS WITHOUT CLAIM TO ANY PARTICULAR FONT, STYLE, SIZE, OR COLOR.

THE ENGLISH TRANSLATION OF "DARUMA" IN THE MARK IS A TYPE OF HOLLOW, ROUND JAPANESE GOOD LUCK DOLL.

FOR RECORD ALBUMS, COMPACT DISCS AND DOWNLOADABLE ELECTRONIC FILES CONTAINING MUSIC; DVDS AND DOWNLOADABLE ELECTRONIC FILES CONTAINING AUDIO-VISUAL MUSICAL PERFORMANCES (U.S. CLS. 21, 23, 26, 36 AND 38).

FIRST USE 3-10-2009; IN COMMERCE 3-10-2009.

CLASS 9—(Continued).

3,807,757. SHORE MICROSYSTEMS, INC., LONG BRANCH, NJ. SN 77-565,737. PUB. 5-12-2009, FILED 9-9-2008.

SHORE MICROSYSTEMS

THE MARK CONSISTS OF STANDARD CHARACTERS WITHOUT CLAIM TO ANY PARTICULAR FONT, STYLE, SIZE, OR COLOR.

NO CLAIM IS MADE TO THE EXCLUSIVE RIGHT TO USE "MICROSYSTEMS", APART FROM THE MARK AS SHOWN.

FOR ETHERNET VOLTAGE SURGE PROTECTORS; ETHERNET BYPASS SWITCHES; TRANSCEIVERS; REDUNDANT TRANSCEIVERS; ELECTRIC BYPASS SWITCHES; COMPUTER NETWORK SWITCHES, ROUTERS, AND HUB ROUTERS; LAN COMPUTER CARDS FOR CONNECTING PORTABLE COMPUTER DEVICES TO COMPUTER NETWORKS; ELECTRICAL WIRES, NAMELY, REGISTERED JACK (RJ45) WIRES, CATEGORY 5 AND 6 ETHERNET WIRES, NETWORK WIRES, TELEPHONE WIRES; (LAN) ACCESS POINTS FOR CONNECTING NETWORK COMPUTER USERS; COMPUTER CHASSIS; COMPUTER HARDWARE AND FIRMWARE FOR USE IN NETWORK MANAGEMENT, INTERFACING HARDWARE FOR USE IN CONNECTING WIRED AND WIRELESS TEXT AND GRAPHICS VIDEO DISPLAY DEVICES; COMPUTER PERIPHERALS; COMPUTER HARDWARE, NAMELY, WIRELESS ACCESS POINT DEVICES; STORAGE AREA NETWORKS AND NETWORKING COMPONENTS, NAMELY, WIRED AND WIRELESS NETWORK INTERFACE HARDWARE AND GRAPHICAL USER INTERFACE SOFTWARE; DIFFERENTIAL SWITCHES AND CONNECTIVITY COMPUTER SWITCHES; COMPUTER SOFTWARE FOR USE IN CONTROLLING AND MANAGING GATEWAY ROUTERS, BRIDGES, HUBS, AND MODEMS, COMPUTER CABLES; INTEGRATED CIRCUITS; COMPUTER HARDWARE, NAMELY, FIREWALLS; COMMUNICATION SYSTEM COMPONENTS, NAMELY, COMPUTER SWITCHES, ROUTERS, HUBS, AND BRIDGES; ANALOG AND DIGITAL TELEPHONY INTERFACE APPARATUS, NAMELY, INTERNET PROTOCOL WIRELESS TELEPHONY APPARATUS; COMPUTER SWITCH CABLES, WAN ACCESS COMPUTER CABLES, MULTI-LINE TELEPHONES, ATTENDANT ELECTRIC DISTRIBUTION CONSOLES; REMOTE ACCESS EQUIPMENT, NAMELY, TERMINAL COMMUNICATIONS SERVERS AND TELEPHONES; COMPUTER SOFTWARE FOR USE IN THE CREATION OF FIREWALLS; VIRTUAL NETWORK INTERFACE CARDS FOR DATA PROCESSING EQUIPMENT IN THE FORM OF PRINTED CIRCUITS; POWER SUPPLIES AND REDUNDANT POWER SUPPLIES, NAMELY, THOSE CONTAINED IN SWITCHES, ROUTERS, NETWORK APPLIANCES, BRIDGES, AND HUBS, WIRELESS ACCESS POINTS, WIRELESS LAN ANTENNAS AND CABLES, PC CARDS, AND INTERFACE CARDS AND MODULES (U.S. CLS. 21, 23, 26, 36 AND 38).

FIRST USE 11-8-1990; IN COMMERCE 11-8-1990.

3,807,748. PROCREATE INC., ANACORTES, WA. SN 77-562,967. PUB. 1-27-2009, FILED 9-5-2008.

PODIUM

THE MARK CONSISTS OF STANDARD CHARACTERS WITHOUT CLAIM TO ANY PARTICULAR FONT, STYLE, SIZE, OR COLOR.

FOR MECHANICAL ACCESSORIES FOR PORTABLE AND HANDHELD DIGITAL ELECTRONIC DEVICES, NAMELY, STANDS, SPECIALLY DESIGNED FOR HOLDING PORTABLE AND HANDHELD DIGITAL ELECTRONIC DEVICES (U.S. CLS. 21, 23, 26, 36 AND 38).

FIRST USE 1-1-2009; IN COMMERCE 1-1-2009.

3,807,751. TJS DMCC, FORMERLY THE JEWELLERY STORE DMCC, DEIRA, DUBAI, UNITED ARAB EMIR.. SN 77-564,130. PUB. 2-3-2009, FILED 9-7-2008.

SENSE AND VISIBILITY

THE MARK CONSISTS OF STANDARD CHARACTERS WITHOUT CLAIM TO ANY PARTICULAR FONT, STYLE, SIZE, OR COLOR.

FOR SOFTWARE, NAMELY, INVENTORY TRACKING SOFTWARE FOR USE IN PRODUCT DISTRIBUTION, OPERATIONS MANAGEMENT, LOGISTICS, REVERSE LOGISTICS, SUPPLY CHAIN AND PRODUCTION SYSTEMS AND DISTRIBUTION SYSTEMS (U.S. CLS. 21, 23, 26, 36 AND 38).

FIRST USE 3-15-2009; IN COMMERCE 9-1-2009.

CLASS 9—(Continued).

3,807,759. VEHICLE TRACKING SOLUTIONS, LLC, DEER PARK, NY. SN 77-566,538. PUB. 1-27-2009, FILED 9-10-2008.



THE MARK CONSISTS OF THE WORDS "SILENT PASSENGER" IN BOLD LETTERS WITH A BLACK FILLED IN SWIRL UNDER THE WORD "PASSENGER" WITH SEVEN WHITE DASHES SPACED EVENLY IN THE SWIRL.

FOR COMPUTER SOFTWARE FOR VEHICLE FLEET MANAGEMENT USING GPS (GLOBAL POSITIONING SYSTEM) TECHNOLOGY TO COLLECT, STORE AND DISPLAY VEHICLE EVENTS TO INCLUDE ENGINE AND ACCESSORY STATUS, SPEED, LOCATION AND STOPS IN REAL TIME (U.S. CLS. 21, 23, 26, 36 AND 38).
FIRST USE 4-1-2010; IN COMMERCE 4-1-2010.

CLASS 9—(Continued).

3,807,766. CURBELL ELECTRONICS, INC., ORCHARD PARK, NY. SN 77-567,470. PUB. 8-11-2009, FILED 9-11-2008.

GEN4

THE MARK CONSISTS OF STANDARD CHARACTERS WITHOUT CLAIM TO ANY PARTICULAR FONT, STYLE, SIZE, OR COLOR.

FOR ELECTRICAL HOSPITAL CALLING APPARATUS, NAMELY, PILLOW SPEAKERS FOR THE PURPOSES OF CALLING AND SIGNALING NURSES (U.S. CLS. 21, 23, 26, 36 AND 38).

FIRST USE 2-12-2009; IN COMMERCE 3-16-2009.

3,807,764. ZEMNO LLC, ENCINO, CA. SN 77-567,104. PUB. 1-27-2009, FILED 9-10-2008.

ModBay

THE MARK CONSISTS OF STANDARD CHARACTERS WITHOUT CLAIM TO ANY PARTICULAR FONT, STYLE, SIZE, OR COLOR.

FOR COMPUTER PERIPHERALS (U.S. CLS. 21, 23, 26, 36 AND 38).

FIRST USE 11-24-2009; IN COMMERCE 11-24-2009.

3,807,775. PINNACLE CALL CENTER SOLUTIONS, INC., UPLAND, CA. SN 77-570,911. PUB. 8-4-2009, FILED 9-16-2008.



NO CLAIM IS MADE TO THE EXCLUSIVE RIGHT TO USE "BILL", APART FROM THE MARK AS SHOWN.

THE COLOR(S) BLACK, YELLOW AND GREEN IS/ARE CLAIMED AS A FEATURE OF THE MARK.

THE MARK CONSISTS OF THE STYLIZED WORDING "BILL LOGIC" IN BLACK TEXT AND A THREE-QUARTERED YELLOW TONED SEMI-CIRCLE WITH AN ARROW HEAD AT ITS END WITH THE CIRCLE STARTING ABOVE THE "O" IN "LOGIC" AND ENDING WITH THE ARROW-HEAD OVER THE "I" IN "BILL", AND IT ALSO HAS A GREEN TONED THREE-QUARTERED SMALLER CIRCLE POSITIONED WITHIN THE LARGER YELLOW CIRCLE AS WELL AS A GREEN TONED TRIANGLE DOTTING THE "I" IN "LOGIC".

FOR CALL CENTER SOFTWARE FOR THE UTILITY MARKET, NAMELY, SOFTWARE USED BY CUSTOMER SERVICE REPRESENTATIVES TO PROVIDE DIRECT ANSWERS TO REAL-TIME, IN-CALL QUERIES RELATED TO CUSTOMERS' COMPLAINTS (U.S. CLS. 21, 23, 26, 36 AND 38).

FIRST USE 9-11-2008; IN COMMERCE 11-7-2009.

3,807,765. ZEMNO LLC, ENCINO, CA. SN 77-567,120. PUB. 1-27-2009, FILED 9-10-2008.

ZEMNO

THE MARK CONSISTS OF STANDARD CHARACTERS WITHOUT CLAIM TO ANY PARTICULAR FONT, STYLE, SIZE, OR COLOR.

FOR COMPUTER PERIPHERALS (U.S. CLS. 21, 23, 26, 36 AND 38).

FIRST USE 11-24-2009; IN COMMERCE 11-24-2009.

CLASS 9—(Continued).

3,807,787. IGT, RENO, NV. SN 77-573,138. PUB. 2-3-2009, FILED 9-18-2008.

TURN OF CHANCE

THE MARK CONSISTS OF STANDARD CHARACTERS WITHOUT CLAIM TO ANY PARTICULAR FONT, STYLE, SIZE, OR COLOR.

FOR GAMING MACHINES, NAMELY, DEVICES WHICH ACCEPT A WAGER (U.S. CLS. 21, 23, 26, 36 AND 38).

FIRST USE 1-29-2010; IN COMMERCE 1-29-2010.

CLASS 9—(Continued).

3,807,808. AWARDSCAN SOFTWARE, INC., KANSAS CITY, MO. SN 77-582,418. PUB. 3-31-2009, FILED 9-30-2008.

AWARDSCAN

THE MARK CONSISTS OF STANDARD CHARACTERS WITHOUT CLAIM TO ANY PARTICULAR FONT, STYLE, SIZE, OR COLOR.

FOR COMPUTER SOFTWARE USED IN RECORDING, TRACKING AND COMPUTING REQUIREMENTS FOR OBTAINING RECOGNITION AND AWARDS IN ORGANIZATIONS AND CONTESTS (U.S. CLS. 21, 23, 26, 36 AND 38).

FIRST USE 3-9-2010; IN COMMERCE 3-9-2010.

3,807,833. IMMUNOLOGY MEDICAL EDUCATION AND RESEARCH CONSULTANTS, INC., GRAYSLAKE, IL. SN 77-595,474. PUB. 1-5-2010, FILED 10-17-2008.

IMERC

THE MARK CONSISTS OF STANDARD CHARACTERS WITHOUT CLAIM TO ANY PARTICULAR FONT, STYLE, SIZE, OR COLOR.

FOR DIGITAL MEDIA, NAMELY, DVDS AND DOWNLOADABLE PODCASTS FEATURING EDUCATIONAL FILMS ON MEDICAL ULTRASOUND IMAGING TECHNIQUES (U.S. CLS. 21, 23, 26, 36 AND 38).

FIRST USE 0-0-2009; IN COMMERCE 0-0-2009.

3,807,790. BATTERY HUB, APPLETON, WI. SN 77-575,419. PUB. 2-10-2009, FILED 9-22-2008.



NO CLAIM IS MADE TO THE EXCLUSIVE RIGHT TO USE "BATTERY", APART FROM THE MARK AS SHOWN.

THE MARK CONSISTS OF THE STYLIZED WORDS "BATTERY HUB" BELOW AN IMAGE OF A ABSTRACT DESIGN.

FOR BATTERIES (U.S. CLS. 21, 23, 26, 36 AND 38). FIRST USE 8-1-2008; IN COMMERCE 11-1-2008.

3,807,834. SPEEDSKIN LLC, DBA SPEEDSKIN LLC, AGOURA HILLS, CA. SN 77-595,985. PUB. 2-24-2009, FILED 10-20-2008.

Type Right Now

THE MARK CONSISTS OF STANDARD CHARACTERS WITHOUT CLAIM TO ANY PARTICULAR FONT, STYLE, SIZE, OR COLOR.

NO CLAIM IS MADE TO THE EXCLUSIVE RIGHT TO USE "TYPE", APART FROM THE MARK AS SHOWN.

FOR EDUCATIONAL SOFTWARE FEATURING INSTRUCTION IN TYPING (U.S. CLS. 21, 23, 26, 36 AND 38).

FIRST USE 2-6-2009; IN COMMERCE 2-6-2009.

CLASS 9—(Continued).

3,807,851. LUXEON INTERNATIONAL HOLDING LIMITED, TORTOLA, BR.VIRGIN ISLANDS. SN 77-605,485. PUB. 7-21-2009, FILED 10-31-2008.



OWNER OF U.S. REG. NO. 2,317,827.

THE MARK CONSISTS OF THE WORD "VIVITEK" WITH A CURVED LINE RUNNING FROM THE TOP OF THE FIRST LETTER "I" OVER THE SECOND LETTER "V" TO THE TOP OF THE SECOND LETTER "I".

FOR TELEVISIONS; TELEVISION MONITORS; DIGITAL SIGNAGE MONITORS; TELEVISION RECEIVERS; COMPUTERS; MONITORS FOR COMPUTERS; LIQUID CRYSTAL DATA DISPLAYS OF AUDIO AND VIDEO APPARATUS; HELMET MOUNTED LIQUID CRYSTAL DISPLAYS FOR BANKING MACHINES; LIQUID CRYSTAL DISPLAYS FOR POINT-OF-SALE TERMINALS; LIQUID CRYSTAL DISPLAYS FOR VIDEO GAMES; GRAPHIC LIQUID CRYSTAL DISPLAYS; CHARACTER LIQUID CRYSTAL DISPLAY DEVICES; ELECTRONIC VIDEO PROJECTORS; FRONT VIDEO PROJECTORS; REAR VIDEO PROJECTORS; 3D EYE GLASSES AND 3D LIQUID CRYSTAL DISPLAYS; FLAT PANEL COMBO LCD TELEVISIONS; FLAT PANEL COMBO LCD HDTVS; FLAT PANEL LCD TVS; FLAT PANEL LCD HDTVS; DIGITAL CABLE LCD TVS; DIGITAL CABLE LCD HDTVS; DIGITAL CABLE COMBO LCD HDTVS; HD READY LCD MONITORS; FLAT PANEL LCD MONITORS; DIGITAL IMAGING SYSTEM TVS; REAR PROJECTION TVS; MICRODISPLAY PROJECTION TVS; MICRODISPLAY PROJECTION DISPLAYS; REAR PROJECTION DISPLAYS; OPTICAL ENGINES; 3 CHIP HOME CINEMA PROJECTORS; SINGLE CHIP HOME CINEMA PROJECTORS; VIDEO WALLS; PLASMA TVS; INSPECTION SYSTEMS, COMPRISED OF ELECTRICAL CONTROL APPARATUS, SIGNAL CAPTURE APPARATUS, COMPUTER WITH INSPECTION ALGORITHM AND HUMAN-MACHINE INTERFACE; IMAGE MEASUREMENT SYSTEMS COMPRISED OF ELECTRICAL CONTROL APPARATUS, IMAGE CAPTURE APPARATUS WITH CAMERA AND LENS, COMPUTER WITH INSPECTION ALGORITHM AND HUMAN-MACHINE INTERFACE; IMAGE RECOGNITION SYSTEMS COMPRISED OF ELECTRICAL CONTROL APPARATUS, IMAGE CAPTURE APPARATUS WITH CAMERA AND LENS, COMPUTER WITH INSPECTION ALGORITHM AND HUMAN-MACHINE INTERFACE; TRANSMISSION BELT AND ELECTRONIC CONTROL DEVICE; IMAGE CAPTURE DEVICE,

CLASS 9—(Continued).

NAMELY, CAMERA AND LENS, COMPUTER WITH INSPECTION ALGORITHM AND DISPLAY DEVICE FOR HUMAN-MACHINE INTERFACE; INSPECTION APPARATUS FOR SOLAR BATTERIES, NAMELY, IMAGE INSPECTING, MEASURING AND RECOGNIZING APPARATUS FOR SOLAR BATTERIES, COMPRISED OF GEAR DEVICES, TRANSMISSION BELTS AND ELECTRONIC CONTROL DEVICE; AUTOMATIC OPTICAL INSPECTION APPARATUS FOR USE IN INDUSTRIAL USE; AUTOMATIC METERS FOR ELECTRIC CIRCUIT; ELECTRICITY MEASURING DEVICES; ELECTRIC CIRCUIT TESTERS; ELECTRIC INDUCTANCE TESTERS; ELECTRIC CAPACITY TESTERS; ELECTRIC RESISTANCES TESTERS; HYBRID AUTOMATIC INSPECTION APPARATUS FOR INSPECTION OF INTEGRATED CIRCUITS; HYBRID AUTOMATIC INSPECTION APPARATUS FOR INSPECTION OF PRINTED CIRCUITS; INSPECTION APPARATUS FOR INSPECTION OF ELECTRIC LEAKAGE; INSPECTION APPARATUS FOR INSPECTION OF INTEGRATED CIRCUITS (U.S. CLS. 21, 23, 26, 36 AND 38).

FIRST USE 1-4-2008; IN COMMERCE 1-15-2008.

3,807,865. KLA-TENCOR CORPORATION, MILPITAS, CA. SN 77-611,427. PUB. 3-24-2009, FILED 11-10-2008.



THE MARK CONSISTS OF STANDARD CHARACTERS WITHOUT CLAIM TO ANY PARTICULAR FONT, STYLE, SIZE, OR COLOR.

FOR COMPUTER HARDWARE, SOFTWARE AND USER MANUALS SOLD AS A UNIT, AND EQUIPMENT, NAMELY, INSPECTION, METROLOGY AND TESTING HARDWARE, ALL FOR INSPECTING AND MEASURING SEMICONDUCTORS DURING MANUFACTURING AND PROCESSING (U.S. CLS. 21, 23, 26, 36 AND 38).

FIRST USE 12-7-2009; IN COMMERCE 12-7-2009.

3,807,876. JOHN BOURQUE, CRANSTON, RI. SN 77-617,662. PUB. 4-7-2009, FILED 11-19-2008.



THE MARK CONSISTS OF STANDARD CHARACTERS WITHOUT CLAIM TO ANY PARTICULAR FONT, STYLE, SIZE, OR COLOR.

FOR SECURITY AND FIRE ALARMS (U.S. CLS. 21, 23, 26, 36 AND 38).

FIRST USE 10-2-2006; IN COMMERCE 10-2-2006.

CLASS 9—(Continued).

3,807,891. PYRAMEX SAFETY PRODUCTS, LLC, COLLIERVILLE, TN. SN 77-629,273. PUB. 4-14-2009, FILED 12-9-2008.

GOLIATH

THE MARK CONSISTS OF STANDARD CHARACTERS WITHOUT CLAIM TO ANY PARTICULAR FONT, STYLE, SIZE, OR COLOR.

FOR SAFETY EYEWEAR (U.S. CLS. 21, 23, 26, 36 AND 38).
FIRST USE 2-1-2009; IN COMMERCE 2-10-2009.



3,807,894. ACELLENT TECHNOLOGIES, INC., SUNNYVALE, CA. SN 77-635,036. PUB. 4-21-2009, FILED 12-17-2008.

SCANSENTRY

THE MARK CONSISTS OF STANDARD CHARACTERS WITHOUT CLAIM TO ANY PARTICULAR FONT, STYLE, SIZE, OR COLOR.

FOR STRUCTURAL HEALTH MONITORING HARDWARE, NAMELY, SCANNERS FOR THE EVALUATION OF STRUCTURAL INTEGRITY FOR AUTOMOTIVE, AVIATION, AEROSPACE, MILITARY, NAVAL, ENERGY, AND/OR CONSTRUCTION APPLICATIONS; SCANNERS FOR EVALUATING STRUCTURAL INTEGRITY OF MILITARY ARMOR, INCLUDING PERSONAL ARMOR AND VEHICLE ARMOR (U.S. CLS. 21, 23, 26, 36 AND 38).
FIRST USE 11-3-2009; IN COMMERCE 11-3-2009.



3,807,897. CASE-ARI, DBA CASE-MATE, TUCKER, GA. SN 77-637,173. PUB. 4-21-2009, FILED 12-19-2008.

Fuel

THE MARK CONSISTS OF STANDARD CHARACTERS WITHOUT CLAIM TO ANY PARTICULAR FONT, STYLE, SIZE, OR COLOR.

FOR CARRYING CASES FOR CELL PHONES; CASES FOR MOBILE PHONES; CASES FOR TELEPHONES; PROTECTIVE CARRYING CASES FOR PORTABLE MUSIC PLAYERS, NAMELY, MP3 PLAYERS (U.S. CLS. 21, 23, 26, 36 AND 38).
FIRST USE 4-23-2009; IN COMMERCE 4-23-2009.

CLASS 9—(Continued).

3,807,900. RAYTHEON COMPANY, TA RTN, WALTHAM, MA. SN 77-639,274. PUB. 12-1-2009, FILED 12-23-2008.

WiPAK

THE MARK CONSISTS OF STANDARD CHARACTERS WITHOUT CLAIM TO ANY PARTICULAR FONT, STYLE, SIZE, OR COLOR.

FOR CONTROL APPARATUS IN THE FIELD OF AVIONICS, NAMELY, ELECTRICAL EQUIPMENT, NAMELY, GROUND-BASED, SHIP-BASED, VEHICLE-BASED, AND AIRCRAFT-BASED ELECTRONIC CONTROLS AND SOFTWARE FOR USE BY GOVERNMENTS, MILITARY, AND OTHER DEFENSE-BASED ENTITIES FOR REMOTE CONTROL OF PRECISION-GUIDED AIR-TO-GROUND AND AIR-TO-AIR MUNITIONS (U.S. CLS. 21, 23, 26, 36 AND 38).
FIRST USE 12-9-2009; IN COMMERCE 12-9-2009.



3,807,907. MICROSOFT CORPORATION, REDMOND, WA. SN 77-644,364. PUB. 4-7-2009, FILED 1-6-2009.

KODU

THE MARK CONSISTS OF STANDARD CHARACTERS WITHOUT CLAIM TO ANY PARTICULAR FONT, STYLE, SIZE, OR COLOR.

FOR COMPUTER SOFTWARE DEVELOPMENT TOOLS FOR DEVELOPING COMPUTER GAMES AND VIDEO GAMES; AND COMPUTER PROGRAMS, NAMELY, GAME SOFTWARE FOR USE ON COMPUTERS AND VIDEO GAME PLAYERS (U.S. CLS. 21, 23, 26, 36 AND 38).
FIRST USE 7-1-2009; IN COMMERCE 7-1-2009.



3,807,939. PRONK TECHNOLOGIES, INC., SUN VALLEY, CA. SN 77-661,631. PUB. 10-13-2009, FILED 2-2-2009.

FLOWTRAX

THE MARK CONSISTS OF STANDARD CHARACTERS WITHOUT CLAIM TO ANY PARTICULAR FONT, STYLE, SIZE, OR COLOR.

FOR APPARATUS TO TEST AND MEASURE PROPERTIES OF LIQUIDS EMITTED BY INFUSION PUMPS AND OTHER MEDICAL DEVICES (U.S. CLS. 21, 23, 26, 36 AND 38).
FIRST USE 2-15-2009; IN COMMERCE 3-9-2010.

CLASS 9—(Continued).

3,807,941. CARL ZEISS AG, 73447 OBERKOCHEN, FED REP GERMANY. SN 77-664,093. PUB. 11-17-2009, FILED 2-5-2009.

FORUM

THE MARK CONSISTS OF STANDARD CHARACTERS WITHOUT CLAIM TO ANY PARTICULAR FONT, STYLE, SIZE, OR COLOR.

FOR SOFTWARE USED TO CAPTURE IMAGES IN THE FIELDS OF OPHTHALMOLOGY AND SURGERY (U.S. CLS. 21, 23, 26, 36 AND 38).

FIRST USE 10-0-2009; IN COMMERCE 10-0-2009.

3,807,944. TYCO SAFETY PRODUCTS CANADA, LTD., CONCORD, ONTARIO, CANADA. SN 77-667,108. PUB. 9-22-2009, FILED 2-10-2009.

ALEXOR

THE MARK CONSISTS OF STANDARD CHARACTERS WITHOUT CLAIM TO ANY PARTICULAR FONT, STYLE, SIZE, OR COLOR.

FOR WIRELESS INTRUSION SECURITY CONTROL MONITORING AND ALARM SYSTEMS AND PARTS THEREFORE, NAMELY, CONTROL PANELS AND KEYPADS; SIRENS; SMOKE DETECTORS; FLOOD AND CO2 DETECTORS; ELECTRONIC SECURITY TOKEN IN THE NATURE OF A FOB-LIKE DEVICE USED BY AN AUTHORIZED USER OF A COMPUTER SYSTEM TO FACILITATE AUTHENTICATION (U.S. CLS. 21, 23, 26, 36 AND 38).

FIRST USE 7-21-2009; IN COMMERCE 7-21-2009.

3,807,945. ISCO INTERNATIONAL, LLC, ELK GROVE VILLAGE, IL. SN 77-667,274. PUB. 6-9-2009, FILED 2-10-2009.

Spectrum View

THE MARK CONSISTS OF STANDARD CHARACTERS WITHOUT CLAIM TO ANY PARTICULAR FONT, STYLE, SIZE, OR COLOR.

FOR COMPUTER SOFTWARE FOR USE WITH INTERFERENCE DETECTION EQUIPMENT IN WIRELESS NETWORKS TO DIAGNOSE AND MANAGE INTERFERENCE EVENTS (U.S. CLS. 21, 23, 26, 36 AND 38).

FIRST USE 1-31-2009; IN COMMERCE 6-30-2009.

CLASS 9—(Continued).

3,807,949. CONCURRENT TECHNOLOGIES CORPORATION, JOHNSTOWN, PA. SN 77-669,305. PUB. 6-9-2009, FILED 2-12-2009.



OWNER OF U.S. REG. NO. 1,954,661.
THE MARK CONSISTS OF THE LETTERS "CTC" FOLLOWED BY TWO CONVERGING SWOOSHES.

FOR BODY ARMOR; PROTECTIVE ARMOR FOR PROTECTING AGAINST BALLISTIC PROJECTILES AND EXPLOSIVE FRAGMENTS INSTALLED IN OR ATTACHED TO VEHICLES, BUILDINGS OR OTHER STRUCTURES (U.S. CLS. 21, 23, 26, 36 AND 38).

FIRST USE 3-5-2010; IN COMMERCE 3-5-2010.

3,807,958. NENG FENG WANG, WENZHOU, CHINA. SN 77-671,602. PUB. 8-25-2009, FILED 2-17-2009.



THE MARK CONSISTS OF A MISCELLANEOUS SYMMETRICAL DESIGN COMPRISED OF BRUSH STROKES AND CIRCLES.

FOR SUNGLASSES (U.S. CLS. 21, 23, 26, 36 AND 38).

FIRST USE 2-16-2007; IN COMMERCE 2-16-2007.

CLASS 9—(Continued).

3,808,013. DELAWARE CAPITAL FORMATION, INC., WILMINGTON, DE. SN 77-687,353. PUB. 8-18-2009, FILED 3-10-2009.



THE MARK CONSISTS OF "21G" FOLLOWED BY A SHADED LEAF CONTAINING THE LETTER "V".
FOR AUTOMATIC SHUT-OFF FUELING NOZZLES FOR FUEL PUMPS (U.S. CLS. 21, 23, 26, 36 AND 38).
FIRST USE 4-30-2009; IN COMMERCE 4-30-2009.

CLASS 9—(Continued).

3,808,033. MANAGEMENT COMPUTER CONTROLS, INC., MEMPHIS, TN. SN 77-690,819. PUB. 12-29-2009, FILED 3-13-2009.



THE COLOR(S) BLUE, WHITE AND ORANGE IS/ARE CLAIMED AS A FEATURE OF THE MARK.
THE MARK CONSISTS OF THE LETTERS "B","I","M" IN ORANGE ADJACENT TO A BLUE SQUARE CONTAINING THE LETTER "C" IN WHITE WITH AN ORANGE EXPONENT "2". THE LETTERS "B","I","M" ARE POSITIONED TO THE LEFT AS IF TO FORM A WALL AND THE BLUE SQUARE TO THE RIGHT AS IF IT WAS ANOTHER WALL IN A PERPENDICULAR RELATIONSHIP AND APPEARS ABOVE A THREE DIMENSIONAL RECTANGLE DESIGN THAT HAS ORANGE LINES, IS BLUE ON THE BOTTOM RECTANGLE SHAPE AND WHITE ON TOP RECTANGLES.
FOR COMPUTER SOFTWARE FOR BUILDING CONSTRUCTION AND OPERATION COST COMPUTATION AND BUILDING INFORMATION MODELING (U.S. CLS. 21, 23, 26, 36 AND 38).
FIRST USE 6-15-2009; IN COMMERCE 6-15-2009.

3,808,027. BULL GUARD LIMITED, LONDON, UNITED KINGDOM. SN 77-690,273. PUB. 7-14-2009, FILED 3-13-2009.

WITH YOU ONLINE

THE MARK CONSISTS OF STANDARD CHARACTERS WITHOUT CLAIM TO ANY PARTICULAR FONT, STYLE, SIZE, OR COLOR.
FOR COMPUTER ANTI-VIRUS SOFTWARE; COMPUTER FIREWALL SOFTWARE; COMPUTER BACK-UP SOFTWARE (U.S. CLS. 21, 23, 26, 36 AND 38).
FIRST USE 11-9-2009; IN COMMERCE 11-9-2009.

3,808,035. GUIDEWIRE SOFTWARE, INC., SAN MATEO, CA. SN 77-691,085. PUB. 7-14-2009, FILED 3-13-2009.

3,808,030. HUNTER INDUSTRIES, INC., SAN MARCOS, CA. SN 77-690,507. PUB. 7-14-2009, FILED 3-13-2009.

I-Core

THE MARK CONSISTS OF STANDARD CHARACTERS WITHOUT CLAIM TO ANY PARTICULAR FONT, STYLE, SIZE, OR COLOR.
FOR ELECTRONIC CONTROLLERS USED TO TURN VALVES ON AND OFF IN WATERING TURF AND OTHER LANDSCAPE VEGETATION WITH SPRINKLERS (U.S. CLS. 21, 23, 26, 36 AND 38).
FIRST USE 10-19-2009; IN COMMERCE 10-19-2009.

GOSU

THE MARK CONSISTS OF STANDARD CHARACTERS WITHOUT CLAIM TO ANY PARTICULAR FONT, STYLE, SIZE, OR COLOR.
FOR COMPUTER SOFTWARE USED TO DEVELOP SOFTWARE PROGRAMS (U.S. CLS. 21, 23, 26, 36 AND 38).
FIRST USE 11-30-2009; IN COMMERCE 11-30-2009.

CLASS 9—(Continued).

3,808,044. TRUE GAMES INTERACTIVE, INC., IRVINE, CA.
SN 77-692,209. PUB. 7-14-2009, FILED 3-16-2009.

WARRIOR EPIC

THE MARK CONSISTS OF STANDARD CHARACTERS WITHOUT CLAIM TO ANY PARTICULAR FONT, STYLE, SIZE, OR COLOR.

FOR COMPUTER GAME SOFTWARE; VIDEO GAME SOFTWARE (U.S. CLS. 21, 23, 26, 36 AND 38).

FIRST USE 5-21-2009; IN COMMERCE 5-21-2009.

3,808,061. SAM VILLA LLC, NOVATO, CA. SN 77-696,138.
PUB. 7-28-2009, FILED 3-20-2009.

SAM VILLA

THE MARK CONSISTS OF STANDARD CHARACTERS WITHOUT CLAIM TO ANY PARTICULAR FONT, STYLE, SIZE, OR COLOR.

OWNER OF U.S. REG. NO. 3,592,888.

THE NAME(S), PORTRAIT(S), AND/OR SIGNATURE(S) SHOWN IN THE MARK IDENTIFIES "SAM VILLA", WHOSE CONSENT(S) TO REGISTER IS MADE OF RECORD.

FOR ELECTRIC HAIR CRIMPER (U.S. CLS. 21, 23, 26, 36 AND 38).

FIRST USE 6-1-2009; IN COMMERCE 6-1-2009.

3,808,072. E. D. BULLARD COMPANY, CYNTHIANA, KY.
SN 77-697,531. PUB. 7-21-2009, FILED 3-24-2009.

TRAKLITE

THE MARK CONSISTS OF STANDARD CHARACTERS WITHOUT CLAIM TO ANY PARTICULAR FONT, STYLE, SIZE, OR COLOR.

FOR HEAD LAMPS FOR USE AN INTEGRATED COMPONENT OF FIRE HELMETS; HEAD LAMPS AND MOUNTING KITS SOLD SEPARATELY FOR USE WITH FIRE HELMETS (U.S. CLS. 21, 23, 26, 36 AND 38).

FIRST USE 6-0-2009; IN COMMERCE 6-0-2009.

CLASS 9—(Continued).

3,808,084. DUOS TECHNOLOGIES, INC., JACKSONVILLE, FL. SN 77-698,787. PUB. 8-4-2009, FILED 3-25-2009.



NO CLAIM IS MADE TO THE EXCLUSIVE RIGHT TO USE "REMOTE", APART FROM THE MARK AS SHOWN.

THE COLOR(S) BLUE AND BLACK IS/ARE CLAIMED AS A FEATURE OF THE MARK.

THE MARK CONSISTS OF THE COLOR BLACK APPEARING IN THE WORDING "REMOTE 2 PRAESIDIUM" AND THE COLOR BLUE APPEARING IN THE OVAL-SHAPED AND QUADRILATERAL-SHAPED DESIGN ELEMENT. THE MARK CONSISTS OF AN OVAL-SHAPED OBJECT WITH AN INDENTATION AND TWO QUADRILATERAL-SHAPED OBJECTS TO THE LEFT AND RIGHT OF THE OVAL-SHAPED OBJECT. A THIRD QUADRILATERAL-SHAPED OBJECT APPEARS TO THE LEFT OF THE OVAL-SHAPED OBJECT AND ABOVE TO THE LEFT MOST QUADRILATERAL-SHAPED OBJECT. THE PHRASE "REMOTE 2 PRAESIDIUM" APPEARS BELOW THE DESIGN ELEMENT.

FOR ACCESS CONTROL AND ALARM MONITORING SYSTEMS, OPERATED REMOTELY VIA THE INTERNET (U.S. CLS. 21, 23, 26, 36 AND 38).

FIRST USE 10-28-2005; IN COMMERCE 10-28-2005.

3,808,093. POPCAP GAMES, INC., SEATTLE, WA. SN 77-700,097. PUB. 7-28-2009, FILED 3-26-2009.

HIDDEN IDENTITY

THE MARK CONSISTS OF STANDARD CHARACTERS WITHOUT CLAIM TO ANY PARTICULAR FONT, STYLE, SIZE, OR COLOR.

FOR INTERACTIVE GAME SOFTWARE; COMPUTER GAME SOFTWARE; VIDEO GAME PROGRAMS; DOWNLOADABLE INTERACTIVE, COMPUTER, VIDEO AND ELECTRONIC GAME PROGRAMS (U.S. CLS. 21, 23, 26, 36 AND 38).

FIRST USE 2-28-2010; IN COMMERCE 2-28-2010.

3,808,098. PORTO FRANCO RECORDS, LLC, SAN FRANCISCO, CA. SN 77-700,400. PUB. 7-21-2009, FILED 3-26-2009.

PORTO FRANCO RECORDS

THE MARK CONSISTS OF STANDARD CHARACTERS WITHOUT CLAIM TO ANY PARTICULAR FONT, STYLE, SIZE, OR COLOR.

CLASS 9—(Continued).

NO CLAIM IS MADE TO THE EXCLUSIVE RIGHT TO USE "RECORDS", APART FROM THE MARK AS SHOWN.

THE ENGLISH TRANSLATION OF "PORTO FRANCO" IN THE MARK IS FREE PORT.

FOR MUSICAL SOUND AND VIDEO RECORDINGS; PRE-RECORDED AUDIO AND VIDEO RECORDINGS, NAMELY, COMPACT DISCS (CDS), LASER DISCS, DVDS, CD-ROMS AND PHONOGRAPH RECORDS FEATURING MUSIC AND MUSICAL ENTERTAINMENT; DIGITAL MUSIC DOWNLOADABLE FROM THE INTERNET; DOWNLOADABLE MP3 FILES AND MP3 RECORDINGS FEATURING MUSIC (U.S. CLS. 21, 23, 26, 36 AND 38).

FIRST USE 2-1-2009; IN COMMERCE 4-1-2009.

3,808,107. KABUSHIKI KAISHA SEGA D/B/A SEGA CORPORATION, OHTA-KU, TOKYO, JAPAN. SN 77-701,885. PUB. 7-28-2009, FILED 3-30-2009.

RESONANCE OF FATE

THE MARK CONSISTS OF STANDARD CHARACTERS WITHOUT CLAIM TO ANY PARTICULAR FONT, STYLE, SIZE, OR COLOR.

FOR VIDEO GAME SOFTWARE; VIDEO GAME PROGRAMS; VIDEO GAME DISCS (U.S. CLS. 21, 23, 26, 36 AND 38).

FIRST USE 3-16-2010; IN COMMERCE 3-16-2010.

3,808,125. VELODYNE ACOUSTICS INC., SACRAMENTO, CA. SN 77-703,742. PUB. 7-28-2009, FILED 3-31-2009.

CHRYSLIS BY VELODYNE

THE MARK CONSISTS OF STANDARD CHARACTERS WITHOUT CLAIM TO ANY PARTICULAR FONT, STYLE, SIZE, OR COLOR.

OWNER OF U.S. REG. NOS. 1,939,515, 3,281,726, AND OTHERS.

FOR LOUDSPEAKERS (U.S. CLS. 21, 23, 26, 36 AND 38).

FIRST USE 5-1-2008; IN COMMERCE 5-1-2008.

CLASS 9—(Continued).

3,808,143. STEMBERGER LARUSSA, ROSEMARY B, DBA NUCLEAR OPTICS EYEWARE, DELTONA, FL. SN 77-705,945. PUB. 8-4-2009, FILED 4-3-2009.



NO CLAIM IS MADE TO THE EXCLUSIVE RIGHT TO USE "OPTICS", APART FROM THE MARK AS SHOWN.

THE MARK CONSISTS OF THE FOLLOWING, IN THE BACKGROUND TWO ELYPTICALS INTERSECTING WITH A SMALL SPHERE AT EACH INTERSECTION. IN THE CENTER OF THE TWO ELYPTICALS IS A LARGE CIRCLE AND ON THE INSIDE EDGE IS A THICK RING. ON TOP OF THICK RING ARE THREE QUADRILATERALS SPACED EQUALLY APART MAKING A NUCLEAR SYMBOL. BETWEEN EACH OF THOSE IS A LETTER "N" "O" "E". THE "N" IS AT THE TOP OF THE CIRCLE THE "O" IS TO THE LEFT AND THE "E" IS TO THE RIGHT. THE QUADRILATERALS ARE POINTING TO A SHADED SPHERE IN THE ABSOLUTE CENTER. AROUND THE OUTSIDE OF THE MAIN CIRCLE ARE THE WORDS "NUCLEAR OPTICS" CENTERED TOP AND BOTTOM IN AN ARCH.

FOR CASES FOR SPECTACLES AND SUNGLASSES; FRAMES FOR SPECTACLES AND SUNGLASSES; LENSES FOR SUNGLASSES; SUNGLASS CHAINS AND CORDS; SUNGLASS LENSES; SUNGLASSES; SUNGLASSES AND SPECTACLES (U.S. CLS. 21, 23, 26, 36 AND 38).

FIRST USE 4-1-2009; IN COMMERCE 11-19-2009.

3,808,153. APOLLO PACS, INC., FALLS CHURCH, VA. SN 77-708,137. PUB. 10-6-2009, FILED 4-7-2009.

APOLLO EPMM

THE MARK CONSISTS OF STANDARD CHARACTERS WITHOUT CLAIM TO ANY PARTICULAR FONT, STYLE, SIZE, OR COLOR.

FOR COMPUTER SOFTWARE FOR CONTROLLING, MANAGING AND SAFEGUARDING PATIENT MEDICAL INFORMATION (U.S. CLS. 21, 23, 26, 36 AND 38).

FIRST USE 9-23-2009; IN COMMERCE 9-23-2009.

CLASS 9—(Continued).

3,808,156. UNICOMCONNECT, LLC, FREEDOM, WY. SN 77-709,056. PUB. 8-11-2009, FILED 4-7-2009.



THE MARK CONSISTS OF THE WORDING "UNICOMCONNECT", WITH "UNICOM" IN SOLID BLACK LETTERS AND "CONNECT" IN WHITE LETTERS OUTLINED IN BLACK, WITH THE EXCEPTION OF THE "O" IN "CONNECT", WHICH IS SOLID BLACK; A LINE EXTENDS FROM THE BOTTOM OF THE BLACK "O" AND LOOPS UP AND BEHIND THE "C", THEN LOOPS DOWN OVER THE FIRST "N" AND ENDS BELOW THE "O", FORMING AN UNCONNECTED OVAL.

FOR COMMUNICATIONS INTEROPERABILITY SYSTEM THAT ENABLES CONTINUOUS CONVERGENCE BETWEEN VOICE, DATA, VIDEO AND FREQUENCY CONTROLLED DEVICES (U.S. CLS. 21, 23, 26, 36 AND 38).

FIRST USE 6-1-2009; IN COMMERCE 6-1-2009.

3,808,169. IGT, RENO, NV. SN 77-710,852. PUB. 8-11-2009, FILED 4-9-2009.

SOARING WINGS

THE MARK CONSISTS OF STANDARD CHARACTERS WITHOUT CLAIM TO ANY PARTICULAR FONT, STYLE, SIZE, OR COLOR.

FOR GAMING MACHINES, NAMELY, DEVICES WHICH ACCEPT A WAGER (U.S. CLS. 21, 23, 26, 36 AND 38).

FIRST USE 2-18-2010; IN COMMERCE 2-23-2010.

3,808,179. HARMONIC INC., SUNNYVALE, CA. SN 77-712,598. PUB. 8-11-2009, FILED 4-13-2009.

ELLIPSE

THE MARK CONSISTS OF STANDARD CHARACTERS WITHOUT CLAIM TO ANY PARTICULAR FONT, STYLE, SIZE, OR COLOR.

FOR COMPUTER HARDWARE, NAMELY, ENCODERS, VIDEO AND AUDIO INPUT PROCESSORS AND EMBEDDED SOFTWARE FOR USE IN THE COMPRESSION AND DECOMPRESSION OF VIDEO AND AUDIO DATA (U.S. CLS. 21, 23, 26, 36 AND 38).

FIRST USE 7-0-2009; IN COMMERCE 8-0-2009.

CLASS 9—(Continued).

3,808,180. TRACFONE WIRELESS, INC., MIAMI, FL. SN 77-712,688. PUB. 7-7-2009, FILED 4-13-2009.

EVERYTHING YOU NEED IN A
CELL PHONE WITHOUT A
CONTRACT

THE MARK CONSISTS OF STANDARD CHARACTERS WITHOUT CLAIM TO ANY PARTICULAR FONT, STYLE, SIZE, OR COLOR.

FOR ELECTRONIC COMMUNICATIONS EQUIPMENT, NAMELY, CELLULAR TELEPHONES; PREPAID AIR TIME CELLULAR TELEPHONES; CELLULAR TELEPHONE ACCESSORIES, NAMELY, BATTERY CHARGERS, STANDS, ANTENNAE, HEADSET KITS COMPRISED OF HANDS FREE ELECTRONIC EARPIECE WITH MICROPHONE AND HOLSTER, HANDS FREE HEADSETS, CASES WITH FLAPS, POWER ADAPTERS, BATTERIES, CARRY SLEEVES, FACE PLATES, BELT CLIPS, HOLSTERS, MOUNTING ATTACHMENTS (U.S. CLS. 21, 23, 26, 36 AND 38).

FIRST USE 6-1-2009; IN COMMERCE 6-1-2009.

3,808,187. PERFORMANCE FABRICS, INC., GRAND RAPIDS, MI. SN 77-713,471. PUB. 8-11-2009, FILED 4-14-2009.

TRUSHIELD

THE MARK CONSISTS OF STANDARD CHARACTERS WITHOUT CLAIM TO ANY PARTICULAR FONT, STYLE, SIZE, OR COLOR.

FOR PROTECTIVE GLOVES FOR INDUSTRIAL USE (U.S. CLS. 21, 23, 26, 36 AND 38).

FIRST USE 10-15-2009; IN COMMERCE 10-15-2009.

3,808,189. LION APPAREL, INC., DAYTON, OH. SN 77-713,536. PUB. 8-11-2009, FILED 4-14-2009.

CB-XIT

THE MARK CONSISTS OF STANDARD CHARACTERS WITHOUT CLAIM TO ANY PARTICULAR FONT, STYLE, SIZE, OR COLOR.

FOR PROTECTIVE APPAREL FOR FIREFIGHTERS (U.S. CLS. 21, 23, 26, 36 AND 38).

FIRST USE 8-0-2009; IN COMMERCE 8-0-2009.

CLASS 9—(Continued).

3,808,200. TELAURUS COMMUNICATIONS LLC, CEDAR KNOLLS, NJ. SN 77-715,195. PUB. 8-18-2009, FILED 4-16-2009.



THE MARK CONSISTS OF "SE@SHIELD" WITH A DESIGN OF A SHIELD.
 FOR ANTI-VIRUS SOFTWARE THAT IS DESIGNED FOR MARITIME CUSTOMERS (U.S. CLS. 21, 23, 26, 36 AND 38).
 FIRST USE 3-31-2009; IN COMMERCE 3-31-2009.

CLASS 9—(Continued).

BAR IN THE COLOR WHITE. THE SMALLEST BAR ON THE LEFT APPEARS IN THE COLOR RED ABOVE THE WHITE PORTION OF THE BAR. TO THE RIGHT OF THE RED BAR, A TALLER BAR APPEARS IN THE COLOR BLUE ABOVE THE WHITE PORTION OF THE BAR. TO THE RIGHT OF THE BLUE BAR AN EVEN TALLER BAR APPEARS IN THE COLOR GREEN ABOVE THE WHITE PORTION OF THE BAR. TO THE RIGHT OF THE GREEN BAR, THE TALLEST BAR APPEARS IN THE COLOR YELLOW ABOVE THE WHITE PORTION OF THE BAR.
 FOR PROVIDING DOWNLOADABLE COMPUTER SOFTWARE FOR ACCESSING AND REPORTING INFORMATION ON NETWORK PROBLEMS, NAMELY, NO WIRELESS NETWORK COVERAGE, DROPPED CALLS, FAILED CALL ATTEMPTS OR FAILED DATA SERVICES, AND WHICH ALLOWS USERS AND NETWORK PROVIDERS TO TRACK PERFORMANCE PROBLEMS ON VOICE AND DATA NETWORKS (U.S. CLS. 21, 23, 26, 36 AND 38).
 FIRST USE 6-7-2009; IN COMMERCE 6-7-2009.

3,808,213. VELODYNE ACOUSTICS, INC., SACRAMENTO, CA. SN 77-717,915. PUB. 8-4-2009, FILED 4-20-2009.

VELODYNE IMPACT

THE MARK CONSISTS OF STANDARD CHARACTERS WITHOUT CLAIM TO ANY PARTICULAR FONT, STYLE, SIZE, OR COLOR.
 OWNER OF U.S. REG. NOS. 1,939,515, 2,795,371, AND 3,281,726.
 FOR LOUDSPEAKERS (U.S. CLS. 21, 23, 26, 36 AND 38).
 FIRST USE 4-1-2008; IN COMMERCE 4-30-2008.

3,808,206. GLOBAL WIRELESS SOLUTIONS, INC., DULLES, VA. SN 77-716,033. PUB. 9-1-2009, FILED 4-17-2009.



THE COLOR(S) RED, BLUE, GREEN, YELLOW, GOLD, GREY AND WHITE ARE CLAIMED IS/ARE CLAIMED AS A FEATURE OF THE MARK.
 THE MARK CONSISTS OF THE WORD "TROUBLESPOTS", WITH THE WORD "TROUBLESPOTS" IN GREY. A SQUARE ICON WITH ROUNDED CORNERS IN THE COLOR GOLD APPEARS ABOVE THE WORD "TROUBLESPOTS". WITHIN THE SQUARE ICON, A SERIES OF 4 VERTICAL BARS INCREASING IN HEIGHT LEFT TO RIGHT APPEAR, WITH THE LOWER PORTION OF EACH

3,808,222. SHANTI GENERATION, LLC, LOS ANGELES, CA. SN 77-720,589. PUB. 12-29-2009, FILED 4-23-2009.

Shanti Generation

THE MARK CONSISTS OF STANDARD CHARACTERS WITHOUT CLAIM TO ANY PARTICULAR FONT, STYLE, SIZE, OR COLOR.
 THE ENGLISH TRANSLATION OF "SHANTI" IN THE MARK IS "PEACE".
 FOR DIGITAL MEDIA, NAMELY, PRE-RECORDED DVDS AND DOWNLOADABLE AUDIO AND VIDEO RECORDINGS FEATURING TELEVISION, CABLE TELEVISION AND INTERNET SHOWS WITH INSTRUCTION ON YOGA AND SELF-IMPROVEMENT FOR CHILDREN IN PRIMARY AND SECONDARY SCHOOL (U.S. CLS. 21, 23, 26, 36 AND 38).
 FIRST USE 3-10-2009; IN COMMERCE 3-10-2009.

CLASS 9—(Continued).

3,808,227. WOLF, PAUL, MANDAN, ND. SN 77-722,937. PUB. 9-22-2009, FILED 4-27-2009.



NO CLAIM IS MADE TO THE EXCLUSIVE RIGHT TO USE "LIGHT", APART FROM THE MARK AS SHOWN. THE STIPPLING IS FOR SHADING PURPOSES ONLY. THE MARK CONSISTS OF THE STYLIZED TEXT "LIGHT CHECK" WITH A LIGHT BULB AND A CHECK. FOR TRAILER LIGHT TESTING AND DIAGNOSTIC DEVICE, NAMELY, FOR BOAT TRAILERS, LIGHT UTILITY TRAILERS AND RECREATIONAL VEHICLE TRAILERS (U.S. CLS. 21, 23, 26, 36 AND 38). FIRST USE 3-1-2009; IN COMMERCE 8-1-2009.

3,808,236. SCRIPTLOGIC CORPORATION, BOCA RATON, FL. SN 77-725,883. PUB. 7-21-2009, FILED 4-30-2009.

PRIVILEGE AUTHORITY

THE MARK CONSISTS OF STANDARD CHARACTERS WITHOUT CLAIM TO ANY PARTICULAR FONT, STYLE, SIZE, OR COLOR. OWNER OF U.S. REG. NOS. 2,934,109 AND 3,123,156. NO CLAIM IS MADE TO THE EXCLUSIVE RIGHT TO USE "PRIVILEGE", APART FROM THE MARK AS SHOWN. FOR COMPUTER SOFTWARE DESIGNED TO DETERMINE AND GRANT THE MINIMAL ACCESS RIGHTS REQUIRED TO RUN APPLICATIONS (U.S. CLS. 21, 23, 26, 36 AND 38). FIRST USE 3-19-2010; IN COMMERCE 3-19-2010.

3,808,257. FRONTIER FASHION, INC., CITY OF INDUSTRY, CA. SN 77-729,927. PUB. 9-15-2009, FILED 5-6-2009.



THE MARK CONSISTS OF A SILHOUETTE OF A LION DESIGN. FOR SUNGLASSES (U.S. CLS. 21, 23, 26, 36 AND 38). FIRST USE 3-1-2007; IN COMMERCE 3-1-2007.

CLASS 9—(Continued).

3,808,290. ACCURI CYTOMETERS, INC., ANN ARBOR, MI. SN 77-739,307. PUB. 11-10-2009, FILED 5-18-2009.

FLOW CYTOMETRY WITHIN REACH

THE MARK CONSISTS OF STANDARD CHARACTERS WITHOUT CLAIM TO ANY PARTICULAR FONT, STYLE, SIZE, OR COLOR.

OWNER OF U.S. REG. NO. 3,428,570.

NO CLAIM IS MADE TO THE EXCLUSIVE RIGHT TO USE "FLOW CYTOMETRY", APART FROM THE MARK AS SHOWN.

FOR SCIENTIFIC EQUIPMENT, NAMELY, CYTOMETERS USED TO MEASURE PHYSICAL AND CHEMICAL CHARACTERISTICS OF CELLS OR OTHER PARTICLES; SCIENTIFIC DEVICES SOLD AS A UNIT, CONSISTING OF CYTOMETERS AND COMPUTER SOFTWARE FOR MEASURING PHYSICAL AND CHEMICAL CHARACTERISTICS OF CELLS OR OTHER PARTICLES; AND COMPUTER SOFTWARE FOR GATHERING, ANALYZING, ORGANIZING, AND DISPLAYING DATA IN THE FIELD OF CELL ANALYSIS (U.S. CLS. 21, 23, 26, 36 AND 38).

FIRST USE 2-28-2010; IN COMMERCE 2-28-2010.

3,808,297. UBISOFT ENTERTAINMENT, RENNES, FRANCE. SN 77-743,845. PUB. 8-18-2009, FILED 5-25-2009.

BEST FRIENDS TONIGHT

THE MARK CONSISTS OF STANDARD CHARACTERS WITHOUT CLAIM TO ANY PARTICULAR FONT, STYLE, SIZE, OR COLOR.

FOR GAME SOFTWARE AND ELECTRONIC GAME PROGRAMS, NAMELY, SOFTWARE GAMES RECORDED ON CD-ROM AND DIGITAL VIDEO DISCS FOR COMPUTERS; SOFTWARE GAMES RECORDED ON CD-ROMS, DIGITAL VIDEO DISCS, AND CARTRIDGES FOR CONSOLE AND INDIVIDUAL, PORTABLE GAMING SYSTEMS; SOFTWARE GAMES THAT ARE DOWNLOADABLE FROM A REMOTE COMPUTER SITE AND ELECTRONIC GAME SOFTWARE FOR MOBILE PHONES, PERSONAL DIGITAL ASSISTANTS, AND HANDHELD COMPUTERS (U.S. CLS. 21, 23, 26, 36 AND 38).

FIRST USE 5-25-2009; IN COMMERCE 2-9-2010.

CLASS 9—(Continued).

3,808,314. RENKARA MEDIA GROUP, INVERNESS, IL. SN 77-750,122. PUB. 11-17-2009, FILED 6-2-2009.

The Factual Intellectual

THE MARK CONSISTS OF STANDARD CHARACTERS WITHOUT CLAIM TO ANY PARTICULAR FONT, STYLE, SIZE, OR COLOR.

FOR SOFTWARE APPLICATIONS FOR USE IN PLAYING GAMES BY UTILIZING MOBILE COMMUNICATION DEVICES (U.S. CLS. 21, 23, 26, 36 AND 38).

FIRST USE 5-25-2009; IN COMMERCE 5-25-2009.

3,808,317. LINCOLN GLOBAL, INC., CITY OF INDUSTRY, CA. SN 77-751,366. PUB. 10-6-2009, FILED 6-3-2009.

SAE

THE MARK CONSISTS OF STANDARD CHARACTERS WITHOUT CLAIM TO ANY PARTICULAR FONT, STYLE, SIZE, OR COLOR.

FOR ENGINE-DRIVEN ARC WELDERS (U.S. CLS. 21, 23, 26, 36 AND 38).

FIRST USE 1-31-1943; IN COMMERCE 1-31-1943.

3,808,319. VULCAN TECHNOLOGIES LLC, SEATTLE, WA. SN 77-751,655. PUB. 10-20-2009, FILED 6-3-2009.

XIANT FILER

THE MARK CONSISTS OF STANDARD CHARACTERS WITHOUT CLAIM TO ANY PARTICULAR FONT, STYLE, SIZE, OR COLOR.

NO CLAIM IS MADE TO THE EXCLUSIVE RIGHT TO USE "FILER", APART FROM THE MARK AS SHOWN.

FOR COMPUTER SOFTWARE FOR IMPROVING PRODUCTIVITY AND EFFICIENCY OF END USERS BY PROVIDING A VIRTUAL COMPUTER INFRASTRUCTURE MANAGEMENT PLATFORM; COMPUTER SOFTWARE FOR ACCOMMODATING AND SUPPORTING MULTIPLE USERS AND ORGANIZATIONAL STYLES AND FACILITATING EFFICIENT SHIFTING BETWEEN PROJECTS OR CONTEXTS; COMPUTER SOFTWARE PLATFORMS FOR OPERATING DISTRIBUTED APPLICATIONS AND COMPUTER NETWORKS; COMPUTER SOFTWARE THAT PROVIDES WEB-BASED ACCESS TO APPLICATIONS AND SERVICES THROUGH A WEB OPERATING SYSTEM OR PORTAL INTERFACE (U.S. CLS. 21, 23, 26, 36 AND 38).

FIRST USE 6-15-2009; IN COMMERCE 6-15-2009.

CLASS 9—(Continued).

3,808,358. UCT, INC., BRISTOL, PA. SN 77-765,215. PUB. 12-29-2009, FILED 6-22-2009.

CLEAN SCREEN XCEL

THE MARK CONSISTS OF STANDARD CHARACTERS WITHOUT CLAIM TO ANY PARTICULAR FONT, STYLE, SIZE, OR COLOR.

OWNER OF U.S. REG. NO. 1,449,533.

NO CLAIM IS MADE TO THE EXCLUSIVE RIGHT TO USE "CLEAN", APART FROM THE MARK AS SHOWN.

FOR FILTERS USED IN SCIENTIFIC AND FORENSIC APPARATUS IN DRUG DETECTION PROCESSES (U.S. CLS. 21, 23, 26, 36 AND 38).

FIRST USE 10-20-2009; IN COMMERCE 10-20-2009.

3,808,364. CISSEL, SCOTT A., RALEIGH, NC. SN 77-767,792. PUB. 11-10-2009, FILED 6-25-2009.

GardenPilot

THE MARK CONSISTS OF STANDARD CHARACTERS WITHOUT CLAIM TO ANY PARTICULAR FONT, STYLE, SIZE, OR COLOR.

FOR COMPUTER APPLICATION SOFTWARE FOR MOBILE PHONES (U.S. CLS. 21, 23, 26, 36 AND 38).

FIRST USE 12-3-2009; IN COMMERCE 12-3-2009.

3,808,366. OCONEE PUBLISHING, INC., SENECA, SC. SN 77-768,147. PUB. 12-15-2009, FILED 6-25-2009.

MY ORANGE UPDATE

THE MARK CONSISTS OF STANDARD CHARACTERS WITHOUT CLAIM TO ANY PARTICULAR FONT, STYLE, SIZE, OR COLOR.

NO CLAIM IS MADE TO THE EXCLUSIVE RIGHT TO USE "UPDATE", APART FROM THE MARK AS SHOWN.

FOR DOWNLOADABLE ELECTRONIC NEWSLETTERS FEATURING COLLEGIATE ATHLETICS (U.S. CLS. 21, 23, 26, 36 AND 38).

FIRST USE 8-24-2009; IN COMMERCE 8-24-2009.

CLASS 9—(Continued).

3,808,387. HONEYWELL INTERNATIONAL INC., MORRISTOWN, NJ. SN 77-777,241. PUB. 12-1-2009, FILED 7-9-2009.

CLASS 9—(Continued).

3,808,413. KABUSHIKI KAISHA SQUARE ENIX (ALSO TRADING AS SQUARE ENIX CO. LTD.), TOKYO, JAPAN. SN 77-788,750. PUB. 12-29-2009, FILED 7-24-2009.

TRUSTABILITY

THE MARK CONSISTS OF STANDARD CHARACTERS WITHOUT CLAIM TO ANY PARTICULAR FONT, STYLE, SIZE, OR COLOR.

FOR PRESSURE SENSORS (U.S. CLS. 21, 23, 26, 36 AND 38).

FIRST USE 7-13-2009; IN COMMERCE 7-22-2009.

GYROMANCER

THE MARK CONSISTS OF STANDARD CHARACTERS WITHOUT CLAIM TO ANY PARTICULAR FONT, STYLE, SIZE, OR COLOR.

FOR COMPUTER GAME SOFTWARE; VIDEO GAME SOFTWARE (U.S. CLS. 21, 23, 26, 36 AND 38).

FIRST USE 11-18-2009; IN COMMERCE 11-18-2009.

3,808,399. GLYNN, JOSEPH M, DBA JOSEPH M GLYNN, SANTA CLARA, CA. SN 77-783,099. PUB. 12-8-2009, FILED 7-16-2009.

3,808,416. METRA ELECTRONICS CORPORATION, HOLLY HILL, FL. SN 77-789,225. PUB. 1-26-2010, FILED 7-24-2009.

Write That Down

THE MARK CONSISTS OF STANDARD CHARACTERS WITHOUT CLAIM TO ANY PARTICULAR FONT, STYLE, SIZE, OR COLOR.

FOR COMPUTER SOFTWARE FOR THE COLLECTION, EDITING, ORGANIZING, MODIFYING, BOOK MARKING, TRANSMISSION, STORAGE AND SHARING OF DATA AND INFORMATION (U.S. CLS. 21, 23, 26, 36 AND 38).

FIRST USE 8-15-2009; IN COMMERCE 8-15-2009.

ICARUS

THE MARK CONSISTS OF STANDARD CHARACTERS WITHOUT CLAIM TO ANY PARTICULAR FONT, STYLE, SIZE, OR COLOR.

FOR HOME THEATER CONNECTION PRODUCTS, NAMELY, HDMI CABLES, AUDIO CABLES, VIDEO CABLES AND LOUDSPEAKER ELECTRICAL WIRES (U.S. CLS. 21, 23, 26, 36 AND 38).

FIRST USE 1-12-2010; IN COMMERCE 1-12-2010.

3,808,404. ESCO TECHNOLOGIES (ASIA) PTE LTD, 486777, SINGAPORE. SN 77-785,479. PUB. 12-1-2009, FILED 7-21-2009.

3,808,418. DAN A. BAKER, DBA HUMORSOFT, DUBLIN, CA. SN 77-790,224. PUB. 12-22-2009, FILED 7-27-2009.

Celculture

THE MARK CONSISTS OF THE WORDING "CELCULTURE" IN A STYLIZED FONT.

FOR LABORATORY INCUBATORS (U.S. CLS. 21, 23, 26, 36 AND 38).

FIRST USE 11-0-2009; IN COMMERCE 3-0-2010.

humorsoft

THE MARK CONSISTS OF STANDARD CHARACTERS WITHOUT CLAIM TO ANY PARTICULAR FONT, STYLE, SIZE, OR COLOR.

FOR COMPUTER SOFTWARE FOR CREATING SEARCHABLE DATABASES OF INFORMATION AND DATA (U.S. CLS. 21, 23, 26, 36 AND 38).

FIRST USE 8-1-2009; IN COMMERCE 9-1-2009.

CLASS 9—(Continued).

3,808,431. STATE ELECTRONICS PARTS CORP, EAST HAN-OVER, NJ. SN 77-794,139. PUB. 12-29-2009, FILED 7-31-2009.

MOD-POT

THE MARK CONSISTS OF STANDARD CHARACTERS WITHOUT CLAIM TO ANY PARTICULAR FONT, STYLE, SIZE, OR COLOR.

FOR ELECTRIC RESISTORS (U.S. CLS. 21, 23, 26, 36 AND 38).

FIRST USE 1-1-1990; IN COMMERCE 1-1-1990.

CLASS 9—(Continued).

3,808,457. HITTITE MICROWAVE CORPORATION, TA HITT, CHELMSFORD, MA. SN 77-802,052. PUB. 1-12-2010, FILED 8-11-2009.

MicroSynth

THE MARK CONSISTS OF STANDARD CHARACTERS WITHOUT CLAIM TO ANY PARTICULAR FONT, STYLE, SIZE, OR COLOR.

FOR DEVICES FOR WIRELESS RADIO TRANSMISSION (U.S. CLS. 21, 23, 26, 36 AND 38).

FIRST USE 10-28-2009; IN COMMERCE 10-28-2009.

3,808,437. SPITFIRE SUNGLASS DESIGN USA, INC., CHICAGO, IL. SN 77-796,733. PUB. 12-29-2009, FILED 8-4-2009.



THE MARK CONSISTS OF THE STYLIZED INITIALS "SP".

FOR EARPHONES AND HEADPHONES; SUNGLASSES (U.S. CLS. 21, 23, 26, 36 AND 38).

FIRST USE 8-1-2009; IN COMMERCE 8-1-2009.

3,808,471. NATIONAL SOLAR PRODUCTS, LLC, FORT LAUDERDALE, FL. SN 77-810,258. PUB. 1-19-2010, FILED 8-21-2009.

Powering Tomorrow Today

3,808,450. PERFORMANCE FABRICS, INC., GRAND RAPIDS, MI. SN 77-799,722. PUB. 12-22-2009, FILED 8-7-2009.

GGT5

THE MARK CONSISTS OF STANDARD CHARACTERS WITHOUT CLAIM TO ANY PARTICULAR FONT, STYLE, SIZE, OR COLOR.

FOR PROTECTIVE GLOVES FOR INDUSTRIAL USE (U.S. CLS. 21, 23, 26, 36 AND 38).

FIRST USE 11-3-2009; IN COMMERCE 12-3-2009.

THE MARK CONSISTS OF STANDARD CHARACTERS WITHOUT CLAIM TO ANY PARTICULAR FONT, STYLE, SIZE, OR COLOR.

FOR APPARATUS FOR CONVERTING ELECTRONIC RADIATION TO ELECTRICAL ENERGY, NAMELY, PHOTOVOLTAIC CLADDING PANELS; APPARATUS FOR CONVERTING ELECTRONIC RADIATION TO ELECTRICAL ENERGY, NAMELY, PHOTOVOLTAIC ROOFING MEMBERS; APPARATUS FOR CONVERTING ELECTRONIC RADIATION TO ELECTRICAL ENERGY, NAMELY, PHOTOVOLTAIC SOLAR HYBRID MODULES; APPARATUS FOR CONVERTING ELECTRONIC RADIATION TO ELECTRICAL ENERGY, NAMELY, PHOTOVOLTAIC SOLAR MODULES; APPARATUS FOR CONVERTING ELECTRONIC RADIATION TO ELECTRICAL ENERGY, NAMELY, PHOTOVOLTAIC THERMAL HYBRID MODULE; APPARATUS FOR CONVERTING ELECTRONIC RADIATION TO ELECTRICAL ENERGY, NAMELY, PHOTOVOLTAIC THERMAL MODULE; APPARATUS FOR CONVERTING ELECTRONIC RADIATION TO ELECTRICAL ENERGY, NAMELY, PVT (PHOTOVOLTAIC THERMAL) MODULE (U.S. CLS. 21, 23, 26, 36 AND 38).

FIRST USE 10-1-2009; IN COMMERCE 10-1-2009.

CLASS 9—(Continued).

3,808,498. STEED HAMMOND PAUL, INC., DBA SHP LEADING DESIGN, CINCINNATI, OH. SN 77-865,433. PUB. 1-19-2010, FILED 11-4-2009.

ECOFLASH

THE MARK CONSISTS OF STANDARD CHARACTERS WITHOUT CLAIM TO ANY PARTICULAR FONT, STYLE, SIZE, OR COLOR.

FOR COMPUTER APPLICATION SOFTWARE FOR MOBILE PHONES, NAMELY, A FLASHCARD STUDY APPLICATION THAT ASSISTS INDIVIDUALS WHO ARE STUDYING FOR A CERTIFICATION EXAM IN THE FIELD OF ENVIRONMENTAL DESIGN, CONSTRUCTION, AND OPERATION OF BUILDINGS AND REAL ESTATE AND THE MAINTENANCE THEREOF; DOWNLOADABLE COMPUTER APPLICATION SOFTWARE FOR MOBILE PHONES, NAMELY, A FLASHCARD STUDY APPLICATION THAT ASSISTS INDIVIDUALS WHO ARE STUDYING FOR A CERTIFICATION EXAM IN THE FIELD OF ENVIRONMENTAL DESIGN, CONSTRUCTION, AND OPERATION OF BUILDINGS AND REAL ESTATE AND THE MAINTENANCE THEREOF (U.S. CLS. 21, 23, 26, 36 AND 38).

FIRST USE 7-7-2009; IN COMMERCE 7-7-2009.

3,808,505. JOHN MEZZALINGUA ASSOCIATES, INC., DBA PPC, EAST SYRACUSE, NY. SN 77-978,588. PUB. 2-17-2009, FILED 11-13-2008.

Perfect Flex

THE MARK CONSISTS OF STANDARD CHARACTERS WITHOUT CLAIM TO ANY PARTICULAR FONT, STYLE, SIZE, OR COLOR.

NO CLAIM IS MADE TO THE EXCLUSIVE RIGHT TO USE "FLEX", APART FROM THE MARK AS SHOWN.

FOR COMMUNICATIONS EQUIPMENT, NAMELY, COAXIAL CABLE FOR USE IN THE CABLE TELEVISION INDUSTRY (U.S. CLS. 21, 23, 26, 36 AND 38).

FIRST USE 5-8-2009; IN COMMERCE 5-8-2009.

3,808,506. JOHN MEZZALINGUA ASSOCIATES, INC., DBA PPC, EAST SYRACUSE, NY. SN 77-978,589. PUB. 2-17-2009, FILED 11-13-2008.

Perfect Flex

NO CLAIM IS MADE TO THE EXCLUSIVE RIGHT TO USE "FLEX", APART FROM THE MARK AS SHOWN.

CLASS 9—(Continued).

THE MARK CONSISTS OF THE WORDS "PERFECT FLEX" AND THE SPACE BETWEEN "PERFECT" AND "FLEX" CONTAINS A CIRCLE ENCLOSING AN ARROW HEAD POINTING FROM LEFT TO RIGHT.

FOR COMMUNICATIONS EQUIPMENT, NAMELY, COAXIAL CABLE FOR USE IN THE CABLE TELEVISION INDUSTRY (U.S. CLS. 21, 23, 26, 36 AND 38).

FIRST USE 5-8-2009; IN COMMERCE 5-8-2009.

3,808,511. FAME IP HOLDING, LLC, HOLLYWOOD, FL. SN 77-979,253. PUB. 7-21-2009, FILED 4-10-2009.



NO CLAIM IS MADE TO THE EXCLUSIVE RIGHT TO USE "NATIVE MUSIC", APART FROM THE MARK AS SHOWN.

THE MARK CONSISTS OF THE WORDS "NATIVE MUSIC" IN A STYLIZED FORMAT ON ONE LINE, FOLLOWED BY THE WORD "ROCKS" IN A STYLIZED FORMAT ON A SECOND LINE, WITH THE WORD "ROCKS" SET FORTH IN A SQUARE SHAPED DESIGN.

FOR MUSICAL SOUND RECORDINGS AND MUSICAL AUDIOVISUAL RECORDINGS; SOUND RECORDINGS AND AUDIOVIDEO RECORDINGS CONCERNING MUSICAL ARTISTS; DOWNLOADABLE MUSICAL SOUND RECORDINGS; DOWNLOADABLE SOUND RECORDINGS CONCERNING MUSICAL ARTISTS; DOWNLOADABLE VIDEO RECORDINGS FEATURING MUSIC; DOWNLOADABLE VIDEO RECORDINGS CONCERNING MUSICAL ARTISTS (U.S. CLS. 21, 23, 26, 36 AND 38).

FIRST USE 10-30-2008; IN COMMERCE 10-30-2008.

3,808,512. FAME IP HOLDING, LLC, HOLLYWOOD, FL. SN 77-979,254. PUB. 7-21-2009, FILED 2-26-2009.

NATIVE MUSIC ROCKS

THE MARK CONSISTS OF STANDARD CHARACTERS WITHOUT CLAIM TO ANY PARTICULAR FONT, STYLE, SIZE, OR COLOR.

NO CLAIM IS MADE TO THE EXCLUSIVE RIGHT TO USE "NATIVE MUSIC", APART FROM THE MARK AS SHOWN.

FOR MUSICAL SOUND RECORDINGS AND MUSICAL AUDIOVISUAL RECORDINGS; SOUND RECORDINGS AND AUDIOVIDEO RECORDINGS CONCERNING MUSICAL ARTISTS; DOWNLOADABLE MUSICAL SOUND RECORDINGS; DOWNLOADABLE SOUND RECORDINGS CONCERNING MUSICAL ARTISTS; DOWNLOADABLE VIDEO RECORDINGS FEATURING MUSIC; DOWNLOADABLE VIDEO RECORDINGS CONCERNING MUSICAL ARTISTS (U.S. CLS. 21, 23, 26, 36 AND 38).

FIRST USE 10-30-2008; IN COMMERCE 10-30-2008.

CLASS 9—(Continued).

3,808,518. SWITCHEASY LIMITED, KOWLOON, HONG KONG. SN 77-979,355. PUB. 6-23-2009, FILED 7-7-2008.

ULTRAFRAME

THE MARK CONSISTS OF STANDARD CHARACTERS WITHOUT CLAIM TO ANY PARTICULAR FONT, STYLE, SIZE, OR COLOR.

FOR PROTECTIVE CASES AND CARRYING CASES FOR PERSONAL ELECTRONIC DEVICES, NAMELY, HANDHELD PERSONAL ELECTRONIC DEVICES, NAMELY, DIGITAL MEDIA PLAYER DEVICES, PERSONAL DIGITAL ASSISTANT, HANDHELD WIRELESS DEVICES, CELLULAR HANDSETS, HANDHELD DIGITAL AUDIO AND/OR VIDEO CAPTURE DEVICES (U.S. CLS. 21, 23, 26, 36 AND 38).

FIRST USE 7-8-2008; IN COMMERCE 7-9-2008.

3,808,520. SWITCHEASY LIMITED, KOWLOON, HONG KONG. SN 77-979,364. PUB. 6-23-2009, FILED 7-29-2008.

CAPSULEREBEL

THE MARK CONSISTS OF STANDARD CHARACTERS WITHOUT CLAIM TO ANY PARTICULAR FONT, STYLE, SIZE, OR COLOR.

FOR PROTECTIVE CASES AND CARRYING CASES FOR PERSONAL ELECTRONIC DEVICES, NAMELY, PORTABLE COMPUTING DEVICES AND HANDHELD PERSONAL ELECTRONIC DEVICES, NAMELY, PORTABLE DIGITAL DATA STORAGE MEDIA DEVICES, DIGITAL MEDIA PLAYER DEVICES, PERSONAL DIGITAL ASSISTANT, HANDHELD WIRELESS DEVICES, CELLULAR HANDSETS, HANDHELD DIGITAL AUDIO AND/OR VIDEO CAPTURE DEVICES (U.S. CLS. 21, 23, 26, 36 AND 38).

FIRST USE 7-8-2008; IN COMMERCE 7-9-2008.

CLASS 9—(Continued).

3,808,538. NATIONAL GEOGRAPHIC SOCIETY, WASHINGTON, DC. SN 77-979,465. PUB. 1-22-2008, FILED 1-30-2007.

**INSPIRING PEOPLE TO CARE
ABOUT THE PLANET**

THE MARK CONSISTS OF STANDARD CHARACTERS WITHOUT CLAIM TO ANY PARTICULAR FONT, STYLE, SIZE, OR COLOR.

FOR DVDS FEATURING GEOGRAPHY, SCIENCE, NATURAL SCIENCE, NATURE, WILDLIFE, ECOLOGY, SOCIAL STUDIES, HISTORY, NATURAL HISTORY, ARCHAEOLOGY, ASTRONOMY, GEOLOGY, ANTHROPOLOGY, ZOOLOGY, BOTANY, AND ENVIRONMENTAL TOPICS (U.S. CLS. 21, 23, 26, 36 AND 38).

FIRST USE 1-0-2010; IN COMMERCE 1-0-2010.

3,808,547. DAVID ANDERSON, APPLETON, WI. SN 77-979,531. PUB. 8-25-2009, FILED 3-11-2009.

METAL MAN

THE MARK CONSISTS OF STANDARD CHARACTERS WITHOUT CLAIM TO ANY PARTICULAR FONT, STYLE, SIZE, OR COLOR.

NO CLAIM IS MADE TO THE EXCLUSIVE RIGHT TO USE "METAL", APART FROM THE MARK AS SHOWN.

FOR CLOTHING FOR PROTECTION AGAINST FIRE; FIRE RESISTANT GLOVES; WELDING HELMETS (U.S. CLS. 21, 23, 26, 36 AND 38).

FIRST USE 7-1-2005; IN COMMERCE 4-30-2008.

3,808,557. CISCO TECHNOLOGY, INC., SAN JOSE, CA. SN 77-979,627. PUB. 9-29-2009, FILED 7-6-2009.

CISCO PULSE

THE MARK CONSISTS OF STANDARD CHARACTERS WITHOUT CLAIM TO ANY PARTICULAR FONT, STYLE, SIZE, OR COLOR.

OWNER OF U.S. REG. NOS. 1,542,339, 2,574,340, AND OTHERS.

FOR ENTERPRISE NETWORK SOFTWARE TO CONNECT COMPUTER NETWORK USERS WITH KNOWLEDGE RESOURCES AND INFORMATION RESIDENT ON THE NETWORK (U.S. CLS. 21, 23, 26, 36 AND 38).

FIRST USE 11-9-2009; IN COMMERCE 11-9-2009.

CLASS 9—(Continued).

3,808,558. DIGITAL HORIZON SOLUTIONS, LLC, FRISCO, TX. SN 78-506,590. PUB. 12-2-2008, FILED 10-27-2004.

ECLIPSE

THE MARK CONSISTS OF STANDARD CHARACTERS WITHOUT CLAIM TO ANY PARTICULAR FONT, STYLE, SIZE, OR COLOR.

FOR BUILDING ACCESS CONTROL SYSTEM FOR PERSONNEL COMPRISED OF PERSONNEL IDENTIFICATION CARDS AND RECOGNITION DEVICES, DATA ENTRY PADS AND BIOMETRIC RECOGNITION DEVICES, ELECTRONIC DATA PROCESSORS, ALARM DEVICES AND DOOR LOCKS (U.S. CLS. 21, 23, 26, 36 AND 38).

FIRST USE 8-1-2006; IN COMMERCE 8-1-2006.

3,808,559. LEVITON MANUFACTURING CO., INC., MELVILLE, NY. SN 78-568,673. PUB. 5-30-2006, FILED 2-16-2005.

MAC-JACK

THE MARK CONSISTS OF STANDARD CHARACTERS WITHOUT CLAIM TO ANY PARTICULAR FONT, STYLE, SIZE, OR COLOR.

NO CLAIM IS MADE TO THE EXCLUSIVE RIGHT TO USE "MAC", APART FROM THE MARK AS SHOWN.

FOR JACKS, OUTLETS, CONNECTOR MODULES, AND CONNECTORS FOR THE TRANSMISSION AND INTERCONNECTION OF DATA SIGNALS (U.S. CLS. 21, 23, 26, 36 AND 38).

FIRST USE 4-2-2010; IN COMMERCE 4-2-2010.

CLASS 9—(Continued).

3,808,571. ROCKWELL COLLINS SIMULATION AND TRAINING SOLUTIONS LLC, CEDAR RAPIDS, IA. SN 78-714,960. PUB. 1-30-2007, FILED 9-16-2005.

ECT

THE MARK CONSISTS OF STANDARD CHARACTERS WITHOUT CLAIM TO ANY PARTICULAR FONT, STYLE, SIZE, OR COLOR.

FOR COMPUTER MODELING DEVICE COMPRISING COMPUTER HARDWARE AND SOFTWARE, FOR THE CREATION, MODIFICATION, AND VERIFICATION OF VISUAL DATABASES (U.S. CLS. 21, 23, 26, 36 AND 38). FIRST USE 10-28-2008; IN COMMERCE 10-28-2008.

3,808,572. BROADCOM CORPORATION, IRVINE, CA. SN 78-721,870. PUB. 7-28-2009, FILED 9-27-2005.



OWNER OF U.S. REG. NOS. 2,326,387, 2,896,055, AND OTHERS.

THE COLOR(S) BLACK, WHITE, GRAY, RED, AND YELLOW IS/ARE CLAIMED AS A FEATURE OF THE MARK.

THE COLOR RED APPEARS AS BACKGROUND WITHIN THE SQUARE-LIKE DESIGN. THE COLOR WHITE APPEARS IN THE WORDING "BROADCOM, NET", AND "NETXTREMEII", AND IN THE CIRCUIT-LIKE DESIGN. THE COLOR BLACK APPEARS AS BACKGROUND IN THE RECTANGLE-LIKE DESIGNS AND AS OUTLINE OF THE WORD NET. THE COLOR GRAY APPEARS ABOVE THE WORDING "NET X II". THE COLOR YELLOW APPEARS IN THE "X" AND "II".

FOR COMPUTER HARDWARE, NAMELY, ETHERNET CONTROLLERS AND ETHERNET CONTROLLER CHIPS; INTEGRATED CIRCUITS; AND SOFTWARE FOR CONTROLLING AND USING INTEGRATED CIRCUITS; COMPUTER SOFTWARE, EMBEDDED COMPUTER SOFTWARE AND SOFTWARE DOWNLOADED FROM AN INTERNET WEBSITE FOR CONTROLLING AND USING ETHERNET CONTROLLERS AND ETHERNET CONTROLLER CHIPS (U.S. CLS. 21, 23, 26, 36 AND 38).

FIRST USE 1-27-2005; IN COMMERCE 1-27-2005.

CLASS 9—(Continued).

3,808,601. ENDICOTT, WILLIAM L., WILMINGTON, DE. SN 78-915,189. PUB. 1-15-2008, FILED 6-23-2006.

ELECTRONIC BREAD CRUMBS

THE MARK CONSISTS OF STANDARD CHARACTERS WITHOUT CLAIM TO ANY PARTICULAR FONT, STYLE, SIZE, OR COLOR.
NO CLAIM IS MADE TO THE EXCLUSIVE RIGHT TO USE "ELECTRONIC", APART FROM THE MARK AS SHOWN.
FOR INTERACTIVE COMPUTER KIOSKS COMPRISING COMPUTERS, COMPUTER HARDWARE, COMPUTER PERIPHERALS, AND COMPUTER OPERATING SOFTWARE UTILIZING BAR CODES FOR USE IN CREATING VIRTUAL SIGNS, PROVIDING DIRECTIONS AND TRACKING (U.S. CLS. 21, 23, 26, 36 AND 38).
FIRST USE 3-1-2010; IN COMMERCE 3-1-2010.

3,808,603. BLAM! VENTURES, LLC, WAPPINGERS FALLS, NY. SN 78-915,590. PUB. 2-13-2007, FILED 6-23-2006.

iMATix

THE MARK CONSISTS OF STANDARD CHARACTERS WITHOUT CLAIM TO ANY PARTICULAR FONT, STYLE, SIZE, OR COLOR.
FOR AUDIOVISUAL RECORDINGS FEATURING ELECTRONIC PUBLICATIONS CONSISTING OF STILL AND ANIMATED IMAGES, AUDIO, TEXT AND DATA FEATURING FICTION AND NON-FICTION STORIES AND CHARACTERS (U.S. CLS. 21, 23, 26, 36 AND 38).
FIRST USE 6-23-2006; IN COMMERCE 4-30-2010.

CLASS 9—(Continued).

3,808,604. NILES AUDIO CORPORATION, MIAMI, FL. SN 78-916,431. PUB. 11-25-2008, FILED 6-26-2006.



THE MARK CONSISTS OF STYLIZED "I" ENCLOSED IN AN ELIPSE.
FOR ELECTRONIC AND MECHANICAL ACCESSORIES FOR PORTABLE AND HANDHELD DIGITAL ELECTRONIC DEVICES FOR RECORDING, ORGANIZING, TRANSMITTING, MANIPULATING, AND REVIEWING TEXT, DATA, AUDIO AND VIDEO FILES, NAMELY, ELECTRONIC DOCKING STATIONS, STANDS SPECIALLY DESIGNED FOR HOLDING PORTABLE AND HANDHELD DIGITAL ELECTRONIC DEVICES, BATTERY CHARGERS, ELECTRICAL CONNECTORS, WIRES, CABLES, AND ADAPTORS (U.S. CLS. 21, 23, 26, 36 AND 38).
FIRST USE 10-20-2006; IN COMMERCE 10-20-2006.

3,808,605. GLOBAL GAMING GROUP INC., LAS VEGAS, NV. SN 78-917,207. PUB. 2-27-2007, FILED 6-26-2006.

Fortune Roulette

THE MARK CONSISTS OF STANDARD CHARACTERS WITHOUT CLAIM TO ANY PARTICULAR FONT, STYLE, SIZE, OR COLOR.
NO CLAIM IS MADE TO THE EXCLUSIVE RIGHT TO USE "ROULETTE", APART FROM THE MARK AS SHOWN.
FOR GAMING EQUIPMENT, NAMELY, SLOT MACHINES WITH OR WITHOUT VIDEO OUTPUT (U.S. CLS. 21, 23, 26, 36 AND 38).
FIRST USE 11-17-2009; IN COMMERCE 11-17-2009.

CLASS 9—(Continued).

3,808,614. INTEGRATED DEVICE TECHNOLOGY, INC., SAN JOSE, CA. SN 78-937,717. PUB. 9-11-2007, FILED 7-26-2006.

MOBIUS MICROSYSTEMS

THE MARK CONSISTS OF STANDARD CHARACTERS WITHOUT CLAIM TO ANY PARTICULAR FONT, STYLE, SIZE, OR COLOR.

NO CLAIM IS MADE TO THE EXCLUSIVE RIGHT TO USE "MICROSYSTEMS", APART FROM THE MARK AS SHOWN.

FOR ANALOG AND MIXED SIGNAL INTEGRATED CIRCUITS; OSCILLATORS; CLOCK OSCILLATORS; OSCILLATOR CONTROL CIRCUITS (U.S. CLS. 21, 23, 26, 36 AND 38).

FIRST USE 10-9-2009; IN COMMERCE 10-9-2009.

CLASS 10—(Continued).

3,807,441. MEDSERV GROUP, INC., VISTA, CA. SN 77-107,269. PUB. 8-14-2007, FILED 2-14-2007.

**WE HAVE ELECTROTHERAPY
DOWN TO A SCIENCE**

THE MARK CONSISTS OF STANDARD CHARACTERS WITHOUT CLAIM TO ANY PARTICULAR FONT, STYLE, SIZE, OR COLOR.

FOR MEDICAL EQUIPMENT; NAMELY, TRANSCUTANEOUS ELECTRONEURAL STIMULATORS, ELECTRONEURAL MUSCULAR STIMULATORS, MUSCLE STIMULATORS; AND A DEVICE FOR VASCULAR CAPILLARIZATION (U.S. CLS. 26, 39 AND 44).

FIRST USE 2-15-2010; IN COMMERCE 4-1-2010.

3,808,623. VASQUEZ, PABLITO, LOS ANGELES, CA. SN 78-981,378. PUB. 1-23-2007, FILED 3-24-2006.

Street Life

THE MARK CONSISTS OF STANDARD CHARACTERS WITHOUT CLAIM TO ANY PARTICULAR FONT, STYLE, SIZE, OR COLOR.

FOR SOUND RECORDINGS, NAMELY, PRERECORDED COMPACT DISCS, TAPES, RECORDS, VIDEOS AND DIGITAL MEDIA AND FILES ALL FEATURING MUSIC (U.S. CLS. 21, 23, 26, 36 AND 38).

FIRST USE 4-0-2009; IN COMMERCE 4-0-2009.

3,807,461. DEPUY, INC., WARSAW, IN. SN 77-184,900. PUB. 10-7-2008, FILED 5-18-2007.

IN MOTION

THE MARK CONSISTS OF STANDARD CHARACTERS WITHOUT CLAIM TO ANY PARTICULAR FONT, STYLE, SIZE, OR COLOR.

FOR ARTIFICIAL SPINAL DISCS, SPINAL IMPLANTS COMPRISED OF ARTIFICIAL MATERIALS; SURGICAL INSTRUMENTS FOR USE WITH ARTIFICIAL SPINAL DISCS AND SPINAL IMPLANTS (U.S. CLS. 26, 39 AND 44).

FIRST USE 0-0-2007; IN COMMERCE 0-0-2007.

CLASS 10—MEDICAL APPARATUS

3,807,392. BUTH, FREDRICK A., SHAWANO, WI. SN 76-695,296. PUB. 9-8-2009, FILED 1-14-2009.

Chi-G

THE MARK CONSISTS OF STANDARD CHARACTERS WITHOUT CLAIM TO ANY PARTICULAR FONT, STYLE, SIZE, OR COLOR.

FOR APPARATUS FOR ACUPRESSURE THERAPY (U.S. CLS. 26, 39 AND 44).

FIRST USE 11-27-2007; IN COMMERCE 8-21-2009.

3,807,486. TELEFLEX INCORPORATED, LIMERICK, PA. SN 77-255,983. PUB. 2-12-2008, FILED 8-15-2007.

CENTAUR

THE MARK CONSISTS OF STANDARD CHARACTERS WITHOUT CLAIM TO ANY PARTICULAR FONT, STYLE, SIZE, OR COLOR.

FOR SURGICAL APPARATUS AND INSTRUMENTS FOR USE IN ORTHOPEDICS (U.S. CLS. 26, 39 AND 44).

FIRST USE 0-0-2007; IN COMMERCE 0-0-2007.

CLASS 10—(Continued).

3,807,623. DEPUY, INC., WARSAW, IN. SN 77-463,647. PUB. 9-16-2008, FILED 5-1-2008.

F.A.S.T. TABS

THE MARK CONSISTS OF STANDARD CHARACTERS WITHOUT CLAIM TO ANY PARTICULAR FONT, STYLE, SIZE, OR COLOR.

NO CLAIM IS MADE TO THE EXCLUSIVE RIGHT TO USE "TABS", APART FROM THE MARK AS SHOWN.

FOR IMPLANTABLE ORTHOPEDIC FIXATION DEVICES, NAMELY, BONE PLATES; ORTHOPAEDIC ANATOMICAL PLATES (U.S. CLS. 26, 39 AND 44).

FIRST USE 2-0-2008; IN COMMERCE 2-0-2008.

3,807,638. DEL PALMA ORTHOPEDICS, LLC, COLUMBIA CITY, IN. SN 77-481,260. PUB. 3-3-2009, FILED 5-22-2008.

**ADVANCING TODAY'S
TECHNIQUES WITH TOMORROW'S
TECHNOLOGY**

THE MARK CONSISTS OF STANDARD CHARACTERS WITHOUT CLAIM TO ANY PARTICULAR FONT, STYLE, SIZE, OR COLOR.

FOR MEDICAL DEVICES AND INSTRUMENTATION FOR FRACTURE FIXATION, JOINT RECONSTRUCTION OR FUSION, AND SOFT TISSUE RELEASES OF THE UPPER AND LOWER EXTREMITIES (HAND, WRIST, ELBOW, FOOT AND ANKLE) (U.S. CLS. 26, 39 AND 44).

FIRST USE 5-22-2009; IN COMMERCE 5-22-2009.

3,807,639. DEL PALMA ORTHOPEDICS, LLC, COLUMBIA CITY, IN. SN 77-481,264. PUB. 3-3-2009, FILED 5-22-2008.

DEL PALMA ORTHOPEDICS

THE MARK CONSISTS OF STANDARD CHARACTERS WITHOUT CLAIM TO ANY PARTICULAR FONT, STYLE, SIZE, OR COLOR.

NO CLAIM IS MADE TO THE EXCLUSIVE RIGHT TO USE "ORTHOPEDICS", APART FROM THE MARK AS SHOWN.

CLASS 10—(Continued).

THE FOREIGN WORDING IN THE MARK TRANSLATES INTO ENGLISH AS "OF THE PALM".

FOR MEDICAL DEVICES AND INSTRUMENTATION FOR FRACTURE FIXATION, JOINT RECONSTRUCTION OR FUSION, AND SOFT TISSUE RELEASES OF THE UPPER AND LOWER EXTREMITIES (HAND, WRIST, ELBOW, FOOT AND ANKLE) (U.S. CLS. 26, 39 AND 44).

FIRST USE 5-22-2009; IN COMMERCE 5-22-2009.

3,807,753. SYNERGY USA, LLC., MIAMI, FL. SN 77-564,809. PUB. 8-4-2009, FILED 9-8-2008.

MICROSECOND FLASH

THE MARK CONSISTS OF STANDARD CHARACTERS WITHOUT CLAIM TO ANY PARTICULAR FONT, STYLE, SIZE, OR COLOR.

FOR DIGITAL THERMOMETERS FOR MEDICAL PURPOSES (U.S. CLS. 26, 39 AND 44).

FIRST USE 12-0-2008; IN COMMERCE 12-0-2008.

3,807,786. THE EXECUTIVE DEN MENS HAIRSTYLIST LLC, NEW YORK, NY. SN 77-573,012. PUB. 8-4-2009, FILED 9-18-2008.

MHP HAIR SYSTEM

THE MARK CONSISTS OF STANDARD CHARACTERS WITHOUT CLAIM TO ANY PARTICULAR FONT, STYLE, SIZE, OR COLOR.

NO CLAIM IS MADE TO THE EXCLUSIVE RIGHT TO USE "HAIR SYSTEM", APART FROM THE MARK AS SHOWN.

FOR HAIR PROSTHESES FOR MEDICAL HAIR LOSS (U.S. CLS. 26, 39 AND 44).

FIRST USE 9-30-2008; IN COMMERCE 9-30-2008.

CLASS 10—(Continued).

3,807,811. TERUMO KABUSHIKI KAISHA, AKA TERUMO CORPORATION, SHIBUYA-KU, TOKYO, JAPAN. SN 77-583,037. PUB. 6-30-2009, FILED 10-1-2008.



OWNER OF JAPAN REG. NO. 5171935, DATED 10-10-2008, EXPIRES 10-10-2018.

FOR OXYGENATORS FOR MEDICAL USE; OXYGENATORS FOR MEDICAL USE SOLD AS A UNIT WITH ONE OR MORE OTHER COMPONENTS, NAMELY, HARDSHELL RESERVOIRS, INTEGRATED HEAT EXCHANGERS, ARTERIAL RESERVOIRS, CARDIOTOMY RESERVOIRS, VENOUS RESERVOIRS, BLOOD PUMPS; PARTS AND FITTINGS FOR THE AFORESAID (U.S. CLS. 26, 39 AND 44).
FIRST USE 12-17-2008; IN COMMERCE 12-17-2008.

CLASS 10—(Continued).

3,807,906. BECTON, DICKINSON AND COMPANY, FRANKLIN LAKES, NJ. SN 77-644,110. PUB. 9-1-2009, FILED 1-6-2009.



THE MARK CONSISTS OF A CIRCLE WITH A DIAGONAL LINE DIVIDING THE MIDDLE OF THE CIRCLE AND WITH TWO ADDITIONAL LINES CROSSING THROUGH THE LINE DIVIDING THE MIDDLE OF THE CIRCLE NEAR BOTH ENDS OF THE LINE.

FOR SYRINGES AND NEEDLES FOR MEDICAL USE (U.S. CLS. 26, 39 AND 44).
FIRST USE 4-30-2008; IN COMMERCE 4-30-2008.

3,807,895. U.S. ENDOSCOPY GROUP, INC., MENTOR, OH. SN 77-635,981. PUB. 11-17-2009, FILED 12-18-2008.

BOOST

THE MARK CONSISTS OF STANDARD CHARACTERS WITHOUT CLAIM TO ANY PARTICULAR FONT, STYLE, SIZE, OR COLOR.

FOR HEAD POSITIONER FOR STABILIZING A PATIENT IN PROPER ORIENTATION DURING AN ENDOSCOPIC PROCEDURE (U.S. CLS. 26, 39 AND 44).
FIRST USE 6-23-2009; IN COMMERCE 6-23-2009.

3,807,974. FIRST WAVE PRODUCTS GROUP, LLC, BATAVIA, NY. SN 77-676,782. PUB. 6-23-2009, FILED 2-24-2009.

FIRST CRUSH

THE MARK CONSISTS OF STANDARD CHARACTERS WITHOUT CLAIM TO ANY PARTICULAR FONT, STYLE, SIZE, OR COLOR.

FOR MEDICAL EQUIPMENT, NAMELY, PILL AND TABLET CRUSHING DEVICES (U.S. CLS. 26, 39 AND 44).
FIRST USE 3-2-2010; IN COMMERCE 3-2-2010.

CLASS 10—(Continued).

3,808,079. MICROVENTION, INC., TUSTIN, CA. SN 77-698,122. PUB. 7-21-2009, FILED 3-24-2009.

HYDROFLOW

THE MARK CONSISTS OF STANDARD CHARACTERS WITHOUT CLAIM TO ANY PARTICULAR FONT, STYLE, SIZE, OR COLOR.

FOR MEDICAL DEVICES, NAMELY, EMBOLIC COILS (U.S. CLS. 26, 39 AND 44).

FIRST USE 9-18-2009; IN COMMERCE 9-18-2009.

3,808,083. UNCLE SAM INTERNATIONAL, TONAWANDA, NY. SN 77-698,650. PUB. 8-4-2009, FILED 3-25-2009.

EaseLife

THE MARK CONSISTS OF STANDARD CHARACTERS WITHOUT CLAIM TO ANY PARTICULAR FONT, STYLE, SIZE, OR COLOR.

FOR ELECTRIC FOOT SPA MASSAGERS; ELECTRIC MASSAGE APPARATUS FOR HOUSEHOLD USE; ELECTRIC MASSAGE APPLIANCES, NAMELY, ELECTRIC VIBRATING MASSAGER; GLOVES FOR MASSAGE; MASSAGE APPARATUS; MASSAGE APPARATUS; MASSAGE APPARATUS; MASSAGE APPARATUS AND INSTRUMENTS; MASSAGE CHAIRS; MASSAGERS IN THE NATURE OF ELECTROMECHANICAL MASSAGE MECHANISM FOR CHAIRS; MASSAGING APPARATUS FOR PERSONAL USE (U.S. CLS. 26, 39 AND 44).

FIRST USE 4-10-2009; IN COMMERCE 5-1-2009.

3,808,095. ULTRADENT PRODUCTS, INC., SOUTH JORDAN, UT. SN 77-700,139. PUB. 12-15-2009, FILED 3-26-2009.

AVEX

THE MARK CONSISTS OF STANDARD CHARACTERS WITHOUT CLAIM TO ANY PARTICULAR FONT, STYLE, SIZE, OR COLOR.

FOR DENTAL PRODUCTS, NAMELY, ORTHODONTIC BRACKETS (U.S. CLS. 26, 39 AND 44).

FIRST USE 5-0-2009; IN COMMERCE 5-0-2009.

CLASS 10—(Continued).

3,808,127. CHI-SAN, LLC, SAN RAFAEL, CA. SN 77-704,400. PUB. 12-8-2009, FILED 4-1-2009.

SLEEP COMFORT CARE PAD

THE MARK CONSISTS OF STANDARD CHARACTERS WITHOUT CLAIM TO ANY PARTICULAR FONT, STYLE, SIZE, OR COLOR.

NO CLAIM IS MADE TO THE EXCLUSIVE RIGHT TO USE "SLEEP" AND "PAD", APART FROM THE MARK AS SHOWN.

FOR MEDICAL DEVICES, NAMELY, PADS FOR RESPIRATOR MASKS (U.S. CLS. 26, 39 AND 44).

FIRST USE 11-18-2009; IN COMMERCE 11-18-2009.

3,808,219. DURA-METRICS, INC., SANTA ROSA, CA. SN 77-719,516. PUB. 9-1-2009, FILED 4-22-2009.

Perfect Prep

THE MARK CONSISTS OF STANDARD CHARACTERS WITHOUT CLAIM TO ANY PARTICULAR FONT, STYLE, SIZE, OR COLOR.

FOR DENTAL BURS (U.S. CLS. 26, 39 AND 44).

FIRST USE 8-5-2009; IN COMMERCE 2-12-2010.

3,808,235. U.S. ENDOSCOPY GROUP, INC., MENTOR, OH. SN 77-725,770. PUB. 9-8-2009, FILED 4-30-2009.

VELOCITY

THE MARK CONSISTS OF STANDARD CHARACTERS WITHOUT CLAIM TO ANY PARTICULAR FONT, STYLE, SIZE, OR COLOR.

FOR MEDICAL DEVICE, NAMELY, PUMP AND IRRIGATION SYSTEM FOR USE IN AN ENDOSCOPIC PROCEDURE (U.S. CLS. 26, 39 AND 44).

FIRST USE 11-19-2009; IN COMMERCE 11-19-2009.

CLASS 10—(Continued).

3,808,393. HEALTH ENTERPRISES, INC., NORTH ATTLEBORO, MA. SN 77-780,368. PUB. 12-8-2009, FILED 7-14-2009.

THERAPOD

THE MARK CONSISTS OF STANDARD CHARACTERS WITHOUT CLAIM TO ANY PARTICULAR FONT, STYLE, SIZE, OR COLOR.
FOR THERAPEUTIC HOT AND COLD THERAPY PACKS (U.S. CLS. 26, 39 AND 44).
FIRST USE 12-16-2009; IN COMMERCE 12-16-2009.

3,808,483. MOXIMED, INC., HAYWARD, CA. SN 77-814,643. PUB. 1-26-2010, FILED 8-27-2009.

MOXIMED

THE MARK CONSISTS OF STANDARD CHARACTERS WITHOUT CLAIM TO ANY PARTICULAR FONT, STYLE, SIZE, OR COLOR.
OWNER OF U.S. REG. NO. 3,716,193.
FOR MEDICAL DEVICES FOR THE TREATMENT OF OSTEOARTHRITIS AND TRAUMA (U.S. CLS. 26, 39 AND 44).
FIRST USE 8-11-2008; IN COMMERCE 8-11-2008.

3,808,552. NIPPON SIGMAX CO., LTD., SHINJUKU-KU, TOKYO, JAPAN. SN 77-979,560. PUB. 8-19-2008, FILED 9-14-2007.

ZAMST

THE WORDING "ZAMST" HAS NO MEANING IN A FOREIGN LANGUAGE.
FOR ORTHOPEDIC MATERIALS AND ARTICLES, NAMELY, SUPPORT BANDAGES AND BANDS FOR ANKLES, CALVES, KNEES, THIGHS, BACKS, SHOULDERS, ELBOWS, FINGERS AND WRISTS; BRACES FOR LIMBS AND JOINTS FOR ORTHOPEDIC USE; SUPPORT BANDAGES FOR PROTECTING MUSCLES; ELASTIC TUBULAR BANDAGES; NON-MEDICATED COMPRESSES; ELASTIC BANDAGES (U.S. CLS. 26, 39 AND 44).
FIRST USE 4-26-2010; IN COMMERCE 4-26-2010.

CLASS 11—ENVIRONMENTAL CONTROL APPARATUS

3,807,394. CAT EYE CO., LTD., OSAKA-SHI, OSAKA, JAPAN. SN 76-695,766. PUB. 1-5-2010, FILED 2-12-2009.



PRIORITY CLAIMED UNDER SEC. 44(D) ON JAPAN APPLICATION NO. 2008-104302, FILED 12-26-2008, REG. NO. 5238314, DATED 6-12-2009, EXPIRES 6-12-2019.
OWNER OF U.S. REG. NOS. 1,121,006, 2,541,315, AND OTHERS.
NO CLAIM IS MADE TO THE EXCLUSIVE RIGHT TO USE "HYBRID", APART FROM THE MARK AS SHOWN.
FOR BICYCLE LIGHTS; BICYCLE REAR LIGHTS AND PARTS THEREFOR (U.S. CLS. 13, 21, 23, 31 AND 34).
FIRST USE 8-26-2009; IN COMMERCE 9-18-2009.

3,807,473. THE DIME GROUP CORPORATION, NEW YORK, NY. SN 77-234,437. PUB. 2-5-2008, FILED 7-20-2007.

KITCHEN CHEF

THE MARK CONSISTS OF STANDARD CHARACTERS WITHOUT CLAIM TO ANY PARTICULAR FONT, STYLE, SIZE, OR COLOR.
NO CLAIM IS MADE TO THE EXCLUSIVE RIGHT TO USE "KITCHEN", APART FROM THE MARK AS SHOWN.
FOR ELECTRIC FRYING PANS, ELECTRIC PANS, ELECTRIC WOKS, AND ELECTRIC FONDUE MAKERS (U.S. CLS. 13, 21, 23, 31 AND 34).
FIRST USE 1-1-2009; IN COMMERCE 1-1-2009.

3,807,652. BIOHITECH INTERNATIONAL, INC., SECAUCUS, NJ, AND KOH, CHUN IL, SECAUCUS, NJ. SN 77-501,312. PUB. 7-21-2009, FILED 6-17-2008.

SuperGo H2O

THE MARK CONSISTS OF STANDARD CHARACTERS WITHOUT CLAIM TO ANY PARTICULAR FONT, STYLE, SIZE, OR COLOR.

CLASS 11—(Continued).

NO CLAIM IS MADE TO THE EXCLUSIVE RIGHT TO USE "H2O", APART FROM THE MARK AS SHOWN.

FOR BIOREACTORS FOR USE IN THE TREATMENT OF ORGANIC WASTE, WATER PURIFICATION UNITS, WASTE WATER PURIFICATION UNITS, WATER FILTERING APPARATUS; FOOD WASTE PROCESSING MACHINES AND ORGANIC WASTE PROCESSING MACHINES, NAMELY, MACHINES USING HEAT AND CHEMICAL BREAKDOWN FOR PROCESSING OF WASTE (U.S. CLS. 13, 21, 23, 31 AND 34).

FIRST USE 3-1-2010; IN COMMERCE 3-1-2010.

3,807,715. LIGHT PRESCRIPTIONS INNOVATORS, LLC, ALTADENA, CA. SN 77-552,711. PUB. 1-20-2009, FILED 8-21-2008.

VIRTUAL FILAMENT

THE MARK CONSISTS OF STANDARD CHARACTERS WITHOUT CLAIM TO ANY PARTICULAR FONT, STYLE, SIZE, OR COLOR.

FOR SOLID STATE LIGHTING, NAMELY, LIGHT EMITTING DIODE BULBS AND OPTICAL LENSES FOR MODIFYING LIGHT FOR USE WITH LIGHT EMITTING DIODE BULBS (U.S. CLS. 13, 21, 23, 31 AND 34).

FIRST USE 1-1-2009; IN COMMERCE 1-1-2009.

3,807,742. RARITAN ENGINEERING COMPANY, INC., MILLVILLE, NJ. SN 77-561,048. PUB. 7-21-2009, FILED 9-3-2008.

VORTEX-VAC

THE MARK CONSISTS OF STANDARD CHARACTERS WITHOUT CLAIM TO ANY PARTICULAR FONT, STYLE, SIZE, OR COLOR.

FOR MARINE TOILET SYSTEMS COMPRISING PRIMARILY BOWLS, PUMPS, CONTROLS AND WIRING HARNESSSES (U.S. CLS. 13, 21, 23, 31 AND 34).

FIRST USE 1-31-2009; IN COMMERCE 1-31-2009.

3,807,760. SYNERGY USA, LLC., MIAMI, FL. SN 77-566,727. PUB. 8-4-2009, FILED 9-10-2008.

BUCCO**STER**

NO CLAIM IS MADE TO THE EXCLUSIVE RIGHT TO USE "UV", APART FROM THE MARK AS SHOWN.

CLASS 11—(Continued).

THE MARK CONSISTS OF THE WORDING "BUCCOSTER" AND IN THE LETTER "O" THE LETTERS "UV".

FOR UV TOOTHBRUSH STERILIZERS (U.S. CLS. 13, 21, 23, 31 AND 34).

FIRST USE 1-0-2008; IN COMMERCE 9-0-2008.

3,807,820. SELECTAFLUSH, LLC, STUART, FL. SN 77-586,574. PUB. 8-18-2009, FILED 10-6-2008.



NO CLAIM IS MADE TO THE EXCLUSIVE RIGHT TO USE "SELECT A FLUSH", APART FROM THE MARK AS SHOWN.

THE COLOR(S) BLACK, WHITE AND BLUE IS/ARE CLAIMED AS A FEATURE OF THE MARK.

THE MARK CONSISTS OF THE WORDS "SELECT A FLUSH" IN BLACK ARCHED OVER TWO BLUE AND WHITE RINGS WHICH REPRESENT WATER RIPPLING FROM A DROP. A BLUE DROP APPEARS BETWEEN THE TWO BLUE AND WHITE RINGS.

FOR TOILETS AND PARTS THEREOF, NAMELY, FLUSH LEVERS (U.S. CLS. 13, 21, 23, 31 AND 34).

FIRST USE 9-1-2008; IN COMMERCE 1-10-2009.

3,807,841. LUMINATION LLC, CLEVELAND, OH. SN 77-598,709. PUB. 3-17-2009, FILED 10-23-2008.

OPTILENS

THE MARK CONSISTS OF STANDARD CHARACTERS WITHOUT CLAIM TO ANY PARTICULAR FONT, STYLE, SIZE, OR COLOR.

FOR OPTICAL LENS COVERS THAT IMPROVES LIGHT OUTPUT AND UNIFORMITY, AND PROTECTS THE LED SOLD AS A FEATURE OF AN LED LIGHTING SYSTEM (U.S. CLS. 13, 21, 23, 31 AND 34).

FIRST USE 10-31-2008; IN COMMERCE 10-31-2008.

CLASS 11—(Continued).

3,807,914. HENNY PENNY CORPORATION, EATON, OH. SN 77-647,774. PUB. 5-5-2009, FILED 1-12-2009.

EVOLUTION ELITE

THE MARK CONSISTS OF STANDARD CHARACTERS WITHOUT CLAIM TO ANY PARTICULAR FONT, STYLE, SIZE, OR COLOR.

FOR COMMERCIAL FOOD SERVICE EQUIPMENT, NAMELY, ELECTRIC AND GAS FOOD FRYERS (U.S. CLS. 13, 21, 23, 31 AND 34).

FIRST USE 4-1-2009; IN COMMERCE 4-1-2009.

3,807,915. HENNY PENNY CORPORATION, EATON, OH. SN 77-647,784. PUB. 5-5-2009, FILED 1-12-2009.

OIL GUARDIAN

THE MARK CONSISTS OF STANDARD CHARACTERS WITHOUT CLAIM TO ANY PARTICULAR FONT, STYLE, SIZE, OR COLOR.

NO CLAIM IS MADE TO THE EXCLUSIVE RIGHT TO USE "OIL", APART FROM THE MARK AS SHOWN.

FOR ELECTRIC AND GAS COMMERCIAL FOOD FRYERS, COMPONENTS FOR ELECTRIC AND GAS COMMERCIAL FRYERS, NAMELY, ELECTRONIC MODULES, SENSORS, AND/OTHER DEVICES FOR DETECTING THE NEED FOR AND FACILITATING AN AUTOMATIC TOP OFF OF THE COOKING MEDIUM (U.S. CLS. 13, 21, 23, 31 AND 34).

FIRST USE 4-1-2009; IN COMMERCE 4-1-2009.

3,807,956. FAROUK SYSTEMS, INC., HOUSTON, TX. SN 77-670,870. PUB. 7-7-2009, FILED 2-14-2009.



THE MARK CONSISTS OF THE WORD "VELOCITY" WITH SOME PARALLEL LINES APPEARING OVER THE WORD "VELOCITY".

FOR HAIR DRYERS (U.S. CLS. 13, 21, 23, 31 AND 34). FIRST USE 3-29-2010; IN COMMERCE 3-29-2010.

CLASS 11—(Continued).

3,808,003. KOHLER CO., KOHLER, WI. SN 77-684,204. PUB. 7-14-2009, FILED 3-5-2009.

PARITY

THE MARK CONSISTS OF STANDARD CHARACTERS WITHOUT CLAIM TO ANY PARTICULAR FONT, STYLE, SIZE, OR COLOR.

FOR BATHTUBS AND BATHTUB SEATS (U.S. CLS. 13, 21, 23, 31 AND 34).

FIRST USE 5-31-2009; IN COMMERCE 5-31-2009.

3,808,040. ZERO TECHNOLOGIES, LLC, BENSALEM, PA. SN 77-692,123. PUB. 7-21-2009, FILED 3-16-2009.

**IF IT'S NOT ALL ZEROS -
IT'S NOT ZEROWATER**

THE MARK CONSISTS OF STANDARD CHARACTERS WITHOUT CLAIM TO ANY PARTICULAR FONT, STYLE, SIZE, OR COLOR.

OWNER OF U.S. REG. NOS. 2,802,616 AND 3,455,859.

FOR WATER FILTERING UNITS FOR HOUSEHOLD USE; WATER FILTERS; WATER FILTRATION BOTTLES AND PITCHERS SOLD EMPTY (U.S. CLS. 13, 21, 23, 31 AND 34).

FIRST USE 12-31-2009; IN COMMERCE 12-31-2009.

3,808,042. ZERO TECHNOLOGIES, LLC, BENSALEM, PA. SN 77-692,160. PUB. 7-21-2009, FILED 3-16-2009.



OWNER OF U.S. REG. NOS. 2,802,616 AND 3,455,859. THE MARK CONSISTS OF THE WORD "ZEROWATER" WITH THE NUMERAL "0" BOTH ABOVE AND BELOW THE "O".

FOR WATER FILTERING UNITS SOLD FOR HOUSEHOLD USE; WATER FILTERS; WATER FILTRATION BOTTLES AND PITCHERS SOLD EMPTY (U.S. CLS. 13, 21, 23, 31 AND 34).

FIRST USE 12-31-2009; IN COMMERCE 12-31-2009.

CLASS 11—(Continued).

3,808,067. LUMIETTE INC., CUPERTINO, CA. SN 77-696,974.
PUB. 7-21-2009, FILED 3-23-2009.

LUMIETTE

THE MARK CONSISTS OF STANDARD CHARACTERS WITHOUT CLAIM TO ANY PARTICULAR FONT, STYLE, SIZE, OR COLOR.

FOR FLAT PANEL LAMPS (U.S. CLS. 13, 21, 23, 31 AND 34).

FIRST USE 7-0-2008; IN COMMERCE 7-0-2008.

3,808,101. WESTERN OILFIELDS SUPPLY COMPANY, BAKERSFIELD, CA. SN 77-700,474. PUB. 7-28-2009, FILED 3-26-2009.

FREEZESENTRY

THE MARK CONSISTS OF STANDARD CHARACTERS WITHOUT CLAIM TO ANY PARTICULAR FONT, STYLE, SIZE, OR COLOR.

FOR ELECTRICALLY HEATED BLANKETS AND WRAPS FOR USE ON INDUSTRIAL EQUIPMENT TO ELEVATE THE TEMPERATURE THEREOF, ON LIQUID HANDLING EQUIPMENT, NAMELY, PIPES, HOSES, MANIFOLDS, TANKS, CONTAINERS, VALVES AND PUMPS TO PREVENT FREEZING AND PROVIDE VISCOSITY CONTROL AND ABOUT PERSONNEL WORK CREW AREAS TO ELEVATE THE TEMPERATURE THEREIN (U.S. CLS. 13, 21, 23, 31 AND 34).

FIRST USE 5-15-2009; IN COMMERCE 5-15-2009.

3,808,116. NATIONAL STEELCRAFTERS OF TEXAS, LLC, ARLINGTON, TX. SN 77-703,097. PUB. 7-28-2009, FILED 3-31-2009.

Mojave

THE MARK CONSISTS OF STANDARD CHARACTERS WITHOUT CLAIM TO ANY PARTICULAR FONT, STYLE, SIZE, OR COLOR.

FOR ELECTRIC STOVES; FIREPLACE INSERTS IN THE NATURE OF STOVES; GAS STOVES; SLOW-BURNING STOVES; SOLID FUEL BURNING STOVES; WOOD BURNING STOVES (U.S. CLS. 13, 21, 23, 31 AND 34).

FIRST USE 4-1-2005; IN COMMERCE 4-1-2005.

CLASS 11—(Continued).

3,808,117. NATIONAL STEELCRAFTERS OF TEXAS, ARLINGTON, TX. SN 77-703,111. PUB. 7-28-2009, FILED 3-31-2009.

Sonora

THE MARK CONSISTS OF STANDARD CHARACTERS WITHOUT CLAIM TO ANY PARTICULAR FONT, STYLE, SIZE, OR COLOR.

FOR ELECTRIC STOVES; FIREPLACE INSERTS IN THE NATURE OF STOVES; GAS STOVES; SLOW-BURNING STOVES; SOLID FUEL BURNING STOVES; WOOD BURNING STOVES (U.S. CLS. 13, 21, 23, 31 AND 34).

FIRST USE 4-1-2005; IN COMMERCE 4-1-2005.

3,808,118. NATIONAL STEELCRAFTERS OF TEXAS, ARLINGTON, TX. SN 77-703,121. PUB. 7-28-2009, FILED 3-31-2009.

Classic Cast

THE MARK CONSISTS OF STANDARD CHARACTERS WITHOUT CLAIM TO ANY PARTICULAR FONT, STYLE, SIZE, OR COLOR.

NO CLAIM IS MADE TO THE EXCLUSIVE RIGHT TO USE "CAST", APART FROM THE MARK AS SHOWN.

FOR ELECTRIC STOVES; FIREPLACE INSERTS IN THE NATURE OF STOVES; GAS STOVES; SLOW-BURNING STOVES; SOLID FUEL BURNING STOVES; WOOD BURNING STOVES (U.S. CLS. 13, 21, 23, 31 AND 34).

FIRST USE 4-1-2005; IN COMMERCE 4-1-2005.

3,808,158. FRANZ KALDEWEI GMBH & CO. KG, AHLEN, FED REP GERMANY. SN 77-709,288. PUB. 8-11-2009, FILED 4-8-2009.

CONOFLAT

THE MARK CONSISTS OF STANDARD CHARACTERS WITHOUT CLAIM TO ANY PARTICULAR FONT, STYLE, SIZE, OR COLOR.

OWNER OF U.S. REG. NO. 3,479,530.
FOR BATHTUBS, SHOWER TRAYS (U.S. CLS. 13, 21, 23, 31 AND 34).

FIRST USE 4-0-2009; IN COMMERCE 4-0-2009.

CLASS 11—(Continued).

3,808,184. EVEREADY BATTERY COMPANY, INC., ST. LOUIS, MO. SN 77-713,123. PUB. 7-28-2009, FILED 4-14-2009.

DUALDRIVE

THE MARK CONSISTS OF STANDARD CHARACTERS WITHOUT CLAIM TO ANY PARTICULAR FONT, STYLE, SIZE, OR COLOR.
FOR FLASHLIGHTS (U.S. CLS. 13, 21, 23, 31 AND 34).
FIRST USE 7-2-2009; IN COMMERCE 7-2-2009.

3,808,224. LF, LLC, WILMINGTON, DE. SN 77-721,838. PUB. 7-21-2009, FILED 4-24-2009.

AQUASOURCE

THE MARK CONSISTS OF STANDARD CHARACTERS WITHOUT CLAIM TO ANY PARTICULAR FONT, STYLE, SIZE, OR COLOR.
OWNER OF U.S. REG. NOS. 2,845,074 AND 2,886,605.
FOR TOILETS; TOILET SEATS (U.S. CLS. 13, 21, 23, 31 AND 34).
FIRST USE 12-0-2005; IN COMMERCE 12-0-2005.

3,808,225. SUREFIRE, LLC, FOUNTAIN VALLEY, CA. SN 77-721,895. PUB. 9-1-2009, FILED 4-24-2009.

MODUS

THE MARK CONSISTS OF STANDARD CHARACTERS WITHOUT CLAIM TO ANY PARTICULAR FONT, STYLE, SIZE, OR COLOR.
FOR FLASHLIGHTS (U.S. CLS. 13, 21, 23, 31 AND 34).
FIRST USE 11-0-2009; IN COMMERCE 11-0-2009.

CLASS 11—(Continued).

3,808,302. NATURE'S SUNSHINE PRODUCTS, INC., PROVO, UT. SN 77-744,876. PUB. 9-22-2009, FILED 5-26-2009.

BOOMERANG

THE MARK CONSISTS OF STANDARD CHARACTERS WITHOUT CLAIM TO ANY PARTICULAR FONT, STYLE, SIZE, OR COLOR.
FOR AIR PURIFIER (U.S. CLS. 13, 21, 23, 31 AND 34).
FIRST USE 8-5-2009; IN COMMERCE 8-5-2009.

3,808,330. PANOR CORPORATION, HAUPPAUGE, NY. SN 77-756,512. PUB. 11-10-2009, FILED 6-10-2009.

MAXXIMA

THE MARK CONSISTS OF STANDARD CHARACTERS WITHOUT CLAIM TO ANY PARTICULAR FONT, STYLE, SIZE, OR COLOR.
OWNER OF U.S. REG. NOS. 1,569,429 AND 2,486,869.
FOR LIGHTS POWERED BY LIGHT EMITTING DIODES FOR ILLUMINATING RESIDENTIAL AND COMMERCIAL BUILDINGS (U.S. CLS. 13, 21, 23, 31 AND 34).
FIRST USE 5-5-2005; IN COMMERCE 5-5-2005.

3,808,386. EVEREADY BATTERY COMPANY, INC., ST. LOUIS, MO. SN 77-776,362. PUB. 11-17-2009, FILED 7-8-2009.



OWNER OF U.S. REG. NOS. 2,500,464, 3,554,124, AND OTHERS.

THE STIPPLING IS FOR SHADING PURPOSES ONLY.
THE MARK CONSISTS OF A DESIGN APPEARING ON PACKAGING FOR THE GOODS. THE DESIGN COMPRISES TWO ARCUATE WAVE BANDS. THE TOP BAND STARTS ON THE LEFT, ASCENDS BRIEFLY, THEN DESCENDS IN A CURVE AND ASCENDS AGAIN THREE-QUARTERS

CLASS 11—(Continued).

ACROSS TO THE RIGHT CREATING A WAVE. THE LOWER BAND STARTS ON THE LEFT AND IS A SIMPLE ARCUATE ASCENDING GENERALLY FROM THE LEFT TO THE RIGHT; THE BAND ITSELF IS WIDEST AT THE LEFT, TAPERS AT THE OFFSET MIDDLE AND RESUMES WIDENING SLIGHTLY AT THE RIGHT. THE BANDS CONSIST OF GRADIENT TONAL VALUES WITH A SOLID ELLIPTICAL BURST PUNCTUATING THE OFFSET RIGHT AREA WHERE THE BANDS CROSS ONE ANOTHER. THE WORD "ENERGIZER" IS SUPERIMPOSED OVER TOP PORTIONS OF THE BANDS. THE STIPPLING SHOWN IN THE DRAWING IS FOR INDICATING THE CONTRASTING ARRANGEMENT; IT IS NOT A FEATURE OF THE MARK AND DOES NOT INDICATE COLOR.

FOR FLASHLIGHTS; LANTERNS (U.S. CLS. 13, 21, 23, 31 AND 34).
FIRST USE 2-11-2010; IN COMMERCE 2-11-2010.



3,808,394. HESMER, WILLIAM RUSSELL, WILSON, NC. SN 77-780,518. PUB. 12-8-2009, FILED 7-14-2009.



THE MARK CONSISTS OF THE WORD "HOTSHEETER" IN STYLIZED FONT AND AN IMAGE REPRESENTING AIR BEING BLOWN AT THE TOP OF THE LETTER "H".

FOR HOT AIR BLOWERS (U.S. CLS. 13, 21, 23, 31 AND 34).
FIRST USE 3-5-2010; IN COMMERCE 3-5-2010.



3,808,430. KAMISORI INC., MARKHAM, ONTARIO, CANADA. SN 77-793,683. PUB. 12-22-2009, FILED 7-30-2009.



THE MARK CONSISTS OF THE WORD "HOTNESS" WITH A DEGREE SYMBOL BY THE "S".
FOR HAIR DRYERS (U.S. CLS. 13, 21, 23, 31 AND 34).
FIRST USE 1-0-2010; IN COMMERCE 1-0-2010.

CLASS 11—(Continued).

3,808,478. MOMENTUM SALES & MARKETING, INC., TAMPA, FL. SN 77-811,853. PUB. 1-19-2010, FILED 8-25-2009.



THE MARK CONSISTS OF STANDARD CHARACTERS WITHOUT CLAIM TO ANY PARTICULAR FONT, STYLE, SIZE, OR COLOR.

OWNER OF U.S. REG. NO. 3,097,308.
FOR DEHUMIDIFIERS (U.S. CLS. 13, 21, 23, 31 AND 34).
FIRST USE 3-31-2009; IN COMMERCE 1-31-2009.



3,808,569. JONATHAN PRODUCT LLC, LINTHICUM HEIGHTS, MD. SN 78-703,463. PUB. 11-21-2006, FILED 8-30-2005.



THE MARK CONSISTS OF STANDARD CHARACTERS WITHOUT CLAIM TO ANY PARTICULAR FONT, STYLE, SIZE, OR COLOR.

NO CLAIM IS MADE TO THE EXCLUSIVE RIGHT TO USE "WATER", APART FROM THE MARK AS SHOWN.

FOR WATER PURIFICATION AND FILTRATION SYSTEMS, NAMELY, WATER PURIFICATION UNITS, WATER FILTERS, WATER FILTER CARTRIDGES, SHOWER HEADS AND REPLACEMENT WATER FILTERS; PORTABLE TRAVEL SHOWERS AND BATHROOM FAUCET WATER FILTERS; AND PLUMBING FIXTURES, NAMELY, WATER PURIFICATION UNITS FOR USE IN SHOWERS AND BATHROOMS (U.S. CLS. 13, 21, 23, 31 AND 34).

FIRST USE 11-1-2005; IN COMMERCE 11-1-2005.



3,808,570. TURBOCHEF TECHNOLOGIES, INC., CARROLLTON, TX. SN 78-704,703. PUB. 11-28-2006, FILED 8-31-2005.



THE MARK CONSISTS OF STANDARD CHARACTERS WITHOUT CLAIM TO ANY PARTICULAR FONT, STYLE, SIZE, OR COLOR.

CLASS 11—(Continued).

OWNER OF U.S. REG. NOS. 1,762,672, 2,662,613, AND 2,715,929.

FOR RESIDENTIAL KITCHEN APPLIANCES, NAMELY, DOMESTIC COOKING OVENS AND COMBINATION MICROWAVE/THERMAL OVENS (U.S. CLS. 13, 21, 23, 31 AND 34).

FIRST USE 12-1-2006; IN COMMERCE 12-1-2006.

CLASS 12—(Continued).

3,807,432. C2IT, LLC, MODESTO, CA. SN 77-079,102. PUB. 8-14-2007, FILED 1-9-2007.

GEAR IN MOTION

THE MARK CONSISTS OF STANDARD CHARACTERS WITHOUT CLAIM TO ANY PARTICULAR FONT, STYLE, SIZE, OR COLOR.

FOR VEHICLE RACKS FOR LUGGAGE, COOLERS, PORTABLE COOLERS, PORTABLE ICE CHESTS, ICE CHESTS AND OTHER STORAGE GEAR; MOUNTABLE TRAILER HITCH RACKS AND MOUNTING BRACKETS FOR TRAILER HITCHES ASSOCIATED THEREWITH; MOUNTING BRACKETS FOR TRAILER HITCHES; TRAILERS AND TRAILER HITCHES (U.S. CLS. 19, 21, 23, 31, 35 AND 44).

FIRST USE 10-8-2009; IN COMMERCE 10-9-2009.

3,808,583. JORO MARKETING LTD., CAMBRIDGE, CANADA. SN 78-776,840. PUB. 8-22-2006, FILED 12-20-2005.

Maxxeon WorkStar

THE MARK CONSISTS OF STANDARD CHARACTERS WITHOUT CLAIM TO ANY PARTICULAR FONT, STYLE, SIZE, OR COLOR.

FOR PORTABLE LIGHTING EQUIPMENT, NAMELY, WORK LIGHTS, INSPECTION LIGHTS AND TASK LAMPS (U.S. CLS. 13, 21, 23, 31 AND 34).

FIRST USE 9-0-2006; IN COMMERCE 9-0-2006.

3,807,433. C2IT, LLC, MODESTO, CA. SN 77-079,118. PUB. 8-14-2007, FILED 1-9-2007.

FROM GEAR TO THERE

THE MARK CONSISTS OF STANDARD CHARACTERS WITHOUT CLAIM TO ANY PARTICULAR FONT, STYLE, SIZE, OR COLOR.

FOR VEHICLE RACKS FOR LUGGAGE, COOLERS, PORTABLE COOLERS, PORTABLE ICE CHESTS, ICE CHESTS AND OTHER STORAGE GEAR; MOUNTABLE TRAILER HITCH RACKS AND MOUNTING BRACKETS FOR TRAILER HITCHES ASSOCIATED THEREWITH; MOUNTING BRACKETS FOR TRAILER HITCHES; TRAILERS AND TRAILER HITCHES (U.S. CLS. 19, 21, 23, 31, 35 AND 44).

FIRST USE 10-8-2009; IN COMMERCE 10-8-2009.

3,808,584. CYBERLUX CORPORATION, DURHAM, NC. SN 78-803,400. PUB. 11-27-2007, FILED 1-31-2006.

RELYON

THE MARK CONSISTS OF STANDARD CHARACTERS WITHOUT CLAIM TO ANY PARTICULAR FONT, STYLE, SIZE, OR COLOR.

FOR PORTABLE WORK LIGHTS (U.S. CLS. 13, 21, 23, 31 AND 34).

FIRST USE 8-25-2005; IN COMMERCE 8-25-2005.

3,807,490. MOMENTUM BICYCLE GROUP LIMITED, AUCKLAND, NEW ZEALAND. SN 77-257,583. PUB. 8-18-2009, FILED 8-16-2007.

GRAMMO

THE MARK CONSISTS OF STANDARD CHARACTERS WITHOUT CLAIM TO ANY PARTICULAR FONT, STYLE, SIZE, OR COLOR.

CLASS 12—VEHICLES

CLASS 12—(Continued).

THE ENGLISH TRANSLATION OF "GRAMMO" IN THE MARK IS GRAM.

FOR BICYCLES; BICYCLE PARTS, NAMELY, BELLS, FRAMES, GEARS, HANDLEBARS, BRAKES, CHANGE-SPEED GEARS, FORKS, PEDALS, PUMPS, SADDLES, WHEELS, AND COMPONENTS FOR THE FOREGOING BICYCLE PARTS, NAMELY, RIMS AND SPOKES FOR BICYCLE WHEELS, HANDLEBAR STEMS, AND HANDLEBAR GRIPS; BICYCLE ACCESSORIES, NAMELY, SADDLE COVERS FOR BICYCLES (U.S. CLS. 19, 21, 23, 31, 35 AND 44).

FIRST USE 4-0-2007; IN COMMERCE 0-0-2003.

3,807,550. MEDICAL DEPOT, INC., PORT WASHINGTON, NY. SN 77-395,780. PUB. 7-1-2008, FILED 2-13-2008.

TROTTER

THE MARK CONSISTS OF STANDARD CHARACTERS WITHOUT CLAIM TO ANY PARTICULAR FONT, STYLE, SIZE, OR COLOR.

FOR STROLLERS (U.S. CLS. 19, 21, 23, 31, 35 AND 44).
FIRST USE 5-0-2008; IN COMMERCE 5-0-2008.

3,807,580. DOUGHERTY, PATRICK S., BOISE, ID. SN 77-428,517. PUB. 8-5-2008, FILED 3-21-2008.

FreeWheel

THE MARK CONSISTS OF STANDARD CHARACTERS WITHOUT CLAIM TO ANY PARTICULAR FONT, STYLE, SIZE, OR COLOR.

FOR A WHEELCHAIR ATTACHMENT COMPRISED OF A WHEEL AND CLAMP SOLD AS AN INTEGRAL COMPONENT OF WHEELCHAIRS (U.S. CLS. 19, 21, 23, 31, 35 AND 44).

FIRST USE 4-15-2008; IN COMMERCE 1-5-2010.

3,807,601. LKQ CORPORATION, CHICAGO, IL. SN 77-442,407. PUB. 4-7-2009, FILED 4-8-2008.

CHROME REMEDIES

THE MARK CONSISTS OF STANDARD CHARACTERS WITHOUT CLAIM TO ANY PARTICULAR FONT, STYLE, SIZE, OR COLOR.

CLASS 12—(Continued).

NO CLAIM IS MADE TO THE EXCLUSIVE RIGHT TO USE "CHROME", APART FROM THE MARK AS SHOWN.

FOR AUTOMOTIVE PARTS AND ACCESSORIES, NAMELY, DOOR HANDLE COVERS, MIRROR COVERS, TAIL LIGHT BEZELS, BILLET GRILLES, TAIL GATE HANDLE COVERS, GRILLE OVERLAYS, PILLAR POST COVERS, FENDER TRIM, SIDE MOLDING, PORT VENTS; DECORATIVE CHROME TRIM (U.S. CLS. 19, 21, 23, 31, 35 AND 44).

FIRST USE 7-8-2008; IN COMMERCE 7-8-2008.

3,807,646. YAMAHA HATSUDOKI KABUSHIKI KAISHA, SHIZUOKA-KEN, JAPAN. SN 77-495,591. PUB. 3-17-2009, FILED 6-10-2008.

SALTWATER SERIES HS

THE MARK CONSISTS OF STANDARD CHARACTERS WITHOUT CLAIM TO ANY PARTICULAR FONT, STYLE, SIZE, OR COLOR.

OWNER OF U.S. REG. NO. 3,363,491.
NO CLAIM IS MADE TO THE EXCLUSIVE RIGHT TO USE "SERIES", APART FROM THE MARK AS SHOWN.

SEC. 2(F) AS TO "SALTWATER SERIES".
FOR PROPELLERS FOR OUTBOARD MOTORS (U.S. CLS. 19, 21, 23, 31, 35 AND 44).

FIRST USE 8-0-2008; IN COMMERCE 8-0-2008.

3,807,660. STUDEBAKER, ROBERT, TULSA, OK. SN 77-509,768. PUB. 11-18-2008, FILED 6-27-2008.

Red Ox

THE MARK CONSISTS OF STANDARD CHARACTERS WITHOUT CLAIM TO ANY PARTICULAR FONT, STYLE, SIZE, OR COLOR.

OWNER OF U.S. REG. NO. 3,361,212.
NO CLAIM IS MADE TO THE EXCLUSIVE RIGHT TO USE "RED", APART FROM THE MARK AS SHOWN.

FOR HAY TRAILERS; FLATBED TRAILERS (U.S. CLS. 19, 21, 23, 31, 35 AND 44).

FIRST USE 4-14-2010; IN COMMERCE 4-14-2010.

CLASS 12—(Continued).

3,807,669. SUZUKI MOTOR CORPORATION, SHIZUOKA-PREF., JAPAN. SN 77-519,029. PUB. 8-18-2009, FILED 7-10-2008.

GLADIUS

THE MARK CONSISTS OF STANDARD CHARACTERS WITHOUT CLAIM TO ANY PARTICULAR FONT, STYLE, SIZE, OR COLOR.

FOR MOTORCYCLES, AND STRUCTURAL PARTS THEREOF (U.S. CLS. 19, 21, 23, 31, 35 AND 44).
FIRST USE 3-1-2009; IN COMMERCE 3-1-2009.

CLASS 12—(Continued).

3,808,383. GULFSTREAM AEROSPACE CORPORATION, SAVANNAH, GA. SN 77-775,010. PUB. 11-10-2009, FILED 7-6-2009.

GVI

THE MARK CONSISTS OF STANDARD CHARACTERS WITHOUT CLAIM TO ANY PARTICULAR FONT, STYLE, SIZE, OR COLOR.

OWNER OF U.S. REG. NOS. 1,858,524, 2,597,911, AND 2,712,678.

FOR AIRPLANES (U.S. CLS. 19, 21, 23, 31, 35 AND 44).
FIRST USE 9-29-2009; IN COMMERCE 9-29-2009.

3,807,713. ELECTRIC MOBILITY CORPORATION, SEWELL, NJ. SN 77-552,269. PUB. 1-13-2009, FILED 8-21-2008.

RASCAL WE GO

THE MARK CONSISTS OF STANDARD CHARACTERS WITHOUT CLAIM TO ANY PARTICULAR FONT, STYLE, SIZE, OR COLOR.

OWNER OF U.S. REG. NOS. 3,090,420, 3,209,212, AND OTHERS.

FOR BATTERY POWERED ELECTRIC WHEEL-CHAIRS (U.S. CLS. 19, 21, 23, 31, 35 AND 44).
FIRST USE 10-22-2009; IN COMMERCE 11-5-2009.

3,808,401. JUST WHEELS & TIRES CO., HUNTINGTON BEACH, CA. SN 77-784,009. PUB. 12-22-2009, FILED 7-17-2009.

LUMARAI

THE MARK CONSISTS OF STANDARD CHARACTERS WITHOUT CLAIM TO ANY PARTICULAR FONT, STYLE, SIZE, OR COLOR.

FOR VEHICLE PARTS, NAMELY, WHEELS (U.S. CLS. 19, 21, 23, 31, 35 AND 44).

FIRST USE 10-22-2009; IN COMMERCE 11-17-2009.

3,808,313. OCEAN PERFORMANCE MANAGEMENT, LLC, ESSEX, CT. SN 77-749,735. PUB. 11-17-2009, FILED 6-2-2009.

POGO

THE MARK CONSISTS OF STANDARD CHARACTERS WITHOUT CLAIM TO ANY PARTICULAR FONT, STYLE, SIZE, OR COLOR.

FOR ANTI-THEFT ALARMS FOR BOATS AND VEHICLES (U.S. CLS. 19, 21, 23, 31, 35 AND 44).
FIRST USE 3-8-2010; IN COMMERCE 3-8-2010.

3,808,415. RACE STAR INDUSTRIES, INC., KEARNEY, MO. SN 77-789,179. PUB. 12-15-2009, FILED 7-24-2009.

Drag Star

THE MARK CONSISTS OF STANDARD CHARACTERS WITHOUT CLAIM TO ANY PARTICULAR FONT, STYLE, SIZE, OR COLOR.

FOR VEHICLE WHEELS (U.S. CLS. 19, 21, 23, 31, 35 AND 44).
FIRST USE 6-1-2009; IN COMMERCE 6-1-2009.

CLASS 12—(Continued).

3,808,492. DYNACRAFT BSC, INC., AMERICAN CANYON, MA. SN 77-827,446. PUB. 1-5-2010, FILED 9-16-2009.

CLASS 13—(Continued).

3,808,012. X-CALIBER, LLC, LAINGSBURG, MI. SN 77-687,315. PUB. 7-14-2009, FILED 3-10-2009.

AFTERMATH

THE MARK CONSISTS OF STANDARD CHARACTERS WITHOUT CLAIM TO ANY PARTICULAR FONT, STYLE, SIZE, OR COLOR.
FOR BICYCLES (U.S. CLS. 19, 21, 23, 31, 35 AND 44).
FIRST USE 10-5-2009; IN COMMERCE 10-5-2009.

X-VIP

THE MARK CONSISTS OF STANDARD CHARACTERS WITHOUT CLAIM TO ANY PARTICULAR FONT, STYLE, SIZE, OR COLOR.
FOR BIPOD STANDS FOR FIREARMS (U.S. CLS. 2 AND 9).
FIRST USE 1-4-2010; IN COMMERCE 1-4-2010.

3,808,493. DYNACRAFT BSC, INC., AMERICAN CANYON, CA. SN 77-827,472. PUB. 1-12-2010, FILED 9-16-2009.

3,808,256. LEE, SHANYAO, SOUTH EL MONTE, CA. AND EN, DAVID, SOUTH EL MONTE, CA. SN 77-729,797. PUB. 9-15-2009, FILED 5-5-2009.

THE PROP

THE MARK CONSISTS OF STANDARD CHARACTERS WITHOUT CLAIM TO ANY PARTICULAR FONT, STYLE, SIZE, OR COLOR.
FOR BICYCLES (U.S. CLS. 19, 21, 23, 31, 35 AND 44).
FIRST USE 10-5-2009; IN COMMERCE 10-5-2009.

AIRBORNE

THE MARK CONSISTS OF STANDARD CHARACTERS WITHOUT CLAIM TO ANY PARTICULAR FONT, STYLE, SIZE, OR COLOR.
FOR AIRSOFT GUNS (U.S. CLS. 2 AND 9).
FIRST USE 3-15-2010; IN COMMERCE 3-15-2010.

CLASS 13—FIREARMS

3,807,582. LASER ENERGETICS, INC., MERCERVILLE, NJ. SN 77-430,170. PUB. 8-5-2008, FILED 3-24-2008.

3,808,258. LEE, SHANYAO, SOUTH EL MONTE, CA. AND EN, DAVID, SOUTH EL MONTE, CA. SN 77-730,343. PUB. 9-15-2009, FILED 5-6-2009.

DAZER LASER

THE MARK CONSISTS OF STANDARD CHARACTERS WITHOUT CLAIM TO ANY PARTICULAR FONT, STYLE, SIZE, OR COLOR.
NO CLAIM IS MADE TO THE EXCLUSIVE RIGHT TO USE "LASER", APART FROM THE MARK AS SHOWN.
FOR NON-LETHAL WEAPONS WHICH FLASH LASER LIGHT TO TEMPORARILY IMPAIR THE VISION OF THE TARGET (U.S. CLS. 2 AND 9).
FIRST USE 3-7-2009; IN COMMERCE 3-7-2009.

DELTA FORCE

THE MARK CONSISTS OF STANDARD CHARACTERS WITHOUT CLAIM TO ANY PARTICULAR FONT, STYLE, SIZE, OR COLOR.
FOR AIRSOFT GUNS (U.S. CLS. 2 AND 9).
FIRST USE 3-15-2010; IN COMMERCE 3-15-2010.

CLASS 13—(Continued).

3,808,259. LEE, SHANYAO, SOUTH EL MONTE, CA. AND EN, DAVID, SOUTH EL MONTE, CA. SN 77-730,467. PUB. 9-15-2009, FILED 5-6-2009.

FORCE RECON

THE MARK CONSISTS OF STANDARD CHARACTERS WITHOUT CLAIM TO ANY PARTICULAR FONT, STYLE, SIZE, OR COLOR.
FOR AIRSOFT GUNS (U.S. CLS. 2 AND 9).
FIRST USE 3-15-2010; IN COMMERCE 3-15-2010.

3,808,260. LEE, SHANYAO, SOUTH EL MONTE, CA. AND EN, DAVID, SOUTH EL MONTE, CA. SN 77-730,919. PUB. 9-15-2009, FILED 5-6-2009.

MARINE

THE MARK CONSISTS OF STANDARD CHARACTERS WITHOUT CLAIM TO ANY PARTICULAR FONT, STYLE, SIZE, OR COLOR.
FOR AIRSOFT GUNS (U.S. CLS. 2 AND 9).
FIRST USE 3-15-2010; IN COMMERCE 3-15-2010.

3,808,264. LEE, SHANYAO, SOUTH EL MONTE, CA. AND EN, DAVID, SOUTH EL MONTE, CA. SN 77-731,289. PUB. 9-15-2009, FILED 5-7-2009.

SWAT

THE MARK CONSISTS OF STANDARD CHARACTERS WITHOUT CLAIM TO ANY PARTICULAR FONT, STYLE, SIZE, OR COLOR.
FOR AIRSOFT GUNS (U.S. CLS. 2 AND 9).
FIRST USE 3-15-2010; IN COMMERCE 3-15-2010.

CLASS 13—(Continued).

3,808,265. SHANYAO LEE, SOUTH EL MONTE, CA. AND DAVID EN, SOUTH EL MONTE, CA. SN 77-731,325. PUB. 9-15-2009, FILED 5-7-2009.

ZOMBIE

THE MARK CONSISTS OF STANDARD CHARACTERS WITHOUT CLAIM TO ANY PARTICULAR FONT, STYLE, SIZE, OR COLOR.
FOR AIRSOFT GUNS (U.S. CLS. 2 AND 9).
FIRST USE 3-15-2010; IN COMMERCE 3-15-2010.

3,808,266. LEE, SHANYAO, SOUTH EL MONTE, CA. AND EN, DAVID, SOUTH EL MONTE, CA. SN 77-731,366. PUB. 9-15-2009, FILED 5-7-2009.

ZOMBAT

THE MARK CONSISTS OF STANDARD CHARACTERS WITHOUT CLAIM TO ANY PARTICULAR FONT, STYLE, SIZE, OR COLOR.
FOR AIRSOFT GUNS (U.S. CLS. 2 AND 9).
FIRST USE 3-15-2010; IN COMMERCE 3-15-2010.

3,808,267. LEE, SHANYAO, SOUTH EL MONTE, CA. AND EN, DAVID, SOUTH EL MONTE, CA. SN 77-731,488. PUB. 9-15-2009, FILED 5-7-2009.

FORECON

THE MARK CONSISTS OF STANDARD CHARACTERS WITHOUT CLAIM TO ANY PARTICULAR FONT, STYLE, SIZE, OR COLOR.
FOR AIRSOFT GUNS (U.S. CLS. 2 AND 9).
FIRST USE 3-15-2010; IN COMMERCE 3-15-2010.

CLASS 14—JEWELRY

CLASS 14—(Continued).

3,807,438. RHODES, HARRY H., III, CAMDEN-WYOMING, DE. SN 77-095,009. PUB. 2-12-2008, FILED 1-30-2007.



THE MARK CONSISTS OF THE CAPITAL LETTER "O" SUPERIMPOSED OVER A CAPITAL LETTER "X", BOTH IN PALATINO LINOTYPE FONT.

FOR BRACELETS; BRONZE JEWELRY; COSTUME JEWELRY; JEWELRY; JEWELRY BOXES; JEWELRY BOXES OF PRECIOUS METAL; JEWELRY CASES; JEWELRY CHAINS; JEWELRY FINDINGS; JEWELRY FOR THE HEAD; JEWELRY PINS FOR USE ON HATS; JEWELRY WATCHES; JEWELRY, NAMELY, AMULETS; JEWELRY, NAMELY, CROSSES; LAPEL PINS; LEATHER JEWELRY AND ACCESSORY BOXES; PINS BEING JEWELRY; RINGS BEING JEWELRY (U.S. CLS. 2, 27, 28 AND 50).

FIRST USE 12-10-2009; IN COMMERCE 12-10-2009.

CLASS 14—(Continued).

3,807,517. RONALD D. HODGES, D.V.M., P.C., WHITEHALL, PA. SN 77-308,395. PUB. 7-8-2008, FILED 10-19-2007.

EQUINE 4 LIFE

THE MARK CONSISTS OF STANDARD CHARACTERS WITHOUT CLAIM TO ANY PARTICULAR FONT, STYLE, SIZE, OR COLOR.

FOR JEWELRY, NAMELY, BRACELETS AND WRISTBANDS (U.S. CLS. 2, 27, 28 AND 50).

FIRST USE 5-0-2009; IN COMMERCE 5-0-2009.

3,807,515. RONALD D. HODGES, D.V.M., P.C., WHITEHALL, PA. SN 77-308,377. PUB. 7-8-2008, FILED 10-19-2007.

K-9 4 LIFE

THE MARK CONSISTS OF STANDARD CHARACTERS WITHOUT CLAIM TO ANY PARTICULAR FONT, STYLE, SIZE, OR COLOR.

FOR JEWELRY, NAMELY, BRACELETS AND WRISTBANDS (U.S. CLS. 2, 27, 28 AND 50).

FIRST USE 5-0-2009; IN COMMERCE 5-0-2009.

3,807,583. TEMPLE CAVE JEWELRY, LOMPOC, CA. SN 77-430,245. PUB. 9-23-2008, FILED 3-24-2008.



3,807,516. RONALD D. HODGES, D.V.M., P.C., WHITEHALL, PA. SN 77-308,387. PUB. 7-8-2008, FILED 10-19-2007.

FELINE 4 LIFE

THE MARK CONSISTS OF STANDARD CHARACTERS WITHOUT CLAIM TO ANY PARTICULAR FONT, STYLE, SIZE, OR COLOR.

FOR JEWELRY, NAMELY, BRACELETS AND WRISTBANDS (U.S. CLS. 2, 27, 28 AND 50).

FIRST USE 5-0-2009; IN COMMERCE 5-0-2009.

THE MARK CONSISTS OF THE LETTER "T" DRAWN IN THE IMAGE OF A TEMPLE COLUMN AND THE LETTER "C" MADE TO RESEMBLE A CRESCENT MOON WITH A SETTING SUN WITH RAYS.

FOR JEWELRY (U.S. CLS. 2, 27, 28 AND 50).

FIRST USE 2-2-2009; IN COMMERCE 3-9-2010.

CLASS 14—(Continued).

3,807,651. DEANNA A. HUBBARD, OSWEGO, NY. SN 77-500,497. PUB. 11-11-2008, FILED 6-17-2008.



THE MARK CONSISTS OF THE WORDS "CLOCK KEEPER" ENCIRCLED BY A CELTIC KNOT DESIGN. FOR WATCHES AND JEWELRY (U.S. CLS. 2, 27, 28 AND 50).
FIRST USE 4-0-2009; IN COMMERCE 4-0-2009.

3,807,756. RICHEMONT INTERNATIONAL SA, VILLARS-SUR-GLANE, SWITZERLAND. SN 77-565,506. PUB. 8-4-2009, FILED 9-9-2008.

QUAI DE L'ILE

THE MARK CONSISTS OF STANDARD CHARACTERS WITHOUT CLAIM TO ANY PARTICULAR FONT, STYLE, SIZE, OR COLOR.

THE ENGLISH TRANSLATION OF THE WORDING "QUAI DE L'ILE" IN THE MARK IS QUAY OF THE ISLAND.

FOR WATCHES, CHRONOMETERS, WATCH STRAPS, WATCH BRACELETS (U.S. CLS. 2, 27, 28 AND 50).

FIRST USE 10-22-2008; IN COMMERCE 10-22-2008.

3,807,803. E-MARKETINGUSA, INC., WENATCHEE, WA. SN 77-580,408. PUB. 8-4-2009, FILED 9-27-2008.

CERAMIC GESTALT

THE MARK CONSISTS OF STANDARD CHARACTERS WITHOUT CLAIM TO ANY PARTICULAR FONT, STYLE, SIZE, OR COLOR.

CLASS 14—(Continued).

NO CLAIM IS MADE TO THE EXCLUSIVE RIGHT TO USE "CERAMIC", APART FROM THE MARK AS SHOWN. FOR JEWELRY; WATCHES (U.S. CLS. 2, 27, 28 AND 50).

FIRST USE 1-11-2010; IN COMMERCE 1-11-2010.

3,807,971. SULLIVAN, DIANE L., DBA LUXECLIPS, NEWPORT BEACH, CA. AND VAUGHAN, JENNIFER S., DBA LUXECLIPS, COSTA MESA, CA. SN 77-675,112. PUB. 6-23-2009, FILED 2-20-2009.

THE MARK CONSISTS OF STYLIZED WORD "LUXECLIPS".

FOR SMALL DECORATIVE OBJECTS MADE OF RUBBER, PLASTIC, PASTE, GLASS, NON-PRECIOUS STONES OR NON-PRECIOUS METAL, NAMELY, SHOE ORNAMENTS, SHOE FASTENERS, AND METAL CLIPS FOR SHOES (U.S. CLS. 2, 27, 28 AND 50).

FIRST USE 6-1-2009; IN COMMERCE 6-1-2009.

3,808,041. COOPER, SANDRA D, DETROIT, MI. SN 77-692,139. PUB. 7-14-2009, FILED 3-16-2009.

Peace of God

THE MARK CONSISTS OF STANDARD CHARACTERS WITHOUT CLAIM TO ANY PARTICULAR FONT, STYLE, SIZE, OR COLOR.

FOR BEADS FOR USE IN THE MANUFACTURE OF JEWELRY; BODY JEWELRY; BRACELETS; BROACHES; BRONZE JEWELRY; BROOCHES; CHARMS; COSTUME JEWELRY; DIAMOND JEWELRY; GEMSTONE JEWELRY; IDENTIFICATION BRACELETS; JEWELRY; JEWELRY AND IMITATION JEWELRY; JEWELRY BOXES; JEWELRY BOXES NOT OF METAL; JEWELRY BOXES OF METAL; JEWELRY BOXES OF PRECIOUS METAL; JEWELRY CASES; JEWELRY CASES NOT OF PRECIOUS METAL (U.S. CLS. 2, 27, 28 AND 50).

FIRST USE 4-22-2009; IN COMMERCE 4-22-2009.

CLASS 14—(Continued).

3,808,047. HYGIEA MESSENGER, LLC, PARKLAND, FL. SN 77-692,518. PUB. 7-14-2009, FILED 3-17-2009.

HYGIEA

THE MARK CONSISTS OF STANDARD CHARACTERS WITHOUT CLAIM TO ANY PARTICULAR FONT, STYLE, SIZE, OR COLOR.

FOR JEWELRY (U.S. CLS. 2, 27, 28 AND 50).
FIRST USE 5-25-2009; IN COMMERCE 5-25-2009.

CLASS 14—(Continued).

3,808,277. SPEES, ROBERT M, PARKER, CO. SN 77-735,119. PUB. 9-22-2009, FILED 5-12-2009.

Clockie Talkie - Say Red
Then Blue And The Time Is
True

THE MARK CONSISTS OF STANDARD CHARACTERS WITHOUT CLAIM TO ANY PARTICULAR FONT, STYLE, SIZE, OR COLOR.

FOR CLOCKS (U.S. CLS. 2, 27, 28 AND 50).
FIRST USE 6-6-2009; IN COMMERCE 9-18-2009.

3,808,168. LUSH JEWELS LTD., NEW YORK, NY. SN 77-710,506. PUB. 8-25-2009, FILED 4-9-2009.

GOSHWARA

THE MARK CONSISTS OF STANDARD CHARACTERS WITHOUT CLAIM TO ANY PARTICULAR FONT, STYLE, SIZE, OR COLOR.

FOR JEWELRY (U.S. CLS. 2, 27, 28 AND 50).
FIRST USE 8-3-2009; IN COMMERCE 8-3-2009.

3,808,318. FRANCO, MOISES JACOBO, AVENTURA, FL. SN 77-751,577. PUB. 10-6-2009, FILED 6-3-2009.

FIREFIGHTER

THE MARK CONSISTS OF STANDARD CHARACTERS WITHOUT CLAIM TO ANY PARTICULAR FONT, STYLE, SIZE, OR COLOR.

FOR CLOCKS AND WATCHES; DIVING WATCHES; JEWELLERY AND WATCHES; JEWELLERY, CLOCKS AND WATCHES; WATCH BANDS; WATCH STRAPS MADE OF METAL OR LEATHER OR PLASTIC (U.S. CLS. 2, 27, 28 AND 50).
FIRST USE 3-11-2010; IN COMMERCE 3-11-2010.

3,808,243. BARILLA G.E.R. FRATELLI - SOCIETÀ PER AZIONI, PARMA, ITALY. SN 77-727,970. PUB. 7-28-2009, FILED 5-4-2009.

SHARE THE TABLE

THE MARK CONSISTS OF STANDARD CHARACTERS WITHOUT CLAIM TO ANY PARTICULAR FONT, STYLE, SIZE, OR COLOR.

FOR PINS (U.S. CLS. 2, 27, 28 AND 50).
FIRST USE 2-0-2010; IN COMMERCE 2-0-2010.

3,808,331. DIAMINTANGIBLES INTERNATIONAL, LTD., NASSAU, BAHAMAS. SN 77-756,662. PUB. 10-6-2009, FILED 6-10-2009.

One life. One dream. One
another... Always.

THE MARK CONSISTS OF STANDARD CHARACTERS WITHOUT CLAIM TO ANY PARTICULAR FONT, STYLE, SIZE, OR COLOR.

FOR JEWELRY (U.S. CLS. 2, 27, 28 AND 50).
FIRST USE 4-13-2010; IN COMMERCE 4-13-2010.

CLASS 14—(Continued).

3,808,356. INVICTA WATCH COMPANY OF AMERICA, INC., HOLLYWOOD, FL. SN 77-764,836. PUB. 10-27-2009, FILED 6-22-2009.

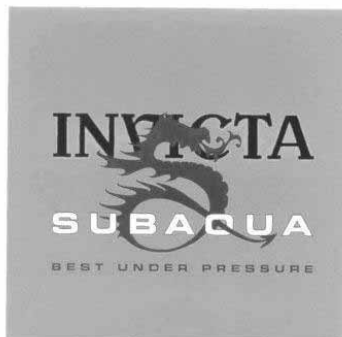

OWNER OF U.S. REG. NOS. 2,850,569, 3,314,314, AND OTHERS.

NO CLAIM IS MADE TO THE EXCLUSIVE RIGHT TO USE "SUBAQUA", APART FROM THE MARK AS SHOWN. THE MARK CONSISTS OF THE TERMS "INVICTA SUBAQUA", THE PHRASE "BEST UNDER PRESSURE", AND A DESIGN OF A DRAGON WITH THE TAIL OF THE DRAGON EXTENDING THROUGH AND DEFINING THE LETTER "Q" IN THE WORD "SUBAQUA".

THE ENGLISH TRANSLATION OF THE WORD "INVICTA" IN THE MARK IS "UNCONQUERED".

FOR WATCHES (U.S. CLS. 2, 27, 28 AND 50).
FIRST USE 7-6-2009; IN COMMERCE 7-6-2009.

3,808,490. DWT INTERNATIONAL, INC., SUGAR LAND, TX. SN 77-824,288. PUB. 2-2-2010, FILED 9-10-2009.

DTEK

THE MARK CONSISTS OF THE LETTERS "D", "T", "E", AND "K" SPELLING OUT "DTEK", THE LETTER "E" WITH CENTER HORIZONTAL LINE PORTION DETACHED FROM THE LETTER AND A VERTICAL LINE WITH ARROW FORMING THE LETTER "K".

FOR BODY JEWELRY; BRACELETS; CHARMS; DIVING WATCHES; DRESS WATCHES; JEWELRY; JEWELRY BOXES; JEWELRY CHAINS; JEWELRY WATCHES; NECKLACES; PENDANTS; RINGS; STAINLESS STEEL JEWELRY BRACELETS; WATCHES AND JEWELRY (U.S. CLS. 2, 27, 28 AND 50).

FIRST USE 1-18-2010; IN COMMERCE 3-1-2010.

CLASS 14—(Continued).

3,808,494. VISCONTI, LTD., BROOKLYN, NY. SN 77-833,862. PUB. 1-12-2010, FILED 9-24-2009.



THE MARK CONSISTS OF THE STYLIZED WORD "VISCONTI" TRAVERSING HORIZONTALLY THROUGH THE MIDDLE OF THE MARK, AND SURROUNDED BY FOUR IDENTICALLY SHAPED STYLIZED LETTER "V" DESIGNS EACH TURNED 90 DEGREES AROUND THE PERIMETER MAKING UP A CIRCULAR DEVICE.

THE ENGLISH TRANSLATION OF "VISCONTI" IN THE MARK IS "VISCOUNT".

FOR CLOCKS; HOROLOGICAL AND CHRONOMETRIC INSTRUMENTS AND CASES THEREFOR; JEWELRY; JEWELRY BOXES; TIMEPIECES AND CHRONOMETRIC INSTRUMENTS; WATCHES (U.S. CLS. 2, 27, 28 AND 50).

FIRST USE 10-14-2009; IN COMMERCE 10-14-2009.

CLASS 15—MUSICAL INSTRUMENTS

3,807,917. KAWAI MUSICAL INSTRUMENTS MANUFACTURING CO., LTD., SHIZUOKA-KEN, JAPAN. SN 77-648,271. PUB. 10-6-2009, FILED 1-13-2009.



NO CLAIM IS MADE TO THE EXCLUSIVE RIGHT TO USE "BLACK SERIES", APART FROM THE MARK AS SHOWN.

THE MARK CONSISTS OF THE WORDING "BLAK" WITH A STYLIZED "B" AND THE WORDING "RX BLAK SERIES".

FOR MUSICAL INSTRUMENTS, NAMELY, PIANOS (U.S. CLS. 2, 21 AND 36).

FIRST USE 1-15-2009; IN COMMERCE 1-15-2009.

CLASS 15—(Continued).

3,808,139. FANZLAW, BRUCE, OCALA, FL. AND FANZLAW, NANCY, OCALA, FL. SN 77-705,438. PUB. 8-4-2009, FILED 4-2-2009.

HÄMBURG & BACH

THE MARK CONSISTS OF STANDARD CHARACTERS WITHOUT CLAIM TO ANY PARTICULAR FONT, STYLE, SIZE, OR COLOR.

FOR PIANOS (U.S. CLS. 2, 21 AND 36).
FIRST USE 5-1-2009; IN COMMERCE 5-1-2009.

CLASS 16—PAPER GOODS AND PRINTED MATTER

3,807,372. SMITH, BELINDA F., HOUSTON, TX. SN 76-565,597. PUB. 7-7-2009, FILED 12-16-2003.



THE MARK CONSISTS OF A DESIGN WHICH RESEMBLES THE LOWER PORTION OF A LADIES LEG, A STILETTO-TYPE FASHION SHOE ON THE LADIES FOOT, AND A FLOWING RIBBON AROUND THE LADIES ANKLE. THE WORD "STILETTO" IS INTEGRATED INTO THE DESIGN IN A MANNER TO RESEMBLE THE SOLE OF THE LADIES FOOT IN THE HIGH HEEL SHOE.

FOR PAPER GOODS, NAMELY, NOTE CARDS, NOTE TABLETS, CARD STOCK, STATIONERY, ENVELOPES, NAPKINS, PLACE MATS, WRAPPING PAPER, PARTY BAGS, PARTY DECORATIONS, TABLE CLOTHS, CALENDARS, PRINTS AND SKETCHES, BUSINESS CARDS, ARTWORK, NAMELY, LITHOGRAPHIC WORKS OF ART AND POSTERS (U.S. CLS. 2, 5, 22, 23, 29, 37, 38 AND 50).

FIRST USE 8-31-2006; IN COMMERCE 8-31-2006.

CLASS 16—(Continued).

3,807,375. ADVANTAGE SALES & MARKETING, LLC, IRVINE, CA. SN 76-659,513. PUB. 12-26-2006, FILED 5-3-2006.

HOMEMADE MAGAZINE

THE MARK CONSISTS OF STANDARD CHARACTERS WITHOUT CLAIM TO ANY PARTICULAR FONT, STYLE, SIZE, OR COLOR.

NO CLAIM IS MADE TO THE EXCLUSIVE RIGHT TO USE "MAGAZINE", APART FROM THE MARK AS SHOWN. FOR PERIODIC FOOD-RELATED MAGAZINE CONTAINING RECIPES, STORIES, AND CREATIVE TIPS (U.S. CLS. 2, 5, 22, 23, 29, 37, 38 AND 50).

FIRST USE 1-31-2006; IN COMMERCE 1-31-2006.

3,807,388. HOUGHTON MIFFLIN HARCOURT PUBLISHING COMPANY, BOSTON, MA. SN 76-692,772. PUB. 2-10-2009, FILED 9-11-2008.

GRAB-AND-GO

THE MARK CONSISTS OF STANDARD CHARACTERS WITHOUT CLAIM TO ANY PARTICULAR FONT, STYLE, SIZE, OR COLOR.

FOR EDUCATIONAL KITS, NAMELY, PRINTED EDUCATIONAL AND INSTRUCTIONAL MATERIALS IN A VARIETY OF SUBJECTS DESIGNED TO PROVIDE SUPPORT FOR ELEMENTARY STUDENTS (U.S. CLS. 2, 5, 22, 23, 29, 37, 38 AND 50).

FIRST USE 9-0-2009; IN COMMERCE 9-0-2009.

3,807,396. HOUGHTON MIFFLIN HARCOURT PUBLISHING COMPANY, BOSTON, MA. SN 76-696,022. PUB. 8-4-2009, FILED 2-27-2009.

WRITE ON COURSE

THE MARK CONSISTS OF STANDARD CHARACTERS WITHOUT CLAIM TO ANY PARTICULAR FONT, STYLE, SIZE, OR COLOR.

FOR PAPER GOODS AND PRINTED MATTER, NAMELY, INSTRUCTIONAL AND EDUCATIONAL MATERIALS IN THE FIELDS OF WRITING (U.S. CLS. 2, 5, 22, 23, 29, 37, 38 AND 50).

FIRST USE 6-15-2009; IN COMMERCE 6-15-2009.

CLASS 16—(Continued).

3,807,591. THE FAMILY TRUST U/T/A DATED DECEMBER 8, 1995, HIGHLAND, IL. SN 77-434,585. PUB. 3-17-2009, FILED 3-28-2008.



THE MARK CONSISTS OF AN IMAGE OF SEVERAL OVERLAPPING STRANDS OF DECORATIVE PAPER MATERIAL.

FOR STRIPS OF CORRUGATED PAPER AND PAPER LAMINATES, NAMELY, FOR USE AS DECORATIVE GRASS, FLOWER POT COVERS, PARTY DECORATIONS, AND CUSHIONING OR PADDING MATERIALS FOR PACKING PURPOSES (U.S. CLS. 2, 5, 22, 23, 29, 37, 38 AND 50).

FIRST USE 2-25-2010; IN COMMERCE 2-25-2010.

3,807,595. PROSTATE NET, INC., THE, HACKENSACK, NJ. SN 77-438,740. PUB. 2-10-2009, FILED 4-3-2008.



THE MARK CONSISTS OF A BLACK OVAL IN THE BOTTOM LEFT CORNER WITH AN ARROW RUNNING THROUGH THE MIDDLE OF THE OVAL POINTING TOWARDS THE UPPER RIGHT CORNER AND A CURVED LINE EMANATING FROM THE OVAL AND THE ARROW AND ENDING NEAR THE UPPER RIGHT CORNER WITH A SOLID BLACK SQUARE BORDER AROUND THE ENTIRE DESIGN.

FOR PAMPHLETS ON THE SUBJECTS OF PROSTATE CANCER AND PROSTATE CANCER TREATMENT (U.S. CLS. 2, 5, 22, 23, 29, 37, 38 AND 50).

FIRST USE 5-31-1999; IN COMMERCE 5-31-1999.

CLASS 16—(Continued).

3,807,598. FUJIFILM MANUFACTURING EUROPE B.V., TILBURG, NETHERLANDS. SN 77-441,509. PUB. 9-1-2009, FILED 4-7-2008.

FUJIFILM EXCELLIGHT

THE MARK CONSISTS OF STANDARD CHARACTERS WITHOUT CLAIM TO ANY PARTICULAR FONT, STYLE, SIZE, OR COLOR.

OWNER OF U.S. REG. NOS. 1,949,724, 3,092,797, AND OTHERS.

FOR PRINT SUBSTRATE, NAMELY, TRANSPARENT, OPAQUE AND TRANSLUCENT FILMS FOR USE WITH INK JET PRINTERS (U.S. CLS. 2, 5, 22, 23, 29, 37, 38 AND 50).

FIRST USE 2-28-2008; IN COMMERCE 5-11-2008.

3,807,662. CODEGA, LLC, HOUSTON, TX. SN 77-511,354. PUB. 7-7-2009, FILED 6-30-2008.

CODEGA

THE MARK CONSISTS OF STANDARD CHARACTERS WITHOUT CLAIM TO ANY PARTICULAR FONT, STYLE, SIZE, OR COLOR.

THE WORDING "CODEGA" HAS NO MEANING IN A FOREIGN LANGUAGE.

FOR PRINTED MATTER, NAMELY, WORKBOOKS, NEWSLETTERS, AND BROCHURES IN THE FIELD OF VEHICLE SAFETY TRAINING AND VEHICLE INSPECTIONS (U.S. CLS. 2, 5, 22, 23, 29, 37, 38 AND 50).

FIRST USE 10-1-2008; IN COMMERCE 10-1-2008.

3,807,680. CHRISTIAN LACROIX, SNC, PARIS, FRANCE. SN 77-533,464. PUB. 1-20-2009, FILED 7-29-2008.

CHRISTIAN LACROIX

THE MARK CONSISTS OF STANDARD CHARACTERS WITHOUT CLAIM TO ANY PARTICULAR FONT, STYLE, SIZE, OR COLOR.

OWNER OF U.S. REG. NOS. 1,499,154 AND 2,896,646.

THE NAME "CHRISTIAN LACROIX" IDENTIFIES A LIVING INDIVIDUAL WHOSE CONSENT IS OF RECORD.

FOR ADDRESS BOOKS, AGENDAS, CORRESPONDENCE CARDS, DIARIES, CALENDARS, BLANK WRITING JOURNALS, NOTE BOOKS, NOTE CARDS, COMPOSITION BOOKS AND POST CARDS (U.S. CLS. 2, 5, 22, 23, 29, 37, 38 AND 50).

FIRST USE 1-1-2010; IN COMMERCE 1-1-2010.

CLASS 16—(Continued).

3,807,771. CENTER FOR ECOLITERACY, BERKELEY, CA. SN 77-569,777. PUB. 1-13-2009, FILED 9-15-2008.

SMART BY NATURE

THE MARK CONSISTS OF STANDARD CHARACTERS WITHOUT CLAIM TO ANY PARTICULAR FONT, STYLE, SIZE, OR COLOR.

FOR EDUCATIONAL PUBLICATIONS, NAMELY, BOOKS, HAND-OUTS, GUIDES, PAMPHLETS, WORKBOOKS, ALL OF THE FOREGOING IN THE FIELD OF SCHOOLING FOR SUSTAINABILITY (U.S. CLS. 2, 5, 22, 23, 29, 37, 38 AND 50).

FIRST USE 10-16-2008; IN COMMERCE 10-16-2008.

3,807,772. THE READING FOUNDATION, DBA NATIONAL CHILDREN'S READING FOUNDATION, KENNEWICK, WA. SN 77-570,499. PUB. 1-27-2009, FILED 9-15-2008.

Cradle to College

THE MARK CONSISTS OF STANDARD CHARACTERS WITHOUT CLAIM TO ANY PARTICULAR FONT, STYLE, SIZE, OR COLOR.

FOR PRINTED EDUCATIONAL PUBLICATIONS, NAMELY, BOOKS, BOOKLETS, MANUALS, PAMPHLETS, BROCHURES AND ARTICLES RELATING TO READING, READING PROFICIENCY, AND TECHNIQUES FOR TEACHING READING TO CHILDREN (U.S. CLS. 2, 5, 22, 23, 29, 37, 38 AND 50).

FIRST USE 10-1-2009; IN COMMERCE 10-1-2009.

CLASS 16—(Continued).

3,807,823. LOGAN IP HOLDINGS, LLC, LOGAN, UT. SN 77-587,834. PUB. 8-4-2009, FILED 10-7-2008.

TROG

THE MARK CONSISTS OF STANDARD CHARACTERS WITHOUT CLAIM TO ANY PARTICULAR FONT, STYLE, SIZE, OR COLOR.

FOR PRINTED MATERIALS, NAMELY, BOOKS, BOOKLETS, PAMPHLETS, MAGAZINES, BROCHURES, INSTRUCTION GUIDES, AND NEWSLETTERS, ALL IN THE FIELDS OF SPORTS, RECREATION AND OUTDOOR RECREATION; WRITING IMPLEMENTS; STATIONARY; OFFICE STATIONARY; STATIONARY GOODS, NAMELY, BOOK COVERS, BOOKMARKS, CALENDARS, DECALS, STICKERS, BUMPER STICKERS, AND WINDOW STICKERS; PAPER GOODS, NAMELY, PAPER, ADHESIVE NOTEPADS, MEMO PADS, ADHESIVE MESSAGE PADS, POSTERS, PRINTED PAPER SIGNS, PAPER BANNERS, NOTE CARDS, NOTEBOOKS, PAPER LABELS, BINDERS, FOLDERS, PAPER BOXES, PAPER BAGS, PAPER CONTAINERS, CUBES OF NOTE-PAPER, BUSINESS CARDS; PRINTED PAPER LABELS AND SIGNS; PRINTED GRAPHICS, NAMELY, HEAT TRANSFER PAPER, PRINTED VISUAL IN THE NATURE OF INFORMATION GRAPHICS; HEAT APPLIED GRAPHICS FOR APPLICATION TO FABRICS, NAMELY, PLASTIC TRANSFERS; ADHESIVE-BACKED DECALS; PRESSURE SENSITIVE PRINTED PAPER LABELS (U.S. CLS. 2, 5, 22, 23, 29, 37, 38 AND 50).

FIRST USE 1-1-2009; IN COMMERCE 5-1-2009.

3,807,854. THE BANK OF NEW YORK MELLON CORPORATION, NEW YORK, NY. SN 77-607,597. PUB. 7-28-2009, FILED 11-5-2008.

LIQUIDITY DIRECTIONS

THE MARK CONSISTS OF STANDARD CHARACTERS WITHOUT CLAIM TO ANY PARTICULAR FONT, STYLE, SIZE, OR COLOR.

NO CLAIM IS MADE TO THE EXCLUSIVE RIGHT TO USE "LIQUIDITY", APART FROM THE MARK AS SHOWN.

FOR NEWSLETTERS RELATING TO FINANCIAL INVESTMENT STRATEGIES (U.S. CLS. 2, 5, 22, 23, 29, 37, 38 AND 50).

FIRST USE 1-31-2010; IN COMMERCE 1-31-2010.

CLASS 16—(Continued).

3,807,940. SCHAMET ANNIE MAE HORSFIELD, DBA OM BABY, MERCER ISLAND, WA. SN 77-662,814. PUB. 7-28-2009, FILED 2-4-2009.



NO CLAIM IS MADE TO THE EXCLUSIVE RIGHT TO USE "BABY", APART FROM THE MARK AS SHOWN.

THE NAME(S), PORTRAIT(S), AND/OR SIGNATURE(S) SHOWN IN THE MARK DOES NOT IDENTIFY A PARTICULAR LIVING INDIVIDUAL.

THE COLOR(S) BLUE, GREEN, YELLOW, ORANGE, BLACK, GRAY, AND APRICOT IS/ARE CLAIMED AS A FEATURE OF THE MARK.

THE MARK CONSISTS OF A LARGE YELLOW STAR THAT IS OUTLINED IN BLACK AND ORANGE. THE TEXT "OM BABY" IS GREEN. THE ONE-EYED CHARACTER IS WEARING GREEN AND BLUE CLOTHES. THE ONE-EYED CHARACTER IS CALLED "OM BABY" AND HAS A GRAY AND BLUE STAR IN HIS EYE. "OM BABY" IS STANDING IN FRONT OF A YELLOW STAR WITH A BLUE SKY FULL OF YELLOW AND ORANGE STARS BEHIND HIM. "OM BABY" IS WEARING ORANGE SHOES. THE OM BABY'S SKIN IS APRICOT COLORED. "OM BABY" IS DRAWN USING A BLACK CALLIGRAPHY PEN AND THE DRAWING IS OUTLINED IN BLACK. A BLUE SYMBOL APPEARS ON THE OM BABY'S SHIRT WHICH REPRESENTS THE SANSKRIT CHARACTER "OM".

THE NON-LATIN CHARACTER IN THE MARK TRANSLITERATES INTO "OM", AND "OM" HAS NO TRANSLATABLE MEANING IN ENGLISH, BUT IS USED AT THE BEGINNING OF PRAYERS, MANTRAS, AND SCRIPTURES AS A WORD OF INVOCATION AND ADORATION.

FOR BABY BOOKS (U.S. CLS. 2, 5, 22, 23, 29, 37, 38 AND 50).

FIRST USE 3-2-2010; IN COMMERCE 3-2-2010.

3,807,960. STEVEN H. SALTZMAN, DBA RATIO INDUSTRIES, INC., CANOGA PARK, CA. SN 77-671,762. PUB. 7-28-2009, FILED 2-17-2009.

REBOXMO

THE MARK CONSISTS OF STANDARD CHARACTERS WITHOUT CLAIM TO ANY PARTICULAR FONT, STYLE, SIZE, OR COLOR.

FOR CARDBOARD PACKAGING; CARDBOARD PACKAGING BOXES IN COLLAPSIBLE FORM; CARDBOARD PACKAGING BOXES IN MADE-UP FORM (U.S. CLS. 2, 5, 22, 23, 29, 37, 38 AND 50).

FIRST USE 10-8-2009; IN COMMERCE 12-10-2009.

CLASS 16—(Continued).

3,807,996. CABRERA, PEDRO AVELINO, SANTA CRUZ, BOLIVIA. SN 77-682,860. PUB. 8-18-2009, FILED 3-4-2009.



THE COLOR(S) GREEN, LIGHT GREEN, ORANGE, TEAL, BLACK, BROWN AND GRAY IS/ARE CLAIMED AS A FEATURE OF THE MARK.

THE MARK CONSISTS OF THE WORD "LAGARTEANDO" OVER A DESIGN OF AN ALLIGATOR ON A LOUNGE CHAIR WITH AN UMBRELLA PROTRUDING ABOVE THE ALLIGATOR. A GLASS WITH A STRAW AND AN ORANGE SLICE IS BALANCED ON THE ALLIGATOR'S TAIL. THE COLORS GREEN AND LIGHT GREEN APPEAR IN THE WORD "LAGARTEANDO" AND THE ALLIGATOR DESIGN; THE COLOR ORANGE APPEARS IN THE UMBRELLA, LOUNGE CHAIR, AS THE LIQUID IN THE GLASS AND THE ORANGE SLICE IN THE GLASS; THE COLOR TEAL APPEARS IN THE UMBRELLA AND THE STRAW; THE COLOR BLACK APPEARS IN THE SUNGLASSES AND THE ALLIGATOR NOSTRIL; THE COLOR BROWN APPEARS IN THE LOUNGE CHAIR AND THE POLE OF THE UMBRELLA; THE COLOR GRAY APPEARS IN THE GLASS DESIGN AND IN THE SHADING UNDER THE LOUNGE CHAIR.

THE ENGLISH TRANSLATION OF "LAGARTEANDO" IN THE MARK IS ENJOYING LEISURE TIME UNDER THE SUN.

FOR SPANISH LANGUAGE MAGAZINES FEATURING GAMES, HUMOR, JOKES, CROSSWORDS, BRAIN TEASERS AND DIVERSE CULTURAL ENTERTAINMENT (U.S. CLS. 2, 5, 22, 23, 29, 37, 38 AND 50).

FIRST USE 3-6-2010; IN COMMERCE 3-6-2010.

3,808,026. CLEARLY CLEAN LLC, SOUTH WINDSOR, CT. SN 77-690,209. PUB. 7-14-2009, FILED 3-13-2009.

PEEL-A-TRAY

THE MARK CONSISTS OF STANDARD CHARACTERS WITHOUT CLAIM TO ANY PARTICULAR FONT, STYLE, SIZE, OR COLOR.

FOR PAINT TRAYS WITH DISPOSABLE LINERS (U.S. CLS. 2, 5, 22, 23, 29, 37, 38 AND 50).

FIRST USE 2-6-2010; IN COMMERCE 2-6-2010.

CLASS 16—(Continued).

3,808,090. KLUTZ, PALO ALTO, CA. SN 77-699,592. PUB. 12-8-2009, FILED 3-26-2009.

THE ENCYCLOPEDIA OF IMMATURITY

THE MARK CONSISTS OF STANDARD CHARACTERS WITHOUT CLAIM TO ANY PARTICULAR FONT, STYLE, SIZE, OR COLOR.

NO CLAIM IS MADE TO THE EXCLUSIVE RIGHT TO USE "ENCYCLOPEDIA", APART FROM THE MARK AS SHOWN.

FOR SERIES OF BOOKS FOR CHILDREN IN THE FIELD OF HUMOR (U.S. CLS. 2, 5, 22, 23, 29, 37, 38 AND 50).

FIRST USE 8-1-2007; IN COMMERCE 8-1-2007.

3,808,106. YOUNG, PATRICK, SUNNYVALE, CA. SN 77-701,764. PUB. 1-12-2010, FILED 3-29-2009.

Munchies For The Mind

THE MARK CONSISTS OF STANDARD CHARACTERS WITHOUT CLAIM TO ANY PARTICULAR FONT, STYLE, SIZE, OR COLOR.

FOR CHILDREN'S ACTIVITY BOOKS; CHILDREN'S BOOKS; CHILDREN'S INTERACTIVE EDUCATIONAL BOOKS; PICTURE BOOKS; STORY BOOKS (U.S. CLS. 2, 5, 22, 23, 29, 37, 38 AND 50).

FIRST USE 12-1-2008; IN COMMERCE 1-1-2009.

3,808,144. MASON, BARBARA J, FRISCO, TX. SN 77-706,045. PUB. 8-4-2009, FILED 4-3-2009.

N DUE SEASON

THE MARK CONSISTS OF STANDARD CHARACTERS WITHOUT CLAIM TO ANY PARTICULAR FONT, STYLE, SIZE, OR COLOR.

FOR BLANK JOURNALS; CALENDARS; GREETING CARDS; NOTEPADS; PAINTINGS AND THEIR REPRODUCTIONS (U.S. CLS. 2, 5, 22, 23, 29, 37, 38 AND 50).

FIRST USE 9-17-2009; IN COMMERCE 4-13-2010.

CLASS 16—(Continued).

3,808,152. THE PROCTER & GAMBLE COMPANY, CINCINNATI, OH. SN 77-708,027. PUB. 8-18-2009, FILED 4-6-2009.



NO CLAIM IS MADE TO THE EXCLUSIVE RIGHT TO USE "THE GRAPHIC OF A DIAPER", APART FROM THE MARK AS SHOWN.

THE MARK CONSISTS OF "DRY MAX", OPEN DISPOSABLE DIAPER AND WATER DROPLET ALL CONTAINED WITHIN A GEOMETRIC SHAPE.

FOR DISPOSABLE DIAPERS (U.S. CLS. 2, 5, 22, 23, 29, 37, 38 AND 50).

FIRST USE 3-31-2010; IN COMMERCE 3-31-2010.

3,808,160. FINGER, DEBORAH, HARTSDALE, NY. AND LEBOWITZ, LYNN, SCARSDALE, NY. SN 77-709,538. PUB. 8-4-2009, FILED 4-8-2009.



NO CLAIM IS MADE TO THE EXCLUSIVE RIGHT TO USE "READING", APART FROM THE MARK AS SHOWN.

THE MARK CONSISTS OF A BOOK COVER WITH HANDS AND FEET, LIFTING A BARBELL, IN THE CENTER OF WHICH THE WORDS "THE READING GYM" APPEAR.

FOR PRINTED WORKBOOKS FEATURING AN EDUCATIONAL READING PROGRAM WHICH SPECIFICALLY TARGETS THE READING SKILLS OF FLUENCY AND DECODING (U.S. CLS. 2, 5, 22, 23, 29, 37, 38 AND 50).

FIRST USE 4-13-2010; IN COMMERCE 4-19-2010.

CLASS 16—(Continued).

3,808,177. IPENSTORE, LLC, SALINE, MI. SN 77-712,234. PUB. 8-11-2009, FILED 4-13-2009.



THE MARK CONSISTS OF THE WORD "ROSETTA" AND A STAR PARTIALLY SURROUNDED BY TWO ENCLOSED CIRCLES APPEARING ABOVE THE LETTER "O".

FOR PENS, NAMELY, BALLPOINT PENS, FOUNTAIN PENS AND ROLLER BALL PENS; AND PENCILS (U.S. CLS. 2, 5, 22, 23, 29, 37, 38 AND 50).

FIRST USE 6-21-2009; IN COMMERCE 6-21-2009.

3,808,205. FELSKE, COERTE, NEW YORK, NY. SN 77-715,829. PUB. 9-8-2009, FILED 4-16-2009.



NO CLAIM IS MADE TO THE EXCLUSIVE RIGHT TO USE "PRESS", APART FROM THE MARK AS SHOWN.

THE MARK CONSISTS OF THE WORDS "THE DOLCE VITA PRESS" WRITTEN WITH ALL FOUR WORDS STACKED VERTICALLY, "THE" AT TOP AND "PRESS" AT BOTTOM, ALL IN A STYLIZED FONT, AND A PAIR OF SUNGLASSES BETWEEN THE "THE" AND "DOLCE".

THE ENGLISH TRANSLATION OF "DOLCE" AND "VITA" IN THE MARK IS THE GOOD LIFE OR THE SWEET LIFE.

FOR SERIES OF FICTION AND NON-FICTION BOOKS ON A VARIETY OF TOPICS (U.S. CLS. 2, 5, 22, 23, 29, 37, 38 AND 50).

FIRST USE 5-1-2009; IN COMMERCE 9-10-2009.

CLASS 16—(Continued).

3,808,246. BARILLA G.E.R. FRATELLI - SOCIETÀ PER AZIONI, PARMA, ITALY. SN 77-728,039. PUB. 9-15-2009, FILED 5-4-2009.

THE BARILLA FAMILY DINNER
PROJECT

THE MARK CONSISTS OF STANDARD CHARACTERS WITHOUT CLAIM TO ANY PARTICULAR FONT, STYLE, SIZE, OR COLOR.

OWNER OF U.S. REG. NO. 897,460.

NO CLAIM IS MADE TO THE EXCLUSIVE RIGHT TO USE "FAMILY DINNER", APART FROM THE MARK AS SHOWN.

FOR PRINTED PUBLICATIONS IN THE NATURE OF A PAMPHLET AND BROCHURE OFFERING RECIPES AND INFORMATION RELATING TO FOOD PRODUCTS, MEALS, DINNERS, AND FAMILY; CALENDARS (U.S. CLS. 2, 5, 22, 23, 29, 37, 38 AND 50).

FIRST USE 6-0-2009; IN COMMERCE 6-0-2009.

3,808,280. SANDERS, SUSAN S., LEWISBURG, WV. SN 77-735,455. PUB. 9-22-2009, FILED 5-12-2009.

BETTER BY CHOICE

THE MARK CONSISTS OF STANDARD CHARACTERS WITHOUT CLAIM TO ANY PARTICULAR FONT, STYLE, SIZE, OR COLOR.

FOR PUBLICATIONS, NAMELY, CARDS IN THE FIELDS OF SELF-HELP AND PERSONAL DEVELOPMENT (U.S. CLS. 2, 5, 22, 23, 29, 37, 38 AND 50).

FIRST USE 8-28-2009; IN COMMERCE 8-28-2009.

3,808,281. SANDERS, SUSAN S., LEWISBURG, WV. SN 77-735,467. PUB. 9-22-2009, FILED 5-12-2009.

STRENGTHS AT WORK

THE MARK CONSISTS OF STANDARD CHARACTERS WITHOUT CLAIM TO ANY PARTICULAR FONT, STYLE, SIZE, OR COLOR.

FOR PUBLICATIONS, NAMELY, CARDS IN THE FIELDS OF SELF-HELP AND PERSONAL DEVELOPMENT (U.S. CLS. 2, 5, 22, 23, 29, 37, 38 AND 50).

FIRST USE 8-28-2009; IN COMMERCE 8-28-2009.

CLASS 16—(Continued).

3,808,312. POPE, RAY, CAMANO ISLAND, WA. SN 77-749,274. PUB. 10-13-2009, FILED 6-1-2009.

EARTHSUIT

THE MARK CONSISTS OF STANDARD CHARACTERS WITHOUT CLAIM TO ANY PARTICULAR FONT, STYLE, SIZE, OR COLOR.

FOR A SERIES OF BOOKS AND WRITTEN ARTICLES IN THE FIELD OF HEALTH, NUTRITION, FITNESS, DIET INFORMATION, PHYSICAL FITNESS INSTRUCTION AND CONSULTATION (U.S. CLS. 2, 5, 22, 23, 29, 37, 38 AND 50).

FIRST USE 6-1-2009; IN COMMERCE 6-1-2009.

3,808,332. POINTGREY DESIGN CO., VANCOUVER BC, CANADA. SN 77-756,909. PUB. 11-17-2009, FILED 6-11-2009.

learning fun

THE MARK CONSISTS OF STANDARD CHARACTERS WITHOUT CLAIM TO ANY PARTICULAR FONT, STYLE, SIZE, OR COLOR.

NO CLAIM IS MADE TO THE EXCLUSIVE RIGHT TO USE "LEARNING", APART FROM THE MARK AS SHOWN.

FOR EDUCATIONAL AND LEARNING PUBLICATIONS, NAMELY, BOOKLETS AND FLASH CARDS ON A VARIETY OF EDUCATIONAL DISCIPLINES IN PRE-SCHOOL THROUGH EIGHTH GRADE (U.S. CLS. 2, 5, 22, 23, 29, 37, 38 AND 50).

FIRST USE 1-1-2010; IN COMMERCE 1-1-2010.

3,808,353. BECK, JENNIFER M, ALEDO, TX. SN 77-763,356. PUB. 11-24-2009, FILED 6-18-2009.



NO CLAIM IS MADE TO THE EXCLUSIVE RIGHT TO USE "RESPONSIBLE KIDS..RESPONSIBLE ADULTS", APART FROM THE MARK AS SHOWN.

THE COLOR(S) BLACK, ORANGE, TEAL, YELLOW IS/ ARE CLAIMED AS A FEATURE OF THE MARK.

CLASS 16—(Continued).

THE MARK CONSISTS OF TEXT "FISHERKIDS" IN BLACK WITH AN ORANGE DOT OVER THE FIRST "I" AND A YELLOW DOT OVER THE SECOND "I"; A TEAL FISH UNDER THE "R" IN "FISHERKIDS"; THE TAIL OF THE "F" IN "FISHERKIDS" TURNS INTO A FISHING HOOK; UNDER "FISHERKIDS" TO THE RIGHT OF THE FISHING HOOK "F" IS TEXT "RESPONSIBLE KIDS" FOLLOWED BY THREE CIRCLES, RESPECTIVELY COLORED TEAL, YELLOW, ORANGE, FOLLOWED BY TEXT "RESPONSIBLE ADULTS" IN TEAL.

FOR PACKAGED KITS COMPRISING PRINTED INSTRUCTIONAL, EDUCATIONAL, AND TEACHING MATERIALS FOR EDUCATIONAL ACTIVITIES IN THE FIELD OF RESPONSIBILITY AND FINANCIAL EDUCATION (U.S. CLS. 2, 5, 22, 23, 29, 37, 38 AND 50).

FIRST USE 6-1-2009; IN COMMERCE 9-1-2009.

3,808,363. TERRA COTTA GARDENS, INC., LAS VEGAS, NV. SN 77-767,477. PUB. 12-8-2009, FILED 6-24-2009.

LE SOLEIL

THE MARK CONSISTS OF STANDARD CHARACTERS WITHOUT CLAIM TO ANY PARTICULAR FONT, STYLE, SIZE, OR COLOR.

THE ENGLISH TRANSLATION OF THE WORD "LE SOLEIL" IN THE MARK IS SUN.

FOR GENERAL FEATURE MAGAZINES (U.S. CLS. 2, 5, 22, 23, 29, 37, 38 AND 50).

FIRST USE 9-9-2009; IN COMMERCE 9-9-2009.

3,808,397. ROCKET 12 CREATIVE, LLC, CHICKAMAUGA, GA. SN 77-782,541. PUB. 12-8-2009, FILED 7-16-2009.

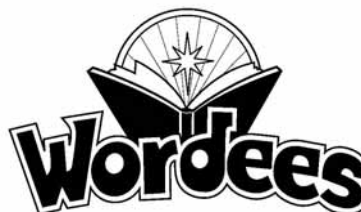

THE MARK CONSISTS OF THE STYLIZED WORD "WORDEES". ABOVE THE STYLIZED WORD IS AN IMAGE OF AN OPEN BOOK EMITTING A STARBURST.

FOR POSTERS; TRADING CARDS (U.S. CLS. 2, 5, 22, 23, 29, 37, 38 AND 50).

FIRST USE 3-30-2010; IN COMMERCE 3-30-2010.

CLASS 16—(Continued).

3,808,412. MATHEMATICALLY SPEAKING, INC., YARDLEY, PA. SN 77-788,659. PUB. 12-29-2009, FILED 7-24-2009.



THE MARK CONSISTS OF WORDING IN VARIOUS FONTS, SPECIFICALLY, THE WORDING "MATHSHAPES!", WITH PUNCTUATION IN THE FORM OF AN ELLIPSIS UNDER THE TERM "MATH" AND THE TERMS "GO FIGURE" TO THE RIGHT OF THE ELLIPSIS, AND THE WORDING "HELPING YOU HELP YOUR CHILD" UNDER THAT, WITH A LARGE EXPLANATION POINT TO THE RIGHT OF ALL THE WORDING.

FOR EDUCATIONAL ENRICHMENT PUBLICATIONS, NAMELY, WORKBOOKS AND PARENT RESOURCE GUIDES IN THE FIELD OF ELEMENTARY MATHEMATICS (U.S. CLS. 2, 5, 22, 23, 29, 37, 38 AND 50). FIRST USE 11-20-2009; IN COMMERCE 11-20-2009.

3,808,475. ADAM UGOLNIK, DBA KARL CLAY, WEST HOLLYWOOD, CA. SN 77-810,628. PUB. 1-19-2010, FILED 8-22-2009.

access mundane

THE MARK CONSISTS OF STANDARD CHARACTERS WITHOUT CLAIM TO ANY PARTICULAR FONT, STYLE, SIZE, OR COLOR.

FOR ART ETCHINGS; ART PICTURES; ART PRINTS; ART PRINTS ON CANVAS; COMIC BOOKS; COMICS; GRAPHIC ART REPRODUCTIONS; GRAPHIC NOVELS; GRAPHIC PRINTS AND REPRESENTATIONS; LITHOGRAPHIC WORKS OF ART; PRINTED ART REPRODUCTIONS; SERIES OF FICTION WORKS, NAMELY, NOVELS AND BOOKS (U.S. CLS. 2, 5, 22, 23, 29, 37, 38 AND 50).

FIRST USE 1-9-2010; IN COMMERCE 2-19-2010.

3,808,500. SAFETY IN MOTION, INC., PORTLAND, OR. SN 77-977,382. PUB. 7-21-2009, FILED 9-4-2008.

SIM4

THE MARK CONSISTS OF STANDARD CHARACTERS WITHOUT CLAIM TO ANY PARTICULAR FONT, STYLE, SIZE, OR COLOR.

CLASS 16—(Continued).

OWNER OF U.S. REG. NO. 2,604,437.

FOR MANUALS, POSTERS, AND EMPLOYEE HAND-OUTS RELATING TO EFFECTIVE AND SAFE ERGONOMIC WORKPLACE SETUP, TECHNIQUES FOR SAFE MATERIAL HANDLING, WORKPLACE PHYSICAL FITNESS, AND OBSERVATION AND REDUCTION OF WORKPLACE PHYSICAL RISK FACTORS (U.S. CLS. 2, 5, 22, 23, 29, 37, 38 AND 50).

FIRST USE 4-2-2009; IN COMMERCE 4-2-2009.

3,808,515. FAME IP HOLDING, LLC, HOLLYWOOD, FL. SN 77-979,296. PUB. 7-21-2009, FILED 2-26-2009.

NATIVE MUSIC ROCKS

THE MARK CONSISTS OF STANDARD CHARACTERS WITHOUT CLAIM TO ANY PARTICULAR FONT, STYLE, SIZE, OR COLOR.

NO CLAIM IS MADE TO THE EXCLUSIVE RIGHT TO USE "NATIVE MUSIC", APART FROM THE MARK AS SHOWN.

FOR PRINTED MATTER, NAMELY, POSTERS, STICKERS, BUMPER STICKERS, PHOTOGRAPHS (U.S. CLS. 2, 5, 22, 23, 29, 37, 38 AND 50).

FIRST USE 10-30-2008; IN COMMERCE 10-30-2008.

3,808,548. ATLAS PAPER MILLS, LLC, MIAMI, FL. SN 77-979,534. PUB. 12-16-2008, FILED 7-23-2008.

NATURAL HARMONY

THE MARK CONSISTS OF STANDARD CHARACTERS WITHOUT CLAIM TO ANY PARTICULAR FONT, STYLE, SIZE, OR COLOR.

FOR BATHROOM TISSUE (U.S. CLS. 2, 5, 22, 23, 29, 37, 38 AND 50).

FIRST USE 4-19-2010; IN COMMERCE 4-19-2010.

CLASS 16—(Continued).

3,808,587. THE SAUL ZAENTZ COMPANY, DBA TOLKIEN ENTERPRISES, BERKELEY, CA. SN 78-814,321. PUB. 2-13-2007, FILED 2-14-2006.



OWNER OF U.S. REG. NOS. 2,897,946, 2,952,841, AND OTHERS.
 THE STIPPLING IS A FEATURE OF THE MARK.
 FOR PICTURE BOOKS (U.S. CLS. 2, 5, 22, 23, 29, 37, 38 AND 50).
 FIRST USE 0-0-2007; IN COMMERCE 0-0-2007.

CLASS 17—(Continued).

3,807,716. SOLUTIA INC., ST. LOUIS, MO. SN 77-553,644. PUB. 12-23-2008, FILED 8-22-2008.

FORMULAONE

THE MARK CONSISTS OF STANDARD CHARACTERS WITHOUT CLAIM TO ANY PARTICULAR FONT, STYLE, SIZE, OR COLOR.
 FOR WEATHERIZED POLYESTER WINDOW FILM; FILMS, PRINCIPALLY OF PLASTIC, FOR USE IN APPLICATION TO VEHICULAR WINDOWS, FOR MINIMIZING ACOUSTIC TRANSMISSION THROUGH WINDOWS; FILMS, PRINCIPALLY OF PLASTIC, FOR USE IN APPLICATION TO VEHICULAR WINDOWS, FOR MINIMIZING OR FILTERING ELECTROMAGNETIC TRANSMISSIONS THROUGH WINDOWS; FILMS, PRINCIPALLY OF PLASTIC, FOR USE IN APPLICATION TO VEHICULAR WINDOWS FOR MINIMIZING OR FILTERING VISUAL TRANSMISSIONS THROUGH WINDOWS (U.S. CLS. 1, 5, 12, 13, 35 AND 50).
 FIRST USE 8-1-1992; IN COMMERCE 8-1-1992.

3,807,737. COZY FOAM, LLC, CONROE, TX. SN 77-560,006. PUB. 2-24-2009, FILED 9-2-2008.



CLASS 17—RUBBER GOODS

3,807,574. JAMES DIEFENTHAL, MANDEVILLE, LA. SN 77-422,249. PUB. 8-5-2008, FILED 3-14-2008.



NO CLAIM IS MADE TO THE EXCLUSIVE RIGHT TO USE "PREMIUM LIQUID RUBBER", APART FROM THE MARK AS SHOWN.
 THE COLOR(S) BLACK AND GOLD IS/ARE CLAIMED AS A FEATURE OF THE MARK.
 THE MARK CONSISTS OF THE WORD "PREMIUM" IN BLACK AND THE WORDS "LIQUID RUBBER" IN GOLD ALONG WITH A GOLD RIBBON ELEMENT.
 FOR LIQUID RUBBER MEMBRANES APPLIED BY SPRAY, ROLLER, BRUSH, OR TROWEL, AND USED FOR WATERPROOFING AND CORROSION PROTECTION (U.S. CLS. 1, 5, 12, 13, 35 AND 50).
 FIRST USE 12-31-2008; IN COMMERCE 12-31-2008.

NO CLAIM IS MADE TO THE EXCLUSIVE RIGHT TO USE "FOAM", APART FROM THE MARK AS SHOWN.
 THE COLOR(S) BROWN, RED, WHITE AND GOLD IS/ARE CLAIMED AS A FEATURE OF THE MARK.
 THE COLOR BROWN APPEARS IN THE TEXT OF THE WORDING "COZY FOAM FOR ITTY BITTY UTILITY BILLS", IN THE STYLIZED "C" DESIGN, IN THE CIRCLE ENCOMPASSING THE STYLIZED "C" AND STAR DESIGNS, AS THE SHADING OF THE LARGE STAR DESIGN, AND THE BACKGROUND ENCOMPASSING THE SMALL STAR DESIGN. THE COLOR RED APPEARS AS THE OUTLINE FOR THE LARGE STAR DESIGN, AND IN THE CIRCLE ENCOMPASSING THE SMALL STAR DESIGN. THE COLOR GOLD APPEARS IN THE SHADING IN THE SMALL STAR DESIGN, IN THE INTERIOR LINE IN THE CIRCLE ENCOMPASSING THE SMALL STAR DESIGN, AND IN THE INTERIOR LINE IN THE OUTLINE OF THE LARGE STAR DESIGN. THE COLOR WHITE APPEARS AS THE BACKGROUND SHADING IN THE CIRCLE ENCOMPASSING THE STYLIZED "C" DESIGN AND STAR DESIGNS.
 FOR FOAM INSULATION FOR USE IN BUILDING AND CONSTRUCTION (U.S. CLS. 1, 5, 12, 13, 35 AND 50).
 FIRST USE 3-1-2009; IN COMMERCE 3-1-2009.

CLASS 17—(Continued).

3,808,320. MULTI-PLASTICS, INC., LEWIS CENTER, OH. SN 77-751,686. PUB. 10-20-2009, FILED 6-4-2009.

DIVERSASEAL

THE MARK CONSISTS OF STANDARD CHARACTERS WITHOUT CLAIM TO ANY PARTICULAR FONT, STYLE, SIZE, OR COLOR.

FOR PLASTIC FLEXIBLE PACKAGING FILM SOLD IN BULK TO INDUSTRIAL AND COMMERCIAL MANUFACTURERS (U.S. CLS. 1, 5, 12, 13, 35 AND 50).

FIRST USE 3-4-2009; IN COMMERCE 3-4-2009.

CLASS 18—LEATHER GOODS

3,807,483. FORTUNE HI-TECH MARKETING, INC., LEXINGTON, KY. SN 77-251,606. PUB. 2-5-2008, FILED 8-9-2007.



FOR BUSINESS CARD CASES; CALLING CARD CASES; CREDIT CARD CASES; BRIEFCASES (U.S. CLS. 1, 2, 3, 22 AND 41).

FIRST USE 3-31-2007; IN COMMERCE 3-31-2007.

3,807,502. KATHERINE FLEMING, LLC, NEW YORK, NY. SN 77-282,817. PUB. 4-1-2008, FILED 9-18-2007.



THE NAME SHOWN IN THE MARK IDENTIFIES "KATHERINE FLEMING" WHOSE CONSENT IS OF RECORD.

CLASS 18—(Continued).

THE MARK CONSISTS OF THE WORDS "KATHERINE FLEMING" AND STYLIZED DESIGN.

FOR SHOULDER BAGS; TOTE BAGS; LEATHER BAGS, SUITCASES AND WALLETS; DUFFEL BAGS; HANDBAGS; PURSES (U.S. CLS. 1, 2, 3, 22 AND 41).

FIRST USE 8-1-2008; IN COMMERCE 8-1-2008.

3,807,612. PM INVESTIGATIONS, INC., ATLANTA, GA. SN 77-450,456. PUB. 9-30-2008, FILED 4-17-2008.



THE MARK CONSISTS OF A DOG WITH A CONTAINER AROUND IT'S NECK.

FOR BOOK BAGS, CHANGE PURSES, COIN PURSES, PURSES, BACKPACKS, SLING BAGS, KNAPSACKS FOR BOOKS, DOG COLLARS, LEATHER KEY CHAINS, AND WALLETS (U.S. CLS. 1, 2, 3, 22 AND 41).

FIRST USE 3-14-2010; IN COMMERCE 3-14-2010.

3,807,874. DOPPLER E. DOPPLER & CO. GMBH, BRAUNAU-RANSHOFEN, AUSTRIA. SN 77-615,641. PUB. 3-31-2009, FILED 11-17-2008.

DOPPLER

THE MARK CONSISTS OF STANDARD CHARACTERS WITHOUT CLAIM TO ANY PARTICULAR FONT, STYLE, SIZE, OR COLOR.

FOR UMBRELLAS, PARASOLS, AND PARASOL SUNSHADES (U.S. CLS. 1, 2, 3, 22 AND 41).

FIRST USE 11-3-2003; IN COMMERCE 11-3-2003.

CLASS 18—(Continued).

3,807,955. RODEO WORLD, INC., GRAPEVINE, TX. SN 77-670,270. PUB. 6-16-2009, FILED 2-13-2009.

ALL AMERICAN COWGIRL CHICKS

THE MARK CONSISTS OF STANDARD CHARACTERS WITHOUT CLAIM TO ANY PARTICULAR FONT, STYLE, SIZE, OR COLOR.

OWNER OF U.S. REG. NO. 2,965,642.

NO CLAIM IS MADE TO THE EXCLUSIVE RIGHT TO USE "COWGIRL", APART FROM THE MARK AS SHOWN. FOR BOOTS FOR HORSES, SADDLE BLANKETS, HORSE HALTERS AND HORSE BRIDLES (U.S. CLS. 1, 2, 3, 22 AND 41).

FIRST USE 7-26-2008; IN COMMERCE 7-26-2008.

3,808,232. TROYER, KATHERINE EMURIAN, RAMSEY, NJ. SN 77-724,914. PUB. 9-8-2009, FILED 4-29-2009.

Bag Hugger

THE MARK CONSISTS OF STANDARD CHARACTERS WITHOUT CLAIM TO ANY PARTICULAR FONT, STYLE, SIZE, OR COLOR.

NO CLAIM IS MADE TO THE EXCLUSIVE RIGHT TO USE "BAG", APART FROM THE MARK AS SHOWN.

FOR TOTE BAGS TO CARRY REUSABLE GROCERY AND/OR SHOPPING BAGS TO FACILITATE THE USE OF REUSABLE GROCERY AND/OR SHOPPING BAGS IN SHOPPING (U.S. CLS. 1, 2, 3, 22 AND 41).

FIRST USE 4-22-2010; IN COMMERCE 4-22-2010.

3,808,244. BARILLA G.E.R. FRATELLI - SOCIETÀ PER AZIONI, PARMA, ITALY. SN 77-727,978. PUB. 8-11-2009, FILED 5-4-2009.

SHARE THE TABLE

THE MARK CONSISTS OF STANDARD CHARACTERS WITHOUT CLAIM TO ANY PARTICULAR FONT, STYLE, SIZE, OR COLOR.

FOR TOTE BAGS, ALL PURPOSE CARRYING BAGS (U.S. CLS. 1, 2, 3, 22 AND 41).

FIRST USE 6-0-2009; IN COMMERCE 6-0-2009.

CLASS 18—(Continued).

3,808,247. BARILLA G.E.R. FRATELLI - SOCIETÀ PER AZIONI, PARMA, ITALY. SN 77-728,146. PUB. 8-11-2009, FILED 5-4-2009.

SHARE THE TABLE THE BARILLA FAMILY DINNER PROJECT

THE MARK CONSISTS OF STANDARD CHARACTERS WITHOUT CLAIM TO ANY PARTICULAR FONT, STYLE, SIZE, OR COLOR.

OWNER OF U.S. REG. NO. 897,460.

FOR TOTE BAGS; ALL PURPOSE CARRYING BAGS (U.S. CLS. 1, 2, 3, 22 AND 41).

FIRST USE 6-0-2009; IN COMMERCE 6-0-2009.

3,808,388. ROBBINS-HAMILTON, CHRISTINE, SPRINGFIELD, MA. SN 77-777,490. PUB. 12-1-2009, FILED 7-9-2009.



THE MARK CONSISTS OF A GRAPHIC OF THE SUN OVER A SUN UMBRELLA HELD BY A LEAPING WOMAN AND THE STYLIZED WORDS "THE CRISSY SUN CATCHER CATCHES THE SUN BEFORE IT CATCHES YOU" SUPERIMPOSED OVER THE UMBRELLA GRAPHIC AND ON THE CANOPY OF THE UMBRELLA.

FOR SUN UMBRELLAS (U.S. CLS. 1, 2, 3, 22 AND 41).

FIRST USE 3-15-2010; IN COMMERCE 3-15-2010.

CLASS 19—NON-METALLIC BUILDING MATERIALS

CLASS 19—(Continued).

3,807,780. CUSTOM STONE WOOD, LLC, AVON, MN. SN 77-571,548. PUB. 2-10-2009, FILED 9-16-2008.



NO CLAIM IS MADE TO THE EXCLUSIVE RIGHT TO USE "CUSTOM STONE WOOD", APART FROM THE MARK AS SHOWN.

THE COLOR(S) BROWN, GREEN, WHITE, AND BLACK IS/ARE CLAIMED AS A FEATURE OF THE MARK.

THE MARK CONSISTS OF GREEN TREE WITH "CSW" IN GREEN IN THE LEFT SIDE OF THE TREES BRANCHES TREE IS IN THE INSIDE OF A BROWN CIRCLE OBJECT, WITH A BLACK RECTANGLE BELOW WITH THE WORDS "CUSTOM STONE WOOD" IN WHITE.

FOR NON-METAL VENT COVER FOR HVAC DUCTS; WOOD MOLDINGS; WOOD TRIM (U.S. CLS. 1, 12, 33 AND 50).

FIRST USE 8-5-2008; IN COMMERCE 8-5-2008.

3,807,832. COLUMBIA INSURANCE COMPANY, OMAHA, NE. SN 77-595,057. PUB. 9-1-2009, FILED 10-17-2008.

LUMINIERE

THE MARK CONSISTS OF STANDARD CHARACTERS WITHOUT CLAIM TO ANY PARTICULAR FONT, STYLE, SIZE, OR COLOR.

FOR FLOOR PROTECTION FINISH SOLD AS A COMPONENT OF LAMINATE FLOORING (U.S. CLS. 1, 12, 33 AND 50).

FIRST USE 1-0-2009; IN COMMERCE 1-0-2009.

CLASS 19—(Continued).

3,807,873. AGRO GLOBAL TRADING INC, INDEPENDENCES, LA. SN 77-615,368. PUB. 10-13-2009, FILED 11-16-2008.



THE COLOR(S) BLACK AND RED IS/ARE CLAIMED AS A FEATURE OF THE MARK.

THE MARK CONSISTS OF THE FOLLOWING: THE WORDING "NEXTEP" IN BLACK, WITH THE INTERIOR OF THE "P" COLORED RED, AND THE LETTER "S" AND THE WORDING "LIVING GREEN" IN RED, WITH THE INTERIOR OF THE "R" COLORED BLACK.

FOR LAMINATE FLOORING (U.S. CLS. 1, 12, 33 AND 50).

FIRST USE 1-1-2009; IN COMMERCE 1-1-2009.

3,807,892. SOPREMA INC., DRUMMONDVILLE, QC, CANADA. SN 77-629,389. PUB. 11-3-2009, FILED 12-9-2008.

INSONOBOIS

THE MARK CONSISTS OF STANDARD CHARACTERS WITHOUT CLAIM TO ANY PARTICULAR FONT, STYLE, SIZE, OR COLOR.

OWNER OF CANADA REG. NO. TMA699240, DATED 10-23-2007, EXPIRES 10-23-2022.

FOR CONSTRUCTION MATERIALS, NAMELY, NON-METAL SUBFLOOR SOUNDPROOFING POLYETHYLENE MEMBRANE AND POLYMER MEMBRANE COATED WITH RUBBER GRANULES FOR RESIDENTIAL AND COMMERCIAL USE (U.S. CLS. 1, 12, 33 AND 50).

FIRST USE 12-1-2003; IN COMMERCE 1-5-2009.

3,807,998. PPG INDUSTRIES OHIO, INC., CLEVELAND, OH. SN 77-683,201. PUB. 12-1-2009, FILED 3-4-2009.

CLARVISTA

THE MARK CONSISTS OF STANDARD CHARACTERS WITHOUT CLAIM TO ANY PARTICULAR FONT, STYLE, SIZE, OR COLOR.

FOR FLAT, FLOAT AND SHEET GLASS ALL FOR BUILDING AND CONSTRUCTION (U.S. CLS. 1, 12, 33 AND 50).

FIRST USE 1-31-2010; IN COMMERCE 1-31-2010.

CLASS 19—(Continued).

3,808,014. BACKYARD LEISURE HOLDINGS, INC., PITTSBURG, KS. SN 77-687,696. PUB. 8-4-2009, FILED 3-10-2009.

BACKYARD BOTANICAL

THE MARK CONSISTS OF STANDARD CHARACTERS WITHOUT CLAIM TO ANY PARTICULAR FONT, STYLE, SIZE, OR COLOR.

NO CLAIM IS MADE TO THE EXCLUSIVE RIGHT TO USE "BOTANICAL", APART FROM THE MARK AS SHOWN.

FOR GARDEN BED KITS CONSISTING PRIMARILY OF PREFABRICATED, NON-METAL ENCLOSURES AND GARDEN BED PARTS FOR MAKING RAISED IRRIGATED GARDEN BEDS (U.S. CLS. 1, 12, 33 AND 50).

FIRST USE 4-0-2009; IN COMMERCE 4-0-2009.

CLASS 19—(Continued).

3,808,198. CLBY, INC., DBA D&M FLOORING, LOS ANGELES, CA. SN 77-714,851. PUB. 11-24-2009, FILED 4-15-2009.



THE COLOR(S) GREEN IS/ARE CLAIMED AS A FEATURE OF THE MARK.

THE MARK CONSISTS OF THE GREEN LETTERING "D&M".

FOR ENGINEERED HARDWOOD FLOORING (U.S. CLS. 1, 12, 33 AND 50).

FIRST USE 5-0-2009; IN COMMERCE 1-0-2010.

3,808,032. ROMEX WORLD TRADE COMPANY, L.L.C., ALEXANDRIA, LA. SN 77-690,759. PUB. 7-21-2009, FILED 3-13-2009.

SMARTPOUR

THE MARK CONSISTS OF STANDARD CHARACTERS WITHOUT CLAIM TO ANY PARTICULAR FONT, STYLE, SIZE, OR COLOR.

FOR PLYWOOD CASTING FORMS FOR CONCRETE (U.S. CLS. 1, 12, 33 AND 50).

FIRST USE 10-14-2009; IN COMMERCE 10-14-2009.

3,808,238. JAMES HARDIE TECHNOLOGY LIMITED, DUBLIN 2, IRELAND. SN 77-726,226. PUB. 7-21-2009, FILED 4-30-2009.

HZ5

3,808,039. SMITH AND FONG COMPANY, SAN FRANCISCO, CA. SN 77-692,003. PUB. 7-14-2009, FILED 3-16-2009.

SIDEWAYS

THE MARK CONSISTS OF STANDARD CHARACTERS WITHOUT CLAIM TO ANY PARTICULAR FONT, STYLE, SIZE, OR COLOR.

FOR ENGINEERED HARDWOOD FLOORING; FLOOR BOARDS; LAMINATE FLOORING; PARQUET FLOORING MADE OF WOOD; PARQUET FLOORING OF WOOD (U.S. CLS. 1, 12, 33 AND 50).

FIRST USE 3-11-2010; IN COMMERCE 3-11-2010.

THE MARK CONSISTS OF STANDARD CHARACTERS WITHOUT CLAIM TO ANY PARTICULAR FONT, STYLE, SIZE, OR COLOR.

FOR BUILDING AND CONSTRUCTION MATERIAL, NAMELY, ENGINEERED CEMENT COMPOSITE PANELS, PLANKS AND BOARDS; FIBER-REINFORCED CEMENT COMPOSITES FOR BUILDING AND CONSTRUCTION, NAMELY, EXTERIOR CLADDING PANELS, PLANKS AND BOARDS (U.S. CLS. 1, 12, 33 AND 50).

FIRST USE 6-1-2009; IN COMMERCE 6-1-2009.

CLASS 19—(Continued).

3,808,239. JAMES HARDIE TECHNOLOGY LIMITED, DUBLIN 2, IRELAND. SN 77-726,308. PUB. 7-21-2009, FILED 4-30-2009.



THE MARK CONSISTS OF A STYLIZED "H" HAVING A SHORTER GRAPHIC LINE ON THE RIGHT SIDE, AND A STYLIZED "Z" WITH THE TOP LINE EXTENDING OVER THE RIGHT SIDE OF THE "H," AND THE BOTTOM LINE EXTENDING UNDER THE NUMBER "5".

FOR BUILDING AND CONSTRUCTION MATERIAL, NAMELY, ENGINEERED CEMENT COMPOSITE PANELS, PLANKS AND BOARDS; FIBER-REINFORCED CEMENT COMPOSITES FOR BUILDING AND CONSTRUCTION, NAMELY, EXTERIOR CLADDING PANELS, PLANKS AND BOARDS (U.S. CLS. 1, 12, 33 AND 50).

FIRST USE 6-1-2009; IN COMMERCE 6-1-2009.

3,808,249. JAMES HARDIE TECHNOLOGY LIMITED, DUBLIN 2, IRELAND. SN 77-728,335. PUB. 7-21-2009, FILED 5-4-2009.

ENGINEERED FOR CLIMATE

THE MARK CONSISTS OF STANDARD CHARACTERS WITHOUT CLAIM TO ANY PARTICULAR FONT, STYLE, SIZE, OR COLOR.

FOR BUILDING AND CONSTRUCTION MATERIAL, NAMELY, ENGINEERED CEMENT COMPOSITE PANELS, PLANKS AND BOARDS; FIBER-REINFORCED CEMENT COMPOSITES FOR BUILDING AND CONSTRUCTION, NAMELY, EXTERIOR CLADDING PANELS, PLANKS AND BOARDS (U.S. CLS. 1, 12, 33 AND 50).

FIRST USE 6-1-2009; IN COMMERCE 6-1-2009.

CLASS 19—(Continued).

3,808,250. JAMES HARDIE TECHNOLOGY LIMITED, DUBLIN 2, IRELAND. SN 77-728,364. PUB. 7-21-2009, FILED 5-4-2009.



THE MARK CONSISTS OF A STYLIZED "H" HAVING A SHORTER GRAPHIC LINE ON THE RIGHT SIDE, AND A STYLIZED "Z" WITH THE TOP LINE EXTENDING OVER THE RIGHT SIDE OF THE "H," AND THE BOTTOM LINE EXTENDING UNDER THE NUMBER 10.

FOR BUILDING AND CONSTRUCTION MATERIAL, NAMELY, ENGINEERED CEMENT COMPOSITE PANELS, PLANKS AND BOARDS; FIBER-REINFORCED CEMENT COMPOSITES FOR BUILDING AND CONSTRUCTION, NAMELY, EXTERIOR CLADDING PANELS, PLANKS AND BOARDS (U.S. CLS. 1, 12, 33 AND 50).

FIRST USE 6-1-2009; IN COMMERCE 6-1-2009.

3,808,254. JAMES HARDIE TECHNOLOGY LIMITED, DUBLIN 2, IRELAND. SN 77-729,443. PUB. 7-21-2009, FILED 5-5-2009.

HZ10

THE MARK CONSISTS OF STANDARD CHARACTERS WITHOUT CLAIM TO ANY PARTICULAR FONT, STYLE, SIZE, OR COLOR.

FOR BUILDING AND CONSTRUCTION MATERIAL, NAMELY, ENGINEERED CEMENT COMPOSITE PANELS, PLANKS AND BOARDS; FIBER-REINFORCED CEMENT COMPOSITES FOR BUILDING AND CONSTRUCTION, NAMELY, EXTERIOR CLADDING PANELS, PLANKS AND BOARDS (U.S. CLS. 1, 12, 33 AND 50).

FIRST USE 6-1-2009; IN COMMERCE 6-1-2009.

3,808,284. CONNOR SPORT COURT INTERNATIONAL, INC., SALT LAKE CITY, UT. SN 77-738,015. PUB. 9-29-2009, FILED 5-15-2009.

SOFT-FIT

THE MARK CONSISTS OF STANDARD CHARACTERS WITHOUT CLAIM TO ANY PARTICULAR FONT, STYLE, SIZE, OR COLOR.

FOR RUBBER FLOORING (U.S. CLS. 1, 12, 33 AND 50).

FIRST USE 4-0-2009; IN COMMERCE 9-0-2009.

CLASS 19—(Continued).

3,808,285. CONNOR SPORT COURT INTERNATIONAL, INC., SALT LAKE CITY, UT. SN 77-738,046. PUB. 9-29-2009, FILED 5-15-2009.

MULTI-FIT

THE MARK CONSISTS OF STANDARD CHARACTERS WITHOUT CLAIM TO ANY PARTICULAR FONT, STYLE, SIZE, OR COLOR.
FOR RUBBER FLOORING (U.S. CLS. 1, 12, 33 AND 50).
FIRST USE 4-0-2009; IN COMMERCE 9-0-2009.

3,808,286. CONNOR SPORT COURT INTERNATIONAL, INC., SALT LAKE CITY, UT. SN 77-738,079. PUB. 9-29-2009, FILED 5-15-2009.

HEAVYWEIGHT

THE MARK CONSISTS OF STANDARD CHARACTERS WITHOUT CLAIM TO ANY PARTICULAR FONT, STYLE, SIZE, OR COLOR.
FOR RUBBER FLOORING (U.S. CLS. 1, 12, 33 AND 50).
FIRST USE 4-0-2009; IN COMMERCE 9-0-2009.

CLASS 20—FURNITURE AND ARTICLES NOT OTHERWISE CLASSIFIED

3,807,702. LIBERTY SAFE AND SECURITY PRODUCTS, INC., PAYSON, UT. SN 77-546,035. PUB. 1-20-2009, FILED 8-13-2008.

COOL POCKET

THE MARK CONSISTS OF STANDARD CHARACTERS WITHOUT CLAIM TO ANY PARTICULAR FONT, STYLE, SIZE, OR COLOR.
NO CLAIM IS MADE TO THE EXCLUSIVE RIGHT TO USE "POCKET", APART FROM THE MARK AS SHOWN.
FOR STORAGE RACKS, NAMELY, A PANEL FOR MOUNTING TO A DOOR COMPRISING ONE OR MORE FIRE PROTECTED STORAGE COMPARTMENTS (U.S. CLS. 2, 13, 22, 25, 32 AND 50).
FIRST USE 2-0-2009; IN COMMERCE 2-0-2009.

CLASS 20—(Continued).

3,807,923. WAL-MART STORES, INC., BENTONVILLE, AR. SN 77-650,516. PUB. 10-6-2009, FILED 1-15-2009.

CARDINAL HILL

THE MARK CONSISTS OF STANDARD CHARACTERS WITHOUT CLAIM TO ANY PARTICULAR FONT, STYLE, SIZE, OR COLOR.
FOR FURNITURE (U.S. CLS. 2, 13, 22, 25, 32 AND 50).
FIRST USE 6-30-2009; IN COMMERCE 6-30-2009.

3,807,932. FAB X FRAME SYSTEMS, LLC, PETOSKEY, MI. SN 77-656,554. PUB. 5-19-2009, FILED 1-26-2009.

CUBEX

THE MARK CONSISTS OF STANDARD CHARACTERS WITHOUT CLAIM TO ANY PARTICULAR FONT, STYLE, SIZE, OR COLOR.
FOR FRAMES FOR ADVERTISING, MARKETING AND PROMOTIONAL FABRICS (U.S. CLS. 2, 13, 22, 25, 32 AND 50).
FIRST USE 2-4-2008; IN COMMERCE 2-4-2008.

3,807,976. ZERBE CORNELSEN, RICHARD M., DBA THE VILLAGE CASKETMAKER, WINNIPEG, MANITOBA R3L 1M4, CANADA. SN 77-676,906. PUB. 7-21-2009, FILED 2-24-2009.

TIMBERWISE

THE MARK CONSISTS OF STANDARD CHARACTERS WITHOUT CLAIM TO ANY PARTICULAR FONT, STYLE, SIZE, OR COLOR.
PRIORITY CLAIMED UNDER SEC. 44(D) ON CANADA APPLICATION NO. 1428774, FILED 2-24-2009.
FOR CASKETS (U.S. CLS. 2, 13, 22, 25, 32 AND 50).
FIRST USE 3-8-2010; IN COMMERCE 3-8-2010.

CLASS 20—(Continued).

3,808,056. ELECTRONIC IMAGING SERVICES, INC., DBA VESTCOM RETAIL SOLUTIONS, LITTLE ROCK, AR. SN 77-695,227. PUB. 7-7-2009, FILED 3-19-2009.



THE MARK CONSISTS OF THE WORD "PEGASSIST" TO THE RIGHT OF FOUR SETS OF A 3-DIMENSIONAL ABSTRACT DESIGN CONSISTING OF THREE SQUARES JOINED TOGETHER BY A ROD.

FOR MERCHANDISE DISPLAYS, NAMELY, HANGING MERCHANDISE DISPLAY RACKS (U.S. CLS. 2, 13, 22, 25, 32 AND 50).

FIRST USE 4-0-2009; IN COMMERCE 4-0-2009.

3,808,164. KINGSDOWN, INC., MEBANE, NC. SN 77-709,747. PUB. 8-4-2009, FILED 4-8-2009.

NO WAKE ZONE

THE MARK CONSISTS OF STANDARD CHARACTERS WITHOUT CLAIM TO ANY PARTICULAR FONT, STYLE, SIZE, OR COLOR.

OWNER OF U.S. REG. NO. 3,121,725.

FOR MATTRESSES AND BOX SPRINGS (U.S. CLS. 2, 13, 22, 25, 32 AND 50).

FIRST USE 5-8-2009; IN COMMERCE 6-22-2009.

CLASS 21—HOUSEWARES AND GLASS

3,807,418. LANE EKBERG, WEST JORDAN, UT. SN 77-051,544. PUB. 2-19-2008, FILED 11-27-2006.

CAMPFIRE KITCHEN

THE MARK CONSISTS OF STANDARD CHARACTERS WITHOUT CLAIM TO ANY PARTICULAR FONT, STYLE, SIZE, OR COLOR.

NO CLAIM IS MADE TO THE EXCLUSIVE RIGHT TO USE "CAMPFIRE", APART FROM THE MARK AS SHOWN.

FOR NON-ELECTRIC HAND-HELD COOKING UTENSILS, NAMELY, SKEWERS WITH COOKING SURFACES AND COOKING CONTAINERS ATTACHABLE TO THE SKEWERS FOR COOKING OVER A CAMPFIRE (U.S. CLS. 2, 13, 23, 29, 30, 33, 40 AND 50).

FIRST USE 12-20-2009; IN COMMERCE 12-20-2009.

CLASS 21—(Continued).

3,807,538. WAUSAU PAPER TOWEL & TISSUE, LLC, MOSINEE, WI. SN 77-364,568. PUB. 5-20-2008, FILED 1-4-2008.

OPTISERV HYBRID

THE MARK CONSISTS OF STANDARD CHARACTERS WITHOUT CLAIM TO ANY PARTICULAR FONT, STYLE, SIZE, OR COLOR.

OWNER OF U.S. REG. NO. 3,157,804.

NO CLAIM IS MADE TO THE EXCLUSIVE RIGHT TO USE "HYBRID", APART FROM THE MARK AS SHOWN.

FOR A HYBRID DISPENSER FOR DISPENSING PAPER TOWELS, NAMELY, A DISPENSER WHICH COMBINES FEATURES OF BOTH AUTOMATIC HANDS-FREE DISPENSING OF PAPER TOWELS AND THE MANUAL DISPENSING OF PAPER TOWELS BY PULLING EXPOSED TOWEL FROM THE DISPENSER CHUTE (U.S. CLS. 2, 13, 23, 29, 30, 33, 40 AND 50).

FIRST USE 10-15-2009; IN COMMERCE 10-15-2009.

3,807,613. PM INVESTIGATIONS, INC., ATLANTA, GA. SN 77-450,466. PUB. 9-30-2008, FILED 4-17-2008.



THE MARK CONSISTS OF A DOG WITH A CONTAINER AROUND ITS NECK.

FOR DOG FEEDING DISHES, WATER BOTTLES SOLD EMPTY, AND COFFEE CUPS (U.S. CLS. 2, 13, 23, 29, 30, 33, 40 AND 50).

FIRST USE 3-13-2010; IN COMMERCE 3-13-2010.

3,807,617. TWO LITTLE FISHIES, MIAMI, FL. SN 77-458,446. PUB. 9-1-2009, FILED 4-25-2008.

VEGGIE MAG

THE MARK CONSISTS OF STANDARD CHARACTERS WITHOUT CLAIM TO ANY PARTICULAR FONT, STYLE, SIZE, OR COLOR.

CLASS 21—(Continued).

NO CLAIM IS MADE TO THE EXCLUSIVE RIGHT TO USE "VEGGIE", APART FROM THE MARK AS SHOWN.
FOR FISH FOOD DISPENSER HOLDERS FOR USE IN AQUARIUMS (U.S. CLS. 2, 13, 23, 29, 30, 33, 40 AND 50).
FIRST USE 2-1-2010; IN COMMERCE 2-1-2010.

3,807,744. LEVINE, MICHAEL, WOODLAND HILLS, CA. SN 77-561,838. PUB. 2-3-2009, FILED 9-3-2008.

THE BUTTERFLY

THE MARK CONSISTS OF STANDARD CHARACTERS WITHOUT CLAIM TO ANY PARTICULAR FONT, STYLE, SIZE, OR COLOR.

FOR BOTTLE OPENERS (U.S. CLS. 2, 13, 23, 29, 30, 33, 40 AND 50).
FIRST USE 5-31-2008; IN COMMERCE 5-31-2008.

3,807,784. BLACK DIAMOND STONEWORKS, INC., SAN CLEMENTE, CA. SN 77-572,399. PUB. 8-18-2009, FILED 9-17-2008.

MICROSWIFT

THE MARK CONSISTS OF STANDARD CHARACTERS WITHOUT CLAIM TO ANY PARTICULAR FONT, STYLE, SIZE, OR COLOR.

FOR FABRIC MICROFIBER CLEANING PADS AND CLOTHS (U.S. CLS. 2, 13, 23, 29, 30, 33, 40 AND 50).
FIRST USE 4-23-2010; IN COMMERCE 4-23-2010.

3,807,984. PEDERSEN, JOHN, BURBANK, CA. SN 77-679,170. PUB. 7-14-2009, FILED 2-26-2009.

HORNSMASHER.COM

THE MARK CONSISTS OF STANDARD CHARACTERS WITHOUT CLAIM TO ANY PARTICULAR FONT, STYLE, SIZE, OR COLOR.

FOR MAINTENANCE KITS FOR MUSICAL INSTRUMENTS CONSISTING PRIMARILY OF CLEANING CLOTHS, SWABS, AND BRUSHES FOR MUSICAL INSTRUMENTS, AND ALSO CONSISTING OF CLEANING SOLVENTS FOR MUSICAL INSTRUMENTS AND LUBRICATING OILS AND GREASES FOR MUSICAL INSTRUMENTS, ALL SOLD TOGETHER AS A KIT (U.S. CLS. 2, 13, 23, 29, 30, 33, 40 AND 50).
FIRST USE 3-13-2010; IN COMMERCE 3-13-2010.

CLASS 21—(Continued).

3,808,025. MEYER MANUFACTURING COMPANY LIMITED, KOWLOON, HONGKONG, CHINA. SN 77-690,203. PUB. 7-21-2009, FILED 3-13-2009.

CONTEMPO

THE MARK CONSISTS OF STANDARD CHARACTERS WITHOUT CLAIM TO ANY PARTICULAR FONT, STYLE, SIZE, OR COLOR.

FOR COOKWARE, NAMELY, POTS AND PANS; COOKWARE, NAMELY, ROASTING PANS; COOKWARE, NAMELY, STEAMERS (U.S. CLS. 2, 13, 23, 29, 30, 33, 40 AND 50).
FIRST USE 3-1-2009; IN COMMERCE 3-1-2009.

3,808,378. COMPAGNIE DE LA FECHT ET DU GOUT SAS, COLMAR, FRANCE. SN 77-771,984. PUB. 11-3-2009, FILED 7-1-2009.

FONTIGNAC

THE MARK CONSISTS OF STANDARD CHARACTERS WITHOUT CLAIM TO ANY PARTICULAR FONT, STYLE, SIZE, OR COLOR.

PRIORITY CLAIMED UNDER SEC. 44(D) ON ERPN CMNTY TM OFC APPLICATION NO. 008277386, FILED 5-4-2009.

FOR BOWLS; CASSEROLES; COOKERY MOLDS; COOKING POT SETS; COOKING UTENSILS, NAMELY, GRILLS; COOKWARE, NAMELY, POTS AND PANS; COOKWARE, NAMELY, ROASTING PANS; COOKWARE, NAMELY, STEAMERS; DISH COVERS; FONDUE POTS WITHOUT HEAT SOURCE; FRYING PANS; NON-ELECTRIC AUTOCLAVES; NON-ELECTRIC GRIDDLES; OVENWARE; POT LIDS; ROASTING DISHES; SERVING DISHES; WOKS (U.S. CLS. 2, 13, 23, 29, 30, 33, 40 AND 50).
FIRST USE 1-1-2009; IN COMMERCE 6-9-2009.

CLASS 21—(Continued).

3,808,410. CHAOZHOU NEW POWER CO., LTD., CHAOZHOU, GUANGDONG, CHINA. SN 77-786,932. PUB. 12-15-2009, FILED 7-22-2009.



THE MARK CONSISTS OF THE WORD "YONG" POSITIONED HORIZONTALLY AND THE WORD "NAN" POSITIONED VERTICALLY WITH THE FIRST "N" IN THE WORD "NAN" INTERSECTING WITH THE "N" IN THE WORD "YONG". AN AMPERSAND SYMBOL SITS ABOVE THE "N" IN THE WORD "YONG".

THE ENGLISH TRANSLATION OF "YONG" IS CITY WALLS. THE ENGLISH TRANSLATION OF "NAN" IS PHOEBE ZHENNAN A TYPE OF EVERGREEN TREE.

FOR BASINS; BEVERAGE GLASSWARE; CERAMIC SCULPTURES, VASES, VESSELS, BOWLS, PLATES AND POTS; CHINA ORNAMENTS; COFFEE CUPS, TEA CUPS AND MUGS; COFFEE POTS NOT OF PRECIOUS METAL; CONTAINERS FOR HOUSEHOLD OR KITCHEN USE; DISHWARE; DRINKING VESSELS; INSULATING JARS; JUGS; MUGS; NON-ELECTRIC KETTLES; PAPER AND PLASTIC CUPS; PLASTIC PLATES; PLATES; POTS; TEA SETS; THERMAL INSULATED CONTAINERS FOR FOOD OR BEVERAGE; WINE GLASSES; WORKS OF ART MADE OF PORCELAIN; WORKS OF ART OF EARTHENWARE (U.S. CLS. 2, 13, 23, 29, 30, 33, 40 AND 50).

FIRST USE 8-25-2009; IN COMMERCE 8-25-2009.

3,808,564. FLORES-CASTANO IMPORTS FROM MEXICO II, L.P., LAREDO, TX. SN 78-608,780. PUB. 1-30-2007, FILED 4-14-2005.

TIPIKOS

THE MARK CONSISTS OF STANDARD CHARACTERS WITHOUT CLAIM TO ANY PARTICULAR FONT, STYLE, SIZE, OR COLOR.

THE FOREIGN WORDING IN THE MARK TRANSLATES INTO ENGLISH AS "TYPICAL" OR "CHARACTERISTIC OF".

FOR HOUSEHOLD ITEMS IN THE NATURE OF KITCHENWARE, NAMELY, TORTILLA PRESSES, CAST IRON GRILLS (U.S. CLS. 2, 13, 23, 29, 30, 33, 40 AND 50). FIRST USE 1-25-2010; IN COMMERCE 2-1-2010.

CLASS 21—(Continued).

3,808,609. ACCESS NATURE, INC., MANORHAVEN, NY. SN 78-919,406. PUB. 1-30-2007, FILED 6-28-2006.

ACCESS NATURE

THE MARK CONSISTS OF STANDARD CHARACTERS WITHOUT CLAIM TO ANY PARTICULAR FONT, STYLE, SIZE, OR COLOR.

FOR INDOOR AND OUTDOOR PET AND WILD ANIMAL WATER AND FEED DISPENSERS, BIRD FEEDERS, FEED SCOOPS AND STORAGE CONTAINERS (U.S. CLS. 2, 13, 23, 29, 30, 33, 40 AND 50).

FIRST USE 3-25-2010; IN COMMERCE 3-25-2010.

CLASS 22—CORDAGE AND FIBERS

3,807,523. POLYTUF BRANDS, INC., CUYAHOGA FALLS, OH. SN 77-333,307. PUB. 11-11-2008, FILED 11-19-2007.

PET-TOUGH

THE MARK CONSISTS OF STANDARD CHARACTERS WITHOUT CLAIM TO ANY PARTICULAR FONT, STYLE, SIZE, OR COLOR.

FOR PET PRODUCTS, NAMELY, TARPAULINS FOR KENNELS, CAGES AND PET CARRIERS (U.S. CLS. 1, 2, 7, 19, 22, 42 AND 50).

FIRST USE 11-1-2009; IN COMMERCE 11-1-2009.

3,807,708. CARAVAN CANOPY INTERNATIONAL, INC., LA MIRADA, CA. SN 77-548,487. PUB. 12-15-2009, FILED 8-15-2008.

BIG FOOT

THE MARK CONSISTS OF STANDARD CHARACTERS WITHOUT CLAIM TO ANY PARTICULAR FONT, STYLE, SIZE, OR COLOR.

FOR TEMPORARY SHADE COVERINGS, NAMELY, CANOPIES HAVING FABRIC OR CANVAS FRAME COVERINGS (U.S. CLS. 1, 2, 7, 19, 22, 42 AND 50).

FIRST USE 12-0-2008; IN COMMERCE 12-0-2008.

CLASS 22—(Continued).

3,808,240. POOLMASTER, INC., SACRAMENTO, CA. SN 77-726,530. PUB. 9-8-2009, FILED 4-30-2009.

Pooltec

THE MARK CONSISTS OF STANDARD CHARACTERS WITHOUT CLAIM TO ANY PARTICULAR FONT, STYLE, SIZE, OR COLOR.

FOR SWIMMING POOL SKIMMING NETS (U.S. CLS. 1, 2, 7, 19, 22, 42 AND 50).
FIRST USE 10-1-2009; IN COMMERCE 3-1-2010.

3,808,428. KLEIN, JAMES C., LAS VEGAS, NV. SN 77-792,781. PUB. 12-22-2009, FILED 7-29-2009.

Beam Screen

THE MARK CONSISTS OF STANDARD CHARACTERS WITHOUT CLAIM TO ANY PARTICULAR FONT, STYLE, SIZE, OR COLOR.

FOR AWNING, PRIMARILY COMPRISED OF FOUR GROUND STAKES, FOUR FLEX POLES, AND A NYLON CANOPY (U.S. CLS. 1, 2, 7, 19, 22, 42 AND 50).
FIRST USE 3-1-2010; IN COMMERCE 3-1-2010.

CLASS 24—FABRICS

3,808,197. B4MARKET GROUP, INC., LONDON, ONTARIO, CANADA. SN 77-714,767. PUB. 8-18-2009, FILED 4-15-2009.

MAGNET & GO

THE MARK CONSISTS OF STANDARD CHARACTERS WITHOUT CLAIM TO ANY PARTICULAR FONT, STYLE, SIZE, OR COLOR.

FOR HOUSEHOLD CONSUMER PRODUCTS MADE FROM TEXTILE MATERIALS, NAMELY, KITCHEN TOWELS MADE FROM A TEXTILE MATERIAL, POTHOLDERS MADE FROM A TEXTILE MATERIAL, AND OVEN MITTS MADE FROM A TEXTILE MATERIAL (U.S. CLS. 42 AND 50).
FIRST USE 3-18-2009; IN COMMERCE 3-18-2009.

CLASS 24—(Continued).

3,808,245. BARILLA G.E R. FRATELLI - SOCIETÀ PER AZIONI, PARMA, ITALY. SN 77-727,987. PUB. 9-1-2009, FILED 5-4-2009.

SHARE THE TABLE

THE MARK CONSISTS OF STANDARD CHARACTERS WITHOUT CLAIM TO ANY PARTICULAR FONT, STYLE, SIZE, OR COLOR.

FOR TABLE CLOTHS NOT OF PAPER; AND CLOTH BANNERS (U.S. CLS. 42 AND 50).
FIRST USE 10-0-2009; IN COMMERCE 10-0-2009.

3,808,248. BARILLA G.E R. FRATELLI - SOCIETÀ PER AZIONI, PARMA, ITALY. SN 77-728,162. PUB. 9-8-2009, FILED 5-4-2009.

SHARE THE TABLE THE BARILLA FAMILY DINNER PROJECT

THE MARK CONSISTS OF STANDARD CHARACTERS WITHOUT CLAIM TO ANY PARTICULAR FONT, STYLE, SIZE, OR COLOR.

OWNER OF U.S. REG. NOS. 897,460, 2,964,682, AND OTHERS.

NO CLAIM IS MADE TO THE EXCLUSIVE RIGHT TO USE "FAMILY DINNER", APART FROM THE MARK AS SHOWN.

FOR TABLE CLOTHS NOT OF PAPER; AND CLOTH BANNERS (U.S. CLS. 42 AND 50).
FIRST USE 10-0-2009; IN COMMERCE 10-0-2009.

CLASS 25—CLOTHING

CLASS 25—(Continued).

3,807,376. CLAYTON, MARK J., GRAND PRAIRIE, TX. SN 76-660,842. PUB. 1-2-2007, FILED 5-31-2006.



THE MARK CONSISTS, IN PART, OF THE STYLIZED REPRESENTATION OF THE LETTER "MC".
FOR CLOTHING, NAMELY, CAPS AND SHIRTS (U.S. CLS. 22 AND 39).
FIRST USE 4-11-2008; IN COMMERCE 4-11-2008.

3,807,380. TIME-OUT, INC., CHARLOTTE, NC. AND RLR ASSOCIATES, LTD., NEW YORK, NY. SN 76-682,244. PUB. 3-11-2008, FILED 9-24-2007.

SURVIVE AND ADVANCE

THE MARK CONSISTS OF STANDARD CHARACTERS WITHOUT CLAIM TO ANY PARTICULAR FONT, STYLE, SIZE, OR COLOR.
FOR MEN'S, WOMEN'S AND CHILDREN'S CLOTHING, NAMELY, T-SHIRTS, SHIRTS, SWEATSHIRTS, TANK TOPS AND CAPS (U.S. CLS. 22 AND 39).
FIRST USE 3-8-2010; IN COMMERCE 3-8-2010.

3,807,381. LIEBERT, MARY ANN, NEW ROCHELLE, NY. SN 76-683,345. PUB. 5-6-2008, FILED 10-26-2007.

FOR CLOTHING, NAMELY, T-SHIRTS, BASEBALL CAPS, NIGHTSHIRTS, NIGHTGOWNS, OVERALLS, DRESSES, SKIRTS, BLOUSES, POLO SHIRTS, FOOTWEAR, HEADWEAR, SLIPPERS, SHOES, SOCKS, BATHROBES, PAJAMAS (U.S. CLS. 22 AND 39).
FIRST USE 5-2-2008; IN COMMERCE 5-2-2008.

CLASS 25—(Continued).

3,807,387. ROPA SIETE LEGUAS S.A. DE C.V., LERDO, DURANGO, MEXICO. SN 76-692,611. PUB. 2-10-2009, FILED 9-8-2008.

SETTE TO B URBAN

NO CLAIM IS MADE TO THE EXCLUSIVE RIGHT TO USE "URBAN", APART FROM THE MARK AS SHOWN.
THE ENGLISH TRANSLATION OF THE WORD "SETTE" IS "SEVEN".
FOR MEN'S, WOMEN'S AND CHILDREN'S CLOTHING, NAMELY, PANTS, JEANS, SHORTS, SKIRTS, JACKETS, CAPRIS, DRESSES, TOPS, T-SHIRTS, SWEATERS, HATS, BELTS, BLOUSES AND SHOES (U.S. CLS. 22 AND 39).
FIRST USE 12-14-2009; IN COMMERCE 12-14-2009.

3,807,389. BABY BOOM CONSUMER PRODUCTS, INC., NEW YORK, NY. SN 76-693,995. PUB. 3-17-2009, FILED 11-3-2008.

LEGAROOZ

THE MARK CONSISTS OF STANDARD CHARACTERS WITHOUT CLAIM TO ANY PARTICULAR FONT, STYLE, SIZE, OR COLOR.
FOR INFANTS' AND CHILDREN'S HOSIERY, INFANTS' AND CHILDREN'S SOCKS, INFANTS' AND CHILDREN'S BOOTIES, INFANTS' AND CHILDREN'S LEG WARMERS, INFANTS' AND CHILDREN'S KNIT LEGWEAR, NAMELY, INFANTS' AND CHILDREN'S LEGGINGS, AND INFANTS' AND CHILDREN'S FOOTWEAR (U.S. CLS. 22 AND 39).
FIRST USE 10-0-2008; IN COMMERCE 10-0-2008.

3,807,402. DESIGNI, INC., BEVERLY HILLS, CA. SN 76-698,064. PUB. 11-10-2009, FILED 6-24-2009.

SOCIALITE

THE MARK CONSISTS OF STANDARD CHARACTERS WITHOUT CLAIM TO ANY PARTICULAR FONT, STYLE, SIZE, OR COLOR.
FOR LADIES CLOTHING, NAMELY, SHIRTS, TOPS, BLOUSES, SKIRTS, COATS, JACKETS, DRESSES, PANTS, SHORTS, SWEATERS, AND CAMISOLES (U.S. CLS. 22 AND 39).
FIRST USE 3-1-2010; IN COMMERCE 3-1-2010.

CLASS 25—(Continued).

3,807,413. JOHN RICH & SONS INVESTMENT HOLDING COMPANY, WILMINGTON, DE. SN 77-036,329. PUB. 6-5-2007, FILED 11-3-2006.

WOOLRICH
JOHN RICH & BROS.

OWNER OF U.S. REG. NOS. 1,404,128, 2,077,561, AND OTHERS.

THE MARK CONSISTS OF "WOOLRICH" OVER "JOHN RICH & BROS."

FOR CLOTHING, NAMELY, PARKAS, COATS, JACKETS, VESTS, GLOVES, SHORTS, SHIRTS, SWEATERS, PULLOVERS, CAPS, T-SHIRTS, HATS, RAINWEAR, PANTS, TROUSERS, JUMPERS, ANORAKS, JEANS, DRESSES, BLOUSES, SPORTS SHIRTS, POLO SHIRTS, SWEATSHIRTS, SWEAT PANTS, TANK TOPS, OUTERWEAR, BATHING SUITS, BELTS (U.S. CLS. 22 AND 39).
FIRST USE 8-1-2009; IN COMMERCE 8-1-2009.

3,807,457. ONE MAN ARMY, INC., POMPANO BEACH, FL. SN 77-173,056. PUB. 7-7-2009, FILED 5-4-2007.

One Man Army, Inc.

NO CLAIM IS MADE TO THE EXCLUSIVE RIGHT TO USE "INC.", APART FROM THE MARK AS SHOWN.

FOR SHORT-SLEEVED OR LONG-SLEEVED T-SHIRTS; T-SHIRTS; TANK TOPS; SHIRTS FOR SUITS; SKI SUITS; SKI SUITS FOR COMPETITION; SKIRT SUITS; SNOW BOARDING SUITS; SNOW SUITS; SUIT COATS; SUITS; SUITS OF LEATHER; SWEAT SUITS; TRACK SUITS; TRAINING SUITS; VESTED SUITS; WARM UP SUITS; WET SUIT GLOVES; WET SUITS; WET SUITS FOR WATER-SKIING AND SUB-AQUA; BANDANAS; HAT BANDS; NECK BANDS; SASH BANDS FOR KIMONO (OBI); SWEAT BANDS; WRIST BANDS; WRISTBANDS; WRISTBANDS CONTAINING A COOLING SUBSTANCE TO COOL THE WEARER; JEANS; ANGLERS' SHOES; APRES-SKI SHOES; ATHLETIC SHOES; BALLET SHOES; BASEBALL SHOES; BEACH SHOES; BOWLING SHOES; BOXING SHOES; CANVAS SHOES; CLEATS FOR ATTACHMENT TO SPORTS SHOES; CYCLING SHOES; DECK-SHOES; DRIVERS; FOOTBALL SHOES; GOLF SHOES; GYMNASTIC SHOES; HANDBALL SHOES; HEEL PIECES FOR SHOES; HOCKEY SHOES; INFANTS' SHOES AND BOOTS; INSOLES; LEATHER SHOES; PAPER SHOES USED WHEN GOING THROUGH METAL DETECTORS TO KEEP FEET AND SOCKS CLEAN; PROTECTIVE METAL MEMBERS FOR

CLASS 25—(Continued).

SHOES AND BOOTS; RUBBER SHOES; RUNNING SHOES; SHOE DOWELS; SHOE INSERTS FOR PRIMARILY NON-ORTHOPEDIC PURPOSES; SHOES; SHOES SOLES FOR REPAIR; SKI AND SNOWBOARD SHOES AND PARTS THEREOF; SKIING SHOES; SOCCER SHOES; TAP SHOES; TENNIS SHOES; TRACK AND FIELD SHOES; TRAINING SHOES; VOLLEYBALL SHOES; WOMEN'S SHOES; WORK SHOES AND BOOTS; DENIM JACKETS; DOWN JACKETS; FISHERMEN'S JACKETS; FUR COATS AND JACKETS; FUR JACKETS; JACKETS; MEN AND WOMEN JACKETS, COATS, TROUSERS, VESTS; RAIN JACKETS; RAINPROOF JACKETS; SKI JACKETS; SPORTS JACKETS; WATER-PROOF JACKETS AND PANTS; WIND RESISTANT JACKETS; HOODS; JERSEYS; SHORT SETS; TIES; TOPS; WRAPS; BUTTON-FRONT ALOHA SHIRTS; CAMP SHIRTS; DRESS SHIRTS; GOLF SHIRTS; KNIT SHIRTS; NIGHT SHIRTS; OPEN-NECKED SHIRTS; POLO SHIRTS; SHIRTS; SPORTS SHIRTS; SPORTS SHIRTS WITH SHORT SLEEVES; SWEAT SHIRTS; WIND SHIRTS; YOGA SHIRTS (U.S. CLS. 22 AND 39).
FIRST USE 5-10-2007; IN COMMERCE 2-25-2009.

3,807,458. STEPHEN SHELBY SAWYER, VERSAILLES, KY. SN 77-176,110. PUB. 12-22-2009, FILED 5-9-2007.

Love God Back

THE MARK CONSISTS OF STANDARD CHARACTERS WITHOUT CLAIM TO ANY PARTICULAR FONT, STYLE, SIZE, OR COLOR.

FOR A-SHIRTS; BUTTON-FRONT ALOHA SHIRTS; CAMP SHIRTS; DRESS SHIRTS; GOLF SHIRTS; KNIT SHIRTS; MARTIAL ARTS UNIFORMS; NIGHT SHIRTS; OPEN-NECKED SHIRTS; PIQUE SHIRTS; POLO SHIRTS; SHIRT FRONTS; SHIRT YOKES; SHIRTS; SHIRTS FOR SUITS; SHORT-SLEEVED OR LONG-SLEEVED T-SHIRTS; SHORT-SLEEVED SHIRTS; SLEEP SHIRTS; SPORT SHIRTS; SPORTS SHIRTS; SPORTS SHIRTS WITH SHORT SLEEVES; SWEAT SHIRTS; T-SHIRTS (U.S. CLS. 22 AND 39).

FIRST USE 1-1-2007; IN COMMERCE 4-12-2010.

3,807,477. GETLOOOSE, LLC, NEW YORK, NY. SN 77-243,080. PUB. 7-21-2009, FILED 7-31-2007.

Getloose

THE MARK CONSISTS OF STANDARD CHARACTERS WITHOUT CLAIM TO ANY PARTICULAR FONT, STYLE, SIZE, OR COLOR.

FOR CLOTHING, NAMELY, SHIRTS, SWEATSHIRTS, T-SHIRTS, SHORTS, CAPS, JACKETS (U.S. CLS. 22 AND 39).

FIRST USE 11-23-2009; IN COMMERCE 11-23-2009.

CLASS 25—(Continued).

3,807,481. ELANIS INC., NEW YORK, NY. SN 77-250,343.
PUB. 2-19-2008, FILED 8-8-2007.

I.B.B.I.

THE MARK CONSISTS OF STANDARD CHARACTERS WITHOUT CLAIM TO ANY PARTICULAR FONT, STYLE, SIZE, OR COLOR.

FOR KNITWEAR, NAMELY, KNIT SHIRTS, CARDIGANS (U.S. CLS. 22 AND 39).

FIRST USE 1-6-2008; IN COMMERCE 1-6-2008.

3,807,485. ATHLETES YOGA, LLC, TEMPE, AZ. SN 77-252,648. PUB. 7-8-2008, FILED 8-10-2007.

CHEWYLOU DESIGNS

THE MARK CONSISTS OF STANDARD CHARACTERS WITHOUT CLAIM TO ANY PARTICULAR FONT, STYLE, SIZE, OR COLOR.

NO CLAIM IS MADE TO THE EXCLUSIVE RIGHT TO USE "DESIGNS", APART FROM THE MARK AS SHOWN.

FOR CLOTHING, NAMELY, MEN'S, WOMENS' AND CHILDRENS' PANTS, SHORTS, T-SHIRTS, SWEATSHIRTS, HATS AND CAPS (U.S. CLS. 22 AND 39).

FIRST USE 9-7-2007; IN COMMERCE 9-7-2007.

3,807,493. GOOD PEOPLE CO., LTD., SEOUL, REPUBLIC OF KOREA. SN 77-264,304. PUB. 7-1-2008, FILED 8-25-2007.



THE COLOR(S) WHITE, RED, BLACK AND PURPLE IS/ ARE CLAIMED AS A FEATURE OF THE MARK.

CLASS 25—(Continued).

THE MARK CONSISTS OF A CARICATURE OF A "DOG" LIKE CREATURE IN WHITE WITH BLACK PATCH OVER ONE EYE, A MOSTLY BLACK NOSE, A PURPLE COLLAR, AND WITH THE EARS BEING RED AND WHITE.

FOR UNDERWEAR, NAMELY, UNDERSHIRTS, UNDERPANTS, BRASSIERES, NIGHT GOWNS, SLIPS; T-SHIRTS; SPORT SHIRTS; JEANS; JACKETS; TROUSERS; SOCKS; GLOVES; TIES; HATS; LEATHER BELTS (U.S. CLS. 22 AND 39).

FIRST USE 4-1-2006; IN COMMERCE 5-24-2009.

3,807,497. WRANGLER APPAREL CORP., WILMINGTON, DE. SN 77-275,181. PUB. 5-27-2008, FILED 9-10-2007.



OWNER OF U.S. REG. NOS. 849,477, 2,998,129, AND OTHERS.

THE MARK CONSISTS OF THE WORD "WRANGLER" IN STYLIZED FORM, APPEARING DIAGONALLY WITHIN A RECTANGLE THAT HAS STITCH MARKS INSIDE THE OUTER EDGES OF THE RECTANGLE.

FOR CLOTHING, NAMELY, MENS, WOMENS AND CHILDRENS TOPS AND BOTTOMS, AND HEADGEAR, NAMELY, HATS AND CAPS (U.S. CLS. 22 AND 39).

FIRST USE 3-31-1960; IN COMMERCE 3-31-1960.

3,807,528. COLUMBIA SPORTSWEAR NORTH AMERICA, INC., PORTLAND, OR. SN 77-344,541. PUB. 4-22-2008, FILED 12-5-2007.

OMNI-SHIELD

THE MARK CONSISTS OF STANDARD CHARACTERS WITHOUT CLAIM TO ANY PARTICULAR FONT, STYLE, SIZE, OR COLOR.

OWNER OF U.S. REG. NO. 2,856,008.

FOR PANTS; SHORTS; SHIRTS; TOPS; SWEATERS; SWEAT SHIRTS; SKIRTS; SKORTS; SWIM WEAR (U.S. CLS. 22 AND 39).

FIRST USE 6-15-2009; IN COMMERCE 6-15-2009.

CLASS 25—(Continued).

3,807,533. TURNER, STEPHANIE, TEMPLETON, CA. SN 77-351,078. PUB. 5-13-2008, FILED 12-13-2007.



NO CLAIM IS MADE TO THE EXCLUSIVE RIGHT TO USE "GIRL RACING", APART FROM THE MARK AS SHOWN.

THE MARK CONSISTS OF THE STYLIZED WORDS "TOUGH GIRL RACING G" WITH A GRAPHIC DESIGN IN THE BACKGROUND.

FOR BATHING SUITS; HATS; JACKETS; PAJAMAS; PANTS; SHIRTS; SHORTS; SKIRTS; SOCKS; SWEAT SHIRTS; UNDERWEAR (U.S. CLS. 22 AND 39).

FIRST USE 11-1-2007; IN COMMERCE 3-8-2008.

3,807,544. BLUE ALPACA, SAC, LIMA, PERU. SN 77-386,745. PUB. 6-30-2009, FILED 2-1-2008.



NO CLAIM IS MADE TO THE EXCLUSIVE RIGHT TO USE "ALPACA", APART FROM THE MARK AS SHOWN.

THE COLOR(S) BROWN AND DARK BLUE IS/ARE CLAIMED AS A FEATURE OF THE MARK.

THE MARK CONSISTS OF A STYLIZED DESIGN OF A LLAMA APPEARING IN BROWN, THE LETTERING "BLUE ALPACA" IN DARK BLUE APPEARS TO THE RIGHT OF THE LLAMA DESIGN.

FOR CLOTHING CONTAINING ALPACA WOOL, NAMELY, SWEATERS (U.S. CLS. 22 AND 39).

FIRST USE 2-20-2010; IN COMMERCE 2-20-2010.

3,807,605. GRIJALVA, ROBERT, BAKERSFIELD, CA. SN 77-445,763. PUB. 12-1-2009, FILED 4-11-2008.

SK8RGRL

THE MARK CONSISTS OF STANDARD CHARACTERS WITHOUT CLAIM TO ANY PARTICULAR FONT, STYLE, SIZE, OR COLOR.

OWNER OF U.S. REG. NO. 3,599,566.

CLASS 25—(Continued).

SEC. 2(F).

FOR CLOTHING, NAMELY, SHIRTS, HATS, AND BEANIES FOR SKATEBOARDERS (U.S. CLS. 22 AND 39).

FIRST USE 11-15-2008; IN COMMERCE 11-15-2008.

3,807,628. HBI BRANDED APPAREL ENTERPRISES, LLC, WINSTON-SALEM, NC. SN 77-471,989. PUB. 3-3-2009, FILED 5-12-2008.

POWER WORKOUT TEE

THE MARK CONSISTS OF STANDARD CHARACTERS WITHOUT CLAIM TO ANY PARTICULAR FONT, STYLE, SIZE, OR COLOR.

NO CLAIM IS MADE TO THE EXCLUSIVE RIGHT TO USE "WORKOUT TEE", APART FROM THE MARK AS SHOWN.

FOR T-SHIRTS (U.S. CLS. 22 AND 39).

FIRST USE 3-16-2008; IN COMMERCE 3-16-2008.

3,807,645. ARIAT INTERNATIONAL, INC., UNION CITY, CA. SN 77-494,672. PUB. 2-24-2009, FILED 6-9-2008.

U-TURN ENTRY SYSTEM

THE MARK CONSISTS OF STANDARD CHARACTERS WITHOUT CLAIM TO ANY PARTICULAR FONT, STYLE, SIZE, OR COLOR.

NO CLAIM IS MADE TO THE EXCLUSIVE RIGHT TO USE "ENTRY SYSTEM", APART FROM THE MARK AS SHOWN.

FOR BOOTS (U.S. CLS. 22 AND 39).

FIRST USE 1-1-2009; IN COMMERCE 1-1-2009.

3,807,650. BDSRCO, INC., WILMINGTON, DE. SN 77-499,522. PUB. 12-23-2008, FILED 6-16-2008.

CORAL BAY

THE MARK CONSISTS OF STANDARD CHARACTERS WITHOUT CLAIM TO ANY PARTICULAR FONT, STYLE, SIZE, OR COLOR.

CLASS 25—(Continued).

OWNER OF U.S. REG. NOS. 2,982,563 AND 2,982,564.
 FOR CLOTHING, NAMELY, COVER UPS, CAPRIS, SKORTS, KNIT TOPS, WOVEN TOPS, DRESSES, SHORTS, FLEECE PULLOVERS, FLEECE SHORTS, FLEECE VEST, SWEATERS, PANTS, JACKETS (U.S. CLS. 22 AND 39).
 FIRST USE 8-1-2009; IN COMMERCE 8-1-2009.

3,807,664. PICAZIO, HEATHER, MYSTIC, CT. SN 77-513,548.
 PUB. 11-25-2008, FILED 7-2-2008.

MYSTIC MONKEY

THE MARK CONSISTS OF STANDARD CHARACTERS WITHOUT CLAIM TO ANY PARTICULAR FONT, STYLE, SIZE, OR COLOR.

FOR CLOTHING, NAMELY, T-SHIRTS, POLO SHIRTS, TANK TOPS, SWEATSHIRTS, JACKETS, SCARVES, BELTS, HEADBANDS, HATS, CAPS, VISORS, CLOTH BIBS, CHILDRENS' ONE-PIECE GARMENTS AND ROMPERS, NOT OFFERED IN ASSOCIATION WITH THE SHAKOPEE MDEWAKANTON SIOUX COMMUNITY'S MYSTIC LAKE CASINO AND HOTEL (U.S. CLS. 22 AND 39).
 FIRST USE 2-1-2008; IN COMMERCE 8-10-2009.

3,807,671. INGRID & ISABEL, LLC, SAN FRANCISCO, CA.
 SN 77-524,115. PUB. 6-16-2009, FILED 7-16-2008.

BE BELLY BEAUTIFUL

THE MARK CONSISTS OF STANDARD CHARACTERS WITHOUT CLAIM TO ANY PARTICULAR FONT, STYLE, SIZE, OR COLOR.

FOR MATERNITY GARMENTS AND ACCESSORIES, NAMELY, BANDS TO BE WORN PRE-PREGNANCY AND POST-PREGNANCY; CLOTHING, NAMELY, MATERNITY BANDS; MATERNITY TOPS (U.S. CLS. 22 AND 39).
 FIRST USE 1-4-2009; IN COMMERCE 1-4-2009.

CLASS 25—(Continued).

3,807,701. ACTIONPACT CORP., BERKELEY, CA. SN 77-545,392. PUB. 12-30-2008, FILED 8-12-2008.

PACT

THE MARK CONSISTS OF STANDARD CHARACTERS WITHOUT CLAIM TO ANY PARTICULAR FONT, STYLE, SIZE, OR COLOR.
 FOR UNDERWEAR (U.S. CLS. 22 AND 39).
 FIRST USE 8-17-2009; IN COMMERCE 8-17-2009.

3,807,705. DISYS KOREA. CO., LTD., GANGNAM-GU, SEOUL, REPUBLIC OF KOREA. SN 77-548,084. PUB. 8-4-2009, FILED 8-15-2008.



NO CLAIM IS MADE TO THE EXCLUSIVE RIGHT TO USE "HOLLYWOOD", APART FROM THE MARK AS SHOWN.

THE NAME(S), PORTRAIT(S), AND/OR SIGNATURE(S) SHOWN IN THE MARK IDENTIFIES "JINNY KIM", WHOSE CONSENT(S) TO REGISTER IS MADE OF RECORD.

THE MARK CONSISTS OF A DOG ON ITS HIND LEGS HOLDING A PILLOW WITH A SHOE ON TOP AND THE WORDS "JINNY KIM HOLLYWOOD" ALL ENCASED IN A PICTURE FRAME WITH A BOW ON TOP.

FOR MONEY BELTS; LEATHER SHOES; RUBBER SHOES; GALOSHES; GOLF SHOES; SHOE SOLES; WOODEN SHOES; ANGLER'S SHOES; BASKETBALL SHOES; SHOES; HEELPIECES FOR BOOTS AND SHOES; MOUNTAINEERING BOOTS; RUGBY SHOES; LACE BOOTS; BATH SANDALS; BATH SLIPPERS; HALF-BOOTS; WINTER BOOTS; BOXING SHOES; BOOTS; VINYL SHOES; BEACH SHOES; SKI BOOTS; SLIPPERS; INNER SOLES; SOLES FOR FOOTWEAR; FOOTWEAR UPPERS; NON-SLIP HEEL PIECES FOR BOOTS AND SHOES; TIPS FOR FOOTWEAR; DECORATIVE METAL MEMBERS FOR SHOES AND BOOTS; TRAINING SHOES; BASEBALL SHOES; ESPARTO SHOES AND SANDALS; OVERSHOES; RAIN BOOTS; FOOTWEAR FOR TRACK AND FIELD ATHLETICS; WORK SHOES AND BOOTS; LONG BOOTS; STRAW SANDALS; GYMNASICS SHOES; FOOTBALL SHOES; LACE BOOTS; HOCKEY SHOES; HANDBALL SHOES; KOREAN FENCING SUITS, NAMELY, KUMDO SUITS; CYCLISTS' CLOTHING, NAMELY, ANORAKS FOR EXERCISING; AEROBICS SUITS; JUDO SUITS; CLOTHING FOR GYMNASICS, NAMELY, TRAINING TOPS AND BOTTOMS; TAEKWONDO SUITS; BREECHES; RIDING BOOTS; MASQUERADE COSTUMES; SCHOOL UNIFORMS; RAINCOATS; OVER-

CLASS 25—(Continued).

COATS; LIVERIES; MANTLES; KNEE TROUSERS; HALF-COATS; BLOUSONS; SARIS; SAFARI SUITS; SUITS; SMOCKS; SKIRTS; SLACKS; MEN'S SUITS; ANORAKS NOT FOR EXERCISING; CHILDREN'S CLOTHING, NAMELY, TROUSERS, PANTS, T-SHIRTS, HOODED T-SHIRTS, JACKETS, AND JUMPERS; CEREMONIAL DRESSES; OVERALLS; OVERCOATS; ONE-PIECE SUITS; INFANT WEAR; EVENING DRESSES; JACKETS; WORKING OVERALLS; JUMPERS; CHASUBLES; BLUE JEANS; CAPES; TOPCOATS; TUXEDOS; TOGAS; TWO-PIECE SUITS; TUNICS; PARKAS; PELISSES; FROCKS; COLLARS FOR COATS; KOREAN CLOTHING, NAMELY, COATS, TOPCOATS, TOP JACKETS, WOMEN'S WAISTCOATS, JACKETS, TROUSERS, UNDERWEAR, AND SKIRTS; GIRDLES; NIGHTGOWNS; BUTTON-FRONT ALOHA SHIRTS; NEGLIGES; DRESSING GOWNS; ROMPERS; LEOTARDS; MANTILLAS; BATH ROBES; BODICES; BODY SHIRTS; BRASSIERES; BLOUSES; SHOWER CAPS; SHIRT YOKES; SHIRT FRONTS; UNDERWEAR; DRAWERS; UNDERSHIRTS; UNDERPANTS; BATHING CAPS; SWIMSUITS; BATHING TRUNKS; CHEMISETTES; CHEMISES; SWEATERS; SWEAT SHIRTS; SWEAT PANTS; SPORTS SHIRTS; SLIPS; WHITE SHIRTS; EXERCISE UNIFORMS; UNITARDS; COLLARS FOR CLOTHING; NIGHTWEAR; JERSEYS; VESTS; CARDIGANS; COLLAR PROTECTORS; COLLAR CUFFS; CAMISOLES; CORSETS; CORSELETS; TANK TOPS; TEDDIES; TRACKSUITS; PAJAMAS; PANTYHOSE; PETTICOATS; POLO SHIRTS; PULLOVERS; TEE-SHIRTS; SPATS; NECKTIES; SWEAT-ABSORBENT STOCKINGS; LEGWARMERS; LEGGINGS; MUFFS; MUFFLERS; BANDANAS; NECKERCHIEFS; EAR MUFFS; WINTER GLOVES; KOREAN SOCKS; KOREAN SOCKS COVERS; MITTENS; VEILS; BOAS; FOOT MUFFS NOT ELECTRICALLY HEATED; SHAWLS; SHOULDER WRAPS; WIMPLES; MANIPLES; SCARVES; STOCKINGS; HEELPIECES FOR STOCKINGS; STOLES; ASCOTS; SOCKS; SOCK COVERS; POCKET SQUARES; APRONS; EXERCISE STOCKINGS; TEXTILE BABY DIAPERS; POCKETS FOR CLOTHING; TIGHTS; PELERINES; KOREAN TRADITIONAL HATS; NIGHTCAPS; KOREAN TRADITIONAL WINTER CAPS, NAMELY, NANBAWI; KOREAN HEADBANDS MADE OF HORSEHAIR, NAMELY, MANGGON; CAPS; SUN VISORS; BERETS; MITERS; HOODS; TURBANS; TOP HATS; WATERPROOF CLOTHING, NAMELY, WATERPROOF JACKETS AND PANTS; GAITERS; KOREAN ANKLE BANDS, NAMELY, DAENIM; STOCKING SUSPENDERS; SOCK SUSPENDERS; CLOTHING SUSPENDERS; LEATHER CLOTHING BELTS (U.S. CLS. 22 AND 39).

FIRST USE 9-12-2007; IN COMMERCE 9-12-2007.

3,807,747. THE PACE COLLECTIVE, LLC, MADISON, MS. SN 77-562,708. PUB. 1-20-2009, FILED 9-4-2008.

MORGANFIELD

THE MARK CONSISTS OF STANDARD CHARACTERS WITHOUT CLAIM TO ANY PARTICULAR FONT, STYLE, SIZE, OR COLOR.

FOR MEN'S DENIM AND KHAKI PANTS, SPORT SHIRTS, KNIT SHIRTS, CAPS, LEATHER BOOTS AND SHOES (U.S. CLS. 22 AND 39).

FIRST USE 3-2-2010; IN COMMERCE 3-2-2010.

CLASS 25—(Continued).

3,807,763. INGENIOUS GENES, INC., PALATINE, IL. SN 77-567,005. PUB. 7-28-2009, FILED 9-10-2008.

KUFF WINKS

THE MARK CONSISTS OF STANDARD CHARACTERS WITHOUT CLAIM TO ANY PARTICULAR FONT, STYLE, SIZE, OR COLOR.

FOR GLOVES AS CLOTHING AND FOR FASHION, INCLUDING GLOVES WITH NO FINGERTIP PORTIONS, GLOVES WITH SOME BUT NOT ALL FINGERTIP PORTIONS, GLOVES WITH NO FINGERS, GLOVES WITH SOME BUT NOT ALL FINGERS, AND WRISTBANDS (U.S. CLS. 22 AND 39).

FIRST USE 12-31-2009; IN COMMERCE 12-31-2009.

3,807,795. FOSTER, DARYL, LOS ANGELES, CA. SN 77-577,226. PUB. 2-3-2009, FILED 9-23-2008.



THE MARK CONSISTS OF A STYLIZED "P" AND "N". FOR SHIRTS; SPORT SHIRTS; LONG-SLEEVED SHIRTS; SHORT-SLEEVED SHIRTS; SHORT-SLEEVED OR LONG-SLEEVED T-SHIRTS; SLEEVELESS SHIRTS; TANK TOPS; SWEAT SHIRTS; HOODED SWEAT SHIRTS; WIND SHIRTS; JACKETS; BASEBALL CAPS; CAPS WITH VISORS; VISORS; KNITTED CAPS; UNDERWEAR; SOCKS; BEANIES; SWEAT BANDS; SHORTS; PANTS (U.S. CLS. 22 AND 39).

FIRST USE 10-28-2009; IN COMMERCE 10-28-2009.

CLASS 25—(Continued).

3,807,797. ST IP, LLC, NEWPORT BEACH, CA. SN 77-578,109.
PUB. 2-17-2009, FILED 9-24-2008.

SYSTEM G2 PLATINUM

THE MARK CONSISTS OF STANDARD CHARACTERS WITHOUT CLAIM TO ANY PARTICULAR FONT, STYLE, SIZE, OR COLOR.

OWNER OF U.S. REG. NOS. 3,098,483, 3,440,580, AND OTHERS.

NO CLAIM IS MADE TO THE EXCLUSIVE RIGHT TO USE "PLATINUM", APART FROM THE MARK AS SHOWN. FOR INSOLES SOLD AS INTEGRAL COMPONENT OF FOOTWEAR (U.S. CLS. 22 AND 39).

FIRST USE 1-19-2010; IN COMMERCE 1-19-2010.

3,807,799. PETER C. KRAY, SANTA FE, NM. SN 77-579,276.
PUB. 2-17-2009, FILED 9-25-2008.

SHRED WHITE & BLUE

THE MARK CONSISTS OF STANDARD CHARACTERS WITHOUT CLAIM TO ANY PARTICULAR FONT, STYLE, SIZE, OR COLOR.

FOR ATHLETIC APPAREL, NAMELY, SHIRTS, PANTS, JACKETS, FOOTWEAR, HATS AND CAPS, ATHLETIC UNIFORMS (U.S. CLS. 22 AND 39).

FIRST USE 8-31-2008; IN COMMERCE 6-1-2009.

3,807,824. LOGAN IP HOLDINGS, LLC, LOGAN, UT. SN 77-587,837. PUB. 8-4-2009, FILED 10-7-2008.

TROG

THE MARK CONSISTS OF STANDARD CHARACTERS WITHOUT CLAIM TO ANY PARTICULAR FONT, STYLE, SIZE, OR COLOR.

FOR CLOTHING, NAMELY, SHIRTS, T-SHIRTS, SWEATSHIRTS, AND JACKETS; SPORTSWEAR, NAMELY, SWEAT SUITS, SHORTS, SWIM WEAR, TANK TOPS, SPORTS SHIRTS, COATS, VESTS, SWEATERS, HEADBANDS, PANTS, BELTS, MUFFS, NECKBANDS, SCARVES, WRISTBANDS, NECKWEAR; HEADWEAR, NAMELY, CAPS, HATS, VISORS AND BANDANAS; HANDWEAR, NAMELY, GLOVES AND MITTENS; SPORTS JERSEYS, SPORT CAPS, SHOES, ATHLETIC SHOES, BOOTS, SLIPPERS, SANDALS; FLEECE GOODS, NAMELY, FLEECE SHIRTS, FLEECE SHORTS, FLEECE PANTS, AND FLEECE JACKETS; GYM SHORTS, COL- LARED SHIRTS, RUGBY SHIRTS, KNIT SHIRTS, POLO SHIRTS, SOCKS, FOOTWEAR (U.S. CLS. 22 AND 39).

FIRST USE 1-1-2009; IN COMMERCE 5-1-2009.

CLASS 25—(Continued).

3,807,835. GYPSY IDEATION LLC, CHASKA, MN. SN 77-596,010. PUB. 3-10-2009, FILED 10-20-2008.

wooo moment

THE MARK CONSISTS OF STANDARD CHARACTERS WITHOUT CLAIM TO ANY PARTICULAR FONT, STYLE, SIZE, OR COLOR.

FOR HATS; JACKETS; POLO SHIRTS; T-SHIRTS (U.S. CLS. 22 AND 39).

FIRST USE 7-1-2009; IN COMMERCE 11-2-2009.

3,807,853. FORTUNE FASHIONS INDUSTRIES LLC, SANTA BARBARA, CA. SN 77-607,273. PUB. 10-6-2009, FILED 11-4-2008.

PARTS & LABOR

THE MARK CONSISTS OF STANDARD CHARACTERS WITHOUT CLAIM TO ANY PARTICULAR FONT, STYLE, SIZE, OR COLOR.

FOR CLOTHING AND APPAREL, NAMELY, TOPS, SHIRTS, SHORT-SLEEVED SHIRTS; T-SHIRTS; TEE SHIRTS (U.S. CLS. 22 AND 39).

FIRST USE 3-9-2010; IN COMMERCE 3-9-2010.

3,807,862. RAYMOND, LARRY, BURBANK, CA. SN 77-609,365. PUB. 3-24-2009, FILED 11-6-2008.

MY FRESH

THE MARK CONSISTS OF STANDARD CHARACTERS WITHOUT CLAIM TO ANY PARTICULAR FONT, STYLE, SIZE, OR COLOR.

FOR BANDANAS; CAPS; HEAD WEAR; HOODED SWEAT SHIRTS; HOODS; JERSEYS; POLO SHIRTS; SHOES; SHORTS; SOCKS; TANK TOPS; TEE SHIRTS (U.S. CLS. 22 AND 39).

FIRST USE 3-1-2010; IN COMMERCE 3-1-2010.

CLASS 25—(Continued).

3,807,875. MOORE, VANORRIS E., MACON, GA. SN 77-616,135. PUB. 12-22-2009, FILED 11-17-2008.



THE MARK CONSISTS OF THE "LOVETASI" LOGO IS HEART SHAPED WITH THREE EYE LASHES. THE MARK HAS AN EYE WITHIN THE HEART. "LOVETASI" IS SPELLED OUT UNDER THE HEART.

FOR GOLF SHIRTS; JEANS; LONG-SLEEVED SHIRTS; POLO SHIRTS; T-SHIRTS (U.S. CLS. 22 AND 39).

FIRST USE 2-14-2006; IN COMMERCE 2-14-2008.

CLASS 25—(Continued).

3,807,898. MICHAEL, DAVID, POINT ROBERTS, WA. SN 77-637,822. PUB. 7-14-2009, FILED 12-22-2008.

SEATTLE METROPOLITANS

THE MARK CONSISTS OF STANDARD CHARACTERS WITHOUT CLAIM TO ANY PARTICULAR FONT, STYLE, SIZE, OR COLOR.

NO CLAIM IS MADE TO THE EXCLUSIVE RIGHT TO USE "SEATTLE", APART FROM THE MARK AS SHOWN.

FOR CLOTHING, NAMELY, ATHLETIC SHOES, BOOTS, CAPES, DRESSES, FOOTBALL SHOES, FOOTWEAR, SKIRTS, JACKETS, JERSEYS, LACROSSE JERSEYS, FOOTBALL JERSEYS, HOCKEY JERSEYS, HATS, SOCKS, SHIRTS, TEE SHIRTS, GOLF SHIRTS, SWEAT SHIRTS, SWEATERS, SLEEPWEAR, PANTS, PULLOVER, SHORT PANTS, NECK WARMERS, SCARVES, SUITS, TURTLENECKS, UNIFORMS, UNDERGARMENTS, BASEBALL UNIFORMS, VESTS, WRIST BANDS, AND SUN VISORS (U.S. CLS. 22 AND 39).

FIRST USE 11-14-2008; IN COMMERCE 11-14-2008.

3,807,877. CARBON ZERO CLOTHING, LLC, REDONDO BEACH, CA. SN 77-618,021. PUB. 3-31-2009, FILED 11-19-2008.

Green religion clothing

THE MARK CONSISTS OF STANDARD CHARACTERS WITHOUT CLAIM TO ANY PARTICULAR FONT, STYLE, SIZE, OR COLOR.

NO CLAIM IS MADE TO THE EXCLUSIVE RIGHT TO USE "GREEN" AND "CLOTHING", APART FROM THE MARK AS SHOWN.

FOR ATHLETIC APPAREL, NAMELY, SHIRTS, PANTS, GOLF SHIRTS; HOODED SWEAT SHIRTS; KNIT SHIRTS; LONG-SLEEVED SHIRTS; OPEN-NECKED SHIRTS; POLO SHIRTS; RUGBY SHIRTS; SHIRTS; SHORT-SLEEVED OR LONG-SLEEVED T-SHIRTS; SHORT-SLEEVED SHIRTS; SPORT SHIRTS; SPORTS PANTS; SPORTS SHIRTS; SPORTS SHIRTS WITH SHORT SLEEVES; STRETCH PANTS; SWEAT PANTS; SWEAT SHIRTS; T-SHIRTS; TEE SHIRTS (U.S. CLS. 22 AND 39).

FIRST USE 2-20-2009; IN COMMERCE 6-10-2009.

3,807,899. MRW HOLDINGS, LLC, BEVERLY HILLS, CA. SN 77-638,947. PUB. 11-24-2009, FILED 12-23-2008.

GET READY TO GET DIRTY

THE MARK CONSISTS OF STANDARD CHARACTERS WITHOUT CLAIM TO ANY PARTICULAR FONT, STYLE, SIZE, OR COLOR.

FOR CLOTHING, NAMELY, PANTS, JEANS, SHIRTS, LOUNGEWEAR, HATS, SOCKS, HEADWEAR, FOOTWEAR, UNDERWEAR, T-SHIRTS, GLOVES, AND OUTERWEAR, NAMELY, COATS, JACKETS, SWEATERS, SWEATSHIRTS, AND COVERALLS (U.S. CLS. 22 AND 39).

FIRST USE 11-1-2009; IN COMMERCE 11-1-2009.

CLASS 25—(Continued).

3,807,918. MICHAEL, DAVID, POINT ROBERTS, WA. SN 77-648,690. PUB. 7-14-2009, FILED 1-13-2009.



NO CLAIM IS MADE TO THE EXCLUSIVE RIGHT TO USE "SEATTLE", APART FROM THE MARK AS SHOWN.

THE MARK CONSISTS OF THE LETTERS "SEATTLE" ARRANGED ON THE STYLIZED LETTER "S".

FOR CLOTHING, NAMELY, ATHLETIC SHOES, BOOTS, CAPES, DRESSES, FOOTBALL SHOES, FOOTWEAR, SKIRTS, JACKETS, JERSEYS, LACROSSE JERSEYS, FOOTBALL JERSEYS, HOCKEY JERSEYS, HATS, SOCKS, SHIRTS, TEE SHIRTS, GOLF SHIRTS, SWEAT SHIRTS, SWEATERS, SLEEPWEAR, PANTS, PULLOVER, SHORT PANTS, NECK WARMERS, SCARVES, SUITS, TURTLENECKS, UNIFORMS, UNDERGARMENTS, BASEBALL UNIFORMS, VESTS, WRIST BANDS, AND SUN VISORS (U.S. CLS. 22 AND 39).

FIRST USE 11-14-2008; IN COMMERCE 11-14-2008.

3,807,961. MEAGHAN WALKER, JEFFENY HUGHES AND MICHELLE ALEXANDER, DBA PRIVATE ARTS, LONG BEACH, CA. SN 77-672,015. PUB. 6-30-2009, FILED 2-17-2009.

PRIVATE ARTS

THE MARK CONSISTS OF STANDARD CHARACTERS WITHOUT CLAIM TO ANY PARTICULAR FONT, STYLE, SIZE, OR COLOR.

FOR LINGERIE (U.S. CLS. 22 AND 39).
FIRST USE 9-30-2009; IN COMMERCE 2-28-2010.

CLASS 25—(Continued).

3,807,972. GOLDEN DELTA ENTERPRISES, INC., DBA PLEASER USA, INC., FULLERTON, CA. SN 77-675,291. PUB. 5-12-2009, FILED 2-21-2009.

SPRING-O-LATORS

THE MARK CONSISTS OF STANDARD CHARACTERS WITHOUT CLAIM TO ANY PARTICULAR FONT, STYLE, SIZE, OR COLOR.

FOR SHOES, NAMELY, MULES, SLIDES, SANDALS, HIGH HEELS, STILETTOS, BOOTS (U.S. CLS. 22 AND 39).

FIRST USE 11-4-2009; IN COMMERCE 11-4-2009.

3,807,995. GAUGHAN, MARTINA, BOHEMIA, NY. SN 77-682,771. PUB. 7-7-2009, FILED 3-3-2009.

mountain menace

THE MARK CONSISTS OF STANDARD CHARACTERS WITHOUT CLAIM TO ANY PARTICULAR FONT, STYLE, SIZE, OR COLOR.

FOR GLOVES; HATS; JACKETS; SWEAT SHIRTS; T-SHIRTS (U.S. CLS. 22 AND 39).

FIRST USE 6-11-2009; IN COMMERCE 6-11-2009.

3,808,008. GARZA, SANDRA, CHICAGO, IL. SN 77-686,337. PUB. 7-14-2009, FILED 3-9-2009.

WHOLLY HATS

THE MARK CONSISTS OF STANDARD CHARACTERS WITHOUT CLAIM TO ANY PARTICULAR FONT, STYLE, SIZE, OR COLOR.

NO CLAIM IS MADE TO THE EXCLUSIVE RIGHT TO USE "HATS", APART FROM THE MARK AS SHOWN.

FOR HATS (U.S. CLS. 22 AND 39).
FIRST USE 3-15-2009; IN COMMERCE 3-15-2009.

CLASS 25—(Continued).

3,808,024. WOLVERINE WORLD WIDE, INC., ROCKFORD, MI. SN 77-689,815. PUB. 7-14-2009, FILED 3-12-2009.



THE MARK CONSISTS OF BODY DESIGN IN A CIRCLE. FOR FOOTWEAR (U.S. CLS. 22 AND 39). FIRST USE 6-10-2009; IN COMMERCE 6-10-2009.

3,808,060. WASHINGTON JR., CLYDE, COLUMBUS, MS. SN 77-695,953. PUB. 7-21-2009, FILED 3-20-2009.

BRIDGES COUTURE

THE MARK CONSISTS OF STANDARD CHARACTERS WITHOUT CLAIM TO ANY PARTICULAR FONT, STYLE, SIZE, OR COLOR.

NO CLAIM IS MADE TO THE EXCLUSIVE RIGHT TO USE "COUTURE", APART FROM THE MARK AS SHOWN. FOR CLOTHING, NAMELY, SHIRTS, PANTS, AND HEADBANDS (U.S. CLS. 22 AND 39). FIRST USE 12-1-2009; IN COMMERCE 12-1-2009.

CLASS 25—(Continued).

3,808,081. DIAZ, OSCAR G, BOCA RATON, FL. SN 77-698,325. PUB. 7-21-2009, FILED 3-24-2009.



THE MARK CONSISTS OF FONT TYPE: KUNSTLER SCRIPT. STYLIZED CAPITAL LETTER "C", LOWER CASE "I", LOWER CASE "T", LOWER CASE "Y", (SPACE BETWEEN WORDS), CAPITAL LETTER "B", LOWER CASE "O", LOWER CASE "Y" (SPELLS "CITY BOY"). BOTH WORDS ARE USED TOGETHER FOR THE TRADEMARK. THE DOT IN THE LETTER "I" IS THE ANATOMY OF A DIAMOND. (IN OTHER WORDS, A PERFECT DIAMOND). FOR T-SHIRTS (U.S. CLS. 22 AND 39). FIRST USE 10-14-2009; IN COMMERCE 10-14-2009.

3,808,089. DELTA APPAREL, INC., DULUTH, GA. SN 77-699,552. PUB. 8-4-2009, FILED 3-26-2009.



OWNER OF U.S. REG. NO. 1,911,515.
NO CLAIM IS MADE TO THE EXCLUSIVE RIGHT TO USE "TEES" OR "ORGANIC BLEND", APART FROM THE MARK AS SHOWN.
THE COLOR(S) BLUE AND GREEN IS/ARE CLAIMED AS A FEATURE OF THE MARK.
THE MARK CONSISTS OF THE WORDS "FUN TEES" IN BLUE, THE WORDS "ORGANIC BLEND" IN GREEN AND A STYLIZED LEAF IN GREEN.
FOR APPAREL, NAMELY, T-SHIRTS MADE IN WHOLE OR IN SUBSTANTIAL PART OF ORGANIC MATERIALS (U.S. CLS. 22 AND 39). FIRST USE 9-3-2009; IN COMMERCE 9-3-2009.

CLASS 25—(Continued).

3,808,094. RBR, LLC, VERNON, CA. SN 77-700,105. PUB. 9-1-2009, FILED 3-26-2009.

FOLLE DE JOIE

THE MARK CONSISTS OF STANDARD CHARACTERS WITHOUT CLAIM TO ANY PARTICULAR FONT, STYLE, SIZE, OR COLOR.

THE ENGLISH TRANSLATION OF "FOLLE DE JOIE" IN THE MARK IS DELIRIOUS.

FOR LINGERIE (U.S. CLS. 22 AND 39).
FIRST USE 2-20-2010; IN COMMERCE 2-20-2010.

3,808,129. CLEATSKINS, INC., ENCINITAS, CA. SN 77-704,587. PUB. 7-28-2009, FILED 4-1-2009.

CLEATSKINS COURT

THE MARK CONSISTS OF STANDARD CHARACTERS WITHOUT CLAIM TO ANY PARTICULAR FONT, STYLE, SIZE, OR COLOR.

OWNER OF U.S. REG. NO. 3,558,029.
NO CLAIM IS MADE TO THE EXCLUSIVE RIGHT TO USE "COURT", APART FROM THE MARK AS SHOWN.
FOR FOOTWEAR (U.S. CLS. 22 AND 39).
FIRST USE 2-15-2010; IN COMMERCE 2-15-2010.

3,808,133. INC INTERNATIONAL CORPORATION, KENNETT SQUARE, PA. SN 77-704,717. PUB. 8-4-2009, FILED 4-1-2009.

THY WILL BE DONE

THE MARK CONSISTS OF STANDARD CHARACTERS WITHOUT CLAIM TO ANY PARTICULAR FONT, STYLE, SIZE, OR COLOR.

FOR ATHLETIC APPAREL, NAMELY, SHIRTS (U.S. CLS. 22 AND 39).
FIRST USE 4-27-2010; IN COMMERCE 4-27-2010.

CLASS 25—(Continued).

3,808,134. LIU, WINNIE, PITTSBURGH, PA. SN 77-704,929. PUB. 8-25-2009, FILED 4-2-2009.



OWNER OF U.S. REG. NO. 3,450,652.
NO CLAIM IS MADE TO THE EXCLUSIVE RIGHT TO USE "SHOES", APART FROM THE MARK AS SHOWN.
THE COLOR(S) BROWN, PINK AND WHITE IS/ARE CLAIMED AS A FEATURE OF THE MARK.

THE BACKGROUND IS BROWN, THE WORDING "JAZZY" AND FOOT DESIGN ARE PINK AND THE TERMS "TOES" AND "NOT QUITE SHOES" ARE WHITE.

FOR ANKLE SOCKS; SANDALS; SHOES; SOCKS; SOCKS AND STOCKINGS; THERMAL SOCKS (U.S. CLS. 22 AND 39).

FIRST USE 3-1-2007; IN COMMERCE 3-1-2007.

3,808,135. LIU, WINNIE, PITTSBURGH, PA. SN 77-704,932. PUB. 8-25-2009, FILED 4-2-2009.

Not Quite Shoes

THE MARK CONSISTS OF STANDARD CHARACTERS WITHOUT CLAIM TO ANY PARTICULAR FONT, STYLE, SIZE, OR COLOR.

NO CLAIM IS MADE TO THE EXCLUSIVE RIGHT TO USE "SHOES", APART FROM THE MARK AS SHOWN.

FOR ANKLE SOCKS; SANDALS; SHOES; SOCKS; SOCKS AND STOCKINGS; THERMAL SOCKS (U.S. CLS. 22 AND 39).

FIRST USE 3-1-2007; IN COMMERCE 3-1-2007.

3,808,136. C. & J. CLARK INTERNATIONAL LIMITED, STREET, SOMERSET, UNITED KINGDOM. SN 77-704,976. PUB. 8-4-2009, FILED 4-2-2009.



OWNER OF U.S. REG. NOS. 540,599, 3,198,948, AND OTHERS.

CLASS 25—(Continued).

NO CLAIM IS MADE TO THE EXCLUSIVE RIGHT TO USE "WATERPROOF", APART FROM THE MARK AS SHOWN. THE COLOR(S) LIGHT BLUE, DARK BLUE AND BRIGHT BLUE IS/ARE CLAIMED AS A FEATURE OF THE MARK.

THE MARK CONSISTS OF A LARGE LIGHT-BLUE DROPLET, IN FRONT OF WHICH APPEAR THE VERTICALLY-ALIGNED STYLIZED WORDING "CLARKS" IN DARK BLUE, "MUCKERS" IN DARK BLUE, AND "WATERPROOF" IN BRIGHT BLUE.

FOR FOOTWEAR, NAMELY, SHOES, BOOTS, AND SANDALS (U.S. CLS. 22 AND 39).

FIRST USE 9-30-2002; IN COMMERCE 9-30-2002.



3,808,151. PROMGIRL, INC., NARBERTH, PA. SN 77-707,746. PUB. 8-11-2009, FILED 4-6-2009.

CLARISSE

THE MARK CONSISTS OF STANDARD CHARACTERS WITHOUT CLAIM TO ANY PARTICULAR FONT, STYLE, SIZE, OR COLOR.

OWNER OF U.S. REG. NO. 3,346,348.

FOR FOOTWEAR (U.S. CLS. 22 AND 39).

FIRST USE 1-1-2010; IN COMMERCE 1-1-2010.



3,808,163. ITALICS&BOLD LLC, NEWPORT BEACH, CA. SN 77-709,688. PUB. 8-4-2009, FILED 4-8-2009.

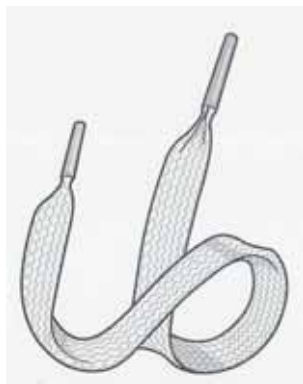

THE MARK CONSISTS OF SHOESTRING DESIGN. FOR CLOTHING, NAMELY, SHIRTS (U.S. CLS. 22 AND 39).

FIRST USE 4-21-2010; IN COMMERCE 4-21-2010.

CLASS 25—(Continued).

3,808,166. RACKS UNLEASHED, LLC, GRANDVILLE, MI. SN 77-709,813. PUB. 8-4-2009, FILED 4-8-2009.



THE MARK CONSISTS OF THE STYLIZED WORDING "RACKS UNLEASHED". A DESIGN OF STYLIZED MOUNTAINS APPEARS ABOVE THE WORDING "RACKS UNLEASHED". THE WORDING "EXPOSED TO THE OUTDOORS" APPEARS BELOW THE WORDING "RACKS UNLEASHED".

FOR HUNTING VESTS; RAINWEAR; CAPS; CAPS WITH VISORS; CLOTHING, NAMELY, COATS, JACKETS, PANTS, CAMOUFLAGE FIELD VESTS, TEE SHIRTS, SHIRTS, BANDANAS, HATS, TOPS, SWEATSHIRTS, SWEATPANTS (U.S. CLS. 22 AND 39).

FIRST USE 11-23-2009; IN COMMERCE 11-23-2009.



3,808,171. D M HASTON HOLDINGS, MOBILE, AL. SN 77-711,600. PUB. 11-24-2009, FILED 4-10-2009.



THE COLOR(S) BLACK AND WHITE IS/ARE CLAIMED AS A FEATURE OF THE MARK.

THE MARK CONSISTS OF A WHITE WHIRLPOOL OUT-

CLASS 25—(Continued).

LINED IN BLACK, WITH A WHITE LIGHTING BOLT OUTLINED IN BLACK TO THE BOTTOM LEFT OF THE WHIRLPOOL. VARIOUS WHITE AND BLACK BIRDS ARE LOCATED AT THE TOP RIGHT OF THE WHIRLPOOL. ON THE TOP LEFT OF THE WHIRLPOOL IS A WHITE THREE PRONGED CROWN WITH A BLACK OUTLINE AND BLACK WAVY DESIGNS, AND TO THE LEFT OF THE CROWN IS A BLACK AND WHITE BIRD WING; BELOW THE DESIGN FEATURE IS THE WORDING "MONOPOLE" IN BLACK.

FOR ATHLETIC APPAREL, NAMELY, SHIRTS, PANTS, JACKETS, FOOTWEAR, HATS AND CAPS, ATHLETIC UNIFORMS; BALLOON PANTS; CAPRI PANTS; CARGO PANTS; CLOTHING FOR ATHLETIC USE, NAMELY, PADDED PANTS; DENIMS; GOLF PANTS, SHIRTS AND SKIRTS; GYM PANTS; JOGGING PANTS; LEATHER PANTS; LOUNGE PANTS; MOISTURE-WICKING SPORTS PANTS; NON-DISPOSABLE CLOTH TRAINING PANTS; NURSE PANTS; PANTS; PETTI-PANTS; SCIENTIFIC AND TECHNOLOGICAL APPAREL, NAMELY, SHIRTS, PANTS, JACKETS, FOOTWEAR, HATS AND CAPS, UNIFORMS; SKI PANTS; SNOW PANTS; SNOWBOARD PANTS; SPORTS PANTS; STRETCH PANTS; SWEAT PANTS; TAP PANTS; TOBOGGAN HATS, PANTS AND CAPS; TRACK PANTS; TRAVEL CLOTHING CONTAINED IN A PACKAGE COMPRISING REVERSIBLE JACKETS, PANTS, SKIRTS, TOPS AND A BELT OR SCARF; WATERPROOF JACKETS AND PANTS; WIND PANTS; YOGA PANTS (U.S. CLS. 22 AND 39).

FIRST USE 12-31-2009; IN COMMERCE 12-31-2009.

3,808,194. LANNA, LLC, NEW YORK, NY. SN 77-714,414. PUB. 8-18-2009, FILED 4-15-2009.



THE MARK CONSISTS OF AN OUTLINE OF AN ELEPHANT WITH THE WORD "LANNA" UNDERNEATH. FOR SHOES (U.S. CLS. 22 AND 39). FIRST USE 6-19-2009; IN COMMERCE 6-19-2009.

CLASS 25—(Continued).

3,808,276. AHMED, SAAD, LOMITA, CA. SN 77-734,971. PUB. 9-22-2009, FILED 5-12-2009.



THE MARK CONSISTS OF THE STYLIZED WORDS "XES CULTURE" OVER AN ARTISTIC RENDERING OF A SHIELD. INSIDE THE SHIELD IS THE ARTISTIC RENDERING OF FLOWERS SEPARATED BY THE ARTISTIC RENDERING OF THE LETTERS "X" "E" AND "S" COMBINED.

FOR CLOTHING, NAMELY, SHIRTS, JEANS, POLOS, BOARD SHORTS, JACKETS, SWEATSHIRTS, SANDALS, AND SHOES (U.S. CLS. 22 AND 39).

FIRST USE 1-1-2010; IN COMMERCE 1-1-2010.

3,808,298. AUSTRALIAN APPAREL, DBA AUSTRALIAN APPAREL, KINGSGROVE, AUSTRALIA. SN 77-744,014. PUB. 10-6-2009, FILED 5-26-2009.

CRYSTAL CYLINDERS

THE MARK CONSISTS OF STANDARD CHARACTERS WITHOUT CLAIM TO ANY PARTICULAR FONT, STYLE, SIZE, OR COLOR.

FOR ATHLETIC APPAREL, NAMELY, SHIRTS, PANTS, JACKETS, FOOTWEAR, HATS AND CAPS, ATHLETIC UNIFORMS (U.S. CLS. 22 AND 39).

FIRST USE 3-1-2009; IN COMMERCE 1-10-2010.

3,808,304. MICHAUD, LOIS, PUEBLO WEST, CO. SN 77-745,251. PUB. 10-6-2009, FILED 5-27-2009.

Lois Trager Designs

THE MARK CONSISTS OF STANDARD CHARACTERS WITHOUT CLAIM TO ANY PARTICULAR FONT, STYLE, SIZE, OR COLOR.

NO CLAIM IS MADE TO THE EXCLUSIVE RIGHT TO USE "DESIGNS", APART FROM THE MARK AS SHOWN.

THE NAME "LOIS TRAGER" IDENTIFIES THE MAIDEN NAME OF LOIS MICHAUD A LIVING INDIVIDUAL WHOSE CONSENT IS OF RECORD.

FOR PAJAMAS; SHIRTS; SWEAT SHIRTS (U.S. CLS. 22 AND 39).

FIRST USE 8-9-2009; IN COMMERCE 4-16-2010.

CLASS 25—(Continued).

3,808,324. MIZUNO CORPORATION, OSAKA, 541-8538, JAPAN. SN 77-752,951. PUB. 11-3-2009, FILED 6-5-2009.

OWNER OF U.S. REG. NO. 2,913,490.
THE MARK CONSISTS OF THE SCRIPT LETTERS "AP" FOLLOWED BY A PLUS SIGN.
FOR FOOTWEAR, NAMELY, ATHLETIC FOOTWEAR, SPORTS SHOES, CASUAL SHOES (U.S. CLS. 22 AND 39).
FIRST USE 12-0-2009; IN COMMERCE 1-0-2010.

3,808,325. MAZUR-HICKS, KARINA, MALIBU, CA. SN 77-753,064. PUB. 10-20-2009, FILED 6-5-2009.



NO CLAIM IS MADE TO THE EXCLUSIVE RIGHT TO USE "CLOTHING", APART FROM THE MARK AS SHOWN.
THE MARK CONSISTS OF THE STYLIZED WORDS "TEA LEAF CLOTHING" INSIDE AN IMAGE OF A LEAF.

FOR CLOTHING, NAMELY, SHAWLS, BEACHWEAR, BEACH COVER UPS, FLIP FLOPS, BATHING SUITS, BLOUSES, BUTTON UP SHIRTS, FEMININE BLOUSES, BODYSUITS, BRA TOPS, BRA TANKS, BRIEFS, MINI DRESSES, MAXI DRESSES, LONG DRESSES, A-LINE SKIRTS, MINI SKIRTS, BOOTY SHORTS, CASUAL SHORTS, SHORT SHORTS, BOXERS, COATS, RAINCOAT, RAIN JACKETS, CROP TOPS, DRESSES, GLOVES, HOODED SWEATSHIRTS, JACKETS, JOGGING SUITS, JUMPSUITS, KNIT SHIRTS, LEG WARMERS, LEGGINGS, LEOTARDS, MITTENS, SHORT-SLEEVE SHIRTS, SWEAT PANTS, PANTS, PONCHOS, PULLOVERS, SCARVES, SHIRTS, SHORTS, SKIRTS, SLEEPWEAR, SUSPENDERS, SWEAT SHIRTS, SWEAT SUITS, SWEATBANDS, SWEATERS, SWEAT SHORTS, SWIMWEAR, TANK TOPS, TIES, T-SHIRTS, UNDERWEAR, VESTS, SWEATSHIRTS WITH ZIPPERS, EMBROIDERED SHIRTS, CASUAL BELTS (U.S. CLS. 22 AND 39).

FIRST USE 12-1-2009; IN COMMERCE 12-1-2009.

CLASS 25—(Continued).

3,808,327. SPANX, INC., ATLANTA, GA. SN 77-754,983. PUB. 9-22-2009, FILED 6-9-2009.

UNDIE-TECTABLE

THE MARK CONSISTS OF STANDARD CHARACTERS WITHOUT CLAIM TO ANY PARTICULAR FONT, STYLE, SIZE, OR COLOR.

FOR CLOTHING, NAMELY, UNDERWEAR (U.S. CLS. 22 AND 39).

FIRST USE 1-25-2010; IN COMMERCE 1-25-2010.

3,808,359. FRANK, GARVEY WILLIAM, TA RIFIFI, MIDDLESEX, UNITED KINGDOM. SN 77-765,572. PUB. 12-1-2009, FILED 6-22-2009.

RIFIFI

THE MARK CONSISTS OF STANDARD CHARACTERS WITHOUT CLAIM TO ANY PARTICULAR FONT, STYLE, SIZE, OR COLOR.

THE ENGLISH TRANSLATION OF "RIFIFI" IN THE MARK IS TROUBLE.

FOR ATHLETIC APPAREL, NAMELY, SHIRTS, PANTS, JACKETS, FOOTWEAR, HATS AND CAPS, ATHLETIC UNIFORMS; BODY SHIRTS; DRESS SHIRTS; GOLF TROUSERS; HOODED SWEAT SHIRTS; JERSEYS; MEN'S AND WOMEN'S JACKETS, COATS, TROUSERS, VESTS; OPEN-NECKED SHIRTS; PIQUE SHIRTS; POLO SHIRTS; SHIRTS AND SHORT-SLEEVED SHIRTS; T-SHIRTS (U.S. CLS. 22 AND 39).

FIRST USE 7-20-2009; IN COMMERCE 7-20-2009.

3,808,372. SHENG HANG INTERNATIONAL INCORPORATED, TEMPLE CITY, CA. SN 77-770,086. PUB. 12-8-2009, FILED 6-29-2009.

BOZZ

THE MARK CONSISTS OF STANDARD CHARACTERS WITHOUT CLAIM TO ANY PARTICULAR FONT, STYLE, SIZE, OR COLOR.

THE WORDING "BOZZ" HAS NO MEANING IN A FOREIGN LANGUAGE.

FOR BLOUSES; JEANS; SHOES; SOCKS; SWEAT SHIRTS; SWEATERS (U.S. CLS. 22 AND 39).

FIRST USE 10-1-2009; IN COMMERCE 10-1-2009.

CLASS 25—(Continued).

3,808,380. DEER STAGS, INC., NEW YORK, NY. SN 77-773,673. PUB. 11-24-2009, FILED 7-2-2009.

DURACUSHION

THE MARK CONSISTS OF STANDARD CHARACTERS WITHOUT CLAIM TO ANY PARTICULAR FONT, STYLE, SIZE, OR COLOR.
FOR FOOTWEAR (U.S. CLS. 22 AND 39).
FIRST USE 6-5-2009; IN COMMERCE 6-5-2009.

3,808,389. HABAND COMPANY, INC., OAKLAND, NJ. SN 77-777,631. PUB. 12-1-2009, FILED 7-9-2009.

ACTIVE JOE

THE MARK CONSISTS OF STANDARD CHARACTERS WITHOUT CLAIM TO ANY PARTICULAR FONT, STYLE, SIZE, OR COLOR.
FOR MEN'S CLOTHING, NAMELY, SLACKS, SHORTS, JEANS, SHIRTS, TIES, COATS, SHOES, SPORT JACKETS, JACKET, SWEATERS, BELTS AND UNDERWEAR; AND FOOTWEAR (U.S. CLS. 22 AND 39).
FIRST USE 0-0-2002; IN COMMERCE 0-0-2002.

3,808,451. DDA HOLDINGS, INC., LOS ANGELES, CA. SN 77-800,161. PUB. 1-12-2010, FILED 8-7-2009.

OF TWO MINDS

THE MARK CONSISTS OF STANDARD CHARACTERS WITHOUT CLAIM TO ANY PARTICULAR FONT, STYLE, SIZE, OR COLOR.
FOR CLOTHING, NAMELY, SHIRTS, T-SHIRTS, TANK TOPS, SWEATERS, TOPS, JACKETS, COATS, PANTS, JEANS, SHORTS, SKIRTS, BOTTOMS, SWEAT SHIRTS, SWEAT PANTS, SWEAT SUITS, DRESSES, BELTS, SCARVES (U.S. CLS. 22 AND 39).
FIRST USE 9-0-2009; IN COMMERCE 9-0-2009.

CLASS 25—(Continued).

3,808,458. DELTA GALIL USA, INC., SEACAUCUS, NJ. SN 77-802,640. PUB. 12-22-2009, FILED 8-12-2009.

ULTIMATE UP-SIZE

THE MARK CONSISTS OF STANDARD CHARACTERS WITHOUT CLAIM TO ANY PARTICULAR FONT, STYLE, SIZE, OR COLOR.
FOR CLOTHING, NAMELY, BRAS, BRASSIERES (U.S. CLS. 22 AND 39).
FIRST USE 3-0-2010; IN COMMERCE 3-0-2010.

3,808,463. ACI INTERNATIONAL, LOS ANGELES, CA. SN 77-803,812. PUB. 12-15-2009, FILED 8-13-2009.

A WORKOUT IN EVERY STEP

THE MARK CONSISTS OF STANDARD CHARACTERS WITHOUT CLAIM TO ANY PARTICULAR FONT, STYLE, SIZE, OR COLOR.
FOR FOOTWEAR (U.S. CLS. 22 AND 39).
FIRST USE 12-30-2009; IN COMMERCE 12-30-2009.

3,808,467. ACI INTERNATIONAL, LOS ANGELES, CA. SN 77-805,896. PUB. 12-15-2009, FILED 8-17-2009.

CRADLE TONING

THE MARK CONSISTS OF STANDARD CHARACTERS WITHOUT CLAIM TO ANY PARTICULAR FONT, STYLE, SIZE, OR COLOR.
FOR FOOTWEAR (U.S. CLS. 22 AND 39).
FIRST USE 11-1-2009; IN COMMERCE 11-1-2009.

CLASS 25—(Continued).

3,808,479. J & M SALES, INC, GARDENA, CA. SN 77-812,190.
PUB. 1-19-2010, FILED 8-25-2009.

AKUMA

THE MARK CONSISTS OF STANDARD CHARACTERS WITHOUT CLAIM TO ANY PARTICULAR FONT, STYLE, SIZE, OR COLOR.

THE ENGLISH TRANSLATION OF "AKUMA" IN THE MARK IS "EVIL SPIRIT."

FOR HATS; HEADBANDS; JACKETS; PANTS; SHIRTS; SHOES; SNEAKERS; SOCKS; SWEAT PANTS; SWEAT SHIRTS; T-SHIRTS (U.S. CLS. 22 AND 39).

FIRST USE 12-5-2009; IN COMMERCE 12-5-2009.

3,808,484. WEINREB, MICHAEL PETER, AVENTURA, FL.
SN 77-815,060. PUB. 1-19-2010, FILED 8-28-2009.

nodoggy

THE MARK CONSISTS OF STANDARD CHARACTERS WITHOUT CLAIM TO ANY PARTICULAR FONT, STYLE, SIZE, OR COLOR.

FOR HATS; JACKETS; T-SHIRTS (U.S. CLS. 22 AND 39).

FIRST USE 2-1-2010; IN COMMERCE 2-1-2010.

3,808,503. CITY OF NEW BERN, NEW BERN, NC. SN 77-977,950. PUB. 6-17-2008, FILED 9-21-2007.



NO CLAIM IS MADE TO THE EXCLUSIVE RIGHT TO USE "NEW BERN", "300 YEARS", "1710", "2010" AND "NORTH CAROLINA", APART FROM THE MARK AS SHOWN.

THE COLOR(S) RED, BLACK, YELLOW AND WHITE IS/ ARE CLAIMED AS A FEATURE OF THE MARK.

CLASS 25—(Continued).

THE MARK CONSISTS OF A BLACK BEAR ON A RED AND YELLOW CREST ON A BLACK BACKGROUND WITH AN INSIDE YELLOW BORDER. THE WORDING "300 YEARS" APPEARS IN RED ON A WHITE BANNER; "NEW BERN" AND "NORTH CAROLINA" APPEARS IN WHITE. THE DATES "1710" AND "2010" APPEAR IN BLACK ON A WHITE BACKGROUND.

FOR HATS, T-SHIRTS, SHIRTS, SWEATSHIRTS AND JACKETS (U.S. CLS. 22 AND 39).

FIRST USE 9-1-2009; IN COMMERCE 9-1-2009.

3,808,508. MILLER INTERNATIONAL, INC., DENVER, CO.
SN 77-979,214. PUB. 9-2-2008, FILED 4-15-2008.

SO. THREAD

THE MARK CONSISTS OF STANDARD CHARACTERS WITHOUT CLAIM TO ANY PARTICULAR FONT, STYLE, SIZE, OR COLOR.

OWNER OF U.S. REG. NO. 3,163,905.

FOR SHIRTS; T-SHIRTS; CAPS; JEANS; SWEATSHIRTS; SHORTS; SANDALS; BANDANAS (U.S. CLS. 22 AND 39).

FIRST USE 12-22-2005; IN COMMERCE 12-22-2005.

3,808,525. FAME IP HOLDING, LLC, HOLLYWOOD, FL. SN 77-979,395. PUB. 6-23-2009, FILED 2-26-2009.

NATIVE MUSIC ROCKS

THE MARK CONSISTS OF STANDARD CHARACTERS WITHOUT CLAIM TO ANY PARTICULAR FONT, STYLE, SIZE, OR COLOR.

FOR CLOTHING, NAMELY, SHIRTS, T-SHIRTS, SWEAT SHIRTS, CAPS, HATS, WRIST BANDS (U.S. CLS. 22 AND 39).

FIRST USE 10-30-2008; IN COMMERCE 10-30-2008.

CLASS 25—(Continued).

3,808,527. HOME BOX OFFICE, INC., NEW YORK, NY. SN 77-979,409. PUB. 12-30-2008, FILED 7-25-2008.

TRUE BLOOD

THE MARK CONSISTS OF STANDARD CHARACTERS WITHOUT CLAIM TO ANY PARTICULAR FONT, STYLE, SIZE, OR COLOR.

FOR CLOTHING, NAMELY, T-SHIRTS (U.S. CLS. 22 AND 39).

FIRST USE 11-30-2008; IN COMMERCE 11-30-2008.

CLASS 25—(Continued).

3,808,599. AHEAD, INC., NEW BEDFORD, MA. SN 78-904,564. PUB. 1-30-2007, FILED 6-9-2006.

DRI-LOOK

THE MARK CONSISTS OF STANDARD CHARACTERS WITHOUT CLAIM TO ANY PARTICULAR FONT, STYLE, SIZE, OR COLOR.

FOR HEADWEAR, NAMELY, HATS, CAPS, AND VISORS (U.S. CLS. 22 AND 39).

FIRST USE 1-0-2008; IN COMMERCE 1-0-2008.

3,808,535. REGENT ENTERPRISES, LLC, ATLANTA, GA. SN 77-979,451. PUB. 5-26-2009, FILED 10-28-2008.

GIGARÉ

THE MARK CONSISTS OF STANDARD CHARACTERS WITHOUT CLAIM TO ANY PARTICULAR FONT, STYLE, SIZE, OR COLOR.

THE WORDING "GIGARÉ" HAS NO MEANING IN A FOREIGN LANGUAGE.

FOR CLOTHING, NAMELY, NECKTIES (U.S. CLS. 22 AND 39).

FIRST USE 3-9-2009; IN COMMERCE 3-9-2009.

3,808,600. TALAMO, TANIA ALESSANDRA, WHITESTONE, NY. SN 78-910,436. PUB. 2-6-2007, FILED 6-16-2006.

ODYSSIA

THE MARK CONSISTS OF STANDARD CHARACTERS WITHOUT CLAIM TO ANY PARTICULAR FONT, STYLE, SIZE, OR COLOR.

FOR CLOTHING, NAMELY, BRASSIERES, UNDERGARMENTS, UNDERWEAR, HOSIERY, LEGGINGS, LINGERIE, BUSTIERS, CAMISOLES, BODY SHAPERS, BATHROBES, SWIM WEAR, HALTER TOPS, TANK TOPS, T-SHIRTS, PANTS AND HATS (U.S. CLS. 22 AND 39).

FIRST USE 6-22-2006; IN COMMERCE 1-25-2010.

3,808,556. TABUE TECHNOLOGY, LP, HUNTINGTON BEACH, CA. SN 77-979,607. PUB. 9-15-2009, FILED 4-22-2008.

SHIBUE

THE MARK CONSISTS OF STANDARD CHARACTERS WITHOUT CLAIM TO ANY PARTICULAR FONT, STYLE, SIZE, OR COLOR.

FOR CLOTHING, NAMELY, LINGERIE, UNDERWEAR (U.S. CLS. 22 AND 39).

FIRST USE 2-0-2008; IN COMMERCE 2-0-2008.

3,808,611. DENOMME, ADAM JAMES, CARDIFF BY THE SEA, CA. AND HAER, TIMOTHY MURPHY, ATLANTIC BEACH, FL. AND FRAMNESS, DYLAN ROBERT, NEPTUNE BEACH, FL. AND TIMM, TRAVIS RICHARD, NEPTUNE BEACH, FL. SN 78-923,142. PUB. 8-21-2007, FILED 7-5-2006.

pepper death

FOR SHIRTS (U.S. CLS. 22 AND 39).

FIRST USE 4-20-2010; IN COMMERCE 4-20-2010.

CLASS 25—(Continued).

3,808,622. JAMES HOTEL MANAGEMENT COMPANY, LLC, NEW YORK, NY. SN 78-981,370. PUB. 6-28-2005, FILED 4-8-2003.

THE JAMES

FOR ROBES (U.S. CLS. 22 AND 39).
FIRST USE 3-31-2006; IN COMMERCE 3-31-2006.

CLASS 26—FANCY GOODS

3,807,629. BEAUTY PLUS TRADING CO., INC., MOON-ACHIE, NY. SN 77-473,289. PUB. 10-20-2009, FILED 5-13-2008.

Noir

THE MARK CONSISTS OF STANDARD CHARACTERS WITHOUT CLAIM TO ANY PARTICULAR FONT, STYLE, SIZE, OR COLOR.
FOR HAIR PIECES AND WIGS (U.S. CLS. 37, 39, 40, 42 AND 50).
FIRST USE 11-10-2008; IN COMMERCE 11-10-2008.

3,807,942. CUGGLY, LLC, BERLIN, MD. SN 77-666,581. PUB. 7-7-2009, FILED 2-9-2009.

CUGGLY

THE MARK CONSISTS OF STANDARD CHARACTERS WITHOUT CLAIM TO ANY PARTICULAR FONT, STYLE, SIZE, OR COLOR.
FOR ORNAMENTAL FABRIC APPLIQUES MADE IN PART OF LEATHER OR SUEDE, WITH OR WITHOUT BEADS (U.S. CLS. 37, 39, 40, 42 AND 50).
FIRST USE 5-0-2009; IN COMMERCE 5-0-2009.

CLASS 26—(Continued).

3,807,970. SULLIVAN, DIANE L., DBA LUXECLIPS, NEW-PORT BEACH, CA. AND VAUGHAN, JENNIFER S., DBA LUXECLIPS, COSTA MESA, CA. SN 77-675,052. PUB. 6-23-2009, FILED 2-20-2009.

luxeclips

THE MARK CONSISTS OF STANDARD CHARACTERS WITHOUT CLAIM TO ANY PARTICULAR FONT, STYLE, SIZE, OR COLOR.
FOR SMALL DECORATIVE OBJECTS MADE OF RUBBER, PLASTIC, PASTE, GLASS, NON-PRECIOUS STONES OR NON-PRECIOUS METAL, NAMELY, SHOE ORNAMENTS, SHOE FASTENERS, AND METAL CLIPS FOR SHOES (U.S. CLS. 37, 39, 40, 42 AND 50).
FIRST USE 6-0-2009; IN COMMERCE 6-0-2009.

3,807,975. GLORY CREATION PTE LTD, SINGAPORE CITY, SINGAPORE. SN 77-676,839. PUB. 7-14-2009, FILED 2-24-2009.

PARAMAHAIR

THE MARK CONSISTS OF STANDARD CHARACTERS WITHOUT CLAIM TO ANY PARTICULAR FONT, STYLE, SIZE, OR COLOR.
FOR WIGS, TOUPEES, HAIRPIECES AND ADD-IN AND ADD-ON HAIR ACCESSORIES CONSTRUCTED PRIMARILY OF SYNTHETIC, ANIMAL AND HUMAN HAIR (U.S. CLS. 37, 39, 40, 42 AND 50).
FIRST USE 3-11-2009; IN COMMERCE 3-28-2009.

3,808,114. PARK, BRANDIE R., ATLANTA, GA. SN 77-702,782. PUB. 8-4-2009, FILED 3-31-2009.



DIVADO

THE MARK CONSISTS OF A TIARA DESIGN CENTERED ABOVE THE WORD "DIVADO".
FOR HAIR ACCESSORIES, NAMELY, CLAW CLIPS, SNAP CLIPS, AND JAW CLIPS (U.S. CLS. 37, 39, 40, 42 AND 50).
FIRST USE 3-21-2009; IN COMMERCE 3-21-2009.

CLASS 27—FLOOR COVERINGS

3,807,674. POLYFLOR LIMITED, RADCLIFFE, MANCHESTER, UNITED KINGDOM. SN 77-529,044. PUB. 12-16-2008, FILED 7-23-2008.

NOBLEFLOOR

THE MARK CONSISTS OF STANDARD CHARACTERS WITHOUT CLAIM TO ANY PARTICULAR FONT, STYLE, SIZE, OR COLOR.

FOR FLOOR COVERINGS FOR EXISTING FLOORS (U.S. CLS. 19, 20, 37, 42 AND 50).

FIRST USE 10-20-2008; IN COMMERCE 10-20-2008.

3,808,338. D.C. HUMPHRYS CO., INC., DBA HUMPHRYS TEXTILE PRODUCTS, INC., PHILADELPHIA, PA. SN 77-758,710. PUB. 12-8-2009, FILED 6-12-2009.

ENVIROSAFE

THE MARK CONSISTS OF STANDARD CHARACTERS WITHOUT CLAIM TO ANY PARTICULAR FONT, STYLE, SIZE, OR COLOR.

FOR MATS FOR FLOORS OR WALLS, NAMELY, FOR WRAPPING AROUND OR MOUNTING ON BEAMS, COLUMNS, FENCES, BACKSTOPS, WALLS, AND STAGES IN GYMNASIUMS AND OTHER ATHLETIC ARENAS (U.S. CLS. 19, 20, 37, 42 AND 50).

FIRST USE 6-1-2009; IN COMMERCE 9-1-2009.

CLASS 28—TOYS AND SPORTING GOODS

3,807,371. JOSEPH ENTERPRISES, INC., SAN FRANCISCO, CA. SN 76-416,852. PUB. 1-30-2007, FILED 6-4-2002.

CHIA

OWNER OF U.S. REG. NOS. 2,090,156, 2,773,363, AND OTHERS.

FOR PLUSH TOYS; TOYS, NAMELY, PLASTIC CHARACTER TOYS; GAMES, NAMELY, CARD GAMES (U.S. CLS. 22, 23, 38 AND 50).

FIRST USE 4-14-2010; IN COMMERCE 4-20-2010.

CLASS 28—(Continued).

3,807,378. JAY FRANCO & SONS, INC., NEW YORK, NY. SN 76-675,604. PUB. 7-7-2009, FILED 4-17-2007.

SNUGGIE POCKETS

THE MARK CONSISTS OF STANDARD CHARACTERS WITHOUT CLAIM TO ANY PARTICULAR FONT, STYLE, SIZE, OR COLOR.

FOR STUFFED TOY ANIMALS AND PLUSH TOY ANIMALS (U.S. CLS. 22, 23, 38 AND 50).

FIRST USE 9-0-2007; IN COMMERCE 9-0-2007.

3,807,390. JEFFRIES & ASSOCIATES, NASHVILLE, TN. SN 76-694,098. PUB. 7-7-2009, FILED 11-7-2008.

CLIFFHOUSE

THE MARK CONSISTS OF STANDARD CHARACTERS WITHOUT CLAIM TO ANY PARTICULAR FONT, STYLE, SIZE, OR COLOR.

FOR BOARD GAMES (U.S. CLS. 22, 23, 38 AND 50).

FIRST USE 5-15-2009; IN COMMERCE 5-15-2009.

3,807,420. DELCA CORPORATION, LAGUNA NIGEL, CA. SN 77-055,453. PUB. 7-31-2007, FILED 12-1-2006.

THINK DOG

THE MARK CONSISTS OF STANDARD CHARACTERS WITHOUT CLAIM TO ANY PARTICULAR FONT, STYLE, SIZE, OR COLOR.

NO CLAIM IS MADE TO THE EXCLUSIVE RIGHT TO USE "DOG", APART FROM THE MARK AS SHOWN.

FOR PET TOYS (U.S. CLS. 22, 23, 38 AND 50).

FIRST USE 5-17-2006; IN COMMERCE 5-17-2006.

CLASS 28—(Continued).

3,807,424. IBET SYSTEMS, LTD., NEW YORK, NY. SN 77-065,188. PUB. 7-17-2007, FILED 12-15-2006.

IBET YOU CAN

THE MARK CONSISTS OF STANDARD CHARACTERS WITHOUT CLAIM TO ANY PARTICULAR FONT, STYLE, SIZE, OR COLOR.

FOR TOYS FOR USE IN CHILDHOOD DEVELOPMENT AND EDUCATION, NAMELY, TOY BUILDING BLOCKS (U.S. CLS. 22, 23, 38 AND 50).

FIRST USE 9-12-2008; IN COMMERCE 9-12-2008.

CLASS 28—(Continued).

3,807,560. PATRICIA A. ALLEN ENTERPRISES, LLC, BLOOMFIELD TWP, MI. SN 77-408,250. PUB. 7-22-2008, FILED 2-28-2008.

IT'S A GREEN LIFE

THE MARK CONSISTS OF STANDARD CHARACTERS WITHOUT CLAIM TO ANY PARTICULAR FONT, STYLE, SIZE, OR COLOR.

FOR BOARD GAMES (U.S. CLS. 22, 23, 38 AND 50).
FIRST USE 5-28-2008; IN COMMERCE 1-11-2010.

3,807,478. SOLOFLEX, INC., HILLSBORO, OR. SN 77-244,820. PUB. 1-19-2010, FILED 8-1-2007.

EXERCISE AND EAT RIGHT

THE MARK CONSISTS OF STANDARD CHARACTERS WITHOUT CLAIM TO ANY PARTICULAR FONT, STYLE, SIZE, OR COLOR.

NO CLAIM IS MADE TO THE EXCLUSIVE RIGHT TO USE "EXERCISE", APART FROM THE MARK AS SHOWN. FOR MANUALLY-OPERATED EXERCISE EQUIPMENT (U.S. CLS. 22, 23, 38 AND 50).

FIRST USE 6-2-2007; IN COMMERCE 6-2-2007.

3,807,636. TOYNAMI, INC., VAN NUYS, CA. SN 77-478,519. PUB. 11-10-2009, FILED 5-19-2008.

SHOGUN WARRIORS

THE MARK CONSISTS OF STANDARD CHARACTERS WITHOUT CLAIM TO ANY PARTICULAR FONT, STYLE, SIZE, OR COLOR.

FOR ACTION FIGURES, TOY VEHICLES, AND PLAYSETS FOR ACTION FIGURES AND TOY VEHICLES (U.S. CLS. 22, 23, 38 AND 50).

FIRST USE 2-16-2010; IN COMMERCE 2-16-2010.

3,807,554. MATTEL, INC., EL SEGUNDO, CA. SN 77-404,243. PUB. 1-20-2009, FILED 2-22-2008.

EEVIL WEEVIL

THE MARK CONSISTS OF STANDARD CHARACTERS WITHOUT CLAIM TO ANY PARTICULAR FONT, STYLE, SIZE, OR COLOR.

FOR TOYS, GAMES AND PLAYTHINGS, NAMELY, TOY VEHICLES AND ACCESSORIES THEREFOR (U.S. CLS. 22, 23, 38 AND 50).

FIRST USE 2-1-2010; IN COMMERCE 2-1-2010.

3,807,681. CARDARELLI, VENANZIO, PLYMOUTH, MA. SN 77-533,536. PUB. 12-16-2008, FILED 7-29-2008.

AEROTEE

THE MARK CONSISTS OF STANDARD CHARACTERS WITHOUT CLAIM TO ANY PARTICULAR FONT, STYLE, SIZE, OR COLOR.

OWNER OF U.S. REG. NO. 2,823,961.

FOR GOLF TEES (U.S. CLS. 22, 23, 38 AND 50).

FIRST USE 1-24-2009; IN COMMERCE 1-24-2009.

CLASS 28—(Continued).

3,807,719. MELVIN D. PLUMMER, LOS ANGELES, CA. SN 77-554,428. PUB. 1-20-2009, FILED 8-24-2008.

On Guard

THE MARK CONSISTS OF STANDARD CHARACTERS WITHOUT CLAIM TO ANY PARTICULAR FONT, STYLE, SIZE, OR COLOR.

FOR AN EXTENDABLE WEIGHTED DEVICE TO BE HAND HELD WHEN ENGAGING IN EXERCISES, PRIMARILY, AEROBICS, WALKING, AND JOGGING (U.S. CLS. 22, 23, 38 AND 50).

FIRST USE 3-1-2009; IN COMMERCE 3-1-2009.

3,807,739. MCPHERSON, MATHEW A., NORWALK, WI. SN 77-560,648. PUB. 1-13-2009, FILED 9-2-2008.

2CPW

THE MARK CONSISTS OF STANDARD CHARACTERS WITHOUT CLAIM TO ANY PARTICULAR FONT, STYLE, SIZE, OR COLOR.

FOR ARCHERY EQUIPMENT, NAMELY, CAMS (U.S. CLS. 22, 23, 38 AND 50).

FIRST USE 10-1-2008; IN COMMERCE 10-1-2008.

3,807,762. BAUM, INC., HARVEY CEDARS, NJ. SN 77-566,959. PUB. 1-27-2009, FILED 9-10-2008.

KBITZ

THE MARK CONSISTS OF STANDARD CHARACTERS WITHOUT CLAIM TO ANY PARTICULAR FONT, STYLE, SIZE, OR COLOR.

FOR STACKING BLOCK GAME (U.S. CLS. 22, 23, 38 AND 50).

FIRST USE 4-8-2010; IN COMMERCE 4-8-2010.

CLASS 28—(Continued).

3,807,782. ANIMAL ADVENTURE, INC., MINNEAPOLIS, MN. SN 77-571,838. PUB. 7-14-2009, FILED 9-17-2008.

SPLISH SPLASHERS

THE MARK CONSISTS OF STANDARD CHARACTERS WITHOUT CLAIM TO ANY PARTICULAR FONT, STYLE, SIZE, OR COLOR.

FOR WATER TOYS (U.S. CLS. 22, 23, 38 AND 50).

FIRST USE 10-31-2009; IN COMMERCE 10-31-2009.

3,807,818. MCCABE PRODUCTIONS, INC., LUTZ, FL. SN 77-585,192. PUB. 6-30-2009, FILED 10-3-2008.

MOGAN

THE MARK CONSISTS OF STANDARD CHARACTERS WITHOUT CLAIM TO ANY PARTICULAR FONT, STYLE, SIZE, OR COLOR.

FOR FISHING EQUIPMENT, NAMELY, FISHING TACKLE, LURES, FISHING RODS, FISHING REELS (U.S. CLS. 22, 23, 38 AND 50).

FIRST USE 1-15-2000; IN COMMERCE 4-15-2001.

3,807,826. LUCKY GROUP (H. K.) LIMITED, TSIMSHATSUI E. KOWLOON, HONG KONG. SN 77-589,680. PUB. 3-3-2009, FILED 10-9-2008.

little sprouts

THE MARK CONSISTS OF THE STYLIZED WORDS "LITTLE SPROUTS".

FOR BABY MULTIPLE ACTIVITY TOYS; BABY RATTLES; BABY RATTLES INCORPORATING TEETHING RINGS; BABY SWINGS; BATH TOYS; BATHTUB TOYS; CHILDREN'S MULTIPLE ACTIVITY TOYS; CRIB TOYS; EDUCATIONAL TOYS FOR TEACHING MATH PRINCIPLES TO CHILDREN, NAMELY, MANIPULATIVE BLOCKS FOR DISPLAYING PATTERNS AND GROUPINGS; ELECTRONIC LEARNING TOYS; INFANT ACTION CRIB TOYS; INFANT DEVELOPMENT TOYS; INFANT TOYS; INFANT'S RATTLES; MUSICAL TOYS; TOY ANIMALS; TOY ANIMALS AND ACCESSORIES THEREFOR; TOY BANKS; TOY BUILDING BLOCKS; TOY BUILDING BLOCKS CAPABLE OF INTERCONNECTION; WATER SQUIRTING TOYS (U.S. CLS. 22, 23, 38 AND 50).

FIRST USE 4-15-2010; IN COMMERCE 4-15-2010.

CLASS 28—(Continued).

3,807,850. MATTEL, INC., EL SEGUNDO, CA. SN 77-605,340.
PUB. 9-15-2009, FILED 10-31-2008.

FAVORITE CLASS

THE MARK CONSISTS OF STANDARD CHARACTERS WITHOUT CLAIM TO ANY PARTICULAR FONT, STYLE, SIZE, OR COLOR.

FOR TOYS, GAMES AND PLAYTHINGS, NAMELY, DOLLS, DOLL CLOTHING AND DOLL ACCESSORIES (U.S. CLS. 22, 23, 38 AND 50).

FIRST USE 8-27-2009; IN COMMERCE 8-27-2009.

CLASS 28—(Continued).

3,807,857. MATTEL, INC., EL SEGUNDO, CA. SN 77-608,270.
PUB. 9-15-2009, FILED 11-5-2008.

DALE MATIAN

THE MARK CONSISTS OF STANDARD CHARACTERS WITHOUT CLAIM TO ANY PARTICULAR FONT, STYLE, SIZE, OR COLOR.

THE NAME "DALE MATIAN" DOES NOT IDENTIFY A LIVING INDIVIDUAL.

FOR TOY FIGURES AND ACCESSORIES THEREFOR (U.S. CLS. 22, 23, 38 AND 50).

FIRST USE 4-23-2010; IN COMMERCE 4-23-2010.

3,807,855. MATTEL, INC., EL SEGUNDO, CA. SN 77-608,264.
PUB. 9-15-2009, FILED 11-5-2008.

MAYOR LINUS KING

THE MARK CONSISTS OF STANDARD CHARACTERS WITHOUT CLAIM TO ANY PARTICULAR FONT, STYLE, SIZE, OR COLOR.

THE NAME "LINUS KING" DOES NOT IDENTIFY A LIVING INDIVIDUAL.

FOR TOY FIGURES AND ACCESSORIES THEREFOR (U.S. CLS. 22, 23, 38 AND 50).

FIRST USE 4-23-2010; IN COMMERCE 4-23-2010.

3,807,856. MATTEL, INC., EL SEGUNDO, CA. SN 77-608,268.
PUB. 9-15-2009, FILED 11-5-2008.

EILEEN DOWN

THE MARK CONSISTS OF STANDARD CHARACTERS WITHOUT CLAIM TO ANY PARTICULAR FONT, STYLE, SIZE, OR COLOR.

THE NAME "EILEEN DOWN" DOES NOT IDENTIFY A LIVING INDIVIDUAL.

FOR TOY FIGURES AND ACCESSORIES THEREFOR (U.S. CLS. 22, 23, 38 AND 50).

FIRST USE 4-23-2010; IN COMMERCE 4-23-2010.

3,807,866. MATTEL, INC., EL SEGUNDO, CA. SN 77-612,092.
PUB. 9-8-2009, FILED 11-11-2008.

AGURA IBADEN

THE MARK CONSISTS OF STANDARD CHARACTERS WITHOUT CLAIM TO ANY PARTICULAR FONT, STYLE, SIZE, OR COLOR.

THE NAME(S), PORTRAIT(S), AND/OR SIGNATURE(S) SHOWN IN THE MARK DOES NOT IDENTIFY A PARTICULAR LIVING INDIVIDUAL.

FOR TOYS, GAMES AND PLAYTHINGS, NAMELY, TOY FIGURES AND ACCESSORIES THEREFOR; TOY ACTION FIGURES AND ACCESSORIES THEREFOR (U.S. CLS. 22, 23, 38 AND 50).

FIRST USE 4-23-2010; IN COMMERCE 4-23-2010.

3,807,867. MATTEL, INC., EL SEGUNDO, CA. SN 77-612,112.
PUB. 9-29-2009, FILED 11-11-2008.

ZELIX

THE MARK CONSISTS OF STANDARD CHARACTERS WITHOUT CLAIM TO ANY PARTICULAR FONT, STYLE, SIZE, OR COLOR.

FOR TOYS, GAMES AND PLAYTHINGS, NAMELY, TOY VEHICLES AND ACCESSORIES THEREFOR (U.S. CLS. 22, 23, 38 AND 50).

FIRST USE 9-10-2009; IN COMMERCE 9-10-2009.

CLASS 28—(Continued).

3,807,868. MATTEL, INC., EL SEGUNDO, CA. SN 77-612,152. PUB. 9-8-2009, FILED 11-11-2008.

ZEMERIK

THE MARK CONSISTS OF STANDARD CHARACTERS WITHOUT CLAIM TO ANY PARTICULAR FONT, STYLE, SIZE, OR COLOR.

FOR TOYS, GAMES AND PLAYTHINGS, NAMELY, TOY FIGURES AND ACCESSORIES THEREFOR; TOY ACTION FIGURES AND ACCESSORIES THEREFOR (U.S. CLS. 22, 23, 38 AND 50).

FIRST USE 4-23-2010; IN COMMERCE 4-23-2010.

3,807,871. KINGMAN INTERNATIONAL CORPORATION, BALDWIN PARK, CA. SN 77-614,187. PUB. 3-31-2009, FILED 11-13-2008.

ADVANCER

THE MARK CONSISTS OF STANDARD CHARACTERS WITHOUT CLAIM TO ANY PARTICULAR FONT, STYLE, SIZE, OR COLOR.

FOR PAINTBALL MARKERS AND ACCESSORIES THEREFORE IN THE NATURE OF BARRELS, GRIP FRAMES, FRAME COVERS, GRIPS, EXPANSION CHAMBERS, SIGHT RAILS, TRIGGER ASSEMBLIES AND BARREL PLUGS (U.S. CLS. 22, 23, 38 AND 50).

FIRST USE 1-19-2010; IN COMMERCE 1-19-2010.

3,807,889. SCHOENBAUM, MARK, FORT COLLINS, CO. SN 77-627,623. PUB. 12-1-2009, FILED 12-5-2008.

PLUMBOBBER

THE MARK CONSISTS OF STANDARD CHARACTERS WITHOUT CLAIM TO ANY PARTICULAR FONT, STYLE, SIZE, OR COLOR.

FOR FLY FISHING TACKLE (U.S. CLS. 22, 23, 38 AND 50).

FIRST USE 10-12-2008; IN COMMERCE 4-14-2009.

CLASS 28—(Continued).

3,807,902. PARLEY ENTERTAINMENT, INC., RALEIGH, NC. SN 77-641,852. PUB. 4-21-2009, FILED 12-31-2008.

PARLEY

THE MARK CONSISTS OF STANDARD CHARACTERS WITHOUT CLAIM TO ANY PARTICULAR FONT, STYLE, SIZE, OR COLOR.

FOR CARD GAMES (U.S. CLS. 22, 23, 38 AND 50).

FIRST USE 11-20-2009; IN COMMERCE 11-20-2009.

3,807,910. MATTEL, INC., EL SEGUNDO, CA. SN 77-645,946. PUB. 9-22-2009, FILED 1-8-2009.

SHADOW JET

THE MARK CONSISTS OF STANDARD CHARACTERS WITHOUT CLAIM TO ANY PARTICULAR FONT, STYLE, SIZE, OR COLOR.

NO CLAIM IS MADE TO THE EXCLUSIVE RIGHT TO USE "JET", APART FROM THE MARK AS SHOWN.

FOR TOYS, GAMES AND PLAYTHINGS, NAMELY, TOY VEHICLES AND ACCESSORIES THEREFOR; TOY AIRPLANES AND ACCESSORIES THEREFOR (U.S. CLS. 22, 23, 38 AND 50).

FIRST USE 3-4-2010; IN COMMERCE 3-4-2010.

3,807,913. JAKKS PACIFIC, INC., MALIBU, CA. SN 77-646,910. PUB. 8-4-2009, FILED 1-9-2009.



THE MARK CONSISTS OF THE WORD "MARBS" SUPERIMPOSED ACROSS A SPHEROID LYING ON A STYLIZED HOLDER.

FOR TOYS GAMES AND PLAYTHINGS, NAMELY, MARBLES (U.S. CLS. 22, 23, 38 AND 50).

FIRST USE 3-15-2009; IN COMMERCE 3-15-2009.

CLASS 28—(Continued).

3,807,951. DOLLAMUR, LP, NASHVILLE, TN. SN 77-669,967.
PUB. 6-16-2009, FILED 2-13-2009.

FLEXI BEAM

THE MARK CONSISTS OF STANDARD CHARACTERS WITHOUT CLAIM TO ANY PARTICULAR FONT, STYLE, SIZE, OR COLOR.

OWNER OF U.S. REG. NO. 3,069,679.

NO CLAIM IS MADE TO THE EXCLUSIVE RIGHT TO USE "BEAM", APART FROM THE MARK AS SHOWN.

FOR SPORTING EQUIPMENT, NAMELY, A SPORTS TRAINING DEVICE TO IMPROVE AND DEVELOP BALANCE (U.S. CLS. 22, 23, 38 AND 50).

FIRST USE 2-12-2010; IN COMMERCE 2-12-2010.

CLASS 28—(Continued).

3,808,212. MATTEL, INC., EL SEGUNDO, CA. SN 77-717,348.
PUB. 8-25-2009, FILED 4-20-2009.

SEASHELL SURPRISE

THE MARK CONSISTS OF STANDARD CHARACTERS WITHOUT CLAIM TO ANY PARTICULAR FONT, STYLE, SIZE, OR COLOR.

FOR TOYS, GAMES AND PLAYTHINGS, NAMELY, DOLLS, DOLL CLOTHING AND DOLL ACCESSORIES, TOY FIGURES, TOY JEWELRY, AND ACCESSORIES FOR ALL OF THE FOREGOING (U.S. CLS. 22, 23, 38 AND 50).

FIRST USE 9-29-2009; IN COMMERCE 9-29-2009.

3,808,203. SHAKESPEARE COMPANY, LLC, COLUMBIA, SC. SN 77-715,510. PUB. 1-5-2010, FILED 4-16-2009.

LADY FISH

NO CLAIM IS MADE TO THE EXCLUSIVE RIGHT TO USE "LADY FISH", APART FROM THE MARK AS SHOWN.

THE MARK CONSISTS OF THE WORDING "LADY FISH" WITH THE DESIGN OF A RIBBON APPEARING BETWEEN "LADY" AND "FISH".

FOR FISHING RODS, FISHING REELS, FISHING TACKLE (U.S. CLS. 22, 23, 38 AND 50).

FIRST USE 11-0-2009; IN COMMERCE 11-0-2009.

3,808,226. MATTEL, INC., EL SEGUNDO, CA. SN 77-721,960.
PUB. 8-25-2009, FILED 4-24-2009.

LADIES OF THE 80S

THE MARK CONSISTS OF STANDARD CHARACTERS WITHOUT CLAIM TO ANY PARTICULAR FONT, STYLE, SIZE, OR COLOR.

FOR TOYS, GAMES AND PLAYTHINGS, NAMELY, DOLLS, DOLL CLOTHING AND DOLL ACCESSORIES (U.S. CLS. 22, 23, 38 AND 50).

FIRST USE 11-17-2009; IN COMMERCE 11-17-2009.

3,808,207. MATTEL, INC., EL SEGUNDO, CA. SN 77-716,055.
PUB. 8-11-2009, FILED 4-17-2009.

MS-T SUZUKA

THE MARK CONSISTS OF STANDARD CHARACTERS WITHOUT CLAIM TO ANY PARTICULAR FONT, STYLE, SIZE, OR COLOR.

FOR TOYS, GAMES AND PLAYTHINGS, NAMELY, TOY VEHICLES AND ACCESSORIES THEREFOR (U.S. CLS. 22, 23, 38 AND 50).

FIRST USE 1-20-2010; IN COMMERCE 1-20-2010.

3,808,234. LAX, CHRISTOPHER M, SOUTHLAKE, TX. SN 77-725,644. PUB. 9-8-2009, FILED 4-30-2009.

Sconudi

THE MARK CONSISTS OF STANDARD CHARACTERS WITHOUT CLAIM TO ANY PARTICULAR FONT, STYLE, SIZE, OR COLOR.

THE WORDING "SCONUDI" HAS NO MEANING IN A FOREIGN LANGUAGE.

FOR CARD GAMES (U.S. CLS. 22, 23, 38 AND 50).
FIRST USE 12-15-2009; IN COMMERCE 3-15-2010.

CLASS 28—(Continued).

3,808,241. MATTEL, INC., EL SEGUNDO, CA. SN 77-726,872.
PUB. 9-8-2009, FILED 5-1-2009.

KID DOCTOR

THE MARK CONSISTS OF STANDARD CHARACTERS WITHOUT CLAIM TO ANY PARTICULAR FONT, STYLE, SIZE, OR COLOR.

FOR TOYS, GAMES AND PLAYTHINGS, NAMELY, DOLLS, DOLL CLOTHING AND DOLL ACCESSORIES (U.S. CLS. 22, 23, 38 AND 50).
FIRST USE 4-23-2010; IN COMMERCE 4-23-2010.

CLASS 28—(Continued).

3,808,292. MATTEL, INC., EL SEGUNDO, CA. SN 77-740,049.
PUB. 9-22-2009, FILED 5-19-2009.

SHYN'E

THE MARK CONSISTS OF STANDARD CHARACTERS WITHOUT CLAIM TO ANY PARTICULAR FONT, STYLE, SIZE, OR COLOR.

FOR TOYS, GAMES AND PLAYTHINGS, NAMELY, DOLLS, DOLL CLOTHING AND DOLL ACCESSORIES (U.S. CLS. 22, 23, 38 AND 50).
FIRST USE 3-30-2010; IN COMMERCE 3-30-2010.

3,808,262. MATTEL, INC., EL SEGUNDO, CA. SN 77-731,243.
PUB. 9-22-2009, FILED 5-7-2009.

BATTLEKEY BLAST

THE MARK CONSISTS OF STANDARD CHARACTERS WITHOUT CLAIM TO ANY PARTICULAR FONT, STYLE, SIZE, OR COLOR.

FOR TOYS, GAMES AND PLAYTHINGS, NAMELY, TOY VEHICLES TRACK SET AND ACCESSORIES THEREFOR (U.S. CLS. 22, 23, 38 AND 50).
FIRST USE 9-10-2009; IN COMMERCE 9-10-2009.

3,808,263. MATTEL, INC., EL SEGUNDO, CA. SN 77-731,248.
PUB. 9-22-2009, FILED 5-7-2009.

GENERATIONS OF DREAMS

THE MARK CONSISTS OF STANDARD CHARACTERS WITHOUT CLAIM TO ANY PARTICULAR FONT, STYLE, SIZE, OR COLOR.

FOR TOYS, GAMES AND PLAYTHINGS, NAMELY, DOLLS, DOLL CLOTHING AND DOLL ACCESSORIES (U.S. CLS. 22, 23, 38 AND 50).
FIRST USE 4-23-2010; IN COMMERCE 4-23-2010.

3,808,321. MAHAR MANUFACTURING CORP., DBA FIEST CONCESSION CORP., VERNON, CA. SN 77-752,340. PUB. 10-13-2009, FILED 6-4-2009.

BUTTONZ

THE MARK CONSISTS OF STANDARD CHARACTERS WITHOUT CLAIM TO ANY PARTICULAR FONT, STYLE, SIZE, OR COLOR.

FOR STUFFED PLUSH TOYS (U.S. CLS. 22, 23, 38 AND 50).
FIRST USE 12-8-2009; IN COMMERCE 12-8-2009.

3,808,405. CEPJA, LLC, ST. LOUIS, MO. SN 77-785,861. PUB. 11-24-2009, FILED 7-21-2009.

ZHUZHU PETS

THE MARK CONSISTS OF STANDARD CHARACTERS WITHOUT CLAIM TO ANY PARTICULAR FONT, STYLE, SIZE, OR COLOR.

CLASS 28—(Continued).

NO CLAIM IS MADE TO THE EXCLUSIVE RIGHT TO USE "PETS", APART FROM THE MARK AS SHOWN.

FOR BATTERY OPERATED ACTION TOYS; ELECTRONIC ACTION TOYS; FANTASY CHARACTER TOYS; MODELED PLASTIC TOY FIGURINES; MOLDED TOY FIGURES; NON-ELECTRONIC TOY VEHICLES; PLASTIC CHARACTER TOYS; PLUSH TOYS; STUFFED AND PLUSH TOYS; STUFFED TOY ANIMALS; STUFFED TOYS; TALKING ELECTRONIC PRESS-DOWN TOY; TALKING TOYS; TOY ACTION FIGURES; TOY ACTION FIGURES AND ACCESSORIES THEREFOR; TOY BUILDING STRUCTURES AND TOY VEHICLE TRACKS; TOY BUILDINGS AND ACCESSORIES THEREFOR; TOY VEHICLE TRACK SETS AND ROADWAYS AND ACCESSORIES THEREFOR; TOY VEHICLES (U.S. CLS. 22, 23, 38 AND 50).

FIRST USE 8-0-2009; IN COMMERCE 8-0-2009.

3,808,406. CEPIA, LLC, ST. LOUIS, MO. SN 77-785,896. PUB. 11-24-2009, FILED 7-21-2009.



NO CLAIM IS MADE TO THE EXCLUSIVE RIGHT TO USE "PETS", APART FROM THE MARK AS SHOWN.

THE BLACK, GRAY AND WHITE IN THE MARK REPRESENT BACKGROUND AND SHADING, AND ARE NOT PART OF THE MARK.

THE MARK CONSISTS OF THE IMAGE OF A MOUSE WITH THE STYLIZED WORDING "ZHUZHU PETS" APPEARING UNDER THE MOUSE.

FOR BATTERY OPERATED ACTION TOYS; ELECTRONIC ACTION TOYS; FANTASY CHARACTER TOYS; MODELED PLASTIC TOY FIGURINES; MOLDED TOY FIGURES; NON-ELECTRONIC TOY VEHICLES; PLASTIC CHARACTER TOYS; PLUSH TOYS; STUFFED AND PLUSH TOYS; STUFFED TOY ANIMALS; STUFFED TOYS; TALKING ELECTRONIC PRESS-DOWN TOY; TALKING TOYS; TOY ACTION FIGURES; TOY ACTION FIGURES AND ACCESSORIES THEREFOR; TOY BUILDING STRUCTURES AND TOY VEHICLE TRACKS; TOY BUILDINGS AND ACCESSORIES THEREFOR; TOY VEHICLE TRACK SETS AND ROADWAYS AND ACCESSORIES THEREFOR; TOY VEHICLES (U.S. CLS. 22, 23, 38 AND 50).

FIRST USE 8-0-2009; IN COMMERCE 8-0-2009.

CLASS 28—(Continued).

3,808,411. GANZ, WOODBRIDGE, ONT, CANADA. SN 77-787,966. PUB. 11-10-2009, FILED 7-23-2009.

KINZ

THE MARK CONSISTS OF STANDARD CHARACTERS WITHOUT CLAIM TO ANY PARTICULAR FONT, STYLE, SIZE, OR COLOR.

OWNER OF U.S. REG. NOS. 3,015,923, 3,207,641, AND 3,565,414.

FOR PLUSH TOYS (U.S. CLS. 22, 23, 38 AND 50).
FIRST USE 8-25-2009; IN COMMERCE 9-28-2009.

3,808,414. RHINO TOYS, INC., SANTA CRUZ, CA. SN 77-788,992. PUB. 12-15-2009, FILED 7-24-2009.

BEADO

THE MARK CONSISTS OF STANDARD CHARACTERS WITHOUT CLAIM TO ANY PARTICULAR FONT, STYLE, SIZE, OR COLOR.

FOR INFANT DEVELOPMENT TOYS; BALLS; AND SOFT SCULPTURE TOYS (U.S. CLS. 22, 23, 38 AND 50).
FIRST USE 3-15-2010; IN COMMERCE 3-15-2010.

3,808,482. MATTEL, INC., EL SEGUNDO, CA. SN 77-814,581. PUB. 1-19-2010, FILED 8-27-2009.

SWIM 'N DANCE

THE MARK CONSISTS OF STANDARD CHARACTERS WITHOUT CLAIM TO ANY PARTICULAR FONT, STYLE, SIZE, OR COLOR.

FOR TOYS, GAMES AND PLAYTHINGS, NAMELY, DOLLS, DOLL CLOTHING AND DOLL ACCESSORIES (U.S. CLS. 22, 23, 38 AND 50).

FIRST USE 3-30-2010; IN COMMERCE 3-30-2010.

CLASS 28—(Continued).

3,808,509. HALLMARK LICENSING, INC., KANSAS CITY, MO. SN 77-979,228. PUB. 7-22-2008, FILED 2-26-2008.

RAINBOW BRITE

THE MARK CONSISTS OF STANDARD CHARACTERS WITHOUT CLAIM TO ANY PARTICULAR FONT, STYLE, SIZE, OR COLOR.

FOR DOLLS; STUFFED TOYS (U.S. CLS. 22, 23, 38 AND 50).

FIRST USE 1-1-2010; IN COMMERCE 1-1-2010.

3,808,516. MGA ENTERTAINMENT, INC., VAN NUYS, CA. SN 77-979,309. PUB. 5-5-2009, FILED 1-19-2009.

STICK TOGETHER. FRIENDS FOREVER.

THE MARK CONSISTS OF STANDARD CHARACTERS WITHOUT CLAIM TO ANY PARTICULAR FONT, STYLE, SIZE, OR COLOR.

FOR TOYS, GAMES AND PLAYTHINGS, NAMELY, DOLLS, DOLL CLOTHING, DOLL ACCESSORIES (U.S. CLS. 22, 23, 38 AND 50).

FIRST USE 5-12-2009; IN COMMERCE 5-12-2009.

CLASS 29—MEATS AND PROCESSED FOODS

3,807,578. SENECA FOODS CORPORATION, MARION, NY. SN 77-426,964. PUB. 8-5-2008, FILED 3-20-2008.

WE FEED THE WORLD

THE MARK CONSISTS OF STANDARD CHARACTERS WITHOUT CLAIM TO ANY PARTICULAR FONT, STYLE, SIZE, OR COLOR.

FOR CANNED FRUITS; CANNED VEGETABLES (U.S. CL. 46).

FIRST USE 12-1-2009; IN COMMERCE 12-1-2009.

CLASS 29—(Continued).

3,807,610. CHAMPION PERFORMANCE PRODUCTS, INC., SUNRISE, FL. SN 77-449,046. PUB. 4-7-2009, FILED 4-15-2008.



OWNER OF U.S. REG. NOS. 2,647,807, 3,247,641, AND OTHERS.

NO CLAIM IS MADE TO THE EXCLUSIVE RIGHT TO USE "NUTRITION", APART FROM THE MARK AS SHOWN.

THE COLOR(S) RED AND WHITE IS/ARE CLAIMED AS A FEATURE OF THE MARK.

THE MARK CONSISTS OF THE COLORS WHITE AND RED, WITH THE COLOR WHITE APPEARING IN THE STYLIZED WORDS "CHAMPION NUTRITION," IN WHICH THE WORD "CHAMPION" APPEARS ABOVE THE WORD "NUTRITION," THE COLOR WHITE ALSO APPEARING IN TWO STRIPES THAT APPEAR DIRECTLY BELOW THE WORDS "CHAMPION NUTRITION," AND THE COLOR RED APPEARING AS OUTLINES AROUND THE LETTERS IN "CHAMPION NUTRITION" AND THE TWO STRIPES.

FOR PROTEIN BASED, NUTRIENT-DENSE SNACK BARS (U.S. CL. 46).

FIRST USE 1-0-2009; IN COMMERCE 1-0-2009.

3,807,667. ALIMENTIAS EMC S.L., EL PUERTO DE SANTA MAR, SPAIN. SN 77-517,560. PUB. 4-14-2009, FILED 7-9-2008.



THE COLOR(S) BLACK, WHITE, RED AND YELLOW IS/ARE CLAIMED AS A FEATURE OF THE MARK.

THE MARK CONSISTS OF A RED SQUARE WITH UNEVEN EDGES, CONTAINING THREE HORIZONTAL, PAINTED STRIPES IN WHITE, YELLOW AND WHITE, TO THE LEFT OF THE WORD "ESPANIA" IN BLACK.

THE WORDING "ESPANIA" HAS NO MEANING IN A FOREIGN LANGUAGE.

SEC. 2(F) AS TO "ESPANIA".

FOR CHEESE (U.S. CL. 46).

FIRST USE 1-10-2008; IN COMMERCE 12-1-2009.

CLASS 29—(Continued).

3,807,697. SENECA FOODS CORPORATION, MARION, NY.
SN 77-542,397. PUB. 4-28-2009, FILED 8-8-2008.

CLASS 29—(Continued).

3,807,825. SENECA FOODS CORPORATION, MARION, NY.
SN 77-588,298. PUB. 4-28-2009, FILED 10-8-2008.

GOLDEN STATE GOODNESS

THE MARK CONSISTS OF STANDARD CHARACTERS WITHOUT CLAIM TO ANY PARTICULAR FONT, STYLE, SIZE, OR COLOR.

NO CLAIM IS MADE TO THE EXCLUSIVE RIGHT TO USE "GOLDEN STATE", APART FROM THE MARK AS SHOWN.

FOR CANNED OR BOTTLED FRUITS (U.S. CL. 46).
FIRST USE 3-1-2009; IN COMMERCE 3-1-2009.



3,807,722. RED ROBIN INTERNATIONAL, INC., GREENWOOD VILLAGE, CO. SN 77-556,128. PUB. 8-4-2009, FILED 8-26-2008.

WHISKEY RIVER

THE MARK CONSISTS OF STANDARD CHARACTERS WITHOUT CLAIM TO ANY PARTICULAR FONT, STYLE, SIZE, OR COLOR.

OWNER OF U.S. REG. NO. 1,430,433.
FOR PREPARED MEAT; PROCESSED VEGETABLES; PREPARED MEALS CONSISTING PRIMARILY OF MEAT OR POULTRY (U.S. CL. 46).

FIRST USE 10-16-1983; IN COMMERCE 5-30-1984.

NO CLAIM IS MADE TO THE EXCLUSIVE RIGHT TO USE "GOLDEN STATE", APART FROM THE MARK AS SHOWN.

THE MARK CONSISTS OF THE WORDS "GOLDEN STATE" AND THE WORD "GOODNESS" UNDERNEATH THEM. BEHIND THE WORDS IS A SMALLER CIRCLE SHAPE WITH A FARMING SCENE IN THE MIDDLE SHOWING PLANTED CROPS ON THE BOTTOM AND SKY ABOVE THE WORDS "GOLDEN STATE".

FOR CANNED OR BOTTLED FRUITS (U.S. CL. 46).
FIRST USE 3-1-2009; IN COMMERCE 3-1-2009.

3,807,776. IMAJEN, LLC, DBA CHEZ GOURMET, WILSONVILLE, OR. SN 77-570,916. PUB. 8-18-2009, FILED 9-16-2008.

Veggi Tots

NO CLAIM IS MADE TO THE EXCLUSIVE RIGHT TO USE "VEGGIE", APART FROM THE MARK AS SHOWN.

THE MARK CONSISTS OF STYLIZED LETTERS OF THE WORDS "VEGGI TOTS".

FOR SOY BURGER PATTIES; VEGGIE BURGER PATTIES (U.S. CL. 46).

FIRST USE 3-1-2008; IN COMMERCE 3-1-2008.

3,807,964. SUNSHINE RAISIN CORPORATION, DBA NATIONAL RAISIN CO., FOWLER, CA. SN 77-673,282. PUB. 6-30-2009, FILED 2-18-2009.

MEXI MOLÉ

THE MARK CONSISTS OF STANDARD CHARACTERS WITHOUT CLAIM TO ANY PARTICULAR FONT, STYLE, SIZE, OR COLOR.

NO CLAIM IS MADE TO THE EXCLUSIVE RIGHT TO USE "MOLE", APART FROM THE MARK AS SHOWN.

FOR SNACK MIX CONSISTING OF DEHYDRATED FRUIT AND PROCESSED NUTS (U.S. CL. 46).

FIRST USE 10-1-2009; IN COMMERCE 10-1-2009.

CLASS 29—(Continued).

3,807,989. NATALIE ELIASON, LITTLE COMPTON, RI. SN 77-681,388. PUB. 7-14-2009, FILED 3-2-2009.

NORTHERN FISHERIES

THE MARK CONSISTS OF STANDARD CHARACTERS WITHOUT CLAIM TO ANY PARTICULAR FONT, STYLE, SIZE, OR COLOR.

NO CLAIM IS MADE TO THE EXCLUSIVE RIGHT TO USE "FISHERIES", APART FROM THE MARK AS SHOWN. FOR SEAFOOD, NAMELY, FROZEN FISH AND FROZEN SHELLFISH (U.S. CL. 46).

FIRST USE 3-15-2009; IN COMMERCE 3-15-2009.

3,808,103. WHITEWAVE SERVICES, INC., DALLAS, TX. SN 77-701,198. PUB. 7-21-2009, FILED 3-27-2009.

**A BLEND OF NATURAL YOGURT,
FRUIT AND VEGGIES IN EVERY
BITE**

THE MARK CONSISTS OF STANDARD CHARACTERS WITHOUT CLAIM TO ANY PARTICULAR FONT, STYLE, SIZE, OR COLOR.

FOR DAIRY PRODUCTS EXCLUDING ICE CREAM, ICE MILK AND FROZEN YOGURT (U.S. CL. 46).

FIRST USE 7-6-2009; IN COMMERCE 7-6-2009.

3,808,149. MY M FRUIT LLC, DBA MBERRY, CHANDLER, AZ. SN 77-707,139. PUB. 8-11-2009, FILED 4-6-2009.



THE MARK CONSISTS OF THE STYLIZED WORD "MBERRY" WITH A STYLIZED LEAF ABOVE THE LETTER "M" IN "MBERRY". FOR DRIED AND PROCESSED FRUITS (U.S. CL. 46). FIRST USE 7-1-2009; IN COMMERCE 12-1-2009.

CLASS 29—(Continued).

3,808,252. CHEESE LAND, INC., SEATTLE, WA. SN 77-729,147. PUB. 9-22-2009, FILED 5-5-2009.

KOKOS

THE MARK CONSISTS OF STANDARD CHARACTERS WITHOUT CLAIM TO ANY PARTICULAR FONT, STYLE, SIZE, OR COLOR.

FOR CHEESE (U.S. CL. 46).

FIRST USE 1-0-2010; IN COMMERCE 1-0-2010.

3,808,253. CHEESE LAND, INC., SEATTLE, WA. SN 77-729,164. PUB. 9-22-2009, FILED 5-5-2009.

HONEY BEE

THE MARK CONSISTS OF STANDARD CHARACTERS WITHOUT CLAIM TO ANY PARTICULAR FONT, STYLE, SIZE, OR COLOR.

FOR CHEESE (U.S. CL. 46).

FIRST USE 1-0-2010; IN COMMERCE 1-0-2010.

3,808,334. SIGMA ALIMENTOS, S.A. DE C.V., SAN PEDRO GARCA GARCIA, MEXICO. SN 77-758,044. PUB. 10-27-2009, FILED 6-12-2009.



OWNER OF U.S. REG. NO. 1,514,742.

THE COLOR(S) WHITE, BLACK AND BROWN IS/ARE CLAIMED AS A FEATURE OF THE MARK.

THE MARK CONSISTS OF THE WORD "LONGMONT" IN WHITE LETTERS WITH BROWN SHADING WITHIN BROWN BORDERING ON A RECTANGULAR BLACK BACKGROUND. A MOUNTAIN IN WHITE ON A SEMI-CIRCULAR BROWN BACKGROUND WITH A BLACK BORDER IS LOCATED ABOVE THE RECTANGULAR BLACK BACKGROUND.

FOR TURKEY FRANKS, TURKEY HAM, TURKEY BOLOGNA, TURKEY SALAMI, TURKEY PASTRAMI, TURKEY SAUSAGE AND GROUND TURKEY (U.S. CL. 46).

FIRST USE 11-0-2009; IN COMMERCE 11-0-2009.

CLASS 29—(Continued).

3,808,348. JAMBA JUICE COMPANY, EMERYVILLE, CA. SN 77-759,966. PUB. 9-8-2009, FILED 6-15-2009.

JAMBA

THE MARK CONSISTS OF STANDARD CHARACTERS WITHOUT CLAIM TO ANY PARTICULAR FONT, STYLE, SIZE, OR COLOR.
OWNER OF U.S. REG. NOS. 2,097,875, 3,375,313, AND OTHERS.

FOR PACKAGED SMOOTHIE KIT CONSISTING PRIMARILY OF FROZEN FRUIT AND FROZEN FRUIT AND YOGURT (U.S. CL. 46).

FIRST USE 3-0-2010; IN COMMERCE 3-0-2010.

CLASS 29—(Continued).

3,808,491. TYSON FOODS, INC., SPRINGDALE, AR. SN 77-827,051. PUB. 12-29-2009, FILED 9-15-2009.

PLATE EXPECTATIONS

THE MARK CONSISTS OF STANDARD CHARACTERS WITHOUT CLAIM TO ANY PARTICULAR FONT, STYLE, SIZE, OR COLOR.

FOR PREPARED ENTREES CONSISTING PRIMARILY OF MEAT OR POULTRY, ALONG WITH VEGETABLES, PASTA OR POTATOES AND SAUCE (U.S. CL. 46).

FIRST USE 10-6-2009; IN COMMERCE 10-6-2009.

3,808,468. OREGON FREEZE DRY, INC., ALBANY, OR. SN 77-807,393. PUB. 1-19-2010, FILED 8-18-2009.

MOUNTAIN HOUSE WRAPS

THE MARK CONSISTS OF STANDARD CHARACTERS WITHOUT CLAIM TO ANY PARTICULAR FONT, STYLE, SIZE, OR COLOR.

OWNER OF U.S. REG. NOS. 992,627 AND 2,839,844.

NO CLAIM IS MADE TO THE EXCLUSIVE RIGHT TO USE "WRAPS", APART FROM THE MARK AS SHOWN.

FOR FREEZE-DRIED PREPARED ENTREES CONSISTING PRIMARILY OF MEAT, POULTRY, VEGETABLES, AND EGGS (U.S. CL. 46).

FIRST USE 7-20-2009; IN COMMERCE 12-22-2009.

3,808,513. FOODMARK, INC., WELLESLEY, MA. SN 77-979,277. PUB. 10-7-2008, FILED 9-20-2007.

GLORIA'S

THE MARK CONSISTS OF STANDARD CHARACTERS WITHOUT CLAIM TO ANY PARTICULAR FONT, STYLE, SIZE, OR COLOR.

OWNER OF U.S. REG. NO. 851,541.

FOR PROCESSED OLIVES (U.S. CL. 46).

FIRST USE 11-20-2009; IN COMMERCE 11-20-2009.

3,808,487. MICHAEL FOODS OF DELAWARE, INC., MINNEAPOLIS, MN. SN 77-816,187. PUB. 12-15-2009, FILED 8-31-2009.



NO CLAIM IS MADE TO THE EXCLUSIVE RIGHT TO USE "POTATOES", APART FROM THE MARK AS SHOWN.
THE MARK CONSISTS OF THE WORDS "NORTHERN STAR" CENTERED ABOVE A NARROW RECTANGULAR BOX CONTAINING THE WORD "POTATOES", WITH A STYLIZED IMAGE OF A STAR IS TO THE LEFT OF THE LETTER "N".

FOR PROCESSED POTATO PRODUCTS, NAMELY, MASHED POTATOES, DICED POTATOES, DICED POTATOES, SHREDDED POTATOES, SLICED POTATOES, WHOLE PEELED POTATOES AND WEDGE POTATOES (U.S. CL. 46).

FIRST USE 9-1-2009; IN COMMERCE 9-1-2009.

3,808,539. FOODMARK, INC., WELLESLEY, MA. SN 77-979,467. PUB. 9-30-2008, FILED 9-20-2007.

GLORIA'S HARVEST

THE MARK CONSISTS OF STANDARD CHARACTERS WITHOUT CLAIM TO ANY PARTICULAR FONT, STYLE, SIZE, OR COLOR.

OWNER OF U.S. REG. NO. 851,541.

FOR PROCESSED OLIVES (U.S. CL. 46).

FIRST USE 11-20-2009; IN COMMERCE 11-20-2009.

CLASS 30—STAPLE FOODS

CLASS 30—(Continued).

3,807,422. AJINOMOTO CO., INC., CHUO-KU, TOKYO, JAPAN. SN 77-058,417. PUB. 2-12-2008, FILED 12-6-2006.

翁仔

THE NAME(S), PORTRAIT(S), AND/OR SIGNATURE(S) SHOWN IN THE MARK DOES NOT IDENTIFY A PARTICULAR LIVING INDIVIDUAL.

THE FOREIGN WORDING IN THE MARK TRANSLITERATE AS "YAP CHAI" AND HAS NO MEANING IN THE ENGLISH LANGUAGE.

FOR SOY SAUCE (U.S. CL. 46).
FIRST USE 12-31-2004; IN COMMERCE 3-31-2010.

3,807,459. INDUSTRIAS OVARB, S.A. DE C.V., IZTAPALAPA, MEXICO. SN 77-179,669. PUB. 11-3-2009, FILED 5-13-2007.

OVARB

THE MARK CONSISTS OF STANDARD CHARACTERS WITHOUT CLAIM TO ANY PARTICULAR FONT, STYLE, SIZE, OR COLOR.

FOR COFFEE, TEA, CACAO, SUGAR, RICE, YEAST, BAKING POWDER, SALT, MUSTARD, VINEGAR, SAUCES, SPICES, ICE, PROCESSED CORN, PROCESSED WHEAT, PROCESSED GRAINS, FLAVORED AND SWEETENED GELATINS (U.S. CL. 46).
FIRST USE 4-11-2007; IN COMMERCE 4-11-2007.

3,807,460. INDUSTRIAS OVARB, S.A. DE C.V., IZTAPALAPA, MEXICO. SN 77-179,670. PUB. 11-3-2009, FILED 5-13-2007.



THE COLOR(S) RED, BLACK, AND YELLOW IS/ARE CLAIMED AS A FEATURE OF THE MARK.

CLASS 30—(Continued).

THE COLOR YELLOW APPEARS IN THE INTERIOR OF THE OVAL; THE COLOR RED APPEARS IN THE LINING IN THE MARK AND THE INTERIOR OUTLINE OF THE OVAL; AND THE COLOR BLACK APPEARS IN THE WORDING "OVARB" AND OUTLINES THE OVAL.

FOR COFFEE, TEA, CACAO, SUGAR, RICE, YEAST, BAKING POWDER, SALT, MUSTARD, VINEGAR, SAUCES, SPICES, ICE, PROCESSED CORN, PROCESSED WHEAT, PROCESSED GRAINS, FLAVORED AND SWEETENED GELATINS (U.S. CL. 46).

FIRST USE 4-11-2007; IN COMMERCE 4-11-2007.

3,807,474. S.H.I. LIMITED, HONG KONG, CHINA. SN 77-238,409. PUB. 7-14-2009, FILED 7-25-2007.

GREAT BITE

THE MARK CONSISTS OF STANDARD CHARACTERS WITHOUT CLAIM TO ANY PARTICULAR FONT, STYLE, SIZE, OR COLOR.

PRIORITY CLAIMED UNDER SEC. 44(D) ON ERPNCMNTY TM OFC APPLICATION NO. 005967724, FILED 6-4-2007.

FOR MINTS AND CANDY (U.S. CL. 46).
FIRST USE 8-31-2007; IN COMMERCE 8-31-2007.

3,807,573. FLORIO FOOD CORP., WYANDANCH, NY. SN 77-419,932. PUB. 2-10-2009, FILED 3-12-2008.

SWEET SOFIA'S BAKERY

THE MARK CONSISTS OF STANDARD CHARACTERS WITHOUT CLAIM TO ANY PARTICULAR FONT, STYLE, SIZE, OR COLOR.

NO CLAIM IS MADE TO THE EXCLUSIVE RIGHT TO USE "BAKERY", APART FROM THE MARK AS SHOWN.

FOR BAKED GOODS, NAMELY, FROZEN BAKERY DESSERTS (U.S. CL. 46).
FIRST USE 2-0-2009; IN COMMERCE 2-0-2009.

CLASS 30—(Continued).

3,807,576. LOVER'S LANE I.P., LTD., PLYMOUTH, MI. SN 77-424,482. PUB. 2-10-2009, FILED 3-18-2008.

LOVERGIRL

THE MARK CONSISTS OF STANDARD CHARACTERS WITHOUT CLAIM TO ANY PARTICULAR FONT, STYLE, SIZE, OR COLOR.

OWNER OF U.S. REG. NOS. 2,565,651 AND 2,582,640.
FOR CANDY AND CHOCOLATE; NOVELTY FOOD ITEMS, NAMELY, EDIBLE UNDERWEAR AND CANDIES IN THE SHAPE OF BODY PARTS (U.S. CL. 46).
FIRST USE 11-0-2008; IN COMMERCE 11-0-2008.

3,807,584. MALT-O-MEAL COMPANY, MINNEAPOLIS, MN. SN 77-430,389. PUB. 7-22-2008, FILED 3-25-2008.

OATHEADS

THE MARK CONSISTS OF STANDARD CHARACTERS WITHOUT CLAIM TO ANY PARTICULAR FONT, STYLE, SIZE, OR COLOR.

FOR BREAKFAST CEREAL (U.S. CL. 46).
FIRST USE 2-27-2010; IN COMMERCE 2-27-2010.

3,807,611. GENERAL MILLS IP HOLDINGS II, LLC, MINNEAPOLIS, MN. SN 77-449,600. PUB. 3-10-2009, FILED 4-16-2008.

**CARDBOARD NO. DELICIOUS
YES.**

THE MARK CONSISTS OF STANDARD CHARACTERS WITHOUT CLAIM TO ANY PARTICULAR FONT, STYLE, SIZE, OR COLOR.

FOR PROCESSED-CEREAL BASED FOOD TO BE USED AS A BREAKFAST FOOD, SNACK FOOD OR INGREDIENT FOR MAKING OTHER FOODS; READY TO EAT CEREAL DERIVED FOOD BARS; BREAD, BUNS, ROLLS, ENGLISH MUFFINS AND BAGELS; BAKING MIXES FOR MAKING MUFFINS AND PANCAKE MIX (U.S. CL. 46).
FIRST USE 2-29-2008; IN COMMERCE 2-29-2008.

CLASS 30—(Continued).

3,807,625. TOTAL HOTTIE, INC., WEST PALM BEACH, FL. SN 77-465,388. PUB. 11-11-2008, FILED 5-5-2008.



NO CLAIM IS MADE TO THE EXCLUSIVE RIGHT TO USE "INC.", APART FROM THE MARK AS SHOWN.

THE COLOR(S) ORANGE, BLACK, WHITE AND YELLOW IS/ARE CLAIMED AS A FEATURE OF THE MARK.

THE MARK CONSISTS OF THE COLOR ORANGE IN THE WORDING "TOTAL HOTTIE", THE COLOR YELLOW IN THE FLAME DESIGN, THE COLOR BLACK IN THE OUTLINING AND IN THE WORDING "INC." AND THE COLOR WHITE IN THE SPACES BETWEEN AND WITHIN THE LETTERING.

FOR HOT SAUCE; SAUCES; SALSA (U.S. CL. 46).
FIRST USE 2-22-2010; IN COMMERCE 2-22-2010.

3,807,712. HOP BREEDING COMPANY, L.L.C., YAKIMA, WA. SN 77-552,113. PUB. 1-20-2009, FILED 8-21-2008.

CITRA

THE MARK CONSISTS OF STANDARD CHARACTERS WITHOUT CLAIM TO ANY PARTICULAR FONT, STYLE, SIZE, OR COLOR.

FOR PROCESSED HOPS, NAMELY, DRIED HOP CONES, PELLETIZED HOPS AND HOP EXTRACTS FOR MAKING BEER (U.S. CL. 46).

FIRST USE 4-7-2008; IN COMMERCE 4-7-2008.

3,807,723. RED ROBIN INTERNATIONAL, INC., GREENWOOD VILLAGE, CO. SN 77-556,130. PUB. 8-4-2009, FILED 8-26-2008.

WHISKEY RIVER

THE MARK CONSISTS OF STANDARD CHARACTERS WITHOUT CLAIM TO ANY PARTICULAR FONT, STYLE, SIZE, OR COLOR.

OWNER OF U.S. REG. NO. 1,430,433.
FOR SAUCES; DIPPING SAUCE; SANDWICHES AND SANDWICH WRAPS (U.S. CL. 46).
FIRST USE 10-16-1983; IN COMMERCE 5-30-1984.

CLASS 30—(Continued).

3,807,821. LINSTROM CORPORATION, EDDY, TX. SN 77-587,248. PUB. 3-3-2009, FILED 10-7-2008.



THE NAME "KELLY'S" IDENTIFIES KELLY MICHELLE LINSTROM AS A LIVING INDIVIDUAL WHOSE CONSENT IS OF RECORD.

THE MARK CONSISTS OF THE STYLIZED TEXT "KELLY'S DELIGHT". THERE ARE BRANCHES AND LEAVES ON THE LEFT AND THE RIGHT SIDE OF THE TEXT.

FOR SUGAR AND SUGAR SUBSTITUTES (U.S. CL. 46).

FIRST USE 3-1-2007; IN COMMERCE 11-1-2008.

3,807,828. RECKITT BENCKISER INC., PARSIPPANY, NJ. SN 77-592,350. PUB. 3-31-2009, FILED 10-14-2008.

FRANK'S REDHOT WINGS

THE MARK CONSISTS OF STANDARD CHARACTERS WITHOUT CLAIM TO ANY PARTICULAR FONT, STYLE, SIZE, OR COLOR.

OWNER OF U.S. REG. NOS. 1,572,239, 2,389,514, AND 2,649,549.

NO CLAIM IS MADE TO THE EXCLUSIVE RIGHT TO USE "WINGS", APART FROM THE MARK AS SHOWN.

FOR FOOD FLAVORINGS, MARINADES, SAUCES, SEASONINGS, AND SPICES FOR FOOD OR FOOD PRODUCTS; CONDIMENTS IN THE NATURE OF HOT SAUCES AND CAYENNE PEPPER SAUCES; COATINGS AND SEASONINGS FOR FOOD, NAMELY, SEASONED COATING FOR MEAT, FISH AND POULTRY (U.S. CL. 46).

FIRST USE 1-5-2001; IN COMMERCE 1-5-2001.

CLASS 30—(Continued).

3,807,927. KITTAS, PAUL, NEW YORK, NY. SN 77-653,612. PUB. 7-28-2009, FILED 1-21-2009.



NO CLAIM IS MADE TO THE EXCLUSIVE RIGHT TO USE "KEY LIME" AND "PIE", APART FROM THE MARK AS SHOWN.

THE COLOR(S) WHITE, YELLOW, GREEN, BEIGE AND BROWN IS/ARE CLAIMED AS A FEATURE OF THE MARK.

THE MARK CONSISTS OF A DEPICTION OF A LARGE PIE. THE PIE IS YELLOW WITH LITTLE GREEN AND WHITE SWIRLS. THE RIM OF THE PIE PLATE IS BROWN. BEHIND THE PIE ARE GREEN PALM TREES. UNDERNEATH THE PIE ARE THE WORDS "KEY LIME DREAM PIE" IN GREEN WORDS ON A BEIGE BANNER WITH A BROWN BORDER. IN THE BACKGROUND ARE ROWS OF SMALL YELLOW PIES, IDENTICAL TO THE LARGE PIE.

FOR PIES (U.S. CL. 46).

FIRST USE 2-6-2010; IN COMMERCE 2-6-2010.

3,807,988. OROGRAIN BAKERIES PRODUCTS, INC., HORSHAM, PA. SN 77-681,221. PUB. 6-30-2009, FILED 3-2-2009.

Fill 'Ems

THE MARK CONSISTS OF STANDARD CHARACTERS WITHOUT CLAIM TO ANY PARTICULAR FONT, STYLE, SIZE, OR COLOR.

FOR BAKERY PRODUCTS, NAMELY, PITAS, SLICED LONG ROLLS AND HOT DOG BUNS (U.S. CL. 46).

FIRST USE 4-12-2010; IN COMMERCE 4-12-2010.

CLASS 30—(Continued).

3,807,993. GUELF, AIDO, ALBUQUERQUE, NM. SN 77-682,204. PUB. 7-7-2009, FILED 3-3-2009.

BELLA VISTA

THE MARK CONSISTS OF STANDARD CHARACTERS WITHOUT CLAIM TO ANY PARTICULAR FONT, STYLE, SIZE, OR COLOR.

THE ENGLISH TRANSLATION OF "BELLA VISTA" IN THE MARK IS BEAUTIFUL VIEW.

FOR COLE SLAW DRESSING; EDIBLE FLOUR; FLOUR; FLOUR FOR FOOD; PASTA SAUCE; PIZZA SAUCE; SALAD DRESSING; SALAD DRESSINGS; SALAD SAUCES; SAUCE MIXES; SAUCES; SPAGHETTI SAUCE; TARTAR SAUCE; TOMATO SAUCE (U.S. CL. 46).

FIRST USE 7-30-2009; IN COMMERCE 3-25-2010.

CLASS 30—(Continued).

3,808,154. KIM CHEE PRIDE, INCORPORATED, MASPETH, NY. SN 77-708,356. PUB. 9-1-2009, FILED 4-7-2009.

MAGIC BEAN

THE MARK CONSISTS OF STANDARD CHARACTERS WITHOUT CLAIM TO ANY PARTICULAR FONT, STYLE, SIZE, OR COLOR.

FOR SALAD DRESSINGS (U.S. CL. 46).
FIRST USE 4-27-2010; IN COMMERCE 4-27-2010.

3,808,174. MCALISTER'S CORPORATION, RIDGELAND, MS. SN 77-711,779. PUB. 11-17-2009, FILED 4-10-2009.

LEAVE SWEET TEA TO THE PROS

THE MARK CONSISTS OF STANDARD CHARACTERS WITHOUT CLAIM TO ANY PARTICULAR FONT, STYLE, SIZE, OR COLOR.

FOR TEA; BEVERAGES MADE OF TEA (U.S. CL. 46).
FIRST USE 6-15-2009; IN COMMERCE 6-15-2009.

3,808,038. TREBOR BASSETT LIMITED, UXBRIDGE, MIDDLESEX, UNITED KINGDOM. SN 77-691,861. PUB. 7-14-2009, FILED 3-16-2009.



3,808,183. JAIPUR AVENUE, INC., SEATTLE, WA. SN 77-713,029. PUB. 8-11-2009, FILED 4-13-2009.

Jaipur Avenue

OWNER OF U.S. REG. NOS. 3,344,344 AND 3,380,480. NO CLAIM IS MADE TO THE EXCLUSIVE RIGHT TO USE "ORGANIC", APART FROM THE MARK AS SHOWN.

THE MARK CONSISTS OF THE WORDS "GREEN & BLACK'S ORGANIC" STYLIZED WITH A LINE.

FOR ORGANIC CHOCOLATE CONFECTIONERY; ORGANIC FROZEN CONFECTIONERY; ORGANIC CHOCOLATE FOOD BEVERAGES NOT BEING DAIRY-BASED OR VEGETABLE-BASED (U.S. CL. 46).

FIRST USE 2-26-2007; IN COMMERCE 2-26-2007.

THE MARK CONSISTS OF STANDARD CHARACTERS WITHOUT CLAIM TO ANY PARTICULAR FONT, STYLE, SIZE, OR COLOR.

FOR MIXES IN THE NATURE OF CONCENTRATES, SYRUPS OR POWDERS USED IN THE PREPARATION OF TEA BASED BEVERAGES (U.S. CL. 46).

FIRST USE 5-31-2009; IN COMMERCE 4-7-2010.

CLASS 30—(Continued).

3,808,323. AVB, INC., MILWAUKIE, OR. SN 77-752,504. PUB. 10-13-2009, FILED 6-4-2009.

CLASS 30—(Continued).

3,808,381. THE MALNATI ORGANIZATION, INC., NORTH-BROOK, IL. SN 77-774,848. PUB. 11-24-2009, FILED 7-6-2009.

SPROOKIES

THE MARK CONSISTS OF STANDARD CHARACTERS WITHOUT CLAIM TO ANY PARTICULAR FONT, STYLE, SIZE, OR COLOR.
FOR COOKIES (U.S. CL. 46).
FIRST USE 5-0-2009; IN COMMERCE 5-0-2009.

Lou-To-Go-Dough

THE MARK CONSISTS OF STANDARD CHARACTERS WITHOUT CLAIM TO ANY PARTICULAR FONT, STYLE, SIZE, OR COLOR.
OWNER OF U.S. REG. NO. 1,940,148.
FOR PIZZA DOUGH (U.S. CL. 46).
FIRST USE 11-19-2009; IN COMMERCE 3-1-2010.

3,808,333. RECKITT BENCKISER INC., PARSIPPANY, NJ. SN 77-757,417. PUB. 8-11-2009, FILED 6-11-2009.

3,808,443. SINELLI, JEFFREY, DALLAS, TX. SN 77-798,504. PUB. 11-3-2009, FILED 8-6-2009.

CATTLEMEN'S ESSENTIALS

THE MARK CONSISTS OF STANDARD CHARACTERS WITHOUT CLAIM TO ANY PARTICULAR FONT, STYLE, SIZE, OR COLOR.
FOR MARINADES; SAUCES AND GLAZES FOR FOOD; CONDIMENTS, NAMELY, HOT PEPPER SAUCE; CHICKEN WING SAUCE (U.S. CL. 46).
FIRST USE 3-15-2010; IN COMMERCE 3-15-2010.

SOUPWICH

THE MARK CONSISTS OF STANDARD CHARACTERS WITHOUT CLAIM TO ANY PARTICULAR FONT, STYLE, SIZE, OR COLOR.
FOR SANDWICHES (U.S. CL. 46).
FIRST USE 11-15-2009; IN COMMERCE 11-15-2009.

3,808,354. HERMANAS, INC., AUSTIN, TX. SN 77-763,829. PUB. 11-17-2009, FILED 6-19-2009.

3,808,465. NEWFRESHCO FOODS, LLC, NAPERVILLE, IL. SN 77-804,956. PUB. 1-12-2010, FILED 8-14-2009.

DON'T PANIC HISPANIC

THE MARK CONSISTS OF STANDARD CHARACTERS WITHOUT CLAIM TO ANY PARTICULAR FONT, STYLE, SIZE, OR COLOR.
FOR SALSA (U.S. CL. 46).
FIRST USE 7-14-2009; IN COMMERCE 7-14-2009.

MAMMOTH

THE MARK CONSISTS OF STANDARD CHARACTERS WITHOUT CLAIM TO ANY PARTICULAR FONT, STYLE, SIZE, OR COLOR.
FOR SANDWICHES (U.S. CL. 46).
FIRST USE 8-17-2009; IN COMMERCE 8-17-2009.

CLASS 30—(Continued).

3,808,477. RIVEREDGE LLC, VOORHEES, NJ. SN 77-810,995.
 PUB. 1-19-2010, FILED 8-24-2009.

TEXAS TEA

THE MARK CONSISTS OF STANDARD CHARACTERS WITHOUT CLAIM TO ANY PARTICULAR FONT, STYLE, SIZE, OR COLOR.
 FOR BEVERAGES MADE OF TEA; FRUIT TEAS; ICED TEA (U.S. CL. 46).
 FIRST USE 9-1-2009; IN COMMERCE 2-18-2010.

3,808,486. RUHANA FOODS USA INC., VALLEY STREAM, NY. SN 77-815,681. PUB. 1-19-2010, FILED 8-28-2009.

RUHANA

THE MARK CONSISTS OF STANDARD CHARACTERS WITHOUT CLAIM TO ANY PARTICULAR FONT, STYLE, SIZE, OR COLOR.
 FOR ENRICHED RICE; HONEY; RICE FLOUR (U.S. CL. 46).
 FIRST USE 4-14-2010; IN COMMERCE 4-14-2010.

3,808,524. F.A.B. INC., ALPHARETTA, GA. SN 77-979,387.
 PUB. 6-9-2009, FILED 12-29-2008.



THE MARK CONSISTS OF THE WORDS "UP FOR GRABS" IN STYLIZED FORM.
 FOR PREPARED PIZZAS AND SANDWICHES (U.S. CL. 46).
 FIRST USE 4-0-2009; IN COMMERCE 4-0-2009.

CLASS 30—(Continued).

3,808,554. JAMBA JUICE COMPANY, EMERYVILLE, CA. SN 77-979,603. PUB. 9-1-2009, FILED 4-23-2009.

JAMBA

THE MARK CONSISTS OF STANDARD CHARACTERS WITHOUT CLAIM TO ANY PARTICULAR FONT, STYLE, SIZE, OR COLOR.
 OWNER OF U.S. REG. NOS. 2,097,875, 3,375,313, AND OTHERS.
 FOR FROZEN NOVELTIES, NAMELY, SORBET, AND FROZEN YOGURT (U.S. CL. 46).
 FIRST USE 3-0-2010; IN COMMERCE 3-0-2010.

3,808,568. CALIP HOLDINGS INC., BRONX, NY. SN 78-660,619. PUB. 8-5-2008, FILED 6-29-2005.

SLENDER TREAT

THE MARK CONSISTS OF STANDARD CHARACTERS WITHOUT CLAIM TO ANY PARTICULAR FONT, STYLE, SIZE, OR COLOR.
 NO CLAIM IS MADE TO THE EXCLUSIVE RIGHT TO USE "TREAT", APART FROM THE MARK AS SHOWN.
 FOR FROZEN CONFECTIONS: ICE CREAM, FROZEN YOGURT, BAKERY GOODS (U.S. CL. 46).
 FIRST USE 12-0-1994; IN COMMERCE 12-0-1994.

3,808,602. NORTON, JOSEPH J., BRIGHTON, MI. SN 78-915,229. PUB. 2-6-2007, FILED 6-23-2006.

BUG JUICE

THE MARK CONSISTS OF STANDARD CHARACTERS WITHOUT CLAIM TO ANY PARTICULAR FONT, STYLE, SIZE, OR COLOR.
 FOR CANDY (U.S. CL. 46).
 FIRST USE 1-1-2007; IN COMMERCE 1-1-2007.

CLASS 30—(Continued).

3,808,616. SWEET CONCESSIONS, INC., NEW YORK, NY. SN 78-945,167. PUB. 3-20-2007, FILED 8-4-2006.

CLASS 31—(Continued).

3,807,562. CAMERON NURSERY, ELTOPIA, WA. SN 77-411,060. PUB. 8-25-2009, FILED 3-3-2008.

INTERMISSION

THE MARK CONSISTS OF STANDARD CHARACTERS WITHOUT CLAIM TO ANY PARTICULAR FONT, STYLE, SIZE, OR COLOR.

FOR CANDY AND CHOCOLATE BARS; BAKERY DESSERTS (U.S. CLS. 1 AND 46).

FIRST USE 1-14-2007; IN COMMERCE 1-14-2007.

Vista

THE MARK CONSISTS OF STANDARD CHARACTERS WITHOUT CLAIM TO ANY PARTICULAR FONT, STYLE, SIZE, OR COLOR.

FOR LIVING COMMERCIAL FRUIT PLANTS SOLD BY COMMERCIAL NURSERIES TO COMMERCIAL GROWERS (U.S. CLS. 1 AND 46).

FIRST USE 11-19-2009; IN COMMERCE 11-19-2009.

CLASS 31—NATURAL AGRICULTURAL PRODUCTS

3,807,411. KENT FEEDS, INC., MUSCATINE, IA. SN 77-028,823. PUB. 5-1-2007, FILED 10-25-2006.

3,807,630. BC HOT HOUSE FOODS INC., LANGLEY, BC, CANADA. SN 77-473,650. PUB. 11-10-2009, FILED 5-13-2008.

Haven

THE MARK CONSISTS OF STANDARD CHARACTERS WITHOUT CLAIM TO ANY PARTICULAR FONT, STYLE, SIZE, OR COLOR.

FOR LIVESTOCK FEEDS, HORSE FEEDS, FOOD FOR SMALL ANIMALS (U.S. CLS. 1 AND 46).

FIRST USE 5-1-2008; IN COMMERCE 5-1-2008.

TASTINI

THE MARK CONSISTS OF STANDARD CHARACTERS WITHOUT CLAIM TO ANY PARTICULAR FONT, STYLE, SIZE, OR COLOR.

PRIORITY CLAIMED UNDER SEC. 44(D) ON CANADA APPLICATION NO. 1393360, FILED 4-29-2008, REG. NO. TMA743768, DATED 7-20-2009, EXPIRES 7-20-2024.

FOR FRESH PRODUCE, NAMELY, FRESH VEGETABLES (U.S. CLS. 1 AND 46).

FIRST USE 5-23-2008; IN COMMERCE 10-15-2008.

3,807,509. K9 NATURAL FOOD LTD., CHRISTCHURCH, NEW ZEALAND. SN 77-291,790. PUB. 3-11-2008, FILED 9-28-2007.

3,807,706. ACE TOMATO CO., INC., MANTECA, CA. SN 77-548,209. PUB. 1-27-2009, FILED 8-15-2008.

GEORGE'S GEMS**Feed your dog's inner wolf**

THE MARK CONSISTS OF STANDARD CHARACTERS WITHOUT CLAIM TO ANY PARTICULAR FONT, STYLE, SIZE, OR COLOR.

FOR DOG FOOD (U.S. CLS. 1 AND 46).

FIRST USE 4-7-2010; IN COMMERCE 4-7-2010.

THE MARK CONSISTS OF STANDARD CHARACTERS WITHOUT CLAIM TO ANY PARTICULAR FONT, STYLE, SIZE, OR COLOR.

THE NAME(S), PORTRAIT(S), AND/OR SIGNATURE(S) SHOWN IN THE MARK DOES NOT IDENTIFY A PARTICULAR LIVING INDIVIDUAL.

FOR FRESH FRUIT AND VEGETABLES (U.S. CLS. 1 AND 46).

FIRST USE 2-5-2008; IN COMMERCE 5-17-2008.

CLASS 31—(Continued).

3,807,814. CATHOLIC FLOWERS, LLC, PHOENIX, AZ. SN 77-584,234. PUB. 2-24-2009, FILED 10-2-2008.

CATHOLIC FLOWERS

THE MARK CONSISTS OF STANDARD CHARACTERS WITHOUT CLAIM TO ANY PARTICULAR FONT, STYLE, SIZE, OR COLOR.

NO CLAIM IS MADE TO THE EXCLUSIVE RIGHT TO USE "FLOWERS", APART FROM THE MARK AS SHOWN. FOR CUT FLOWERS; FLOWERS; LIVE FLOWER ARRANGEMENTS (U.S. CLS. 1 AND 46).

FIRST USE 11-21-2009; IN COMMERCE 11-21-2009.

3,807,815. CATHOLIC FLOWERS, LLC, PHOENIX, AZ. SN 77-584,252. PUB. 7-28-2009, FILED 10-2-2008.

FAITH AND FLOWERS

THE MARK CONSISTS OF STANDARD CHARACTERS WITHOUT CLAIM TO ANY PARTICULAR FONT, STYLE, SIZE, OR COLOR.

NO CLAIM IS MADE TO THE EXCLUSIVE RIGHT TO USE "FLOWERS", APART FROM THE MARK AS SHOWN. FOR CUT FLOWERS; FLOWERS; LIVE FLOWER ARRANGEMENTS (U.S. CLS. 1 AND 46).

FIRST USE 11-21-2009; IN COMMERCE 11-21-2009.

3,808,124. LIVING RIBBON, SANTA CLARA, CA. SN 77-703,704. PUB. 8-4-2009, FILED 3-31-2009.



NO CLAIM IS MADE TO THE EXCLUSIVE RIGHT TO USE "LIVING", APART FROM THE MARK AS SHOWN.

CLASS 31—(Continued).

THE MARK CONSISTS OF AN IMAGE OF A TOPIARY PLANT IN THE SHAPE OF A RIBBON INSIDE A BOX. THE STYLIZED WORD "LIVING" IS ABOVE THE BOX. THE STYLIZED WORD "RIBBON" IS BELOW THE BOX. FOR LIVING PLANTS (U.S. CLS. 1 AND 46). FIRST USE 8-11-2009; IN COMMERCE 3-23-2009.

3,808,204. LAMSA CORPORATION, CHULA VISTA, CA. SN 77-715,658. PUB. 8-18-2009, FILED 4-16-2009.

LADY B

THE MARK CONSISTS OF STANDARD CHARACTERS WITHOUT CLAIM TO ANY PARTICULAR FONT, STYLE, SIZE, OR COLOR.

FOR FRESH FRUIT AND VEGETABLES (U.S. CLS. 1 AND 46).

FIRST USE 10-31-2009; IN COMMERCE 10-31-2009.

3,808,209. WELLPET LLC, TEWKSBURY, MA. SN 77-716,278. PUB. 8-4-2009, FILED 4-17-2009.

SELECT ACTIVES

THE MARK CONSISTS OF STANDARD CHARACTERS WITHOUT CLAIM TO ANY PARTICULAR FONT, STYLE, SIZE, OR COLOR.

NO CLAIM IS MADE TO THE EXCLUSIVE RIGHT TO USE "SELECT", APART FROM THE MARK AS SHOWN.

FOR PET FOOD AND PET TREATS (U.S. CLS. 1 AND 46).

FIRST USE 9-30-2009; IN COMMERCE 9-30-2009.

3,808,215. GREEN CIRCLE GROWERS, INC., OBERLIN, OH. SN 77-718,188. PUB. 9-22-2009, FILED 4-21-2009.

JUST ADD ICE ORCHIDS

THE MARK CONSISTS OF STANDARD CHARACTERS WITHOUT CLAIM TO ANY PARTICULAR FONT, STYLE, SIZE, OR COLOR.

NO CLAIM IS MADE TO THE EXCLUSIVE RIGHT TO USE "ORCHIDS", APART FROM THE MARK AS SHOWN.

FOR LIVE ORCHIDS (U.S. CLS. 1 AND 46). FIRST USE 6-1-2009; IN COMMERCE 6-1-2009.

CLASS 31—(Continued).

3,808,275. WELLPET LLC, TEWKSBURY, MA. SN 77-734,588.
PUB. 8-4-2009, FILED 5-12-2009.

GIVE 'EM SOME SNACK LOVE

THE MARK CONSISTS OF STANDARD CHARACTERS WITHOUT CLAIM TO ANY PARTICULAR FONT, STYLE, SIZE, OR COLOR.
FOR PET FOOD AND PET TREATS (U.S. CLS. 1 AND 46).
FIRST USE 2-28-2009; IN COMMERCE 2-28-2009.

3,808,351. CITROMAX FLAVORS, INC., CARLSTADT, NJ.
SN 77-761,011. PUB. 1-19-2010, FILED 6-16-2009.

BERRYMAX

THE MARK CONSISTS OF STANDARD CHARACTERS WITHOUT CLAIM TO ANY PARTICULAR FONT, STYLE, SIZE, OR COLOR.
FOR FRESH FRUITS (U.S. CLS. 1 AND 46).
FIRST USE 10-0-2009; IN COMMERCE 10-0-2009.

CLASS 32—LIGHT BEVERAGES

3,807,434. JOHN L. BURLESON, DANDRIDGE, TN. SN 77-083,492. PUB. 8-28-2007, FILED 1-16-2007.

CAMENAE

THE MARK CONSISTS OF STANDARD CHARACTERS WITHOUT CLAIM TO ANY PARTICULAR FONT, STYLE, SIZE, OR COLOR.
FOR BOTTLED WATER (U.S. CLS. 45, 46 AND 48).
FIRST USE 4-16-2010; IN COMMERCE 4-16-2010.

CLASS 32—(Continued).

3,807,488. SIGN QUENCHER, LLC, MINDEN, NV. SN 77-257,465. PUB. 2-19-2008, FILED 8-16-2007.

The Sign Quencher

THE MARK CONSISTS OF STANDARD CHARACTERS WITHOUT CLAIM TO ANY PARTICULAR FONT, STYLE, SIZE, OR COLOR.

NO CLAIM IS MADE TO THE EXCLUSIVE RIGHT TO USE "QUENCHER", APART FROM THE MARK AS SHOWN.

FOR SHELF STABLE NON-ALCOHOLIC BEVERAGES, NAMELY, CARBONATED WATER, NON-CARBONATED WATER, SODA WATER AND SELTZER WATER, ALL FLAVORED WITH FRUITS AND HERBS (U.S. CLS. 45, 46 AND 48).
FIRST USE 3-1-2010; IN COMMERCE 3-1-2010.

3,807,489. SIGN QUENCHER, LLC, MINDEN, NV. SN 77-257,482. PUB. 2-19-2008, FILED 8-16-2007.

Orb

THE MARK CONSISTS OF STANDARD CHARACTERS WITHOUT CLAIM TO ANY PARTICULAR FONT, STYLE, SIZE, OR COLOR.

FOR SHELF STABLE NON-ALCOHOLIC BEVERAGES, NAMELY, CARBONATED WATER, NON-CARBONATED WATER, SODA WATER AND SELTZER WATER, ALL FLAVORED WITH FRUITS AND HERBS (U.S. CLS. 45, 46 AND 48).
FIRST USE 3-1-2010; IN COMMERCE 3-1-2010.

3,807,600. PURBLU BEVERAGES, INC., PITTSBURGH, PA.
SN 77-442,257. PUB. 1-19-2010, FILED 4-7-2008.

DRINK GIVE. DO GOOD.

THE MARK CONSISTS OF STANDARD CHARACTERS WITHOUT CLAIM TO ANY PARTICULAR FONT, STYLE, SIZE, OR COLOR.

FOR BOTTLED WATER, SOFT DRINKS, NAMELY, NON-CARBONATED AND FLAVORED (U.S. CLS. 45, 46 AND 48).
FIRST USE 11-1-2006; IN COMMERCE 7-15-2007.

CLASS 32—(Continued).

3,807,659. MILLERCOORS LLC, WILMINGTON, DE. SN 77-509,665. PUB. 4-14-2009, FILED 6-27-2008.



OWNER OF U.S. REG. NOS. 519,643, 2,145,822, AND OTHERS.

NO CLAIM IS MADE TO THE EXCLUSIVE RIGHT TO USE "BREWING COMPANY", APART FROM THE MARK AS SHOWN.

THE MARK CONSISTS OF A CIRCULAR DESIGN WITH TWO CONCENTRIC CIRCLES AND TWO TRIANGULAR BANDS EXTENDING FROM BOTH SIDES OF THE CIRCULAR DESIGN. THE INTERIOR PORTION OF THE CIRCULAR DESIGN CONTAINS A STYLIZED MOUNTAIN AND THE LETTER "C". THE EXTERIOR PORTION OF THE CIRCULAR DESIGN CONTAINS THE WORDS "COORS BREWING COMPANY GOLDEN, COLORADO". THE WORDS "ALWAYS SMOOTH" APPEAR BETWEEN THE TRIANGULAR BANDS ON THE LEFT AND RIGHT SIDES, RESPECTIVELY, OF THE CIRCULAR DESIGN.

SEC. 2(F) AS TO "GOLDEN, COLORADO".

FOR BEER (U.S. CLS. 45, 46 AND 48).

FIRST USE 1-1-2007; IN COMMERCE 1-1-2007.

3,807,672. INNOVATIVE BEVERAGE GROUP, INC., HOUSTON, TX. SN 77-525,976. PUB. 10-6-2009, FILED 7-18-2008.

DRANK DEUCE

THE MARK CONSISTS OF STANDARD CHARACTERS WITHOUT CLAIM TO ANY PARTICULAR FONT, STYLE, SIZE, OR COLOR.

FOR SOFT DRINKS, NAMELY, NON-CARBONATED SOFT DRINKS (U.S. CLS. 45, 46 AND 48).

FIRST USE 12-19-2008; IN COMMERCE 12-19-2008.

3,807,838. ROLANDO CURTIS FOODS MS, INC., UPPER MARLBORO, MD. SN 77-596,669. PUB. 3-17-2009, FILED 10-21-2008.

BLUE DELTA H2O

THE MARK CONSISTS OF STANDARD CHARACTERS WITHOUT CLAIM TO ANY PARTICULAR FONT, STYLE, SIZE, OR COLOR.

CLASS 32—(Continued).

NO CLAIM IS MADE TO THE EXCLUSIVE RIGHT TO USE "H2O", APART FROM THE MARK AS SHOWN.

FOR BOTTLED WATER; DRINKING WATER (U.S. CLS. 45, 46 AND 48).

FIRST USE 12-0-2008; IN COMMERCE 12-0-2008.

3,807,869. LIQUID LIGHTNING CORPORATION, POMPTON LAKES, NJ. SN 77-613,887. PUB. 9-8-2009, FILED 11-13-2008.

First Real Beverage

THE MARK CONSISTS OF STANDARD CHARACTERS WITHOUT CLAIM TO ANY PARTICULAR FONT, STYLE, SIZE, OR COLOR.

NO CLAIM IS MADE TO THE EXCLUSIVE RIGHT TO USE "BEVERAGE", APART FROM THE MARK AS SHOWN.

FOR ENERGY DRINKS (U.S. CLS. 45, 46 AND 48).

FIRST USE 3-1-2009; IN COMMERCE 3-1-2009.

3,807,870. PURBLU BEVERAGES, INC., PITTSBURGH, PA. SN 77-613,943. PUB. 10-6-2009, FILED 11-13-2008.

POTION HERBAL REMEDY

THE MARK CONSISTS OF STANDARD CHARACTERS WITHOUT CLAIM TO ANY PARTICULAR FONT, STYLE, SIZE, OR COLOR.

NO CLAIM IS MADE TO THE EXCLUSIVE RIGHT TO USE "HERBAL REMEDY", APART FROM THE MARK AS SHOWN.

FOR BEVERAGES, NAMELY, NON-ALCOHOLIC DRINKS IN THE NATURE OF JUICES AND EXTRACTS CONTAINING VITAMINS, MINERALS, HERBS OR SUPPLEMENTS, ENERGY DRINKS AND SPORTS DRINKS (U.S. CLS. 45, 46 AND 48).

FIRST USE 5-15-2009; IN COMMERCE 5-15-2009.

CLASS 32—(Continued).

3,807,903. INNOVATIVE BEVERAGE GROUP, INC., HOUSTON, TX. SN 77-643,001. PUB. 4-21-2009, FILED 1-4-2009.



THE COLOR(S) PURPLE, GOLD IS/ARE CLAIMED AS A FEATURE OF THE MARK.

THE MARK CONSISTS OF THE LETTER "D" IN LOWER CASE GOLD WITH A SINGLE GOLD OUTLINE AND INTERNAL PURPLE GEMSTONES SURROUNDING A FIVE POINTED GOLD STAR OVER THE "DEUCE" STYLIZED MARK; TOPPED BY A GOLD CROWN; EMBELLISHED BY BAROQUE AND/OR LEAF LIKE DESIGN.

FOR ENERGY DRINKS; FRUIT DRINKS AND FRUIT JUICES; FRUIT DRINKS AND JUICES; ISOTONIC DRINKS; SOFT DRINKS, NAMELY, NON-CARBONATED SOFT DRINKS AND CARBONATED SOFT DRINKS; SPORTS DRINKS, NAMELY, ENERGY DRINKS (U.S. CLS. 45, 46 AND 48).

FIRST USE 12-19-2008; IN COMMERCE 12-19-2008.

3,808,009. NEPHRO-FRESH, INC., YONKERS, NY. SN 77-686,414. PUB. 12-8-2009, FILED 3-9-2009.

WATER WORX

THE MARK CONSISTS OF STANDARD CHARACTERS WITHOUT CLAIM TO ANY PARTICULAR FONT, STYLE, SIZE, OR COLOR.

NO CLAIM IS MADE TO THE EXCLUSIVE RIGHT TO USE "WATER", APART FROM THE MARK AS SHOWN.

FOR SOFT DRINKS, NAMELY, MINERAL WATERS (U.S. CLS. 45, 46 AND 48).

FIRST USE 4-30-2010; IN COMMERCE 4-30-2010.

CLASS 32—(Continued).

3,808,141. VERYFINE PRODUCTS, INC., CINCINNATI, OH. SN 77-705,759. PUB. 8-11-2009, FILED 4-2-2009.

THE WONDERS OF FRUIT. THE REFRESHMENT OF WATER.

THE MARK CONSISTS OF STANDARD CHARACTERS WITHOUT CLAIM TO ANY PARTICULAR FONT, STYLE, SIZE, OR COLOR.

FOR NON ALCOHOLIC BEVERAGES, NAMELY, FRUIT FLAVORED DRINKING WATER (U.S. CLS. 45, 46 AND 48).

FIRST USE 3-1-2010; IN COMMERCE 3-1-2010.

3,808,270. MONAVIE, LLC, SOUTH JORDAN, UT. SN 77-732,115. PUB. 8-18-2009, FILED 5-7-2009.

MonaVie ^{mv}

OWNER OF U.S. REG. NOS. 3,106,146, 3,111,333, AND OTHERS.

THE MARK CONSISTS OF A STYLIZED "MONAVIE" AND A STYLIZED "E" WITH A STYLIZED AND SUPERSCRIPT "MV".

FOR JUICE, NAMELY, FRUIT JUICES; ENERGY DRINKS (U.S. CLS. 45, 46 AND 48).

FIRST USE 6-13-2009; IN COMMERCE 6-13-2009.

3,808,293. NESTLE WATERS NORTH AMERICA INC., GREENWICH, CT. SN 77-740,305. PUB. 8-4-2009, FILED 5-19-2009.

BORN BETTER

THE MARK CONSISTS OF STANDARD CHARACTERS WITHOUT CLAIM TO ANY PARTICULAR FONT, STYLE, SIZE, OR COLOR.

FOR SPRING WATER (U.S. CLS. 45, 46 AND 48).

FIRST USE 4-1-2010; IN COMMERCE 4-1-2010.

CLASS 32—(Continued).

3,808,371. SOSRODJOJO, SOEKIANTO SOSRODJOJO, SOEWITO SOSRODJOJO, SOEJANI SOSRODJOJO, KUNIARTI SOSRODJOJO, SUKOWATI, KELAPA GADING, JAKARTA, INDONESIA. SN 77-769,993. PUB. 11-24-2009, FILED 6-29-2009.



OWNER OF U.S. REG. NO. 1,821,569.
 THE COLOR(S) RED AND WHITE IS/ARE CLAIMED AS A FEATURE OF THE MARK.
 THE MARK CONSISTS OF THE WORD "SOSRO" IN WHITE INSIDE A RED CIRCLE.
 FOR BEVERAGES AND NON-ALCOHOLIC DRINKS WITH TEA AND FRUIT FLAVORS, FRUIT DRINKS AND FRUIT JUICES; NON-ALCOHOLIC MINERAL AND AERATED WATERS (U.S. CLS. 45, 46 AND 48).
 FIRST USE 7-1-2008; IN COMMERCE 7-1-2008.

3,808,439. NAKED JUICE CO. OF GLENDORA, INC., AZUSA, CA. SN 77-797,276. PUB. 1-12-2010, FILED 8-5-2009.

**NOTHING BUT NATURALLY
 DELICIOUS**

THE MARK CONSISTS OF STANDARD CHARACTERS WITHOUT CLAIM TO ANY PARTICULAR FONT, STYLE, SIZE, OR COLOR.
 FOR FRUIT AND VEGETABLE JUICES, FRUIT JUICE DRINKS AND FRUIT FLAVORED WATERS (U.S. CLS. 45, 46 AND 48).
 FIRST USE 9-30-2009; IN COMMERCE 9-30-2009.

CLASS 32—(Continued).

3,808,449. B-MELO LLC, NEW YORK, NY. SN 77-799,420. PUB. 1-5-2010, FILED 8-7-2009.



OWNER OF U.S. REG. NO. 3,702,719.
 THE MARK CONSISTS OF THE WORDS "B-MELO HAPPINESS IN A BOTTLE" PLUS THE DESIGN OF A BODHI TREE LEAF.
 FOR NON-ALCOHOLIC BEVERAGES, NAMELY, FRUIT DRINKS, FROZEN FRUIT BEVERAGES, CARBONATED BEVERAGES, BOTTLED WATER AND RELAXATION DRINKS, NAMELY, NON-CARBONATED AND CARBONATED SOFT DRINKS CONTAINING CALMING AGENTS (U.S. CLS. 45, 46 AND 48).
 FIRST USE 9-10-2009; IN COMMERCE 9-10-2009.

CLASS 33—WINES AND SPIRITS

3,807,379. DON CARLO VENTURES, INC., ATHENA, OR. SN 76-678,669. PUB. 11-24-2009, FILED 6-25-2007.

DON CARLO VINEYARD

THE MARK CONSISTS OF STANDARD CHARACTERS WITHOUT CLAIM TO ANY PARTICULAR FONT, STYLE, SIZE, OR COLOR.
 NO CLAIM IS MADE TO THE EXCLUSIVE RIGHT TO USE "VINEYARD", APART FROM THE MARK AS SHOWN.
 THE NAME "DON CARLO" DOES NOT IDENTIFY A LIVING INDIVIDUAL.
 FOR WINE (U.S. CLS. 47 AND 49).
 FIRST USE 9-22-2009; IN COMMERCE 9-22-2009.

3,807,410. DISTELL LIMITED, STELLENBOSCH, SOUTH AFRICA. SN 77-027,321. PUB. 7-10-2007, FILED 10-23-2006.

AFRICAN ROCK

THE MARK CONSISTS OF STANDARD CHARACTERS WITHOUT CLAIM TO ANY PARTICULAR FONT, STYLE, SIZE, OR COLOR.

CLASS 33—(Continued).

NO CLAIM IS MADE TO THE EXCLUSIVE RIGHT TO USE "AFRICAN", APART FROM THE MARK AS SHOWN.
 FOR WINES (U.S. CLS. 47 AND 49).
 FIRST USE 0-0-2007; IN COMMERCE 0-0-2007.

3,807,445. OTTON, TERRY, NAPA, CA. AND OTTON, NANCY, NAPA, CA. SN 77-119,070. PUB. 8-28-2007, FILED 2-28-2007.

RAMSPUR

THE MARK CONSISTS OF STANDARD CHARACTERS WITHOUT CLAIM TO ANY PARTICULAR FONT, STYLE, SIZE, OR COLOR.
 FOR WINE (U.S. CLS. 47 AND 49).
 FIRST USE 4-1-2010; IN COMMERCE 4-1-2010.

3,807,452. RIVERAERIE CELLARS LLC, PROSSER, WA. SN 77-147,951. PUB. 8-4-2009, FILED 4-3-2007.

RiverAerie

THE MARK CONSISTS OF STANDARD CHARACTERS WITHOUT CLAIM TO ANY PARTICULAR FONT, STYLE, SIZE, OR COLOR.
 FOR WINE (U.S. CLS. 47 AND 49).
 FIRST USE 6-1-2005; IN COMMERCE 9-1-2007.

3,807,462. BODEGAS BARBADILLO, S.L., CÁDIZ, SPAIN. SN 77-193,122. PUB. 7-14-2009, FILED 5-30-2007.



THE NAME SHOWN IN THE MARK DOES NOT IDENTIFY A PARTICULAR LIVING INDIVIDUAL.

CLASS 33—(Continued).

THE MARK CONSISTS OF A PICTURE OF A CASTLE. UNDERNEATH THE CASTLE THE WORDS "ANTONIO BARBADILLO" ARE IN BOLD. UNDER THE WORDS "ANTONIO BARBADILLO" THE WORDS "CASTILLO DE SAN DIEGO" ARE IN CURSIVE. AT THE BOTTOM OF THE DRAWING THERE ARE TWO HORIZONTAL LINES AND A SHIELD WITH A CROWN SITS ON TOP OF THE LINES.

THE ENGLISH TRANSLATION OF "CASTILLO" IN THE MARK IS "CASTLE".
 FOR ALCOHOLIC BEVERAGES EXCEPT BEERS, NAMELY, WINE (U.S. CLS. 47 AND 49).
 FIRST USE 6-4-2004; IN COMMERCE 6-4-2004.

3,807,641. ANDERSON & MIDDLETON COMPANY, HOQUIAM, WA. SN 77-482,457. PUB. 10-28-2008, FILED 5-23-2008.

ADOBE PINK

THE MARK CONSISTS OF STANDARD CHARACTERS WITHOUT CLAIM TO ANY PARTICULAR FONT, STYLE, SIZE, OR COLOR.
 OWNER OF U.S. REG. NO. 3,355,672.
 NO CLAIM IS MADE TO THE EXCLUSIVE RIGHT TO USE "PINK", APART FROM THE MARK AS SHOWN.
 FOR WINE (U.S. CLS. 47 AND 49).
 FIRST USE 4-22-2010; IN COMMERCE 4-22-2010.

3,807,752. PECOS TRADING, CORP., DBA ARTISAN BRANDS, MIAMI LAKES, FL. SN 77-564,256. PUB. 1-6-2009, FILED 9-8-2008.



THE MARK CONSISTS OF A SNAKEHEAD DESIGN. FOR DISTILLED SPIRITS (U.S. CLS. 47 AND 49).
 FIRST USE 4-1-2009; IN COMMERCE 4-8-2009.

CLASS 33—(Continued).

3,807,847. COLLE DI BOASI S.A., MENDOZA, ARGENTINA. SN 77-601,797. PUB. 9-22-2009, FILED 10-28-2008.

BENVENUTO DE LA SERNA

THE MARK CONSISTS OF STANDARD CHARACTERS WITHOUT CLAIM TO ANY PARTICULAR FONT, STYLE, SIZE, OR COLOR.

THE ENGLISH TRANSLATION OF "BENVENUTO" IN THE MARK IS WELCOME.

THE WORDING "DE LA SERNA" HAS NO MEANING IN A FOREIGN LANGUAGE.

FOR ALCOHOLIC BEVERAGES, NAMELY, WINES (U.S. CLS. 47 AND 49).

FIRST USE 6-30-2004; IN COMMERCE 1-16-2008.

3,807,879. T. EDWARD WINES LTD., NEW YORK, NY. SN 77-619,454. PUB. 4-7-2009, FILED 11-21-2008.

MAPUCHE

THE MARK CONSISTS OF STANDARD CHARACTERS WITHOUT CLAIM TO ANY PARTICULAR FONT, STYLE, SIZE, OR COLOR.

FOR WINES (U.S. CLS. 47 AND 49).

FIRST USE 11-6-2008; IN COMMERCE 3-16-2009.

3,807,880. T. EDWARD WINES LTD., NEW YORK, NY. SN 77-619,462. PUB. 4-7-2009, FILED 11-21-2008.

TERMINUS

THE MARK CONSISTS OF STANDARD CHARACTERS WITHOUT CLAIM TO ANY PARTICULAR FONT, STYLE, SIZE, OR COLOR.

FOR WINES (U.S. CLS. 47 AND 49).

FIRST USE 8-16-2008; IN COMMERCE 11-17-2008.

CLASS 33—(Continued).

3,807,881. T. EDWARD WINES LTD., NEW YORK, NY. SN 77-619,473. PUB. 4-7-2009, FILED 11-21-2008.

MIDSLOPE

THE MARK CONSISTS OF STANDARD CHARACTERS WITHOUT CLAIM TO ANY PARTICULAR FONT, STYLE, SIZE, OR COLOR.

FOR WINES (U.S. CLS. 47 AND 49).

FIRST USE 9-1-2008; IN COMMERCE 9-24-2008.

3,807,886. COMPAÑIA TEQUILERA DE JALISCO SA DE CV, VILLA HIDALGO, MEXICO. SN 77-624,425. PUB. 10-27-2009, FILED 12-2-2008.

NUESTRO ORGULLO

THE MARK CONSISTS OF STANDARD CHARACTERS WITHOUT CLAIM TO ANY PARTICULAR FONT, STYLE, SIZE, OR COLOR.

OWNER OF U.S. REG. NO. 3,551,613.

THE FOREIGN WORDING IN THE MARK TRANSLATES INTO ENGLISH AS "OUR PRIDE".

FOR TEQUILA (U.S. CLS. 47 AND 49).

FIRST USE 11-19-2008; IN COMMERCE 11-19-2008.

3,807,887. QUADY WINERY INC, MADERA, CA. SN 77-624,539. PUB. 4-7-2009, FILED 12-2-2008.

Salt of the Earth

THE MARK CONSISTS OF STANDARD CHARACTERS WITHOUT CLAIM TO ANY PARTICULAR FONT, STYLE, SIZE, OR COLOR.

FOR WINES AND FORTIFIED WINES (U.S. CLS. 47 AND 49).

FIRST USE 1-15-2010; IN COMMERCE 1-15-2010.

CLASS 33—(Continued).

3,807,934. BRAZOS WINE IMPORTS, HILTON HEAD, SC. SN 77-657,603. PUB. 5-19-2009, FILED 1-27-2009.

brazoswineimports

THE MARK CONSISTS OF STANDARD CHARACTERS WITHOUT CLAIM TO ANY PARTICULAR FONT, STYLE, SIZE, OR COLOR.

FOR RED WINE; RED WINES; SPARKLING WINES; TABLE WINES; WHITE WINE; WINE; WINES; WINES AND SPARKLING WINES (U.S. CLS. 47 AND 49).

FIRST USE 7-15-2009; IN COMMERCE 7-15-2009.

3,807,935. VIRIDIAN SPIRITS LLC, NEW YORK, NY. SN 77-658,571. PUB. 5-19-2009, FILED 1-28-2009.



THE COLOR(S) GREEN AND BLACK IS/ARE CLAIMED AS A FEATURE OF THE MARK.

THE MARK CONSISTS OF THE IMAGE OF A KNEELING GREEN FAIRY WITH BLACK SHADED WINGS AND HOLDING A BLACK GARMENT WRAP.

FOR DISTILLED SPIRITS (U.S. CLS. 47 AND 49).

FIRST USE 7-30-2008; IN COMMERCE 7-30-2008.

3,808,053. JAQK, INC., SAN FRANCISCO, CA. SN 77-694,231. PUB. 7-21-2009, FILED 3-18-2009.

BLACK CLOVER

THE MARK CONSISTS OF STANDARD CHARACTERS WITHOUT CLAIM TO ANY PARTICULAR FONT, STYLE, SIZE, OR COLOR.

FOR WINE (U.S. CLS. 47 AND 49).

FIRST USE 10-8-2008; IN COMMERCE 10-8-2008.

CLASS 33—(Continued).

3,808,064. DROWN CORP., EAST AMHERST, NY. SN 77-696,697. PUB. 7-21-2009, FILED 3-23-2009.

RIVER GATE

THE MARK CONSISTS OF STANDARD CHARACTERS WITHOUT CLAIM TO ANY PARTICULAR FONT, STYLE, SIZE, OR COLOR.

FOR WINE (U.S. CLS. 47 AND 49).

FIRST USE 9-7-2009; IN COMMERCE 9-7-2009.

3,808,155. MEGAWINE, INC., VAN NUYS, CA. SN 77-709,053. PUB. 8-4-2009, FILED 4-7-2009.

DOMAIN PASO

THE MARK CONSISTS OF STANDARD CHARACTERS WITHOUT CLAIM TO ANY PARTICULAR FONT, STYLE, SIZE, OR COLOR.

THE ENGLISH TRANSLATION OF "PASO" IN THE MARK IS STEP OR PASSAGE.

FOR WINE (U.S. CLS. 47 AND 49).

FIRST USE 3-25-2010; IN COMMERCE 3-25-2010.

3,808,251. HEARTSMART WINE, LLC, LONG BEACH, CA. SN 77-728,563. PUB. 9-8-2009, FILED 5-4-2009.

GREAT DANE

THE MARK CONSISTS OF STANDARD CHARACTERS WITHOUT CLAIM TO ANY PARTICULAR FONT, STYLE, SIZE, OR COLOR.

FOR WINE (U.S. CLS. 47 AND 49).

FIRST USE 4-26-2010; IN COMMERCE 4-26-2010.

CLASS 33—(Continued).

3,808,350. D'ARENBERG PTY LTD, SOUTH AUSTRALIA, AUSTRALIA. SN 77-760,978. PUB. 12-29-2009, FILED 6-16-2009.

D'ARRYS ORIGINAL

THE MARK CONSISTS OF STANDARD CHARACTERS WITHOUT CLAIM TO ANY PARTICULAR FONT, STYLE, SIZE, OR COLOR.

NO CLAIM IS MADE TO THE EXCLUSIVE RIGHT TO USE "ORIGINAL", APART FROM THE MARK AS SHOWN. FOR WINE (U.S. CLS. 47 AND 49).
FIRST USE 5-31-1996; IN COMMERCE 9-30-1996.

3,808,598. BRONCO WINE COMPANY, CERES, CA. SN 78-899,760. PUB. 1-2-2007, FILED 6-2-2006.

RSVP

THE MARK CONSISTS OF STANDARD CHARACTERS WITHOUT CLAIM TO ANY PARTICULAR FONT, STYLE, SIZE, OR COLOR.

FOR WINES (U.S. CLS. 47 AND 49).
FIRST USE 11-1-2009; IN COMMERCE 11-1-2009.

CLASS 34—SMOKERS' ARTICLES

3,808,274. K. HANSOTIA & CO., INC., MIAMI, FL. SN 77-734,503. PUB. 9-22-2009, FILED 5-12-2009.

HUDSON BAY

THE MARK CONSISTS OF STANDARD CHARACTERS WITHOUT CLAIM TO ANY PARTICULAR FONT, STYLE, SIZE, OR COLOR.

FOR CIGARS (U.S. CLS. 2, 8, 9 AND 17).
FIRST USE 1-17-2008; IN COMMERCE 1-17-2008.

CLASS 34—(Continued).

3,808,307. THE MOB, LITTLETON, CO. SN 77-746,763. PUB. 10-6-2009, FILED 5-28-2009.

MOB

THE MARK CONSISTS OF STANDARD CHARACTERS WITHOUT CLAIM TO ANY PARTICULAR FONT, STYLE, SIZE, OR COLOR.

FOR CIGARS: TOBACCO (U.S. CLS. 2, 8, 9 AND 17).
FIRST USE 9-0-2009; IN COMMERCE 9-0-2009.

3,808,409. PAVOL MUDRIK, MIAMI, FL. SN 77-786,696. PUB. 12-15-2009, FILED 7-22-2009.

RIVAL

THE MARK CONSISTS OF STANDARD CHARACTERS WITHOUT CLAIM TO ANY PARTICULAR FONT, STYLE, SIZE, OR COLOR.

FOR CIGAR BOXES; CIGAR CASES; CIGAR CUTTERS; CIGAR HOLDERS; CIGAR HUMIDIFIERS; CIGAR LIGHTERS; CIGAR TUBES; CIGARS (U.S. CLS. 2, 8, 9 AND 17).
FIRST USE 2-1-2009; IN COMMERCE 2-1-2009.

3,808,517. TOP TOBACCO, LP, GLENVIEW, IL. SN 77-979,343. PUB. 1-13-2009, FILED 8-25-2008.

BO BROWNING

THE MARK CONSISTS OF STANDARD CHARACTERS WITHOUT CLAIM TO ANY PARTICULAR FONT, STYLE, SIZE, OR COLOR.

THE NAME "BO BROWNING" DOES NOT IDENTIFY A LIVING INDIVIDUAL.
FOR TOBACCO (U.S. CLS. 2, 8, 9 AND 17).
FIRST USE 3-18-2010; IN COMMERCE 3-18-2010.

CLASS 34—(Continued).

3,808,532. TOP TOBACCO L.P., GLENVIEW, IL. SN 77-979,429. PUB. 7-7-2009, FILED 9-4-2008.

DRUM WORLD BLENDS

THE MARK CONSISTS OF STANDARD CHARACTERS WITHOUT CLAIM TO ANY PARTICULAR FONT, STYLE, SIZE, OR COLOR.

OWNER OF U.S. REG. NO. 2,392,549.

NO CLAIM IS MADE TO THE EXCLUSIVE RIGHT TO USE "BLENDS", APART FROM THE MARK AS SHOWN. FOR TOBACCO; CIGARETTE PAPERS (U.S. CLS. 2, 8, 9 AND 17).

FIRST USE 11-26-2008; IN COMMERCE 11-26-2008.

SERVICE MARKS**CLASS 35—ADVERTISING AND BUSINESS**

3,807,437. THE NEXT COOL THING, INC., SANDY, UT. SN 77-092,525. PUB. 7-10-2007, FILED 1-26-2007.

THE NEXT COOL THING

THE MARK CONSISTS OF STANDARD CHARACTERS WITHOUT CLAIM TO ANY PARTICULAR FONT, STYLE, SIZE, OR COLOR.

FOR ADVERTISING AND PUBLICITY SERVICES, NAMELY, PROMOTING THE GOODS, SERVICES, BRAND IDENTITY AND COMMERCIAL INFORMATION AND NEWS OF OTHERS THROUGH PRINT, AUDIO, VIDEO, DIGITAL AND ON-LINE MEDIUM (U.S. CLS. 100, 101 AND 102).

FIRST USE 2-20-2010; IN COMMERCE 2-20-2010.

3,807,439. LINDA RILEY, BELTON, TX. SN 77-102,255. PUB. 1-8-2008, FILED 2-8-2007.

MY POLITICAL PETS

THE MARK CONSISTS OF STANDARD CHARACTERS WITHOUT CLAIM TO ANY PARTICULAR FONT, STYLE, SIZE, OR COLOR.

CLASS 35—(Continued).

NO CLAIM IS MADE TO THE EXCLUSIVE RIGHT TO USE "PETS", APART FROM THE MARK AS SHOWN.

FOR ONLINE SERVICES FOR PETS, NAMELY, AN ONLINE SURVEY FOR SURVEYING PET OWNERS REGARDING THEIR PETS' SPECIAL INTERESTS INCLUDING POLITICAL VIEWS, PET MERCHANDISE, PET SUPPLIES, AND PET INFORMATION FOR MARKETING PURPOSES AND, PROVIDING AN ASSOCIATED WEBSITE FOR ONLINE REGISTRATION BY PET OWNERS FOR CREATING A DATABASE OF SUCH SPECIAL INTERESTS FOR MARKETING PURPOSES; RETAIL STORE SERVICES AND RETAIL DISTRIBUTORSHIPS FEATURING PET SUPPLIES; COMPUTERIZED ON-LINE ORDERING SERVICES FEATURING PET SUPPLIES AND ACCESSORIES; ADMINISTRATION OF AN ONLINE PROGRAM FOR ENABLING PARTICIPANTS TO OBTAIN DISCOUNTS ON GOODS AND RECEIVE IMPROVED SERVICES FOR PETS (U.S. CLS. 100, 101 AND 102).

FIRST USE 11-1-2008; IN COMMERCE 11-1-2008.

3,807,444. FORD MOTOR COMPANY, DEARBORN, MI. SN 77-117,525. PUB. 7-17-2007, FILED 2-27-2007.

OWNER ADVANTAGE

THE MARK CONSISTS OF STANDARD CHARACTERS WITHOUT CLAIM TO ANY PARTICULAR FONT, STYLE, SIZE, OR COLOR.

OWNER OF U.S. REG. NOS. 2,381,480, 2,381,527, AND OTHERS.

FOR PROMOTING THE SALE OF GOODS AND SERVICES OF AUTOMOBILE DEALERSHIPS THROUGH AN ONLINE GLOBAL COMPUTER NETWORK, THROUGH THE DISTRIBUTION OF PRINTED MATERIAL, TELEVISION AND RADIO BROADCASTS, AND THROUGH THE ADMINISTRATION OF CUSTOMER LOYALTY PROGRAMS (U.S. CLS. 100, 101 AND 102).

FIRST USE 12-31-2007; IN COMMERCE 12-31-2007.

3,807,449. MCKINLEY MEDIA, LLC, EAU CLAIRE, WI. SN 77-132,705. PUB. 7-8-2008, FILED 3-16-2007.

YAYBOO

THE MARK CONSISTS OF STANDARD CHARACTERS WITHOUT CLAIM TO ANY PARTICULAR FONT, STYLE, SIZE, OR COLOR.

THE WORDING "YAYBOO" HAS NO MEANING IN A FOREIGN LANGUAGE.

FOR PROVIDING A WEBSITE FOR USERS TO VOTE AND TO CREATE AND TO MANIPULATE VOTING LISTS AND VOTING DATA (U.S. CLS. 100, 101 AND 102).

FIRST USE 9-0-2007; IN COMMERCE 9-0-2007.

CLASS 35—(Continued).

3,807,451. FIREOVED, THOMAS, DALLAS, TX. SN 77-145,608. PUB. 10-7-2008, FILED 3-31-2007.

Franchise Sports

THE MARK CONSISTS OF STANDARD CHARACTERS WITHOUT CLAIM TO ANY PARTICULAR FONT, STYLE, SIZE, OR COLOR.

NO CLAIM IS MADE TO THE EXCLUSIVE RIGHT TO USE "SPORTS", APART FROM THE MARK AS SHOWN.

FOR ADVERTISING AND PROMOTION SERVICES AND RELATED CONSULTING IN THE SPORTS INDUSTRY; MANAGEMENT OF PROFESSIONAL ATHLETES (U.S. CLS. 100, 101 AND 102).

FIRST USE 10-1-2007; IN COMMERCE 10-1-2007.

3,807,453. TESSCO COMMUNICATIONS INCORPORATED, HUNT VALLEY, MD. SN 77-162,744. PUB. 7-14-2009, FILED 4-23-2007.



OWNER OF U.S. REG. NOS. 1,664,567, 2,705,928, AND OTHERS.

NO CLAIM IS MADE TO THE EXCLUSIVE RIGHT TO USE "WIRELESS", APART FROM THE MARK AS SHOWN.

THE COLOR(S) RED AND BLUE IS/ARE CLAIMED AS A FEATURE OF THE MARK.

THE MARK CONSISTS OF A RED BOX AND THE WORDING "TESSCO YOUR TOTAL SOURCE FOR WIRELESS" IN BLUE.

SEC. 2(F) AS TO "YOUR TOTAL SOURCE".

FOR WHOLESALE AND RETAIL DISTRIBUTORSHIPS IN THE FIELD OF TELECOMMUNICATIONS PRODUCTS; AND BUSINESS CONSULTING SERVICES RELATING TO SUPPLY CHAIN SOLUTIONS TO THE PROFESSIONALS THAT DESIGN, BUILD, RUN, USE AND MAINTAIN WIRELESS VOICE, DATA, MESSAGING, LOCATION TRACKING AND INTERNET SYSTEMS (U.S. CLS. 100, 101 AND 102).

FIRST USE 5-0-2007; IN COMMERCE 5-0-2007.

3,807,456. MORGAN JEWELERS OF SALT LAKE CITY, INC., SALT LAKE CITY, UT. SN 77-171,723. PUB. 11-24-2009, FILED 5-3-2007.

ALWAYS BRILLIANT

THE MARK CONSISTS OF STANDARD CHARACTERS WITHOUT CLAIM TO ANY PARTICULAR FONT, STYLE, SIZE, OR COLOR.

CLASS 35—(Continued).

NO CLAIM IS MADE TO THE EXCLUSIVE RIGHT TO USE "BRILLIANT", APART FROM THE MARK AS SHOWN. FOR RETAIL JEWELRY STORE SERVICES (U.S. CLS. 100, 101 AND 102).

FIRST USE 5-31-2007; IN COMMERCE 5-31-2007.

3,807,505. NELSONQUICK GROUP, LLC, STILLWATER, OK. SN 77-283,691. PUB. 9-23-2008, FILED 9-19-2007.

PERFORMANCE FROM WITHIN

THE MARK CONSISTS OF STANDARD CHARACTERS WITHOUT CLAIM TO ANY PARTICULAR FONT, STYLE, SIZE, OR COLOR.

FOR EXPERT EVALUATIONS AND REPORTS RELATING TO INDIVIDUALS AND WORK PERFORMANCE, NAMELY, PROVIDING CUSTOMIZED ASSESSMENTS IN THE FIELD OF ORGANIZATIONAL BEHAVIOR AND MANAGEMENT (U.S. CLS. 100, 101 AND 102).

FIRST USE 12-13-2007; IN COMMERCE 12-13-2007.

3,807,529. LAS VEGAS CHAMBER OF COMMERCE LLC, LAS VEGAS, NV. SN 77-344,781. PUB. 8-19-2008, FILED 12-5-2007.

BUSINESS QUALITY OF LIFE INDEX

THE MARK CONSISTS OF STANDARD CHARACTERS WITHOUT CLAIM TO ANY PARTICULAR FONT, STYLE, SIZE, OR COLOR.

NO CLAIM IS MADE TO THE EXCLUSIVE RIGHT TO USE "BUSINESS QUALITY" AND "INDEX", APART FROM THE MARK AS SHOWN.

FOR BUSINESS CONSULTATION, PROVIDING BUSINESS REPORTS IN THE FIELD OF ECONOMIC FACTORS; PROVIDING STATISTICAL INFORMATION FOR BUSINESS AND BUSINESS DATA TO OTHERS (U.S. CLS. 100, 101 AND 102).

FIRST USE 5-9-2010; IN COMMERCE 5-9-2010.

CLASS 35—(Continued).

3,807,563. DOCTATIONS, INC., GARDEN CITY, NY. SN 77-411,989. PUB. 1-27-2009, FILED 3-3-2008.

**SHARED PATIENT DATABASE
(SPDB)**

THE MARK CONSISTS OF STANDARD CHARACTERS WITHOUT CLAIM TO ANY PARTICULAR FONT, STYLE, SIZE, OR COLOR.

NO CLAIM IS MADE TO THE EXCLUSIVE RIGHT TO USE "SHARED PATIENT DATABASE", APART FROM THE MARK AS SHOWN.

FOR PROVIDING AN INTERNET-BASED DATABASE OF PATIENT MEDICAL INFORMATION DESIGNED TO FACILITATE PATIENT-AUTHORIZED, HIPAA-COMPLIANT SHARING AND MAINTENANCE OF PATIENT MEDICAL INFORMATION AMONGST A PATIENT'S DOCTORS SUCH THAT THIS INFORMATION CAN BE DIRECTLY INSERTED INTO THE DOCTOR'S MEDICAL REPORTS AS A MEANS OF INCREASING MEDICAL RECORD GENERATION EFFICIENCY AND ACCURACY (U.S. CLS. 100, 101 AND 102).

FIRST USE 10-21-2009; IN COMMERCE 10-21-2009.

3,807,621. 20/20 COMMUNICATIONS, INC., FORT WORTH, TX. SN 77-462,549. PUB. 6-30-2009, FILED 4-30-2008.



NO CLAIM IS MADE TO THE EXCLUSIVE RIGHT TO USE "COMMUNICATIONS", APART FROM THE MARK AS SHOWN.

THE MARK CONSISTS OF THE NUMBER "20" IN A BLOCK NEXT TO THE NUMBER "20" IN ANOTHER BLOCK FORMING THE NUMBERS "2020" OVER THE WORD "COMMUNICATIONS".

FOR SALES AND MARKETING SERVICES, NAMELY, DIRECT SALES CONSULTATION, EVENT MARKETING, AND RETAIL SALES STAFFING FOR THE TELECOMMUNICATIONS, CABLE, AND ENERGY INDUSTRIES (U.S. CLS. 100, 101 AND 102).

FIRST USE 3-18-2008; IN COMMERCE 3-18-2008.

CLASS 35—(Continued).

3,807,626. TAILS & COMPANY, LLC, CHICAGO, IL. SN 77-467,229. PUB. 10-7-2008, FILED 5-6-2008.

TAILS & COMPANY

THE MARK CONSISTS OF STANDARD CHARACTERS WITHOUT CLAIM TO ANY PARTICULAR FONT, STYLE, SIZE, OR COLOR.

NO CLAIM IS MADE TO THE EXCLUSIVE RIGHT TO USE "& COMPANY", APART FROM THE MARK AS SHOWN.

FOR ONLINE RETAIL STORE SERVICES FEATURING PET SUPPLIES, PET BOWLS, PET CLOTHES, PET TOYS, PET FOOD, PET COLLARS, PET JEWELRY, PET LEASHES, PET CARRIERS, PET BEDS, PET PHOTOGRAPHS, BOOKS AND MAGAZINES CONCERNING PETS, PET GROOMING SUPPLIES AND EQUIPMENT (U.S. CLS. 100, 101 AND 102).

FIRST USE 3-25-2008; IN COMMERCE 3-25-2008.

3,807,631. MITCHELL, PACE & ASSOCIATES, INC., WAUKESHA, WI. SN 77-473,997. PUB. 1-19-2010, FILED 5-14-2008.



NO CLAIM IS MADE TO THE EXCLUSIVE RIGHT TO USE "GREEN DESIGN CENTER", APART FROM THE MARK AS SHOWN.

THE MARK CONSISTS OF TWO LEAVES ABOVE THE WORDS "GREEN DESIGNCENTER".

FOR RETAIL STORE SERVICES FEATURING INTERIOR DESIGN ITEMS, CONSTRUCTION MATERIALS AND BUILDING MATERIALS (U.S. CLS. 100, 101 AND 102).

FIRST USE 3-1-2009; IN COMMERCE 3-1-2009.

CLASS 35—(Continued).

3,807,653. MARITZ HOLDINGS INC., FENTON, MO. SN 77-502,116. PUB. 7-7-2009, FILED S.R. 6-18-2008; AM. P.R. 5-28-2009.

REWARDS DIRECT BY MARITZ

THE MARK CONSISTS OF STANDARD CHARACTERS WITHOUT CLAIM TO ANY PARTICULAR FONT, STYLE, SIZE, OR COLOR.

OWNER OF U.S. REG. NOS. 747,058, 1,438,281, AND 3,090,911.

SEC. 2(F) AS TO "REWARDS DIRECT" AND "MARITZ". FOR MAIL-ORDER AND ELECTRONIC ONLINE CATALOG SERVICES FEATURING DO-IT-YOURSELF TOOLS AND POWER TOOLS, ELECTRONICS, APPLIANCES, HOME PRODUCTS, HOUSEWARES, FOOD, FLOWERS, ACCESSORIES, HANDBAGS, FASHION, JEWELRY, WATCHES, HEALTH, BEAUTY, FITNESS, CHILDREN'S RECREATION AND EDUCATION, OUTDOOR LIVING, PETS, AND SPORTS MERCHANDISE OFFERED IN CONNECTION WITH SALES, PERFORMANCE AND LOYALTY INCENTIVE PROGRAMS FOR EMPLOYEES, DISTRIBUTORS, PARTNERS AND CUSTOMERS (U.S. CLS. 100, 101 AND 102).

FIRST USE 8-12-2008; IN COMMERCE 8-12-2008.

3,807,655. KP STYLE LTD., DMITROVSKOE SHOSSE, RUSSIAN FED.. SN 77-503,622. PUB. 7-28-2009, FILED 6-19-2008.

KIRA PLASTININA

THE MARK CONSISTS OF STANDARD CHARACTERS WITHOUT CLAIM TO ANY PARTICULAR FONT, STYLE, SIZE, OR COLOR.

OWNER OF U.S. REG. NOS. 3,352,727 AND 3,539,344.

THE NAME PLASTININA KIRA SERGEEVNA IS THE NAME OF A LIVING INDIVIDUAL WHOSE CONSENT TO THE REGISTRATION OF HER NAME IN THE FORM "KIRA PLASTININA" IS OF RECORD.

FOR RETAIL STORE SERVICES FEATURING COSMETICS, SOAP, PERFUME, NON-MEDICATED SKIN CARE PREPARATIONS, NON-MEDICATED HAIR CARE PREPARATIONS, DEODORANTS, BEAUTY CREAMS FOR BODY CARE, EYEWEAR, ACCESSORIES OF EYEWEAR, NAMELY, STRAPS, NECK CORDS, JEWELRY, WATCHES, CLOCKS, ACCESSORIES, NAMELY, BRACELETS, CHARMS, BROOCHES, ORNAMENTAL PINS, LUGGAGE, ALL PURPOSE CARRYING BAGS, CLOTHING, NAMELY, TROUSERS, BREECHES FOR WEAR, OVERCOATS, JACKETS, VESTS, TURTLENECKS, OVERALLS, SKIRTS, FROCKS, HEADGEAR, NAMELY, KNITTED HEADWEAR, CAPS, CAP PEAKS, HEADBANDS, FOOTWEAR (U.S. CLS. 100, 101 AND 102).

FIRST USE 3-0-2007; IN COMMERCE 5-0-2008.

CLASS 35—(Continued).

3,807,657. HANSO CORPORATION, BETHESDA, MD. SN 77-508,688. PUB. 3-3-2009, FILED 6-26-2008.

klaggle

THE MARK CONSISTS OF STANDARD CHARACTERS WITHOUT CLAIM TO ANY PARTICULAR FONT, STYLE, SIZE, OR COLOR.

THE WORDING "KLAGGLE" HAS NO MEANING IN A FOREIGN LANGUAGE.

FOR PROVIDING ONLINE CONSUMER PRODUCT AND SERVICE INFORMATION VIA THE INTERNET; PROVIDING ONLINE INFORMATION REGARDING MARKET RESEARCH AND ANALYSIS FOR CONSUMER PRODUCTS AND SERVICES VIA THE INTERNET (U.S. CLS. 100, 101 AND 102).

FIRST USE 10-30-2009; IN COMMERCE 10-30-2009.

3,807,676. EMPLOYER HEALTH CARE ALLIANCE COOPERATIVE, MADISON, WI. SN 77-529,991. PUB. 6-16-2009, FILED 7-23-2008.

THE ALLIANCE 
Employers moving health care forward

OWNER OF U.S. REG. NO. 2,408,779.

THE MARK CONSISTS OF THE WORDS "THE ALLIANCE", WITH THE WORDS "EMPLOYERS MOVING HEALTH CARE FORWARD" DIRECTLY UNDERNEATH, ALONG WITH AN ARROW DESIGN DIRECTLY TO THE RIGHT OF THE WORDS "THE ALLIANCE EMPLOYERS MOVING HEALTH CARE FORWARD".

FOR BUSINESS MANAGEMENT AND CONSULTATION SERVICES RELATING TO COOPERATIVE HEALTHCARE PURCHASING (U.S. CLS. 100, 101 AND 102).

FIRST USE 9-5-2008; IN COMMERCE 9-5-2008.

3,807,677. EMPLOYER HEALTH CARE ALLIANCE COOPERATIVE, MADISON, WI. SN 77-529,999. PUB. 6-16-2009, FILED 7-23-2008.

THE ALLIANCE

THE MARK CONSISTS OF STANDARD CHARACTERS WITHOUT CLAIM TO ANY PARTICULAR FONT, STYLE, SIZE, OR COLOR.

CLASS 35—(Continued).

OWNER OF U.S. REG. NO. 2,408,779.

FOR BUSINESS MANAGEMENT AND CONSULTATION SERVICES RELATING TO COOPERATIVE HEALTHCARE PURCHASING (U.S. CLS. 100, 101 AND 102).

FIRST USE 12-31-1990; IN COMMERCE 12-31-1990.

3,807,679. MONTERREY PROVISION COMPANY, SAN DIEGO, CA. SN 77-531,432. PUB. 3-10-2009, FILED 7-25-2008.

GOLDEN SELECTIONS
FOODSERVICE

THE MARK CONSISTS OF STANDARD CHARACTERS WITHOUT CLAIM TO ANY PARTICULAR FONT, STYLE, SIZE, OR COLOR.

NO CLAIM IS MADE TO THE EXCLUSIVE RIGHT TO USE "SELECTIONS FOODSERVICE", APART FROM THE MARK AS SHOWN.

FOR STREET VENDOR SERVICES FEATURING FOOD; VENDING IN THE FIELD OF FOOD; WHOLESALE FOOD DISTRIBUTORSHIP SERVICES (U.S. CLS. 100, 101 AND 102).

FIRST USE 7-1-2008; IN COMMERCE 7-15-2008.

3,807,704. HAN GROUP LLC, MCLEAN, VA. SN 77-546,970. PUB. 8-4-2009, FILED 8-14-2008.

HAN GROUP

THE MARK CONSISTS OF STANDARD CHARACTERS WITHOUT CLAIM TO ANY PARTICULAR FONT, STYLE, SIZE, OR COLOR.

NO CLAIM IS MADE TO THE EXCLUSIVE RIGHT TO USE "GROUP", APART FROM THE MARK AS SHOWN.

FOR ACCOUNTING SERVICES; ACCOUNTING CONSULTATION; PROVIDING TAX AND ACCOUNTING INFORMATION; CONSULTATION, CALCULATION, PREPARATION AND FILING SERVICES AND BUSINESS MANAGEMENT CONSULTING; CONSULTING SERVICES, NAMELY, EXPERT ANALYSIS AND MANAGEMENT CONSULTING IN ECONOMICS AND ACCOUNTING; BUSINESS INFORMATION AND ACCOUNTING ADVISORY SERVICES; ACCOUNT AUDITING; ADMINISTRATIVE ACCOUNTING; ADMINISTRATION, BILLING AND RECONCILIATION OF ACCOUNTS ON BEHALF OF OTHERS (U.S. CLS. 100, 101 AND 102).

FIRST USE 10-31-2008; IN COMMERCE 10-31-2008.

CLASS 35—(Continued).

3,807,718. SAVORY SPICE SHOP, INC., DENVER, CO. SN 77-554,048. PUB. 7-21-2009, FILED 8-22-2008.



OWNER OF U.S. REG. NO. 3,605,176.

NO CLAIM IS MADE TO THE EXCLUSIVE RIGHT TO USE "SPICE SHOP", APART FROM THE MARK AS SHOWN.

THE MARK CONSISTS OF A DESIGN WITH THE WORD "SAVORY" BELOW IT AND THE WORDS "SPICE SHOP" BELOW THE WORD "SAVORY".

FOR RETAIL STORE AND RETAIL STORE SERVICES FEATURING SPICES, SPICE BLENDS, SEASONINGS, PROCESSED HERBS NOT WITHIN THE GENUS SATUREJA, EXTRACTS USED FOR FLAVORING; ONLINE RETAIL STORE SERVICES FEATURING SPICES, SPICE BLENDS, SEASONINGS, PROCESSED HERBS NOT WITHIN THE GENUS SATUREJA, EXTRACTS USED FOR FLAVORING; FRANCHISE SERVICES, NAMELY, OFFERING TECHNICAL AND BUSINESS MANAGEMENT ASSISTANCE IN THE ESTABLISHMENT AND OPERATION OF RETAIL SPICE STORES (U.S. CLS. 100, 101 AND 102).

FIRST USE 3-9-2009; IN COMMERCE 3-9-2009.

3,807,720. THE WECK CORPORATION, NEW YORK, NY. SN 77-554,726. PUB. 7-14-2009, FILED 8-25-2008.

GRACIOUS HOME

est. 1963

OWNER OF U.S. REG. NOS. 3,264,838, 3,408,659, AND OTHERS.

NO CLAIM IS MADE TO THE EXCLUSIVE RIGHT TO USE "EST. 1963", APART FROM THE MARK AS SHOWN.

THE MARK CONSISTS OF "GRACIOUS HOME EST. 1963".

FOR ONLINE RETAIL AND RETAIL STORE SERVICES IN THE FIELD OF RETAIL GIFT, HARDWARE, HOUSE WARES AND HOME FURNISHINGS (U.S. CLS. 100, 101 AND 102).

FIRST USE 1-0-2009; IN COMMERCE 1-0-2009.

CLASS 35—(Continued).

3,807,725. ROCK BOTTOM PROPERTY, INC., MIAMI, FL. SN 77-556,929. PUB. 8-25-2009, FILED 8-27-2008.



THE MARK CONSISTS OF THE WORDS "ROCK BOTTOM" WITH A VERTICAL LINE SEPARATING THEM. FOR REAL ESTATE ADVERTISING SERVICES (U.S. CLS. 100, 101 AND 102). FIRST USE 10-0-2008; IN COMMERCE 10-0-2008.

3,807,726. ROCK BOTTOM PROPERTY, INC., MIAMI, FL. SN 77-556,931. PUB. 8-25-2009, FILED 8-27-2008.

ROCK BOTTOM

THE MARK CONSISTS OF STANDARD CHARACTERS WITHOUT CLAIM TO ANY PARTICULAR FONT, STYLE, SIZE, OR COLOR. FOR REAL ESTATE ADVERTISING SERVICES (U.S. CLS. 100, 101 AND 102). FIRST USE 10-0-2008; IN COMMERCE 10-0-2008.

3,807,731. INTERO FRANCHISE SERVICES, INC., CUPERTINO, CA. SN 77-558,025. PUB. 1-20-2009, FILED 8-28-2008.

INTERO ANDARE

THE MARK CONSISTS OF STANDARD CHARACTERS WITHOUT CLAIM TO ANY PARTICULAR FONT, STYLE, SIZE, OR COLOR. OWNER OF U.S. REG. NOS. 3,046,209, 3,097,514, AND OTHERS. THE ENGLISH TRANSLATION OF "INTERO ANDARE" IS "ENTIRE TO GO". FOR FRANCHISE SERVICES, NAMELY, OFFERING BUSINESS MANAGEMENT ASSISTANCE IN THE ESTABLISHMENT AND OPERATION OF REAL ESTATE BROKERAGE OFFICES (U.S. CLS. 100, 101 AND 102). FIRST USE 4-11-2010; IN COMMERCE 4-11-2010.

CLASS 35—(Continued).

3,807,735. BBY SOLUTIONS, INC., RICHFIELD, MN. SN 77-559,242. PUB. 3-10-2009, FILED 8-29-2008.



OWNER OF U.S. REG. NOS. 2,196,852, 3,416,626, AND OTHERS.

THE MARK CONSISTS OF THE WORDS "BEST BUY" AND A TAG DESIGN.

SEC. 2(F) AS TO "BEST BUY". FOR RETAIL STORE SERVICES IN THE FIELD OF CONSUMER ELECTRONICS, MAJOR HOUSEHOLD APPLIANCES, HOME THEATER EQUIPMENT, PHOTOGRAPHIC EQUIPMENT, CELLULAR PHONES, TELECOMMUNICATIONS PRODUCTS AND SERVICES, INFORMATION TECHNOLOGY PRODUCTS, VIDEO EQUIPMENT, AUDIO EQUIPMENT, PORTABLE ELECTRONIC DEVICES AND RELATED ACCESSORIES, PERSONAL COMPUTERS AND OTHER HOME OFFICE PRODUCTS, IMAGING EQUIPMENT, DIGITAL EQUIPMENT, VIDEO AND ELECTRONIC GAMES, VIDEO AND ELECTRONIC GAME EQUIPMENT AND ACCESSORIES, ENTERTAINMENT FURNITURE, COMPUTER SOFTWARE, ENTERTAINMENT SOFTWARE, COMPACT DISCS, DIGITAL VERSATILE DISCS OR DVDS, AUDIO AND VIDEO RECORDINGS, GIFT CARDS, BOOKS, MAGAZINES, BATTERIES, AUTOMOTIVE AUDIO EQUIPMENT; PROVISION OF CONSUMER PRODUCT INFORMATION AND CONSUMER ADVICE RELATING TO THE FOREGOING (U.S. CLS. 100, 101 AND 102).

FIRST USE 8-7-2008; IN COMMERCE 8-7-2008.

3,807,749. SUMMIT AUTOMOTIVE, LLC, GREENWOOD VILLAGE, CO. SN 77-563,573. PUB. 7-14-2009, FILED 9-5-2008.

THIS IS WHERE IT'S AT.

THE MARK CONSISTS OF STANDARD CHARACTERS WITHOUT CLAIM TO ANY PARTICULAR FONT, STYLE, SIZE, OR COLOR. FOR AUTOMOBILE DEALERSHIPS (U.S. CLS. 100, 101 AND 102). FIRST USE 1-19-2009; IN COMMERCE 1-19-2009.

CLASS 35—(Continued).

3,807,773. SHAREMEISTER, LLC, FRESNO, CA. SN 77-570,874. PUB. 7-28-2009, FILED 9-16-2008.

SHAREMEISTER

THE MARK CONSISTS OF STANDARD CHARACTERS WITHOUT CLAIM TO ANY PARTICULAR FONT, STYLE, SIZE, OR COLOR.

FOR ONLINE ADVERTISING ON COMPUTER COMMUNICATION NETWORKS; ONLINE RETAIL STORE SERVICES FEATURING MUSIC, VIDEOS, TELEVISION PROGRAMS, MOVIES, GAMES, BOOKS, ARTICLES, MAGAZINES AND OTHER ELECTRONIC PRINT; PROVIDING ONLINE TRACKING OF DIGITAL MEDIA PRINT FOR FINANCIAL COMPENSATION FOR OTHERS, FEATURING MUSIC, VIDEOS, TELEVISION PROGRAMS, MOVIES, GAMES, BOOKS, ARTICLES, MAGAZINES AND OTHER ELECTRONIC; FACILITATING THE EXCHANGE OF DIGITAL MEDIA FEATURING MUSIC, VIDEOS, TELEVISION PROGRAMS, MOVIES, GAMES, BOOKS, ARTICLES, MAGAZINES AND OTHER ELECTRONIC PRINT FOR FINANCIAL COMPENSATION VIA THE INTERNET; COMPUTERIZED ONLINE RETAIL STORE SERVICES IN THE FIELD OF ENTERTAINMENT, NAMELY, MUSIC, VIDEOS, TELEVISION PROGRAMS, MOVIES, GAMES, BOOKS, ARTICLES, MAGAZINES AND OTHER ELECTRONIC PRINT; FACILITATING THE EXCHANGE OF TANGIBLE ENTERTAINMENT RELATED GOODS AND SERVICES, NAMELY, MUSIC, VIDEOS, TELEVISION PROGRAMS, MOVIES, GAMES, BOOKS, ARTICLES, MAGAZINES AND OTHER PRINT MEDIA FOR FINANCIAL COMPENSATION VIA THE INTERNET; ONLINE DISTRIBUTION OF ADVERTISEMENTS OF OTHERS (U.S. CLS. 100, 101 AND 102).

FIRST USE 11-30-2007; IN COMMERCE 11-30-2007.

CLASS 35—(Continued).

3,807,774. SHAREMEISTER, LLC, FRESNO, CA. SN 77-570,895. PUB. 7-28-2009, FILED 9-16-2008.

COST-PER-TIME

THE MARK CONSISTS OF STANDARD CHARACTERS WITHOUT CLAIM TO ANY PARTICULAR FONT, STYLE, SIZE, OR COLOR.

FOR ONLINE ADVERTISING ON COMPUTER COMMUNICATION NETWORKS; ONLINE RETAIL STORE SERVICES FEATURING MUSIC, VIDEOS, TELEVISION PROGRAMS, MOVIES, GAMES, BOOKS, ARTICLES, MAGAZINES AND OTHER ELECTRONIC PRINT; PROVIDING ONLINE TRACKING OF DIGITAL MEDIA PRINT FOR FINANCIAL COMPENSATION FOR OTHERS, FEATURING MUSIC, VIDEOS, TELEVISION PROGRAMS, MOVIES, GAMES, BOOKS, ARTICLES, MAGAZINES AND OTHER ELECTRONIC; FACILITATING THE EXCHANGE OF DIGITAL MEDIA FEATURING MUSIC, VIDEOS, TELEVISION PROGRAMS, MOVIES, GAMES, BOOKS, ARTICLES, MAGAZINES AND OTHER ELECTRONIC PRINT FOR FINANCIAL COMPENSATION VIA THE INTERNET; COMPUTERIZED ONLINE RETAIL STORE SERVICES IN THE FIELD OF ENTERTAINMENT, NAMELY, MUSIC, VIDEOS, TELEVISION PROGRAMS, MOVIES, GAMES, BOOKS, ARTICLES, MAGAZINES AND OTHER ELECTRONIC PRINT; FACILITATING THE EXCHANGE OF TANGIBLE ENTERTAINMENT RELATED GOODS AND SERVICES, NAMELY, MUSIC, VIDEOS, TELEVISION PROGRAMS, MOVIES, GAMES, BOOKS, ARTICLES, MAGAZINES AND OTHER PRINT MEDIA FOR FINANCIAL COMPENSATION VIA THE INTERNET; ONLINE DISTRIBUTION OF ADVERTISEMENTS OF OTHERS (U.S. CLS. 100, 101 AND 102).

FIRST USE 5-30-2008; IN COMMERCE 5-30-2008.

3,807,778. ALLEGHENY CONFERENCE ON COMMUNITY DEVELOPMENT, PITTSBURGH, PA. SN 77-571,195. PUB. 2-24-2009, FILED 9-16-2008.

COMPETEPA

THE MARK CONSISTS OF STANDARD CHARACTERS WITHOUT CLAIM TO ANY PARTICULAR FONT, STYLE, SIZE, OR COLOR.

FOR PROMOTION OF BUSINESS OPPORTUNITIES (U.S. CLS. 100, 101 AND 102).

FIRST USE 5-31-2005; IN COMMERCE 5-31-2005.

CLASS 35—(Continued).

3,807,779. ALLEGHENY CONFERENCE ON COMMUNITY DEVELOPMENT, PITTSBURGH, PA. SN 77-571,201. PUB. 2-24-2009, FILED 9-16-2008.



NO CLAIM IS MADE TO THE EXCLUSIVE RIGHT TO USE THE PICTORIAL REPRESENTATION OF THE STATE OF PENNSYLVANIA, APART FROM THE MARK AS SHOWN.

THE MARK CONSISTS OF A SILHOUETTE OF THE STATE OF PENNSYLVANIA WITH A VERTICAL ARROW IN THE MIDDLE OF THE SILHOUETTE WITH THE POINT ORIENTED UPWARD.

FOR PROMOTION OF BUSINESS OPPORTUNITIES (U.S. CLS. 100, 101 AND 102).

FIRST USE 5-31-2005; IN COMMERCE 5-31-2005.

3,807,809. MID PAC PETROLEUM, LLC., HONOLULU, HI. SN 77-582,479. PUB. 2-17-2009, FILED 9-30-2008.

Kama`aina Rewards

THE MARK CONSISTS OF STANDARD CHARACTERS WITHOUT CLAIM TO ANY PARTICULAR FONT, STYLE, SIZE, OR COLOR.

NO CLAIM IS MADE TO THE EXCLUSIVE RIGHT TO USE "REWARDS", APART FROM THE MARK AS SHOWN.

FOR ARRANGING AND CONDUCTING INCENTIVE REWARD PROGRAMS TO PROMOTE THE SALE OF PETROLEUM AND OTHER PRODUCTS; CONTESTS AND INCENTIVE AWARD PROGRAMS TO PROMOTE THE SALE OF PRODUCTS AND SERVICES OF OTHERS; INCENTIVE AWARD PROGRAMS TO PROMOTE THE SALE OF PRODUCTS AND SERVICES OF OTHERS (U.S. CLS. 100, 101 AND 102).

FIRST USE 6-1-2008; IN COMMERCE 6-1-2008.

CLASS 35—(Continued).

3,807,822. LEIFER, MICHAEL, FAIRFAX, CA. SN 77-587,399. PUB. 8-18-2009, FILED 10-7-2008.



THE MARK CONSISTS OF THE TERM "ECODADS" IN LOWER CASE LETTERS WITH A STYLIZED SQUARE ENCOMPASSING THE LETTER "E".

FOR PROMOTING PUBLIC AWARENESS OF GLOBAL WARMING, CLIMATE CHANGE AND ENVIRONMENTAL ISSUES; PUBLIC ADVOCACY TO PROMOTE AWARENESS OF GLOBAL WARMING, CLIMATE CHANGE AND ENVIRONMENTAL ISSUES; PROVIDING CONSUMER INFORMATION IN THE FIELDS OF GLOBAL WARMING, CLIMATE CHANGE AND THE ENVIRONMENT; PROVIDING AN INTERNET WEBSITE TO PROMOTE PUBLIC AWARENESS OF GLOBAL WARMING, CLIMATE CHANGE AND ENVIRONMENTAL ISSUES; ORGANIZING FATHERS TO CONDUCT PROGRAMS AND COMMUNITY SERVICE PROJECTS TO REDUCE GLOBAL WARMING AND CLIMATE CHANGE; ON-LINE RETAIL STORE SERVICES FEATURING PRODUCTS THAT HELP PRESERVE THE ENVIRONMENT AND PREVENT GLOBAL WARMING AND CLIMATE CHANGE, NAMELY, HOME IMPROVEMENT PRODUCTS, CHILD CARE PRODUCTS, KITCHEN PRODUCTS, HOME FURNISHINGS, LAWN AND GARDEN PRODUCTS, HEATING AND COOLING FIXTURES, PEST CONTROL PRODUCTS, AUTOMOTIVE PRODUCTS, CAMPING PRODUCTS, PERSONAL CARE PRODUCTS, FURNITURE, CLOTHING, WATER TESTING AND PURIFICATION PRODUCTS, TOYS AND GAMES, HOME CLEANING AND JANITORIAL PRODUCTS, ART SUPPLIES, OFFICE REQUISITES, JEWELRY, MUSICAL INSTRUMENTS, REUSABLE SHOPPING BAGS, LUGGAGE, PET CARE PRODUCTS, HOME SAFETY PRODUCTS, POOL AND SPA SUPPLIES AND ELECTROMAGNETIC FIELD DETECTION AND PROTECTION PRODUCTS (U.S. CLS. 100, 101 AND 102).

FIRST USE 5-5-2009; IN COMMERCE 6-17-2009.

3,807,840. MARLENE GUMMO, DBA 3PSOURCING, WASHINGTON, DC. SN 77-598,609. PUB. 3-17-2009, FILED 10-22-2008.



NO CLAIM IS MADE TO THE EXCLUSIVE RIGHT TO USE "SOURCING", APART FROM THE MARK AS SHOWN. THE COLOR(S) ORANGE, WHITE, AND BLACK IS/ARE CLAIMED AS A FEATURE OF THE MARK.

THE MARK CONSISTS OF THE STYLIZED CHARAC-

CLASS 35—(Continued).

TERS "3P" IN WHITE SURROUNDED BY THE DESIGN OF ORANGE SQUARE. ABOVE THE WHITE NUMERAL "3" THERE IS A WHITE DOT AND ABOVE THE WHITE LETTER "P" THERE IS A WHITE DOT. NEXT TO THE ORANGE SQUARE IS THE STYLIZED CHARACTERS "3P" IN ORANGE AND THE STYLIZED WORDING "SOURCING" IN BLACK. THE STYLIZED WORDING "SUSTAINING PEOPLE, PLANET, PROFIT" APPEARS IN ORANGE, BELOW THE ORANGE CHARACTERS "3P" AND BLACK WORDING "SOURCING".

FOR IMPORT AND EXPORT AGENCIES (U.S. CLS. 100, 101 AND 102).

FIRST USE 11-1-2008; IN COMMERCE 12-1-2008.

3,807,844. S.N.MOORE ENTERPRISES, L.L.C., HOWELL, MI. SN 77-599,511. PUB. 3-24-2009, FILED 10-23-2008.

MY CRATE MOTOR

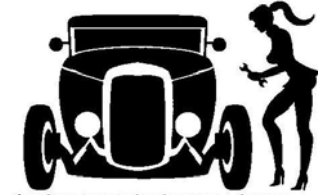

HOT ROD, OEM, PERFORMANCE & RACING
MYCRATEMOTOR.COM
HOWELL MI.

NO CLAIM IS MADE TO THE EXCLUSIVE RIGHT TO USE "CRATE MOTOR", "HOT ROD, OEM, PERFORMANCE & RACING" AND "HOWELL MI", APART FROM THE MARK AS SHOWN.

THE MARK CONSISTS OF A SILHOUETTE OF A HOT ROD CAR AND A GIRL WITH SKIRT AND PONYTAIL, HOLDING A WRENCH.

FOR ON-LINE RETAIL STORE SERVICES FEATURING CLOTHING AND CRATE ENGINES (U.S. CLS. 100, 101 AND 102).

FIRST USE 10-23-2008; IN COMMERCE 10-23-2008.

3,807,860. PRICEFALLS, LLC, LAS VEGAS, NV. SN 77-609,332. PUB. 3-31-2009, FILED 11-6-2008.

PRICEFALLS

THE MARK CONSISTS OF STANDARD CHARACTERS WITHOUT CLAIM TO ANY PARTICULAR FONT, STYLE, SIZE, OR COLOR.

FOR AUCTION MANAGEMENT SERVICES PROVIDED TO OTHERS OVER AN ON-LINE WEB SITE ACCESSED THROUGH A GLOBAL COMPUTER NETWORK; AUCTIONING VIA TELECOMMUNICATION NETWORKS (U.S. CLS. 100, 101 AND 102).

FIRST USE 8-16-2008; IN COMMERCE 8-16-2008.

CLASS 35—(Continued).

3,807,861. PRICEFALLS, LLC, LAS VEGAS, NV. SN 77-609,341. PUB. 3-31-2009, FILED 11-6-2008.



THE MARK CONSISTS OF LETTERS "PF" IN A BOX. FOR AUCTION MANAGEMENT SERVICES PROVIDED TO OTHERS OVER AN ON-LINE WEB SITE ACCESSED THROUGH A GLOBAL COMPUTER NETWORK; AUCTIONING VIA TELECOMMUNICATION NETWORKS (U.S. CLS. 100, 101 AND 102).

FIRST USE 8-16-2008; IN COMMERCE 8-16-2008.

3,807,863. MEHYPE, LLC, DAYTONA BEACH, FL. SN 77-610,730. PUB. 11-3-2009, FILED 11-10-2008.

MeHype

THE MARK CONSISTS OF STANDARD CHARACTERS WITHOUT CLAIM TO ANY PARTICULAR FONT, STYLE, SIZE, OR COLOR.

FOR ON-LINE ADVERTISING AND MARKETING SERVICES (U.S. CLS. 100, 101 AND 102).

FIRST USE 7-1-2009; IN COMMERCE 7-1-2009.

CLASS 35—(Continued).

3,807,878. SUE LECRAW, ATLANTA, GA. SN 77-618,525.
PUB. 8-4-2009, FILED 11-20-2008.

WORLD HEADQUARTERS

THE MARK CONSISTS OF STANDARD CHARACTERS WITHOUT CLAIM TO ANY PARTICULAR FONT, STYLE, SIZE, OR COLOR.

FOR PROMOTING AWARENESS OF THE NEED TO PRESERVE THE ENVIRONMENT AND CONSERVE NATURAL RESOURCES; PROMOTING AWARENESS OF THE NEED FOR A SUSTAINABLE ENVIRONMENT; ON-LINE, RETAIL, AND MAIL-ORDER STORE SERVICES FEATURING HOUSEWARES, APPLIANCES, FURNITURE, JEWELRY, CLOTHING, ART, FURNITURE, FOOD PRODUCTS, GARDEN SEEDS, GARDEN SUPPLIES, AND GENERAL MERCHANDISE; PROVIDING INFORMATION IN THE FIELD OF ENVIRONMENTAL AWARENESS, NAMELY, INFORMATION ABOUT PROMOTING PUBLIC AWARENESS OF ENVIRONMENTAL ISSUES AND INITIATIVES (U.S. CLS. 100, 101 AND 102).

FIRST USE 4-27-2010; IN COMMERCE 4-27-2010.

3,807,980. SCHORR, MELISSA, NEW YORK, NY. SN 77-677,554. PUB. 11-3-2009, FILED 2-24-2009.

DivorceYourJewelry

THE MARK CONSISTS OF STANDARD CHARACTERS WITHOUT CLAIM TO ANY PARTICULAR FONT, STYLE, SIZE, OR COLOR.

FOR A SCRAP DEALERSHIP, NAMELY, FOR THE PURCHASE OF SCRAP JEWELRY FOR MELTING DOWN (U.S. CLS. 100, 101 AND 102).

FIRST USE 4-18-2009; IN COMMERCE 4-18-2009.

3,808,010. KIDROBOT, INC., NEW YORK, NY. SN 77-686,575.
PUB. 9-22-2009, FILED 3-9-2009.

BEAUTIFUL PLASTIC

THE MARK CONSISTS OF STANDARD CHARACTERS WITHOUT CLAIM TO ANY PARTICULAR FONT, STYLE, SIZE, OR COLOR.

CLASS 35—(Continued).

NO CLAIM IS MADE TO THE EXCLUSIVE RIGHT TO USE "PLASTIC", APART FROM THE MARK AS SHOWN.

FOR WHOLESALE DISTRIBUTORSHIP SERVICES FEATURING TOYS AND CLOTHING (U.S. CLS. 100, 101 AND 102).

FIRST USE 4-29-2009; IN COMMERCE 4-29-2009.

3,808,011. TSA STORES, INC., ENGLEWOOD, CO. SN 77-687,217. PUB. 8-4-2009, FILED 3-10-2009.

RUNNING AUTHORITY

THE MARK CONSISTS OF STANDARD CHARACTERS WITHOUT CLAIM TO ANY PARTICULAR FONT, STYLE, SIZE, OR COLOR.

OWNER OF U.S. REG. NOS. 1,529,035, 3,386,679, AND OTHERS.

NO CLAIM IS MADE TO THE EXCLUSIVE RIGHT TO USE "RUNNING", APART FROM THE MARK AS SHOWN.

FOR RETAIL STORE SERVICES IN THE FIELD OF SPORTING GOODS AND EQUIPMENT, APPAREL, FOOTWEAR, HEADGEAR AND RELATED GOODS AND SERVICES (U.S. CLS. 100, 101 AND 102).

FIRST USE 4-11-2010; IN COMMERCE 4-11-2010.

3,808,031. WHITE STONE FOODS LLC, WESTON, FL. SN 77-690,584. PUB. 7-14-2009, FILED 3-13-2009.

Keepin' it REAL

THE MARK CONSISTS OF STANDARD CHARACTERS WITHOUT CLAIM TO ANY PARTICULAR FONT, STYLE, SIZE, OR COLOR.

FOR FRANCHISE SERVICES, NAMELY, OFFERING BUSINESS MANAGEMENT ASSISTANCE IN THE ESTABLISHMENT AND OPERATION OF RESTAURANTS (U.S. CLS. 100, 101 AND 102).

FIRST USE 4-17-2008; IN COMMERCE 4-17-2008.

CLASS 35—(Continued).

3,808,036. SPACE-TIME COMMUNICATIONS, INC., GASTONIA, NC. SN 77-691,821. PUB. 7-21-2009, FILED 3-16-2009.

SAY IT HERE

THE MARK CONSISTS OF STANDARD CHARACTERS WITHOUT CLAIM TO ANY PARTICULAR FONT, STYLE, SIZE, OR COLOR.

FOR AGENCIES FOR ADVERTISING TIME AND SPACE; COOPERATIVE ADVERTISING AND MARKETING; PLACING ADVERTISEMENTS FOR OTHERS; PROVIDING CONSULTING SERVICES IN THE FIELD OF FACILITATING THE PLANNING, BUYING, AND SELLING OF MEDIA (U.S. CLS. 100, 101 AND 102).

FIRST USE 11-30-2009; IN COMMERCE 11-30-2009.

3,808,057. ELECTRONIC IMAGING SERVICES, INC., DBA VESTCOM RETAIL SOLUTIONS, LITTLE ROCK, AR. SN 77-695,249. PUB. 7-21-2009, FILED 3-19-2009.



THE MARK CONSISTS OF THE WORD "PEGASSIST" TO THE RIGHT OF FOUR SETS OF A 3-DIMENSIONAL ABSTRACT DESIGN CONSISTING OF THREE SQUARES JOINED TOGETHER BY A ROD.

FOR MARKETING SERVICES, NAMELY, ARRANGING AND CONDUCTING MARKETING AND PRODUCT PLACEMENT PROMOTIONAL CAMPAIGNS FOR RETAILERS (U.S. CLS. 100, 101 AND 102).

FIRST USE 4-0-2009; IN COMMERCE 4-0-2009.

3,808,070. UHS OF DELAWARE, INC., KING OF PRUSSIA, PA. SN 77-697,478. PUB. 7-7-2009, FILED 3-24-2009.



OWNER OF U.S. REG. NOS. 2,026,844 AND 3,497,241.
NO CLAIM IS MADE TO THE EXCLUSIVE RIGHT TO USE "KIDS" AND "HEALTH SYSTEM", APART FROM THE MARK AS SHOWN.

CLASS 35—(Continued).

THE MARK CONSISTS OF A STAR TO DOT THE "I" IN THE WORD "KIDS" AND A SUNBURST IN THE WORD "ADVANTAGE", WITH THE WORDS "THE VALLEY HEALTH SYSTEM" UNDERNEATH.

SEC. 2(F) AS TO "THE VALLEY HEALTH SYSTEM".

FOR ADMINISTRATION OF A DISCOUNT PROGRAM FOR ENABLING PARTICIPANTS TO OBTAIN FREE AND DISCOUNTED GOODS AND SERVICES THAT HELP ENHANCE THE HEALTH AND WELL-BEING OF CHILDREN, THROUGH THE USE OF A DISCOUNT MEMBERSHIP CARD (U.S. CLS. 100, 101 AND 102).

FIRST USE 5-0-2009; IN COMMERCE 5-0-2009.

3,808,074. WINE GEEKS LLC, NEW YORK, NY. SN 77-697,695. PUB. 7-28-2009, FILED 3-24-2009.



NO CLAIM IS MADE TO THE EXCLUSIVE RIGHT TO USE "WINE" AND "ARMONK", APART FROM THE MARK AS SHOWN.

THE MARK CONSISTS OF THE STYLIZED TEXT "WINE GEEKS ARMONK" WITH A CORKSCREW IN THE MIDDLE.

FOR RETAIL STORES FEATURING WINE AND WINE ACCESSORIES (U.S. CLS. 100, 101 AND 102).

FIRST USE 10-7-2007; IN COMMERCE 6-4-2009.

3,808,096. DOLLARS INSIDE FRANCHISING LLC, CAPE CORAL, FL. SN 77-700,145. PUB. 7-28-2009, FILED 3-26-2009.

LeadPay

THE MARK CONSISTS OF STANDARD CHARACTERS WITHOUT CLAIM TO ANY PARTICULAR FONT, STYLE, SIZE, OR COLOR.

FOR FRANCHISE SERVICES, NAMELY, OFFERING BUSINESS MANAGEMENT ASSISTANCE IN THE ESTABLISHMENT AND OPERATION OF BUSINESS ENTITIES WHICH CREATE, MARKET AND DISTRIBUTE ADVERTISING PAMPHLETS AND COUPON BOOKS DESIGNED TO PROMOTE THE GOODS AND SERVICES OF OTHERS (U.S. CLS. 100, 101 AND 102).

FIRST USE 5-22-2009; IN COMMERCE 5-22-2009.

CLASS 35—(Continued).

3,808,099. PORTO FRANCO RECORDS, LLC, SAN FRANCISCO, CA. SN 77-700,409. PUB. 7-21-2009, FILED 3-26-2009.

PORTO FRANCO RECORDS

THE MARK CONSISTS OF STANDARD CHARACTERS WITHOUT CLAIM TO ANY PARTICULAR FONT, STYLE, SIZE, OR COLOR.

NO CLAIM IS MADE TO THE EXCLUSIVE RIGHT TO USE "RECORDS", APART FROM THE MARK AS SHOWN. THE ENGLISH TRANSLATION OF "PORTO FRANCO" IN THE MARK IS FREE PORT.

FOR PROMOTION AND DISTRIBUTORSHIP SERVICES FOR OTHERS IN THE FIELD OF SOUND AND VISUAL RECORDINGS (U.S. CLS. 100, 101 AND 102).

FIRST USE 2-1-2009; IN COMMERCE 4-1-2009.

CLASS 35—(Continued).

3,808,147. PERFORMANCE, INC., CHAPEL HILL, NC. SN 77-706,252. PUB. 7-21-2009, FILED 4-3-2009.

WHERE GREAT RIDES BEGIN

THE MARK CONSISTS OF STANDARD CHARACTERS WITHOUT CLAIM TO ANY PARTICULAR FONT, STYLE, SIZE, OR COLOR.

FOR CATALOG ORDERING SERVICE FEATURING PRODUCTS AND SERVICES IN THE FIELD OF BICYCLES AND BICYCLE PARTS, BICYCLE REPAIR AND APPAREL; DISTRIBUTORSHIPS IN THE FIELD OF BICYCLES, BICYCLE PARTS, BICYCLE REPAIR AND APPAREL; ELECTRONIC CATALOG SERVICES FEATURING PRODUCTS AND SERVICES IN THE FIELD OF BICYCLES AND BICYCLE PARTS, BICYCLE REPAIR AND APPAREL; MAIL ORDER CATALOG SERVICES FEATURING PRODUCTS AND SERVICES IN THE FIELD OF BICYCLES AND BICYCLE PARTS, BICYCLE REPAIR AND APPAREL; ON-LINE RETAIL STORE SERVICES FEATURING PRODUCTS AND SERVICES IN THE FIELD OF BICYCLES AND BICYCLE PARTS, BICYCLE REPAIR AND APPAREL; RETAIL STORE SERVICES FEATURING PRODUCTS AND SERVICES IN THE FIELD OF BICYCLES AND BICYCLE PARTS, BICYCLE REPAIR AND APPAREL; WHOLESALE DISTRIBUTORSHIPS FEATURING PRODUCTS AND SERVICES IN THE FIELD OF BICYCLES AND BICYCLE PARTS, BICYCLE REPAIR AND APPAREL (U.S. CLS. 100, 101 AND 102).

FIRST USE 4-9-2010; IN COMMERCE 4-9-2010.

3,808,137. FIDO FRIENDLY, INC., MARSING, ID. SN 77-705,172. PUB. 9-1-2009, FILED 4-2-2009.

GET YOUR LICKS ON ROUTE 66

THE MARK CONSISTS OF STANDARD CHARACTERS WITHOUT CLAIM TO ANY PARTICULAR FONT, STYLE, SIZE, OR COLOR.

FOR PROMOTING PUBLIC AWARENESS OF THE NEED FOR PET ADOPTION AND RESPONSIBLE PET OWNERSHIP; PROMOTING PUBLIC AWARENESS OF PET RESCUE (U.S. CLS. 100, 101 AND 102).

FIRST USE 6-6-2009; IN COMMERCE 6-6-2009.

3,808,188. ICE STEW LLC, LONG BEACH, CA. SN 77-713,514. PUB. 8-11-2009, FILED 4-14-2009.

3,808,142. CONSERVE BY COMPETING, LLC, MARINA DEL REY, CA. SN 77-705,828. PUB. 8-4-2009, FILED 4-2-2009.

NOTSOMUCH

THE MARK CONSISTS OF STANDARD CHARACTERS WITHOUT CLAIM TO ANY PARTICULAR FONT, STYLE, SIZE, OR COLOR.

FOR PROVIDING A WEBSITE FEATURING PROMOTIONAL PROGRAMS, NAMELY, A WEBSITE PROMOTING PUBLIC AWARENESS OF THE NEED FOR CONSERVATION OF ENERGY AND NATURAL RESOURCES (U.S. CLS. 100, 101 AND 102).

FIRST USE 6-30-2009; IN COMMERCE 6-30-2009.

ice stew

THE MARK CONSISTS OF STANDARD CHARACTERS WITHOUT CLAIM TO ANY PARTICULAR FONT, STYLE, SIZE, OR COLOR.

FOR ADVERTISING AND INFORMATION DISTRIBUTION SERVICES, NAMELY, PROVIDING CLASSIFIED ADVERTISING SPACE VIA THE GLOBAL COMPUTER NETWORK (U.S. CLS. 100, 101 AND 102).

FIRST USE 2-19-2009; IN COMMERCE 2-19-2009.

CLASS 35—(Continued).

3,808,214. SET STUFF, INC., LOS ANGELES, CA. SN 77-718,026. PUB. 8-25-2009, FILED 4-20-2009.

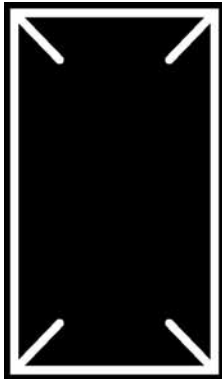

THE MARK CONSISTS OF VERTICAL BOX WITH A LINE COMING OUT OF EACH CORNER.
FOR ADVERTISING AND MARKETING (U.S. CLS. 100, 101 AND 102).
FIRST USE 8-10-2007; IN COMMERCE 4-19-2009.

3,808,233. EHRIG, NANCY, HENDERSON, NV. SN 77-725,292. PUB. 10-27-2009, FILED 4-29-2009.



THE STIPPLING IS FOR SHADING PURPOSES ONLY.
THE MARK CONSISTS OF WINGS OVER THE "T", A ROSE AND A SKULL INSERTED BETWEEN THE LETTERS "RTB", A CHAIN WITH A HEART, AND INSIDE THE HEART THE WORDS "REALTOUGHBITCH".
FOR RETAIL STORE SERVICES FEATURING CLOTHING, PURSES, PATCHES, AND JEWELRY (U.S. CLS. 100, 101 AND 102).
FIRST USE 10-4-2009; IN COMMERCE 10-4-2009.

CLASS 35—(Continued).

3,808,261. INDEPENDENT MITIGATION & CLEANING CONSERVATION NETWORK, CORP., DBA IMACC, NAPERVILLE, IL. SN 77-731,222. PUB. 7-21-2009, FILED 5-7-2009.

RADAR

THE MARK CONSISTS OF STANDARD CHARACTERS WITHOUT CLAIM TO ANY PARTICULAR FONT, STYLE, SIZE, OR COLOR.
FOR PROVIDING AUDITING AND REVIEW SERVICES OF PROPERTY DAMAGE RESTORATION CONTRACTOR ESTIMATES TO ASSURE THE AUTHENTICITY OF ESTIMATE LINE ITEMS (U.S. CLS. 100, 101 AND 102).
FIRST USE 3-10-2010; IN COMMERCE 3-10-2010.

3,808,326. JACKSON, DAMIAN B., VISTA, CA. SN 77-754,309. PUB. 11-10-2009, FILED 6-8-2009.



NO CLAIM IS MADE TO THE EXCLUSIVE RIGHT TO USE "MC", APART FROM THE MARK AS SHOWN.
THE COLOR(S) ROYAL BLUE, WHITE, AND BLACK IS/ARE CLAIMED AS A FEATURE OF THE MARK.
THE MARK CONSISTS OF THE STYLIZED MARK IS OF A SHIELD - TYPE 24.01 - WITH A BANNER ACROSS THE TOP OF THE SHIELD AND A BANNER ACROSS THE BOTTOM OF THE SHIELD. THERE ARE THREE (3) FOUR-LEAF CLOVERS ACROSS THE INSIDE EDGE OF THE SHIELD, ABOVE THE UPPER BANNER. THE MARK HAS TWO (2) SKULLS IN THE CENTER OF THE SHIELD, WITH ONE FACING TO THE LEFT AND A SKULL FACING TO THE RIGHT. BELOW THE SKULLS AND CENTERED, IS A FOUR-LEAF CLOVER. BETWEEN THE BOTTOM OF THE LOWER BANNER AND THE BOTTOM OF THE SHIELD ARE THE LETTERS "MC". THE MARK FEATURES THE COLOR ROYAL BLUE IN THE OUTLINE OF THE SHIELD, AS THE BACKGROUND OF THE UPPER BANNER CONTAINING THE WORD "HALLOWED" AT THE TOP OF THE SHIELD, AS THE BACKGROUND OF THE LOWER BANNER CONTAINING THE WORD "FEW" AT THE BOTTOM OF THE SHIELD, IN THREE FOUR-LEAF CLOVERS AT TOP OF THE SHIELD, AND IN A FOUR-LEAF CLOVER IN THE CENTER OF THE SHIELD. THE MARK ALSO FEATURES THE COLOR WHITE AS THE BACKGROUND OF THE SHIELD, IN THE WORD "HALLOWED" IN WHITE

CLASS 35—(Continued).

LETTERS IN THE UPPER BANNER AT THE TOP OF THE SHIELD. IN THE WORD "FEW" IN WHITE LETTERS IN THE LOWER BANNER AT THE BOTTOM OF THE SHIELD, AND IN TWO WHITE SKULLS IN THE CENTER OF THE SHIELD. THE MARK ALSO FEATURES THE COLOR BLACK IN THE LETTERS "MC" AT THE BOTTOM OF THE SHIELD, OUTLINING THE UPPER BANNER AT THE TOP OF THE SHIELD, OUTLINING THE LOWER BANNER AT THE BOTTOM OF THE SHIELD, AND OUTLINING THE TWO SKULLS IN THE CENTER OF THE SHIELD.

FOR CLUB SERVICES, NAMELY, PROMOTING THE INTERESTS OF MOTORCYCLE RIDING POLICE OFFICERS, DEPUTIES, LAW ENFORCEMENT OFFICERS (U.S. CLS. 100, 101 AND 102).

FIRST USE 9-14-2009; IN COMMERCE 9-14-2009.



3,808,339. SINT, LLC, HICKSVILLE, NY. SN 77-759,622. PUB. 10-27-2009, FILED 6-15-2009.

RENEWABLE ENERGY STARTS
WITH A GREAT NIGHT'S SLEEP.

THE MARK CONSISTS OF STANDARD CHARACTERS WITHOUT CLAIM TO ANY PARTICULAR FONT, STYLE, SIZE, OR COLOR.

FOR RETAIL STORES FEATURING BEDS, BEDDING AND SLEEP PRODUCTS (U.S. CLS. 100, 101 AND 102).

FIRST USE 6-21-2009; IN COMMERCE 6-21-2009.



3,808,340. SINT, LLC, HICKSVILLE, NY. SN 77-759,628. PUB. 10-27-2009, FILED 6-15-2009.

A BETTER TOMORROW STARTS
WITH A GREAT NIGHT'S SLEEP.

THE MARK CONSISTS OF STANDARD CHARACTERS WITHOUT CLAIM TO ANY PARTICULAR FONT, STYLE, SIZE, OR COLOR.

FOR RETAIL STORES FEATURING BEDS, BEDDING AND SLEEP PRODUCTS (U.S. CLS. 100, 101 AND 102).

FIRST USE 7-21-2009; IN COMMERCE 7-21-2009.

CLASS 35—(Continued).

3,808,341. SINT, LLC, HICKSVILLE, NY. SN 77-759,630. PUB. 10-27-2009, FILED 6-15-2009.

WHAT WE KNOW ABOUT
MATTRESSES WILL PUT YOU TO
SLEEP.

THE MARK CONSISTS OF STANDARD CHARACTERS WITHOUT CLAIM TO ANY PARTICULAR FONT, STYLE, SIZE, OR COLOR.

FOR RETAIL STORES FEATURING BEDS, BEDDING AND SLEEP PRODUCTS (U.S. CLS. 100, 101 AND 102).

FIRST USE 4-5-2009; IN COMMERCE 4-5-2009.



3,808,342. SINT, LLC, HICKSVILLE, NY. SN 77-759,634. PUB. 10-27-2009, FILED 6-15-2009.

MAKE LAST NIGHT YOUR LAST
BAD NIGHT'S SLEEP.

THE MARK CONSISTS OF STANDARD CHARACTERS WITHOUT CLAIM TO ANY PARTICULAR FONT, STYLE, SIZE, OR COLOR.

FOR RETAIL STORES FEATURING BEDS, BEDDING AND SLEEP PRODUCTS (U.S. CLS. 100, 101 AND 102).

FIRST USE 4-5-2009; IN COMMERCE 4-5-2009.



3,808,343. SINT, LLC, HICKSVILLE, NY. SN 77-759,653. PUB. 11-17-2009, FILED 6-15-2009.

1/3 OF ALL AMERICANS WON'T
SLEEP WELL TONIGHT.

THE MARK CONSISTS OF STANDARD CHARACTERS WITHOUT CLAIM TO ANY PARTICULAR FONT, STYLE, SIZE, OR COLOR.

FOR RETAIL STORES FEATURING BEDS, BEDDING AND SLEEP PRODUCTS (U.S. CLS. 100, 101 AND 102).

FIRST USE 3-31-2009; IN COMMERCE 3-31-2009.

CLASS 35—(Continued).

3,808,344. SINT, LLC, HICKSVILLE, NY. SN 77-759,661. PUB. 11-17-2009, FILED 6-15-2009.

YOUR MOST VALUABLE NATURAL
RESOURCE. SLEEP.

THE MARK CONSISTS OF STANDARD CHARACTERS WITHOUT CLAIM TO ANY PARTICULAR FONT, STYLE, SIZE, OR COLOR.

FOR RETAIL STORES FEATURING BEDS, BEDDING AND SLEEP PRODUCTS (U.S. CLS. 100, 101 AND 102).
FIRST USE 7-30-2009; IN COMMERCE 7-30-2009.

3,808,345. SINT, LLC, HICKSVILLE, NY. SN 77-759,667. PUB. 10-27-2009, FILED 6-15-2009.

A MATTRESS IS THE MOST
IMPORTANT PURCHASE OF YOUR
LIFETIME.

THE MARK CONSISTS OF STANDARD CHARACTERS WITHOUT CLAIM TO ANY PARTICULAR FONT, STYLE, SIZE, OR COLOR.

FOR RETAIL STORES FEATURING BEDS, BEDDING AND SLEEP PRODUCTS (U.S. CLS. 100, 101 AND 102).
FIRST USE 3-15-2009; IN COMMERCE 3-15-2009.

3,808,346. SINT, LLC, HICKSVILLE, NY. SN 77-759,679. PUB. 10-27-2009, FILED 6-15-2009.

SLEEP. IT'S THE NEW
ALL-NIGHTER.

THE MARK CONSISTS OF STANDARD CHARACTERS WITHOUT CLAIM TO ANY PARTICULAR FONT, STYLE, SIZE, OR COLOR.

FOR RETAIL STORES FEATURING BEDS, BEDDING AND SLEEP PRODUCTS (U.S. CLS. 100, 101 AND 102).
FIRST USE 4-5-2009; IN COMMERCE 4-5-2009.

CLASS 35—(Continued).

3,808,347. CUPS LJ, INC., DBA CUPS, LA JOLLA, CA. SN 77-759,942. PUB. 10-20-2009, FILED 6-15-2009.

cups
lounge

NO CLAIM IS MADE TO THE EXCLUSIVE RIGHT TO USE "LOUNGE", APART FROM THE MARK AS SHOWN.

THE MARK CONSISTS OF THE WORD "CUPS" IN LOWER CASE LETTERS, FOLLOWED BY THE WORD "LOUNGE" IN LOWER CASE LETTERS, WITH THE WORD "LOUNGE" BEING LOCATED BENEATH THE "P" AND "S" OF THE WORD "CUPS".

FOR RETAIL BAKERY SHOPS, RETAIL CUPCAKE SHOPS (U.S. CLS. 100, 101 AND 102).
FIRST USE 11-27-2009; IN COMMERCE 11-27-2009.

3,808,365. NATIONAL TOUR ASSOCIATION, INC., LEXINGTON, KY. SN 77-767,908. PUB. 12-29-2009, FILED 6-25-2009.

NTA
partner²partner

OWNER OF U.S. REG. NOS. 1,502,649, 3,504,582, AND OTHERS.

NO CLAIM IS MADE TO THE EXCLUSIVE RIGHT TO USE "PARTNER TO PARTNER", APART FROM THE MARK AS SHOWN.

THE MARK CONSISTS OF A STYLIZED GLOBE DESIGN WITH THE LETTERS "NTA" POSITIONED TO THE RIGHT THEREOF AND THE LETTERS "PARTNER2PARTNER" WITH THE NUMBER "2" POSITIONED BETWEEN THE WORDS "PARTNER" POSITIONED BELOW AND TO THE RIGHT OF THE "NTA" LOGO.

FOR GENERAL BUSINESS NETWORKING REFERRAL SERVICES, NAMELY, PROMOTING THE GOODS AND SERVICES OF OTHERS BY PASSING BUSINESS LEADS AND REFERRALS AMONG GROUP MEMBERS (U.S. CLS. 100, 101 AND 102).

FIRST USE 11-14-2009; IN COMMERCE 11-14-2009.

3,808,376. SEPHORA USA, INC., SAN FRANCISCO, CA. SN 77-770,865. PUB. 12-8-2009, FILED 6-30-2009.

V.I.B. BEAUTYINSIDER

THE MARK CONSISTS OF STANDARD CHARACTERS WITHOUT CLAIM TO ANY PARTICULAR FONT, STYLE, SIZE, OR COLOR.

CLASS 35—(Continued).

OWNER OF U.S. REG. NO. 3,181,800.

FOR RETAIL STORE SERVICES IN THE FIELD OF COSMETICS, SKIN CARE, HAIR CARE, AND PERFUMERY FEATURING A BONUS INCENTIVE PROGRAM FOR CUSTOMERS (U.S. CLS. 100, 101 AND 102).

FIRST USE 7-22-2009; IN COMMERCE 7-22-2009.

3,808,377. SEPHORA USA, INC., SAN FRANCISCO, CA. SN 77-770,866. PUB. 12-8-2009, FILED 6-30-2009.

**VERY IMPORTANT BEAUTY
INSIDER**

THE MARK CONSISTS OF STANDARD CHARACTERS WITHOUT CLAIM TO ANY PARTICULAR FONT, STYLE, SIZE, OR COLOR.

OWNER OF U.S. REG. NO. 3,181,800.

NO CLAIM IS MADE TO THE EXCLUSIVE RIGHT TO USE "BEAUTY", APART FROM THE MARK AS SHOWN.

FOR RETAIL STORE SERVICES IN THE FIELD OF COSMETICS, SKIN CARE, HAIR CARE, AND PERFUMERY FEATURING A BONUS INCENTIVE PROGRAM FOR CUSTOMERS (U.S. CLS. 100, 101 AND 102).

FIRST USE 7-22-2009; IN COMMERCE 7-22-2009.

3,808,390. GALAN, MARIA, WAYNE, NJ. SN 77-778,715. PUB. 11-24-2009, FILED 7-10-2009.



THE COLOR(S) GREY AND YELLOW IS/ARE CLAIMED AS A FEATURE OF THE MARK.

THE MARK CONSISTS OF A GREY OUTLINE FIGURE OF A WOMAN WITH A YELLOW SCARF DRAPED AROUND HER NECK. THE SCARF IS ALSO HANGING DOWN ON THE RIGHT SIDE OF THE FIGURE. THE GREY AND YELLOW WORDS "SISTERS IN SYNC" ARE WRITTEN AT THE BOTTOM OF THE WOMAN'S FIGURE.

FOR ASSOCIATION SERVICES, NAMELY, PROMOTING THE INTERESTS OF WOMEN CONCERNED WITH EMPOWERMENT AND SELF-ACTUALIZATION ISSUES (U.S. CLS. 100, 101 AND 102).

FIRST USE 11-1-2009; IN COMMERCE 11-1-2009.

CLASS 35—(Continued).

3,808,417. PALSIE'S, LLC, DBA PALSIE'S POPCORN & SWEETS, YOUNGSVILLE, NC. SN 77-789,942. PUB. 1-5-2010, FILED 7-27-2009.

PALSIE'S POPCORN & SWEETS

THE MARK CONSISTS OF STANDARD CHARACTERS WITHOUT CLAIM TO ANY PARTICULAR FONT, STYLE, SIZE, OR COLOR.

NO CLAIM IS MADE TO THE EXCLUSIVE RIGHT TO USE "POPCORN & SWEETS", APART FROM THE MARK AS SHOWN.

THE NAME "PALSIE" DOES NOT IDENTIFY A LIVING INDIVIDUAL.

FOR RETAIL CANDY STORES (U.S. CLS. 100, 101 AND 102).

FIRST USE 9-15-2009; IN COMMERCE 9-15-2009.

3,808,419. LOWER CAPE FEAR HOSPICE INC., WILMINGTON, NC. SN 77-790,527. PUB. 12-22-2009, FILED 7-27-2009.

BEGIN THE CONVERSATION

THE MARK CONSISTS OF STANDARD CHARACTERS WITHOUT CLAIM TO ANY PARTICULAR FONT, STYLE, SIZE, OR COLOR.

FOR PROMOTING PUBLIC AWARENESS OF THE NEED TO HELP INDIVIDUALS PLAN AND UNDERSTAND THEIR HEALTH CARE CHOICES (U.S. CLS. 100, 101 AND 102).

FIRST USE 10-1-2009; IN COMMERCE 10-1-2009.

3,808,420. LEADERSHIP III, LLC, EDINA, MN. SN 77-790,543. PUB. 12-22-2009, FILED 7-27-2009.

LEADERSHIP III

THE MARK CONSISTS OF STANDARD CHARACTERS WITHOUT CLAIM TO ANY PARTICULAR FONT, STYLE, SIZE, OR COLOR.

NO CLAIM IS MADE TO THE EXCLUSIVE RIGHT TO USE "LEADERSHIP", APART FROM THE MARK AS SHOWN.

FOR BUSINESS CONSULTING SERVICES IN THE FIELDS OF LEADERSHIP DEVELOPMENT, MANAGEMENT DEVELOPMENT, ORGANIZATIONAL DEVELOPMENT, CHANGE MANAGEMENT AND BUSINESS PERFORMANCE (U.S. CLS. 100, 101 AND 102).

FIRST USE 8-16-2009; IN COMMERCE 8-21-2009.

CLASS 35—(Continued).

3,808,425. HENRY FLEMING CO, CORNELIUS, NC. SN 77-791,490. PUB. 12-22-2009, FILED 7-28-2009.

CLASS 35—(Continued).

3,808,447. EVCARCO, INC., DBA EVCARCO.COM, FORT WORTH, TX. SN 77-799,356. PUB. 11-17-2009, FILED 8-7-2009.

All the tools the
consultants use...without
the consultants.

THE MARK CONSISTS OF STANDARD CHARACTERS WITHOUT CLAIM TO ANY PARTICULAR FONT, STYLE, SIZE, OR COLOR.

FOR BUSINESS INFORMATION MANAGEMENT, NAMELY, ELECTRONIC REPORTING OF BUSINESS INFORMATION, BUSINESS ANALYTICS, NAMELY, BUSINESS INVESTIGATIONS, EVALUATIONS, EXPERT APPRAISALS, INFORMATION AND RESEARCH, TRADE SPEND BUSINESS MANAGEMENT; BUSINESS MANAGEMENT CONSULTING WITH RELATION TO STRATEGY, MARKETING, SALES, OPERATION, PRODUCT DESIGN PARTICULARLY SPECIALIZING IN THE USE OF ANALYTIC AND STATISTIC MODELS FOR THE UNDERSTANDING AND PREDICTING OF CONSUMERS, BUSINESSES, AND MARKET TRENDS AND ACTIONS; CONSUMER STRATEGY BUSINESS CONSULTING IN THE FIELDS OF MARKETING, SALES, OPERATION, AND PRODUCT DESIGN PARTICULARLY SPECIALIZING IN THE USE OF ANALYTIC MODELS FOR THE UNDERSTANDING AND PREDICTING OF CONSUMER, BUSINESS, AND RETAIL MARKET TRENDS AND ACTIONS (U.S. CLS. 100, 101 AND 102).

FIRST USE 1-3-2010; IN COMMERCE 4-1-2010.

Future Driven

3,808,446. EVCARCO, INC., DBA EVCARCO.COM, FORT WORTH, TX. SN 77-799,343. PUB. 11-3-2009, FILED 8-7-2009.

EV-CAR-CO

THE MARK CONSISTS OF STANDARD CHARACTERS WITHOUT CLAIM TO ANY PARTICULAR FONT, STYLE, SIZE, OR COLOR.

FOR ASSISTANCE IN BUSINESS MANAGEMENT AND PRODUCT COMMERCIALIZATION, WITHIN THE FRAMEWORK OF A FRANCHISE CONTRACT; AUTOMOBILE DEALERSHIPS; FRANCHISE SERVICES, NAMELY, OFFERING BUSINESS MANAGEMENT ASSISTANCE IN THE ESTABLISHMENT AND OPERATION OF AUTOMOBILE DEALERSHIPS; FRANCHISING, NAMELY, CONSULTATION AND ASSISTANCE IN BUSINESS MANAGEMENT, ORGANIZATION AND PROMOTION; FRANCHISING, NAMELY, OFFERING TECHNICAL ASSISTANCE IN THE ESTABLISHMENT AND/OR OPERATION OF AUTOMOBILE DEALERSHIPS; PROVIDING INFORMATION ABOUT AUTOMOBILES FOR SALE BY MEANS OF THE INTERNET; RETAIL AUTOMOBILE PARTS AND ACCESSORIES STORES (U.S. CLS. 100, 101 AND 102).

FIRST USE 7-1-2009; IN COMMERCE 9-1-2009.

THE MARK CONSISTS OF STANDARD CHARACTERS WITHOUT CLAIM TO ANY PARTICULAR FONT, STYLE, SIZE, OR COLOR.

FOR ASSISTANCE IN BUSINESS MANAGEMENT AND PRODUCT COMMERCIALIZATION, WITHIN THE FRAMEWORK OF A FRANCHISE CONTRACT; AUTOMOBILE DEALERSHIPS; FRANCHISE SERVICES, NAMELY, OFFERING BUSINESS MANAGEMENT ASSISTANCE IN THE ESTABLISHMENT AND OPERATION OF AUTOMOBILE DEALERSHIPS; FRANCHISING, NAMELY, CONSULTATION AND ASSISTANCE IN BUSINESS MANAGEMENT, ORGANIZATION AND PROMOTION; FRANCHISING, NAMELY, OFFERING TECHNICAL ASSISTANCE IN THE ESTABLISHMENT AND/OR OPERATION OF AUTOMOBILE DEALERSHIPS; PROVIDING INFORMATION ABOUT AUTOMOBILES FOR SALE BY MEANS OF THE INTERNET; RETAIL AUTOMOBILE PARTS AND ACCESSORIES STORES (U.S. CLS. 100, 101 AND 102).

FIRST USE 7-1-2009; IN COMMERCE 9-1-2009.

CLASS 35—(Continued).

3,808,448. EVCARCO, INC., DBA EVCARCO.COM, FORT WORTH, TX. SN 77-799,389. PUB. 11-3-2009, FILED 8-7-2009.



THE MARK CONSISTS OF A GLOBE WITH OCEANS AND CONTINENTS. IT IS LIGHTER ON TOP RIGHT AND SHADED TOWARD THE BOTTOM LEFT. A BRANCH IN A FORM OF A LINE IS TRACING THE GLOBE FROM ABOUT 10 O'CLOCK POSITION TO ABOUT 2 O'CLOCK POSITION. THERE ARE FOUR LEAVES ON THE BRANCH AROUND 4 O'CLOCK POSITION. THERE IS A SHADOW UNDER THE GLOBE, AS THOUGH IT RESTS ON SOME FLAT SURFACE (INVISIBLE). BELOW THE GLOBE, THERE IS A "EV.CAR.CO" IN BOLD CAPITAL LETTERS".

FOR ASSISTANCE IN BUSINESS MANAGEMENT AND PRODUCT COMMERCIALIZATION, WITHIN THE FRAMEWORK OF A FRANCHISE CONTRACT; AUTOMOBILE DEALERSHIPS; FRANCHISE SERVICES, NAMELY, OFFERING BUSINESS MANAGEMENT ASSISTANCE IN THE ESTABLISHMENT AND OPERATION OF AUTOMOBILE DEALERSHIPS; FRANCHISING, NAMELY, CONSULTATION AND ASSISTANCE IN BUSINESS MANAGEMENT, ORGANIZATION AND PROMOTION; FRANCHISING, NAMELY, OFFERING TECHNICAL ASSISTANCE IN THE ESTABLISHMENT AND/OR OPERATION OF AUTOMOBILE DEALERSHIPS; PROVIDING INFORMATION ABOUT AUTOMOBILES FOR SALE BY MEANS OF THE INTERNET; RETAIL AUTOMOBILE PARTS AND ACCESSORIES STORES (U.S. CLS. 100, 101 AND 102).
FIRST USE 7-1-2009; IN COMMERCE 9-1-2009.

3,808,454. BLUMER, MARC, CHICAGO, IL. SN 77-801,177. PUB. 1-12-2010, FILED 8-10-2009.

B2B Marketing Made to Measure

THE MARK CONSISTS OF STANDARD CHARACTERS WITHOUT CLAIM TO ANY PARTICULAR FONT, STYLE, SIZE, OR COLOR.

NO CLAIM IS MADE TO THE EXCLUSIVE RIGHT TO USE "B2B MARKETING", APART FROM THE MARK AS SHOWN.

FOR ADVERTISING, MARKETING AND PROMOTION SERVICES (U.S. CLS. 100, 101 AND 102).
FIRST USE 8-0-2009; IN COMMERCE 8-0-2009.

CLASS 35—(Continued).

3,808,466. SOUTH CAROLINA DEPARTMENT OF PARKS, RECREATION & TOURISM, COLUMBIA, SC. SN 77-805,683. PUB. 1-12-2010, FILED 8-17-2009.

MADE FOR VACATION

THE MARK CONSISTS OF STANDARD CHARACTERS WITHOUT CLAIM TO ANY PARTICULAR FONT, STYLE, SIZE, OR COLOR.

FOR PROMOTING RECREATION AND TOURISM IN SOUTH CAROLINA (U.S. CLS. 100, 101 AND 102).
FIRST USE 1-1-2010; IN COMMERCE 1-1-2010.

3,808,474. ERBA, KATHLEEN E., DBA COLDWELL BANKER COAST PROPERTIES, BODEGA BAY, CA. SN 77-810,458. PUB. 1-19-2010, FILED 8-21-2009.

The Pacific Ocean in your front yard, Wine Country in your back yard.

THE MARK CONSISTS OF STANDARD CHARACTERS WITHOUT CLAIM TO ANY PARTICULAR FONT, STYLE, SIZE, OR COLOR.

FOR ADVERTISING OF COMMERCIAL OR RESIDENTIAL REAL ESTATE (U.S. CLS. 100, 101 AND 102).
FIRST USE 8-22-2009; IN COMMERCE 8-22-2009.

3,808,485. FUNSHERPA LLC, BROADVIEW, IL. SN 77-815,227. PUB. 1-26-2010, FILED 8-28-2009.

FUNSHERPA

THE MARK CONSISTS OF STANDARD CHARACTERS WITHOUT CLAIM TO ANY PARTICULAR FONT, STYLE, SIZE, OR COLOR.

FOR PROMOTING THE GOODS AND SERVICES OF OTHERS BY MEANS OF ISSUING VOUCHERS, GIFT CARDS, AND GIFT CERTIFICATES FOR A WIDE VARIETY OF GOODS AND SERVICES OF OTHERS, VIA A RETAIL WEB SITE ON A GLOBAL COMPUTER NETWORK, AND ALSO FEATURING THE MAKING OF RESERVATIONS FOR THE SELECTED ACTIVITIES (U.S. CLS. 100, 101 AND 102).

FIRST USE 11-0-2009; IN COMMERCE 11-0-2009.

CLASS 35—(Continued).

3,808,489. PRAECERE PUBLIC RELATIONS LLC, WASHINGTON, DC. SN 77-823,590. PUB. 2-2-2010, FILED 9-10-2009.

Praecere

THE MARK CONSISTS OF STANDARD CHARACTERS WITHOUT CLAIM TO ANY PARTICULAR FONT, STYLE, SIZE, OR COLOR.

FOR ADVERTISING SERVICES, PUBLIC RELATIONS AND MARKETING SERVICES, NAMELY, PROMOTING AND MARKETING THE GOODS AND SERVICES OF OTHERS THROUGH ALL PUBLIC COMMUNICATION MEANS; CUSTOM WRITING SERVICES COMPRISING PUBLIC RELATIONS AND MARKETING MATERIALS FOR THE AUDIO, VIDEO AND TECHNOLOGY INDUSTRIES; PUBLIC RELATIONS (U.S. CLS. 100, 101 AND 102).

FIRST USE 9-25-2009; IN COMMERCE 9-25-2009.

CLASS 35—(Continued).

3,808,526. PRINCE DIMITRI LLC, NEW YORK, NY. SN 77-979,401. PUB. 10-14-2008, FILED 11-7-2007.

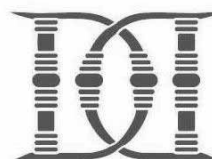

OWNER OF U.S. REG. NO. 3,073,863.

THE MARK CONSISTS OF A PICTURE OF A CROWN APPEARING ABOVE A "D" INTERTWINED WITH ITS MIRROR IMAGE.

FOR RETAIL STORE SERVICES FEATURING JEWELRY; RETAIL STORE SERVICES FEATURING ACCESSORIES, NAMELY, CUFFLINKS AND HAIR ACCESSORIES (U.S. CLS. 100, 101 AND 102).

FIRST USE 9-0-2008; IN COMMERCE 9-0-2009.

3,808,521. JUST BORN, INC., BETHLEHEM, PA. SN 77-979,369. PUB. 12-1-2009, FILED 7-1-2009.

PEEPS & COMPANY

THE MARK CONSISTS OF STANDARD CHARACTERS WITHOUT CLAIM TO ANY PARTICULAR FONT, STYLE, SIZE, OR COLOR.

OWNER OF U.S. REG. NO. 2,229,060.

NO CLAIM IS MADE TO THE EXCLUSIVE RIGHT TO USE "COMPANY", APART FROM THE MARK AS SHOWN.

FOR RETAIL STORE AND ON-LINE RETAIL STORE SERVICES FEATURING CANDY, BOOKS, STATIONERY, APPAREL, TOYS, GIFT ITEMS AND NOVELTIES (U.S. CLS. 100, 101 AND 102).

FIRST USE 11-23-2009; IN COMMERCE 11-23-2009.

3,808,541. STUDIO USA, LLC, SANTA MONICA, CA. SN 77-979,479. PUB. 7-21-2009, FILED 1-16-2009.

STUDIO BEAUTY MIX

THE MARK CONSISTS OF STANDARD CHARACTERS WITHOUT CLAIM TO ANY PARTICULAR FONT, STYLE, SIZE, OR COLOR.

FOR RETAIL STORE SERVICES FEATURING PERSONAL CARE PRODUCTS AND CANDLES (U.S. CLS. 100, 101 AND 102).

FIRST USE 3-1-2009; IN COMMERCE 3-1-2009.

CLASS 35—(Continued).

3,808,551. PET STOP MART, INC., SAVANNAH, GA. SN 77-979,559. PUB. 11-6-2007, FILED 5-11-2007.

TAILSSPIN

THE MARK CONSISTS OF STANDARD CHARACTERS WITHOUT CLAIM TO ANY PARTICULAR FONT, STYLE, SIZE, OR COLOR.

FOR RETAIL STORES FEATURING PET SUPPLIES (U.S. CLS. 100, 101 AND 102).
FIRST USE 10-1-2007; IN COMMERCE 10-1-2007.

3,808,553. LYNXXIT, INC., RESTON, VA. SN 77-979,583. PUB. 8-19-2008, FILED 2-15-2008.

LYNXXIT

THE MARK CONSISTS OF STANDARD CHARACTERS WITHOUT CLAIM TO ANY PARTICULAR FONT, STYLE, SIZE, OR COLOR.

FOR RETAIL STORE SERVICES FEATURING COMPUTER HARDWARE AND SOFTWARE SECURITY SYSTEMS FOR COMPUTERS AND OTHER COMPUTING AND COMMUNICATIONS DEVICES, CELL PHONES AND PDAS (U.S. CLS. 100, 101 AND 102).
FIRST USE 12-18-2009; IN COMMERCE 3-5-2010.

3,808,574. ATC TECHNOLOGY CORPORATION, DOWNERS GROVE, IL. SN 78-724,491. PUB. 6-5-2007, FILED 9-30-2005.



OWNER OF U.S. REG. NOS. 2,662,147, 2,939,046, AND OTHERS.

NO CLAIM IS MADE TO THE EXCLUSIVE RIGHT TO USE "CORP.", APART FROM THE MARK AS SHOWN.

THE MARK CONSISTS OF THE WORDING "AFTERMARKET TECHNOLOGY CORP." AND A DESIGN OF TWO ARROWS POINTING CLOCKWISE AND ENCIRCLING THE LETTERS "ATC".

CLASS 35—(Continued).

SEC. 2(F) AS TO "AFTERMARKET TECHNOLOGY CORP.", FOR INVENTORY CONTROL, NAMELY, INVENTORY TRACKING SERVICES; INVENTORY MANAGEMENT SERVICES IN THE FIELD OF AUTOMOTIVE PRODUCTS; WHOLESALE DISTRIBUTORSHIP IN THE FIELD OF AUTOMOTIVE PRODUCTS; MERCHANDISE PACKAGING SERVICES; BUSINESS INFORMATION SERVICES IN THE FIELD OF SUPPLY CHAIN MANAGEMENT; AND BUSINESS MANAGEMENT AND CONSULTATION SERVICES (U.S. CLS. 100, 101 AND 102).

FIRST USE 6-3-2008; IN COMMERCE 6-3-2008.

3,808,615. THE W SHOES COMPANY, MIAMI, FL. SN 78-942,367. PUB. 7-17-2007, FILED 8-1-2006.

W SHOES

THE MARK CONSISTS OF STANDARD CHARACTERS WITHOUT CLAIM TO ANY PARTICULAR FONT, STYLE, SIZE, OR COLOR.

NO CLAIM IS MADE TO THE EXCLUSIVE RIGHT TO USE "SHOES", APART FROM THE MARK AS SHOWN.
FOR RETAIL STORE FEATURING SHOES, SOCKS, HOSIERY, HANDBAGS, JEWELRY AND EYEGLASSES (U.S. CLS. 100, 101 AND 102).
FIRST USE 12-28-2006; IN COMMERCE 12-28-2006.

3,808,617. GOLD VILLAGE ENTERTAINMENT INC., LOS ANGELES, CA. SN 78-945,569. PUB. 3-20-2007, FILED 8-4-2006.

GOLD VILLAGE ENTERTAINMENT INC.

THE MARK CONSISTS OF STANDARD CHARACTERS WITHOUT CLAIM TO ANY PARTICULAR FONT, STYLE, SIZE, OR COLOR.

NO CLAIM IS MADE TO THE EXCLUSIVE RIGHT TO USE "ENTERTAINMENT INC.", APART FROM THE MARK AS SHOWN.

FOR TALENT MANAGEMENT FOR MUSICIANS, RECORD AND VIDEO PRODUCERS, ENTERTAINERS AND SONGWRITERS (U.S. CLS. 100, 101 AND 102).
FIRST USE 5-15-2006; IN COMMERCE 5-15-2006.

CLASS 36—INSURANCE AND FINANCIAL

CLASS 36—(Continued).

3,807,423. CRCM L.P., SAN FRANCISCO, CA. SN 77-064,684.
PUB. 8-14-2007, FILED 12-14-2006.

CHINAROCK CAPITAL MANAGEMENT

THE MARK CONSISTS OF STANDARD CHARACTERS WITHOUT CLAIM TO ANY PARTICULAR FONT, STYLE, SIZE, OR COLOR.

NO CLAIM IS MADE TO THE EXCLUSIVE RIGHT TO USE "CAPITAL MANAGEMENT", APART FROM THE MARK AS SHOWN.

FOR FINANCIAL SERVICES, NAMELY, ASSET AND INVESTMENT MANAGEMENT SERVICES (U.S. CLS. 100, 101 AND 102).

FIRST USE 5-1-2007; IN COMMERCE 5-1-2007.

3,807,548. TRANSOFT INTERNATIONAL, INC., CARY, NC.
SN 77-391,462. PUB. 8-4-2009, FILED 2-7-2008.



THE MARK CONSISTS OF THE WORD "TRANSOFT" IN A STYLIZED FORM INSIDE AN OVAL DESIGN.

FOR CURRENCY MANAGEMENT SERVICES TO THE BANKING INDUSTRY (U.S. CLS. 100, 101 AND 102).

FIRST USE 12-31-2009; IN COMMERCE 12-31-2009.

3,807,565. BLUEPRINT GROWTH INSTITUTE, INC., OVERLAND PARK, KS. SN 77-412,187. PUB. 7-22-2008, FILED 3-4-2008.

BLUEPRINT QUARTERLY

THE MARK CONSISTS OF STANDARD CHARACTERS WITHOUT CLAIM TO ANY PARTICULAR FONT, STYLE, SIZE, OR COLOR.

OWNER OF U.S. REG. NO. 3,154,747.

FOR INVESTMENT ADVISORY SERVICES AND INVESTMENT FUND MANAGEMENT (U.S. CLS. 100, 101 AND 102).

FIRST USE 4-14-2010; IN COMMERCE 4-14-2010.

CLASS 36—(Continued).

3,807,592. GLOBAL 1 ENTERPRISES, INC., HOUSTON, TX.
SN 77-435,670. PUB. 8-5-2008, FILED 3-31-2008.

CMONEY

THE MARK CONSISTS OF STANDARD CHARACTERS WITHOUT CLAIM TO ANY PARTICULAR FONT, STYLE, SIZE, OR COLOR.

FOR ELECTRONIC CASH TRANSACTIONS (U.S. CLS. 100, 101 AND 102).

FIRST USE 3-0-2010; IN COMMERCE 3-0-2010.

3,807,599. BANCO DO BRASIL S.A., NEW YORK, NY. SN 77-441,558. PUB. 9-9-2008, FILED 4-7-2008.



OWNER OF U.S. REG. NO. 1,937,080.

THE MARK CONSISTS OF THREE ARROWS OVERLAPPING WITH A PARTIAL INTERLOCKING B DESIGN.

FOR MONEY TRANSFERS (U.S. CLS. 100, 101 AND 102).

FIRST USE 6-22-2009; IN COMMERCE 6-22-2009.

CLASS 36—(Continued).

3,807,632. AF FINANCIAL GROUP, WEST JEFFERSON, NC. SN 77-474,867. PUB. 10-14-2008, FILED 5-15-2008.

MY LIFE PLAN

THE MARK CONSISTS OF STANDARD CHARACTERS WITHOUT CLAIM TO ANY PARTICULAR FONT, STYLE, SIZE, OR COLOR.

FOR BANKING SERVICES; FINANCIAL SERVICES, NAMELY, PROVIDING FINANCIAL PLANNING, COMMERCIAL AND CONSUMER LENDING AND LEASING SERVICES, MORTGAGE LENDING AND LOAN FINANCING; CHECKING ACCOUNT SERVICES; CREDIT CARD SERVICES; DEBIT CARD SERVICES; ELECTRONIC PAYMENT, NAMELY, ELECTRONIC PROCESSING AND TRANSMISSION OF BILL PAYMENT DATA; CASH MANAGEMENT; MORTGAGE BANKING; SAFETY DEPOSIT BOX SERVICES; SAVINGS ACCOUNT SERVICES; PROVIDING EDUCATIONAL SCHOLARSHIPS; AUTOMATED TELLER MACHINE SERVICES; TRUST MANAGEMENT; INSURANCE SERVICES, NAMELY, PROVIDING INSURANCE ADMINISTRATION, AGENCY, BROKERAGE AND CONSULTATION SERVICES IN THE FIELDS OF LIFE, PROPERTY AND CASUALTY, ACCIDENT, HEALTH, CREDIT AND DISABILITY INSURANCE (U.S. CLS. 100, 101 AND 102).

FIRST USE 2-3-2010; IN COMMERCE 2-3-2010.

CLASS 36—(Continued).

3,807,707. VIST FINANCIAL, FORMERLY LEESPORT FINANCIAL, WYOMISSING, PA. SN 77-548,339. PUB. 1-27-2009, FILED 8-15-2008.



THE COLOR(S) GRAY, ORANGE, YELLOW AND BROWN IS/ARE CLAIMED AS A FEATURE OF THE MARK.

THE MARK CONSISTS OF THE WORD "EQUILOCK" WHERE A PADLOCK FORMS THE LETTER "O" IN THE WORD "LOCK". THERE IS AN OUTLINE OF A HOUSE AROUND THE LETTERS "EQU" IN THE WORD "EQUI". THE COLOR GRAY APPEARS IN THE LETTERS "EQUI", THE TOP PORTION OF THE PADLOCK AND THE OUTLINE OF THE HOUSE. THE COLOR ORANGE APPEARS IN THE WORD "LOCK". THE COLOR YELLOW APPEARS IN THE BOTTOM CIRCULAR PORTION OF THE PADLOCK. THE COLOR BROWN APPEARS IN THE KEYHOLE PORTION OF THE PADLOCK.

FOR FINANCIAL SERVICES, NAMELY, HOME EQUITY LOANS AND LINES OF CREDIT (U.S. CLS. 100, 101 AND 102).

FIRST USE 3-23-2010; IN COMMERCE 3-23-2010.

3,807,732. INTERO FRANCHISE SERVICES, INC., CUPERTINO, CA. SN 77-558,055. PUB. 1-20-2009, FILED 8-28-2008.

INTERO ANDARE

THE MARK CONSISTS OF STANDARD CHARACTERS WITHOUT CLAIM TO ANY PARTICULAR FONT, STYLE, SIZE, OR COLOR.

OWNER OF U.S. REG. NOS. 3,046,209, 3,097,514, AND OTHERS.

THE ENGLISH TRANSLATION OF "INTERO ANDARE" IS "ENTIRE TO GO".

FOR REAL ESTATE BROKERAGE SERVICES (U.S. CLS. 100, 101 AND 102).

FIRST USE 4-11-2010; IN COMMERCE 4-11-2010.

3,807,673. OXYGEN FINANCIAL, INC., MILTON, GA. SN 77-526,736. PUB. 4-14-2009, FILED 7-20-2008.

PRIVATE CFO

THE MARK CONSISTS OF STANDARD CHARACTERS WITHOUT CLAIM TO ANY PARTICULAR FONT, STYLE, SIZE, OR COLOR.

FOR FINANCIAL SERVICES, NAMELY, CONSULTATION IN THE FIELDS OF ASSET MANAGEMENT, PROPERTY AND CASUALTY INSURANCE, AND MORTGAGES (U.S. CLS. 100, 101 AND 102).

FIRST USE 8-1-2008; IN COMMERCE 8-1-2008.

3,807,755. CONCERN WORLDWIDE, DUBLIN 2, IRELAND. SN 77-565,355. PUB. 8-4-2009, FILED 9-9-2008.

OWNER OF ERPN CMNTY TM OFC REG. NO. 006740195, DATED 1-16-2009, EXPIRES 3-10-2018.

CLASS 36—(Continued).

NO CLAIM IS MADE TO THE EXCLUSIVE RIGHT TO USE "WORLDWIDE", APART FROM THE MARK AS SHOWN.

THE MARK CONSISTS OF THE WORD "CONCERN" ON A DIAGONAL, WITH THE WORD "WORLDWIDE" BELOW IT.

FOR CHARITABLE FUND RAISING; CHARITABLE FUND RAISING SERVICES, NAMELY, COLLECTION OF MONEY IN CONNECTION WITH THE IMPLEMENTATION OF RELIEF AND DEVELOPMENT PROGRAMS FOR THE ALLEVIATION OF POVERTY IN LESS-DEVELOPED COUNTRIES OF THE WORLD (U.S. CLS. 100, 101 AND 102).

FIRST USE 4-0-1993; IN COMMERCE 4-0-1993.

3,807,769. IN MARJOLEIN'S MEMORY INC., HARTSDALE, NY. SN 77-568,721. PUB. 7-14-2009, FILED 9-12-2008.

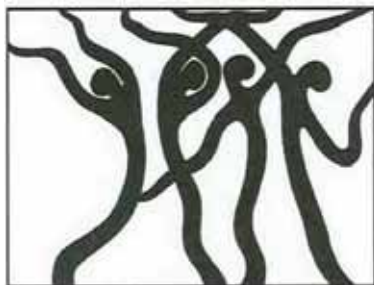

Friends & Cancer

NO CLAIM IS MADE TO THE EXCLUSIVE RIGHT TO USE "CANCER", APART FROM THE MARK AS SHOWN.

THE MARK CONSISTS OF THE WORDING "FRIENDS & CANCER" AND A DESIGN OF FOUR SWAYING STICK FIGURES ENCASED IN A SINGLE LINE RECTANGLE.

FOR CHARITABLE FUNDRAISING SERVICES FOR PROMOTING AWARENESS, RESEARCH, EDUCATION AND OTHER ACTIVITIES RELATING TO CANCER AND RELATED HEALTH ISSUES, INCLUDING ORGANIZING AND SPONSORING EVENTS TO RAISE FUNDS FOR CANCER AWARENESS, RESEARCH AND EDUCATION; FINANCIAL SPONSORSHIP OF HEALTH AWARENESS PROGRAMS TO PROMOTE THE SPREAD OF CANCER-RELATED INFORMATION AND DISTRIBUTION OF INFORMATION RELATED TO CANCER RESEARCH AND EDUCATION (U.S. CLS. 100, 101 AND 102).

FIRST USE 3-18-2010; IN COMMERCE 3-18-2010.

CLASS 36—(Continued).

3,807,872. COMMERCIAL PROPERTY EXPERTISE HOLDINGS LTD, BROOKLYN, NY. SN 77-615,040. PUB. 3-31-2009, FILED 11-14-2008.

CPEX

THE MARK CONSISTS OF STANDARD CHARACTERS WITHOUT CLAIM TO ANY PARTICULAR FONT, STYLE, SIZE, OR COLOR.

FOR EQUITY CAPITAL INVESTMENT IN THE FIELD OF REAL ESTATE; FINANCIAL INFORMATION AND ADVISORY SERVICES IN THE FIELD OF REAL ESTATE; FINANCIAL INVESTMENT IN THE FIELD OF REAL ESTATE; FINANCIAL MANAGEMENT IN THE FIELD OF REAL ESTATE; INVESTMENT BANKING SERVICES; PRIVATE EQUITY FUND INVESTMENT SERVICES; REAL ESTATE EQUITY SHARING, NAMELY, MANAGING AND ARRANGING FOR CO-OWNERSHIP OF REAL ESTATE (U.S. CLS. 100, 101 AND 102).

FIRST USE 7-1-2009; IN COMMERCE 7-1-2009.

3,807,890. REGIONS ASSET COMPANY, WILMINGTON, DE. SN 77-628,329. PUB. 3-3-2009, FILED 12-8-2008.

DEPOSITSMART ATMS

THE MARK CONSISTS OF STANDARD CHARACTERS WITHOUT CLAIM TO ANY PARTICULAR FONT, STYLE, SIZE, OR COLOR.

NO CLAIM IS MADE TO THE EXCLUSIVE RIGHT TO USE "ATMS", APART FROM THE MARK AS SHOWN.

FOR ATM BANKING SERVICES (U.S. CLS. 100, 101 AND 102).

FIRST USE 1-28-2009; IN COMMERCE 1-28-2009.

3,807,908. DAN KARALIS, ROSEMONT, IL. SN 77-644,622. PUB. 5-5-2009, FILED 1-7-2009.

**FirstSecure Bank and Trust
Co.**

THE MARK CONSISTS OF STANDARD CHARACTERS WITHOUT CLAIM TO ANY PARTICULAR FONT, STYLE, SIZE, OR COLOR.

CLASS 36—(Continued).

NO CLAIM IS MADE TO THE EXCLUSIVE RIGHT TO USE "IST", APART FROM THE MARK AS SHOWN.

FOR ATM BANKING SERVICES; BANKING; BANKING AND FINANCING SERVICES; BANKING CONSULTATION; BANKING SERVICES; BANKING SERVICES PROVIDED BY MOBILE TELEPHONE CONNECTIONS; CREDIT AND FINANCIAL CONSULTATION; ELECTRONIC BANKING VIA A GLOBAL COMPUTER NETWORK; FINANCIAL ADVICE; FINANCIAL ADVICE AND CONSULTANCY SERVICES; FINANCIAL CONSULTANCY; FINANCIAL CONSULTING; FINANCIAL PLANNING; FINANCIAL PLANNING CONSULTATION; FINANCIAL PORTFOLIO MANAGEMENT; FINANCIAL RESEARCH; FINANCIAL SERVICES IN THE FIELD OF MONEY LENDING; FINANCIAL TRUST OPERATIONS; HOME BANKING; ISSUANCE OF BANK CHECKS; ISSUING OF BANK CHEQUES; MERCHANT BANKING AND INVESTMENT BANKING SERVICES; MORTGAGE BANKING; ON-LINE BANKING SERVICES; PROVIDING BANK ACCOUNT INFORMATION BY TELEPHONE; PROVIDING FINANCIAL INFORMATION; PROVISION OF FINANCIAL INFORMATION; SAVINGS BANK SERVICES; SAVINGS BANKS (U.S. CLS. 100, 101 AND 102).

FIRST USE 12-1-2009; IN COMMERCE 12-1-2009.

3,807,909. DENVER INVESTMENT ADVISORS LLC, DENVER, CO. SN 77-644,967. PUB. 5-5-2009, FILED 1-7-2009.



NO CLAIM IS MADE TO THE EXCLUSIVE RIGHT TO USE "DENVER INVESTMENTS", APART FROM THE MARK AS SHOWN.

THE MARK CONSISTS OF A TWO-PEAKED MOUNTAIN DESIGN WITH THE WORDS "DENVER INVESTMENTS" CENTERED UNDER THE DESIGN.

FOR INVESTMENT MANAGEMENT AND ADVISORY SERVICES; FINANCIAL SERVICES, NAMELY, FINANCIAL MANAGEMENT, FINANCIAL PLANNING AND FINANCIAL ADVISORY SERVICES; WEALTH MANAGEMENT AND ADVISORY SERVICES; ASSET MANAGEMENT AND ADVISORY SERVICES; PROVIDING OF AND MANAGEMENT OF MUTUAL FUNDS (U.S. CLS. 100, 101 AND 102).

FIRST USE 1-28-2009; IN COMMERCE 1-28-2009.

CLASS 36—(Continued).

3,807,931. MICHAEL J. CURTIN & ASSOCIATES, INC., PARKLAND, FL. SN 77-656,428. PUB. 6-16-2009, FILED 1-26-2009.



THE NAME "MICHAEL J. CURTIN" IDENTIFIES A LIVING INDIVIDUAL WHOSE CONSENT IS OF RECORD.

THE MARK CONSISTS OF THE STYLIZED LETTERS AND WORDS "M MICHAEL J. CURTIN & ASSOCIATES RISING ABOVE EXPECTATIONS". ABOVE THE TEXT IS AN IMAGE OF A PHOENIX WITH A LEAF SURROUNDING AN OVAL WITH THE LETTER "M" IN THE CENTER.

FOR INSURANCE ADMINISTRATION SERVICES, NAMELY, ASSISTING OTHERS WITH ADJUSTING INSURANCE CLAIMS (U.S. CLS. 100, 101 AND 102).

FIRST USE 10-1-2006; IN COMMERCE 10-1-2006.

3,807,946. ALLIED WORLD ASSURANCE COMPANY (U.S.) INC., NEW YORK, NY. SN 77-667,302. PUB. 8-11-2009, FILED 2-10-2009.

Executive ForceField

THE MARK CONSISTS OF STANDARD CHARACTERS WITHOUT CLAIM TO ANY PARTICULAR FONT, STYLE, SIZE, OR COLOR.

NO CLAIM IS MADE TO THE EXCLUSIVE RIGHT TO USE "EXECUTIVE", APART FROM THE MARK AS SHOWN.

FOR INSURANCE SERVICES, NAMELY, INSURANCE UNDERWRITING, LIABILITY RISK MANAGEMENT SERVICES AND INSURANCE CLAIMS ADJUSTMENT SERVICES, IN THE FIELD OF EXECUTIVE AND PROFESSIONAL LIABILITY; UNDERWRITING OF EXECUTIVE AND PROFESSIONAL LIABILITY INSURANCE (U.S. CLS. 100, 101 AND 102).

FIRST USE 7-1-2009; IN COMMERCE 7-1-2009.

CLASS 36—(Continued).

3,807,967. THE WESTERN AND SOUTHERN LIFE INSURANCE COMPANY, CINCINNATI, OH. SN 77-674,360. PUB. 1-19-2010, FILED 2-20-2009.

MAKING A DIFFERENCE IN LIFE

THE MARK CONSISTS OF STANDARD CHARACTERS WITHOUT CLAIM TO ANY PARTICULAR FONT, STYLE, SIZE, OR COLOR.

FOR FINANCIAL SERVICES, NAMELY, BANKING SERVICES; INVESTMENT SERVICES, NAMELY, INVESTMENT CONSULTATION, FUNDS INVESTMENT, ISSUANCE AND ADMINISTRATION OF ANNUITIES; INSURANCE SERVICES, NAMELY, INSURANCE UNDERWRITING AND ADMINISTRATION IN THE FIELDS OF LIFE, HEALTH AND DISABILITY INSURANCE (U.S. CLS. 100, 101 AND 102).

FIRST USE 5-0-2009; IN COMMERCE 5-0-2009.

3,807,987. MERIT PROPERTY MANAGEMENT, INC., ALISO VIEJO, CA. SN 77-679,912. PUB. 12-15-2009, FILED 2-27-2009.



OWNER OF U.S. REG. NO. 2,705,078.

THE MARK CONSISTS OF THE WORD "MERIT" IN BLOCK LETTERS INSIDE A BOX ABOVE THE WORDS "ENHANCING COMMUNITY LIFESTYLE" IN CURSIVE LETTERS.

FOR REAL PROPERTY MANAGEMENT SERVICES AND CONSULTATION SERVICES RELATED THERETO (U.S. CLS. 100, 101 AND 102).

FIRST USE 8-0-2008; IN COMMERCE 8-0-2008.

3,808,006. MISSION: FREEDOM'S CHILDREN, AMARILLO, TX. SN 77-685,101. PUB. 7-7-2009, FILED 3-6-2009.

MISSION: FREEDOM'S CHILDREN

THE MARK CONSISTS OF STANDARD CHARACTERS WITHOUT CLAIM TO ANY PARTICULAR FONT, STYLE, SIZE, OR COLOR.

CLASS 36—(Continued).

NO CLAIM IS MADE TO THE EXCLUSIVE RIGHT TO USE "CHILDREN", APART FROM THE MARK AS SHOWN.

FOR CHARITABLE FUND RAISING AND PROVISION OF GRANTS TO CHARITABLE ORGANIZATIONS TO PROVIDE ASSISTANCE TO CHILDREN OF MEMBERS OF THE U.S. MILITARY (U.S. CLS. 100, 101 AND 102).

FIRST USE 10-0-2009; IN COMMERCE 10-0-2009.

3,808,076. THE NASDAQ OMX GROUP, INC., NEW YORK, NY. SN 77-697,918. PUB. 8-11-2009, FILED 3-24-2009.

OWNER OF U.S. REG. NOS. 922,973, 2,156,078, AND OTHERS.

NO CLAIM IS MADE TO THE EXCLUSIVE RIGHT TO USE "FUTURES EXCHANGE", APART FROM THE MARK AS SHOWN.

THE MARK CONSISTS OF THE TERMS "NASDAQ OMX" ABOVE A LINE AND ALL ABOVE THE TERMS "FUTURES EXCHANGE".

FOR FUTURES EXCHANGE SERVICES (U.S. CLS. 100, 101 AND 102).

FIRST USE 1-20-2009; IN COMMERCE 1-20-2009.

3,808,078. ZIONS BANCORPORATION, SALT LAKE CITY, UT. SN 77-698,053. PUB. 9-1-2009, FILED 3-24-2009.

WE ARE ARIZONA

THE MARK CONSISTS OF STANDARD CHARACTERS WITHOUT CLAIM TO ANY PARTICULAR FONT, STYLE, SIZE, OR COLOR.

NO CLAIM IS MADE TO THE EXCLUSIVE RIGHT TO USE "ARIZONA", APART FROM THE MARK AS SHOWN.

FOR BANKING SERVICES; FINANCIAL SERVICES, NAMELY, INVESTMENT ADVICE AND INVESTMENT MANAGEMENT; WEALTH MANAGEMENT SERVICES (U.S. CLS. 100, 101 AND 102).

FIRST USE 5-15-2009; IN COMMERCE 5-15-2009.

CLASS 36—(Continued).

3,808,159. BANK OF THE WEST, SAN FRANCISCO, CA. SN 77-709,444. PUB. 8-4-2009, FILED 4-8-2009.

BEST OF THE WEST

THE MARK CONSISTS OF STANDARD CHARACTERS WITHOUT CLAIM TO ANY PARTICULAR FONT, STYLE, SIZE, OR COLOR.

FOR FINANCIAL SERVICES, NAMELY, BANKING AND CHECKING SERVICES (U.S. CLS. 100, 101 AND 102).

FIRST USE 4-1-2010; IN COMMERCE 4-1-2010.



3,808,165. FIA CARD SERVICES, NATIONAL ASSOCIATION, WILMINGTON, DE. SN 77-709,791. PUB. 8-4-2009, FILED 4-8-2009.



THE MARK CONSISTS OF THE DESIGN OF A STETHOSCOPE.

FOR BANKING AND RELATED FINANCIAL SERVICES, NAMELY, CREDIT CARD SERVICES (U.S. CLS. 100, 101 AND 102).

FIRST USE 9-30-2008; IN COMMERCE 9-30-2008.



3,808,175. WASSERMAN COMMERCIAL REAL ESTATE CORPORATION, SANTA MONICA, CA. SN 77-711,912. PUB. 8-11-2009, FILED 4-10-2009.

**SOUND ADVICE, SUCCESSFUL
NEGOTIATIONS**

THE MARK CONSISTS OF STANDARD CHARACTERS WITHOUT CLAIM TO ANY PARTICULAR FONT, STYLE, SIZE, OR COLOR.

FOR REAL ESTATE BROKERAGE (U.S. CLS. 100, 101 AND 102).

FIRST USE 6-4-2009; IN COMMERCE 6-4-2009.

CLASS 36—(Continued).

3,808,178. BULL PATH CAPITAL MANAGEMENT LLC, NEW YORK, NY. SN 77-712,405. PUB. 8-11-2009, FILED 4-13-2009.

KNOWLEDGE IS ALPHA

THE MARK CONSISTS OF STANDARD CHARACTERS WITHOUT CLAIM TO ANY PARTICULAR FONT, STYLE, SIZE, OR COLOR.

FOR FINANCIAL SERVICES, NAMELY, INVESTMENT MANAGEMENT AND ADVISORY SERVICES; MUTUAL FUND INVESTMENT SERVICES (U.S. CLS. 100, 101 AND 102).

FIRST USE 6-0-2009; IN COMMERCE 6-0-2009.



3,808,199. CONVERGENT WEALTH ADVISORS, LLC, ROCKVILLE, MD. SN 77-714,990. PUB. 8-18-2009, FILED 4-16-2009.

**NEW IDEAS. SOUND ADVICE.
MAKING IT HAPPEN.**

THE MARK CONSISTS OF STANDARD CHARACTERS WITHOUT CLAIM TO ANY PARTICULAR FONT, STYLE, SIZE, OR COLOR.

FOR FINANCIAL SERVICES, NAMELY, PORTFOLIO ANALYSIS, FINANCIAL ADVISORY AND CONSULTANCY SERVICES, FINANCIAL PLANNING SERVICES, AND THE INVESTMENT OF FUNDS OF OTHERS (U.S. CLS. 100, 101 AND 102).

FIRST USE 7-31-2009; IN COMMERCE 7-31-2009.



3,808,282. REALTY CONNECTION, INC., FRESNO, CA. SN 77-736,965. PUB. 10-27-2009, FILED 5-14-2009.



NO CLAIM IS MADE TO THE EXCLUSIVE RIGHT TO USE "REALTY" AND "INC.", APART FROM THE MARK AS SHOWN.

CLASS 36—(Continued).

THE MARK CONSISTS OF THE STYLIZED WORD "REALTY" IN LARGE TYPE FACE OVER "CONNECTION, INC." IN SMALLER TYPE FACE, ALL TO THE RIGHT OF AN ABSTRACT DESIGN COMPRISED OF DOTS, AND SHADOWS OF THE SAME DOTS.

FOR REAL ESTATE BROKERAGE; REAL ESTATE MANAGEMENT (U.S. CLS. 100, 101 AND 102).
FIRST USE 12-15-2008; IN COMMERCE 1-1-2009.

3,808,287. CROSS CURRENT RESEARCH LLC, PRINCETON, NJ. SN 77-738,763. PUB. 9-29-2009, FILED 5-16-2009.

Cross Current

THE MARK CONSISTS OF STANDARD CHARACTERS WITHOUT CLAIM TO ANY PARTICULAR FONT, STYLE, SIZE, OR COLOR.

FOR FINANCIAL ANALYSIS AND RESEARCH SERVICES; FINANCIAL RESEARCH (U.S. CLS. 100, 101 AND 102).

FIRST USE 3-19-2010; IN COMMERCE 3-19-2010.

3,808,288. CROSS CURRENT RESEARCH LLC, PRINCETON, NJ. SN 77-738,765. PUB. 9-29-2009, FILED 5-16-2009.

Cross Current Research

THE MARK CONSISTS OF STANDARD CHARACTERS WITHOUT CLAIM TO ANY PARTICULAR FONT, STYLE, SIZE, OR COLOR.

NO CLAIM IS MADE TO THE EXCLUSIVE RIGHT TO USE "RESEARCH", APART FROM THE MARK AS SHOWN.

FOR FINANCIAL ANALYSIS AND RESEARCH SERVICES; FINANCIAL RESEARCH (U.S. CLS. 100, 101 AND 102).

FIRST USE 3-19-2010; IN COMMERCE 3-19-2010.

3,808,289. CYMER, THOMAS X., RESTON, VA. SN 77-739,285. PUB. 9-29-2009, FILED 5-18-2009.

OPULEN FINANCIAL GROUP

THE MARK CONSISTS OF STANDARD CHARACTERS WITHOUT CLAIM TO ANY PARTICULAR FONT, STYLE, SIZE, OR COLOR.

CLASS 36—(Continued).

NO CLAIM IS MADE TO THE EXCLUSIVE RIGHT TO USE "FINANCIAL GROUP", APART FROM THE MARK AS SHOWN.

FOR FINANCIAL ASSET MANAGEMENT; FINANCIAL PLANNING AND INVESTMENT ADVISORY SERVICES (U.S. CLS. 100, 101 AND 102).

FIRST USE 5-18-2009; IN COMMERCE 5-18-2009.

3,808,295. GLC ADVISORS & CO., LLC, SAN FRANCISCO, CA. SN 77-743,438. PUB. 9-29-2009, FILED 5-22-2009.

GLCA

THE MARK CONSISTS OF STANDARD CHARACTERS WITHOUT CLAIM TO ANY PARTICULAR FONT, STYLE, SIZE, OR COLOR.

FOR FINANCIAL SERVICES, NAMELY, FINANCIAL RESTRUCTURING SERVICES (U.S. CLS. 100, 101 AND 102).

FIRST USE 10-30-2009; IN COMMERCE 10-30-2009.

3,808,296. GLC ADVISORS & CO., LLC, SAN FRANCISCO, CA. SN 77-743,442. PUB. 10-27-2009, FILED 5-22-2009.

GLC ADVISORS

THE MARK CONSISTS OF STANDARD CHARACTERS WITHOUT CLAIM TO ANY PARTICULAR FONT, STYLE, SIZE, OR COLOR.

NO CLAIM IS MADE TO THE EXCLUSIVE RIGHT TO USE "ADVISORS", APART FROM THE MARK AS SHOWN.

FOR FINANCIAL SERVICES, NAMELY, FINANCIAL RESTRUCTURING SERVICES (U.S. CLS. 100, 101 AND 102).

FIRST USE 10-30-2009; IN COMMERCE 10-30-2009.

3,808,308. SAVE 9 LLC, SEATTLE, WA. SN 77-747,002. PUB. 10-27-2009, FILED 5-28-2009.

SAVE 9

THE MARK CONSISTS OF STANDARD CHARACTERS WITHOUT CLAIM TO ANY PARTICULAR FONT, STYLE, SIZE, OR COLOR.

CLASS 36—(Continued).

NO CLAIM IS MADE TO THE EXCLUSIVE RIGHT TO USE "SAVE", APART FROM THE MARK AS SHOWN.
 FOR FINANCIAL PLANNING CONSULTATION (U.S. CLS. 100, 101 AND 102).
 FIRST USE 7-1-2009; IN COMMERCE 7-1-2009.

3,808,309. BOROUGH OF COLUMBIA, DBA COLUMBIA HISTORIC MARKET HOUSE, COLUMBIA, PA. SN 77-747,368. PUB. 11-17-2009, FILED 5-29-2009.



NO CLAIM IS MADE TO THE EXCLUSIVE RIGHT TO USE "COLUMBIA HISTORIC MARKET HOUSE", "1869", AND "COLUMBIA PENNSYLVANIA", APART FROM THE MARK AS SHOWN.

THE COLOR(S) CRIMSON RED, GOLD, BLACK, WHITE AND SHADES OF GRAY IS/ARE CLAIMED AS A FEATURE OF THE MARK.

THE MARK CONSISTS OF THE FOLLOWING WORDING AND YEAR IN CRIMSON RED, NAMELY, "COLUMBIA HISTORIC MARKET HOUSE 1869 COLUMBIA PENNSYLVANIA", THE IMAGE OF THE MARKET HOUSE IN BLACK, WHITE AND SHADES OF GRAY, WITH THE WORDING AND IMAGE APPEARING IN AN OVAL WITH A GOLD BACKGROUND AND OUTLINED IN CRIMSON RED.

FOR FARMERS MARKET, NAMELY, RENTAL OF SPACE IN MARKETPLACES FOR SELLERS OF GOODS AND/OR SERVICES (U.S. CLS. 100, 101 AND 102).

FIRST USE 12-16-2009; IN COMMERCE 12-16-2009.

3,808,361. CREXUS INVESTMENT CORP., NEW YORK, NY. SN 77-767,160. PUB. 11-24-2009, FILED 6-24-2009.

CreXus Investment Corp.

THE MARK CONSISTS OF STANDARD CHARACTERS WITHOUT CLAIM TO ANY PARTICULAR FONT, STYLE, SIZE, OR COLOR.

NO CLAIM IS MADE TO THE EXCLUSIVE RIGHT TO USE "INVESTMENT CORP.", APART FROM THE MARK AS SHOWN.

FOR FINANCIAL AND INVESTMENT SERVICES, NAMELY, INVESTMENT AND TRADING IN COMMERCIAL REAL ESTATE RELATED SECURITIES FOR OTHERS, ORIGINATION AND FUNDING OF COMMERCIAL REAL ESTATE MORTGAGE LOANS, INVESTMENT AND TRADING IN AGENCY RESIDENTIAL MORTGAGE BACKED SECURITIES FOR OTHERS, AND PORTFOLIO MANAGEMENT; COMMERCIAL REAL ESTATE MORTGAGE LOANS (U.S. CLS. 100, 101 AND 102).
 FIRST USE 9-17-2009; IN COMMERCE 9-17-2009.

CLASS 36—(Continued).

3,808,427. PENTUCKET BANK, HAVERHILL, MA. SN 77-791,985. PUB. 1-19-2010, FILED 7-29-2009.

Pentucket Business Express

THE MARK CONSISTS OF STANDARD CHARACTERS WITHOUT CLAIM TO ANY PARTICULAR FONT, STYLE, SIZE, OR COLOR.

NO CLAIM IS MADE TO THE EXCLUSIVE RIGHT TO USE "BUSINESS", APART FROM THE MARK AS SHOWN.

FOR BANKING SERVICES; NAMELY, PROVIDING DEPOSIT AND LOAN PRODUCTS AND SERVICES TO CUSTOMERS AND BUSINESSES AND CONVENIENT ONLINE DELIVERY ACCESS TO THOSE PRODUCTS (U.S. CLS. 100, 101 AND 102).

FIRST USE 3-1-2010; IN COMMERCE 3-1-2010.

3,808,497. AMERICAN INTERNATIONAL GROUP, INC., NEW YORK, NY. SN 77-861,467. PUB. 1-26-2010, FILED 10-30-2009.

SUNAMERICA PROTECTION SUITE

THE MARK CONSISTS OF STANDARD CHARACTERS WITHOUT CLAIM TO ANY PARTICULAR FONT, STYLE, SIZE, OR COLOR.

OWNER OF U.S. REG. NOS. 1,055,824, 2,662,917, AND 3,182,092.

NO CLAIM IS MADE TO THE EXCLUSIVE RIGHT TO USE "PROTECTION SUITE", APART FROM THE MARK AS SHOWN.

FOR FINANCIAL INVESTMENT IN THE FIELD OF RETIREMENT PLANS AND ANNUITIES; INVESTMENT ADVICE (U.S. CLS. 100, 101 AND 102).

FIRST USE 1-19-2010; IN COMMERCE 1-19-2010.

3,808,499. PHYSICIANS FOR REFORM, HICKORY, NC. SN 77-975,308. PUB. 12-9-2008, FILED 5-2-2007.

Physicians for Reform

THE MARK CONSISTS OF STANDARD CHARACTERS WITHOUT CLAIM TO ANY PARTICULAR FONT, STYLE, SIZE, OR COLOR.

NO CLAIM IS MADE TO THE EXCLUSIVE RIGHT TO USE "PHYSICIANS", APART FROM THE MARK AS SHOWN.

FOR CHARITABLE FUND RAISING (U.S. CLS. 100, 101 AND 102).

FIRST USE 2-1-2007; IN COMMERCE 2-1-2007.

CLASS 36—(Continued).

3,808,560. GEORGE M. RAJACICH, M.D., INC., VAN NUYS, CA. SN 78-584,569. PUB. 4-29-2008, FILED 3-10-2005.

AMERISIGHT

THE MARK CONSISTS OF STANDARD CHARACTERS WITHOUT CLAIM TO ANY PARTICULAR FONT, STYLE, SIZE, OR COLOR.

FOR MEDICAL BENEFITS ADMINISTRATION IN THE FIELD OF EYE CARE, NAMELY, ADMINISTRATION OF EMPLOYEE BENEFIT PLANS (U.S. CLS. 100, 101 AND 102).

FIRST USE 7-20-2009; IN COMMERCE 7-20-2009.

3,808,585. NEXT STREET FINANCIAL LLC, ROXBURY, MA. SN 78-808,122. PUB. 5-1-2007, FILED 2-6-2006.

NEXT STREET

THE MARK CONSISTS OF STANDARD CHARACTERS WITHOUT CLAIM TO ANY PARTICULAR FONT, STYLE, SIZE, OR COLOR.

FOR BANKING, INVESTMENT AND FINANCIAL SERVICES, NAMELY, COMMERCIAL LENDING AND MONEY LENDING; BROKERAGE SERVICES, NAMELY, REAL ESTATE BROKERAGE, LOAN BROKERAGE; EQUITY AND DEBT INVESTMENT SERVICES; INVESTMENT BANKING SERVICES; REAL ESTATE FINANCING SERVICES; FINANCIAL MANAGEMENT SERVICES; AND CONSULTANCY, ADVISORY AND INFORMATION SERVICES RELATING TO ALL THE AFORESAID SERVICES (U.S. CLS. 100, 101 AND 102).

FIRST USE 10-0-2005; IN COMMERCE 11-0-2007.

CLASS 36—(Continued).

3,808,596. BANCO ITAU S.A., SAO PAULO, BRAZIL. SN 78-888,031. PUB. 7-31-2007, FILED 5-19-2006.



OWNER OF U.S. REG. NOS. 1,198,257 AND 2,677,383.

THE COLOR(S) BLUE AND YELLOW IS/ARE CLAIMED AS A FEATURE OF THE MARK.

THE MARK CONSISTS OF A BLUE SQUARE BACKGROUND AND YELLOW LETTERING.

THE FOREIGN WORDING IN THE MARK TRANSLATES INTO ENGLISH AS "BLACK STONES".

FOR BANKING SERVICES; CURRENCY EXCHANGE; LOAN FINANCING; INVESTMENT SERVICES, NAMELY, ASSET ACQUISITION, CONSULTATION AND DEVELOPMENT SERVICES; ELECTRONIC PAYMENT, NAMELY, ELECTRONIC PROCESSING AND TRANSMISSION OF BILL PAYMENT DATA; FINANCIAL ADVISORY SERVICES; COMMERCIAL LENDING SERVICES; PROVIDING LINES OF CREDIT FOR COMMERCIAL PURPOSES; PROVIDING LOAN GUARANTEES; CASH MANAGEMENT SERVICES; TRADE SERVICES, NAMELY, IMPORT AND EXPORT COLLECTION TRANSACTIONS AND DOCUMENT PROCESSING FOR IMPORTS AND EXPORTS; INVESTMENT BANKING SERVICES; INVESTMENT OF FUNDS FOR OTHERS; INVESTMENT ADVISORY SERVICES; EQUITY CAPITAL MARKET SERVICES, NAMELY, ADVISING ON AND PROVIDING PRIMARY AND SECONDARY PUBLIC OFFERINGS, INITIAL PUBLIC OFFERINGS, SHARE TENDER OFFERS; DEBT CAPITAL MARKET SERVICES, NAMELY, ADVISING ON AND PROVIDING LOCAL AND INTERNATIONAL FIXED INCOME INSTRUMENTS (U.S. CLS. 100, 101 AND 102).

FIRST USE 0-0-2003; IN COMMERCE 0-0-2003.

3,808,597. STANLEY, NEIL, OMAHA, NE. SN 78-896,816. PUB. 2-26-2008, FILED 5-31-2006.

CD REVOLUTION

THE MARK CONSISTS OF STANDARD CHARACTERS WITHOUT CLAIM TO ANY PARTICULAR FONT, STYLE, SIZE, OR COLOR.

CLASS 36—(Continued).

NO CLAIM IS MADE TO THE EXCLUSIVE RIGHT TO USE "CD", APART FROM THE MARK AS SHOWN.

FOR FINANCIAL SERVICES PROVIDED TO BANKS AND FINANCIAL INSTITUTIONS IN THE NATURE OF TRACKING, CALCULATING AND PRICING, NAMELY, ISSUANCE AND MANAGEMENT OF CERTIFICATES OF DEPOSIT AND OTHER FINANCIAL INSTRUMENTS; FINANCIAL CONSULTING; TRACKING, CALCULATING AND PRICING CERTIFICATES OF DEPOSIT AND OTHER FINANCIAL INSTRUMENTS, NAMELY, CERTIFICATE OF DEPOSIT ACCOUNT SERVICES (U.S. CLS. 100, 101 AND 102).
FIRST USE 4-28-2010; IN COMMERCE 4-28-2010.

3,808,620. SELECTHEALTH, INC., SALT LAKE CITY, UT. SN 78-965,482. PUB. 10-6-2009, FILED 8-31-2006.



NO CLAIM IS MADE TO THE EXCLUSIVE RIGHT TO USE "TRANSITION", APART FROM THE MARK AS SHOWN.

THE MARK CONSISTS OF THE WORDING "SELECT-CARE TRANSITION" TO THE RIGHT OF A STYLIZED DESIGN OF A CHECK MARK IN A BOX.

FOR UNDERWRITING AND ADMINISTRATION OF MEDICAL, HEALTH AND PRESCRIPTION DRUG INSURANCE PLANS (U.S. CLS. 100, 101 AND 102).
FIRST USE 10-31-2006; IN COMMERCE 10-31-2006.

CLASS 37—CONSTRUCTION AND REPAIR

3,807,382. FELL, MICHAEL, MURRIETA, CA. SN 76-683,604. PUB. 3-31-2009, FILED 11-2-2007.

YOUR HOME IS YOUR LIFE ... DESIGN ACCORDINGLY

THE MARK CONSISTS OF STANDARD CHARACTERS WITHOUT CLAIM TO ANY PARTICULAR FONT, STYLE, SIZE, OR COLOR.

FOR HOME IMPROVEMENT SERVICES, NAMELY, PAINTING, FRAMING CONTRACTOR SERVICES, AND THE INSTALLATION, REPAIR, AND MAINTENANCE OF FLOORING, PLUMBING, CABINETS, KITCHENS, BATHROOMS, HOUSEHOLD APPLIANCES, DOORS, WINDOWS, COUNTERTOPS, DRYWALL, ELECTRICAL SYSTEMS, LANDSCAPING, POOLS, PONDS, AND BARBECUE ISLANDS (U.S. CLS. 100, 103 AND 106).
FIRST USE 3-31-2009; IN COMMERCE 3-31-2009.

CLASS 37—(Continued).

3,807,531. LEISURE CARE LLC, SEATTLE, WA. SN 77-349,597. PUB. 7-22-2008, FILED 12-11-2007.

ONE EIGHTY

THE MARK CONSISTS OF STANDARD CHARACTERS WITHOUT CLAIM TO ANY PARTICULAR FONT, STYLE, SIZE, OR COLOR.

FOR PLANNING, LAYING OUT AND DEVELOPING RETIREMENT HOME AND SENIOR HOUSING COMMUNITIES AND ASSISTED LIVING AND ALZHEIMER'S CENTERS; CONSTRUCTION DEVELOPMENT MANAGEMENT SERVICES IN THE FIELD OF RETIREMENT CENTERS, ASSISTED LIVING CENTERS, SENIOR HOUSING AND ALZHEIMER'S CENTERS (U.S. CLS. 100, 103 AND 106).
FIRST USE 6-18-2008; IN COMMERCE 6-18-2008.

3,807,754. HARRELL'S EQUIPMENT & SUPPLY CO., INC., INDIANAPOLIS, IN. SN 77-565,337. PUB. 1-27-2009, FILED 9-9-2008.

WASH. DRY. RIDE.

THE MARK CONSISTS OF STANDARD CHARACTERS WITHOUT CLAIM TO ANY PARTICULAR FONT, STYLE, SIZE, OR COLOR.

FOR AUTOMATED MOTORCYCLE WASHING SERVICES (U.S. CLS. 100, 103 AND 106).
FIRST USE 7-0-2009; IN COMMERCE 9-0-2009.

3,807,791. HAWK'S LANDING, LLC, SEATTLE, WA. SN 77-575,613. PUB. 2-10-2009, FILED 9-22-2008.

HAWK'S LANDING

THE MARK CONSISTS OF STANDARD CHARACTERS WITHOUT CLAIM TO ANY PARTICULAR FONT, STYLE, SIZE, OR COLOR.

FOR LAND DEVELOPMENT, NAMELY, PLANNING AND LAYING OUT MIXED USE REAL ESTATE DEVELOPMENTS (U.S. CLS. 100, 103 AND 106).
FIRST USE 8-8-2008; IN COMMERCE 8-8-2008.

CLASS 37—(Continued).

3,808,023. WINCHESTER HOMES, INC., GREENBELT, MD. SN 77-689,755. PUB. 7-28-2009, FILED 3-12-2009.

**YOUR HOME. YOUR WAY.
DESIGN FOR THE AGES.**

THE MARK CONSISTS OF STANDARD CHARACTERS WITHOUT CLAIM TO ANY PARTICULAR FONT, STYLE, SIZE, OR COLOR.

FOR CONSTRUCTION AND HOME BUILDING SERVICES, NAMELY, PLANNING AND DEVELOPMENT OF RESIDENTIAL COMMUNITIES (U.S. CLS. 100, 103 AND 106).

FIRST USE 4-10-2010; IN COMMERCE 4-10-2010.

3,808,037. GUY GAUTHIER, ST-NICOLAS, CANADA. SN 77-691,828. PUB. 7-21-2009, FILED 3-16-2009.



THE MARK CONSISTS OF THE STYLISED WORD "MIDEX" SURROUNDED BY A REPRESENTATION OF 4 LINKED ATOMS.

FOR INSTALLATION OF FIBERGLASS USED FOR BUILDINGS (U.S. CLS. 100, 103 AND 106).

FIRST USE 2-28-2007; IN COMMERCE 3-30-2010.

3,808,071. YORK CARPET & RUG CARE, INC., UNION CITY, NJ. SN 77-697,499. PUB. 8-25-2009, FILED 3-24-2009.

York Carpet Cleaning

THE MARK CONSISTS OF STANDARD CHARACTERS WITHOUT CLAIM TO ANY PARTICULAR FONT, STYLE, SIZE, OR COLOR.

NO CLAIM IS MADE TO THE EXCLUSIVE RIGHT TO USE "CARPET CLEANING", APART FROM THE MARK AS SHOWN.

FOR CLEANING OF RUGS, CARPETS AND UPHOLSTERY (U.S. CLS. 100, 103 AND 106).

FIRST USE 3-1-2010; IN COMMERCE 1-1-2010.

CLASS 37—(Continued).

3,808,322. BATHPERFECT, LLC, TOWSON, MD. SN 77-752,416. PUB. 10-20-2009, FILED 6-4-2009.

BathPerfect

THE MARK CONSISTS OF STANDARD CHARACTERS WITHOUT CLAIM TO ANY PARTICULAR FONT, STYLE, SIZE, OR COLOR.

FOR INSTALLATION OF WATERPROOF MEMBRANES, WATERPROOF POLYETHYLENE UNCOUPLING MEMBRANES, TILE, AND FIXTURES FOR THE RENOVATION OF BATHS, KITCHENS, AND TILED SURFACES (U.S. CLS. 100, 103 AND 106).

FIRST USE 7-1-2009; IN COMMERCE 10-16-2009.

3,808,408. SKY LAUNDROMAT, INC., JACKSON HEIGHTS, NY. SN 77-786,055. PUB. 12-29-2009, FILED 7-21-2009.

SKY LAUNDROMAT

THE MARK CONSISTS OF STANDARD CHARACTERS WITHOUT CLAIM TO ANY PARTICULAR FONT, STYLE, SIZE, OR COLOR.

NO CLAIM IS MADE TO THE EXCLUSIVE RIGHT TO USE "LAUNDROMAT", APART FROM THE MARK AS SHOWN.

FOR PROVIDING WASHING AND DRYING LAUNDRY FACILITIES (U.S. CLS. 100, 103 AND 106).

FIRST USE 5-18-2009; IN COMMERCE 5-18-2009.

CLASS 37—(Continued).

3,808,576. CLOCKWORK IP, LLC, SARASOTA, FL. SN 78-728,932. PUB. 6-20-2006, FILED 10-7-2005.



FOR REPAIR, MAINTENANCE, AND INSTALLATION OF ELECTRICAL WIRING, OUTLETS, LIGHT FIXTURES, AND ELECTRICAL PANELS; ELECTRICAL CONTRACTOR SERVICES (U.S. CLS. 100, 103 AND 106). FIRST USE 9-14-2009; IN COMMERCE 9-14-2009.

CLASS 38—(Continued).

3,807,412. LX NETWORKS LLC, NEW YORK, NY. SN 77-032,276. PUB. 11-27-2007, FILED 10-30-2006.

LX

THE MARK CONSISTS OF STANDARD CHARACTERS WITHOUT CLAIM TO ANY PARTICULAR FONT, STYLE, SIZE, OR COLOR.

FOR BROADCASTING SERVICES AND PROVISION OF TELECOMMUNICATION ACCESS TO VIDEO AND AUDIO CONTENT PROVIDED VIA A VIDEO-ON-DEMAND SERVICE VIA THE INTERNET AND WIRELESS DEVICES; STREAMING OF AUDIO AND VIDEO MATERIAL ON THE INTERNET AND OVER WIRELESS DEVICES; TELEVISION BROADCASTING; CABLE TELEVISION BROADCASTING; INTERNET PROTOCOL TELEVISION (IPTV) SERVICES; MOBILE MEDIA AND ENTERTAINMENT SERVICES IN THE NATURE OF ELECTRONIC TRANSMISSION OF ENTERTAINMENT MEDIA CONTENT (U.S. CLS. 100, 101 AND 104). FIRST USE 9-14-2009; IN COMMERCE 9-14-2009.

3,808,577. CLOCKWORK IP, LLC, SARASOTA, FL. SN 78-729,065. PUB. 6-27-2006, FILED 10-7-2005.



NO CLAIM IS MADE TO THE EXCLUSIVE RIGHT TO USE "ELECTRICIANS", APART FROM THE MARK AS SHOWN.

THE MARK CONSISTS OF AN IMAGE OF A FRONT DOOR TO A HOME.

FOR REPAIR, MAINTENANCE, AND INSTALLATION OF ELECTRICAL WIRING, OUTLETS, LIGHT FIXTURES, AND ELECTRICAL PANELS; ELECTRICAL CONTRACTOR SERVICES (U.S. CLS. 100, 103 AND 106). FIRST USE 9-14-2009; IN COMMERCE 9-14-2009.

3,807,421. YOURTEL AMERICA, INC., KANSAS CITY, MO. SN 77-056,695. PUB. 8-25-2009, FILED 12-4-2006.



NO CLAIM IS MADE TO THE EXCLUSIVE RIGHT TO USE "AMERICA", APART FROM THE MARK AS SHOWN.

FOR TELECOMMUNICATION SERVICES AND EQUIPMENT, NAMELY, PERSONAL COMMUNICATION SERVICES, VOICE OVER IP SERVICES, LAND LINE TELEPHONE COMMUNICATION SERVICES, CELLULAR TELEPHONE AND WIRELESS ELECTRONIC TRANSMISSION AND RECEPTION OF VOICE SIGNALS, DATA, FACSIMILES, IMAGES, VIDEO, AUDIO AND INFORMATION COMMUNICATION SERVICES, INTERNET TELEPHONY SERVICES; LEASING OF TELECOMMUNICATION EQUIPMENT, NAMELY, TELEPHONES, FACSIMILE MACHINES, AND MODEMS (U.S. CLS. 100, 101 AND 104). FIRST USE 1-17-2007; IN COMMERCE 1-17-2007.

CLASS 38—COMMUNICATION

CLASS 38—(Continued).

3,807,500. VANCEINFO TECHNOLOGIES INC., GEORGE TOWN, CAYMAN ISLANDS. SN 77-281,679. PUB. 3-4-2008, FILED 9-17-2007.

VANCEINFO

THE MARK CONSISTS OF STANDARD CHARACTERS WITHOUT CLAIM TO ANY PARTICULAR FONT, STYLE, SIZE, OR COLOR.

FOR COMMUNICATION SERVICES, NAMELY, ELECTRONIC TRANSMISSION OF DATA AND DOCUMENTS AMONG USERS OF COMPUTERS; DATA COMMUNICATION BY ELECTRONIC MAIL; DATA TRANSMISSION AND RECEPTION SERVICES VIA TELECOMMUNICATION MEANS; ELECTRONIC EXCHANGE OF DATA STORED IN DATABASES ACCESSIBLE VIA TELECOMMUNICATION NETWORKS; ELECTRONIC TRANSMISSION OF DATA AND DOCUMENTS VIA COMPUTER TERMINALS; ELECTRONIC TRANSMISSION OF FACSIMILE COMMUNICATIONS AND DATA FEATURING ENCRYPTION AND DECRYPTION; ELECTRONIC, ELECTRIC, AND DIGITAL TRANSMISSION OF VOICE, DATA, IMAGES, SIGNALS, AND MESSAGES; PROVIDING THIRD PARTY USERS WITH ACCESS TO TELECOMMUNICATION INFRASTRUCTURE; TELECOMMUNICATION SERVICES, NAMELY, LOCAL AND LONG DISTANCE TRANSMISSION OF VOICE, DATA, GRAPHICS BY MEANS OF TELEPHONE, TELEGRAPHIC, CABLE, AND SATELLITE TRANSMISSIONS (U.S. CLS. 100, 101 AND 104).

FIRST USE 11-26-2007; IN COMMERCE 11-26-2007.

3,807,541. EARLES FAMILY L.L.C., ELLETTSVILLE, IN. SN 77-374,807. PUB. 5-27-2008, FILED 1-17-2008.

SMART SAVER

THE MARK CONSISTS OF STANDARD CHARACTERS WITHOUT CLAIM TO ANY PARTICULAR FONT, STYLE, SIZE, OR COLOR.

FOR WIRELESS TELEPHONE SERVICES (U.S. CLS. 100, 101 AND 104).

FIRST USE 3-30-2008; IN COMMERCE 3-30-2008.

CLASS 38—(Continued).

3,807,794. CENTER FOR ECOLITERACY, BERKELEY, CA. SN 77-577,104. PUB. 1-13-2009, FILED 9-23-2008.

SMART BY NATURE

THE MARK CONSISTS OF STANDARD CHARACTERS WITHOUT CLAIM TO ANY PARTICULAR FONT, STYLE, SIZE, OR COLOR.

FOR PROVIDING ON-LINE FORUMS FOR TRANSMISSION OF MESSAGES AMONG COMPUTER USERS CONCERNING EDUCATION AND SCHOOLING FOR SUSTAINABILITY; PROVIDING ELECTRONIC BULLETIN BOARDS FOR TRANSMISSION OF MESSAGES AMONG COMPUTER USERS CONCERNING EDUCATION AND SCHOOLING FOR SUSTAINABILITY; TRANSMISSION OF TEXT, DATA, IMAGES, AUDIO AND VIDEO CONCERNING EDUCATION AND SCHOOLING FOR SUSTAINABILITY (U.S. CLS. 100, 101 AND 104).

FIRST USE 1-11-2010; IN COMMERCE 1-11-2010.

3,807,977. COOKIE JAR ENTERTAINMENT INC., TORONTO, ONTARIO, CANADA. SN 77-676,915. PUB. 8-4-2009, FILED 2-24-2009.

COOKIE JAR TV

THE MARK CONSISTS OF STANDARD CHARACTERS WITHOUT CLAIM TO ANY PARTICULAR FONT, STYLE, SIZE, OR COLOR.

OWNER OF U.S. REG. NOS. 3,145,569, 3,278,059, AND OTHERS.

NO CLAIM IS MADE TO THE EXCLUSIVE RIGHT TO USE "TV", APART FROM THE MARK AS SHOWN.

FOR BROADCASTING OF TELEVISION PROGRAMS, NAMELY, CHILDREN'S TELEVISION PROGRAMS IN THE FIELDS OF CHILDREN'S EDUCATION AND ENTERTAINMENT FEATURING A WIDE RANGE OF INFORMATION ON TOPICS OF INTEREST TO CHILDREN AND THEIR PARENTS AND CAREGIVERS (U.S. CLS. 100, 101 AND 104).

FIRST USE 8-22-2009; IN COMMERCE 8-22-2009.

CLASS 38—(Continued).

3,808,311. ZENITH INFOTECH, INC., WARRENDALE, PA. SN 77-748,268. PUB. 10-6-2009, FILED 5-29-2009.

MSPtv

THE MARK CONSISTS OF STANDARD CHARACTERS WITHOUT CLAIM TO ANY PARTICULAR FONT, STYLE, SIZE, OR COLOR.

FOR BROADCAST SERVICES, NAMELY, PROVISION OF LIVE AND PRE-RECORDED DIGITAL CONTENT OVER THE INTERNET; BROADCAST OF INFORMATION BY MEANS OF INTERNET-BASED TRANSMISSION; BROADBAND BROADCASTING AND TRANSMISSION OF AUDIO AND VISUAL PROGRAMMING; BROADCASTING OF EDUCATIONAL EVENTS AND EDUCATIONAL PROGRAMS OVER THE INTERNET (U.S. CLS. 100, 101 AND 104).

FIRST USE 1-25-2008; IN COMMERCE 3-1-2008.

CLASS 39—(Continued).

3,807,501. VANCEINFO TECHNOLOGIES INC., GEORGE TOWN, CAYMAN ISLANDS. SN 77-281,680. PUB. 3-4-2008, FILED 9-17-2007.

VANCEINFO

THE MARK CONSISTS OF STANDARD CHARACTERS WITHOUT CLAIM TO ANY PARTICULAR FONT, STYLE, SIZE, OR COLOR.

FOR ELECTRONIC STORAGE OF MESSAGES AND DATA; ELECTRONIC STORAGE OF DATA FOR OTHERS; STORAGE SERVICES FOR ARCHIVING DATABASES, IMAGES AND OTHER ELECTRONIC DATA (U.S. CLS. 100 AND 105).

FIRST USE 11-26-2007; IN COMMERCE 11-26-2007.

3,807,506. FOUR TRUCKERS, INC., VALDESE, NC. SN 77-284,856. PUB. 4-8-2008, FILED 9-20-2007.

ASIA TO THE HOME

CLASS 39—TRANSPORTATION AND STORAGE

3,807,414. OSPREY AVIATION, LLC, FORT MYERS, FL. SN 77-036,991. PUB. 7-31-2007, FILED 11-4-2006.

OSPREY AVIATION

THE MARK CONSISTS OF STANDARD CHARACTERS WITHOUT CLAIM TO ANY PARTICULAR FONT, STYLE, SIZE, OR COLOR.

NO CLAIM IS MADE TO THE EXCLUSIVE RIGHT TO USE "AVIATION", APART FROM THE MARK AS SHOWN. FOR COMMERCIAL AIRPLANE PILOTING SERVICES (U.S. CLS. 100 AND 105).

FIRST USE 4-21-2010; IN COMMERCE 4-21-2010.

THE MARK CONSISTS OF STANDARD CHARACTERS WITHOUT CLAIM TO ANY PARTICULAR FONT, STYLE, SIZE, OR COLOR.

FOR DELIVERY, DISTRIBUTION AND WAREHOUSING SERVICES, NAMELY, STORAGE, DISTRIBUTION, PICK-UP, PACKAGING AND SHIPPING OF FURNITURE AND HOME FURNISHINGS (U.S. CLS. 100 AND 105).

FIRST USE 1-31-2009; IN COMMERCE 1-31-2009.

3,808,105. TRANSLAGO LTDA., BOGOTÁ, COLOMBIA. SN 77-701,514. PUB. 7-28-2009, FILED 3-28-2009.

TRANSLAGO

THE MARK CONSISTS OF STANDARD CHARACTERS WITHOUT CLAIM TO ANY PARTICULAR FONT, STYLE, SIZE, OR COLOR.

CLASS 39—(Continued).

THE WORDING "TRANSLAGO" HAS NO MEANING IN A FOREIGN LANGUAGE.

FOR AIR CHARTER TRANSPORTATION SERVICES; AIR FREIGHT SHIPPING SERVICES; AIR TRANSPORT; AIR TRANSPORT AND STORAGE OF GOODS; AIR TRANSPORT SERVICES; AIR TRANSPORTATION; BOAT TRANSPORT; CAR TRANSPORT; CARGO HANDLING; CARGO SHIP TRANSPORT; CORRESPONDENCE DELIVERY BY POST AND/OR MESSENGER; COURIER SERVICES; DELIVERY AND STORAGE OF GOODS; DOCUMENT DELIVERY; FREIGHT FORWARDING SERVICES; FREIGHT SHIP TRANSPORT; MARINE TRANSPORT; PACKING ARTICLES FOR TRANSPORTATION; PARCEL DELIVERY; PARCEL SHIPPING SERVICES; POSTAL, FREIGHT AND COURIER SERVICES; TRANSPORT AND DELIVERY OF GOODS; TRANSPORTATION AND DELIVERY SERVICES BY AIR, ROAD, RAIL AND SEA; WAREHOUSE STORAGE (U.S. CLS. 100 AND 105).

FIRST USE 7-31-1984; IN COMMERCE 6-30-1985.

3,808,121. ZEEP TRAVEL NETWORK, INC., HOUSTON, TX.
SN 77-703,447. PUB. 7-28-2009, FILED 3-31-2009.

WAKANOW

THE MARK CONSISTS OF STANDARD CHARACTERS WITHOUT CLAIM TO ANY PARTICULAR FONT, STYLE, SIZE, OR COLOR.

THE ENGLISH TRANSLATION OF "WAKANOW" IN THE MARK IS "MOVE NOW".

FOR PROVIDING AN ON-LINE COMPUTER DATABASE IN THE FIELD OF TRAVEL INFORMATION SERVICES; PROVIDING AN ON-LINE SEARCHABLE COMPUTER DATABASE FEATURING INFORMATION ON TRAVEL; PROVIDING LINKS TO WEB SITES OF OTHERS FEATURING TRAVEL; PROVISION OF TRAVEL INFORMATION; RENTAL CAR RESERVATION; RESERVATION AND BOOKING OF SEATS FOR TRAVEL; TRANSPORTATION RESERVATION SERVICES; TRAVEL AGENCY SERVICES, NAMELY, MAKING RESERVATIONS AND BOOKINGS FOR TRANSPORTATION; TRAVEL BOOKING AGENCIES; TRAVEL INFORMATION; TRAVEL INFORMATION SERVICES (U.S. CLS. 100 AND 105).

FIRST USE 2-19-2009; IN COMMERCE 2-19-2009.

3,808,283. CRYSTAL CRUISES, INC., LOS ANGELES, CA. SN
77-737,571. PUB. 10-27-2009, FILED 5-14-2009.

The Farther You Go, The Clearer Things Become

THE MARK CONSISTS OF STANDARD CHARACTERS WITHOUT CLAIM TO ANY PARTICULAR FONT, STYLE, SIZE, OR COLOR.

FOR CRUISE SHIP SERVICES (U.S. CLS. 100 AND 105).
FIRST USE 5-1-2009; IN COMMERCE 5-1-2009.

CLASS 39—(Continued).

3,808,299. OLD GOAT TRAVEL, LLC, WASHINGTON, DC.
SN 77-744,377. PUB. 10-6-2009, FILED 5-26-2009.



NO CLAIM IS MADE TO THE EXCLUSIVE RIGHT TO USE "TRAVEL, LLC", APART FROM THE MARK AS SHOWN.

THE STIPPLING IS FOR SHADING PURPOSES ONLY.

THE MARK CONSISTS OF THE WORDING "OLD GOAT TRAVEL, LLC" BELOW A WOMAN. THE WOMAN WEARS EYEGASSES, A HAT, EARRINGS, A NECKLACE OF PEARLS, A FLOWERED DRESS, AND SHOES. THE WOMAN HOLDS AN UMBRELLA IN ONE HAND AND CARRIES A PURSE. A FLOWER AND FEATHERS ARE ATTACHED TO HER HAT.

FOR ARRANGING TRAVEL TOURS; COORDINATING TRAVEL ARRANGEMENTS FOR INDIVIDUALS AND FOR GROUPS; PROVIDING INFORMATION, NEWS AND COMMENTARY IN THE FIELD OF TRAVEL; TRAVEL AND TOUR TICKET RESERVATION SERVICE; TRAVEL BOOKING AGENCIES (U.S. CLS. 100 AND 105).

FIRST USE 12-1-2008; IN COMMERCE 12-1-2008.

3,808,480. ENTERPRISE HOLDINGS, INC., ST. LOUIS, MO.
SN 77-812,754. PUB. 12-22-2009, FILED 8-26-2009.



OWNER OF U.S. REG. NOS. 1,864,905, 3,503,173, AND OTHERS.

THE COLOR(S) WHITE AND GREEN IS/ARE CLAIMED AS A FEATURE OF THE MARK.

CLASS 39—(Continued).

THE MARK CONSISTS OF THE COLOR WHITE WHICH APPEARS IN THE OUTER AND INNER BORDERS OF THE LETTER "E". THE COLOR GREEN APPEARS IN A DARKER SHADE IN THE BOTTOM HALF OF THE RECTANGLE AND BETWEEN THE WHITE BORDERS IN THE BOTTOM HALF OF THE LETTER "E". THE COLOR GREEN APPEARS IN A LIGHTER SHADE IN THE UPPER HALF OF THE RECTANGLE AND BETWEEN THE WHITE BORDERS IN THE UPPER HALF OF THE LETTER "E".

FOR VEHICLE RENTAL AND LEASING SERVICES AND RESERVATION SERVICES FOR THE RENTAL AND LEASING OF VEHICLES (U.S. CLS. 100 AND 105).
FIRST USE 11-10-2009; IN COMMERCE 11-10-2009.

3,808,549. FPL GROUP, INC., JUNO BEACH, FL. SN 77-979,537. PUB. 1-5-2010, FILED 9-22-2009.



OWNER OF U.S. REG. NOS. 1,659,135, 3,710,381, AND OTHERS.

NO CLAIM IS MADE TO THE EXCLUSIVE RIGHT TO USE "ENERGY POWER MARKETING", APART FROM THE MARK AS SHOWN.

THE MARK CONSISTS OF THE WORDS "NEXTERA ENERGY" APPEARING ABOVE A CURVED LINE. A FULLY SHADED INCOMPLETE CIRCLE OVER WHICH AN UNSHADED ZIGZAG LINE IS SUPERIMPOSED APPEARS TO THE RIGHT OF THE WORD "ENERGY" AND TOUCHES THE CURVED LINE. THE WORDS "POWER MARKETING" APPEAR BELOW THE CURVED LINE AND CIRCLE.

FOR PROVIDING AND SUPPLYING ELECTRICITY TO WHOLESALE COUNTER PARTIES, POWER POOLS, AND LOADS (U.S. CLS. 100 AND 105).

FIRST USE 10-29-2009; IN COMMERCE 10-29-2009.

CLASS 40—MATERIAL TREATMENT

3,807,579. MILLIKEN & COMPANY, SPARTANBURG, SC. SN 77-427,553. PUB. 2-17-2009, FILED 3-20-2008.

ECOUNTABILITY

THE MARK CONSISTS OF STANDARD CHARACTERS WITHOUT CLAIM TO ANY PARTICULAR FONT, STYLE, SIZE, OR COLOR.

FOR PROVIDING INFORMATION AND ADVISORY SERVICES IN THE FIELD OF ENVIRONMENTAL AND SUSTAINABLE PRACTICES, NAMELY, RECYCLING AND RECLAMATION (U.S. CLS. 100, 103 AND 106).

FIRST USE 11-15-2007; IN COMMERCE 11-15-2007.

CLASS 40—(Continued).

3,807,740. CHRISTIE, SHARON K., HUNTINGTON STATION, NY. SN 77-560,697. PUB. 1-20-2009, FILED 9-2-2008.

MIXOLOGY

THE MARK CONSISTS OF STANDARD CHARACTERS WITHOUT CLAIM TO ANY PARTICULAR FONT, STYLE, SIZE, OR COLOR.

FOR CUSTOM BLENDING SERVICES FOR AROMATHERAPY BATH AND BODY PRODUCTS, NAMELY, CREAMS, LOTIONS, OILS, MASSAGE OIL, EXFOLIATING BODY SCRUBS (U.S. CLS. 100, 103 AND 106).

FIRST USE 9-26-2008; IN COMMERCE 9-26-2008.

3,807,842. ROBERT CAREY, DBA MEETINGS & HOSPITALITY INSIGHT INC., BAYSIDE, NY. SN 77-598,809. PUB. 3-17-2009, FILED 10-23-2008.

ohmyGOLF!

THE MARK CONSISTS OF STANDARD CHARACTERS WITHOUT CLAIM TO ANY PARTICULAR FONT, STYLE, SIZE, OR COLOR.

FOR CUSTOMIZED IMPRINTING OF COMPANY NAMES AND LOGOS ON THE GOODS OF OTHERS, NAMELY, ON PROMOTIONAL MERCHANDISE, APPAREL AND CORPORATE GIFTS; IMPRINTING MESSAGES ON WEARING APPAREL, ACCESSORIES AND MUGS (U.S. CLS. 100, 103 AND 106).

FIRST USE 10-23-2009; IN COMMERCE 10-23-2009.

3,807,896. NATURAL ENVIRONMENTAL SYSTEMS, LLC, DALLAS, TX. SN 77-636,171. PUB. 12-1-2009, FILED 12-18-2008.

Natural Enviro

THE MARK CONSISTS OF STANDARD CHARACTERS WITHOUT CLAIM TO ANY PARTICULAR FONT, STYLE, SIZE, OR COLOR.

OWNER OF U.S. REG. NO. 3,328,476.
NO CLAIM IS MADE TO THE EXCLUSIVE RIGHT TO USE "NATURAL", APART FROM THE MARK AS SHOWN.

FOR ENVIRONMENTAL REMEDIATION SERVICES, NAMELY, SOIL, WASTE AND/OR WATER TREATMENT SERVICES (U.S. CLS. 100, 103 AND 106).

FIRST USE 11-17-2005; IN COMMERCE 8-21-2009.

CLASS 40—(Continued).

3,808,422. BROADVIEW INVESTMENTS, LLC, ROYSTON, GA. SN 77-791,245. PUB. 1-19-2010, FILED 7-28-2009.

OUTSOURCING DONE RIGHT.

THE MARK CONSISTS OF STANDARD CHARACTERS WITHOUT CLAIM TO ANY PARTICULAR FONT, STYLE, SIZE, OR COLOR.

OWNER OF U.S. REG. NO. 3,690,550.

NO CLAIM IS MADE TO THE EXCLUSIVE RIGHT TO USE "OUTSOURCING", APART FROM THE MARK AS SHOWN.

FOR CONTRACT MANUFACTURING FOR THE PHARMACEUTICAL AND HEALTH AND BEAUTY AIDS INDUSTRIES (U.S. CLS. 100, 103 AND 106).

FIRST USE 8-3-2009; IN COMMERCE 8-3-2009.

3,808,555. NEXT-END, LLC, ROSEMONT, IL. SN 77-979,606. PUB. 8-11-2009, FILED 7-3-2008.

E-CART

THE MARK CONSISTS OF STANDARD CHARACTERS WITHOUT CLAIM TO ANY PARTICULAR FONT, STYLE, SIZE, OR COLOR.

FOR RECYCLING SERVICES (U.S. CLS. 100, 103 AND 106).

FIRST USE 2-19-2009; IN COMMERCE 2-19-2009.

3,808,579. SOLAROAD TECHNOLOGIES INC., TOWSON, MD. SN 78-751,515. PUB. 2-6-2007, FILED 11-10-2005.

SOLAROAD RUN WITH THE SUN

THE MARK CONSISTS OF STANDARD CHARACTERS WITHOUT CLAIM TO ANY PARTICULAR FONT, STYLE, SIZE, OR COLOR.

FOR NONREGULATED UTILITY SERVICES, NAMELY, THE GENERATION OF ELECTRICITY (U.S. CLS. 100, 103 AND 106).

FIRST USE 3-15-2010; IN COMMERCE 3-15-2010.

CLASS 41—EDUCATION AND ENTERTAINMENT**CLASS 41—(Continued).**

3,807,398. BROWN, NOEL, WILMINGTON, NC. SN 76-696,754. PUB. 8-11-2009, FILED 4-8-2009.

CAPTURING LIFE IN CHERISHED KEEPSAKES

THE MARK CONSISTS OF STANDARD CHARACTERS WITHOUT CLAIM TO ANY PARTICULAR FONT, STYLE, SIZE, OR COLOR.

FOR PHOTOGRAPHY SERVICES; PORTRAIT PHOTOGRAPHY (U.S. CLS. 100, 101 AND 107).

FIRST USE 7-10-2009; IN COMMERCE 7-10-2009.

3,807,400. DINASTIA, INC., RANCHO CUCAMONGA, CA. SN 76-697,188. PUB. 10-13-2009, FILED 5-4-2009.

LIRA RECORDS

THE MARK CONSISTS OF STANDARD CHARACTERS WITHOUT CLAIM TO ANY PARTICULAR FONT, STYLE, SIZE, OR COLOR.

NO CLAIM IS MADE TO THE EXCLUSIVE RIGHT TO USE "RECORDS", APART FROM THE MARK AS SHOWN.

FOR PRODUCTION OF MUSIC SOUND RECORDINGS ON COMPACT DISCS, PRODUCTION OF AUDIO AND VIDEO RECORDINGS ON DVDS, ALL FEATURING MUSIC IN SPANISH (U.S. CLS. 100, 101 AND 107).

FIRST USE 12-18-2009; IN COMMERCE 12-18-2009.

3,807,408. SPEAKLE LLC, AMENIA, NY. SN 77-016,298. PUB. 5-22-2007, FILED 10-6-2006.

SPEAKLE

THE MARK CONSISTS OF STANDARD CHARACTERS WITHOUT CLAIM TO ANY PARTICULAR FONT, STYLE, SIZE, OR COLOR.

FOR INDIVIDUALIZED LANGUAGE INSTRUCTION PROVIDED ONLINE (U.S. CLS. 100, 101 AND 107).

FIRST USE 4-23-2010; IN COMMERCE 4-23-2010.

CLASS 41—(Continued).

3,807,475. TV ONE, LLC, SILVER SPRING, MD. SN 77-240,916. PUB. 11-17-2009, FILED 7-27-2007.

THE BLACKLIST

THE MARK CONSISTS OF STANDARD CHARACTERS WITHOUT CLAIM TO ANY PARTICULAR FONT, STYLE, SIZE, OR COLOR.

FOR ENTERTAINMENT SERVICES, NAMELY, AN ON-GOING TELEVISION SERIES FEATURING BLACK HISTORY AND CULTURE (U.S. CLS. 100, 101 AND 107).
FIRST USE 8-31-2008; IN COMMERCE 8-31-2008.

3,807,494. LEARNING TREE INTERNATIONAL, INC., RESTON, VA. SN 77-268,362. PUB. 7-29-2008, FILED 8-30-2007.



THE MARK CONSISTS OF THE WORD "REALITYPLUS" AND A SERIES OF DOTS FORMING A CROSS.

FOR EDUCATION AND TRAINING SERVICES IN THE FIELDS OF BUSINESS AND MANAGEMENT SKILLS, NAMELY, PROVIDING CLASSES, WORKSHOPS, COURSES AND SEMINARS IN BUSINESS MANAGEMENT, FINANCE, CHANGE MANAGEMENT, BUSINESS PROCESS RE-ENGINEERING, LEADERSHIP, INFLUENCE AND COMMUNICATION SKILLS, TIME MANAGEMENT, PRESENTATION SKILLS, NEGOTIATION SKILLS, CRITICAL THINKING SKILLS, TECHNICAL WRITING, AND PROJECT MANAGEMENT; EDUCATIONAL SERVICES, NAMELY, DESIGNING, DEVELOPING, ORGANIZING, AND OFFERING COURSES, CLASSES, SEMINARS, AND WORKSHOPS IN THE FIELDS OF BUSINESS AND MANAGEMENT SKILLS, NAMELY, BUSINESS MANAGEMENT, FINANCE, CHANGE MANAGEMENT, BUSINESS PROCESS RE-ENGINEERING, LEADERSHIP, INFLUENCE AND COMMUNICATION SKILLS, TIME MANAGEMENT, PRESENTATION SKILLS, NEGOTIATION SKILLS, CRITICAL THINKING SKILLS, TECHNICAL WRITING, AND PROJECT MANAGEMENT; EDUCATIONAL CONSULTING SERVICES, NAMELY, CONSULTING SERVICES IN THE FIELDS OF EDUCATIONAL DEVELOPMENT AND ADMINISTERING OF EDUCATION AND TRAINING IN THE FIELD OF BUSINESS AND MANAGEMENT SKILLS, NAMELY, BUSINESS MANAGEMENT, FINANCE, CHANGE MANAGEMENT, BUSINESS PROCESS RE-ENGINEERING, LEADERSHIP, INFLUENCE AND COMMUNICATION SKILLS, TIME MANAGEMENT, PRESENTATION SKILLS, NEGOTIATION SKILLS, CRITICAL THINKING SKILLS, TECHNICAL WRITING, AND PROJECT MANAGEMENT (U.S. CLS. 100, 101 AND 107).
FIRST USE 10-0-2006; IN COMMERCE 10-0-2006.

CLASS 41—(Continued).

3,807,499. SO-NET M3 USA CORPORATION, WASHINGTON, DC. SN 77-280,567. PUB. 8-26-2008, FILED 9-16-2007.

SMARTESTDOC

THE MARK CONSISTS OF STANDARD CHARACTERS WITHOUT CLAIM TO ANY PARTICULAR FONT, STYLE, SIZE, OR COLOR.

FOR ARRANGING AND CONDUCTING CONTESTS FOR PHYSICIANS TO ASCERTAIN THEIR LEVEL OF COMPETENCY IN THE PRACTICE OF MEDICINE, MEDICAL PROCEDURES, MEDICAL EQUIPMENT AND KNOWLEDGE OF PHARMACEUTICALS AND OFFERING AN AWARD FOR THE HIGHEST SCORING MEDICAL PROFESSIONAL AND COLLECTING, ANALYZING AND DISSEMINATING CONTEST RESULT DATA TO THE MEDICAL AND PHARMACEUTICAL INDUSTRIES FOR USE IN DETERMINING ADDITIONAL EDUCATIONAL NEEDS FOR PHYSICIANS IN SPECIFIC AREAS OF THE PRACTICE OF MEDICINE, MEDICAL PROCEDURES, MEDICAL EQUIPMENT AND KNOWLEDGE OF PHARMACEUTICALS (U.S. CLS. 100, 101 AND 107).
FIRST USE 5-14-2010; IN COMMERCE 5-14-2010.

3,807,503. BR CONSULTING, INC., SEDONA, AZ. SN 77-283,232. PUB. 7-29-2008, FILED 9-19-2007.

Earth Management

THE MARK CONSISTS OF STANDARD CHARACTERS WITHOUT CLAIM TO ANY PARTICULAR FONT, STYLE, SIZE, OR COLOR.

FOR EDUCATIONAL SERVICES, NAMELY, CONDUCTING SEMINARS, CONFERENCES, EXHIBITIONS AND CLASSES FOR CULTURAL PURPOSES IN THE FIELDS OF WORLD PEACE AND BRAIN PHILOSOPHY (U.S. CLS. 100, 101 AND 107).
FIRST USE 6-21-2009; IN COMMERCE 6-21-2009.

3,807,507. HALLIBURTON ENERGY SERVICES, INC., CARROLLTON, TX. SN 77-285,398. PUB. 3-11-2008, FILED 9-21-2007.

HALLIBURTON UNIVERSITY

THE MARK CONSISTS OF STANDARD CHARACTERS WITHOUT CLAIM TO ANY PARTICULAR FONT, STYLE, SIZE, OR COLOR.

CLASS 41—(Continued).

OWNER OF U.S. REG. NOS. 2,575,819, 2,839,228, AND OTHERS.

NO CLAIM IS MADE TO THE EXCLUSIVE RIGHT TO USE "UNIVERSITY", APART FROM THE MARK AS SHOWN.

FOR EDUCATIONAL AND TRAINING SERVICES, NAMELY, CONDUCTING AND PROVIDING ON-LINE VIA THE INTERNET AS WELL AS IN A CLASSROOM SETTING, INSTRUCTION, SEMINARS, CONFERENCES, WORKSHOPS AND OTHER CLASSES AND EDUCATIONAL TESTING CONCERNING INDIVIDUAL PROFESSIONAL DEVELOPMENT, CAREER ENHANCEMENT, AND COMPETENCY STATEMENTS AND ASSESSMENT CRITERIA RELATED TO VARIOUS ASPECTS OF THE OIL AND GAS INDUSTRY, AND THE DISTRIBUTION OF PRINTED MATERIALS AND CERTIFICATES IN CONNECTION THEREWITH (U.S. CLS. 100, 101 AND 107).

FIRST USE 9-28-2007; IN COMMERCE 9-28-2007.

3,807,512. STATE OF OREGON ACTING BY AND THROUGH THE STATE BOARD OF HIGHER EDUCATION ON BEHALF OF THE UNIVERSITY OF OREGON, EUGENE, OR. SN 77-304,048. PUB. 6-17-2008, FILED 10-15-2007.

TRACK TOWN

THE MARK CONSISTS OF STANDARD CHARACTERS WITHOUT CLAIM TO ANY PARTICULAR FONT, STYLE, SIZE, OR COLOR.

NO CLAIM IS MADE TO THE EXCLUSIVE RIGHT TO USE "TRACK", APART FROM THE MARK AS SHOWN.

FOR ARRANGING AND CONDUCTING ATHLETIC EVENTS, TOURNAMENTS, AND SPORTS EXHIBITIONS (U.S. CLS. 100, 101 AND 107).

FIRST USE 6-25-2009; IN COMMERCE 6-25-2009.

3,807,514. BR CONSULTING, INC., SEDONA, AZ. SN 77-305,523. PUB. 7-22-2008, FILED 10-16-2007.

Tao Life

THE MARK CONSISTS OF STANDARD CHARACTERS WITHOUT CLAIM TO ANY PARTICULAR FONT, STYLE, SIZE, OR COLOR.

NO CLAIM IS MADE TO THE EXCLUSIVE RIGHT TO USE "TAO", APART FROM THE MARK AS SHOWN.

FOR EDUCATIONAL SERVICES, NAMELY, CONDUCTING SEMINARS, CONFERENCES, EXHIBITIONS AND CLASSES IN THE FIELDS OF MEDITATION, RELAXATION, AND ENERGY HEALING (U.S. CLS. 100, 101 AND 107).

FIRST USE 6-10-2008; IN COMMERCE 6-10-2008.

CLASS 41—(Continued).

3,807,542. DR. LISA COONEY, DBA LEI - LIFE EMPOWERMENT INSTITUTE, SAN FRANCISCO, CA. SN 77-377,985. PUB. 6-17-2008, FILED 1-22-2008.

CIRCLE OF EMPOWERMENT -
THE CIRCLE OF
TRANSFORMATION 1.
CONSCIOUS AND MINDFUL
CHOICE MAKING 2. DIRECT
FOCUS AND GUIDED ALIGNMENT
3. TRUTH, INTEGRITY AND LOVE
4. KINDNESS, COMPASSION AND
SELF ACCEPTANCE

THE MARK CONSISTS OF STANDARD CHARACTERS WITHOUT CLAIM TO ANY PARTICULAR FONT, STYLE, SIZE, OR COLOR.

FOR WORKSHOPS AND SEMINARS IN THE FIELD OF SELF AWARENESS, PERSONAL GROWTH AND TRANSFORMATION (U.S. CLS. 100, 101 AND 107).

FIRST USE 1-1-2007; IN COMMERCE 1-1-2008.

3,807,551. N.V.L.A., INC., CALABASAS, CA. SN 77-396,852. PUB. 12-23-2008, FILED 2-14-2008.

GENIUS MINDS

THE MARK CONSISTS OF STANDARD CHARACTERS WITHOUT CLAIM TO ANY PARTICULAR FONT, STYLE, SIZE, OR COLOR.

FOR ARRANGING AND CONDUCTING CONFERENCES, CONGRESSES, SEMINARS, LECTURES, SYMPOSIUMS, DEALING WITH CULTURAL AND EDUCATIONAL ISSUES IN THE FIELD OF SCIENCE, MEDICINE, LITERATURE, HUMAN AND POLITICAL RELATIONS AND ECONOMICS; PROVIDING INFORMATION IN THE EDUCATION FIELD DEALING WITH CULTURAL AND EDUCATIONAL ISSUES IN THE FIELDS OF SCIENCE, RESEARCH, MEDICINE, LITERATURE, HUMAN AND POLITICAL RELATIONS AND ECONOMICS; PROVIDING INFORMATION IN THE ENTERTAINMENT FIELD DEALING WITH CULTURAL AND EDUCATIONAL ISSUES IN THE FIELDS OF SCIENCE, RESEARCH, MEDICINE, LITERATURE, HUMAN AND POLITICAL RELATIONS AND ECONOMICS; ELECTRONIC PUBLISHING OF TEXT AND GRAPHIC COURSE MATERIAL OF OTHERS DISTRIBUTED AT SEMINARS ON DVDS AND THE INTERNET FEATURING SCIENCE, RESEARCH, MEDICINE, LITERATURE, HUMAN AND POLITICAL RELATION AND ECONOMICS; PUBLICATION OF TEXTS OTHER THAN PUBLICITY TEXTS (U.S. CLS. 100, 101 AND 107).

FIRST USE 11-10-2007; IN COMMERCE 11-10-2007.

CLASS 41—(Continued).

3,807,608. DONEN, JOSH, BEVERLY HILLS, CA. SN 77-447,802. PUB. 9-9-2008, FILED 4-14-2008.

STARS ROAD

THE MARK CONSISTS OF STANDARD CHARACTERS WITHOUT CLAIM TO ANY PARTICULAR FONT, STYLE, SIZE, OR COLOR.

FOR PRODUCTION AND DISTRIBUTION OF MOTION PICTURES; PRODUCTION AND DISTRIBUTION OF TELEVISION SHOWS AND MOVIES (U.S. CLS. 100, 101 AND 107).

FIRST USE 2-1-2010; IN COMMERCE 2-1-2010.

3,807,622. BECTON, DICKINSON AND COMPANY, FRANKLIN LAKES, NJ. SN 77-463,263. PUB. 1-20-2009, FILED 5-1-2008.

BD VACUTAINER E-TECHTALK

THE MARK CONSISTS OF STANDARD CHARACTERS WITHOUT CLAIM TO ANY PARTICULAR FONT, STYLE, SIZE, OR COLOR.

OWNER OF U.S. REG. NOS. 2,858,038, 3,252,827, AND OTHERS.

FOR PROFESSIONAL ONLINE EDUCATION PROGRAMS FOCUSED ON CLINICAL LABORATORY PREANALYTICAL PROCESS IMPROVEMENTS (U.S. CLS. 100, 101 AND 107).

FIRST USE 4-12-2010; IN COMMERCE 4-12-2010.

3,807,633. PRESTON MEDIA, LLC, WELLESLEY, MA. SN 77-474,878. PUB. 3-17-2009, FILED 5-15-2008.

NORTH AMERICAN SPIRITNOW ASSOCIATION (NASA)

THE MARK CONSISTS OF STANDARD CHARACTERS WITHOUT CLAIM TO ANY PARTICULAR FONT, STYLE, SIZE, OR COLOR.

NO CLAIM IS MADE TO THE EXCLUSIVE RIGHT TO USE "NORTH AMERICAN" AND "ASSOCIATION", APART FROM THE MARK AS SHOWN.

FOR ENTERTAINMENT SERVICES, NAMELY, PROVISION OF WEB SITE ACCESSIBLE VIA GLOBAL COMPUTER NETWORKS CONTAINING PSYCHIC, INSPIRATIONAL AND MOTIVATIONAL THEMES (U.S. CLS. 100, 101 AND 107).

FIRST USE 5-5-2010; IN COMMERCE 5-5-2010.

CLASS 41—(Continued).

3,807,643. SONY PICTURES RELEASING CORPORATION, CULVER CITY, CA. SN 77-488,290. PUB. 12-23-2008, FILED 6-2-2008.

IF YOU CAN'T BE THERE, BE HERE

THE MARK CONSISTS OF STANDARD CHARACTERS WITHOUT CLAIM TO ANY PARTICULAR FONT, STYLE, SIZE, OR COLOR.

FOR ENTERTAINMENT SERVICES, NAMELY, PROVIDING NON-DOWNLOADABLE PRE-RECORDED AUDIO AND VIDEO PERFORMANCES OF MUSIC, COMEDY, DRAMA, SPORTS, ATHLETIC COMPETITIONS, NON-ATHLETIC COMPETITIONS, FILMS AND PERFORMING ARTS EVENTS, NAMELY, MUSICAL, DANCE AND DRAMATIC PERFORMANCES, ALL ONLINE VIA A GLOBAL COMPUTER NETWORK; ENTERTAINMENT SERVICES, NAMELY, PROVIDING NON-DOWNLOADABLE PRE-RECORDED PERFORMANCES OF MUSIC, COMEDY, DRAMA, SPORTS, ATHLETIC COMPETITIONS, NON-ATHLETIC COMPETITIONS, FILMS AND PERFORMING ARTS EVENTS, NAMELY, MUSICAL, DANCE AND DRAMATIC PERFORMANCES, PRESENTED TO MOBILE COMMUNICATIONS DEVICES VIA A GLOBAL COMPUTER NETWORK AND WIRELESS NETWORKS; ENTERTAINMENT SERVICES, NAMELY, AN ONGOING SERIES OF LIVE PERFORMANCES OF MUSIC, COMEDY, DRAMA, SPORTS, ATHLETIC COMPETITIONS, NON-ATHLETIC COMPETITIONS, FILMS AND PERFORMING ARTS EVENTS PRESENTED VIA RADIO AND TELEVISION SIMULCASTS; EDUCATIONAL SERVICES, NAMELY, LECTURES, SPEECHES, SEMINARS, INFORMATIONAL AND EDUCATIONAL PRESENTATIONS ABOUT FILM, MEDIA, CURRENT EVENTS, AND ACADEMIC COURSE SUBJECT MATTER IN THE FIELD OF THE SCIENCES, HUMANITIES, SOCIAL SCIENCES, MATHEMATICS AND FOREIGN LANGUAGES PRESENTED VIA RADIO AND TELEVISION SIMULCASTS AND VIA THE INTERNET AND PRESENTED TO MOBILE COMMUNICATIONS DEVICES VIA A GLOBAL COMPUTER NETWORK AND WIRELESS NETWORKS (U.S. CLS. 100, 101 AND 107).

FIRST USE 5-20-2008; IN COMMERCE 5-20-2008.

3,807,656. GUDNI GUNNARSSON, ENCINO, CA. SN 77-503,673. PUB. 11-11-2008, FILED 6-20-2008.

GLO MOTION

THE MARK CONSISTS OF STANDARD CHARACTERS WITHOUT CLAIM TO ANY PARTICULAR FONT, STYLE, SIZE, OR COLOR.

CLASS 41—(Continued).

NO CLAIM IS MADE TO THE EXCLUSIVE RIGHT TO USE "MOTION", APART FROM THE MARK AS SHOWN.

FOR PHYSICAL FITNESS CONDITIONING CLASSES; PHYSICAL FITNESS CONSULTATION; PHYSICAL FITNESS INSTRUCTION; PHYSICAL FITNESS TRAINING SERVICES; PROVIDING A WEB SITE FEATURING INFORMATION ON EXERCISE AND FITNESS; PROVIDING AN ON-LINE COMPUTER DATABASE FEATURING INFORMATION REGARDING EXERCISE AND FITNESS; PROVIDING AN ON-LINE COMPUTER DATABASE FEATURING INFORMATION REGARDING EXERCISE AND FITNESS BEFORE AND AFTER PREGNANCY; PROVIDING ASSISTANCE, PERSONAL TRAINING AND PHYSICAL FITNESS CONSULTATION TO CORPORATE CLIENTS TO HELP THEIR EMPLOYEES MAKE PHYSICAL FITNESS, STRENGTH, CONDITIONING, AND EXERCISE ALTERATIONS IN THEIR DAILY LIVING; PROVIDING ASSISTANCE, PERSONAL TRAINING AND PHYSICAL FITNESS CONSULTATION TO INDIVIDUALS TO HELP THEM MAKE PHYSICAL FITNESS, STRENGTH, CONDITIONING, AND EXERCISE IMPROVEMENT IN THEIR DAILY LIVING; PROVIDING FITNESS AND EXERCISE FACILITIES (U.S. CLS. 100, 101 AND 107).

FIRST USE 1-1-2008; IN COMMERCE 1-1-2009.

3,807,665. PAR EMPRIZES INCORPORATED, SALINAS, CA. SN 77-513,854. PUB. 1-13-2009, FILED 7-2-2008.



NO CLAIM IS MADE TO THE EXCLUSIVE RIGHT TO USE "GOLF", APART FROM THE MARK AS SHOWN.

THE MARK CONSISTS OF AN OUTLINE OF A HOUSE WITH A GOLF FLAG ON THE ROOF WITH THE NUMBER "19" ON THE FLAG, THE WORDS "BLUEPRINT FOR GOLF" WITH A DRIVER GOLF CLUB POSITIONED BEHIND A GOLF BALL ON A GOLF TEE WITHIN THE FRAME OF THE HOUSE WITH THE SHAFT OF THE CLUB POSITIONED BETWEEN THE "B" AND "U" IN THE WORD "BLUEPRINT" AND ALSO SERVING AS THE LETTER "L" IN THE WORD "BLUEPRINT".

FOR GOLF INSTRUCTION (U.S. CLS. 100, 101 AND 107).

FIRST USE 9-7-2008; IN COMMERCE 10-9-2009.

3,807,675. PER4MANCE PLUS, LLC, ORLANDO, FL. SN 77-529,585. PUB. 12-30-2008, FILED 7-23-2008.

HYDRATION FUEL RECOVERY STRUCTURE

THE MARK CONSISTS OF STANDARD CHARACTERS WITHOUT CLAIM TO ANY PARTICULAR FONT, STYLE, SIZE, OR COLOR.

CLASS 41—(Continued).

NO CLAIM IS MADE TO THE EXCLUSIVE RIGHT TO USE "HYDRATION FUEL RECOVERY", APART FROM THE MARK AS SHOWN.

FOR EDUCATION SERVICES, NAMELY, PROVIDING LIVE AND ON-LINE CLASSES, SEMINARS, CONFERENCES, AND WORKSHOPS IN THE FIELD OF HEALTH AND WEIGHT MANAGEMENT FOCUSING ON ENHANCED SPORTS PERFORMANCE AND DISTRIBUTION OF COURSE MATERIAL IN CONNECTION THEREWITH; EDUCATIONAL AND ENTERTAINMENT SERVICES, NAMELY, A CONTINUING PROGRAM ABOUT HEALTH AND WEIGHT MANAGEMENT FOCUSING ON ENHANCED SPORTS PERFORMANCE ACCESSIBLE BY RADIO, TELEVISION, SATELLITE, AUDIO, VIDEO AND COMPUTER NETWORKS; EDUCATIONAL AND ENTERTAINMENT SERVICES, NAMELY, PROVIDING MOTIVATIONAL AND EDUCATIONAL SPEAKERS; EDUCATIONAL AND ENTERTAINMENT SERVICES, NAMELY, PROVIDING MOTIVATIONAL AND EDUCATIONAL SPEAKERS IN THE FIELD OF SELF- AND PERSONAL IMPROVEMENT; EDUCATIONAL AND ENTERTAINMENT SERVICES, NAMELY, PROVIDING MOTIVATIONAL SPEAKING SERVICES IN THE FIELD OF HEALTH AND WEIGHT MANAGEMENT FOCUSING ON ENHANCED SPORTS PERFORMANCE; EDUCATIONAL SERVICES, NAMELY, CONDUCTING INFORMAL ON-LINE PROGRAMS IN THE FIELDS OF HEALTH AND WEIGHT MANAGEMENT FOCUSING ON ENHANCED SPORTS PERFORMANCE, AND PRINTABLE MATERIALS DISTRIBUTED THEREWITH; EDUCATIONAL SERVICES, NAMELY, CONDUCTING INFORMAL PROGRAMS IN THE FIELDS OF HEALTH AND WEIGHT MANAGEMENT FOCUSING ON ENHANCED SPORTS PERFORMANCE, USING ON-LINE ACTIVITIES AND INTERACTIVE EXHIBITS, AND PRINTABLE MATERIALS DISTRIBUTED THEREWITH; EDUCATIONAL SERVICES, NAMELY, CONDUCTING ON-LINE EXHIBITIONS AND DISPLAYS AND INTERACTIVE EXHIBITS IN THE FIELD OF HEALTH AND WEIGHT MANAGEMENT FOCUSING ON ENHANCED SPORTS PERFORMANCE; EDUCATIONAL SERVICES, NAMELY, CONDUCTING WORKOUTS, WORKSHOPS, PRESENTATIONS, RETREATS, AND PERSONAL TRAINING IN THE FIELD OF HEALTH AND WEIGHT MANAGEMENT AND DISTRIBUTION OF COURSE MATERIAL IN CONNECTION THEREWITH; EDUCATIONAL SERVICES, NAMELY, DEVELOPING, ARRANGING, AND CONDUCTING EDUCATIONAL CONFERENCES AND PROGRAMS AND PROVIDING COURSES OF INSTRUCTION IN THE FIELD OF HEALTH AND WEIGHT MANAGEMENT FOCUSING ON ENHANCED SPORTS PERFORMANCE; EDUCATIONAL SERVICES, NAMELY, PROVIDING SEMINARS, LECTURES, TELESEMINARS, CLASSES, TELECLASSES, WORKSHOPS, AND DISTRIBUTING COURSE MATERIALS, NAMELY, DVDS, IN CONNECTION THEREWITH, IN THE FIELDS OF HEALTH AND WEIGHT MANAGEMENT; EDUCATIONAL SERVICES, NAMELY, CONDUCTING SEMINARS, LECTURES, TELESEMINARS, TELECLASSES, AND WORKSHOPS IN THE FIELD OF HEALTH AND WEIGHT MANAGEMENT (U.S. CLS. 100, 101 AND 107).

FIRST USE 12-7-2008; IN COMMERCE 12-7-2008.

CLASS 41—(Continued).

3,807,711. TEAM 2 LEARN, INC., DACULA, GA. SN 77-551,823. PUB. 3-10-2009, FILED 8-20-2008.

**MORE FOR LESS,
FASTER, EASIER, BETTER**

THE MARK CONSISTS OF STANDARD CHARACTERS WITHOUT CLAIM TO ANY PARTICULAR FONT, STYLE, SIZE, OR COLOR.

FOR EDUCATIONAL SERVICES TRAINING MATERIAL USED IN BUSINESS RETREATS, MAGAZINE ARTICLES (U.S. CLS. 100, 101 AND 107).
FIRST USE 6-24-2009; IN COMMERCE 6-24-2009.

3,807,717. ROYAL KAAPALI HOLDINGS, LLC, LOS ANGELES, CA. SN 77-553,786. PUB. 7-7-2009, FILED 8-22-2008.



THE MARK CONSISTS OF A PICTURE OF A WHALE TAIL.
FOR GOLF COURSE SERVICES (U.S. CLS. 100, 101 AND 107).
FIRST USE 11-1-2006; IN COMMERCE 11-1-2006.

3,807,736. REALTIME WORLDS LTD., DUNDEE, UNITED KINGDOM. SN 77-559,334. PUB. 7-14-2009, FILED 8-29-2008.

REALTIME WORLDS

THE MARK CONSISTS OF STANDARD CHARACTERS WITHOUT CLAIM TO ANY PARTICULAR FONT, STYLE, SIZE, OR COLOR.
OWNER OF U.S. REG. NO. 3,120,663.

CLASS 41—(Continued).

NO CLAIM IS MADE TO THE EXCLUSIVE RIGHT TO USE "REAL TIME", APART FROM THE MARK AS SHOWN.

FOR ENTERTAINMENT SERVICES, NAMELY, PROVIDING A COMPUTER GAME THAT MAY BE ACCESSED NETWORK-WIDE BY NETWORK USERS, NAMELY, PROVIDING A MULTIPLE-USER AND MULTIPLE-PLAYER ONLINE VIDEO COMPUTER GAME ON A GLOBAL COMPUTER INFORMATION NETWORK PROVIDED BY MEANS OF COMMUNICATIONS BY COMPUTER TERMINALS (U.S. CLS. 100, 101 AND 107).
FIRST USE 2-15-2005; IN COMMERCE 2-16-2009.

3,807,798. UNITED BUSINESS MEDIA LLC, MANHASSET, NY. SN 77-578,128. PUB. 7-28-2009, FILED 9-24-2008.

ART WARS

THE MARK CONSISTS OF STANDARD CHARACTERS WITHOUT CLAIM TO ANY PARTICULAR FONT, STYLE, SIZE, OR COLOR.

NO CLAIM IS MADE TO THE EXCLUSIVE RIGHT TO USE "ART", APART FROM THE MARK AS SHOWN.

FOR ENTERTAINMENT SERVICES, NAMELY, ARRANGING, ORGANIZING AND CONDUCTING COMPETITIONS WHICH RECOGNIZES ACHIEVEMENT WITH REGARD TO ART AND ARTISTIC DESIGN IN THE FIELDS OF MULTIMEDIA GAMES AND GAME DESIGN, AND PROVIDING RECOGNITION AND INCENTIVES BY THE WAY OF AWARDS TO DEMONSTRATE INDIVIDUAL EXCELLENCE IN CREATIVITY AND INNOVATION THE FIELDS OF ART AND ARTISTIC DESIGN IN THE FIELDS OF MULTIMEDIA GAMES AND GAME DESIGN (U.S. CLS. 100, 101 AND 107).
FIRST USE 3-1-2008; IN COMMERCE 3-1-2008.

3,807,810. THE FASHIONISTAS, DALLAS, TX. SN 77-582,992. PUB. 8-11-2009, FILED 10-1-2008.

F2

THE MARK CONSISTS OF STANDARD CHARACTERS WITHOUT CLAIM TO ANY PARTICULAR FONT, STYLE, SIZE, OR COLOR.

FOR EDUCATION SERVICES, NAMELY, PROVIDING CLASSES, SEMINARS, WORKSHOPS IN THE FIELD OF FASHION; EDUCATION SERVICES, NAMELY, MENTORING IN THE FIELD OF FASHION CAREERS (U.S. CLS. 100, 101 AND 107).
FIRST USE 7-0-2006; IN COMMERCE 7-0-2006.

CLASS 41—(Continued).

3,807,829. SCRIPPS NETWORKS, LLC, KNOXVILLE, TN. SN 77-592,530. PUB. 8-4-2009, FILED 10-14-2008.

WORTH EVERY PENNY

THE MARK CONSISTS OF STANDARD CHARACTERS WITHOUT CLAIM TO ANY PARTICULAR FONT, STYLE, SIZE, OR COLOR.

FOR EDUCATIONAL AND ENTERTAINMENT SERVICES, NAMELY, AN ASPIRATIONAL CONTINUING PROGRAM ABOUT HOME AND LIFESTYLE, ACCESSIBLE BY RADIO, TELEVISION, CABLE, FIBER OPTIC NETWORKS, WIRELESS NETWORKS, SATELLITE, AUDIO VIDEO, AND COMPUTER NETWORKS (U.S. CLS. 100, 101 AND 107).

FIRST USE 11-6-2009; IN COMMERCE 11-6-2009.

3,807,911. K2 NETWORK, IRVINE, CA. SN 77-645,995. PUB. 12-22-2009, FILED 1-8-2009.



NO CLAIM IS MADE TO THE EXCLUSIVE RIGHT TO USE "RACER", APART FROM THE MARK AS SHOWN.

THE COLOR(S) GREY, ORANGE, WHITE, BLACK IS/ARE CLAIMED AS A FEATURE OF THE MARK.

THE MARK CONSISTS OF STYLIZED FORM OF THE WORD "GOGO" WITH THE "O'S AS TIRES AND THE "GS" WITH TIRE TREADS. "RACER" HAS WIND MARKS IN FRONT OF IT. THERE IS STYLIZED ORANGEY AND GREY LETTERS IN THE FORM OF CAR TIRES WITH A BLACK AND WHITE CHECKERED FLAG IN THE BACK WITH A GREY SMOKE CLOUD.

FOR ENTERTAINMENT SERVICES, NAMELY, PROVIDING AN ON-LINE COMPUTER GAME (U.S. CLS. 100, 101 AND 107).

FIRST USE 12-0-2009; IN COMMERCE 12-0-2009.

3,807,921. SMITH, Y.M., KESWICK, VA. SN 77-649,057. PUB. 5-26-2009, FILED 1-14-2009.

Zavvi Rodaine

THE MARK CONSISTS OF STANDARD CHARACTERS WITHOUT CLAIM TO ANY PARTICULAR FONT, STYLE, SIZE, OR COLOR.

CLASS 41—(Continued).

THE NAME "ZAVVI RODAINE" DOES NOT IDENTIFY A PARTICULAR LIVING INDIVIDUAL.

FOR ON-LINE JOURNALS, NAMELY, BLOGS FEATURING LIFESTYLE ISSUES (U.S. CLS. 100, 101 AND 107).

FIRST USE 3-31-2010; IN COMMERCE 3-31-2010.

3,807,930. MONCADA, CARLOS, SALINAS, CA. SN 77-656,146. PUB. 5-12-2009, FILED 1-26-2009.

KEPADRE

THE MARK CONSISTS OF STANDARD CHARACTERS WITHOUT CLAIM TO ANY PARTICULAR FONT, STYLE, SIZE, OR COLOR.

THE WORDING "KEPADRE" HAS NO MEANING IN A FOREIGN LANGUAGE.

FOR RADIO NETWORK PROGRAMMING (U.S. CLS. 100, 101 AND 107).

FIRST USE 3-1-2009; IN COMMERCE 4-15-2009.

3,807,952. JACKSON, JEFFREY, FAR HILLS, NJ. SN 77-669,978. PUB. 5-19-2009, FILED 2-13-2009.

Digital Epic

THE MARK CONSISTS OF STANDARD CHARACTERS WITHOUT CLAIM TO ANY PARTICULAR FONT, STYLE, SIZE, OR COLOR.

NO CLAIM IS MADE TO THE EXCLUSIVE RIGHT TO USE "DIGITAL", APART FROM THE MARK AS SHOWN.

FOR ENTERTAINMENT SERVICES, NAMELY, WEBSITES FEATURING FILMS, ONLINE GAMES, MUSIC, STORIES, AND OTHER INTERACTIVE MEDIA CONTENT (U.S. CLS. 100, 101 AND 107).

FIRST USE 4-25-2010; IN COMMERCE 4-25-2010.

CLASS 41—(Continued).

3,807,966. PRAXIS LANGUAGE LTD., GEORGE TOWN, CAYMAN ISLANDS. SN 77-673,633. PUB. 1-12-2010, FILED 2-19-2009.

OPENLANGUAGE

THE MARK CONSISTS OF STANDARD CHARACTERS WITHOUT CLAIM TO ANY PARTICULAR FONT, STYLE, SIZE, OR COLOR.

FOR LANGUAGE INSTRUCTION; PROVIDING ON-LINE LANGUAGE LEARNING MEDIA, LANGUAGE LEARNING COLLABORATION TOOLS, AND LANGUAGE LEARNING COURSE MANAGEMENT AND ANALYTICAL TOOLS (U.S. CLS. 100, 101 AND 107).

FIRST USE 2-10-2010; IN COMMERCE 2-10-2010.

3,807,978. COOKIE JAR ENTERTAINMENT INC., TORONTO, ONTARIO, CANADA. SN 77-676,916. PUB. 8-4-2009, FILED 2-24-2009.

COOKIE JAR TV

THE MARK CONSISTS OF STANDARD CHARACTERS WITHOUT CLAIM TO ANY PARTICULAR FONT, STYLE, SIZE, OR COLOR.

OWNER OF U.S. REG. NOS. 3,145,569, 3,278,059, AND OTHERS.

NO CLAIM IS MADE TO THE EXCLUSIVE RIGHT TO USE "TV", APART FROM THE MARK AS SHOWN.

FOR EDUCATIONAL AND ENTERTAINMENT SERVICES IN THE NATURE OF CHILDREN'S TELEVISION PROGRAMS IN THE FIELDS OF CHILDREN'S EDUCATION AND ENTERTAINMENT FEATURING A WIDE RANGE OF INFORMATION ON TOPICS OF INTEREST TO CHILDREN AND THEIR PARENTS AND CAREGIVERS; PROVIDING INFORMATION VIA THE INTERNET IN THE FIELDS OF CHILDREN'S EDUCATION AND ENTERTAINMENT RELATING TO A WIDE RANGE OF EDUCATION AND ENTERTAINMENT INFORMATION ON TOPICS OF INTEREST TO CHILDREN AND THEIR PARENTS AND CAREGIVERS, NAMELY, INFORMATION ON ENTERTAINMENT FOR AND EDUCATION OF CHILDREN (U.S. CLS. 100, 101 AND 107).

FIRST USE 8-22-2009; IN COMMERCE 8-22-2009.

CLASS 41—(Continued).

3,807,983. STEPHEN TSAI, DBA INTERNATIONAL COLLEGE OF COMPLEMENTARY AND ALTERNATIVE MEDICINE, FULLERTON, CA. SN 77-679,123. PUB. 6-23-2009, FILED 2-26-2009.



NO CLAIM IS MADE TO THE EXCLUSIVE RIGHT TO USE "INTERNATIONAL COLLEGE OF COMPLEMENTARY AND ALTERNATIVE MEDICINE" AND THE MEDICAL CADUCEUS SYMBOL, APART FROM THE MARK AS SHOWN.

THE COLOR(S) DARK BLUE, PURPLE, LEAF GREEN, BROWN, WHITE, AND SKY BLUE IS/ARE CLAIMED AS A FEATURE OF THE MARK.

THE MARK CONSISTS OF THE WORDS IN DARK BLUE AND STATE "ICCAM" AND "INTERNATIONAL COLLEGE OF COMPLEMENTARY AND ALTERNATIVE MEDICINE". THE OUTER SHIELD HAS A DARK BLUE LINE WITH A WHITE INSIDE BORDER. THE INNER SHIELD IS PURPLE AND SEPARATED INTO 4 QUADRANTS. IN THE UPPER LEFT CORNER, IT HAS A SKY BLUE GLOBE WITH MERIDIANS AND PARALLELS ONLY WITH A DARK BLUE OUTLINE. THE LOWER LEFT CORNER HAS A BROWN MORTAR AND PESTLE WITH A DARK BLUE OUTLINE. IN THE UPPER RIGHT CORNER, IT HAS A LEAF GREEN WITH A DARK BLUE OUTLINE. THE LOWER RIGHT CORNER HAS THE MEDICAL CADUCEUS SYMBOL IN WHITE WITH A DARK BLUE OUTLINE.

FOR CONSULTING SERVICES IN THE FIELD OF COMPLEMENTARY AND ALTERNATIVE MEDICINE EDUCATION, NAMELY, COMPREHENSIVE POST-GRADUATE MEDICAL PLACEMENT SERVICES FOR INTERNATIONAL MEDICAL GRADUATES; EDUCATING AT UNIVERSITY OR COLLEGES IN THE FIELD OF COMPLEMENTARY AND ALTERNATIVE MEDICINE; EDUCATIONAL SERVICES, NAMELY, CONDUCTING DISTANCE LEARNING INSTRUCTION AT THE SECONDARY, COLLEGE AND GRADUATE LEVELS IN THE FIELD OF COMPLEMENTARY AND ALTERNATIVE MEDICINE; EDUCATIONAL SERVICES, NAMELY, PROVIDING COURSES OF INSTRUCTION AT THE GRADUATE LEVEL IN THE FIELD OF COMPLEMENTARY AND ALTERNATIVE MEDICINE; EDUCATIONAL SERVICES, NAMELY, PROVIDING COURSES OF INSTRUCTION AT THE GRADUATE LEVEL AND DISTRIBUTION OF COURSE MATERIAL IN CONNECTION THEREWITH IN THE FIELD OF COMPLEMEN-

CLASS 41—(Continued).

TARY AND ALTERNATIVE MEDICINE; ORGANIZATION OF SEMINARS, WORKING GROUPS, RESEARCH GROUPS AND CONVENTIONS, IN THE FIELD OF COMPLEMENTARY AND ALTERNATIVE MEDICINE; PROVIDING A WEB SITE THAT FEATURES INFORMATION ON ATTENDING COLLEGE AND UNIVERSITY WITH AN EMPHASIS ON NEWLY ENROLLED STUDENTS IN THE FIELD OF COMPLEMENTARY AND ALTERNATIVE MEDICINE; PROVIDING COURSES OF INSTRUCTION AT THE GRADUATE LEVEL IN THE FIELD OF COMPLEMENTARY AND ALTERNATIVE MEDICINE; PROVIDING ON-LINE DOCUMENTS FOR APPLICATIONS CONCERNING COLLEGE IN THE FIELD OF COMPLEMENTARY AND ALTERNATIVE MEDICINE; PUBLISHING OF JOURNALS, BOOKS AND HANDBOOKS IN THE FIELD OF COMPLEMENTARY AND ALTERNATIVE MEDICINE; SPONSORING, DEVELOPING, AND CARRYING OUT INTERNATIONAL STUDENT EXCHANGE PROGRAMS IN THE FIELD OF COMPLEMENTARY AND ALTERNATIVE MEDICINE (U.S. CLS. 100, 101 AND 107).

FIRST USE 3-2-2009; IN COMMERCE 3-2-2009.

3,808,043. TRUE GAMES INTERACTIVE, INC., IRVINE, CA. SN 77-692,208. PUB. 7-14-2009, FILED 3-16-2009.

WARRIOR EPIC

THE MARK CONSISTS OF STANDARD CHARACTERS WITHOUT CLAIM TO ANY PARTICULAR FONT, STYLE, SIZE, OR COLOR.

FOR ENTERTAINMENT SERVICES, NAMELY, PROVIDING COMPETITIVE MULTI-PLAYER VIDEO GAMING VIA A GLOBAL COMPUTER NETWORK (U.S. CLS. 100, 101 AND 107).

FIRST USE 5-21-2009; IN COMMERCE 5-21-2009.

3,808,046. FANDANGO, INC., LOS ANGELES, CA. SN 77-692,419. PUB. 7-28-2009, FILED 3-17-2009.



NO CLAIM IS MADE TO THE EXCLUSIVE RIGHT TO USE "MOVIES.COM", APART FROM THE MARK AS SHOWN.

THE COLOR(S) RED AND DARK GRAY IS/ARE CLAIMED AS A FEATURE OF THE MARK.

CLASS 41—(Continued).

THE MARK CONSISTS OF A RED STYLIZED "M", SUGGESTIVE OF CURTAINS IN A MOVIE THEATER, ABOVE THE TERM "MOVIES.COM" IN THE COLOR DARK GRAY.

FOR PROVIDING NEWS AND EDITORIAL, PROMOTIONAL AND FACTUAL INFORMATION ABOUT PAST, PRESENT AND FUTURE MOVIES, MOVIE LISTINGS, MOVIE SCHEDULES, MOVIE LOCATIONS, MOVIE THEATERS AND MOVIE-RELATED EVENTS, VIA THE INTERNET, MOBILE PHONES, CELLULAR PHONES, DIGITAL PHONES, PERSONAL DIGITAL ASSISTANTS AND OTHER ELECTRONIC COMMUNICATIONS NETWORKS; PROVIDING VIDEO AND AUDIO FILM CLIPS FROM MOVIES, CONCERTS, SHOWS AND OTHER ENTERTAINMENT EVENTS VIA THE INTERNET, MOBILE PHONES, CELLULAR PHONES, DIGITAL PHONES, PERSONAL DIGITAL ASSISTANTS AND OTHER ELECTRONIC COMMUNICATIONS NETWORKS; ONLINE TICKETING AND RESERVATION SERVICES FOR MOVIES, CONCERTS, SHOWS AND OTHER ENTERTAINMENT EVENTS (U.S. CLS. 100, 101 AND 107).

FIRST USE 4-15-2010; IN COMMERCE 4-15-2010.

3,808,063. SANTANA, SERGIO, SEFFNER, FL. SN 77-696,660. PUB. 7-28-2009, FILED 3-23-2009.



NO CLAIM IS MADE TO THE EXCLUSIVE RIGHT TO USE "RECORDS", APART FROM THE MARK AS SHOWN.

THE MARK CONSISTS OF THE STYLIZED WORDING "FLOHIO RECORDS". THE LETTER "F" IN THE MARK FEATURES AN OUTLINE OF THE STATE OF FLORIDA, WHILE THE SECOND LETTER "O" IN THE MARK IS PRESENTED AS AN OUTLINE OF THE STATE OF OHIO.

FOR AUDIO RECORDING AND PRODUCTION; MULTIMEDIA ENTERTAINMENT SERVICES IN THE NATURE OF RECORDING, PRODUCTION AND POST-PRODUCTION SERVICES IN THE FIELDS OF MUSIC, VIDEO, AND FILMS (U.S. CLS. 100, 101 AND 107).

FIRST USE 5-22-2009; IN COMMERCE 11-29-2009.

3,808,075. THE CARTOON NETWORK, INC., ATLANTA, GA. SN 77-697,795. PUB. 7-21-2009, FILED 3-24-2009.

GENERATOR REX

THE MARK CONSISTS OF STANDARD CHARACTERS WITHOUT CLAIM TO ANY PARTICULAR FONT, STYLE, SIZE, OR COLOR.

FOR ENTERTAINMENT SERVICES, NAMELY, A MULTIMEDIA PROGRAM SERIES FEATURING COMEDY, ACTION AND ADVENTURE DISTRIBUTED VIA VARIOUS PLATFORMS ACROSS MULTIPLE FORMS OF TRANSMISSION MEDIA (U.S. CLS. 100, 101 AND 107).

FIRST USE 4-23-2010; IN COMMERCE 4-23-2010.

CLASS 41—(Continued).

3,808,087. NATALIE M. SPILGER, SAN FRANCISCO, CA. SN 77-698,990. PUB. 7-28-2009, FILED 3-25-2009.

GREENLACES

THE MARK CONSISTS OF STANDARD CHARACTERS WITHOUT CLAIM TO ANY PARTICULAR FONT, STYLE, SIZE, OR COLOR.

FOR EDUCATIONAL SERVICES, NAMELY, PROVIDING SEMINARS IN THE FIELD OF ENVIRONMENTAL AWARENESS; EDUCATIONAL SERVICES, NAMELY, THE ORGANIZATION OF GAMES, AND CONDUCTING PROGRAMS AND SPORTING ACTIVITIES IN THE FIELD OF ENVIRONMENTAL AWARENESS (U.S. CLS. 100, 101 AND 107).
FIRST USE 3-15-2008; IN COMMERCE 3-15-2008.

3,808,100. PORTO FRANCO RECORDS, LLC, SAN FRANCISCO, CA. SN 77-700,414. PUB. 7-21-2009, FILED 3-26-2009.

PORTO FRANCO RECORDS

THE MARK CONSISTS OF STANDARD CHARACTERS WITHOUT CLAIM TO ANY PARTICULAR FONT, STYLE, SIZE, OR COLOR.

NO CLAIM IS MADE TO THE EXCLUSIVE RIGHT TO USE "RECORDS", APART FROM THE MARK AS SHOWN.

THE ENGLISH TRANSLATION OF "PORTO FRANCO" IN THE MARK IS FREE PORT.

FOR MUSICAL ENTERTAINMENT SERVICES, NAMELY, PROVIDING PRE-RECORDED AUDIO AND VIDEO RECORDINGS FEATURING MUSIC ONLINE VIA A GLOBAL COMPUTER NETWORK, RECORD MASTER PRODUCTION, MUSIC PRODUCTION SERVICES, AND PROVIDING A WEBSITE OVER A GLOBAL COMPUTER INFORMATION NETWORK FEATURING INFORMATION ON A RECORD LABEL, ITS ARTISTS AND THE MUSIC FEATURED (U.S. CLS. 100, 101 AND 107).
FIRST USE 2-1-2009; IN COMMERCE 3-1-2009.

CLASS 41—(Continued).

3,808,119. INDIANAPOLIS COLTS, INC., INDIANAPOLIS, IN. SN 77-703,337. PUB. 7-28-2009, FILED 3-31-2009.



THE COLOR(S) BLUE, DARK BLUE AND WHITE IS/ARE CLAIMED AS A FEATURE OF THE MARK.

THE MARK CONSISTS OF A RUNNING HORSE OUTLINED IN DARK BLUE AND COLORED IN WITH THE COLOR BLUE, WITH DARK BLUE SHADING ON THE LEGS, SIDE, CHEST, NECK AND FACE, WHITE HOOVES WITH DARK BLUE SHADING, A WHITE MANE AND TAIL AND WHITE EYES AND TEETH.

FOR ENTERTAINMENT SERVICES IN THE FORM OF PROFESSIONAL FOOTBALL GAMES AND EXHIBITIONS (U.S. CLS. 100, 101 AND 107).
FIRST USE 8-14-2009; IN COMMERCE 8-14-2009.

3,808,123. GBG, LLP, BLOOMINGTON, MN. SN 77-703,600. PUB. 12-22-2009, FILED 3-31-2009.

RICK BRONSON'S HOUSE OF COMEDY

THE MARK CONSISTS OF STANDARD CHARACTERS WITHOUT CLAIM TO ANY PARTICULAR FONT, STYLE, SIZE, OR COLOR.

NO CLAIM IS MADE TO THE EXCLUSIVE RIGHT TO USE "COMEDY", APART FROM THE MARK AS SHOWN.

THE NAME(S), PORTRAIT(S), AND/OR SIGNATURE(S) SHOWN IN THE MARK IDENTIFIES "RICK BRONSON", WHOSE CONSENT(S) TO REGISTER IS MADE OF RECORD.

FOR ENTERTAINMENT SERVICES IN THE NATURE OF COMEDY SHOWS (U.S. CLS. 100, 101 AND 107).
FIRST USE 7-29-2009; IN COMMERCE 7-29-2009.

CLASS 41—(Continued).

3,808,131. CLINICAL CARE OPTIONS, LLC, RESTON, VA. SN 77-704,639. PUB. 8-4-2009, FILED 4-1-2009.

CCO ONCOLOGY INPRACTICE

THE MARK CONSISTS OF STANDARD CHARACTERS WITHOUT CLAIM TO ANY PARTICULAR FONT, STYLE, SIZE, OR COLOR.

OWNER OF U.S. REG. NOS. 3,238,703, 3,238,705, AND OTHERS.

NO CLAIM IS MADE TO THE EXCLUSIVE RIGHT TO USE "ONCOLOGY", APART FROM THE MARK AS SHOWN.

FOR EDUCATIONAL SERVICES, NAMELY, CONDUCTING CLASSES, SEMINARS, CONFERENCES AND WORKSHOPS THAT ARE PRESENTED LIVE AND PRESENTED ONLINE IN THE FIELD OF ONCOLOGY (U.S. CLS. 100, 101 AND 107).

FIRST USE 10-27-2009; IN COMMERCE 10-27-2009.

3,808,132. CLINICAL CARE OPTIONS, LLC, RESTON, VA. SN 77-704,658. PUB. 8-4-2009, FILED 4-1-2009.

CCO HIV INPRACTICE

THE MARK CONSISTS OF STANDARD CHARACTERS WITHOUT CLAIM TO ANY PARTICULAR FONT, STYLE, SIZE, OR COLOR.

OWNER OF U.S. REG. NOS. 3,238,703, 3,238,705, AND OTHERS.

NO CLAIM IS MADE TO THE EXCLUSIVE RIGHT TO USE "HIV", APART FROM THE MARK AS SHOWN.

FOR EDUCATIONAL SERVICES, NAMELY, CONDUCTING CLASSES, SEMINARS, CONFERENCES AND WORKSHOPS THAT ARE PRESENTED LIVE AND PRESENTED ONLINE IN THE FIELD OF HIV (U.S. CLS. 100, 101 AND 107).

FIRST USE 10-27-2009; IN COMMERCE 10-27-2009.

CLASS 41—(Continued).

3,808,182. NBC UNIVERSAL, INC., NEW YORK, NY. SN 77-713,016. PUB. 9-29-2009, FILED 4-13-2009.

GREEN LIVES HERE

THE MARK CONSISTS OF STANDARD CHARACTERS WITHOUT CLAIM TO ANY PARTICULAR FONT, STYLE, SIZE, OR COLOR.

FOR ENTERTAINMENT SERVICES, NAMELY, TELEVISION PROGRAMMING RELATED TO ENVIRONMENTAL CONCERNS; ENTERTAINMENT SERVICES, NAMELY, A WEBSITE FEATURING INFORMATION ABOUT ENTERTAINMENT PROGRAMMING IN THE FIELD OF ENVIRONMENTAL TOPICS AS THEY RELATE TO FOOD, PERSONAL RELATIONSHIPS, PARENTING, STYLE, BEAUTY, HOME, AND HEALTH; AMUSEMENT PARK SERVICES; PROVIDING A WEBSITE FOR VIEWING ENTERTAINMENT PROGRAMMING RELATED TO ENVIRONMENTAL ISSUES; EDUCATIONAL SERVICES, NAMELY, CONDUCTING PROGRAMS FOR ADULTS AND CHILDREN IN THE FIELD OF THE ENVIRONMENT AND CONSERVATION (U.S. CLS. 100, 101 AND 107).

FIRST USE 6-0-2009; IN COMMERCE 6-0-2009.

3,808,191. RENAISSANCE LEARNING, INC., WISCONSIN RAPIDS, WI. SN 77-714,096. PUB. 8-25-2009, FILED 4-15-2009.

DEEP CAPACITY

THE MARK CONSISTS OF STANDARD CHARACTERS WITHOUT CLAIM TO ANY PARTICULAR FONT, STYLE, SIZE, OR COLOR.

FOR SEMINARS AND WORKSHOPS FOR EDUCATORS IN THE FIELD OF K12 EDUCATION; CONSULTING SERVICES FOR SCHOOLS, SCHOOL SYSTEMS AND K12 EDUCATORS IN THE FIELD OF EDUCATION (U.S. CLS. 100, 101 AND 107).

FIRST USE 8-31-2009; IN COMMERCE 8-31-2009.

3,808,201. CHEER BRANDS, INC., ROUND ROCK, TX. SN 77-715,349. PUB. 8-18-2009, FILED 4-16-2009.

CHEER WORLD

THE MARK CONSISTS OF STANDARD CHARACTERS WITHOUT CLAIM TO ANY PARTICULAR FONT, STYLE, SIZE, OR COLOR.

CLASS 41—(Continued).

NO CLAIM IS MADE TO THE EXCLUSIVE RIGHT TO USE "CHEER", APART FROM THE MARK AS SHOWN.

FOR ENTERTAINMENT SERVICES, NAMELY, ARRANGING AND CONDUCTING OF COMPETITIONS FOR CHEERLEADING, DANCE, DRILL TEAMS, AND POM POM SQUADS (U.S. CLS. 100, 101 AND 107).

FIRST USE 4-24-2010; IN COMMERCE 4-24-2010.

3,808,216. JEFFERSON, ROSALIE, DALLAS, TX. SN 77-718,391. PUB. 8-25-2009, FILED 4-21-2009.

**Marriage Interrupted
"Coaching You Through
Life's Interruptions"**

THE MARK CONSISTS OF STANDARD CHARACTERS WITHOUT CLAIM TO ANY PARTICULAR FONT, STYLE, SIZE, OR COLOR.

NO CLAIM IS MADE TO THE EXCLUSIVE RIGHT TO USE "MARRIAGE", APART FROM THE MARK AS SHOWN.

FOR PERSONAL COACHING SERVICES IN THE FIELD OF MARRIAGE AND DIVORCE (U.S. CLS. 100, 101 AND 107).

FIRST USE 10-6-2009; IN COMMERCE 2-2-2010.

3,808,310. HAAG, JESSE C, TROY, MT. SN 77-748,212. PUB. 10-6-2009, FILED 5-29-2009.

Sonic Distiller

THE MARK CONSISTS OF STANDARD CHARACTERS WITHOUT CLAIM TO ANY PARTICULAR FONT, STYLE, SIZE, OR COLOR.

FOR AUDIO AND VIDEO RECORDING SERVICES; AUDIO RECORDING AND PRODUCTION; MULTIMEDIA ENTERTAINMENT SERVICES IN THE NATURE OF RECORDING, PRODUCTION AND POST-PRODUCTION SERVICES IN THE FIELDS OF MUSIC, VIDEO, AND FILMS; PRODUCTION OF SOUND AND MUSIC VIDEO RECORDINGS; PRODUCTION OF SOUND RECORDINGS; RECORDING STUDIO SERVICES; RECORDING STUDIOS (U.S. CLS. 100, 101 AND 107).

FIRST USE 9-18-2006; IN COMMERCE 9-18-2006.

CLASS 41—(Continued).

3,808,375. FLATH, CARL, ELKHORN, WI. SN 77-770,680.

PUB. 11-24-2009, FILED 6-29-2009.



NO CLAIM IS MADE TO THE EXCLUSIVE RIGHT TO USE "PRODUCTIONS", APART FROM THE MARK AS SHOWN.

THE STIPPLING IS FOR SHADING PURPOSES ONLY.

THE MARK CONSISTS OF AN OPEN CLAP BOARD, WITH WINGS, AND RUNNING PAINT AT THE BOTTOM. A SKULL IS PLACED IN BETWEEN "CUT" AND "WING".

FOR VIDEO PRODUCTION SERVICES (U.S. CLS. 100, 101 AND 107).

FIRST USE 2-23-2010; IN COMMERCE 2-23-2010.

3,808,384. ROBERT ETOLL PRODUCTIONS, INC., CULVER CITY, CA. SN 77-775,080. PUB. 12-1-2009, FILED 7-6-2009.

TONAL INJECTION

THE MARK CONSISTS OF STANDARD CHARACTERS WITHOUT CLAIM TO ANY PARTICULAR FONT, STYLE, SIZE, OR COLOR.

FOR MAINTAINING A LIBRARY OF RECORDED MUSIC (U.S. CLS. 100, 101 AND 107).

FIRST USE 9-15-2009; IN COMMERCE 9-15-2009.

3,808,459. THE 100 MILE MAN LLC, NEW YORK, NY. SN 77-802,934. PUB. 1-19-2010, FILED 8-12-2009.

CITY TO THE SAND

THE MARK CONSISTS OF STANDARD CHARACTERS WITHOUT CLAIM TO ANY PARTICULAR FONT, STYLE, SIZE, OR COLOR.

FOR ENTERTAINMENT SERVICES, NAMELY, ORGANIZING AND CONDUCTING RUNNING RACES (U.S. CLS. 100, 101 AND 107).

FIRST USE 6-15-2009; IN COMMERCE 6-15-2009.

CLASS 41—(Continued).

3,808,476. NORTH CAROLINA SUSTAINABLE ENTREPRENEURS GROUP, DBA ENTREDOT, WAKE FOREST, NC. SN 77-810,772. PUB. 1-19-2010, FILED 8-23-2009.

EntreDot

THE MARK CONSISTS OF STANDARD CHARACTERS WITHOUT CLAIM TO ANY PARTICULAR FONT, STYLE, SIZE, OR COLOR.

FOR EDUCATION SERVICES, NAMELY, PROVIDING MENTORING, TUTORING, CLASSES, SEMINARS AND WORKSHOPS IN THE FIELD OF BUSINESS (U.S. CLS. 100, 101 AND 107).

FIRST USE 12-1-2009; IN COMMERCE 2-1-2010.

3,808,496. BARTOL, CARL A., N. WHITE PLAINS, NY. SN 77-840,884. PUB. 12-29-2009, FILED 10-4-2009.

LEGALAGE

THE MARK CONSISTS OF STANDARD CHARACTERS WITHOUT CLAIM TO ANY PARTICULAR FONT, STYLE, SIZE, OR COLOR.

FOR ENTERTAINMENT SERVICES, NAMELY, PROVIDING A WEB SITE FEATURING ADULT-THEMED PHOTOGRAPHS AND VIDEOS (U.S. CLS. 100, 101 AND 107).

FIRST USE 2-1-2010; IN COMMERCE 2-1-2010.

3,808,542. HUNEEUS VINTNERS LLC, RUTHERFORD, CA. SN 77-979,510. PUB. 4-24-2007, FILED 8-25-2006.

FAUST

THE MARK CONSISTS OF STANDARD CHARACTERS WITHOUT CLAIM TO ANY PARTICULAR FONT, STYLE, SIZE, OR COLOR.

FOR ENTERTAINMENT SERVICES, NAMELY, WINE TASTINGS AND CONDUCTING ENTERTAINMENT EXHIBITIONS IN THE NATURE OF WINE FESTIVALS AND WINE RELEASE PARTIES (U.S. CLS. 100, 101 AND 107).

FIRST USE 10-0-2005; IN COMMERCE 10-0-2005.

CLASS 41—(Continued).

3,808,624. SESAME WORKSHOP, NEW YORK, NY. SN 78-981,384. PUB. 12-8-2009, FILED 2-9-2005.

PINKY DINKY DOO

THE MARK CONSISTS OF STANDARD CHARACTERS WITHOUT CLAIM TO ANY PARTICULAR FONT, STYLE, SIZE, OR COLOR.

FOR ONGOING TELEVISION PROGRAM FEATURING ANIMATION, EDUCATIONAL THEMES AND ENTERTAINMENT DIRECTED TO CHILDREN; PROVIDING ONLINE EDUCATIONAL INFORMATION, NAMELY, LEARNING EXERCISES, GAMES, ANIMATION, AND ENTERTAINMENT DIRECTED TO CHILDREN; PROVIDING ON-LINE COMPUTER GAMES AND ACTIVITIES VIA THE INTERNET, ALL FEATURING LEARNING EXERCISES, ANIMATION AND ENTERTAINMENT DIRECTED TO CHILDREN (U.S. CLS. 100, 101 AND 107).

FIRST USE 4-10-2006; IN COMMERCE 4-10-2006.

CLASS 42—SCIENTIFIC AND COMPUTER SERVICES

3,807,383. NUMEROLOGIC IP HOLDINGS LLC, DALLAS, TX. SN 76-689,372. PUB. 10-28-2008, FILED 5-6-2008.

XZOTTO

THE MARK CONSISTS OF STANDARD CHARACTERS WITHOUT CLAIM TO ANY PARTICULAR FONT, STYLE, SIZE, OR COLOR.

FOR TEAM MANAGEMENT SOFTWARE FOR MANAGING LOTTERY ENTHUSIASTS, NAMELY, ON-LINE NON-DOWNLOADABLE SOFTWARE FOR ALLOWING LOTTERY ENTHUSIASTS TO POOL MONEY TO BUY LOTTERY TICKETS AS A GROUP (U.S. CLS. 100 AND 101).

FIRST USE 9-25-2008; IN COMMERCE 9-25-2008.

CLASS 42—(Continued).

3,807,431. CONENZA, INC., SEATTLE, WA. SN 77-078,773. PUB. 1-13-2009, FILED 1-9-2007.

CONENZA

THE MARK CONSISTS OF STANDARD CHARACTERS WITHOUT CLAIM TO ANY PARTICULAR FONT, STYLE, SIZE, OR COLOR.

THE WORDING "CONENZA" HAS NO MEANING IN A FOREIGN LANGUAGE.

FOR APPLICATION SERVICE PROVIDER, NAMELY, DEVELOPING AND MAINTAINING ONLINE COMMUNITIES FOR OTHERS IN THE FIELD OF BUSINESS RELATIONSHIPS, ALUMNI RELATIONSHIPS, REFERRAL RELATIONSHIPS AND RECRUITMENT ACTIVITIES; COMPUTER CONSULTATION; COMPUTER SOFTWARE DEVELOPMENT; HOSTING THE WEB SITES OF OTHERS ON A COMPUTER SERVER FOR A GLOBAL COMPUTER NETWORK; COMPUTER SERVICES, NAMELY, DESIGNING AND IMPLEMENTING WEB SITES FOR OTHERS; COMPUTER SERVICES, NAMELY, CREATING AND MAINTAINING WEB SITES FOR OTHERS; PROVIDING CUSTOMIZED ONLINE WEB PAGES FEATURING USER-DEFINED INFORMATION, WHICH INCLUDES SEARCH ENGINES AND ONLINE WEB LINKS TO OTHER WEB SITES (U.S. CLS. 100 AND 101).

FIRST USE 1-18-2007; IN COMMERCE 1-18-2007.

3,807,435. REDFLEX TRAFFIC SYSTEMS, INC., SCOTTS-DALE, AZ. SN 77-084,016. PUB. 8-28-2007, FILED 1-16-2007.

REDFLEXSPEED

THE MARK CONSISTS OF STANDARD CHARACTERS WITHOUT CLAIM TO ANY PARTICULAR FONT, STYLE, SIZE, OR COLOR.

FOR PROVIDING TEMPORARY USE OF ON-LINE NON-DOWNLOADABLE COMPUTER SOFTWARE FOR TRAFFIC MONITORING, TRAFFIC INFORMATION PROCESSING, TRAFFIC LIGHT CONTROL AND TRAFFIC CITATION MANAGEMENT, ALL IN THE FIELD OF MOTOR VEHICLE TRAFFIC MANAGEMENT (U.S. CLS. 100 AND 101).

FIRST USE 1-16-2007; IN COMMERCE 1-16-2007.

CLASS 42—(Continued).

3,807,472. QIX INFORMATION TECHNOLOGY LLC, DBA QIXIT, O'FALLON, MO. SN 77-233,896. PUB. 9-1-2009, FILED 7-19-2007.

Qixit

THE MARK CONSISTS OF STANDARD CHARACTERS WITHOUT CLAIM TO ANY PARTICULAR FONT, STYLE, SIZE, OR COLOR.

FOR PROVIDING TEMPORARY USE OF NON-DOWNLOADABLE COMPUTER SOFTWARE FOR ENABLING SECURE FINANCIAL TRANSACTIONS VIA THE INTERNET AND SECURE ELECTRONIC MESSAGING FEATURING OPTIONAL COLLECTION AND DISSEMINATION OF MARKETING DATA VIA THE INTERNET TO FACILITATE THE EXCHANGE OF USER GENERATED INFORMATION, FUNDS, MERCHANDISE AND SERVICES (U.S. CLS. 100 AND 101).

FIRST USE 6-21-2007; IN COMMERCE 3-12-2008.

3,807,524. THRUBIT B.V., RIJSWIJK ZUID-HOLLAND, NETHERLANDS. SN 77-333,853. PUB. 5-20-2008, FILED 11-20-2007.

SURELOG

THE MARK CONSISTS OF STANDARD CHARACTERS WITHOUT CLAIM TO ANY PARTICULAR FONT, STYLE, SIZE, OR COLOR.

FOR OIL WELL EVALUATION, NAMELY, WELL LOGGING, FORMATION FLUID SAMPLING AND FORMATION FLUID PRESSURE TESTING USING EQUIPMENT DEPLOYED IN WELLBORES THROUGH SPECIALIZED DRILL BITS AND MILLING TOOLS HAVING THROUGH PASSAGES (U.S. CLS. 100 AND 101).

FIRST USE 1-26-2010; IN COMMERCE 1-26-2010.

3,807,552. REDHOSTING, INC., LAS VEGAS, NV. SN 77-403,774. PUB. 1-27-2009, FILED 2-22-2008.

REDHOSTING

THE MARK CONSISTS OF STANDARD CHARACTERS WITHOUT CLAIM TO ANY PARTICULAR FONT, STYLE, SIZE, OR COLOR.

FOR HOSTING THE WEB SITES OF OTHERS ON A COMPUTER SERVER FOR A GLOBAL COMPUTER NETWORK (U.S. CLS. 100 AND 101).

FIRST USE 8-4-2008; IN COMMERCE 8-4-2008.

CLASS 42—(Continued).

3,807,564. DOCTATIONS, INC., GARDEN CITY, NY. SN 77-412,006. PUB. 1-27-2009, FILED 3-3-2008.

WEB INTEGRATED HEALTH CARE
COMMUNITY (WIHCC)

THE MARK CONSISTS OF STANDARD CHARACTERS WITHOUT CLAIM TO ANY PARTICULAR FONT, STYLE, SIZE, OR COLOR.

NO CLAIM IS MADE TO THE EXCLUSIVE RIGHT TO USE "WEB INTEGRATED HEALTH CARE COMMUNITY", APART FROM THE MARK AS SHOWN.

FOR PROVIDING ON-LINE NON-DOWNLOADABLE SOFTWARE FOR EFFICIENTLY GENERATING, MANAGING AND EXCHANGING MEDICAL INFORMATION AND DOCUMENTS, COMMUNICATING SYNCHRONOUSLY AND ASYNCHRONOUSLY AND CONNECTING PHYSICIANS AND THEIR PATIENTS REGARDLESS OF MEDICAL ORGANIZATION OR GEOGRAPHIC LOCATION; APPLICATION SERVICE PROVIDER (ASP) FEATURING SOFTWARE FOR USE IN EFFICIENTLY GENERATING, MANAGING AND EXCHANGING MEDICAL INFORMATION AND DOCUMENTS, COMMUNICATING SYNCHRONOUSLY AND ASYNCHRONOUSLY AND CONNECTING PHYSICIANS AND THEIR PATIENTS REGARDLESS OF MEDICAL ORGANIZATION OR GEOGRAPHIC LOCATION; PROVIDING TEMPORARY USE OF ON-LINE NON-DOWNLOADABLE SOFTWARE FOR EFFICIENTLY GENERATING, MANAGING AND EXCHANGING MEDICAL INFORMATION AND DOCUMENTS, COMMUNICATING SYNCHRONOUSLY AND ASYNCHRONOUSLY AND CONNECTING PHYSICIANS AND THEIR PATIENTS REGARDLESS OF MEDICAL ORGANIZATION OR GEOGRAPHIC LOCATION; PROVIDING A WEBSITE FOR USE BY PHYSICIANS TO GENERATE, MANAGE AND EXCHANGE MEDICAL INFORMATION AND DOCUMENTS REGARDLESS OF MEDICAL ORGANIZATION OR GEOGRAPHIC LOCATION (U.S. CLS. 100 AND 101).

FIRST USE 10-21-2009; IN COMMERCE 10-21-2009.

3,807,620. PETROMATERIALS CORPORATION, TOKYO, JAPAN. SN 77-459,539. PUB. 9-29-2009, FILED 4-28-2008.



OWNER OF JAPAN REG. NO. 4982134, DATED 8-25-2006, EXPIRES 8-25-2016.

THE COLOR(S) BLACK, WHITE, ORANGE AND BROWN IS/ARE CLAIMED AS A FEATURE OF THE MARK.

CLASS 42—(Continued).

THE MARK CONSISTS OF THE COLORS BLACK, WHITE, ORANGE AND BROWN, WITH THE COLOR BLACK APPEARING IN THE WORDING "PETROMATERIALS", AND THE COLOR WHITE APPEARING IN THE LETTER "P" AND THE BACKGROUND AND BORDER OF THE MARK; THE COLOR ORANGE APPEARS IN THE SETTING SUN DESIGN AND COLOR BROWN APPEARS AS THE FILL COLOR FOR THE REMAINDER OF THE RECTANGLE DESIGN.

FOR PETROLEUM EXPLORATION (U.S. CLS. 100 AND 101).

FIRST USE 1-1-2008; IN COMMERCE 1-1-2008.

3,807,683. SWISS AMERICAN WATCHMAKERS TRAINING ALLIANCE LLC, NEW YORK, NY. SN 77-534,431. PUB. 2-17-2009, FILED 7-30-2008.

SAWTA

THE MARK CONSISTS OF STANDARD CHARACTERS WITHOUT CLAIM TO ANY PARTICULAR FONT, STYLE, SIZE, OR COLOR.

THE WORDING "SAWTA" HAS NO MEANING IN A FOREIGN LANGUAGE.

FOR ACCREDITATION SERVICES, NAMELY, DEVELOPING, EVALUATING AND TESTING STANDARDS FOR WATCHMAKING FOR THE PURPOSE OF ACCREDITATION (U.S. CLS. 100 AND 101).

FIRST USE 12-15-2009; IN COMMERCE 12-15-2009.

3,807,710. IMAGINE SOLUTIONS, INC., FARMERS BRANCH, TX. SN 77-549,819. PUB. 6-30-2009, FILED 8-18-2008.



OWNER OF U.S. REG. NOS. 2,982,797, 3,043,705, AND OTHERS.

NO CLAIM IS MADE TO THE EXCLUSIVE RIGHT TO USE "SOLUTIONS", APART FROM THE MARK AS SHOWN.

THE MARK CONSISTS OF THE WORDS "IMAGINE SOLUTIONS" CENTERED BELOW A RECTANGLE MADE OF GEOMETRIC FIGURES.

FOR CONSULTING SERVICES IN THE FIELD OF DESIGN, SELECTION, IMPLEMENTATION AND USE OF COMPUTER HARDWARE AND SOFTWARE SYSTEMS FOR OTHERS; CUSTOMIZED SOFTWARE DEVELOPMENT SERVICES; DESIGN, DEVELOPMENT AND IMPLEMENTATION OF SOFTWARE (U.S. CLS. 100 AND 101).

FIRST USE 11-1-2008; IN COMMERCE 11-1-2008.

CLASS 42—(Continued).

3,807,768. OMNI-ID CAYMAN, LTD., KY1 1108, CAYMAN ISLANDS. SN 77-568,141. PUB. 7-28-2009, FILED 9-11-2008.

OMNI-ID

THE MARK CONSISTS OF STANDARD CHARACTERS WITHOUT CLAIM TO ANY PARTICULAR FONT, STYLE, SIZE, OR COLOR.

FOR HARDWARE PROGRAMMING SERVICES FOR RADIO FREQUENCY IDENTIFICATION TAGS, TECHNOLOGY AND SYSTEMS (U.S. CLS. 100 AND 101).

FIRST USE 1-0-2008; IN COMMERCE 1-0-2008.

3,807,793. KNOTT MECHANICAL, INC., TIMONIUM, MD. SN 77-576,806. PUB. 7-21-2009, FILED 9-23-2008.

KTRACK

THE MARK CONSISTS OF STANDARD CHARACTERS WITHOUT CLAIM TO ANY PARTICULAR FONT, STYLE, SIZE, OR COLOR.

FOR PROVIDING TEMPORARY USE OF ON-LINE NON-DOWNLOADABLE COMPUTER SOFTWARE FOR PLANNING, SCHEDULING, CONTROLLING, MONITORING, MANAGING AND PROVIDING INFORMATION ON HEATING, VENTILATION AND AIR CONDITIONING SYSTEMS AND PLUMBING EQUIPMENT AND SYSTEMS AND MAINTENANCE, REPAIR AND REPLACEMENT NEEDS AND EXPENSES RELATING THERETO (U.S. CLS. 100 AND 101).

FIRST USE 1-1-2009; IN COMMERCE 1-1-2009.

3,807,802. GREAT AMERICANS HOLDINGS, INC., VIENNA, VA. SN 77-580,171. PUB. 9-22-2009, FILED 9-26-2008.



OWNER OF U.S. REG. NO. 3,406,244. NO CLAIM IS MADE TO THE EXCLUSIVE RIGHT TO USE "AMERICANS", APART FROM THE MARK AS SHOWN.

THE COLOR(S) WHITE, BLUE, RED AND BROWN IS/ ARE CLAIMED AS A FEATURE OF THE MARK.

THE MARK CONSISTS OF THE CHARACTERS "GA" IN

CLASS 42—(Continued).

WHITE LETTERING SUPERIMPOSED ON A BLUE STYLIZED GLOBE WITH WHITE STARS. THE WORD "GREAT" IN RED LETTERING DISPLAYED ABOVE THE WORD "AMERICANS" IN WHITE LETTERING APPEAR TO THE RIGHT OF THE STYLIZED GLOBE. THE WORDS "ORDINARY PEOPLE." IN BROWN LETTERING DISPLAYED ABOVE THE WORDS "EXTRAORDINARY DEEDS." IN BROWN LETTERING APPEAR TO THE LEFT OF THE STYLIZED GLOBE. THE BLACK BACKGROUND IS NOT PART OF THE MARK.

FOR HOSTING AN ONLINE WEBSITE FEATURING BIOGRAPHICAL INFORMATION PERTAINING TO FAMOUS UNITED STATES CITIZENS (U.S. CLS. 100 AND 101).

FIRST USE 11-11-2008; IN COMMERCE 11-11-2008.

3,807,813. THE LIENSTAR GROUP, LLC, SAN ANTONIO, TX. SN 77-584,208. PUB. 7-21-2009, FILED 10-2-2008.

LIENSTAR

THE MARK CONSISTS OF STANDARD CHARACTERS WITHOUT CLAIM TO ANY PARTICULAR FONT, STYLE, SIZE, OR COLOR.

FOR PROVIDING TEMPORARY USE OF NON-DOWNLOADABLE INTERACTIVE COMPUTER SOFTWARE FOR USE IN THE CREATION AND MANAGEMENT OF DOCUMENTS FOR PERFECTING RESIDENTIAL AND COMMERCIAL CONSTRUCTION MECHANIC'S LIEN AND PAYMENT BOND CLAIMS, AND FOR USE IN DOCKETING DEADLINES ASSOCIATED WITH MECHANIC'S LIEN AND PAYMENT BOND CLAIMS, AND FOR USE COMMUNICATIONS REGARDING MECHANIC'S LIEN AND PAYMENT BOND CLAIMS (U.S. CLS. 100 AND 101).

FIRST USE 1-10-2010; IN COMMERCE 1-10-2010.

3,807,816. THE LIENSTAR GROUP, LLC, SAN ANTONIO, TX. SN 77-584,494. PUB. 7-21-2009, FILED 10-2-2008.



THE MARK CONSISTS OF FLAG WITH A SHOOTING STAR ON THE LEFT SIDE OF THE FLAG.

FOR PROVIDING TEMPORARY USE OF NON-DOWNLOADABLE INTERACTIVE COMPUTER SOFTWARE FOR USE IN THE CREATION AND MANAGEMENT OF DOCUMENTS FOR PERFECTING RESIDENTIAL AND COMMERCIAL CONSTRUCTION MECHANIC'S LIEN AND PAYMENT BOND CLAIMS, AND FOR USE IN DOCKETING DEADLINES ASSOCIATED WITH MECHANIC'S LIEN AND PAYMENT BOND CLAIMS, AND FOR USE COMMUNICATIONS REGARDING MECHANIC'S LIEN AND PAYMENT BOND CLAIMS (U.S. CLS. 100 AND 101).

FIRST USE 1-10-2010; IN COMMERCE 1-10-2010.

CLASS 42—(Continued).

3,807,888. FUHU, INC., EL SEGUNDO, CA. SN 77-626,216.
PUB. 7-7-2009, FILED 12-4-2008.



THE COLOR(S) WHITE, BLACK, RED, YELLOW, GREY, ORANGE, GREEN AND TAN IS/ARE CLAIMED AS A FEATURE OF THE MARK.

THE MARK CONSISTS OF A MAN WEARING GLASSES WITH ORANGE HAIR AND A TAN FACE WEARING A WHITE LAB COAT WITH A GREY, YELLOW AND RED PEN IN HIS POCKET AND WEARING A RED TIE AND BLACK PANTS HOLDING A BEAKER WITH GREEN LIQUID WITH THE WORDS "SPINLETS" IN GREY AND "LAB" IN ORANGE TO HIS RIGHT.

FOR PROVIDING TEMPORARY USE OF ON-LINE NON-DOWNLOADABLE SOFTWARE THAT ALLOWS PERSONALIZED INTERACTION OVER NETWORKED MEDIA BY ENABLING THE USER TO ORGANIZE, ACCESS AND SHARE USER-DEFINED DATA WITH OTHERS (U.S. CLS. 100 AND 101).

FIRST USE 1-1-2008; IN COMMERCE 1-1-2008.

3,807,916. JOHNSON, BRIAN, TUCSON, AZ. SN 77-648,225.
PUB. 7-7-2009, FILED 1-13-2009.

ENVOLVEIT

THE MARK CONSISTS OF STANDARD CHARACTERS WITHOUT CLAIM TO ANY PARTICULAR FONT, STYLE, SIZE, OR COLOR.

FOR DEVELOPMENT AND INTEGRATION OF VOLUNTARY STANDARDS AND DE-FACTO STANDARDS FOR USERS OF ELECTRONIC INFORMATION FOR ENTERPRISE SOFTWARE APPLICATIONS (U.S. CLS. 100 AND 101).

FIRST USE 3-29-2010; IN COMMERCE 3-29-2010.

3,807,920. RECRO PHARMA, INC., MALVERN, PA. SN 77-649,020. PUB. 1-12-2010, FILED 1-14-2009.

GARNET BIOTHERAPEUTICS

THE MARK CONSISTS OF STANDARD CHARACTERS WITHOUT CLAIM TO ANY PARTICULAR FONT, STYLE, SIZE, OR COLOR.

CLASS 42—(Continued).

NO CLAIM IS MADE TO THE EXCLUSIVE RIGHT TO USE "BIOTHERAPEUTICS", APART FROM THE MARK AS SHOWN.

FOR DEVELOPMENT OF PHARMACEUTICAL PREPARATIONS AND MEDICINES; PHARMACEUTICAL DRUG DEVELOPMENT SERVICES; PHARMACEUTICAL RESEARCH AND DEVELOPMENT; PHARMACEUTICAL RESEARCH SERVICES (U.S. CLS. 100 AND 101).
FIRST USE 12-1-2008; IN COMMERCE 12-1-2008.

3,807,933. CUNA MUTUAL INSURANCE SOCIETY, MADISON, WI. SN 77-656,855. PUB. 12-22-2009, FILED 1-26-2009.

LDP ZONE

THE MARK CONSISTS OF STANDARD CHARACTERS WITHOUT CLAIM TO ANY PARTICULAR FONT, STYLE, SIZE, OR COLOR.

FOR COMPUTER SERVICES, NAMELY, PROVIDING A WEBSITE FOR CREDIT UNIONS AND THEIR EMPLOYEES FEATURING AN ON-LINE COMMUNITY TO PARTICIPATE IN DISCUSSIONS, GET FEEDBACK FROM THEIR PEERS, AND SHARE CONTENT AND DATA IN THE FIELD OF LENDING AND CREDIT INSURANCE COUNSELING (U.S. CLS. 100 AND 101).

FIRST USE 1-26-2009; IN COMMERCE 1-26-2009.

3,807,950. YFYJUPITER, INC., AKA JUPITER GROUP, INC., CHICAGO, IL. SN 77-669,531. PUB. 6-16-2009, FILED 2-12-2009.



THE COLOR(S) RED, GREY, WHITE IS/ARE CLAIMED AS A FEATURE OF THE MARK.

THE MARK CONSISTS OF A RED CIRCLE WITH A CUT OUT WHITE DIAMOND WITH A SMALL RED DIAMOND IN THE CENTER. THE LETTERS "YFYJUPITER" APPEAR IN GREY BELOW THE DESIGN.

FOR DESIGNING OF PACKAGING AND WRAPPING MATERIALS; GRAPHIC DESIGN SERVICES; PACKAGING DESIGN FOR OTHERS (U.S. CLS. 100 AND 101).

FIRST USE 1-1-2010; IN COMMERCE 1-1-2010.

CLASS 42—(Continued).

3,807,999. CN FINANCIAL SERVICES, LLC, BOWLING GREEN, KY. SN 77-683,415. PUB. 6-30-2009, FILED 3-4-2009.

CONNECT MICHIGAN

THE MARK CONSISTS OF STANDARD CHARACTERS WITHOUT CLAIM TO ANY PARTICULAR FONT, STYLE, SIZE, OR COLOR.

OWNER OF U.S. REG. NOS. 3,471,039, 3,580,338, AND 3,583,063.

NO CLAIM IS MADE TO THE EXCLUSIVE RIGHT TO USE "MICHIGAN", APART FROM THE MARK AS SHOWN.

FOR CONSULTING IN THE FIELD OF INFORMATION TECHNOLOGY; CONSULTING IN THE FIELD OF TELECOMMUNICATIONS TECHNOLOGY; RESEARCH SERVICES IN THE FIELD OF INFORMATION AND TELECOMMUNICATIONS TECHNOLOGY (U.S. CLS. 100 AND 101).

FIRST USE 10-14-2009; IN COMMERCE 10-14-2009.

3,808,015. TECHNOLOGY SOLUTIONS, INC., WATERLOO, IN. SN 77-688,014. PUB. 7-7-2009, FILED 3-11-2009.

CHAP

THE MARK CONSISTS OF STANDARD CHARACTERS WITHOUT CLAIM TO ANY PARTICULAR FONT, STYLE, SIZE, OR COLOR.

FOR TESTING, ANALYSIS AND EVALUATION OF THE MEDICAL CODING AUDITING SERVICES OF OTHERS FOR THE PURPOSE OF CERTIFICATION (U.S. CLS. 100 AND 101).

FIRST USE 3-20-2010; IN COMMERCE 3-29-2010.

3,808,022. HEARTLAND PAYMENT SYSTEMS, INC., PRINCETON, NJ. SN 77-689,721. PUB. 7-21-2009, FILED 3-12-2009.



NO CLAIM IS MADE TO THE EXCLUSIVE RIGHT TO USE "END-TO-END ENCRYPTION" AND "PAYMENT SYSTEMS", APART FROM THE MARK AS SHOWN.

CLASS 42—(Continued).

THE MARK CONSISTS OF AN OUTLINE OF A LOCK WITH THE LETTERS "E3" INSIDE AND WITH THE NUMBERS "010101" AS A BACKGROUND SITUATED TO THE LEFT OF THE WORDS "END-TO-END ENCRYPTION" WITH THE WORDS "POWERED BY HEARTLAND PAYMENT SYSTEMS" BELOW.

FOR DATA ENCRYPTION SERVICES IN THE FIELD OF PAYMENT CARD PROCESSING (U.S. CLS. 100 AND 101).

FIRST USE 6-30-2009; IN COMMERCE 6-30-2009.

3,808,029. BULL GUARD LIMITED, LONDON, UNITED KINGDOM. SN 77-690,280. PUB. 7-14-2009, FILED 3-13-2009.

WITH YOU ONLINE

THE MARK CONSISTS OF STANDARD CHARACTERS WITHOUT CLAIM TO ANY PARTICULAR FONT, STYLE, SIZE, OR COLOR.

FOR BACK-UP SERVICES FOR COMPUTER DATA; TECHNICAL SUPPORT SERVICES, NAMELY, ASSISTING USERS WITH COMPUTER SOFTWARE INSTALLATION, OPERATION AND TROUBLE-SHOOTING (U.S. CLS. 100 AND 101).

FIRST USE 11-9-2009; IN COMMERCE 11-9-2009.

3,808,034. BRADFORD TECHNOLOGIES, INC., SAN JOSE, CA. SN 77-691,003. PUB. 9-29-2009, FILED 3-13-2009.



NO CLAIM IS MADE TO THE EXCLUSIVE RIGHT TO USE "CLICK TALK", APART FROM THE MARK AS SHOWN.

THE MARK CONSISTS OF THE WORDS "CLICK" AND "TALK" WITH A SPEAR OR ARROW AS THE BOTTOM PORTION OF THE "K" IN "CLICK". THE WORD "TALK" IS CAPITALIZED AND IN BOLD LETTERING.

FOR HOSTING AN ONLINE COMMUNITY WEBSITE FEATURING SHARED COMMUNICATIONS BETWEEN COMMUNITY MEMBERS INTERESTED IN PERSONAL AND SMALL BUSINESS COMPUTER INFORMATION SECURITY (U.S. CLS. 100 AND 101).

FIRST USE 3-13-2009; IN COMMERCE 3-13-2009.

CLASS 42—(Continued).

3,808,052. CONCERTENT, LLC, WICHITA, KS. SN 77-693,532. PUB. 7-28-2009, FILED 3-18-2009.

OTTO DATA STORAGE & BACKUP

THE MARK CONSISTS OF STANDARD CHARACTERS WITHOUT CLAIM TO ANY PARTICULAR FONT, STYLE, SIZE, OR COLOR.

NO CLAIM IS MADE TO THE EXCLUSIVE RIGHT TO USE "DATA STORAGE & BACKUP", APART FROM THE MARK AS SHOWN.

FOR REMOTE ONLINE BACKUP OF COMPUTER DATA (U.S. CLS. 100 AND 101).

FIRST USE 1-26-2009; IN COMMERCE 1-26-2009.

3,808,055. ELECTRONIC IMAGING SERVICES, INC., DBA VESTCOM RETAIL SOLUTIONS, LITTLE ROCK, AR. SN 77-695,197. PUB. 7-7-2009, FILED 3-19-2009.



THE MARK CONSISTS OF THE WORD "PEGASSIST" TO THE RIGHT OF FOUR SETS OF A 3-DIMENSIONAL ABSTRACT DESIGN CONSISTING OF THREE SQUARES JOINED TOGETHER BY A ROD.

FOR CREATION AND DESIGN OF PLANOGRAMS, NAMELY, COMPUTERIZED PLANS FOR DISPLAYING MERCHANDISE FOR RETAILERS (U.S. CLS. 100 AND 101).

FIRST USE 4-0-2009; IN COMMERCE 4-0-2009.

3,808,126. EYEBLASTER LTD. (ISRAEL), RA'ANANA, ISRAEL. SN 77-704,010. PUB. 9-1-2009, FILED 4-1-2009.

MEDIAMIND

THE MARK CONSISTS OF STANDARD CHARACTERS WITHOUT CLAIM TO ANY PARTICULAR FONT, STYLE, SIZE, OR COLOR.

FOR PROVIDING ON-LINE NON-DOWNLOADABLE SOFTWARE FOR USE IN MANAGING DIGITAL ADVERTISING CAMPAIGNS, INCLUDING CAMPAIGN CREATION, AND THE SERVING, MONITORING, TRACKING, AND ANALYSIS OF DIGITAL ADVERTISING (U.S. CLS. 100 AND 101).

FIRST USE 9-0-2009; IN COMMERCE 9-0-2009.

CLASS 42—(Continued).

3,808,140. SEAGHOST TECHNOLOGIES INC., JACKSONVILLE, FL. SN 77-705,749. PUB. 8-11-2009, FILED 4-2-2009.

The Long Road Just Got Shorter

THE MARK CONSISTS OF STANDARD CHARACTERS WITHOUT CLAIM TO ANY PARTICULAR FONT, STYLE, SIZE, OR COLOR.

FOR APPLICATION SERVICE PROVIDER (ASP) FEATURING SOFTWARE FOR USE IN FACILITATING COMMUNICATION BETWEEN BUSINESSES AND MOBILE COMPUTING DEVICE USERS, ALLOWING BUSINESSES TO ADVERTISE SERVICES AND PRODUCTS IN REAL-TIME TO SERVICE SUBSCRIBERS VIA MOBILE COMMUNICATION DEVICES (U.S. CLS. 100 AND 101).

FIRST USE 9-20-2008; IN COMMERCE 4-4-2009.

3,808,150. IOXUS, INC., ONEONTA, NY. SN 77-707,298. PUB. 8-4-2009, FILED 4-6-2009.

IOXUS

THE MARK CONSISTS OF STANDARD CHARACTERS WITHOUT CLAIM TO ANY PARTICULAR FONT, STYLE, SIZE, OR COLOR.

FOR TECHNOLOGY CONSULTING SERVICES IN THE FIELD OF ENERGY STORAGE (U.S. CLS. 100 AND 101).

FIRST USE 4-0-2009; IN COMMERCE 4-0-2009.

3,808,279. HOIKE SERVICES, INC., HONOLULU, HI. SN 77-735,452. PUB. 9-15-2009, FILED 5-12-2009.

PIPELINECLAIMS

THE MARK CONSISTS OF STANDARD CHARACTERS WITHOUT CLAIM TO ANY PARTICULAR FONT, STYLE, SIZE, OR COLOR.

FOR PROVIDING TEMPORARY USE OF ON-LINE NON-DOWNLOADABLE SOFTWARE FOR ASSEMBLING, PROCESSING, MANAGING, STORING, ACCESSING, ANALYZING, ADMINISTERING AND PAYING CLAIMS FOR USE IN THE FIELD OF PROPERTY AND CASUALTY INSURANCE (U.S. CLS. 100 AND 101).

FIRST USE 9-11-2008; IN COMMERCE 9-11-2008.

CLASS 42—(Continued).

3,808,336. PALMER, GEOFFREY M, DBA SURVEYONTHESpot, NEWTON, MA. SN 77-758,150. PUB. 1-12-2010, FILED 6-12-2009.

SurveyOnTheSpot

THE MARK CONSISTS OF STANDARD CHARACTERS WITHOUT CLAIM TO ANY PARTICULAR FONT, STYLE, SIZE, OR COLOR.

FOR HOSTING OF WEB SITES FEATURING WEB-BASED AND MOBILE-BASED PUBLIC OPINION SURVEYS, POLLS AND OTHER FEEDBACK AND DATA COLLECTION INSTRUMENTS (U.S. CLS. 100 AND 101). FIRST USE 11-1-2009; IN COMMERCE 11-1-2009.

3,808,337. PALMER, GEOFFREY M, DBA SURVEYONTHESpot, NEWTON, MA. SN 77-758,166. PUB. 1-12-2010, FILED 6-12-2009.

OnTheSpot

THE MARK CONSISTS OF STANDARD CHARACTERS WITHOUT CLAIM TO ANY PARTICULAR FONT, STYLE, SIZE, OR COLOR.

FOR HOSTING OF WEB SITES FEATURING WEB-BASED AND MOBILE-BASED PUBLIC OPINION SURVEYS, POLLS AND OTHER FEEDBACK AND DATA COLLECTION INSTRUMENTS (U.S. CLS. 100 AND 101). FIRST USE 11-1-2009; IN COMMERCE 11-1-2009.

CLASS 42—(Continued).

3,808,368. CONVENEER AB, LOS ALTOS, CA. SN 77-769,951. PUB. 11-17-2009, FILED 6-29-2009.

MASHMOBILE

THE MARK CONSISTS OF STANDARD CHARACTERS WITHOUT CLAIM TO ANY PARTICULAR FONT, STYLE, SIZE, OR COLOR.

FOR PROVIDING ONLINE, NONDOWNLOADABLE COMPUTER PROGRAMS FOR WIRELESS AND ONLINE CONTENT DELIVERY; PROVIDING, HOSTING, MANAGING, DEVELOPING, AND MAINTAINING APPLICATIONS, SOFTWARE, WEB SITES, AND DATABASES IN THE FIELDS OF PERSONAL PRODUCTIVITY, WIRELESS COMMUNICATION, MOBILE INFORMATION ACCESS, AND REMOTE DATA MANAGEMENT FOR WIRELESS DELIVERY OF CONTENT TO HANDHELD COMPUTERS, LAPTOPS AND MOBILE ELECTRONIC DEVICES; COMPUTER SOFTWARE DEVELOPMENT IN THE FIELD OF MOBILE APPLICATIONS (U.S. CLS. 100 AND 101).

FIRST USE 6-24-2009; IN COMMERCE 6-24-2009.

3,808,429. DISINTEGRATED COMMUNICATION SYSTEMS, LLC, TIGER, GA. SN 77-793,004. PUB. 12-29-2009, FILED 7-30-2009.

HealthiGator

THE MARK CONSISTS OF STANDARD CHARACTERS WITHOUT CLAIM TO ANY PARTICULAR FONT, STYLE, SIZE, OR COLOR.

FOR PROVIDING AN INTERACTIVE WEB SITE THAT ENABLES USERS TO ENTER, ACCESS, TRACK, MONITOR AND GENERATE HEALTH AND MEDICAL INFORMATION AND REPORTS (U.S. CLS. 100 AND 101).

FIRST USE 8-1-2009; IN COMMERCE 8-1-2009.

3,808,436. THE ONE PLANNER, LLC, RICHMOND, VA. SN 77-795,336. PUB. 1-5-2010, FILED 8-3-2009.

 THE ONE PLANNER.COM

NO CLAIM IS MADE TO THE EXCLUSIVE RIGHT TO USE "PLANNER.COM", APART FROM THE MARK AS SHOWN.

CLASS 42—(Continued).

THE MARK CONSISTS OF A CHECK MARK INSIDE A BOX WITH THE STYLIZED TEXT "THE ONE PLANNER.COM".

FOR PROVIDING TEMPORARY USE OF NON-DOWNLOADABLE SOFTWARE THAT ASSISTS CLIENTS IN SCHEDULING AND COORDINATING GROUP ACTIVITIES BY MEANS OF AN AUTOMATED CALENDARING AND RESERVATION SYSTEM (U.S. CLS. 100 AND 101).

FIRST USE 5-19-2009; IN COMMERCE 12-18-2009.

3,808,440. ADVANCEDMD SOFTWARE, INC., DRAPER, UT. SN 77-797,707. PUB. 12-15-2009, FILED 8-5-2009.

*Advanced***BILLER**

OWNER OF U.S. REG. NOS. 3,039,850, 3,299,686, AND OTHERS.

THE MARK CONSISTS OF THE STYLIZED TEXT "ADVANCEDBILLER".

FOR APPLICATION SERVICE PROVIDER (ASP) FEATURING SOFTWARE FOR USE IN MEDICAL BILLING (U.S. CLS. 100 AND 101).

FIRST USE 2-17-2010; IN COMMERCE 2-17-2010.

3,808,445. VERISK HEALTH, INC., BOSTON, MA. SN 77-799,285. PUB. 12-29-2009, FILED 8-7-2009.

OncologyClaim Insight

THE MARK CONSISTS OF STANDARD CHARACTERS WITHOUT CLAIM TO ANY PARTICULAR FONT, STYLE, SIZE, OR COLOR.

NO CLAIM IS MADE TO THE EXCLUSIVE RIGHT TO USE "ONCOLOGY CLAIM", APART FROM THE MARK AS SHOWN.

FOR PROVIDING TEMPORARY USE OF NON-DOWNLOADABLE WEB-BASED SOFTWARE FOR IDENTIFYING FRAUD, ABUSE AND OVERPAYMENTS IN ONCOLOGY-RELATED CLAIM SUBMISSIONS, PRESCRIPTIONS AND CASE MANAGEMENT (U.S. CLS. 100 AND 101).

FIRST USE 11-15-2009; IN COMMERCE 11-15-2009.

CLASS 42—(Continued).

3,808,469. COMCAST CORPORATION, PHILADELPHIA, PA. SN 77-807,669. PUB. 12-22-2009, FILED 8-19-2009.



THE MARK CONSISTS OF A TEARDROP WITH A WHITE CIRCLE INSIDE AND A DARK CIRCLE INSIDE THE WHITE CIRCLE.

FOR PROVIDING USE OF ONLINE NON-DOWNLOADABLE SOFTWARE TO ENABLE USERS TO MANAGE, SCHEDULE AND PROGRAM THEIR DVRs REMOTELY AND TO SHARE THEIR SCHEDULED PROGRAMMING ONLINE OR ELECTRONICALLY WITH OTHERS (U.S. CLS. 100 AND 101).

FIRST USE 7-20-2009; IN COMMERCE 7-20-2009.

CLASS 43—HOTEL AND RESTAURANT SERVICES

3,807,406. CARL KARCHER ENTERPRISES, INC., CARPINTERIA, CA. SN 77-007,125. PUB. 10-23-2007, FILED 9-25-2006.



OWNER OF U.S. REG. NOS. 901,315, 2,220,433, AND OTHERS.

NO CLAIM IS MADE TO THE EXCLUSIVE RIGHT TO USE "CHARBROILED BURGERS", APART FROM THE MARK AS SHOWN.

FOR RESTAURANT SERVICES (U.S. CLS. 100 AND 101).

FIRST USE 1-0-2007; IN COMMERCE 1-0-2007.

CLASS 43—(Continued).

3,807,415. KERZNER INTERNATIONAL RESORTS, INC., PLANTATION, FL. SN 77-039,841. PUB. 9-18-2007, FILED 11-8-2006.

THE COVE ATLANTIS

THE MARK CONSISTS OF STANDARD CHARACTERS WITHOUT CLAIM TO ANY PARTICULAR FONT, STYLE, SIZE, OR COLOR.

OWNER OF U.S. REG. NOS. 1,857,994 AND 2,810,825. FOR PROVIDING RESORT HOTELS AND LODGING SERVICES; TRAVEL AGENCY SERVICES, NAMELY, MAKING RESERVATIONS AND BOOKINGS FOR TEMPORARY LODGING (U.S. CLS. 100 AND 101). FIRST USE 3-28-2007; IN COMMERCE 3-28-2007.

CLASS 43—(Continued).

3,807,455. THE TRIANGLE X RANCH PARTNERSHIP, MOOSE, WY. SN 77-167,811. PUB. 7-29-2008, FILED 4-27-2007.



FOR DUDE AND GUEST RANCH SERVICES (U.S. CLS. 100 AND 101). FIRST USE 9-0-1926; IN COMMERCE 9-0-1926.

3,807,427. BANANA LEAF (ASIA PACIFIC) CATERING GROUP LIMITED, NEW TERRITORIES, HONG KONG. SN 77-069,263. PUB. 5-27-2008, FILED 12-21-2006.



OWNER OF HONG KONG REG. NO. 199508120, DATED 9-26-1995, RENEWED AS REG. NO. 199508120, DATED 9-26-1995, EXPIRES 12-1-2014.

THE COLOR(S) GREEN, YELLOW AND WHITE IS/ARE CLAIMED AS A FEATURE OF THE MARK.

THE MARK CONSISTS OF A GREEN LEAF WITH WHITE CENTER LINE AND THE WORDS "BANANA LEAF" IN LOWER PART, WITH GREEN CHINESE CHARACTERS BELOW IT.

THE NON-LATIN CHARACTERS IN THE MARK TRANSLITERATE TO JIAO, YE, AND THIS MEANS BANANA, LEAF IN ENGLISH.

FOR CATERING OF CURRY FOOD, SINGAPORE AND MALAYSIAN FOOD; RESTAURANT SERVICES; SERVICES FOR PROVIDING FOOD AND DRINK; PREPARATION OF FOODS AND MEALS FOR TAKE-OUT (U.S. CLS. 100 AND 101). FIRST USE 12-31-1995; IN COMMERCE 3-31-2010.

3,807,468. JUNE BUG ENTERPRISES, INC., BEVERLY HILLS, CA. SN 77-209,506. PUB. 10-2-2007, FILED 6-19-2007.

MAGIC JOHNSON MARKETPLACE

THE MARK CONSISTS OF STANDARD CHARACTERS WITHOUT CLAIM TO ANY PARTICULAR FONT, STYLE, SIZE, OR COLOR.

OWNER OF U.S. REG. NOS. 1,555,839, 3,226,680, AND OTHERS.

NO CLAIM IS MADE TO THE EXCLUSIVE RIGHT TO USE "MARKETPLACE", APART FROM THE MARK AS SHOWN.

THE NAME IN THE MARK IDENTIFIES A LIVING INDIVIDUAL WHOSE CONSENT IS OF RECORD.

FOR RESTAURANT SERVICES (U.S. CLS. 100 AND 101). FIRST USE 3-11-2009; IN COMMERCE 3-11-2009.

CLASS 43—(Continued).

3,807,484. LAKE LUCIANA LLC, ST. HELENA, CA. SN 77-252,387. PUB. 7-1-2008, FILED 8-10-2007.

AETNA SPRINGS

THE MARK CONSISTS OF STANDARD CHARACTERS WITHOUT CLAIM TO ANY PARTICULAR FONT, STYLE, SIZE, OR COLOR.

FOR BAR AND RESTAURANT SERVICES (U.S. CLS. 100 AND 101).

FIRST USE 5-31-2008; IN COMMERCE 5-31-2008.

3,807,555. ACHIM'S FRANCHISING, LLC, ATHENS, GA. SN 77-404,270. PUB. 9-8-2009, FILED 2-22-2008.

KEBA SPITFIRE GRILL

THE MARK CONSISTS OF STANDARD CHARACTERS WITHOUT CLAIM TO ANY PARTICULAR FONT, STYLE, SIZE, OR COLOR.

NO CLAIM IS MADE TO THE EXCLUSIVE RIGHT TO USE "GRILL", APART FROM THE MARK AS SHOWN.

FOR RESTAURANT SERVICES (U.S. CLS. 100 AND 101).

FIRST USE 6-26-2009; IN COMMERCE 6-26-2009.

3,807,587. QUANTUM FOODS LLC, BOLINGBROOK, IL. SN 77-431,824. PUB. 8-25-2009, FILED 3-26-2008.

QUANTUMIZED

THE MARK CONSISTS OF STANDARD CHARACTERS WITHOUT CLAIM TO ANY PARTICULAR FONT, STYLE, SIZE, OR COLOR.

FOR CONSULTING SERVICES IN THE FIELD OF FOOD PREPARATION AND CULINARY CREATIONS (U.S. CLS. 100 AND 101).

FIRST USE 4-0-2008; IN COMMERCE 4-0-2008.

CLASS 43—(Continued).

3,807,588. QUANTUM FOODS LLC, BOLINGBROOK, IL. SN 77-431,833. PUB. 8-25-2009, FILED 3-26-2008.

GET QUANTUMIZED

THE MARK CONSISTS OF STANDARD CHARACTERS WITHOUT CLAIM TO ANY PARTICULAR FONT, STYLE, SIZE, OR COLOR.

FOR CONSULTING SERVICES IN THE FIELD OF FOOD PREPARATION AND CULINARY CREATIONS (U.S. CLS. 100 AND 101).

FIRST USE 4-0-2008; IN COMMERCE 4-0-2008.

3,807,593. SOUP & SCOOP, LLC, SHELBY TOWNSHIP, MI. SN 77-437,568. PUB. 11-3-2009, FILED 4-2-2008.

THE SOUP LADY

THE MARK CONSISTS OF STANDARD CHARACTERS WITHOUT CLAIM TO ANY PARTICULAR FONT, STYLE, SIZE, OR COLOR.

NO CLAIM IS MADE TO THE EXCLUSIVE RIGHT TO USE "SOUP", APART FROM THE MARK AS SHOWN.

FOR RESTAURANT SERVICES, INCLUDING SIT-DOWN SERVICE OF FOOD AND TAKE-OUT RESTAURANT SERVICES (U.S. CLS. 100 AND 101).

FIRST USE 4-0-2008; IN COMMERCE 12-0-2009.

3,807,606. CITYCENTER LAND, LLC, LAS VEGAS, NV. SN 77-445,978. PUB. 3-3-2009, FILED 4-11-2008.

ARIA

THE MARK CONSISTS OF STANDARD CHARACTERS WITHOUT CLAIM TO ANY PARTICULAR FONT, STYLE, SIZE, OR COLOR.

FOR HOTELS, HOTEL RESORT SERVICES; PROVISION OF CONVENTION, CONFERENCE, EXHIBITION AND MEETING FACILITIES; RESTAURANT AND BAR SERVICES, CAFES; CAFETERIAS; CATERING; CHILD CARE; BUFFET STYLE RESTAURANTS; COCKTAIL LOUNGES; ARENA SERVICES, NAMELY, PROVIDING FACILITIES FOR SPORTS, CONCERTS, CONVENTIONS AND EXHIBITIONS; AND SNACK BARS; TRAVEL AGENCY SERVICES, NAMELY, MAKING RESERVATIONS AND BOOKINGS FOR RESTAURANTS AND MEALS (U.S. CLS. 100 AND 101).

FIRST USE 12-16-2009; IN COMMERCE 12-16-2009.

CLASS 43—(Continued).

3,807,666. KETTLE MAID, LLC, INDIANAPOLIS, IN. SN 77-514,642. PUB. 6-23-2009, FILED 7-3-2008.

CANTINA DIABLOS

THE MARK CONSISTS OF STANDARD CHARACTERS WITHOUT CLAIM TO ANY PARTICULAR FONT, STYLE, SIZE, OR COLOR.

NO CLAIM IS MADE TO THE EXCLUSIVE RIGHT TO USE "CANTINA", APART FROM THE MARK AS SHOWN.

THE ENGLISH TRANSLATION OF "DIABLOS" IN THE MARK IS DEVILS.

FOR RESTAURANT AND BAR SERVICES, INCLUDING THE PROVISION OF FOOD AND DRINK IN RESTAURANTS (U.S. CLS. 100 AND 101).

FIRST USE 4-30-2010; IN COMMERCE 4-30-2010.

3,807,678. PECHANGA BAND OF LUISEÑO MISSION INDIANS OF THE PECHANGA RESERVATION, CALIFORNIA, TEMECULA, CA. SN 77-530,387. PUB. 12-22-2009, FILED 7-24-2008.



OWNER OF U.S. REG. NOS. 3,192,746, 3,247,029, AND OTHERS.

THE MARK CONSISTS OF A STYLIZED TEXT FOR THE TERMS "JOURNEY'S END" AND ANOTHER TEXT FOR "AT PECHANGA", AND THE "J" IN THE TERM "JOURNEY'S" IS A GOLF FLAG.

FOR RESTAURANT SERVICES (U.S. CLS. 100 AND 101).

FIRST USE 11-30-2008; IN COMMERCE 11-30-2008.

3,807,733. ZIGO INC., CAMBRIDGE, MA. SN 77-558,833. PUB. 8-18-2009, FILED 8-29-2008.

GOOD FOOD FOR BUSY PEOPLE

THE MARK CONSISTS OF STANDARD CHARACTERS WITHOUT CLAIM TO ANY PARTICULAR FONT, STYLE, SIZE, OR COLOR.

FOR RESTAURANT SERVICES; CATERING SERVICES; TAKE-OUT RESTAURANT SERVICES (U.S. CLS. 100 AND 101).

FIRST USE 1-31-2009; IN COMMERCE 1-31-2009.

CLASS 43—(Continued).

3,807,843. MELODIE HAYS, COCOA, FL. SN 77-599,201. PUB. 8-18-2009, FILED 10-23-2008.

MELODIE'S PLACE

THE MARK CONSISTS OF STANDARD CHARACTERS WITHOUT CLAIM TO ANY PARTICULAR FONT, STYLE, SIZE, OR COLOR.

NO CLAIM IS MADE TO THE EXCLUSIVE RIGHT TO USE "PLACE", APART FROM THE MARK AS SHOWN.

FOR PROVIDING ASSISTED LIVING CARE FACILITIES (U.S. CLS. 100 AND 101).

FIRST USE 11-13-2008; IN COMMERCE 11-13-2008.

3,807,858. UNION SQUARE HOSPITALITY GROUP, LLC, NEW YORK, NY. SN 77-608,693. PUB. 7-21-2009, FILED 11-6-2008.

BOX FRITES

THE MARK CONSISTS OF STANDARD CHARACTERS WITHOUT CLAIM TO ANY PARTICULAR FONT, STYLE, SIZE, OR COLOR.

NO CLAIM IS MADE TO THE EXCLUSIVE RIGHT TO USE "FRITES", APART FROM THE MARK AS SHOWN.

THE ENGLISH TRANSLATION OF "FRITES" IN THE MARK IS FRENCH FRIES.

FOR PROVIDING FOOD AND DRINK (U.S. CLS. 100 AND 101).

FIRST USE 4-13-2010; IN COMMERCE 4-13-2010.

3,807,885. LETNES RESTAURANT GROUP, INC., WAITE PARK, MN. SN 77-624,002. PUB. 11-24-2009, FILED 12-1-2008.



OWNER OF U.S. REG. NOS. 2,237,905 AND 2,360,247. THE MARK CONSISTS OF THE STYLIZED TERM "GRIZZLY'S" WITH A BEAR PAW PRINT ON EITHER SIDE, BENEATH A STYLIZED GRIZZLY BEAR ALL SUPERIMPOSED ON A SIGN CONSISTING OF A RECTANGULAR BOTTOM AND SEMI-CIRCULAR TOP WITH AN IRREGULAR BORDER.

FOR RESTAURANT SERVICES (U.S. CLS. 100 AND 101).

FIRST USE 3-0-2008; IN COMMERCE 3-0-2008.

CLASS 43—(Continued).

3,807,904. NASSER RAZACK, BRADENTON, FL. SN 77-643,861. PUB. 8-25-2009, FILED 1-6-2009.



NO CLAIM IS MADE TO THE EXCLUSIVE RIGHT TO USE "ST. PETE'S ORIGINAL", APART FROM THE MARK AS SHOWN.

THE MARK CONSISTS OF A HOT DOG POSITIONED IN A HOT DOG BUN HAVING AN OBLONG OVAL SURROUNDING THE PERIMETER OF THE HOT DOG POSITIONED WITHIN THE HOT DOG BUN. UNDERNEATH THE OBLONG OVAL ARE THE WORDS "KEEPING IT SIMPLE, KEEPING IT REAL", WHEREIN THE AFOREMENTIONED WORDS ARE ARCUATELY SHAPED AROUND THE BOTTOM PORTION OF THE OBLONG OVAL. THE WORD "RAZBO'S" IS POSITIONED DIRECTLY ABOVE THE UPPER PORTION OF THE HOT DOG BUN, WHEREIN THE AFOREMENTIONED WORD EXTENDS BEYOND BOTH OF THE OBLONG OVAL'S OUTER PERIMETERS AND UPPER PERIMETER. THE TAIL OF THE LETTER "S" IN THE WORD "RAZBO'S" IS IN DIRECT CONTACT WITH THE UPPER PORTION OF THE HOT DOG BUN. POSITIONED OVER THE LOWER RIGHT-HAND PORTION OF THE LETTER "O" IN THE WORD "RAZBO'S" AND OVER A PORTION OF THE TAIL OF THE LETTER "S" IN THE WORD "RAZBO'S" IS A CIRCLE HAVING THE WORDS "ST. PETE'S ORIGINAL". THE AFOREMENTIONED WORDS ENIRCLE THE INSIDE PERIMETER OF THE CIRCLE, WHEREIN A SMALLER CIRCLE IS POSITIONED INSIDE THE MIDDLE OF THE WORDS "ST. PETE'S ORIGINAL".

FOR RESTAURANT SERVICES, RESTAURANTS, CARRY-OUT RESTAURANTS (U.S. CLS. 100 AND 101). FIRST USE 6-15-2009; IN COMMERCE 6-15-2009.

3,807,947. FT 245 CORPORATION, NEW YORK CITY, NY. SN 77-667,781. PUB. 7-7-2009, FILED 2-10-2009.

VELOCE CIBO

THE MARK CONSISTS OF STANDARD CHARACTERS WITHOUT CLAIM TO ANY PARTICULAR FONT, STYLE, SIZE, OR COLOR.

NO CLAIM IS MADE TO THE EXCLUSIVE RIGHT TO USE "CIBO", APART FROM THE MARK AS SHOWN.

THE ENGLISH TRANSLATION OF THE WORDS IN THE MARK IS FAST AND FOOD RESPECTIVELY.

FOR RESTAURANT AND BAR SERVICES (U.S. CLS. 100 AND 101).

FIRST USE 2-25-2009; IN COMMERCE 2-25-2009.

CLASS 43—(Continued).

3,807,982. VACATION MOUSE, INC., NEWPORT, RI. SN 77-679,070. PUB. 7-21-2009, FILED 2-26-2009.

VACATION MOUSE

THE MARK CONSISTS OF STANDARD CHARACTERS WITHOUT CLAIM TO ANY PARTICULAR FONT, STYLE, SIZE, OR COLOR.

NO CLAIM IS MADE TO THE EXCLUSIVE RIGHT TO USE "VACATION", APART FROM THE MARK AS SHOWN. FOR PROVIDING TEMPORARY LODGING INFORMATION VIA THE INTERNET (U.S. CLS. 100 AND 101). FIRST USE 1-30-2009; IN COMMERCE 1-30-2009.

3,808,122. GBG, LLP, BLOOMINGTON, MN. SN 77-703,505. PUB. 12-22-2009, FILED 3-31-2009.

R. BURGER BAR

THE MARK CONSISTS OF STANDARD CHARACTERS WITHOUT CLAIM TO ANY PARTICULAR FONT, STYLE, SIZE, OR COLOR.

NO CLAIM IS MADE TO THE EXCLUSIVE RIGHT TO USE "BURGER BAR", APART FROM THE MARK AS SHOWN.

FOR RESTAURANT SERVICES (U.S. CLS. 100 AND 101).

FIRST USE 7-6-2009; IN COMMERCE 7-6-2009.

3,808,161. 12TH STREET ASSOCIATES, LLC, NEW YORK, NY. SN 77-709,665. PUB. 8-4-2009, FILED 4-8-2009.

STAND4

THE MARK CONSISTS OF STANDARD CHARACTERS WITHOUT CLAIM TO ANY PARTICULAR FONT, STYLE, SIZE, OR COLOR.

FOR RESTAURANT SERVICES (U.S. CLS. 100 AND 101).

FIRST USE 7-0-2009; IN COMMERCE 7-0-2009.

CLASS 43—(Continued).

3,808,190. THE ST. JOE COMPANY, JACKSONVILLE, FL. SN 77-713,700. PUB. 8-11-2009, FILED 4-14-2009.



THE MARK CONSISTS OF A SCHOOL OF FISH IN THE SHAPE OF A FISH.
FOR RESTAURANT AND BAR SERVICES (U.S. CLS. 100 AND 101).
FIRST USE 9-30-2008; IN COMMERCE 9-30-2008.

CLASS 43—(Continued).

3,808,335. PATACHOU, INC., INDIANAPOLIS, IN. SN 77-758,101. PUB. 1-19-2010, FILED 6-12-2009.

NAPOLESE

THE MARK CONSISTS OF STANDARD CHARACTERS WITHOUT CLAIM TO ANY PARTICULAR FONT, STYLE, SIZE, OR COLOR.
FOR CAFE AND RESTAURANT SERVICES; CATERING (U.S. CLS. 100 AND 101).
FIRST USE 4-26-2010; IN COMMERCE 4-26-2010.

3,808,196. MEKPONGSATORN, JOHN SURAPOL, ALHAMBRA, CA. SN 77-714,753. PUB. 8-18-2009, FILED 4-15-2009.

Slurpin' Good

THE MARK CONSISTS OF STANDARD CHARACTERS WITHOUT CLAIM TO ANY PARTICULAR FONT, STYLE, SIZE, OR COLOR.
FOR RESTAURANT SERVICES (U.S. CLS. 100 AND 101).
FIRST USE 6-8-2009; IN COMMERCE 6-8-2009.

3,808,360. BURGER KING CORPORATION, MIAMI, FL. SN 77-765,824. PUB. 10-20-2009, FILED 6-23-2009.

KING DEALS

THE MARK CONSISTS OF STANDARD CHARACTERS WITHOUT CLAIM TO ANY PARTICULAR FONT, STYLE, SIZE, OR COLOR.
NO CLAIM IS MADE TO THE EXCLUSIVE RIGHT TO USE "DEALS", APART FROM THE MARK AS SHOWN.
FOR RESTAURANT SERVICES (U.S. CLS. 100 AND 101).
FIRST USE 9-9-2009; IN COMMERCE 9-9-2009.

3,808,268. MALT-O-MEAL COMPANY, MINNEAPOLIS, MN. SN 77-731,814. PUB. 9-22-2009, FILED 5-7-2009.

MILLION BOWLS

THE MARK CONSISTS OF STANDARD CHARACTERS WITHOUT CLAIM TO ANY PARTICULAR FONT, STYLE, SIZE, OR COLOR.
FOR CHARITABLE SERVICES, NAMELY, PROVIDING FOOD TO NEEDY PERSONS (U.S. CLS. 100 AND 101).
FIRST USE 9-25-2009; IN COMMERCE 9-25-2009.

3,808,398. LAND O'LAKES, INC., ARDEN HILLS, MN. SN 77-782,672. PUB. 11-10-2009, FILED 7-16-2009.

FAMILY KITCHEN

THE MARK CONSISTS OF STANDARD CHARACTERS WITHOUT CLAIM TO ANY PARTICULAR FONT, STYLE, SIZE, OR COLOR.
FOR PROVIDING AN ONLINE COMPUTER DATABASE FOR OTHERS WHERE USERS CAN ORGANIZE THEIR RECIPES AND COOKING INFORMATION (U.S. CLS. 100 AND 101).
FIRST USE 6-30-2009; IN COMMERCE 6-30-2009.

CLASS 43—(Continued).

3,808,424. SCOTTO BROTHERS ENTERPRISES, INC., WOODBURY, NY. SN 77-791,381. PUB. 1-19-2010, FILED 7-28-2009.

RARE 650

THE MARK CONSISTS OF STANDARD CHARACTERS WITHOUT CLAIM TO ANY PARTICULAR FONT, STYLE, SIZE, OR COLOR.
FOR RESTAURANT AND BAR SERVICES (U.S. CLS. 100 AND 101).
FIRST USE 12-31-2009; IN COMMERCE 12-31-2009.

3,808,426. CHOPPERS CUSTOM SALADS, INC., VAIL, CO. SN 77-791,651. PUB. 12-29-2009, FILED 7-28-2009.



NO CLAIM IS MADE TO THE EXCLUSIVE RIGHT TO USE "CUSTOM SALADS", APART FROM THE MARK AS SHOWN.

THE MARK CONSISTS OF A CIRCLE WITHIN WHICH IS A WEDGE OF A SMILING FACE OVER THE WORDS "CHOPPERS" IN ALL CAPS AND BOLD LETTERS, CENTERED OVER THE WORDS "CUSTOM SALADS" IN ALL CAPS.

FOR RESTAURANT SERVICES (U.S. CLS. 100 AND 101).
FIRST USE 8-20-2009; IN COMMERCE 8-20-2009.

3,808,444. SALT LIFE HOLDINGS LLC, JACKSONVILLE, FL. SN 77-798,851. PUB. 1-5-2010, FILED 8-6-2009.

OWNER OF U.S. REG. NOS. 2,959,429 AND 3,001,343.

CLASS 43—(Continued).

THE MARK CONSISTS OF THE WORDS "SALT LIFE" FOR RESTAURANT AND BAR SERVICES (U.S. CLS. 100 AND 101).
FIRST USE 1-4-2010; IN COMMERCE 1-4-2010.

3,808,460. NOTHING HEAVY INC., NEW YORK, NY. SN 77-803,083. PUB. 1-12-2010, FILED 8-12-2009.



**THE HIPPEST
DINER ON EARTH**

NO CLAIM IS MADE TO THE EXCLUSIVE RIGHT TO USE "DINER", APART FROM THE MARK AS SHOWN.

THE MARK CONSISTS OF THE WORDS "THE HIPPEST DINER ON EARTH" BENEATH A STYLIZED IMAGE OF A BUILDING.

FOR RESTAURANT SERVICES (U.S. CLS. 100 AND 101).
FIRST USE 10-2-2009; IN COMMERCE 10-2-2009.

3,808,462. ZB IMPORTING, INC., CICERO, IL. SN 77-803,780. PUB. 1-26-2010, FILED 8-13-2009.

NO CLAIM IS MADE TO THE EXCLUSIVE RIGHT TO USE "FALAFEL", APART FROM THE MARK AS SHOWN.

THE MARK CONSISTS OF A HALF CIRCLE DESIGN REPRESENTING A BOWL WITH THREE SHADED CIRCLES MEANT TO REPRESENT FOOD APPEARING IN AN ARCH ABOVE THE BOWL, WITH THE WORD "FALAFILL" SHOWN IN STYLIZED FONT TO THE RIGHT OF THE DESIGN.

THE WORDING "FALAFILL" HAS NO MEANING IN A FOREIGN LANGUAGE.
FOR RESTAURANT SERVICES (U.S. CLS. 100 AND 101).

FIRST USE 9-1-2009; IN COMMERCE 9-1-2009.

CLASS 43—(Continued).

3,808,481. MARRIOTT INTERNATIONAL, INC., BETHESDA, MD. SN 77-813,314. PUB. 1-12-2010, FILED 8-26-2009.

AUTOGRAPH COLLECTION

THE MARK CONSISTS OF STANDARD CHARACTERS WITHOUT CLAIM TO ANY PARTICULAR FONT, STYLE, SIZE, OR COLOR.

NO CLAIM IS MADE TO THE EXCLUSIVE RIGHT TO USE "COLLECTION", APART FROM THE MARK AS SHOWN.

FOR HOTEL SERVICES; RESTAURANT, CATERING, BAR AND COCKTAIL LOUNGE SERVICES; RESORT LODGING SERVICES; PROVISION OF GENERAL-PURPOSE FACILITIES FOR MEETINGS, CONFERENCES AND EXHIBITIONS; PROVISION OF BANQUET AND SOCIAL FUNCTION FACILITIES FOR SPECIAL OCCASIONS; AND RESERVATIONS SERVICES FOR HOTEL ACCOMMODATIONS FOR OTHERS (U.S. CLS. 100 AND 101).

FIRST USE 3-18-2010; IN COMMERCE 3-18-2010.

3,808,502. BURGER LOUNGE OF AMERICA LLC, SAN DIEGO, CA. SN 77-977,773. PUB. 11-11-2008, FILED 9-13-2007.



NO CLAIM IS MADE TO THE EXCLUSIVE RIGHT TO USE "BURGER LOUNGE" AND "PREMIUM BURGERS", APART FROM THE MARK AS SHOWN.

THE COLOR(S) ORANGE, BLACK AND WHITE IS/ARE CLAIMED AS A FEATURE OF THE MARK.

THE MARK CONSISTS OF THE WORDING "BURGER-LOUNGE PREMIUM BURGERS" APPEARING BENEATH THE DESIGN OF A STYLIZED ROUND BARBEQUE. THE WORDS "BURGER" AND "PREMIUM BURGERS" ARE IN BLACK LETTERING. THE WORD "LOUNGE" IS IN ORANGE LETTERING. THE LEGS OF THE BARBEQUE ARE BLACK, THE BASE IS WHITE WITH BLACK LINING, THE GRILL TOP GRID IS ORANGE AND THE INSIDE OF THE GRILL IS WHITE.

FOR CARRY-OUT RESTAURANTS; FAST FOOD AND NON-STOP RESTAURANT SERVICES; FAST-FOOD RESTAURANTS; FAST-FOOD RESTAURANTS AND SNACKBARS (U.S. CLS. 100 AND 101).

FIRST USE 4-1-2007; IN COMMERCE 7-19-2007.

CLASS 43—(Continued).

3,808,531. DIAMOND RESORTS HOLDINGS, LLC, LAS VEGAS, NV. SN 77-979,420. PUB. 11-3-2009, FILED 6-17-2009.

MAUI PIZZA CO.

THE MARK CONSISTS OF STANDARD CHARACTERS WITHOUT CLAIM TO ANY PARTICULAR FONT, STYLE, SIZE, OR COLOR.

NO CLAIM IS MADE TO THE EXCLUSIVE RIGHT TO USE "PIZZA COMPANY", APART FROM THE MARK AS SHOWN.

FOR BAR AND RESTAURANT SERVICES; CARRY-OUT RESTAURANTS (U.S. CLS. 100 AND 101).

FIRST USE 2-11-2010; IN COMMERCE 2-11-2010.

CLASS 44—MEDICAL, BEAUTY AND AGRICULTURAL SERVICES

3,807,401. CARDIAC PACEMAKERS, INC., ST. PAUL, MN. SN 76-697,427. PUB. 9-22-2009, FILED 5-18-2009.

ALTITUDE

THE MARK CONSISTS OF STANDARD CHARACTERS WITHOUT CLAIM TO ANY PARTICULAR FONT, STYLE, SIZE, OR COLOR.

FOR EVALUATION OF THERAPIES USED TO TREAT CARDIAC ARRHYTHMIA (U.S. CLS. 100 AND 101).

FIRST USE 5-0-2009; IN COMMERCE 5-0-2009.

3,807,403. TRAN, LINDA, CHINO, CA. SN 76-698,397. PUB. 12-22-2009, FILED 7-13-2009.



NO CLAIM IS MADE TO THE EXCLUSIVE RIGHT TO USE "KIDS DENTAL SPECIALISTS", APART FROM THE MARK AS SHOWN.

THE COLOR(S) LIGHT BLUE PURPLE, YELLOW GREEN, SKY BLUE, GOLD, ROYAL BLUE, RED, YELLOW, BABY BLUE AND WHITE IS/ARE CLAIMED AS A FEATURE OF THE MARK.

THE MARK CONSISTS OF AN OUTLINING OF THE OUTER CORE OF THE CIRCLE IS IN GOLD. THERE IS A LINING OF A CIRCLE WITHIN THE OUTER CORE IN WHITE. WITHIN THE WHITE LINING THERE IS A

CLASS 44—(Continued).

THICKER LINING OF A CIRCLE IN BABY BLUE, ON THAT CIRCLE THE WORD "KIDS DENTAL" IS WRITTEN IN WHITE CAPITAL LETTERS NEAR THE TOP OF THE CIRCLE AND THE WORD "SPECIALISTS" IS WRITTEN IN WHITE CAPITAL LETTERS NEAR THE BOTTOM OF THE SAME CIRCLE. THE WORDS "KIDS DENTAL" AND "SPECIALISTS" ARE SEPARATED BY TINY YELLOW CIRCLES ON THE SIDES OF THAT SAME CIRCLE. WITHIN THE BABY BLUE CORE THERE IS ANOTHER CORE IN LIGHT BLUE PURPLE INSIDE THIS CORE THERE IS AN OUTLINING OF A GIRL WITH SHORT HAIR, LEFT HAND HOLDING A STRING, BOTH LEFT HAND AND LEG ARE BENT, BOTH RIGHT ARM AND LEG ARE STRETCHED. THE YELLOW STRINGS THAT HOLD THE FIVE (5) BALLOONS CROSS THE LIGHT BLUE PURPLE AND BABY BLUE CORE. THE ROYAL BLUE BALLOON TOUCHES THE TOP OF THE BABY BLUE CORE AND SURPASSES THE WHITE AND GOLD OUTER CORE. THE SKY BLUE BALLOON IS UNDER THE ROYAL BLUE BALLOON, THE YELLOW GREEN BALLOON IS UNDER THE BABY BLUE TO THE LEFT AND THE RED BALLOON IS ALSO UNDER THE BABY BLUE BALLOON AND IS TO THE RIGHT SIDE. THE YELLOW BALLOON IS UNDER BOTH THE SKY BLUE AND RED BALLOON.

FOR DENTIST SERVICES (U.S. CLS. 100 AND 101).
FIRST USE 3-19-2009; IN COMMERCE 3-19-2009.

3,807,699. TOTAL TESTING SOLUTIONS, LLC, COLORADO SPRINGS, CO. SN 77-544,231. PUB. 9-1-2009, FILED 8-11-2008.

CONSPIRE!

THE MARK CONSISTS OF STANDARD CHARACTERS WITHOUT CLAIM TO ANY PARTICULAR FONT, STYLE, SIZE, OR COLOR.

FOR PROVIDING DRUG TESTING SERVICES IN THE FIELD OF PRE-EMPLOYMENT, SECURITY CLEARANCE, VOLUNTEER WORKERS, CONTRACTOR AND TENANT CHECKS (U.S. CLS. 100 AND 101).

FIRST USE 1-1-2009; IN COMMERCE 1-1-2009.

3,807,839. THE STAYWELL COMPANY, LLC, YARDLEY, PA. SN 77-598,180. PUB. 5-5-2009, FILED 10-22-2008.



The logo for StayWell Choice features the words "StayWell Choice" in a sans-serif font. The letter "o" in "Choice" is replaced by a stylized apple icon with a leaf.

OWNER OF U.S. REG. NOS. 1,189,585, 3,104,648, AND OTHERS.

NO CLAIM IS MADE TO THE EXCLUSIVE RIGHT TO USE "CHOICE", APART FROM THE MARK AS SHOWN.

THE MARK CONSISTS OF THE WORDS "STAYWELL CHOICE" WHEREIN THE "O" IN CHOICE IS AN APPLE.

FOR HEALTH CARE SERVICES, NAMELY, WELLNESS PROGRAMS FOR PROVIDING ASSISTANCE TO INDIVIDUALS TO HELP THEM MAKE HEALTH, WELLNESS AND NUTRITIONAL CHANGES IN THEIR DAILY LIVING TO IMPROVE HEALTH (U.S. CLS. 100 AND 101).

FIRST USE 10-18-2004; IN COMMERCE 10-18-2004.

CLASS 44—(Continued).

3,807,846. HAGAN, ROBERT R., ST. LOUIS, MO. SN 77-601,485. PUB. 7-21-2009, FILED 10-27-2008.

NEUROPAX

THE MARK CONSISTS OF STANDARD CHARACTERS WITHOUT CLAIM TO ANY PARTICULAR FONT, STYLE, SIZE, OR COLOR.

FOR MEDICAL SERVICES, NAMELY, NERVE DECOMPRESSION AND SEGMENTAL DENERVATION SURGERY (U.S. CLS. 100 AND 101).

FIRST USE 5-31-2009; IN COMMERCE 5-31-2009.

3,807,882. CHAO, D.D.S., JOHN, ALHAMBRA, CA. SN 77-622,505. PUB. 9-22-2009, FILED 11-26-2008.

PINHOLE

THE MARK CONSISTS OF STANDARD CHARACTERS WITHOUT CLAIM TO ANY PARTICULAR FONT, STYLE, SIZE, OR COLOR.

FOR DENTAL SURGERY SERVICES FEATURING GUM RECONSTRUCTION SURGICAL TECHNIQUE (U.S. CLS. 100 AND 101).

FIRST USE 4-1-2010; IN COMMERCE 4-1-2010.

3,807,883. JOHN CHAO, D.D.S., ALHAMBRA, CA. SN 77-622,531. PUB. 4-7-2009, FILED 11-26-2008.

PST

THE MARK CONSISTS OF STANDARD CHARACTERS WITHOUT CLAIM TO ANY PARTICULAR FONT, STYLE, SIZE, OR COLOR.

FOR DENTAL SURGERY SERVICES FEATURING GUM RECONSTRUCTION SURGICAL TECHNIQUE (EXCLUDING GENETIC TESTING FOR PERIODONTITIS) (U.S. CLS. 100 AND 101).

FIRST USE 4-1-2010; IN COMMERCE 4-1-2010.

CLASS 44—(Continued).

3,807,924. MINNESOTA ONCOLOGY HEMATOLOGY, P.A., ST. PAUL, MN. SN 77-650,941. PUB. 12-1-2009, FILED 1-16-2009.

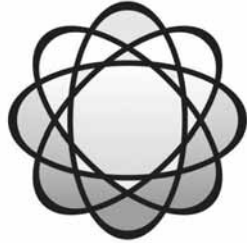

THE MARK CONSISTS OF A MOLECULAR MODEL DESIGN.
FOR HEALTH CARE SERVICES IN THE FIELD OF ONCOLOGY (U.S. CLS. 100 AND 101).
FIRST USE 3-19-2009; IN COMMERCE 3-19-2009.

3,807,957. NUTRI-GREEN LAWN CARE, LONG LAKE, MN. SN 77-671,219. PUB. 6-9-2009, FILED 2-16-2009.

Got Weeds?

THE MARK CONSISTS OF STANDARD CHARACTERS WITHOUT CLAIM TO ANY PARTICULAR FONT, STYLE, SIZE, OR COLOR.
FOR SPREADING OF FERTILIZERS AND OTHER AGRICULTURAL CHEMICALS (U.S. CLS. 100 AND 101).
FIRST USE 4-1-2009; IN COMMERCE 4-1-2009.

3,807,959. CONGREGATIONAL HEALTH RESOURCE, LLC, WOODBRIDGE, VA. SN 77-671,730. PUB. 7-7-2009, FILED 2-17-2009.

HealthCongregations

THE MARK CONSISTS OF STANDARD CHARACTERS WITHOUT CLAIM TO ANY PARTICULAR FONT, STYLE, SIZE, OR COLOR.
FOR CONSULTING SERVICES IN THE FIELD OF HEALTH; PROVIDING A WEBSITE FEATURING INFORMATION CONCERNING ALTERNATIVE HEALTH AND HEALING (U.S. CLS. 100 AND 101).
FIRST USE 9-15-2009; IN COMMERCE 10-1-2009.

CLASS 44—(Continued).

3,808,048. LARRY PAUL, LTD., TERRE HAUTE, IN. SN 77-693,386. PUB. 7-28-2009, FILED 3-18-2009.

SIMPLICITY MEMBERSHIP

THE MARK CONSISTS OF STANDARD CHARACTERS WITHOUT CLAIM TO ANY PARTICULAR FONT, STYLE, SIZE, OR COLOR.

NO CLAIM IS MADE TO THE EXCLUSIVE RIGHT TO USE "MEMBERSHIP", APART FROM THE MARK AS SHOWN.

FOR TANNING SALONS, SKIN TANNING SERVICES FOR HUMANS FOR COSMETIC PURPOSES; HEALTH SPA SERVICES, NAMELY, COSMETIC BODY CARE SERVICES IN THE NATURE OF TANNING SPAS (U.S. CLS. 100 AND 101).

FIRST USE 4-30-2009; IN COMMERCE 4-30-2009.

3,808,049. LARRY PAUL, LTD., TERRE HAUTE, IN. SN 77-693,397. PUB. 7-28-2009, FILED 3-18-2009.

PASS ON THE SHINE

THE MARK CONSISTS OF STANDARD CHARACTERS WITHOUT CLAIM TO ANY PARTICULAR FONT, STYLE, SIZE, OR COLOR.

FOR TANNING SALONS, SKIN TANNING SERVICES FOR HUMANS FOR COSMETIC PURPOSES; HEALTH SPA SERVICES, NAMELY, COSMETIC BODY CARE SERVICES IN THE NATURE OF TANNING SPAS (U.S. CLS. 100 AND 101).

FIRST USE 3-18-2010; IN COMMERCE 3-18-2010.

3,808,050. LARRY PAUL, LTD., TERRE HAUTE, IN. SN 77-693,399. PUB. 7-28-2009, FILED 3-18-2009.

SHINE THROUGH

THE MARK CONSISTS OF STANDARD CHARACTERS WITHOUT CLAIM TO ANY PARTICULAR FONT, STYLE, SIZE, OR COLOR.

FOR TANNING SALONS, SKIN TANNING SERVICES FOR HUMANS FOR COSMETIC PURPOSES; HEALTH SPA SERVICES, NAMELY, COSMETIC BODY CARE SERVICES IN THE NATURE OF TANNING SPAS (U.S. CLS. 100 AND 101).

FIRST USE 3-18-2010; IN COMMERCE 3-18-2010.

CLASS 44—(Continued).

3,808,051. LARRY PAUL, LTD., TERRE HAUTE, IN. SN 77-693,409. PUB. 7-28-2009, FILED 3-18-2009.

WE MAKE TANNING SIMPLE

THE MARK CONSISTS OF STANDARD CHARACTERS WITHOUT CLAIM TO ANY PARTICULAR FONT, STYLE, SIZE, OR COLOR.

FOR TANNING SALONS, SKIN TANNING SERVICES FOR HUMANS FOR COSMETIC PURPOSES; HEALTH SPA SERVICES, NAMELY, COSMETIC BODY CARE SERVICES IN THE NATURE OF TANNING SPAS (U.S. CLS. 100 AND 101).

FIRST USE 4-30-2009; IN COMMERCE 4-30-2009.

CLASS 44—(Continued).

3,808,181. 1LIFE HEALTHCARE, INC., SAN FRANCISCO, CA. SN 77-713,015. PUB. 11-3-2009, FILED 4-13-2009.

ONE MEDICAL GROUP

THE MARK CONSISTS OF STANDARD CHARACTERS WITHOUT CLAIM TO ANY PARTICULAR FONT, STYLE, SIZE, OR COLOR.

NO CLAIM IS MADE TO THE EXCLUSIVE RIGHT TO USE "MEDICAL GROUP", APART FROM THE MARK AS SHOWN.

FOR MEDICAL CARE SERVICES, NAMELY, PRIMARY CARE MEDICAL SERVICES, FAMILY MEDICINE, AND SPECIALIZED MEDICAL CARE SERVICES IN THE MANAGEMENT OF COMPLEX AND CHRONIC DISEASES, NAMELY, DIABETES, HIGH BLOOD PRESSURE, HIGH CHOLESTEROL, THYROID DISORDERS, HEART DISEASE, ASTHMA AND ARTHRITIS; OSTEO-PATHIC MEDICAL SERVICES; NATUROPATHIC MEDICAL SERVICES; INTEGRATIVE MEDICAL SERVICES; PROVIDING PREVENTATIVE HEALTH INFORMATION; COUNSELING SERVICES IN THE FIELDS OF HEALTH, NUTRITION, WEIGHT MANAGEMENT, HERBALISM, AND LIFESTYLE WELLNESS; COUNSELING SERVICES IN THE FIELD OF DISEASE MANAGEMENT; MENTAL HEALTH SERVICES FEATURING STRESS MANAGEMENT COUNSELING; REHABILITATION PATIENT CARE SERVICES, NAMELY, OUTPATIENT CARE; MEDICAL SERVICES IN THE NATURE OF CHRONIC PAIN MANAGEMENT MEDICAL SERVICES; MEDICAL SERVICES IN THE FIELDS OF WOMEN HEALTH, BIRTH CONTROL COUNSELING; PROVIDING IN-PERSON HOLISTIC HEALTH CARE SERVICES; HEALTH CARE SERVICES IN PREPARATION FOR TRAVELING INCLUDING IMMUNIZATION SERVICES; MEDICAL SERVICES, NAMELY, DIAGNOSIS AND TREATMENT OF SPORTS INJURIES; MEDICAL SERVICES, NAMELY, DIAGNOSIS AND TREATMENT OF SKIN DISORDERS; ACUPUNCTURE; CHIROPRACTIC SERVICES; MEDICAL AND PHARMACEUTICAL CONSULTATION; MEDICAL DIAGNOSTIC TESTING, MONITORING, AND REPORTING SERVICES; MAINTAINING PERSONAL MEDICAL HISTORY RECORDS AND FILES; PROVIDING A WEB SITE FEATURING INFORMATION ON HEALTH AND WELLNESS; PSYCHOLOGICAL ASSESSMENT SERVICES; PSYCHOLOGICAL COUNSELING; PROVIDING A WEB SITE FOR MEDICAL PATIENTS THAT ALLOWS ACCESS TO A PATIENT'S PERSONAL MEDICAL HISTORY RECORDS; PROVIDING AN INTERNET-BASED PRESCRIPTION RENEWAL SERVICE (U.S. CLS. 100 AND 101).

FIRST USE 6-22-2009; IN COMMERCE 6-22-2009.

3,808,115. INTRAOP MEDICAL CORPORATION, SUNNYVALE, CA. SN 77-702,952. PUB. 7-28-2009, FILED 3-31-2009.

DERMABEAM

THE MARK CONSISTS OF STANDARD CHARACTERS WITHOUT CLAIM TO ANY PARTICULAR FONT, STYLE, SIZE, OR COLOR.

FOR RADIOTHERAPY SERVICES FOR THE TREATMENT OF CANCER (U.S. CLS. 100 AND 101).

FIRST USE 3-31-2009; IN COMMERCE 3-31-2009.

3,808,138. SL ENTERPRISES LLC, IDAHO FALLS, ID. SN 77-705,287. PUB. 8-4-2009, FILED 4-2-2009.

Walk-In Weight Loss

THE MARK CONSISTS OF STANDARD CHARACTERS WITHOUT CLAIM TO ANY PARTICULAR FONT, STYLE, SIZE, OR COLOR.

NO CLAIM IS MADE TO THE EXCLUSIVE RIGHT TO USE "WEIGHT LOSS", APART FROM THE MARK AS SHOWN.

FOR WEIGHT REDUCTION DIET PLANNING AND SUPERVISION (U.S. CLS. 100 AND 101).

FIRST USE 3-25-2010; IN COMMERCE 3-25-2010.

CLASS 44—(Continued).

3,808,208. DENTAL ONE CARE, STERLING HEIGHTS, MI.
SN 77-716,145. PUB. 8-25-2009, FILED 4-17-2009.



NO CLAIM IS MADE TO THE EXCLUSIVE RIGHT TO USE "DENTAL" AND "CARE", APART FROM THE MARK AS SHOWN.

THE STIPPLING IS FOR SHADING PURPOSES ONLY.

THE MARK CONSISTS OF THE LITERAL ELEMENT "DENTAL ONE CARE" AND A DESIGN ELEMENT CONSISTING OF A SERIES OF DOTS ARRANGED TO LOOK LIKE A SMILE, THE DOTS VARYING IN SIZE FROM THE LARGEST IN THE CENTER AND SMALLEST FARTHEST FROM THE CENTER, AND WHEREIN THE LITERAL ELEMENT IS LOCATED BELOW THE DESIGN ELEMENT WITH THE WORD "DENTAL" LOCATED ABOVE THE WORDS "ONE CARE", AND WHEREIN FURTHER, THE LITERAL AND THE DESIGN ELEMENT ARE SUPERIMPOSED UPON A SQUARE FEATURING ROUNDED EDGES.

FOR DENTISTRY (U.S. CLS. 100 AND 101).

FIRST USE 4-1-2009; IN COMMERCE 4-1-2009.

3,808,294. TOTHTOP LLC, LOCUST GROVE, GA. SN 77-742,190. PUB. 9-29-2009, FILED 5-21-2009.

STUNNAZ

THE MARK CONSISTS OF STANDARD CHARACTERS WITHOUT CLAIM TO ANY PARTICULAR FONT, STYLE, SIZE, OR COLOR.

FOR HAIR SALON SERVICES (U.S. CLS. 100 AND 101).
FIRST USE 1-4-2010; IN COMMERCE 1-4-2010.

CLASS 44—(Continued).

3,808,357. MARIA POWELL, SAN PABLO, CA. SN 77-765,077.
PUB. 11-3-2009, FILED 6-22-2009.

HAPPY LASHES

THE MARK CONSISTS OF STANDARD CHARACTERS WITHOUT CLAIM TO ANY PARTICULAR FONT, STYLE, SIZE, OR COLOR.

NO CLAIM IS MADE TO THE EXCLUSIVE RIGHT TO USE "LASHES", APART FROM THE MARK AS SHOWN.

FOR BEAUTY SALON SERVICES, NAMELY, EYE-LASH APPLICATION, BODY WAXING, FACIALS (U.S. CLS. 100 AND 101).

FIRST USE 2-0-2009; IN COMMERCE 2-0-2009.

3,808,423. ESTEE LAUDER INC., NEW YORK, NY. SN 77-791,361. PUB. 1-19-2010, FILED 7-28-2009.

LET'S PLAY MAKEOVER

THE MARK CONSISTS OF STANDARD CHARACTERS WITHOUT CLAIM TO ANY PARTICULAR FONT, STYLE, SIZE, OR COLOR.

NO CLAIM IS MADE TO THE EXCLUSIVE RIGHT TO USE "MAKEOVER", APART FROM THE MARK AS SHOWN.

FOR CONSULTATION SERVICES IN THE FIELD OF MAKEUP, NAMELY, ON-LINE MAKEUP CONSULTATION SERVICES AND IN-PERSON MAKEUP CONSULTATION AND APPLICATION SERVICES (U.S. CLS. 100 AND 101).

FIRST USE 8-18-2009; IN COMMERCE 8-18-2009.

3,808,455. HOME ACCESS REHABILITATION, DEVON, PA.
SN 77-801,689. PUB. 1-12-2010, FILED 8-11-2009.

Quality Care for Quality of Life

THE MARK CONSISTS OF STANDARD CHARACTERS WITHOUT CLAIM TO ANY PARTICULAR FONT, STYLE, SIZE, OR COLOR.

FOR PHYSICAL THERAPY (U.S. CLS. 100 AND 101).
FIRST USE 10-1-2009; IN COMMERCE 10-1-2009.

CLASS 44—(Continued).

3,808,563. FREE & CLEAR, INC., SEATTLE, WA. SN 78-606,397. PUB. 7-21-2009, FILED 4-11-2005.

ACCOMPLISH

THE MARK CONSISTS OF STANDARD CHARACTERS WITHOUT CLAIM TO ANY PARTICULAR FONT, STYLE, SIZE, OR COLOR.

FOR WEIGHT MANAGEMENT PROGRAM, NAMELY, WEIGHT REDUCTION DIET PLANNING AND SUPERVISION (U.S. CLS. 100 AND 101).

FIRST USE 10-0-2005; IN COMMERCE 10-0-2005.

CLASS 45—(Continued).

3,807,442. THE EVANGELICAL FREE CHURCH OF AMERICA, MINNEAPOLIS, MN. SN 77-107,733. PUB. 10-27-2009, FILED 2-14-2007.

TOUCHGLOBAL

THE MARK CONSISTS OF STANDARD CHARACTERS WITHOUT CLAIM TO ANY PARTICULAR FONT, STYLE, SIZE, OR COLOR.

FOR EVANGELICAL MISSIONARY AND MINISTERIAL SERVICES; CHARITABLE SERVICES, NAMELY, ORGANIZING GROUPS TO UNDERTAKE PROJECTS TO BENEFIT THE NEEDY AND THE COMMUNITY TO ENCOURAGE LEADERSHIP, CHARACTER, COMPASSION, AND GOOD CITIZENSHIP; COUNSELING SERVICES IN THE FIELD OF CHRISTIAN CONDUCT IN PERSONAL RELATIONSHIPS; PROVIDING ON-LINE INFORMATION IN THE FIELD OF RELIGION, SPIRITUALITY, SELF-HELP, AND PERSONAL EMPOWERMENT SUBJECT MATTERS (U.S. CLS. 100 AND 101).

FIRST USE 1-31-2007; IN COMMERCE 1-31-2007.

3,807,491. ABELMAN, FRAYNE & SCHWAB, NEW YORK, NY. SN 77-258,515. PUB. 8-12-2008, FILED 8-17-2007.

CLASS 45—PERSONAL AND LEGAL SERVICES

3,807,440. GOODMAIL SYSTEMS, INC., MOUNTAIN VIEW, CA. SN 77-103,441. PUB. 8-14-2007, FILED 2-9-2007.

GOODMAIL SYSTEMS

THE MARK CONSISTS OF STANDARD CHARACTERS WITHOUT CLAIM TO ANY PARTICULAR FONT, STYLE, SIZE, OR COLOR.

OWNER OF U.S. REG. NOS. 3,231,717 AND 3,248,669.

NO CLAIM IS MADE TO THE EXCLUSIVE RIGHT TO USE "SYSTEMS", APART FROM THE MARK AS SHOWN.

FOR PROVIDING ELECTRONIC IDENTIFICATION AND AUTHENTICATION SERVICES, NAMELY, PROVIDING ENCRYPTION CODES FOR USE AS AN ELECTRONIC STAMP FOR SENDERS OF ELECTRONIC MESSAGES TO NOTIFY AND AUTHENTICATE FOR THE RECIPIENT OR THE RECIPIENT'S MESSAGE SERVICE PROVIDER THAT THE ELECTRONIC MESSAGE IS LEGITIMATE (U.S. CLS. 100 AND 101).

FIRST USE 5-4-2006; IN COMMERCE 5-4-2006.

ABELAW

THE MARK CONSISTS OF STANDARD CHARACTERS WITHOUT CLAIM TO ANY PARTICULAR FONT, STYLE, SIZE, OR COLOR.

OWNER OF U.S. REG. NO. 2,825,427.

FOR LEGAL SERVICES (U.S. CLS. 100 AND 101).

FIRST USE 4-21-2010; IN COMMERCE 4-21-2010.

3,807,540. 23ANDME, INC., MOUNTAIN VIEW, CA. SN 77-371,353. PUB. 2-10-2009, FILED 1-14-2008.

PERSONAL GENOME SERVICE

THE MARK CONSISTS OF STANDARD CHARACTERS WITHOUT CLAIM TO ANY PARTICULAR FONT, STYLE, SIZE, OR COLOR.

NO CLAIM IS MADE TO THE EXCLUSIVE RIGHT TO USE "GENOME SERVICE", APART FROM THE MARK AS SHOWN.

FOR ONLINE SOCIAL NETWORKING IN THE FIELD OF GENETICS (U.S. CLS. 100 AND 101).

FIRST USE 4-30-2010; IN COMMERCE 4-30-2010.

CLASS 45—(Continued).

3,807,607. CITYCENTER LAND, LLC, LAS VEGAS, NV. SN 77-445,981. PUB. 9-2-2008, FILED 4-11-2008.

ARIA

THE MARK CONSISTS OF STANDARD CHARACTERS WITHOUT CLAIM TO ANY PARTICULAR FONT, STYLE, SIZE, OR COLOR.

FOR WEDDING CHAPEL SERVICES; HOTEL CONCIERGE SERVICES (U.S. CLS. 100 AND 101).

FIRST USE 12-16-2009; IN COMMERCE 12-16-2009.

3,807,658. CSIDENTITY CORPORATION, AUSTIN, TX. SN 77-509,125. PUB. 11-18-2008, FILED 6-26-2008.

CYBERAGENT

THE MARK CONSISTS OF STANDARD CHARACTERS WITHOUT CLAIM TO ANY PARTICULAR FONT, STYLE, SIZE, OR COLOR.

FOR MONITORING AND FRAUD ALERT SERVICES IN THE FIELD OF PERSONAL AND FINANCIAL IDENTITY SECURITY AND PROTECTION; BACKGROUND SCREENING SERVICES (U.S. CLS. 100 AND 101).

FIRST USE 3-31-2006; IN COMMERCE 3-31-2006.

3,807,692. GRIFFIN PROTECTION GROUP, INC., O'FAL-
LON, MO. SN 77-540,071. PUB. 7-14-2009, FILED 8-6-2008.

GRIFFIN PROTECTION GROUP

THE MARK CONSISTS OF STANDARD CHARACTERS WITHOUT CLAIM TO ANY PARTICULAR FONT, STYLE, SIZE, OR COLOR.

NO CLAIM IS MADE TO THE EXCLUSIVE RIGHT TO USE "PROTECTION GROUP", APART FROM THE MARK AS SHOWN.

FOR CUSTOMER AND CONSULTING SERVICES IN THE FIELD OF PRIVACY, PERSONAL SECURITY, FRAUD PREPARATION, AND IDENTITY THEFT PROTECTION AND RESOLUTION IN RELATION TO REPAIR AND PREVENTION OF DAMAGES AND LOSSES DUE TO MISAPPROPRIATION OF PERSONAL AND FINANCIAL INFORMATION AND DATA (U.S. CLS. 100 AND 101).

FIRST USE 6-17-2008; IN COMMERCE 6-17-2008.

CLASS 45—(Continued).

3,807,864. MY FASHION DATABASE, LLC, ENCINO, CA. SN 77-611,201. PUB. 7-14-2009, FILED 11-10-2008.

MyFDB

THE MARK CONSISTS OF STANDARD CHARACTERS WITHOUT CLAIM TO ANY PARTICULAR FONT, STYLE, SIZE, OR COLOR.

FOR PROVIDING ONLINE MULTI-MEDIA DATABASES FEATURING FASHION INFORMATION VIA AN INTERNET SUBSCRIPTION SERVICE (U.S. CLS. 100 AND 101).

FIRST USE 11-1-2009; IN COMMERCE 11-1-2009.

3,807,926. THE LOCAL CRITIC, INC., ATLANTA, GA. SN 77-651,830. PUB. 5-5-2009, FILED 1-18-2009.

CtoureLife

THE MARK CONSISTS OF STANDARD CHARACTERS WITHOUT CLAIM TO ANY PARTICULAR FONT, STYLE, SIZE, OR COLOR.

FOR PROVIDING A SOCIAL NETWORKING WEBSITE FOR ENTERTAINMENT PURPOSES (U.S. CLS. 100 AND 101).

FIRST USE 5-1-2010; IN COMMERCE 5-1-2010.

3,808,113. CALDWELL, MICHAEL, SANTA CLARA, CA. SN 77-702,396. PUB. 9-1-2009, FILED 3-30-2009.

Patent River

THE MARK CONSISTS OF STANDARD CHARACTERS WITHOUT CLAIM TO ANY PARTICULAR FONT, STYLE, SIZE, OR COLOR.

NO CLAIM IS MADE TO THE EXCLUSIVE RIGHT TO USE "PATENT", APART FROM THE MARK AS SHOWN.

FOR INFORMATION SERVICES, NAMELY, PROVIDING CURRENT AND HISTORICAL DATA RELATED TO PATENTS (U.S. CLS. 100 AND 101).

FIRST USE 11-29-2009; IN COMMERCE 11-29-2009.

CLASS 45—(Continued).

3,808,211. DUTCH & DUTCHESS CHRISTIAN FELLOWSHIP, INC., ANCHORAGE, AK. SN 77-717,096. PUB. 8-18-2009, FILED 4-19-2009.



NO CLAIM IS MADE TO THE EXCLUSIVE RIGHT TO USE "FELLOWSHIP", APART FROM THE MARK AS SHOWN.

THE COLOR(S) DARK BLUE, WHITE, TEAL, ORANGE, GREEN, RED IS/ARE CLAIMED AS A FEATURE OF THE MARK.

THE MARK CONSISTS OF THE WORDING "DUTCH & DUTCHESS" IN DARK BLUE ON A WHITE FIELD, THE WORDING "FELLOWSHIP" IN WHITE ON A BLUE FIELD, TOGETHER FORMING A BLUE BORDERED RECTANGLE, AND, A STYLIZED TREE WITH TRUNK AND BRANCHES IN TEAL BLUE FORMING SPACES OF GREEN, RED, AND ORANGE FADED TO WHITE.

FOR RELIGIOUS AND SPIRITUAL SERVICES, NAMELY, PROVIDING GATHERINGS AND RETREATS TO DEVELOP AND ENHANCE THE SPIRITUAL LIVES OF INDIVIDUALS (U.S. CLS. 100 AND 101).

FIRST USE 11-1-2009; IN COMMERCE 3-5-2010.

3,808,461. ALEXSAM T, LLC, CLEARWATER, FL. SN 77-803,745. PUB. 1-12-2010, FILED 8-13-2009.



OWNER OF U.S. REG. NOS. 3,069,439 AND 3,072,161.

CLASS 45—(Continued).

THE COLOR(S) BLUE, WHITE, GREY AND PURPLE IS/ARE CLAIMED AS A FEATURE OF THE MARK.

THE MARK CONSISTS OF THE WORDS "PREGUNTA-AHORA" WITH "PREGUNTA" IN BLUE WITH AN OUTLINING AND SHADOWING EFFECT IN WHITE AND GREY, "AHORA" IN PURPLE WITH AN OUTLINING AND SHADOWING EFFECT IN WHITE AND GREY. ABOVE THE LETTERS "AAHORA" THERE IS A DESIGN OF A STAR AND CRESCENT MOON WITH THE STAR BEING IN BLUE AND THE CRESCENT MOON BEING IN BLUE WITH SEVERAL WHITE STARS LOCATED IN THE INTERIOR OF THE CRESCENT MOON. THE STAR AND CRESCENT MOON DESIGN HAVE AN OUTLINING AND SHADOWING EFFECT THAT IS WHITE AND GREY.

THE ENGLISH TRANSLATION OF "PREGUNTA AHORA" IN THE MARK IS "ASK NOW".

FOR PSYCHIC SERVICES, NAMELY, ASTROLOGICAL FORECASTING, TAROT CARD READINGS, PSYCHIC CONSULTATION AND READINGS, PROVIDED VIA THE TELEPHONE AND THE INTERNET (U.S. CLS. 100 AND 101).

FIRST USE 9-0-2009; IN COMMERCE 9-0-2009.

3,808,470. DAVIS KINARD & CO, PC, ABILENE, TX. SN 77-809,867. PUB. 1-19-2010, FILED 8-21-2009.



NO CLAIM IS MADE TO THE EXCLUSIVE RIGHT TO USE "LINE AND SECURE ANONYMOUS FRAUD REPORTING", APART FROM THE MARK AS SHOWN.

THE COLOR(S) BLUE AND LIGHT BLUE IS/ARE CLAIMED AS A FEATURE OF THE MARK.

THE MARK CONSISTS OF THE WORDING "SAFR LINE SECURE ANONYMOUS FRAUD REPORTING" IN STYLIZED FONT WITH THE WORDING "SAFR" AND THE LETTERS "SAFR" IN "SECURE ANONYMOUS FRAUD REPORTING" APPEARING IN BLUE AND THE WORDING "LINE" AND "ECURE NONYMOUS RAUD EPORTING" APPEARING IN LIGHT BLUE

FOR FRAUD DETECTION SERVICES IN THE FIELD OF ACCOUNTING AND BUSINESS PRACTICES, NAMELY, PROVIDING A FRAUD HOT-LINE FOR COLLECTING INFORMATION ON ILLEGAL OR FRAUDULENT ACTIVITY FOR THE PURPOSE OF FRAUD DETECTION (U.S. CLS. 100 AND 101).

FIRST USE 10-9-2009; IN COMMERCE 10-9-2009.

PRIOR UNITED STATES CLASSIFICATION

APPLICATION IN ONE CLASS

COLLECTIVE MEMBERSHIP MARKS

3,808,407. FTI GROUP, INC., KELLER, TX. SN 77-785,951.
PUB. 12-1-2009, FILED 7-21-2009.

twoPartners

THE MARK CONSISTS OF STANDARD CHARACTERS WITHOUT CLAIM TO ANY PARTICULAR FONT, STYLE, SIZE, OR COLOR.

FOR INDICATING MEMBERSHIP IN AN ORGANIZATION THAT ENABLES PARTICIPANTS TO OBTAIN DISCOUNTS ON GOODS AND SERVICES, RECEIVE IMPROVED SERVICES, AND RECEIVE BUSINESS BENEFITS (U.S. CL. 200).

FIRST USE 7-15-2009; IN COMMERCE 7-15-2009.

CLASS 200—COLLECTIVE MEMBERSHIP

* * * * *

SUPPLEMENTAL REGISTER

These registrations are not subject to opposition.

SECTION 1.— INTERNATIONAL CLASSIFICATION

The short titles associated below with the international class numbers are terms designed merely for quick identification and are not an official part of the international classification. The full names of international classes are given in section 6.1 of the trademark rules of practice.

The designation "U.S. Cl." appearing in this section refers to the U.S. class in effect prior to Sep. 1, 1973 rather than the international class which applies to applications filed on or after that date. For adoption of international classification see notice in the OFFICIAL GAZETTE of Jun. 26, 1973 (911 O.G. TM 210).

Application in more than one class

3,808,625. EADS SPACE TRANSPORTATION GMBH, D-28199 BREMEN, FED REP GERMANY. SN 76-587,524. FILED P.R. 4-19-2004; AM. S.R. 4-1-2010.

CLASS 7—MACHINERY

FOR MACHINE TOOLS AND MACHINES FOR MANUFACTURING PARTS FOR USE IN TURBOJET ENGINES, RAM JET ENGINES, PULSE JET ENGINES AND MISSILES WITH ROCKET ENGINES; MOTORS AND ENGINES OF ALL KINDS FOR FIXED OR MOBILE INSTALLATIONS EXCEPT FOR LAND VEHICLES, NAMELY, GAS TURBINE ENGINES, HEAT ENGINES, ELECTROTHERMAL ENGINES, JET ENGINES, NUCLEAR ENGINES, COMBINED PROPULSION ENGINES, ROCKET ENGINES, HYPERSONIC ENGINES, CRYOGENIC ROCKET MOTORS, ROCKET MOTORS FOR SATELLITE LAUNCHERS AND FOR BALLISTIC AND TACTICAL MISSILES, ROCKET ENGINES AND VERNIER ENGINES FOR SATELLITES; ION ENGINES, ELECTRIC ENGINES, PLASMA ENGINES, ARC JETS FOR NON-LAND VEHICLES; PLASMA SOURCES FOR PROVISION OF PLASMA BEAMS FOR CREATING, PROCESSING, ANALYZING, FORMING AND DESTROYING OF MATERIALS OR OBJECTS; THRUST REVERSERS FOR AEROPLANE ENGINES; PARTS OF THE AFORESAID MOTORS, ENGINES, THRUST REVERSERS AND PROPULSION UNITS, NAMELY, COMBUSTION CHAMBERS, PROPELLING NOZZLES, AIR INLETS, PROFILES, BOARDS, SHEETS, BLOCKS, RODS, TUBES AND PELLETS (U.S. CLS. 13, 19, 21, 23, 31, 34 AND 35).

SICBRAZE

CLASS 9—ELECTRICAL AND SCIENTIFIC APPARATUS

FOR SATELLITES (U.S. CLS. 21, 23, 26, 36 AND 38).

THE MARK CONSISTS OF STANDARD CHARACTERS WITHOUT CLAIM TO ANY PARTICULAR FONT, STYLE, SIZE, OR COLOR.

PRIORITY CLAIMED UNDER SEC. 44(D) ON FED REP GERMANY APPLICATION NO. 003637782, FILED 1-30-2004, REG. NO. 003637782, DATED 5-4-2005, EXPIRES 1-30-2014.

CLASS 6—METAL GOODS

FOR STRUCTURED COMPOSITE MATERIALS, MAINLY WITH A MATRIX OF METAL, IN THE FORM OF PROFILES, BOARDS, SHEETS, BLOCKS, RODS, TUBES, POWDERS AND PELLETS, FOR USE IN SATELLITES, ROCKETS, MISSILES, OPTICAL MIRRORS AND BRAKES; SEMI-PROCESSED AND PROCESSED CARBON COMPOSITE MATERIALS, MAINLY WITH A MATRIX OF METAL, IN THE FORM OF PROFILES, BOARDS, SHEETS, BLOCKS, RODS, TUBES, POWDERS AND PELLETS, FOR USE IN FRICTION-STRESSED PARTS; COMPOSITE CONSTRUCTIONAL ELEMENTS WITH CONSTRUCTIONAL COMPONENTS MADE OF A COMPOSITE MATERIAL, MAINLY WITH A MATRIX OF METAL (U.S. CLS. 2, 12, 13, 14, 23, 25 AND 50).

CLASS 11—ENVIRONMENTAL CONTROL APPARATUS

FOR ELECTRIC HEATERS FOR COMMERCIAL AND PRIVATE USE, STEAM GENERATORS, FURNACES, OVENS, MICROWAVE OVENS, INCINERATORS, NAMELY, WASTE INCINERATORS AND PARTS FOR INCINERATORS; DISTANCE PLATES AND SPACERS MADE FROM COMPOSITE MATERIALS WITH CARBON OR CERAMIC BLANKS, FOR USE IN FURNACES; THERMAL PROTECTION SYSTEMS AND HEAT PROTECTION DEVICES IN THE FORM OF SUPERSTRUCTURES AND LININGS, INCLUDING HEAT SHIELDS, FOR PROPULSION AND FUSION TECHNOLOGY AND THEIR INDUSTRIAL APPLICATIONS (U.S. CLS. 13, 21, 23, 31 AND 34).

CLASS 12—VEHICLES

FOR AIRCRAFT AND SPACE VEHICLES OF ALL KINDS, INCLUDING MANNED AND UNMANNED SPACE VEHICLES; LAUNCH ROCKETS IN THE NATURE OF SPACE VEHICLES, ROCKETS FOR SPACE TRAVEL; SPACE SHUTTLES FOR SPACE TRAVEL, INCLUDING WITH HYPERSONIC ENGINES; SPACE STATIONS; PARTS FOR SPACE VEHICLES, NAMELY, ROCKET CHAMBERS, PROPELLING NOZZLES AND AIR INLETS; BRAKING DEVICES FOR MOTOR VEHICLES, RAIL VEHICLES AND AIRCRAFT, NAMELY, BRAKE DRUMS, BRAKE LININGS, BRAKE DISCS AND BRAKE SEGMENTS (U.S. CLS. 19, 21, 23, 31, 35 AND 44).

CLASS 13—FIREARMS

FOR GUIDED AND BALLISTIC ROCKET-PROPELLED MISSILES (U.S. CLS. 2 AND 9).

CLASS 16—PAPER GOODS AND PRINTED MATTER

FOR PAMPHLETS, PERIODICALS, BROCHURES, BOOKS, IN THE FIELDS OF AEROSPACE TECHNOLOGY, COMPOSITE MATERIALS TECHNOLOGY, FURNACE AND COMBUSTION TECHNOLOGY, ENGINE TECHNOLOGY AND VEHICLE TECHNOLOGY (U.S. CLS. 2, 5, 22, 23, 29, 37, 38 AND 50).

CLASS 17—RUBBER GOODS

FOR STRUCTURED COMPOSITE MATERIALS, MAINLY WITH A MATRIX OF PLASTIC, IN THE FORM OF PROFILES, BOARDS, SHEETS, BLOCKS, RODS, TUBES, POWDER AND PELLETS, FOR USE IN SATELLITES, ROCKETS, MISSILES, OPTICAL MIRRORS AND BRAKES; SEMI-PROCESSED AND PROCESSED CARBON COMPOSITE MATERIALS, MAINLY WITH A MATRIX OF PLASTIC, IN THE FORM OF PROFILES, BOARDS, SHEETS, BLOCKS, RODS, TUBES, POWDER AND PELLETS, FOR USE IN FRICTION-STRESSED PARTS; COMPOSITE CONSTRUCTIONAL ELEMENTS WITH CONSTRUCTIONAL COMPONENTS MADE OF A COMPOSITE MATERIAL, MAINLY WITH A MATRIX OF PLASTIC (U.S. CLS. 1, 5, 12, 13, 35 AND 50).

CLASS 19—NON-METALLIC BUILDING MATERIALS

FOR STRUCTURED COMPOSITE MATERIALS, MAINLY WITH A CERAMIC MATRIX, IN THE FORM OF PROFILES, BOARDS, SHEETS, BLOCKS, RODS, TUBES, POWDER AND PELLETS, FOR USE IN SATELLITES, ROCKETS, MISSILES, OPTICAL MIRRORS AND BRAKES; SEMI-PROCESSED AND PROCESSED CARBON COMPOSITE MATERIALS, MAINLY WITH A CERAMIC MATRIX, IN THE FORM OF PROFILES, BOARDS, SHEETS, BLOCKS, RODS, TUBES, POWDER AND PELLETS, FOR USE IN FRICTION-STRESSED PARTS; SEMI-PROCESSED AND PROCESSED CERAMIC MATRIX COMPOSITES IN THE FORM OF PROFILES, BOARDS, SHEETS, BLOCKS, RODS, TUBES, POWDERS AND PELLETS; CERAMIC MATRIX REFRACTORY MATERIALS; COMPOSITE CONSTRUCTIONAL ELEMENTS WITH CONSTRUCTIONAL COMPONENTS MADE OF A COMPOSITE MATERIAL, MAINLY WITH A CERAMIC MATRIX (U.S. CLS. 1, 12, 33 AND 50).

CLASS 37—CONSTRUCTION AND REPAIR

FOR CONSTRUCTION, REPAIR AND MAINTENANCE OF AIR VEHICLES, SPACE VEHICLES, SPACE STATIONS, MISSILES, ROCKETS AND LAUNCH ROCKETS, COMBUSTION CHAMBERS, ROCKET CHAMBERS, PROPELLING NOZZLES AND AIR INLETS; CONSTRUCTION OF INDUSTRIAL BUILDINGS AND TEST STANDS FOR PROPULSION UNITS FOR ROCKET ENGINES; REPAIR AND SERVICING OF AEROSPACE PROPULSION UNITS; CONSTRUCTION, REPAIR AND SERVICING OF THE HOT PART OF FURNACES AND OTHER COMPONENTS MADE FROM HEAT-RESISTANT COMPOSITE MATERIALS, COMBUSTION CHAMBERS, ROCKET CHAMBERS, PROPELLING NOZZLES AND AIR INLETS; CONSTRUCTION, REPAIR AND MAINTENANCE OF FRICTION-STRESSED PARTS, NAMELY, BRAKE DRUMS, BRAKE LININGS, BRAKE DISCS AND BRAKE SEGMENTS; PROVIDING INFORMATION RELATING TO CONSTRUCTION AND REPAIR IN THE FIELDS OF AEROSPACE TECHNOLOGY, COMPOSITE MATERIALS TECHNOLOGY, FURNACE AND COMBUSTION TECHNOLOGY, ENGINE TECHNOLOGY AND VEHICLE TECHNOLOGY (U.S. CLS. 100, 103 AND 106).

CLASS 40—MATERIAL TREATMENT

FOR TREATMENT OF MATERIALS AND CONSTRUCTIONAL ELEMENTS, NAMELY, CREATING, PROCESSING, ANALYZING, FORMING AND DESTROYING OF MATERIALS, CONSTRUCTIONAL ELEMENTS, JOINTS BETWEEN MATERIALS AND JOINTS BETWEEN CONSTRUCTIONAL ELEMENTS; WELDING, SOLDERING AND BRAZING TO MAKE JOINTS BETWEEN MATERIALS OR CONSTRUCTIONAL ELEMENTS; WELDING, SOLDERING AND BRAZING TO MAKE COATINGS ON MATERIALS OR CONSTRUCTIONAL ELEMENTS; HEAT TREATMENT OF COMPOSITE MATERIALS; PHYSICO-CHEMICAL ANTIOXIDANT AND ANTICORROSIVE PROTECTION TREATMENTS FOR METALLIC AND NON-METALLIC COMPOSITE MATERIALS; PROVIDING INFORMATION IN THE FIELDS OF THE AFORESAID MATERIAL TREATMENTS (U.S. CLS. 100, 103 AND 106).

CLASS 41—EDUCATION AND ENTERTAINMENT

FOR EDUCATION AND TRAINING, NAMELY, CONDUCTING EDUCATIONAL SEMINARS IN THE FIELDS OF AEROSPACE TECHNOLOGY, COMPOSITE MATERIALS TECHNOLOGY, FURNACE AND COMBUSTION TECHNOLOGY, ENGINE TECHNOLOGY AND VEHICLE TECHNOLOGY; TRAINING SERVICES IN THE FIELDS OF AEROSPACE TECHNOLOGY, COMPOSITE MATERIALS TECHNOLOGY, FURNACE AND COMBUSTION TECHNOLOGY, ENGINE TECHNOLOGY AND VEHICLE TECHNOLOGY (U.S. CLS. 100, 101 AND 107).

CLASS 42—SCIENTIFIC AND COMPUTER SERVICES

FOR DEVELOPMENT AND MAINTENANCE OF COMPUTER PROGRAMS FOR CONTROLLING MACHINES FOR TREATMENT OF MATERIALS AND CONSTRUCTIONAL ELEMENTS; ENGINEERING SERVICES; ENGINEERING CONSULTANCY; MATERIAL TESTING; LABORATORY, SCIENTIFIC AND INDUSTRIAL RESEARCH SERVICES IN THE FIELDS OF AEROSPACE TECHNOLOGY, COMPOSITE MATERIALS TECHNOLOGY, FURNACE AND COMBUSTION TECHNOLOGY, ENGINE TECHNOLOGY AND VEHICLE TECHNOLOGY; PROVIDING INFORMATION AND TECHNICAL INFORMATION IN THE FIELDS OF AEROSPACE TECHNOLOGY, COMPOSITE MATERIALS TECHNOLOGY, FURNACE AND COMBUSTION TECHNOLOGY, ENGINE TECHNOLOGY AND VEHICLE TECHNOLOGY (U.S. CLS. 100 AND 101).

3,808,626. EADS SPACE TRANSPORTATION GMBH, D-28199 BREMEN, FED REP GERMANY. SN 76-598,116. FILED P.R. 6-18-2004; AM. S.R. 4-1-2010.

SICARBON

THE MARK CONSISTS OF STANDARD CHARACTERS WITHOUT CLAIM TO ANY PARTICULAR FONT, STYLE, SIZE, OR COLOR.

PRIORITY CLAIMED UNDER SEC. 44(D) ON FED REP GERMANY APPLICATION NO. 003796828, FILED 4-27-2004, REG. NO. 003796828, DATED 7-6-2005, EXPIRES 4-27-2014.

CLASS 6—METAL GOODS

FOR STRUCTURED COMPOSITE MATERIALS, MAINLY WITH A MATRIX OF METAL, IN THE FORM OF PROFILES, BOARDS, SHEETS, BLOCKS, RODS, TUBES, POWDERS AND PELLETS, FOR USE IN SATELLITES, ROCKETS, MISSILES, OPTICAL MIRRORS AND BRAKES; SEMI-PROCESSED AND PROCESSED CARBON COMPOSITE MATERIALS, MAINLY WITH A MATRIX OF METAL, IN THE FORM OF PROFILES, BOARDS, SHEETS, BLOCKS, RODS, TUBES, POWDERS AND PELLETS, FOR USE IN FRICTION-STRESSED PARTS (U.S. CLS. 2, 12, 13, 14, 23, 25 AND 50).

CLASS 7—MACHINERY

FOR MACHINE TOOLS AND MACHINES FOR MANUFACTURING PARTS FOR USE IN TURBOJET ENGINES, RAM JET ENGINES, PULSE JET ENGINES AND MISSILES WITH ROCKET ENGINES; MOTORS AND ENGINES OF ALL KINDS FOR FIXED OR MOBILE INSTALLATIONS EXCEPT FOR LAND VEHICLES, NAMELY, GAS TURBINE ENGINES, HEAT ENGINES, ELECTROTHERMAL ENGINES, JET ENGINES, NUCLEAR ENGINES, COMBINED PROPULSION ENGINES, ROCKET ENGINES, HYPERSONIC ENGINES, CRYOGENIC ROCKET MOTORS, ROCKET MOTORS FOR SATELLITE LAUNCHERS AND FOR BALLISTIC AND TACTICAL MISSILES, ROCKET ENGINES AND VERNIER ENGINES FOR SATELLITES; ION ENGINES, ELECTRIC ENGINES, PLASMA ENGINES, ARC JETS FOR NON-LAND VEHICLES; PLASMA SOURCES FOR PROVISION OF PLASMA BEAMS FOR CREATING, PROCESSING, ANALYZING, FORMING AND DESTROYING OF MATERIALS OR OBJECTS; THRUST REVERSERS FOR AEROPLANE ENGINES; PARTS OF THE AFORESAID MOTORS, ENGINES, THRUST REVERSERS AND PROPULSION UNITS, NAMELY, COMBUSTION CHAMBERS, PROPELLING NOZZLES, AIR INLETS, PROFILES, BOARDS, SHEETS, BLOCKS, RODS, TUBES AND PELLETS (U.S. CLS. 13, 19, 21, 23, 31, 34 AND 35).

CLASS 9—ELECTRICAL AND SCIENTIFIC APPARATUS

FOR SATELLITES (U.S. CLS. 21, 23, 26, 36 AND 38).

CLASS 11—ENVIRONMENTAL CONTROL APPARATUS

FOR ELECTRIC HEATERS FOR COMMERCIAL AND PRIVATE USE, STEAM GENERATORS, FURNACES, OVENS, MICROWAVE OVENS, INCINERATORS, NAMELY, WASTE INCINERATORS AND PARTS FOR INCINERATORS; DISTANCE PLATES AND SPACERS MADE FROM COMPOSITE MATERIALS WITH CARBON OR CERAMIC BLANKS, FOR USE IN FURNACES; THERMAL PROTECTION SYSTEMS AND HEAT PROTECTION DEVICES IN THE FORM OF SUPER STRUCTURES AND LININGS, INCLUDING HEAT SHIELDS, FOR PROPULSION AND FUSION TECHNOLOGY AND THEIR INDUSTRIAL APPLICATIONS (U.S. CLS. 13, 21, 23, 31 AND 34).

CLASS 12—VEHICLES

FOR AIRCRAFT AND SPACE VEHICLES OF ALL KINDS, INCLUDING MANNED AND UNMANNED SPACE VEHICLES; LAUNCH ROCKETS IN THE NATURE OF SPACE VEHICLES, ROCKETS FOR SPACE TRAVEL; SPACE SHUTTLES FOR SPACE TRAVEL, INCLUDING WITH HYPERSONIC ENGINES; SPACE STATIONS; BRAKING DEVICES FOR MOTOR VEHICLES, RAIL VEHICLES AND AIRCRAFT, NAMELY, BRAKE DRUMS, BRAKE LININGS, BRAKE DISCS AND BRAKE SEGMENTS (U.S. CLS. 19, 21, 23, 31, 35 AND 44).

CLASS 13—FIREARMS

FOR GUIDED AND BALLISTIC ROCKET-PROPELLED MISSILES (U.S. CLS. 2 AND 9).

CLASS 16—PAPER GOODS AND PRINTED MATTER

FOR PAMPHLETS, PERIODICALS, BROCHURES, BOOKS, IN THE FIELDS OF AEROSPACE TECHNOLOGY, COMPOSITE MATERIALS TECHNOLOGY, FURNACE AND COMBUSTION TECHNOLOGY, ENGINE TECHNOLOGY AND VEHICLE TECHNOLOGY (U.S. CLS. 2, 5, 22, 23, 29, 37, 38 AND 50).

CLASS 17—RUBBER GOODS

FOR STRUCTURED COMPOSITE MATERIALS, MAINLY WITH A MATRIX OF PLASTIC, IN THE FORM OF PROFILES, BOARDS, SHEETS, BLOCKS, RODS, TUBES, POWDER AND PELLETS, FOR USE IN SATELLITES, ROCKETS, MISSILES, OPTICAL MIRRORS AND BRAKES; CARBON COMPOSITE MATERIALS, MAINLY WITH A MATRIX OF PLASTIC, IN THE FORM OF PROFILES, BOARDS, SHEETS, BLOCKS, RODS, TUBES, POWDER AND PELLETS, FOR USE IN FRICTION-STRESSED PARTS (U.S. CLS. 1, 5, 12, 13, 35 AND 50).

CLASS 19—NON-METALLIC BUILDING MATERIALS

FOR STRUCTURED COMPOSITE MATERIALS, MAINLY WITH A CERAMIC MATRIX, IN THE FORM OF PROFILES, BOARDS, SHEETS, BLOCKS, RODS, TUBES, POWDER AND PELLETS, FOR USE IN SATELLITES, ROCKETS, MISSILES, OPTICAL MIRRORS AND BRAKES; SEMI-PROCESSED AND PROCESSED CARBON COMPOSITE MATERIALS, MAINLY WITH A CERAMIC MATRIX, IN THE FORM OF PROFILES, BOARDS, SHEETS, BLOCKS, RODS, TUBES, POWDER AND PELLETS, FOR USE IN FRICTION-STRESSED PARTS; SEMI-PROCESSED AND PROCESSED CERAMIC MATRIX COMPOSITES IN THE FORM OF PROFILES, BOARDS, SHEETS, BLOCKS, RODS, TUBES, POWDERS AND PELLETS; CERAMIC MATRIX REFRACTORY MATERIALS (U.S. CLS. 1, 12, 33 AND 50).

CLASS 37—CONSTRUCTION AND REPAIR

3,808,633. ISHRED, LLC, AVON, MA. SN 77-069,813. FILED P.R. 12-21-2006; AM. S.R. 12-31-2008.

FOR CONSTRUCTION, REPAIR AND MAINTENANCE OF AIR VEHICLES, SPACE VEHICLES, SPACE STATIONS, MISSILES, ROCKETS AND LAUNCH ROCKETS; CONSTRUCTION OF INDUSTRIAL BUILDINGS AND TEST STANDS FOR PROPULSION UNITS FOR ROCKET ENGINES; REPAIR AND SERVICING OF AEROSPACE PROPULSION UNITS; REPAIR AND SERVICING OF THE HOT PART OF FURNACES AND OTHER COMPONENTS MADE FROM HEAT-RESISTANT COMPOSITE MATERIALS, COMBUSTION CHAMBERS, ROCKET CHAMBERS, PROPELLING NOZZLES AND AIR INLETS; REPAIR AND MAINTENANCE OF FRICTION-STRESSED PARTS, NAMELY, BRAKE DRUMS, BRAKE LININGS, BRAKE DISCS AND BRAKE SEGMENTS; PROVIDING INFORMATION RELATING TO CONSTRUCTION AND REPAIR IN THE FIELDS OF AEROSPACE TECHNOLOGY, COMPOSITE MATERIALS TECHNOLOGY, FURNACE AND COMBUSTION TECHNOLOGY, ENGINE TECHNOLOGY AND VEHICLE TECHNOLOGY (U.S. CLS. 100, 103 AND 106).

Pink Crates

THE MARK CONSISTS OF STANDARD CHARACTERS WITHOUT CLAIM TO ANY PARTICULAR FONT, STYLE, SIZE, OR COLOR.

CLASS 20—FURNITURE AND ARTICLES NOT OTHERWISE CLASSIFIED

FOR PLASTIC CRATES, WOOD CRATES (U.S. CLS. 2, 13, 22, 25, 32 AND 50).
FIRST USE 12-22-2006; IN COMMERCE 2-1-2007.

CLASS 40—MATERIAL TREATMENT

FOR CREATING, PROCESSING AND FORMING PROFILES, BOARDS, SHEETS, BLOCKS, RODS, TUBES AND PELLETS OF COMPOSITE MATERIALS; HEAT TREATMENT OF COMPOSITE MATERIALS; INCINERATION OF WASTE AND RUBBISH; PHYSICO-CHEMICAL ANTI-OXIDANT AND ANTI-CORROSIVE PROTECTION TREATMENTS FOR METALLIC AND NON-METALLIC COMPOSITE MATERIALS; PROVIDING INFORMATION IN THE FIELDS OF THE AFORESAID PROTECTION TREATMENTS (U.S. CLS. 100, 103 AND 106).

CLASS 36—INSURANCE AND FINANCIAL

FOR CHARITABLE FUND RAISING (U.S. CLS. 100, 101 AND 102).
FIRST USE 12-22-2006; IN COMMERCE 2-1-2007.

CLASS 39—TRANSPORTATION AND STORAGE

FOR RENTAL OF MOVING AND STORAGE EQUIPMENT, NAMELY, CRATES, DOLLIES, CARRIERS, HAND TRUCKS, TRUCKS, VANS, AUTOMOBILES, AUTOMOBILE FREIGHT TRAILERS, HITCHES, PADS, TOW BARS, VEHICLES, MOVING VANS, MOVING BOXES, STORAGE ROOMS, STORAGE CONTAINERS, SHIPPING CONTAINERS, GENERAL STORAGE SERVICES; WAREHOUSE SPACE, STORAGE SPACE, CARGO HANDLING, MOVING VAN SERVICES, MOVING VAN TRANSPORT, DELIVERY OF GOODS BY TRUCK, CAR OR VAN (U.S. CLS. 100 AND 105).
FIRST USE 12-22-2006; IN COMMERCE 2-1-2007.

CLASS 41—EDUCATION AND ENTERTAINMENT

FOR EDUCATION AND TRAINING, NAMELY, CONDUCTING EDUCATIONAL SEMINARS IN THE FIELDS OF AEROSPACE TECHNOLOGY, COMPOSITE MATERIALS TECHNOLOGY, FURNACE AND COMBUSTION TECHNOLOGY, ENGINE TECHNOLOGY AND VEHICLE TECHNOLOGY; TRAINING SERVICES IN THE FIELDS OF AEROSPACE TECHNOLOGY, COMPOSITE MATERIALS TECHNOLOGY, FURNACE AND COMBUSTION TECHNOLOGY, ENGINE TECHNOLOGY AND VEHICLE TECHNOLOGY (U.S. CLS. 100, 101 AND 107).

3,808,637. TECHNOLOGIES COFFEA INC., QUEBEC (QUEBEC), CANADA. SN 77-346,401. FILED P.R. 12-7-2007; AM. S.R. 5-10-2010.

COFFEA

CLASS 42—SCIENTIFIC AND COMPUTER SERVICES

FOR ENGINEERING SERVICES; ENGINEERING CONSULTANCY; MATERIAL TESTING; LABORATORY, SCIENTIFIC AND INDUSTRIAL RESEARCH SERVICES IN THE FIELDS OF AEROSPACE TECHNOLOGY, COMPOSITE MATERIALS TECHNOLOGY, FURNACE AND COMBUSTION TECHNOLOGY, ENGINE TECHNOLOGY AND VEHICLE TECHNOLOGY; PROVIDING INFORMATION AND TECHNICAL INFORMATION IN THE FIELDS OF AEROSPACE TECHNOLOGY, COMPOSITE MATERIALS TECHNOLOGY, FURNACE AND COMBUSTION TECHNOLOGY, ENGINE TECHNOLOGY AND VEHICLE TECHNOLOGY (U.S. CLS. 100 AND 101).

THE MARK CONSISTS OF STANDARD CHARACTERS WITHOUT CLAIM TO ANY PARTICULAR FONT, STYLE, SIZE, OR COLOR.

PRIORITY CLAIMED UNDER SEC. 44(D) ON CANADA APPLICATION NO. 1351062, FILED 6-11-2007, REG. NO. TMA751477, DATED 10-28-2009, EXPIRES 10-28-2024.

CLASS 11—ENVIRONMENTAL CONTROL APPARATUS

FOR ELECTRIC MACHINES FOR MAKING COFFEE, CAPPUCCHINO, TEA, HERBAL TEA, HOT MILK, SOUP AND HOT CHOCOLATE (U.S. CLS. 13, 21, 23, 31 AND 34).

CLASS 40—MATERIAL TREATMENT

FOR CUSTOM MANUFACTURE OF ELECTRIC MACHINES FOR MAKING COFFEE, CAPPUCCINO, TEA, HERBAL TEA, HOT MILK, SOUP AND HOT CHOCOLATE, FOR OTHERS (U.S. CLS. 100, 103 AND 106).

3,808,640. HAUCK, BARBARA, CORONA, CA. SN 77-393,621.
FILED P.R. 2-11-2008; AM. S.R. 5-13-2010.

Plenty of Blessings

THE MARK CONSISTS OF STANDARD CHARACTERS WITHOUT CLAIM TO ANY PARTICULAR FONT, STYLE, SIZE, OR COLOR.

CLASS 16—PAPER GOODS AND PRINTED MATTER

FOR STICKERS, STICKERS FOR CAR WINDOWS, PICTURES, DECALS, DECORATIVE STICKERS, BUMPER STICKERS, PAPER BANNERS, PAPER STATIONERY, AND JOURNAL BOOKS (U.S. CLS. 2, 5, 22, 23, 29, 37, 38 AND 50).

FIRST USE 3-16-2010; IN COMMERCE 3-16-2010.

CLASS 25—CLOTHING

FOR T-SHIRTS, HATS, SWEATSHIRTS, JACKETS, HOODED SWEATSHIRTS, AND WIND-RESISTANT JACKETS (U.S. CLS. 22 AND 39).

FIRST USE 3-16-2010; IN COMMERCE 3-16-2010.

3,808,641. DURHAM, STACEY, AUSTIN, TX. SN 77-441,443.
FILED P.R. 4-7-2008; AM. S.R. 3-8-2010.

IMA GOODEGG!

THE MARK CONSISTS OF STANDARD CHARACTERS WITHOUT CLAIM TO ANY PARTICULAR FONT, STYLE, SIZE, OR COLOR.

CLASS 25—CLOTHING

FOR BABY BIBS NOT OF PAPER; BABY BODYSUITS; BASEBALL CAPS; CHILDREN'S AND INFANTS' CLOTH BIBS; CHILDREN'S CLOTH EATING BIBS; CLOTH BIBS; CREEPERS; EYESHADES; INFANT AND TODDLER ONE PIECE CLOTHING; INFANT WEAR; ONE PIECE GARMENT FOR INFANTS AND TODDLERS; SHIRTS; SHORT-SLEEVED OR LONG-SLEEVED T-SHIRTS; SOCKS (U.S. CLS. 22 AND 39).

FIRST USE 5-19-2005; IN COMMERCE 5-19-2005.

CLASS 28—TOYS AND SPORTING GOODS

FOR BALLOONS; CHILDREN'S MULTIPLE ACTIVITY TOYS SOLD AS A UNIT WITH PRINTED BOOKS; STUFFED AND PLUSH TOYS; STUFFED DOLLS AND ANIMALS (U.S. CLS. 22, 23, 38 AND 50).

FIRST USE 4-21-2006; IN COMMERCE 4-21-2006.

3,808,645. FEDERATED MEDIA PUBLISHING, INC., SAN FRANCISCO, CA. SN 77-514,081. FILED P.R. 7-2-2008;
AM. S.R. 5-13-2010.

CONVERSATIONAL MARKETING SUMMIT

THE MARK CONSISTS OF STANDARD CHARACTERS WITHOUT CLAIM TO ANY PARTICULAR FONT, STYLE, SIZE, OR COLOR.

NO CLAIM IS MADE TO THE EXCLUSIVE RIGHT TO USE "MARKETING", APART FROM THE MARK AS SHOWN.

CLASS 9—ELECTRICAL AND SCIENTIFIC APPARATUS

FOR DOWNLOADABLE PODCASTS AND WEBCASTS IN THE FIELD OF BRANDING, MARKETING, INTERNET MEDIA AND WEB SITE DEVELOPMENT (U.S. CLS. 21, 23, 26, 36 AND 38).

FIRST USE 0-0-2007; IN COMMERCE 0-0-2007.

CLASS 35—ADVERTISING AND BUSINESS

FOR BUSINESS CONSULTING AND INFORMATION SERVICES; BUSINESS MARKETING CONSULTING SERVICES; ADVERTISING, MARKETING AND PROMOTION SERVICES; BUSINESS NETWORKING; CONDUCTING TRADE SHOWS IN THE FIELDS OF ADVERTISING, ONLINE MARKETING, GENERAL BUSINESS, INTERNET BUSINESS, THE WORLDWIDE WEB AND BLOGS (U.S. CLS. 100, 101 AND 102).

FIRST USE 0-0-2007; IN COMMERCE 0-0-2007.

CLASS 41—EDUCATION AND ENTERTAINMENT

FOR EDUCATION AND ENTERTAINMENT SERVICES, NAMELY, ORGANIZING AND CONDUCTING SEMINARS, CONFERENCES, EDUCATIONAL CONVENTIONS, ROUNDTABLES AND EXHIBITIONS ALL IN THE FIELD OF BRANDING, MARKETING, INTERNET MEDIA AND WEB SITE DEVELOPMENT; PRINTED AND PRINTABLE MATERIALS DISTRIBUTED THEREWITH (U.S. CLS. 100, 101 AND 107).

FIRST USE 0-0-2007; IN COMMERCE 0-0-2007.

3,808,646. GREEN AMERICA, WASHINGTON, DC. SN 77-520,002. FILED 7-11-2008.

GREEN BUSINESS NETWORK

THE MARK CONSISTS OF STANDARD CHARACTERS WITHOUT CLAIM TO ANY PARTICULAR FONT, STYLE, SIZE, OR COLOR.

CLASS 9—ELECTRICAL AND SCIENTIFIC APPARATUS

FOR DOWNLOADABLE ELECTRONIC NEWSLETTERS IN THE FIELD OF ENVIRONMENTAL EDUCATION AND ACTIVISM, PURCHASING AND INVESTING CHOICES THAT PROMOTE SOCIAL JUSTICE AND ENVIRONMENTAL SUSTAINABILITY, HEALTHY AND SUSTAINABLE LIVING, GREEN BUILDING, ENVIRONMENTAL UPGRADES FOR THE HOME, HEALTH AND PHYSICAL FITNESS, YOGA AND MOVEMENT CLASSES, ENVIRONMENTAL FILMS, ENVIRONMENTALLY-FRIENDLY CUISINE, ORGANIC CUISINE AND BEVERAGES, FAIR TRADE CUISINE, LOCAL CUISINE AND BEVERAGES, SOCIALLY RESPONSIBLE AND VALUES-BASED INVESTING, SOCIAL AND PROFESSIONAL NETWORKING EVENTS, LOCAL FARMING, AND ENVIRONMENTALLY-FRIENDLY GOODS FOR THE HOME AND PERSON, SUSTAINABLE HOME AND PERSONAL GOODS, INCLUDING SUSTAINABLE FASHION, HEALTH PRODUCTS AND SERVICES, SOLAR PANELS, HOME UPGRADES, AND FAIRLY-TRADED GIFTS AND CRAFTS (U.S. CLS. 21, 23, 26, 36 AND 38).

FIRST USE 8-28-2004; IN COMMERCE 8-28-2004.

CLASS 35—ADVERTISING AND BUSINESS

FOR PROVIDING CONSUMER INFORMATION AND RELATED NEWS IN THE FIELD OF SOCIALLY AND ENVIRONMENTALLY RESPONSIBLE BUSINESS PRACTICES (U.S. CLS. 100, 101 AND 102).

FIRST USE 10-2-2002; IN COMMERCE 10-2-2002.

CLASS 41—EDUCATION AND ENTERTAINMENT

FOR EDUCATIONAL SERVICES, NAMELY, PROVIDING INCENTIVES TO ORGANIZATIONS AND INDIVIDUALS TO DEMONSTRATE EXCELLENCE IN THE FIELD OF SOCIAL AND ENVIRONMENTAL CONSCIOUSNESS THROUGH THE ISSUANCE OF AWARDS; PROVIDING NEWSLETTERS IN THE FIELD OF ENVIRONMENTAL EDUCATION AND ACTIVISM, PURCHASING AND INVESTING CHOICES THAT PROMOTE SOCIAL JUSTICE AND ENVIRONMENTAL SUSTAINABILITY, HEALTHY AND SUSTAINABLE LIVING, GREEN BUILDING, ENVIRONMENTAL UPGRADES FOR THE HOME, HEALTH AND PHYSICAL FITNESS, YOGA AND MOVEMENT CLASSES, ENVIRONMENTAL FILMS, ENVIRONMENTALLY-FRIENDLY CUISINE, ORGANIC CUISINE AND BEVERAGES, FAIR TRADE CUISINE, LOCAL CUISINE AND BEVERAGES, SOCIALLY RESPONSIBLE AND VALUES-BASED INVESTING, SOCIAL AND PROFESSIONAL NETWORKING EVENTS, LOCAL FARMING, AND ENVIRONMENTALLY-FRIENDLY GOODS FOR THE HOME AND PERSON, SUSTAINABLE HOME AND PERSONAL GOODS, INCLUDING SUSTAINABLE FASHION, HEALTH PRODUCTS AND SERVICES, SOLAR PANELS, HOME UPGRADES, AND FAIRLY-TRADED GIFTS

AND CRAFTS VIA E-MAIL; PROVIDING ON-LINE ELECTRONIC NEWSLETTERS IN THE FIELD OF ENVIRONMENTAL EDUCATION AND ACTIVISM, PURCHASING AND INVESTING CHOICES THAT PROMOTE SOCIAL JUSTICE AND ENVIRONMENTAL SUSTAINABILITY, HEALTHY AND SUSTAINABLE LIVING, GREEN BUILDING, ENVIRONMENTAL UPGRADES FOR THE HOME, HEALTH AND PHYSICAL FITNESS, YOGA AND MOVEMENT CLASSES, ENVIRONMENTAL FILMS, ENVIRONMENTALLY-FRIENDLY CUISINE, ORGANIC CUISINE AND BEVERAGES, FAIR TRADE CUISINE, LOCAL CUISINE AND BEVERAGES, SOCIALLY RESPONSIBLE AND VALUES-BASED INVESTING, SOCIAL AND PROFESSIONAL NETWORKING EVENTS, LOCAL FARMING, AND ENVIRONMENTALLY-FRIENDLY GOODS FOR THE HOME AND PERSON, SUSTAINABLE HOME AND PERSONAL GOODS, INCLUDING SUSTAINABLE FASHION, HEALTH PRODUCTS AND SERVICES, SOLAR PANELS, HOME UPGRADES, AND FAIRLY-TRADED GIFTS AND CRAFTS (U.S. CLS. 100, 101 AND 107).

FIRST USE 10-10-2002; IN COMMERCE 10-10-2002.

3,808,652. AMERICAN DREAMCARD, LLC, LAS VEGAS, NV. SN 77-582,605. FILED P.R. 9-30-2008; AM. S.R. 5-6-2010.

POOLED REWARDS

THE MARK CONSISTS OF STANDARD CHARACTERS WITHOUT CLAIM TO ANY PARTICULAR FONT, STYLE, SIZE, OR COLOR.

CLASS 35—ADVERTISING AND BUSINESS

FOR CONTESTS AND INCENTIVE AWARD PROGRAMS TO PROMOTE THE SALE OF PRODUCTS AND SERVICES OF OTHERS (U.S. CLS. 100, 101 AND 102).

FIRST USE 9-23-2008; IN COMMERCE 9-23-2008.

CLASS 36—INSURANCE AND FINANCIAL

FOR FINANCIAL SERVICES, NAMELY, CREDIT CARD SERVICES WHICH INCLUDE ASSOCIATED CONTESTS AND INCENTIVE PROGRAMS (U.S. CLS. 100, 101 AND 102).

FIRST USE 9-23-2008; IN COMMERCE 9-23-2008.

3,808,653. LOCAL INSIGHT MEDIA HOLDINGS, INC., ENGLEWOOD, CO. SN 77-586,714. FILED P.R. 10-7-2008; AM. S.R. 1-20-2010.

YOUR LOCAL LEADS EXPERT

THE MARK CONSISTS OF STANDARD CHARACTERS WITHOUT CLAIM TO ANY PARTICULAR FONT, STYLE, SIZE, OR COLOR.

CLASS 16—PAPER GOODS AND PRINTED MATTER

FOR PRINTED TELEPHONE DIRECTORIES (U.S. CLS. 2, 5, 22, 23, 29, 37, 38 AND 50).
FIRST USE 12-19-2009; IN COMMERCE 12-19-2009.

CLASS 35—ADVERTISING AND BUSINESS

FOR TELEPHONE DIRECTORY AND ADVERTISING SERVICES, NAMELY, PROMOTING THE GOODS AND SERVICES OF OTHERS VIA THE PREPARATION AND DISSEMINATION OF ADVERTISEMENTS AND LISTINGS AND VIA CONSULTING SERVICES RELATED THERETO, AND PLACING SUCH ADVERTISEMENTS AND LISTINGS IN PRINTED PUBLICATIONS AND DIRECTORIES, AND IN ON-LINE PUBLICATIONS AND DIRECTORIES; COMPUTER SERVICES, NAMELY, PROVIDING ON-LINE TELEPHONE DIRECTORIES VIA THE GLOBAL COMPUTER NETWORK; BUSINESS MARKETING AND DIRECT MAIL CONSULTING SERVICES (U.S. CLS. 100, 101 AND 102).

FIRST USE 3-1-2009; IN COMMERCE 3-1-2009.

CLASS 41—EDUCATION AND ENTERTAINMENT

FOR PUBLICATION OF TELEPHONE DIRECTORIES (U.S. CLS. 100, 101 AND 107).

FIRST USE 6-5-2009; IN COMMERCE 6-5-2009.

CLASS 42—SCIENTIFIC AND COMPUTER SERVICES

FOR COMPUTER SERVICES AND WEBSITE CONSULTING SERVICES, NAMELY, DESIGNING, DEVELOPING, HOSTING AND MAINTAINING THE WEBSITES OF OTHERS ON A COMPUTER SERVER FOR A GLOBAL COMPUTER NETWORK; CONSULTING AND ADVICE IN THE FIELD OF DESIGNING, DEVELOPING, HOSTING, MAINTAINING AND MANAGING ONLINE COMMERCE WEBSITES; CREATING INDEXES OF SEARCHABLE INFORMATION, WEBSITES, KEY WORDS AND OTHER RESOURCES AVAILABLE ON A GLOBAL COMPUTER NETWORK (U.S. CLS. 100 AND 101).

FIRST USE 3-1-2009; IN COMMERCE 3-1-2009.

3,808,663. THE BRITISH COMPUTER SOCIETY, SWINDON SN2 1FA, UNITED KINGDOM. SN 77-637,765. FILED P.R. 12-22-2008; AM. S.R. 3-23-2010.

CHARTERED INSTITUTE FOR IT

THE MARK CONSISTS OF STANDARD CHARACTERS WITHOUT CLAIM TO ANY PARTICULAR FONT, STYLE, SIZE, OR COLOR.

PRIORITY CLAIMED UNDER SEC. 44(D) ON ERP CMNTY TM OFC APPLICATION NO. 007443864, FILED 12-5-2008, REG. NO. 007443864, DATED 6-16-2009, EXPIRES 12-5-2018.

NO CLAIM IS MADE TO THE EXCLUSIVE RIGHT TO USE "INSTITUTE" FOR CLASSES 35, 41, AND 42 AND "IT" FOR CLASSES 16, 41, AND 42, APART FROM THE MARK AS SHOWN.

CLASS 16—PAPER GOODS AND PRINTED MATTER

FOR PRINTED MATTER, NAMELY, PRINTED INSTRUCTIONAL AND TEACHING MATERIAL IN THE FIELD OF INFORMATION TECHNOLOGY, PUBLICATIONS, NAMELY, MAGAZINES, BOOKS, WORKBOOKS IN THE FIELD OF INFORMATION TECHNOLOGY (U.S. CLS. 2, 5, 22, 23, 29, 37, 38 AND 50).

CLASS 35—ADVERTISING AND BUSINESS

FOR BUSINESS MANAGEMENT AND BUSINESS ADMINISTRATION SERVICES; RECRUITMENT SERVICES, NAMELY, PERSONNEL PLACEMENT AND RECRUITMENT; EMPLOYMENT AGENCIES SERVICES; EMPLOYMENT CONSULTANCY, NAMELY, CONSULTANCY OF PERSONNEL RECRUITMENT; EMPLOYMENT COUNSELING AND RECRUITMENT; JOB AGENCY SERVICES; PERSONNEL PLACEMENT; PERSONNEL RECRUITMENT; CONSULTANCY, INFORMATION AND ADVISORY SERVICES RELATING TO BUSINESS MANAGEMENT, BUSINESS ADMINISTRATION AND RECRUITMENT SERVICES, INCLUDING SUCH SERVICES AS PROVIDED VIA A LOCAL OR INTERNATIONAL COMPUTER NETWORK (U.S. CLS. 100, 101 AND 102).

CLASS 38—COMMUNICATION

FOR TELECOMMUNICATIONS SERVICES, NAMELY, PROVIDING TELECOMMUNICATIONS CONNECTIONS TO A GLOBAL COMPUTER NETWORK (U.S. CLS. 100, 101 AND 104).

CLASS 41—EDUCATION AND ENTERTAINMENT

FOR EDUCATION AND TRAINING SERVICES, NAMELY, CLASSES, COURSES, SEMINARS IN THE FIELD OF INFORMATION TECHNOLOGY, ORGANIZATION OF EVENTS, NAMELY, EDUCATION EXAMINATIONS, SEMINARS AND EXHIBITIONS IN THE FIELD OF INFORMATION TECHNOLOGY, ENTERTAINMENT, NAMELY, PROVIDING MOTIVATIONAL AND EDUCATIONAL SPEAKERS IN THE FIELD OF INFORMATION TECHNOLOGY, CULTURAL ACTIVITIES, NAMELY, EXHIBITIONS IN THE FIELD OF INFORMATION TECHNOLOGY (U.S. CLS. 100, 101 AND 107).

CLASS 42—SCIENTIFIC AND COMPUTER SERVICES

FOR SCIENTIFIC RESEARCH, TECHNOLOGICAL SERVICES, NAMELY, TECHNOLOGICAL CONSULTATION IN THE TECHNOLOGY FIELD OF INFORMATION TECHNOLOGY, INDUSTRIAL ANALYSIS AND RESEARCH SERVICES, NAMELY, IN THE FIELD OF INFORMATION TECHNOLOGY, DESIGN AND DEVELOPMENT OF COMPUTER HARDWARE AND SOFTWARE (U.S. CLS. 100 AND 101).

3,808,669. DIGICON CORPORATION, HERNDON, VA. SN 77-666,905. FILED P.R. 2-10-2009; AM. S.R. 5-5-2010.

VIRTUAL PRESENCE

THE MARK CONSISTS OF STANDARD CHARACTERS WITHOUT CLAIM TO ANY PARTICULAR FONT, STYLE, SIZE, OR COLOR.

NO CLAIM IS MADE TO THE EXCLUSIVE RIGHT TO USE "VIRTUAL", APART FROM THE MARK AS SHOWN.

CLASS 38—COMMUNICATION

FOR ELECTRONIC, ELECTRIC AND DIGITAL TRANSMISSION OF VOICE, DATA IMAGES, SIGNALS AND MESSAGES; TELECOMMUNICATIONS SERVICES, NAMELY, LOCAL AND LONG DISTANCE TRANSMISSION OF VOICE, DATA, GRAPHICS BY MEANS OF TELEPHONE, TELEGRAPHIC, CABLE AND SATELLITE TRANSMISSIONS (U.S. CLS. 100, 101 AND 104).

FIRST USE 8-21-2008; IN COMMERCE 11-14-2008.

CLASS 42—SCIENTIFIC AND COMPUTER SERVICES

FOR COMPUTER CONSULTING SERVICES, APPLICATION SERVICE PROVIDER, NAMELY, HOSTING COMPUTER SOFTWARE APPLICATIONS OF OTHERS; DATA WAREHOUSING; HOSTING THE INTERNET WEBSITES OF OTHERS (U.S. CLS. 100 AND 101).

FIRST USE 8-21-2008; IN COMMERCE 11-14-2008.

3,808,672. THE VASCULAR DISEASE FOUNDATION, INC., LAKEWOOD, CO. SN 77-675,124. FILED P.R. 2-20-2009; AM. S.R. 5-10-2010.

**P.A.D. PERIPHERAL ARTERIAL
DISEASE COALITION**

THE MARK CONSISTS OF STANDARD CHARACTERS WITHOUT CLAIM TO ANY PARTICULAR FONT, STYLE, SIZE, OR COLOR.

NO CLAIM IS MADE TO THE EXCLUSIVE RIGHT TO USE "COALITION", APART FROM THE MARK AS SHOWN.

CLASS 16—PAPER GOODS AND PRINTED MATTER

FOR PRINTED MATERIALS, NAMELY, EDUCATIONAL PAMPHLETS, BROCHURES, LEAFLETS, NEWSLETTERS, JOURNALS, BOOKLETS, BOOKS, REFERENCE GUIDES, AND WALL CHARTS PUBLICIZING RESEARCH, PREVENTION, DIAGNOSIS, TREATMENT AND LEGISLATION RELATING TO PERIPHERAL ARTERIAL DISEASE (U.S. CLS. 2, 5, 22, 23, 29, 37, 38 AND 50).

FIRST USE 1-15-2003; IN COMMERCE 1-4-2006.

CLASS 35—ADVERTISING AND BUSINESS

FOR ADVOCACY, NAMELY, PROMOTING THE INTERESTS OF THOSE WITH PERIPHERAL ARTERIAL DISEASE AND THOSE AFFECTED BY IT BY RAISING AWARENESS ABOUT PERIPHERAL ARTERIAL DISEASE BEFORE THE GENERAL PUBLIC, POLITICAL ENTITIES, AND HEALTH CARE PROVIDERS; PROMOTING THE INTERESTS OF THOSE CONCERNED WITH THE PREVENTION, EARLY DIAGNOSIS, TREATMENT, AND ELIMINATION OF PERIPHERAL ARTERIAL DISEASE; PROMOTING PUBLIC AWARENESS OF THE IMPORTANCE OF RESEARCH, PREVENTION, EARLY DIAGNOSIS, AND TREATMENT OF PERIPHERAL ARTERIAL DISEASE VIA MULTI MEDIA WEBSITES; PROMOTING PUBLIC AWARENESS OF RESEARCH IN THE FIELDS OF PREVENTION, EARLY DIAGNOSIS, TREATMENT AND LEGISLATION RELATING TO PERIPHERAL ARTERIAL DISEASE; CONSULTING SERVICES RELATING TO THE ADMINISTRATIVE COORDINATION OF ORGANIZATIONS TO PROVIDE AWARENESS AND EDUCATION ACTIVITIES RELATING TO PERIPHERAL ARTERIAL DISEASE; CONSULT-

ING SERVICES RELATING TO PUBLICITY; ADMINISTRATION OF MEMBERSHIP PROGRAMS FOR HEALTH CARE PROVIDERS, PROFESSIONAL SOCIETIES, AND GOVERNMENT AGENCIES, WHICH PROVIDE PARTICIPANTS WITH EDUCATIONAL AND AWARENESS RESOURCES REGARDING PERIPHERAL ARTERIAL DISEASE, A NETWORK OF HEALTHCARE PROVIDERS, AND DISCOUNTS ON PROFESSIONAL AND PATIENT RESOURCES; DISSEMINATION OF ADVERTISEMENTS RELATING TO PERIPHERAL ARTERIAL DISEASE; DISSEMINATION OF ADVERTISING FOR OTHERS VIA THE INTERNET; PROVIDING ON-LINE DIRECTORY INFORMATION SERVICES, ALSO FEATURING HYPERLINKS TO OTHER WEBSITES; DEVELOPING AND MANAGING CHARITABLE COLLECTIONS AND CHARITABLE FUNDRAISING FOR OTHERS; RETAIL STORE SERVICES AND ONLINE RETAIL STORE SERVICES FEATURING PRINTED EDUCATIONAL MATERIALS, BOOKS, DVDS, PINS, TIES, AND PROMOTIONAL GIFT ITEMS; PROVIDING A WEBSITE FEATURING INFORMATION REGARDING LEGISLATION RELATING TO PERIPHERAL ARTERIAL DISEASE (U.S. CLS. 100, 101 AND 102).

FIRST USE 3-20-2006; IN COMMERCE 3-20-2006.

CLASS 36—INSURANCE AND FINANCIAL

FOR CHARITABLE FUNDRAISING; RAISING MONEY TO SUPPORT EDUCATIONAL AND INFORMATIONAL PROGRAMS ON PERIPHERAL ARTERIAL DISEASE, AND TO SUPPORT SCIENTIFIC RESEARCH ON PERIPHERAL ARTERIAL DISEASE (U.S. CLS. 100, 101 AND 102).

FIRST USE 3-20-2006; IN COMMERCE 3-20-2006.

CLASS 41—EDUCATION AND ENTERTAINMENT

FOR EDUCATIONAL SERVICES, NAMELY, PROVIDING LECTURES, CLASSES, SEMINARS, WORKSHOPS, CONFERENCES, EDUCATIONAL PROGRAMS IN THE AREA OF PERIPHERAL ARTERIAL DISEASE; PUBLICATION OF PAMPHLETS, BROCHURES, LEAFLETS, NEWSLETTERS, JOURNALS, BOOKLETS, BOOKS, REFERENCE GUIDES, WALL CHARTS, AND OTHER PRINTED MATERIALS, ALL IN THE AREA OF PERIPHERAL ARTERIAL DISEASE; PUBLICATION OF EDUCATIONAL MATERIALS ONLINE, NAMELY, ELECTRONIC JOURNALS, NEWSLETTERS, AND NEWS ALERTS IN THE AREA OF PERIPHERAL ARTERIAL DISEASE; MULTI-MEDIA PUBLISHING SERVICES; ONLINE LIBRARY SERVICES, NAMELY, PROVIDING ELECTRONIC LIBRARY SERVICES WHICH FEATURE NEWSPAPERS, MAGAZINES, PHOTOGRAPHS AND PICTURES VIA AN ON-LINE COMPUTER NETWORK; ENTERTAINMENT SERVICES, NAMELY, ORGANIZING COMMUNITY SPORTING ACTIVITIES AND CULTURAL PROGRAMS IN SUPPORT OF PERIPHERAL ARTERIAL DISEASE AWARENESS AND RESEARCH (U.S. CLS. 100, 101 AND 107).

FIRST USE 3-20-2006; IN COMMERCE 3-20-2006.

3,808,680. BRC IP PTY LIMITED, ULTIMO SYDNEY NSW, AUSTRALIA. SN 77-747,119. FILED P.R. 5-28-2009; AM. S.R. 5-10-2010.

WEBNEURO

THE MARK CONSISTS OF STANDARD CHARACTERS WITHOUT CLAIM TO ANY PARTICULAR FONT, STYLE, SIZE, OR COLOR.

OWNER OF AUSTRALIA REG. NO. 1002771, DATED 1-4-2005, EXPIRES 5-20-2011.

CLASS 9—ELECTRICAL AND SCIENTIFIC APPARATUS

FOR COMPUTER SOFTWARE IN THE NATURE OF INTERACTIVE INDIVIDUAL ASSESSMENT SOFTWARE FOR HUMAN RESOURCE AND WORKPLACE MANAGEMENT, EVALUATION AND TESTING AND FOR PSYCHOLOGICAL TESTING; COMPUTER SOFTWARE IN THE NATURE OF CLINICAL DECISION SUPPORT SOFTWARE FOR HUMAN RESOURCE AND WORKPLACE MANAGEMENT, EVALUATION AND TESTING AND FOR PSYCHOLOGICAL TESTING (U.S. CLS. 21, 23, 26, 36 AND 38).

FIRST USE 1-28-2009; IN COMMERCE 1-28-2009.

CLASS 44—MEDICAL, BEAUTY AND AGRICULTURAL SERVICES

FOR PSYCHOLOGICAL TESTING AND EVALUATION; PSYCHOLOGICAL ASSESSMENT SERVICES IN THE NATURE OF COGNITIVE PROFILING AND TESTING (U.S. CLS. 100 AND 101).

FIRST USE 1-28-2009; IN COMMERCE 1-28-2009.

3,808,690. INNER KNOWING, INC., LOS ANGELES, CA. SN 77-778,870. FILED P.R. 7-10-2009; AM. S.R. 4-8-2010.

The Practices

THE MARK CONSISTS OF STANDARD CHARACTERS WITHOUT CLAIM TO ANY PARTICULAR FONT, STYLE, SIZE, OR COLOR.

CLASS 9—ELECTRICAL AND SCIENTIFIC APPARATUS

FOR CDS, DVDS, DOWNLOADABLE MP3 FILES, DOWNLOADABLE MP3 RECORDINGS AND DOWNLOADABLE PODCASTS IN THE FIELD OF MEDITATION AND SPIRITUALITY (U.S. CLS. 21, 23, 26, 36 AND 38).

FIRST USE 4-20-2009; IN COMMERCE 5-7-2009.

CLASS 16—PAPER GOODS AND PRINTED MATTER

FOR A SERIES OF BOOKS, WRITTEN ARTICLES, HAND-OUTS, WORK-SHEETS, IN THE FIELD OF MEDITATION AND SPIRITUALITY; PRINTED MATTER, NAMELY, PAMPHLETS, NEWS RELEASES, BROCHURES, MEDIA KITS COMPRISED OF NEWS RELEASES AND EVENT SCHEDULES, ALL IN THE FIELD OF MEDITATION AND SPIRITUALITY; PHOTOGRAPHS AND STATIONERY (U.S. CLS. 2, 5, 22, 23, 29, 37, 38 AND 50).

FIRST USE 4-20-2009; IN COMMERCE 5-7-2009.

CLASS 41—EDUCATION AND ENTERTAINMENT

FOR EDUCATION SERVICES, NAMELY, PROVIDING CLASSES, SEMINARS, PROGRAMS, WORKSHOPS, LECTURES AND DISCUSSIONS IN THE FIELD OF MEDITATION PRACTICES FOR ALL AGES; ENTERTAINMENT SERVICES, NAMELY, PROVIDING PODCASTS FEATURING MEDITATION PRACTICES FOR ALL AGES (U.S. CLS. 100, 101 AND 107).

FIRST USE 4-20-2009; IN COMMERCE 5-7-2009.

3,808,691. INNER KNOWING, INC., LOS ANGELES, CA. SN 77-778,900. FILED P.R. 7-10-2009; AM. S.R. 4-8-2010.

Stillness Sessions

THE MARK CONSISTS OF STANDARD CHARACTERS WITHOUT CLAIM TO ANY PARTICULAR FONT, STYLE, SIZE, OR COLOR.

CLASS 9—ELECTRICAL AND SCIENTIFIC APPARATUS

FOR CDS, DVDS, DOWNLOADABLE MP3 FILES, DOWNLOADABLE MP3 RECORDINGS AND DOWNLOADABLE PODCASTS IN THE FIELD OF MEDITATION AND SPIRITUALITY (U.S. CLS. 21, 23, 26, 36 AND 38).

FIRST USE 4-20-2009; IN COMMERCE 5-7-2009.

CLASS 16—PAPER GOODS AND PRINTED MATTER

FOR A SERIES OF BOOKS, WRITTEN ARTICLES, HAND-OUTS, WORK-SHEETS, IN THE FIELD OF MEDITATION AND SPIRITUALITY; PRINTED MATTER, NAMELY, PAMPHLETS, NEWS RELEASES, BROCHURES, MEDIA KITS COMPRISED OF NEWS RELEASES AND EVENT SCHEDULES, ALL IN THE FIELD OF MEDITATION AND SPIRITUALITY; PHOTOGRAPHS AND STATIONERY (U.S. CLS. 2, 5, 22, 23, 29, 37, 38 AND 50).

FIRST USE 1-6-2006; IN COMMERCE 3-6-2006.

CLASS 41—EDUCATION AND ENTERTAINMENT

FOR EDUCATION SERVICES, NAMELY, PROVIDING CLASSES, SEMINARS, PROGRAMS, WORKSHOPS, LECTURES AND DISCUSSIONS IN THE FIELD OF MEDITATION PRACTICES FOR ALL AGES; ENTERTAINMENT SERVICES, NAMELY, PROVIDING PODCASTS FEATURING MEDITATION PRACTICES FOR ALL AGES (U.S. CLS. 100, 101 AND 107).

FIRST USE 1-6-2006; IN COMMERCE 3-6-2006.

3,808,704. CENTERSTONE INSURANCE AND FINANCIAL SERVICES, INC., DBA BENEFITMALL, DALLAS, TX. SN 77-790,599. FILED P.R. 7-27-2009; AM. S.R. 4-29-2010.

HEALTHCARE EXCHANGE

THE MARK CONSISTS OF STANDARD CHARACTERS WITHOUT CLAIM TO ANY PARTICULAR FONT, STYLE, SIZE, OR COLOR.

CLASS 35—ADVERTISING AND BUSINESS

FOR INSURANCE LEAD COLLECTION AND MATCHING SERVICES, NAMELY, MATCHING CONSUMER REQUESTS FOR INSURANCE POLICY QUOTES COLLECTED OVER THE INTERNET TO PRE-QUALIFIED INSURANCE BROKERS, AGENTS AND AGENCIES (U.S. CLS. 100, 101 AND 102).

FIRST USE 5-3-2009; IN COMMERCE 7-26-2009.

CLASS 36—INSURANCE AND FINANCIAL

FOR PROVIDING AN ON-LINE COMPUTER DATABASE TO INSURANCE BROKERS, NAMELY, PROVIDING INSURANCE INFORMATION REGARDING VARIOUS FULL SERVICE INSURANCE AGENCIES AND THEIR INSURANCE PROGRAMS, BENEFITS, PRODUCTS AND SERVICES (U.S. CLS. 100, 101 AND 102).

FIRST USE 5-3-2009; IN COMMERCE 7-26-2009.

CLASS 42—SCIENTIFIC AND COMPUTER SERVICES

FOR HOSTING AN ON-LINE COMMUNITY WEB SITE FEATURING INFORMATION RELEVANT TO THE INSURANCE BROKERAGE BUSINESS (U.S. CLS. 100 AND 101).

FIRST USE 5-3-2009; IN COMMERCE 7-26-2009.

3,808,705. ABP INTERNATIONAL, INC., NEW YORK, NY. SN 77-792,975. FILED P.R. 7-30-2009; AM. S.R. 4-22-2010.

GREEN DESIGN & MANUFACTURING

THE MARK CONSISTS OF STANDARD CHARACTERS WITHOUT CLAIM TO ANY PARTICULAR FONT, STYLE, SIZE, OR COLOR.

CLASS 41—EDUCATION AND ENTERTAINMENT

FOR PROVIDING NEWSLETTERS VIA E-MAIL FOR DESIGN ENGINEERS AND ENGINEERING MANAGERS ACROSS SEVERAL INDUSTRY SECTORS WHO ARE DEVELOPING ENERGY-EFFICIENT, ENVIRONMENTALLY-FRIENDLY PRODUCTS; PROVIDING ON-LINE MAGAZINES FOR DESIGN ENGINEERS AND ENGINEERING MANAGERS ACROSS SEVERAL INDUSTRY SECTORS WHO ARE DEVELOPING ENERGY-EFFICIENT, ENVIRONMENTALLY-FRIENDLY PRODUCTS (U.S. CLS. 100, 101 AND 107).

FIRST USE 5-0-2009; IN COMMERCE 5-0-2009.

CLASS 42—SCIENTIFIC AND COMPUTER SERVICES

FOR PROVIDING A WEBSITE FEATURING INFORMATION FOR DESIGN ENGINEERS AND ENGINEERING MANAGERS ACROSS SEVERAL INDUSTRY SECTORS WHO ARE DEVELOPING ENERGY-EFFICIENT, ENVIRONMENTALLY-FRIENDLY PRODUCTS (U.S. CLS. 100 AND 101).

FIRST USE 5-0-2009; IN COMMERCE 5-0-2009.

3,808,730. TORTI GALLAS AND PARTNERS, INC., SILVER SPRING, MD. SN 77-829,838. FILED P.R. 9-18-2009; AM. S.R. 4-22-2010.

TOWN INFORMATION MODELING

THE MARK CONSISTS OF STANDARD CHARACTERS WITHOUT CLAIM TO ANY PARTICULAR FONT, STYLE, SIZE, OR COLOR.

CLASS 37—CONSTRUCTION AND REPAIR

FOR PLANNING AND LAYING OUT OF RESIDENTIAL COMMUNITIES; MASTER PLANNING AND LAYING OUT OF RESIDENTIAL COMMUNITIES (U.S. CLS. 100, 103 AND 106).

FIRST USE 5-13-2009; IN COMMERCE 5-13-2009.

CLASS 42—SCIENTIFIC AND COMPUTER SERVICES

FOR ARCHITECTURAL AND ENGINEERING SERVICES; RETAIL, OFFICE, INDUSTRIAL, HEALTH CARE, COMMUNITY, RECREATIONAL, CIVIC, INSTITUTIONAL, RELIGIOUS AND RESIDENTIAL BUILDING DESIGN SERVICES; URBAN DESIGN; URBAN PLANNING; COMMUNITY AND URBAN PLANNING, NAMELY, DEVELOPING MASTER PLANS; INFRASTRUCTURE MAPPING (U.S. CLS. 100 AND 101).

FIRST USE 5-13-2009; IN COMMERCE 5-13-2009.

3,808,733. DRAINLOCK, LLC, BAY SHORE, NY. SN 77-840,022. FILED P.R. 10-2-2009; AM. S.R. 4-20-2010.

DRAINLOCK

THE MARK CONSISTS OF STANDARD CHARACTERS WITHOUT CLAIM TO ANY PARTICULAR FONT, STYLE, SIZE, OR COLOR.

CLASS 6—METAL GOODS

FOR METAL DRAIN PIPES (U.S. CLS. 2, 12, 13, 14, 23, 25 AND 50).
FIRST USE 2-14-2000; IN COMMERCE 2-8-2001.

CLASS 11—ENVIRONMENTAL CONTROL APPARATUS

FOR PLUMBING FITTINGS, NAMELY, DRAINS (U.S. CLS. 13, 21, 23, 31 AND 34).
FIRST USE 2-14-2000; IN COMMERCE 2-8-2001.

CLASS 19—NON-METALLIC BUILDING MATERIALS

FOR NONMETALLIC CONSTRUCTION MATERIALS, NAMELY, DRAIN BASES AND GRATES (U.S. CLS. 1, 12, 33 AND 50).
FIRST USE 2-14-2000; IN COMMERCE 2-8-2001.

CLASS 21—HOUSEWARES AND GLASS

FOR DRAIN STOPPERS FOR SINKS AND DRAINS (U.S. CLS. 2, 13, 23, 29, 30, 33, 40 AND 50).
FIRST USE 2-14-2000; IN COMMERCE 2-8-2001.

3,808,741. SPA DEAL FINDER, ARVADA, CO. SN 77-870,094. FILED P.R. 11-11-2009; AM. S.R. 5-5-2010.

Spa Deal Finder

THE MARK CONSISTS OF STANDARD CHARACTERS WITHOUT CLAIM TO ANY PARTICULAR FONT, STYLE, SIZE, OR COLOR.

CLASS 16—PAPER GOODS AND PRINTED MATTER

FOR PRINTED AWARD AND GIFT CERTIFICATES AND GIFT CARDS (U.S. CLS. 2, 5, 22, 23, 29, 37, 38 AND 50).
FIRST USE 9-2-2009; IN COMMERCE 11-2-2009.

CLASS 35—ADVERTISING AND BUSINESS

FOR ADVERTISING AND MARKETING FOR HEALTH SPAS, BEAUTY SALONS, GYMS, BEAUTY, HEALTH, AND WELLNESS ESTABLISHMENTS; BUSINESS CONSULTING SERVICES FOR HEALTH SPAS, BEAUTY SALONS, GYMS, BEAUTY, HEALTH, AND WELLNESS ESTABLISHMENTS; ISSUING GIFT CERTIFICATES THAT MAY BE REDEEMED FOR OTHERS' GOODS AND SERVICES, PROMOTING THE GOODS OR SERVICES OF OTHERS BY PROVIDING HYPERTEXT LINKS TO THE WEBSITES OF OTHERS (U.S. CLS. 100, 101 AND 102).

FIRST USE 9-2-2009; IN COMMERCE 11-2-2009.

3,808,745. INNOVATIVE TAPE SOLUTIONS, INC., CHARLOTTE, NC. SN 77-878,907. FILED 11-23-2009.



THE COLOR(S) ORANGE IS/ARE CLAIMED AS A FEATURE OF THE MARK.

THE MARK CONSISTS OF A SPECIFIC SHADE OF ORANGE APPLIED TO THE ENTIRE VISIBLE SURFACE OF THE GOODS. THE REPRESENTATION OF THE GOODS SHOWN IN DOTTED LINES IS INTENDED TO SHOW THE POSITION OF THE MARK AND IS NOT A PART OF THE MARK.

CLASS 16—PAPER GOODS AND PRINTED MATTER

FOR ADHESIVE TAPES FOR STATIONERY OR HOUSEHOLD PURPOSES (U.S. CLS. 2, 5, 22, 23, 29, 37, 38 AND 50).

FIRST USE 8-0-2009; IN COMMERCE 10-0-2009.

CLASS 17—RUBBER GOODS

FOR ADHESIVE TAPE FOR INDUSTRIAL AND COMMERCIAL USE (U.S. CLS. 1, 5, 12, 13, 35 AND 50).
FIRST USE 8-0-2009; IN COMMERCE 10-0-2009.

3,808,747. PEOPLEMOVERS.COM, INC., DETROIT, MI. SN 77-884,689. FILED P.R. 12-2-2009; AM. S.R. 5-11-2010.

THE COMMUNITY NETWORK

THE MARK CONSISTS OF STANDARD CHARACTERS WITHOUT CLAIM TO ANY PARTICULAR FONT, STYLE, SIZE, OR COLOR.

NO CLAIM IS MADE TO THE EXCLUSIVE RIGHT TO USE "NETWORK", APART FROM THE MARK AS SHOWN.

CLASS 35—ADVERTISING AND BUSINESS

FOR PROVIDING A WEBSITE FEATURING NEWS IN THE FIELD OF COMMUNITY BUSINESS DEVELOPMENT AND VOLUNTEER OPPORTUNITIES (U.S. CLS. 100, 101 AND 102).

FIRST USE 9-1-2009; IN COMMERCE 9-1-2009.

CLASS 41—EDUCATION AND ENTERTAINMENT

FOR ENTERTAINMENT AND EDUCATIONAL SERVICES, NAMELY, PROVIDING AN ONGOING NEWS AND VARIETY SHOW, CLASSES, SEMINARS, AND WORKSHOPS IN THE FIELD OF VOLUNTEERING AND COMMUNITY DEVELOPMENT OVER TELEVISION, SATELLITE, RADIO AND INTERNET; PROVIDING A WEBSITE FEATURING NEWS IN THE FIELD OF COMMUNITY CULTURAL DEVELOPMENT (U.S. CLS. 100, 101 AND 107).

FIRST USE 9-1-2009; IN COMMERCE 9-1-2009.

CLASS 42—SCIENTIFIC AND COMPUTER SERVICES

FOR PROVIDING A WEBSITE THAT GIVES USERS THE ABILITY TO EXCHANGE INFORMATION IN THE FIELD OF VOLUNTEERING AND COMMUNITY DEVELOPMENT (U.S. CLS. 100 AND 101).

FIRST USE 9-1-2009; IN COMMERCE 9-1-2009.

3,808,751. ALO NETWORKS LLC, ROCKVILLE, MD. SN 77-896,933. FILED P.R. 12-18-2009; AM. S.R. 4-26-2010.

THE MOBILE HISPANIC NETWORK

THE MARK CONSISTS OF STANDARD CHARACTERS WITHOUT CLAIM TO ANY PARTICULAR FONT, STYLE, SIZE, OR COLOR.

CLASS 35—ADVERTISING AND BUSINESS

FOR TELEMARKETING IN THE NATURE OF THE DISSEMINATION, MONITORING AND CONTROL OF TARGETED ADVERTISING INFORMATION AND COMMERCIAL ANNOUNCEMENTS BY TELEPHONE (U.S. CLS. 100, 101 AND 102).

FIRST USE 7-0-2008; IN COMMERCE 7-0-2008.

CLASS 38—COMMUNICATION

FOR PROVIDING CELLULAR TELEPHONE SERVICES FOR USE IN CONJUNCTION WITH PREPAID AIRTIME CELLULAR PHONES AND DEBIT CARDS; PROVIDING MOBILE TEXT MESSAGE SERVICES TO BROADCAST ADVERTISING INFORMATION AND COMMERCIAL ANNOUNCEMENTS TO OTHERS (U.S. CLS. 100, 101 AND 104).

FIRST USE 7-0-2008; IN COMMERCE 7-0-2008.

3,808,766. BUCK KNOB PUBLISHING LLC, LOOGOOTE, IN. SN 77-922,959. FILED P.R. 1-28-2010; AM. S.R. 5-13-2010.

Hunting Fitness Magazine

THE MARK CONSISTS OF STANDARD CHARACTERS WITHOUT CLAIM TO ANY PARTICULAR FONT, STYLE, SIZE, OR COLOR.

NO CLAIM IS MADE TO THE EXCLUSIVE RIGHT TO USE "MAGAZINE", APART FROM THE MARK AS SHOWN.

CLASS 9—ELECTRICAL AND SCIENTIFIC APPARATUS

FOR ELECTRONIC PUBLICATION, NAMELY, MAGAZINE FEATURING PHYSICAL AND MENTAL PREPARATION FOR IMPROVING HUNTING PERFORMANCE RECORDED ON COMPUTER MEDIA (U.S. CLS. 21, 23, 26, 36 AND 38).

FIRST USE 5-12-2010; IN COMMERCE 5-12-2010.

CLASS 41—EDUCATION AND ENTERTAINMENT

FOR PROVIDING ON-LINE MAGAZINES IN THE FIELD OF PHYSICAL FITNESS PREPARATION FOR HUNTING PERFORMANCE (U.S. CLS. 100, 101 AND 107).

FIRST USE 5-12-2010; IN COMMERCE 5-12-2010.

3,808,767. CHEN, CHONGWEI, HANGZHOU, ZHEJIANG, CHINA. SN 77-923,053. FILED P.R. 1-28-2010; AM. S.R. 4-30-2010.

BEST RECOVERY GUARANTEE

THE MARK CONSISTS OF STANDARD CHARACTERS WITHOUT CLAIM TO ANY PARTICULAR FONT, STYLE, SIZE, OR COLOR.

CLASS 9—ELECTRICAL AND SCIENTIFIC APPARATUS

FOR COMPUTER SOFTWARE PROGRAMS AND DOWNLOADABLE SOFTWARE PROGRAMS FOR USE WITH DATA AND FILE REPAIR AND RESTORATION (U.S. CLS. 21, 23, 26, 36 AND 38).

FIRST USE 1-23-2010; IN COMMERCE 1-23-2010.

CLASS 42—SCIENTIFIC AND COMPUTER SERVICES

FOR COMPUTER SERVICES, NAMELY, DATA RESTORATION SERVICES; CUSTOMIZED COMPUTER SOFTWARE DEVELOPMENT SERVICES (U.S. CLS. 100 AND 101).
FIRST USE 1-23-2010; IN COMMERCE 1-23-2010.

* * * * *

SECTION 2.— INTERNATIONAL CLASSIFICATION

The short titles associated below with the international class numbers are terms designed merely for quick identification and are not an official part of the international classification. The full names of international classes are given in section 6.1 of the trademark rules of practice.

The designation "U.S. Cl." appearing in this section refers to the U.S. class in effect prior to Sep. 1, 1973 rather than the international class which applies to applications filed on or after that date. For adoption of international classification see notice in the OFFICIAL GAZETTE of Jun. 26, 1973 (911 O.G. TM 210).

Application in one class

CLASS 2—PAINTS

3,808,686. ASHLAND LICENSING AND INTELLECTUAL PROPERTY LLC, DUBLIN, OH. SN 77-765,747. FILED P.R. 6-23-2009; AM. S.R. 3-18-2010.

KEEP CLEAN

THE MARK CONSISTS OF STANDARD CHARACTERS WITHOUT CLAIM TO ANY PARTICULAR FONT, STYLE, SIZE, OR COLOR.

FOR WHEEL BRAKE DUST AND ROAD GRIME REPELLANT, NAMELY, CLEAR COATING PROTECTANT IN THE FORM OF NANOPARTICLES FOR VEHICLE WHEELS (U.S. CLS. 6, 11 AND 16).

FIRST USE 1-31-2009; IN COMMERCE 1-31-2009.

CLASS 3—COSMETICS AND CLEANING PREPARATIONS

3,808,682. WANZO, MIRACLE M, DBA NALA & COMPANY, VALLEJO, CA. SN 77-753,860. FILED P.R. 6-7-2009; AM. S.R. 4-19-2010.

undiewash

FOR FABRIC SOFTENERS; FABRIC SOFTENERS FOR LAUNDRY USE; LAUNDRY BLEACH; LAUNDRY DETERGENT; LAUNDRY DETERGENTS; LAUNDRY FABRIC CONDITIONER; LAUNDRY PRE-SOAK; LAUNDRY SOAP; LAUNDRY STARCH; SCENTED BODY SPRAY; SCENTED FABRIC REFRESHER SPRAY; SCENTED LINEN SPRAYS; SCENTED LINEN WATER; SCENTED ROOM SPRAYS; STAIN REMOVERS (U.S. CLS. 1, 4, 6, 50, 51 AND 52).

FIRST USE 11-2-2008; IN COMMERCE 3-1-2009.

CLASS 3—(Continued).

3,808,702. INNOVATIVE SALON PRODUCTS INC., MONROE, WA. SN 77-789,584. FILED P.R. 7-25-2009; AM. S.R. 4-28-2010.

Nourishing Oil Treatment

THE MARK CONSISTS OF STANDARD CHARACTERS WITHOUT CLAIM TO ANY PARTICULAR FONT, STYLE, SIZE, OR COLOR.

NO CLAIM IS MADE TO THE EXCLUSIVE RIGHT TO USE "OIL", APART FROM THE MARK AS SHOWN.

FOR CONDITIONERS; COSMETIC PREPARATIONS FOR BODY CARE; COSMETIC PREPARATIONS FOR THE HAIR AND SCALP; HAIR CARE PREPARATIONS; HAIR CONDITIONER; HAIR CONDITIONERS; HAIR STYLING PREPARATIONS; HAIR TONICS; NON-MEDICATED HAIR RESTORATION LOTIONS; OILS FOR HAIR CONDITIONING (U.S. CLS. 1, 4, 6, 50, 51 AND 52).

FIRST USE 9-16-2009; IN COMMERCE 9-16-2009.

3,808,720. NORTH AMERICAN MEDICAL SERVICES, INC., VANCOUVER, BC, CANADA. SN 77-800,329. FILED P.R. 8-9-2009; AM. S.R. 5-12-2010.

MANDELIC MARINE

THE MARK CONSISTS OF STANDARD CHARACTERS WITHOUT CLAIM TO ANY PARTICULAR FONT, STYLE, SIZE, OR COLOR.

OWNER OF U.S. REG. NOS. 2,293,723 AND 3,148,659.

FOR NON-MEDICATED SKIN CARE PREPARATIONS CONTAINING MANDELIC ACID AND MARINE EXTRACTS (U.S. CLS. 1, 4, 6, 50, 51 AND 52).

FIRST USE 3-1-2010; IN COMMERCE 3-1-2010.

CLASS 3—(Continued).

3,808,721. ABSOLUTE COATINGS, INC., NEW ROCHELLE, NY. SN 77-800,824. FILED P.R. 8-10-2009; AM. S.R. 5-7-2010.

PREMIUM GREEN

THE MARK CONSISTS OF STANDARD CHARACTERS WITHOUT CLAIM TO ANY PARTICULAR FONT, STYLE, SIZE, OR COLOR.

FOR WATER-BASED PAINT REMOVER (U.S. CLS. 1, 4, 6, 50, 51 AND 52).

FIRST USE 8-10-2009; IN COMMERCE 2-17-2010.

3,808,722. EVERT-FRESH CORPORATION, KATY, TX. SN 77-802,525. FILED P.R. 8-12-2009; AM. S.R. 5-10-2010.

GREEN BAG WASH

THE MARK CONSISTS OF STANDARD CHARACTERS WITHOUT CLAIM TO ANY PARTICULAR FONT, STYLE, SIZE, OR COLOR.

OWNER OF U.S. REG. NO. 2,359,179.
FOR CLEANING SOLUTION TO RESTORE REUSABLE PLASTIC BAGS, NAMELY, CLEANING PREPARATIONS (U.S. CLS. 1, 4, 6, 50, 51 AND 52).

FIRST USE 1-31-2009; IN COMMERCE 1-31-2009.

3,808,757. PHARMWEST, INC., MARINA DEL REY, CA. SN 77-907,058. FILED P.R. 1-7-2010; AM. S.R. 3-31-2010.

POLY-NEUROPEPTIDE

THE MARK CONSISTS OF STANDARD CHARACTERS WITHOUT CLAIM TO ANY PARTICULAR FONT, STYLE, SIZE, OR COLOR.

FOR AMINO ACID INGREDIENT COMPLEX SOLD AS AN INTEGRAL COMPONENT OF THE FOLLOWING, NAMELY, ANTI-AGING CREAM; ANTI-WRINKLE CREAM; BEAUTY CREAMS; BODY CREAM; COSMETIC CREAMS; COSMETIC CREAMS FOR SKIN CARE; COSMETIC PREPARATIONS FOR SKIN RENEWAL; COSMETIC PREPARATIONS FOR THE CARE OF MOUTH AND TEETH; FACE AND BODY CREAMS; FACE CREAMS; HAIR CARE CREAMS; HAIR CARE LOTIONS; HAIR CARE PREPARATIONS; HAIR CLEANING PREPARATIONS; HAIR CONDITIONERS; HAIR CREAMS; HAIR EMOLLIENTS; HAIR FIXERS; HAIR LOTIONS; HAIR NOURISHERS; HAIR OILS; HAIR POMADES; HAIR RINSES; HAIR SHAMPOO; HAIR SPRAY; HAIR STYLING GEL; HAIR STYLING SPRAY; HAIR TONICS; MEDICATED SOAP; MOUTHWASH; MOUTHWASHES;

CLASS 3—(Continued).

NON-MEDICATED BATH PREPARATIONS; NON-MEDICATED BODY SOAKS; NON-MEDICATED FOOT CREAM; NON-MEDICATED LIP CARE PREPARATIONS; NON-MEDICATED LIP PROTECTOR; NON-MEDICATED MOUTH RINSE; NON-MEDICATED MOUTH WASH AND RINSE; NON-MEDICATED MOUTHWASH AND GARGLE; NON-MEDICATED OINTMENTS FOR THE PREVENTION AND TREATMENT OF SUNBURN; NON-MEDICATED SKIN CARE PREPARATIONS; NON-MEDICATED SKIN CREAMS; NON-MEDICATED STIMULATING LOTIONS FOR THE SKIN; OIL BATHS FOR HAIR CARE; OILS FOR HAIR CONDITIONING; SKIN CARE PRODUCTS, NAMELY, NON-MEDICATED SKIN SERUM; SKIN CLEANSERS; SKIN CLEANSING LOTION; SKIN CONDITIONERS; SKIN CREAM; SKIN CREAMS IN LIQUID AND IN SOLID FORM; SKIN LOTION; SKIN MOISTURIZER; SKIN TEXTURIZERS; SKIN TONERS; TOOTH CLEANING PREPARATIONS; TOOTH GEL; TOOTH PASTE; TOOTH POLISH; TOOTH WHITENING CREAMS; TOOTH WHITENING GELS; TOOTH WHITENING PASTES; TOOTH WHITENING PREPARATIONS; TOOTHPASTE; TOOTHPASTES (U.S. CLS. 1, 4, 6, 50, 51 AND 52).

FIRST USE 5-22-2009; IN COMMERCE 5-22-2009.

CLASS 4—LUBRICANTS AND FUELS

3,808,687. RENNSPORT CLASSIC CARS LLC, SAN JOSE, CA. SN 77-769,824. FILED P.R. 6-28-2009; AM. S.R. 5-17-2010.

Better Charge

THE MARK CONSISTS OF STANDARD CHARACTERS WITHOUT CLAIM TO ANY PARTICULAR FONT, STYLE, SIZE, OR COLOR.

FOR ELECTRICAL ENERGY (U.S. CLS. 1, 6 AND 15).

FIRST USE 6-28-2009; IN COMMERCE 3-15-2010.

CLASS 5—PHARMACEUTICALS

3,808,673. MARTECH MEDICAL PRODUCTS, INC., HARLEYSVILLE, PA. SN 77-679,153. FILED P.R. 2-26-2009; AM. S.R. 5-11-2010.

SUPER SHARP NEEDLE

THE MARK CONSISTS OF STANDARD CHARACTERS WITHOUT CLAIM TO ANY PARTICULAR FONT, STYLE, SIZE, OR COLOR.

NO CLAIM IS MADE TO THE EXCLUSIVE RIGHT TO USE "NEEDLE", APART FROM THE MARK AS SHOWN, FOR NEEDLES FOR MEDICAL PURPOSES (U.S. CLS. 6, 18, 44, 46, 51 AND 52).

FIRST USE 10-30-2006; IN COMMERCE 10-30-2006.

CLASS 5—(Continued).

3,808,709. ROBERT TODD REUM, CARSON CITY, NV. SN 77-793,607. FILED P.R. 7-30-2009; AM. S.R. 4-30-2010.

GERM PROOF

THE MARK CONSISTS OF STANDARD CHARACTERS WITHOUT CLAIM TO ANY PARTICULAR FONT, STYLE, SIZE, OR COLOR.

FOR HAND SANITIZERS (U.S. CLS. 6, 18, 44, 46, 51 AND 52).
FIRST USE 4-22-2010; IN COMMERCE 4-22-2010.

3,808,717. AGROLABS, INC., HILLSIDE, NJ. SN 77-797,019. FILED P.R. 8-4-2009; AM. S.R. 4-20-2010.



THE MARK CONSISTS OF THE WORD "AÇAI" IN A HIGHLY STYLIZED FONT, POSITIONED ABOVE THE WORDS "DAILY CLEANSE" IN A STYLIZED BLOCK LETTER FONT.

FOR LIQUID NUTRITIONAL SUPPLEMENT (U.S. CLS. 6, 18, 44, 46, 51 AND 52).
FIRST USE 6-30-2009; IN COMMERCE 6-30-2009.

3,808,736. HEALTH PLUS INCORPORATED, CHINO, CA. SN 77-848,658. FILED P.R. 10-14-2009; AM. S.R. 5-4-2010.

Super Fiber Blend

THE MARK CONSISTS OF STANDARD CHARACTERS WITHOUT CLAIM TO ANY PARTICULAR FONT, STYLE, SIZE, OR COLOR.

CLASS 5—(Continued).

NO CLAIM IS MADE TO THE EXCLUSIVE RIGHT TO USE "FIBER BLEND", APART FROM THE MARK AS SHOWN.

FOR DIETARY AND NUTRITIONAL SUPPLEMENTS; DIETARY SUPPLEMENT FOR ELIMINATING TOXINS FROM THE INTESTINAL TRACT; DIETARY SUPPLEMENTS FOR HUMAN CONSUMPTION; NUTRITIONAL SUPPLEMENT FOR ELIMINATING TOXINS FROM THE INTESTINAL TRACT; ALL OF THE AFOREMENTIONED GOODS CONTAINING A FIBER BLEND (U.S. CLS. 6, 18, 44, 46, 51 AND 52).

FIRST USE 4-29-2009; IN COMMERCE 4-29-2009.

CLASS 6—METAL GOODS

3,808,769. SIMPSON STRONG-TIE COMPANY, INC., PLEASANTON, CA. SN 77-926,350. FILED 2-2-2010.

STRONG-BOLT

THE MARK CONSISTS OF STANDARD CHARACTERS WITHOUT CLAIM TO ANY PARTICULAR FONT, STYLE, SIZE, OR COLOR.

OWNER OF U.S. REG. NOS. 801,188, 3,203,436, AND OTHERS.

FOR METAL ANCHORS (U.S. CLS. 2, 12, 13, 14, 23, 25 AND 50).
FIRST USE 9-30-2008; IN COMMERCE 9-30-2008.

CLASS 7—MACHINERY

3,808,630. BURR, RICKY, DBA RICKY BURR, HUGO, MN. SN 76-700,674. FILED P.R. 12-4-2009; AM. S.R. 4-23-2010.



FOR METAL LIFT BOXES SPECIALLY FOR USE WITH FORKLIFTS (U.S. CLS. 13, 19, 21, 23, 31, 34 AND 35).

FIRST USE 1-1-2007; IN COMMERCE 1-1-2007.

CLASS 8—HAND TOOLS

CLASS 8—(Continued).

3,808,649. WAHL CLIPPER CORPORATION, STERLING, IL. SN 77-568,501. FILED P.R. 9-12-2008; AM. S.R. 1-28-2010.

AMERICA'S CLIPPER COMPANY

THE MARK CONSISTS OF STANDARD CHARACTERS WITHOUT CLAIM TO ANY PARTICULAR FONT, STYLE, SIZE, OR COLOR.

NO CLAIM IS MADE TO THE EXCLUSIVE RIGHT TO USE "CLIPPER COMPANY", APART FROM THE MARK AS SHOWN.

FOR ELECTRIC HAIR CLIPPERS AND TRIMMERS (U.S. CLS. 23, 28 AND 44).

FIRST USE 6-17-2009; IN COMMERCE 6-17-2009.

3,808,710. MARKET OF AMERICA, INC., IRVINE, CA. SN 77-793,862. FILED P.R. 7-30-2009; AM. S.R. 4-29-2010.

Laguna Cutlery

THE MARK CONSISTS OF STANDARD CHARACTERS WITHOUT CLAIM TO ANY PARTICULAR FONT, STYLE, SIZE, OR COLOR.

NO CLAIM IS MADE TO THE EXCLUSIVE RIGHT TO USE "CUTLERY", APART FROM THE MARK AS SHOWN.

FOR CUTLERY, NAMELY, KNIVES; KNIFE SHARPENERS; NON-ELECTRIC VEGETABLE PEELERS; KNIFE PROTECTORS MADE OF PLASTIC; VEGETABLE SLICERS (U.S. CLS. 23, 28 AND 44).

FIRST USE 9-2-2009; IN COMMERCE 9-2-2009.

CLASS 9—ELECTRICAL AND SCIENTIFIC APPARATUS

CLASS 9—(Continued).

3,808,650. REAL ESTATE BUSINESS SERVICES, INC., LOS ANGELES, CA. SN 77-570,145. FILED P.R. 9-15-2008; AM. S.R. 10-15-2009.

EPUBS

THE MARK CONSISTS OF STANDARD CHARACTERS WITHOUT CLAIM TO ANY PARTICULAR FONT, STYLE, SIZE, OR COLOR.

FOR DOWNLOADABLE ELECTRONIC PUBLICATIONS IN THE NATURE OF CONSUMER GUIDES FEATURING DISCLOSURES REQUIRED BY LAW, INFORMATION AND MATERIALS IN CONNECTION WITH THE PURCHASE, SALE OR LEASE OF REAL PROPERTY, IN THE FIELD OF REAL PROPERTY (U.S. CLS. 21, 23, 26, 36 AND 38).

FIRST USE 10-1-2008; IN COMMERCE 10-1-2008.

3,808,658. DISCOVERY INSTITUTE OF MEDICAL EDUCATION, INC., CHICAGO, IL. SN 77-621,955. FILED P.R. 11-25-2008; AM. S.R. 3-29-2010.

PERFORMANCE CME

THE MARK CONSISTS OF STANDARD CHARACTERS WITHOUT CLAIM TO ANY PARTICULAR FONT, STYLE, SIZE, OR COLOR.

FOR EDUCATIONAL SOFTWARE FEATURING INSTRUCTION IN THE FIELD OF MEDICINE REGARDING EFFICIENT PLANNING AND DESIGN OF TREATMENT PLANS FOR PATIENTS (U.S. CLS. 21, 23, 26, 36 AND 38).

FIRST USE 1-14-2008; IN COMMERCE 1-1-2009.

CLASS 9—(Continued).

3,808,660. ZITAN ENTERPRISES LLC, KAILUA KONA, HI. SN 77-627,998. FILED P.R. 12-6-2008; AM. S.R. 4-30-2010.

THE MARK CONSISTS OF A UNIQUELY SPELLED SINGLE WORD THAT INCLUDES A LATIN SMALL LETTER "O" WITH A MACRON OVER IT AND IS PHONETICALLY PRONOUNCED "PHONEBELT". GRAPHICALLY, THE TOP OF THE FIRST CHARACTER ("F") EXTENDS ACROSS THE TOP OF THE ENTIRE WORD AND CONNECTS WITH THE LAST LETTER ("T").

FOR CARRYING CASES FOR CELL PHONES; CASES FOR MOBILE PHONES; SPECIALTY HOLSTER FOR CARRYING MOBILE DEVICES (U.S. CLS. 21, 23, 26, 36 AND 38).

FIRST USE 3-1-2008; IN COMMERCE 6-1-2008.

3,808,668. EXÁGO, INC., SHELTON, CT. SN 77-665,176. FILED P.R. 2-6-2009; AM. S.R. 10-26-2009.

THE MARK CONSISTS OF STANDARD CHARACTERS WITHOUT CLAIM TO ANY PARTICULAR FONT, STYLE, SIZE, OR COLOR.

FOR COMPUTER SOFTWARE FOR USE IN ENTERPRISE REPORTING AND ANALYSIS AND FOR BUILDING APPLICATIONS FOR THE MANAGEMENT AND TRACKING OF DATA FOR ENTERPRISE REPORTING; COMPUTER DATABASE PROGRAMS AND DATA ACCESS COMPUTER PERIPHERALS FOR USE IN CONNECTION WITH DECISION SUPPORT, ANALYSIS, AND REPORTING PROGRAMS; COMPUTER SOFTWARE DEVELOPMENT TOOLS FOR USE IN DEVELOPING DECISION SUPPORT, ANALYSIS, AND REPORTING COMPUTER PERIPHERALS AND APPLICATIONS; COMPUTER SOFTWARE, NAMELY, CLIENT/SERVER REPORTING, ANALYSIS AND DECISION SUPPORT TOOLS; COMPUTERIZED DATABASE, REPORTING, AND ANALYSIS COMPUTER SOFTWARE FOR USE ON CORPORATE INTRANET WEB SITES; ENTERPRISE SERVER SOFTWARE FOR USE IN WEB BASED DATA PUBLISHING, REPORTING, AND ANALYSIS SOLUTIONS; COMPUTER SOFTWARE FOR ACCESSING DATABASES BY MEANS OF GLOBAL COMPUTER NETWORKS TO GENERATE REPORTS; SOFTWARE DEVELOPMENT TOOLS FOR MAKING REPORTING AND ANALYSIS AVAILABLE THROUGH GLOBAL COMPUTER NETWORK WORLDWIDE WEBSITES AND FOR EXTENDING THE FUNCTIONALITY OF ENTERPRISE REPORTING AND ANALYSIS SYSTEMS ON TO GLOBAL COMPUTER NETWORKS; AND COMPUTER SOFTWARE FOR ACCESSING AND UPDATING DATABASES THROUGH GLOBAL COMPUTER NETWORKS (U.S. CLS. 21, 23, 26, 36 AND 38).

FIRST USE 7-1-2006; IN COMMERCE 7-1-2006.

CLASS 9—(Continued).

3,808,677. FEDERAL HOME LOAN MORTGAGE CORPORATION, MCLEAN, VA. SN 77-728,216. FILED P.R. 5-4-2009; AM. S.R. 1-28-2010.

THE MARK CONSISTS OF STANDARD CHARACTERS WITHOUT CLAIM TO ANY PARTICULAR FONT, STYLE, SIZE, OR COLOR.

FOR COMPUTER SOFTWARE FOR USE IN ANALYZING MORTGAGE LOAN DATA (U.S. CLS. 21, 23, 26, 36 AND 38).

FIRST USE 10-14-2009; IN COMMERCE 10-14-2009.

3,808,683. VINAY ATHMA, DBA SPICELOOP, SUNNYVALE, CA. SN 77-753,919. FILED P.R. 6-7-2009; AM. S.R. 4-23-2010.

THE MARK CONSISTS OF STANDARD CHARACTERS WITHOUT CLAIM TO ANY PARTICULAR FONT, STYLE, SIZE, OR COLOR.

FOR COMPUTER APPLICATION SOFTWARE FOR MOBILE PHONES (U.S. CLS. 21, 23, 26, 36 AND 38).

FIRST USE 2-14-2009; IN COMMERCE 3-19-2009.

3,808,692. UBM IP LUXEMBOURG SARL, L-1723 LUXEMBOURG, LUXEMBOURG. SN 77-780,834. FILED P.R. 7-14-2009; AM. S.R. 4-25-2010.

THE MARK CONSISTS OF STANDARD CHARACTERS WITHOUT CLAIM TO ANY PARTICULAR FONT, STYLE, SIZE, OR COLOR.

NO CLAIM IS MADE TO THE EXCLUSIVE RIGHT TO USE "ON-DEMAND", APART FROM THE MARK AS SHOWN.

FOR PROVIDING PRE-RECORDED CD-ROMS, DOWNLOADABLE PRERECORDED AUDIO RECORDINGS, DOWNLOADABLE VIDEO RECORDINGS, PRE-RECORDED DOWNLOADABLE WEBINARS ALL IN THE FIELDS OF MEDICINE, NEUROLOGY AND MENTAL HEALTHCARE (U.S. CLS. 21, 23, 26, 36 AND 38).

FIRST USE 12-0-2009; IN COMMERCE 12-0-2009.

CLASS 9—(Continued).

3,808,695. CBS INTERACTIVE INC., NEW YORK, NY. SN 77-783,033. FILED P.R. 7-16-2009; AM. S.R. 4-14-2010.

VERSIONTRACKER

THE MARK CONSISTS OF STANDARD CHARACTERS WITHOUT CLAIM TO ANY PARTICULAR FONT, STYLE, SIZE, OR COLOR.

FOR DOWNLOADABLE COMPUTER SOFTWARE, NAMELY, FOR ORGANIZING AND MANAGING INVENTORY OF INSTALLED SOFTWARE AND DRIVERS AND MATCHING THE SOFTWARE AND DRIVERS TO A DATABASE VIA THE INTERNET AND FOR USE IN ENHANCING THE INSTALLATION OF SOFTWARE AND DRIVERS, NAMELY, BY PROVIDING REVIEWS AND ADVICE ON SOFTWARE AND DRIVER UPDATES, NOT FOR USE IN A HEALTHCARE FACILITY (U.S. CLS. 21, 23, 26, 36 AND 38).

FIRST USE 1-31-2000; IN COMMERCE 1-31-2000.

3,808,698. SKYLINE THINKING, LLC, WINONA, MN. SN 77-784,510. FILED P.R. 7-20-2009; AM. S.R. 4-22-2010.

Model Streaming

THE MARK CONSISTS OF STANDARD CHARACTERS WITHOUT CLAIM TO ANY PARTICULAR FONT, STYLE, SIZE, OR COLOR.

FOR COMPUTER PROGRAMS RECORDED ON DATA MEDIA (SOFTWARE) DESIGNED FOR USE IN CONSTRUCTION AND AUTOMATED MANUFACTURING (CAD/CAM) (U.S. CLS. 21, 23, 26, 36 AND 38).

FIRST USE 0-0-2009; IN COMMERCE 0-0-2009.

3,808,714. JOHN MAHASSEL, DBA DIVERSIFIED SPECIALTIES, WORDCESTER, MA. SN 77-795,689. FILED P.R. 8-3-2009; AM. S.R. 4-23-2010.

WorkPadds

THE MARK CONSISTS OF STANDARD CHARACTERS WITHOUT CLAIM TO ANY PARTICULAR FONT, STYLE, SIZE, OR COLOR.

FOR KNEE PADS FOR WORKERS (U.S. CLS. 21, 23, 26, 36 AND 38).

FIRST USE 10-1-2004; IN COMMERCE 10-1-2004.

CLASS 9—(Continued).

3,808,716. VIM VENTURE INC., LOS ANGELES, CA. SN 77-796,346. FILED P.R. 8-4-2009; AM. S.R. 5-7-2010.

LEAVES

THE MARK CONSISTS OF STANDARD CHARACTERS WITHOUT CLAIM TO ANY PARTICULAR FONT, STYLE, SIZE, OR COLOR.

FOR DOWNLOADABLE GRAPHICS FOR MOBILE PHONES (U.S. CLS. 21, 23, 26, 36 AND 38).

FIRST USE 7-26-2009; IN COMMERCE 7-26-2009.

3,808,718. WALTER HNOT, PHILLIPSBURG, NJ. SN 77-797,500. FILED P.R. 8-5-2009; AM. S.R. 4-16-2010.

Musical Hypnotherapy

THE MARK CONSISTS OF STANDARD CHARACTERS WITHOUT CLAIM TO ANY PARTICULAR FONT, STYLE, SIZE, OR COLOR.

FOR AMUSEMENT APPARATUS AND GAMES ADAPTED FOR USE WITH TELEVISION RECEIVERS OR WITH VIDEO OR COMPUTER MONITORS; AUDIO AND VIDEO RECORDINGS FEATURING SPOKEN WORD, ROCK, HIP HOP, ACOUSTIC SONGS, ELECTRIC SONGS, R AND B, NEW AGE, EXPERIMENTAL, ACTION, COMEDY, DRAMA; COMPUTER PROGRAMS RECORDED ON DATA MEDIA (SOFTWARE) DESIGNED FOR USE IN CONSTRUCTION AND AUTOMATED MANUFACTURING (CAD/CAM); DIGITAL MEDIA HUBS; DOWNLOADABLE MULTIMEDIA FILE CONTAINING ARTWORK, TEXT, AUDIO, VIDEO, GAMES; PRE-RECORDED ELECTRONIC AND DIGITAL MEDIA FEATURING SPOKEN WORD, ROCK, HIP HOP, ACOUSTIC SONGS, ELECTRIC SONGS, R AND B, NEW AGE, EXPERIMENTAL, ACTION, COMEDY, DRAMA; WEB CONSOLES; WEB SITE DEVELOPMENT SOFTWARE (U.S. CLS. 21, 23, 26, 36 AND 38).

FIRST USE 6-24-2006; IN COMMERCE 6-24-2006.

3,808,729. FORESIGHT CORPORATION, DUBLIN, OH. SN 77-823,592. FILED P.R. 9-10-2009; AM. S.R. 5-12-2010.

HIPAA Change Interpretation Guide

THE MARK CONSISTS OF STANDARD CHARACTERS WITHOUT CLAIM TO ANY PARTICULAR FONT, STYLE, SIZE, OR COLOR.

CLASS 9—(Continued).

NO CLAIM IS MADE TO THE EXCLUSIVE RIGHT TO USE "HIPAA" AND "GUIDE", APART FROM THE MARK AS SHOWN.

FOR COMPUTER SOFTWARE FOR USE IN THE HEALTHCARE FIELD THAT INTEGRATES DESCRIPTIVE AND INTERPRETIVE INFORMATION ABOUT CHANGES IN THE HIPAA (HEALTH INSURANCE PORTABILITY AND ACCOUNTABILITY ACT) FOR THE PURPOSE OF INTEGRATING E-COMMERCE ELECTRONIC TRANSACTION STANDARD VERSIONS INTO AN E-COMMERCE GUIDELINE MANAGEMENT, TESTING, AND ANALYSIS SOFTWARE PROGRAM FOR THE PURPOSE OF ON-SCREEN AND HARD-COPY DISPLAY OF THIS COMPARATIVE INFORMATION (U.S. CLS. 21, 23, 26, 36 AND 38).

FIRST USE 8-28-2009; IN COMMERCE 8-28-2009.

3,808,742. BEI COMMUNICATIONS, DBA BEI SECURITY, STAFFORD, TX. SN 77-870,264. FILED P.R. 11-11-2009; AM. S.R. 5-13-2010.

SmartFence

THE MARK CONSISTS OF STANDARD CHARACTERS WITHOUT CLAIM TO ANY PARTICULAR FONT, STYLE, SIZE, OR COLOR.

FOR BUILDING SECURITY SYSTEMS COMPRISING SOFTWARE AND HARDWARE FOR PROVIDING PICTURE, VIDEO, ALARM STATUS, BUILDING PLANS, AND OTHER INFORMATION TO A REMOTE STATION; ELECTRONIC SECURITY AND SURVEILLANCE DEVICES, NAMELY, ELECTRONIC SECURITY TAGS AND LABELS, ACOUSTIC TAGS, MAGNETIC TAGS; FIBER OPTIC CABLES; OPTICAL FIBER CABLES (U.S. CLS. 21, 23, 26, 36 AND 38).

FIRST USE 2-1-2003; IN COMMERCE 2-1-2003.

3,808,773. ACCOUNTABILITY TOOLS, LLC., FT. LAUDERDALE, FL. SN 77-928,196. FILED P.R. 2-4-2010; AM. S.R. 5-11-2010.

Accountability Tools

THE MARK CONSISTS OF STANDARD CHARACTERS WITHOUT CLAIM TO ANY PARTICULAR FONT, STYLE, SIZE, OR COLOR.

NO CLAIM IS MADE TO THE EXCLUSIVE RIGHT TO USE "TOOLS", APART FROM THE MARK AS SHOWN.

FOR INTERNET MONITORING AND SURVEILLANCE SOFTWARE (U.S. CLS. 21, 23, 26, 36 AND 38).

FIRST USE 2-15-2010; IN COMMERCE 2-15-2010.

CLASS 9—(Continued).

3,808,776. VARDAMAN, PASADENA, TX. SN 77-929,639. FILED P.R. 2-5-2010; AM. S.R. 5-11-2010.

INDUSTRIAL STATUS VIEWER

THE MARK CONSISTS OF STANDARD CHARACTERS WITHOUT CLAIM TO ANY PARTICULAR FONT, STYLE, SIZE, OR COLOR.

FOR COMPUTER SOFTWARE FOR INDUSTRIAL PLANNING, SCHEDULING, AND LOGISTIC MONITORING, NAMELY, SOFTWARE FOR TRACKING, LOGGING, INTEGRATING AND VIEWING INDUSTRIAL EQUIPMENT MAINTENANCE INFORMATION, INDUSTRIAL EQUIPMENT SAFETY INFORMATION, AND INDUSTRIAL EQUIPMENT PERSONNEL AVAILABILITY AND MOVEMENT (U.S. CLS. 21, 23, 26, 36 AND 38).

FIRST USE 11-7-2008; IN COMMERCE 2-1-2009.

3,808,780. RAYSPAN CORPORATION, SAN DIEGO, CA. SN 77-955,973. FILED 3-10-2010.

MTM

THE MARK CONSISTS OF STANDARD CHARACTERS WITHOUT CLAIM TO ANY PARTICULAR FONT, STYLE, SIZE, OR COLOR.

FOR AMPLIFIER FOR WIRELESS COMMUNICATIONS; ANTENNAE FILTERS; ANTENNAS; ANTENNAS FOR RADIO, FOR TELEVISION; ANTENNAS FOR WIRELESS COMMUNICATIONS APPARATUS; COMPUTER HARDWARE, NAMELY, WIRELESS ACCESS POINT (WAP) DEVICES; DEVICES FOR WIRELESS RADIO TRANSMISSION; INTEGRATED CIRCUITS AND INTEGRATED CIRCUIT CORES FOR USE IN WIRELESS COMMUNICATIONS AND WIRELESS COMMUNICATION EQUIPMENT AND APPARATUS AND DIGITAL SIGNAL PROCESSORS (DSP); MICROWAVE ANTENNAE; WIRELESS TELEPHONES; WIRELESS TELEPHONY APPARATUS (U.S. CLS. 21, 23, 26, 36 AND 38).

FIRST USE 4-0-2006; IN COMMERCE 4-0-2006.

CLASS 10—MEDICAL APPARATUS

CLASS 10—(Continued).

3,808,666. BIOLOGICS, INC., CLEARWATER, FL. SN 77-652,493. FILED P.R. 1-20-2009; AM. S.R. 4-28-2010.

FLUID IMMERSION SIMULATION

THE MARK CONSISTS OF STANDARD CHARACTERS WITHOUT CLAIM TO ANY PARTICULAR FONT, STYLE, SIZE, OR COLOR.

FOR MATTRESS FOR MEDICAL USE (U.S. CLS. 26, 39 AND 44).

FIRST USE 12-31-2000; IN COMMERCE 12-31-2000.

CLASS 11—ENVIRONMENTAL CONTROL APPARATUS

3,808,655. SALT CITY CANDLE COMPANY, INC., WEST JORDAN, UT. SN 77-609,081. FILED P.R. 11-6-2008; AM. S.R. 3-23-2010.

MELTER TOWER

THE MARK CONSISTS OF STANDARD CHARACTERS WITHOUT CLAIM TO ANY PARTICULAR FONT, STYLE, SIZE, OR COLOR.

FOR ELECTRIC WARMERS FOR MELTING FRAGRANT WAX (U.S. CLS. 13, 21, 23, 31 AND 34).

FIRST USE 7-1-2008; IN COMMERCE 7-1-2008.

CLASS 12—VEHICLES

3,808,662. TECH M3, INC., ESCONDIDO, CA. SN 77-634,260. FILED P.R. 12-16-2008; AM. S.R. 4-29-2010.

ATOMIC-FORGED

THE MARK CONSISTS OF STANDARD CHARACTERS WITHOUT CLAIM TO ANY PARTICULAR FONT, STYLE, SIZE, OR COLOR.

FOR BRAKE PADS, BRAKE ROTORS FOR LAND VEHICLES, MOUNTING BOLTS FOR LAND VEHICLE BRAKE ROTORS, FRICTION RINGS FOR LAND VEHICLE BRAKE ROTORS AND BUTTONS FOR LAND VEHICLE BRAKE ROTORS (U.S. CLS. 19, 21, 23, 31, 35 AND 44).

FIRST USE 2-7-2009; IN COMMERCE 2-7-2009.

CLASS 16—PAPER GOODS AND PRINTED MATTER

3,808,701. ELAM, KEITH R., SPRINGFIELD, OR. SN 77-787,032. FILED P.R. 7-22-2009; AM. S.R. 4-21-2010.

HEMP PUBLISHING COMPANY

THE MARK CONSISTS OF STANDARD CHARACTERS WITHOUT CLAIM TO ANY PARTICULAR FONT, STYLE, SIZE, OR COLOR.

NO CLAIM IS MADE TO THE EXCLUSIVE RIGHT TO USE "PUBLISHING COMPANY", APART FROM THE MARK AS SHOWN.

FOR PRINTED MATTER, NAMELY, BOOKS, PAMPHLETS, AND POSTERS IN THE FIELD OF RELIGION AND PHILOSOPHY (U.S. CLS. 2, 5, 22, 23, 29, 37, 38 AND 50).

FIRST USE 4-8-2010; IN COMMERCE 4-8-2010.

3,808,758. SHELF TALKER PUBLICATIONS INC, NEW YORK, NY. SN 77-908,960. FILED P.R. 1-11-2010; AM. S.R. 5-13-2010.

Wine Reporter

THE MARK CONSISTS OF STANDARD CHARACTERS WITHOUT CLAIM TO ANY PARTICULAR FONT, STYLE, SIZE, OR COLOR.

NO CLAIM IS MADE TO THE EXCLUSIVE RIGHT TO USE "REPORTER", APART FROM THE MARK AS SHOWN.

FOR MAGAZINES IN THE FIELD OF WINE (U.S. CLS. 2, 5, 22, 23, 29, 37, 38 AND 50).

FIRST USE 1-1-2000; IN COMMERCE 1-1-2000.

3,808,764. MOSS ADAMS LLP, SANTA ROSA, CA. SN 77-921,754. FILED 1-27-2010.

Wine Industry Financial Benchmarking Report

THE MARK CONSISTS OF STANDARD CHARACTERS WITHOUT CLAIM TO ANY PARTICULAR FONT, STYLE, SIZE, OR COLOR.

NO CLAIM IS MADE TO THE EXCLUSIVE RIGHT TO USE "FINANCIAL BENCHMARKING REPORT", APART FROM THE MARK AS SHOWN.

FOR RESEARCH REPORTS FEATURING OPERATING AND FINANCIAL TRENDS IN THE WINE INDUSTRY (U.S. CLS. 2, 5, 22, 23, 29, 37, 38 AND 50).

FIRST USE 1-13-2010; IN COMMERCE 1-13-2010.

CLASS 16—(Continued).

3,808,785. BELO INTERACTIVE, INC., DALLAS, TX. SN 77-979,556. FILED P.R. 1-28-2008; AM. S.R. 5-5-2010.



NO CLAIM IS MADE TO THE EXCLUSIVE RIGHT TO USE "HS GAME", APART FROM THE MARK AS SHOWN.

THE MARK CONSISTS OF THE CAPITAL LETTERS "H" AND "S" AND THE WORDS "GAME TIME" WHICH OVERLAP THE CAPITAL LETTER "S". THE WORD "TIME" IS DIRECTLY UNDERNEATH THE WORD "GAME" AND THE ENTIRE MARK IS SLANTED DIAGONALLY.

FOR RECURRING NEWSPAPER SECTION ON THE SUBJECT OF SPORTS (U.S. CLS. 2, 5, 22, 23, 29, 37, 38 AND 50).

FIRST USE 8-30-2007; IN COMMERCE 8-30-2007.

CLASS 19—NON-METALLIC BUILDING MATERIALS

3,808,699. KITCHENRITE, LLC, DBA THE COUNTERTOP SHOP, SARASOTA, FL. SN 77-786,373. FILED P.R. 7-21-2009; AM. S.R. 4-19-2010.

StoneCovers

THE MARK CONSISTS OF STANDARD CHARACTERS WITHOUT CLAIM TO ANY PARTICULAR FONT, STYLE, SIZE, OR COLOR.

FOR BUILDING MATERIALS, NAMELY, NON-METAL COUNTERTOPS FOR FURTHER INSTALLATION; NONSTRUCTURAL BUILDING MATERIALS, NAMELY, GRANITE USED IN DECORATIVE SURFACE APPLICATIONS FOR COUNTERTOPS AND VANITY TOPS; ROCK MATERIALS USED IN THE MANUFACTURE OF FLOORING, ROOFING, COUNTERTOPS, WALLS, CLADDING AND FIREPLACES (U.S. CLS. 1, 12, 33 AND 50).

FIRST USE 7-7-2009; IN COMMERCE 7-17-2009.

CLASS 17—RUBBER GOODS

3,808,743. UNITED STATES GYPSUM COMPANY, CHICAGO, IL. SN 77-872,360. FILED 11-13-2009.



THE COLOR(S) PURPLE IS/ARE CLAIMED AS A FEATURE OF THE MARK.

THE MARK CONSISTS OF THE COLOR PURPLE AS APPLIED TO THE WHOLE VISIBLE SURFACE OF THE LID OF THE PAIL AS SHOWN. THE MARK CONSISTS OF THE COLOR PURPLE ONLY INSOFAR AS THE COLOR IS APPLIED TO THE PACKAGING OF THE GOODS, BUT NOT THE ACTUAL GOODS THEMSELVES. THE DOTTED LINES IN THE DRAWING ARE SOLELY TO SHOW THE POSITION OF THE MARK ON THE PACKAGING AND ARE NOT PART OF THE MARK.

FOR DRYWALL JOINT COMPOUND (U.S. CLS. 1, 5, 12, 13, 35 AND 50).

FIRST USE 12-31-1997; IN COMMERCE 12-31-1997.

CLASS 21—HOUSEWARES AND GLASS

3,808,754. LEAFWARE LLC, FOLSOM, CA. SN 77-901,576. FILED P.R. 12-28-2009; AM. S.R. 4-23-2010.

LEAFWARE

THE MARK CONSISTS OF STANDARD CHARACTERS WITHOUT CLAIM TO ANY PARTICULAR FONT, STYLE, SIZE, OR COLOR.

FOR DINNERWARE; DINNERWARE, NAMELY, PLATES, BOWLS, AND SERVING TRAYS; DISHES AND PLATES; DISPOSABLE DINNERWARE, NAMELY, PLATES, BOWLS, AND SERVING TRAYS; SERVING TRAYS (U.S. CLS. 2, 13, 23, 29, 30, 33, 40 AND 50).

FIRST USE 11-16-2009; IN COMMERCE 11-16-2009.

CLASS 24—FABRICS

CLASS 24—(Continued).

3,808,782. SHAVEL ASSOCIATES INC., DBA SHAVEL HOME PRODUCTS, PRINCETON, NJ. SN 77-977,108. FILED P.R. 6-30-2008; AM. S.R. 10-23-2009.

MICRO FLANNEL

THE MARK CONSISTS OF STANDARD CHARACTERS WITHOUT CLAIM TO ANY PARTICULAR FONT, STYLE, SIZE, OR COLOR.

NO CLAIM IS MADE TO THE EXCLUSIVE RIGHT TO USE "FLANNEL", APART FROM THE MARK AS SHOWN. FOR BEDDING MADE OF FLANNEL FABRIC, NAMELY, BED LINEN AND BED SHEETS (U.S. CLS. 42 AND 50).

FIRST USE 10-27-2008; IN COMMERCE 10-27-2008.

CLASS 25—(Continued).

3,808,628. ARTHEIA E. DINGLE, UPPER MARLBORO, MD. AND CORETTA DINGLE, UPPER MARLBORO, MD. SN 76-694,334. FILED P.R. 11-19-2008; AM. S.R. 5-6-2010.

Please let me sleep
on my back.

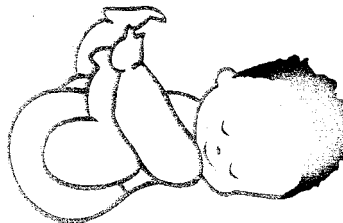

FOR INFANT APPAREL, NAMELY, SHIRTS AND BODYSUITS (U.S. CLS. 22 AND 39).

FIRST USE 12-12-2008; IN COMMERCE 12-12-2008.

3,808,634. WILKINSON, JOHN, GRAND JUNCTION, CO. SN 77-219,693. FILED P.R. 6-29-2007; AM. S.R. 12-29-2008.

CLASS 25—CLOTHING

3,808,627. WHACK, JOSEPH, DBA URBAN ENTERPRISES, PHILADELPHIA, PA. SN 76-673,763. FILED P.R. 3-8-2007; AM. S.R. 5-14-2010.



THE MARK CONSISTS OF A DESIGN OF A FLAME WITH A SKATEBOARD IN THE MIDDLE AND THE LETTERS "US" TO THE RIGHT OF THE DESIGN.

FOR APPAREL, NAMELY, SHIRTS, TEE-SHIRTS (U.S. CLS. 22 AND 39).

FIRST USE 12-15-2008; IN COMMERCE 7-14-2009.

Heretic T-Shirts

THE MARK CONSISTS OF STANDARD CHARACTERS WITHOUT CLAIM TO ANY PARTICULAR FONT, STYLE, SIZE, OR COLOR.

NO CLAIM IS MADE TO THE EXCLUSIVE RIGHT TO USE "T-SHIRTS", APART FROM THE MARK AS SHOWN. FOR T-SHIRTS (U.S. CLS. 22 AND 39).

FIRST USE 3-11-2008; IN COMMERCE 4-19-2008.

3,808,647. CUPP, TRAVIS, KNOVILLE, TN. SN 77-542,554. FILED P.R. 8-8-2008; AM. S.R. 5-5-2010.

CAGE KILLER

THE MARK CONSISTS OF STANDARD CHARACTERS WITHOUT CLAIM TO ANY PARTICULAR FONT, STYLE, SIZE, OR COLOR.

FOR CLOTHING, NAMELY, T-SHIRTS, CAPS (U.S. CLS. 22 AND 39).

FIRST USE 4-21-2009; IN COMMERCE 4-21-2009.

CLASS 25—(Continued).

3,808,674. 100MC, LLC, LARKSPUR, CA. SN 77-693,018. FILED P.R. 3-17-2009; AM. S.R. 5-10-2010.

THE BEST TEE SHIRT IN THE WORLD

THE MARK CONSISTS OF STANDARD CHARACTERS WITHOUT CLAIM TO ANY PARTICULAR FONT, STYLE, SIZE, OR COLOR.

NO CLAIM IS MADE TO THE EXCLUSIVE RIGHT TO USE "TEE SHIRT", APART FROM THE MARK AS SHOWN. FOR CLOTHING, NAMELY, MEN'S, WOMEN'S AND CHILDREN'S SHIRTS AND TOPS (U.S. CLS. 22 AND 39). FIRST USE 4-12-2010; IN COMMERCE 4-12-2010.

3,808,777. MEESH CLOTHING COMPANY LLC, TROY, MI. SN 77-930,902. FILED P.R. 2-8-2010; AM. S.R. 5-10-2010.

Meesh

THE MARK CONSISTS OF STANDARD CHARACTERS WITHOUT CLAIM TO ANY PARTICULAR FONT, STYLE, SIZE, OR COLOR.

FOR WEARABLE GARMENTS AND CLOTHING, NAMELY, SHIRTS (U.S. CLS. 22 AND 39). FIRST USE 6-20-2006; IN COMMERCE 2-1-2010.

3,808,783. RETAIL LICENSING COMPANY, LAS VEGAS, NV. SN 77-979,031. FILED P.R. 6-11-2008; AM. S.R. 5-13-2010.

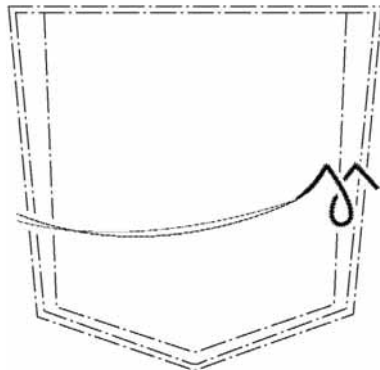

THE MARK CONSISTS OF A POCKET STITCH DESIGN. FOR CLOTHING, NAMELY, SKIRTS, SHORTS, PANTS, AND JEANS (U.S. CLS. 22 AND 39). FIRST USE 7-0-2007; IN COMMERCE 7-0-2007.

CLASS 25—(Continued).

3,808,784. RETAIL LICENSING COMPANY, LAS VEGAS, NV. SN 77-979,113. FILED P.R. 6-10-2008; AM. S.R. 5-13-2010.

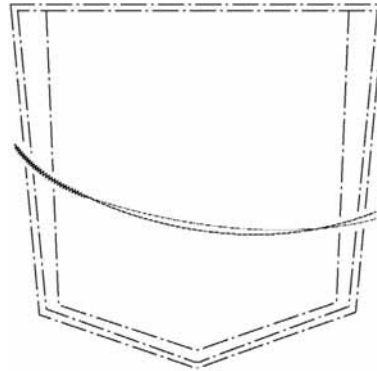

THE MARK CONSISTS OF A POCKET STITCH DESIGN. FOR CLOTHING, NAMELY, SKIRTS, SHORTS, PANTS, AND JEANS (U.S. CLS. 22 AND 39). FIRST USE 7-0-2007; IN COMMERCE 7-0-2007.

CLASS 28—TOYS AND SPORTING GOODS

3,808,642. ALDILA, INC., POWAY, CA. SN 77-450,094. FILED P.R. 4-16-2008; AM. S.R. 1-20-2010.

THE COLOR(S) GREEN IS/ARE CLAIMED AS A FEATURE OF THE MARK.

THE MARK CONSISTS OF THE COLOR GREEN APPLIED TO THE ENTIRE SURFACE OF A GOLF CLUB SHAFT. THE DOTTED LINES ARE INTENDED TO SHOW THE POSITION OF THE MARK AND ARE NOT PART OF THE MARK AS SHOWN.

FOR GOLF CLUB SHAFTS (U.S. CLS. 22, 23, 38 AND 50). FIRST USE 6-5-2003; IN COMMERCE 6-5-2003.

3,808,689. MAUI TOYS, INC., YOUNGSTOWN, OH. SN 77-778,863. FILED P.R. 7-10-2009; AM. S.R. 4-14-2010.

WATER BOUNCER

THE MARK CONSISTS OF STANDARD CHARACTERS WITHOUT CLAIM TO ANY PARTICULAR FONT, STYLE, SIZE, OR COLOR.

FOR BOUNCE BALLS FILLED WITH FLUID (U.S. CLS. 22, 23, 38 AND 50). FIRST USE 12-31-2008; IN COMMERCE 12-31-2008.

CLASS 28—(Continued).

3,808,750. LANDSCAPE STRUCTURES, INC., DELANO, MN.
SN 77-894,840. FILED P.R. 12-16-2009; AM. S.R. 5-5-2010.

SENSORY PLAY CENTER

THE MARK CONSISTS OF STANDARD CHARACTERS WITHOUT CLAIM TO ANY PARTICULAR FONT, STYLE, SIZE, OR COLOR.

NO CLAIM IS MADE TO THE EXCLUSIVE RIGHT TO USE "PLAY CENTER", APART FROM THE MARK AS SHOWN.

FOR PLAYGROUND EQUIPMENT, NAMELY, ACTIVITY PANELS (U.S. CLS. 22, 23, 38 AND 50).

FIRST USE 10-1-2009; IN COMMERCE 10-1-2009.

3,808,786. SEC - SPORTS EQUIPMENT CANADA INC.,
LANGLEY, CANADA. SN 78-935,274. FILED P.R. 7-21-
2006; AM. S.R. 4-22-2010.

ULTIMATE SPORTS EQUIPMENT

THE MARK CONSISTS OF STANDARD CHARACTERS WITHOUT CLAIM TO ANY PARTICULAR FONT, STYLE, SIZE, OR COLOR.

PRIORITY CLAIMED UNDER SEC. 44(D) ON CANADA APPLICATION NO. 1290610, FILED 2-20-2006, REG. NO. TMA735.301, DATED 2-26-2009, EXPIRES 2-26-2024.

PRIORITY CLAIMED UNDER SEC. 44(D) ON CANADA APPLICATION NO. 1309961, FILED 7-20-2006, REG. NO. TMA745.092, DATED 8-12-2009, EXPIRES 8-12-2024.

NO CLAIM IS MADE TO THE EXCLUSIVE RIGHT TO USE "SPORTS EQUIPMENT", APART FROM THE MARK AS SHOWN.

FOR SPORTING GOODS, NAMELY, AEROBIC STEPS, WEIGHTED EXERCISE BALLS, TONING TUBES, JUMP ROPES, DUMBBELLS, BARBELLS, BOXING GLOVES, SKIPPING ROPES, BAGS FOR BOXING, MOUTH GUARDS FOR ATHLETIC USE, ATHLETIC TAPE, ATHLETIC SUPPORTERS, FOR WEIGHT LIFTING; AEROBIC STEP MACHINES; ATHLETIC EQUIPMENT, NAMELY, HAND WRAPS; ANKLE AND WRIST WEIGHTS FOR EXERCISE; ATHLETIC EQUIPMENT, NAMELY, STRIKING BAGS AND STRIKING SHIELDS; BACKBOARDS FOR BASKETBALL; BALANCE BEAMS FOR GYMNASTICS; BOXING SPEED BAGS; DUMBBELL SETS; DUMB-BELL SHAFTS FOR WEIGHT LIFTING; ELLIPTICAL EXERCISE MACHINES; EPEE; EXERCISE AND GYMNASTIC BANNERS; EXERCISE BALLS; EXERCISE BARS, NAMELY, PUSH-UP BARS; EXERCISE EQUIPMENT, NAMELY, ABDOMINAL BOARDS, EXERCISE RING MADE OF RUBBER FOR USE IN THE PRACTICE OF PILATES; CHEST PULLS, NAMELY, YOGA STRAPS AND YOGA BLOCKS; EXERCISE BALLS, NAMELY, MEDICINE BALLS AND SPEED BALLS; EXERCISE BARS; EXERCISE BENCHES; EXERCISE DOORWAY GYM BARS; EXERCISE EQUIPMENT FOR LATERAL MOVEMENT IN A SKATING MOTION; EXERCISE EQUIPMENT, NAMELY, MANUALLY OPERATED JOGGING MACHINES, ROWING MACHINES, STAIR-STEPPING MACHINES, STATIONARY CYCLES, ABDOMINAL BOARDS, CHEST EXPANDERS, CHEST PULLS AND SHOULDER STRETCHER USING RESISTANCE CABLES; EXERCISE PLATFORMS;

CLASS 28—(Continued).

EXERCISE TRAMPOLINES; EXERCISE TREADMILLS; EXERCISE WEIGHT CUFFS; EXERCISE WEIGHTS; EXERCISING EQUIPMENT, NAMELY, POWERED TREADMILLS FOR RUNNING, PULLEYS AND WEIGHT LIFTING MACHINES; GYMNASTIC APPARATUS; HANDLE GRIPS FOR SPORTING EQUIPMENT; KARATE GLOVES; KARATE HEAD GUARDS; KARATE KICK PADS; KARATE SHIN PADS; KARATE TARGET PADS; NEEDLES FOR PUMPS FOR INFLATING SPORTS EQUIPMENT; PUMPS FOR INFLATING SPORTS EQUIPMENT, NAMELY, BASKETBALLS, FOOTBALLS AND VOLLEYBALLS; PERSONAL EXERCISE MATS, NAMELY, YOGA MATS; PUNCHING MITTS, NAMELY, BOXING GLOVES; SPORTING GOODS AND EQUIPMENT FOR SPEED TRAINING, NAMELY, RINGS, CONES, SPEED LADDERS, COACHING STICKS, TRAINING ARCHES, ANKLE BANDS, RESISTANCE CHUTES, HURDLES; SPORTS EQUIPMENT FOR BOXING, MARTIAL ARTS, AND THE LIKE, NAMELY, PROTECTIVE BRAS; SPORTS EQUIPMENT, NAMELY, NORDIC WALKING POLES; WEIGHT LIFTING BELTS; WEIGHT LIFTING BENCHES AND BENCH ACCESSORIES; WORK-OUT GLOVES (U.S. CLS. 22, 23, 38 AND 50).

CLASS 29—MEATS AND PROCESSED FOODS

3,808,665. IBITTA ENTERPRISES, INC., DBA NATURAL AND HEALTHY PRODUCTS, SHERMAN OAKS, CA. SN 77-648,267. FILED P.R. 1-13-2009; AM. S.R. 4-19-2010.

KAKTY

THE MARK CONSISTS OF STANDARD CHARACTERS WITHOUT CLAIM TO ANY PARTICULAR FONT, STYLE, SIZE, OR COLOR.

FOR SPECIALLY PROCESSED LEAF, VEGETABLE-BASED SNACK FOODS (U.S. CL. 46).

FIRST USE 11-3-2008; IN COMMERCE 11-3-2008.

3,808,678. ALTINEGE TBB GIDA TEKSTIL SAN. VE TIC. LTD. STI., SEFERIHISAR/IZMIR, TURKEY. SN 77-731,055. FILED P.R. 5-7-2009; AM. S.R. 9-16-2009.

EGELI

THE MARK CONSISTS OF STANDARD CHARACTERS WITHOUT CLAIM TO ANY PARTICULAR FONT, STYLE, SIZE, OR COLOR.

THE ENGLISH TRANSLATION OF THE WORD "EGELI" IN THE MARK IS "GOODS FROM AEGEAN".

FOR OLIVE OIL (U.S. CL. 46).

FIRST USE 5-20-2009; IN COMMERCE 5-20-2009.

CLASS 29—(Continued).

3,808,744. WISCONSIN CHEESE COMPANY LLC,
STOUGHTON, WI. SN 77-878,492. FILED 11-23-2009.



NO CLAIM IS MADE TO THE EXCLUSIVE RIGHT TO USE "CHEESE COMPANY" AND "CHEESE", APART FROM THE MARK AS SHOWN.

THE MARK CONSISTS OF THE STYLIZED WORDS "WISCONSIN CHEESE COMPANY" IN WHICH EACH WORD APPEARS ON A SEPARATE LINE AND EACH LETTER IS PARTICULARLY SHADED SO AS TO CREATE THE ILLUSION THAT IT IS THREE-DIMENSIONAL, ALL PLACED TO THE LEFT OF A MAP OF THE STATE OF WISCONSIN THAT IS SOLIDLY FILLED EXCEPT FOR THE STYLIZED WORDS "100% WISCONSIN CHEESE", THE LETTERS OF WHICH ARE UNIQUELY POSITIONED SO THE WORDS APPEAR TO FLOW IN A NON-LINEAR, RIBBON-LIKE MANNER.

FOR CHEESE (U.S. CL. 46).

FIRST USE 3-18-2009; IN COMMERCE 3-18-2009.

3,808,756. NEBRASKA FINEST MEATS, LLC, RANDOLPH,
NE. SN 77-902,865. FILED P.R. 12-30-2009; AM. S.R. 5-7-
2010.

NEBRASKA'S FINEST MEATS

THE MARK CONSISTS OF STANDARD CHARACTERS WITHOUT CLAIM TO ANY PARTICULAR FONT, STYLE, SIZE, OR COLOR.

NO CLAIM IS MADE TO THE EXCLUSIVE RIGHT TO USE "MEATS", APART FROM THE MARK AS SHOWN.

FOR BEEF; BEEF PATTIES; HAMBURGER; MEAT; MEAT, FROZEN; PROCESSED MEAT; UNCOOKED HAMBURGER PATTIES (U.S. CL. 46).

FIRST USE 2-1-2006; IN COMMERCE 2-1-2006.

CLASS 30—STAPLE FOODS**CLASS 30—(Continued).**

3,808,675. TASTY BITES OF WISCONSIN, LLC, APPLETON,
WI. SN 77-697,600. FILED P.R. 3-24-2009; AM. S.R. 1-14-2010.

Tastee Bites

THE MARK CONSISTS OF STANDARD CHARACTERS WITHOUT CLAIM TO ANY PARTICULAR FONT, STYLE, SIZE, OR COLOR.

FOR HANDHELD FROZEN AND REFRIGERATED DOUGH ENROBED SNACKS CONSISTING OF A DOUGH-BASED WRAPPER WITH FILLINGS CONSISTING PRIMARILY OF MEAT, DAIRY PRODUCTS IN THE NATURE OF CHEESE, SAUCES, VEGETABLES AND/OR FRUIT, WHICH ARE NOT ENTREES, SANDWICHES OR HAMBURGER SANDWICHES AND ARE NOT IN THE STYLES OF INDIAN, THAI AND OTHER ASIAN COOKING (U.S. CL. 46).

FIRST USE 6-1-2009; IN COMMERCE 6-1-2009.

3,808,703. BRETON ENTERPRISES, INC., HUNTINGTON,
NY. SN 77-790,089. FILED P.R. 7-27-2009; AM. S.R. 5-3-2010.

BAGUETTE BITES

THE MARK CONSISTS OF STANDARD CHARACTERS WITHOUT CLAIM TO ANY PARTICULAR FONT, STYLE, SIZE, OR COLOR.

NO CLAIM IS MADE TO THE EXCLUSIVE RIGHT TO USE "BAGUETTE", APART FROM THE MARK AS SHOWN.

FOR GRAIN-BASED SNACK FOODS; WHEAT-BASED SNACK FOODS (U.S. CL. 46).

FIRST USE 10-5-2009; IN COMMERCE 10-5-2009.

CLASS 31—NATURAL AGRICULTURAL PRODUCTS

3,808,723. AGPRO INDUSTRIES, LLC, EASTMAN, GA. SN
77-805,923. FILED P.R. 8-17-2009; AM. S.R. 3-22-2010.

BUCK BALE

THE MARK CONSISTS OF STANDARD CHARACTERS WITHOUT CLAIM TO ANY PARTICULAR FONT, STYLE, SIZE, OR COLOR.

NO CLAIM IS MADE TO THE EXCLUSIVE RIGHT TO USE "BALE", APART FROM THE MARK AS SHOWN.

FOR ANIMAL FEED (U.S. CLS. 1 AND 46).

FIRST USE 7-1-2009; IN COMMERCE 7-1-2009.

CLASS 31—(Continued).

3,808,781. WORLD OF GOOD PETS, SAN FRANCISCO, CA.
SN 77-959,881. FILED P.R. 3-16-2010; AM. S.R. 5-11-2010.

GoodTreat

THE MARK CONSISTS OF STANDARD CHARACTERS
WITHOUT CLAIM TO ANY PARTICULAR FONT, STYLE,
SIZE, OR COLOR.
FOR PET TREATS (U.S. CLS. 1 AND 46).
FIRST USE 1-10-2010; IN COMMERCE 1-10-2010.

CLASS 32—(Continued).

3,808,734. MCKENZIE RIVER CORPORATION, SAN FRAN-
CISCO, CA. SN 77-847,930. FILED P.R. 10-13-2009; AM. S.R.
5-13-2010.

BEST BEER ON THE PLANET

THE MARK CONSISTS OF STANDARD CHARACTERS
WITHOUT CLAIM TO ANY PARTICULAR FONT, STYLE,
SIZE, OR COLOR.
FOR BEER (U.S. CLS. 45, 46 AND 48).
FIRST USE 4-12-2010; IN COMMERCE 4-12-2010.

CLASS 32—LIGHT BEVERAGES

3,808,719. OLD EUROPEAN BREWERY COMPANY, SAN
DIEGO, CA. SN 77-798,087. FILED P.R. 8-5-2009; AM. S.R. 4-
19-2010.

DOUBLE PINTS

THE MARK CONSISTS OF STANDARD CHARACTERS
WITHOUT CLAIM TO ANY PARTICULAR FONT, STYLE,
SIZE, OR COLOR.
FOR BEER AND ALE (U.S. CLS. 45, 46 AND 48).
FIRST USE 7-6-2009; IN COMMERCE 7-6-2009.

3,808,735. MILLERCOORS LLC, CHICAGO, IL. SN 77-848,160.
FILED P.R. 10-14-2009; AM. S.R. 4-29-2010.

ICE BREWED BELOW FREEZING

THE MARK CONSISTS OF STANDARD CHARACTERS
WITHOUT CLAIM TO ANY PARTICULAR FONT, STYLE,
SIZE, OR COLOR.
OWNER OF U.S. REG. NOS. 3,205,166 AND 3,365,512.
FOR BEER (U.S. CLS. 45, 46 AND 48).
FIRST USE 4-1-2010; IN COMMERCE 4-1-2010.

3,808,728. BARANTSEVICH, ANZHEY, ENCINO, CA. SN 77-
823,308. FILED P.R. 9-9-2009; AM. S.R. 5-13-2010.

BOTANIQ

THE MARK CONSISTS OF STANDARD CHARACTERS
WITHOUT CLAIM TO ANY PARTICULAR FONT, STYLE,
SIZE, OR COLOR.
FOR CONCENTRATED FRUIT JUICE; FRUIT CON-
CENTRATES AND PUREES USED AS INGREDIENTS OF
BEVERAGES; FRUIT DRINKS AND FRUIT JUICES;
FRUIT FLAVORED DRINKS; SOFT DRINKS (U.S. CLS.
45, 46 AND 48).
FIRST USE 1-10-2010; IN COMMERCE 1-10-2010.

CLASS 33—WINES AND SPIRITS

3,808,667. PAMPLIN VINEYARDS LLC, SHERWOOD, OR.
SN 77-665,094. FILED P.R. 2-6-2009; AM. S.R. 5-12-2010.

PAMPLIN FAMILY WINERY

THE MARK CONSISTS OF STANDARD CHARACTERS
WITHOUT CLAIM TO ANY PARTICULAR FONT, STYLE,
SIZE, OR COLOR.
NO CLAIM IS MADE TO THE EXCLUSIVE RIGHT TO
USE "FAMILY WINERY", APART FROM THE MARK AS
SHOWN.
FOR WINE (U.S. CLS. 47 AND 49).
FIRST USE 4-23-2010; IN COMMERCE 5-10-2010.

CLASS 33—(Continued).

3,808,697. ROBERT A. MERRY & COMPANY LIMITED, CO. TIPPERARY, IRELAND. SN 77-783,337. FILED 7-17-2009.

CLASS 35—(Continued).

3,808,644. SP PRODUCTIONS, CHAPMANSBORO, TN. SN 77-476,682. FILED P.R. 5-16-2008; AM. S.R. 3-6-2009.

MCGRATH'S

THE MARK CONSISTS OF STANDARD CHARACTERS WITHOUT CLAIM TO ANY PARTICULAR FONT, STYLE, SIZE, OR COLOR.

OWNER OF U.S. REG. NO. 3,257,338.
FOR CREAM LIQUEURS (U.S. CLS. 47 AND 49).
FIRST USE 8-31-2006; IN COMMERCE 8-31-2006.

MusicCityFashionWeek

THE MARK CONSISTS OF STANDARD CHARACTERS WITHOUT CLAIM TO ANY PARTICULAR FONT, STYLE, SIZE, OR COLOR.

FOR FASHION SHOW EXHIBITIONS FOR COMMERCIAL PURPOSES (U.S. CLS. 100, 101 AND 102).
FIRST USE 5-15-2008; IN COMMERCE 5-15-2008.

CLASS 34—SMOKERS' ARTICLES

3,808,670. STARBUZZ TOBACCO, INC., ANAHEIM, CA. SN 77-667,816. FILED P.R. 2-10-2009; AM. S.R. 5-4-2010.

3,808,661. REMEDY DRUG STORE CO. INC., MARKHAM, CANADA. SN 77-631,451. FILED P.R. 12-11-2008; AM. S.R. 4-12-2010.

Pink Champagne

THE MARK CONSISTS OF STANDARD CHARACTERS WITHOUT CLAIM TO ANY PARTICULAR FONT, STYLE, SIZE, OR COLOR.

FOR PIPE TOBACCO, MOLASSES TOBACCO, TOBACCO, SMOKING TOBACCO, FLAVORED TOBACCO; TOBACCO SUBSTITUTE, NAMELY, HERBAL MOLASSES (U.S. CLS. 2, 8, 9 AND 17).
FIRST USE 4-30-2010; IN COMMERCE 4-30-2010.

THE LOCAL DRUGSTORE

THE MARK CONSISTS OF STANDARD CHARACTERS WITHOUT CLAIM TO ANY PARTICULAR FONT, STYLE, SIZE, OR COLOR.

OWNER OF CANADA REG. NO. TMA713797, DATED 5-7-2008, EXPIRES 5-7-2023.
NO CLAIM IS MADE TO THE EXCLUSIVE RIGHT TO USE "DRUGSTORE", APART FROM THE MARK AS SHOWN.
FOR RETAIL DRUG STORE SERVICES; RETAIL DRUG STORES (U.S. CLS. 100, 101 AND 102).

SERVICE MARKS**CLASS 35—ADVERTISING AND BUSINESS**

3,808,631. MARTIN PORTER ASSOCIATES, INC., PORT WASHINGTON, NY. SN 76-701,136. FILED P.R. 1-8-2010; AM. S.R. 5-6-2010.

3,808,694. STAFF PRO, AKA EVENT MANAGEMENT SERVICES, STAFFPRO SECURITY INC., STAFFPRO SERVICES INC., STAFFPRO INC., EVENT SECURITY MANAGEMENT, LLC., HUNTINGTON BEACH, CA. SN 77-782,127. FILED P.R. 7-15-2009; AM. S.R. 4-23-2010.

ENTERTAINMENT SUPPLY CHAIN ACADEMY

THE MARK CONSISTS OF STANDARD CHARACTERS WITHOUT CLAIM TO ANY PARTICULAR FONT, STYLE, SIZE, OR COLOR.

NO CLAIM IS MADE TO THE EXCLUSIVE RIGHT TO USE "ACADEMY", APART FROM THE MARK AS SHOWN.

FOR ARRANGING AND CONDUCTING BUSINESS MEETINGS AND CONFERENCES FOR PROVIDERS IN THE HOME ENTERTAINMENT BUSINESS (U.S. CLS. 100, 101 AND 102).
FIRST USE 6-1-2006; IN COMMERCE 6-1-2006.

THE EVENT STAFFING PROFESSIONALS

THE MARK CONSISTS OF STANDARD CHARACTERS WITHOUT CLAIM TO ANY PARTICULAR FONT, STYLE, SIZE, OR COLOR.

CLASS 35—(Continued).

NO CLAIM IS MADE TO THE EXCLUSIVE RIGHT TO USE "EVENT STAFFING", APART FROM THE MARK AS SHOWN.

FOR EMPLOYMENT STAFFING IN THE FIELD OF AUDIENCE/CROWD MANAGEMENT, LICENSED SECURITY, USHERS, TICKET TAKERS, ALCOHOL ENFORCEMENT, EVENT MANAGERS, AND TRADE SHOW CONSULTANTS FOR, NAMELY, AWARD SHOWS, FAIRS, FESTIVALS, SPECIAL EVENTS, MOVIE PREMIERES, PRIVATE EVENTS, SPORTING EVENTS, CONVENTION AND TRADE SHOWS, ARENAS, AMPHITHEATRES, PERFORMING ARTS CENTERS, STADIUMS, CONVENTION CENTERS, AND EXPOSITION HALLS (U.S. CLS. 100, 101 AND 102).

FIRST USE 1-0-2008; IN COMMERCE 2-0-2008.

CLASS 35—(Continued).

3,808,727. FAIRWAY GROUP ACQUISITION COMPANY, NEW YORK, NY. SN 77-821,826. FILED P.R. 9-8-2009; AM. S.R. 5-6-2010.

THE WORLD'S GREATEST FOOD
STORE

3,808,712. SEARCH HOLISTIC, LLC, WASHINGTON CROSS, PA. SN 77-794,827. FILED P.R. 7-31-2009; AM. S.R. 5-10-2010.

SEARCHHOLISTIC.COM

THE MARK CONSISTS OF STANDARD CHARACTERS WITHOUT CLAIM TO ANY PARTICULAR FONT, STYLE, SIZE, OR COLOR.

FOR PROVIDING CONSUMER INFORMATION IN THE FIELD OF HOLISTIC HEALTH SERVICES AND PRODUCTS (U.S. CLS. 100, 101 AND 102).

FIRST USE 3-1-2009; IN COMMERCE 3-1-2009.

THE MARK CONSISTS OF STANDARD CHARACTERS WITHOUT CLAIM TO ANY PARTICULAR FONT, STYLE, SIZE, OR COLOR.

NO CLAIM IS MADE TO THE EXCLUSIVE RIGHT TO USE "FOOD STORE", APART FROM THE MARK AS SHOWN.

FOR SUPERMARKET SERVICES; ON-LINE RETAIL STORE SERVICES AND ON-LINE ORDERING SERVICES IN THE FIELD OF SUPERMARKETS, INTERNATIONAL AND OTHER FOODS, GROCERIES, BAKERY, MEATS, DELICATESSEN, CHEESES, FRESH JUICES, FRUITS AND VEGETABLES, MILK, ORGANIC MILK, EGGS, ORGANIC EGGS, BEER, WINE, DISTILLED SPIRITS, ALCOHOLIC BEVERAGES, WINE ACCESSORIES AND GIFT ITEMS, NATURAL ORGANIC BEAUTY CARE PRODUCTS (U.S. CLS. 100, 101 AND 102).

FIRST USE 5-0-2009; IN COMMERCE 5-0-2009.

3,808,739. BUYSSELLADS.COM, SOUTH BOSTON, MA. SN 77-862,409. FILED P.R. 11-2-2009; AM. S.R. 4-14-2010.

BuySellAds.com

3,808,713. CBR SYSTEMS, INC., SAN BRUNO, CA. SN 77-795,636. FILED P.R. 8-3-2009; AM. S.R. 5-11-2010.

CORD BLOOD PARENTS

THE MARK CONSISTS OF STANDARD CHARACTERS WITHOUT CLAIM TO ANY PARTICULAR FONT, STYLE, SIZE, OR COLOR.

FOR A CUSTOMER REFERRAL PROGRAM IN THE FIELD OF UMBILICAL CORD BLOOD PRESERVATION AND DONATION; PROMOTING PUBLIC AWARENESS OF THE BENEFITS OF UMBILICAL CORD BLOOD PRESERVATION AND DONATION (U.S. CLS. 100, 101 AND 102).

FIRST USE 8-0-2009; IN COMMERCE 8-0-2009.

THE MARK CONSISTS OF STANDARD CHARACTERS WITHOUT CLAIM TO ANY PARTICULAR FONT, STYLE, SIZE, OR COLOR.

FOR ADVERTISING SERVICES; ADVERTISING AGENCIES; ADVERTISING CONSULTATION; RENTAL OF ADVERTISING SPACE ON WEB SITES; ONLINE SEARCHABLE DATABASE FEATURING ADVERTISING; ONLINE ADVERTISING FOR BUSINESSES, CONSUMERS, ADVERTISERS AND WEB TRAVELERS OF ALL AGES; PROMOTING THE GOODS AND SERVICES OF OTHERS VIA A GLOBAL COMPUTER NETWORK (U.S. CLS. 100, 101 AND 102).

FIRST USE 2-1-2008; IN COMMERCE 2-20-2008.

CLASS 35—(Continued).

3,808,760. NEWSOME INTERACTIVE, LLC, SIGNAL MOUNTAIN, TN. SN 77-916,991. FILED P.R. 1-21-2010; AM. S.R. 5-5-2010.

LANDSALELISTINGS

THE MARK CONSISTS OF STANDARD CHARACTERS WITHOUT CLAIM TO ANY PARTICULAR FONT, STYLE, SIZE, OR COLOR.

FOR REAL ESTATE ADVERTISING SERVICES; REAL ESTATE MARKETING ANALYSIS (U.S. CLS. 100, 101 AND 102).

FIRST USE 7-1-2007; IN COMMERCE 7-1-2007.



3,808,765. SOUTHERN BULLION TRADING, LLC, DALLAS, TX. SN 77-922,820. FILED P.R. 1-28-2010; AM. S.R. 4-29-2010.

SOUTHERN BULLION COIN & JEWELRY

THE MARK CONSISTS OF STANDARD CHARACTERS WITHOUT CLAIM TO ANY PARTICULAR FONT, STYLE, SIZE, OR COLOR.

NO CLAIM IS MADE TO THE EXCLUSIVE RIGHT TO USE "BULLION COIN & JEWELRY", APART FROM THE MARK AS SHOWN.

FOR DEALERSHIPS IN THE FIELD OF GOLD SILVER AND PRECIOUS METALS (U.S. CLS. 100, 101 AND 102).

FIRST USE 12-1-2009; IN COMMERCE 12-1-2009.



3,808,768. HENSLEY FONTANA, LLC, CHARLOTTE, NC. SN 77-925,663. FILED P.R. 2-2-2010; AM. S.R. 5-3-2010.

CHARLOTTE RESTAURANT WEEK

THE MARK CONSISTS OF STANDARD CHARACTERS WITHOUT CLAIM TO ANY PARTICULAR FONT, STYLE, SIZE, OR COLOR.

CLASS 35—(Continued).

NO CLAIM IS MADE TO THE EXCLUSIVE RIGHT TO USE "RESTAURANT WEEK", APART FROM THE MARK AS SHOWN.

FOR ADVERTISING SERVICES, NAMELY, PROMOTING AND MARKETING THE GOODS AND SERVICES OF OTHERS IN THE FIELD OF UPSCALE CHOICES SUCH AS CULTURAL EVENTS, RESTAURANTS, SHOPPING, AND TRAVEL VIA PRINT AND ELECTRONIC MEDIA; ADVERTISING SERVICES, NAMELY, PROMOTING AND MARKETING THE GOODS AND SERVICES OF OTHERS THROUGH ALL PUBLIC COMMUNICATION MEANS; ADVERTISING SERVICES, NAMELY, PROMOTING THE BRANDS, GOODS AND SERVICES OF OTHERS; ADVERTISING SERVICES, NAMELY, PROMOTING THE FOOD AND WINE OF OTHERS; ARRANGING AND CONDUCTING MARKETING PROMOTIONAL EVENTS FOR OTHERS; PROMOTING RECREATION AND TOURISM IN THE CHARLOTTE, NORTH CAROLINA AREA BY PROMOTING RESTAURANTS OFFERING DISCOUNTED MEALS DURING A SPECIFIED TIME PERIOD; PROMOTING THE GOODS AND SERVICES OF OTHERS BY PROVIDING A WEB SITE AT WHICH USERS CAN LINK TO RESTAURANTS OFFERING DISCOUNTED MEALS DURING A SPECIFIED TIME PERIOD (U.S. CLS. 100, 101 AND 102).

FIRST USE 5-1-2008; IN COMMERCE 5-1-2008.



3,808,774. SOUTHEAST CARBON MANAGEMENT, LLC, NEW SMYRNA BEACH, FL. SN 77-928,295. FILED P.R. 2-4-2010; AM. S.R. 5-12-2010.



THE COLOR(S) DARK GREEN AND LIGHT GREEN IS/ ARE CLAIMED AS A FEATURE OF THE MARK.

THE MARK CONSISTS OF THE STYLIZED WORDING "SOUTHEAST CARBON". THE COLOR DARK GREEN APPEARS IN THE WORDING "SOUTHEAST"; THE COLOR LIGHT GREEN APPEARS IN THE WORDING "CARBON".

FOR FORESTRY MANAGEMENT SERVICES (U.S. CLS. 100, 101 AND 102).

FIRST USE 5-1-2008; IN COMMERCE 5-1-2008.



3,808,775. GRYNKIV, ANTON, BROOKLYN, NY. SN 77-929,424. FILED P.R. 2-5-2010; AM. S.R. 2-5-2010.

RUSSIAN YELLOW PAGES

THE MARK CONSISTS OF STANDARD CHARACTERS WITHOUT CLAIM TO ANY PARTICULAR FONT, STYLE, SIZE, OR COLOR.

CLASS 35—(Continued).

NO CLAIM IS MADE TO THE EXCLUSIVE RIGHT TO USE "YELLOW PAGES", APART FROM THE MARK AS SHOWN. FOR CLASSIFIED ADVERTISING SERVICES; ON-LINE ADVERTISING AND MARKETING SERVICES; ON-LINE BUSINESS DIRECTORIES FEATURING A WIDE VARIETY OF BUSINESSES (U.S. CLS. 100, 101 AND 102).

FIRST USE 8-0-2008; IN COMMERCE 8-0-2008.

3,808,779. THE BOSTON CONSULTING GROUP, INC., BOSTON, MA. SN 77-939,098. FILED P.R. 2-18-2010; AM. S.R. 5-11-2010.

RIGOROUS PROGRAM MANAGEMENT

THE MARK CONSISTS OF STANDARD CHARACTERS WITHOUT CLAIM TO ANY PARTICULAR FONT, STYLE, SIZE, OR COLOR.

NO CLAIM IS MADE TO THE EXCLUSIVE RIGHT TO USE "PROGRAM MANAGEMENT", APART FROM THE MARK AS SHOWN.

FOR PROVIDING BUSINESS MANAGEMENT CONSULTING SERVICES; ADVISING BUSINESSES IN STRATEGIC MANAGEMENT AND DEVELOPMENT OF OVERALL CORPORATE STRATEGY AND BUSINESS INITIATIVES; CORPORATE MANAGEMENT CONSULTING SERVICES TO ASSIST EXECUTIVES IN BUSINESS DECISION MAKING; ADVISING BUSINESSES THROUGH THE USE OF CONSULTING TOOLS AND TECHNIQUES THAT ENABLE STRATEGIC BUSINESS DECISION MAKING; PROVIDING BUSINESS PROJECT MANAGEMENT CONSULTING SERVICES, NAMELY, PREDICTING PROJECT OUTCOMES AND MODIFYING PROJECT IMPLEMENTATION TO INCREASE LIKELIHOOD OF SUCCESS IN BUSINESS TRANSFORMATION PROJECTS (U.S. CLS. 100, 101 AND 102).

FIRST USE 8-18-2009; IN COMMERCE 8-18-2009.

CLASS 36—INSURANCE AND FINANCIAL

3,808,638. GREENWOOD, GREG T., WEST CHESTER, OH. SN 77-354,247. FILED P.R. 12-17-2007; AM. S.R. 4-13-2010.

HOME FOR THE HOLIDAYS

THE MARK CONSISTS OF STANDARD CHARACTERS WITHOUT CLAIM TO ANY PARTICULAR FONT, STYLE, SIZE, OR COLOR.

FOR CHARITABLE FOUNDATION SERVICES, NAMELY, PROVIDING FINANCIAL SUPPORT TO INDIVIDUALS WHO ARE SEEKING TO BE WITH FAMILY DURING THE HOLIDAYS BUT ARE UNABLE DUE TO FINANCIAL CONSTRAINTS (U.S. CLS. 100, 101 AND 102).

FIRST USE 3-0-2010; IN COMMERCE 3-0-2010.

CLASS 36—(Continued).

3,808,679. SHELLEY, DOUGLAS P., SUMMIT, NJ. SN 77-739,263. FILED P.R. 5-18-2009; AM. S.R. 5-7-2010.

Multifamily Capital Funding LLC

THE MARK CONSISTS OF STANDARD CHARACTERS WITHOUT CLAIM TO ANY PARTICULAR FONT, STYLE, SIZE, OR COLOR.

NO CLAIM IS MADE TO THE EXCLUSIVE RIGHT TO USE "CAPITAL FUNDING LLC", APART FROM THE MARK AS SHOWN.

FOR FINANCING OF REAL ESTATE DEVELOPMENT PROJECTS; LAND ACQUISITION, NAMELY, REAL ESTATE BROKERAGE; PROVIDING INFORMATION IN THE FIELD OF REAL ESTATE VIA THE INTERNET; REAL ESTATE BROKERAGE; REAL ESTATE CONSULTANCY; REAL ESTATE CONSULTATION; REAL ESTATE EQUITY SHARING, NAMELY, MANAGING AND ARRANGING FOR CO-OWNERSHIP OF REAL ESTATE; REAL ESTATE FINANCING SERVICES; REAL ESTATE INVESTMENT; REAL ESTATE INVESTMENT SERVICES IN THE NATURE OF PURCHASING AND SELLING OF REAL ESTATE FOR OTHERS; REAL ESTATE LENDING SERVICES; REAL ESTATE MANAGEMENT CONSULTATION; REAL ESTATE MANAGEMENT SERVICES; REAL ESTATE SYNDICATION (U.S. CLS. 100, 101 AND 102).

FIRST USE 2-1-2009; IN COMMERCE 2-1-2009.

3,808,708. STRATEGIC GLOBAL ADVISORS, LLC, NEWPORT BEACH, CA. SN 77-793,267. FILED P.R. 7-30-2009; AM. S.R. 5-10-2010.

Strategic Global Advisors

THE MARK CONSISTS OF STANDARD CHARACTERS WITHOUT CLAIM TO ANY PARTICULAR FONT, STYLE, SIZE, OR COLOR.

NO CLAIM IS MADE TO THE EXCLUSIVE RIGHT TO USE "ADVISORS", APART FROM THE MARK AS SHOWN. FOR FINANCIAL SERVICES, NAMELY, INVESTMENT ADVICE, INVESTMENT MANAGEMENT, INVESTMENT CONSULTATION AND INVESTMENT OF FUNDS FOR OTHERS, INCLUDING PUBLIC EQUITY INVESTMENT SERVICES (U.S. CLS. 100, 101 AND 102).

FIRST USE 11-0-2005; IN COMMERCE 11-0-2005.

CLASS 36—(Continued).

3,808,726. YORKVILLE ADVISORS, LLC, JERSEY CITY, NJ.
SN 77-812,978. FILED P.R. 8-26-2009; AM. S.R. 5-4-2010.

SEDA

THE MARK CONSISTS OF STANDARD CHARACTERS WITHOUT CLAIM TO ANY PARTICULAR FONT, STYLE, SIZE, OR COLOR.

FOR EQUITY CAPITAL INVESTMENT; FINANCIAL AND INVESTMENT SERVICES, NAMELY, MANAGEMENT AND BROKERAGE IN THE FIELDS OF STOCKS, BONDS, OPTIONS, COMMODITIES, FUTURES AND OTHER SECURITIES, AND THE INVESTMENT OF FUNDS OF OTHERS; FINANCIAL INVESTMENT BROKERAGE; HEDGE FUND INVESTMENT SERVICES; INVESTMENT BROKERAGE; INVESTMENT MANAGEMENT; PRIVATE EQUITY FUND INVESTMENT SERVICES; PRIVATE PLACEMENTS OF HEDGE FUNDS, PRIVATE EQUITY FUNDS, SECURITIES AND DERIVATIVES FOR OTHERS (U.S. CLS. 100, 101 AND 102).

FIRST USE 0-0-2001; IN COMMERCE 0-0-2001.

3,808,740. AUDIT INTEGRITY, INC., LOS ANGELES, CA. SN
77-869,677. FILED P.R. 11-10-2009; AM. S.R. 5-10-2010.

RiskBook

THE MARK CONSISTS OF STANDARD CHARACTERS WITHOUT CLAIM TO ANY PARTICULAR FONT, STYLE, SIZE, OR COLOR.

FOR FINANCIAL RISK INFORMATION SERVICES, NAMELY, COMPILING AND CONSOLIDATING CORPORATE FINANCIAL INFORMATION AND KEY FINANCIAL RISK INDICATORS AND PROVIDING THE INFORMATION TO INVESTORS, AUDITORS, AND INSURANCE UNDERWRITERS TO ALLOW THEM TO MAKE BETTER FINANCIAL RISK ASSESSMENTS (U.S. CLS. 100, 101 AND 102).

FIRST USE 4-9-2009; IN COMMERCE 4-9-2009.

3,808,770. AVILA CAPITAL MARKETS, LLC, NEW YORK, NY. SN 77-926,659. FILED P.R. 2-3-2010; AM. S.R. 5-5-2010.

Avila Capital Markets

THE MARK CONSISTS OF STANDARD CHARACTERS WITHOUT CLAIM TO ANY PARTICULAR FONT, STYLE, SIZE, OR COLOR.

CLASS 36—(Continued).

NO CLAIM IS MADE TO THE EXCLUSIVE RIGHT TO USE "CAPITAL MARKETS", APART FROM THE MARK AS SHOWN.

FOR BANKING AND FINANCING SERVICES; CORPORATE FINANCE SERVICES, NAMELY, CONSULTATION IN THE FIELD OF CAPITAL STRUCTURE; FINANCIAL CONSULTING SERVICES, NAMELY, EXPERT ANALYSIS IN FINANCE; FINANCING SERVICES; PROVIDING INFORMATION AND ADVICE IN THE FIELD OF FINANCE, FINANCIAL INVESTMENTS, FINANCIAL VALUATIONS, AND THE FINANCIAL ASPECTS OF RETIREMENT; PROVIDING INFORMATION AND RESEARCH IN THE FIELD OF FINANCE AND FINANCIAL INVESTMENTS (U.S. CLS. 100, 101 AND 102).

FIRST USE 1-28-2009; IN COMMERCE 1-28-2009.

CLASS 37—CONSTRUCTION AND REPAIR

3,808,759. INDY JET HOLDINGS, LLC, GREENFIELD, IN.
SN 77-915,457. FILED P.R. 1-20-2010; AM. S.R. 4-28-2010.

INDY JET

THE MARK CONSISTS OF STANDARD CHARACTERS WITHOUT CLAIM TO ANY PARTICULAR FONT, STYLE, SIZE, OR COLOR.

FOR AIRCRAFT MAINTENANCE AND REPAIR SERVICES; FUELING SERVICES FOR AIRCRAFT; OUTER AND INNER CLEANING OF AIRCRAFT (U.S. CLS. 100, 103 AND 106).

FIRST USE 6-1-2009; IN COMMERCE 6-1-2009.

CLASS 38—COMMUNICATION

3,808,632. ME MARKETING AND ADVERTISING SERVICES, INC, HOUSTON, TX. SN 76-701,462. FILED P.R. 2-3-2010; AM. S.R. 5-14-2010.

Inmigrante TV

THE MARK CONSISTS OF STANDARD CHARACTERS WITHOUT CLAIM TO ANY PARTICULAR FONT, STYLE, SIZE, OR COLOR.

THE FOREIGN WORDING IN THE MARK TRANSLATES INTO ENGLISH AS "IMMIGRANT".

FOR TELEVISION BROADCASTING; CABLE TELEVISION BROADCASTING; SATELLITE TRANSMISSION; PRESS AGENCIES AND INFORMATION AGENCIES, NAMELY, THE TRANSMISSION OF NEWS ITEMS TO NEW REPORTING ORGANIZATIONS (U.S. CLS. 100, 101 AND 104).

FIRST USE 12-24-2009; IN COMMERCE 12-24-2009.

CLASS 38—(Continued).

3,808,651. INTRINSIC SOLUTIONS, L.P., SEABROOK, TX. SN 77-578,692. FILED P.R. 9-25-2008; AM. S.R. 4-19-2010.

INTRINSIC SOLUTIONS

THE MARK CONSISTS OF STANDARD CHARACTERS WITHOUT CLAIM TO ANY PARTICULAR FONT, STYLE, SIZE, OR COLOR.

FOR LEASING OF INTRINSICALLY SAFE TELECOMMUNICATION EQUIPMENT (U.S. CLS. 100, 101 AND 104).

FIRST USE 6-30-2007; IN COMMERCE 6-30-2007.

CLASS 41—EDUCATION AND ENTERTAINMENT

3,808,656. INTERNATIONAL CENTERS FOR SPIRITUAL LIVING, SPOKANE, WA. SN 77-611,837. FILED P.R. 11-11-2008; AM. S.R. 4-21-2010.

**International Centers For
Spiritual Living**

THE MARK CONSISTS OF STANDARD CHARACTERS WITHOUT CLAIM TO ANY PARTICULAR FONT, STYLE, SIZE, OR COLOR.

NO CLAIM IS MADE TO THE EXCLUSIVE RIGHT TO USE "CENTERS", APART FROM THE MARK AS SHOWN.

FOR RELIGIOUS INSTRUCTION SERVICES (U.S. CLS. 100, 101 AND 107).

FIRST USE 7-25-2008; IN COMMERCE 7-25-2008.

3,808,676. SWADESH ANIMATION PRIVATE LIMITED, BANGALORE, INDIA. SN 77-722,769. FILED P.R. 4-27-2009; AM. S.R. 5-12-2010.

ONLINE TALES

THE MARK CONSISTS OF STANDARD CHARACTERS WITHOUT CLAIM TO ANY PARTICULAR FONT, STYLE, SIZE, OR COLOR.

NO CLAIM IS MADE TO THE EXCLUSIVE RIGHT TO USE "ONLINE", APART FROM THE MARK AS SHOWN.

FOR ENTERTAINMENT SERVICES, NAMELY, PROVIDING ON-LINE COMPUTER GAMES (U.S. CLS. 100, 101 AND 107).

FIRST USE 3-15-2009; IN COMMERCE 4-26-2009.

CLASS 41—(Continued).

3,808,684. SITV, INC., GLENDALE, CA. SN 77-755,491. FILED P.R. 6-9-2009; AM. S.R. 4-20-2010.



THE COLOR(S) GOLD AND PURPLE IS/ARE CLAIMED AS A FEATURE OF THE MARK.

THE MARK CONSISTS OF THE WORD "MODEL" IN GOLD PRECEDING THE WORD "LATINA" IN PURPLE.

FOR ENTERTAINMENT SERVICES, NAMELY, AN ON-GOING SERIES FEATURING REALITY-BASED ENTERTAINMENT PROVIDED THROUGH CABLE AND SATELLITE TELEVISION, WIRELESS NETWORKS AND WEBCASTS (U.S. CLS. 100, 101 AND 107).

FIRST USE 7-27-2008; IN COMMERCE 7-27-2008.

3,808,685. BEMPORAD BARANOWSKI, INC., NEW YORK, NY. SN 77-765,157. FILED P.R. 6-22-2009; AM. S.R. 3-23-2010.

BRANDING FOR SUSTAINABILITY

THE MARK CONSISTS OF STANDARD CHARACTERS WITHOUT CLAIM TO ANY PARTICULAR FONT, STYLE, SIZE, OR COLOR.

NO CLAIM IS MADE TO THE EXCLUSIVE RIGHT TO USE "BRANDING", APART FROM THE MARK AS SHOWN.

FOR WORKSHOPS AND SEMINARS IN THE FIELD OF BRANDING AND NAMING SERVICES, CORPORATE IDENTITY DEVELOPMENT, CREATING, EVALUATING AND MANAGING BRAND NAMES, SERVICE MARKS AND BUSINESS NAMES FOR OTHERS, MARKET RESEARCH SERVICES, MARKET STRATEGY SERVICES, AND ADVERTISING AGENCY SERVICES, AND DISTRIBUTION OF COURSE MATERIALS IN CONNECTION THEREWITH (U.S. CLS. 100, 101 AND 107).

FIRST USE 9-17-2008; IN COMMERCE 9-17-2008.

CLASS 41—(Continued).

3,808,688. CHALLENGE ONLINE GAMES, INC., FORMERLY OXYGEN GAMES, AUSTIN, TX. SN 77-771,170. FILED P.R. 6-30-2009; AM. S.R. 4-19-2010.

GRIDIRON LIVE

THE MARK CONSISTS OF STANDARD CHARACTERS WITHOUT CLAIM TO ANY PARTICULAR FONT, STYLE, SIZE, OR COLOR.

FOR ENTERTAINMENT SERVICES, NAMELY, PROVIDING ON-LINE COMPUTER GAMES (U.S. CLS. 100, 101 AND 107).

FIRST USE 10-14-2009; IN COMMERCE 10-14-2009.

3,808,693. UBM IP LUXEMBOURG SARL, L-1723 LUXEMBOURG, LUXEMBOURG. SN 77-780,835. FILED P.R. 7-14-2009; AM. S.R. 4-25-2010.

PSYCH CONGRESS ON-DEMAND

THE MARK CONSISTS OF STANDARD CHARACTERS WITHOUT CLAIM TO ANY PARTICULAR FONT, STYLE, SIZE, OR COLOR.

NO CLAIM IS MADE TO THE EXCLUSIVE RIGHT TO USE "ON-DEMAND", APART FROM THE MARK AS SHOWN.

FOR ARRANGING AND CONDUCTING ON-LINE EDUCATIONAL SEMINARS, ON-LINE TRAINING CLASSES, CONFERENCES AND WORKSHOPS IN THE FIELDS OF MEDICINE, NEUROLOGY AND MENTAL HEALTHCARE, PROVIDING ON-LINE NEWSLETTERS IN THE FIELDS OF THE MENTAL HEALTHCARE, NEUROLOGY AND MEDICINE, CONDUCTING EDUCATIONAL SEMINARS, NAMELY, IN THE FIELDS OF THE MENTAL HEALTHCARE, NEUROLOGY AND MEDICINE (U.S. CLS. 100, 101 AND 107).

FIRST USE 12-0-2009; IN COMMERCE 12-0-2009.

3,808,706. NATIONAL STAFF DEVELOPMENT COUNCIL, OXFORD, OH. SN 77-792,992. FILED P.R. 7-30-2009; AM. S.R. 5-16-2010.

Learning School Alliance

THE MARK CONSISTS OF STANDARD CHARACTERS WITHOUT CLAIM TO ANY PARTICULAR FONT, STYLE, SIZE, OR COLOR.

CLASS 41—(Continued).

NO CLAIM IS MADE TO THE EXCLUSIVE RIGHT TO USE "SCHOOL ALLIANCE", APART FROM THE MARK AS SHOWN.

FOR EDUCATION SERVICES, NAMELY, PROVIDING LIVE AND ON-LINE CONFERENCES, SEMINARS, AND FACILITATED CONVERSATIONS FOR K-12 SCHOOLS IN THE FIELD OF PROFESSIONAL DEVELOPMENT TO CREATE A NETWORK OF SCHOOLS COMMITTED TO PROFESSIONAL DEVELOPMENT PRACTICES THAT PROMOTE STUDENT ACHIEVEMENT THROUGH COLLABORATIVE LEARNING IN THEIR OWN SCHOOLS AND WITH OTHER SCHOOLS (U.S. CLS. 100, 101 AND 107).

FIRST USE 11-18-2008; IN COMMERCE 11-18-2008.

3,808,711. NORTHWESTERN UNIVERSITY, EVANSTON, IL. SN 77-794,019. FILED P.R. 7-31-2009; AM. S.R. 5-12-2010.

THE BUDDY PROGRAM

THE MARK CONSISTS OF STANDARD CHARACTERS WITHOUT CLAIM TO ANY PARTICULAR FONT, STYLE, SIZE, OR COLOR.

NO CLAIM IS MADE TO THE EXCLUSIVE RIGHT TO USE "PROGRAM", APART FROM THE MARK AS SHOWN.

FOR EDUCATIONAL SERVICES, NAMELY, CONDUCTING CLASSES, SEMINARS AND WORKSHOPS IN THE FIELDS OF MEDICAL EDUCATION AND HEALTH AND SOCIAL SCIENCES EDUCATION AND DISTRIBUTION OF COURSE MATERIAL IN CONNECTION THEREWITH; EDUCATIONAL SERVICES, NAMELY, CONDUCTING CLASSES, SEMINARS AND WORKSHOPS IN THE FIELDS OF NEURODEGENERATIVE DISEASES, SUCH AS ALZHEIMER'S DISEASE AND RELATED DISORDERS, AND DISTRIBUTION OF TRAINING MATERIAL IN CONNECTION THEREWITH (U.S. CLS. 100, 101 AND 107).

FIRST USE 10-31-1997; IN COMMERCE 10-1-1998.

3,808,724. THE PRACTICAL EXPERT, LLC, AUGUSTA, ME. SN 77-807,657. FILED P.R. 8-19-2009; AM. S.R. 5-12-2010.

THE PRACTICAL EXPERT

THE MARK CONSISTS OF STANDARD CHARACTERS WITHOUT CLAIM TO ANY PARTICULAR FONT, STYLE, SIZE, OR COLOR.

FOR LIFE COACHING SERVICES IN THE FIELD OF HEALTHY LIVING AND LIFESTYLE WELLNESS (U.S. CLS. 100, 101 AND 107).

FIRST USE 7-1-2009; IN COMMERCE 7-1-2009.

CLASS 41—(Continued).

3,808,725. MICHAEL J NAPOLI JR, DBA PERFORMING ARTS LIVE, PALM SPRINGS, CA. SN 77-812,007. FILED P.R. 8-25-2009; AM. S.R. 5-18-2010.

Performing Arts LIVE

THE MARK CONSISTS OF STANDARD CHARACTERS WITHOUT CLAIM TO ANY PARTICULAR FONT, STYLE, SIZE, OR COLOR.

NO CLAIM IS MADE TO THE EXCLUSIVE RIGHT TO USE "PERFORMING ARTS", APART FROM THE MARK AS SHOWN.

FOR ARRANGING FOR TICKET RESERVATIONS FOR SHOWS AND OTHER ENTERTAINMENT EVENTS; ENTERTAINMENT AND EDUCATIONAL SERVICES, NAMELY, PROVIDING ADVICE AND INFORMATION FOR MUSIC, VIDEO AND FILM CONCEPT AND SCRIPT DEVELOPMENT; ENTERTAINMENT INFORMATION; ENTERTAINMENT SERVICES IN THE NATURE OF LIVE MUSICAL PERFORMANCES; ENTERTAINMENT TICKET AGENCY SERVICES; ENTERTAINMENT, NAMELY, LIVE MUSIC CONCERTS; INFORMATION RELATING TO ENTERTAINMENT AND EDUCATION, PROVIDED ON-LINE FROM A COMPUTER DATABASE OR THE INTERNET; ON-LINE ENTERTAINMENT TICKET AGENCY SERVICES; PROVIDING A WEB SITE WHERE USERS CAN POST RATINGS, REVIEWS AND RECOMMENDATIONS ON EVENTS AND ACTIVITIES IN THE FIELD OF ENTERTAINMENT AND EDUCATION; PROVIDING A WEBSITE FEATURING EDUCATION AND ENTERTAINMENT FOR CHILDREN; PROVIDING AN INTERNET WEBSITE PORTAL FEATURING LINKS TO MUSICAL ARTIST WEBSITES AND MUSIC PERFORMANCE TICKET INFORMATION; PROVIDING AN INTERNET WEBSITE PORTAL IN THE FIELD OF ENTERTAINMENT, CULTURAL AND SPORTING EVENTS; PROVISION OF INFORMATION RELATING TO LIVE ENTERTAINMENT; PROVISION OF INFORMATION RELATING TO LIVE PERFORMANCES, ROAD SHOWS, LIVE STAGE EVENTS, THEATRICAL PERFORMANCES, LIVE MUSIC CONCERTS AND AUDIENCE PARTICIPATION IN SUCH EVENTS (U.S. CLS. 100, 101 AND 107).

FIRST USE 5-1-2009; IN COMMERCE 5-1-2009.

3,808,731. GREAT NECK ARTS CENTER, GREAT NECK, NY. SN 77-832,128. FILED P.R. 9-22-2009; AM. S.R. 5-11-2010.

GOLD COAST INTERNATIONAL FILM FESTIVAL

THE MARK CONSISTS OF STANDARD CHARACTERS WITHOUT CLAIM TO ANY PARTICULAR FONT, STYLE, SIZE, OR COLOR.

NO CLAIM IS MADE TO THE EXCLUSIVE RIGHT TO USE "INTERNATIONAL FILM FESTIVAL", APART FROM THE MARK AS SHOWN.

FOR ENTERTAINMENT SERVICES, NAMELY, PLANNING AND CONDUCTING A FILM FESTIVAL (U.S. CLS. 100, 101 AND 107).

FIRST USE 1-31-2009; IN COMMERCE 1-31-2009.

CLASS 41—(Continued).

3,808,732. THE SINGULARITY INSTITUTE FOR ARTIFICIAL INTELLIGENCE, PALO ALTO, CA. SN 77-838,713. FILED P.R. 9-30-2009; AM. S.R. 5-19-2010.

Singularity Summit

THE MARK CONSISTS OF STANDARD CHARACTERS WITHOUT CLAIM TO ANY PARTICULAR FONT, STYLE, SIZE, OR COLOR.

NO CLAIM IS MADE TO THE EXCLUSIVE RIGHT TO USE "SUMMIT", APART FROM THE MARK AS SHOWN.

FOR ARRANGING AND CONDUCTING EDUCATIONAL CONFERENCES IN THE FIELD OF THE TECHNOLOGICAL SINGULARITY (U.S. CLS. 100, 101 AND 107).

FIRST USE 10-1-2007; IN COMMERCE 10-1-2007.

3,808,737. STRATFORD FOUNDATION, INC., DBA READ MTI, THE MULTISENSORY TRAINING INSTITUTE, NEEDHAM, MA. SN 77-858,414. FILED P.R. 10-27-2009; AM. S.R. 5-17-2010.

Reading Foundations

THE MARK CONSISTS OF STANDARD CHARACTERS WITHOUT CLAIM TO ANY PARTICULAR FONT, STYLE, SIZE, OR COLOR.

FOR EDUCATIONAL SERVICES, NAMELY, PROVIDING CONTINUING PROFESSIONAL EDUCATION COURSES IN THE FIELD OF TEACHING, WITH A FOCUS ON READING (U.S. CLS. 100, 101 AND 107).

FIRST USE 12-1-2008; IN COMMERCE 1-5-2009.

3,808,752. ONLINE OCCUPATIONAL DEVELOPMENT CENTER LLC, AKA OODC, DALLAS, TX. SN 77-897,836. FILED P.R. 12-21-2009; AM. S.R. 5-11-2010.

ONLINE OCCUPATIONAL DEVELOPMENT CENTER

THE MARK CONSISTS OF STANDARD CHARACTERS WITHOUT CLAIM TO ANY PARTICULAR FONT, STYLE, SIZE, OR COLOR.

FOR EDUCATIONAL SERVICES, NAMELY, DEVELOPING AND CONDUCTING TRAINING COURSES AND DISTRIBUTION OF TRAINING MATERIALS IN CONNECTION THEREWITH FOR SUBJECT MATTERS AS REQUESTED OR DESIRED BY CUSTOMERS (U.S. CLS. 100, 101 AND 107).

FIRST USE 11-4-2009; IN COMMERCE 11-4-2009.

CLASS 41—(Continued).

3,808,755. MUSCOGEE MOMS, LLC, COLUMBUS, GA. SN 77-902,604. FILED P.R. 12-30-2009; AM. S.R. 5-7-2010.

MUSCOGEE MOMS

THE MARK CONSISTS OF STANDARD CHARACTERS WITHOUT CLAIM TO ANY PARTICULAR FONT, STYLE, SIZE, OR COLOR.

FOR PROVISION OF INFORMATION RELATING TO EDUCATIONAL AND ENTERTAINMENT ACTIVITIES AND EVENTS FOR CHILDREN VIA A WEBSITE (U.S. CLS. 100, 101 AND 107).

FIRST USE 8-15-2008; IN COMMERCE 8-15-2008.

CLASS 41—(Continued).

3,808,771. SIMPLE LEADERSHIP STRATEGIES, LLC, FORT WORTH, TX. SN 77-926,660. FILED P.R. 2-3-2010; AM. S.R. 5-13-2010.

**The Transformational
Leader-Manager**

THE MARK CONSISTS OF STANDARD CHARACTERS WITHOUT CLAIM TO ANY PARTICULAR FONT, STYLE, SIZE, OR COLOR.

FOR EDUCATION AND TRAINING SERVICES, NAMELY, DEVELOPING AND FACILITATING A LEADERSHIP DEVELOPMENT PROGRAM (U.S. CLS. 100, 101 AND 107).

FIRST USE 12-1-2009; IN COMMERCE 12-1-2009.

3,808,762. THE FLORIDA GOLF SCHOOL, INC., DBA UNITED STATES GOLF TEACHERS FEDERATION, PORT ST. LUCIE, FL. SN 77-919,425. FILED P.R. 1-25-2010; AM. S.R. 4-29-2010.

THE SENIOR GOLF TOUR USA

THE MARK CONSISTS OF STANDARD CHARACTERS WITHOUT CLAIM TO ANY PARTICULAR FONT, STYLE, SIZE, OR COLOR.

NO CLAIM IS MADE TO THE EXCLUSIVE RIGHT TO USE "SENIOR GOLF TOUR", APART FROM THE MARK AS SHOWN.

FOR ENTERTAINMENT IN THE NATURE OF GOLF TOURNAMENTS (U.S. CLS. 100, 101 AND 107).

FIRST USE 1-28-2010; IN COMMERCE 1-28-2010.

3,808,772. PORT SALERNO COMMERCIAL FISHING DOCK AUTHORITY, INC., PORT SALERNO, FL. SN 77-928,170. FILED P.R. 2-4-2010; AM. S.R. 5-7-2010.

**PORT SALERNO SEAFOOD
FESTIVAL**

THE MARK CONSISTS OF STANDARD CHARACTERS WITHOUT CLAIM TO ANY PARTICULAR FONT, STYLE, SIZE, OR COLOR.

NO CLAIM IS MADE TO THE EXCLUSIVE RIGHT TO USE "SEAFOOD FESTIVAL", APART FROM THE MARK AS SHOWN.

FOR ENTERTAINMENT IN THE NATURE OF A SEAFOOD FESTIVAL (U.S. CLS. 100, 101 AND 107).

FIRST USE 1-1-2007; IN COMMERCE 1-1-2007.

3,808,763. THE FLORIDA GOLF SCHOOL, INC., DBA UNITED STATES GOLF TEACHERS FEDERATION, PORT ST. LUCIE, FL. SN 77-919,431. FILED P.R. 1-25-2010; AM. S.R. 4-29-2010.

**THE PROFESSIONAL GOLF TOUR
USA**

THE MARK CONSISTS OF STANDARD CHARACTERS WITHOUT CLAIM TO ANY PARTICULAR FONT, STYLE, SIZE, OR COLOR.

NO CLAIM IS MADE TO THE EXCLUSIVE RIGHT TO USE "PROFESSIONAL GOLF TOUR", APART FROM THE MARK AS SHOWN.

FOR ENTERTAINMENT IN THE NATURE OF GOLF TOURNAMENTS (U.S. CLS. 100, 101 AND 107).

FIRST USE 1-21-2010; IN COMMERCE 1-21-2010.

3,808,778. NEW MEDIA ARTS TRAINING CENTERS, INC., MADISON, WI. SN 77-937,411. FILED 2-17-2010.

MINNEAPOLIS MEDIA INSTITUTE

THE MARK CONSISTS OF STANDARD CHARACTERS WITHOUT CLAIM TO ANY PARTICULAR FONT, STYLE, SIZE, OR COLOR.

OWNER OF U.S. REG. NO. 3,507,177. NO CLAIM IS MADE TO THE EXCLUSIVE RIGHT TO USE "MEDIA INSTITUTE", APART FROM THE MARK AS SHOWN.

FOR PROVIDING COURSES OF INSTRUCTION AT THE COLLEGE LEVEL (U.S. CLS. 100, 101 AND 107).

FIRST USE 11-1-2009; IN COMMERCE 11-1-2009.

CLASS 42—SCIENTIFIC AND COMPUTER SERVICES

3,808,639. 23ANDME, INC., MOUNTAIN VIEW, CA. SN 77-371,361. FILED P.R. 1-14-2008; AM. S.R. 5-4-2010.

PERSONAL GENOME SERVICE

THE MARK CONSISTS OF STANDARD CHARACTERS WITHOUT CLAIM TO ANY PARTICULAR FONT, STYLE, SIZE, OR COLOR.

NO CLAIM IS MADE TO THE EXCLUSIVE RIGHT TO USE "GENOME SERVICE", APART FROM THE MARK AS SHOWN.

FOR PROVIDING SCIENTIFIC ANALYSIS FEATURING INFORMATIONAL REPORTS BASED UPON RESULTS OF LABORATORY TESTING IN THE FIELD OF GENETICS; APPLICATION SERVICE PROVIDER (ASP) FEATURING SOFTWARE FOR USE IN DATA MANAGEMENT, DATA STORAGE, DATA ANALYSIS, REPORT GENERATION, USER IDENTIFICATION, AND MEMBERSHIP IDENTIFICATION, ALL IN THE FIELDS OF GENETICS AND GENETIC TESTING; SCIENTIFIC RESEARCH IN THE FIELDS OF GENETICS, GENETIC TESTING, GENETIC SCREENING, GENOTYPING, PHENOTYPING, MOLECULAR ANALYTICS, AND ANCESTRY; PROVIDING AN INTERACTIVE WEBSITE FEATURING INFORMATION AND RESEARCH IN THE FIELD OF GENETICS (U.S. CLS. 100 AND 101).

FIRST USE 4-30-2010; IN COMMERCE 4-30-2010.

3,808,643. JEFFEREY BERARDELLI, MIAMI BEACH, FL. SN 77-470,210. FILED P.R. 5-9-2008; AM. S.R. 4-14-2010.

ZoomRadar

THE MARK CONSISTS OF STANDARD CHARACTERS WITHOUT CLAIM TO ANY PARTICULAR FONT, STYLE, SIZE, OR COLOR.

FOR WEATHER INFORMATION SERVICES; MAPPING (U.S. CLS. 100 AND 101).

FIRST USE 5-1-2008; IN COMMERCE 5-1-2008.

CLASS 42—(Continued).

3,808,659. DISCOVERY INSTITUTE OF MEDICAL EDUCATION, INC., CHICAGO, IL. SN 77-621,987. FILED P.R. 11-25-2008; AM. S.R. 3-29-2010.

PerformanceCME

THE MARK CONSISTS OF STANDARD CHARACTERS WITHOUT CLAIM TO ANY PARTICULAR FONT, STYLE, SIZE, OR COLOR.

FOR PROVIDING TEMPORARY USE OF ON-LINE NON-DOWNLOADABLE EDUCATIONAL SOFTWARE FEATURING INSTRUCTION IN THE FIELD OF MEDICINE REGARDING EFFICIENT PLANNING AND DESIGN OF TREATMENT PLANS FOR PATIENTS (U.S. CLS. 100 AND 101).

FIRST USE 1-14-2008; IN COMMERCE 1-1-2009.

3,808,664. GENZYME CORPORATION, CAMBRIDGE, MA. SN 77-643,838. FILED P.R. 1-6-2009; AM. S.R. 5-3-2010.

DESIGN FOR PEPTIDE DELIVERY

THE MARK CONSISTS OF STANDARD CHARACTERS WITHOUT CLAIM TO ANY PARTICULAR FONT, STYLE, SIZE, OR COLOR.

FOR MEDICAL AND SCIENTIFIC RESEARCH IN THE FIELD OF DRUG DELIVERY BASE PREFORMULATION SCREENING AND OPTIMIZATION (U.S. CLS. 100 AND 101).

FIRST USE 5-15-2006; IN COMMERCE 5-15-2006.

CLASS 42—(Continued).

3,808,696. CBS INTERACTIVE INC., NEW YORK, NY. SN 77-783,060. FILED P.R. 7-16-2009; AM. S.R. 4-14-2010.

VERSIONTRACKER

THE MARK CONSISTS OF STANDARD CHARACTERS WITHOUT CLAIM TO ANY PARTICULAR FONT, STYLE, SIZE, OR COLOR.

FOR PROVIDING TEMPORARY USE OF NON-DOWNLOADABLE COMPUTER SOFTWARE FOR ORGANIZING AND MANAGING INVENTORY OF INSTALLED SOFTWARE AND DRIVERS AND MATCHING THE SOFTWARE AND DRIVERS TO A DATABASE VIA THE INTERNET AND FOR USE IN ENHANCING THE INSTALLATION OF SOFTWARE AND DRIVERS, NAMELY, BY PROVIDING REVIEWS AND ADVICE ON SOFTWARE AND DRIVER UPDATES, NOT FOR USE IN A HEALTHCARE FACILITY (U.S. CLS. 100 AND 101).

FIRST USE 1-31-2000; IN COMMERCE 1-31-2000.

3,808,707. LAIHO, SHANNON, PARRISH, FL. SN 77-793,026. FILED P.R. 7-30-2009; AM. S.R. 5-4-2010.

Crewlog

THE MARK CONSISTS OF STANDARD CHARACTERS WITHOUT CLAIM TO ANY PARTICULAR FONT, STYLE, SIZE, OR COLOR.

FOR CREATING AN ON-LINE COMMUNITY FOR YACHT CREW WHERE YACHT CREW CAN TRACK THEIR MILES, FIND THE CURRENT LOCATION OF THEIR FRIENDS, AND SHARE THEIR YACHTING HISTORY VIA AN ON-LINE LOG BOOK (U.S. CLS. 100 AND 101).

FIRST USE 6-12-2009; IN COMMERCE 3-26-2010.

3,808,715. AMERICAN ASSOCIATION OF PHYSICIAN SPECIALISTS, INC., TAMPA, FL. SN 77-796,256. FILED P.R. 8-4-2009; AM. S.R. 4-30-2010.

**American Board of Women's
Medicine**

THE MARK CONSISTS OF STANDARD CHARACTERS WITHOUT CLAIM TO ANY PARTICULAR FONT, STYLE, SIZE, OR COLOR.

OWNER OF U.S. REG. NOS. 2,980,426, 3,539,136, AND OTHERS.

CLASS 42—(Continued).

NO CLAIM IS MADE TO THE EXCLUSIVE RIGHT TO USE "BOARD OF WOMEN'S MEDICINE", APART FROM THE MARK AS SHOWN.

FOR ACCREDITATION SERVICES, NAMELY, DEVELOPING, EVALUATING, AND TESTING STANDARDS FOR PHYSICIANS FOR THE PURPOSE OF ACCREDITATION IN THE FIELD OF WOMEN'S MEDICINE (U.S. CLS. 100 AND 101).

FIRST USE 2-10-2010; IN COMMERCE 2-10-2010.

3,808,753. FOX, DAVID, SYOSSET, NY. SN 77-898,643. FILED P.R. 12-21-2009; AM. S.R. 5-7-2010.

TUNETICKER

THE MARK CONSISTS OF STANDARD CHARACTERS WITHOUT CLAIM TO ANY PARTICULAR FONT, STYLE, SIZE, OR COLOR.

FOR CLOUD COMPUTING FEATURING SOFTWARE FOR THE INSTANT SHARING OF MUSIC PLAYLIST INFORMATION SUCH AS SONG NAME, SONG ARTIST AND SONG GENRE AMONGST FRIENDS AND COLLEAGUES VIA PROGRAMS AND INTERFACES WRITTEN USING A SERIES OF APPLICATION PROGRAMMING INTERFACES (APIS) PROVIDED BY THE SOFTWARE (U.S. CLS. 100 AND 101).

FIRST USE 9-25-2009; IN COMMERCE 10-1-2009.

CLASS 43—HOTEL AND RESTAURANT SERVICES

3,808,629. CHESAPEAKE HOSPITAL AUTHORITY, NORTH CHESAPEAKE, VA. SN 76-700,010. FILED P.R. 10-23-2009; AM. S.R. 5-12-2010.

CHESAPEAKE REGIONAL MEDICAL CENTER

OWNER OF U.S. REG. NOS. 3,596,744 AND 3,671,125.

NO CLAIM IS MADE TO THE EXCLUSIVE RIGHT TO USE "REGIONAL" AND "CENTER", APART FROM THE MARK AS SHOWN.

FOR DAY CARE CENTERS; PROVIDING ELDER CARE (U.S. CLS. 100 AND 101).

FIRST USE 8-15-2007; IN COMMERCE 8-15-2007.

3,808,635. MANHATTAN, LLC, MINNEAPOLIS, MN. SN 77-228,287. FILED 7-12-2007.



NO CLAIM IS MADE TO THE EXCLUSIVE RIGHT TO USE "RESTAURANT & BAR", APART FROM THE MARK AS SHOWN.

THE COLOR(S) WHITE, BLACK AND REDDISH BROWN IS/ARE CLAIMED AS A FEATURE OF THE MARK.

CLASS 43—(Continued).

THE MARK CONSISTS OF WHITE LETTERING ON A BLACK BACKGROUND WITH A REDDISH BROWN WOOD PANEL BACKGROUND.

FOR RESTAURANT AND BAR SERVICES (U.S. CLS. 100 AND 101).

FIRST USE 6-6-2007; IN COMMERCE 6-6-2007.

3,808,636. MANHATTAN, LLC, MINNEAPOLIS, MN. SN 77-228,311. FILED 7-12-2007.

MANHATTANS RESTAURANT & BAR

THE MARK CONSISTS OF STANDARD CHARACTERS WITHOUT CLAIM TO ANY PARTICULAR FONT, STYLE, SIZE, OR COLOR.

NO CLAIM IS MADE TO THE EXCLUSIVE RIGHT TO USE "RESTAURANT & BAR", APART FROM THE MARK AS SHOWN.

FOR RESTAURANT AND BAR SERVICES (U.S. CLS. 100 AND 101).

FIRST USE 6-6-2007; IN COMMERCE 6-6-2007.

CLASS 44—MEDICAL, BEAUTY AND AGRICULTURAL SERVICES

3,808,671. JIFFY PRODUCTS OF AMERICA, INC., NORWALK, OH. SN 77-673,702. FILED 2-19-2009.

Gardener's Helpline

THE MARK CONSISTS OF STANDARD CHARACTERS WITHOUT CLAIM TO ANY PARTICULAR FONT, STYLE, SIZE, OR COLOR.

NO CLAIM IS MADE TO THE EXCLUSIVE RIGHT TO USE "HELPLINE", APART FROM THE MARK AS SHOWN.

FOR CONSULTATION SERVICES IN THE FIELDS OF GARDENING, GARDEN CARE, FLOWER ARRANGING, FLOWER BED CARE, AND GARDEN TREE PLANTING (U.S. CLS. 100 AND 101).

FIRST USE 0-0-1996; IN COMMERCE 0-0-1996.

CLASS 44—(Continued).

3,808,700. ALLIANCE FOR PATIENT MEDICATION SAFETY, RICHMOND, VA. SN 77-786,463. FILED P.R. 7-21-2009; AM. S.R. 4-28-2010.

ALLIANCE FOR PATIENT
MEDICATION SAFETY

THE MARK CONSISTS OF STANDARD CHARACTERS WITHOUT CLAIM TO ANY PARTICULAR FONT, STYLE, SIZE, OR COLOR.

FOR MEDICAL CONSULTING AND EVALUATION SERVICES IN THE FIELD OF MEDICATION ERRORS, MEDICATION USE AND PATIENT CARE; PROVIDING A WEB SITE FEATURING INFORMATION REGARDING REDUCING MEDICATION ERRORS, IMPROVING MEDICATION USE, AND ENHANCING PATIENT CARE (U.S. CLS. 100 AND 101).

FIRST USE 8-0-2008; IN COMMERCE 8-0-2008.

3,808,738. SKIN DIAGNOSTICS GROUP, P.C., BIRMINGHAM, AL. SN 77-860,037. FILED P.R. 10-29-2009; AM. S.R. 4-12-2010.

SKINDX
SKIN DIAGNOSTICS GROUP, PC

NO CLAIM IS MADE TO THE EXCLUSIVE RIGHT TO USE "DIAGNOSTICS GROUP, PC", APART FROM THE MARK AS SHOWN.

THE MARK CONSISTS OF THE WORD, "SKIN" (IN LARGER LETTERS), AND LETTERS, "DX" (IN SMALLER LETTERS), WITH A BOLD HORIZONTAL LINE ABOVE, AND A BOLD HORIZONTAL BOX BELOW CONTAINING THE WORDS, "SKIN DIAGNOSTICS GROUP, PC".

FOR MEDICAL SERVICES, NAMELY, PATHOLOGY SERVICES (U.S. CLS. 100 AND 101).

FIRST USE 12-15-2009; IN COMMERCE 12-15-2009.

CLASS 44—(Continued).

3,808,748. MERIDIAN LIFEFORCE INC., SCARBOROUGH, ONTARIO, CANADA. AND OHENHEN, KINGSLEY, SCARBOROUGH, ONTARIO, CANADA. SN 77-889,153. FILED P.R. 12-9-2009; AM. S.R. 5-7-2010.

Extra Excellence

THE MARK CONSISTS OF STANDARD CHARACTERS WITHOUT CLAIM TO ANY PARTICULAR FONT, STYLE, SIZE, OR COLOR.

FOR CONSULTING SERVICES IN THE FIELDS OF HEALTH AND NUTRITION; COUNSELING SERVICES IN THE FIELDS OF HEALTH, HERBALISM, AND LIFESTYLE WELLNESS; COUNSELING SERVICES IN THE FIELDS OF HEALTH, NUTRITION AND LIFESTYLE WELLNESS; HEALTH CARE SERVICES, NAMELY, WELLNESS PROGRAMS; PROVIDING A WEB SITE FEATURING INFORMATION ON HEALTH AND NUTRITION; PROVIDING A WEBSITE FEATURING INFORMATION CONCERNING ALTERNATIVE HEALTH AND HEALING; PROVIDING HEALTH CARE INFORMATION BY TELEPHONE AND THE INTERNET; PROVIDING WELLNESS SERVICES, NAMELY, PERSONAL ASSESSMENTS, PERSONALIZED ROUTINES, MAINTENANCE SCHEDULES, AND COUNSELING; WELLNESS AND HEALTH-RELATED CONSULTING SERVICES (U.S. CLS. 100 AND 101).

FIRST USE 7-17-2005; IN COMMERCE 7-17-2005.

3,808,749. GARRAMONE, CHARLES, SUNRISE, FL. SN 77-891,361. FILED P.R. 12-11-2009; AM. S.R. 5-4-2010.

FTM Top Surgery

THE MARK CONSISTS OF STANDARD CHARACTERS WITHOUT CLAIM TO ANY PARTICULAR FONT, STYLE, SIZE, OR COLOR.

NO CLAIM IS MADE TO THE EXCLUSIVE RIGHT TO USE "SURGERY", APART FROM THE MARK AS SHOWN. FOR COSMETIC AND PLASTIC SURGERY (U.S. CLS. 100 AND 101).

FIRST USE 2-13-2006; IN COMMERCE 2-13-2006.

CLASS 44—(Continued).

3,808,761. JASTER, BRENT, DENVER, CO. SN 77-917,446. FILED P.R. 1-21-2010; AM. S.R. 4-28-2010.

JASTER HEALTH

THE MARK CONSISTS OF STANDARD CHARACTERS WITHOUT CLAIM TO ANY PARTICULAR FONT, STYLE, SIZE, OR COLOR.

NO CLAIM IS MADE TO THE EXCLUSIVE RIGHT TO USE "HEALTH", APART FROM THE MARK AS SHOWN.

FOR WELLNESS AND HEALTH-RELATED CONSULTING SERVICES (U.S. CLS. 100 AND 101).

FIRST USE 4-27-2004; IN COMMERCE 5-29-2009.

CLASS 45—PERSONAL AND LEGAL SERVICES

3,808,648. TRUEBEGINNINGS, LLC, IRVING, TX. SN 77-549,771. FILED P.R. 8-18-2008; AM. S.R. 10-22-2009.

THE MATCHING EXPERTS

THE MARK CONSISTS OF STANDARD CHARACTERS WITHOUT CLAIM TO ANY PARTICULAR FONT, STYLE, SIZE, OR COLOR.

NO CLAIM IS MADE TO THE EXCLUSIVE RIGHT TO USE "MATCHING", APART FROM THE MARK AS SHOWN.

FOR COMPUTER DATING SERVICES; DATING SERVICES; INVESTIGATION OR SURVEILLANCE ON BACKGROUND PROFILES; MATCHMAKING SERVICES; ON-LINE SOCIAL NETWORKING SERVICES; PROVIDING INFORMATION IN THE FIELD OF SELF-IMPROVEMENT; VIDEO DATING SERVICES (U.S. CLS. 100 AND 101).

FIRST USE 7-20-2008; IN COMMERCE 7-20-2008.

3,808,654. INTERCESSIONS WORD MINISTRY, INC., ROYAL OAK, MI. SN 77-604,966. FILED P.R. 10-31-2008; AM. S.R. 5-7-2010.

RECONCILIATION WORD MINISTRY

THE MARK CONSISTS OF STANDARD CHARACTERS WITHOUT CLAIM TO ANY PARTICULAR FONT, STYLE, SIZE, OR COLOR.

CLASS 45—(Continued).

NO CLAIM IS MADE TO THE EXCLUSIVE RIGHT TO USE "MINISTRY", APART FROM THE MARK AS SHOWN.

FOR MINISTERIAL AND EVANGELISTIC SERVICES, NAMELY, PREACHING BIBLE-BASED SERMONS AND CHRISTIAN-THEMED MESSAGES, CONDUCTING RELIGIOUS WORSHIP SERVICES, CONDUCTING BIBLE STUDIES, CONDUCTING PRAYER MEETINGS, CONDUCTING REVIVAL MEETINGS, SPEAKING AT PASTORAL CONFERENCES, PROVIDING GUEST-PASTOR SPEAKING SERVICES, CONDUCTING WEDDING, FUNERAL, COMMUNION, AND/OR BAPTISMAL SERVICES, PROVIDING SPIRITUAL AND BIBLE-BASED PERSONAL SOCIAL COUNSELING, PROVIDING MARRIAGE AND FAMILY COUNSELING, PROVIDING COUNSELING FOR RESTORING CHRISTIAN CONDUCT IN INTERPERSONAL RELATIONSHIPS, PROVIDING DIVORCE RECOVERY ASSISTANCE, PROVIDING GRIEF RECOVERY ASSISTANCE, PROVIDING ASSISTANCE IN ALCOHOL OR DRUG ABUSE RECOVERY IN THE NATURE OF SPIRITUAL GUIDANCE, MENTORING YOUTH IN THE NATURE OF PROVIDING SPIRITUAL GUIDANCE, MINISTERING TO THE POOR AND NEEDY THROUGH DONATIONS OF FOOD AND/OR CLOTHING FOR THE PURPOSE OF SPREADING THE GOSPEL AND PROPAGATING THE CHRISTIAN FAITH, PROVIDING BIBLES AND CHRISTIAN LITERATURE, PROVIDING HOME, HOSPITAL, AND/OR PRISON VISITATION SERVICES, CONDUCTING SPIRITUAL AND/OR MORAL ACCOUNTABILITY GROUPS, AND PROVIDING ASSISTANCE IN THE ASSESSMENT OF SPIRITUAL GIFTS (U.S. CLS. 100 AND 101).

FIRST USE 1-1-2007; IN COMMERCE 1-1-2007.

CLASS 45—(Continued).

3,808,657. BENETECH, INC., MONTGOMERY, IL. SN 77-616,715. FILED P.R. 11-18-2008; AM. S.R. 10-11-2009.

PLANT PROFESSIONALS

THE MARK CONSISTS OF STANDARD CHARACTERS WITHOUT CLAIM TO ANY PARTICULAR FONT, STYLE, SIZE, OR COLOR.

FOR REVIEWING STANDARDS AND PRACTICES TO ASSURE COMPLIANCE WITH MATERIAL HANDLING, PLANT OPERATION, COMBUSTIBLE DUST CONTROL LAWS AND REGULATIONS FOR POWER PLANTS; CONSULTING IN THE FIELD OF POWER PLANT WORKPLACE SAFETY; INSPECTION OF FACTORIES FOR SAFETY PURPOSES (U.S. CLS. 100 AND 101).

FIRST USE 4-1-2008; IN COMMERCE 4-1-2008.

3,808,746. IPUSA, PLLC, WASHINGTON, DC. SN 77-880,861. FILED P.R. 11-25-2009; AM. S.R. 5-13-2010.

IPUSA

THE MARK CONSISTS OF STANDARD CHARACTERS WITHOUT CLAIM TO ANY PARTICULAR FONT, STYLE, SIZE, OR COLOR.

FOR PATENT AGENT SERVICES; PATENT AND INDUSTRIAL PROPERTY CONSULTATION; INTELLECTUAL PROPERTY CONSULTATION; INTELLECTUAL PROPERTY WATCH SERVICES; LICENSING OF INTELLECTUAL PROPERTY; PROVIDING INFORMATION ABOUT INTELLECTUAL AND INDUSTRIAL PROPERTY RIGHTS; LEGAL SERVICES, NAMELY, PREPARATION OF APPLICATIONS FOR TRADEMARK REGISTRATION; LEGAL SERVICES, NAMELY, TRADEMARK MAINTENANCE SERVICES; PROVIDING ASSISTANCE IN THE PROSECUTION OF TRADEMARK APPLICATIONS (U.S. CLS. 100 AND 101).

FIRST USE 4-9-2008; IN COMMERCE 4-9-2008.

* * * * *

PRIOR UNITED STATES CLASSIFICATION

APPLICATION IN ONE CLASS

CERTIFICATION MARKS

CLASS A—GOODS

3,808,681. NSF INTERNATIONAL, ANN ARBOR, MI. SN 77-748,553. FILED P.R. 6-1-2009; AM. S.R. 5-5-2010.

NO CLAIM IS MADE TO THE EXCLUSIVE RIGHT TO USE "CERTIFIED", APART FROM THE MARK AS SHOWN.

THE CERTIFICATION MARK, AS USED BY AUTHORIZED PERSONS, CERTIFIES THAT THE GOODS PROVIDED CONFORM TO PUBLIC HEALTH AND ENVIRONMENTAL QUALITY STANDARDS, REGULATIONS, AND SPECIFICATIONS SET FORTH BY THE CERTIFIER.

FOR DIETARY SUPPLEMENTS; FUNCTIONAL FOODS; NUTRITIONAL PRODUCTS (U.S. CL. A).
FIRST USE 4-14-2006; IN COMMERCE 4-14-2006.

CERTIFIED FOR SPORT

THE MARK CONSISTS OF STANDARD CHARACTERS WITHOUT CLAIM TO ANY PARTICULAR FONT, STYLE, SIZE, OR COLOR.

* * * * *

TRADEMARK REGISTRATIONS RENEWED

The designation "U.S. Cl." appearing in this section refers to the U.S. class in effect prior to Sep. 1, 1973 rather than the international class which applies to applications filed on or after that date. For adoption of international classification see notice in the OFFICIAL GAZETTE of Jun. 26, 1973 (911 O.G. TM 210).

- | | | | |
|----------|--|------------|---|
| 133,047. | STERLING (STYLIZED). U.S. CL. 21. (INT. CL. 17). REG. 7-6-1920. | 891,325. | MISCELLANEOUS DESIGN. U.S. CL. 46. (INT. CLS. 1, 5, 29, 30, 31 AND 32). REG. 5-19-1970. |
| 270,786. | NEWSPAPERDOM (STYLIZED). U.S. CL. 38. (INT. CL. 16). REG. 5-13-1930. | 891,390. | COMPU SEARCH. U.S. CL. 101. (INT. CL. 35). REG. 5-19-1970. |
| 270,787. | THE PHILADELPHIA INQUIRER (STYLIZED). U.S. CL. 38. (INT. CL. 16). REG. 5-13-1930. | 891,674. | CORY. U.S. CL. 46. (INT. CL. 30). REG. 5-26-1970. |
| 373,159. | THE ASSOCIATED GENERAL CONTRACTORS OF AMERICA AGCA AND DESIGN. U.S. CL. 38. (INT. CLS. 9, 16 AND 28). REG. 11-28-1939. | 891,729. | TURTLE CREEK. U.S. CL. 101. (INT. CLS. 35, 36, 38, 41 AND 42). REG. 5-26-1970. |
| 378,389. | WHO'S WHO IN AMERICA (STYLIZED). U.S. CL. 38. (INT. CL. 16). REG. 6-11-1940. | 892,042. | PERFORMER. U.S. CL. 35. (INT. CL. 17). REG. 6-2-1970. |
| 378,705. | MISCELLANEOUS DESIGN. U.S. CL. 4. (INT. CL. 3). REG. 6-18-1940. | 895,466. | VAUGHAN (STYLIZED). U.S. CL. 23. (INT. CL. 8). REG. 7-28-1970. |
| 525,085. | BACTINE (STYLIZED). U.S. CL. 18. (INT. CL. 5). REG. 5-9-1950. | 897,699. | PABAC. U.S. CL. 18. (INT. CL. 5). REG. 9-1-1970. |
| 526,917. | GD (STYLIZED). U.S. CL. 6. (INT. CL. 1). REG. 6-27-1950. | 899,235. | ASTERIX. U.S. CL. 38. (INT. CL. 16). REG. 9-22-1970. |
| 686,586. | DATSUN. U.S. CL. 19. (INT. CLS. 7, 12, 22 AND 27). REG. 10-13-1959. | 899,900. | MARRIOTT. U.S. CL. 100. (INT. CL. 42). REG. 9-29-1970. |
| 688,149. | SUPERCLEAR. U.S. CL. 6. (INT. CLS. 1 AND 2). REG. 11-17-1959. | 905,886. | LEUPOLD. U.S. CL. 26. (INT. CL. 13). REG. 1-12-1971. |
| 697,138. | "THE PINK SHEET". U.S. CL. 38. (INT. CL. 16). REG. 5-3-1960. | 1,131,264. | KURODA. INT. CL. 9. (U.S. CL. 21). REG. 2-26-1980. |
| 697,326. | POWER-POINT. U.S. CL. 9. (INT. CL. 13). REG. 5-10-1960. | 1,131,542. | COLD-MOUNT (STYLIZED). INT. CLS. 1, 7 AND 16. (U.S. CLS. 5, 23 AND 37). REG. 3-11-1980. |
| 697,713. | FEL-O-VAX. U.S. CL. 18. (INT. CL. 5). REG. 5-17-1960. | 1,134,920. | VIBRACURE. INT. CL. 1. (U.S. CL. 6). REG. 5-13-1980. |
| 697,721. | TRUCKWELD (STYLIZED). U.S. CL. 19. (INT. CLS. 7, 12, 22 AND 27). REG. 5-17-1960. | 1,134,926. | PROCAT. INT. CL. 1. (U.S. CL. 6). REG. 5-13-1980. |
| 697,743. | TRILENE. U.S. CL. 22. (INT. CLS. 16, 18, 20, 22, 25 AND 28). REG. 5-17-1960. | 1,134,975. | SMOOTH-TEX. INT. CL. 6. (U.S. CL. 13). REG. 5-13-1980. |
| 697,773. | VMC. U.S. CL. 23. (INT. CL. 7). REG. 5-17-1960. | 1,135,046. | TACC. INT. CL. 9. (U.S. CL. 21). REG. 5-13-1980. |
| 698,893. | DAIHATSU (STYLIZED). U.S. CL. 19. (INT. CLS. 7, 12, 22 AND 27). REG. 6-7-1960. | 1,135,155. | NAUTA. INT. CL. 20. (U.S. CL. 2). REG. 5-13-1980. |
| 699,023. | BNA AND DESIGN. U.S. CL. 38. (INT. CL. 16). REG. 6-7-1960. | 1,135,161. | NANIK. INT. CL. 20. (U.S. CL. 32). REG. 5-13-1980. |
| 700,821. | DIMETAPP. U.S. CL. 18. (INT. CL. 5). REG. 7-12-1960. | 1,135,196. | MISCELLANEOUS DESIGN. INT. CL. 25. (U.S. CLS. 22 AND 39). REG. 5-13-1980. |
| 700,835. | PANOLOG. U.S. CL. 18. (INT. CL. 5). REG. 7-12-1960. | 1,135,339. | CHANNEL. INT. CL. 42. (U.S. CL. 101). REG. 5-13-1980. |
| 702,654. | SOLUSET. U.S. CL. 44. (INT. CL. 10). REG. 8-9-1960. | 1,135,378. | DRIL BOX AND DESIGN. INT. CL. 6. (U.S. CL. 2). REG. 5-13-1980. |
| 704,008. | CHAMPS ELYSEE (STYLIZED). U.S. CL. 39. (INT. CL. 25). REG. 9-6-1960. | 1,135,448. | PIG GOLD. INT. CL. 5. (U.S. CL. 18). REG. 5-20-1980. |
| 709,543. | ALLEREST. U.S. CL. 18. (INT. CL. 5). REG. 1-10-1961. | 1,135,455. | NOLVALUBE. INT. CL. 5. (U.S. CL. 18). REG. 5-20-1980. |
| 709,731. | SUNSHINE. U.S. CL. 46. (INT. CLS. 1, 5, 29, 30, 31 AND 32). REG. 1-10-1961. | 1,135,489. | T AND DESIGN. INT. CL. 6. (U.S. CL. 13). REG. 5-20-1980. |
| 714,075. | BACID (STYLIZED). U.S. CL. 18. (INT. CL. 5). REG. 4-18-1961. | 1,135,512. | METROLINER. INT. CL. 7. (U.S. CL. 23). REG. 5-20-1980. |
| 880,665. | CARGILL. U.S. CL. 105. (INT. CL. 39). REG. 11-11-1969. | 1,135,594. | CRESSI-SUB (STYLIZED). INT. CLS. 9, 25 AND 28. (U.S. CLS. 22, 26 AND 39). REG. 5-20-1980. |
| 880,734. | STYROPAKE. U.S. CL. 11. (INT. CL. 2). REG. 11-18-1969. | 1,137,437. | DEXTER (STYLIZED). INT. CL. 25. (U.S. CL. 39). REG. 7-1-1980. |
| 885,294. | TURBO-CASCADE. U.S. CL. 13. (INT. CL. 6). REG. 2-3-1970. | 1,138,210. | SPLASHPROOF. INT. CL. 7. (U.S. CL. 23). REG. 7-29-1980. |
| 888,422. | DW AND DESIGN. U.S. CL. 100. (INT. CL. 42). REG. 3-24-1970. | 1,138,809. | "DUAL MIRROR" (STYLIZED). INT. CL. 24. (U.S. CL. 42). REG. 8-19-1980. |
| 890,766. | TDW AND DESIGN. U.S. CLS. 13 AND 23. (INT. CLS. 6, 7 AND 17). REG. 5-12-1970. | 1,147,815. | USAIG UNITED STATES AIRCRAFT INSURANCE GROUP (STYLIZED). INT. CL. 36. (U.S. CLS. 100, 101 AND 102). REG. 2-24-1981. |
| 890,855. | GEROLER. U.S. CL. 23. (INT. CL. 7). REG. 5-12-1970. | 1,150,254. | MODEL 919. INT. CL. 9. (U.S. CL. 26). REG. 4-7-1981. |
| 890,990. | POLAR FROST. U.S. CL. 46. (INT. CL. 30). REG. 5-12-1970. | 1,150,839. | BEAR CLAW. INT. CL. 8. (U.S. CL. 23). REG. 4-14-1981. |
| 891,053. | BEAUTI LAC. U.S. CL. 51. (INT. CL. 3). REG. 5-12-1970. | 1,151,033. | ISSHP. INT. CL. 16. (U.S. CL. 38). REG. 4-14-1981. |
| 891,082. | WHATABURGER (STYLIZED). U.S. CL. 100. (INT. CL. 42). REG. 5-12-1970. | 1,152,395. | NATIONAL GEOGRAPHIC AND DESIGN. INT. CL. 16. (U.S. CL. 38). REG. 4-28-1981. |
| 891,131. | GROEN. U.S. CLS. 2, 23 AND 34 ONLY. (INT. CLS. 6, 7 AND 11). REG. 5-19-1970. | 1,153,498. | INNER CIRCLE PIZZA AND DESIGN. INT. CL. 42. (U.S. CL. 100). REG. 5-5-1981. |
| | | 1,529,356. | MISCELLANEOUS DESIGN. INT. CL. 8. (U.S. CLS. 23 AND 28). REG. 3-14-1989. |
| | | 1,531,672. | MISCELLANEOUS DESIGN. INT. CL. 8. (U.S. CLS. 23 AND 28). REG. 3-28-1989. |

- 1,565,563. BELL. INT. CLS. 16, 35 AND 38 ONLY. (U.S. CLS. 2, 5, 22, 23, 29, 37, 38, 50, 101 AND 104). REG. 11-14-1989.
- 1,565,916. LINCOLN SEAL. INT. CL. 17. (U.S. CL. 12). REG. 11-14-1989.
- 1,566,161. MRRIB AND DESIGN. INT. CL. 29. (U.S. CL. 46). REG. 11-14-1989.
- 1,568,118. PERFORMANCE RECORDINGS. INT. CL. 9. (U.S. CLS. 21, 23, 26, 36 AND 38). REG. 11-28-1989.
- 1,569,851. ELMER LITTLE. INT. CL. 25. (U.S. CL. 39). REG. 12-5-1989.
- 1,569,852. ELMER LITTLE AND DESIGN. INT. CL. 25. (U.S. CL. 39). REG. 12-5-1989.
- 1,570,391. MISCELLANEOUS DESIGN. INT. CL. 42. (U.S. CL. 100). REG. 12-5-1989.
- 1,574,151. IMS. INT. CLS. 2, 3 AND 4. (U.S. CLS. 4, 6, 15, 16 AND 52). REG. 1-2-1990.
- 1,576,402. GRID-LOK. INT. CL. 20. (U.S. CL. 32). REG. 1-9-1990.
- 1,577,432. FORTUNA RECORDS. INT. CL. 9. (U.S. CLS. 21, 23, 26, 36 AND 38). REG. 1-16-1990.
- 1,581,248. EZBARCODE. INT. CL. 9. (U.S. CLS. 26 AND 38). REG. 2-6-1990.
- 1,582,256. DIAMOND JET. INT. CL. 7. (U.S. CL. 23). REG. 2-13-1990.
- 1,587,707. MISCELLANEOUS DESIGN. INT. CLS. 16, 21, 28 AND 42. (U.S. CLS. 2, 22, 37, 38, 100 AND 107). REG. 3-20-1990.
- 1,590,089. FARAON AND DESIGN. INT. CL. 30. (U.S. CL. 46). REG. 4-3-1990.
- 1,590,749. MINI-FIN. INT. CL. 11. (U.S. CL. 34). REG. 4-10-1990.
- 1,594,924. CAP CODES. INT. CL. 9. (U.S. CL. 26). REG. 5-8-1990.
- 1,595,041. QUADPLEX. INT. CL. 9. (U.S. CL. 21). REG. 5-8-1990.
- 1,595,106. MISCELLANEOUS DESIGN. INT. CL. 9. (U.S. CL. 21). REG. 5-8-1990.
- 1,595,146. EXB. INT. CL. 9. (U.S. CLS. 21, 23, 26, 36 AND 38). REG. 5-8-1990.
- 1,595,284. TREACYFACES. INT. CLS. 16 AND 42. (U.S. CLS. 14, 38, 100 AND 101). REG. 5-8-1990.
- 1,595,451. OSBORNE & LITTLE. INT. CLS. 24 AND 27. (U.S. CLS. 38 AND 42). REG. 5-8-1990.
- 1,595,605. GRADUATES. INT. CL. 32 ONLY. (U.S. CL. 46). REG. 5-8-1990.
- 1,595,814. MISCELLANEOUS DESIGN. INT. CL. 42. (U.S. CL. 100). REG. 5-8-1990.
- 1,595,887. ENERGEAR. INT. CL. 4 ONLY. (U.S. CLS. 1, 6 AND 15). REG. 5-15-1990.
- 1,595,897. PHARMATOSE. INT. CLS. 1 AND 5. (U.S. CLS. 6 AND 18). REG. 5-15-1990.
- 1,596,094. SS SSANGYONG (STYLIZED). INT. CL. 7. (U.S. CL. 23). REG. 5-15-1990.
- 1,596,117. ZEBRA THAILAND AND DESIGN. INT. CLS. 8 AND 21. (U.S. CLS. 2, 13, 23 AND 30). REG. 5-15-1990.
- 1,596,132. WOODSTOCK. INT. CL. 9. (U.S. CLS. 36 AND 38). REG. 5-15-1990.
- 1,596,207. AUTO-MATT. INT. CL. 10. (U.S. CL. 44). REG. 5-15-1990.
- 1,596,213. DFS. INT. CL. 10. (U.S. CL. 44). REG. 5-15-1990.
- 1,596,216. THREE-D ORTHOPEDIC, INC.. INT. CL. 10. (U.S. CL. 44). REG. 5-15-1990.
- 1,596,268. TOUR EASE. INT. CL. 12. (U.S. CLS. 19, 21, 23, 31, 35 AND 44). REG. 5-15-1990.
- 1,596,274. QUINTANA ROO. INT. CL. 12. (U.S. CL. 19). REG. 5-15-1990.
- 1,596,305. KORLOFF. INT. CL. 14. (U.S. CL. 28). REG. 5-15-1990.
- 1,596,392. LAS. INT. CL. 16. (U.S. CL. 38). REG. 5-15-1990.
- 1,596,405. TRANSPACKER. INT. CL. 16. (U.S. CL. 2). REG. 5-15-1990.
- 1,596,497. AZURLITE. INT. CL. 21. (U.S. CL. 33). REG. 5-15-1990.
- 1,596,520. BARNIE'S COFFEE & TEA COMPANY. INT. CL. 25. (U.S. CL. 39). REG. 5-15-1990.
- 1,596,708. INSTA*STARCH. INT. CL. 30. (U.S. CL. 46). REG. 5-15-1990.
- 1,596,726. OPTICARB (STYLIZED). INT. CL. 32. (U.S. CL. 45). REG. 5-15-1990.
- 1,596,734. RON PONTALBA. INT. CL. 33. (U.S. CLS. 47 AND 49). REG. 5-15-1990.
- 1,596,752. ACCOUNTING RESOURCES. INT. CL. 35. (U.S. CL. 101). REG. 5-15-1990.
- 1,596,838. THE WATER EXPERTS. INT. CL. 40 ONLY. (U.S. CL. 106). REG. 5-15-1990.
- 1,596,912. PACIFIC ARCHITECTS AND ENGINEERS INCORPORATED. INT. CL. 42. (U.S. CL. 100). REG. 5-15-1990.
- 1,597,013. HOSTALUX. INT. CL. 1. (U.S. CL. 6). REG. 5-22-1990.
- 1,597,123. MCT FUEL. INT. CL. 5. (U.S. CL. 18). REG. 5-22-1990.
- 1,597,155. IMP. INT. CL. 6. (U.S. CL. 14). REG. 5-22-1990.
- 1,597,170. MOLDMAX. INT. CL. 6. (U.S. CL. 14). REG. 5-22-1990.
- 1,597,260. HYGROMER. INT. CL. 9. (U.S. CL. 26). REG. 5-22-1990.
- 1,597,307. TUFF CUFF. INT. CL. 10. (U.S. CL. 44). REG. 5-22-1990.
- 1,597,652. AUNT JANE'S (STYLIZED). INT. CLS. 29 AND 30. (U.S. CL. 46). REG. 5-22-1990.
- 1,598,020. MARLO THERM. INT. CL. 1. (U.S. CL. 6). REG. 5-29-1990.
- 1,598,173. CODE-A-WASH. INT. CLS. 7 AND 9. (U.S. CLS. 23 AND 26). REG. 5-29-1990.
- 1,598,234. PGA TOUR. INT. CL. 9. (U.S. CL. 21). REG. 5-29-1990.
- 1,598,487. BLAZING SKIES. INT. CL. 13. (U.S. CL. 9). REG. 5-29-1990.
- 1,598,488. COLORFUL DELIGHT. INT. CL. 13. (U.S. CL. 9). REG. 5-29-1990.
- 1,598,690. BOBCAT. INT. CL. 25. (U.S. CL. 39). REG. 5-29-1990.
- 1,599,028. ANNIE'S. INT. CL. 42. (U.S. CL. 101). REG. 5-29-1990.
- 1,599,106. BIO CLEAN AND DESIGN. INT. CL. 3. (U.S. CLS. 1, 4, 6, 50, 51 AND 52). REG. 6-5-1990.
- 1,599,356. IBR. INT. CLS. 9 AND 42. (U.S. CLS. 21, 23, 26, 36, 38, 100 AND 101). REG. 6-5-1990.
- 1,599,566. WHO'S WHO IN ENTERTAINMENT. INT. CL. 16. (U.S. CL. 38). REG. 6-5-1990.
- 1,600,330. ELECTROLYTEGOLD. INT. CL. 5. (U.S. CL. 18). REG. 6-12-1990.
- 1,600,410. MISCELLANEOUS DESIGN. INT. CL. 9. (U.S. CLS. 21 AND 23). REG. 6-12-1990.
- 1,600,416. PGA TOUR AND DESIGN. INT. CL. 9. (U.S. CL. 21). REG. 6-12-1990.
- 1,600,583. V AND DESIGN. INT. CL. 9. (U.S. CL. 26). REG. 6-12-1990.
- 1,601,210. KENTUCKY SILK PIE. INT. CL. 30. (U.S. CL. 46). REG. 6-12-1990.
- 1,601,702. HEALTH INDUSTRY BUSINESS COMMUNICATIONS COUNCIL. INT. CL. 42. (U.S. CL. 100). REG. 6-12-1990.
- 1,601,725. POWERLITE. INT. CL. 1. (U.S. CLS. 6 AND 15). REG. 6-19-1990.
- 1,601,767. NSI. INT. CL. 3. (U.S. CLS. 1, 4, 6, 50, 51 AND 52). REG. 6-19-1990.
- 1,602,016. KOSS. INT. CL. 9. (U.S. CLS. 21, 23, 26, 36 AND 38). REG. 6-19-1990.
- 1,602,289. ENVELON (STYLIZED). INT. CL. 17. (U.S. CL. 35). REG. 6-19-1990.
- 1,602,724. 101 AND DESIGN. INT. CL. 35. (U.S. CLS. 100, 101 AND 102). REG. 6-19-1990.
- 1,603,100. CRITERIUM (STYLIZED). INT. CL. 42. (U.S. CL. 100). REG. 6-19-1990.
- 1,603,238. SPORT & HEALTH CLUBS AND DESIGN. INT. CL. 41. (U.S. CL. 107). REG. 6-19-1990.
- 1,603,311. ROSA VENUS. INT. CL. 3. (U.S. CL. 52). REG. 6-26-1990.
- 1,603,616. OMEGAFLEX. INT. CL. 11. (U.S. CL. 13). REG. 6-26-1990.
- 1,603,706. TIGHT SPOT. INT. CL. 16. (U.S. CL. 29). REG. 6-26-1990.
- 1,603,747. MAFTEC. INT. CL. 17. (U.S. CL. 35). REG. 6-26-1990.
- 1,604,074. WHEATON WORLD WIDE MOVING (STYLIZED). INT. CL. 39. (U.S. CL. 105). REG. 6-26-1990.
- 1,604,960. LAGONDA. INT. CL. 37. (U.S. CL. 103). REG. 7-3-1990.
- 1,605,427. MISCELLANEOUS DESIGN. INT. CL. 12. (U.S. CLS. 19 AND 23). REG. 7-10-1990.
- 1,606,164. CALLXPRESS. INT. CLS. 9 AND 16. (U.S. CLS. 26 AND 38). REG. 7-17-1990.

- 1,606,320. WORLD WIND. INT. CL. 11. (U.S. CL. 44). REG. 7-17-1990.
- 1,607,327. HAWAII CALLS. INT. CL. 9. (U.S. CL. 36). REG. 7-24-1990.
- 1,608,007. REALITY (STYLIZED). INT. CL. 10 ONLY. (U.S. CLS. 26, 39 AND 44). REG. 7-31-1990.
- 1,608,031. RISCO AND DESIGN. INT. CL. 7. (U.S. CL. 23). REG. 7-31-1990.
- 1,608,394. CENTRAL GROCERY'S. INT. CL. 29. (U.S. CL. 46). REG. 7-31-1990.
- 1,608,525. CULVER (STYLIZED). INT. CL. 41. (U.S. CL. 107). REG. 7-31-1990.
- 1,609,141. SS STUNNER (STYLIZED). INT. CL. 24. (U.S. CL. 42). REG. 8-7-1990.
- 1,610,251. ACT-100 AND DESIGN. U.S. CL. A. REG. 8-14-1990.
- 1,610,987. MISCELLANEOUS DESIGN. INT. CL. 3. (U.S. CL. 6). REG. 8-28-1990.
- 1,612,598. UNICARE. INT. CL. 5. (U.S. CL. 18). REG. 9-11-1990.
- 1,613,177. WARRIOR. INT. CL. 33. (U.S. CL. 47). REG. 9-11-1990.
- 1,614,136. NIMROD. INT. CL. 33. (U.S. CL. 47). REG. 9-18-1990.
- 1,615,455. INCRA. INT. CL. 8. (U.S. CL. 23). REG. 10-2-1990.
- 1,615,583. PSL. INT. CL. 10. (U.S. CL. 44). REG. 10-2-1990.
- 1,615,828. SADDLE KING WESTERN. INT. CL. 25. (U.S. CL. 39). REG. 10-2-1990.
- 1,616,961. HAWAII'S OWN. INT. CL. 32. (U.S. CL. 45). REG. 10-9-1990.
- 1,623,195. BRIGHTBOY AND DESIGN. INT. CLS. 3 AND 7. (U.S. CLS. 4 AND 23). REG. 11-20-1990.
- 1,623,271. SAFETEE DONUT. INT. CL. 6. (U.S. CLS. 23 AND 25). REG. 11-20-1990.
- 1,623,867. TADIN AND DESIGN. INT. CL. 30. (U.S. CL. 46). REG. 11-20-1990.
- 1,623,876. ANDREWS. INT. CL. 30. (U.S. CL. 46). REG. 11-20-1990.
- 1,624,559. UFO. INT. CL. 9. (U.S. CL. 21). REG. 11-27-1990.
- 1,626,928. BAIR HUGGER AND DESIGN. INT. CL. 10. (U.S. CL. 44). REG. 12-11-1990.
- 1,629,800. MAR-V-CIDE. INT. CL. 5. (U.S. CLS. 6 AND 18). REG. 1-1-1991.
- 1,631,868. LOVE FUND. INT. CL. 36. (U.S. CL. 102). REG. 1-15-1991.
- 1,632,069. 555. INT. CL. 1. (U.S. CL. 10). REG. 1-22-1991.
- 1,633,011. JD EDWARDS. INT. CL. 9. (U.S. CL. 38). REG. 1-29-1991.
- 1,638,521. MISCELLANEOUS DESIGN. INT. CL. 32 ONLY. (U.S. CLS. 45, 46 AND 48). REG. 3-19-1991.
- 1,640,872. AMERITURF AND DESIGN. INT. CL. 42. (U.S. CLS. 100 AND 103). REG. 4-9-1991.
- 1,640,951. HOT WRAPS. INT. CL. 30. (U.S. CL. 46). REG. 4-9-1991.
- 1,641,011. EAGLE AND DESIGN. INT. CL. 5. (U.S. CLS. 6, 18, 44, 46, 51 AND 52). REG. 4-16-1991.
- 1,641,051. POLY LIFT. INT. CL. 7. (U.S. CLS. 13, 19, 21, 23, 31, 34 AND 35). REG. 4-16-1991.
- 1,641,510. ADDRESSMATCH. INT. CL. 35. (U.S. CLS. 101 AND 104). REG. 4-16-1991.
- 1,641,756. ACCU-COUNT. INT. CL. 31. (U.S. CL. 1). REG. 4-16-1991.
- 1,643,537. PARCAR. INT. CL. 12. (U.S. CL. 19). REG. 5-7-1991.
- 1,644,153. BARAMIX. INT. CL. 1. (U.S. CL. 6). REG. 5-14-1991.
- 1,644,495. THE RIDER TAROT DECK. INT. CL. 28. (U.S. CLS. 22 AND 38). REG. 5-14-1991.
- 2,043,638. RE-FREEZ-R-BRIX. INT. CL. 1. (U.S. CLS. 1, 5, 6, 10, 26 AND 46). REG. 3-11-1997.
- 2,197,665. CELPAD. INT. CL. 16. (U.S. CLS. 2, 5, 22, 23, 29, 37, 38 AND 50). REG. 10-20-1998.
- 2,227,285. PTC. INT. CLS. 9, 16 AND 38. (U.S. CLS. 2, 5, 21, 22, 23, 26, 29, 36, 37, 38, 50, 100, 101 AND 104). REG. 3-2-1999.
- 2,240,092. ZIVERSYS ZIV APLICACIONES Y TECNOLOGIA, S.A. AND DESIGN. INT. CLS. 9, 37 AND 42. (U.S. CLS. 21, 23, 26, 36, 38, 100, 101, 103 AND 106). REG. 4-20-1999.
- 2,246,677. AMERICAN SPIRIT ARMS. INT. CL. 13. (U.S. CLS. 2 AND 9). REG. 5-18-1999.
- 2,261,832. ON-HIT RECORDS AND DESIGN. INT. CL. 9. (U.S. CLS. 21, 23, 26, 36 AND 38). REG. 7-20-1999.
- 2,287,618. LUMIJET. INT. CL. 16. (U.S. CLS. 2, 5, 22, 23, 29, 37, 38 AND 50). REG. 10-19-1999.
- 2,291,898. MISCELLANEOUS DESIGN. INT. CL. 25. (U.S. CLS. 22 AND 39). REG. 11-16-1999.
- 2,291,940. AMERICAN STONEHENGE AND DESIGN. INT. CL. 37. (U.S. CLS. 100, 103 AND 106). REG. 11-16-1999.
- 2,293,709. FAT CHANCE. INT. CLS. 16 AND 28. (U.S. CLS. 2, 5, 22, 23, 29, 37, 38 AND 50). REG. 11-16-1999.
- 2,294,021. ULTRA VENT. INT. CL. 11. (U.S. CLS. 13, 21, 23, 31 AND 34). REG. 11-23-1999.
- 2,294,109. COLLINS. INT. CL. 16. (U.S. CLS. 2, 5, 22, 23, 29, 37, 38 AND 50). REG. 11-23-1999.
- 2,294,517. THE COAST STARLIGHT AND DESIGN. INT. CL. 39. (U.S. CLS. 100 AND 105). REG. 11-23-1999.
- 2,294,518. CASCADES. INT. CL. 39. (U.S. CLS. 100 AND 105). REG. 11-23-1999.
- 2,295,951. THIS AND DESIGN. INT. CL. 34. (U.S. CLS. 2, 8, 9 AND 17). REG. 11-30-1999.
- 2,296,328. BIOARCHIVE. INT. CL. 10. (U.S. CLS. 26, 39 AND 44). REG. 11-30-1999.
- 2,296,622. JAVANILLA. INT. CL. 30. (U.S. CL. 46). REG. 11-30-1999.
- 2,297,498. TW GARNER FOOD COMPANY AND DESIGN. INT. CL. 30. (U.S. CL. 46). REG. 12-7-1999.
- 2,298,074. MISCELLANEOUS DESIGN. INT. CL. 16. (U.S. CLS. 2, 5, 22, 23, 29, 37, 38 AND 50). REG. 12-7-1999.
- 2,299,777. COMPLEX USA AND DESIGN. INT. CL. 41. (U.S. CLS. 100, 101 AND 107). REG. 12-14-1999.
- 2,301,185. MILLINIUMN TECHNOLOGY AND DESIGN. INT. CL. 9. (U.S. CLS. 21, 23, 26, 36 AND 38). REG. 12-21-1999.
- 2,302,242. GROVE MILL. INT. CL. 33. (U.S. CLS. 47 AND 49). REG. 12-21-1999.
- 2,305,271. MEANT TO INVENT!. INT. CL. 41. (U.S. CLS. 100, 101 AND 107). REG. 1-4-2000.
- 2,306,475. JOHN LETTERS OF SCOTLAND. INT. CL. 28. (U.S. CLS. 22, 23, 38 AND 50). REG. 1-4-2000.
- 2,311,077. THE DIGITAL CLINICIAN. INT. CL. 9. (U.S. CLS. 21, 23, 26, 36 AND 38). REG. 1-25-2000.
- 2,313,988. AQUA MOON & CO. AND DESIGN. INT. CL. 25. (U.S. CLS. 22 AND 39). REG. 2-1-2000.
- 2,318,102. HI-SPOT. INT. CL. 11. (U.S. CLS. 13, 21, 23, 31 AND 34). REG. 2-15-2000.
- 2,318,485. S&R ASSOCIATES THE SENSIBLE SOLUTION FOR PROJECT MANAGEMENT. INT. CL. 35. (U.S. CLS. 100, 101 AND 102). REG. 2-15-2000.
- 2,318,609. K.I.C.S. KIDS IN COOL SLIPPERS. INT. CL. 25. (U.S. CLS. 22 AND 39). REG. 2-15-2000.
- 2,322,178. SPACEDIRECT. INT. CL. 36. (U.S. CLS. 100, 101 AND 102). REG. 2-22-2000.
- 2,322,209. SUNLIGHT SUPPLY. INT. CL. 11. (U.S. CLS. 13, 21, 23, 31 AND 34). REG. 2-22-2000.
- 2,325,327. C CUMSA (STYLIZED). INT. CL. 7. (U.S. CLS. 13, 19, 21, 23, 31, 34 AND 35). REG. 3-7-2000.
- 2,326,831. CARTA VIEJA. INT. CL. 33. (U.S. CLS. 47 AND 49). REG. 3-7-2000.
- 2,327,063. CARE RX. INT. CL. 42. (U.S. CLS. 100 AND 101). REG. 3-7-2000.
- 2,327,645. SUPERIOR. INT. CL. 20. (U.S. CLS. 2, 13, 22, 25, 32 AND 50). REG. 3-14-2000.
- 2,328,906. AF ACCUFORCE AND DESIGN. INT. CL. 35. (U.S. CLS. 100, 101 AND 102). REG. 3-14-2000.
- 2,329,382. CHURCH INITIATIVE. INT. CLS. 9 AND 16. (U.S. CLS. 2, 5, 21, 22, 23, 26, 29, 36, 37, 38 AND 50). REG. 3-14-2000.
- 2,329,521. MISCELLANEOUS DESIGN. INT. CL. 36. (U.S. CLS. 100, 101 AND 102). REG. 3-14-2000.
- 2,330,274. MAX GIRL. INT. CL. 25. (U.S. CLS. 22 AND 39). REG. 3-14-2000.
- 2,331,713. BUTNON (STYLIZED). INT. CL. 25. (U.S. CLS. 22 AND 39). REG. 3-21-2000.
- 2,332,908. CLOSE ENCOUNTERS WITH MUSIC. INT. CL. 41. (U.S. CLS. 100, 101 AND 107). REG. 3-21-2000.
- 2,333,045. SPACE. INT. CL. 3. (U.S. CLS. 1, 4, 6, 50, 51 AND 52). REG. 3-21-2000.
- 2,333,244. ENTACT AND DESIGN. INT. CL. 42. (U.S. CLS. 100 AND 101). REG. 3-21-2000.
- 2,335,823. IMPROVISATIONAL GRILL. INT. CL. 42. (U.S. CLS. 100 AND 101). REG. 3-28-2000.
- 2,336,176. CANTERBURY TRUST. INT. CL. 36. (U.S. CLS. 100, 101 AND 102). REG. 3-28-2000.
- 2,336,499. SHADOW LEAF. INT. CLS. 24 AND 25. (U.S. CLS. 22, 39, 42 AND 50). REG. 3-28-2000.

- 2,336,958. NETCRAFT. INT. CLS. 35 AND 42. (U.S. CLS. 100, 101 AND 102). REG. 4-4-2000.
- 2,337,324. HAWKINS. INT. CL. 21. (U.S. CLS. 2, 13, 23, 29, 30, 33, 40 AND 50). REG. 4-4-2000.
- 2,338,088. AGRIMICROBE SALES FORMULA V. INT. CL. 1. (U.S. CLS. 1, 5, 6, 10, 26 AND 46). REG. 4-4-2000.
- 2,338,708. CHIROFLOW. INT. CL. 10. (U.S. CLS. 26, 39 AND 44). REG. 4-4-2000.
- 2,338,776. USCIB. INT. CLS. 16, 41 AND 42. (U.S. CLS. 2, 5, 22, 23, 29, 37, 38, 50, 100, 101 AND 107). REG. 4-4-2000.
- 2,339,820. COMMUNITY CHALLENGE. INT. CL. 42. (U.S. CLS. 100 AND 101). REG. 4-11-2000.
- 2,339,863. GUARD1 AND DESIGN. INT. CL. 9. (U.S. CLS. 21, 23, 26, 36 AND 38). REG. 4-11-2000.
- 2,340,015. NETVET. INT. CL. 42. (U.S. CLS. 100 AND 101). REG. 4-11-2000.
- 2,340,389. CARBOPLAN. INT. CL. 7 ONLY. (U.S. CLS. 13, 19, 21, 23, 31, 34 AND 35). REG. 4-11-2000.
- 2,340,820. LA FEMME PUBLIQUE AND DESIGN. INT. CL. 25. (U.S. CLS. 22 AND 39). REG. 4-11-2000.
- 2,340,831. KOA (STYLIZED). INT. CL. 9. (U.S. CLS. 21, 23, 26, 36 AND 38). REG. 4-11-2000.
- 2,343,137. PRO-LEASH. INT. CL. 18. (U.S. CLS. 1, 2, 3, 22 AND 41). REG. 4-18-2000.
- 2,343,871. THERMAL SOLUTIONS. INT. CL. 11. (U.S. CLS. 13, 21, 23, 31 AND 34). REG. 4-18-2000.
- 2,344,881. ALICE STARMORE. INT. CL. 23. (U.S. CL. 43). REG. 4-25-2000.
- 2,346,127. YOUR FREEDOM TO DRIVE IS PRICELESS. INT. CL. 39. (U.S. CLS. 100 AND 105). REG. 4-25-2000.
- 2,346,687. A B & C (STYLIZED). INT. CL. 16. (U.S. CLS. 2, 5, 22, 23, 29, 37, 38 AND 50). REG. 5-2-2000.
- 2,346,862. NORDIPENMATE. INT. CL. 10. (U.S. CLS. 26, 39 AND 44). REG. 5-2-2000.
- 2,347,379. THE BALANCED APPROACH. INT. CLS. 41 AND 42. (U.S. CLS. 100, 101 AND 107). REG. 5-2-2000.
- 2,347,506. MISCELLANEOUS DESIGN. INT. CL. 25. (U.S. CLS. 22 AND 39). REG. 5-2-2000.
- 2,347,634. MISCELLANEOUS DESIGN. INT. CL. 9. (U.S. CLS. 21, 23, 26, 36 AND 38). REG. 5-2-2000.
- 2,347,997. SAN FRANCISCO FLOWER & GARDEN SHOW. INT. CLS. 35 AND 41. (U.S. CLS. 100, 101, 102 AND 107). REG. 5-9-2000.
- 2,348,003. ALICANTE. INT. CL. 30. (U.S. CL. 46). REG. 5-9-2000.
- 2,348,388. CASONA. INT. CL. 33. (U.S. CLS. 47 AND 49). REG. 5-9-2000.
- 2,348,447. ROCHE. INT. CL. 42. (U.S. CLS. 100 AND 101). REG. 5-9-2000.
- 2,348,642. MISCELLANEOUS DESIGN. INT. CL. 42. (U.S. CLS. 100 AND 101). REG. 5-9-2000.
- 2,348,721. HORTULUS FARM. INT. CL. 31. (U.S. CLS. 1 AND 46). REG. 5-9-2000.
- 2,348,814. SOLUTION. INT. CL. 42. (U.S. CLS. 100 AND 101). REG. 5-9-2000.
- 2,348,861. CITY SLICKER. INT. CL. 42. (U.S. CLS. 100 AND 101). REG. 5-9-2000.
- 2,348,914. PUFFER. INT. CL. 5. (U.S. CLS. 6, 18, 44, 46, 51 AND 52). REG. 5-9-2000.
- 2,348,921. EPD.CONNECT. INT. CL. 9. (U.S. CLS. 21, 23, 26, 36 AND 38). REG. 5-9-2000.
- 2,348,965. TERRAMATER. INT. CL. 33. (U.S. CLS. 47 AND 49). REG. 5-9-2000.
- 2,349,000. CHILDREN'S DAY USA AND DESIGN. INT. CL. 41. (U.S. CLS. 100, 101 AND 107). REG. 5-9-2000.
- 2,349,010. PHOENIX. INT. CL. 9. (U.S. CLS. 21, 23, 26, 36 AND 38). REG. 5-9-2000.
- 2,349,017. FRESHPACK. INT. CL. 21. (U.S. CLS. 2, 13, 23, 29, 30, 33, 40 AND 50). REG. 5-9-2000.
- 2,349,071. CHEMQUIK. INT. CL. 17. (U.S. CLS. 1, 5, 12, 13, 35 AND 50). REG. 5-9-2000.
- 2,349,107. FLAVOR PORES. INT. CL. 16. (U.S. CLS. 2, 5, 22, 23, 29, 37, 38 AND 50). REG. 5-9-2000.
- 2,349,188. AVALANCHE. INT. CL. 32. (U.S. CLS. 45, 46 AND 48). REG. 5-16-2000.
- 2,349,241. DEFCON. INT. CL. 9. (U.S. CLS. 21, 23, 26, 36 AND 38). REG. 5-16-2000.
- 2,349,247. ELOMATIC AND DESIGN. INT. CL. 42. (U.S. CLS. 100 AND 101). REG. 5-16-2000.
- 2,349,279. GYPTONE. INT. CLS. 17 AND 19. (U.S. CLS. 1, 5, 12, 13, 33, 35 AND 50). REG. 5-16-2000.
- 2,349,294. LIFEWISE. INT. CL. 36. (U.S. CLS. 100, 101 AND 102). REG. 5-16-2000.
- 2,349,299. LASSEN XW MOISTURE GUARD. INT. CL. 16. (U.S. CLS. 2, 5, 22, 23, 29, 37, 38 AND 50). REG. 5-16-2000.
- 2,349,300. OXFORD READING TREE. INT. CL. 16. (U.S. CLS. 2, 5, 22, 23, 29, 37, 38 AND 50). REG. 5-16-2000.
- 2,349,310. MISCELLANEOUS DESIGN. INT. CL. 25. (U.S. CLS. 22 AND 39). REG. 5-16-2000.
- 2,349,316. CLARIANT AND DESIGN. INT. CLS. 1 AND 2. (U.S. CLS. 1, 5, 6, 10, 11, 16, 26 AND 46). REG. 5-16-2000.
- 2,349,409. OXFORD READING TREE. INT. CL. 9. (U.S. CLS. 21, 23, 26, 36 AND 38). REG. 5-16-2000.
- 2,349,423. PHYTOCHROME. INT. CL. 5. (U.S. CLS. 6, 18, 44, 46, 51 AND 52). REG. 5-16-2000.
- 2,349,432. CHIPPERY. INT. CLS. 29, 30 AND 42. (U.S. CLS. 46, 100 AND 101). REG. 5-16-2000.
- 2,349,437. MODUSERV. INT. CL. 21. (U.S. CLS. 2, 13, 23, 29, 30, 33, 40 AND 50). REG. 5-16-2000.
- 2,349,486. VETERINARY INFORMATION NETWORK. INT. CLS. 41 AND 42. (U.S. CLS. 100, 101 AND 107). REG. 5-16-2000.
- 2,349,497. APOLLO AND DESIGN. INT. CLS. 9 AND 11. (U.S. CLS. 13, 21, 23, 26, 31, 34, 36 AND 38). REG. 5-16-2000.
- 2,349,513. CSC AND DESIGN. INT. CL. 35. (U.S. CLS. 100, 101 AND 102). REG. 5-16-2000.
- 2,349,521. EVANS SERVICES. INT. CL. 37. (U.S. CLS. 100, 103 AND 106). REG. 5-16-2000.
- 2,349,524. H AND DESIGN. INT. CL. 25. (U.S. CLS. 22 AND 39). REG. 5-16-2000.
- 2,349,540. EDMONTON. INT. CL. 20. (U.S. CLS. 2, 13, 22, 25, 32 AND 50). REG. 5-16-2000.
- 2,349,565. CARPE DATUM 01000101000010100100 AND DESIGN. INT. CL. 42. (U.S. CLS. 100 AND 101). REG. 5-16-2000.
- 2,349,569. INNOWAVE UVF (STYLIZED). INT. CL. 11. (U.S. CLS. 13, 21, 23, 31 AND 34). REG. 5-16-2000.
- 2,349,607. LONGABERGER. INT. CLS. 6, 9 AND 20. (U.S. CLS. 2, 12, 13, 14, 21, 22, 23, 25, 26, 32, 36, 38 AND 50). REG. 5-16-2000.
- 2,349,624. ALCAZAR. INT. CL. 34. (U.S. CLS. 2, 8, 9 AND 17). REG. 5-16-2000.
- 2,349,628. ESPUMIL. INT. CL. 3. (U.S. CLS. 1, 4, 6, 50, 51 AND 52). REG. 5-16-2000.
- 2,349,657. ANNALEE. INT. CLS. 16, 28, 35 AND 41. (U.S. CLS. 2, 5, 22, 23, 29, 37, 38, 50, 100, 101, 102 AND 107). REG. 5-16-2000.
- 2,349,669. SERVO COMMAND. INT. CL. 9. (U.S. CLS. 21, 23, 26, 36 AND 38). REG. 5-16-2000.
- 2,349,707. OMNISUITE. INT. CL. 9. (U.S. CLS. 21, 23, 26, 36 AND 38). REG. 5-16-2000.
- 2,349,774. PAXTON AND DESIGN. INT. CL. 7. (U.S. CLS. 13, 19, 21, 23, 31, 34 AND 35). REG. 5-16-2000.
- 2,349,822. IMPALA. INT. CL. 16. (U.S. CLS. 2, 5, 22, 23, 29, 37, 38 AND 50). REG. 5-16-2000.
- 2,349,842. CORRECTIVE ACTION HELPER. INT. CL. 9. (U.S. CLS. 21, 23, 26, 36 AND 38). REG. 5-16-2000.
- 2,349,843. CORRECTIVE ACTION HELPER. INT. CL. 41. (U.S. CLS. 100, 101 AND 107). REG. 5-16-2000.
- 2,349,852. BEECOMIST. INT. CL. 7. (U.S. CLS. 13, 19, 21, 23, 31, 34 AND 35). REG. 5-16-2000.
- 2,349,884. COURTESY BUILDING SERVICES. INT. CL. 37. (U.S. CLS. 100, 103 AND 106). REG. 5-16-2000.
- 2,349,901. PORT-A-HEAT. INT. CL. 11. (U.S. CLS. 13, 21, 23, 31 AND 34). REG. 5-16-2000.
- 2,349,914. ESCOTT. INT. CL. 35. (U.S. CLS. 100, 101 AND 102). REG. 5-16-2000.
- 2,349,929. LOEWS CINEPLEX AND DESIGN. INT. CL. 41. (U.S. CLS. 100, 101 AND 107). REG. 5-16-2000.
- 2,349,945. MICHAEL'S BIGGER BURGERS, BETTER CUSTARD. INT. CL. 42. (U.S. CLS. 100 AND 101). REG. 5-16-2000.
- 2,349,971. CUESTA REY CENTENARIO. INT. CL. 34. (U.S. CLS. 2, 8, 9 AND 17). REG. 5-16-2000.
- 2,350,011. STRATEGIC EXPEDITIONS. INT. CL. 35. (U.S. CLS. 100, 101 AND 102). REG. 5-16-2000.
- 2,350,021. TMP. INT. CL. 7. (U.S. CLS. 13, 19, 21, 23, 31, 34 AND 35). REG. 5-16-2000.
- 2,350,036. POWERSINE. INT. CL. 9. (U.S. CLS. 21, 23, 26, 36 AND 38). REG. 5-16-2000.
- 2,350,046. CYDECTIN. INT. CL. 5. (U.S. CLS. 6, 18, 44, 46, 51 AND 52). REG. 5-16-2000.
- 2,350,053. E SCOTT AND DESIGN. INT. CL. 35. (U.S. CLS. 100, 101 AND 102). REG. 5-16-2000.

- 2,350,061. SKYCONEX. INT. CL. 9. (U.S. CLS. 21, 23, 26, 36 AND 38). REG. 5-16-2000.
- 2,350,083. AGA AND DESIGN. INT. CL. 42. (U.S. CLS. 100 AND 101). REG. 5-16-2000.
- 2,350,166. SAINT MICKAEL. INT. CL. 35. (U.S. CLS. 100, 101 AND 102). REG. 5-16-2000.
- 2,350,261. BINNY'S BEVERAGE DEPOT. INT. CLS. 32, 33 AND 34. (U.S. CLS. 2, 8, 9, 17, 45, 46, 47, 48 AND 49). REG. 5-16-2000.
- 2,350,347. S AND DESIGN. INT. CL. 36. (U.S. CLS. 100, 101 AND 102). REG. 5-16-2000.
- 2,350,414. STREAMLINE. INT. CL. 25. (U.S. CLS. 22 AND 39). REG. 5-16-2000.
- 2,350,459. STRIKER AND DESIGN. INT. CL. 16 ONLY. (U.S. CLS. 2, 5, 22, 23, 29, 37, 38 AND 50). REG. 5-16-2000.
- 2,350,472. LAZYMANS. INT. CL. 12. (U.S. CLS. 19, 21, 23, 31, 35 AND 44). REG. 5-16-2000.
- 2,350,512. SINTERMESH. INT. CL. 17. (U.S. CLS. 1, 5, 12, 13, 35 AND 50). REG. 5-16-2000.
- 2,350,578. UNBURRITABLE. INT. CL. 42. (U.S. CLS. 100 AND 101). REG. 5-16-2000.
- 2,350,757. ASCEND. INT. CL. 25. (U.S. CLS. 22 AND 39). REG. 5-16-2000.
- 2,350,782. MAGNELINK. INT. CL. 7. (U.S. CLS. 13, 19, 21, 23, 31, 34 AND 35). REG. 5-16-2000.
- 2,350,828. MISCELLANEOUS DESIGN. INT. CLS. 9 AND 42. (U.S. CLS. 21, 23, 26, 36, 38, 100 AND 101). REG. 5-16-2000.
- 2,350,836. TRASHBUSTERS. INT. CL. 39. (U.S. CLS. 100 AND 105). REG. 5-16-2000.
- 2,350,852. PROCLOSE. INT. CL. 36. (U.S. CLS. 100, 101 AND 102). REG. 5-16-2000.
- 2,350,853. GIARDIAVAX. INT. CL. 5. (U.S. CLS. 6, 18, 44, 46, 51 AND 52). REG. 5-16-2000.
- 2,350,909. GROUP X. INT. CL. 41. (U.S. CLS. 100, 101 AND 107). REG. 5-16-2000.
- 2,350,939. LAURA MERCIER. INT. CLS. 16 AND 42. (U.S. CLS. 2, 5, 22, 23, 29, 37, 38, 50, 100 AND 101). REG. 5-16-2000.
- 2,350,958. OPENDEPLOY. INT. CL. 9. (U.S. CLS. 21, 23, 26, 36 AND 38). REG. 5-16-2000.
- 2,351,031. FROM MILLIWATTS TO KILOWATTS. INT. CLS. 9 AND 35. (U.S. CLS. 21, 23, 26, 36, 38, 100, 101 AND 102). REG. 5-16-2000.
- 2,351,072. MUJI (STYLIZED). INT. CLS. 3, 6, 8, 9, 11, 16, 18, 20, 21, 24, 25 AND 42 ONLY. (U.S. CLS. 1, 2, 3, 4, 5, 6, 12, 13, 14, 21, 22, 23, 25, 26, 28, 29, 30, 31, 32, 33, 34, 36, 37, 38, 39, 40, 41, 42, 44, 50, 51, 52, 100 AND 101). REG. 5-23-2000.
- 2,351,089. BLAIR'S DEATH. INT. CL. 30. (U.S. CL. 46). REG. 5-23-2000.
- 2,351,092. WOODSMOKE PROVISIONS. INT. CL. 29. (U.S. CL. 46). REG. 5-23-2000.
- 2,351,180. SNUGGIES (STYLIZED). INT. CL. 25. (U.S. CLS. 22 AND 39). REG. 5-23-2000.
- 2,351,191. ABREU. INT. CLS. 39 AND 42. (U.S. CLS. 100, 101 AND 105). REG. 5-23-2000.
- 2,351,211. COMMUNITY CHALLENGES. INT. CL. 42. (U.S. CLS. 100 AND 101). REG. 5-23-2000.
- 2,351,242. METROWEST WELLNESS CENTER AND DESIGN. INT. CLS. 41 AND 42. (U.S. CLS. 100, 101 AND 107). REG. 5-23-2000.
- 2,351,288. YMS. INT. CL. 42. (U.S. CLS. 100 AND 101). REG. 5-23-2000.
- 2,351,320. KIA AND DESIGN. INT. CL. 12. (U.S. CLS. 19, 21, 23, 31, 35 AND 44). REG. 5-23-2000.
- 2,351,558. EXPERIENCE BASED LEARNING AND DESIGN. INT. CLS. 35 AND 41. (U.S. CLS. 100, 101, 102 AND 107). REG. 5-23-2000.
- 2,351,595. GOLDEN STAR BRAND KAO LIANG CHIEW AND DESIGN. INT. CL. 33. (U.S. CLS. 47 AND 49). REG. 5-23-2000.
- 2,351,616. SLAPWRAP. INT. CL. 25. (U.S. CLS. 22 AND 39). REG. 5-23-2000.
- 2,351,726. WINBOOK. INT. CL. 35. (U.S. CLS. 100, 101 AND 102). REG. 5-23-2000.
- 2,351,732. HIT. INT. CL. 7. (U.S. CLS. 13, 19, 21, 23, 31, 34 AND 35). REG. 5-23-2000.
- 2,351,778. GULLIVER'S TRAVEL GIANT DEALS (STYLIZED). INT. CL. 39. (U.S. CLS. 100 AND 105). REG. 5-23-2000.
- 2,351,827. LINDAL. INT. CL. 19. (U.S. CLS. 1, 12, 33 AND 50). REG. 5-23-2000.
- 2,351,837. HUMMBRELLA. INT. CL. 21. (U.S. CLS. 2, 13, 23, 29, 30, 33, 40 AND 50). REG. 5-23-2000.
- 2,351,845. G209. INT. CL. 6. (U.S. CLS. 2, 12, 13, 14, 23, 25 AND 50). REG. 5-23-2000.
- 2,351,912. MEDAL. INT. CL. 19. (U.S. CLS. 1, 12, 33 AND 50). REG. 5-23-2000.
- 2,351,913. ROCKSPAR. INT. CL. 19. (U.S. CLS. 1, 12, 33 AND 50). REG. 5-23-2000.
- 2,352,139. MISCELLANEOUS DESIGN. INT. CL. 28. (U.S. CLS. 22, 23, 38 AND 50). REG. 5-23-2000.
- 2,352,143. TELLING. INT. CL. 41. (U.S. CLS. 100, 101 AND 107). REG. 5-23-2000.
- 2,352,210. MISCELLANEOUS DESIGN. INT. CL. 28 ONLY. (U.S. CLS. 22, 23, 38 AND 50). REG. 5-23-2000.
- 2,352,300. WIL-PRO. INT. CL. 2. (U.S. CLS. 6, 11 AND 16). REG. 5-23-2000.
- 2,352,336. WE ARE ONE. INT. CL. 41. (U.S. CLS. 100, 101 AND 107). REG. 5-23-2000.
- 2,352,531. OLEOPEIN. INT. CL. 1. (U.S. CLS. 1, 5, 6, 10, 26 AND 46). REG. 5-23-2000.
- 2,352,571. VALTEC. INT. CL. 2. (U.S. CLS. 6, 11 AND 16). REG. 5-23-2000.
- 2,352,719. BREEDER AIDE. INT. CL. 5. (U.S. CLS. 6, 18, 44, 46, 51 AND 52). REG. 5-23-2000.
- 2,352,794. 55 DSL. INT. CL. 25. (U.S. CLS. 22 AND 39). REG. 5-23-2000.
- 2,352,795. PRO CHANNEL. INT. CL. 11. (U.S. CLS. 13, 21, 23, 31 AND 34). REG. 5-23-2000.
- 2,352,961. EXPEDITION. INT. CL. 25. (U.S. CLS. 22 AND 39). REG. 5-30-2000.
- 2,352,997. SUPERMED HMO. INT. CL. 36. (U.S. CLS. 100, 101 AND 102). REG. 5-30-2000.
- 2,353,041. BIGFOOT. INT. CLS. 35 AND 38. (U.S. CLS. 100, 101, 102 AND 104). REG. 5-30-2000.
- 2,353,060. 3 TOUR CHALLENGE. INT. CL. 41. (U.S. CLS. 100, 101 AND 107). REG. 5-30-2000.
- 2,353,074. DETROL. INT. CL. 5. (U.S. CLS. 6, 18, 44, 46, 51 AND 52). REG. 5-30-2000.
- 2,353,076. SSD. INT. CL. 9. (U.S. CLS. 21, 23, 26, 36 AND 38). REG. 5-30-2000.
- 2,353,096. ANTI-STRESS BY UPPER CANADA. INT. CL. 3. (U.S. CLS. 1, 4, 6, 50, 51 AND 52). REG. 5-30-2000.
- 2,353,232. BIG AMERICAN MAN. INT. CL. 25. (U.S. CLS. 22 AND 39). REG. 5-30-2000.
- 2,353,258. INFOGROUP NORTHWEST. INT. CL. 42. (U.S. CLS. 100 AND 101). REG. 5-30-2000.
- 2,353,283. REAL ESTATE CHAMPIONS. INT. CLS. 35 AND 41. (U.S. CLS. 100, 101, 102 AND 107). REG. 5-30-2000.
- 2,353,358. NATIONAL TAX INSTITUTE. INT. CL. 41. (U.S. CLS. 100, 101 AND 107). REG. 5-30-2000.
- 2,353,389. LEFT BEHIND. INT. CLS. 9 AND 16. (U.S. CLS. 2, 5, 21, 22, 23, 26, 29, 36, 37, 38 AND 50). REG. 5-30-2000.
- 2,353,552. MID ROW BANDERS. INT. CL. 7. (U.S. CLS. 13, 19, 21, 23, 31, 34 AND 35). REG. 5-30-2000.
- 2,353,562. ANSYR. INT. CL. 5. (U.S. CLS. 6, 18, 44, 46, 51 AND 52). REG. 5-30-2000.
- 2,353,602. SPACE ZONE. INT. CL. 28. (U.S. CLS. 22, 23, 38 AND 50). REG. 5-30-2000.
- 2,353,847. UNILETE. INT. CL. 25. (U.S. CLS. 22 AND 39). REG. 5-30-2000.
- 2,353,914. UMBERTO CAZZOLA 1929 (STYLIZED). INT. CL. 14. (U.S. CLS. 2, 27, 28 AND 50). REG. 5-30-2000.
- 2,353,945. S AND DESIGN. INT. CL. 25. (U.S. CLS. 22 AND 39). REG. 5-30-2000.
- 2,354,020. DONALDSON DYNAMIC. INT. CL. 35. (U.S. CLS. 100, 101 AND 102). REG. 5-30-2000.
- 2,354,092. EASYSPIRIT (STYLIZED). INT. CL. 25. (U.S. CLS. 22 AND 39). REG. 5-30-2000.
- 2,354,116. HOCKEY UNIVERSE. INT. CL. 35. (U.S. CLS. 100, 101 AND 102). REG. 5-30-2000.
- 2,354,120. MILES OF HOPE. INT. CL. 42. (U.S. CLS. 100 AND 101). REG. 5-30-2000.
- 2,354,234. AMERICAN SUPERSTORE. INT. CL. 35. (U.S. CLS. 100, 101 AND 102). REG. 5-30-2000.
- 2,354,338. MISCELLANEOUS DESIGN. INT. CL. 16. (U.S. CLS. 2, 5, 22, 23, 29, 37, 38 AND 50). REG. 6-6-2000.
- 2,354,622. VOLT AND DESIGN. INT. CLS. 35, 37, 40, 41 AND 42 ONLY. (U.S. CLS. 100, 101, 102, 103, 106 AND 107). REG. 6-6-2000.
- 2,354,744. SPACERACER. INT. CL. 20. (U.S. CLS. 2, 13, 22, 25, 32 AND 50). REG. 6-6-2000.

- 2,354,773. 24/7 (STYLIZED). INT. CL. 16. (U.S. CLS. 2, 5, 22, 23, 29, 37, 38 AND 50). REG. 6-6-2000.
- 2,354,803. TERMINATOR. INT. CL. 9. (U.S. CLS. 21, 23, 26, 36 AND 38). REG. 6-6-2000.
- 2,354,882. FOGMASTER. INT. CL. 9. (U.S. CLS. 21, 23, 26, 36 AND 38). REG. 6-6-2000.
- 2,354,995. ZD. INT. CL. 33. (U.S. CLS. 47 AND 49). REG. 6-6-2000.
- 2,355,029. CG CAMGUARD AND DESIGN. INT. CL. 37. (U.S. CLS. 100, 103 AND 106). REG. 6-6-2000.
- 2,355,206. PROXIMITY SYSTEMS. INT. CL. 20. (U.S. CLS. 2, 13, 22, 25, 32 AND 50). REG. 6-6-2000.
- 2,355,343. BLAZIN'. INT. CL. 30. (U.S. CL. 46). REG. 6-6-2000.
- 2,355,643. PIRANHA BAY AND DESIGN. INT. CL. 29. (U.S. CL. 46). REG. 6-6-2000.
- 2,355,778. EMERALD ENVIRONMENTAL, INC. AND DESIGN. INT. CL. 42. (U.S. CLS. 100 AND 101). REG. 6-6-2000.
- 2,355,956. ACF. INT. CL. 35. (U.S. CLS. 100, 101 AND 102). REG. 6-6-2000.
- 2,356,152. YOUR NUTRITIONAL ANSWERS COMPANY (STYLIZED). INT. CL. 35. (U.S. CLS. 100, 101 AND 102). REG. 6-6-2000.
- 2,356,174. FIRST CLASS. INT. CL. 20. (U.S. CLS. 2, 13, 22, 25, 32 AND 50). REG. 6-6-2000.
- 2,356,304. QUEST DIAGNOSTICS AND DESIGN. INT. CL. 42. (U.S. CLS. 100 AND 101). REG. 6-6-2000.
- 2,356,339. QUALITY BLANKS INTERNATIONAL. INT. CL. 40. (U.S. CLS. 100, 103 AND 106). REG. 6-6-2000.
- 2,356,350. INDICATOR SHAFT. INT. CL. 10. (U.S. CLS. 26, 39 AND 44). REG. 6-6-2000.
- 2,356,351. DOC CARE. INT. CL. 42. (U.S. CLS. 100 AND 101). REG. 6-6-2000.
- 2,356,520. MASTER OF COMPLICATIONS. INT. CL. 14. (U.S. CLS. 2, 27, 28 AND 50). REG. 6-13-2000.
- 2,356,558. NICE AND DESIGN. INT. CL. 30. (U.S. CL. 46). REG. 6-13-2000.
- 2,356,718. SURE TERM. INT. CL. 36. (U.S. CLS. 100, 101 AND 102). REG. 6-13-2000.
- 2,356,767. JUMPSTART. INT. CL. 41. (U.S. CLS. 100, 101 AND 107). REG. 6-13-2000.
- 2,356,865. FILE FLYER. INT. CL. 20. (U.S. CLS. 2, 13, 22, 25, 32 AND 50). REG. 6-13-2000.
- 2,356,919. FUTURE AND DESIGN. INT. CL. 42. (U.S. CLS. 100 AND 101). REG. 6-13-2000.
- 2,357,056. BNL. INT. CLS. 25 AND 41 ONLY. (U.S. CLS. 22, 39, 100, 101 AND 107). REG. 6-13-2000.
- 2,357,341. NICHELINI. INT. CL. 33. (U.S. CLS. 47 AND 49). REG. 6-13-2000.
- 2,357,342. THE BAFFLER. INT. CL. 16. (U.S. CLS. 2, 5, 22, 23, 29, 37, 38 AND 50). REG. 6-13-2000.
- 2,357,443. DP (STYLIZED). INT. CL. 41. (U.S. CLS. 100, 101 AND 107). REG. 6-13-2000.
- 2,357,464. CHARITABLE MULTIPLIER. INT. CL. 16. (U.S. CLS. 2, 5, 22, 23, 29, 37, 38 AND 50). REG. 6-13-2000.
- 2,357,558. TOTE-A-LUBE. INT. CL. 20. (U.S. CLS. 2, 13, 22, 25, 32 AND 50). REG. 6-13-2000.
- 2,357,705. MISCELLANEOUS DESIGN. INT. CL. 10. (U.S. CLS. 26, 39 AND 44). REG. 6-13-2000.
- 2,357,757. CAPTIVATE. INT. CL. 35. (U.S. CLS. 100, 101 AND 102). REG. 6-13-2000.
- 2,357,806. SOLTEX. INT. CL. 25. (U.S. CLS. 22 AND 39). REG. 6-13-2000.
- 2,357,943. STAR MATH. INT. CL. 9. (U.S. CLS. 21, 23, 26, 36 AND 38). REG. 6-13-2000.
- 2,358,028. DON VALENTIN BIANCHI LACRADO. INT. CL. 33. (U.S. CLS. 47 AND 49). REG. 6-13-2000.
- 2,358,201. BACVIEW (STYLIZED). INT. CL. 9. (U.S. CLS. 21, 23, 26, 36 AND 38). REG. 6-13-2000.
- 2,358,257. COOL OFF. INT. CL. 32. (U.S. CLS. 45, 46 AND 48). REG. 6-13-2000.
- 2,358,399. TWI. INT. CLS. 40 AND 41. (U.S. CLS. 100, 101, 103, 106 AND 107). REG. 6-13-2000.
- 2,358,448. NO EQUAL IN THE WORLD. INT. CLS. 3 AND 16 ONLY. (U.S. CLS. 1, 2, 4, 5, 6, 22, 23, 29, 37, 38, 50, 51 AND 52). REG. 6-13-2000.
- 2,358,603. TAMALE FIXIN'S. INT. CL. 30. (U.S. CL. 46). REG. 6-13-2000.
- 2,358,812. WIDEVISION. INT. CL. 9. (U.S. CLS. 21, 23, 26, 36 AND 38). REG. 6-13-2000.
- 2,359,120. CREDIT MONITOR. INT. CL. 9. (U.S. CLS. 21, 23, 26, 36 AND 38). REG. 6-20-2000.
- 2,359,234. LIQUIGRIP. INT. CL. 1. (U.S. CLS. 1, 5, 6, 10, 26 AND 46). REG. 6-20-2000.
- 2,359,257. EARLYBIRD (STYLIZED). INT. CLS. 35 AND 36. (U.S. CLS. 100, 101 AND 102). REG. 6-20-2000.
- 2,359,484. HYPHOBE (STYLIZED). INT. CL. 24. (U.S. CLS. 42 AND 50). REG. 6-20-2000.
- 2,359,493. MISCELLANEOUS DESIGN. INT. CL. 16. (U.S. CLS. 2, 5, 22, 23, 29, 37, 38 AND 50). REG. 6-20-2000.
- 2,359,518. S-FLAT. INT. CL. 9. (U.S. CLS. 21, 23, 26, 36 AND 38). REG. 6-20-2000.
- 2,359,621. LACTOVAL. INT. CL. 1. (U.S. CLS. 1, 5, 6, 10, 26 AND 46). REG. 6-20-2000.
- 2,359,629. MISCELLANEOUS DESIGN. INT. CL. 3. (U.S. CLS. 1, 4, 6, 50, 51 AND 52). REG. 6-20-2000.
- 2,359,870. CREAMY COUNTRY. INT. CL. 29. (U.S. CL. 46). REG. 6-20-2000.
- 2,360,009. DENTAL CONCIERGE. INT. CLS. 35 AND 41. (U.S. CLS. 100, 101, 102 AND 107). REG. 6-20-2000.
- 2,360,022. SHOP WHERE IT MATTERS. INT. CL. 35. (U.S. CLS. 100, 101 AND 102). REG. 6-20-2000.
- 2,360,271. SWING+. INT. CL. 20. (U.S. CLS. 2, 13, 22, 25, 32 AND 50). REG. 6-20-2000.
- 2,361,005. MISCELLANEOUS DESIGN. INT. CL. 25. (U.S. CLS. 22 AND 39). REG. 6-27-2000.
- 2,361,147. DD DOLBY DIGITAL AND DESIGN. INT. CL. 9. (U.S. CLS. 21, 23, 26, 36 AND 38). REG. 6-27-2000.
- 2,361,260. ASSOCIATED AND DESIGN. INT. CL. (U.S. CLS.). U.S. CL. 200. REG. 6-27-2000.
- 2,361,365. MANUAL-PAK. INT. CL. 16. (U.S. CLS. 2, 5, 22, 23, 29, 37, 38 AND 50). REG. 6-27-2000.
- 2,361,395. MISCELLANEOUS DESIGN. INT. CL. 37. (U.S. CLS. 100, 103 AND 106). REG. 6-27-2000.
- 2,361,400. FOOTCUSH AND DESIGN. INT. CL. 27. (U.S. CLS. 19, 20, 37, 42 AND 50). REG. 6-27-2000.
- 2,361,975. CLICK-N-SEAL (STYLIZED). INT. CL. 20. (U.S. CLS. 2, 13, 22, 25, 32 AND 50). REG. 6-27-2000.
- 2,362,047. LAMSON. INT. CL. 7. (U.S. CLS. 13, 19, 21, 23, 31, 34 AND 35). REG. 6-27-2000.
- 2,362,115. LBI (STYLIZED). INT. CL. 9. (U.S. CLS. 21, 23, 26, 36 AND 38). REG. 6-27-2000.
- 2,362,170. EZ-LOAD. INT. CL. 39. (U.S. CLS. 100 AND 105). REG. 6-27-2000.
- 2,362,191. MISCELLANEOUS DESIGN. INT. CL. 41. (U.S. CLS. 100, 101 AND 107). REG. 6-27-2000.
- 2,362,275. HANDS ON. INT. CL. 16. (U.S. CLS. 2, 5, 22, 23, 29, 37, 38 AND 50). REG. 6-27-2000.
- 2,362,356. FLAP HAPPY. INT. CL. 25. (U.S. CLS. 22 AND 39). REG. 6-27-2000.
- 2,362,423. PHYTO-PHENOLICS. INT. CLS. 29, 30 AND 32. (U.S. CLS. 45, 46 AND 48). REG. 6-27-2000.
- 2,362,467. ISCOMATRIX. INT. CL. 5. (U.S. CLS. 6, 18, 44, 46, 51 AND 52). REG. 6-27-2000.
- 2,362,748. WEATHER STOPPER. INT. CL. 19. (U.S. CLS. 1, 12, 33 AND 50). REG. 6-27-2000.
- 2,362,956. ACCUCORE. INT. CL. 10. (U.S. CLS. 26, 39 AND 44). REG. 6-27-2000.
- 2,363,161. THE ROCK PILE. INT. CL. 35. (U.S. CLS. 100, 101 AND 102). REG. 6-27-2000.
- 2,363,163. INTEGRITY COACHING. INT. CL. 41. (U.S. CLS. 100, 101 AND 107). REG. 6-27-2000.
- 2,363,307. ART-O-MAT AND DESIGN. INT. CL. 9. (U.S. CLS. 21, 23, 26, 36 AND 38). REG. 6-27-2000.
- 2,363,333. ETS AND DESIGN. INT. CLS. 9, 16, 41 AND 42. (U.S. CLS. 2, 5, 21, 22, 23, 26, 29, 36, 37, 38, 50, 100, 101 AND 107). REG. 6-27-2000.
- 2,363,455. CONTEMPORARY STONE & TILE DESIGN. INT. CL. 16. (U.S. CLS. 2, 5, 22, 23, 29, 37, 38 AND 50). REG. 6-27-2000.
- 2,363,648. LIFE FOR CHILDREN INTERNATIONAL. INT. CL. 36. (U.S. CLS. 100, 101 AND 102). REG. 7-4-2000.
- 2,363,742. CD DIMENSIONS. INT. CL. 35. (U.S. CLS. 100, 101 AND 102). REG. 7-4-2000.
- 2,364,076. WHERE PUMPS GET CONNECTED. INT. CLS. 6 AND 17. (U.S. CLS. 1, 2, 5, 12, 13, 14, 23, 25, 35 AND 50). REG. 7-4-2000.
- 2,364,594. AMBER LODGING. INT. CL. 42. (U.S. CLS. 100 AND 101). REG. 7-4-2000.
- 2,364,699. GLUCOSATRIN. INT. CL. 5. (U.S. CLS. 6, 18, 44, 46, 51 AND 52). REG. 7-4-2000.
- 2,364,795. NATURE'S SECRETS. INT. CL. 1. (U.S. CLS. 1, 5, 6, 10, 26 AND 46). REG. 7-4-2000.
- 2,364,869. TOPEXPORT. INT. CL. 31. (U.S. CLS. 1 AND 46). REG. 7-4-2000.

- 2,364,935. SIGNALMX. INT. CL. 9. (U.S. CLS. 21, 23, 26, 36 AND 38). REG. 7-4-2000.
- 2,364,958. NASHVILLE PREDATORS. INT. CL. 25. (U.S. CLS. 22 AND 39). REG. 7-4-2000.
- 2,364,967. D688. INT. CL. 8. (U.S. CLS. 23, 28 AND 44). REG. 7-4-2000.
- 2,365,726. BILSTEIN. INT. CL. 6. (U.S. CLS. 2, 12, 13, 14, 23, 25 AND 50). REG. 7-11-2000.
- 2,365,805. TRIMCO. INT. CL. 6. (U.S. CLS. 2, 12, 13, 14, 23, 25 AND 50). REG. 7-11-2000.
- 2,366,495. RUBBER-NECK. INT. CL. 20. (U.S. CLS. 2, 13, 22, 25, 32 AND 50). REG. 7-11-2000.
- 2,367,052. NAPEO MEMBER NATIONAL ASSOCIATION OF PROFESSIONAL EMPLOYER ORGANIZATIONS AND DESIGN. U.S. CL. 200. REG. 7-11-2000.
- 2,367,099. DENALI. INT. CL. 9. (U.S. CLS. 21, 23, 26, 36 AND 38). REG. 7-11-2000.
- 2,367,603. RHETECH. INT. CL. 37. (U.S. CLS. 100, 103 AND 106). REG. 7-18-2000.
- 2,367,822. THE COMPANY CORPORATION. INT. CL. 35. (U.S. CLS. 100, 101 AND 102). REG. 7-18-2000.
- 2,367,905. SUREFIT. INT. CL. 9. (U.S. CLS. 21, 23, 26, 36 AND 38). REG. 7-18-2000.
- 2,368,009. NATIONAL BREAST CANCER COALITION. INT. CLS. 41 AND 42. (U.S. CLS. 100, 101 AND 107). REG. 7-18-2000.
- 2,368,087. MASTERMARK. INT. CLS. 16 AND 20. (U.S. CLS. 2, 5, 13, 22, 23, 25, 29, 32, 37, 38 AND 50). REG. 7-18-2000.
- 2,368,575. 24 AND DESIGN. INT. CL. 36. (U.S. CLS. 100, 101 AND 102). REG. 7-18-2000.
- 2,369,124. ZIG EMBOSS. INT. CL. 16. (U.S. CLS. 2, 5, 22, 23, 29, 37, 38 AND 50). REG. 7-18-2000.
- 2,369,287. STAGERIGHT. INT. CL. 19. (U.S. CLS. 1, 12, 33 AND 50). REG. 7-18-2000.
- 2,369,656. PERFORMANCE. INT. CLS. 9, 12, 28 AND 35. (U.S. CLS. 19, 21, 22, 23, 26, 31, 35, 36, 38, 44, 50, 100, 101 AND 102). REG. 7-25-2000.
- 2,369,832. 97 AND DESIGN. INT. CL. 41. (U.S. CLS. 100, 101 AND 107). REG. 7-25-2000.
- 2,370,330. NATIONAL FILM PRESERVATION FOUNDATION AND DESIGN. INT. CL. 42. (U.S. CLS. 100 AND 101). REG. 7-25-2000.
- 2,370,617. SENSITEMP. INT. CL. 5. (U.S. CLS. 6, 18, 44, 46, 51 AND 52). REG. 7-25-2000.
- 2,370,886. SCIENCE IN A NUTSHELL. INT. CLS. 9 AND 16. (U.S. CLS. 2, 5, 21, 22, 23, 26, 29, 36, 37, 38 AND 50). REG. 7-25-2000.
- 2,370,982. MONEY CENTER 24. INT. CL. 36. (U.S. CLS. 100, 101 AND 102). REG. 7-25-2000.
- 2,371,078. ARNET. INT. CL. 5. (U.S. CLS. 6, 18, 44, 46, 51 AND 52). REG. 7-25-2000.
- 2,371,212. ECLIPSE. INT. CL. 3. (U.S. CLS. 1, 4, 6, 50, 51 AND 52). REG. 7-25-2000.
- 2,371,286. ACT. INT. CL. 1. (U.S. CLS. 1, 5, 6, 10, 26 AND 46). REG. 7-25-2000.
- 2,371,333. WAVE 'N DRY. INT. CL. 21. (U.S. CLS. 2, 13, 23, 29, 30, 33, 40 AND 50). REG. 7-25-2000.
- 2,371,765. OCEAN JOURNEY. INT. CL. 25. (U.S. CLS. 22 AND 39). REG. 7-25-2000.
- 2,372,150. LAFFORT. INT. CLS. 1 AND 30. (U.S. CLS. 1, 5, 6, 10, 26 AND 46). REG. 8-1-2000.
- 2,372,304. GREYHAWK AND DESIGN. INT. CL. 42. (U.S. CLS. 100 AND 101). REG. 8-1-2000.
- 2,372,659. DOLEX DOLLAR EXPRESS. INT. CL. 36. (U.S. CLS. 100, 101 AND 102). REG. 8-1-2000.
- 2,372,819. TERMIUM. INT. CL. 9. (U.S. CLS. 21, 23, 26, 36 AND 38). REG. 8-1-2000.
- 2,372,878. ATH. INT. CL. 36. (U.S. CLS. 100, 101 AND 102). REG. 8-1-2000.
- 2,373,107. SOLAR-E. INT. CL. 19. (U.S. CLS. 1, 12, 33 AND 50). REG. 8-1-2000.
- 2,373,381. GEMSTAR. INT. CL. 10. (U.S. CLS. 26, 39 AND 44). REG. 8-1-2000.
- 2,373,509. SILVERADO. INT. CL. 12. (U.S. CLS. 19, 21, 23, 31, 35 AND 44). REG. 8-1-2000.
- 2,373,760. ARCTIC BLUE. INT. CL. 19. (U.S. CLS. 1, 12, 33 AND 50). REG. 8-1-2000.
- 2,373,820. AMERICA'S BEST TAN. INT. CL. 35. (U.S. CLS. 100, 101 AND 102). REG. 8-1-2000.
- 2,374,179. LAWRENCE FRAMES. INT. CL. 20. (U.S. CLS. 2, 13, 22, 25, 32 AND 50). REG. 8-8-2000.
- 2,374,258. BETTY BOOP. INT. CL. 9. (U.S. CLS. 21, 23, 26, 36 AND 38). REG. 8-8-2000.
- 2,374,544. RYAN LAWN & TREE AND DESIGN. INT. CL. 42 ONLY. (U.S. CLS. 100 AND 101). REG. 8-8-2000.
- 2,374,708. NATIONAL GROCERS ASSOCIATION. INT. CL. 42. (U.S. CLS. 100 AND 101). REG. 8-8-2000.
- 2,374,865. SELECT OFFICE SOLUTIONS. INT. CLS. 35 AND 37. (U.S. CLS. 100, 101, 102, 103 AND 106). REG. 8-8-2000.
- 2,374,882. OLD WORLD. INT. CL. 29. (U.S. CL. 46). REG. 8-8-2000.
- 2,374,930. PHYTO-COLA. INT. CL. 32. (U.S. CLS. 45, 46 AND 48). REG. 8-8-2000.
- 2,375,137. ROBI. INT. CLS. 9 AND 35. (U.S. CLS. 21, 23, 26, 36, 38, 100, 101 AND 102). REG. 8-8-2000.
- 2,375,434. SLE (STYLIZED). INT. CL. 42. (U.S. CLS. 100 AND 101). REG. 8-8-2000.
- 2,375,492. CUNARD WORLD CLUB. INT. CL. 39. (U.S. CLS. 100 AND 105). REG. 8-8-2000.
- 2,375,670. VERSA-TORCH. INT. CL. 7. (U.S. CLS. 13, 19, 21, 23, 31, 34 AND 35). REG. 8-8-2000.
- 2,375,925. 00 AND DESIGN. INT. CL. 41. (U.S. CLS. 100, 101 AND 107). REG. 8-8-2000.
- 2,376,545. MISCELLANEOUS DESIGN. INT. CL. 9. (U.S. CLS. 21, 23, 26, 36 AND 38). REG. 8-15-2000.
- 2,376,996. JM MARK OF EXCELLENCE AND DESIGN. INT. CL. 41. (U.S. CLS. 100, 101 AND 107). REG. 8-15-2000.
- 2,377,002. PREMIER AND DESIGN. INT. CL. 16. (U.S. CLS. 2, 5, 22, 23, 29, 37, 38 AND 50). REG. 8-15-2000.
- 2,377,636. WORKING FOR YOU. INT. CL. 41. (U.S. CLS. 100, 101 AND 107). REG. 8-15-2000.
- 2,377,662. JUDGMENT FREE ZONE. INT. CL. 41. (U.S. CLS. 100, 101 AND 107). REG. 8-15-2000.
- 2,377,934. TWISTER. INT. CL. 9. (U.S. CLS. 21, 23, 26, 36 AND 38). REG. 8-15-2000.
- 2,378,296. THE MS CHRONICLE. INT. CL. 16. (U.S. CLS. 2, 5, 22, 23, 29, 37, 38 AND 50). REG. 8-15-2000.
- 2,378,474. BETTY BOOP. INT. CL. 16. (U.S. CLS. 2, 5, 22, 23, 29, 37, 38 AND 50). REG. 8-22-2000.
- 2,378,690. BLITZ. INT. CL. 41. (U.S. CLS. 100, 101 AND 107). REG. 8-22-2000.
- 2,378,703. POURFORM-107. INT. CL. 19. (U.S. CLS. 1, 12, 33 AND 50). REG. 8-22-2000.
- 2,378,868. CNN (STYLIZED). INT. CL. 8. (U.S. CLS. 23, 28 AND 44). REG. 8-22-2000.
- 2,379,207. AQUA ALLEGORIA. INT. CL. 3. (U.S. CLS. 1, 4, 6, 50, 51 AND 52). REG. 8-22-2000.
- 2,379,536. BRAZENHEAD. INT. CL. 42. (U.S. CLS. 100 AND 101). REG. 8-22-2000.
- 2,379,549. AQUADRAIN. INT. CL. 17. (U.S. CLS. 1, 5, 12, 13, 35 AND 50). REG. 8-22-2000.
- 2,379,634. CRAZY 8THS. INT. CL. 28. (U.S. CLS. 22, 23, 38 AND 50). REG. 8-22-2000.
- 2,379,921. SINGLE SHOT. INT. CL. 9. (U.S. CLS. 21, 23, 26, 36 AND 38). REG. 8-22-2000.
- 2,380,002. ELITE PHYSICIANS. INT. CL. 35. (U.S. CLS. 100, 101 AND 102). REG. 8-22-2000.
- 2,380,082. PRODUCTIZING. INT. CL. 35. (U.S. CLS. 100, 101 AND 102). REG. 8-22-2000.
- 2,381,146. 2 AND DESIGN. INT. CLS. 9 AND 35. (U.S. CLS. 21, 23, 26, 36, 38, 100, 101 AND 102). REG. 8-29-2000.
- 2,381,558. GOODFELLOWS. INT. CL. 42. (U.S. CLS. 100 AND 101). REG. 8-29-2000.
- 2,381,639. COOLWEAR. INT. CL. 25. (U.S. CLS. 22 AND 39). REG. 8-29-2000.
- 2,381,944. ULTRA FLEXIBLE. INT. CL. 17. (U.S. CLS. 1, 5, 12, 13, 35 AND 50). REG. 8-29-2000.
- 2,381,984. AMERICAN PSYCHOTHERAPY ASSOCIATION. INT. CL. 42. (U.S. CLS. 100 AND 101). REG. 8-29-2000.
- 2,382,351. MODIS (STYLIZED). INT. CL. 42. (U.S. CLS. 100 AND 101). REG. 9-5-2000.
- 2,382,593. GREAT NORTHERN CONSULTING SERVICES. INT. CL. 35. (U.S. CLS. 100, 101 AND 102). REG. 9-5-2000.
- 2,382,594. GREAT NORTHERN CONSULTING SERVICES AND DESIGN. INT. CL. 35. (U.S. CLS. 100, 101 AND 102). REG. 9-5-2000.
- 2,382,606. GREAT NORTHERN AND DESIGN. INT. CL. 35. (U.S. CLS. 100, 101 AND 102). REG. 9-5-2000.
- 2,382,967. ESSENCE OF PEARL. INT. CL. 3. (U.S. CLS. 1, 4, 6, 50, 51 AND 52). REG. 9-5-2000.
- 2,383,091. KBC BEARINGS (STYLIZED). INT. CL. 12. (U.S. CLS. 19, 21, 23, 31, 35 AND 44). REG. 9-5-2000.

- 2,383,289. TECHNOMETRICS. INT. CL. 16. (U.S. CLS. 2, 5, 22, 23, 29, 37, 38 AND 50). REG. 9-5-2000.
- 2,383,300. YOUR HOME IS WITH US. INT. CL. 36. (U.S. CLS. 100, 101 AND 102). REG. 9-5-2000.
- 2,383,453. TOBIAS STUCCO. INT. CL. 2. (U.S. CLS. 6, 11 AND 16). REG. 9-5-2000.
- 2,383,480. FUSION. INT. CL. 9. (U.S. CLS. 21, 23, 26, 36 AND 38). REG. 9-5-2000.
- 2,383,761. SMALL WORLD TRAVEL. INT. CL. 39. (U.S. CLS. 100 AND 105). REG. 9-5-2000.
- 2,383,767. JERDON. INT. CL. 11. (U.S. CLS. 13, 21, 23, 31 AND 34). REG. 9-5-2000.
- 2,383,768. FIRST CLASS. INT. CL. 11. (U.S. CLS. 13, 21, 23, 31 AND 34). REG. 9-5-2000.
- 2,383,865. AMERICAN TRIM AND DESIGN. INT. CL. 40. (U.S. CLS. 100, 103 AND 106). REG. 9-5-2000.
- 2,383,940. CANNON BRAND AND DESIGN. INT. CL. 13. (U.S. CLS. 2 AND 9). REG. 9-5-2000.
- 2,384,489. THINBIT.COM. INT. CL. 37. (U.S. CLS. 100, 103 AND 106). REG. 9-12-2000.
- 2,384,505. BANDANA'S BAR-B-Q SMELL THAT SMOKE AND DESIGN. INT. CL. 42. (U.S. CLS. 100 AND 101). REG. 9-12-2000.
- 2,384,861. TASTE OF THE NFL. INT. CLS. 16 AND 36. (U.S. CLS. 2, 5, 22, 23, 29, 37, 38, 50, 100, 101 AND 102). REG. 9-12-2000.
- 2,384,969. MISCELLANEOUS DESIGN. INT. CL. 42. (U.S. CLS. 100 AND 101). REG. 9-12-2000.
- 2,385,476. ASTORIA FEDERAL MONEYPLUS. INT. CL. 36. (U.S. CLS. 100, 101 AND 102). REG. 9-12-2000.
- 2,385,974. FUND-MARK. INT. CL. 16. (U.S. CLS. 2, 5, 22, 23, 29, 37, 38 AND 50). REG. 9-12-2000.
- 2,386,039. THERMAPLEX AND DESIGN. INT. CL. 4. (U.S. CLS. 1, 6 AND 15). REG. 9-12-2000.
- 2,386,093. IF THESE WALLS COULD TALK, THEY'D SING. INT. CL. 41. (U.S. CLS. 100, 101 AND 107). REG. 9-12-2000.
- 2,386,374. ROTO-SHAKE GENIE. INT. CL. 9. (U.S. CLS. 21, 23, 26, 36 AND 38). REG. 9-12-2000.
- 2,386,759. SMITH EQUIPMENT (STYLIZED). INT. CLS. 7 AND 9. (U.S. CLS. 13, 19, 21, 23, 26, 31, 34, 35, 36 AND 38). REG. 9-19-2000.
- 2,386,820. ART TECHNOLOGIES. INT. CL. 42. (U.S. CLS. 100 AND 101). REG. 9-19-2000.
- 2,387,618. DUAL ADVANTAGE MORTGAGE. INT. CL. 36. (U.S. CLS. 100, 101 AND 102). REG. 9-19-2000.
- 2,387,870. GOLD STANDARD. INT. CL. 41. (U.S. CLS. 100, 101 AND 107). REG. 9-19-2000.
- 2,388,130. MISCELLANEOUS DESIGN. INT. CL. 41. (U.S. CLS. 100, 101 AND 107). REG. 9-19-2000.
- 2,388,452. INFIN-A-TEK AND DESIGN. INT. CL. 7. (U.S. CLS. 13, 19, 21, 23, 31, 34 AND 35). REG. 9-19-2000.
- 2,388,520. QUALSTAR. INT. CL. 36. (U.S. CLS. 100, 101 AND 102). REG. 9-19-2000.
- 2,389,141. DANIEL AND DESIGN. INT. CLS. 9 AND 40. (U.S. CLS. 21, 23, 26, 36, 38, 100, 103 AND 106). REG. 9-26-2000.
- 2,389,239. TRAILWAYS AND DESIGN. U.S. CL. 200. REG. 9-26-2000.
- 2,389,476. AARCORP.COM. INT. CLS. 35, 37, 39 AND 42. (U.S. CLS. 100, 101, 102, 103, 105 AND 106). REG. 9-26-2000.
- 2,389,914. LITTLE JOE. INT. CL. 9. (U.S. CLS. 21, 23, 26, 36 AND 38). REG. 9-26-2000.
- 2,390,319. PLAY STICKS. INT. CL. 3. (U.S. CLS. 1, 4, 6, 50, 51 AND 52). REG. 9-26-2000.
- 2,390,335. COCONUT KIDS. INT. CL. 28. (U.S. CLS. 22, 23, 38 AND 50). REG. 9-26-2000.
- 2,390,517. WEB - BOND. INT. CL. 36. (U.S. CLS. 100, 101 AND 102). REG. 9-26-2000.
- 2,390,532. NW NATURAL. INT. CLS. 36 AND 39. (U.S. CLS. 100, 101, 102 AND 105). REG. 9-26-2000.
- 2,390,789. DEFOR AND DESIGN. INT. CL. 16. (U.S. CLS. 2, 5, 22, 23, 29, 37, 38 AND 50). REG. 10-3-2000.
- 2,391,064. TYC (STYLIZED). INT. CLS. 7, 11 AND 12. (U.S. CLS. 13, 19, 21, 23, 31, 34, 35 AND 44). REG. 10-3-2000.
- 2,391,071. MISCELLANEOUS DESIGN. INT. CLS. 7, 11 AND 12. (U.S. CLS. 13, 19, 21, 23, 31, 34, 35 AND 44). REG. 10-3-2000.
- 2,391,124. DOWN TO THE BONE. INT. CLS. 9 AND 41. (U.S. CLS. 21, 23, 26, 36, 38, 100, 101 AND 107). REG. 10-3-2000.
- 2,391,437. MISCELLANEOUS DESIGN. INT. CL. 41. (U.S. CLS. 100, 101 AND 107). REG. 10-3-2000.
- 2,391,619. NETATTITUDE. INT. CL. 42. (U.S. CLS. 100 AND 101). REG. 10-3-2000.
- 2,392,376. FAITH FIRST. INT. CLS. 9, 16 AND 18. (U.S. CLS. 1, 2, 3, 5, 21, 22, 23, 26, 29, 36, 37, 38, 41 AND 50). REG. 10-3-2000.
- 2,393,524. STEELY DAN. INT. CL. 41. (U.S. CLS. 100, 101 AND 107). REG. 10-10-2000.
- 2,393,736. MISCELLANEOUS DESIGN. INT. CL. 30. (U.S. CL. 46). REG. 10-10-2000.
- 2,393,853. XFET. INT. CL. 9. (U.S. CLS. 21, 23, 26, 36 AND 38). REG. 10-10-2000.
- 2,393,861. AMERICAN EAGLE OUTFITTERS. INT. CL. 3. (U.S. CLS. 1, 4, 6, 50, 51 AND 52). REG. 10-10-2000.
- 2,394,174. CUTIE PIE. INT. CLS. 24 AND 25. (U.S. CLS. 22, 39, 42 AND 50). REG. 10-10-2000.
- 2,394,453. CERTIFIED DIRECTORY ENGINEER. INT. CLS. 16, 37, 41 AND 42. (U.S. CLS. 2, 5, 22, 23, 29, 37, 38, 50, 100, 101, 103, 106 AND 107). REG. 10-10-2000.
- 2,395,729. NO=EQL + AND DESIGN. INT. CL. 28. (U.S. CLS. 22, 23, 38 AND 50). REG. 10-17-2000.
- 2,396,053. OPPORTUNITY PROGRAM. INT. CL. 35. (U.S. CLS. 100, 101 AND 102). REG. 10-17-2000.
- 2,396,757. KING OF FANS. INT. CL. 11. (U.S. CLS. 13, 21, 23, 31 AND 34). REG. 10-24-2000.
- 2,396,939. APF. INT. CLS. 7, 9, 37, 40 AND 42. (U.S. CLS. 13, 19, 21, 23, 26, 31, 34, 35, 36, 38, 100, 101, 103 AND 106). REG. 10-24-2000.
- 2,397,214. STINGER. INT. CL. 7. (U.S. CLS. 13, 19, 21, 23, 31, 34 AND 35). REG. 10-24-2000.
- 2,397,470. BUTCH HARMON SCHOOL OF GOLF AND DESIGN. INT. CLS. 25 AND 41. (U.S. CLS. 22, 39, 100, 101 AND 107). REG. 10-24-2000.
- 2,397,552. PAPER SHAPERS. INT. CL. 16. (U.S. CLS. 2, 5, 22, 23, 29, 37, 38 AND 50). REG. 10-24-2000.
- 2,398,316. SDS. INT. CL. 9. (U.S. CLS. 21, 23, 26, 36 AND 38). REG. 10-24-2000.
- 2,398,524. LIFECYCLE. INT. CL. 9. (U.S. CLS. 21, 23, 26, 36 AND 38). REG. 10-24-2000.
- 2,398,999. AMERICAN GAS ASSOCIATION. INT. CL. 42. (U.S. CLS. 100 AND 101). REG. 10-31-2000.
- 2,399,621. GIANT EAGLE. INT. CL. 25. (U.S. CLS. 22 AND 39). REG. 10-31-2000.
- 2,399,734. MISSION STEPS. INT. CL. 36. (U.S. CLS. 100, 101 AND 102). REG. 10-31-2000.
- 2,399,853. WORD WAYS. INT. CL. 16. (U.S. CLS. 2, 5, 22, 23, 29, 37, 38 AND 50). REG. 10-31-2000.
- 2,401,831. STRADIVARI CLASSICS. INT. CL. 9. (U.S. CLS. 21, 23, 26, 36 AND 38). REG. 11-7-2000.
- 2,402,496. WHIRLYGIG. INT. CL. 19. (U.S. CLS. 1, 12, 33 AND 50). REG. 11-7-2000.
- 2,402,537. W & T (STYLIZED). INT. CL. 26. (U.S. CLS. 37, 39, 40, 42 AND 50). REG. 11-7-2000.
- 2,402,543. ANGELO PIETRO AND DESIGN. INT. CL. 42. (U.S. CLS. 100 AND 101). REG. 11-7-2000.
- 2,402,718. SPILLTRAP. INT. CL. 27. (U.S. CLS. 19, 20, 37, 42 AND 50). REG. 11-7-2000.
- 2,403,370. NATIONAL FILM PRESERVATION FOUNDATION. INT. CLS. 36 AND 42. (U.S. CLS. 100, 101 AND 102). REG. 11-14-2000.
- 2,403,485. READE AND DESIGN. INT. CL. 35. (U.S. CLS. 100, 101 AND 102). REG. 11-14-2000.
- 2,403,489. GEORGE SPELLWIN. INT. CL. 41. (U.S. CLS. 100, 101 AND 107). REG. 11-14-2000.
- 2,403,656. SOFT WORKS. INT. CLS. 8, 9 AND 21. (U.S. CLS. 2, 13, 21, 23, 26, 28, 29, 30, 33, 36, 38, 40, 44 AND 50). REG. 11-14-2000.
- 2,403,789. MS DINNER OF HOPE. INT. CL. 36. (U.S. CLS. 100, 101 AND 102). REG. 11-14-2000.
- 2,404,022. HSMAL. INT. CL. 35. (U.S. CLS. 100, 101 AND 102). REG. 11-14-2000.
- 2,404,070. INFORMATION, ETC.. INT. CL. 35. (U.S. CLS. 100, 101 AND 102). REG. 11-14-2000.
- 2,404,121. CENTRACARE HEALTH SYSTEM. INT. CLS. 36 AND 42. (U.S. CLS. 100, 101 AND 102). REG. 11-14-2000.
- 2,404,341. GENTS. INT. CL. 10. (U.S. CLS. 26, 39 AND 44). REG. 11-14-2000.
- 2,404,890. RETAILPLUS!. INT. CL. 35. (U.S. CLS. 100, 101 AND 102). REG. 11-14-2000.
- 2,405,113. BOMBAY BRAND AND DESIGN. INT. CLS. 29 AND 30. (U.S. CL. 46). REG. 11-21-2000.

- 2,405,684. ROTO-DISC. INT. CL. 9. (U.S. CLS. 21, 23, 26, 36 AND 38). REG. 11-21-2000.
- 2,405,685. AETHALOMETER. INT. CL. 9. (U.S. CLS. 21, 23, 26, 36 AND 38). REG. 11-21-2000.
- 2,405,857. LABPLAS. INT. CL. 9. (U.S. CLS. 21, 23, 26, 36 AND 38). REG. 11-21-2000.
- 2,406,757. IRON GIANT. INT. CL. 9. (U.S. CLS. 21, 23, 26, 36 AND 38). REG. 11-21-2000.
- 2,407,496. RAINBOW ACCENTS. INT. CL. 20. (U.S. CLS. 2, 13, 22, 25, 32 AND 50). REG. 11-21-2000.
- 2,407,990. SIMODRIVE POSMO. INT. CLS. 7 AND 9. (U.S. CLS. 13, 19, 21, 23, 26, 31, 34, 35, 36 AND 38). REG. 11-28-2000.
- 2,408,613. RADIO KING ORCHESTRA. INT. CL. 41. (U.S. CLS. 100, 101 AND 107). REG. 11-28-2000.
- 2,409,673. QUIK-COMBO. INT. CL. 10. (U.S. CLS. 26, 39 AND 44). REG. 12-5-2000.
- 2,409,695. GRACELAND FRUIT AND DESIGN. INT. CL. 29. (U.S. CL. 46). REG. 12-5-2000.
- 2,410,599. QUANTA SERVICES. INT. CL. 42. (U.S. CLS. 100 AND 101). REG. 12-5-2000.
- 2,410,600. QUANTA SERVICES. INT. CL. 37. (U.S. CLS. 100, 103 AND 106). REG. 12-5-2000.
- 2,411,178. MISCELLANEOUS DESIGN. INT. CL. 9. (U.S. CLS. 21, 23, 26, 36 AND 38). REG. 12-5-2000.
- 2,411,547. TEE OFF AGAINST MS. INT. CL. 36. (U.S. CLS. 100, 101 AND 102). REG. 12-5-2000.
- 2,411,649. SILVERTONE. INT. CL. 15. (U.S. CLS. 2, 21 AND 36). REG. 12-12-2000.
- 2,411,683. MONTANA SILVERSMITHS. INT. CLS. 8 AND 14. (U.S. CLS. 2, 23, 27, 28, 44 AND 50). REG. 12-12-2000.
- 2,413,847. PC MASTER LITE. INT. CL. 9. (U.S. CLS. 21, 23, 26, 36 AND 38). REG. 12-19-2000.
- 2,414,030. CORONET. INT. CL. 10. (U.S. CLS. 26, 39 AND 44). REG. 12-19-2000.
- 2,414,513. ALBERTO BIANI. INT. CL. 25. (U.S. CLS. 22 AND 39). REG. 12-19-2000.
- 2,415,199. FANCY. INT. CL. 14. (U.S. CLS. 2, 27, 28 AND 50). REG. 12-26-2000.
- 2,416,199. SECUREFIT. INT. CL. 10. (U.S. CLS. 26, 39 AND 44). REG. 12-26-2000.
- 2,416,973. ZUCKERMANN. INT. CL. 15. (U.S. CLS. 2, 21 AND 36). REG. 1-2-2001.
- 2,417,441. WESTERN RESEARCH. INT. CL. 9. (U.S. CLS. 21, 23, 26, 36 AND 38). REG. 1-2-2001.
- 2,421,478. MODUVAN (STYLIZED). INT. CL. 12. (U.S. CLS. 19, 21, 23, 31, 35 AND 44). REG. 1-16-2001.
- 2,421,495. BOSTONIA. INT. CL. 16. (U.S. CLS. 2, 5, 22, 23, 29, 37, 38 AND 50). REG. 1-16-2001.
- 2,421,554. URBAN WALKERS. INT. CL. 25. (U.S. CLS. 22 AND 39). REG. 1-16-2001.
- 2,422,517. DRIVING FORCE. INT. CL. 25. (U.S. CLS. 22 AND 39). REG. 1-23-2001.
- 2,422,569. HARWIL. INT. CL. 9. (U.S. CLS. 21, 23, 26, 36 AND 38). REG. 1-23-2001.
- 2,422,579. ASPREY (STYLIZED). INT. CL. 20. (U.S. CLS. 2, 13, 22, 25, 32 AND 50). REG. 1-23-2001.
- 2,423,236. PRICELESS RENT-A-CAR AND DESIGN. INT. CL. 39. (U.S. CLS. 100 AND 105). REG. 1-23-2001.
- 2,423,939. GOLD FLEX. INT. CLS. 3 AND 7. (U.S. CLS. 1, 4, 6, 13, 19, 21, 23, 31, 34, 35, 50, 51 AND 52). REG. 1-23-2001.
- 2,424,543. GRANDE BRAND FIOR DI LATTE AND DESIGN. INT. CL. 29. (U.S. CL. 46). REG. 1-30-2001.
- 2,424,920. CARDINAL 400. INT. CL. 9. (U.S. CLS. 21, 23, 26, 36 AND 38). REG. 1-30-2001.
- 2,425,920. CERTIFIED PLANT MAINTENANCE MANAGER. INT. CLS. 41 AND 42. (U.S. CLS. 100, 101 AND 107). REG. 1-30-2001.
- 2,426,614. FUSION. INT. CL. 31. (U.S. CLS. 1 AND 46). REG. 2-6-2001.
- 2,427,117. WESTERN ASSET AND DESIGN. INT. CL. 36. (U.S. CLS. 100, 101 AND 102). REG. 2-6-2001.
- 2,427,118. WESTERN ASSET. INT. CL. 36. (U.S. CLS. 100, 101 AND 102). REG. 2-6-2001.
- 2,427,119. WESTERN ASSET MANAGEMENT COMPANY. INT. CL. 36. (U.S. CLS. 100, 101 AND 102). REG. 2-6-2001.
- 2,427,427. HIFOCUS. INT. CL. 10. (U.S. CLS. 26, 39 AND 44). REG. 2-6-2001.
- 2,428,107. MIX GROUP. INT. CL. 35. (U.S. CLS. 100, 101 AND 102). REG. 2-13-2001.
- 2,428,224. IRRIT TECH. INT. CL. 37. (U.S. CLS. 100, 103 AND 106). REG. 2-13-2001.
- 2,428,378. WVASE32. INT. CLS. 9 AND 16. (U.S. CLS. 2, 5, 21, 22, 23, 26, 29, 36, 37, 38 AND 50). REG. 2-13-2001.
- 2,428,991. SENIORSTORE. INT. CL. 35. (U.S. CLS. 100, 101 AND 102). REG. 2-13-2001.
- 2,430,568. EXPERIENCE BASED LEARNING. INT. CLS. 35 AND 41. (U.S. CLS. 100, 101, 102 AND 107). REG. 2-20-2001.
- 2,430,636. DAILY-C. INT. CL. 5. (U.S. CLS. 6, 18, 44, 46, 51 AND 52). REG. 2-27-2001.
- 2,430,975. SIS. INT. CL. 35. (U.S. CLS. 100, 101 AND 102). REG. 2-27-2001.
- 2,432,163. PARIS LAS VEGAS AND DESIGN. INT. CLS. 41 AND 42. (U.S. CLS. 100, 101 AND 107). REG. 2-27-2001.
- 2,432,664. RAYMOND JAMES STADIUM. INT. CLS. 39, 41 AND 42. (U.S. CLS. 100, 101, 105 AND 107). REG. 3-6-2001.
- 2,433,131. XACTA. INT. CL. 11 ONLY. (U.S. CLS. 13, 21, 23, 31 AND 34). REG. 3-6-2001.
- 2,433,925. MISCELLANEOUS DESIGN. INT. CL. 25. (U.S. CLS. 22 AND 39). REG. 3-6-2001.
- 2,434,061. BRANDOLOGY. INT. CL. 35. (U.S. CLS. 100, 101 AND 102). REG. 3-6-2001.
- 2,435,822. HOMESOURCE AND DESIGN. INT. CL. 35. (U.S. CLS. 100, 101 AND 102). REG. 3-13-2001.
- 2,436,090. FIRST AND DESIGN. INT. CL. 41. (U.S. CLS. 100, 101 AND 107). REG. 3-20-2001.
- 2,436,250. THE PROBLEM SKIN SPECIALISTS. INT. CLS. 3 AND 42. (U.S. CLS. 1, 4, 6, 50, 51, 52, 100 AND 101). REG. 3-20-2001.
- 2,436,377. XOXO. INT. CL. 25. (U.S. CLS. 22 AND 39). REG. 3-20-2001.
- 2,437,039. A SCOTTISH CHRISTMAS. INT. CL. 41. (U.S. CLS. 100, 101 AND 107). REG. 3-20-2001.
- 2,437,795. CRB COUNTRY RADIO BROADCASTERS. INT. CL. 41. (U.S. CLS. 100, 101 AND 107). REG. 3-27-2001.
- 2,438,114. DAVE MATTHEWS BAND. INT. CL. 26. (U.S. CLS. 37, 39, 40, 42 AND 50). REG. 3-27-2001.
- 2,438,456. VANASOL. INT. CL. 1. (U.S. CLS. 1, 5, 6, 10, 26 AND 46). REG. 3-27-2001.
- 2,438,771. ELDERTRUST. INT. CL. 36. (U.S. CLS. 100, 101 AND 102). REG. 3-27-2001.
- 2,439,790. CPI. INT. CL. 9. (U.S. CLS. 21, 23, 26, 36 AND 38). REG. 4-3-2001.
- 2,439,928. LIFE ON THE EDGE. INT. CL. 16. (U.S. CLS. 2, 5, 22, 23, 29, 37, 38 AND 50). REG. 4-3-2001.
- 2,439,936. POWERVCR. INT. CL. 9. (U.S. CLS. 21, 23, 26, 36 AND 38). REG. 4-3-2001.
- 2,440,055. CULINOLOGY. INT. CL. 16. (U.S. CLS. 2, 5, 22, 23, 29, 37, 38 AND 50). REG. 4-3-2001.
- 2,440,688. PAASCHE. INT. CLS. 6 AND 7. (U.S. CLS. 2, 12, 13, 14, 19, 21, 23, 25, 31, 34, 35 AND 50). REG. 4-3-2001.
- 2,440,690. OAKVILLE GROCERY AND DESIGN. INT. CLS. 29, 30 AND 33. (U.S. CLS. 46, 47 AND 49). REG. 4-3-2001.
- 2,440,804. CKP. INT. CL. 42. (U.S. CLS. 100 AND 101). REG. 4-3-2001.
- 2,441,395. SHOCK LATTE. INT. CL. 30. (U.S. CL. 46). REG. 4-3-2001.
- 2,441,607. EYE-VIBE. INT. CL. 5. (U.S. CLS. 6, 18, 44, 46, 51 AND 52). REG. 4-3-2001.
- 2,441,792. REK-TANG. INT. CL. 6. (U.S. CLS. 2, 12, 13, 14, 23, 25 AND 50). REG. 4-10-2001.
- 2,441,852. AV MARKETPLACE (STYLIZED). INT. CL. 35. (U.S. CLS. 100, 101 AND 102). REG. 4-10-2001.
- 2,441,923. THE ROSE SHOP. INT. CL. 35. (U.S. CLS. 100, 101 AND 102). REG. 4-10-2001.
- 2,443,911. CSAA. INT. CLS. 37, 39 AND 42. (U.S. CLS. 100, 101, 103, 105 AND 106). REG. 4-17-2001.
- 2,444,143. WEATHER-CLAD. INT. CL. 2. (U.S. CLS. 6, 11 AND 16). REG. 4-17-2001.
- 2,444,313. EZCURE. INT. CL. 11. (U.S. CLS. 13, 21, 23, 31 AND 34). REG. 4-17-2001.
- 2,444,754. FREAKIEWEAR. INT. CL. 25. (U.S. CLS. 22 AND 39). REG. 4-17-2001.
- 2,444,827. JERDON. INT. CL. 20. (U.S. CLS. 2, 13, 22, 25, 32 AND 50). REG. 4-17-2001.
- 2,445,477. JUST BEND IT. INT. CL. 9. (U.S. CLS. 21, 23, 26, 36 AND 38). REG. 4-24-2001.
- 2,445,630. E AND DESIGN. INT. CL. 38. (U.S. CLS. 100, 101 AND 104). REG. 4-24-2001.
- 2,446,133. HOFFMAN CHALLENGE. INT. CL. 41. (U.S. CLS. 100, 101 AND 107). REG. 4-24-2001.

2,446,441.	PI AND DESIGN. INT. CL. 42. (U.S. CLS. 100 AND 101). REG. 4-24-2001.	2,448,608.	SELECT INTERNATIONAL. INT. CL. 35. (U.S. CLS. 100, 101 AND 102). REG. 5-8-2001.
2,446,919.	EXICOR. INT. CL. 9. (U.S. CLS. 21, 23, 26, 36 AND 38). REG. 4-24-2001.	2,449,157.	HIGH ROLLERS. INT. CL. 32. (U.S. CLS. 45, 46 AND 48). REG. 5-8-2001.
2,446,971.	SMARTPROCESS. INT. CL. 35. (U.S. CLS. 100, 101 AND 102). REG. 4-24-2001.	2,449,571.	SUREFLOW. INT. CL. 11. (U.S. CLS. 13, 21, 23, 31 AND 34). REG. 5-8-2001.
2,447,349.	PAWS SIGNS STORIES AND DESIGN. INT. CL. 9 ONLY. (U.S. CLS. 21, 23, 26, 36 AND 38). REG. 5-1-2001.	2,450,024.	CENTRUM PERFORMANCE. INT. CL. 5. (U.S. CLS. 6, 18, 44, 46, 51 AND 52). REG. 5-8-2001.
2,447,751.	M AND DESIGN. INT. CL. 35. (U.S. CLS. 100, 101 AND 102). REG. 5-1-2001.	2,450,222.	SPINLIFE.COM. INT. CL. 35. (U.S. CLS. 100, 101 AND 102). REG. 5-8-2001.
2,448,022.	24. INT. CL. 9. (U.S. CLS. 21, 23, 26, 36 AND 38). REG. 5-1-2001.	2,450,365.	TELECOM PARK. INT. CL. 37. (U.S. CLS. 100, 103 AND 106). REG. 5-8-2001.
2,448,132.	MINNESOTA LYNX. INT. CL. 25. (U.S. CLS. 22 AND 39). REG. 5-1-2001.	2,450,415.	NUTRISLIM. INT. CL. 5. (U.S. CLS. 6, 18, 44, 46, 51 AND 52). REG. 5-15-2001.
2,448,231.	WHEREHOUSE MUSIC. INT. CL. 35 ONLY. (U.S. CLS. 100, 101 AND 102). REG. 5-1-2001.	2,450,962.	WINTER SOLSTICE. INT. CL. 32. (U.S. CLS. 45, 46 AND 48). REG. 5-15-2001.
		2,451,573.	PINNACOL ASSURANCE. INT. CL. 36. (U.S. CLS. 100, 101 AND 102). REG. 5-15-2001.

* * * * *

TRADEMARK REGISTRATIONS CANCELED

The designation "U.S. Cl." appearing in this section refers to the U.S. class in effect prior to Sep. 1, 1973 rather than the international class which applies to applications filed on or after that date. For adoption of international classification see notice in the OFFICIAL GAZETTE of Jun. 26, 1973 (911 O.G. TM 210).

SECTION 7(D)

- 2,173,991. MISCELLANEOUS DESIGN. INT. CL. 34. REG. 7-14-1998.
- 2,202,169. RENWOOD. INT. CL. 34. REG. 11-3-1998.
- 2,376,268. NEW HAMPSHIRE MAGAZINE. INT. CL. 16. REG. 8-8-2000.
- 2,655,293. NYFIX MILLENNIUM. INT. CLS. 9 AND 36. REG. 12-3-2002.
- 2,711,256. TODAY. TOMORROW. TOGETHER.. INT. CL. 36. REG. 4-29-2003.
- 2,801,897. CATALOG EXPLORER AND DESIGN. INT. CL. 42. REG. 1-6-2004.
- 2,807,521. INDUSTRY MALL. INT. CL. 35. REG. 1-20-2004.
- 2,895,213. SELF + HEALTH. INT. CL. 41. REG. 10-19-2004.
- 2,927,710. SELF REGIONAL HEALTHCARE AND DESIGN. INT. CLS. 41 AND 44. REG. 2-22-2005.
- 3,077,116. KING KOIL - MAKING THE MOST COMFORTABLE MATTRESSES IN THE WORLD. INT. CL. 20. REG. 4-4-2006.
- 3,203,528. TAWIRA STANDARD CHARACTER MARK. INT. CLS. 3 AND 26. REG. 1-30-2007.
- 3,246,361. VILLAGE WALK STANDARD CHARACTER MARK. INT. CLS. 37 AND 42. REG. 5-29-2007.
- 3,261,870. ENPATH MEDICAL STANDARD CHARACTER MARK. INT. CLS. 10, 35, 40 AND 42. REG. 7-10-2007.
- 3,327,003. RENWOOD FOR THOSE WHO KNOW ZIN STANDARD CHARACTER MARK. INT. CL. 33. REG. 10-30-2007.
- 3,395,555. TECHNOJIB STANDARD CHARACTER MARK. INT. CL. 7. REG. 3-11-2008.
- 3,501,815. MY SCORE PLUS STANDARD CHARACTER MARK. INT. CL. 36. REG. 9-16-2008.
- 3,506,432. THIS FIRM MEANS BUSINESS STANDARD CHARACTER MARK. INT. CL. 42. REG. 9-23-2008.
- 3,548,168. NATURALLY JOJO AND DESIGN. INT. CL. 35 ONLY. REG. 12-16-2008.
- 3,696,493. DON'T SETTLE FOR ANYTHING LESS STANDARD CHARACTER MARK. INT. CL. 45. REG. 10-13-2009.
- 3,707,242. MISCELLANEOUS DESIGN. INT. CL. 7. REG. 11-10-2009.
- 3,707,244. MISCELLANEOUS DESIGN. INT. CL. 7. REG. 11-10-2009.
- 1,559,466. TAQTRACK. INT. CL. 1. REG. 10-10-1989.
- 1,559,468. COMPLIMENT. INT. CL. 1. REG. 10-10-1989.
- 1,559,472. S-LESS. INT. CL. 1. REG. 10-10-1989.
- 1,559,475. AGFASTAR. INT. CL. 1. REG. 10-10-1989.
- 1,559,476. SLIPSAFE. INT. CL. 1. REG. 10-10-1989.
- 1,559,477. OPTI-MEEN. INT. CL. 1. REG. 10-10-1989.
- 1,559,483. STEFANEL AND DESIGN. INT. CLS. 3, 9, 14, 18 AND 42. REG. 10-10-1989.
- 1,559,492. WILLIAM & CLARISSA. INT. CL. 3. REG. 10-10-1989.
- 1,559,493. EYELASTIC LIFT. INT. CL. 3. REG. 10-10-1989.
- 1,559,497. FACE MIRACLE. INT. CL. 3. REG. 10-10-1989.
- 1,559,498. TRAVALLO. INT. CL. 3. REG. 10-10-1989.
- 1,559,499. NATURE GUARD. INT. CLS. 3 AND 16. REG. 10-10-1989.
- 1,559,503. BLACK & WHITE. INT. CL. 3. REG. 10-10-1989.
- 1,559,507. EVERAFTER. INT. CL. 3. REG. 10-10-1989.
- 1,559,516. DURLIFT. INT. CL. 4. REG. 10-10-1989.
- 1,559,517. GO! AND DESIGN. INT. CL. 5. REG. 10-10-1989.
- 1,559,518. GAMMASAN. INT. CL. 5. REG. 10-10-1989.
- 1,559,525. KYO-DOPHILUS. INT. CL. 5. REG. 10-10-1989.
- 1,559,528. BOWIE CLAY PLUS. INT. CL. 5. REG. 10-10-1989.
- 1,559,535. LYNX. INT. CL. 5. REG. 10-10-1989.
- 1,559,539. GREEN SWEEP. INT. CL. 5. REG. 10-10-1989.
- 1,559,541. GANTON AND DESIGN. INT. CLS. 6 AND 9. REG. 10-10-1989.
- 1,559,544. VERSA-NUT INSERT. INT. CL. 6. REG. 10-10-1989.
- 1,559,545. WES CAL AND DESIGN. INT. CL. 6. REG. 10-10-1989.
- 1,559,547. HYDROPLY. INT. CL. 7. REG. 10-10-1989.
- 1,559,548. MESANOR. INT. CL. 7. REG. 10-10-1989.
- 1,559,552. QUIK PIK. INT. CL. 7. REG. 10-10-1989.
- 1,559,553. P-O-E-M AND DESIGN. INT. CL. 7. REG. 10-10-1989.
- 1,559,564. LOW PRO. INT. CL. 7. REG. 10-10-1989.
- 1,559,568. DESITECH. INT. CL. 7. REG. 10-10-1989.
- 1,559,569. TILT-A-MIX. INT. CL. 7. REG. 10-10-1989.
- 1,559,570. "U" MAX DRYER. INT. CL. 7. REG. 10-10-1989.
- 1,559,574. REVERE WARE. INT. CL. 8. REG. 10-10-1989.
- 1,559,575. GRAY MOUNTAIN AND DESIGN. INT. CL. 8. REG. 10-10-1989.
- 1,559,577. TIMBERLINE. INT. CL. 8. REG. 10-10-1989.
- 1,559,578. AMSILCO. INT. CL. 8. REG. 10-10-1989.
- 1,559,582. FERMAC. INT. CL. 9. REG. 10-10-1989.
- 1,559,584. CONCERTWARE. INT. CL. 9. REG. 10-10-1989.
- 1,559,591. GIE TELAS. INT. CL. 9. REG. 10-10-1989.
- 1,559,598. MISCELLANEOUS DESIGN. INT. CL. 9. REG. 10-10-1989.
- 1,559,604. RAN. INT. CL. 9. REG. 10-10-1989.
- 1,559,605. INSIDE MEDICINE. INT. CLS. 9 AND 16. REG. 10-10-1989.
- 1,559,606. VISION. INT. CL. 9. REG. 10-10-1989.
- 1,559,609. JL THE JOE LAND COMPANY. INT. CL. 9. REG. 10-10-1989.
- 1,559,611. HIFAX. INT. CL. 9. REG. 10-10-1989.
- 1,559,619. ALPHA SERIES AND DESIGN. INT. CL. 9. REG. 10-10-1989.
- 1,559,621. CHAMELEON. INT. CL. 9. REG. 10-10-1989.
- 1,559,627. KIDDESIGNS. INT. CLS. 9 AND 11. REG. 10-10-1989.
- 1,559,628. THE PRODUCTION ANALYST. INT. CL. 9. REG. 10-10-1989.
- 1,559,631. EPE. INT. CL. 9. REG. 10-10-1989.

SECTION 8

- 771,288. THE CONTINENTAL INSURANCE COMPANIES AND DESIGN. U.S. CL. 102. REG. 6-9-1964.
- 878,014. ERKANTOL. U.S. CL. 6. REG. 10-7-1969.
- 878,025. CORRSTAN. U.S. CL. 12. REG. 10-7-1969.
- 1,133,675. SPAZIO. INT. CL. 18. REG. 4-22-1980.
- 1,394,987. SPAZIO. INT. CL. 25. REG. 5-27-1986.
- 1,504,198. PENGUIN'S. INT. CL. 30. REG. 9-13-1988.
- 1,559,465. SAFE-STRIDE. INT. CL. 1. REG. 10-10-1989.

- 1,559,632. V CONNECTOR. INT. CL. 9. REG. 10-10-1989.
 1,559,636. MULTIGRAM. INT. CL. 9. REG. 10-10-1989.
 1,559,643. TORUS CCS (STYLIZED). INT. CL. 9. REG. 10-10-1989.
 1,559,653. MISCELLANEOUS DESIGN. INT. CLS. 9 AND 12. REG. 10-10-1989.
 1,559,654. ONDESK. INT. CL. 9. REG. 10-10-1989.
 1,559,663. PEACHTREE DATA QUERY. INT. CL. 9. REG. 10-10-1989.
 1,559,668. S-MOD. INT. CL. 9. REG. 10-10-1989.
 1,559,669. BOTTOM LINE. INT. CL. 9. REG. 10-10-1989.
 1,559,671. DPEC (STYLIZED). INT. CL. 9. REG. 10-10-1989.
 1,559,672. VERIFAULT-XL. INT. CL. 9. REG. 10-10-1989.
 1,559,674. E-A-R GROUP. INT. CL. 10. REG. 10-10-1989.
 1,559,678. FITTED HEAT. INT. CL. 10. REG. 10-10-1989.
 1,559,682. FLEXIBEND. INT. CL. 10. REG. 10-10-1989.
 1,559,683. K-BLADE. INT. CL. 10. REG. 10-10-1989.
 1,559,684. KM. INT. CL. 10. REG. 10-10-1989.
 1,559,690. NATIONAL. INT. CL. 10. REG. 10-10-1989.
 1,559,694. MHZ AND DESIGN. INT. CLS. 11, 20, 22 AND 24. REG. 10-10-1989.
 1,559,696. PLUS 90I (STYLIZED). INT. CL. 11. REG. 10-10-1989.
 1,559,698. REFLEX AND DESIGN. INT. CL. 11. REG. 10-10-1989.
 1,559,703. THE NORTH POLE VILLAGE. INT. CLS. 11 AND 20. REG. 10-10-1989.
 1,559,704. GOLDEN GLOW. INT. CL. 11. REG. 10-10-1989.
 1,559,710. POWRKUT. INT. CL. 11. REG. 10-10-1989.
 1,559,715. CONTAGITROL. INT. CL. 11. REG. 10-10-1989.
 1,559,716. CADRE. INT. CL. 11. REG. 10-10-1989.
 1,559,722. ROADSTAR. INT. CL. 12. REG. 10-10-1989.
 1,559,724. STARBLAZER. INT. CL. 12. REG. 10-10-1989.
 1,559,728. DIAMOND AUTO GLASS. INT. CL. 12. REG. 10-10-1989.
 1,559,729. NO-MORFLATS AND DESIGN. INT. CL. 12. REG. 10-10-1989.
 1,559,735. GRAND SPORT HOOD MASK. INT. CL. 12. REG. 10-10-1989.
 1,559,740. CAVALIER. INT. CL. 12. REG. 10-10-1989.
 1,559,742. IBOC AND DESIGN. INT. CL. 12. REG. 10-10-1989.
 1,559,757. FIVE LEGGED KITTY. INT. CL. 14. REG. 10-10-1989.
 1,559,768. STAC-PAC. INT. CL. 16. REG. 10-10-1989.
 1,559,775. SAKYO. INT. CL. 16. REG. 10-10-1989.
 1,559,776. DUSTY RAINBOW. INT. CLS. 16, 25 AND 28. REG. 10-10-1989.
 1,559,784. BAPTIST YOUTH. INT. CL. 16. REG. 10-10-1989.
 1,559,785. N.Y. GOLD. INT. CL. 16. REG. 10-10-1989.
 1,559,790. DBASE IV (STYLIZED). INT. CL. 16. REG. 10-10-1989.
 1,559,794. NEBRASKA DEPARTMENT OF REVENUE (STYLIZED). INT. CL. 16. REG. 10-10-1989.
 1,559,797. VAPO-WRAP. INT. CL. 16. REG. 10-10-1989.
 1,559,798. TEKNA-CAL. INT. CL. 16. REG. 10-10-1989.
 1,559,806. COUNTRY HOME. INT. CL. 16. REG. 10-10-1989.
 1,559,810. TORTURE TESTED. INT. CL. 16. REG. 10-10-1989.
 1,559,812. TUSCARORA PLASTICS. INT. CL. 17. REG. 10-10-1989.
 1,559,815. LAMISEAL. INT. CL. 17. REG. 10-10-1989.
 1,559,820. HI POINT. INT. CLS. 18, 20 AND 22. REG. 10-10-1989.
 1,559,822. PRET BY SUSAN BENNIS WARREN EDWARDS (STYLIZED). INT. CL. 18. REG. 10-10-1989.
 1,559,823. LORIANCRYS. INT. CL. 18. REG. 10-10-1989.
 1,559,824. ULTIMATE DIRECTION AND DESIGN. INT. CL. 18. REG. 10-10-1989.
 1,559,828. VS (STYLIZED). INT. CL. 18. REG. 10-10-1989.
 1,559,830. FIRST MATE AND DESIGN. INT. CLS. 18 AND 22. REG. 10-10-1989.
 1,559,831. CHIFFONNERIE (STYLIZED). INT. CLS. 18, 22 AND 24. REG. 10-10-1989.
 1,559,833. SAZABY (STYLIZED). INT. CL. 18. REG. 10-10-1989.
 1,559,835. UMEN USWEAT AND DESIGN. INT. CLS. 18 AND 25. REG. 10-10-1989.
 1,559,839. SEAL KING. INT. CL. 19. REG. 10-10-1989.
 1,559,842. FREEDOM. INT. CL. 19. REG. 10-10-1989.
 1,559,843. ORO-PINE. INT. CL. 19. REG. 10-10-1989.
 1,559,844. DAWN-LITE. INT. CL. 19. REG. 10-10-1989.
 1,559,846. CHUBB. INT. CL. 20. REG. 10-10-1989.
 1,559,847. C AND DESIGN. INT. CL. 20. REG. 10-10-1989.
 1,559,849. CATCH-ALL AND DESIGN. INT. CL. 20. REG. 10-10-1989.
 1,559,850. THE HEART OF YOUR MATTRESS AND DESIGN. INT. CL. 20. REG. 10-10-1989.
 1,559,855. SELECTWARE. INT. CL. 20. REG. 10-10-1989.
 1,559,860. RAINBOW CASTLE. INT. CL. 21. REG. 10-10-1989.
 1,559,863. MAXI-GROW AND DESIGN. INT. CL. 21. REG. 10-10-1989.
 1,559,876. TWIN TUSKER AND DESIGN. INT. CL. 24. REG. 10-10-1989.
 1,559,884. GHOST. INT. CL. 25. REG. 10-10-1989.
 1,559,886. MISCELLANEOUS DESIGN. INT. CL. 25. REG. 10-10-1989.
 1,559,893. PUBLIC SAFETY APPAREL TOPPS MFG. CO. AND DESIGN. INT. CL. 25. REG. 10-10-1989.
 1,559,901. MISCELLANEOUS DESIGN. INT. CL. 25. REG. 10-10-1989.
 1,559,902. HAPPY KIDS. INT. CL. 25. REG. 10-10-1989.
 1,559,917. REED ST. JAMES LOAFERS. INT. CL. 25. REG. 10-10-1989.
 1,559,919. SEDGFIELD JEANS WITH THE PHYSICAL FIT. INT. CL. 25. REG. 10-10-1989.
 1,559,921. WE BELIEVE THAT CHILDREN SHOULD BE SEEN AS WELL AS HEARD. INT. CL. 25. REG. 10-10-1989.
 1,559,923. SURF STREET. INT. CL. 25. REG. 10-10-1989.
 1,559,924. ALPINE SHIRT CO. T. SCHERTZ & SWEDTZ, PROPRIETORS. INT. CL. 25. REG. 10-10-1989.
 1,559,925. FOR FREEDOM OF MOVEMENT FOR FREEDOM OF FASHION. INT. CL. 25. REG. 10-10-1989.
 1,559,926. WEATHER GUARD. INT. CL. 25. REG. 10-10-1989.
 1,559,927. KATHERINE HALL. INT. CL. 25. REG. 10-10-1989.
 1,559,931. CHARLES KAMMER. INT. CL. 25. REG. 10-10-1989.
 1,559,936. CONCEPT II. INT. CL. 25. REG. 10-10-1989.
 1,559,948. 8 AND DESIGN. INT. CL. 25. REG. 10-10-1989.
 1,559,949. VALERIE STEVENS. INT. CL. 25. REG. 10-10-1989.
 1,559,951. ADIPROMED (STYLIZED). INT. CL. 25. REG. 10-10-1989.
 1,559,954. SUSAN ALLEN (STYLIZED). INT. CL. 25. REG. 10-10-1989.
 1,559,968. HOLDTEX. INT. CL. 25. REG. 10-10-1989.
 1,559,974. SLEEPY DREAMS. INT. CL. 25. REG. 10-10-1989.
 1,559,975. SANDY JACK. INT. CL. 25. REG. 10-10-1989.
 1,559,981. CALIFORNIA TALK AND DESIGN. INT. CL. 25. REG. 10-10-1989.
 1,559,988. ZIANETTI. INT. CL. 25. REG. 10-10-1989.
 1,559,990. CATCHIN' RAYS. INT. CL. 25. REG. 10-10-1989.
 1,559,997. ATTACH II (STYLIZED). INT. CL. 26. REG. 10-10-1989.
 1,560,000. ANNETTE HIMSTEDT. INT. CL. 28. REG. 10-10-1989.
 1,560,006. FITNESS FURNITURE. INT. CL. 28. REG. 10-10-1989.
 1,560,009. O.P.P.E.. INT. CL. 28. REG. 10-10-1989.
 1,560,016. U GRIPS. INT. CL. 28. REG. 10-10-1989.
 1,560,031. DYLAN'S FARM. INT. CLS. 29, 30, 31 AND 42. REG. 10-10-1989.
 1,560,036. OL'MCFARLAND'S. INT. CL. 29. REG. 10-10-1989.
 1,560,050. JOSEPH SCHMIDT CONFECTIONS S AND DESIGN. INT. CL. 30. REG. 10-10-1989.
 1,560,051. AMBAKE. INT. CL. 30. REG. 10-10-1989.
 1,560,052. PODS AND DESIGN. INT. CL. 30. REG. 10-10-1989.
 1,560,055. TABASCO 7 SPICE CHILI RECIPE AND DESIGN. INT. CL. 30. REG. 10-10-1989.
 1,560,059. DOORBELL MIX. INT. CL. 30. REG. 10-10-1989.
 1,560,060. THANKSGIVING COFFEE CO.. INT. CL. 30. REG. 10-10-1989.
 1,560,068. SABETHA SEED. INT. CL. 31. REG. 10-10-1989.
 1,560,074. KENTUCKY ROYALE. INT. CL. 31. REG. 10-10-1989.

- 1,560,081. GOLDEN KOLA AND DESIGN. INT. CL. 32. REG. 10-10-1989.
- 1,560,084. DEL PAIS. INT. CL. 32. REG. 10-10-1989.
- 1,560,092. ANTEPRIMA. INT. CL. 33. REG. 10-10-1989.
- 1,560,094. DIAMOND WHITE. INT. CL. 33. REG. 10-10-1989.
- 1,560,095. YAMATANO OROCHI. INT. CL. 33. REG. 10-10-1989.
- 1,560,098. AMERICAN LIGHTS. INT. CL. 34. REG. 10-10-1989.
- 1,560,100. TOM CAT AND DESIGN. INT. CL. 35. REG. 10-10-1989.
- 1,560,105. AMERICAN INTERIORS. INT. CL. 35. REG. 10-10-1989.
- 1,560,107. A AND DESIGN. INT. CLS. 35 AND 42. REG. 10-10-1989.
- 1,560,118. GENE DESIGNER PAVILION AND DESIGN. INT. CL. 35. REG. 10-10-1989.
- 1,560,119. DEMOSELECT. INT. CL. 35. REG. 10-10-1989.
- 1,560,120. MAKE IT EASIER FOR THOSE YOU SERVE. INT. CL. 35. REG. 10-10-1989.
- 1,560,121. AWARDBANQ (STYLIZED). INT. CL. 35. REG. 10-10-1989.
- 1,560,125. COMPASS-G AND DESIGN. INT. CL. 36. REG. 10-10-1989.
- 1,560,128. MESIROW. INT. CL. 36. REG. 10-10-1989.
- 1,560,130. PSM (STYLIZED). INT. CL. 36. REG. 10-10-1989.
- 1,560,132. FANNIE MAE THE KEY TO EASIER SALES. AND DESIGN. INT. CL. 36. REG. 10-10-1989.
- 1,560,133. POCKETTELLER. INT. CL. 36. REG. 10-10-1989.
- 1,560,137. POST VILLAGE. INT. CLS. 36 AND 37. REG. 10-10-1989.
- 1,560,155. LAKEWOOD. INT. CL. 37. REG. 10-10-1989.
- 1,560,156. TELEPOSTAGE. INT. CL. 37. REG. 10-10-1989.
- 1,560,159. MISCELLANEOUS DESIGN. INT. CLS. 37 AND 42. REG. 10-10-1989.
- 1,560,168. FUTURES WORLD NEWS. INT. CL. 38. REG. 10-10-1989.
- 1,560,170. PRIME SPORTS NETWORK (STYLIZED). INT. CLS. 38 AND 41. REG. 10-10-1989.
- 1,560,177. SUMMER RENT CONTROL. INT. CL. 39. REG. 10-10-1989.
- 1,560,185. COLORADO STATE. INT. CL. 41. REG. 10-10-1989.
- 1,560,188. TNN AND DESIGN. INT. CL. 41. REG. 10-10-1989.
- 1,560,192. MISCELLANEOUS DESIGN. INT. CLS. 41 AND 42. REG. 10-10-1989.
- 1,560,205. BIG DADDY. INT. CL. 41. REG. 10-10-1989.
- 1,560,215. OPERATION SANTA CLAUS. INT. CL. 41. REG. 10-10-1989.
- 1,560,218. INMA AND DESIGN. INT. CL. 42. REG. 10-10-1989.
- 1,560,226. HELP. INT. CL. 42. REG. 10-10-1989.
- 1,560,229. AGOSTINO'S. INT. CL. 42. REG. 10-10-1989.
- 1,560,232. LIFE MASTERY CENTER INC. A CLINICAL APPROACH TO MASTERING YOUR LIFE AND DESIGN. INT. CL. 42. REG. 10-10-1989.
- 1,560,233. IMAGINATION IN PROGRESS... (STYLIZED). INT. CL. 42. REG. 10-10-1989.
- 1,560,257. HEALTHY ALTERNATIVES. INT. CL. 42. REG. 10-10-1989.
- 1,560,262. RAY DEPARTMENT STORES. INT. CL. 42. REG. 10-10-1989.
- 1,560,266. SPLIT SECOND. INT. CL. 42. REG. 10-10-1989.
- 1,560,268. EYE SUPPLY. INT. CL. 42. REG. 10-10-1989.
- 1,560,269. NATIONAL HEARING AID SOCIETY. U.S. CL. 200. REG. 10-10-1989.
- 1,560,270. SAO CAFE AND DESIGN. U.S. CL. 200. REG. 10-10-1989.
- 1,560,275. CUSTOM MADE. INT. CL. 7. REG. 10-10-1989.
- 1,560,277. MULTI MEDIA ACCESS CENTER. INT. CL. 9. REG. 10-10-1989.
- 1,560,280. SEAMON. INT. CL. 9. REG. 10-10-1989.
- 1,560,281. VIDEO SOUNDMIXER. INT. CL. 9. REG. 10-10-1989.
- 1,560,282. FLIP-A-SWITCH AND DESIGN. INT. CL. 9. REG. 10-10-1989.
- 1,560,283. IMAGING. INT. CL. 9. REG. 10-10-1989.
- 1,560,287. E-Z COUPLER (STYLIZED). INT. CL. 12. REG. 10-10-1989.
- 1,560,288. HYATT. INT. CL. 12. REG. 10-10-1989.
- 1,560,291. WOMAN INC.. INT. CL. 16. REG. 10-10-1989.
- 1,560,292. SUMMERLIN. INT. CL. 16. REG. 10-10-1989.
- 1,560,295. LATINFINANCE. INT. CL. 16. REG. 10-10-1989.
- 1,560,302. MISCELLANEOUS DESIGN. INT. CL. 25. REG. 10-10-1989.
- 1,560,309. INTERNATIONAL LEATHER EXPO. INT. CL. 35. REG. 10-10-1989.
- 1,560,311. TURNER MANAGEMENT GROUP. INT. CL. 35. REG. 10-10-1989.
- 1,560,314. TOUR OF LOTTIE MOON'S CHINA. INT. CL. 39. REG. 10-10-1989.
- 1,560,316. WANG AND WANG. INT. CL. 42. REG. 10-10-1989.
- 1,560,318. B.J. SMITH. INT. CL. 42. REG. 10-10-1989.
- 1,565,563. BELL. INT. CLS. 9 AND 41 ONLY. REG. 11-14-1989.
- 2,277,224. O.A.R.S.. INT. CLS. 39 AND 42. REG. 9-14-1999.
- 2,284,309. IM (STYLIZED). INT. CL. 14. REG. 10-12-1999.
- 2,284,310. THE CLEAR CHOICE. INT. CLS. 2, 3, 4 AND 9. REG. 10-12-1999.
- 2,284,327. BILL'S PRIVATE STOCK. INT. CL. 32. REG. 10-12-1999.
- 2,284,334. ALTA SPRINGS. INT. CL. 32. REG. 10-12-1999.
- 2,284,347. MAIL AUTHORITY. INT. CLS. 35 AND 39. REG. 10-12-1999.
- 2,284,349. VUEPOINT. INT. CL. 41. REG. 10-12-1999.
- 2,284,370. ORIGINAL CAST. INT. CL. 41. REG. 10-12-1999.
- 2,284,372. PAUL BRUNO. INT. CL. 33. REG. 10-12-1999.
- 2,284,382. USA DANCESPORT AND DESIGN. INT. CL. 41. REG. 10-12-1999.
- 2,284,394. TRIPLE CASH. INT. CL. 35. REG. 10-12-1999.
- 2,284,395. DATA VISTA (STYLIZED). INT. CL. 9. REG. 10-12-1999.
- 2,284,399. AMERICA'S STORE. INT. CL. 38. REG. 10-12-1999.
- 2,284,402. BRONCO. INT. CL. 8. REG. 10-12-1999.
- 2,284,413. GRACIE'S AND DESIGN. INT. CLS. 21, 25 AND 42. REG. 10-12-1999.
- 2,284,415. CERTINET. INT. CLS. 9, 35, 37, 41 AND 42. REG. 10-12-1999.
- 2,284,438. DOVE AND DESIGN. INT. CL. 30. REG. 10-12-1999.
- 2,284,439. FLAV-R-PAC JUSTADD BEEF! AND DESIGN. INT. CL. 29. REG. 10-12-1999.
- 2,284,440. BLUJAZZ PRODUCTIONS (STYLIZED). INT. CL. 9. REG. 10-12-1999.
- 2,284,444. EASYCARE. INT. CL. 9. REG. 10-12-1999.
- 2,284,449. DRUM TALK. INT. CL. 41. REG. 10-12-1999.
- 2,284,460. ICAS. INT. CLS. 35, 37 AND 42. REG. 10-12-1999.
- 2,284,465. COFFIN NAILS. INT. CL. 16. REG. 10-12-1999.
- 2,284,466. COFFIN CORNER. INT. CL. 16. REG. 10-12-1999.
- 2,284,481. GENKI SUSHI HAWAII AND DESIGN. INT. CLS. 30 AND 42. REG. 10-12-1999.
- 2,284,488. PINKERTON COMPUTER CONSULTANTS. INT. CLS. 37 AND 42. REG. 10-12-1999.
- 2,284,495. A NAME YOU KNOW. A NAME YOU CAN TRUST.. INT. CL. 35. REG. 10-12-1999.
- 2,284,507. HEELIES (STYLIZED). INT. CL. 25. REG. 10-12-1999.
- 2,284,525. WILD WILD BEST. INT. CL. 35. REG. 10-12-1999.
- 2,284,526. HOME CHOICE AND DESIGN. INT. CL. 35. REG. 10-12-1999.
- 2,284,533. COOL-IT (STYLIZED). INT. CL. 25. REG. 10-12-1999.
- 2,284,547. J.G. DURAND. INT. CL. 21. REG. 10-12-1999.
- 2,284,550. DURAND. INT. CL. 21. REG. 10-12-1999.
- 2,284,555. MISCELLANEOUS DESIGN. INT. CL. 35. REG. 10-12-1999.
- 2,284,572. FLYWHEEL MUSIC AND DESIGN. INT. CL. 9. REG. 10-12-1999.
- 2,284,574. DISCOVERLY. INT. CLS. 41 AND 42. REG. 10-12-1999.
- 2,284,575. GRAFICO AND DESIGN. INT. CL. 40. REG. 10-12-1999.
- 2,284,578. WRIGHT WORKOUT. INT. CL. 41. REG. 10-12-1999.

- 2,284,580. WE DO COURTHOUSES. INT. CL. 42. REG. 10-12-1999.
- 2,284,582. QUALITY IS OUR PRIORITY. INT. CL. 31. REG. 10-12-1999.
- 2,284,590. ROSEVILLE'S PINK PASSION. INT. CL. 31. REG. 10-12-1999.
- 2,284,591. BILLIARDS EXPRESS AND DESIGN. INT. CL. 35. REG. 10-12-1999.
- 2,284,622. MISCELLANEOUS DESIGN. INT. CL. 42. REG. 10-12-1999.
- 2,284,623. DESERET AUDIO LIBRARY. INT. CL. 9. REG. 10-12-1999.
- 2,284,624. MISCELLANEOUS DESIGN. INT. CL. 10. REG. 10-12-1999.
- 2,284,629. APR USA AND DESIGN. INT. CLS. 6 AND 7. REG. 10-12-1999.
- 2,284,646. OPTIFLEX. INT. CL. 9. REG. 10-12-1999.
- 2,284,647. FEG (STYLIZED). INT. CL. 36. REG. 10-12-1999.
- 2,284,655. WALKER. INT. CL. 6. REG. 10-12-1999.
- 2,284,659. GRACIOUS HOME. INT. CLS. 2, 3, 4, 8, 11, 14, 16, 20, 21, 24, 25 AND 26. REG. 10-12-1999.
- 2,284,662. WE OPEN MORE DOORS. AND CLOSE MORE SALES. INT. CL. 36. REG. 10-12-1999.
- 2,284,666. ACONDA. INT. CL. 16. REG. 10-12-1999.
- 2,284,680. LD-SPORT INTERNATIONAL AND DESIGN. INT. CL. 25. REG. 10-12-1999.
- 2,284,681. COURAGE TO CHANGE CATALOG FOR LIFE'S CHALLENGES AND DESIGN. INT. CL. 35. REG. 10-12-1999.
- 2,284,682. WORK YOUR IMAGE!. INT. CL. 41. REG. 10-12-1999.
- 2,284,697. FRIENDS OF ISRAEL TODAY. INT. CL. 41. REG. 10-12-1999.
- 2,284,722. SOHO AMERICA THE SMALL-BUSINESS BENEFITS ASSOCIATION AND DESIGN. INT. CL. 35. REG. 10-12-1999.
- 2,284,733. ELEGANCE. INT. CL. 16. REG. 10-12-1999.
- 2,284,738. THE CHELSEA ASSISTED LIVING RESIDENCES AND DESIGN. INT. CL. 42. REG. 10-12-1999.
- 2,284,759. LUCASARTS AND DESIGN. INT. CL. 21. REG. 10-12-1999.
- 2,284,767. AMERICAN CORPORATE CORONARY CARE AND DESIGN. INT. CL. 41. REG. 10-12-1999.
- 2,284,768. BIOLATERAL (STYLIZED). INT. CL. 9. REG. 10-12-1999.
- 2,284,771. DOWNTOWN DC AND DESIGN. INT. CLS. 16, 37 AND 42. REG. 10-12-1999.
- 2,284,772. DOWNTOWN SAM SAFETY AND MAINTENANCE AND DESIGN. INT. CLS. 37 AND 42. REG. 10-12-1999.
- 2,284,775. MISCELLANEOUS DESIGN. INT. CLS. 25 AND 28. REG. 10-12-1999.
- 2,284,784. MAINECAREERS. INT. CL. 35. REG. 10-12-1999.
- 2,284,793. MISCELLANEOUS DESIGN. INT. CL. 42. REG. 10-12-1999.
- 2,284,794. CHAIM SOUTINE (STYLIZED). INT. CL. 31. REG. 10-12-1999.
- 2,284,799. THE ADVENTURES OF MARY-KATE & ASHLEY. INT. CLS. 9 AND 16. REG. 10-12-1999.
- 2,284,804. WAX'N WAXING (STYLIZED). INT. CLS. 3 AND 21. REG. 10-12-1999.
- 2,284,810. MISCELLANEOUS DESIGN. INT. CLS. 16, 35, 38 AND 39. REG. 10-12-1999.
- 2,284,826. SWINERTON. INT. CL. 36. REG. 10-12-1999.
- 2,284,827. MISCELLANEOUS DESIGN. INT. CL. 36. REG. 10-12-1999.
- 2,284,844. FAMOUS FLAMING STONE BEER. INT. CL. 32. REG. 10-12-1999.
- 2,284,845. UNIPA NYTEF PLASTICS, LTD. (STYLIZED). INT. CL. 17. REG. 10-12-1999.
- 2,284,850. DIAL-A-WAITER AND DESIGN. INT. CL. 39. REG. 10-12-1999.
- 2,284,864. HOME OF THE FRESHABLES (STYLIZED). INT. CL. 35. REG. 10-12-1999.
- 2,284,868. FUSION. INT. CL. 20. REG. 10-12-1999.
- 2,284,870. HISPANIC JOURNAL AND DESIGN. INT. CL. 16. REG. 10-12-1999.
- 2,284,881. SILTRON. INT. CL. 5. REG. 10-12-1999.
- 2,284,887. SAY WHAT?. INT. CL. 16. REG. 10-12-1999.
- 2,284,889. BIRCHWOOD PARK HOMES QUALITY BUILT BY QUALITY BUILDERS AND DESIGN. INT. CL. 37. REG. 10-12-1999.
- 2,284,893. DRAWBASE AND DESIGN. INT. CL. 9. REG. 10-12-1999.
- 2,284,895. NATSUKI FLUTE. INT. CL. 15. REG. 10-12-1999.
- 2,284,907. JUSTIN TIME AUCTION AND DESIGN. INT. CL. 35. REG. 10-12-1999.
- 2,284,911. VISTAWEAR AND DESIGN. INT. CLS. 25 AND 35. REG. 10-12-1999.
- 2,284,912. GETHEALTHY.COM AND DESIGN. INT. CL. 5. REG. 10-12-1999.
- 2,284,937. L'ATTITUDE ADVENTURES. INT. CL. 39. REG. 10-12-1999.
- 2,284,940. MISCELLANEOUS DESIGN. INT. CL. 10. REG. 10-12-1999.
- 2,284,944. ATLAS ADMINISTRATORS, INC. AND DESIGN. INT. CL. 36. REG. 10-12-1999.
- 2,284,950. BEAUTE' AND DESIGN. INT. CLS. 16 AND 35. REG. 10-12-1999.
- 2,284,955. GLAMOUR GEAR (STYLIZED). INT. CLS. 3 AND 28. REG. 10-12-1999.
- 2,284,966. DERMESCAPE SPECIALTY SKIN SALON AND DESIGN. INT. CL. 42. REG. 10-12-1999.
- 2,284,968. OUTSOURCE FINANCIAL SERVICES. INT. CL. 36. REG. 10-12-1999.
- 2,284,973. GLOBAL SATELLITE COMMUNICATIONS AND DESIGN. INT. CL. 35. REG. 10-12-1999.
- 2,284,978. THE SOUTH VALLEY BEE. INT. CL. 16. REG. 10-12-1999.
- 2,284,981. S.U.R.E. - FIRE. INT. CL. 35. REG. 10-12-1999.
- 2,284,982. CHASE. INT. CL. 12. REG. 10-12-1999.
- 2,284,984. FASLATA. INT. CL. 5. REG. 10-12-1999.
- 2,284,985. CAPITAL ENHANCEMENT, L.L.C.. INT. CL. 36. REG. 10-12-1999.
- 2,285,012. PER-FIX. INT. CL. 2. REG. 10-12-1999.
- 2,285,013. THE TIP PLAN. INT. CL. 36. REG. 10-12-1999.
- 2,285,031. BMSI AND DESIGN. INT. CL. 41. REG. 10-12-1999.
- 2,285,043. SOLUTION ADVISOR. INT. CL. 35. REG. 10-12-1999.
- 2,285,044. GENTLE BLUE. INT. CL. 10. REG. 10-12-1999.
- 2,285,058. MISCELLANEOUS DESIGN. INT. CL. 42. REG. 10-12-1999.
- 2,285,074. H.S.I. FUSION SERVICES. INT. CLS. 35 AND 40. REG. 10-12-1999.
- 2,285,075. WMR (STYLIZED). INT. CL. 36. REG. 10-12-1999.
- 2,285,083. HI CAST AND DESIGN. INT. CLS. 7 AND 12. REG. 10-12-1999.
- 2,285,085. HAWKING TECHNOLOGY AND DESIGN. INT. CL. 9. REG. 10-12-1999.
- 2,285,087. SOLANO STRIP STEAK. INT. CL. 29. REG. 10-12-1999.
- 2,285,088. HERB'S HERBS. INT. CL. 35. REG. 10-12-1999.
- 2,285,094. FEATHERLITE VOGUE. INT. CL. 12. REG. 10-12-1999.
- 2,285,096. STOP IT. INT. CL. 9. REG. 10-12-1999.
- 2,285,108. W AND DESIGN. INT. CL. 35. REG. 10-12-1999.
- 2,285,109. GOTHIC AT MIDNIGHT. INT. CL. 41. REG. 10-12-1999.
- 2,285,110. IMAGINATION TOOLKIT. INT. CL. 41. REG. 10-12-1999.
- 2,285,111. MISCELLANEOUS DESIGN. INT. CL. 35. REG. 10-12-1999.
- 2,285,133. POLYFLEC. INT. CL. 22. REG. 10-12-1999.
- 2,285,137. ITXC CORP.. INT. CL. 38. REG. 10-12-1999.
- 2,285,146. PAXKO (STYLIZED). INT. CL. 25. REG. 10-12-1999.
- 2,285,154. WC AND DESIGN. INT. CL. 25. REG. 10-12-1999.
- 2,285,161. MEET THE MUSICIANS AND DESIGN. INT. CL. 41. REG. 10-12-1999.
- 2,285,162. TUNEYVILLE CHOO CHOO. INT. CL. 28. REG. 10-12-1999.
- 2,285,174. CC CAPPUCINO CREME AND DESIGN. INT. CL. 30. REG. 10-12-1999.
- 2,285,181. TRADE SOLUTIONS SOLUTIONS BEYOND THE OBVIOUS AND DESIGN. INT. CL. 35. REG. 10-12-1999.

- 2,285,182. CYTOSKELETON AND DESIGN. INT. CL. 42. REG. 10-12-1999.
- 2,285,188. OCT GROUP. INT. CL. 35. REG. 10-12-1999.
- 2,285,189. MISCELLANEOUS DESIGN. INT. CL. 42. REG. 10-12-1999.
- 2,285,205. PME COMPANIES. INT. CL. 42. REG. 10-12-1999.
- 2,285,212. SPOTTED DOG GRAPHICS AND DESIGN. INT. CL. 42. REG. 10-12-1999.
- 2,285,218. CASINO BUSHING. INT. CL. 9. REG. 10-12-1999.
- 2,285,219. THE BIG 80'S. INT. CL. 9. REG. 10-12-1999.
- 2,285,220. MAG SHIELD AND DESIGN. INT. CL. 1. REG. 10-12-1999.
- 2,285,221. ALTIA AND DESIGN. INT. CLS. 9 AND 42. REG. 10-12-1999.
- 2,285,223. BABY NOUVEAU AND DESIGN. INT. CL. 25. REG. 10-12-1999.
- 2,285,233. LOOK-ALIKES AND DESIGN. INT. CL. 16. REG. 10-12-1999.
- 2,285,234. MISCELLANEOUS DESIGN. INT. CLS. 38 AND 42. REG. 10-12-1999.
- 2,285,236. BRIGHT CHOICE. INT. CL. 38. REG. 10-12-1999.
- 2,285,242. RECORDMAX. INT. CL. 39. REG. 10-12-1999.
- 2,285,245. MARTIMUS SPORT AND DESIGN. INT. CL. 25. REG. 10-12-1999.
- 2,285,247. CHICKEN SENSATIONS. INT. CL. 29. REG. 10-12-1999.
- 2,285,248. CONSUMER REPORTS ONLINE. INT. CL. 42. REG. 10-12-1999.
- 2,285,255. AUGURI. INT. CL. 9. REG. 10-12-1999.
- 2,285,258. STRIDER & CLINE. INT. CL. 35. REG. 10-12-1999.
- 2,285,279. TRANSPORTATION TECHNOLOGY R & D CENTER (STYLIZED). INT. CL. 16. REG. 10-12-1999.
- 2,285,281. LEASE EDGE. INT. CL. 36. REG. 10-12-1999.
- 2,285,293. OLD ELM AND DESIGN. INT. CLS. 21, 25, 28 AND 41. REG. 10-12-1999.
- 2,285,300. ZS. INT. CL. 14. REG. 10-12-1999.
- 2,285,307. THE POWER TO MAKE A DIFFERENCE. INT. CL. 41. REG. 10-12-1999.
- 2,285,311. PME COMPANIES AND DESIGN. INT. CL. 42. REG. 10-12-1999.
- 2,285,312. IMPACT. INT. CL. 1. REG. 10-12-1999.
- 2,285,319. ARANESSA. INT. CL. 35. REG. 10-12-1999.
- 2,285,322. FOTOFILIP. INT. CL. 41. REG. 10-12-1999.
- 2,285,335. GREATER PHOENIX PHX CONVENTION & VISITORS BUREAU AND DESIGN. INT. CL. 35. REG. 10-12-1999.
- 2,285,350. STAEDTLER INTEGRITY AND DESIGN. INT. CL. 16. REG. 10-12-1999.
- 2,285,363. DESERT DOCUMENT SERVICES. INT. CLS. 9 AND 35. REG. 10-12-1999.
- 2,285,364. H AND DESIGN. INT. CL. 35. REG. 10-12-1999.
- 2,285,365. STRETCH RITE AND DESIGN. INT. CL. 28. REG. 10-12-1999.
- 2,285,370. MCCREADE SYSTEMS. INT. CL. 35. REG. 10-12-1999.
- 2,285,378. RE AND DESIGN. INT. CLS. 39 AND 42. REG. 10-12-1999.
- 2,285,379. YOUR ANSWERING SERVICE AND DESIGN. INT. CL. 35. REG. 10-12-1999.
- 2,285,386. IT'S A MIRACLE. INT. CL. 41. REG. 10-12-1999.
- 2,285,392. GREENERGY. INT. CL. 28. REG. 10-12-1999.
- 2,285,393. MISCELLANEOUS DESIGN. INT. CL. 18. REG. 10-12-1999.
- 2,285,397. MISCELLANEOUS DESIGN. INT. CL. 41. REG. 10-12-1999.
- 2,285,403. RED ZONE. INT. CL. 28. REG. 10-12-1999.
- 2,285,407. DIFFERENCE. INT. CL. 28. REG. 10-12-1999.
- 2,285,408. POP 'N PAK. INT. CL. 16. REG. 10-12-1999.
- 2,285,410. TOOLS PARADISE. INT. CL. 35. REG. 10-12-1999.
- 2,285,411. ENTERPRISE PARADISE. INT. CL. 35. REG. 10-12-1999.
- 2,285,433. SOUTHERN STAR MORTGAGE CORP. AND DESIGN. INT. CL. 36. REG. 10-12-1999.
- 2,285,440. GLASS SHAD (STYLIZED). INT. CL. 28. REG. 10-12-1999.
- 2,285,449. ASTERISQUES. INT. CL. 14. REG. 10-12-1999.
- 2,285,459. GARM. INT. CL. 36. REG. 10-12-1999.
- 2,285,470. EDUWEB. INT. CL. 42. REG. 10-12-1999.
- 2,285,471. DYNAMIC ROOTS. INT. CL. 16. REG. 10-12-1999.
- 2,285,483. TLC. INT. CL. 2. REG. 10-12-1999.
- 2,285,484. RECOIL. INT. CL. 28. REG. 10-12-1999.
- 2,285,498. WE WORRY ABOUT THE BIG PICTURE SO YOU DON'T HAVE TO. INT. CL. 37. REG. 10-12-1999.
- 2,285,500. LOTSA'. INT. CL. 32. REG. 10-12-1999.
- 2,285,504. CHILLY NAVEL. INT. CL. 32. REG. 10-12-1999.
- 2,285,508. CHILDHHELP USA. INT. CL. 41. REG. 10-12-1999.
- 2,285,509. HEINEKEN EN VIVO. INT. CL. 32. REG. 10-12-1999.
- 2,285,511. VIVOSONIC. INT. CL. 10. REG. 10-12-1999.
- 2,285,512. SOMNUS. INT. CL. 10. REG. 10-12-1999.
- 2,285,527. OLD FASHIONED BLOOMERS ANTIQUE ROSES AND DESIGN. INT. CL. 31. REG. 10-12-1999.
- 2,285,537. IPSOLON. INT. CL. 42. REG. 10-12-1999.
- 2,285,540. DOWN 'N DIRTY BBQ AND DESIGN. INT. CLS. 30 AND 42. REG. 10-12-1999.
- 2,285,543. KICK YO' ASS HOT!. INT. CL. 32. REG. 10-12-1999.
- 2,285,566. OPEI AND DESIGN. INT. CL. 42. REG. 10-12-1999.
- 2,285,569. PIT ROW. INT. CL. 37. REG. 10-12-1999.
- 2,285,580. MISCELLANEOUS DESIGN. INT. CL. 33. REG. 10-12-1999.
- 2,285,600. TIGER KING. INT. CL. 29. REG. 10-12-1999.
- 2,285,603. ROAD MANAGER. INT. CL. 36. REG. 10-12-1999.
- 2,285,605. SUNFED AND DESIGN. INT. CL. 31. REG. 10-12-1999.
- 2,285,606. KEMPTON CLARK. INT. CL. 33. REG. 10-12-1999.
- 2,285,608. TROPIC'S AND DESIGN. INT. CL. 29. REG. 10-12-1999.
- 2,285,615. THE OUTLET STORE IN YOUR HOME. INT. CL. 35. REG. 10-12-1999.
- 2,285,634. LIL TORT. INT. CL. 30. REG. 10-12-1999.
- 2,285,637. MAD ABOUT MAHJ. INT. CL. 30. REG. 10-12-1999.
- 2,285,638. CREW. INT. CL. 41. REG. 10-12-1999.
- 2,285,640. WELCOME TO THE CLUB. INT. CL. 35. REG. 10-12-1999.
- 2,285,649. KATABOOM. INT. CL. 30. REG. 10-12-1999.
- 2,285,658. APPLE SIDRA COSCO AND DESIGN. INT. CL. 32. REG. 10-12-1999.
- 2,285,660. ATHENA DIGITAL. INT. CL. 9. REG. 10-12-1999.
- 2,285,662. I-TEX. INT. CL. 9. REG. 10-12-1999.
- 2,285,663. PAUL REVERE (STYLIZED). INT. CL. 21. REG. 10-12-1999.
- 2,285,667. CUSOURCE. INT. CL. 36. REG. 10-12-1999.
- 2,285,682. FMK WORLD KARATE FEDERATION AND DESIGN. INT. CLS. 16 AND 41. REG. 10-12-1999.
- 2,285,684. LASER TOUCH. INT. CL. 7. REG. 10-12-1999.
- 2,285,689. TURBO-PDT. INT. CL. 10. REG. 10-12-1999.
- 2,285,700. GR8. INT. CL. 25. REG. 10-12-1999.
- 2,285,706. EMP. INT. CL. 18. REG. 10-12-1999.
- 2,285,710. SHADOW RECORDS. INT. CL. 25. REG. 10-12-1999.
- 2,285,726. H₂O + AND DESIGN. INT. CL. 21. REG. 10-12-1999.
- 2,285,729. THE 6P CORP.. INT. CL. 28. REG. 10-12-1999.
- 2,285,732. THE GRIFFIN GROUP AND DESIGN. INT. CL. 41. REG. 10-12-1999.
- 2,285,738. SKEET. INT. CL. 28. REG. 10-12-1999.
- 2,285,761. RARE HOSPITALITY. INT. CL. 42. REG. 10-12-1999.
- 2,285,766. MENSWEAR. INT. CL. 3. REG. 10-12-1999.
- 2,285,768. SNEAKERS. INT. CL. 14. REG. 10-12-1999.
- 2,285,771. PARISELLA, VINCELLI ASSOCIATES PVA CONSULTING GROUP INC. MANAGEMENT AND PRODUCTIVITY DEVELOPMENT AND DESIGN. INT. CL. 35. REG. 10-12-1999.
- 2,285,779. PORSCHE (STYLIZED). INT. CL. 34. REG. 10-12-1999.
- 2,285,785. SHADOW AMERICAN CLASSIC EDITION. INT. CLS. 16, 25 AND 28. REG. 10-12-1999.
- 2,285,788. POLTI. INT. CL. 9. REG. 10-12-1999.
- 2,285,790. PHOTOSPIN POWERPHOTOS. INT. CL. 9. REG. 10-12-1999.
- 2,285,791. BROKER'S FOUNDATION TITLE FUND AND DESIGN. INT. CL. 36. REG. 10-12-1999.
- 2,285,801. RISHALOCK. INT. CL. 6. REG. 10-12-1999.

- 2,285,814. MOM. INT. CL. 35. REG. 10-12-1999.
 2,285,824. METRILUBE. INT. CL. 5. REG. 10-12-1999.
 2,285,825. BREWLIIOUS. INT. CLS. 30 AND 42. REG. 10-12-1999.
 2,285,826. YUKLA27. INT. CL. 36. REG. 10-12-1999.
 2,285,829. FIBRYMID. INT. CL. 5. REG. 10-12-1999.
 2,285,831. SALT & PEPPER KITCHEN WEAR AND DESIGN. INT. CL. 25. REG. 10-12-1999.
 2,285,834. LEARNING MAINTENANCE ORGANIZATION. INT. CL. 41. REG. 10-12-1999.
 2,285,843. DR. PAUL HERSCU. INT. CL. 41. REG. 10-12-1999.
 2,285,851. RELAX UNDER PRESSURE AND DESIGN. INT. CLS. 10, 35, 37 AND 40. REG. 10-12-1999.
 2,285,855. MISCELLANEOUS DESIGN. INT. CLS. 9, 41 AND 42. REG. 10-12-1999.
 2,285,860. BETA-TRIM. INT. CL. 1. REG. 10-12-1999.
 2,285,869. SHERWOOD. INT. CL. 42. REG. 10-12-1999.
 2,285,872. WEATHERVANE HILL. INT. CLS. 20, 24 AND 27. REG. 10-12-1999.
 2,285,879. HARMONY. INT. CL. 9. REG. 10-12-1999.
 2,285,888. DXR AND DESIGN. INT. CL. 9. REG. 10-12-1999.
 2,285,902. BRANDT. INT. CL. 3. REG. 10-12-1999.
 2,285,908. BIOLOGIC SIMPLY MAKES SENSE. INT. CL. 10. REG. 10-12-1999.
 2,285,914. G GOSS AND DESIGN. INT. CLS. 7 AND 9. REG. 10-12-1999.
 2,285,917. SPONGE-A-STORY (STYLIZED). INT. CL. 16. REG. 10-12-1999.
 2,285,924. JEWELS OF TIME. INT. CL. 9. REG. 10-12-1999.
 2,285,926. SOLAR F/X. INT. CL. 3. REG. 10-12-1999.
 2,285,935. SCRUB STAR AND DESIGN. INT. CL. 25. REG. 10-12-1999.
 2,285,938. CONSTELLAR. INT. CL. 9. REG. 10-12-1999.
 2,285,940. GUARDDOG. INT. CL. 9. REG. 10-12-1999.
 2,285,942. POCKETCAD. INT. CL. 9. REG. 10-12-1999.
 2,285,945. PROBUBUSINESS. INT. CL. 36. REG. 10-12-1999.
 2,285,956. VIGEVANO (STYLIZED). INT. CL. 18. REG. 10-12-1999.
 2,285,975. HELADOS LA IBENSE BORNAY AND DESIGN. INT. CL. 30. REG. 10-12-1999.
 2,285,976. SLABGUARD. INT. CL. 8. REG. 10-12-1999.
 2,285,978. FULL VALUE BROKERAGE. INT. CL. 36. REG. 10-12-1999.
 2,285,981. VISIONARY BOWLING PRODUCTS AND DESIGN. INT. CL. 28. REG. 10-12-1999.
 2,285,993. KALAHARI PEPPER COMPANY. INT. CL. 30. REG. 10-12-1999.
 2,286,011. THE DAILY PLAN-IT AND DESIGN. INT. CL. 16. REG. 10-12-1999.
 2,286,012. TAX MINIMISER. INT. CL. 16. REG. 10-12-1999.
 2,286,016. OLD LINER. INT. CL. 25. REG. 10-12-1999.
 2,286,022. POP SHOTS. INT. CL. 30. REG. 10-12-1999.
 2,286,029. ACRP ASSOCIATION OF CLINICAL RESEARCH PROFESSIONALS AND DESIGN. INT. CL. 42. REG. 10-12-1999.
 2,286,033. DESKMAIL 2000. INT. CL. 9. REG. 10-12-1999.
 2,286,053. VCAMPUS. INT. CLS. 9, 16, 35, 41 AND 42. REG. 10-12-1999.
 2,286,055. RC TRAIN AND DESIGN. INT. CL. 28. REG. 10-12-1999.
 2,286,065. MISCELLANEOUS DESIGN. INT. CL. 16. REG. 10-12-1999.
 2,286,069. MISCELLANEOUS DESIGN. INT. CLS. 9 AND 11. REG. 10-12-1999.
 2,286,084. PLUG INTO THE ANSWER. INT. CL. 7. REG. 10-12-1999.
 2,286,091. FLOWSONEX. INT. CL. 9. REG. 10-12-1999.
 2,286,092. AC AND DESIGN. INT. CLS. 25 AND 41. REG. 10-12-1999.
 2,286,093. ATLANTIC CITY SURF. INT. CLS. 25 AND 41. REG. 10-12-1999.
 2,286,098. PENINSULA. INT. CL. 33. REG. 10-12-1999.
 2,286,103. ROOMSOURCE. INT. CL. 39. REG. 10-12-1999.
 2,286,114. BI-LO CENTER (STYLIZED). INT. CL. 25. REG. 10-12-1999.
 2,286,116. POWERTAB. INT. CL. 9. REG. 10-12-1999.
 2,286,122. FILLY. INT. CL. 3. REG. 10-12-1999.
 2,286,135. CII FLAV-R-BITES. INT. CL. 30. REG. 10-12-1999.
 2,286,142. FOG RUNNER. INT. CL. 7. REG. 10-12-1999.
 2,286,145. DELFINA SWIMWEAR AND DESIGN. INT. CL. 25. REG. 10-12-1999.
 2,286,146. DELFINA. INT. CL. 25. REG. 10-12-1999.
 2,286,154. PROTEINCHIP. INT. CL. 9. REG. 10-12-1999.
 2,286,160. BELLA SPAZIO. INT. CL. 42. REG. 10-12-1999.
 2,286,164. WONDER TREE. INT. CL. 28. REG. 10-12-1999.
 2,286,166. MOBILITY ELECTRONICS. INT. CL. 9. REG. 10-12-1999.
 2,286,167. GOD'S SHOP. INT. CL. 25. REG. 10-12-1999.
 2,286,180. MOVEXPRESS. INT. CLS. 37, 38 AND 42. REG. 10-12-1999.
 2,286,187. SUNPOWER KIDZ. INT. CL. 28. REG. 10-12-1999.
 2,286,197. REBOOT. INT. CL. 9. REG. 10-12-1999.
 2,286,198. LITTLE GUYS MOVERS AND DESIGN. INT. CL. 39. REG. 10-12-1999.
 2,286,203. SEGRIDOR. INT. CL. 19. REG. 10-12-1999.
 2,286,213. KYST. INT. CL. 14. REG. 10-12-1999.
 2,286,215. MAIN STREET. INT. CL. 16. REG. 10-12-1999.
 2,286,225. SAFETY WASH. INT. CL. 37. REG. 10-12-1999.
 2,286,230. FYRTARD. INT. CL. 20. REG. 10-12-1999.
 2,286,231. CHEMTUF. INT. CL. 20. REG. 10-12-1999.
 2,286,253. COCONUT JOE. INT. CLS. 9 AND 41. REG. 10-12-1999.
 2,286,254. VITRILIFE. INT. CL. 40. REG. 10-12-1999.
 2,286,255. TOMMY HILFIGER. INT. CL. 42. REG. 10-12-1999.
 2,286,264. PORTOBELLO. INT. CL. 33. REG. 10-12-1999.
 2,286,265. VAC-CHECK. INT. CL. 9. REG. 10-12-1999.
 2,286,269. REEF (STYLIZED). INT. CL. 25. REG. 10-12-1999.
 2,286,279. EIFFEL TOWER. INT. CL. 21. REG. 10-12-1999.
 2,286,282. BMI AUTOMATION, INC. AND DESIGN. INT. CLS. 7 AND 42. REG. 10-12-1999.
 2,286,288. KOKA. INT. CL. 25. REG. 10-12-1999.
 2,286,292. VIGNETTE.COM. INT. CL. 9. REG. 10-12-1999.
 2,286,294. ONELOOK. INT. CL. 9. REG. 10-12-1999.
 2,286,327. SKILLSMITH. INT. CL. 41. REG. 10-12-1999.
 2,286,328. TG-MAX. INT. CL. 5. REG. 10-12-1999.
 2,286,339. LUBE SUIT. INT. CL. 25. REG. 10-12-1999.
 2,286,350. 622KP. INT. CL. 9. REG. 10-12-1999.
 2,286,363. MISCELLANEOUS DESIGN. INT. CL. 7. REG. 10-12-1999.
 2,286,364. NO HANDS! RIBBON WIZARD. INT. CL. 7. REG. 10-12-1999.
 2,286,374. TOUCHTEX. INT. CL. 25. REG. 10-12-1999.
 2,286,381. Q PROQUEST INSURANCE AGENCY AND DESIGN. INT. CL. 36. REG. 10-12-1999.
 2,286,393. FDSP. INT. CL. 15. REG. 10-12-1999.
 2,286,398. RESCUE ONE. INT. CL. 8. REG. 10-12-1999.
 2,286,409. MOORCRAFT SUPER SPEC. INT. CL. 2. REG. 10-12-1999.
 2,286,442. MORTON BERNARD. INT. CL. 25. REG. 10-12-1999.
 2,286,459. PATHFINDER. INT. CL. 9. REG. 10-12-1999.
 2,286,461. TOKYO GO GO. INT. CL. 42. REG. 10-12-1999.
 2,286,466. GLOVIA AND DESIGN. INT. CL. 9. REG. 10-12-1999.
 2,286,473. SIGNATURE BY HARVE BENARD (STYLIZED). INT. CL. 25. REG. 10-12-1999.
 2,286,477. PROGRESS INTERNATIONAL. INT. CL. 16. REG. 10-12-1999.
 2,286,480. HEALTHBOUND AND DESIGN. INT. CL. 16. REG. 10-12-1999.
 2,286,481. TCC. INT. CL. 16. REG. 10-12-1999.
 2,286,499. RUIZ FAMILY AND DESIGN. INT. CL. 30. REG. 10-12-1999.
 2,286,508. MISCELLANEOUS DESIGN. INT. CL. 30. REG. 10-12-1999.
 2,286,509. COLORWORKS. INT. CL. 24. REG. 10-12-1999.
 2,286,512. PRICE CHOICE FOODMARKETS AND DESIGN. INT. CL. 35. REG. 10-12-1999.
 2,286,517. NINE CHOIRS OF ANGELS. INT. CL. 16. REG. 10-12-1999.
 2,286,518. COMING HOME TO AFFORDABLE HOUSING. INT. CL. 36. REG. 10-12-1999.
 2,286,530. PATHWORKS, INCORPORATED. INT. CL. 27. REG. 10-12-1999.
 2,286,541. FINALITE 1.6. INT. CL. 9. REG. 10-12-1999.

- 2,286,566. MAKEVC. INT. CL. 9. REG. 10-12-1999.
- 2,286,576. BOBBY JOE'S HOTDOG SAUCE. INT. CL. 30. REG. 10-12-1999.
- 2,286,581. CABINET AND DESIGN. INT. CL. 20. REG. 10-12-1999.
- 2,286,587. GENESTORM. INT. CL. 1. REG. 10-12-1999.
- 2,286,588. REMORA. INT. CL. 25. REG. 10-12-1999.
- 2,286,593. PICAS CENTRALAB (STYLIZED). INT. CL. 9. REG. 10-12-1999.
- 2,286,603. CARTEL CLOTHING. INT. CL. 25. REG. 10-12-1999.
- 2,286,607. SATIN WONDERS. INT. CL. 24. REG. 10-12-1999.
- 2,286,614. YOUNG TIMER. INT. CL. 25. REG. 10-12-1999.
- 2,286,620. NORDIC LIGHTS. INT. CL. 25. REG. 10-12-1999.
- 2,286,638. SMOKY CREEK GRILL. INT. CL. 42. REG. 10-12-1999.
- 2,286,640. MAPLE GREATS. INT. CL. 30. REG. 10-12-1999.
- 2,286,644. WESTERN UNION GIRO TELEGRAFICO. INT. CL. 36. REG. 10-12-1999.
- 2,286,653. P'NUT FLUFFER. INT. CL. 30. REG. 10-12-1999.
- 2,286,666. THE SHORTEST DISTANCE BETWEEN VISION AND REALITY. INT. CL. 42. REG. 10-12-1999.
- 2,286,669. FACTSYSTEM. INT. CL. 42. REG. 10-12-1999.
- 2,286,675. MANI-KARE. INT. CLS. 5 AND 21. REG. 10-12-1999.
- 2,286,678. RELIABOT. INT. CL. 9. REG. 10-12-1999.
- 2,286,689. REALM. INT. CL. 16. REG. 10-12-1999.
- 2,286,692. LOOKING BACK. INT. CL. 16. REG. 10-12-1999.
- 2,286,704. MARKETSOFT. INT. CL. 9. REG. 10-12-1999.
- 2,286,717. LEGEND OF THE ELFLORD. INT. CL. 16. REG. 10-12-1999.
- 2,286,729. VODOO RAIN. INT. CL. 32. REG. 10-12-1999.
- 2,286,736. THE ORATECH GROUP (STYLIZED). INT. CL. 42. REG. 10-12-1999.
- 2,286,753. DO YOU YAHOO!?. INT. CLS. 16, 25, 28 AND 35. REG. 10-12-1999.
- 2,286,757. WILD DISCOVERY. INT. CLS. 16, 25 AND 38. REG. 10-12-1999.
- 2,286,758. NEUTROGENA CLEAN. INT. CL. 3. REG. 10-12-1999.
- 2,286,762. CHICAGO FIRE AND DESIGN. INT. CLS. 16 AND 41. REG. 10-12-1999.
- 2,286,785. MISCELLANEOUS DESIGN. INT. CL. 7. REG. 10-12-1999.
- 2,286,791. AUCTION EXPRESS. INT. CL. 35. REG. 10-12-1999.
- 2,286,806. RV BUYS. INT. CL. 16. REG. 10-12-1999.
- 2,286,811. DESIGN CLASSICS. INT. CL. 11. REG. 10-12-1999.
- 2,286,813. AMERICAN SHUTTER PRODUCTS. INT. CL. 6. REG. 10-12-1999.
- 2,286,824. MACHINEFINDER. INT. CL. 35. REG. 10-12-1999.
- 2,286,825. TAGGIO. INT. CL. 25. REG. 10-12-1999.
- 2,286,834. COMMUNICATING FOR SUCCESS... EVERYDAY. INT. CL. 41. REG. 10-12-1999.
- 2,286,842. ARIZONA CHILI COMPANY. INT. CL. 29. REG. 10-12-1999.
- 2,286,851. BUDGET ROOTER PLUMBING SERVICE. INT. CL. 37. REG. 10-12-1999.
- 2,286,854. PRESSCUT. INT. CL. 40. REG. 10-12-1999.
- 2,340,389. CARBOPLAN. INT. CL. 17 ONLY. REG. 4-11-2000.
- 2,352,210. MISCELLANEOUS DESIGN. INT. CL. 11 ONLY. REG. 5-23-2000.
- 2,354,622. VOLT AND DESIGN. INT. CL. 36 ONLY. REG. 6-6-2000.
- 2,357,056. BNL. INT. CL. 16 ONLY. REG. 6-13-2000.
- 2,447,349. PAWS SIGNS STORIES AND DESIGN. INT. CLS. 16 AND 25 ONLY. REG. 5-1-2001.
- 2,711,122. A AND DESIGN. INT. CL. 7 ONLY. REG. 4-29-2003.
- 2,770,507. HOSTEXPLORER (STYLIZED). INT. CL. 9. REG. 10-7-2003.
- 2,770,509. THE KING BISCUIT TIMES. INT. CL. 16. REG. 10-7-2003.
- 2,770,510. MOBILEDISPATCH (STYLIZED). INT. CL. 9. REG. 10-7-2003.
- 2,770,512. TRADECONNECT. INT. CLS. 36, 38 AND 42. REG. 10-7-2003.
- 2,770,514. CLOMP (STYLIZED). INT. CLS. 40 AND 42. REG. 10-7-2003.
- 2,770,515. MILLENNIUM. INT. CL. 38. REG. 10-7-2003.
- 2,770,516. LOC-PAIN. INT. CL. 5. REG. 10-7-2003.
- 2,770,521. BOOKKIT. INT. CLS. 9 AND 42. REG. 10-7-2003.
- 2,770,523. POWER XTREME. INT. CL. 7. REG. 10-7-2003.
- 2,770,524. ST2. INT. CL. 25. REG. 10-7-2003.
- 2,770,526. WUSTENROT (STYLIZED). INT. CL. 36. REG. 10-7-2003.
- 2,770,528. KNUCKLE HEAD. INT. CL. 33. REG. 10-7-2003.
- 2,770,529. MISCELLANEOUS DESIGN. INT. CLS. 9, 16, 25, 28, 41 AND 42. REG. 10-7-2003.
- 2,770,531. PLAYERS ONLY. INT. CL. 25. REG. 10-7-2003.
- 2,770,533. COCO WHY NOT COCO AND DESIGN. INT. CL. 41. REG. 10-7-2003.
- 2,770,536. MQP DISCOVER THE WORLD DECOUVREZ LE MONDE AND DESIGN. INT. CL. 9. REG. 10-7-2003.
- 2,770,538. UTM (STYLIZED). INT. CL. 5. REG. 10-7-2003.
- 2,770,542. NETPATENTS.COM. INT. CL. 42. REG. 10-7-2003.
- 2,770,544. PVV EASYCOLOR AND DESIGN. INT. CL. 7. REG. 10-7-2003.
- 2,770,545. KOFI ENTERTAINMENT AND DESIGN. INT. CL. 41. REG. 10-7-2003.
- 2,770,547. OLA. INT. CLS. 36 AND 42. REG. 10-7-2003.
- 2,770,549. DISCOVER AND DESIGN. INT. CL. 9. REG. 10-7-2003.
- 2,770,552. MOLECULE BLEUE. INT. CLS. 3, 5 AND 42. REG. 10-7-2003.
- 2,770,554. MICHAEL GRAVES' DREAMSCAPE. INT. CLS. 6 AND 11. REG. 10-7-2003.
- 2,770,555. TINMAN. INT. CLS. 9 AND 41. REG. 10-7-2003.
- 2,770,557. FOLLICLE TARGETING SYSTEM AND DESIGN. INT. CLS. 3 AND 5. REG. 10-7-2003.
- 2,770,561. ICEBOX. INT. CL. 9. REG. 10-7-2003.
- 2,770,564. DS 650. INT. CLS. 12, 25 AND 28. REG. 10-7-2003.
- 2,770,565. DANAREX. INT. CL. 11. REG. 10-7-2003.
- 2,770,566. NUDY AND DESIGN. INT. CL. 3. REG. 10-7-2003.
- 2,770,568. ALTERNATIVE CINEMA. INT. CL. 16. REG. 10-7-2003.
- 2,770,569. TANGO. INT. CL. 9. REG. 10-7-2003.
- 2,770,570. CARSIGN VEHICLE CERTIFICATION AND DESIGN. INT. CLS. 9, 35 AND 42. REG. 10-7-2003.
- 2,770,573. DYNAMIC STRENGTH TRAINING. INT. CL. 41. REG. 10-7-2003.
- 2,770,574. ONEZONE. INT. CL. 35. REG. 10-7-2003.
- 2,770,575. ALPHA UNIVERSITY. INT. CL. 14. REG. 10-7-2003.
- 2,770,576. MICHAEL GRAVES' DREAMSCAPE. INT. CLS. 20 AND 21. REG. 10-7-2003.
- 2,770,577. MISCELLANEOUS DESIGN. INT. CLS. 20, 21 AND 24. REG. 10-7-2003.
- 2,770,580. BARAKA AND DESIGN. INT. CLS. 3, 4, 5 AND 31. REG. 10-7-2003.
- 2,770,581. SCH. INT. CLS. 16 AND 36. REG. 10-7-2003.
- 2,770,583. ASCLEPION-MEDITEC. INT. CL. 10. REG. 10-7-2003.
- 2,770,584. SOFT TOUCH. INT. CLS. 6 AND 20. REG. 10-7-2003.
- 2,770,586. FOR SISTERS ONLY AND DESIGN. INT. CL. 35. REG. 10-7-2003.
- 2,770,587. MICROGUARD BY LEE FASHION FABRICS. INT. CL. 24. REG. 10-7-2003.
- 2,770,589. YOU INSPIRE ME AND DESIGN. INT. CL. 16. REG. 10-7-2003.
- 2,770,591. OLFIL. INT. CL. 7. REG. 10-7-2003.
- 2,770,592. CLUBBER. INT. CLS. 9, 14, 16, 18, 24, 25, 28, 35, 38, 39, 41 AND 42. REG. 10-7-2003.
- 2,770,594. TRITON. INT. CL. 8. REG. 10-7-2003.
- 2,770,596. KYOLIC HI-PO. INT. CL. 5. REG. 10-7-2003.
- 2,770,599. SOLINET. INT. CLS. 9, 16, 35, 38, 41 AND 42. REG. 10-7-2003.
- 2,770,601. TENNIS MASTERS SERIES AND DESIGN. INT. CLS. 9, 18, 25 AND 28. REG. 10-7-2003.
- 2,770,604. SEALEDMEDIA. INT. CLS. 9 AND 42. REG. 10-7-2003.
- 2,770,605. TRITHOR. INT. CL. 9. REG. 10-7-2003.

- 2,770,606. TRACKPLAY. INT. CLS. 35 AND 38. REG. 10-7-2003.
- 2,770,609. GLOBUS PROJECT. INT. CL. 9. REG. 10-7-2003.
- 2,770,613. WOLF LAUREL OUTDOORS AND DESIGN. INT. CL. 41. REG. 10-7-2003.
- 2,770,614. ACTIVE MINING. INT. CLS. 35, 38, 41 AND 42. REG. 10-7-2003.
- 2,770,615. ASID AMERICAN SOCIETY OF INTERIOR DESIGNERS AND DESIGN. U.S. CL. 200. REG. 10-7-2003.
- 2,770,618. LIFE LONG COMPOSITE DECKING. INT. CL. 19. REG. 10-7-2003.
- 2,770,619. ! AND DESIGN. INT. CL. 35. REG. 10-7-2003.
- 2,770,621. E-DOOR (STYLIZED). INT. CL. 9. REG. 10-7-2003.
- 2,770,622. ECOKNIT SYSTEM BY SITIP AND DESIGN. INT. CLS. 7, 23, 24 AND 25. REG. 10-7-2003.
- 2,770,627. PROLEAN (STYLIZED). INT. CLS. 16, 35 AND 42. REG. 10-7-2003.
- 2,770,630. DALLASCOWBOYS.COM AND DESIGN. INT. CLS. 25, 38 AND 41. REG. 10-7-2003.
- 2,770,631. SICPASSURE. INT. CLS. 2, 9, 16, 38, 39 AND 42. REG. 10-7-2003.
- 2,770,632. SICPASECUR. INT. CLS. 2, 9, 16, 38, 39 AND 42. REG. 10-7-2003.
- 2,770,635. HELP-Y. INT. CLS. 9, 16, 35, 36, 37, 38 AND 42. REG. 10-7-2003.
- 2,770,636. ZED AND DESIGN. INT. CL. 41. REG. 10-7-2003.
- 2,770,639. BOULDER PLAZA. INT. CLS. 35 AND 36. REG. 10-7-2003.
- 2,770,640. THE ONE SOURCE FOR BROADBAND. INT. CLS. 38 AND 42. REG. 10-7-2003.
- 2,770,642. CLICKINCOME. INT. CLS. 35 AND 42. REG. 10-7-2003.
- 2,770,645. WEBOA WWW.WEBOA.COM AND DESIGN. INT. CL. 9. REG. 10-7-2003.
- 2,770,647. WHAT PAPER CAN DO. INT. CLS. 1, 14, 16, 18, 19, 25, 28, 35, 39 AND 42. REG. 10-7-2003.
- 2,770,648. ANIMALMANIA. INT. CL. 35. REG. 10-7-2003.
- 2,770,652. C AND DESIGN. INT. CLS. 9, 16, 35, 38, 41 AND 42. REG. 10-7-2003.
- 2,770,657. A BLAST! BAND'S AND DJ'S AND DESIGN. INT. CL. 41. REG. 10-7-2003.
- 2,770,658. BALLYCASHEL. INT. CL. 29. REG. 10-7-2003.
- 2,770,660. C-BRAKE. INT. CL. 12. REG. 10-7-2003.
- 2,770,661. MISCELLANEOUS DESIGN. INT. CL. 9. REG. 10-7-2003.
- 2,770,662. ENAME EQUITY. INT. CL. 35. REG. 10-7-2003.
- 2,770,664. ZIG MEMORY SYSTEM. INT. CL. 1. REG. 10-7-2003.
- 2,770,666. SIX CONTINENTS. INT. CLS. 16, 35, 41 AND 42. REG. 10-7-2003.
- 2,770,667. PURESTREAM. INT. CLS. 1, 5, 40 AND 42. REG. 10-7-2003.
- 2,770,668. HEATWAVE. INT. CL. 41. REG. 10-7-2003.
- 2,770,672. SOFLO. INT. CL. 37. REG. 10-7-2003.
- 2,770,673. SPICE PLATINUM LIVE. INT. CL. 41. REG. 10-7-2003.
- 2,770,674. MUNICIPAL WEB SERVICES AND DESIGN. INT. CL. 42. REG. 10-7-2003.
- 2,770,675. G-SAVIOUR. INT. CL. 41. REG. 10-7-2003.
- 2,770,676. KANARI AND DESIGN. INT. CLS. 9, 38 AND 42. REG. 10-7-2003.
- 2,770,680. BIOTREND AND DESIGN. INT. CL. 5. REG. 10-7-2003.
- 2,770,681. ULTRALIGN. INT. CLS. 7 AND 9. REG. 10-7-2003.
- 2,770,683. POWERNOMICS CORPORATION OF AMERICA P AND DESIGN. INT. CL. 41. REG. 10-7-2003.
- 2,770,684. SEATTLELOCK. INT. CL. 10. REG. 10-7-2003.
- 2,770,686. INSTRUCT. INT. CL. 42. REG. 10-7-2003.
- 2,770,688. CPM AND DESIGN. INT. CLS. 4, 35, 39, 40 AND 42. REG. 10-7-2003.
- 2,770,689. GALIOS. INT. CLS. 1, 5 AND 42. REG. 10-7-2003.
- 2,770,690. POPETTES. INT. CL. 30. REG. 10-7-2003.
- 2,770,695. AUTOSUITE. INT. CLS. 35 AND 42. REG. 10-7-2003.
- 2,770,697. OVATION. INT. CL. 16. REG. 10-7-2003.
- 2,770,700. ASIA MILES TOP UP. INT. CLS. 39 AND 42. REG. 10-7-2003.
- 2,770,701. SEMAIA PHARMACEUTICALS. INT. CLS. 1, 3 AND 5. REG. 10-7-2003.
- 2,770,702. AMERICAN ENGINE INSTALLATIONS. INT. CL. 37. REG. 10-7-2003.
- 2,770,703. IT'S THE HAIR! CUTS & COLOR ART (STYLIZED). INT. CL. 42. REG. 10-7-2003.
- 2,770,704. CUT. INT. CLS. 6 AND 10. REG. 10-7-2003.
- 2,770,706. BOOMERANG FISHING PRO AND DESIGN. INT. CL. 28. REG. 10-7-2003.
- 2,770,707. AMG SONICGUIDE. INT. CL. 9. REG. 10-7-2003.
- 2,770,708. CLICK 2 FLY FREE. INT. CLS. 16 AND 35. REG. 10-7-2003.
- 2,770,710. E2E. INT. CLS. 9 AND 42. REG. 10-7-2003.
- 2,770,713. AMG ALL GAME GUIDE. INT. CL. 41. REG. 10-7-2003.
- 2,770,716. UBS PAINWEBBER THANK YOU AND DESIGN. INT. CLS. 35, 36 AND 41. REG. 10-7-2003.
- 2,770,719. OCTAQUEST. INT. CL. 1. REG. 10-7-2003.
- 2,770,720. DISTRIBUTED VENDING. INT. CLS. 35 AND 42. REG. 10-7-2003.
- 2,770,722. HUF TOOLS (STYLIZED). INT. CL. 7. REG. 10-7-2003.
- 2,770,723. FIVESON'S FOODS (STYLIZED). INT. CL. 29. REG. 10-7-2003.
- 2,770,724. CW WEBB CONSULTING AND DESIGN. INT. CLS. 35 AND 42. REG. 10-7-2003.
- 2,770,725. STARS AND DESIGN. INT. CL. 31. REG. 10-7-2003.
- 2,770,726. STARS. INT. CL. 31. REG. 10-7-2003.
- 2,770,731. MISCELLANEOUS DESIGN. INT. CL. 16. REG. 10-7-2003.
- 2,770,732. SEX MATTERS. INT. CL. 42. REG. 10-7-2003.
- 2,770,733. RENOVATORS PLACE AND DESIGN. INT. CL. 42. REG. 10-7-2003.
- 2,770,734. SMARTRACK. INT. CLS. 7, 9 AND 11. REG. 10-7-2003.
- 2,770,736. JANNYEI AND DESIGN. INT. CL. 7. REG. 10-7-2003.
- 2,770,738. CHIMITOS AND DESIGN. INT. CL. 30. REG. 10-7-2003.
- 2,770,741. CONSPECIFIER. INT. CL. 9. REG. 10-7-2003.
- 2,770,744. ANGUS & COOTE AND DESIGN. INT. CLS. 14 AND 37. REG. 10-7-2003.
- 2,770,745. CERAMBOARD. INT. CLS. 9 AND 35. REG. 10-7-2003.
- 2,770,746. SILICA SERVING CHEMISTRY. INT. CLS. 9 AND 40. REG. 10-7-2003.
- 2,770,751. CORPORATE IDENTITY ASSURANCE ONLINE, ON-TIME, ON-DEMAND AND DESIGN. INT. CL. 42. REG. 10-7-2003.
- 2,770,753. SAINTY HIRD. INT. CL. 35. REG. 10-7-2003.
- 2,770,754. SAFE MONEY METRICS BY SANCTITY "YOUR DIRECT RISK MANAGEMENT SOLUTION FOR DERIVATIVES" (STYLIZED). INT. CL. 42. REG. 10-7-2003.
- 2,770,755. MOTOR RACE. INT. CL. 12. REG. 10-7-2003.
- 2,770,756. MOTOR RACE. INT. CL. 7. REG. 10-7-2003.
- 2,770,757. VISCOSTAR. INT. CL. 1. REG. 10-7-2003.
- 2,770,762. H.E.L.P. AND DESIGN. INT. CLS. 5 AND 10. REG. 10-7-2003.
- 2,770,763. IMIRA SCREENING. INT. CL. 9. REG. 10-7-2003.
- 2,770,766. SAMAY QUARTZ (STYLIZED). INT. CL. 14. REG. 10-7-2003.
- 2,770,768. DOOZY. INT. CL. 28. REG. 10-7-2003.
- 2,770,771. SHARE PLUS. INT. CL. 36. REG. 10-7-2003.
- 2,770,774. TRANSPARENT ENERGY. INT. CLS. 9, 37, 38 AND 42. REG. 10-7-2003.
- 2,770,778. 'BURGH BUSTERS AND DESIGN. INT. CL. 41. REG. 10-7-2003.
- 2,770,779. ADVVALUE MEDIA (STYLIZED). INT. CL. 35. REG. 10-7-2003.
- 2,770,780. DEBTSTER. INT. CLS. 9, 36, 38 AND 42. REG. 10-7-2003.
- 2,770,782. TINDLES. INT. CL. 4. REG. 10-7-2003.
- 2,770,783. RALLY TROPHY AND DESIGN. INT. CL. 9. REG. 10-7-2003.

- 2,770,784. STEP STUDENT TRAINING EMPOWERMENT PROGRAM AND DESIGN. INT. CL. 16. REG. 10-7-2003.
- 2,770,785. GENESIS INTERNATIONAL LLC AND DESIGN. INT. CL. 36. REG. 10-7-2003.
- 2,770,787. ABBA FATHER AND DESIGN. INT. CL. 25. REG. 10-7-2003.
- 2,770,789. MAZDA 7 (STYLIZED). INT. CL. 12. REG. 10-7-2003.
- 2,770,793. DOCUCORP. INT. CLS. 35 AND 42. REG. 10-7-2003.
- 2,770,794. BUILT FOR LIFE. INT. CL. 12. REG. 10-7-2003.
- 2,770,795. UNIQUE TECHNOLOGIES. INT. CL. 42. REG. 10-7-2003.
- 2,770,796. LIP LAVA. INT. CL. 3. REG. 10-7-2003.
- 2,770,797. SKYSEATS. INT. CL. 39. REG. 10-7-2003.
- 2,770,798. SKYAGENT. INT. CL. 39. REG. 10-7-2003.
- 2,770,807. MISCELLANEOUS DESIGN. INT. CLS. 9 AND 10. REG. 10-7-2003.
- 2,770,812. EMPOWERING IDENTIFICATION. INT. CL. 9. REG. 10-7-2003.
- 2,770,813. VAPP-DOCS. INT. CLS. 9, 35, 37, 41 AND 42. REG. 10-7-2003.
- 2,770,814. PEGASUS DIGITAL ONE PLAN AND DESIGN. INT. CLS. 38 AND 41. REG. 10-7-2003.
- 2,770,815. TIGERLINE AND DESIGN. INT. CL. 9. REG. 10-7-2003.
- 2,770,816. FDS. INT. CL. 9. REG. 10-7-2003.
- 2,770,817. PRO WORLD AND DESIGN. INT. CLS. 16, 35, 36, 37, 39, 40, 41 AND 42. REG. 10-7-2003.
- 2,770,818. PROGRESS TELECOM AND DESIGN. INT. CL. 38. REG. 10-7-2003.
- 2,770,820. TRX. INT. CL. 35. REG. 10-7-2003.
- 2,770,821. VITAMIN ZOO. INT. CLS. 5, 16 AND 32. REG. 10-7-2003.
- 2,770,823. TRIRIGA INTELLIGENT BUSINESS SYSTEM. INT. CL. 9. REG. 10-7-2003.
- 2,770,824. DEPOSITIONS ON DEMAND. INT. CL. 39. REG. 10-7-2003.
- 2,770,826. TOPONOMICS. INT. CLS. 1, 5, 9, 16 AND 42. REG. 10-7-2003.
- 2,770,827. MISCELLANEOUS DESIGN. INT. CLS. 12 AND 25. REG. 10-7-2003.
- 2,770,828. THE RIVER CITY GROUP. INT. CL. 35. REG. 10-7-2003.
- 2,770,829. MUD SHARK. INT. CL. 12. REG. 10-7-2003.
- 2,770,830. ORIGINAL TRADEMARK DUNGAREES TOP WESTERN JEANS AND DESIGN. INT. CL. 25. REG. 10-7-2003.
- 2,770,834. OUR MISSION: YOUR SUCCESS AND DESIGN. INT. CL. 11. REG. 10-7-2003.
- 2,770,842. EIE AND DESIGN. INT. CL. 41. REG. 10-7-2003.
- 2,770,843. PLAY-OH!. INT. CL. 41. REG. 10-7-2003.
- 2,770,846. SOCUSIL. INT. CL. 5. REG. 10-7-2003.
- 2,770,849. OLD TOWN IMPORTS AND DESIGN. INT. CL. 21. REG. 10-7-2003.
- 2,770,854. LITE WEIGHTS AND DESIGN. INT. CL. 28. REG. 10-7-2003.
- 2,770,855. PERLEGEN AND DESIGN. INT. CL. 42. REG. 10-7-2003.
- 2,770,856. MISCELLANEOUS DESIGN. INT. CL. 42. REG. 10-7-2003.
- 2,770,858. A 220. INT. CLS. 12, 28 AND 37. REG. 10-7-2003.
- 2,770,863. THE WORLD'S LOCAL BREWER. INT. CLS. 32, 35 AND 41. REG. 10-7-2003.
- 2,770,866. HEALTHCAREIRA AND DESIGN. INT. CLS. 36 AND 44. REG. 10-7-2003.
- 2,770,867. RCR. INT. CLS. 1, 5, 9 AND 42. REG. 10-7-2003.
- 2,770,868. MEIGA OYI AND DESIGN. INT. CLS. 9 AND 10. REG. 10-7-2003.
- 2,770,870. CARGOBAT. INT. CL. 12. REG. 10-7-2003.
- 2,770,871. IMAGES. INT. CL. 19. REG. 10-7-2003.
- 2,770,874. CUSTOM FIT GUTTER "CONTINUOUS ALUMINUM SERVICES GUTTERS" AND DESIGN. INT. CL. 6. REG. 10-7-2003.
- 2,770,876. ENTICEME. INT. CL. 41. REG. 10-7-2003.
- 2,770,877. MISCELLANEOUS DESIGN. INT. CLS. 1, 3, 5, 11, 16, 19, 20 AND 21. REG. 10-7-2003.
- 2,770,878. POCO. INT. CL. 12. REG. 10-7-2003.
- 2,770,879. RITEPROBE (STYLIZED). INT. CLS. 9 AND 42. REG. 10-7-2003.
- 2,770,885. PRODUCTVINE. INT. CL. 9. REG. 10-7-2003.
- 2,770,886. TAKE 2 VIDEO AND DESIGN. INT. CL. 41. REG. 10-7-2003.
- 2,770,887. RHYTHM JOURNEY AND DESIGN. INT. CL. 41. REG. 10-7-2003.
- 2,770,888. SNOOZE NEWS. INT. CL. 44. REG. 10-7-2003.
- 2,770,892. WAR MYTHOLOGIES AND DESIGN. INT. CL. 16. REG. 10-7-2003.
- 2,770,895. JPG PARIS AND DESIGN. INT. CL. 28. REG. 10-7-2003.
- 2,770,896. SONIC CHAIN SUPPLIER. INT. CL. 35. REG. 10-7-2003.
- 2,770,900. AMT. INT. CLS. 1, 5 AND 42. REG. 10-7-2003.
- 2,770,904. YOU COULD GET USED TO THIS. INT. CL. 36. REG. 10-7-2003.
- 2,770,905. FLORIDA RENT FINDERS AND DESIGN. INT. CL. 36. REG. 10-7-2003.
- 2,770,907. CUSTOMERCARE. INT. CLS. 37 AND 42. REG. 10-7-2003.
- 2,770,909. CUSTOMETRICS. INT. CL. 35. REG. 10-7-2003.
- 2,770,910. MONDE CHIC (STYLIZED). INT. CL. 25. REG. 10-7-2003.
- 2,770,911. GUERBET AND DESIGN. INT. CL. 5. REG. 10-7-2003.
- 2,770,912. RALF NAGEL AND DESIGN. INT. CLS. 3, 5 AND 32. REG. 10-7-2003.
- 2,770,920. ERGO WORKS. INT. CL. 42. REG. 10-7-2003.
- 2,770,923. HAVANA BAY COMPANY AND DESIGN. INT. CLS. 31 AND 32. REG. 10-7-2003.
- 2,770,924. FORERUNNER. INT. CL. 35. REG. 10-7-2003.
- 2,770,925. ANIMAL WISE AND DESIGN. INT. CLS. 41 AND 43. REG. 10-7-2003.
- 2,770,926. ANIMALWISE. INT. CLS. 41 AND 43. REG. 10-7-2003.
- 2,770,928. FERNDALE AND DESIGN. INT. CLS. 5 AND 30. REG. 10-7-2003.
- 2,770,929. FLOOR 17. INT. CL. 42. REG. 10-7-2003.
- 2,770,930. WE KNOW THE COURSE. INT. CL. 36. REG. 10-7-2003.
- 2,770,931. W AND DESIGN. INT. CL. 42. REG. 10-7-2003.
- 2,770,934. VITALFA. INT. CL. 5. REG. 10-7-2003.
- 2,770,936. GSI (STYLIZED). INT. CL. 8. REG. 10-7-2003.
- 2,770,937. SOULWORKS COACHING AND DESIGN. INT. CL. 41. REG. 10-7-2003.
- 2,770,942. E2 & ME CATERING AND DESIGN. INT. CL. 43. REG. 10-7-2003.
- 2,770,945. AUSTRALIAN AND DESIGN. INT. CLS. 39 AND 43. REG. 10-7-2003.
- 2,770,951. XS ENGINEERING. INT. CLS. 7 AND 37. REG. 10-7-2003.
- 2,770,956. SPICE UP THE NIGHT. INT. CL. 36. REG. 10-7-2003.
- 2,770,957. THE LION ADVISOR ACCOUNT. INT. CL. 36. REG. 10-7-2003.
- 2,770,958. VITACREME. INT. CL. 3. REG. 10-7-2003.
- 2,770,960. PIC-TV. INT. CL. 35. REG. 10-7-2003.
- 2,770,962. ANYTHING! ANYTIME!. INT. CL. 43. REG. 10-7-2003.
- 2,770,963. UNIT SPECS. INT. CL. 16. REG. 10-7-2003.
- 2,770,964. WILSON & WILSON FOLK ART COMPANY. INT. CLS. 16, 20, 21 AND 24. REG. 10-7-2003.
- 2,770,969. FENATTY. INT. CL. 5. REG. 10-7-2003.
- 2,770,971. KILLER LOOP AND DESIGN. INT. CL. 3. REG. 10-7-2003.
- 2,770,973. BICO AND DESIGN. INT. CLS. 20 AND 24. REG. 10-7-2003.
- 2,770,978. HANCOCK PARTNERS. INT. CL. 36. REG. 10-7-2003.
- 2,770,982. CONFORT-RICHE MASQUE. INT. CL. 3. REG. 10-7-2003.
- 2,770,983. BEMER MEDIZIN TECHNIK AND DESIGN. INT. CL. 10. REG. 10-7-2003.
- 2,770,985. STARPOINT SCROLLER. INT. CL. 9. REG. 10-7-2003.

- 2,770,987. BUILDING SYNTHETIC VOICES. INT. CL. 9. REG. 10-7-2003.
- 2,770,988. BARRY'S MONTANA BEEF "QUALITY FROM CONCEPTION TO CONSUMPTION" AND DESIGN. INT. CL. 29. REG. 10-7-2003.
- 2,770,989. WINDING IS MORE. INT. CLS. 7, 9 AND 42. REG. 10-7-2003.
- 2,770,990. LU:B (STYLIZED). INT. CLS. 3, 5 AND 10. REG. 10-7-2003.
- 2,770,995. CT AND DESIGN. INT. CL. 5. REG. 10-7-2003.
- 2,770,997. SHINE POWER. INT. CL. 3. REG. 10-7-2003.
- 2,771,002. DVD INTERNATIONAL.COM DVDS THAT FIRE THE IMAGINATION. INT. CLS. 35 AND 41. REG. 10-7-2003.
- 2,771,006. TMARIE. INT. CL. 41. REG. 10-7-2003.
- 2,771,007. RCST. U.S. CL. B. REG. 10-7-2003.
- 2,771,008. CITIZENS AND SOUTHERN. INT. CL. 36. REG. 10-7-2003.
- 2,771,009. MAKI MAKI AND DESIGN. INT. CL. 43. REG. 10-7-2003.
- 2,771,011. "SAVVY SENIOR" (STYLIZED). INT. CL. 16. REG. 10-7-2003.
- 2,771,014. RAINLINK. INT. CL. 9. REG. 10-7-2003.
- 2,771,015. NETMET NETWORK NEUROMETRICS. INT. CL. 9. REG. 10-7-2003.
- 2,771,018. CHEMSPIRE. INT. CL. 9. REG. 10-7-2003.
- 2,771,020. TRIUMPH LEARNING IMPROVING SCORES. IMPROVING SCHOOLS. IMPROVING LIVES. AND DESIGN. INT. CLS. 9 AND 16. REG. 10-7-2003.
- 2,771,027. ENERGY PROFILER. INT. CL. 9. REG. 10-7-2003.
- 2,771,030. WRITING LISTENING SPEAKING THINKING READING AND DESIGN. INT. CLS. 16 AND 41. REG. 10-7-2003.
- 2,771,031. DESIGNWRAPS AND DESIGN. INT. CLS. 26 AND 41. REG. 10-7-2003.
- 2,771,032. THREAD-GLYDE FDA. INT. CL. 4. REG. 10-7-2003.
- 2,771,033. BY THE COLORIST, FOR THE COLORIST. INT. CL. 26. REG. 10-7-2003.
- 2,771,034. READY 212 CONFERENCE. INT. CL. 38. REG. 10-7-2003.
- 2,771,036. MAPCODE AND DESIGN. INT. CL. 9. REG. 10-7-2003.
- 2,771,037. MIDTOWN CENTER. INT. CL. 36. REG. 10-7-2003.
- 2,771,041. BIOETT AND DESIGN. INT. CL. 9. REG. 10-7-2003.
- 2,771,042. DISCOVERING WHAT CARBON AND GRAPHITE CAN DO.... INT. CL. 40. REG. 10-7-2003.
- 2,771,043. EPIFOAM. INT. CL. 5. REG. 10-7-2003.
- 2,771,049. DYNAMIC ESSENTIALS. INT. CL. 35. REG. 10-7-2003.
- 2,771,053. ERGOSCAPE. INT. CL. 20. REG. 10-7-2003.
- 2,771,055. CONSECC AND DESIGN. INT. CL. 36. REG. 10-7-2003.
- 2,771,056. METALPOWER. INT. CLS. 7 AND 11. REG. 10-7-2003.
- 2,771,057. VINVEN. INT. CL. 33. REG. 10-7-2003.
- 2,771,058. PACIFIC TOWER. INT. CL. 37. REG. 10-7-2003.
- 2,771,060. JUST FLAKES (STYLIZED). INT. CL. 30. REG. 10-7-2003.
- 2,771,063. AESP AND DESIGN. INT. CL. 9. REG. 10-7-2003.
- 2,771,064. PERFECT VOICE ANSWER. INT. CL. 9. REG. 10-7-2003.
- 2,771,065. AQUAPORT INTERNATIONAL AND DESIGN. INT. CL. 11. REG. 10-7-2003.
- 2,771,068. TABUA CLUB AND DESIGN. INT. CL. 39. REG. 10-7-2003.
- 2,771,070. APPLIQUE BY IMPERIAL AND DESIGN. INT. CL. 27. REG. 10-7-2003.
- 2,771,072. BOAO AND DESIGN. INT. CL. 9. REG. 10-7-2003.
- 2,771,073. URBANESQUE. INT. CLS. 9, 35 AND 41. REG. 10-7-2003.
- 2,771,075. OMISTRAN. INT. CL. 9. REG. 10-7-2003.
- 2,771,077. LIBERTY BANKERS LIFE ADVANTAGE 5. INT. CL. 36. REG. 10-7-2003.
- 2,771,080. MUSCLEFILL. INT. CL. 19. REG. 10-7-2003.
- 2,771,081. SM SUPPLYMAN AND DESIGN. INT. CL. 35. REG. 10-7-2003.
- 2,771,082. EVOLUTIONSURF AND DESIGN. INT. CL. 25. REG. 10-7-2003.
- 2,771,083. OCCASIONAL DESIGNS. INT. CL. 16. REG. 10-7-2003.
- 2,771,084. STRAWBRIDGE'S. INT. CL. 35. REG. 10-7-2003.
- 2,771,086. SEISMIC SOLUTIONS. INT. CL. 6. REG. 10-7-2003.
- 2,771,087. TEEN TEEN COLLECTION AND DESIGN. INT. CL. 26. REG. 10-7-2003.
- 2,771,091. ASIAN CLASSIC. INT. CL. 29. REG. 10-7-2003.
- 2,771,092. BURGER LOVER. INT. CL. 43. REG. 10-7-2003.
- 2,771,097. CORINTHIAN HOMES AND DESIGN. INT. CL. 37. REG. 10-7-2003.
- 2,771,099. MISCELLANEOUS DESIGN. INT. CL. 33. REG. 10-7-2003.
- 2,771,101. COMPREHENSIVE SOLUTIONS FOR COMPLEX PROBLEMS. INT. CLS. 9, 35 AND 42. REG. 10-7-2003.
- 2,771,102. FOR THE CLOTHES YOU GO OUT OF TOWN TO FIND. INT. CL. 35. REG. 10-7-2003.
- 2,771,103. MALE CORPS WWW.MALECORPS.COM AND DESIGN. INT. CLS. 35, 41 AND 45. REG. 10-7-2003.
- 2,771,107. GLUCOSTAR. INT. CL. 10. REG. 10-7-2003.
- 2,771,108. IRVINE RANCH LAND RESERVE AND DESIGN. INT. CL. 25. REG. 10-7-2003.
- 2,771,109. IRVINE RANCH LAND RESERVE. INT. CL. 25. REG. 10-7-2003.
- 2,771,112. THE POWERPUFF GIRLS AND DESIGN. INT. CL. 20. REG. 10-7-2003.
- 2,771,114. PT TRACKER. INT. CL. 9. REG. 10-7-2003.
- 2,771,117. HASTA LA PASTA. INT. CL. 43. REG. 10-7-2003.
- 2,771,118. LIFESTYLE YOGA. INT. CL. 16. REG. 10-7-2003.
- 2,771,120. PLLP. INT. CL. 9. REG. 10-7-2003.
- 2,771,127. MISCELLANEOUS DESIGN. INT. CL. 43. REG. 10-7-2003.
- 2,771,128. WB AND DESIGN. INT. CL. 25. REG. 10-7-2003.
- 2,771,129. MISCELLANEOUS DESIGN. INT. CL. 25. REG. 10-7-2003.
- 2,771,132. MASTERPIECES OF MATURITY. INT. CL. 41. REG. 10-7-2003.
- 2,771,134. 40 & BEYOND. INT. CL. 41. REG. 10-7-2003.
- 2,771,135. CLEARCOSTCOLOR. INT. CL. 37. REG. 10-7-2003.
- 2,771,137. HOOP WORLD USA AND DESIGN. INT. CL. 25. REG. 10-7-2003.
- 2,771,142. DATE CARD. INT. CL. 16. REG. 10-7-2003.
- 2,771,145. CARTRONICS. INT. CLS. 35 AND 37. REG. 10-7-2003.
- 2,771,150. AUTHENEX. INT. CL. 42. REG. 10-7-2003.
- 2,771,151. CORAL RIDGE MINISTRIES AND DESIGN. INT. CL. 16. REG. 10-7-2003.
- 2,771,152. PRO-4-LIFE. INT. CL. 31. REG. 10-7-2003.
- 2,771,154. KAPACHI. INT. CL. 25. REG. 10-7-2003.
- 2,771,160. "GIGGLES" COMEDY CLUBS (STYLIZED). INT. CL. 41. REG. 10-7-2003.
- 2,771,162. CHEMESTANDARDS SPEAK THE SAME LANGUAGE AND DESIGN. INT. CL. 42. REG. 10-7-2003.
- 2,771,163. UVIDEM. INT. CLS. 1 AND 5. REG. 10-7-2003.
- 2,771,166. OSIDEM (STYLIZED). INT. CLS. 1 AND 5. REG. 10-7-2003.
- 2,771,167. N AND DESIGN. INT. CL. 42. REG. 10-7-2003.
- 2,771,168. NEOSCAPE. INT. CL. 42. REG. 10-7-2003.
- 2,771,173. X-FORCE. INT. CLS. 41 AND 42. REG. 10-7-2003.
- 2,771,177. MAIN STREET GOURMET FOOD & GIFTS. INT. CL. 39. REG. 10-7-2003.
- 2,771,179. TRI2 AND DESIGN. INT. CL. 28. REG. 10-7-2003.
- 2,771,180. USBSEC. INT. CL. 9. REG. 10-7-2003.
- 2,771,181. CAVIAR IN THE SURF. INT. CL. 43. REG. 10-7-2003.
- 2,771,182. (NAUGHTY) AND DESIGN. INT. CL. 3. REG. 10-7-2003.
- 2,771,183. RASH & ASSOCIATES AND DESIGN. INT. CL. 35. REG. 10-7-2003.
- 2,771,184. SAMMYCARE. INT. CL. 37. REG. 10-7-2003.
- 2,771,185. SB (STYLIZED). INT. CL. 44. REG. 10-7-2003.

- 2,771,187. MISS MONTHLY'S MENSTRUAL KIT AND DESIGN. INT. CL. 5. REG. 10-7-2003.
- 2,771,188. D (STYLIZED). INT. CLS. 20 AND 40. REG. 10-7-2003.
- 2,771,191. DEN OF INIQUITY. INT. CL. 41. REG. 10-7-2003.
- 2,771,193. MAD RUBBER. INT. CL. 25. REG. 10-7-2003.
- 2,771,198. JANAINA & SEBASTIAO'S MANGO SAMBA (STYLIZED). INT. CL. 3. REG. 10-7-2003.
- 2,771,199. JET-SET. INT. CL. 3. REG. 10-7-2003.
- 2,771,200. G AND DESIGN. INT. CLS. 3, 8, 9, 11, 13, 18, 20, 21, 25, 28, 33, 34 AND 35. REG. 10-7-2003.
- 2,771,201. PROVEN STRENGTH. FUTURE READY.. INT. CLS. 35 AND 42. REG. 10-7-2003.
- 2,771,202. SEAHAWKS STADIUM AND EXHIBITION CENTER. INT. CLS. 35 AND 41. REG. 10-7-2003.
- 2,771,203. SEAHAWKS EXHIBITION CENTER. INT. CLS. 35 AND 41. REG. 10-7-2003.
- 2,771,204. SEAHAWKS STADIUM AND EXHIBITION CENTER AND DESIGN. INT. CLS. 35 AND 41. REG. 10-7-2003.
- 2,771,207. NORDIC. INT. CL. 17. REG. 10-7-2003.
- 2,771,209. LEGEND TOYZ. INT. CLS. 10 AND 25. REG. 10-7-2003.
- 2,771,211. TIME MACHINE. INT. CL. 5. REG. 10-7-2003.
- 2,771,219. GAIL P. GILL CONSUMER HEALTH LIBRARY AND DESIGN. INT. CL. 41. REG. 10-7-2003.
- 2,771,220. HOJO RECORDS AND DESIGN. INT. CL. 41. REG. 10-7-2003.
- 2,771,221. NETCREATIONS. INT. CLS. 35 AND 38. REG. 10-7-2003.
- 2,771,222. SEIZE THE DAY AND DESIGN. INT. CL. 16. REG. 10-7-2003.
- 2,771,223. GRADUATED COMPRESSION AND DESIGN. INT. CLS. 10 AND 25. REG. 10-7-2003.
- 2,771,225. STOKIYO (STYLIZED). INT. CL. 25. REG. 10-7-2003.
- 2,771,229. CARITEN WELLNESSTRACKER. INT. CL. 44. REG. 10-7-2003.
- 2,771,230. LOOKCLICKPRINT. INT. CLS. 16 AND 35. REG. 10-7-2003.
- 2,771,236. SLR.UNLIMITED. INT. CLS. 12 AND 28. REG. 10-7-2003.
- 2,771,237. MISCELLANEOUS DESIGN. INT. CL. 37. REG. 10-7-2003.
- 2,771,241. ROLLING BEAR. INT. CL. 28. REG. 10-7-2003.
- 2,771,243. FACERECO AND DESIGN. INT. CL. 9. REG. 10-7-2003.
- 2,771,244. SLEEPYTIME PONIES. INT. CL. 16. REG. 10-7-2003.
- 2,771,245. CONNECTED IN CHRIST. INT. CL. 41. REG. 10-7-2003.
- 2,771,246. KOOLOS. INT. CL. 25. REG. 10-7-2003.
- 2,771,247. BVS. INT. CLS. 35 AND 41. REG. 10-7-2003.
- 2,771,248. SCOOPER. INT. CL. 10. REG. 10-7-2003.
- 2,771,250. POLUX. INT. CL. 35. REG. 10-7-2003.
- 2,771,253. OHR AND ASSOCIATES. INT. CL. 36. REG. 10-7-2003.
- 2,771,255. HRC. INT. CL. 16. REG. 10-7-2003.
- 2,771,256. GOOD BAD UGLY. INT. CL. 9. REG. 10-7-2003.
- 2,771,258. AFMA MEMBER PRODUCT GUIDE (STYLIZED). INT. CL. 16. REG. 10-7-2003.
- 2,771,260. SPORTMASTERS. INT. CL. 40. REG. 10-7-2003.
- 2,771,261. ROCK CARPET WWW.ROCKCARPET.COM AND DESIGN. INT. CL. 27. REG. 10-7-2003.
- 2,771,266. AUTO LOGIC AND DESIGN. INT. CL. 10. REG. 10-7-2003.
- 2,771,267. NIMBUS LOGIC AND DESIGN. INT. CL. 10. REG. 10-7-2003.
- 2,771,268. ECIS. INT. CL. 9. REG. 10-7-2003.
- 2,771,269. PLASMA EXTREME. INT. CL. 35. REG. 10-7-2003.
- 2,771,275. SUNSTRIP. INT. CL. 9. REG. 10-7-2003.
- 2,771,276. WEALTH ADVISOR SUMMIT. INT. CL. 41. REG. 10-7-2003.
- 2,771,277. CARE EMG. INT. CL. 10. REG. 10-7-2003.
- 2,771,279. MADCAP ADVENTURES AND DESIGN. INT. CL. 25. REG. 10-7-2003.
- 2,771,282. CHAUCER GROUP, INC. AND DESIGN. INT. CL. 42. REG. 10-7-2003.
- 2,771,283. TRIPLE NINE. INT. CL. 25. REG. 10-7-2003.
- 2,771,287. PRESTON'S PALS. INT. CL. 36. REG. 10-7-2003.
- 2,771,289. PRORATENIH. INT. CL. 41. REG. 10-7-2003.
- 2,771,290. GOLFLOGIX. INT. CL. 41. REG. 10-7-2003.
- 2,771,295. LENOX SQUARE LEGENDARY SHOPPING. INT. CL. 36. REG. 10-7-2003.
- 2,771,297. SERPENT PSYCLES. INT. CL. 43. REG. 10-7-2003.
- 2,771,300. PIXSTORM AND DESIGN. INT. CL. 9. REG. 10-7-2003.
- 2,771,304. MISCELLANEOUS DESIGN. INT. CL. 35. REG. 10-7-2003.
- 2,771,306. LANCOME CONNEXION. INT. CL. 3. REG. 10-7-2003.
- 2,771,307. STAR GLOSS. INT. CL. 3. REG. 10-7-2003.
- 2,771,308. TATHO. INT. CL. 35. REG. 10-7-2003.
- 2,771,309. FRUCTIS STYLE HARD. INT. CL. 3. REG. 10-7-2003.
- 2,771,313. POWERSSET. INT. CL. 19. REG. 10-7-2003.
- 2,771,315. THE POWER OF INNOVATION!. INT. CL. 7. REG. 10-7-2003.
- 2,771,317. A HERD OF FLAVOR IN EVERY SCOOP!. INT. CL. 30. REG. 10-7-2003.
- 2,771,322. EZ OPERATOR. INT. CL. 9. REG. 10-7-2003.
- 2,771,325. TARGET FLOW. INT. CL. 9. REG. 10-7-2003.
- 2,771,329. GOVERNMENT FINANCIAL MANAGEMENT TOPICS. INT. CL. 16. REG. 10-7-2003.
- 2,771,332. SPIDERCHARGER. INT. CL. 9. REG. 10-7-2003.
- 2,771,333. BNZ. INT. CL. 14. REG. 10-7-2003.
- 2,771,334. NTUNNEL. INT. CL. 14. REG. 10-7-2003.
- 2,771,335. ALL SLOTS. ALL LOOSE. ALL THE TIME.. INT. CL. 41. REG. 10-7-2003.
- 2,771,336. BRAND MACHINES AND DESIGN. INT. CL. 9. REG. 10-7-2003.
- 2,771,337. BRAND FLAT VEND AND DESIGN. INT. CL. 16. REG. 10-7-2003.
- 2,771,338. BRAND BULK AND DESIGN. INT. CL. 28. REG. 10-7-2003.
- 2,771,340. BALL BEARING AND DESIGN. INT. CL. 6. REG. 10-7-2003.
- 2,771,341. THE DRIVE TO DISCOVER...THE DISCIPLINE TO DELIVER. INT. CL. 42. REG. 10-7-2003.
- 2,771,348. ESC/PAGE (STYLIZED). INT. CL. 9. REG. 10-7-2003.
- 2,771,350. BACCHUS. INT. CL. 35. REG. 10-7-2003.
- 2,771,353. MANULIFE PRIVATE ACCOUNT. INT. CL. 36. REG. 10-7-2003.
- 2,771,358. LEHIGH JOBTRAK. INT. CL. 42. REG. 10-7-2003.
- 2,771,359. MISCELLANEOUS DESIGN. INT. CL. 37. REG. 10-7-2003.
- 2,771,360. MISCELLANEOUS DESIGN. INT. CL. 37. REG. 10-7-2003.
- 2,771,361. MISCELLANEOUS DESIGN. INT. CL. 37. REG. 10-7-2003.
- 2,771,363. MY PET SHELL. INT. CL. 20. REG. 10-7-2003.
- 2,771,364. SUBZZA GENUINE PIZZA SANDWICH AND DESIGN. INT. CL. 30. REG. 10-7-2003.
- 2,771,365. ASSURANCE INTEGRATION. INT. CL. 42. REG. 10-7-2003.
- 2,771,366. WEDNESDAY WIND DOWN. INT. CL. 41. REG. 10-7-2003.
- 2,771,367. MISCELLANEOUS DESIGN. INT. CL. 42. REG. 10-7-2003.
- 2,771,372. INTELLIGENT ASSET MANAGEMENT. INT. CL. 42. REG. 10-7-2003.
- 2,771,375. FOSSIL HUNTER. INT. CL. 8. REG. 10-7-2003.
- 2,771,378. MORTHOSETH. INT. CL. 8. REG. 10-7-2003.
- 2,771,380. KRAKEN. INT. CL. 8. REG. 10-7-2003.
- 2,771,382. VALERMOS. INT. CL. 8. REG. 10-7-2003.
- 2,771,385. MISSION SPOTLIGHT AND DESIGN. INT. CL. 9. REG. 10-7-2003.
- 2,771,386. DR. SCHOLL'S AND DESIGN. INT. CL. 11. REG. 10-7-2003.
- 2,771,398. 1 AMERICA DISCOUNT CRUISES. INT. CL. 39. REG. 10-7-2003.
- 2,771,402. PR812. INT. CL. 12. REG. 10-7-2003.
- 2,771,408. FIX-A-DENT. INT. CL. 37. REG. 10-7-2003.
- 2,771,410. HAPPY PROFESSIONAL. INT. CL. 3. REG. 10-7-2003.

- 2,771,411. RIBBONS. INT. CL. 28. REG. 10-7-2003.
2,771,412. WE PUT PEOPLE TO SLEEP. INT. CL. 35. REG. 10-7-2003.
2,771,414. PERDUE AND DESIGN. INT. CL. 29. REG. 10-7-2003.
2,771,417. ACCU DATA PAYROLL. INT. CL. 35. REG. 10-7-2003.
2,771,418. RAJEUNIR. INT. CL. 3. REG. 10-7-2003.
2,771,421. B&T LINK ONLINE AND DESIGN. INT. CL. 35. REG. 10-7-2003.
2,771,424. MISCELLANEOUS DESIGN. INT. CL. 40. REG. 10-7-2003.
2,771,425. THE LEWIS HORWITZ ORGANIZATION. INT. CL. 36. REG. 10-7-2003.
2,771,427. VEND-A-TAN. INT. CL. 9. REG. 10-7-2003.
2,771,428. TONIX. INT. CL. 20. REG. 10-7-2003.
2,771,429. SIGNAL (STYLIZED). INT. CL. 9. REG. 10-7-2003.
2,771,430. THE TEXAS PARTY STATION. INT. CL. 38. REG. 10-7-2003.
2,771,436. SWAGGERTY'S COUNTRY SAUSAGE. INT. CL. 29. REG. 10-7-2003.
2,771,437. WINDY CITY ANTIQUE SHOW CHICAGO AND DESIGN. INT. CL. 35. REG. 10-7-2003.
2,771,441. WWW.FIRSTHOPE.COM. INT. CL. 35. REG. 10-7-2003.
2,771,443. CIDA AND DESIGN. INT. CL. 36. REG. 10-7-2003.
2,771,444. MUFFALINI. INT. CL. 30. REG. 10-7-2003.
2,771,445. YOUR HIGH PERFORMANCE LENDER. INT. CL. 36. REG. 10-7-2003.
2,771,450. KDL 106.7 FM. INT. CL. 38. REG. 10-7-2003.
2,771,451. RENDITOR. INT. CL. 30. REG. 10-7-2003.
2,771,452. MEGATOR. INT. CL. 1. REG. 10-7-2003.
2,771,453. LIQUITOR. INT. CL. 1. REG. 10-7-2003.
2,771,454. SUAVEMEX. INT. CL. 30. REG. 10-7-2003.
2,771,458. DRIVEN TO DO THINGS BETTER. INT. CL. 36. REG. 10-7-2003.
2,771,459. MARKET MAKER. INT. CL. 35. REG. 10-7-2003.
2,771,460. MARKET MAKER AND DESIGN. INT. CL. 35. REG. 10-7-2003.
2,771,462. TIEN LUNG TAO. INT. CL. 41. REG. 10-7-2003.
2,771,463. THE NEXT STEP IN HORSE BEDDING. INT. CL. 31. REG. 10-7-2003.
2,771,464. MISCELLANEOUS DESIGN. INT. CL. 30. REG. 10-7-2003.
2,771,465. MISCELLANEOUS DESIGN. INT. CL. 21. REG. 10-7-2003.
2,771,466. HARRIET HUBBARD AYER SKIN NURSE. INT. CL. 3. REG. 10-7-2003.
2,771,467. LULU'S CLUB MARDI GRAS. INT. CL. 43. REG. 10-7-2003.
2,771,471. FITNESS SCOUTS. INT. CL. 41. REG. 10-7-2003.
2,771,472. COMMITTED TO BRINGING OUT THE BEST IN MEDICINE. INT. CL. 44. REG. 10-7-2003.
2,771,473. CHAN BADA. INT. CL. 29. REG. 10-7-2003.
2,771,476. PRIMROSE PALS. INT. CL. 41. REG. 10-7-2003.
2,771,480. CAMBRIDGE EYE MASK. INT. CL. 10. REG. 10-7-2003.
2,771,488. SIZZLIN' 16. INT. CL. 41. REG. 10-7-2003.
2,771,491. MINOO. INT. CL. 30. REG. 10-7-2003.
2,771,493. MUNCHURIAN MADNESS. INT. CL. 30. REG. 10-7-2003.
2,771,495. THE CANDY SHOP AND DESIGN. INT. CL. 30. REG. 10-7-2003.
2,771,496. BEHLE STREET CAFE. INT. CL. 43. REG. 10-7-2003.
2,771,497. MILL CREEK BANK AND DESIGN. INT. CL. 36. REG. 10-7-2003.
2,771,498. GENOME BIOSCIENCES INNOVATION IN GENE TARGETING AND DESIGN. INT. CL. 42. REG. 10-7-2003.
2,771,499. FASTBROWNFIELD. INT. CL. 36. REG. 10-7-2003.
2,771,500. FASTMEGASITES. INT. CL. 36. REG. 10-7-2003.
2,771,501. FASTWAREHOUSE. INT. CL. 36. REG. 10-7-2003.
2,771,502. FASTR&D. INT. CL. 36. REG. 10-7-2003.
2,771,503. VM+SD. INT. CL. 16. REG. 10-7-2003.
2,771,505. TRIPOINT. INT. CL. 40. REG. 10-7-2003.
2,771,506. BIG BLOC ENTERTAINMENT INC.. INT. CL. 41. REG. 10-7-2003.
2,771,507. BULLSEYE DISC. INT. CL. 40. REG. 10-7-2003.
2,771,510. NEARLY FAMOUS. INT. CL. 41. REG. 10-7-2003.
2,771,511. WHO THE HELL IS THIS?. INT. CL. 41. REG. 10-7-2003.
2,771,512. MONDAY NIGHT AT MORTON'S. INT. CL. 41. REG. 10-7-2003.
2,771,513. XONAIR VOD. INT. CL. 38. REG. 10-7-2003.
2,771,517. E-ONEHUNDRED GROUP. INT. CLS. 35, 41 AND 42. REG. 10-7-2003.
2,771,518. FOTOLEC. INT. CL. 11. REG. 10-7-2003.
2,771,519. MASTERFRAME. INT. CL. 19. REG. 10-7-2003.
2,771,522. GOLDPASS. INT. CL. 42. REG. 10-7-2003.
2,771,523. BLOOD BROTHERS MC AND DESIGN. U.S. CL. 200. REG. 10-7-2003.
2,771,526. P.AUDIO (STYLIZED). INT. CL. 9. REG. 10-7-2003.
2,771,527. EASTMAN. INT. CL. 7. REG. 10-7-2003.
2,771,528. TEXINK. INT. CL. 2. REG. 10-7-2003.
2,771,529. TURBO TUNG. INT. CL. 7. REG. 10-7-2003.
2,771,530. SCOTCH & SIRLOIN STEAK - SEAFOOD - SPIRITS EST. 1971 AND DESIGN. INT. CL. 42. REG. 10-7-2003.
2,771,531. SAN JOSE INTERNATIONAL MARIACHI FESTIVAL AND CONFERENCE. INT. CL. 41. REG. 10-7-2003.
2,771,533. INTERCONTROLLERS PUTTING THE PIECES TOGETHER AND DESIGN. INT. CL. 35. REG. 10-7-2003.
2,771,535. GLOBAL AUTOMOTIVE SOLUTIONS. INT. CL. 37. REG. 10-7-2003.
2,771,536. HARMONY WIRELESS COMMUNICATION SYSTEM. INT. CL. 9. REG. 10-7-2003.
2,771,537. DRUGSTORE COWGIRL. INT. CL. 3. REG. 10-7-2003.
2,771,539. CASTLE KEEPERS OF CHARLESTON AND DESIGN. INT. CL. 37. REG. 10-7-2003.
2,771,542. MISCELLANEOUS DESIGN. INT. CL. 25. REG. 10-7-2003.
2,771,543. METAVANTAGE. INT. CL. 42. REG. 10-7-2003.
2,771,544. EASY VIEW HEALTH LOG. INT. CL. 16. REG. 10-7-2003.
2,771,545. ECONF AND DESIGN. INT. CLS. 9, 38 AND 42. REG. 10-7-2003.
2,771,546. LUMA PAINT. INT. CL. 2. REG. 10-7-2003.
2,771,547. EASYCAR AND DESIGN. INT. CLS. 16, 39 AND 42. REG. 10-7-2003.
2,771,548. COWORKER. INT. CL. 9. REG. 10-7-2003.
2,771,551. BIOIMAGE. INT. CLS. 1, 5 AND 42. REG. 10-7-2003.
2,771,552. HYPERDATA AND DESIGN. INT. CL. 9. REG. 10-7-2003.
2,771,554. ZOMARIC. INT. CL. 5. REG. 10-7-2003.
2,771,555. CWD AND DESIGN. INT. CL. 25. REG. 10-7-2003.
2,771,556. E-LERT (STYLIZED). INT. CL. 38. REG. 10-7-2003.
2,771,558. CAMDEN RIVERSHARKS. INT. CL. 16. REG. 10-7-2003.
2,771,560. VELOCITY CDN. INT. CL. 9. REG. 10-7-2003.
2,771,561. DEERBLOCKER. INT. CL. 9. REG. 10-7-2003.
2,771,563. THICKENTHIN NOT/STARCH. INT. CL. 30. REG. 10-7-2003.
2,771,564. BABY CITY. INT. CL. 42. REG. 10-7-2003.
2,771,566. RAPIDTEMP. INT. CL. 37. REG. 10-7-2003.
2,771,567. THINK AN INTERACTIVE NEWSPAPER FOR KIDS & THEIR FAMILIES AND DESIGN. INT. CL. 16. REG. 10-7-2003.
2,771,568. EVERYTHANGS GONNA BE ALL WHITE. INT. CL. 25. REG. 10-7-2003.
2,771,570. CUSTODIAN. INT. CL. 7. REG. 10-7-2003.
2,771,572. SPANKERS AND DESIGN. INT. CL. 25. REG. 10-7-2003.
2,771,573. MIZA.COM. INT. CL. 42. REG. 10-7-2003.
2,771,580. ALEX GOEN. INT. CL. 41. REG. 10-7-2003.
2,771,581. EDGEPOP. INT. CLS. 38 AND 39. REG. 10-7-2003.
2,771,582. MEET THE MAKERS. INT. CLS. 9 AND 41. REG. 10-7-2003.
2,771,584. WERK 1. INT. CLS. 14 AND 34. REG. 10-7-2003.

- 2,771,586. ATLANTIC ANGLER (STYLIZED). INT. CL. 16. REG. 10-7-2003.
- 2,771,588. THE ORANGE ON-TIME MACHINE. INT. CLS. 35 AND 39. REG. 10-7-2003.
- 2,771,592. BROCK LESNAR. INT. CL. 41. REG. 10-7-2003.
- 2,771,594. WOVEN CLASSICS. INT. CL. 27. REG. 10-7-2003.
- 2,771,595. CHASKI AND DESIGN. INT. CL. 39. REG. 10-7-2003.
- 2,771,597. FERROL COMPOUND AND DESIGN. INT. CL. 5. REG. 10-7-2003.
- 2,771,598. ADIA. INT. CLS. 35, 41 AND 42. REG. 10-7-2003.
- 2,771,599. VERYWENDY CUSTOM DESIGN & ILLUSTRATION WWW.VERYWENDY.COM AND DESIGN. INT. CL. 42. REG. 10-7-2003.
- 2,771,600. CAO. INT. CL. 1. REG. 10-7-2003.
- 2,771,601. FIRENZE. INT. CL. 11. REG. 10-7-2003.
- 2,771,603. UP & UP PRODUCTIONS. INT. CL. 41. REG. 10-7-2003.
- 2,771,605. WEBTONICA. INT. CL. 42. REG. 10-7-2003.
- 2,771,608. LUMAVEN. INT. CL. 5. REG. 10-7-2003.
- 2,771,610. R OPTIONRATS AND DESIGN. INT. CLS. 36 AND 42. REG. 10-7-2003.
- 2,771,611. COACHING INTELLIGENCE. INT. CL. 41. REG. 10-7-2003.
- 2,771,614. ANOTHAI (STYLIZED). INT. CLS. 14, 18 AND 25. REG. 10-7-2003.
- 2,771,615. PUNCHKING. INT. CL. 9. REG. 10-7-2003.
- 2,771,616. ALUFUN. INT. CL. 12. REG. 10-7-2003.
- 2,771,619. HOMEFUELER. INT. CLS. 7 AND 11. REG. 10-7-2003.
- 2,771,620. ANYWAY... AND DESIGN. INT. CL. 41. REG. 10-7-2003.
- 2,771,622. SALONPAS ELASTIC PATCH. INT. CL. 5. REG. 10-7-2003.
- 2,771,623. SALONPAS GLIDE ON RELIEF CREAM. INT. CL. 5. REG. 10-7-2003.
- 2,771,624. SALONPAS SMOOTH ON RELIEF CREAM. INT. CL. 5. REG. 10-7-2003.
- 2,771,625. ANATOMIC SLEEP SUPPORT SURFACE TECHNOLOGY. INT. CLS. 20 AND 24. REG. 10-7-2003.
- 2,771,626. MUSIC-CALS. INT. CL. 16. REG. 10-7-2003.
- 2,771,627. CARL. INT. CLS. 35 AND 41. REG. 10-7-2003.
- 2,771,633. EYEDOODLE AND DESIGN. INT. CL. 42. REG. 10-7-2003.
- 2,771,634. QUEXEL. INT. CL. 5. REG. 10-7-2003.
- 2,771,635. AMERIWORLD MORTGAGE, INC. AND DESIGN. INT. CL. 36. REG. 10-7-2003.
- 2,771,636. BECRUX. INT. CL. 33. REG. 10-7-2003.
- 2,771,638. DATAYSTICS (STYLIZED). INT. CL. 35. REG. 10-7-2003.
- 2,771,640. YOGA FOR HEALTHY LIVING (STYLIZED). INT. CL. 41. REG. 10-7-2003.
- 2,771,641. MR (STYLIZED). INT. CL. 43. REG. 10-7-2003.
- 2,771,642. SEMILLA DE ORO. INT. CL. 30. REG. 10-7-2003.
- 2,771,647. LICOSPERS. INT. CL. 2. REG. 10-7-2003.
- 2,771,650. SPAKID. INT. CL. 41. REG. 10-7-2003.
- 2,771,651. THAI KITCHEN AUTHENTIC THAI CUISINE AND DESIGN. INT. CLS. 16, 29 AND 30. REG. 10-7-2003.
- 2,771,655. SONNY JURGENSEN. INT. CL. 34. REG. 10-7-2003.
- 2,771,656. OLD TOM AND DESIGN. INT. CL. 32. REG. 10-7-2003.
- 2,771,658. EMPIRE STAPLE. INT. CL. 6. REG. 10-7-2003.
- 2,771,660. SEEING THE LIGHT IN ELECTRONICS. INT. CL. 9. REG. 10-7-2003.
- 2,771,661. BOTTLE BUDDIES AND DESIGN. INT. CL. 21. REG. 10-7-2003.
- 2,771,663. NEDA. INT. CL. 36. REG. 10-7-2003.
- 2,771,666. KOOLTIME WATCHES AND DESIGN. INT. CL. 35. REG. 10-7-2003.
- 2,771,668. LEGACY NAVIGATOR. INT. CL. 9. REG. 10-7-2003.
- 2,771,669. IRIS. INT. CL. 9. REG. 10-7-2003.
- 2,771,672. WONDER FIX. INT. CL. 3. REG. 10-7-2003.
- 2,771,674. TRIP AIDE. INT. CL. 9. REG. 10-7-2003.
- 2,771,675. CLAUDE'S. INT. CL. 30. REG. 10-7-2003.
- 2,771,676. WELLWAVE. INT. CL. 20. REG. 10-7-2003.
- 2,771,677. ILLUMINE. INT. CL. 41. REG. 10-7-2003.
- 2,771,678. CHANGING SPACE INTO ATMOSPHERE. INT. CL. 9. REG. 10-7-2003.
- 2,771,680. FOREVER YOURS. INT. CL. 20. REG. 10-7-2003.
- 2,771,681. DEMISTIFIER. INT. CL. 3. REG. 10-7-2003.
- 2,771,682. FREEWARDS. INT. CL. 43. REG. 10-7-2003.
- 2,771,686. PERFECTIL. INT. CL. 3. REG. 10-7-2003.
- 2,771,689. HYPERREACH. INT. CL. 38. REG. 10-7-2003.
- 2,771,692. 4SHOW. INT. CL. 25. REG. 10-7-2003.
- 2,771,693. HYDRONIC HEART. INT. CL. 9. REG. 10-7-2003.
- 2,771,695. E2 BOOKING AND DESIGN. INT. CLS. 39 AND 43. REG. 10-7-2003.
- 2,771,700. S2 SCUBA SAN ANDRES AND DESIGN. INT. CL. 39. REG. 10-7-2003.
- 2,771,702. SHARKYJONES. INT. CL. 42. REG. 10-7-2003.
- 2,771,703. STIX BY DIX ANDROS, BAHAMAS-COCOA BEACH, FLA. CUSTOM SURFBOARDS AND DESIGN. INT. CLS. 25 AND 28. REG. 10-7-2003.
- 2,771,704. KENTOUR. INT. CL. 18. REG. 10-7-2003.
- 2,771,705. BIG BRAND INTEGRATION GROUP AND DESIGN. INT. CL. 35. REG. 10-7-2003.
- 2,771,706. UA UNITED AIRCONDITIONING AND DESIGN. INT. CL. 37. REG. 10-7-2003.
- 2,771,707. GIVING PEACE A VOICE. INT. CL. 36. REG. 10-7-2003.
- 2,771,709. MSE. INT. CLS. 2, 16 AND 40. REG. 10-7-2003.
- 2,771,711. LASER CLEANSE. INT. CL. 44. REG. 10-7-2003.
- 2,771,712. TELEMATES AND DESIGN. INT. CL. 45. REG. 10-7-2003.
- 2,771,713. MEGA PHONE AND DESIGN. INT. CL. 45. REG. 10-7-2003.
- 2,771,714. DECOPAVE. INT. CL. 37. REG. 10-7-2003.
- 2,771,715. CXC (STYLIZED). INT. CL. 9. REG. 10-7-2003.
- 2,771,716. BIOTIC BUDDIES. INT. CL. 5. REG. 10-7-2003.
- 2,771,718. HISTORICANA. INT. CL. 35. REG. 10-7-2003.
- 2,771,723. ADGEEK. INT. CL. 42. REG. 10-7-2003.
- 2,771,725. CASESTACK. INT. CLS. 35 AND 39. REG. 10-7-2003.
- 2,771,726. 9 NINE WEST NINEWEST.COM AND DESIGN. INT. CL. 25. REG. 10-7-2003.
- 2,771,731. FACILITRAXX. INT. CL. 21. REG. 10-7-2003.
- 2,771,732. BABUYER. INT. CL. 35. REG. 10-7-2003.
- 2,771,733. BAOWNER. INT. CL. 35. REG. 10-7-2003.
- 2,771,734. BABIZ-SCREEN. INT. CL. 35. REG. 10-7-2003.
- 2,771,737. BAYWOLF (STYLIZED). INT. CL. 41. REG. 10-7-2003.
- 2,771,738. TEI INTERNATIONAL AND DESIGN. INT. CL. 37. REG. 10-7-2003.
- 2,771,740. MIDWEST WIRELESS. INT. CL. 38. REG. 10-7-2003.
- 2,771,741. BIOWEAR. INT. CL. 24. REG. 10-7-2003.
- 2,771,744. SPORTS AUTHORITY AND DESIGN. INT. CL. 35. REG. 10-7-2003.
- 2,771,745. FRIENDLY SERVICE, REAL VALUE - GUARANTEED. INT. CL. 35. REG. 10-7-2003.
- 2,771,747. HARVATEK. INT. CL. 9. REG. 10-7-2003.
- 2,771,749. SONICWEB. INT. CL. 9. REG. 10-7-2003.
- 2,771,753. SIATECH. INT. CL. 41. REG. 10-7-2003.
- 2,771,754. LOVE COOKIES AND DESIGN. INT. CL. 30. REG. 10-7-2003.
- 2,771,755. HOOFF ARMOR. INT. CL. 1. REG. 10-7-2003.
- 2,771,766. CURIOTICA (STYLIZED). INT. CL. 35. REG. 10-7-2003.
- 2,771,768. CURTIS HYLER & JUBILATION. INT. CL. 41. REG. 10-7-2003.
- 2,771,775. LANDSEA AND DESIGN. INT. CL. 25. REG. 10-7-2003.
- 2,771,778. 3D-DOCTOR. INT. CL. 9. REG. 10-7-2003.
- 2,771,781. BLUE MOUNTAIN AND DESIGN. INT. CL. 35. REG. 10-7-2003.
- 2,771,782. BLUE MOUNTAIN AND DESIGN. INT. CL. 38. REG. 10-7-2003.
- 2,771,783. BLUE MOUNTAIN AND DESIGN. INT. CL. 45. REG. 10-7-2003.
- 2,771,784. SMARTSWITCH. INT. CL. 35. REG. 10-7-2003.
- 2,771,786. DOOZIE. INT. CL. 28. REG. 10-7-2003.
- 2,771,787. IT'S A DOOZIE. INT. CL. 28. REG. 10-7-2003.

- 2,771,788. HEALTHY CUP. INT. CL. 30. REG. 10-7-2003.
 2,771,789. HEALTHY CUP. INT. CL. 29. REG. 10-7-2003.
 2,771,791. COTTON REAL ESTATE. INT. CL. 36. REG. 10-7-2003.
 2,771,792. SOME OF OUR BEST FRIENDS ARE WATCHING. INT. CL. 41. REG. 10-7-2003.
 2,771,794. G-100. INT. CL. 28. REG. 10-7-2003.
 2,771,795. MISCELLANEOUS DESIGN. INT. CL. 35. REG. 10-7-2003.
 2,771,798. DAN LOC (STYLIZED). INT. CL. 6. REG. 10-7-2003.
 2,771,799. SNOWVERALLS. INT. CL. 25. REG. 10-7-2003.
 2,771,801. CE CORNER. INT. CL. 41. REG. 10-7-2003.
 2,771,805. X3D. INT. CL. 9. REG. 10-7-2003.
 2,771,806. LULLABY CLUB. INT. CL. 35. REG. 10-7-2003.
 2,771,807. SUPER VALUE MEAL. INT. CL. 30. REG. 10-7-2003.
 2,771,808. ESS-13. INT. CL. 1. REG. 10-7-2003.
 2,771,809. SS-13. INT. CL. 1. REG. 10-7-2003.
 2,771,810. BULL GEAR. INT. CL. 35. REG. 10-7-2003.
 2,771,812. TIME OUT. INT. CL. 4. REG. 10-7-2003.
 2,771,813. HUNGRY RED PLANET. INT. CL. 9. REG. 10-7-2003.
 2,771,814. TIMBERMAN. INT. CL. 7. REG. 10-7-2003.
 2,771,815. BANDIT. INT. CL. 7. REG. 10-7-2003.
 2,771,818. FUM RECORDS. INT. CL. 9. REG. 10-7-2003.
 2,771,819. CARANAVI ORO. INT. CL. 30. REG. 10-7-2003.
 2,771,824. MURDERDOLLS. INT. CL. 41. REG. 10-7-2003.
 2,771,826. HERMANS. INT. CL. 43. REG. 10-7-2003.
 2,771,827. WDS. INT. CL. 17. REG. 10-7-2003.
 2,771,830. BENEFIBER AND DESIGN. INT. CL. 5. REG. 10-7-2003.
 2,771,833. LOCALSCORE. INT. CL. 35. REG. 10-7-2003.
 2,771,834. BLOOM. INT. CL. 5. REG. 10-7-2003.
 2,771,836. LIBERTY BANKERS LIFE INSURANCE COMPANY. INT. CL. 36. REG. 10-7-2003.
 2,771,838. DREAMSEEKERS. INT. CL. 41. REG. 10-7-2003.
 2,771,841. CATALYST. INT. CL. 16. REG. 10-7-2003.
 2,771,844. FLAVOR CRAZED. INT. CL. 30. REG. 10-7-2003.
 2,771,845. EZCAM AND DESIGN. INT. CL. 9. REG. 10-7-2003.
 2,771,846. ANASAZI. INT. CL. 41. REG. 10-7-2003.
 2,771,847. EXTRAVACANZA AND DESIGN. INT. CL. 35. REG. 10-7-2003.
 2,771,848. PAPER PANDEMONIUM. INT. CL. 35. REG. 10-7-2003.
 2,771,849. CIRCLE OF LIGHT. INT. CL. 41. REG. 10-7-2003.
 2,771,859. SOUTHWEST BIO AND DESIGN. INT. CL. 41. REG. 10-7-2003.
 2,771,860. PETREFRESH. INT. CL. 31. REG. 10-7-2003.
 2,771,863. FRESHTRONIC. INT. CL. 9. REG. 10-7-2003.
 2,771,864. EDESK. INT. CL. 9. REG. 10-7-2003.
 2,771,868. CUSTOMER SATISFACTION IN EVERY TRANSACTION!. INT. CL. 35. REG. 10-7-2003.
 2,771,869. SWEET TIDINGS. INT. CL. 30. REG. 10-7-2003.
 2,771,870. POSTERIZED. INT. CL. 25. REG. 10-7-2003.
 2,771,873. TORRID. INT. CL. 16. REG. 10-7-2003.
 2,771,874. HOMEPAD. INT. CL. 11. REG. 10-7-2003.
 2,771,878. LANCE FRESHNESS POPPERS AND DESIGN. INT. CL. 30. REG. 10-7-2003.
 2,771,879. BENEFIBER. INT. CL. 5. REG. 10-7-2003.
 2,771,880. RAINMAKER. INT. CL. 11. REG. 10-7-2003.
 2,771,881. PROFITWATCH. INT. CL. 35. REG. 10-7-2003.
 2,771,882. PASS THE PEACE. INT. CL. 16. REG. 10-7-2003.
 2,771,884. FLEX-CREDIT. INT. CL. 36. REG. 10-7-2003.
 2,771,885. VEE GEE. INT. CL. 35. REG. 10-7-2003.
 2,771,889. FOLIOLIVE. INT. CL. 42. REG. 10-7-2003.
 2,771,890. NEONAMES. INT. CL. 42. REG. 10-7-2003.
 2,771,891. GREEN ENVY (STYLIZED). INT. CL. 41. REG. 10-7-2003.
 2,771,893. IBILL AND DESIGN. INT. CLS. 35, 36 AND 42. REG. 10-7-2003.
 2,771,894. SIN TWINS. INT. CL. 41. REG. 10-7-2003.
 2,771,901. TENDER HARVEST. INT. CL. 5. REG. 10-7-2003.
 2,771,902. THE AUTOMOTIVE ATMARKET. INT. CL. 35. REG. 10-7-2003.
 2,771,903. D&T DRAWN AND THINNED. INT. CLS. 6, 9, 10, 14 AND 21. REG. 10-7-2003.
 2,771,904. NITMEISTER. INT. CL. 10. REG. 10-7-2003.
 2,771,905. L'AQUALE. INT. CL. 3. REG. 10-7-2003.
 2,771,906. THE GREENSKEEPER GK IT WORKS!!! AND DESIGN. INT. CL. 21. REG. 10-7-2003.
 2,771,907. CFM.CMA INSTITUTE OF MANAGEMENT ACCOUNTANTS AND DESIGN. INT. CLS. 41 AND 42. REG. 10-7-2003.
 2,771,910. OLGA FRENCH ACCENT. INT. CL. 25. REG. 10-7-2003.
 2,771,911. GOLD PEAK AND DESIGN. INT. CL. 16. REG. 10-7-2003.
 2,771,912. CYBEREAGLE. INT. CL. 42. REG. 10-7-2003.
 2,771,913. BOY MEETS GRILL. INT. CLS. 8, 21, 25 AND 30. REG. 10-7-2003.
 2,771,914. AUTO BIOGRAPHY AND DESIGN. INT. CL. 41. REG. 10-7-2003.
 2,771,915. SPRINT. INT. CL. 9. REG. 10-7-2003.
 2,771,917. MILLENNIUM 2000. INT. CL. 9. REG. 10-7-2003.
 2,771,918. MSC INDUSTRIAL SUPPLY CO. SHOP, HOME & HOBBY AND DESIGN. INT. CL. 35. REG. 10-7-2003.
 2,771,922. MISCELLANEOUS DESIGN. INT. CL. 9. REG. 10-7-2003.
 2,771,924. MILLER'S DEALS AND DESIGN. INT. CL. 35. REG. 10-7-2003.
 2,771,925. AWARD MORTGAGE. INT. CL. 36. REG. 10-7-2003.
 2,771,927. GENESIS LOAN. INT. CL. 36. REG. 10-7-2003.
 2,771,928. ROTTEN RALPH. INT. CLS. 9 AND 16. REG. 10-7-2003.
 2,771,930. PROFESSIONAL DEVELOPMENT SOLUTIONS. INT. CL. 42. REG. 10-7-2003.
 2,771,931. SAPIT. INT. CL. 35. REG. 10-7-2003.
 2,771,935. FLUGELSPINDLE. INT. CLS. 6, 7 AND 9. REG. 10-7-2003.
 2,771,936. DOT-LINK. INT. CL. 9. REG. 10-7-2003.
 2,771,937. UV123 PROTECTING EYESIGHT FOR A LIFETIME AND DESIGN. INT. CL. 9. REG. 10-7-2003.
 2,771,938. GET IN THE GAME. INT. CL. 21. REG. 10-7-2003.
 2,771,946. LORD WEST. INT. CL. 25. REG. 10-7-2003.
 2,771,947. SUPER SHOPPER PAD. INT. CL. 20. REG. 10-7-2003.
 2,771,949. IN A FLASH. INT. CL. 35. REG. 10-7-2003.
 2,771,950. MOMATT AND DESIGN. INT. CL. 7. REG. 10-7-2003.
 2,771,951. WE BRING GOOD THINGS TO LIFE. INT. CLS. 7, 9, 11 AND 20. REG. 10-7-2003.
 2,771,954. CHAIKEN. INT. CL. 18. REG. 10-7-2003.
 2,771,955. MAINSTREAM. INT. CL. 10. REG. 10-7-2003.
 2,771,956. VISTA QUANTUM ANNUITY SERIES. INT. CL. 36. REG. 10-7-2003.
 2,771,957. VISTA QUANTUM POINT ANNUITY. INT. CL. 36. REG. 10-7-2003.
 2,771,958. VISTA QUANTUM AVERAGE ANNUITY. INT. CL. 36. REG. 10-7-2003.
 2,771,960. PAIN RELIEF TECHNOLOGY AND DESIGN. INT. CL. 20. REG. 10-7-2003.
 2,771,963. TEQUILA EQUIPAL. INT. CL. 33. REG. 10-7-2003.
 2,771,965. SLUSHAROO. INT. CL. 30. REG. 10-7-2003.
 2,771,966. STARTUP. INT. CL. 28. REG. 10-7-2003.
 2,771,967. UNIVERSAL ASSURANCE. INT. CL. 35. REG. 10-7-2003.
 2,771,968. BACHMANN SPRINGS. INT. CL. 25. REG. 10-7-2003.
 2,771,969. LUNA INNOVATIONS. INT. CLS. 1, 9 AND 42. REG. 10-7-2003.
 2,771,970. BACHMANN SPRINGS. INT. CL. 41. REG. 10-7-2003.
 2,771,971. BROADWING NETWORK. INT. CL. 38. REG. 10-7-2003.
 2,771,972. EDGESPORTS.COM. INT. CL. 28. REG. 10-7-2003.
 2,771,973. SCABBERS. INT. CL. 16. REG. 10-7-2003.
 2,771,974. ALBUS DUMBLEDORE. INT. CL. 9. REG. 10-7-2003.
 2,771,977. ON THE LEVEL. INT. CL. 38. REG. 10-7-2003.
 2,771,980. IT'S YOUR MONEY, IT'S YOUR CHOICE. INT. CL. 36. REG. 10-7-2003.

- 2,771,982. WS WINNER STEEL, INC. AND DESIGN. INT. CL. 37. REG. 10-7-2003.
- 2,771,983. LIFENHANCE.COM. INT. CL. 42. REG. 10-7-2003.
- 2,771,986. 1784 FLEET FLEETBOSTON FINANCIAL AND DESIGN. INT. CL. 36. REG. 10-7-2003.
- 2,771,987. MISERY LOVES COMPANY. INT. CL. 41. REG. 10-7-2003.
- 2,771,989. SMALL PLANET FOODS. INT. CL. 30. REG. 10-7-2003.
- 2,771,990. CULTURETEK. INT. CL. 35. REG. 10-7-2003.
- 2,771,991. POLYNORM AND DESIGN. INT. CL. 12. REG. 10-7-2003.
- 2,771,993. THE BEST NEW IDEA SINCE PLUMBING CAME INDOORS. INT. CL. 11. REG. 10-7-2003.
- 2,771,997. GIDION'S SOULMATE. INT. CLS. 3 AND 4. REG. 10-7-2003.
- 2,771,999. VOLUNTEER ADVANTAGE. INT. CLS. 9, 16 AND 35. REG. 10-7-2003.
- 2,772,000. GOT TIME ON YOUR HANDS?. INT. CL. 35. REG. 10-7-2003.
- 2,772,001. CONNECTING YOU TO THE COMMUNITY. INT. CL. 35. REG. 10-7-2003.
- 2,772,002. NETUNE. INT. CL. 38. REG. 10-7-2003.
- 2,772,003. GE NETREPORT. INT. CL. 35. REG. 10-7-2003.
- 2,772,004. Q-CLEAN. INT. CL. 11. REG. 10-7-2003.
- 2,772,005. Q-CHARGE. INT. CL. 11. REG. 10-7-2003.
- 2,772,009. SARA LEE. INT. CL. 30. REG. 10-7-2003.
- 2,772,011. DSL GEEKS. INT. CL. 38. REG. 10-7-2003.
- 2,772,014. BODYFLEX (STYLIZED). INT. CL. 25. REG. 10-7-2003.
- 2,772,015. BAZAARDECOR. INT. CL. 35. REG. 10-7-2003.
- 2,772,016. ECHI-FEND. INT. CL. 5. REG. 10-7-2003.
- 2,772,020. ENVIRONNE. INT. CL. 3. REG. 10-7-2003.
- 2,772,021. MISCELLANEOUS DESIGN. INT. CL. 36. REG. 10-7-2003.
- 2,772,025. VPATH.NET. INT. CL. 38. REG. 10-7-2003.
- 2,772,029. ELEVATOR PORTAL. INT. CLS. 9 AND 37. REG. 10-7-2003.
- 2,772,031. STARWOOD. INT. CL. 41. REG. 10-7-2003.
- 2,772,032. FRUMMUS. INT. CL. 29. REG. 10-7-2003.
- 2,772,033. MEARIN TOPFIX. INT. CLS. 6 AND 19. REG. 10-7-2003.
- 2,772,036. OPEN RESOURCE. INT. CL. 35. REG. 10-7-2003.
- 2,772,037. STRATEX NETWORKS. INT. CLS. 9, 37 AND 42. REG. 10-7-2003.
- 2,772,038. ADVENTURE COLLECTION (STYLIZED). INT. CL. 39. REG. 10-7-2003.
- 2,772,039. SUREFLOW. INT. CL. 6. REG. 10-7-2003.
- 2,772,042. PUMPMASTER. INT. CL. 9. REG. 10-7-2003.
- 2,772,043. TERE NET AND DESIGN. INT. CL. 35. REG. 10-7-2003.
- 2,772,044. JMHE-SALES AID. INT. CL. 36. REG. 10-7-2003.
- 2,772,049. KEN VET AND DESIGN. INT. CL. 5. REG. 10-7-2003.
- 2,772,050. PROJECT E. INT. CL. 36. REG. 10-7-2003.
- 2,772,051. PROJECT E. INT. CL. 42. REG. 10-7-2003.
- 2,772,053. ANCIENT RHINO MEDIA PRODUCTIONS LTD.. INT. CL. 9. REG. 10-7-2003.
- 2,772,054. MOONLIGHT SYSTEMS AND DESIGN. INT. CLS. 9, 35, 41 AND 42. REG. 10-7-2003.
- 2,772,055. MOONLIGHT SYSTEMS. INT. CLS. 9, 35, 41 AND 42. REG. 10-7-2003.
- 2,772,056. MISCELLANEOUS DESIGN. INT. CLS. 9, 35, 41 AND 42. REG. 10-7-2003.
- 2,772,059. ZEBRA PROMOTIONS. INT. CL. 35. REG. 10-7-2003.
- 2,772,060. RIVERFEST AND DESIGN. INT. CL. 41. REG. 10-7-2003.
- 2,772,063. THE HANDLE WITH CARE. INT. CL. 11. REG. 10-7-2003.
- 2,772,064. SIMPLY DAZZLING. INT. CL. 25. REG. 10-7-2003.
- 2,772,066. CARL MARKS & CO. CREATING VALUE.. INT. CL. 36. REG. 10-7-2003.
- 2,772,067. CONSULTANTSNOW.COM. INT. CL. 35. REG. 10-7-2003.
- 2,772,070. PHOTOTIME. INT. CL. 40. REG. 10-7-2003.
- 2,772,071. FUTURAMENTE. INT. CL. 42. REG. 10-7-2003.
- 2,772,072. AMPHIBIAN. INT. CL. 18. REG. 10-7-2003.
- 2,772,073. EZV. INT. CL. 18. REG. 10-7-2003.
- 2,772,079. HA HYPO ALLERGENIC (STYLIZED). INT. CL. 31. REG. 10-7-2003.
- 2,772,082. THE WEIGH OF THE FUTURE. INT. CL. 9. REG. 10-7-2003.
- 2,772,086. MOBILE MATRIX. INT. CLS. 9, 35 AND 42. REG. 10-7-2003.
- 2,772,087. ANGEL OF MY OWN. INT. CL. 28. REG. 10-7-2003.
- 2,772,088. DENTAL DIALOGUE AND DESIGN. INT. CL. 16. REG. 10-7-2003.
- 2,772,089. ENERGY MANAGEMENT AND DESIGN. INT. CL. 41. REG. 10-7-2003.
- 2,772,090. MOONWATCH MEDIA. INT. CL. 38. REG. 10-7-2003.
- 2,772,091. MOONWATCH MEDIA. INT. CL. 16. REG. 10-7-2003.
- 2,772,092. MOONWATCH MEDIA. INT. CL. 35. REG. 10-7-2003.
- 2,772,093. MOONWATCH MEDIA. INT. CL. 41. REG. 10-7-2003.
- 2,772,094. LA COTORRA AND DESIGN. INT. CL. 32. REG. 10-7-2003.
- 2,772,098. FXALIVE AND DESIGN. INT. CL. 9. REG. 10-7-2003.
- 2,772,099. AQUAFUN AND DESIGN. INT. CL. 12. REG. 10-7-2003.
- 2,772,100. SIMCOASTER. INT. CL. 9. REG. 10-7-2003.
- 2,772,104. RS WEB. INT. CL. 9. REG. 10-7-2003.
- 2,772,107. STREAMRAID. INT. CL. 9. REG. 10-7-2003.
- 2,772,110. HOODINI. INT. CL. 8. REG. 10-7-2003.
- 2,772,112. CUFFTACK. INT. CL. 10. REG. 10-7-2003.
- 2,772,114. COLLABORATIVE VOICE COLLECTION. INT. CL. 27. REG. 10-7-2003.
- 2,772,116. GOOD CENTS. INT. CL. 9. REG. 10-7-2003.
- 2,772,118. FLOATING BALL. INT. CL. 10. REG. 10-7-2003.
- 2,772,123. STRONG WEAKNESS. INT. CL. 25. REG. 10-7-2003.
- 2,772,127. 969. INT. CL. 25. REG. 10-7-2003.
- 2,772,128. CLYDE. INT. CL. 28. REG. 10-7-2003.
- 2,772,129. VIRTUAL DRAWER. INT. CL. 9. REG. 10-7-2003.
- 2,772,130. NUBIAN HEALTH PRODUCTS. INT. CL. 5. REG. 10-7-2003.
- 2,772,133. DENDARA AND DESIGN. INT. CL. 14. REG. 10-7-2003.
- 2,772,134. PREFERXENCE AND DESIGN. INT. CL. 42. REG. 10-7-2003.
- 2,772,135. DESTIN. INT. CL. 21. REG. 10-7-2003.
- 2,772,136. KOMPOGAS. INT. CLS. 7 AND 42. REG. 10-7-2003.
- 2,772,137. Y-NOTE. INT. CL. 16. REG. 10-7-2003.
- 2,772,138. CASA DEL BIANCO. INT. CL. 24. REG. 10-7-2003.
- 2,772,139. "HOMEFIELD ADVANTAGE". INT. CL. 2. REG. 10-7-2003.
- 2,772,140. KEEN. INT. CL. 41. REG. 10-7-2003.
- 2,772,144. SYNERTIVE. INT. CL. 4. REG. 10-7-2003.
- 2,772,145. GEORGE NEW YORK. INT. CL. 25. REG. 10-7-2003.
- 2,772,146. SOMEBODYLOVESYOU AND DESIGN. INT. CL. 42. REG. 10-7-2003.
- 2,772,150. SILVANUS. INT. CL. 20. REG. 10-7-2003.
- 2,772,151. INDELIQ. INT. CLS. 41 AND 42. REG. 10-7-2003.
- 2,772,152. OPTINETRICS. INT. CL. 9. REG. 10-7-2003.
- 2,772,153. WE MAKE TECHNOLOGY RELEVANT. INT. CL. 42. REG. 10-7-2003.
- 2,772,154. HONGSAM NARA AND DESIGN. INT. CL. 35. REG. 10-7-2003.
- 2,772,155. INTELLIFREEZE. INT. CL. 9. REG. 10-7-2003.
- 2,772,156. SLIMELIGHT. INT. CLS. 41 AND 42. REG. 10-7-2003.
- 2,772,157. NICHOLAS TSELEPIS NOONESELLSMORE. INT. CL. 36. REG. 10-7-2003.
- 2,772,158. TRUST-MART AND DESIGN. INT. CL. 35. REG. 10-7-2003.
- 2,772,163. AGRISILICA. U.S. CL. A. REG. 10-7-2003.
- 2,772,164. MAGIS AND DESIGN. INT. CL. 9. REG. 10-7-2003.
- 2,772,166. LUND INTERNATIONAL AND DESIGN. INT. CLS. 6 AND 12. REG. 10-7-2003.
- 2,772,167. STO. INT. CL. 13. REG. 10-7-2003.

- 2,772,168. KENAMEA. INT. CLS. 38 AND 42. REG. 10-7-2003.
2,772,169. FUNNY PUPPY. INT. CL. 28. REG. 10-7-2003.
2,772,170. FIBONAIR WEAR. INT. CL. 25. REG. 10-7-2003.
2,772,171. BOA BAGS. INT. CL. 9. REG. 10-7-2003.
2,772,172. RIFFEL AND DESIGN. INT. CL. 12. REG. 10-7-2003.
2,772,173. NEW ORLEANS FAMOUS FRENCH MARKET SINCE 1890 AND DESIGN. INT. CL. 29. REG. 10-7-2003.
2,772,175. SMARTPAPER. INT. CL. 9. REG. 10-7-2003.
2,772,176. SOUTHERN ELEGANCE. INT. CL. 19. REG. 10-7-2003.
2,772,177. HENRY ENGINEERED ADHESIVES. INT. CL. 1. REG. 10-7-2003.
2,772,179. SY & CO. SYMON AND COMPANY.. INT. CLS. 16 AND 18. REG. 10-7-2003.
2,772,180. CORVUS RARA AVIS EST AND DESIGN. INT. CLS. 9, 41 AND 42. REG. 10-7-2003.
2,772,183. STREETGUARD. INT. CLS. 9, 38 AND 42. REG. 10-7-2003.
2,772,184. THE BEARSTONE COLLECTION. INT. CL. 20. REG. 10-7-2003.
2,772,185. BANG. INT. CL. 28. REG. 10-7-2003.
2,772,186. LUZIT AND DESIGN. INT. CL. 18. REG. 10-7-2003.
2,772,187. PLAY-N-PRO. INT. CL. 28. REG. 10-7-2003.
2,772,188. IDEAL TRENDS. INT. CL. 35. REG. 10-7-2003.
2,772,191. TRANSTEM. INT. CL. 5. REG. 10-7-2003.
2,772,192. SOUPER SALAD THE FRESH PLACE TO BE. INT. CL. 42. REG. 10-7-2003.
2,772,193. JETPROOF. INT. CL. 42. REG. 10-7-2003.
2,772,197. FIESTA THREE YEAR BURNER WARRANTY TWO YEAR PARTS WARRANTY 32 AND LIFETIME CASTING AND DESIGN. INT. CL. 11. REG. 10-7-2003.
2,772,199. ISTARTSCHOOL. INT. CL. 9. REG. 10-7-2003.
2,772,203. SPEED SET. INT. CL. 20. REG. 10-7-2003.
2,772,204. TIAN CAN AND DESIGN. INT. CL. 25. REG. 10-7-2003.
2,772,205. JETMATCH. INT. CL. 35. REG. 10-7-2003.
2,772,208. TWIRL-BRITE. INT. CL. 11. REG. 10-7-2003.
2,772,210. SILVER PORTAL. INT. CL. 36. REG. 10-7-2003.
2,772,211. COLD RUSH. INT. CL. 3. REG. 10-7-2003.
2,772,213. HOME FUNDS DIRECT AND DESIGN. INT. CL. 36. REG. 10-7-2003.
2,772,214. CASINO FORTUNE. INT. CL. 41. REG. 10-7-2003.
2,772,215. MA PAU. INT. CL. 41. REG. 10-7-2003.
2,772,216. OMP ORGASMIC MUSIC PRODUCTIONS AND DESIGN. INT. CL. 9. REG. 10-7-2003.
2,772,217. COMPRESS IT. INT. CL. 9. REG. 10-7-2003.
2,772,218. AIS (STYLIZED). INT. CL. 9. REG. 10-7-2003.
2,772,219. FAMOUS EDDIE'S. INT. CL. 42. REG. 10-7-2003.
2,772,227. TATTLETAILS AND DESIGN. INT. CL. 35. REG. 10-7-2003.
2,772,230. FF AND DESIGN. INT. CL. 17. REG. 10-7-2003.
2,772,231. PEACEFULNESS. INT. CL. 3. REG. 10-7-2003.
2,772,236. X-PILOT (STYLIZED). INT. CL. 9. REG. 10-7-2003.
2,772,239. SWS CLEARING. INT. CL. 36. REG. 10-7-2003.
2,772,240. I-4C AND DESIGN. INT. CL. 42. REG. 10-7-2003.
2,772,243. WRISTEASE AND DESIGN. INT. CL. 10. REG. 10-7-2003.
2,772,244. HC EXPRESSARRAY. INT. CL. 1. REG. 10-7-2003.
2,772,245. HIEI. INT. CL. 28. REG. 10-7-2003.
2,772,246. KUWABARA. INT. CL. 28. REG. 10-7-2003.
2,772,247. YUSUKE. INT. CL. 28. REG. 10-7-2003.
2,772,248. BOTAN. INT. CL. 28. REG. 10-7-2003.
2,772,249. T-SHIRT HELL. INT. CL. 35. REG. 10-7-2003.
2,772,255. BIOALUMIN LST. INT. CL. 17. REG. 10-7-2003.
2,772,256. MISCELLANEOUS DESIGN. INT. CL. 5. REG. 10-7-2003.
2,772,258. INCREDIBLE CURVES (STYLIZED). INT. CL. 25. REG. 10-7-2003.
2,772,260. TCG THE CRAWFORD GROUP, INC. AND DESIGN. INT. CL. 35. REG. 10-7-2003.
2,772,261. VIGILANZ. INT. CL. 42. REG. 10-7-2003.
2,772,262. ECOBUSINESS SCHOOL AND DESIGN. INT. CL. 41. REG. 10-7-2003.
2,772,263. SCHWAB RT ADMINISTRATION SOLUTIONS. INT. CL. 9. REG. 10-7-2003.
2,772,264. 242. INT. CL. 42. REG. 10-7-2003.
2,772,265. WEB AND DESIGN. INT. CLS. 5 AND 9. REG. 10-7-2003.
2,772,266. WOWTAB AND DESIGN. INT. CL. 5. REG. 10-7-2003.
2,772,267. MISCELLANEOUS DESIGN. INT. CL. 42. REG. 10-7-2003.
2,772,268. TOP DIAMONDS INTL. INT. CL. 35. REG. 10-7-2003.
2,772,269. THINK NAKED. INT. CL. 16. REG. 10-7-2003.
2,772,272. DSG HOME SOLVE. INT. CL. 9. REG. 10-7-2003.
2,772,273. ADS ON A ROLL AND DESIGN. INT. CL. 35. REG. 10-7-2003.
2,772,274. EFFORTLESS ENTREES. INT. CLS. 29 AND 30. REG. 10-7-2003.
2,772,275. PORTWATCH. INT. CL. 9. REG. 10-7-2003.
2,772,278. CRISTALLA.COM AND DESIGN. INT. CL. 41. REG. 10-7-2003.
2,772,279. ALDERWOODS. INT. CLS. 6, 16, 19, 20, 31 AND 42. REG. 10-7-2003.
2,772,280. MEDVIEW. INT. CL. 9. REG. 10-7-2003.
2,772,284. THE MEGAMARKET. INT. CL. 28. REG. 10-7-2003.
2,772,289. ADIRONACK SALSA. INT. CL. 30. REG. 10-7-2003.
2,772,290. PERRY SWENSON. INT. CL. 25. REG. 10-7-2003.
2,772,291. GOOD FAITH. INT. CL. 36. REG. 10-7-2003.
2,772,293. AL*PROFILER. INT. CLS. 35 AND 36. REG. 10-7-2003.
2,772,294. ESL EXPRESS. INT. CL. 41. REG. 10-7-2003.
2,772,296. MYTSA.COM BUILDING YOUR RETIREMENT (STYLIZED). INT. CL. 36. REG. 10-7-2003.
2,772,299. CADKEY GRAPHX. INT. CL. 9. REG. 10-7-2003.
2,772,300. CADKEY WORKSHOP. INT. CL. 9. REG. 10-7-2003.
2,772,301. NO-NUT. INT. CL. 9. REG. 10-7-2003.
2,772,304. NVISIO AND DESIGN. INT. CL. 9. REG. 10-7-2003.
2,772,308. MISCELLANEOUS DESIGN. INT. CL. 25. REG. 10-7-2003.
2,772,309. QWIK RELEASE AND DESIGN. INT. CL. 9. REG. 10-7-2003.
2,772,310. CONNECTING WITH OUR BUSINESS PARTNERS ALCOA DIRECT AND DESIGN. INT. CLS. 9 AND 35. REG. 10-7-2003.
2,772,311. CLAYS CAR. INT. CL. 12. REG. 10-7-2003.
2,772,314. POWERING THE 21ST CENTURY. INT. CL. 9. REG. 10-7-2003.
2,772,315. KIDPRESSIONS AND DESIGN. INT. CL. 16. REG. 10-7-2003.
2,772,316. MISCELLANEOUS DESIGN. INT. CL. 41. REG. 10-7-2003.
2,772,319. STAR400. INT. CL. 6. REG. 10-7-2003.
2,772,320. GIRLIE GIRLZ. INT. CL. 28. REG. 10-7-2003.
2,772,321. FRONTLINE. INT. CL. 11. REG. 10-7-2003.
2,772,322. GROW AGAIN. INT. CL. 3. REG. 10-7-2003.
2,772,324. AMBUSH. INT. CL. 28. REG. 10-7-2003.
2,772,326. HEAD NODDERZ. INT. CL. 20. REG. 10-7-2003.
2,772,328. MISCELLANEOUS DESIGN. INT. CL. 42. REG. 10-7-2003.
2,772,331. TRANS-LUX DIGITAL MEDIA SOLUTIONS. INT. CLS. 35, 37 AND 42. REG. 10-7-2003.
2,772,332. STREET TUNERS. INT. CL. 37. REG. 10-7-2003.
2,772,333. DASZIGN. INT. CLS. 25 AND 35. REG. 10-7-2003.
2,772,334. VIBRANT. INT. CL. 9. REG. 10-7-2003.
2,772,336. MISCELLANEOUS DESIGN. INT. CLS. 25 AND 42. REG. 10-7-2003.
2,772,337. MANAGER CONNECT AND DESIGN. INT. CL. 36. REG. 10-7-2003.
2,772,338. LAS AMERICAS LA PUERTA THE GATEWAY. INT. CLS. 14, 16, 18, 21, 25, 28, 36 AND 37. REG. 10-7-2003.
2,772,341. THE DENTAL HYGIENE TEAM. INT. CL. 10. REG. 10-7-2003.
2,772,344. AFTER HOURS FORMALWEAR AND DESIGN. INT. CLS. 14, 16 AND 25. REG. 10-7-2003.

- 2,772,345. EMERALD EDITION. INT. CL. 28. REG. 10-7-2003.
- 2,772,349. STARTLIVING. INT. CL. 42. REG. 10-7-2003.
- 2,772,350. STARTDIRECTIONS. INT. CL. 41. REG. 10-7-2003.
- 2,772,351. STARTWORKS. INT. CLS. 35 AND 41. REG. 10-7-2003.
- 2,772,352. REAKT AND DESIGN. INT. CLS. 20 AND 25. REG. 10-7-2003.
- 2,772,354. MXWEATHERSPAN. INT. CLS. 9 AND 42. REG. 10-7-2003.
- 2,772,355. BABY SOUNDS. INT. CL. 28. REG. 10-7-2003.
- 2,772,356. IJADK. INT. CL. 9. REG. 10-7-2003.
- 2,772,357. RAPIDFAB. INT. CL. 40. REG. 10-7-2003.
- 2,772,358. SUNDARA SPA. INT. CLS. 3, 25 AND 42. REG. 10-7-2003.
- 2,772,360. WRENCH!. INT. CL. 28. REG. 10-7-2003.
- 2,772,361. ALL-TITE. INT. CL. 6. REG. 10-7-2003.
- 2,772,362. BEAUTY AND THE BEADS. INT. CL. 14. REG. 10-7-2003.
- 2,772,368. CONNECTING EQUINE BUYERS AND SELLERS. INT. CL. 16. REG. 10-7-2003.
- 2,772,372. PAPRIKA. INT. CL. 14. REG. 10-7-2003.
- 2,772,375. MISCELLANEOUS DESIGN. INT. CL. 9. REG. 10-7-2003.
- 2,772,376. SOLUTIONS FOR EVERY SURFACE. INT. CL. 17. REG. 10-7-2003.
- 2,772,377. JEFFERSON PAVILION. INT. CL. 37. REG. 10-7-2003.
- 2,772,378. MACROSAFE. INT. CL. 9. REG. 10-7-2003.
- 2,772,379. LASH EXPANSION. INT. CL. 3. REG. 10-7-2003.
- 2,772,381. GELATO. INT. CL. 16. REG. 10-7-2003.
- 2,772,383. FLYING BUTTRESS. INT. CL. 28. REG. 10-7-2003.
- 2,772,384. IMAGINEAIR. INT. CL. 2. REG. 10-7-2003.
- 2,772,385. BIG-MOUTHS. INT. CL. 28. REG. 10-7-2003.
- 2,772,387. KBSH CAPITAL MANAGEMENT AND DESIGN. INT. CL. 36. REG. 10-7-2003.
- 2,772,389. COLOR MY HEART... RED. INT. CL. 3. REG. 10-7-2003.
- 2,772,390. SUPERKICK. INT. CL. 28. REG. 10-7-2003.
- 2,772,392. SHIN ZU SHING SMART-PONG AND DESIGN. INT. CL. 28. REG. 10-7-2003.
- 2,772,393. WEBJET. INT. CL. 9. REG. 10-7-2003.
- 2,772,396. BEYOND BIG. INT. CL. 20. REG. 10-7-2003.
- 2,772,397. CARE FREE FINANCING. INT. CL. 35. REG. 10-7-2003.
- 2,772,398. RIVIERA. INT. CL. 11. REG. 10-7-2003.
- 2,772,400. GOLDLUCK. INT. CL. 11. REG. 10-7-2003.
- 2,772,401. G (STYLIZED). INT. CL. 11. REG. 10-7-2003.
- 2,772,402. GOLDLUCK. INT. CLS. 18 AND 25. REG. 10-7-2003.
- 2,772,403. G (STYLIZED). INT. CL. 25. REG. 10-7-2003.
- 2,772,404. G (STYLIZED). INT. CL. 18. REG. 10-7-2003.
- 2,772,405. I'M WITH THE BAND. INT. CL. 38. REG. 10-7-2003.
- 2,772,406. FINALLY TUNED PRODUCTIONS. INT. CLS. 9 AND 41. REG. 10-7-2003.
- 2,772,407. INCOME PROTECTION PLUS. INT. CL. 36. REG. 10-7-2003.
- 2,772,410. SUNBEAM SHOPPER-TUNITY SWEEPSTAKES AND DESIGN. INT. CL. 35. REG. 10-7-2003.
- 2,772,411. BLUEDESERT. INT. CL. 12. REG. 10-7-2003.
- 2,772,412. TECHNOLOGY CHANGES. COMPASSION DOES NOT.. INT. CL. 44. REG. 10-7-2003.
- 2,772,413. S.T.U.N.. INT. CLS. 9 AND 41. REG. 10-7-2003.
- 2,772,414. WE HAVE AN EYE FOR IMAGING. INT. CL. 44. REG. 10-7-2003.
- 2,772,417. EDITION 1. INT. CL. 7. REG. 10-7-2003.
- 2,772,418. PASEOS. INT. CL. 37. REG. 10-7-2003.
- 2,772,419. INTERAKTIV. INT. CL. 11. REG. 10-7-2003.
- 2,772,422. GOLDLUCK. INT. CL. 14. REG. 10-7-2003.
- 2,772,423. THE APPLICATION IS THE ORCHESTRATION. INT. CL. 9. REG. 10-7-2003.
- 2,772,424. G (STYLIZED). INT. CL. 14. REG. 10-7-2003.
- 2,772,425. ROLLER BELTZ. INT. CL. 30. REG. 10-7-2003.
- 2,772,427. TREVA. INT. CL. 12. REG. 10-7-2003.
- 2,772,430. EN VÂN (STYLIZED). INT. CL. 10. REG. 10-7-2003.
- 2,772,435. PRIMENTIA. INT. CL. 42. REG. 10-7-2003.
- 2,772,437. KNI. INT. CL. 42. REG. 10-7-2003.
- 2,772,441. GOLDLUCK. INT. CL. 20. REG. 10-7-2003.
- 2,772,442. SHERBROOKE. INT. CL. 20. REG. 10-7-2003.
- 2,772,443. DURANGO. INT. CL. 14. REG. 10-7-2003.
- 2,772,445. MISCELLANEOUS DESIGN. INT. CL. 8. REG. 10-7-2003.
- 2,772,446. SIZE DOES MATTER. INT. CL. 31. REG. 10-7-2003.
- 2,772,448. GARAGE RECORDS. INT. CLS. 9 AND 25. REG. 10-7-2003.
- 2,772,452. FLEXOR. INT. CL. 12. REG. 10-7-2003.
- 2,772,454. CINEMACHINE. INT. CL. 9. REG. 10-7-2003.
- 2,772,459. MAGNA MEASURE. INT. CL. 9. REG. 10-7-2003.
- 2,772,462. MATRAN. INT. CL. 5. REG. 10-7-2003.
- 2,772,468. SECURITYADVANTAGE. INT. CL. 36. REG. 10-7-2003.
- 2,772,469. AROMA DRY. INT. CL. 11. REG. 10-7-2003.
- 2,772,470. WATER WORM. INT. CL. 28. REG. 10-7-2003.
- 2,772,471. WHO ARE THOSE GUYS. INT. CL. 35. REG. 10-7-2003.
- 2,772,472. 1901. INT. CL. 11. REG. 10-7-2003.
- 2,772,476. CONCERN. INT. CLS. 1 AND 31. REG. 10-7-2003.
- 2,772,477. AMETA. INT. CL. 25. REG. 10-7-2003.
- 2,772,479. METRO LUXE. INT. CL. 35. REG. 10-7-2003.
- 2,772,481. SWISSGLIDE. INT. CL. 5. REG. 10-7-2003.
- 2,772,483. PERFECT COOKIE. INT. CL. 21. REG. 10-7-2003.
- 2,772,485. VERSA. INT. CL. 14. REG. 10-7-2003.
- 2,772,486. CAMBRIDGE CITY AND DESIGN. INT. CL. 18. REG. 10-7-2003.
- 2,772,488. MIMER TIMER. INT. CL. 28. REG. 10-7-2003.
- 2,772,489. MISCELLANEOUS DESIGN. INT. CL. 42. REG. 10-7-2003.
- 2,772,490. HOLLOWCORE. INT. CL. 25. REG. 10-7-2003.
- 2,772,493. "BOOK-IT!". INT. CL. 41. REG. 10-7-2003.
- 2,772,496. DELIVERING THE RIGHT MESSAGE TO THE RIGHT AUDIENCE. INT. CL. 36. REG. 10-7-2003.
- 2,772,497. DELIVERING THE RIGHT MESSAGE TO THE RIGHT AUDIENCE. INT. CL. 38. REG. 10-7-2003.
- 2,772,498. ARBOL DORADO. INT. CL. 29. REG. 10-7-2003.
- 2,772,500. HEAD INTO HAPPINESS. INT. CL. 3. REG. 10-7-2003.
- 2,772,501. SIGNATURE POINTS. INT. CL. 35. REG. 10-7-2003.
- 2,772,504. HIP-ARMOR. INT. CL. 10. REG. 10-7-2003.
- 2,772,505. MISCELLANEOUS DESIGN. INT. CL. 27. REG. 10-7-2003.
- 2,772,508. THE SHARPER IMAGE. INT. CL. 35. REG. 10-7-2003.
- 2,772,510. FOUR LEAVES AND DESIGN. INT. CL. 25. REG. 10-7-2003.
- 2,772,513. FRANCESCA. INT. CL. 19. REG. 10-7-2003.
- 2,772,515. ONE CHECKING. INT. CL. 36. REG. 10-7-2003.
- 2,772,518. SIGNATURE POINTS (STYLIZED). INT. CL. 35. REG. 10-7-2003.
- 2,772,522. PROJECT SKATEBOARD HARDWARE. INT. CLS. 25 AND 28. REG. 10-7-2003.
- 2,772,523. STARTER. INT. CL. 25. REG. 10-7-2003.
- 2,772,524. S AND DESIGN. INT. CL. 25. REG. 10-7-2003.
- 2,772,525. S STARTER AND DESIGN. INT. CL. 25. REG. 10-7-2003.
- 2,772,528. TASKDIRECT. INT. CL. 9. REG. 10-7-2003.
- 2,772,531. SIERRA TRADITIONS. INT. CL. 35. REG. 10-7-2003.
- 2,772,534. MAMMOREADER. INT. CL. 9. REG. 10-7-2003.
- 2,772,536. FUGITIVE HUNTER. INT. CL. 9. REG. 10-7-2003.
- 2,772,539. SWEET 16 PARTY. INT. CL. 28. REG. 10-7-2003.
- 2,772,541. C.O.O.L. MINISTRIES. INT. CL. 25. REG. 10-7-2003.
- 2,772,544. FUND RAISER PLUS. INT. CL. 42. REG. 10-7-2003.
- 2,772,546. HUMAN INTEREST TODAY. INT. CL. 41. REG. 10-7-2003.
- 2,772,547. COME BUILD HOPE. INT. CL. 42. REG. 10-7-2003.
- 2,772,548. ASSISTANTTREASURER.COM. INT. CL. 36. REG. 10-7-2003.
- 2,772,554. DEALSHARE. INT. CL. 42. REG. 10-7-2003.
- 2,772,556. DBIQ (STYLIZED). INT. CL. 9. REG. 10-7-2003.

- 2,772,557. SUPPORT SYSTEMS. INT. CL. 42. REG. 10-7-2003.
2,772,558. MSM5500. INT. CL. 9. REG. 10-7-2003.
2,772,559. FANDANGO. INT. CL. 28. REG. 10-7-2003.
2,772,560. SCHMUCK UNIVERSITY. INT. CL. 16. REG. 10-7-2003.
2,772,561. AMERIHOTEL INNS & SUITES AND DESIGN. INT. CLS. 35 AND 42. REG. 10-7-2003.
2,772,562. THE RITE CONNECTION, THE RITE TOOLS. INT. CL. 42. REG. 10-7-2003.
2,772,563. RISK TAKERS. INT. CL. 41. REG. 10-7-2003.
2,772,564. TOP AUDIO. INT. CL. 9. REG. 10-7-2003.
2,772,565. CUSTOMIZER. INT. CL. 18. REG. 10-7-2003.
2,772,566. WHEN YOUR LIFE DEPENDS ON YOUR GEAR...GET THE GEAR YOUR LIFE CAN DEPEND ON. INT. CL. 8. REG. 10-7-2003.
2,772,568. FRUGALIDS. INT. CL. 16. REG. 10-7-2003.
2,772,570. CONCOURSE PROSPECT DIALOGS. INT. CL. 35. REG. 10-7-2003.
2,772,571. HOODZ. INT. CL. 28. REG. 10-7-2003.
2,772,572. GOTHAM POWER. INT. CLS. 35 AND 37. REG. 10-7-2003.
2,772,573. LEADSTREAM WEBCASTS. INT. CL. 42. REG. 10-7-2003.
2,772,574. WYNN'S SHIELD. INT. CL. 1. REG. 10-7-2003.
2,772,577. LIL SHE CREATURES AND DESIGN. INT. CL. 25. REG. 10-7-2003.
2,772,583. THE PLAYFUL PARENT. INT. CL. 16. REG. 10-7-2003.
2,772,587. OUT OF YOUR MIND AND DESIGN. INT. CLS. 35 AND 42. REG. 10-7-2003.
2,772,588. BISTRO BREAKFAST KITCHEN. INT. CL. 30. REG. 10-7-2003.
2,772,589. AWHERE SPATIAL INFORMATION SYSTEMS. INT. CL. 9. REG. 10-7-2003.
2,772,593. JBLEND. INT. CL. 42. REG. 10-7-2003.
2,772,594. ABERRATION BLOCKING TECHNOLOGY AND DESIGN. INT. CL. 9. REG. 10-7-2003.
2,772,596. BUMPS. INT. CL. 25. REG. 10-7-2003.
2,772,597. KILLS GERMS FOR A CLEAN MOUTH FEELING...ANYTIME, ANYWHERE. INT. CL. 3. REG. 10-7-2003.
2,772,598. LIKE SILK IN MOTION. INT. CL. 25. REG. 10-7-2003.
2,772,601. MANYWORLDS SIGNAL. INT. CL. 16. REG. 10-7-2003.
2,772,602. STRIP FOR BEER. INT. CL. 9. REG. 10-7-2003.
2,772,603. ALPHAKY. INT. CL. 1. REG. 10-7-2003.
2,772,605. DREAM WEAVERS AND DESIGN. INT. CL. 41. REG. 10-7-2003.
2,772,607. POWERSTRUXURE (STYLIZED). INT. CL. 42. REG. 10-7-2003.
2,772,608. INFR@CONFIG. INT. CL. 42. REG. 10-7-2003.
2,772,609. MYGO. INT. CL. 7. REG. 10-7-2003.
2,772,611. EVIEW 360. INT. CL. 42. REG. 10-7-2003.
2,772,612. NEWGAME. INT. CL. 35. REG. 10-7-2003.
2,772,615. SPOOKMASTER. INT. CL. 16. REG. 10-7-2003.
2,772,618. MISCELLANEOUS DESIGN. INT. CL. 37. REG. 10-7-2003.
2,772,619. AEA APPLIED ECONOMICS ASSOCIATION. INT. CL. 35. REG. 10-7-2003.
2,772,625. DEMIVISION. INT. CL. 9. REG. 10-7-2003.
2,772,626. "NEVER UNDERESTIMATE THE POWER OF A LOGO!". INT. CL. 35. REG. 10-7-2003.
2,772,628. SHIELD FLEX. INT. CL. 17. REG. 10-7-2003.
2,772,630. FITS MY FANCY. INT. CL. 25. REG. 10-7-2003.
2,772,632. DUCK PLUCK. INT. CL. 36. REG. 10-7-2003.
2,772,633. MANETAINER. INT. CL. 18. REG. 10-7-2003.
2,772,634. GET CHIPPED. INT. CL. 9. REG. 10-7-2003.
2,772,635. ENERGY MATTERS. INT. CLS. 35 AND 41. REG. 10-7-2003.
2,772,638. LOVE ANGELES. INT. CL. 25. REG. 10-7-2003.
2,772,639. LEAK GUARD. INT. CL. 12. REG. 10-7-2003.
2,772,640. NETWORKING NETWORK TECHNOLOGY AND DESIGN. INT. CL. 9. REG. 10-7-2003.
2,772,641. PMC STONECARE. INT. CL. 3. REG. 10-7-2003.
2,772,643. URISLEEVE. INT. CL. 11. REG. 10-7-2003.
2,772,644. SOLO MINUET. INT. CL. 11. REG. 10-7-2003.
2,772,645. FLURRYVILLE COLLECTION. INT. CL. 21. REG. 10-7-2003.
2,772,650. KISSER CARMA ENTERPRISES OUR ANSWER IS ALWAYS—KNOW!. INT. CL. 16. REG. 10-7-2003.
2,772,653. MEGA MASQUE. INT. CL. 3. REG. 10-7-2003.
2,772,654. AETNA DIRECT. INT. CL. 36. REG. 10-7-2003.
2,772,657. PLANETAIRE. INT. CL. 28. REG. 10-7-2003.
2,772,658. E TRAINER AND DESIGN. INT. CL. 9. REG. 10-7-2003.
2,772,659. HOMIEHOPPERZ. INT. CL. 28. REG. 10-7-2003.
2,772,661. EXPANDED LIFE. INT. CL. 11. REG. 10-7-2003.
2,772,663. LINEAR. INT. CL. 8. REG. 10-7-2003.
2,772,664. PENNINGTON. INT. CL. 8. REG. 10-7-2003.
2,772,666. PRIMOPOKER. INT. CL. 9. REG. 10-7-2003.
2,772,667. WISDOM QUEST. INT. CL. 41. REG. 10-7-2003.
2,772,669. PROJECT GOOD DEEDS. INT. CL. 36. REG. 10-7-2003.
2,772,670. BAZICS. INT. CL. 42. REG. 10-7-2003.
2,772,672. N VASSARETTE V (STYLIZED). INT. CL. 25. REG. 10-7-2003.
2,772,673. PIERRE DUMAS SPORT. INT. CL. 25. REG. 10-7-2003.
2,772,675. AT&T SPARKLE TONE. INT. CL. 38. REG. 10-7-2003.
2,772,678. BECAUSE YOU'RE NOT JUST INVESTED. YOU'RE PERSONALLY INVESTED.. INT. CL. 36. REG. 10-7-2003.
2,772,680. GRAPE ESCAPE. INT. CL. 3. REG. 10-7-2003.
2,772,682. CDROOM AND DESIGN. INT. CL. 9. REG. 10-7-2003.
2,772,687. 360° BLACK EXPERIENCE IN SOUND AND DESIGN. INT. CL. 41. REG. 10-7-2003.
2,772,688. TESSERA. INT. CL. 27. REG. 10-7-2003.
2,772,690. POWERFUL ON STAINS, SAFE FOR BABY'S SKIN. INT. CL. 3. REG. 10-7-2003.
2,772,692. DIPS 'N DOGS. INT. CL. 43. REG. 10-7-2003.
2,772,693. LET'S GO. INT. CL. 36. REG. 10-7-2003.
2,772,694. PROSPERITAS CONSULTING AND DESIGN. INT. CL. 44. REG. 10-7-2003.
2,772,699. BASIL'S TREATS FLAVOR SHAKER. INT. CL. 20. REG. 10-7-2003.
2,772,700. STARWARE. INT. CL. 9. REG. 10-7-2003.
2,772,702. SEARCHPORT. INT. CL. 42. REG. 10-7-2003.
2,772,703. AMY WEBER. INT. CL. 41. REG. 10-7-2003.
2,772,704. CUTSMART. INT. CL. 35. REG. 10-7-2003.
2,772,706. LEAWOOD. INT. CL. 34. REG. 10-7-2003.
2,772,707. RUMBLE THROUGH THE TUNNELS. INT. CLS. 14, 25 AND 35. REG. 10-7-2003.
2,772,708. MAZEL NOSH. INT. CLS. 29 AND 30. REG. 10-7-2003.
2,772,710. QUICK SWAP AND DESIGN. INT. CL. 9. REG. 10-7-2003.
2,772,712. THE SUGGESTION FACTORY. INT. CL. 42. REG. 10-7-2003.
2,772,714. BRAIN ON. INT. CL. 41. REG. 10-7-2003.
2,772,715. GOSPEL VOICE (STYLIZED). INT. CL. 16. REG. 10-7-2003.
2,772,717. DIGITRAVELER. INT. CL. 9. REG. 10-7-2003.
2,772,719. WHACKED OUT WATER. INT. CL. 32. REG. 10-7-2003.
2,772,720. ADVANCETRACT. INT. CL. 10. REG. 10-7-2003.
2,772,721. SOAK 'N SPLASH. INT. CL. 28. REG. 10-7-2003.
2,772,729. RATTLESNAKE RODEO. INT. CL. 36. REG. 10-7-2003.
2,772,731. CROWE. INT. CL. 35. REG. 10-7-2003.
2,772,733. PIXEL FOR PIXEL. INT. CL. 9. REG. 10-7-2003.
2,772,735. WALKWAY TREES. INT. CL. 28. REG. 10-7-2003.
2,772,737. STYLE SCALE. INT. CL. 16. REG. 10-7-2003.
2,772,738. EXECUTIVE MENTOR TEAM. INT. CL. 35. REG. 10-7-2003.
2,772,740. TECHNOLOGY ENGINEERS AND DESIGN. INT. CL. 42. REG. 10-7-2003.
2,772,741. THE CHAMBER REWARDS CARD (STYLIZED). INT. CL. 9. REG. 10-7-2003.
2,772,743. SUPER CLIP. INT. CL. 20. REG. 10-7-2003.
2,772,744. CUSTOMER INTERACTION CENTER. INT. CL. 36. REG. 10-7-2003.

- 2,772,746. FAITH COMMUNITIES PROJECT. INT. CL. 41. REG. 10-7-2003.
- 2,772,747. SHORT COURSE GOLF CHAMPIONSHIP. INT. CL. 41. REG. 10-7-2003.
- 2,772,748. SPAULDING BRICK. INT. CL. 19. REG. 10-7-2003.
- 2,772,749. BEST TEEN CHEF IN AMERICA. INT. CL. 41. REG. 10-7-2003.
- 2,772,751. DOCTORS REGIONAL CANCER TREATMENT CENTER. INT. CL. 44. REG. 10-7-2003.
- 2,772,752. MISSISSIPPI CATHOLIC. INT. CLS. 9 AND 45. REG. 10-7-2003.
- 2,772,754. DUAL SOURCE. INT. CL. 7. REG. 10-7-2003.
- 2,772,756. COMMUNITY PPO OF MIDDLE TENNESSEE. INT. CL. 36. REG. 10-7-2003.
- 2,772,760. HOME CARE DENTURES. INT. CL. 44. REG. 10-7-2003.
- 2,772,763. THE PRENEED STORE. INT. CL. 36. REG. 10-7-2003.
- 2,772,765. INTERNATIONAL SPY MUSEUM. INT. CLS. 35 AND 41. REG. 10-7-2003.
- 2,778,839. SPORT SUPPLY GROUP, INC.. INT. CLS. 24 AND 25 ONLY. REG. 11-4-2003.
- 2,778,946. BOLSHOI. INT. CLS. 3, 14, 20, 21 AND 25 ONLY. REG. 11-4-2003.
- 2,780,109. SIC 'EM BEARS. INT. CLS. 18, 26 AND 28 ONLY. REG. 11-4-2003.
- 2,781,022. EDDIE IZZARD. INT. CLS. 3, 18, 21 AND 34 ONLY. REG. 11-11-2003.
- 2,781,150. MISCELLANEOUS DESIGN. INT. CLS. 3, 9, 18, 24 AND 35 ONLY. REG. 11-11-2003.
- 2,783,856. AQUARELLE. INT. CL. 38 ONLY. REG. 11-18-2003.
- 2,803,902. CRYSTALGROUP.COM. INT. CL. 38 ONLY. REG. 1-13-2004.
- 2,817,079. LEVECELL. INT. CLS. 1 AND 27 ONLY. REG. 2-24-2004.
- 2,823,420. EQUIPMENT. INT. CLS. 4 AND 28 ONLY. REG. 3-16-2004.
- 2,831,062. ARCLIGHT. INT. CLS. 9 AND 13 ONLY. REG. 4-13-2004.
- 2,834,346. ALPHA SCREEN. INT. CL. 41 ONLY. REG. 4-20-2004.
- 2,835,703. LOVIVE AND DESIGN. INT. CLS. 10 AND 42 ONLY. REG. 4-27-2004.
- 2,835,754. MISCELLANEOUS DESIGN. INT. CLS. 39, 41 AND 42 ONLY. REG. 4-27-2004.
- 2,837,705. C 30. INT. CL. 37 ONLY. REG. 5-4-2004.
- 2,838,337. ROLLIN' ON. INT. CL. 12 ONLY. REG. 5-4-2004.
- 2,838,809. HERO ARTS WWW.HEROARTS.COM AND DESIGN. INT. CL. 20 ONLY. REG. 5-4-2004.
- 2,839,241. ADVANCE YOUR PROFESSION. INT. CL. 35 ONLY. REG. 5-4-2004.
- 2,841,042. MX FACTOR. INT. CL. 1 ONLY. REG. 5-11-2004.
- 2,841,380. URBANOLOGY. INT. CLS. 18 AND 35 ONLY. REG. 5-11-2004.
- 2,843,464. CUBO. INT. CL. 17 ONLY. REG. 5-18-2004.
- 2,843,566. BASIC INSTINCT. INT. CL. 4 ONLY. REG. 5-18-2004.
- 2,855,552. IBENA. INT. CLS. 9, 10, 20 AND 22 ONLY. REG. 6-22-2004.
- 2,884,365. NAPLES LAKES COUNTRY CLUB. INT. CL. 37 ONLY. REG. 9-14-2004.
- 2,892,232. SKYLINE AND DESIGN. INT. CL. 38 ONLY. REG. 10-12-2004.
- 2,911,167. MISCELLANEOUS DESIGN. INT. CLS. 14 AND 18 ONLY. REG. 12-14-2004.
- 2,929,575. FEDEXFORUM. INT. CL. 25 ONLY. REG. 3-1-2005.
- 2,937,458. UNVISIBLE UNIVERSE STANDARD CHARACTER MARK. INT. CL. 16 ONLY. REG. 4-5-2005.
- 2,940,524. WATERPACK. INT. CL. 1 ONLY. REG. 4-12-2005.

SECTION 18

- 2,869,194. FRESH...FOR LIFE!. INT. CL. 35. REG. 8-3-2004.
- 2,887,433. MOONSUN (STYLIZED). INT. CL. 33. REG. 9-21-2004.
- 3,097,246. GREENTREE LENDING STANDARD CHARACTER MARK. INT. CL. 36. REG. 5-30-2006.
- 3,131,616. CONTRACTOR TOUGH. GUARANTEED. STANDARD CHARACTER MARK. INT. CLS. 7 AND 8. REG. 8-22-2006.
- 3,209,825. JOJOBA BUTTER BEADS STANDARD CHARACTER MARK. INT. CL. 4. REG. 2-13-2007.
- 3,502,379. BODY ALIVE STANDARD CHARACTER MARK. INT. CL. 5. REG. 9-16-2008.
- 3,592,548. DEFIANT STANDARD CHARACTER MARK. INT. CL. 3. REG. 3-17-2009.

* * * * *

TRADEMARK REGISTRATIONS AMENDED, CORRECTED, ETC.

The designation "U.S. Cl." appearing in this section refers to the U.S. class in effect prior to Sep. 1, 1973 rather than the international class which applies to applications filed on or after that date. For adoption of international classification see notice in the OFFICIAL GAZETTE of Jun. 26, 1973 (911 O.G. TM 210).

Any change to the registration will be indicated at the bottom of each entry under ELEMENTS AMENDED, CORRECTED OR RESTRICTED. With the exception of changes to the goods and services, additions to the registration will appear in asterisks and deletions of the registration will appear in brackets. Elements which are only changed will be listed with no punctuation. As to the goods/services statement, amendments to the goods/services will appear in asterisks and deletions will appear in brackets. In addition if any change to the goods/services occurs, the element "Goods/Services" will be listed under ELEMENTS AMENDED, CORRECTED OR RESTRICTED.

852,718. REG. 7-16-1968. COLUMBIA INSURANCE COMPANY (NEBRASKA CORPORATION) 3024 HARNEY STREET, 84 CORPORATE WOODS, OVERLAND PARK, KS, 66210, SN 72-288,515. FILED 1-10-1968. PRINCIPAL REGISTER.

INT. CL. 14/U.S. CL. 28
FOR CHARM BRACELETS, DIAMOND RINGS, MOUNTED DIAMONDS, AND JEWELRY MANUFACTURED OF PRECIOUS METALS.
FIRST USE 10-30-1967; IN COMMERCE 10-30-1967.

ELEMENTS AMENDED
MARK

1,599,507. REG. 6-5-1990. D'ADDARIO & COMPANY, INC. (NEW YORK CORPORATION) 595 SMITH STREET, FARMINGDALE, NY, 11735, SN 73-740,698. FILED 7-18-1988. PRINCIPAL REGISTER.

OWNER OF U.S. REG. NO. 1,106,621.
THE ENGLISH TRANSLATION OF THE WORDS "D'ADDARIO PRO-ARTE" IN THE MARK IS "FOR THE ARTS".
INT. CL. 15/U.S. CLS. 2, 21 AND 36

FOR GUITAR [AND ELECTRIC BASS] STRINGS.
FIRST USE 6-12-1978; IN COMMERCE 6-12-1978.

ELEMENTS AMENDED
GOODS/SERVICES

1,604,098. REG. 6-26-1990. EDUCATION MANAGEMENT LLC (DELAWARE LIMITED LIABILITY COMPANY) 210 SIXTH AVENUE, PITTSBURGH, PA, 15222, SN 73-825,593. FILED 9-15-1989. PRINCIPAL REGISTER.

THE ART INSTITUTE OF ATLANTA

NO CLAIM IS MADE TO THE EXCLUSIVE RIGHT TO USE "ART INSTITUTE", APART FROM THE MARK AS SHOWN.

SEC. 2(F).

INT. CL. 41/U.S. CLS. 100, 101 AND 107

FOR EDUCATION SERVICES, NAMELY POST SECONDARY INSTRUCTION IN THE FIELDS OF VISUAL COMMUNICATION ARTS AND DESIGN; INTERIOR [AND LANDSCAPE] DESIGN; [FASHION ILLUSTRATION AND MARKETING; MUSIC AND] VIDEO BUSINESS; AND PHOTOGRAPHY.

FIRST USE 1-0-1974; IN COMMERCE 1-0-1974.

ELEMENTS AMENDED
MARK

1,620,329. REG. 10-30-1990. WARWICK GROUP, INC., THE (RHODE ISLAND CORPORATION) 130 TAUNTON AVE., EAST PROVIDENCE, RI, 02914, SN 73-821,386. FILED 8-24-1989. PRINCIPAL REGISTER.

SEC. 2(F).

INT. CL. 35/U.S. CL. 101

FOR PHOTOCOPYING SERVICES.

FIRST USE 8-5-1988; IN COMMERCE 8-5-1988.

INT. CL. 42/U.S. CL. 100

FOR PRINTING SERVICES.
FIRST USE 8-5-1988; IN COMMERCE 8-5-1988.

ELEMENTS AMENDED
MARK

1,993,844. REG. 8-13-1996. NRI, INC. (DELAWARE CORPORATION) 1015 18TH STREET, NW, SUITE 710, WASHINGTON, DC, 20036, SN 74-494,606. FILED 2-25-1994. PRINCIPAL REGISTER.



NRI
STAFFING RESOURCES

OWNER OF U.S. REG. NOS. 1,005,926 AND 1,079,515.
NO CLAIM IS MADE TO THE EXCLUSIVE RIGHT TO USE "STAFFING RESOURCES", APART FROM THE MARK AS SHOWN.

INT. CL. 35/U.S. CLS. 100, 101 AND 102

FOR TEMPORARY EMPLOYMENT AGENCY SERVICES; PERSONNEL PLACEMENT AND RECRUITMENT SERVICES.

FIRST USE 3-1-1994; IN COMMERCE 3-1-1994.

ELEMENTS CORRECTED
[DBA/AKA]

2,251,175. REG. 6-8-1999. MAUI JIM, INC. (ILLINOIS CORPORATION) 930 WAINEE STREET, SUITE 9, LAHAINA, MAUI, HI, 96761, SN 75-426,889. FILED 2-2-1998. PRINCIPAL REGISTER.

POLARIZEDPLUS

OWNER OF U.S. REG. NO. 1,781,170.
INT. CL. 9/U.S. CLS. 21, 23, 26, 36 AND 38
FOR EYEGLASSES AND EYEGLASS LENSES.
FIRST USE 4-1-1989; IN COMMERCE 4-1-1989.

ELEMENTS AMENDED
MARK
[DISCLAIMER]

2,501,329. REG. 10-30-2001. DURAMAX MARINE, LLC (OHIO CORPORATION) 17990 GREAT LAKES PARKWAY, HIRAM, OH, 442349681, SN 75-778,192. FILED 8-17-1999. PRINCIPAL REGISTER.

DURAMAX

INT. CL. 12/U.S. CLS. 19, 21, 23, 31, 35 AND 44

FOR COMPONENTS FOR SHIPS AND BOATS, NAMELY, RUDDER BUSHINGS, [STUFFING BOXES, STERN CASTINGS,] KEEL COOLERS, DOCK BUMPERS, SHIP FENDERS, BATTER BOARDS, PUSHER BUMPERS AND [DECK ASSEMBLIES, TORQUE JOURNAL HUB PROPELLERS,] PROPELLER SHAFT SEAL SYSTEMS; [BRAKE PEDALS, GAS PEDALS; CRUISE CONTROL VACUUM ASSEMBLIES, NAMELY, HOSE GROMMETS; FUEL SHIELDS; GEARSHIFT BOOTS AND AUTOMOTIVE PARTS NAMELY, BOOTS; GLOVE BOX DOOR BUMPERS, INSULATORS COMPOSED OF RUBBER SPRING SEATS AND VIBRATION ISOLATORS FOR USE IN SOUND AND VIBRATION ISOLATION; MOLDED AIR DUCTS FOR USE IN ENGINE INDUCTION AND EXHAUST APPLICATIONS; STRUCTURAL PARTS OF BOATS, NAMELY, WINDOWS AND DOORS, MUFFLER SUPPORT BRACKETS,] CLOSURE SEALS FOR WINDOWS AND DOORS.

FIRST USE 0-0-1969; IN COMMERCE 0-0-1969.
INT. CL. 17/U.S. CLS. 1, 5, 12, 13, 35 AND 50

FOR [RUBBER TUBING FOR USE IN THE INDUSTRIAL ARTS, NAMELY CLOSURE SEALS AND GASKETS, RUBBER GASKETS FOR MARINE HATCH COVERS; INFLATABLE RUBBER AIR SEAL RINGS FOR STUFFING BOXES, RUBBER WINDOW CHANNELS AND RUBBER WEATHER STRIPPING FOR USE ON SHIPS AND BOATS; RUBBER FUEL VAPOR HOSES; RUBBER CLIMATE CONTROL HOSES FOR USE IN HEAT EXCHANGERS; RUBBER HOSES FOR APPLIANCES FOR USE IN WASHING MACHINES, REFRIGERATORS, HEATERS; NON-METAL HOSES FOR USE IN THE MANUFACTURE OF BOATS AND AUTOMOBILES; NON-METALLIC GROMMETS FOR USE IN THE MANUFACTURE OF AUTOMOBILES; NON-METALLIC TUBING; MANDREL FORMED TUBING; WINDOW WEATHER STRIPPING WINDOW WASHER HOSES NOT MADE OF METAL, NON-METALLIC HOSES, NON-METALLIC GASKETS, NON-METAL SEALS FOR USE IN HYDRAULIC MACHINERY; NAMELY, PLUGS, SEALING PLUGS MADE OF RUBBER].

FIRST USE 8-18-1995; IN COMMERCE 8-18-1995.

ELEMENTS AMENDED
GOODS/SERVICES

2,655,719. REG. 12-3-2002. GFC BRANDS, INC. (DELAWARE CORPORATION) 1007 ORANGE STREET, WILMINGTON, DE, 19801, SN 76-195,345. FILED 1-18-2001. PRINCIPAL REGISTER.

GIANT

REGISTRATION IS RESTRICTED TO THE TERRITORY COMPRISING THE UNITED STATES EAST OF THE MISSISSIPPI RIVER FROM ITS ORIGIN IN THE STATE OF MINNESOTA TO ITS MOUTH IN THE GULF OF MEXICO.
INT. CL. 35/U.S. CLS. 100, 101 AND 102

FOR RETAIL STORE SERVICES FEATURING CONVENIENCE STORE ITEMS AND GASOLINE.
FIRST USE 11-0-1998; IN COMMERCE 11-0-1998.

ELEMENTS AMENDED
ORDER RESTRICTING THE SCOPE OF REG.
GOODS/SERVICES

2,686,950. REG. 2-11-2003. CANTERBURY ENTERPRISES, INC. (CALIFORNIA CORPORATION), DBA: CANTERBURY ENTERPRISES, INC. 440 EAST HARRISON, CORONA, CA, 92879. SN 75-827,288. FILED 10-21-1999. PRINCIPAL REGISTER.

GRILL THREADS

NO CLAIM IS MADE TO THE EXCLUSIVE RIGHT TO USE "GRILL", APART FROM THE MARK AS SHOWN.
INT. CL. 11/U.S. CLS. 13, 21, 23, 31 AND 34
FOR BARBECUE GRILL COVERS.
FIRST USE 6-0-2000; IN COMMERCE 6-0-2000.

ELEMENTS AMENDED
OWNER NAME
OWNER ADDRESS
DBA/AKA

2,698,677. REG. 3-18-2003. STURGIS AREA CHAMBER OF COMMERCE (SOUTH DAKOTA CORPORATION) PO BOX 504, STURGIS, SD, 57785, SN 78-010,763. FILED 6-1-2000. PRINCIPAL REGISTER.

TAKE THE RIDE TO STURGIS

OWNER OF U.S. REG. NO. 1,948,097.
SEC. 2(F).
INT. CL. 25/U.S. CLS. 22 AND 39
FOR CLOTHING - NAMELY, T-SHIRTS AND SWEAT-SHIRTS AND CAPS.
FIRST USE 8-5-1996; IN COMMERCE 8-5-1996.

ELEMENTS CORRECTED
ASSIGNMENT/NAME CHANGE
OWNER NAME
OWNER ADDRESS
CITIZENSHIP
ENTITY

2,711,738. REG. 4-29-2003. EVERDRY MARKETING & MANAGEMENT, INC. (OHIO CORPORATION) 365 E. HIGHLAND ROAD, MACEDONIA, OH, 44056, SN 76-047,000. FILED 5-15-2000. PRINCIPAL REGISTER.

STABL WALL

INT. CL. 19/U.S. CLS. 1, 12, 33 AND 50
FOR POLYMER MATERIAL SOLD IN ROLLS OR STRIPS USED FOR BRACING AND REINFORCING WALLS, NAMELY, FOUNDATION WALLS IN BUILDINGS.
FIRST USE 7-0-2000; IN COMMERCE 10-0-2000.

ELEMENTS CORRECTED
OWNER NAME

2,715,295. REG. 5-13-2003. INSURANCE EXCHANGE, INC., THE (MARYLAND CORPORATION) 9713 KEY WEST AVE., SUITE 401, ROCKVILLE, MD, 20850, SN 76-363,774. FILED 1-28-2002. PRINCIPAL REGISTER.



THE INSURANCE EXCHANGE

NO CLAIM IS MADE TO THE EXCLUSIVE RIGHT TO USE "THE INSURANCE EXCHANGE", APART FROM THE MARK AS SHOWN.
INT. CL. 36/U.S. CLS. 100, 101 AND 102
FOR BROKERAGE IN THE FIELD OF INSURANCE, STOCKS AND MUTUAL FUNDS; FINANCIAL SERVICES IN THE NATURE OF AN INVESTMENT SECURITY; INSURANCE AGENCIES; INVESTMENT MANAGEMENT OF AND DISTRIBUTION OF VARIABLE ANNUITIES, CONSULTATION WITH REGARD TO INSURANCE AND INVESTMENTS.
FIRST USE 11-7-1979; IN COMMERCE 11-7-1979.

ELEMENTS AMENDED
MARK
DISCLAIMER

2,718,407. REG. 5-27-2003. SCILLARD INVESTMENTS LIMITED (CYPRUS LIMITED LIABILITY COMPANY) ANAFSEOS, 1, AGIOS NIKOLAOS, P.C., LIMASSOL, CYPRUS, 3906, SN 76-055,947. FILED 5-22-2000. PRINCIPAL REGISTER.

BELUGA

OWNER OF FRANCE REG. NO. 1,644,724, DATED 2-15-1991, EXPIRES 2-15-2011.
INT. CL. 33/U.S. CLS. 47 AND 49
FOR ALCOHOLIC BEVERAGES, NAMELY, VODKA.
FIRST USE ; IN COMMERCE .

ELEMENTS CORRECTED
INTERNATIONAL CLASS(ES)

2,751,198. REG. 8-12-2003. PBI BANK, INC. (KENTUCKY CORPORATION) 2500 EASTPOINT PARKWAY, LOUISVILLE, KY, 40223, SN 76-371,221. FILED 2-14-2002. PRINCIPAL REGISTER.

ASCENCIA

THE MARK CONSISTS OF STANDARD CHARACTERS WITHOUT CLAIM TO ANY PARTICULAR FONT, STYLE, SIZE, OR COLOR.
INT. CL. 36/U.S. CLS. 100, 101 AND 102
FOR BANKING SERVICES.
FIRST USE 8-1-2002; IN COMMERCE 8-1-2002.

ELEMENTS AMENDED
MARK
[DISCLAIMER]

2,758,490. REG. 9-2-2003. DBS MARKETING, INC. (NEVADA CORPORATION) 7512 DR. PHILLIPS BLVD, ORLANDO, FL, 32819, SN 76-441,254. FILED 8-19-2002. PRINCIPAL REGISTER.

THE ALKALIZER

INT. CL. 11/U.S. CLS. 13, 21, 23, 31 AND 34
FOR WATER PURIFICATION UNITS FOR DOMESTIC, COMMERCIAL AND INDUSTRIAL USE.
FIRST USE 4-0-1994; IN COMMERCE 4-0-1994.

ELEMENTS CORRECTED
OWNER NAME

FOR COMPUTER CONSULTATION [; DESIGNING AND IMPLEMENTING NEW COMPUTER NETWORKS, NAMELY, LOCAL AND WIDE AREA HARDWARE, OPERATING SYSTEMS AND NETWORK APPLICATION SOFTWARE; ENHANCING THE CAPABILITIES OF EXISTING NETWORKS BOTH WIDE AND LOCAL AREA AND INTEGRATING THEM INTO EXISTING COMPUTER INFRASTRUCTURE, NAMELY, LOCAL AND WIDE AREA HARDWARE, OPERATING SYSTEMS AND NETWORK APPLICATION SOFTWARE; ON-SITE OR REMOTE COMPUTER ADMINISTRATION SERVICES, NAMELY, MANAGING COMPUTER SYSTEMS FOR OTHERS IN THE AREAS OF LOCAL AND WIDE AREA NETWORKS, HARDWARE, AND SOFTWARE SUPPORT; PROVIDING TEMPORARY USE OF ON-LINE NON-DOWNLOADABLE SOFTWARE, NAMELY, MEDICAL APPLICATIONS FINANCIAL APPLICATIONS, GENERAL DATABASE APPLICATIONS, MANUFACTURING APPLICATIONS, NOT FOR PROFIT APPLICATIONS, AND GENERALLY AVAILABLE BUSINESS WORD PROCESSING, SPREADSHEET, DATABASE GRAPHICS AND PRESENTATION PROGRAMS].
FIRST USE 1-0-2001; IN COMMERCE 1-0-2001.

ELEMENTS AMENDED
MARK
[DISCLAIMER]

2,767,736. REG. 9-23-2003. INNOVATIVE U.S.A., INC. (CONNECTICUT CORPORATION) 18 ANN STREET, NORWALK, CT, 068542258, SN 76-351,065. FILED 12-20-2001. PRINCIPAL REGISTER.

HANDS-ON MINDS-ON

THE MARK CONSISTS OF STANDARD CHARACTERS WITHOUT CLAIM TO ANY PARTICULAR FONT, STYLE, SIZE, OR COLOR.

INT. CL. 16/U.S. CLS. 2, 5, 22, 23, 29, 37, 38 AND 50
FOR SERIES OF CHILDREN'S BOOKS.
FIRST USE 2-12-2001; IN COMMERCE 2-12-2001.

ELEMENTS AMENDED
MARK
[DISCLAIMER]

2,776,648. REG. 10-21-2003. LUSTRELAB LXR, INCORPORATED (GEORGIA CORPORATION) P.O. BOX 1045, ROME, GA, 30162, SN 76-402,452. FILED 5-1-2002. PRINCIPAL REGISTER.

LUSTRELAB

INT. CL. 3/U.S. CLS. 1, 4, 6, 50, 51 AND 52
FOR PREPARATIONS FOR CLEANING AND POLISHING VEHICLES, NAMELY CAR WASH PREPARATIONS FOR CLEANING THE WINDOWS, WHEELS AND EXTERIOR OF A VEHICLE.
FIRST USE 12-0-2002; IN COMMERCE 12-0-2002.

ELEMENTS CORRECTED
CITIZENSHIP

2,776,232. REG. 10-21-2003. SINGLE POINT SYSTEMS, INC. (PENNSYLVANIA CORPORATION) 10 BEDFORD SQUARE, PITTSBURGH, PA, 15203, SN 76-200,967. FILED 1-26-2001. PRINCIPAL REGISTER.

RED SQUARE

THE MARK CONSISTS OF STANDARD CHARACTERS WITHOUT CLAIM TO ANY PARTICULAR FONT, STYLE, SIZE, OR COLOR.
INT. CL. 42/U.S. CLS. 100 AND 101

2,825,875. REG. 3-23-2004. DISTRIGAS OF MASSACHUSETTS LLC (DELAWARE LIMITED LIABILITY COMPANY) ONE LIBERTY SQUARE 10TH FLOOR, BOSTON, MA, 02109, SN 76-374,622. FILED 2-22-2002. PRINCIPAL REGISTER.

 **Distrigas**

INT. CL. 39/U.S. CLS. 100 AND 105
FOR UTILITY SERVICES IN THE NATURE OF NATURAL GAS AND LIQUEFIED NATURAL GAS DISTRIBUTION; TRANSPORTATION OF LIQUEFIED NATURAL GAS VIA TRUCK.
FIRST USE 6-10-2002; IN COMMERCE 6-10-2002.

ELEMENTS AMENDED
MARK

2,828,366. REG. 3-30-2004. WILLIAM GRANT & SONS, INC. (NEW JERSEY CORPORATION) 130 FIELDCREST AVENUE, EDISON, NJ, 08837, SN 76-398,896. FILED 4-22-2002. PRINCIPAL REGISTER.

bennett family

INT. CL. 33/U.S. CLS. 47 AND 49
FOR WINES.
FIRST USE 12-3-2003; IN COMMERCE 12-3-2003.

ELEMENTS AMENDED
MARK

2,831,483. REG. 4-13-2004. KERNER, MARC M. (UNITED STATES INDIVIDUAL) 18350 ROSCOE BLVD., SUITE 318, NORTHRIDGE, CA, 91325, SN 76-473,155. FILED 12-9-2002. PRINCIPAL REGISTER.

DERMATIQUE MEDICAL
CENTER FOR ADVANCED
SKINCARE

REGISTRATION IS RESTRICTED TO THE TERRITORY COMPRISING THE ENTIRE UNITED STATES WEST OF THE MISSISSIPPI RIVER.

NO CLAIM IS MADE TO THE EXCLUSIVE RIGHT TO USE "MEDICAL CENTER FOR ADVANCED SKINCARE", APART FROM THE MARK AS SHOWN.

INT. CL. 44/U.S. CLS. 100 AND 101

FOR PROVIDING MEDICAL SERVICES FOR THE SKIN, INCLUDING BUT NOT LIMITED TO, BOTOX, LASER HAIR REMOVAL, PERCUTANEOUS COLLAGEN STIMULATION, MICRODERMABRASION, PHOTOFACIAL REJUVENATION WITH IPL, NON INVASIVE LEG VEIN THERAPY OR TREATMENT.

FIRST USE 10-1-2002; IN COMMERCE 10-1-2002.

ELEMENTS AMENDED
GOODS/SERVICES

2,836,265. REG. 4-27-2004. MORRIS PUBLISHING GROUP, LLC (GEORGIA LIMITED LIABILITY COMPANY) 725 BROAD STREET, AUGUSTA, GA, 30901, SN 76-524,481. FILED 6-23-2003. PRINCIPAL REGISTER.

H MAGAZINE THE PULSE OF
TODAY'S HEALTH

THE MARK CONSISTS OF STANDARD CHARACTERS WITHOUT CLAIM TO ANY PARTICULAR FONT, STYLE, SIZE, OR COLOR.

NO CLAIM IS MADE TO THE EXCLUSIVE RIGHT TO USE "HEALTH" AND "MAGAZINE", APART FROM THE MARK AS SHOWN.

INT. CL. 16/U.S. CLS. 2, 5, 22, 23, 29, 37, 38 AND 50

FOR MAGAZINE REGARDING GENERAL HEALTH CARE ISSUES.

FIRST USE 5-19-2003; IN COMMERCE 5-19-2003.

ELEMENTS AMENDED
MARK
DISCLAIMER

2,836,900. REG. 4-27-2004. CYGNUS BUSINESS MEDIA, INC. (DELAWARE CORPORATION) 1233 JANESVILLE AVENUE, FORT ATKINSON, WI, 53538, SN 76-311,351. FILED 9-12-2001. PRINCIPAL REGISTER.

FIREHOUSE WORLD

THE MARK CONSISTS OF STANDARD CHARACTERS WITHOUT CLAIM TO ANY PARTICULAR FONT, STYLE, SIZE, OR COLOR.

NO CLAIM IS MADE TO THE EXCLUSIVE RIGHT TO USE "WORLD", APART FROM THE MARK AS SHOWN.

INT. CL. 35/U.S. CLS. 100, 101 AND 102

FOR PROMOTING, ORGANIZING AND CONDUCTING TRADE SHOW EXHIBITIONS IN THE FIELDS OF FIREFIGHTING AND EMERGENCY MEDICAL SERVICES.

FIRST USE 2-18-2003; IN COMMERCE 2-18-2003.

INT. CL. 41/U.S. CLS. 100, 101 AND 107

FOR EDUCATIONAL SERVICES, NAMELY, CONDUCTING CLASSES, SEMINARS, CONFERENCES AND WORKSHOPS IN THE FIELDS OF FIREFIGHTING AND EMERGENCY MEDICAL SERVICES.

FIRST USE 2-18-2003; IN COMMERCE 2-18-2003.

ELEMENTS AMENDED
DISCLAIMER
MARK

2,850,049. REG. 6-8-2004. MAIRDUMONT GMBH & CO. KG (FED REP GERMANY CORPORATION) MARCO-POLO-STRASSE 1, OSTFILDERN, FED REP GERMANY, 73760, SN 76-203,346. FILED 1-17-2001. PRINCIPAL REGISTER.

MARCO  POLO

PRIORITY CLAIMED UNDER SEC. 44(D) ON FED REP GERMANY APPLICATION NO. 30053108.7/4, FILED 7-17-2000, REG. NO. 30053108, DATED 10-5-2000.

INT. CL. 35/U.S. CLS. 100, 101 AND 102

FOR COMPUTERIZED ONLINE ORDERING SERVICES AND ONLINE ADVERTISING SERVICES IN THE FIELD OF BOOKS, LEISURE, SPORT, LIFESTYLE, FASHION, LIVING, COOKERY, AND ARCHITECTURE; COMPUTERIZED ONLINE RETAIL SERVICES IN THE FIELD OF BOOKS, LEISURE, SPORT, LIFESTYLE, FASHION, LIVING, COOKERY, AND ARCHITECTURE; DISSEMINATION OF ADVERTISING FOR OTHERS VIA AN ONLINE ELECTRONIC COMMUNICATIONS NETWORK; PROMOTING THE GOODS AND SERVICES OF OTHERS BY PREPARING AND PLACING ADVERTISEMENTS IN AN ELECTRONIC MAGAZINE ACCESSED THROUGH A GLOBAL COMPUTER NETWORK; ELECTRONIC RETAILING SERVICES VIA COMPUTER FEATURING BOOKS, LEISURE, SPORT, LIFESTYLE, FASHION, LIVING, COOKERY, AND ARCHITECTURE; PROVIDING ONLINE DATABASES IN THE FIELD OF BUSINESS INFORMATION.

FIRST USE ; IN COMMERCE .

INT. CL. 38/U.S. CLS. 100, 101 AND 104

FOR TELECOMMUNICATIONS SERVICES, NAMELY, PERSONAL COMMUNICATIONS SERVICES, PROVIDING TELECOMMUNICATIONS CONNECTIONS TO A GLOBAL COMPUTER NETWORK; TELECOMMUNICATIONS GATEWAY SERVICES; TELECOMMUNICATIONS SERVICES, NAMELY, ISDN SERVICES; ELECTRONIC MAIL SERVICES; TELEPHONE COMMUNICATIONS SERVICES; ELECTRONIC TRANSMISSION OF DATA AND DOCUMENTS VIA A COMPUTER TERMINALS; ELECTRONIC TRANSMISSION OF MESSAGES AND DATA; PROVIDING MULTIPLE-USER ACCESS TO A GLOBAL COMPUTER INFORMATION NETWORK; PROVIDING TELECOMMUNICATIONS CONNECTIONS TO A GLOBAL COMPUTER NETWORK.

FIRST USE ; IN COMMERCE .

INT. CL. 39/U.S. CLS. 100 AND 105

FOR PROVIDING ONLINE DATABASES AND ROUTING PROGRAMS IN THE FIELD OF TRAVEL AND TOURISM.

FIRST USE ; IN COMMERCE .
INT. CL. 42/U.S. CLS. 100 AND 101

FOR COMPUTER SERVICES, NAMELY, DESIGNING AND IMPLEMENTING NETWORK WEB PAGES FOR OTHERS; COMPUTER SERVICES, NAMELY, DESIGNING AND IMPLEMENTING WEB SITES FOR OTHERS, COMPUTER SERVICES, NAMELY, PROVIDING ON-LINE DATABASES AND ROUTING PROGRAMS IN THE FIELD OF CARTOGRAPHY, NAVIGATION, AND ARCHITECTURE; COMPUTER SERVICES, NAMELY, PROVIDING SEARCH ENGINES FOR OBTAINING DATA ON A GLOBAL COMPUTER NETWORK; HOSTING WEB SITES OF OTHERS ON A COMPUTER SERVER FOR A GLOBAL COMPUTER NETWORK.
FIRST USE ; IN COMMERCE .

ELEMENTS AMENDED
MARK



2,853,244. REG. 6-15-2004. PRODUCT PARTNERS, LLC (CALIFORNIA LIMITED LIABILITY COMPANY) 3301 EXPOSITION BOULEVARD, 3RD FLOOR, SANTA MONICA, CA, 90404, SN 76-529,751. FILED 7-14-2003. PRINCIPAL REGISTER.



THE MARK CONSISTS OF A SWIRL IN A CIRCLE DESIGN.

INT. CL. 5/U.S. CLS. 6, 18, 44, 46, 51 AND 52

FOR MEAL REPLACEMENT PROTEIN BARS, DIETARY SUPPLEMENTS AND DIET AIDS, NAMELY VITAMINS AND MINERAL SUPPLEMENTS.

FIRST USE 6-0-2003; IN COMMERCE 6-0-2003.

INT. CL. 9/U.S. CLS. 21, 23, 26, 36 AND 38

FOR PRE-RECORDED VIDEO TAPES, DVDS, AND CDS, FEATURING EXERCISE, FITNESS AND DIETARY INFORMATION AND INSTRUCTION.

FIRST USE 6-0-2003; IN COMMERCE 6-0-2003.

INT. CL. 41/U.S. CLS. 100, 101 AND 107

FOR EDUCATIONAL SERVICES, NAMELY INSTRUCTION IN THE FIELDS OF EXERCISE EQUIPMENT AND DIET PROGRAMS.

FIRST USE 6-0-2003; IN COMMERCE 6-0-2003.

ELEMENTS CORRECTED
DESCRIPTION OF MARK

2,862,918. REG. 7-13-2004. PLATINUM PERFORMANCE INC. (CALIFORNIA CORPORATION) UNIT 100, 67 COMMERCE DRIVE, BUELLTON, CA, 93427, SN 78-281,502. FILED 7-31-2003. PRINCIPAL REGISTER.

BETA LIP-OX

NO CLAIM IS MADE TO THE EXCLUSIVE RIGHT TO USE REPRESENTATION OF THE GREEK LETTER BETA, APART FROM THE MARK AS SHOWN.

INT. CL. 5/U.S. CLS. 6, 18, 44, 46, 51 AND 52

FOR NUTRITIONAL SUPPLEMENTS FOR WEIGHT MANAGEMENT IN HUMANS AND ANIMALS.

FIRST USE 7-0-2001; IN COMMERCE 7-0-2001.

ELEMENTS AMENDED
MARK



2,863,176. REG. 7-13-2004. INDEPENDENT INSURANCE AGENTS & BROKERS OF AMERICA, INC. (NEW YORK CORPORATION) 127 SOUTH PEYTON STREET, ALEXANDRIA, VA, 22314, SN 76-279,735. FILED 7-2-2001. PRINCIPAL REGISTER.

TRUSTED CHOICE

INT. CL. 36/U.S. CLS. 100, 101 AND 102

FOR INSURANCE SERVICES, NAMELY, PROVIDING INSURANCE AND ANNUITY BROKERAGE AND UNDERWRITING SERVICES IN THE FIELD OF AGRICULTURAL INSURANCE, AUTO INSURANCE, AVIATION INSURANCE, COMPUTER/TECHNOLOGY INSURANCE, CONSTRUCTION INSURANCE, DISABILITY INSURANCE, EMPLOYMENT INSURANCE, FISHING INSURANCE, FORESTRY INSURANCE, HEALTH INSURANCE, LIFE INSURANCE, MEDICAL INSURANCE, MARINE INSURANCE, MINING INSURANCE, MUNICIPALITY INSURANCE, PROFESSIONAL INSURANCE, PROPERTY INSURANCE, PUBLIC ADMINISTRATION INSURANCE, PUBLIC UTILITY INSURANCE, RECREATIONAL VEHICLE INSURANCE, TRANSPORTATION INSURANCE, AND SHIPPING INSURANCE; INSURANCE AGENCIES, INSURANCE CONSULTATION AND BROKERAGE IN THE FIELDS LIFE, PROPERTY AND CASUALTY, ACCIDENT AND HEALTH; FINANCIAL SERVICES, NAMELY, PROVIDING FINANCIAL ANALYSIS, CONSULTATION, PLANNING AND MANAGEMENT, STOCK BROKERAGE AND PORTFOLIO MANAGEMENT, COMMERCIAL AND CONSUMER LENDING, MORTGAGE LENDING, AND MORTGAGE FINANCING, PROVIDING FINANCIAL INFORMATION IN THE NATURE OF RIGHT TO EXCHANGE, ESTATE PLANNING, AND FINANCIAL PLANNING SERVICES IN THE NATURE OF RETIREMENT, GIFT, AND DISTRIBUTION PLANNING *; ALL THE FOREGOING EXCLUDING CREDIT CARD AND DEBIT CARD SERVICES*.

FIRST USE 10-24-2001; IN COMMERCE 10-24-2001.

ELEMENTS AMENDED
GOODS/SERVICES



2,868,298. REG. 8-3-2004. NUTRITION RESOURCE, INC. (CALIFORNIA CORPORATION) P.O. BOX 238, LAKEPORT, CA, 95453, SN 76-301,244. FILED 8-17-2001. PRINCIPAL REGISTER.

META-C

INT. CL. 5/U.S. CLS. 6, 18, 44, 46, 51 AND 52

FOR VITAMIN SUPPLEMENTS.
FIRST USE 12-6-1992; IN COMMERCE 12-20-1992.

ELEMENTS CORRECTED

DBA/AKA
OWNER NAME
CITIZENSHIP
ENTITY

2,924,758. REG. 2-8-2005. KERNER, MARC M. (UNITED STATES INDIVIDUAL) 18350 ROSCOE BLVD., SUITE 318, NORTHRIDGE, CA, 91325, SN 76-544,776. FILED 9-15-2003. PRINCIPAL REGISTER.



REGISTRATION IS RESTRICTED TO THE TERRITORY COMPRISING THE ENTIRE UNITED STATES WEST OF THE MISSISSIPPI RIVER.

NO CLAIM IS MADE TO THE EXCLUSIVE RIGHT TO USE "MEDICAL CENTER FOR ADVANCED SKINCARE, INC.", APART FROM THE MARK AS SHOWN.
INT. CL. 44/U.S. CLS. 100 AND 101

FOR PROVIDING MEDICAL SERVICES FOR THE SKIN, INCLUDING BUT NOT LIMITED TO, BOTOX, LASER HAIR REMOVAL, PERCUTANEOUS COLLAGEN STIMULATION, MICRODERMABRASION, PHOTOFACIAL REJUVENATION WITH IPL, NON INVASIVE LEG VEIN THERAPY OR TREATMENT.
FIRST USE 10-1-2002; IN COMMERCE 10-1-2002.

ELEMENTS AMENDED

ORDER RESTRICTING THE SCOPE OF REG.
GOODS/SERVICES

2,942,708. REG. 4-19-2005. ROYAL VENDORS, INC. (WEST VIRGINIA CORPORATION) 426 INDUSTRIAL BLVD., KEARNEYSVILLE, WV, 254302776, SN 76-520,882. FILED 6-5-2003. PRINCIPAL REGISTER.



OWNER OF U.S. REG. NOS. 2,178,409 AND 2,250,272.
NO CLAIM IS MADE TO THE EXCLUSIVE RIGHT TO USE VENDER, APART FROM THE MARK AS SHOWN.
INT. CL. 9/U.S. CLS. 21, 23, 26, 36 AND 38

FOR VENDING MACHINES.
FIRST USE 12-22-2002; IN COMMERCE 3-2-2003.

ELEMENTS AMENDED
OWNER ADDRESS
MARK

2,958,172. REG. 5-31-2005. SUN DENSHI KABUSHIKI KAISHA (JAPAN CORPORATION), TA SUN CORPORATION, 250 ASAHI, KOCHINO-CHO, KONAN, AICHI 483-8555, JAPAN., SN 78-264,013. FILED 6-18-2003. PRINCIPAL REGISTER.

ALBERT ODYSSEY

THE NAME SHOWN IN THE MARK DOES NOT IDENTIFY A PARTICULAR LIVING INDIVIDUAL.

INT. CL. 9/U.S. CLS. 21, 23, 26, 36 AND 38
FOR VIDEO GAME DISCS, COMPUTER GAME PROGRAMS, AND COMPUTER GAME DISCS ON CD-ROM.
FIRST USE 3-5-1993; IN COMMERCE 3-5-1993.

ELEMENTS CORRECTED

DBA/AKA
OWNER NAME
OWNER ADDRESS

3,019,624. REG. 11-29-2005. M. & B. MARCHI E BREVETTI S.R.L. (ITALY JOINT STOCK COMPANY) VIA SAN FILIPO, 2, FABRIANO (AN), ITALY, I60044, SN 78-279,022. FILED 7-25-2003. PRINCIPAL REGISTER.



OWNER OF ITALY REG. NO. 00887454, DATED 4-7-2003.
INT. CL. 7/U.S. CLS. 13, 19, 21, 23, 31, 34 AND 35

FOR [WASHING MACHINES, WASHING-DRYING MACHINES, DISHWASHERS, ELECTRIC COFFEE MILLS, ELECTRIC MIXERS, ELECTRIC GRINDERS, VACUUM CLEANERS, ELECTRIC CARPET BEATERS, ELECTRIC POLISHING MACHINES,] CIRCULATING PUMPS.

FIRST USE ; IN COMMERCE .
INT. CL. 9/U.S. CLS. 21, 23, 26, 36 AND 38

FOR [ELECTRIC FLAT IRONS,] ELECTRIC RESISTANCES, ELECTRONIC BOARDS, THERMOSTATS, BAR CODE READERS, COMPUTERS, COMPUTER SOFTWARE FOR HOUSEHOLD APPLIANCES AUTOMATION PURPOSE, ELECTRONIC NOTICE BOARDS, SMOKE DETECTORS, ELECTRONIC CONTROLLING DEVICES, NAMELY, AUTO-DIAGNOSTIC SYSTEM AND INTEGRATED ADVANCED CONTROLS BUILT IN FOR THE FUNCTIONING SURVEY OF HOUSEHOLD APPLIANCES, DISTRIBUTION BOARDS, DISTRIBUTION BOXES, FIRE ALARMS, FLUORESCENT SCREEN, MEASURING APPARATUS, NAMELY, THERMOMETERS, PRESSURE INDICATORS, CONDUCTIVITY INDICATORS, MODEMS, MONITORS, NOTEBOOK COMPUTERS, REDUCERS, PLUGS, SOCKETS, ELECTRONIC SMART ADAPTER, PROCESSORS, INTEGRATED CIRCUIT CARDS, TELEMETERS, TELEPHONE RECEIVERS AND TRANSMITTERS, TELEVISION APPARATUS, NAMELY, TELEVISION SETS, VIDEO TELEPHONES, WATER LEVEL INDICATORS.

FIRST USE ; IN COMMERCE .
INT. CL. 11/U.S. CLS. 13, 21, 23, 31 AND 34

FOR [ELECTRIC COFFEE MACHINES, DRYING MACHINES FOR WASHING, HAIR DRIERS, VENTILATION HOODS, FILTERING HOODS, FREEZERS, GAS AND ELECTRIC COOKERS, EGGS COOKERS, KITCHEN RANGES, OVENS, MICROWAVES OVENS, FREEZING AND REFRIGERATING MACHINES, REFRIGERATORS, GRILLS, COOKING HOBS, FEEDING-BOTTLE HEATERS, TOASTERS,] REGULATING AND SECURITY VALVES FOR GAS APPARATUS, NAMELY, REGISTER VALVES, FLUE DAMPER VALVES, REGULATOR VALVES, RELIEF VALVES, SAFETY VALVES, STOP VALVES, DIVERTER VALVES, DRAIN VALVES, MIXING VALVES, ESCAPE VALVES, SHOWER CUBICLES, BURNERS, HEATING BOILERS, AIR CONDITIONING UNITS, SINKS, SOLAR PANELS, RADIATING PLATES, SHOWER TRAYS, HEAT PUMPS, HEATING ELECTRIC STOVES, HEATING GAS STOVES, HEATING RADIATORS, WATER HEATERS, BATH TUBS.

FIRST USE ; IN COMMERCE .

INT. CL. 20/U.S. CLS. 2, 13, 22, 25, 32 AND 50

FOR REMOVABLE MATS OR COVERS FOR SINKS, BATHROOM FURNITURE, KITCHEN FURNITURE.

FIRST USE ; IN COMMERCE .

INT. CL. 37/U.S. CLS. 100, 103 AND 106

FOR [INSTALLATION AND REPAIR OF WASHING MACHINES, WASHING-DRYING MACHINES, DISHWASHERS, ELECTRIC COFFEE MILLS, ELECTRIC MIXERS, ELECTRIC GRINDERS, VACUUM CLEANERS, ELECTRIC CARPET BEATERS, ELECTRIC POLISHING MACHINES,] INSTALLATION AND REPAIR OF CIRCULATING PUMPS; [ELECTRIC FLAT IRONS,] ELECTRIC RESISTANCES, ELECTRONIC BOARDS, THERMOSTATS, BAR CODE READERS, MAGNETIC CARDS, TIMES CLOCKS (TIME RECORDING DEVICES), TIME RECORDING APPARATUS, COMPUTERS, COMPUTER SOFTWARE, ELECTRONIC NOTICE BOARDS, SMOKE DETECTORS, DIAGNOSTIC APPARATUS NOT FOR MEDICAL PURPOSES, DISTRIBUTION BOARDS, DISTRIBUTION BOXES, FIRE ALARMS, FLUORESCENT SCREEN, MEASURING APPARATUS, ELECTRIC MEASURING DEVICES, MEASURING INSTRUMENTS, MODEMS, MONITORS, NOTEBOOK COMPUTERS, REDUCERS, PLUGS, SOCKETS AND OTHER ELECTRIC CONNECTIONS, ELECTRONIC SMART ADAPTER, PROCESSORS, ELECTRIC INSTALLATION FOR THE REMOTE CONTROL OF INDUSTRIAL OPERATION, INTEGRATED CIRCUIT CARDS, TELEMETERS, TELEPHONE APPARATUS, TELEPHONE RECEIVERS AND TRANSMITTERS, TELEVISION APPARATUS, VIDEO TELEPHONES, WATER LEVEL INDICATORS; [ELECTRIC COFFEE MACHINES, DRYING MACHINES FOR WASHING, HAIR DRIERS, VENTILATION HOODS, FILTERING HOODS, FREEZERS, COOKERS (GAS; ELECTRIC), EGGS COOKERS, KITCHEN RANGES, OVENS, MICROWAVES OVENS, FREEZING AND REFRIGERATING MACHINES, REFRIGERATORS, GRILLS, COOKING HOBS, FEEDING-BOTTLE HEATERS, TOASTERS,] REGULATING AND SAFETY ACCESSORIES FOR GAS APPARATUS, SHOWER CUBICLES, BURNERS, HEATING APPARATUS, HEATING BOILERS, AIR CONDITIONING APPARATUS, SINKS, SOLAR PANELS, RADIATING PLATES, SHOWER TRAYS, HEAT PUMPS, HEATING ELECTRIC STOVES, HEATING GAS STOVES, RADIATORS (HEATING), WATER HEATERS, BATH TUBS; REMOVABLE MATS OR COVERS FOR SINKS, BATHROOM FURNITURE, KITCHEN FURNITURE.

FIRST USE ; IN COMMERCE .

ELEMENTS AMENDED
GOODS/SERVICES

3,087,313. REG. 5-2-2006. CEU.COM (CONNECTICUT CORPORATION) 140 FERRY ROAD, OLD SAYBROOK, CT, 06475, SN 78-520,747. FILED 11-22-2004. PRINCIPAL REGISTER.



NO CLAIM IS MADE TO THE EXCLUSIVE RIGHT TO USE "CEU.COM", APART FROM THE MARK AS SHOWN. THE COLOR(S) BLUE AND NAVY IS/ARE CLAIMED AS A FEATURE OF THE MARK.

THE LETTERS CEU AND THE LEFT HALF OF THE OPEN BOOK DESIGN IS IN NAVY, THE LETTERS .COM AND THE RIGHT HALF OF THE OPEN BOOK DESIGN ARE IN THE COLOR BLUE.

INT. CL. 41/U.S. CLS. 100, 101 AND 107

FOR EDUCATIONAL SERVICES, NAMELY, PROVIDING ONLINE COURSES OF INSTRUCTION IN THE FIELD OF INSURANCE.

FIRST USE 1-1-1999; IN COMMERCE 1-1-1999.

ELEMENTS CORRECTED
OWNER NAME

3,335,750. REG. 11-13-2007. GERHARD D. WEMPE KG (FED REP GERMANY LIMITED PARTNERSHIP) STEINSTRASSE 23, HAMBURG, FED REP GERMANY, D-20095, SN 76-978,631. FILED 10-23-2003. PRINCIPAL REGISTER.

BY KIM

THE MARK CONSISTS OF STANDARD CHARACTERS WITHOUT CLAIM TO ANY PARTICULAR FONT, STYLE, SIZE, OR COLOR.

PRIORITY CLAIMED UNDER SEC. 44(D) ON ERPNCMNTY TM OFC APPLICATION NO. 003281748, FILED 7-23-2003, REG. NO. 003281748, DATED 3-31-2005.

INT. CL. 14/U.S. CLS. 2, 27, 28 AND 50

FOR PRECIOUS METALS AND THEIR ALLOYS; HANDCRAFTED ITEMS MADE OF, OR PLATED WITH, PRECIOUS METALS AND/OR THEIR ALLOYS, NAMELY, JEWELRY, NECKLACES, BRACELETS, BANGLES, EAR CLIPS, EARRINGS, RINGS, PENDANTS FOR NECKLACES, [BROOCHES, WRIST AND POCKET WATCHES, MONEY CLIPS,] CUFF LINKS, KEY CHAINS AND TAGS, [PILL BOXES,] PICTURE FRAMES; ITEMS MADE OF, OR PLATED WITH, PRECIOUS METALS AND/OR THEIR ALLOYS, NAMELY, JEWELRY, NECKLACES, BRACELETS, BANGLES, EAR CLIPS, EARRINGS, RINGS, PENDANTS FOR NECKLACES, [BROOCHES, WRIST AND POCKET WATCHES, MONEY CLIPS,] CUFF LINKS, KEY CHAINS AND TAGS, [PILL BOXES,] PICTURE FRAMES; PRECIOUS STONES; [CHRONOMETERS].

FIRST USE 5-5-2003; IN COMMERCE 5-5-2003.

ELEMENTS AMENDED
GOODS/SERVICES
OWNER NAME

3,375,185. REG. 1-29-2008. THE SKIN CANCER FOUNDATION, INC. (NEW YORK NON-PROFIT CORPORATION) SUITE 901, 149 MADISON AVENUE, NEW YORK, NY, 10016, SN 77-140,037. FILED 3-26-2007. PRINCIPAL REGISTER.



NO CLAIM IS MADE TO THE EXCLUSIVE RIGHT TO USE "FOUNDATION", APART FROM THE MARK AS SHOWN.

THE COLOR(S) BLUE, YELLOW AND WHITE IS/ARE CLAIMED AS A FEATURE OF THE MARK.

THE MARK CONSISTS OF THE WORDS SKIN CANCER PRINTED IN WHITE ON A BLUE BACKGROUND, WITH THE WORD FOUNDATION PRINTED IN LIGHT BLUE; ABOVE THE WORD SKIN IS A YELLOW ARC THAT NARROWS LEFT TO RIGHT; AND BELOW THE WORD FOUNDATION IS A YELLOW ARC THAT NARROWS FROM RIGHT TO LEFT.

"SKIN CANCER".
 INT. CL. 35/U.S. CLS. 100, 101 AND 102
 FOR ADMINISTRATION AND MANAGEMENT OF RESEARCH GRANTS; PROMOTING PUBLIC AWARENESS OF SKIN CANCER; PROMOTING PUBLIC AWARENESS OF THE NEED FOR SKIN CANCER RESEARCH, SKIN SELF-EXAMINATION, SUN PROTECTION, SUN SAFETY AND CONTINUING MEDICAL EDUCATION; PUBLIC ADVOCACY TO PROMOTE AWARENESS OF SKIN CANCER PREVENTION; AND PRODUCTION OF TELEVISION COMMERCIALS AND PUBLIC SERVICE ANNOUNCEMENTS.
 FIRST USE 1-31-2006; IN COMMERCE 1-31-2006.
 INT. CL. 41/U.S. CLS. 100, 101 AND 107
 FOR ARRANGING AND CONDUCTING EDUCATIONAL CONFERENCES IN THE FIELD OF DERMATOLOGY AND SKIN CANCER.
 FIRST USE 1-31-2006; IN COMMERCE 1-31-2006.
 INT. CL. 42/U.S. CLS. 100 AND 101
 FOR MEDICAL AND SCIENTIFIC RESEARCH SERVICES IN THE FIELD OF SKIN CANCER TREATMENT AND DIAGNOSIS.
 FIRST USE 1-31-2006; IN COMMERCE 1-31-2006.

ELEMENTS CORRECTED
 OWNER NAME

3,427,072. REG. 5-13-2008. TUI AG (FED REP GERMANY JOINT STOCK COMPANY) KARL-WIECHERT-ALLEE 4, 30625 HANNOVER, FED REP GERMANY., SN 79-035,207. FILED 3-1-2007. PRINCIPAL REGISTER.

Hapag-Lloyd

OWNER OF INTERNATIONAL REGISTRATION 0915459 DATED 3-1-2007, EXPIRES 3-1-2017.
 OWNER OF U.S. REG. NO. 1,514,877.
 INT. CL. 39/U.S. CLS. 100 AND 105

FOR [TRANSPORT BY ROAD, RAIL AND SHIP AND WAREHOUSING AND THE BROKERING OF SERVICES THEREFORE; TRANSPORT OF PERSONS, GOODS, SAMPLES AND MERCHANDISE OF ALL KINDS, AND DELIVERY THEREOF TO THE RECEIVER BY ROAD, RAIL AND SHIP; PROVIDING FREIGHT FORWARDING SERVICES OF ALL KINDS, FREIGHT FORWARDING AND STORAGE OF DOCUMENTS, LUGGAGE, RAW MATERIALS, FURNITURE AND OTHER FREIGHT; LOADING AND UNLOADING OF TRANSPORT OF ALL KINDS, NAMELY, SHIP UNLOADING; PASSENGER SHIPPING SERVICES, NAMELY, PICKUP, TRANSPORTATION AND DELIVERY OF PASSENGERS; CLEARING OF SHIPS AND FREIGHTING, NAMELY, UNLOADING; BROKERING OF SHIPS, SHIPS' CARGOES, CARGO SPACE AND BERTHS; RENTAL OF ROAD AND RAIL VEHICLES, NAMELY, TANKERS; RENTAL OF TANK HOLDS, TANK CONTAINER SERVICES, RENTAL OF RAIL TANKERS AND OTHER SPECIAL-PURPOSE VEHICLES, TRUCK RENTAL; LOCAL AND LONG DISTANCE COMMERCIAL ROAD TRANSPORT BY CAR AND TRUCK; ARRANGING OF TOURS, ARRANGING OF CRUISES; PROVIDING OF INFORMATION RELATING TO TRANSPORT BY MEANS OF COMPUTER, TELECOMMUNICATIONS AND ELECTRONIC COMMUNICATIONS NETWORKS] * TRANSPORT BY ROAD, RAIL AND SHIP AND WAREHOUSING AND THE BROKERING OF SERVICES THEREFORE, NOT FOR FREIGHT LOGISTICS BUT INCLUSIVE OF AIR FREIGHT; TRANSPORT OF PERSONS AND DELIVERY THEREOF TO THE RECEIVER BY ROAD, RAIL AND SHIP; PROVIDING FREIGHT FORWARDING SERVICES FOR PASSENGER TRANSPORT AND AIR FREIGHT; PASSENGER SHIPPING SERVICES, NAMELY, PICKUP, TRANSPORTATION AND DELIVERY OF PASSENGERS; BROKERING OF PASSENGER SHIPS; ARRANGING OF TOURS, ARRANGING OF CRUISES; PROVIDING OF INFORMATION RELATING TO TRANSPORT BY MEANS OF COMPUTER, TELECOMMUNICATIONS AND ELECTRONIC COMMUNICATIONS DEVICES, NOT FOR FREIGHT LOGISTICS BUT INCLUSIVE OF AIR FREIGHT *.

FIRST USE ; IN COMMERCE .
 INT. CL. 43/U.S. CLS. 100 AND 101
 FOR SERVING OF FOOD AND DRINK *NOT FOR FREIGHT LOGISTICS BUT INCLUSIVE OF AIR FREIGHT*; OUTSIDE CATERING *NOT FOR FREIGHT LOGISTICS BUT INCLUSIVE OF AIR FREIGHT*; PROVIDING TEMPORARY ACCOMMODATION.
 FIRST USE ; IN COMMERCE .
 INT. CL. 44/U.S. CLS. 100 AND 101
 FOR PROVIDING WELLNESS FACILITIES, NAMELY, HEALTH SPA SAUNA SERVICES FOR HEALTH AND WELLNESS OF THE BODY AND SPIRIT OFFERED AT A HEALTH RESORT; MASSAGE, HAIRDRESSING AND BEAUTY SALONS.
 FIRST USE ; IN COMMERCE .

ELEMENTS AMENDED
 GOODS/SERVICES

3,462,902. REG. 7-8-2008. EARTHWORKS SYSTEM, LLC (OHIO LIMITED LIABILITY COMPANY) 33200 BAINBRIDGE ROAD, SOLON, OH, 44139, SN 77-002,662. FILED 9-19-2006. PRINCIPAL REGISTER.

EARTHWORKS

THE MARK CONSISTS OF STANDARD CHARACTERS WITHOUT CLAIM TO ANY PARTICULAR FONT, STYLE, SIZE, OR COLOR.
 INT. CL. 9/U.S. CLS. 21, 23, 26, 36 AND 38

FOR MAGNETICALLY ENCODED PLASTIC TRANSACTION, INFORMATION AND IDENTIFICATION CARDS.

FIRST USE 4-1-2007; IN COMMERCE 4-1-2007.
INT. CL. 16/U.S. CLS. 2, 5, 22, 23, 29, 37, 38 AND 50

FOR NON-MAGNETICALLY ENCODED PLASTIC TRANSACTION, INFORMATION AND IDENTIFICATION CARDS.

FIRST USE 4-1-2007; IN COMMERCE 4-1-2007.
INT. CL. 17/U.S. CLS. 1, 5, 12, 13, 35 AND 50

FOR PLASTIC MATERIAL IN THE FORM OF SHEETS FOR USE IN THE MANUFACTURE OF TRANSACTION, INFORMATION AND IDENTIFICATION CARDS.

FIRST USE 5-1-2006; IN COMMERCE 5-1-2006.

ELEMENTS CORRECTED
OWNER NAME

3,476,938. REG. 7-29-2008. ACTARIS S.A.S. (FRANCE SOCIÉTÉ PAR ACTIONS SIMPLIFIÉE) 62 BIS, AVENUE ANDRÉ MORIZET, F-92100 BOULOGNE-BILLANCOURT, FRANCE., SN 79-042,717. FILED 8-3-2007. PRINCIPAL REGISTER.

EASYCO

PRIORITY DATE OF 2-27-2007 IS CLAIMED.

OWNER OF INTERNATIONAL REGISTRATION 0934877 DATED 8-3-2007, EXPIRES 8-3-2017.

INT. CL. 9/U.S. CLS. 21, 23, 26, 36 AND 38

FOR FLOW METERS AND FLUID METERS FOR GAS, WATER AND THERMAL ENERGY; FLUID OSCILLATORS, ELECTROMAGNETIC STATIC FLOW METERS; ELECTRONIC OR MECHANICAL ELECTRICITY METERS; SPARE PARTS RELATED TO SUCH FLOW METERS; PREPAYMENT APPARATUS FOR SUCH FLOW METERS AND METERS, NAMELY, TOKEN-OPERATED, COIN-OPERATED, CARD-OPERATED, SMART-CARD OPERATED, KEY-PAD OPERATED METERS FOR ELECTRICITY, GAS AND FLUID FLOW METERS AND SUPPLY; APPARATUS FOR THE MEMORIZATION OF DATA RELATED TO SUCH FLOW METERS, NAMELY, EVENT RECORDERS AND COMPUTERS; APPARATUS, NAMELY, RADIO TRANSMITTERS, CABLE TRANSMITTERS FOR THE ELECTRONIC TRANSMISSION OF DATA; SYSTEMS CONSISTING OF COMPUTERS AND COMPUTER SOFTWARE FOR USE IN DATABASE MANAGEMENT, RADIO TRANSMITTERS, CABLE TRANSMITTERS, COMPUTER NETWORK HUBS AND COMPUTER PRINTERS FOR REMOTELY READING AND/OR REMOTELY TRANSMITTING AND/OR REMOTELY RETRIEVING AND REVIEWING DATA RELATED TO SUCH METERS; ELECTRONIC MODEMS; ELECTRONIC PAYMENT TERMINALS; TERMINALS FOR TRANSACTION MANAGEMENT; * THE AFORESAID GOODS CONCERNING THE REMOTE READING AND TRANSMISSION OF DATA COLLECTED FROM METERS *.

FIRST USE ; IN COMMERCE .

INT. CL. 35/U.S. CLS. 100, 101 AND 102

FOR UTILITY METERS READING SERVICES, NAMELY, READING AND RECORDING IN A COMPUTER FILE OF DATA RELATING TO WATER, GAS, THERMAL ENERGY AND/OR ELECTRICITY METERS; AUTOMATIC BILLING SERVICE; REMOTE UTILITY METER READING; * THE AFORESAID SERVICES CONCERNING THE REMOTE READING AND TRANSMISSION OF DATA COLLECTED FROM METERS *.

FIRST USE ; IN COMMERCE .

INT. CL. 38/U.S. CLS. 100, 101 AND 104

FOR ELECTRONIC REMOTE TRANSMISSION OF DATA RELATING TO WATER, GAS, THERMAL ENERGY AND/OR ELECTRICITY METERS; RADIO, TELEGRAPH OR TELEPHONE COMMUNICATION SERVICES; ELECTRONIC DATA TRANSMISSION OF MESSAGES AND INFORMATION VIA ELECTRONIC COMMUNICATIONS NETWORK; COMMUNICATIONS BETWEEN COMPUTER TERMINALS AND/OR BETWEEN A METER, A DETECTOR, A DATA READER AND A COMPUTER TERMINAL; * THE AFORESAID SERVICES CONCERNING THE REMOTE READING AND TRANSMISSION OF DATA COLLECTED FROM METERS *.

FIRST USE ; IN COMMERCE .
INT. CL. 42/U.S. CLS. 100 AND 101

FOR COMPUTER PROGRAMMING, PROVIDING TECHNICAL INFORMATION AND ADVICE RELATING TO REMOTE METER READING AND AUTOMATIC BILLING; * THE AFORESAID SERVICES CONCERNING THE REMOTE READING AND TRANSMISSION OF DATA COLLECTED FROM METERS *.

FIRST USE ; IN COMMERCE .

ELEMENTS CORRECTED
GOODS/SERVICES

3,480,580. REG. 8-5-2008. MECENA FINANCE LTD. (SWITZERLAND LIMITED LIABILITY JOINT STOCK COMPANY) C/O JURIS TREUHAND A.G. INDUSTRIESTRASSE, 47, ZUG, SWITZERLAND, CH-6304, SN 78-475,547. FILED 8-30-2004. PRINCIPAL REGISTER.

PHILANTHROPIA

PRIORITY CLAIMED UNDER SEC. 44(D) ON ERPNCMNTY TM OFC APPLICATION NO. 003908647, FILED 7-4-2004, REG. NO. 003908647, DATED 9-5-2006.

THE COLOR(S) OLIVE GREEN AND BLACK IS/ARE CLAIMED AS A FEATURE OF THE MARK.

THE MARK CONSISTS OF "PHILANTHROPIA" WHERE THE FANCIFUL LETTER "I" IS OLIVE GREEN AND THE REMAINING LETTERS OF THE MARK ARE BLACK.

INT. CL. 35/U.S. CLS. 100, 101 AND 102

FOR ASSISTING CULTURAL ORGANIZATIONS, SUCH AS MUSEUMS, ASSOCIATIONS, FOUNDATIONS, UNIVERSITIES AND COLLEGES TO ATTAIN THEIR FINANCIAL AND FUND RAISING OBJECTIVES, NAMELY, BUSINESS MANAGEMENT OF FUND RAISING CAMPAIGNS, CONDUCTING MARKET STUDIES AND OUTSOURCING OF HUMAN RESOURCES IN THE FIELD OF FUND RAISING *; ALL SERVICES EXCLUDING ORGANIZING AND HOSTING FUND RAISING EVENTS *.

FIRST USE ; IN COMMERCE .

ELEMENTS AMENDED
GOODS/SERVICES

3,487,267. REG. 8-19-2008. CDC ENTERPRISES, INC. (MINNESOTA CORPORATION) SUITE M, 13355 GEORGE WEBBER DRIVE, ROGERS, MN, 55374, SN 77-220,218. FILED 7-2-2007. PRINCIPAL REGISTER.

3,518,316. REG. 10-14-2008. PSB SHOE GROUP LLC (WASHINGTON LIMITED LIABILITY COMPANY) 4742 42ND AVE SW #396, SEATTLE, WA, 981164553, SN 78-825,066. FILED 2-28-2006. PRINCIPAL REGISTER.



OWNER OF U.S. REG. NOS. 3,096,513 AND 3,107,725. NO CLAIM IS MADE TO THE EXCLUSIVE RIGHT TO USE "ENTERPRISES, INC.", APART FROM THE MARK AS SHOWN.

THE COLOR(S) BLUE IS/ARE CLAIMED AS A FEATURE OF THE MARK.

"THE MARK CONSISTS OF THE STYLIZED LETTER "C" SURROUNDING A BACKWARD LETTER "D" WITH THE LETTER "C" CONTAINED INSIDE THE ENCIRCLED PORTION OF THE LETTER "D" NEXT TO THE WORDS CDC ENTERPRISES, INC. ABOVE THE WORDS "THE EVOLUTION OF DUCTWORK," WITH THE DESIGN AND TEXT IN BLUE."

INT. CL. 37/U.S. CLS. 100, 103 AND 106

FOR INSTALLATION, MAINTENANCE AND REPAIR OF NON-METAL DUCTS AND FITTINGS, NON-METAL VENTILATING DUCTS AND FITTINGS, AND NON-METAL AIR DUCTS AND FITTINGS FOR HEATING AND COOLING BUILDINGS.

FIRST USE 5-15-2007, THE NAME CDC ENTERPRISES, INC. WAS FIRST USED AS EARLY AS SEPTEMBER, 1, 2001.; IN COMMERCE 5-15-2007.

INT. CL. 42/U.S. CLS. 100 AND 101

FOR TESTING OF NON-METAL DUCTS AND FITTINGS.

FIRST USE 5-15-2007, THE NAME CDC ENTERPRISES, INC. WAS FIRST USED AS EARLY AS SEPTEMBER, 1, 2001.; IN COMMERCE 5-15-2007.

ELEMENTS CORRECTED
DATE OF FIRST USE

THE MARK CONSISTS OF A STYLIZED LETTER "A", LOWER CASE.

INT. CL. 10/U.S. CLS. 26, 39 AND 44

FOR ORTHOTIC INSERTS FOR FOOTWEAR; ORTHOTICS FOR FEET.

FIRST USE 7-31-2005; IN COMMERCE 7-31-2005.

INT. CL. 25/U.S. CLS. 22 AND 39

FOR ATHLETIC SHOES; LEATHER SHOES; SHOES; WOMEN'S SHOES.

FIRST USE 7-31-2005; IN COMMERCE 7-31-2005.

ELEMENTS CORRECTED
GOODS/SERVICES

3,487,616. REG. 8-19-2008. FUSION MULTISYSTEMS, INC. (NEVADA CORPORATION), DBA FUSION-IO, INC., 6350 S. 3000 E. 6TH FLOOR, SALT LAKE CITY, UT, 84121, SN 77-292,182. FILED 9-28-2007. PRINCIPAL REGISTER.

3,531,675. REG. 11-11-2008. ICON BURGER DEVELOPMENT COMPANY, LLC (DELAWARE LIMITED LIABILITY COMPANY) 1515 ARAPAHOE STREET, TOWER 1, DENVER, CO, 80202, SN 77-107,650. FILED 2-14-2007. PRINCIPAL REGISTER.

FUSION IO

SMASHBURGER

THE MARK CONSISTS OF STANDARD CHARACTERS WITHOUT CLAIM TO ANY PARTICULAR FONT, STYLE, SIZE, OR COLOR.

NO CLAIM IS MADE TO THE EXCLUSIVE RIGHT TO USE "IO", APART FROM THE MARK AS SHOWN.

INT. CL. 9/U.S. CLS. 21, 23, 26, 36 AND 38

FOR COMPUTER EXPANSION BOARDS; COMPUTER CARD ADAPTER; COMPUTER MEMORY HARDWARE; COMPUTER STORAGE DEVICES, NAMELY, FLASH DRIVES.

FIRST USE 3-14-2007; IN COMMERCE 3-14-2007.

ELEMENTS CORRECTED
OWNER NAME
OWNER ADDRESS
DBA/AKA

THE MARK CONSISTS OF STANDARD CHARACTERS WITHOUT CLAIM TO ANY PARTICULAR FONT, STYLE, SIZE, OR COLOR.

NO CLAIM IS MADE TO THE EXCLUSIVE RIGHT TO USE "BURGER", APART FROM THE MARK AS SHOWN.

INT. CL. 43/U.S. CLS. 100 AND 101

FOR CARRY-OUT RESTAURANTS; CATERING; RESTAURANT AND BAR SERVICES; SELF SERVICE RESTAURANTS.

FIRST USE 6-19-2007; IN COMMERCE 6-19-2007.

ELEMENTS AMENDED
MARK

3,537,101. REG. 11-25-2008. BRAINJUICER LTD (UNITED KINGDOM CORPORATION) 77 OXFORD STREET, LONDON, UNITED KINGDOM, W1D2ES, SN 78-737.678. FILED 10-21-2005. PRINCIPAL REGISTER.

Quali-Taxi

THE MARK CONSISTS OF STANDARD CHARACTERS WITHOUT CLAIM TO ANY PARTICULAR FONT, STYLE, SIZE, OR COLOR.

PRIORITY CLAIMED UNDER SEC. 44(D) ON UNITED KINGDOM APPLICATION NO. REF200550095, FILED 9-5-2005, REG. NO. 2472470, DATED 5-16-2008, EXPIRES 11-15-2017.

INT. CL. 35/U.S. CLS. 100, 101 AND 102

FOR CONDUCTING BUSINESS AND MARKET RESEARCH SURVEYS; CONSUMER RESEARCH.
FIRST USE ; IN COMMERCE .

ELEMENTS CORRECTED
FOREIGN REG. DATE

3,537,330. REG. 11-25-2008. WEIGHTPACK S.P.A. (ITALY JOINT STOCK COMPANY) STRADA BARDELLETTA, 10/B-C, I-46044 GOITO (MANTOVA), ITALY., SN 79-047,919. FILED 7-2-2007. PRINCIPAL REGISTER.



WEIGHTPACK
packaging machinery

PRIORITY DATE OF 5-4-2007 IS CLAIMED.

OWNER OF INTERNATIONAL REGISTRATION 0947959 DATED 7-2-2007, EXPIRES 7-2-2017.

NO CLAIM IS MADE TO THE EXCLUSIVE RIGHT TO USE "PACKAGING MACHINERY", APART FROM THE MARK AS SHOWN.

THE MARK CONSISTS OF A SIGN DEPICTING THE WORDING "WEIGHTPACK PACKAGING MACHINERY" IN STYLIZED FONT, THE PORTION "PACK" OF THE WORDING "WEIGHTPACK" BEING OF GREATER THICKNESS, ALL ABOVE THE WORDING "PACKAGING MACHINERY" OF A SMALLER SIZE, PLACED ON THE LEFT THERE IS A QUADRILATERAL SHAPE WITH ROUNDED CORNERS INSIDE WHICH THERE ARE TWO TRIANGLES WITH THE VERTEX TURNED TOWARDS THE BOTTOM, OF WHICH THE UPPER TRIANGLE PROTRUDES FROM THE QUADRILATERAL SHAPE AND OVERLAPS THE OTHER TRIANGLE HALFWAY.

INT. CL. 7/U.S. CLS. 13, 19, 21, 23, 31, 34 AND 35

FOR PACKAGING MACHINES; BOTTLING MACHINES; PACKAGING MACHINES, NAMELY, LIQUID CONTAINER FILLERS; BOTTLE FILLING MACHINES; BOTTLE CAPPING MACHINES; BOTTLE SEALING MACHINES; BOTTLE STOPPERING MACHINES; MACHINES, NAMELY, CAPPING MACHINES FOR DOSING-PUMPS-CAPS, CAPPING MACHINES FOR TRIGGER-PUMPS-CAPS, BOTTLE RINSING MACHINES, BOTTLE AIR CLEANER MACHINES, BOTTLE NECK TRIMMER, ISOBAROMETRIC FILLERS, FILLER FOR CARBONATED BEVERAGES; WRAPPING MACHINES; PACKING MACHINES UNDER VACUUM; MACHINES FOR THE FILLING AND THE CLOSING OF CONTAINERS FOR TYPICALLY ALIMENTARY PRODUCTS LIKE MILK, FRUIT JUICES, ISOTONIC DRINKS, ICE TEA; MACHINES FOR CAPS AND BOTTLES STERILIZATION; MACHINES FOR CAPS AND BOTTLES DECONTAMINATION.
FIRST USE ; IN COMMERCE .

INT. CL. 9/U.S. CLS. 21, 23, 26, 36 AND 38

FOR COMPUTER HARDWARE AND OPERATING SOFTWARE FOR APPLICATION TO MACHINES AND APPARATUS FOR PACKING AND PACKAGING, BOTTLING MACHINES, PACKAGING MACHINES, NAMELY, LIQUID CONTAINER FILLERS, BOTTLE FILLING MACHINES, BOTTLE CAPPING MACHINES, BOTTLE SEALING MACHINES, BOTTLE STOPPERING MACHINES, WRAPPING MACHINES AND PACKING MACHINES UNDER VACUUM; COMPUTER HARDWARE AND OPERATING SOFTWARE PROGRAMS FOR APPLICATION TO MACHINES AND APPARATUS FOR PACKING AND PACKAGING, BOTTLING MACHINES, PACKAGING MACHINES, NAMELY, LIQUID CONTAINER FILLERS, BOTTLE FILLING MACHINES, BOTTLE CAPPING MACHINES, BOTTLE SEALING MACHINES, BOTTLE STOPPERING MACHINES, WRAPPING MACHINES AND PACKING MACHINES UNDER VACUUM .

FIRST USE ; IN COMMERCE .

INT. CL. 42/U.S. CLS. 100 AND 101

FOR PACKAGING DESIGN; DESIGN OF APPARATUS AND MACHINES FOR OTHERS FOR STERILIZATION, FILLING, PACKAGING, PACKING, BOTTLING, CAPPING, SEALING, STOPPERING AND WRAPPING PURPOSES; DESIGN OF APPARATUS AND MACHINES FOR OTHERS IN THE FIELD OF STERILIZATION, FILLING, PACKAGING, PACKING, BOTTLING, CAPPING, SEALING, STOPPERING AND WRAPPING; TECHNICAL ANALYSIS AND RESEARCH IN THE FIELD OF STERILIZATION, FILLING, PACKAGING, PACKING, BOTTLING, CAPPING, SEALING, STOPPERING AND WRAPPING; DESIGN AND DEVELOPMENT OF MACHINES AND APPARATUS FOR OTHERS FOR PACKING AND PACKAGING, BOTTLING MACHINES, PACKAGING MACHINES, NAMELY, LIQUID CONTAINER FILLERS, BOTTLE FILLING MACHINES, BOTTLE CAPPING MACHINES, BOTTLE SEALING MACHINES, BOTTLE STOPPERING MACHINES, WRAPPING MACHINES AND PACKING MACHINES UNDER VACUUM; TECHNICAL CONSULTANCY AND INDUSTRIAL RESEARCH IN THE FIELD OF PACKAGING DESIGN; DESIGNING OF PACKAGING AND WRAPPING MATERIALS FOR OTHERS; DEVELOPMENT FOR OTHERS OF TECHNOLOGIES FOR THE DESIGN OF MACHINES AND APPARATUS FOR PACKING AND PACKAGING, BOTTLING MACHINES, PACKAGING MACHINES, NAMELY, LIQUID CONTAINER FILLERS, BOTTLE FILLING MACHINES, BOTTLE CAPPING MACHINES, BOTTLE SEALING MACHINES, BOTTLE STOPPERING MACHINES, WRAPPING MACHINES AND PACKING MACHINES UNDER VACUUM; ENGINEERING; ENGINEERING SERVICES FOR THE CONSTRUCTION OF MACHINES AND APPARATUS FOR PACKING AND PACKAGING, BOTTLING MACHINES, PACKAGING MACHINES, NAMELY, LIQUID CONTAINER FILLERS, BOTTLE FILLING MACHINES, BOTTLE CAPPING MACHINES, BOTTLE SEALING MACHINES, BOTTLE STOPPERING MACHINES, WRAPPING MACHINES AND PACKING MACHINES UNDER VACUUM; INDUSTRIAL DESIGN.
FIRST USE ; IN COMMERCE .

ELEMENTS CORRECTED
CITIZENSHIP
ENTITY

3,547,499. REG. 12-16-2008. BBP, LLC (NEVADA LIMITED LIABILITY COMPANY) C/O FERBER CHAN ESSNER & COLLIER, LLP, 530 FIFTH AVENUE, NEW YORK, NY, 10036, SN 77-138,917. FILED 3-23-2007. PRINCIPAL REGISTER.

3,552,055. REG. 12-23-2008. THE CHILDREN'S MEMORIAL MEDICAL CENTER, INC. (ILLINOIS NON-PROFIT CORPORATION) 2300 CHILDREN'S PLAZA, CHICAGO, IL, 60616, SN 78-890,333. FILED 5-23-2006. PRINCIPAL REGISTER.

CRUNCHBURGER

CLOCC

THE MARK CONSISTS OF STANDARD CHARACTERS WITHOUT CLAIM TO ANY PARTICULAR FONT, STYLE, SIZE, OR COLOR.

INT. CL. 30/U.S. CL. 46

FOR PREPARED FOODS, NAMELY, SANDWICHES.
FIRST USE 7-9-2008; IN COMMERCE 7-9-2008.

ELEMENTS CORRECTED
CITIZENSHIP

THE MARK CONSISTS OF STANDARD CHARACTERS WITHOUT CLAIM TO ANY PARTICULAR FONT, STYLE, SIZE, OR COLOR.

INT. CL. 35/U.S. CLS. 100, 101 AND 102

FOR PROMOTING PUBLIC AWARENESS REGARDING THE PREVENTION AND TREATMENT OF OBESITY IN CHILDREN.

FIRST USE 1-0-2006; IN COMMERCE 1-0-2006.

ELEMENTS CORRECTED
MARK

3,548,168. REG. 12-16-2008. GWEI TING INTERNATIONAL FASHION CORPORATION (CHINA CORPORATION) 7F, NO. 49, LANE 35, JI-HU ROAD, TAIPEI, TAIWAN., SN 78-332,841. FILED 11-25-2003. PRINCIPAL REGISTER.

3,558,027. REG. 1-6-2009. TRI-STATE LOTTO COMMISSION (VERMONT INTERSTATE AGENCY OF NEW HAMPSHIRE, VERMONT AND MAINE) ROUTE 14, SOUTH BARRE, VT, 05670, SN 77-032,518. FILED 10-30-2006. PRINCIPAL REGISTER.



THE MARK CONSISTS OF "NATURALLY JOJO" ENCLOSED WITHIN A RECTANGLE DESIGN.

INT. CL. 18/U.S. CLS. 1, 2, 3, 22 AND 41

FOR BOSTON BAGS; PURSES; RUCKSACKS; HANDBAGS; VANITY BAGS SOLD EMPTY; BACKPACKS; WALLETS.

FIRST USE 11-27-1993; IN COMMERCE 4-17-2008.

INT. CL. 35/U.S. CLS. 100, 101 AND 102

FOR [RETAIL STORES FOR GLASSES; RETAIL STORES FOR CLOCKS, WATCHES AND PERSONAL ORNAMENTS; RETAIL STORES FOR STATIONERY; RETAIL STORES FOR BAGS; RETAIL STORES FOR BEDDING AND TOWELS].

FIRST USE 11-27-1993; IN COMMERCE 4-17-2008.

ELEMENTS AMENDED
GOODS/SERVICES

OWNER OF U.S. REG. NOS. 2,677,274, 2,783,685 AND OTHERS.

NO CLAIM IS MADE TO THE EXCLUSIVE RIGHT TO USE "TRI-STATE", APART FROM THE MARK AS SHOWN. THE MARK CONSISTS OF THE WORD "TRI-STATE" ABOVE THE STYLIZED WORD "PAYCHECK", WITH A FANCY UNDERLINE.

INT. CL. 41/U.S. CLS. 100, 101 AND 107

FOR LOTTERY SERVICES AND ADMINISTRATION OF LOTTERIES FOR OTHERS IN THE STATES OF MAINE, NEW HAMPSHIRE AND VERMONT.

FIRST USE 1-20-2007; IN COMMERCE 1-20-2007.

ELEMENTS CORRECTED
ENTITY

3,563,160. REG. 1-20-2009. BROCK CABINETS INCORPORATED (NORTH CAROLINA CORPORATION) 2218 WINGATE RD, FAYETTEVILLE, NC, 28304, SN 77-304,859. FILED 10-16-2007. PRINCIPAL REGISTER.

3,567,956. REG. 1-27-2009. BAXTERBEAR LIMITED (UNITED KINGDOM LIMITED COMPANY) BOX 6, 196 ROSE STREET EDINBURGH, SCOTLAND EH2 4AT, UNITED KINGDOM., SN 79-053,284. FILED 12-17-2007. PRINCIPAL REGISTER.



PRIORITY DATE OF 12-7-2007 IS CLAIMED.
OWNER OF INTERNATIONAL REGISTRATION 0962850 DATED 12-17-2007, EXPIRES 12-17-2017.

THE COLOR(S) BLACK, WHITE, BROWN, GREEN, TEAL BLUE, DARK MAGENTA AND YELLOW IS/ARE CLAIMED AS A FEATURE OF THE MARK.

THE MARK CONSISTS OF A DESIGN OF A MID BROWN TEDDY BEAR WITH LIGHT BROWN FEET AND SNOUT. THE EYES, NOSE AND MOUTH AS WELL AS THE OUTLINES AND DETAILS OF FUR ARE IN DARK BROWN. ON THE BEAR'S CHEST IS A WHITE LABEL OUTLINED IN DARK BROWN WHICH HAS THE WORDS "BAXTERBEAR" IN BLACK. ON THE BEAR'S SHOULDER IS A PATCH OF TARTAN IN THE COLORS TEAL BLUE, GREEN, MAGENTA AND YELLOW AND OUTLINED IN BLACK.

INT. CL. 9/U.S. CLS. 21, 23, 26, 36 AND 38

FOR APPARATUS AND INSTRUMENTS FOR RECORDING, TRANSMISSION, PRODUCTION OR REPRODUCTION OF SOUND, SPEECH OR IMAGES; BLANK MAGNETIC DATA CARRIERS, PRE-RECORDED MAGNETIC DATA CARRIERS FEATURING FILMS AND ANIMATED VIDEOS, ALL RELATING TO FICTITIOUS BEARS AND FICTITIOUS CHARACTERS, COMPUTER SOFTWARE CONTAINING GAMES PROGRAMS FOR EDUCATIONAL AND ENTERTAINMENT PURPOSES, BLANK CD-ROMS, PRE-RECORDED CD-ROMS FEATURING FILMS AND ANIMATED VIDEOS, ALL RELATING TO FICTITIOUS BEARS AND FICTITIOUS CHARACTERS, BLANK DVDS, PRE-RECORDED DVDS FEATURING FILMS AND ANIMATED VIDEOS, ALL RELATING TO FICTITIOUS BEARS AND FICTITIOUS CHARACTERS, ELECTRONIC PUBLICATIONS, NAMELY, BOOKS, BOOKLETS, COMIC BOOKS, MAGAZINES, LEAFLETS, NEWSLETTERS, CATALOGUES, RECORDED ON MAGNETIC DATA CARRIERS, FEATURING FICTITIOUS BEARS AND FICTITIOUS CHARACTERS, ELECTRONIC BOOKS RECORDED ON MAGNETIC DATA CARRIERS, FEATURING FICTITIOUS BEARS AND FICTITIOUS CHARACTERS, PRE-RECORDED COMPACT DISCS FEATURING AUDIO RECORDINGS FEATURING FICTITIOUS BEARS AND FICTITIOUS CHARACTERS, PRE-RECORDED CASSETTE TAPES FEATURING AUDIO RECORDINGS FEATURING FICTITIOUS BEARS AND FICTITIOUS CHARACTERS, PRE-RECORDED MINI-DISCS FEATURING FILMS AND ANIMATED VIDEOS FEATURING FICTITIOUS BEARS AND FICTITIOUS CHARACTERS, PRE-RECORDED VIDEO TAPES FEATURING FILMS AND ANIMATED VIDEOS FEATURING FICTITIOUS BEARS AND FICTITIOUS CHARACTERS, COMPUTER GAMES PROGRAMS FOR EDUCATIONAL AND ENTERTAINMENT PURPOSES, ELECTRONIC AMUSEMENT APPARATUS FOR USE WITH TELEVISION RECEIVERS, TEACHING AND INSTRUCTIONAL APPARATUS, NAMELY, AUDIOVISUAL APPARATUS FOR RECORDING, TRANSMISSION, PRODUCTION OR REPRODUCTION OF SOUND, SPEECH OR IMAGES.

FIRST USE ; IN COMMERCE .
INT. CL. 16/U.S. CLS. 2, 5, 22, 23, 29, 37, 38 AND 50

REGISTRATION IS RESTRICTED TO THE TERRITORY COMPRISING OF THE ENTIRE UNITED STATES EXCEPT THE STATE OF GEORGIA.

NO CLAIM IS MADE TO THE EXCLUSIVE RIGHT TO USE "CABINETS", APART FROM THE MARK AS SHOWN.

THE MARK CONSISTS OF A RECTANGULAR BACKGROUND WITH A STYLIZED LETTER "B" BELOW WHICH IS LOCATED THE WORDING "BROCK", BELOW WHICH IS LOCATED THE WORDING "CABINETS".

INT. CL. 20/U.S. CLS. 2, 13, 22, 25, 32 AND 50
FOR KITCHEN CABINETS.

FIRST USE 0-0-2001; IN COMMERCE 0-0-2001.

ELEMENTS AMENDED
ORDER RESTRICTING THE SCOPE OF REG.

FOR PRINTED MATTER AND PUBLICATIONS, NAMELY, BOOKS, COMIC BOOKS, NEWSPAPERS, BOOKLETS, FACT SHEETS, MANUALS, GUIDES, MAPS, WRITING PADS, WRITING PAPER, DRAWING PADS, NOTE PADS, MANUALS, CAR STICKERS, ALBUMS, SCRAPBOOKS, CATALOGUES, GREETING CARDS, POSTCARDS, MAGAZINES, NEWSLETTERS, PAMPHLETS, BROCHURES, PHOTOGRAPH ALBUMS, FEATURING FICTITIOUS BEARS AND FICTITIOUS CHARACTERS; LABELS OF PAPER, STICKERS, PRINTS, POSTERS, BADGES MADE OF PAPER, STATIONERY, PAPER ARTICLES, NAMELY, PRINTED PAPER, PHOTOCOPY PAPER, PRINTER PAPER, FLAGS OF PAPER, PAPER BAGS, PAPER CARRIER BAGS, PAPER NAPKINS AND TABLECLOTHS, TOILET PAPER, ENVELOPES, PAPER WRAPPERS, ROLLS OF PAPER ALL FOR USE IN THE KITCHEN, TISSUES, GIFT WRAPPING AND PACKING PAPER, BOOKMARKS OF PAPER, CHRISTMAS DECORATIONS OF PAPER, NAME TAGS OF PAPER, PAPER GIFT TAGS AND LABELS; TEACHING AND INSTRUCTIONAL MATERIALS, NAMELY, CHILDREN'S INSTRUCTION BOOKS AND HANDBOOKS IN THE NATURE OF MINIATURE ENCYCLOPEDIAS, TRAVEL GUIDE BOOKS FEATURING FICTIONAL STORIES, CHARTS, COPYING PAPER, DRAWING MATERIALS, NAMELY, ARTS AND CRAFTS PAINT KITS, TRACING PAPER, IN THE FIELD OF ENTERTAINMENT; PENS, PENCILS, WRITING INSTRUMENTS, DIARIES, CALENDARS, ARTIST'S MATERIALS, NAMELY, PAINT BOXES, PAINT BRUSHES, EASELS, WRITING AND STAMPING INK, PASTELS, PHOTOGRAPHS, DECALCOMANIAS.
FIRST USE ; IN COMMERCE .

INT. CL. 24/U.S. CLS. 42 AND 50

FOR TEXTILES AND TEXTILE GOODS, NAMELY, CURTAINS, COVERS FOR CUSHIONS, TOWELS, FACE TOWELS, FLAGS, UNFITTED FURNITURE COVERINGS, HANDKERCHIEFS, LABELS, PILLOWCASES, TABLE LINEN, BED COVERS AND BED LINEN, DUVETS.
FIRST USE ; IN COMMERCE .

INT. CL. 25/U.S. CLS. 22 AND 39

FOR CLOTHING, NAMELY, COATS, SUITS, JACKETS, PARKAS, PANTS, TROUSERS, JEANS, SHORTS, SHIRTS, TEE-SHIRTS, POLO SHIRTS, JUMPERS, JERSEYS, CARDIGANS, DRESSES, SKIRTS, FROCKS, BLOUSES, VESTS, TIES, SCARVES, SOCKS, BELTS, SHAWLS, WAISTCOATS, PYJAMAS, GLOVES, DRESSING GOWNS, BATH ROBES, LINGERIE, STOCKINGS, SWIMWEAR, UNDERWEAR; FOOTWEAR AND HEADGEAR, NAMELY, HATS, CAPS, BATHING CAPS, SHOWER CAPS, BERETS, HEADBANDS.
FIRST USE ; IN COMMERCE .

INT. CL. 28/U.S. CLS. 22, 23, 38 AND 50

FOR [TOYS, NAMELY, BUILDING BLOCKS, DOLLS' HOUSES, DOLL'S CLOTHING, DOLL'S FURNITURE, TOY ACTION FIGURES, TOY VEHICLES, TOY MASKS, SCALE MODEL VEHICLES, TOY MONEY BOXES, TOY MOBILES, SPINNING TOPS, TOYS FOR DOMESTIC PETS; GAMES, NAMELY, BOARD GAMES, PLAYING CARDS, DOMINOES, MARBLES, JIGSAW PUZZLES, SKITTLES; PLAYTHINGS, NAMELY, BATS, BALLS FOR GAMES, BALLOONS, DARTS, HOCKEY STICKS, KITES, INFLATABLE SWIMMING POOLS, PUPPETS, ROLLER SKATES, SKATEBOARDS, SKITTLES, SLIDES, SWINGS; APPARATUS FOR COMPUTER GAMES OTHER THAN ADAPTED WITH AN EXTERNAL DISPLAY SCREEN OR MONITOR; DOLLS;] TEDDY BEARS.
FIRST USE ; IN COMMERCE .

ELEMENTS CORRECTED
CITIZENSHIP
GOODS/SERVICES
OWNER ADDRESS

3,589,951. REG. 3-17-2009. THE BRENNAN GROUP PERFORMANCE IMPROVEMENT INCORPORATED (CANADA CORPORATION) 216-1096 QUEEN ST, HALIFAX, CANADA. B3H 2R9, SN 77-379,658. FILED 1-24-2008. PRINCIPAL REGISTER.

HiringSmart

OWNER OF CANADA REG. NO. TMA695189, DATED 8-30-2007, EXPIRES 8-30-2022.
INT. CL. 35/U.S. CLS. 100, 101 AND 102

FOR CONSULTANCY OF PERSONNEL RECRUITMENT, CONSULTANCY SERVICES IN THE FIELD OF HUMAN RESOURCES, NAMELY, FOR THE DEVELOPMENT, SELECTION, ASSESSMENT AND RETENTION OF EMPLOYEES, MANAGEMENT AND BUSINESS CONSULTANCY SERVICES IN THE FIELD OF TRAINING AND RECRUITMENT.

ELEMENTS CORRECTED
OWNER NAME

3,591,369. REG. 3-17-2009. EWALD DÖRKEN AG (FED REP GERMANY AG (JOINT STOCK COMPANY)) WETTERSTRASSE 58, 58313 HERDECKE, FED REP GERMANY., SN 79-044,430. FILED 10-1-2007. PRINCIPAL REGISTER.

MAXX-TITAN

OWNER OF INTERNATIONAL REGISTRATION 0889558 DATED 4-6-2006, EXPIRES 4-6-2016.

INT. CL. 17/U.S. CLS. 1, 5, 12, 13, 35 AND 50

FOR SEMI-FINISHED GOODS MADE FROM PLASTICS, NAMELY, PLASTIC SHEETING FOR USE AS DROP CLOTHS; SEALING MATERIAL, NAMELY, POLYURETHANE FILM FOR USE IN SEALING AND INSULATING; SEALING AND INSULATING SHEETS, NAMELY, SHEETS OF PLASTIC FABRIC USED AS AN INSULATING INFILTRATION BARRIER FOR BUILDING CONSTRUCTION; ROOF UNDERLAY, NAMELY, PLASTIC SHEETING USED IN THE CONSTRUCTION INDUSTRY AS A VAPOR BARRIER; PLASTIC SHEETING USED IN THE CONSTRUCTION INDUSTRY, NAMELY, CARRIER SHEETS, DIMPLED SHEETS, SHEETS FOR HIGH-PITCHED ROOFS, SCAFFOLDING SHEETS MADE FROM PLASTIC; PLASTIC SHEETING USED IN THE CONSTRUCTION INDUSTRY, NAMELY, SEALING AND INSULATING PLASTIC SHEETS IN THE NATURE OF WRAPPINGS FOR FOUNDATIONS AND BASEMENT; PLASTIC SHEETING FOR USE AS DROP CLOTHS, NAMELY, SHEETS FOR HIGH PITCHED ROOFS, SCAFFOLDING SHEETS MADE FROM PLASTIC FOR CONSTRUCTION PURPOSES; INSULATING PLASTIC FILMS, NAMELY, SHEETS OF PLASTIC FABRIC USED AS AN INSULATING INFILTRATION BARRIER IN BUILDING OR BUILDING INSULATION, INSULATING WATERPROOFING MEMBRANES; PLASTIC SHEETING FOR AGRICULTURAL PURPOSES; PROTECTION AND DRAINING SHEETS MADE FROM PLASTIC, NAMELY, PLASTIC SHEETING FOR UNDERGROUND CONSTRUCTION PURPOSES, NAMELY,

COVERING AND PROTECTING THE EXTERIOR SURFACES OF BASEMENT AND FOUNDATION WALLS; BUILDING INSULATION, NAMELY, INSULATING FILMS, INSULATING FABRICS; INSULATING MATERIALS FOR BUILDINGS; * EXCEPT INNER TUBES FOR TYRE EQUIPMENT OF ALL KINDS FOR BICYCLES, MOTORCYCLES, AUTOMOBILES AND LORRIES, ALL OF RUBBER, RUBBER SUBSTITUTE MATERIALS AND PLASTICS, THE AFORESAID GOODS WITH OR WITHOUT TEXTILE AND/OR METALLIC STRESS BEARING INSERTS; * SCAFFOLDING SHEETS FOR CONSTRUCTION PURPOSES.

FIRST USE ; IN COMMERCE .

INT. CL. 19/U.S. CLS. 1, 12, 33 AND 50

FOR REINFORCED AND NON-REINFORCED SEPARATING, PROTECTING AND DRAINING SHEETS FOR CONSTRUCTION PURPOSES, NAMELY, PLASTIC WEBBING MATERIAL USED TO REINFORCE BITUMINOUS WATERPROOFING SHEETS; REINFORCED AND NON-REINFORCED DIMPLED SHEETS FOR CONSTRUCTION PURPOSES, NAMELY, PLASTIC WEBBING MATERIAL USED TO REINFORCE BITUMINOUS WATERPROOFING SHEETS; REINFORCED AND NON-REINFORCED CARRIER SHEETS FOR CONSTRUCTION PURPOSES, NAMELY, PLASTIC COMPOSITE SHEETS FOR BUILDING PURPOSES; INDUSTRIAL TEXTILES AND WOVEN FABRICS FOR CONSTRUCTION PURPOSES, NAMELY, GEOTEXTILES FOR USE IN CONNECTION WITH ROAD CONSTRUCTION, RAILROAD CONSTRUCTION, TUNNEL CONSTRUCTION, WATERWAY CONSTRUCTION AND PUBLIC WORKS CONSTRUCTION; GEOTEXTILES FOR THE PURPOSES OF DRAINAGE, STABILIZING INCLINES, RECULTIVATION, PLANT SUPPORT, ABSORPTION, FILTRATION, SEPARATION, STABILIZATION AND REINFORCEMENT OF THE SOIL.

FIRST USE ; IN COMMERCE .

INT. CL. 22/U.S. CLS. 1, 2, 7, 19, 22, 42 AND 50

FOR TARPAULINS FOR CONSTRUCTION PURPOSES; STEEP ROOF TARPAULINS, COVERING- AND SCAFFOLDING TARPAULINS MADE FROM PLASTICS; COVERING- AND SCAFFOLDING TARPAULINS FOR CONSTRUCTION PURPOSES.

FIRST USE ; IN COMMERCE .

ELEMENTS CORRECTED
GOODS/SERVICES

3,597,982. REG. 3-31-2009. NO LIMIT LLC (CONNECTICUT LIMITED LIABILITY COMPANY) 246 POST ROAD EAST, POB 791, WESTPORT, CT, 068810791, SN 77-548,274. FILED 8-15-2008. PRINCIPAL REGISTER.

IN CRUST WE TRUST

INT. CL. 30/U.S. CL. 46

FOR PIZZA; PIZZA CRUST.

FIRST USE 6-13-2008; IN COMMERCE 6-13-2008.

ELEMENTS CORRECTED
[DESCRIPTION OF MARK]
[COLOR DESCRIPTION STATEMENT]

3,627,016. REG. 5-26-2009. ROSSI, VALENTINO (ITALY INDIVIDUAL) VIALE XXVIII GIUGNO, 39, TAVULLIA PU, ITALY, 61010, SN 78-883,757. FILED 5-15-2006. PRINCIPAL REGISTER.

VALE 46

OWNER OF ERPN CMNTY TM OFC REG. NO. 5242516, DATED 1-8-2008.

OWNER OF ERPN CMNTY TM OFC REG. NO. 4583225, DATED 8-2-2006.

OWNER OF ERPN CMNTY TM OFC REG. NO. 2235588, DATED 1-8-2007.

OWNER OF ITALY REG. NO. 1119410, DATED 6-18-2008.

INT. CL. 9/U.S. CLS. 21, 23, 26, 36 AND 38

FOR (BASED ITALY REGISTRATION NO. 1119410) PHOTOGRAPHIC APPARATUS AND INSTRUMENTS, NAMELY, CAMERA LENSES AND LENS HOODS; CINEMATOGGRAPHIC APPARATUS AND INSTRUMENTS, NAMELY, CINEMATOGGRAPHIC FILM; OPTICAL APPARATUS AND INSTRUMENTS, NAMELY, CORRECTIVE OPTICAL LENSES, FRAMES FOR EYE GLASSES AND SUNGLASSES, MAGNIFYING GLASSES, INSTRUMENTS CONTAINING EYEPIECES, NAMELY, MICROSCOPES, TELESCOPES, OPTICAL LENS SIGHTS, TELESCOPIC LENS SIGHTS, AND MAGNIFYING PEEPHOLES FOR DOORS; MEASURING APPARATUS AND INSTRUMENTS, NAMELY, MEASURING LABORATORY GLASSWARE, GRADUATED GLASSWARE; EYE GLASSES AND SUNGLASSES; PINCE-NEZ; EYEPIECES; CASES FOR EYE GLASSES AND SUNGLASSES; CONTACT LENS CASES; CORDS AND CHAINS FOR EYE GLASSES, SUNGLASSES AND PINCE-NEZ; PINCE-NEZ CASES; MOTORCYCLE GOGGLES; APPARATUS AND INSTRUMENTS FOR CONDUCTING, SWITCHING, TRANSFORMING, ACCUMULATING, REGULATING OR CONTROLLING ELECTRICITY, NAMELY, CAPACITORS; APPARATUS FOR RECORDING, TRANSMISSION OR REPRODUCTION OF DATA, SOUND AND IMAGES, NAMELY, VIDEO TELEPHONES, PORTABLE TELEPHONES, PERSONAL DIGITAL AUDIO PLAYERS, ELECTRONIC AGENDAS, JUKEBOXES, VIDEO GAME MACHINES FOR USE WITH TELEVISIONS, ELECTRONIC GAME CONSOLES FOR USE WITH TELEVISIONS, FACSIMILE MACHINES, RADIOS, VEHICLE RADIOS; BLANK MAGNETIC DATA CARRIERS, NAMELY, VIDEOCASSETTES, AUDIO CASSETTES, AND RECORDING DISCS, NAMELY, FLOPPY DISCS, CDS, CD-ROMS AND DVDS; PRERECORDED PHONOGRAPHIC RECORDS, AUDIO CASSETTES, VIDEO CASSETTES AND COMPACT DISCS FEATURING AUDIO CONTENT IN THE NATURE OF MUSIC AND INTERVIEWS, VIDEO CONTENT IN THE FIELD OF SPORTS AND OF MOTORCYCLE RACING, AND COMPUTER PROGRAMS FOR PRERECORDED GAMES; PRERECORDED VIDEO GAME MEMORY CARTRIDGES; AUTOMATIC VENDING MACHINES; CASH REGISTERS; CALCULATING MACHINES, NAMELY, ACCOUNTING MACHINES, ADDING MACHINES, POCKET CALCULATORS; DATA PROCESSING EQUIPMENT, NAMELY, NOTEBOOK COMPUTERS, LAPTOP COMPUTERS, COMPUTER HARDWARE; COMPUTER SOFTWARE, NAMELY, COMPUTER APPLICATION SOFTWARE FOR MOBILE PHONES AND FOR DIGITAL CAMERAS AND COMPUTER GAME SOFTWARE, COMPUTER OPERATING SYSTEMS, AND DOWNLOADABLE ELECTRONIC PUBLICATIONS IN THE NATURE OF MAGAZINES AND JOURNALS IN THE FIELD OF SPORTS, GAMES, RECREATION, MUSIC, CLOTHING FASHION, TRAVEL, THEATRE, FILMS, CARTOONS, EDUCATION, HEALTH AND ECOLOGY; VIDEO DISKS AND VIDEO TAPES WITH RECORDED ANIMATED CARTOONS; PROTECTIVE HELMETS; DIVING HELMETS; SCUBA DIVING MASKS; DIVING SUITS.

FIRST USE ; IN COMMERCE .

INT. CL. 12/U.S. CLS. 19, 21, 23, 31, 35 AND 44

FOR (BASED EUROPEAN COMMUNITY REGISTRATION NO. 2235588) LAND VEHICLES; AIR AND WATER VEHICLES, NAMELY, HELICOPTERS, BOATS, AND STRUCTURAL PARTS THEREFOR; APPARATUS FOR LOCOMOTION BY LAND, AIR OR WATER, NAMELY, AUTOMOBILES, TRICYCLES, BICYCLES, MOTORCYCLE SIDECARS; MOTORCYCLES; AUTOMOBILES; BOATS; PARTS AND ACCESSORIES FOR VEHICLES, NAMELY, WINDSHIELD WIPERS; SLEIGHS.

FIRST USE ; IN COMMERCE .

INT. CL. 14/U.S. CLS. 2, 27, 28 AND 50

FOR (BASED EUROPEAN COMMUNITY REGISTRATION NO. 2235588) [PRECIOUS METALS AND THEIR ALLOYS;] GOODS IN PRECIOUS METALS OR COATED THEREWITH, NAMELY, AMULETS, BADGES, JEWELRY BOXES, BUCKLES FOR WATCHSTRAPS, JEWELRY CASES, KEY CHAINS, JEWELRY CHAINS, CHARMS, COLLECTIBLE COINS, COMMEMORATIVE COINS, PILLBOXES MADE OF PRECIOUS METAL, MEDALS, ORNAMENTAL PINS, ORNAMENTS, STUETTETS, WATCH STRAPS, TIE CLIPS, TIE PINS, CUFF LINKS, AND TRINKETS BEING JEWELRY; JEWELRY; [PRECIOUS STONES;] NECKLACES; BRACELETS; RINGS BEING JEWELRY; EARRINGS; ANKLE BRACELETS; PENDANTS; BROOCHES; WRISTWATCHES; POCKET WATCHES; TABLE CLOCKS; PENDULUM CLOCKS; HOROLOGICAL AND CHRONOMETRIC INSTRUMENTS.

FIRST USE ; IN COMMERCE .

INT. CL. 16/U.S. CLS. 2, 5, 22, 23, 29, 37, 38 AND 50

FOR (BASED EUROPEAN COMMUNITY REGISTRATION NO. 5242516) PAPER; CARDBOARD; ARTICLES MADE FROM PAPER OR CARDBOARD, NAMELY, BOXES, CARTONS, LABELS, ADHESIVES FOR STATIONERY PURPOSES; PRINTED MAGAZINES, EVENT PROGRAMS AND PERIODICALS IN THE FIELD OF MOTORCYCLE RACING, SPORTS, GAMES, RECREATION, MUSIC, CLOTHING, FASHION, TRAVEL, THEATRE, FILMS, CARTOONS, EDUCATION, HEALTH AND ECOLOGY; PHOTOGRAPHS; STATIONERY.

FIRST USE ; IN COMMERCE .

INT. CL. 18/U.S. CLS. 1, 2, 3, 22 AND 41

FOR (BASED EUROPEAN COMMUNITY REGISTRATION NO. 4583225) LEATHER; IMITATION LEATHER SOLD IN BULK; GOODS MADE OF LEATHER AND IMITATION LEATHER, NAMELY, HATBOXES FOR TRAVEL NOT OF PAPER OR CARDBOARD, ANIMAL LEASHES, SHOULDER BELTS, STRAPS, THONGS, RIDING SADDLES AND VANITY CASES SOLD EMPTY; ANIMAL SKINS; TRUNKS; SUITCASES; BAGS, NAMELY, BACKPACKS, BEACH BAGS, HANDBAGS, HAVESACKS, NET MESH BAGS FOR SHOPPING, POUCHES OF LEATHER OR FELT, PURSES, RUCKSACKS, SATCHELS, SCHOOL BAGS, SCHOOL SATCHELS, LEATHER SHOPPING BAGS, SLING BAGS FOR CARRYING INFANTS, TOOL BAGS SOLD EMPTY, TRAVELING BAGS, VALISES, AND WHEELED SHOPPING BAGS; WALLETS; BRIEFCASES; UMBRELLAS, PARASOLS; WALKING STICKS; PURSES MADE OF PRECIOUS METAL.

FIRST USE ; IN COMMERCE .

INT. CL. 25/U.S. CLS. 22 AND 39

FOR (BASED EUROPEAN COMMUNITY REGISTRATION NO. 2235588) CLOTHING, NAMELY, APRONS, ASCOTS, BABIES' PANTS, BANDANAS AND NECKERCHIEFS, BATHROBES, BATHING DRAWERS; BATHING SUITS, BATHING TRUNKS, BEACHWEAR, BOAS, BODICES, BRASSIERES, BREECHES, CAMISOLES, CAP PEAKS, CAPS, CHEMISETTES, GYMNASICS WEAR, NAMELY, LEOTARDS, TRACK SUITS, COATS, TOPCOATS, CYCLIST CLOTHING, NAMELY, JERSEYS, SHORTS, PANTS, HATS, GLOVES, DRAWERS, DRESS SHIELDS, DRESSING GOWNS, FOOTMUFFS, FROCKS, FUR STOLEES, FUR COATS, GABARDINES, GARTER BELTS, GIRDLES, GLOVES, HOSIERY, JACKETS, JERSEYS, JUMPERS, KNITWEAR, NAMELY, SWEATERS, SCARVES, HATS, AND GLOVES, BODY LINEN, NAMELY, PANTIES AND UNDERWEAR, MITTENS, MONEY BELTS, MUFFS, NECKTIES, OUTERWEAR, NAMELY, COATS, RAINCOATS; OVERALLS, OVERCOATS, PAJAMAS, PANTS, PELERINES, PELISSES, PULLOVERS, SASHES, SCARVES, SHAWLS, SHIRT YOKES, SHIRTS, SHOULDER WRAPS, STOCK-

INGS, SUITS, SUNVISORS, SWEATERS, SWIMSUITS, TEDDIES, T-SHIRTS, TIGHTS, TROUSERS, UNDERGARMENTS, UNDERPANTS, UNDERWEAR, UNIFORMS, VEILS, VESTS, VISORS, WATERPROOF PANTS, WATERPROOF SHIRTS, WATERPROOF JACKETS, WATERPROOF COATS, RAIN SLICKERS, WIMPLES, AND WRISTBANDS; FOOTWEAR; HEADGEAR, NAMELY, HATS, BERETS, HOODS, SKULL CAPS, TOP HATS, TURBANS, AND HEADBANDS; GOODS MADE OF LEATHER AND IMITATION LEATHER, NAMELY, HEADBANDS, ARMBANDS, WRISTBANDS, SASHES, AND BELTS.

FIRST USE ; IN COMMERCE .

INT. CL. 28/U.S. CLS. 22, 23, 38 AND 50

FOR (BASED EUROPEAN COMMUNITY REGISTRATION NO. 2235588) PLAYTHINGS, NAMELY, SOCCER BALLS, BASEBALLS, BASKET BALLS, GOLF BALLS, FOOTBALLS, CRICKET BALLS, TENNIS BALLS, GYMNASICS EXERCISE BALLS, AND PLAY BALLOONS; TOYS, NAMELY BATH TOYS, DOLLS, PUPPETS; TOY MODEL VEHICLES; GYMNASIC APPARATUS; SPORTING ARTICLES, NAMELY, BATTING GLOVES, BOB-SLEIGHS, BODY BOARDS, BODY-BUILDING APPARATUS, NAMELY WEIGHT WORK-OUT BENCHES, BODY TRAINING APPARATUS, NAMELY, ELLIPTICAL EXERCISE MACHINES, EXERCISE EQUIPMENT, NAMELY, STATIONARY CYCLES, ELECTRONIC SPORTS TRAINING SIMULATORS, NAMELY, SKI SIMULATORS AND JOGGING SIMULATORS, CHEST EXPANDERS, COVERS FOR SKI BINDINGS, ELBOW GUARDS FOR ATHLETIC USE, CHEST EXPANDERS, FLIPPERS FOR SWIMMING, SPORTS GLOVES, NAMELY, SOFTBALL GLOVES, BASEBALL GLOVES, BOXING GLOVES, GOLF GLOVES, GOLF CLUBS, TOY GUNS; SCUBA EQUIPMENT, NAMELY, SPEAR FISHING HARPOON GUNS AND SPEAR FISHING HARPOONS THEREFOR, HARNESES FOR SAILBOARDS, ICE SKATES, IN-LINE ROLLER SKATES, KNEE GUARDS FOR ATHLETIC USE, MACHINES FOR PHYSICAL EXERCISE, MASTS FOR SAILBOARDS, RACKETS, EXERCISE APPARATUS FOR THE BODY, NAMELY, TREADMILLS, ROWING MACHINES, ROLLER SKATES, SAILBOARDS FOR BOARD SAILING, SHINGUARDS FOR ATHLETIC USE, SKATEBOARDS, SKIS, PLAYGROUND EQUIPMENT, NAMELY, SLIDES, SNOWSHOES, STATIONARY EXERCISE BICYCLES, SURFBOARDS, SURF SKIS AND WATER SKIS; CHRISTMAS TREE DECORATIONS NOT INCLUDING CONFECTIONERY OR ILLUMINATION ARTICLES; PLAYING CARDS; HANG GLIDERS; GOLF CLUB BAGS.

FIRST USE ; IN COMMERCE .

INT. CL. 38/U.S. CLS. 100, 101 AND 104

FOR (BASED EUROPEAN COMMUNITY REGISTRATION NO. 4583225) TELECOMMUNICATIONS SERVICES, NAMELY PERSONAL COMMUNICATION SERVICES, PROVIDING MULTIPLE USER DIAL-UP AND DEDICATED ACCESS TO THE INTERNET, PROVIDING REMOTE INTERNET ACCESS, PROVIDING MULTIPLE USER DIAL-UP AND DEDICATED ACCESS TO THE INTERNET INCLUDING PORTALS ON THE INTERNET, PROVIDING INTERNET CHATROOMS, INTERNET BASED VOICE CHAT SERVICES, ELECTRONIC MAIL SERVICES, WEB MESSAGING, COMPUTER-AIDED TRANSMISSION OF MESSAGES AND IMAGES; TELEPHONE COMMUNICATIONS SERVICES.

FIRST USE ; IN COMMERCE .

ELEMENTS AMENDED
GOODS/SERVICES

3,628,739. REG. 5-26-2009. INTERNATIONAL BUSINESS MACHINES CORPORATION (NEW YORK CORPORATION) NEW ORCHARD ROAD, ARMONK, NY, 10504, SN 78-457,938. FILED 7-28-2004. PRINCIPAL REGISTER.

WORLD COMMUNITY GRID

THE MARK CONSISTS OF STANDARD CHARACTERS WITHOUT CLAIM TO ANY PARTICULAR FONT, STYLE, SIZE, OR COLOR.

NO CLAIM IS MADE TO THE EXCLUSIVE RIGHT TO USE "GRID", APART FROM THE MARK AS SHOWN.

INT. CL. 16/U.S. CLS. 2, 5, 22, 23, 29, 37, 38 AND 50

FOR [PRINTED MATTER, NAMELY, MAGAZINES, BOOKS, PAMPHLETS, BROCHURES, MANUALS, PRESENTATION MATERIALS, TEACHING MATERIALS; ALL IN THE FIELD OF CHARITABLE SERVICES; PHILANTHROPIC SERVICES; AND VOLUNTEER SERVICES] *PRINTED MATTER, NAMELY, MAGAZINES, BOOKS, PAMPHLETS, BROCHURES, MANUALS, PRESENTATION MATERIALS, AND TEACHING MATERIALS, ALL RELATING TO THE USE OF GRID COMPUTING FOR CHARITABLE SERVICES OFFERED IN THE FORM OF ORGANIZING, ADMINISTERING AND COORDINATING VOLUNTEER EFFORTS THROUGH THE USE OF GRID COMPUTING TECHNOLOGY FOR HUMANITARIAN EFFORTS THROUGH SCIENTIFIC, MEDICAL AND HUMANITIES RESEARCH*.

FIRST USE 5-0-2004; IN COMMERCE 5-0-2004.

INT. CL. 35/U.S. CLS. 100, 101 AND 102

FOR [CHARITABLE SERVICES, PHILANTHROPIC SERVICES AND VOLUNTEER SERVICES, NAMELY, ORGANIZING AND CONDUCTING VOLUNTEER PROGRAMS AND COMMUNITY SERVICE PROJECTS IN THE FIELD OF COMPUTER TECHNOLOGY FOR HUMANITARIAN EFFORTS; CHARITABLE SERVICES, NAMELY, ORGANIZATION, ADMINISTRATION AND COORDINATION OF A VOLUNTEER EFFORT IN THE FIELD OF COMPUTER TECHNOLOGY FOR HUMANITARIAN EFFORTS] *ORGANIZATION, ADMINISTRATION AND COORDINATION OF VOLUNTEER EFFORTS IN THE FIELD OF GRID COMPUTER TECHNOLOGY ON A CHARITABLE BASIS FOR HUMANITARIAN EFFORTS THROUGH SCIENTIFIC, MEDICAL AND HUMANITIES RESEARCH*.

FIRST USE 11-16-2004; IN COMMERCE 11-16-2004.

INT. CL. 36/U.S. CLS. 100, 101 AND 102

FOR PHILANTHROPIC SERVICES CONCERNING MONETARY DONATIONS.

FIRST USE 11-16-2004; IN COMMERCE 11-16-2004.

INT. CL. 41/U.S. CLS. 100, 101 AND 107

FOR [CHARITABLE SERVICES, NAMELY, PROVIDING ONE-ON-ONE MENTORING AND CONDUCTING ONLINE AND IN PERSON CLASSES, SEMINARS AND CONFERENCES IN THE FIELD OF COMPUTER TECHNOLOGY AND THE INTERNET; CONDUCTING VOLUNTEER EDUCATION ONLINE AND IN PERSON CLASSES, SEMINARS AND CONFERENCES IN THE FIELD OF COMPUTER TECHNOLOGY AND THE INTERNET; EDUCATIONAL SERVICES, NAMELY, CONDUCTING VOLUNTEER ONLINE AND IN PERSON CLASSES, SEMINARS AND CONFERENCES IN THE FIELD OF COMPUTER TECHNOLOGY SYSTEMS] *EDUCATIONAL SERVICES, ON A CHARITABLE BASIS, NAMELY, PROVIDING ONE-ON-ONE MENTORING AND CONDUCTING ONLINE AND IN PERSON CLASSES, SEMINARS AND CONFERENCES IN THE FIELD OF COMPUTER TECHNOLOGY AND THE INTERNET, NAMELY, THE USE OF GRID COMPUTING; CONDUCTING VOLUNTEER EDUCATION ONLINE AND IN PERSON CLASSES, SEMINARS AND CONFERENCES IN THE FIELD OF COMPUTER TECHNOLOGY AND THE INTERNET, NAMELY, THE USE OF GRID COMPUTING*.

FIRST USE 11-16-2004; IN COMMERCE 11-16-2004.

INT. CL. 42/U.S. CLS. 100 AND 101

FOR [CHARITABLE, PHILANTHROPIC, AND VOLUNTEER SERVICES, ALL IN THE AREA OF COMPUTER SYSTEMS AND INTERNET TECHNOLOGY CONSULTATION] *CONSULTING SERVICES ON A CHARITABLE BASIS IN THE AREA OF COMPUTER SYSTEMS AND INTERNET TECHNOLOGY CONSULTATION TO SUPPORT SCIENTIFIC, MEDICAL AND HUMANITIES RESEARCH*.

FIRST USE 11-16-2004; IN COMMERCE 11-16-2004.

ELEMENTS AMENDED
GOODS/SERVICES

3,641,623. REG. 6-23-2009. TRI-STATE LOTTO COMMISSION (VERMONT INTERSTATE AGENCY OF NEW HAMPSHIRE, VERMONT AND MAINE) ROUTE 14, SOUTH BARRÉ, VT, 05670, SN 76-692,897. FILED 9-16-2008. PRINCIPAL REGISTER.



OWNER OF U.S. REG. NOS. 2,695,116, 2,736,018 AND OTHERS.

NO CLAIM IS MADE TO THE EXCLUSIVE RIGHT TO USE "PICK 3", APART FROM THE MARK AS SHOWN.

INT. CL. 41/U.S. CLS. 100, 101 AND 107

FOR LOTTERY SERVICES AND ADMINISTRATION OF LOTTERIES FOR OTHERS .

FIRST USE 6-29-2003; IN COMMERCE 6-29-2003.

ELEMENTS CORRECTED
ENTITY

3,641,624. REG. 6-23-2009. TRI-STATE LOTTO COMMISSION (VERMONT INTERSTATE AGENCY OF NEW HAMPSHIRE, VERMONT AND MAINE) ROUTE 14, SOUTH BARRÉ, VT, 05670, SN 76-692,899. FILED 9-16-2008. PRINCIPAL REGISTER.



OWNER OF U.S. REG. NOS. 2,677,276, 2,685,915 AND OTHERS.

NO CLAIM IS MADE TO THE EXCLUSIVE RIGHT TO USE "PICK 4", APART FROM THE MARK AS SHOWN.

INT. CL. 41/U.S. CLS. 100, 101 AND 107

FOR LOTTERY SERVICES AND ADMINISTRATION OF LOTTERIES FOR OTHERS .

FIRST USE 6-29-2003; IN COMMERCE 6-29-2003.

ELEMENTS CORRECTED
ENTITY

3,641,625. REG. 6-23-2009. TRI-STATE LOTTO COMMISSION (VERMONT INTERSTATE AGENCY OF NEW HAMPSHIRE, VERMONT AND MAINE) ROUTE 14, SOUTH BARRE, VT, 05670, SN 76-692,900. FILED 9-16-2008. PRINCIPAL REGISTER.

3,656,969. REG. 7-21-2009. MARKZWARE (CALIFORNIA CORPORATION) 1805 EAST DYER ROAD, SUITE 101, SANTA ANA, CA, 92705, SN 77-560,604. FILED 9-2-2008. PRINCIPAL REGISTER.



OWNER OF U.S. REG. NOS. 2,677,276, 2,685,915 AND OTHERS.
 NO CLAIM IS MADE TO THE EXCLUSIVE RIGHT TO USE "PICK 3" AND "PICK 4", APART FROM THE MARK AS SHOWN.
 INT. CL. 41/U.S. CLS. 100, 101 AND 107
 FOR LOTTERY SERVICES AND ADMINISTRATION OF LOTTERIES FOR OTHERS .
 FIRST USE 6-29-2003; IN COMMERCE 6-29-2003.

ELEMENTS CORRECTED
 ENTITY

3,647,745. REG. 6-30-2009. ECO-PLAN CO., LTD. (JAPAN CORPORATION) TWINS SHINJUKU BUILDING, 10-15, SHINJUKU 5-CHOME, SHINJUKU-KU; TOKYO 160-0022, JAPAN., SN 79-055,147. FILED 5-28-2008. PRINCIPAL REGISTER.

ECO-PLAN

THE MARK CONSISTS OF STANDARD CHARACTERS WITHOUT CLAIM TO ANY PARTICULAR FONT, STYLE, SIZE, OR COLOR.
 PRIORITY DATE OF 5-2-2008 IS CLAIMED.
 OWNER OF INTERNATIONAL REGISTRATION 0967903 DATED 5-28-2008, EXPIRES 5-28-2018.
 INT. CL. 37/U.S. CLS. 100, 103 AND 106
 FOR INSTALLATION OF VENTILATING APPARATUS; INSTALLATION OF AIR-CONDITIONING APPARATUS FOR INDUSTRIAL PURPOSES; INSTALLATION OF FREEZING MACHINES AND APPARATUS; INSTALLATION OF AIR-CONDITIONING APPARATUS FOR HOUSEHOLD PURPOSES; INSTALLATION OF KITCHEN APPLIANCES; INSTALLATION OF BATHROOMS AND BATHTUBS; PAINTING OF BATHROOMS AND BATHTUBS; PLUMBING; UPHOLSTERING; CONSTRUCTION CONSULTANCY; REPAIR OR MAINTENANCE OF AIR-CONDITIONING APPARATUS FOR INDUSTRIAL PURPOSES; CLEANING OF AIR-CONDITIONING APPARATUS FOR INDUSTRIAL PURPOSES; REPAIR OR MAINTENANCE OF FREEZING MACHINES AND APPARATUS; CLEANING OF FREEZING MACHINES AND APPARATUS; REPAIR OR MAINTENANCE OF VENTILATING APPARATUS; CLEANING OF VENTILATING APPARATUS; REPAIR OR MAINTENANCE OF AIR-CONDITIONING APPARATUS FOR HOUSEHOLD PURPOSES; CLEANING OF AIR-CONDITIONING APPARATUS FOR HOUSEHOLD PURPOSES; REPAIR OR MAINTENANCE OF BATHROOMS AND BATHTUBS; KITCHEN CLEANING; REPAIR OR MAINTENANCE OF [KITCHEN APPLIANCES] * NON-ELECTRIC COOKING HEATERS, KITCHEN WORK-TOPS AND KITCHEN SINKS *.
 FIRST USE ; IN COMMERCE .

ELEMENTS CORRECTED
 GOODS/SERVICES

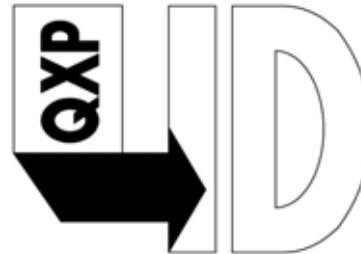

NO CLAIM IS MADE TO THE EXCLUSIVE RIGHT TO USE "QXP", APART FROM THE MARK AS SHOWN.
 THE MARK CONSISTS OF LETTERS "Q", "X", "P", INSIDE OF A BOX WITH AN ARROW AT THE BOTTOM POINTING TO LETTERS "ID".
 INT. CL. 9/U.S. CLS. 21, 23, 26, 36 AND 38
 FOR COMPUTER GRAPHICS SOFTWARE FOR USE IN GRAPHICAL LAYOUT APPLICATIONS *, BUT NOT FOR COMPUTER AND VIDEO GAMES *.
 FIRST USE 10-27-2005; IN COMMERCE 10-27-2005.

ELEMENTS AMENDED
 GOODS/SERVICES

3,656,970. REG. 7-21-2009. MARKZWARE (CALIFORNIA CORPORATION) 1805 EAST DYER ROAD, SUITE 101, SANTA ANA, CA, 92705, SN 77-560,611. FILED 9-2-2008. PRINCIPAL REGISTER.

ID2Q

THE MARK CONSISTS OF STANDARD CHARACTERS WITHOUT CLAIM TO ANY PARTICULAR FONT, STYLE, SIZE, OR COLOR.
 INT. CL. 9/U.S. CLS. 21, 23, 26, 36 AND 38
 FOR COMPUTER GRAPHICS SOFTWARE FOR USE IN GRAPHICAL LAYOUT APPLICATIONS *, BUT NOT FOR COMPUTER AND VIDEO GAMES *.
 FIRST USE 1-20-2005; IN COMMERCE 1-20-2005.

ELEMENTS AMENDED
 GOODS/SERVICES

3,662,575. REG. 8-4-2009. VISION GROUP INTERNATIONAL LIMITED (HONG KONG CORPORATION) UNIT 3903/4, 39TH FLOOR, CABLE TV TOWER, 9 HOI SHING ROAD, TSUEN WAN, HONG KONG., SN 77-453,819. FILED 4-21-2008. PRINCIPAL REGISTER.

FOR COMPUTER GRAPHICS SOFTWARE FOR USE IN GRAPHICAL LAYOUT APPLICATIONS *, BUT NOT FOR COMPUTER AND VIDEO GAMES *.
FIRST USE 11-27-2007; IN COMMERCE 11-27-2007.

ELEMENTS AMENDED
GOODS/SERVICES

PELADA

THE MARK CONSISTS OF STANDARD CHARACTERS WITHOUT CLAIM TO ANY PARTICULAR FONT, STYLE, SIZE, OR COLOR.

OWNER OF UNITED KINGDOM REG. NO. 2349277, DATED 4-23-2004, EXPIRES 4-23-2014.

THE ENGLISH TRANSLATION OF THE WORD "PELADA" IN THE MARK IS NAKED.

INT. CL. 18/U.S. CLS. 1, 2, 3, 22 AND 41

FOR (BASED ON USE IN COMMERCE) ARTICLES MADE FROM LEATHER OR IMITATION LEATHER, NAMELY, SPORTS BAGS, RUCKSACKS, BACKPACKS; SPORTS BAGS, RUCKSACKS.

FIRST USE 2-23-2009; IN COMMERCE 2-23-2009.

INT. CL. 25/U.S. CLS. 22 AND 39

FOR (BASED ON 44(E)) CLOTHING, NAMELY, T-SHIRTS, POLO SHIRTS, SWEATSHIRTS, SOCCER SHIRTS, HOODED SWEATSHIRTS FLEECE TOPS, JACKETS, COATS, WOVEN PANTS, JEANS, SHORTS, SOCCER SHORTS, SWIM SHORTS, WOVEN SHIRTS, LADIES TOPS, BLOUSES, LEGGINS, SKIRTS, SKORTS, CULOTTES, DRESSES, SWEATERS, JUMPERS, CARDIGANS, TRACKS SUITS, RAIN JACKETS, RAIN PANTS, LONG-SLEEVED SHIRTS, SOCKS, GLOVES, SCARVES, UNDERWEAR, NIGHTWEAR; HEADGEAR, NAMELY, CAPS, BEANIES AND KNITTED CAPS.

FIRST USE ; IN COMMERCE .

INT. CL. 28/U.S. CLS. 22, 23, 38 AND 50

FOR (BASED ON 44(E)) SPORTING ARTICLES, NAMELY, SOCCER BALLS.

FIRST USE ; IN COMMERCE .

ELEMENTS CORRECTED
GOODS/SERVICES
DATE OF FIRST USE
DATE OF FIRST USE IN COMMERCE

3,671,950. REG. 8-25-2009. MARKZWARE (CALIFORNIA CORPORATION) 1805 EAST DYER ROAD, SUITE 101, SANTA ANA, CA, 92705, SN 77-560,574. FILED 9-2-2008. PRINCIPAL REGISTER.



NO CLAIM IS MADE TO THE EXCLUSIVE RIGHT TO USE "PUB", APART FROM THE MARK AS SHOWN.

THE MARK CONSISTS OF LETTERS "PUB" INSIDE OF A BOX WITH AN ARROW AT BOTTOM POINTING TO LETTERS "ID".

INT. CL. 9/U.S. CLS. 21, 23, 26, 36 AND 38

3,681,569. REG. 9-8-2009. EARTHWORKS SYSTEM, LLC (OHIO LIMITED LIABILITY COMPANY) 33200 BAINBRIDGE ROAD, SOLON, OH, 44139, SN 78-819,190. FILED 2-20-2006. PRINCIPAL REGISTER.

GOODSHEET

THE MARK CONSISTS OF STANDARD CHARACTERS WITHOUT CLAIM TO ANY PARTICULAR FONT, STYLE, SIZE, OR COLOR.

INT. CL. 17/U.S. CLS. 1, 5, 12, 13, 35 AND 50

FOR PLASTIC MATERIAL COMPOSED OF POLYVINYL CHLORIDE SHEETING FOR USE IN MAKING TRANSACTION, INFORMATION AND IDENTIFICATION CARDS AND SIGNS .

FIRST USE 6-30-2009; IN COMMERCE 6-30-2009.

ELEMENTS CORRECTED
OWNER NAME

3,683,262. REG. 9-15-2009. PRIMETECH S.P.A. (ITALY JOINT STOCK COMPANY) ZONA PRODUTTIVA, 18, I-38013 FONDO (TRENTO), ITALY., SN 79-053,809. FILED 5-8-2008. PRINCIPAL REGISTER.

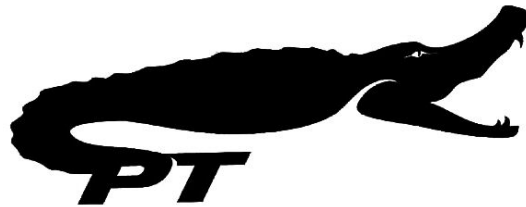

PRIORITY DATE OF 1-18-2008 IS CLAIMED.
OWNER OF INTERNATIONAL REGISTRATION 0964230 DATED 5-8-2008, EXPIRES 5-8-2018.

INT. CL. 7/U.S. CLS. 13, 19, 21, 23, 31, 34 AND 35

FOR EARTH MOVING MACHINES AND STRUCTURAL PARTS THEREFORE FOR SOIL CULTIVATION AND EARTH MOVING, IN PARTICULAR IN THE FIELDS OF AGRICULTURE AND FORESTRY; * ALL THE AFORESAID GOODS OTHER THAN FOR MACHINES, MECHANICAL TOOLS AND PARTS THEREFOR FOR BUILDING CONSTRUCTION *.

FIRST USE ; IN COMMERCE .

INT. CL. 12/U.S. CLS. 19, 21, 23, 31, 35 AND 44

FOR VEHICLES, NAMELY, ALL-TERRAIN, SELF-PROPELLED TRACKED CARRIERS AND TRACTORS FOR USE IN AGRICULTURE AND FORESTRY, AND STRUCTURAL PARTS THEREFORE; APPARATUS FOR LOCOMOTION BY LAND, AIR OR WATER, NAMELY, BOATS; * ALL THE AFORESAID GOODS OTHER THAN FOR MACHINES, MECHANICAL TOOLS AND PARTS THEREFOR FOR BUILDING CONSTRUCTION *.

FIRST USE ; IN COMMERCE .

INT. CL. 44/U.S. CLS. 100 AND 101

FOR RENTAL OF AGRICULTURAL AND FORESTRY EQUIPMENT AND MACHINES; * ALL THE AFORESAID SERVICES OTHER THAN FOR MACHINES, MECHANICAL TOOLS AND PARTS THEREFOR FOR BUILDING CONSTRUCTION *.
FIRST USE ; IN COMMERCE .

3,691,660. REG. 10-6-2009. FOXWOOD GROUP, INC. (ARKANSAS CORPORATION) 3900 FRONT STREET, SUITE 1, FAYETTEVILLE, AR, 72703, SN 77-629,979. FILED 12-10-2008. PRINCIPAL REGISTER.

ELEMENTS CORRECTED
GOODS/SERVICES



3,686,150. REG. 9-22-2009. KOMVOORT B.V. (NETHERLANDS LIMITED LIABILITY COMPANY) CELSIUSSTRAAT 8, NL-7701 BW DEDEMSVAART, NETHERLANDS., SN 79-043,073. FILED 6-5-2007. PRINCIPAL REGISTER.

NO CLAIM IS MADE TO THE EXCLUSIVE RIGHT TO USE "SPORTS", APART FROM THE MARK AS SHOWN.

THE COLOR(S) RED AND BLACK IS/ARE CLAIMED AS A FEATURE OF THE MARK.

THE MARK CONSISTS OF A STYLIZED BLACK "X" PATTERN BELOW A CIRCLE, RESEMBLING A PERSON, WITH A RED BACKGROUND ENCLOSED IN A CIRCLE, NEXT TO THE WORD "FOXWOOD" OVER THE WORD "SPORTS", WITH "FOXWOOD" AND "SPORTS" BEING BLACK.

INT. CL. 16/U.S. CLS. 2, 5, 22, 23, 29, 37, 38 AND 50

FOR PROMOTING THE GOODS AND SERVICES OF OTHERS BY ARRANGING FOR SPONSORS TO AFFILIATE THEIR GOODS AND SERVICES WITH LOCAL SPORTS EVENTS; PREPARING AND PLACING ADVERTISEMENTS FOR OTHERS.

FIRST USE 11-25-2008; IN COMMERCE 11-25-2008.

FKO FIRE KNOCK-OUT

ELEMENTS AMENDED
MARK
DESCRIPTION OF MARK

PRIORITY DATE OF 1-24-2007 IS CLAIMED.
OWNER OF INTERNATIONAL REGISTRATION 0935635 DATED 6-5-2007, EXPIRES 6-5-2017.

NO CLAIM IS MADE TO THE EXCLUSIVE RIGHT TO USE "FIRE", APART FROM THE MARK AS SHOWN.

INT. CL. 1/U.S. CLS. 1

FOR [CHEMICALS USED IN INDUSTRY AND SCIENCE FOR FIRE-EXTINGUISHING COMPOSITIONS AND PREPARATIONS;] UNPROCESSED ARTIFICIAL RESINS, UNPROCESSED PLASTICS; [FIRE EXTINGUISHING COMPOSITIONS AND PREPARATIONS; FIRE PROTECTION AND FLAME PROTECTION PREPARATIONS; FIRE RETARDANT COMPOSITIONS;] ADHESIVES USED IN INDUSTRY.

FIRST USE ; IN COMMERCE .

INT. CL. 9/U.S. CLS. 21, 23, 26, 36 AND 38

FOR [FIRE EXTINGUISHING APPARATUS; APPARATUS AND INSTRUMENTS FOR CONDUCTING, SWITCHING, TRANSFORMING, ACCUMULATING OR CONTROLLING ELECTRICITY FOR FIRE EXTINGUISHING APPARATUS AND DEVICES;] AUTOMATIC VENDING MACHINES FOR FIRE EXTINGUISHING APPARATUS AND DEVICES AND MECHANICAL COIN OPERATED APPARATUS FOR USE IN CONNECTION WITH AUTOMATIC VENDING MACHINES; [DATA PROCESSING EQUIPMENT AND COMPUTERS RELATED TO FIRE EXTINGUISHING APPARATUS AND DEVICES; FIRE PROTECTION APPARATUS, NAMELY, FIRE EXTINGUISHERS, FIRE PROTECTION CLOTHING AND DEVICES, NAMELY, FIRE SAFETY GOGGLES, RESPIRATORY MASK FILTERS, FIRE ESCAPE LADDERS, THERMALLY ACTIVATED FIRE SAFETY VALVES; FIRE-EXTINGUISHING APPARATUS AND DEVICES].

FIRST USE ; IN COMMERCE .

INT. CL. 35/U.S. CLS. 100, 101 AND 102

FOR ADVERTISING; BUSINESS MANAGEMENT; BUSINESS ADMINISTRATION; OFFICE FUNCTIONS.

FIRST USE ; IN COMMERCE .

ELEMENTS CORRECTED
GOODS/SERVICES

3,695,531. REG. 10-13-2009. UNIVERSAL GENEVE SA (SWITZERLAND CORPORATION) 6, RTE DES ACACIAS, LES ACACIAS-GENEVA, SWITZERLAND, 1227, SN 77-699,607. FILED 3-26-2009. PRINCIPAL REGISTER.

AERO-COMPAX

THE MARK CONSISTS OF STANDARD CHARACTERS WITHOUT CLAIM TO ANY PARTICULAR FONT, STYLE, SIZE, OR COLOR.

OWNER OF SWITZERLAND REG. NO. 379884, DATED 9-10-1990, EXPIRES 9-10-2010.

INT. CL. 14/U.S. CLS. 2, 27, 28 AND 50

FOR WATCHES AND CLOCKS AND PARTS THEREFOR.

ELEMENTS CORRECTED
OWNER NAME

3,707,440. REG. 11-10-2009. SPARKPOINT, INC. (IOWA CORPORATION) 1001 OFFICE PARK ROAD, WEST DES MOINES, IA, 50265, SN 77-439,034. FILED 4-3-2008. PRINCIPAL REGISTER.

3,723,459. REG. 12-8-2009. GRANGE MUTUAL CASUALTY COMPANY (OHIO CORPORATION) 650 SOUTH FRONT STREET, COLUMBUS, OH, 43206, SN 77-575,521. FILED 9-22-2008. PRINCIPAL REGISTER.

SPARKPOINT



THE MARK CONSISTS OF STANDARD CHARACTERS WITHOUT CLAIM TO ANY PARTICULAR FONT, STYLE, SIZE, OR COLOR.

INT. CL. 35/U.S. CLS. 100, 101 AND 102

FOR BUSINESS CONSULTING SERVICES RELATING TO PERFORMANCE IMPROVEMENT TRAINING AND COURSE DEVELOPMENT, EXCLUDING TRAINING AND COURSE DEVELOPMENT RELATING TO GOAL-SETTING AND ACHIEVEMENT RELATIVE TO FITNESS, NUTRITION, SLEEP, BREATHING, AND GENERAL HEALTH.

FIRST USE 10-1-2007; IN COMMERCE 10-1-2007.

ELEMENTS CORRECTED
GOODS/SERVICES

OWNER OF U.S. REG. NOS. 3,153,377, 3,337,631 AND 3,337,639.

THE MARK CONSISTS OF THE WORDS "GRANGE EODB EASE OF DOING BUSINESS" IN A STYLIZED FONT WITH FIVE PARALLEL RECTANGLES OF DIFFERENT LENGTHS ARRANGED AT AN ANGLE.

INT. CL. 36/U.S. CLS. 100, 101 AND 102

FOR INSURANCE SERVICES, NAMELY, INSURANCE UNDERWRITING IN THE FIELD OF AUTO, HOME, FARM, BUSINESS, LIFE, PROPERTY, CASUALTY, ACCIDENT, HEALTH, DISABILITY, ANNUITIES.

FIRST USE 2-23-2009; IN COMMERCE 2-23-2009.

ELEMENTS CORRECTED
MARK

3,713,994. REG. 11-24-2009. TAKEDA PHARMACEUTICAL COMPANY LIMITED (JAPAN CORPORATION) 1-1, DOSHOMACHI 4-CHOME, CHUO-KU, OSAKA, JAPAN., SN 77-540,510. FILED 8-6-2008. PRINCIPAL REGISTER.

BEYASO

3,723,460. REG. 12-8-2009. GRANGE MUTUAL CASUALTY COMPANY (OHIO CORPORATION) 650 SOUTH FRONT STREET, COLUMBUS, OH, 43206, SN 77-575,526. FILED 9-22-2008. PRINCIPAL REGISTER.



THE MARK CONSISTS OF STANDARD CHARACTERS WITHOUT CLAIM TO ANY PARTICULAR FONT, STYLE, SIZE, OR COLOR.

OWNER OF JAPAN REG. NO. 5132423, DATED 4-25-2008, EXPIRES 4-25-2018.

INT. CL. 5/U.S. CLS. 6, 18, 44, 46, 51 AND 52

FOR PHARMACEUTICAL PREPARATIONS FOR THE TREATMENT AND PREVENTION OF DIABETIC DISEASES.

ELEMENTS CORRECTED
OWNER NAME

OWNER OF U.S. REG. NOS. 3,153,377, 3,337,631 AND 3,337,639.

THE MARK CONSISTS OF THE WORDS "GRANGE EODB" IN A STYLIZED FONT WITH FIVE PARALLEL RECTANGLES OF DIFFERENT LENGTHS ARRANGED AT AN ANGLE.

INT. CL. 36/U.S. CLS. 100, 101 AND 102

FOR INSURANCE SERVICES, NAMELY, INSURANCE UNDERWRITING IN THE FIELD OF AUTO, HOME, FARM, BUSINESS, LIFE, PROPERTY, CASUALTY, ACCIDENT, HEALTH, DISABILITY, ANNUITIES.

FIRST USE 2-23-2009; IN COMMERCE 2-23-2009.

ELEMENTS CORRECTED
MARK

3,730,442. REG. 12-29-2009. IFA INDUSTRIELLE WIEGE-TECHNIK GMBH (FED REP GERMANY LIMITED LIABILITY COMPANY) JURASTRASSE 10, 86641 RAIN AM LECH, FED REP GERMANY, 86641, SN 77-385,306. FILED 1-31-2008. PRINCIPAL REGISTER.

IFA

THE MARK CONSISTS OF STANDARD CHARACTERS WITHOUT CLAIM TO ANY PARTICULAR FONT, STYLE, SIZE, OR COLOR.

PRIORITY CLAIMED UNDER SEC. 44(D) ON FED REP GERMANY APPLICATION NO. 30751115.4, FILED 8-3-2007, REG. NO. 30751115, DATED 1-31-2008, EXPIRES 8-31-2017.

INT. CL. 6/U.S. CLS. 2, 12, 13, 14, 23, 25 AND 50

FOR STORAGE TANKS, NAMELY, METAL FLUID STORAGE TANKS AND METAL STORAGE TANKS AND ROOFS THEREFORE; CONTAINERS, FLOATING CONTAINERS, SILOS, AND STORAGE TANKS MADE OF METAL FOR LIQUID FUEL.

FIRST USE 12-31-1989; IN COMMERCE 12-31-1989.

INT. CL. 7/U.S. CLS. 13, 19, 21, 23, 31, 34 AND 35

FOR MACHINES FOR PROCESSING RAW LIQUID AND SOLID MATERIALS FOR INDUSTRIAL USE, NAMELY, MACHINES FOR DOSING, MIXING, HOMOGENIZING, DISPERSING, GRINDING, CONVEYING, FILLING RAW LIQUID AND SOLID MATERIALS FOR INDUSTRIAL USE; DOSING SYSTEMS, NAMELY, HOPPERS, FEEDERS, DISCHARGERS AND CONDUITS FOR CONTROLLABLY FEEDING AND DISCHARGING RAW LIQUID AND SOLID MATERIALS FOR INDUSTRIAL USE, MIXER MACHINES, HOMOGENIZER MACHINES, DISPERSER MACHINES, NAMELY, KNEADERS, BALL MILLS, GRINDER MACHINES, CONVEYER MACHINES; REPLACEMENT PARTS FOR MIXER MACHINES, HOMOGENIZER MACHINES, DISPERSER MACHINES, GRINDING MACHINES, CONVEYING MACHINES; SACK FEEDING STATIONS, NAMELY, MACHINES FOR FEEDING MATERIALS OUT OF SACKS, BIG BAGS, OCTABIN LINER, CARDBOARD BOXES AND CONTAINERS; SACK SEWING MACHINES AND PACKING MACHINES AS WELL AS TINTING MACHINES FOR THE PRODUCTION OF COLORS AND LACQUERS FOR INDUSTRIAL USE.

FIRST USE 12-31-1989; IN COMMERCE 12-31-1989.

INT. CL. 9/U.S. CLS. 21, 23, 26, 36 AND 38

FOR ELECTRIC AND ELECTRONIC CONTROL SYSTEMS, NAMELY, METERING SENSOR ELEMENTS FOR MEASURING WEIGHT, FLOW RATES, AIR PRESSURE, TEMPERATURE, AND FILLING LEVELS OF RAW LIQUID AND SOLID MATERIALS, COMPUTER HARDWARE AND SOFTWARE FOR MONITORING OF METERING SENSOR ELEMENTS FOR MEASURING WEIGHT, FLOW RATES, AIR PRESSURE, TEMPERATURE, AND FILLING LEVELS OF RAW LIQUID AND SOLID MATERIALS FOR INDUSTRIAL USE IN STORAGE TANKS, CONTAINERS, FLOATING CONTAINERS, SILOS AND FOR CONTROLLING THE ADDITION AND THE DISCHARGE OF PRE-DETERMINED DOSAGES OF LIQUID AND SOLID RAW MATERIALS TO INDUSTRIAL PROCESSES; DOSING APPARATUSES, NAMELY, FOR DISPENSING RAW LIQUID AND SOLID MATERIALS FOR INDUSTRIAL USE; SCALES FOR WEIGHING RAW LIQUID AND SOLID RAW MATERIALS FOR INDUSTRIAL USE USED TOGETHER WITH MACHINES FOR, DOSING, MIXING, HOMOGENIZING, DISPERSING, GRINDING, CONVEYING, FILLING RAW LIQUID AND SOLID MATERIALS FOR INDUSTRIAL USE.

FIRST USE 12-31-1989; IN COMMERCE 12-31-1989.

INT. CL. 20/U.S. CLS. 2, 13, 22, 25, 32 AND 50

FOR (BASED ON 44(E)) STORAGE TANKS, CONTAINERS, FLOATING CONTAINERS, AND CONTAINERS, FOR INDUSTRIAL OR COMMERCIAL USE, NAMELY, FOR LIQUID FUEL TOO, NEITHER MADE OF METAL NOR OF MASONRY.

FIRST USE ; IN COMMERCE .

INT. CL. 37/U.S. CLS. 100, 103 AND 106

FOR INSTALLATION, REPAIR, AND MAINTENANCE OF MACHINES, DEVICES AND SYSTEMS AND LINES, NAMELY, MACHINES FOR, DOSING, MIXING, HOMOGENIZING, DISPERSING, GRINDING, CONVEYING, FILLING RAW LIQUID AND SOLID MATERIALS FOR INDUSTRIAL USE.

FIRST USE 12-31-1989; IN COMMERCE 12-31-1989.

INT. CL. 42/U.S. CLS. 100 AND 101

FOR TECHNICAL CONSULTING, TECHNICAL DEVELOPMENT FOR OTHERS, NAMELY, DEVELOPMENT OF TECHNOLOGY IN MACHINES FOR, DOSING, MIXING, HOMOGENIZING, DISPERSING, GRINDING, CONVEYING, FILLING RAW LIQUID AND SOLID MATERIALS FOR INDUSTRIAL USE; TECHNICAL SUPPORT SERVICES, NAMELY, TROUBLESHOOTING OF INDUSTRIAL PROCESS CONTROL COMPUTER SOFTWARE PROBLEMS; TECHNICAL DESIGN FOR OTHERS, NAMELY, TECHNICAL DESIGN OF MACHINES FOR, DOSING, MIXING, HOMOGENIZING, DISPERSING, GRINDING, CONVEYING, FILLING RAW LIQUID AND SOLID MATERIALS FOR INDUSTRIAL USE .

FIRST USE 12-31-1989; IN COMMERCE 12-31-1989.

ELEMENTS CORRECTED
GOODS/SERVICES
OWNER ADDRESS

3,732,146. REG. 12-29-2009. BOB EVANS RESTAURANTS OF MICHIGAN, LLC (DELAWARE CORPORATION) 305 EAST EISENHOWER PARKWAY, SUITE 200, ANN ARBOR, MI, 48108, SN 77-441,226. FILED 4-7-2008. PRINCIPAL REGISTER.

BOB EVANS SIGNATURE CANDLE

THE MARK CONSISTS OF STANDARD CHARACTERS WITHOUT CLAIM TO ANY PARTICULAR FONT, STYLE, SIZE, OR COLOR.

OWNER OF U.S. REG. NOS. 846,356, 876,145 AND 992,146. NO CLAIM IS MADE TO THE EXCLUSIVE RIGHT TO USE "CANDLE", APART FROM THE MARK AS SHOWN.

THE NAME(S), PORTRAIT(S), AND/OR SIGNATURE(S) SHOWN IN THE MARK DOES NOT IDENTIFY A PARTICULAR LIVING INDIVIDUAL.

INT. CL. 4/U.S. CLS. 1, 6 AND 15

FOR CANDLES.

FIRST USE 5-1-2008; IN COMMERCE 5-1-2008.

ELEMENTS CORRECTED
OWNER NAME

3,737,113. REG. 1-12-2010. ENGINEERING SPA (ITALY JOINT STOCK COMPANY) VIA SANT'ORSOLA, 51/1, I-47023 CESENA (FC), ITALY., SN 79-063,103. FILED 9-1-2008. PRINCIPAL REGISTER.



The logo for RuleDesigner features the word "Rule" in a blue, sans-serif font and "Designer" in a green, sans-serif font. A small graphic of a cube with a red, blue, and green face is positioned above the letter "e" in "Designer". A yellow dotted arrow points from the top of the cube towards the letter "d" in "Designer".

OWNER OF INTERNATIONAL REGISTRATION 0987522 DATED 9-1-2008, EXPIRES 9-1-2018.

THE COLOR(S) BLUE, RED, WHITE, BLACK, YELLOW, YELLOW OCHRE, GREEN IS/ARE CLAIMED AS A FEATURE OF THE MARK.

ALL THE LETTERS ARE WHITE; EACH LETTER OF THE WORD "RULE" HAS A BLUE CONTOUR; EACH LETTER OF THE WORDING "DESI" HAS A RED CONTOUR; EACH LETTER OF THE WORDING "GNER" HAS A GREEN CONTOUR; THE THREE-DIMENSIONAL CUBE HAS THREE SIDES, WHICH ARE RED, BLUE AND GREEN, RESPECTIVELY; THE LETTER "E" IN THE VISIBLE ANGLE OF THE CUBE IS WHITE WITH A BLACK CONTOUR; THE SQUARE FRAME IS OF YELLOW OCHRE COLOR; THE DOTTED ARROW BY THE LETTER "D" IS OF YELLOW OCHRE COLOR.

THE MARK CONSISTS OF THE WORDING "RULEDESIGNER" IN ITALIC CHARACTERS; THE LETTER "R" OF RULE AND THE LETTER "D" OF "DESIGNER" ARE CAPITALIZED WHILE THE REMAINING LETTERS ARE LOWERCASE; ALL THE LETTERS ARE IN WHITE; EACH LETTER OF THE WORD "RULE" HAS A BLUE CONTOUR AND A "RELIEF" EFFECT; THE WORD "DESIGNER" IS COMPOSED OF TWO COLORS: THE LETTERS "DESI" HAVE A RED CONTOUR AND A RELIEF EFFECT, WHILE THE LETTERS "GNER" HAVE A GREEN CONTOUR AND A RELIEF EFFECT; THE LETTER "I" OF THE WORD "DESIGNER" IS SURMOUNTED BY A THREE-DIMENSIONAL CUBE WITH THREE VISIBLE SIDES WHICH ARE RED, BLUE AND GREEN, RESPECTIVELY; IN THE VISIBLE ANGLE OF THE CUBE, WHERE THE THREE FACES TOUCH, THERE IS A YELLOW TRIANGLE ON WHICH THE LETTER "E" RESTS; THIS LETTER "E" IS IN WHITE WITH A BLACK CONTOUR; A DOTTED ARROW OF YELLOW OCHRE COLOR LEADS FROM THE LETTER "D" OF THE WORD "DESIGNER" TO THE SQUARE FRAME, ALSO OF YELLOW OCHRE COLOR, THAT SURROUNDS THE IMAGE OF THE THREE-DIMENSIONAL CUBE.

INT. CL. 9/U.S. CLS. 21, 23, 26, 36 AND 38

FOR COMPUTER PROGRAMS AND SOFTWARE FOR PRODUCT LIFECYCLE MANAGEMENT.

INT. CL. 42/U.S. CLS. 100 AND 101

FOR DESIGN AND DEVELOPMENT OF * COMPUTER * SOFTWARE.

FIRST USE ; IN COMMERCE .

ELEMENTS CORRECTED
GOODS/SERVICES

3,745,839. REG. 2-9-2010. TAKEDA PHARMACEUTICAL COMPANY LIMITED (JAPAN CORPORATION) 1-1, DOSHOMACHI 4-CHOME, CHUO-KU, OSAKA, JAPAN., SN 77-540,466. FILED 8-6-2008. PRINCIPAL REGISTER.

NESATOS

THE MARK CONSISTS OF STANDARD CHARACTERS WITHOUT CLAIM TO ANY PARTICULAR FONT, STYLE, SIZE, OR COLOR.

PRIORITY CLAIMED UNDER SEC. 44(D) ON JAPAN APPLICATION NO. 2008-21651, FILED 3-24-2008, REG. NO. 5177550, DATED 10-31-2008, EXPIRES 10-31-2018.

INT. CL. 5/U.S. CLS. 6, 18, 44, 46, 51 AND 52

FOR PHARMACEUTICAL PREPARATIONS FOR THE TREATMENT AND PREVENTION OF DIABETIC DISEASES.

ELEMENTS CORRECTED
OWNER NAME

3,747,993. REG. 2-9-2010. MED-EL ELEKTROMEDIZINISCHE GERATE GES. M.B.H. (AUSTRIA CORPORATION) FURSTENWEG 77A, 6020 INNSBRUCK, AUSTRIA., SN 78-389,797. FILED P.R. 3-24-2004; AM. S.R. 10-10-2006. SUPPLEMENTAL REGISTER.

EAS

THE MARK CONSISTS OF STANDARD CHARACTERS WITHOUT CLAIM TO ANY PARTICULAR FONT, STYLE, SIZE, OR COLOR.

OWNER OF ERPN CMNTY TM OFC REG. NO. 003714151, DATED 3-18-2004, EXPIRES 3-24-2014.

INT. CL. 9/U.S. CLS. 21, 23, 26, 36 AND 38

FOR MICROPROCESSORS, SPEECH PROCESSORS FOR COCHLEAR IMPLANTS; SOFTWARE AND COMPUTER PROGRAMS FEATURING INTERACTIVE TEACHING AND TESTING MATERIAL FOR AUDITORY AND OPTICAL TRAINING; PRERECORDED DATA CARRIERS WITH INFORMATION FOR SURGICAL AND AUDIO LOGY TRAINING; PRERECORDED DATA CARRIERS WITH PROGRAMS FOR TESTING AND EVALUATION OF SPEECH RECOGNITION.

FIRST USE ; IN COMMERCE .

INT. CL. 10/U.S. CLS. 26, 39 AND 44

FOR SURGICAL IMPLANTS COMPOSED PRIMARILY OF ARTIFICIAL MATERIAL, COCHLEAR IMPLANTS; COCHLEAR IMPLANTS COMPOSED PRIMARILY OF ARTIFICIAL MATERIAL; ELECTRODES FOR MEDICAL PURPOSES, ELECTRODES FOR USE IN IMPLANTS COMPOSED OF ELECTRODE MATERIAL; HEARING AIDS; HEARING PROSTHESES; HEARING AIDS FOR PARTIAL OR COMPLETE IMPLANTATION.

FIRST USE ; IN COMMERCE .

INT. CL. 16/U.S. CLS. 2, 5, 22, 23, 29, 37, 38 AND 50

FOR PRINTED BOOKS AND JOURNALS IN THE FIELD OF EDUCATION AND TRAINING IN SURGERY AND AUDIO LOGY; PRINTED TEST REPORTS FOR TESTING AND EVALUATION OF SPEECH RECOGNITION .

FIRST USE ; IN COMMERCE .

INT. CL. 41/U.S. CLS. 100, 101 AND 107

FOR TEACHING IN THE FIELD OF SURGERY AND AUDIO LOGY; PROVIDING MEDICAL TRAINING IN THE HELD OF SURGERY AND AUDIO LOGY.

FIRST USE ; IN COMMERCE .

ELEMENTS CORRECTED
FOREIGN COUNTRY OF ORIGIN
FOREIGN REG. DATE
PRIORITY CLAIMED STATEMENT
[FOREIGN APPLICATION NO.]
[FOREIGN APPLICATION FILING DATE]

3,753,760. REG. 3-2-2010. MCKINNEY ROGERS INTERNATIONAL LIMITED (UNITED KINGDOM CORPORATION) 23 BUCKINGHAM GATE, LONDON, UNITED KINGDOM, SW1E6LB. SN 77-632,968. FILED 12-15-2008. PRINCIPAL REGISTER.

3,754,824. REG. 3-2-2010. L.O.T. LOW OXYGEN TECHNOLOGY GMBH (FED REP GERMANY LIMITED LIABILITY COMPANY) ROBERT-ROSSLE-STRASSE 10, HAUS D85; 13125 BERLIN, FED REP GERMANY. SN 79-056,795. FILED 11-22-2007. PRINCIPAL REGISTER.

MCKINNEY ROGERS

THE MARK CONSISTS OF STANDARD CHARACTERS WITHOUT CLAIM TO ANY PARTICULAR FONT, STYLE, SIZE, OR COLOR.

PRIORITY CLAIMED UNDER SEC. 44(D) ON UNITED KINGDOM APPLICATION NO. 2504490, FILED 12-10-2008, REG. NO. 2504490, DATED 4-17-2009, EXPIRES 12-10-2018.

THE MARK "MCKINNEY ROGERS" DOES NOT IDENTIFY A LIVING INDIVIDUAL.

INT. CL. 9/U.S. CLS. 21, 23, 26, 36 AND 38

FOR COMPUTER PROGRAMS FOR TRAINING BUSINESS PERSONNEL FEATURING TRAINING INFORMATION IN THE FIELD OF BUSINESS MANAGEMENT.

FIRST USE ; IN COMMERCE .

INT. CL. 16/U.S. CLS. 2, 5, 22, 23, 29, 37, 38 AND 50

FOR PRINTED MATERIALS, NAMELY, BROCHURES, NEWSLETTERS, BOOKS, AND PRINTED INSTRUCTIONAL AND TEACHING MATERIALS FOR TRAINING BUSINESS PERSONNEL IN THE FIELD OF BUSINESS MANAGEMENT .

FIRST USE ; IN COMMERCE .

INT. CL. 35/U.S. CLS. 100, 101 AND 102

FOR BUSINESS MANAGEMENT ORGANIZATION CONSULTING; PERSONNEL CONSULTATION, NAMELY, PERSONNEL RESOURCE DEVELOPMENT; ADVICE IN THE FIELD OF BUSINESS MANAGEMENT; BUSINESS MANAGEMENT CONSULTING; ADVICE IN THE FIELD OF COMMERCIAL MANAGEMENT; ADVICE IN THE FIELD OF MARKETING MANAGEMENT; ADVICE IN THE FIELD OF PERSONNEL MANAGEMENT; ADVISORY SERVICES FOR BUSINESS MANAGEMENT; BUSINESS MANAGEMENT ADVICE; CONSULTANCY RELATING TO BUSINESS MANAGEMENT; COMMERCIAL OR INDUSTRIAL MANAGEMENT ASSISTANCE; PROVISION OF BUSINESS MANAGEMENT ASSISTANCE; MANAGEMENT AND BUSINESS CONSULTING SERVICES IN THE FIELD OF TRAINING AND RECRUITMENT.

FIRST USE ; IN COMMERCE .

INT. CL. 41/U.S. CLS. 100, 101 AND 107

FOR EDUCATIONAL SERVICES, NAMELY, TRAINING IN THE FIELD OF BUSINESS MANAGEMENT; EDUCATIONAL TRAINING COURSES IN THE FIELD OF BUSINESS MANAGEMENT AND PERSONNEL MANAGEMENT; ORGANIZATION OF EXHIBITIONS FOR EDUCATIONAL PURPOSES IN THE FIELD OF BUSINESS MANAGEMENT AND STRATEGY EXECUTION.

FIRST USE ; IN COMMERCE .

ELEMENTS CORRECTED
GOODS/SERVICES

LOXYMED

THE MARK CONSISTS OF STANDARD CHARACTERS WITHOUT CLAIM TO ANY PARTICULAR FONT, STYLE, SIZE, OR COLOR.

OWNER OF INTERNATIONAL REGISTRATION 0972087 DATED 11-22-2007, EXPIRES 11-22-2017.

INT. CL. 9/U.S. CLS. 21, 23, 26, 36 AND 38

FOR BREATHING APPARATUS, NOT FOR ARTIFICIAL RESPIRATION, NAMELY, FOR PROVIDING REDUCED OXYGEN BREATHING AIR FOR SPORTS TRAINING AND ALPINISM.

FIRST USE ; IN COMMERCE .

INT. CL. 11/U.S. CLS. 13, 21, 23, 31 AND 34

FOR AIR PROCESSING INSTALLATIONS FOR THE TREATMENT OF AMBIENT AIR IN ENCLOSED AND SEMI-ENCLOSED SPACES BY REDUCING THE OXYGEN PARTIAL PRESSURE OF THE AMBIENT AIR.

FIRST USE ; IN COMMERCE .

INT. CL. 37/U.S. CLS. 100, 103 AND 106

FOR CONSTRUCTION OF BUILDINGS AND ROOMS WITH REDUCIBLE OXYGEN PARTIAL PRESSURE OF THE AMBIENT AIR WITHIN; INSTALLATION OF FIRE PROTECTION EQUIPMENT FOR BUILDINGS AND ROOMS.

FIRST USE ; IN COMMERCE .

INT. CL. 41/U.S. CLS. 100, 101 AND 107

FOR PROVIDING HIGH ALTITUDE TRAINING SERVICES, NAMELY, PROVIDING INSTRUCTION AND TRAINING ON USE OF REDUCED OXYGEN BREATHING AIR FOR MEDICAL TREATMENT, MEDICAL THERAPY, MEDICAL REHABILITATION, SPORTS TRAINING AND ALPINISM; AND PROVIDING FITNESS AND EXERCISE FACILITIES.

FIRST USE ; IN COMMERCE .

INT. CL. 42/U.S. CLS. 100 AND 101

FOR TECHNICAL PLANNING OF HIGH ALTITUDE TRAINING EQUIPMENT AND OF ROOMS WITH REDUCIBLE OXYGEN PARTIAL PRESSURE WITHIN; TECHNICAL PLANNING OF FIRE PROTECTION EQUIPMENT BASED ON THE REDUCTION OF OXYGEN PARTIAL PRESSURE IN ROOMS INTENDED FOR FIRE PROTECTION.

FIRST USE ; IN COMMERCE .

INT. CL. 43/U.S. CLS. 100 AND 101

FOR PROVIDING TEMPORARY ACCOMMODATIONS FOR GUESTS.

FIRST USE ; IN COMMERCE .

INT. CL. 44/U.S. CLS. 100 AND 101

FOR OPERATION OF MEDICAL EQUIPMENT FOR THE TREATMENT OF PATIENTS WITH REDUCED OXYGEN BREATHING AIR; MEDICAL TREATMENT SERVICES BY PROVIDING PATIENTS WITH REDUCED OXYGEN BREATHING AIR; MEDICAL LABORATORY SERVICES; HEALTH CLINIC SERVICES BY PROVIDING PATIENTS WITH REDUCED OXYGEN BREATHING AIR; PROVISION OF PHYSICIAN SERVICES; HEALTH SPA SERVICES FOR HEALTH AND WELLNESS OF THE BODY AND SPIRIT, NAMELY, PROVIDING CLIENTS WITH REDUCED OXYGEN BREATHING AIR OFFERED AT A HEALTH CLUB FACILITY; HOSPITAL SERVICES; REST HOME SERVICES; CONVALESCENT HOME SERVICES; MEDICAL CLINIC SERVICES FOR OUTPATIENT CARE; SANATORIUM SERVICES, NAMELY, SANATORIA; REHABILITATION CENTER SERVICES FOR PHYSICAL REHABILITATION.

FIRST USE ; IN COMMERCE .

ELEMENTS CORRECTED
[GOODS/SERVICES]
[INTERNATIONAL CLASS(ES)]

3,756,521. REG. 3-9-2010. COFRESCO FRISCHHALTEPRODUKTE GMBH & CO.KG (FED REP GERMANY LIMITED PARTNERSHIP) RINGSTRASSE 99, MINDEN, FED REP GERMANY, 32427, SN 77-458,965. FILED 4-27-2008. PRINCIPAL REGISTER.

3,759,350. REG. 3-9-2010. VICTOR, HUGH (UNITED STATES INDIVIDUAL) 25467 WAREHAM DRIVE, HUNTINGTON WOODS, MI, 48070, SN 78-716,433. FILED 9-20-2005. PRINCIPAL REGISTER.



OWNER OF FED REP GERMANY REG. NO. 39932879, DATED 10-28-1999, RENEWED AS REG. NO. 39932879, DATED 6-1-2009, EXPIRES 5-31-2019.

OWNER OF U.S. REG. NO. 2,638,385.
THE COLOR(S) BLUE, RED AND WHITE IS/ARE CLAIMED AS A FEATURE OF THE MARK.

THE MARK CONSISTS OF THE WORD "TOPPITS" AND THE OUTER BORDER IN BLUE; THE INNER BORDER AND THE DESIGN ABOVE THE WORD ARE RED; THE REMAINDER OF THE MARK IS WHITE.

INT. CL. 6/U.S. CLS. 2, 12, 13, 14, 23, 25 AND 50

FOR ALUMINUM FOILS; PACKAGING MATERIAL OF METAL FOILS; [] CLOSURE CLIPS OF METAL FOR BAGS, CONTAINERS AND BOTTLES, CLAMPS OF METAL; ALUMINUM FOILS COATED WITH PLASTIC.

FIRST USE ; IN COMMERCE .

INT. CL. 16/U.S. CLS. 2, 5, 22, 23, 29, 37, 38 AND 50

FOR PACKAGING MATERIAL OF PAPER, NAMELY, BAGS, ENVELOPES AND POUCHES, CARDBOARD IN FORM OF FOILS, TUBES, SHEETS, ROLLS, BAGS, BOXES AND CONTAINERS AND PLASTIC FILM, FOILS, AND BAGS FOR USE IN HOUSEHOLD AND KITCHEN FOR STORING, BAKING, ROASTING, COOKING, FRESHKEEPING AND FREEZING PURPOSES; MICROWAVE COOKING BAGS; PENS FOR WRITING ON FOILS; PARCHMENT AND BAKING PAPER, PAPER FOR COOKING AND BAKING PURPOSES; BAKING AND ROASTING PAPER; PLASTIC OR PAPER ICE CUBE BAGS.

FIRST USE ; IN COMMERCE .

INT. CL. 21/U.S. CLS. 2, 13, 23, 29, 30, 33, 40 AND 50

FOR ALUMINUM GRILL PANS; PLASTIC BOXES FOR USE IN HOUSEHOLD AND KITCHEN FOR STORING, BAKING, ROASTING, COOKING, FRESHKEEPING AND FREEZING PURPOSES; BAKING MOLDS OF PAPER; PLASTIC CONTAINERS FOR USE IN HOUSEHOLD AND KITCHEN FOR STORING, BAKING, ROASTING, COOKING, FRESHKEEPING AND FREEZING PURPOSES; BAKING AND ROASTING MOLDS OF ALUMINUM FOIL; BAKING MOLD INSERTS AND PAN INSERTS OF ALUMINUM FOIL.

FIRST USE ; IN COMMERCE .

ELEMENTS CORRECTED
GOODS/SERVICES

PROPER LOCK

THE MARK CONSISTS OF STANDARD CHARACTERS WITHOUT CLAIM TO ANY PARTICULAR FONT, STYLE, SIZE, OR COLOR.

NO CLAIM IS MADE TO THE EXCLUSIVE RIGHT TO USE "LOCK", APART FROM THE MARK AS SHOWN.

INT. CL. 13/U.S. CLS. 2 AND 9

FOR SECURITY DEVICES FOR FIREARMS, NAMELY, GUN LOCKS.

FIRST USE 12-6-2009; IN COMMERCE 12-6-2009.

ELEMENTS CORRECTED

DATE OF FIRST USE

DATE OF FIRST USE IN COMMERCE

3,761,342. REG. 3-16-2010. GOVERNMENT OF THE NORTHWEST TERRITORIES (CANADA TERRITORIAL GOVERNMENT) 5102-50TH AVE., 6TH FLOOR, SCOTIA CENTR, E., YELLOWKNIFE, CANADA, X1A2L9, SN 78-374,129. FILED 2-25-2004. PRINCIPAL REGISTER.



PRIORITY CLAIMED UNDER SEC. 44(D) ON CANADA APPLICATION NO. 1206497, FILED 2-16-2004, REG. NO. TMA725312, DATED 10-3-2008, EXPIRES 10-3-2023.

NO CLAIM IS MADE TO THE EXCLUSIVE RIGHT TO USE "GOVERNMENT CERTIFIED", APART FROM THE MARK AS SHOWN.

THE MARK CONSISTS OF DIAMOND DESIGN WITH MAPLE LEAF.

INT. CL. 9/U.S. CLS. 21, 23, 26, 36 AND 38

FOR AUDIO VISUAL AND MULTIMEDIA PRODUCTS EXCLUDING SOFTWARE, NAMELY, PRERECORDED AUDIO AND PRERECORDED VIDEO CASSETTES, PRERECORDED COMPACT DISCS, PRERECORDED CD-ROMS, PRERECORDED DVDS, ALL RELATING TO TOURISM, TOURISM PRODUCTS, ECONOMIC DEVELOPMENT, AND NATURAL RESOURCES OF THE NORTHWEST TERRITORIES OF CANADA AND TO DIAMONDS AND THE DIAMOND INDUSTRY IN CANADA.

INT. CL. 14/U.S. CLS. 2, 27, 28 AND 50

FOR DIAMONDS, JEWELRY, AND ORNAMENTAL PINS.

INT. CL. 16/U.S. CLS. 2, 5, 22, 23, 29, 37, 38 AND 50

FOR PRINTED PROMOTIONAL MATERIALS REGARDING DIAMONDS AND THE DIAMOND INDUSTRY IN CANADA, NAMELY, BOOKS, BROCHURES, LEAFLETS, PAMPHLETS, CATALOGUES, CERTIFICATES, POST CARDS, MAPS, NEWSLETTERS, PRESS RELEASES, INFORMATION GUIDES, POSTERS, GREETING CARDS, TOURIST AND MEDIA INFORMATION KITS, STATIONERY KITS, NAMELY, ENVELOPES, WRITING PAPER, PENS AND CARDS; WRITING PADS, RETAIL TAGS ON THE SUBJECT OF DIAMONDS; PAPER FLAGS; AND PENS.

FIRST USE ; IN COMMERCE .
INT. CL. 35/U.S. CLS. 100, 101 AND 102

FOR PROMOTING WHOLESALE AND RETAIL JEWELRY STORE SERVICES OF OTHERS FEATURING DIAMONDS AND JEWELRY THROUGH THE DISTRIBUTION OF PROMOTIONAL MATERIALS AND BY RENDERING SALES PROMOTION ADVICE, AND BY PREPARING AND PLACING ADVERTISEMENTS IN AN ELECTRONIC MAGAZINE ACCESSED THROUGH A GLOBAL COMPUTER NETWORK; WHOLESALE AND RETAIL STORES FEATURING DIAMONDS AND JEWELRY.

ELEMENTS CORRECTED
ENTITY

3,763,831. REG. 3-23-2010. AMERICAN CANCER SOCIETY, INC. (NEW YORK CORPORATION) 250 WILLIAMS STREET, ATLANTA, GA, 303031002, SN 77-340,839. FILED 11-30-2007. PRINCIPAL REGISTER.

AMERICAN CANCER SOCIETY
DISCOVERY BALL

THE MARK CONSISTS OF STANDARD CHARACTERS WITHOUT CLAIM TO ANY PARTICULAR FONT, STYLE, SIZE, OR COLOR.

OWNER OF U.S. REG. NOS. 1,371,902, 2,628,775 AND OTHERS.

NO CLAIM IS MADE TO THE EXCLUSIVE RIGHT TO USE "BALL", APART FROM THE MARK AS SHOWN.

AS TO "AMERICAN CANCER SOCIETY".
INT. CL. 35/U.S. CLS. 100, 101 AND 102

FOR ORGANIZING AND CONDUCTING CHARITY AUCTIONS FOR CHARITABLE FUNDRAISING SERVICES.

FIRST USE 12-8-2009; IN COMMERCE 12-8-2009.
INT. CL. 36/U.S. CLS. 100, 101 AND 102

FOR CHARITABLE FUNDRAISING SERVICES BY MEANS OF AN ANNUAL BLACK-TIE ENTERTAINMENT EVENT.

FIRST USE 12-8-2009; IN COMMERCE 12-8-2009.

ELEMENTS CORRECTED
DATE OF FIRST USE

3,771,761. REG. 4-6-2010. VIROC PORTUGAL -; INDÚSTRIAS DE MADEIRAE CIMENTO, S.A. (PORTUGAL SCOCIETE ANONYME) VALE DA ROSA, ESTRADA NACIONAL 10, KM 44.7; P-2914-519SETUBAL, PORTUGAL., SN 79-067,370. FILED 1-16-2009. PRINCIPAL REGISTER.



PRIORITY DATE OF 7-17-2008 IS CLAIMED.
OWNER OF INTERNATIONAL REGISTRATION 0998979 DATED 1-16-2009, EXPIRES 1-16-2019.

OWNER OF U.S. REG. NO. 2,387,252.
THE COLOR(S) ORANGE AND GREY IS/ARE CLAIMED AS A FEATURE OF THE MARK.

ORANGE LINES AND THE WORD "VIROC" IN GREY.
THE MARK CONSISTS OF ORANGE LINES AND THE WORD "VIROC" IN GREY.

THE WORDING "VIROC" HAS NO MEANING IN A FOREIGN LANGUAGE.

INT. CL. 19/U.S. CLS. 1, 12, 33 AND 50
FOR NON-METALLIC RIGID PIPES FOR BUILDING; ASPHALT, PITCH AND BITUMEN; NON-METALLIC TRANSPORTABLE CONSTRUCTIONS, NON-METALLIC MONUMENTS, NAMELY, CEMENT-BACKED WOOD PARTICLE BOARDS FOR WALLS, NON-METALLIC PARTITIONS, CEILING PANELS AND FLOORING.

FIRST USE ; IN COMMERCE .
INT. CL. 37/U.S. CLS. 100, 103 AND 106
FOR CONSTRUCTION OF BUILDINGS; CLEANING AND REPAIR OF BUILDINGS; PAINTING.
FIRST USE ; IN COMMERCE .

ELEMENTS CORRECTED
[PRIOR U.S. REGS.]

3,772,522. REG. 4-6-2010. LEVITY RECORDS, LLC (TENNESSEE LIMITED LIABILITY COMPANY) 12347 VISTA BROOKE LANE, KNOXVILLE, TN, 37934, SN 77-511,426. FILED 6-30-2008. PRINCIPAL REGISTER.

CALLANN LANE

THE MARK CONSISTS OF STANDARD CHARACTERS WITHOUT CLAIM TO ANY PARTICULAR FONT, STYLE, SIZE, OR COLOR.

INT. CL. 25/U.S. CLS. 22 AND 39
FOR CLOTHING, NAMELY, T-SHIRTS.
FIRST USE 12-9-2009; IN COMMERCE 12-9-2009.

ELEMENTS CORRECTED
GOODS/SERVICES

3,773,730. REG. 4-6-2010. SIEMENS HEALTHCARE DIAGNOSTICS INC. (CALIFORNIA CORPORATION) 1717 DEERFIELD ROAD, DEERFIELD, IL, 60015, SN 77-678,358. FILED P.R. 2-25-2009; AM. S.R. 1-20-2010. SUPPLEMENTAL REGISTER.

3,774,343. REG. 4-13-2010. MESOPHASE TECHNOLOGIES INC. (TAIWAN CORPORATION) 3F. NO. 10, LANE 31, SEC.1, HUNG DUNG RD, TAINAN SCIENCE PARK, SINSHIH TOWNSHIP, TAIWAN, R.O.C., SN 77-774,481. FILED 7-6-2009. PRINCIPAL REGISTER.

Oncogene Science

THE MARK CONSISTS OF STANDARD CHARACTERS WITHOUT CLAIM TO ANY PARTICULAR FONT, STYLE, SIZE, OR COLOR.

NO CLAIM IS MADE TO THE EXCLUSIVE RIGHT TO USE "SCIENCE", APART FROM THE MARK AS SHOWN.

INT. CL. 1/U.S. CLS. 1

FOR DIAGNOSTIC PREPARATIONS FOR SCIENTIFIC OR RESEARCH USE; DIAGNOSTIC REAGENTS FOR CLINICAL OR MEDICAL LABORATORY USE.

FIRST USE 3-31-1999; IN COMMERCE 3-31-1999.

INT. CL. 5/U.S. CLS. 6, 18, 44, 46, 51 AND 52

FOR MEDICAL DIAGNOSTIC REAGENTS.

FIRST USE 3-31-1999; IN COMMERCE 3-31-1999.

ELEMENTS AMENDED
CITIZENSHIP

3,773,834. REG. 4-13-2010. LIMITLESS SOLUTIONS LLC (DELAWARE LIMITED LIABILITY COMPANY) 709 N. CABLE ROAD, LIMA, OH, 45805, SN 76-688,081. FILED 3-26-2008. PRINCIPAL REGISTER.

THIN & HEALTHY

THE MARK CONSISTS OF STANDARD CHARACTERS WITHOUT CLAIM TO ANY PARTICULAR FONT, STYLE, SIZE, OR COLOR.

SEC. 2(F).

INT. CL. 44/U.S. CLS. 100 AND 101

FOR WEIGHT REDUCTION, DIET AND HEALTH PLANNING, AND SUPERVISION FOR MEN AND WOMEN.

FIRST USE 3-1-1994; IN COMMERCE 3-1-1994.

ELEMENTS CORRECTED
OWNER ADDRESS



THE MARK CONSISTS OF THE CAPITAL LETTERS "R, T, S, E" AND "S" WITH A LEAF DESIGN ABOVE AND BETWEEN THE LAST TWO LETTERS.

INT. CL. 3/U.S. CLS. 1, 4, 6, 50, 51 AND 52

FOR ESSENTIAL OILS, ASTRINGENTS FOR COSMETIC PURPOSES, BEAUTY MASKS, COSMETICS, COSMETIC CREAMS, PERFUMES, GREASES FOR COSMETIC PURPOSES, HAIR LOTIONS, LOTIONS FOR COSMETIC PURPOSES, MEDICATED SOAP, NAIL POLISH, OILS FOR PERFUMES AND SCENTS, SHAMPOOS, COSMETIC PREPARATIONS FOR SKIN CARE, SKIN WHITENING CREAMS, COSMETIC PREPARATIONS FOR SLIMMING PURPOSES, NAMELY, CREAMS AND LOTIONS FOR CELLULITE REDUCTION, CLEANSING MILK FOR TOILET PURPOSES, MAKE-UP PREPARATIONS, SUNSCREEN PREPARATIONS.

FIRST USE 11-12-2007; IN COMMERCE 11-12-2007.

INT. CL. 5/U.S. CLS. 6, 18, 44, 46, 51 AND 52

FOR DIETETIC BEVERAGES ADAPTED FOR MEDICAL PURPOSES; DIETETIC SUBSTANCES ADAPTED FOR MEDICAL USE, NAMELY, NUTRITIONAL SUPPLEMENTS AND FOOD FOR BABIES; DIETETIC FOODS ADAPTED FOR MEDICAL PURPOSES; MINERAL FOOD-SUPPLEMENTS; NUTRITIONAL ADDITIVES FOR MEDICAL PURPOSES FOR USE IN FOOD AND DIETARY SUPPLEMENTS FOR HUMAN CONSUMPTION; MEDICAL PREPARATIONS FOR SLIMMING PURPOSES, NAMELY, APPETITE SUPPRESSANTS, DIET CAPSULES AND PILLS; VITAMIN PREPARATIONS; PHARMACEUTICAL PREPARATIONS FOR SKIN CARE; OINTMENTS FOR PHARMACEUTICAL PURPOSES FOR THE TREATMENT OF CANCER; DRIED MEDICINAL HERBS; NON-NUTRITIVE EDIBLE PLANT FIBERS FOR THE TREATMENT OF CONSTIPATION; LECITHIN FOR MEDICAL PURPOSES; HERB TEAS FOR MEDICINAL PURPOSES.

FIRST USE 11-12-2007; IN COMMERCE 11-12-2007.

INT. CL. 7/U.S. CLS. 13, 19, 21, 23, 31, 34 AND 35

FOR MACHINES AND MACHINE TOOLS, NAMELY, FOR THE CHEMICAL, PHARMACEUTICAL, BIOCHEMICAL, COSMETIC AND BIOTECHNOLOGICAL INDUSTRIES AND THE FOOD INDUSTRY, NAMELY, MACHINES AND MACHINE TOOLS USED FOR GROWING, PROCESSING, EXTRACTING, AND STORING BACTERIA, ANIMAL CELLS AND PLANT CELLS FOR THE PRODUCTION OF BIOLOGICAL PRODUCTS IN THE NATURE OF VACCINES, THERAPEUTIC AND DIAGNOSTIC PREPARATIONS AND PROTEINS AND FOOD AND COSMETIC AND COMPONENT PARTS THEREOF, ELECTROMECHANICAL MACHINES FOR FOOD PREPARATION AND COSMETIC, CENTRIFUGAL MACHINES, FLOUR MILL MACHINES, MIXING MACHINES, BIODIESEL MACHINES, NAMELY, MIXING EQUIPMENT, PUMPS AND HEATERS.

FIRST USE 11-12-2007; IN COMMERCE 11-12-2007.

ELEMENTS CORRECTED
OWNER ADDRESS

JUNE 22, 2010

U.S. PATENT AND TRADEMARK OFFICE

TM 1637

3,779,971. REG. 4-27-2010. TAKEDA PHARMACEUTICAL
COMPANY LIMITED (JAPAN CORPORATION) 1-1,
DOSHOMACHI 4-CHOME, CHUO-KU, OSAKA, JAPAN.,
SN 77-540,448. FILED 8-6-2008. PRINCIPAL REGISTER.

FOR PHARMACEUTICAL PREPARATIONS FOR THE
TREATMENT AND PREVENTION OF DIABETIC DIS-
EASES.

ELEMENTS CORRECTED
OWNER NAME

NESACTO

THE MARK CONSISTS OF STANDARD CHARACTERS
WITHOUT CLAIM TO ANY PARTICULAR FONT, STYLE,
SIZE, OR COLOR.

PRIORITY CLAIMED UNDER SEC. 44(D) ON JAPAN
APPLICATION NO. 2008-21650, FILED 3-24-2008, REG. NO.
5220532, DATED 4-3-2009, EXPIRES 4-3-2019.
INT. CL. 5/U.S. CLS. 6, 18, 44, 46, 51 AND 52

* * * * *

TRADEMARK REGISTRATIONS—NEW CERTIFICATES

New Certificates issued under section 7(d) of the Trademark Act of 1946 for the unexpired term of the original registrations.

1,362,018. VITAMINS. INT. CL. 25. CELEBRITY INTERNATIONAL, INC., NEW YORK, NY. REG. 9-24-1985. NEW CERT. SEC. 7(D) TO REGISTRANT.

3,760,097. RESCUE INK STANDARD CHARACTER MARK. INT. CL. 39. RESCUE INK PRODUCTIONS LLC, FARMINGVILLE, NY. REG. 3-16-2010. NEW CERT. SEC. 7(D) TO

3,801,436. ARISTON AND DESIGN, INT. CLS. 7, 9, 11 AND 37. M. & B. MARCHI E BREVETTI S.R.L., FABRIANO (AN), ITALY. REG. 11-29-2005. NEW CERT. SEC. 7(D) TO REGISTRANT.

* * * * *

INDEX OF REGISTRANTS

JUNE 22, 2010

(Registered; Renewed; Canceled; Amended, Corrected, etc.; New Certificates; 12c Publications.)

The designation "U.S. Cl." appearing in this section refers to the U.S. class in effect prior to Sep. 1, 1973 rather than the international class which applies to applications filed on or after that date. For adoption of international classification see notice in the OFFICIAL GAZETTE of Jun. 26, 1973 (911 O.G. TM 210).

- @RTMOLECULE, FRANCE:
3,807,149, PUB. 4-6-2010. MULTIPLE CLASS, INT. CLS. 1,
5 AND 42.
- "HTL-STREFA" SPÓLKA AKCYJNA, POLAND:
3,807,326, PUB. 4-6-2010. MULTIPLE CLASS, INT. CLS. 10
AND 16.
- ÉELIOS, INC., OMAHA, NE:
3,806,706, PUB. 4-6-2010. INT. CL. 9.
- A & H SPORTSWEAR CO., INC., STOCKERTOWN, PA:
2,350,414, REN. 5-20-10. INT. CL. 25.
- A CHEERFUL GIVER INC., ELMER, NJ:
2,770,782, CANC. INT. CL. 4.
- A. DALUMI DIAMONDS LTD., RAMAT GAN, ISRAEL:
3,805,433, PUB. 4-6-2010. INT. CL. 14.
- A. RICHARD TOOLS CO., BERTHIERVILLE, QUEBEC,
CANADA:
3,805,348, PUB. 4-6-2010. MULTIPLE CLASS, INT. CLS. 6,
16 AND 20.
- A.H. BEARD PTY LTD, PADSTOW, AUSTRALIA:
3,805,305, PUB. 9-1-2009. INT. CL. 20.
- A.P. GREEN INDUSTRIES, INC., MOON TOWNSHIP, PA:
3,805,555, PUB. 4-6-2010. INT. CL. 19.
- A.V. BRANDS, INC., BALTIMORE, MD, DBA AVENÍU
BRANDS:
3,805,895, PUB. 4-6-2010. INT. CL. 35.
3,805,896, PUB. 4-6-2010. INT. CL. 35.
- A&D ENVIRONMENTAL SERVICES, INC., HIGH POINT,
NC:
3,805,363, PUB. 4-6-2010. MULTIPLE CLASS, INT. CLS.
37, 40 AND 42.
- A&E TELEVISION NETWORKS, LLC, NEW YORK, NY:
2,771,914, CANC. INT. CL. 41.
- A-BOY SUPPLY CO., PORTLAND, OR:
2,286,811, CANC. INT. CL. 11.
- A-LIST PROMOTIONS, LLC, PHILADELPHIA, PA:
2,771,795, CANC. INT. CL. 35.
- AAR CORP., WOOD DALE, IL:
2,389,476, REN. 5-19-10. MULTIPLE CLASS, INT. CLS. 35,
37, 39 AND 42.
- AARONSON, KATHLEEN, BEVERLY HILLS, CA:
3,806,549, PUB. 4-6-2010. INT. CL. 35.
- AB HOLDINGS, LLC, BOISE, ID:
2,356,152, REN. 5-14-10. INT. CL. 35.
- ABAKUS WERTKONTOR AG, D-10115, BERLIN, FED REP
GERMANY:
2,770,780, CANC. MULTIPLE CLASS, INT. CLS. 9, 36, 38
AND 42.
- ABB AG, AUSTRIA:
3,807,120, PUB. 4-6-2010. MULTIPLE CLASS, INT. CLS. 7
AND 9.
3,807,121, PUB. 4-6-2010. MULTIPLE CLASS, INT. CLS. 7
AND 9.
- ABBEY COLOR INCORPORATED, PHILADELPHIA, PA:
2,197,665, REN. 5-18-10. INT. CL. 16.
- ABBEY GROUP LTD., THE, LOMBARD, IL:
1,560,107, CANC. MULTIPLE CLASS, INT. CLS. 35 AND
42.
- ABBYLAND FOODS, INC., ABBOTSFORD, WI:
1,640,951, REN. 5-17-10. INT. CL. 30.
- ABELMAN, FRAYNE & SCHWAB, NEW YORK, NY:
3,807,491, INT. CL. 45.
- ABLE SOFTWARE CORP., LEXINGTON, MA:
2,771,778, CANC. INT. CL. 9.
- ABOCOM SYSTEMS, INC., HSINCHU, TAIWAN:
2,772,236, CANC. INT. CL. 9.
- ABP INTERNATIONAL, INC., NEW YORK, NY:
3,808,705, MULTIPLE CLASS, INT. CLS. 41 AND 42.
- ABREU TOURS, INC., NEW YORK, NY:
2,351,191, REN. 5-18-10. MULTIPLE CLASS, INT. CLS. 39
AND 42.
- ABSOLUTE COATINGS, INC., NEW ROCHELLE, NY:
3,808,721, INT. CL. 3.
- ABSTRACT INTERNATIONAL, INC., SAN DIEGO, CA:
3,806,826, PUB. 4-6-2010. INT. CL. 32.
- AC-CETERA, INC., PITTSBURGH, PA:
2,366,495, REN. 5-19-10. INT. CL. 20.
- ACADEMY BROADWAY CORP., SMITHTOWN, NY:
1,559,820, CANC. MULTIPLE CLASS, INT. CLS. 18, 20
AND 22.
- ACADEMY OF APPLIED SCIENCE, INC., CONCORD, NH:
2,305,271, REN. 5-18-10. INT. CL. 41.
- ACADEMY, LTD., KATY, TX:
2,838,337, CANC. INT. CL. 12.
- ACAPULCO GOLD LLC, BROOKLYN, NY:
3,806,476, PUB. 4-6-2010. INT. CL. 35.
- ACCELA COMMUNICATIONS INC, SOUTHBOROUGH,
MA:
2,772,573, CANC. INT. CL. 42.
- ACCELLION, INC., SAN JOSE, CA:
2,771,581, CANC. MULTIPLE CLASS, INT. CLS. 38 AND
39.
- ACCENT ENERGY GROUP LLC, DUBLIN, OH:
3,806,543, PUB. 4-6-2010. INT. CL. 35.
- ACCENT ENERGY TEXAS LP, DUBLIN, OH:
3,806,545, PUB. 4-6-2010. INT. CL. 35.
- ACCESS BRAND STRATEGIES, FRANKLIN, TN:
3,805,879, PUB. 12-29-2009. INT. CL. 35.
- ACCESS NATURE, INC., MANORHAVEN, NY:
3,808,609, INT. CL. 21.
- ACCO BRANDS CORPORATION, LINCOLNSHIRE, IL,
ACCO BRANDS, INC., LINCOLNSHIRE, IL:
2,349,497, REN. 5-18-10. MULTIPLE CLASS, INT. CLS. 9
AND 11.
- ACCOUNTABILITY TOOLS, LLC., FT. LAUDERDALE, FL:
3,808,773, INT. CL. 9.
- ACCREDITED HOME CAPITAL, INC., SAN DIEGO, CA:
2,772,213, CANC. INT. CL. 36.
- ACCU DATA CORP., HICKSVILLE, NY:
2,771,417, CANC. INT. CL. 35.
- ACCUFORCE STAFFING SERVICES, LLC, KINGSPORT,
TN:
2,328,906, REN. 5-14-10. INT. CL. 35.
- ACCURI CYTOMETERS, INC., ANN ARBOR, MI:
3,808,290, INT. CL. 9.
- ACCURIDE INTERNATIONAL INC., SANTA FE SPRINGS,
CA:
3,808,229, INT. CL. 6.
- ACE TOMATO CO., INC., MANTECA, CA:
3,807,706, INT. CL. 31.
- ACELLENT TECHNOLOGIES, INC., SUNNYVALE, CA:
3,807,894, INT. CL. 9.
- ACF COMPONENTS & FASTENERS, INC., HAYWARD, CA:
2,355,956, REN. 5-20-10. INT. CL. 35.

- ACH FOAM TECHNOLOGIES, LLC, DENVER, CO:
3,806,709, PUB. 4-6-2010. INT. CL. 19.
3,806,714, PUB. 4-6-2010. INT. CL. 20.
- ACH FOOD COMPANIES, INC., CORDOVA, TN:
1,596,405. REN. 5-18-10. INT. CL. 16.
- ACHIM'S FRANCHISING, LLC, ATHENS, GA:
3,807,555, INT. CL. 43.
- ACI INTERNATIONAL, LOS ANGELES, CA:
3,808,463, INT. CL. 25.
3,808,467, INT. CL. 25.
- ACME FOAM COMPANY, WEST PALM BEACH, FL, DBA AZTECH SUPPLIES:
3,806,436, PUB. 4-6-2010. MULTIPLE CLASS, INT. CLS. 9 AND 17.
- ACONDA PAPER, S.A., 08008-BARCELONA, SPAIN:
2,284,666, CANC. INT. CL. 16.
- ACOR ORTHOPAEDIC, INC., CLEVELAND, OH:
2,421,554. REN. 5-20-10. INT. CL. 25.
- ACROLAB LTD., WINDSOR, ONTARIO, CANADA:
3,806,158, PUB. 4-6-2010. INT. CL. 6.
- ACRY FAB, INC., SUN PRAIRIE, WI:
2,349,437. REN. 5-18-10. INT. CL. 21.
- ACTARIS S.A.S., F-92100 BOULOGNE-BILLAN COURT, FRANCE:
3,476,938, COR. MULTIPLE CLASS, INT. CLS. 9, 35, 38 AND 42.
- ACTIONPACT CORP., BERKELEY, CA:
3,807,701, INT. CL. 25.
- ACTIVE MINING AG, 86150 AUGSBURG, FED REP GERMANY:
2,770,614, CANC. MULTIPLE CLASS, INT. CLS. 35, 38, 41 AND 42.
- ACTIVE ORGANICS, LP, LEWISVILLE, TX:
3,807,530, INT. CL. 3.
- ACTIVENGAGE, INC., ORLANDO, FL:
3,806,634, PUB. 4-6-2010. INT. CL. 35.
- ACUMANTRA SOLUTIONS, INC., LEXINGTON, KY:
3,806,715, PUB. 4-6-2010. INT. CL. 35.
- ACUMENT INTELLECTUAL PROPERTIES, LLC, WILMINGTON, DE:
1,559,544, CANC. INT. CL. 6.
- ACUNIA, B-3000 LEUVEN, BELGIUM:
2,770,570, CANC. MULTIPLE CLASS, INT. CLS. 9, 35 AND 42.
- ADAM UGOLNIK, WEST HOLLYWOOD, CA, DBA KARL CLAY:
3,808,475, INT. CL. 16.
- ADAMS SALES, INC., BONITA SPRINGS, FL:
3,806,910, PUB. 4-6-2010. INT. CL. 35.
- ADVANCED RESPONSE CORPORATION, NEW YORK, NY:
2,772,481, CANC. INT. CL. 5.
- ADC TELECOMMUNICATIONS, INC., EDEN PRAIRIE, MN:
2,379,921. REN. 5-18-10. INT. CL. 9.
3,807,417, MULTIPLE CLASS, INT. CLS. 37 AND 41.
- ADCO PRODUCTS, INC., MICHIGAN CENTER, MI:
3,807,777, MULTIPLE CLASS, INT. CLS. 1 AND 17.
- ADECCO SA, CHESEREX, SWITZERLAND:
2,771,598, CANC. MULTIPLE CLASS, INT. CLS. 35, 41 AND 42.
- ADELANTE CREATIONS, SHERMAN OAKS, CA:
2,771,870, CANC. INT. CL. 25.
- ADELHOLZENER ALPENQUELLEN GMBH, SIEGSDORF, FED REP GERMANY:
3,807,247, PUB. 4-6-2010. INT. CL. 32.
- ADERRA INC., SOUTH PASADENA, CA, DBA EDWARD DONNELLY:
3,805,244, PUB. 10-21-2008. INT. CL. 9.
- ADIDAS SPORTSCHUHFABRIKEN ADI DASSLER STIFTUNG & CO. KG, HERZOGENAURACH, FED REP GERMANY TO ADIDAS AG, D-91074/HERZOGENAURACH, FED REP GERMANY:
1,559,951, CANC. INT. CL. 25.
- ADITALL, LLC, NEW YORK, NY:
3,807,464, MULTIPLE CLASS, INT. CLS. 35 AND 41.
- ADIUM, LLC, JACKSONVILLE, FL:
3,806,072, PUB. 4-6-2010. INT. CL. 36.
- ADP PLEASANTON NATIONAL SERVICE CENTER, INC., PLEASANTON, CA:
2,285,945, CANC. INT. CL. 36.
- ADRIAN FABRICATORS, INC., ADRIAN, MI:
3,807,482, INT. CL. 6.
- ADRIEN ARPEL, INC., NEW YORK, NY:
1,559,493, CANC. INT. CL. 3.
- ADS INC., ST-ELZÉAR, BEAUCE NORD, CANADA:
3,805,218, PUB. 3-2-2010. INT. CL. 3.
- AD SIGNALS, INC., SUNNYVALE, CA:
3,806,485, PUB. 4-6-2010. INT. CL. 35.
- ADVALUE MEDIA AB, STOCKHOLM 114 83, SWEDEN:
2,770,779, CANC. INT. CL. 35.
- ADVANCE CHOICE GROUP, LLC, AURORA, CO:
3,806,993, PUB. 4-6-2010. INT. CL. 44.
3,806,994, PUB. 4-6-2010. INT. CL. 44.
- ADVANCE MAGAZINE PUBLISHERS INC., NEW YORK, NY:
3,807,399, MULTIPLE CLASS, INT. CLS. 35 AND 43.
- ADVANCE MAGAZINE PUBLISHERS, INC., NEW YORK, NY:
3,808,202, MULTIPLE CLASS, INT. CLS. 16 AND 28.
- ADVANCED BIONICS, LLC, VALENCIA, CA:
2,427,427. REN. 5-14-10. INT. CL. 10.
- ADVANCED DISPLAY TECHNOLOGY AG, CH-9050 APENZELL, SWITZERLAND:
3,807,107, PUB. 4-6-2010. MULTIPLE CLASS, INT. CLS. 9, 14 AND 16.
- ADVANCED DRIVE TECHNOLOGY, GYEONGGI-DO, REPUBLIC OF KOREA:
3,806,684, PUB. 4-6-2010. INT. CL. 9.
- ADVANCED MEASUREMENT TECHNOLOGY, INC., OAK RIDGE, TN:
2,350,036. REN. 5-15-10. INT. CL. 9.
- ADVANCED MEDICAL TECHNOLOGY ASSOCIATION, WASHINGTON, DC:
3,808,592, MULTIPLE CLASS, INT. CLS. 16 AND 42.
- ADVANCED SEMICONDUCTOR ENGINEERING, INC., KAOHSIUNG, TAIWAN:
2,771,120, CANC. INT. CL. 9.
- ADVANCED TECHNOLOGY LABORATORIES, INC., A PHILIPS MEDICAL SYSTEMS COMPANY, BOTHELL, WA:
2,770,907, CANC. MULTIPLE CLASS, INT. CLS. 37 AND 42.
- ADVANCEDMD SOFTWARE, INC., DRAPER, UT:
3,808,440, INT. CL. 42.
- ADVANTACLEAN SYSTEMS, INC., HUNTERSVILLE, NC:
3,805,697, PUB. 4-6-2010. INT. CL. 37.
- ADVANTAGE HOUSEWARES, INC., BUFFALO, NY:
2,772,743, CANC. INT. CL. 20.
- ADVANTAGE MARKETING INCORPORATED, SALT LAKE CITY, UT:
3,806,452, PUB. 4-6-2010. INT. CL. 40.
- ADVANTAGE SALES & MARKETING, LLC, IRVINE, CA:
3,807,375, INT. CL. 16.
- ADVANTEX MARKETING INTERNATIONAL INC., ONTARIO, CANADA:
2,770,708, CANC. MULTIPLE CLASS, INT. CLS. 16 AND 35.
- ADVENTURE HOLDINGS LLC, PUKALANI, HI:
3,805,718, PUB. 4-6-2010. INT. CL. 41.
- ADVOCARE INTERNATIONAL, L.L.C., CARROLLTON, TX:
2,771,716, CANC. INT. CL. 5.
- AEROBICS AND FITNESS ASSOCIATION OF AMERICA, SHERMAN OAKS, CA:
3,807,370, MULTIPLE CLASS, INT. CLS. 41 AND 42.
- AEROFRAME SERVICES, LLC, LAKE CHARLES, LA:
3,806,722, PUB. 4-6-2010. INT. CL. 37.
- AES ENGINEERING LTD., ROTHERHAM, UNITED KINGDOM:
3,805,202, PUB. 4-6-2010. MULTIPLE CLASS, INT. CLS. 6, 7, 17, 37 AND 42.
- AESCULAP IMPLANT SYSTEMS, INC., CENTER VALLEY, PA:
3,806,171, PUB. 4-6-2010. INT. CL. 10.
- AESTHETIC FACTORS, LLC, WAYNE, NJ:
3,806,155, PUB. 4-6-2010. INT. CL. 10.

AETNA INC., BLUE BELL, PA:
2,772,654, CANC. INT. CL. 36.

AF FINANCIAL GROUP, WEST JEFFERSON, NC:
3,807,632, INT. CL. 36.

AFFILIATED REGIONAL COMMUNICATIONS, LTD., HOUSTON, TX:
1,560,170, CANC. MULTIPLE CLASS, INT. CLS. 38 AND 41.

AFFINITY INSURANCE SERVICES, INC., CHICAGO, IL:
3,806,468, PUB. 4-6-2010. INT. CL. 36.

AFFILIATED INDEPENDENT DISTRIBUTORS, INC., KING OF PRUSSIA, PA:
2,352,795. REN. 5-14-10. INT. CL. 11.

AFTABEL UNLIMITED, LLC, COOPER CITY, FL:
3,805,827, PUB. 4-6-2010. INT. CL. 9.

AGA RANGEMASTER GROUP PLC, WARWICKSHIRE, UNITED KINGDOM:
3,807,089, PUB. 4-6-2010. MULTIPLE CLASS, INT. CLS. 11, 35 AND 37.

AGEE, JOHN M., SACRAMENTO, CA, AGEE, JOHN M., SACRAMENTO, CA:
2,357,705. REN. 5-19-10. INT. CL. 10.

AGENCY FOR SCIENCE, TECHNOLOGY AND; RESEARCH, SINGAPORE:
3,807,278, PUB. 4-6-2010. MULTIPLE CLASS, INT. CLS. 9, 42 AND 44.

AGENZIA NAZIONALE PER L'ATTRAZIONE DEGLI INVESTIMENTI E LO SVILUPPO D'IMPRESA S.P.A. ITALY:
3,807,208, PUB. 4-6-2010. MULTIPLE CLASS, INT. CLS. 35 AND 36.

AGFA-GEVAERT AKTIENGESELLSCHAFT, LEVERKUSEN, FED REP GERMANY:
1,559,475, CANC. INT. CL. 1.

AGGREGATE SYSTEMS, INC., BLUFFTON, IN:
2,771,261, CANC. INT. CL. 27.

AGNEW, LELA RHIS USRY, CHARLESTON, SC:
2,771,707, CANC. INT. CL. 36.

AGOSTINO'S RESTAURANT, INCORPORATED, CREVE COEUR, MO, AKA AGOSTINO'S COLOSSEUM:
1,560,229, CANC. INT. CL. 42.

AGPRO INDUSTRIES, LLC, EASTMAN, GA:
3,808,723, INT. CL. 31.

AGRIMICROBE SALES, L.C., BROADNAX, VA:
2,338,088. REN. 5-14-10. INT. CL. 1.

AGRO GLOBAL TRADING INC, INDEPENDENCES, LA:
3,807,873, INT. CL. 19.

AGROLABS, INC., HILLSIDE, NJ:
3,808,717, INT. CL. 5.

AGROSELECT SNACKS, C.A., CANTAURA, EDO., ANZOATEGUI, VENEZUELA:
2,285,608, CANC. INT. CL. 29.

AGS ADVANCED GLOBAL SERVICES LLC, LONG BEACH, CA:
3,806,258, PUB. 4-6-2010. INT. CL. 32.

AGUERRE, ALBERTO FERNANDO, SAN DIEGO, CA:
2,772,127, CANC. INT. CL. 25.

AGUILAR ALMANZA, RICARDO ANTONIO, GUADALAJARA, JALISCO, MEXICO:
3,806,668, PUB. 4-6-2010. INT. CL. 33.

AHEAD, INC., NEW BEDFORD, MA:
3,808,599, INT. CL. 25.

AHMED O. ELHADARY, GLENDALE, CA:
3,806,809, PUB. 4-6-2010. INT. CL. 21.

AHMED, SAAD, LOMITA, CA:
3,808,276, INT. CL. 25.

AIR CONDITIONING CONTRACTORS OF AMERICA, WASHINGTON, DC:
2,428,107. REN. 5-17-10. INT. CL. 35.

AIR LIQUIDE AMERICA SPECIALTY GASES LLC., HOUSTON, TX:
2,349,914. REN. 5-19-10. INT. CL. 35.
2,350,053. REN. 5-19-10. INT. CL. 35.

AIR PACIFIC LTD., NADI, FIJI:
2,771,068, CANC. INT. CL. 39.

AIR PRODUCTS AND CHEMICALS, INC., ALLENTOWN, PA:
1,559,698, CANC. INT. CL. 11.
2,371,286. REN. 5-19-10. INT. CL. 1.

AIRBAND COMMUNICATIONS, INC., DALLAS, TX:
2,772,405, CANC. INT. CL. 38.

AIRCRAFT RUBBER MANUFACTURING, INC, REDMOND, OR:
3,806,077, PUB. 4-6-2010. INT. CL. 12.

AIRLINES REPORTING CORPORATION, ARLINGTON, VA:
3,805,958, PUB. 4-6-2010. MULTIPLE CLASS, INT. CLS. 35 AND 42.

AISIN SEIKI CO. LTD., AICHI, JAPAN:
1,559,553, CANC. INT. CL. 7.

AJINOMOTO CO., INC., CHUO-KU, TOKYO, JAPAN:
3,807,422, INT. CL. 30.

AKEMI CHEMISCH TECHNISCHE SPEZIALFABRIK GMBH, 90451 NUREMBERG, FED REP GERMANY:
3,805,497, PUB. 4-6-2010. MULTIPLE CLASS, INT. CLS. 1, 3, 17 AND 19.

AKITA, INC., WILMINGTON, DE:
3,806,914, PUB. 4-6-2010. INT. CL. 36.

ALBAUM, ABBY, ST. PETERSBURG, FL:
3,806,694, PUB. 4-6-2010. INT. CL. 28.

ALBERT GELI MARTI, SPAIN:
3,807,224, PUB. 4-6-2010. INT. CL. 19.

ALBERTO BIANI S.P.A., NOVENTA VICENTINA (VICENZA), ITALY:
2,414,513. REN. 5-15-10. INT. CL. 25.

ALCOA INC., PITTSBURGH, PA:
2,772,310, CANC. MULTIPLE CLASS, INT. CLS. 9 AND 35.

ALCON, INC., CH-6331 HUNENBERG, SWITZERLAND:
3,805,184, PUB. 4-6-2010. INT. CL. 5.

ALCON, INC., CH-6331 HÜNENBERG, SWITZERLAND:
3,805,825, PUB. 4-6-2010. INT. CL. 9.

ALDERWOODS GROUP INC., CINCINNATI, OH:
2,772,279, CANC. MULTIPLE CLASS, INT. CLS. 6, 16, 19, 20, 31 AND 42.

ALDILA, INC., POWAY, CA:
3,808,642, INT. CL. 28.

ALEGGUP, LLC, SIMPSONVILLE, SC:
3,806,858, PUB. 4-6-2010. INT. CL. 41.

ALEX LEE, INC., HICKORY, NC:
2,350,828. REN. 5-18-10. MULTIPLE CLASS, INT. CLS. 9 AND 42.

ALEXANDER G. SZYNALSKI, CEDAR KNOLLS, NJ:
2,771,580, CANC. INT. CL. 41.

ALEXICO CORPORATION, OVERLAND PARK, KS:
2,285,281, CANC. INT. CL. 36.

ALEXSAM T, LLC, CLEARWATER, FL:
3,808,461, INT. CL. 45.

ALI INDUSTRIES, INC., FAIRBORN, OH:
2,423,939. REN. 5-18-10. MULTIPLE CLASS, INT. CLS. 3 AND 7.

ALIBABA.COM LIMITED, GRAND CAYMAN, CAYMAN ISLANDS:
3,807,065, PUB. 4-6-2010. MULTIPLE CLASS, INT. CLS. 35, 36, 38 AND 42.

ALIMENTIAS EMC S.L., EL PUERTO DE SANTA MAR, SPAIN:
3,807,667, INT. CL. 29.

ALIPHCOM, SAN FRANCISCO, CA:
3,807,619, INT. CL. 9.

ALIVIA, PHARR, TX:
3,806,661, PUB. 4-6-2010. INT. CL. 32.

ALL ABOUT LEARNING PRESS, INC., EAGLE RIVER, WI:
3,806,513, PUB. 4-6-2010. INT. CL. 38.

ALL ENGLAND ENTERPRISES, LTD., MINNEAPOLIS, MN:
3,808,595, MULTIPLE CLASS, INT. CLS. 21 AND 25.

ALL INTERIOR SUPPLY, INC., HIALEAH, FL:
3,805,603, PUB. 4-6-2010. INT. CL. 35.

ALLEGHENY CONFERENCE ON COMMUNITY DEVELOPMENT, PITTSBURGH, PA:
3,807,778, INT. CL. 35.
3,807,779, INT. CL. 35.

ALLEGIS CORPORATION, MINNEAPOLIS, MN:
3,805,694, PUB. 4-6-2010. INT. CL. 35.

ALLEGRA HOLDINGS LLC, NORTHVILLE, MI:
2,770,751, CANC. INT. CL. 42.

- ALLFAST FASTENING SYSTEMS, INC., CITY OF INDUSTRY, CA:
2,772,361, CANC. INT. CL. 6.
- ALLIANCE FOR PATIENT MEDICATION SAFETY, RICHMOND, VA:
3,808,700, INT. CL. 44.
- ALLIED WORLD ASSURANCE COMPANY (U.S.) INC., NEW YORK, NY:
3,807,946, INT. CL. 36.
- ALLOFE SOLUTIONS, LAWRENCE, KS:
3,806,636, PUB. 4-6-2010. INT. CL. 42.
- ALLSTAR MARKETING GROUP, LLC, SCHUYKILL, PA:
2,351,180, REN. 5-18-10. INT. CL. 25.
- ALLTEL COMMUNICATIONS, LLC, LITTLE ROCK, AR:
2,771,740, CANC. INT. CL. 38.
- ALMOST AWESOME INC., CHICAGO, IL:
3,806,179, PUB. 4-6-2010. MULTIPLE CLASS, INT. CLS. 9 AND 41.
- ALO NETWORKS LLC, ROCKVILLE, MD:
3,808,751, MULTIPLE CLASS, INT. CLS. 35 AND 38.
- ALOE VERA OF AMERICA, DALLAS, TX:
3,808,403, INT. CL. 5.
- ALPHA CREATIONS, INC., HOUSTON, TX:
3,808,148, MULTIPLE CLASS, INT. CLS. 14 AND 35.
- ALPHA PHI ALPHA FRATERNITY, INC., BALTIMORE, MD:
2,770,575, CANC. INT. CL. 14.
- ALPHA-OMEGA COMMUNICATIONS, LONGBOAT KEY, FL:
2,771,669, CANC. INT. CL. 9.
- ALPINE SHIRT CO., EVERGREEN, CO:
1,559,924, CANC. INT. CL. 25.
- ALPIQ HOLDING LTD., CH-2001 NEUCHATEL 1, SWITZERLAND:
3,805,425, PUB. 4-6-2010. MULTIPLE CLASS, INT. CLS. 4, 7, 9, 11, 36, 37, 39, 40 AND 42.
- ALTERA CORPORATION, SAN JOSE, CA:
2,284,646, CANC. INT. CL. 9.
- ALTERNATIVE CINEMA, INC., MONTCLAIR, NY:
2,770,568, CANC. INT. CL. 16.
- ALTIA, INC., COLORADO SPRINGS, CO:
2,285,221, CANC. MULTIPLE CLASS, INT. CLS. 9 AND 42.
- ALTINEGE TBB GIDA TEKSTIL SAN. VE TIC. LTD. STI., SEFERIHISAR/IZMIR, TURKEY:
3,808,678, INT. CL. 29.
- ALVAREZ, MARTIN, CORAL GABLES, FL:
3,805,649, PUB. 4-6-2010. INT. CL. 12.
- ALVEY, BRIAN, WEST HARRISON, NY:
2,771,582, CANC. MULTIPLE CLASS, INT. CLS. 9 AND 41.
- ALZCHEM TROSTBERG GMBH, TROSTBERG, FED REP GERMANY:
3,807,884, INT. CL. 1.
- AMANA TOOL CORPORATION, FARMINGDALE, NY:
3,808,221, INT. CL. 7.
- AMANDA MICHELLE ALLERTON, UNITED KINGDOM:
3,807,321, PUB. 4-6-2010. MULTIPLE CLASS, INT. CLS. 20 AND 24.
3,807,324, PUB. 4-6-2010. MULTIPLE CLASS, INT. CLS. 20 AND 24.
- AMASH IMPORTS, INC., GRAND RAPIDS, MI, DBA MICHIGAN INDUSTRIAL TOOLS:
3,808,059, MULTIPLE CLASS, INT. CLS. 6, 8, 17, 21 AND 22.
- AMATO, JAMES, BROWN DEER, WI, DBA AMEDIA ENTERTAINMENT LLC:
3,806,849, PUB. 4-6-2010. INT. CL. 9.
- AMATO, JAMES, BROWN DEER, WI:
3,806,855, PUB. 4-6-2010. INT. CL. 9.
- AMAZON THUNDER INC., CARSON CITY, NV:
3,805,365, PUB. 4-6-2010. INT. CL. 29.
- AMB MEDICAL SERVICES, HAUPPAUGE, NY:
2,356,351, REN. 5-17-10. INT. CL. 42.
- AMBER LOUNGE LTD, ST. HELIER, JERSEY:
3,805,376, PUB. 4-6-2010. MULTIPLE CLASS, INT. CLS. 9, 25 AND 43.
- AMBIR TECHNOLOGY, INC., ELMHURST, IL:
3,805,965, PUB. 4-6-2010. INT. CL. 9.
- AMBRY GENETICS, ALISO VIEJO, CA:
3,807,498, MULTIPLE CLASS, INT. CLS. 35, 41 AND 44.
- AMCAST INDUSTRIAL CORPORATION, FREMONT, IN:
2,285,083, CANC. MULTIPLE CLASS, INT. CLS. 7 AND 12.
- AMCRAFT BUILDING PRODUCTS CO., INC., BELOIT, WI:
3,806,391, PUB. 4-6-2010. INT. CL. 19.
- AMDEGA LIMITED, CO DURHAM, ENGLAND:
3,808,567, MULTIPLE CLASS, INT. CLS. 6, 19, 20, 37 AND 42.
- AMERICA'S COMPANION SERVICES, PENSACOLA, FL:
3,805,386, PUB. 8-25-2009. INT. CL. 45.
- AMERICA'S FLEET SERVICE, INC, MORRIS, IL:
3,805,908, PUB. 4-6-2010. INT. CL. 37.
- AMERICAN AMARANTH, INC., BRICELYN, MN:
1,560,051, CANC. INT. CL. 30.
- AMERICAN ASSOCIATION FOR SEX ADDICTION THERAPY, COLORADO SPRINGS, CO:
3,806,137, PUB. 4-6-2010. INT. CL. 35.
- AMERICAN ASSOCIATION OF PHYSICIAN SPECIALISTS, INC., TAMPA, FL:
3,808,715, INT. CL. 42.
- AMERICAN BOTANICAL PHARMACY, MARINA DEL REY, CA:
3,805,766, PUB. 4-6-2010. INT. CL. 5.
- AMERICAN CANCER SOCIETY, INC., ATLANTA, GA:
3,763,831, COR. MULTIPLE CLASS, INT. CLS. 35 AND 36.
- AMERICAN CONSOLIDATED MANUFACTURING CO., INC., WEST CONSHOHOCKEN, PA:
1,601,767, REN. 5-18-10. INT. CL. 3.
- AMERICAN DAIRY QUEEN CORPORATION, EDINA, MN:
2,771,807, CANC. INT. CL. 30.
3,806,824, PUB. 4-6-2010. INT. CL. 43.
- AMERICAN DREAMCARD, LLC, LAS VEGAS, NV:
3,808,652, MULTIPLE CLASS, INT. CLS. 35 AND 36.
- AMERICAN ENVIRONMENTAL SYSTEMS, INC., BOULDER, CO:
1,559,631, CANC. INT. CL. 9.
- AMERICAN FIDELITY ASSURANCE COMPANY, OKLAHOMA CITY, OK:
2,772,407, CANC. INT. CL. 36.
- AMERICAN FRUITS AND FLAVORS, PACOIMA, CA, DBA AMERICAN FRUIT PROCESSORS:
2,362,423, REN. 5-18-10. MULTIPLE CLASS, INT. CLS. 29, 30 AND 32.
2,374,930, REN. 5-19-10. INT. CL. 32.
- AMERICAN GAS ASSOCIATION, WASHINGTON, DC:
2,350,083, REN. 5-18-10. INT. CL. 42.
- AMERICAN GAS ASSOCIATION, ARLINGTON, VA:
2,398,999, REN. 5-17-10. INT. CL. 42.
- AMERICAN INTERIORS, LTD., SOMERS, CT:
1,560,105, CANC. INT. CL. 35.
- AMERICAN INTERNATIONAL GROUP, INC., NEW YORK, NY:
2,771,884, CANC. INT. CL. 36.
2,772,493, CANC. INT. CL. 41.
3,805,829, PUB. 4-6-2010. INT. CL. 36.
3,808,497, INT. CL. 36.
- AMERICAN IRONHORSE MOTORCYCLE COMPANY, INC., FORT WORTH, TX:
2,771,424, CANC. INT. CL. 40.
- AMERICAN LITHO, INC., GRAND RAPIDS, MI:
2,711,122, CANC. INT. CL. 7.
- AMERICAN MASSAGE THERAPY ASSOCIATION, EVANSTON, IL:
2,362,275, REN. 5-18-10. INT. CL. 16.
- AMERICAN MILLS, INC., GRIFFIN, GA:
2,286,509, CANC. INT. CL. 24.
- AMERICAN MULTI-CINEMA, INC., KANSAS CITY, MO:
2,349,929, REN. 5-19-10. INT. CL. 41.
- AMERICAN OSTEOPATHIC ASSOCIATION, CHICAGO, IL:
3,805,857, PUB. 4-6-2010. INT. CL. 35.
- AMERICAN POWER CONVERSION CORPORATION, W. KINGSTON, RI:
2,772,607, CANC. INT. CL. 42.

AMERICAN PROMOTIONAL EVENTS, INC., FLORENCE, AL, CHINA PYROTECHNICS, INC., FLORENCE, AL:
1,598,487. REN. 5-20-10. INT. CL. 13.
1,598,488. REN. 5-20-10. INT. CL. 13.

AMERICAN RECREATION COMPANY, INC., COMMACK, NY:
1,559,742. CANC. INT. CL. 12.

AMERICAN RECREATION PRODUCTS, INC., CHESTERFIELD, MO:
1,559,824. CANC. INT. CL. 18.

AMERICAN RICE, INC., HOUSTON, TX:
3,806,208. PUB. 4-6-2010. INT. CL. 30.

AMERICAN SHUTTER PRODUCTS, INC., FORT MYERS, FL:
2,286,813. CANC. INT. CL. 6.

AMERICAN SOCIETY OF INTERIOR DESIGNERS, INC., NEW YORK, NY:
2,770,615. CANC. U.S. CL. 200.

AMERICAN SOY PRODUCTS, INC. SALINE, MI:
1,638,521. REN. 5-19-10. INT. CL. 32.

AMERICAN STATISTICAL ASSOCIATION, ALEXANDRIA, VA:
2,383,289. REN. 5-14-10. INT. CL. 16.

AMERICAN STONEHENGE INVESTMENT PARTNERS, LOWELL, MA:
2,291,940. REN. 5-19-10. INT. CL. 37.

AMERICAN SUPERCONDUCTOR CORPORATION, DEVERNS, MA:
3,805,786. PUB. 4-6-2010. INT. CL. 9.

AMERICAN TRIM, L.L.C., LIMA, OH:
2,383,865. REN. 5-14-10. INT. CL. 40.

AMERICANESSE, INC., SAN FRANCISCO, CA:
2,286,461. CANC. INT. CL. 42.

AMERIPUMPS, LLC, CHATTANOOGA, TN:
3,806,416. PUB. 4-6-2010. INT. CL. 7.

AMERITURF, INC., MARIETTA, OH:
1,640,872. REN. 5-17-10. INT. CL. 42.

AMERIWORLD MORTGAGE, INC., CONCORD, CA:
2,771,635. CANC. INT. CL. 36.

AMETA CORPORATION, HACIENDA HEIGHTS, CA:
2,772,477. CANC. INT. CL. 25.

AMETEK, INC., KENT, OH:
2,388,452. REN. 5-14-10. INT. CL. 7.

AMETEK, INC., PAOLI, PA:
2,417,441. REN. 5-19-10. INT. CL. 9.

AMI ENTERTAINMENT NETWORK, INC., BRISTOL, PA:
2,772,345. CANC. INT. CL. 28.

AMN HEALTHCARE, INC., SAN DIEGO, CA:
2,839,241. CANC. INT. CL. 35.

AMNESTY INTERNATIONAL LIMITED, UNITED KINGDOM:
3,807,135. PUB. 4-6-2010. MULTIPLE CLASS, INT. CLS. 9, 16, 25, 41 AND 45.

AMOCO OIL COMPANY, CHICAGO, IL:
1,560,266. CANC. INT. CL. 42.

AMOR MINISTRIES, INC., SAN DIEGO, CA:
2,772,547. CANC. INT. CL. 42.

AMSOIL INC., SUPERIOR, WI:
3,805,915. PUB. 4-6-2010. MULTIPLE CLASS, INT. CLS. 4, 16 AND 25.

AMT B.V., 1105 BA AMSTERDAM, NETHERLANDS:
2,770,900. CANC. MULTIPLE CLASS, INT. CLS. 1, 5 AND 42.

AMTOTE INTERNATIONAL, INC., HUNT VALLEY, MD:
3,805,323. PUB. 4-6-2010. MULTIPLE CLASS, INT. CLS. 41 AND 42.

AMUSEMENT TRADES LIMITED, LONDON, UNITED KINGDOM:
2,770,828. CANC. INT. CL. 35.

AMX LLC, RICHARDSON, TX:
3,805,151. PUB. 4-6-2010. INT. CL. 9.

ANA VERGARA, GARDEN GROVE, CA, DBA CLASSIC GLAMOUR DOLLS:
3,805,823. PUB. 4-6-2010. INT. CL. 3.

ANALOG DEVICES, INC., NORWOOD, MA:
2,393,853. REN. 5-18-10. INT. CL. 9.

ANCHOR BREWING COMPANY, SAN FRANCISCO, CA:
3,806,040. PUB. 4-6-2010. INT. CL. 32.

ANCHORFREE, INC., SUNNYVALE, CA:
3,806,944. PUB. 4-6-2010. INT. CL. 9.

ANCIENT RHINO MEDIA PRODUCTIONS, LTD., PARMA, OH:
2,772,053. CANC. INT. CL. 9.

ANDERSON & MIDDLETON COMPANY, HOQUIAM, WA:
3,807,641. INT. CL. 33.

ANDERSON VALLEY ACQUISITION COMPANY LLC, BOONVILLE, CA:
2,449,157. REN. 5-19-10. INT. CL. 32.
2,450,962. REN. 5-19-10. INT. CL. 32.

ANDERSON, DONALD O., KNOXVILLE, TN:
3,806,431. PUB. 4-6-2010. INT. CL. 9.

ANDERSON, KENT, BISMARCK, ND:
2,301,185. REN. 5-19-10. INT. CL. 9.

ANDERSON, KENT G., BISMARCK, NV:
2,356,919. REN. 5-19-10. INT. CL. 42.

ANDERSON, KENT G., BISMARCK, ND:
2,390,335. REN. 5-19-10. INT. CL. 28.

ANDERSONS, THE, MAUMEE, OH TO MONSANTO COMPANY, ST. LOUIS, MO:
1,559,539. CANC. INT. CL. 5.

ANDREAS HEINE, PENDLETON, SC:
3,808,065. MULTIPLE CLASS, INT. CLS. 24 AND 35.

ANDRESEN, SCOTT A., CHICAGO, IL AND GILBERT, CHARLES W., CHICAGO, IL:
2,771,297. CANC. INT. CL. 43.

ANDREW D PERKINS, KENTON, OH:
2,771,891. CANC. INT. CL. 41.

ANDREWS MCMEEL UNIVERSAL, KANSAS CITY, MO:
2,388,130. REN. 5-14-10. INT. CL. 41.

ANDREWS, JOHN E., KATY, TX:
2,361,400. REN. 5-20-10. INT. CL. 27.

ANDRIA'S FOOD GROUP, INC., O'FALLON, IL:
3,805,154. PUB. 4-6-2010. MULTIPLE CLASS, INT. CLS. 30 AND 43.

ANGEL LEGACY, L.L.C., ROSEVILLE, CA:
2,772,293. CANC. MULTIPLE CLASS, INT. CLS. 35 AND 36.

ANGEL OF MY OWN, LLC, ST. CHARLES, MO:
2,772,087. CANC. INT. CL. 28.

ANGELA SHELTON, LOS ANGELES, CA AND FRANCES CALLIER, LOS ANGELES, CA:
3,806,314. PUB. 4-6-2010. INT. CL. 16.

ANGUS & COOTE PTY LTD, 2138 NEW SOUTH WALES, AUSTRALIA:
2,770,744. CANC. MULTIPLE CLASS, INT. CLS. 14 AND 37.

ANIMAL ADVENTURE, INC., MINNEAPOLIS, MN:
3,807,782. INT. CL. 28.

ANIMALMANIA, FORT LAUDERDALE, FL:
2,770,648. CANC. INT. CL. 35.

ANIMALWISE, INC., DENVER, CO:
2,770,925. CANC. MULTIPLE CLASS, INT. CLS. 41 AND 43.
2,770,926. CANC. MULTIPLE CLASS, INT. CLS. 41 AND 43.

ANNALEE DOLLS, INC., MEREDITH, NH:
2,349,657. REN. 5-19-10. MULTIPLE CLASS, INT. CLS. 16, 28, 35 AND 41.

ANSELL HEALTHCARE PRODUCTS LLC, RED BANK, NJ:
3,806,417. PUB. 4-6-2010. INT. CL. 10.

ANTHONY & MIDDLEBROOK, P.C., GRAPEVINE, TX:
3,805,663. PUB. 4-6-2010. MULTIPLE CLASS, INT. CLS. 16 AND 41.

ANTONIO PRECISE PRODUCTS MANUFACTORY LIMITED, HONG KONG SCIENCE PARK, HONG KONG:
3,805,445. PUB. 4-6-2010. INT. CL. 9.

ANW/CRESTWOOD, INC., LYNDBURST, NJ:
2,771,083. CANC. INT. CL. 16.

ANYTIME PRODUCTION EQUIPMENT RENTALS, INC., LOS ANGELES, CA:
3,806,589. PUB. 4-6-2010. INT. CL. 41.

AONIX, SAN DIEGO, CA TO AONIX, SAN DIEGO, CA:
2,285,855. CANC. MULTIPLE CLASS, INT. CLS. 9, 41 AND 42.

AONIX, ISSY LES MOULINEAUX, FRANCE:
3,807,566. INT. CL. 9.

- AOSOM LLC, TIGARD, OR:
3,808,303, MULTIPLE CLASS, INT. CLS. 9, 10 AND 20.
- APD CRYOGENICS, INC., ALLENTOWN, PA:
2,771,915, CANC. INT. CL. 9.
- APLIX CORPORATION, TOKYO, JAPAN:
2,772,593, CANC. INT. CL. 2.
- APOGEE ELECTRONICS CORPORATION, SANTA MONI-
CA, CA:
3,805,400, PUB. 4-6-2010. INT. CL. 9.
- APOLLO PACS, INC., FALLS CHURCH, VA:
3,808,153, INT. CL. 9.
- APONIA SOFTWARE, S.R.O., CZECH REPUBLIC:
3,807,156, PUB. 4-6-2010. INT. CL. 9.
- APPLE BLOSSOM, LLC, AMHERST, MA:
2,285,843, CANC. INT. CL. 41.
- APPLICA CONSUMER PRODUCTS, INC., MIRAMAR, FL:
2,771,749, CANC. INT. CL. 9.
- APPLIED MATERIALS GMBH & CO. KG, ALZENAU, FED
REP GERMANY:
3,805,414, PUB. 4-6-2010. INT. CL. 9.
- APPLIED MEDIA SOLUTIONS, LLC, MOUNT LAUREL, NJ:
3,806,360, PUB. 4-6-2010. INT. CL. 43.
- APPLIED VOICE & SPEECH TECHNOLOGIES, INC., FOOT-
HILL RANCH, CA, APPLIED VOICE TECHNOLOGY,
INC., KIRKLAND, WA:
1,606,164, REN. 5-19-10. MULTIPLE CLASS, INT. CLS. 9
AND 16.
- APR INDUSTRIES INC., DENVILLE, NJ:
2,284,629, CANC. MULTIPLE CLASS, INT. CLS. 6 AND 7.
- APRESVIN ENTERPRISES, INC., PROSSER, WA:
3,805,462, PUB. 4-6-2010. INT. CL. 29.
- APTOCORE APS, DK-2200 COPENHAGEN N, DENMARK:
3,806,772, PUB. 4-6-2010. INT. CL. 42.
- AQUAPORT PTY LTD, FLINDERS PARK, SOUTH AUS-
TRALIA, AUSTRALIA:
2,771,065, CANC. INT. CL. 11.
- AQUARELL (SOCIETE PAR ACTIONS SIMPLIFEE), PARIS,
FRANCE:
2,783,856, CANC. INT. CL. 38.
- AQUARIUS PUBLISHING, HUALIEN, TAIWAN:
3,805,457, PUB. 4-6-2010. MULTIPLE CLASS, INT. CLS. 16
AND 28.
- ARAIGNEE NOIR ENTERTAINMENT, INC., WEST OR-
ANGE, NJ:
2,770,910, CANC. INT. CL. 25.
- ARAMARK CORPORATION, PHILADELPHIA, PA, CORY
CORPORATION, CHICAGO, IL:
891,674, REN. 5-19-10. U.S. CL. 46 (INT. CL. 30).
- ARANESSA ENTERPRISES, INC., HAVRE DE GRACE, MD:
2,285,319, CANC. INT. CL. 35.
- ARCADIA GROUP BRANDS LIMITED, LONDON, UNITED
KINGDOM:
3,807,075, PUB. 8-12-2008. INT. CL. 25.
- ARCH ALUMINUM & GLASS, LLC, TAMARAC, FL:
2,772,357, CANC. INT. CL. 40.
- ARCHIPELAGO LEARNING, LLC, DALLAS, TX:
3,806,805, PUB. 4-6-2010. INT. CL. 42.
- ARCLIGHT CINEMA COMPANY, LOS ANGELES, CA:
2,831,062, CANC. MULTIPLE CLASS, INT. CLS. 9 AND
13.
- ARDEN CRAVATS, INC., RAMSEUR, NC:
1,559,988, CANC. INT. CL. 25.
- ARENA ONLINE SERVICES LIMITED, SURREY, GU1 3DA,
ENGLAND:
2,770,606, CANC. MULTIPLE CLASS, INT. CLS. 35 AND
38.
- ARGON TECHNOLOGIES, INC., OGDEN, UT:
3,806,226, PUB. 4-6-2010. INT. CL. 1.
- ARGUS TECHNOLOGIES LTD., BURNABY, BRITISH CO-
LUMBIA V5J 5E5, CANADA:
2,286,459, CANC. INT. CL. 9.
- ARIAT INTERNATIONAL, INC., UNION CITY, CA:
3,807,645, INT. CL. 25.
- ARIE E. DE GROOT H.O.D.N. VIAVAC VACUUM LIFTING,
NL-3404 AC IJSSELSTEIN, NETHERLANDS, DBA VIA-
VAC VACUUM LIFTING:
3,807,308, PUB. 4-6-2010. MULTIPLE CLASS, INT. CLS. 7
AND 37.
- ARIZANT HEALTHCARE INC., EDEN PRAIRIE, MN:
1,626,928, REN. 5-17-10. INT. CL. 10.
- ARIZONA CHILI COMPANY, SCOTTSDALE, AZ:
2,286,842, CANC. INT. CL. 29.
- ARLON SILICONE TECHNOLOGIES DIVISION, BEAR, DE:
3,806,254, PUB. 4-6-2010. INT. CL. 17.
3,806,444, PUB. 4-6-2010. INT. CL. 17.
3,806,526, PUB. 4-6-2010. INT. CL. 17.
3,806,640, PUB. 4-6-2010. INT. CL. 17.
- ARMOR BOND BUILDING PRODUCTS, INC., TORONTO
TORONTO, ONTARIO M5H 3Y2, CANADA:
1,559,842, CANC. INT. CL. 19.
- ARMOS VENTURES INTERNATIONAL, LLC, BROOKLYN,
NY:
3,806,401, PUB. 4-6-2010. INT. CL. 36.
- ARMOUR, STEPHEN RICHARD, GRANTS PASS, OR:
3,807,568, INT. CL. 9.
- ARMOUREX, LLC, FLINT, MI:
3,806,124, PUB. 4-6-2010. INT. CL. 10.
- ARMY AND NAVY STORES OF LAREDO, INC., LAREDO,
TX:
2,350,757, REN. 5-18-10. INT. CL. 25.
- ARNET PHARMACEUTICAL CORPORATION, DAVIE, FL:
2,371,078, REN. 5-17-10. INT. CL. 5.
- ARNOLD, MERIT R., SAN MARCOS, CA:
2,351,031, REN. 5-17-10. MULTIPLE CLASS, INT. CLS. 9
AND 35.
- ARTHEIA E. DINGLE, UPPER MARLBORO, MD AND
CORETTA DINGLE, UPPER MARLBORO, MD:
3,808,628, INT. CL. 25.
- ARTILIZE WORLDWIDE CO., LTD., TAIPEI, TAIWAN:
3,806,946, PUB. 4-6-2010. INT. CL. 21.
- ARTISAN CONFECTIONS COMPANY, HERSHEY, PA:
1,560,050, CANC. INT. CL. 30.
- ARTIST J, LLC, GROVETOWN, GA:
3,807,849, MULTIPLE CLASS, INT. CLS. 16 AND 25.
- ARTOOLS, LLC, MIDVALE, UT:
2,772,025, CANC. INT. CL. 38.
- ARYSTA LIFESCIENCE NORTH AMERICA, LLC, CARY,
NC:
1,559,518, CANC. INT. CL. 5.
3,807,743, INT. CL. 5.
3,807,830, INT. CL. 5.
- AS IP HOLDCO, LLC, PISCATAWAY, NJ:
2,771,993, CANC. INT. CL. 11.
- ASCARI HOLDINGS LIMITED, ABERDEEN, UNITED
KINGDOM:
2,770,827, CANC. MULTIPLE CLASS, INT. CLS. 12 AND
25.
- ASCENCIA BANK, INC., LOUISVILLE, KY TO PBI BANK,
INC., LOUISVILLE, KY:
2,751,198, AM. INT. CL. 36.
- ASHBY, DAVID C., LOS ALTOS, CA:
2,771,966, CANC. INT. CL. 28.
- ASHE MASSAGE CENTER, LLC, WEST JEFFERSON, NC:
3,805,979, PUB. 4-6-2010. INT. CL. 44.
- ASHLAND LICENSING AND INTELLECTUAL PROPERTY
LLC, DUBLIN, OH:
3,808,686, INT. CL. 2.
- ASHTON & ASSOCIATES, INC., WINTER PARK, FL:
2,390,517, REN. 5-18-10. INT. CL. 36.
- ASHUR, JEFFREY, NEWTON, MA:
3,807,618, INT. CL. 9.
- ASPECTS, INC., WARREN, RI:
2,351,837, REN. 5-18-10. INT. CL. 21.
- ASPEN DENTAL MANAGEMENT, INC, EAST SYRACUSE,
NY:
3,805,809, PUB. 4-6-2010. INT. CL. 35.
3,805,810, PUB. 4-6-2010. INT. CL. 35.
- ASSISTANT TREASURER LLC, EAST EDISON, NJ:
2,772,548, CANC. INT. CL. 36.
- ASSOCIATED CAPITAL SERVICES INC., LAS VEGAS, NV,
DBA D MOVING:
3,806,386, PUB. 4-6-2010. INT. CL. 35.
- ASSOCIATED GENERAL CONTRACTORS OF AMERICA,
INC., THE, WASHINGTON, DC:
373,159, REN. 5-17-10. U.S. CL. 38 (INT. CLS. 9, 16 AND
28).

ASSOCIATED GROCERS, INC., BATON ROUGE, LA:
2,361,260. REN. 5-20-10. MULTIPLE CLASS, U.S. CL. 200
INT. CL. 35.

ASSOCIATED OTEL COMPANY LIMITED, THE, MAN-
CHESTER, UNITED KINGDOM:
2,770,719, CANC. INT. CL. 1.

ASSOCIATES & WILSON, INC., ROSEMONT, PA:
2,286,480, CANC. INT. CL. 16.

ASSOCIATION FOR FACILITIES ENGINEERING, HERN-
DON, VA:
2,425,920. REN. 5-19-10. MULTIPLE CLASS, INT. CLS. 41
AND 42.

ASSOCIATION OF CLINICAL RESEARCH PROFES-
SIONALS, THE, WASHINGTON, DC:
2,286,029, CANC. INT. CL. 42.

ASSOCIATION OF GOVERNMENT ACCOUNTANTS,
ALEXANDRIA, VA:
2,771,329, CANC. INT. CL. 16.

ASSOCIATION OF HISPANIC ADVERTISING AGENCIES,
CHICAGO, IL:
2,772,071, CANC. INT. CL. 42.

ASTELLAS PHARMACEUTICAL CO., LTD., CHUO-KU,
TOKYO, JAPAN:
2,772,266, CANC. INT. CL. 5.

ASTON MARTIN LAGONDA LIMITED, WARWICK, UNI-
TED KINGDOM:
1,604,960. REN. 5-20-10. INT. CL. 37.

ASTONISH RESULTS, LP, WARWICK, RI:
3,806,528, PUB. 4-6-2010. INT. CL. 41.

ASTORIA FEDERAL SAVINGS AND LOAN ASSOCIATION,
LAKE SUCCESS, NY:
2,385,476. REN. 5-18-10. INT. CL. 36.

ASTRAZENECA AB, S-151 85 SODERTALJE, SWEDEN:
2,770,516, CANC. INT. CL. 5.

ASTRAZENECA AB, SÖDERTÄLJE, SWEDEN:
3,805,275, PUB. 4-6-2010. INT. CL. 5.
3,805,276, PUB. 4-6-2010. INT. CL. 5.
3,805,277, PUB. 4-6-2010. INT. CL. 5.
3,805,278, PUB. 4-6-2010. INT. CL. 5.
3,805,282, PUB. 4-6-2010. INT. CL. 5.
3,805,283, PUB. 4-6-2010. INT. CL. 5.
3,805,284, PUB. 4-6-2010. INT. CL. 5.
3,805,285, PUB. 4-6-2010. INT. CL. 5.
3,805,286, PUB. 4-6-2010. INT. CL. 5.

ASTRAZENECA AB, SÖDERTÄLJE, SWEDEN:
3,805,315, PUB. 4-6-2010. INT. CL. 5.

ASTRAZENECA AB, SÖDERTÄLJE, SWEDEN:
3,805,324, PUB. 4-6-2010. INT. CL. 5.

ASTRAZENECA AB, SÖDERTÄLJE, SWEDEN:
3,805,456, PUB. 4-6-2010. INT. CL. 5.

ASYNCAST CORP., CAMPBELL, CA:
3,807,539, MULTIPLE CLASS, INT. CLS. 9 AND 38.

AT&T INTELLECTUAL PROPERTY II, L.P., RENO, NV:
2,772,675, CANC. INT. CL. 38.
3,805,891, PUB. 4-6-2010. INT. CL. 38.

ATC TECHNOLOGY CORPORATION, DOWNERS GROVE,
IL:
3,805,468, PUB. 4-6-2010. INT. CL. 37.
3,808,574, INT. CL. 35.

ATG VENTURES, LLC, POINT PLEASANT, NJ:
3,808,092, MULTIPLE CLASS, INT. CLS. 20 AND 24.

ATHLETES YOGA, LLC, TEMPE, AZ:
3,807,485, INT. CL. 25.

ATK GROUP, LLC, MANISTEE, MI, DBA THE SEATCAR-
RY:
3,806,633, PUB. 4-6-2010. INT. CL. 13.

ATLANTIC CITY SURF PROFESSIONAL BASEBALL CLUB,
INC., WEST CHESTER, PA:
2,286,092, CANC. MULTIPLE CLASS, INT. CLS. 25 AND
41.
2,286,093, CANC. MULTIPLE CLASS, INT. CLS. 25 AND
41.

ATLANTIS COMPONENTS, INC., CAMBRIDGE, MA:
2,284,940, CANC. INT. CL. 10.

ATLANTIS HEALTH PLAN, INC., NEW YORK, NY:
3,805,613, PUB. 4-6-2010. INT. CL. 36.

ATLAS PAPER MILLS, LLC, MIAMI, FL:
3,808,548, INT. CL. 16.

ATLEY PHARMACEUTICALS, INC., ASHLAND, VA:
3,807,696, INT. CL. 5.

ATMEL CORPORATION, SAN JOSE, CA:
3,807,495, INT. CL. 9.

ATRONIC INTERNATIONAL GMBH, LÜBBECKE, FED
REP GERMANY:
3,805,321, PUB. 4-6-2010. INT. CL. 9.
3,805,322, PUB. 4-6-2010. INT. CL. 9.
3,806,509, PUB. 4-6-2010. INT. CL. 9.

ATTRACTION INDUSTRIES, INC., VICTORVILLE, CA:
3,806,445, PUB. 4-6-2010. INT. CL. 35.

ATYPO SPOL. S R.O., CZECH REPUBLIC:
3,807,305, PUB. 4-6-2010. INT. CL. 1.

AUBREY DANIELS INTERNATIONAL, ATLANTA, GA:
3,806,705, PUB. 4-6-2010. INT. CL. 16.

AUDIO PRODUCTS INTERNATIONAL CORP., SCARBOR-
OUGH, ONTARIO, CANADA:
2,285,660, CANC. INT. CL. 9.

AUDIO VISUAL INNOVATIONS, INC., TAMPA, FL:
2,441,852. REN. 5-17-10. INT. CL. 35.

AUDIT INTEGRITY, INC., LOS ANGELES, CA:
3,808,740, INT. CL. 36.

AUDITORIUM THEATRE OF ROOSEVELT UNIVERSITY,
INC., CHICAGO, IL:
2,386,093. REN. 5-18-10. INT. CL. 41.

AUDREY EDELMAN & ASSOCIATES REAL ESTATE,
ITHACA, NY:
2,284,662, CANC. INT. CL. 36.

AUGURI CORPORATION, BELMONT, CA:
2,285,255, CANC. INT. CL. 9.

AUGUSTWAVE, LLC, SPRING HILL, TN:
3,805,377, PUB. 4-6-2010. INT. CL. 42.

AURAFIN LLC, TAMARAC, FL:
2,772,362, CANC. INT. CL. 14.

AUSTRALIAN AIRLINES LIMITED, MASCOT, SOUTH
WALES, AUSTRALIA:
2,770,945, CANC. MULTIPLE CLASS, INT. CLS. 39 AND
43.

AUSTRALIAN APPAREL, KINGSGROVE, AUSTRALIA,
DBA AUSTRALIAN APPAREL:
3,808,298, INT. CL. 25.

AUTHENEX INC., OAKLAND, CA:
2,771,150, CANC. INT. CL. 42.

AUTHENTIC RESPONSE, INC., NEW YORK, NY:
2,771,221, CANC. MULTIPLE CLASS, INT. CLS. 35 AND
38.

AUTHENTIUM, INC., PALM BEACH GARDENS, FL:
3,805,917, PUB. 4-6-2010. INT. CL. 9.

AUTOMATED LOGIC CORPORATION, KENNESAW, GA:
2,358,201. REN. 5-18-10. INT. CL. 9.

AUTOMATED MEDIA PROCESSING SOLUTIONS, INC.,
SAUSALITO, CA:
3,807,465, INT. CL. 9.

AUTOMOTIVE INDUSTRIAL MARKETING CORPORA-
TION, PORTLAND, OR:
3,805,146, PUB. 4-6-2010. INT. CL. 7.

AUTOMOTIVE TEST SOLUTIONS, LOS ALAMOS, NM:
2,772,658, CANC. INT. CL. 9.

AUTOPART INTERNATIONAL, INC., NORTON, MA:
3,807,446, INT. CL. 9.

AUTOPILOT CARWASH CONTROL SYSTEMS, INC., TA-
MARAC, FL:
3,806,850, PUB. 4-6-2010. INT. CL. 9.

AUTOWEB.COM, INC., SANTA CLARA, CA:
2,770,695, CANC. MULTIPLE CLASS, INT. CLS. 35 AND
42.

AUTRY NATIONAL CENTER OF THE AMERICAN WEST,
LOS ANGELES, CA:
3,806,019, PUB. 4-6-2010. INT. CL. 41.

AVADO BRANDS, INC., MADISON, GA TO AVADO
BRANDS, INC., MADISON, GA:
2,286,666, CANC. INT. CL. 42.

AVAWORKS, INC., SANTA MONICA, CA:
3,806,551, PUB. 4-6-2010. INT. CL. 9.

AVB, INC., MILWAUKIE, OR:
3,806,109, PUB. 4-6-2010. INT. CL. 30.
3,808,323, INT. CL. 30.

- AVEDA CORPORATION, MINNEAPOLIS, MN:
3,805,339, PUB. 4-6-2010. INT. CL. 3.
3,805,340, PUB. 4-6-2010. INT. CL. 3.
- AVENTIS PHARMA S.A., ANTONY, FRANCE:
2,771,634, CANC. INT. CL. 5.
- AVIAT U.S., INC., MORRISVILLE, NC:
2,772,037, CANC. MULTIPLE CLASS, INT. CLS. 9, 37
AND 42.
- AVID DATING LIFE INC., TORONTO, ONTARIO, CANA-
DA:
3,807,001, PUB. 4-6-2010. MULTIPLE CLASS, INT. CLS. 38
AND 45.
- AVILA CAPITAL MARKETS, LLC, NEW YORK, NY:
3,808,770, INT. CL. 36.
- AVIOQ, INC., ROCKVILLE, MD:
3,808,080, INT. CL. 1.
- AVON PRODUCTS, INC., NEW YORK, NY:
1,559,507, CANC. INT. CL. 3.
- AWARDSCAN SOFTWARE, INC., KANSAS CITY, MO:
3,807,808, INT. CL. 9.
- AXELGAARD MANUFACTURING COMPANY, LTD.,
FALLBROOK, CA:
3,806,815, PUB. 4-6-2010. INT. CL. 21.
- AZEK BUILDING PRODUCTS, INC., SCRANTON, PA:
3,806,726, PUB. 4-6-2010. INT. CL. 19.
3,806,729, PUB. 4-6-2010. INT. CL. 19.
3,806,730, PUB. 4-6-2010. INT. CL. 19.
- AZTECA INTERNATIONAL CORP, GLENDALE, CA:
3,806,281, PUB. 4-6-2010. INT. CL. 41.
- AZTECA INTERNATIONAL CORPORATION, GLENDALE,
CA:
3,806,255, PUB. 4-6-2010. INT. CL. 41.
- AZUR PHARMA INTERNATIONAL II LIMITED, HAMIL-
TON, BERMUDA:
3,806,629, PUB. 4-6-2010. INT. CL. 5.
- AZURE HOLDINGS, L.P., AUSTIN, TX:
2,364,594, REN. 5-17-10. INT. CL. 42.
- B + V INDUSTRIE TECHNIK GMBH, D-20457 HAMBURG,
FED REP GERMANY:
2,340,389, REN. 5-19-10. INT. CL. 7.
2,340,389, CANC. INT. CL. 17.
- B & F SYSTEM, INC., THE, DALLAS, TX:
2,286,398, CANC. INT. CL. 8.
- B EDWARD PTY LTD, BALLARAT, VICTORIA 3350,
AUSTRALIA:
2,770,928, CANC. MULTIPLE CLASS, INT. CLS. 5 AND
30.
- B. BRAUN AVITUM AG, MELSUNGEN, FED REP GER-
MANY:
2,770,762, CANC. MULTIPLE CLASS, INT. CLS. 5 AND
10.
- B.E.T. TRUCKING, INC., HUDSON, OH, DBA SAGAMORE
SOILS:
3,805,441, PUB. 4-6-2010. INT. CL. 1.
- B.F. RICH CO., INC., NEWARK, DE:
3,805,907, PUB. 4-6-2010. MULTIPLE CLASS, INT. CLS. 19
AND 40.
- B.V. SPACE NK, AMSTERDAM, NETHERLANDS:
2,333,045, REN. 5-17-10. INT. CL. 3.
- B-MELO LLC, NEW YORK, NY:
3,808,449, INT. CL. 32.
- BA DHUN NA NGALL TEORANTA, BLARNEY, COUNTY
CORK, IRELAND:
1,559,886, CANC. INT. CL. 25.
- BABCO ASSOCIATES, LTD., RICHMOND, VA:
3,806,790, PUB. 4-6-2010. INT. CL. 41.
- BABY BOOM CONSUMER PRODUCTS, INC., NEW YORK,
NY:
3,807,389, INT. CL. 25.
- BACCHUS, INC., MT. PLEASANT, SC:
2,771,350, CANC. INT. CL. 35.
- BACHMANN SPRINGS LTD., TOMBSTONE, AZ:
2,771,968, CANC. INT. CL. 25.
2,771,970, CANC. INT. CL. 41.
- BACKROADS, BERKELEY, CA:
2,772,038, CANC. INT. CL. 39.
- BACKYARD LEISURE HOLDINGS, INC., PITTSBURG, KS:
3,808,014, INT. CL. 19.
- BADGER AIR BRUSH COMPANY, FRANKLIN PARK, IL:
2,772,384, CANC. INT. CL. 2.
- BAFFLER LITERARY MAGAZINE, INC., THE, CHICAGO,
IL:
2,357,342, REN. 5-17-10. INT. CL. 16.
- BAHRAM HAKAKIAN, NEW YORK, NY:
3,805,713, PUB. 4-6-2010. INT. CL. 35.
- BAIN & COMPANY, BOSTON, MA:
3,805,364, PUB. 4-6-2010. INT. CL. 35.
- BAITH, DONALD W., BRADENTON, FL, DBA GREEN
LIGHTING SOLUTIONS:
3,807,741, MULTIPLE CLASS, INT. CLS. 11 AND 37.
- BAKER & TAYLOR, INC., CHARLOTTE, NC:
2,771,421, CANC. INT. CL. 35.
3,806,025, PUB. 4-6-2010. INT. CL. 16.
- BAKER HUGHES INCORPORATED, HOUSTON, TX:
2,771,527, CANC. INT. CL. 7.
- BALANCED APPROACH, LLC, THE, BOULDER, CO:
2,347,379, REN. 5-14-10. MULTIPLE CLASS, INT. CLS. 41
AND 42.
- BALKIS SA, SWITZERLAND:
3,807,222, PUB. 4-6-2010. INT. CL. 14.
- BALTIC LATVIAN UNIVERSAL ELECTRONICS, LLC, WES-
TLAKE VILLAGE, CA:
3,807,377, INT. CL. 9.
- BALTIMOREANIMAL MEDICINE INCORPORATED, BAL-
TIMORE, MD:
3,807,527, INT. CL. 5.
- BAMA RAGS, INC., CHARLOTTESVILLE, VA:
2,438,114, REN. 5-18-10. INT. CL. 26.
- BAMBOO REALTY, INC., HOUSTON, TX:
3,806,333, PUB. 4-6-2010. INT. CL. 36.
- BANANA LEAF (ASIA PACIFIC) CATERING GROUP LIM-
ITED, NEW TERRITORIES, HONG KONG:
3,807,427, INT. CL. 43.
- BANC ONE COLORADO CORPORATION, DENVER, CO:
1,560,133, CANC. INT. CL. 36.
- BANCO DO BRASIL S.A., NEW YORK, NY:
3,807,599, INT. CL. 36.
- BANCO ITAU S.A., SAO PAULO, BRAZIL:
3,808,596, INT. CL. 36.
- BANCO SANTANDER CENTRAL HISPANO, S.A., MADRID,
SPAIN:
2,770,581, CANC. MULTIPLE CLASS, INT. CLS. 16 AND
36.
- BANDANA'S MISSOURI, L.L.C., CHESTERFIELD, MO:
2,384,505, REN. 5-14-10. INT. CL. 42.
- BANDSINTOWN, INC, FRANKLIN, MA:
3,806,463, PUB. 4-6-2010. INT. CL. 41.
- BANK OF AMERICA CORPORATION, CHARLOTTE, NC:
2,771,008, CANC. INT. CL. 36.
2,771,986, CANC. INT. CL. 36.
- BANK OF THE WEST, SAN FRANCISCO, CA:
3,808,159, INT. CL. 36.
- BARANTSEVICH, ANZHEY, ENCINO, CA:
3,808,728, INT. CL. 32.
- BARBARA CHRISTINE JACKSON, STAFFORD, VA, DBA
JBM SOLUTIONS, LLC:
3,805,946, PUB. 4-6-2010. INT. CL. 35.
- BARBARA YANEY DESIGNS, INC., VERONA, NJ:
3,806,863, PUB. 4-6-2010. INT. CL. 28.
- BARBARA'S WAY LLC, GREENWICH, CT:
3,808,002, INT. CL. 8.
- BARBARIAN CO., LTD., JAPAN:
3,807,145, PUB. 4-6-2010. MULTIPLE CLASS, INT. CLS. 5,
20, 24, 25 AND 44.
- BARE ESCENTUALS BEAUTY, INC., SAN FRANCISCO, CA:
3,808,000, INT. CL. 3.
3,808,001, INT. CL. 3.

BARILLA G.E.R. FRATELLI - SOCIETÀ PER AZIONI, PARMA, ITALY:
 3,808,243, INT. CL. 14.
 3,808,244, INT. CL. 18.
 3,808,245, INT. CL. 24.
 3,808,246, INT. CL. 16.
 3,808,247, INT. CL. 18.
 3,808,248, INT. CL. 24.
 3,808,536, MULTIPLE CLASS, INT. CLS. 35 AND 43.
 3,808,537, MULTIPLE CLASS, INT. CLS. 35 AND 43.

BARNETT, JAMES, TALLAHASSEE, FL:
 3,806,683, PUB. 4-6-2010. INT. CL. 25.

BARNIE'S II, INC., ORLANDO, FL:
 1,596,520. REN. 5-14-10. INT. CL. 25.

BARR LABORATORIES, INC., MONTVALE, NJ:
 3,807,078, PUB. 10-7-2008. INT. CL. 5.

BARRETT FIREARMS MFG., INC., MURFREESBORO, TN:
 3,806,843, PUB. 4-6-2010. INT. CL. 13.

BARRY'S MONTANA BEEF, INC., HARRISON, MT:
 2,770,988, CANC. INT. CL. 29.

BART-PLANGE, SELINA, NEW YORK, NY:
 3,807,721, MULTIPLE CLASS, INT. CLS. 14 AND 25.

BARTOL, CARL A., N. WHITE PLAINS, NY:
 3,808,496, INT. CL. 41.

BASEBALL INVENTIONS, LLC, SCOTTSDALE, AZ:
 3,807,695, MULTIPLE CLASS, INT. CLS. 17, 28 AND 35.

BASF CATALYSTS LLC, FLORHAM PARK, NJ, ENGELHARD MINERALS & CHEMICALS CORPORATION, EDISON, NJ:
 1,134,926. REN. 5-19-10. INT. CL. 1.

BASF SE, LUDWIGSHAFEN AM RHEIN, FED REP GERMANY:
 3,807,635, INT. CL. 5.

BASISNOTE AG, BERN, SWITZERLAND:
 3,807,129, PUB. 4-6-2010. MULTIPLE CLASS, INT. CLS. 1, 3, 5 AND 42.

BASS ASSASSIN LURES, INC., MAYO, FL:
 2,285,440, CANC. INT. CL. 28.

BATA BRANDS S.A.R.L. LUXEMBOURG, SUCCURSALE DE LAUSANNE, LAUSANNE, SWITZERLAND:
 1,559,926, CANC. INT. CL. 25.

BATAN & SHARRO AB, SWEDEN:
 3,807,349, PUB. 4-6-2010. INT. CL. 3.

BATH & BODY WORKS BRAND MANAGEMENT, INC., REYNOLDSBURG, OH:
 3,808,172, INT. CL. 3.
 3,808,173, INT. CL. 3.

BATH SOLUTIONS, INC., BENSENVILLE, IL:
 3,807,922, INT. CL. 5.

BATHPERFECT, LLC, TOWSON, MD:
 3,808,322, INT. CL. 37.

BATTELLE MEMORIAL INSTITUTE, COLUMBUS, OH:
 3,807,053, PUB. 8-19-2008. INT. CL. 42.
 3,807,054, PUB. 8-19-2008. INT. CL. 42.
 3,807,055, PUB. 8-19-2008. INT. CL. 42.

BATTERY HUB, APPLETON, WI:
 3,807,790, INT. CL. 9.

BATTLE FOAM, LLC, GILBERT, AZ:
 3,805,467, PUB. 4-6-2010. MULTIPLE CLASS, INT. CLS. 17 AND 18.

BAUM, INC., HARVEY CEDARS, NJ:
 3,807,762, INT. CL. 28.

BAUMES, RAYMOND L., DEERFIELD BEACH, FL:
 3,806,361, PUB. 4-6-2010. INT. CL. 41.

BAXTERBEAR LIMITED, EDINBURGH, SCOTLAND, UNITED KINGDOM:
 3,567,956, COR. MULTIPLE CLASS, INT. CLS. 9, 16, 24, 25 AND 28.

BAYER AKTIENGESELLSCHAFT, 51373 LEVERKUSEN, FED REP GERMANY:
 1,559,535, CANC. INT. CL. 5.

BAYER HEALTHCARE LLC, PITTSBURGH, PA, MILES LABORATORIES, INC., ELKHART, IN:
 525,085. REN. 5-18-10. U.S. CL. 18 (INT. CL. 5).

BAYLOR UNIVERSITY, WACO, TX:
 2,780,109, CANC. MULTIPLE CLASS, INT. CLS. 18, 26 AND 28.

BAZAARDECOR SARL, NEUCHATEL, SWITZERLAND:
 2,772,015, CANC. INT. CL. 35.

BBCOS S.N.C.; DI BERTOLA RAFFAELE & C., ITALY:
 3,807,173, PUB. 4-6-2010. INT. CL. 3.

BBI ACQUISITION CO., DENVER, CO, JIM BEAM BRANDS CO., DEERFIELD, IL:
 2,349,188. REN. 5-19-10. INT. CL. 32.

BBIP, LLC, MIAMI, FL:
 3,805,833, PUB. 4-6-2010. INT. CL. 41.

BBP, LLC, NEW YORK, NY:
 3,547,499, COR. INT. CL. 30.

BBY SOLUTIONS, INC., RICHFIELD, MN:
 3,805,658, PUB. 4-6-2010. INT. CL. 9.
 3,807,735, INT. CL. 35.

BC HOT HOUSE FOODS INC., LANGLEY, BC, CANADA:
 3,807,630, INT. CL. 31.

BC INTERNATIONAL COSMETIC & IMAGE SERVICES, INC., ORLANDO, FL:
 2,285,766, CANC. INT. CL. 3.

BCM ADVANCED RESEARCH, IRVINE, CA:
 3,806,063, PUB. 4-6-2010. MULTIPLE CLASS, INT. CLS. 9 AND 42.

BDS GLOBAL DETAILING PTY LIMITED, AUSTRALIA:
 3,807,301, PUB. 4-6-2010. MULTIPLE CLASS, INT. CLS. 37 AND 42.

BDSRCO, INC., WILMINGTON, DE:
 3,807,650, INT. CL. 25.

BEACON SALES ACQUISITION, INC., PEABODY, MA:
 2,369,287. REN. 5-20-10. INT. CL. 19.

BEALL CORPORATION, PORTLAND, OR:
 697,721. REN. 5-18-10. U.S. CL. 19 (INT. CLS. 7, 12, 22 AND 27).

BEASLEY, BRYAN T., PHOENIX, AZ:
 2,937,458, CANC. INT. CL. 16.

BEAUTE CREATEURS (SOCIETE ANONYME), PARIS, FRANCE:
 2,771,672, CANC. INT. CL. 3.

BEAUTY PLUS TRADING CO., INC., MOONACHIE, NY:
 3,807,629, INT. CL. 26.

BECK GMBH DRUCKKONTROLLTECHNIK, 71144 STEINBRONN, FED REP GERMANY:
 3,807,163, PUB. 4-6-2010. MULTIPLE CLASS, INT. CLS. 7 AND 9.

BECK, JENNIFER M., ALEDO, TX:
 3,808,353, INT. CL. 16.

BECKETT CORPORATION, DALLAS, TX:
 1,559,564, CANC. INT. CL. 7.

BECKWORTH, CARTER, HOUSTON, TX:
 3,806,845, PUB. 4-6-2010. INT. CL. 41.

BECTON, DICKINSON AND COMPANY, FRANKLIN LAKES, NJ:
 3,806,085, PUB. 4-6-2010. INT. CL. 10.
 3,807,622, INT. CL. 41.
 3,807,906, INT. CL. 10.

BEECH-NUT NUTRITION CORPORATION, LATHAM, NY:
 3,805,612, PUB. 4-6-2010. MULTIPLE CLASS, INT. CLS. 5, 29, 30 AND 32.

BETLE MED, LLC, ESCONDIDO, CA:
 3,805,676, PUB. 4-6-2010. INT. CL. 35.

BEHAN, KEVIN, NEWFANE, VT AND BEHAN, AGI, NEWFANE, VT:
 3,805,731, PUB. 4-6-2010. INT. CL. 41.

BEHLE STREET CAFE, LLC, CRESTVIEW HILLS, KY:
 2,771,496, CANC. INT. CL. 43.

BEI COMMUNICATIONS, STAFFORD, TX, DBA BEI SECURITY:
 3,808,742, INT. CL. 9.

BEIERSDORF AKTIENGESELLSCHAFT, 20245 HAMBURG, FED REP GERMANY:
 2,770,557, CANC. MULTIPLE CLASS, INT. CLS. 3 AND 5.

BEIJING MEIGAOYI SOFTWARE CO., LTD., CHANGPING, BEIJING, CHINA:
 2,770,868, CANC. MULTIPLE CLASS, INT. CLS. 9 AND 10.

BEIJING WATCH DATA SYSTEM CO., LTD., CHINA:
 3,807,170, PUB. 4-6-2010. INT. CL. 9.

- BELL ENVIRONMENTAL SERVICES, INC., PARSIPPANY, NJ, AKA BELL BED BUGS, BELL BIRD CONTROL: 3,806,336, PUB. 4-6-2010. MULTIPLE CLASS, INT. CLS. 37 AND 42.
- BELL INNOVATIVE PRODUCTS, INC., SYLMAR, CA: 2,286,363, CANC. INT. CL. 7.
2,286,364, CANC. INT. CL. 7.
2,772,063, CANC. INT. CL. 11.
- BELL SPORTS, INC., SCOTTS VALLEY, CA: 1,559,729, CANC. INT. CL. 12.
- BELL, RANDALL, LAGUNA BEACH, CA: 2,772,619, CANC. INT. CL. 35.
- BELLA BABY FOODS INC., PORT WASHINGTON, NY: 3,807,525, INT. CL. 5.
- BELLA SPAZIO, LLC, KNOXVILLE, TN: 2,286,160, CANC. INT. CL. 42.
- BELLANCA, BRIAN, NEW YORK, NY: 2,772,471, CANC. INT. CL. 35.
- BELLSOUTH INTELLECTUAL PROPERTY CORPORATION, WILMINGTON, DE: 2,285,043, CANC. INT. CL. 35.
2,286,180, CANC. MULTIPLE CLASS, INT. CLS. 37, 38 AND 42.
- BELO INTERACTIVE, INC., DALLAS, TX: 3,807,051, PUB. 4-6-2010. MULTIPLE CLASS, INT. CLS. 38, 41 AND 42.
3,807,052, PUB. 4-6-2010. MULTIPLE CLASS, INT. CLS. 38, 41 AND 42.
3,808,785, INT. CL. 16.
- BELOIT RIVERFEST FESTIVALS, INC., BELOIT, WI: 2,772,060, CANC. INT. CL. 41.
- BEMPORAD BARANOWSKI, INC., NEW YORK, NY: 3,808,685, INT. CL. 41.
- BENCO DENTAL SUPPLY COMPANY, WILKES BARRE, PA, DBA TRANSITIONS GROUP NORTH AMERICA: 3,805,646, PUB. 4-6-2010. INT. CL. 35.
- BENEFIT COSMETICS, LLC, SAN FRANCISCO, CA, BENEFIT COSMETICS, LLC, SAN FRANCISCO, CA: 2,390,319, REN. 5-17-10. INT. CL. 3.
- BENETECH, INC., MONTGOMERY, IL: 3,808,657, INT. CL. 45.
- BENETTON GROUP S.P.A., 31050 PONZANO VENETO TREVISO, ITALY: 2,770,971, CANC. INT. CL. 3.
- BENNELLI, LLC, VEMON, CA: 2,841,042, CANC. INT. CL. 1.
- BENNEY WATCHES PLC, LONDON, UNITED KINGDOM: 3,805,470, PUB. 4-6-2010. INT. CL. 14.
- BENSON, ANTHONY, DETROIT, MI: 2,771,137, CANC. INT. CL. 25.
- BENTLEY SYSTEMS, INCORPORATED, EXTON, PA: 2,772,042, CANC. INT. CL. 9.
- BERENSON CORP, BUFFALO, NY: 3,805,532, PUB. 4-6-2010. INT. CL. 6.
- BERGHOFF RESTAURANT COMPANY OF DELAWARE, INC., BROOKFIELD, IL: 3,806,318, PUB. 4-6-2010. INT. CL. 43.
3,806,319, PUB. 4-6-2010. INT. CL. 43.
3,806,321, PUB. 4-6-2010. INT. CL. 43.
- BERKLEY INC., SPIRT LAKE, IA: 697,743, REN. 5-18-10. U.S. CL. 22 (INT. CLS. 16, 18, 20, 22, 25 AND 28).
- BERNAL, GUSTAVUS, VENTURA, CA: 3,806,387, PUB. 4-6-2010. INT. CL. 11.
3,806,388, PUB. 4-6-2010. INT. CL. 7.
- BERU AG, FED REP GERMANY: 3,807,148, PUB. 4-6-2010. MULTIPLE CLASS, INT. CLS. 7, 9 AND 11.
- BEST WINDOW AND DOOR COMPANY, JOHNSTOWN, PA: 3,806,265, PUB. 4-6-2010. INT. CL. 19.
- BESTVIEW INTERNATIONAL COMPANY, WOOD DALE, IL: 3,806,145, PUB. 4-6-2010. MULTIPLE CLASS, INT. CLS. 6, 11, 19 AND 37.
- BETA SYSTEMS SOFTWARE AG, FED REP GERMANY: 3,807,172, PUB. 4-6-2010. INT. CL. 9.
- BETTER BORROWERS, LLC, CARROLLTON, TX: 3,805,980, PUB. 4-6-2010. INT. CL. 36.
- BETTER HARVEST INC., N.P.B., FL: 2,285,791, CANC. INT. CL. 36.
- BETZ LABORATORIES, INC., TREVOSE, PA: 1,559,477, CANC. INT. CL. 1.
- BEYER, APRIL, LOS ANGELES, CA: 3,805,963, PUB. 4-6-2010. INT. CL. 45.
- BGL 1, INC., CHICAGO, IL, DBA RYMER INTERNATIONAL SEAFOOD: 2,285,600, CANC. INT. CL. 29.
- BHINDI K INTERNATIONAL, ARTESIA, CA, DBA BHINDI JEWELLERS: 3,805,989, PUB. 4-6-2010. INT. CL. 35.
- BI-LO, LLC, GREENVILLE, SC: 2,286,114, CANC. INT. CL. 25.
- BIBIT, LLC, SPOKANE, MT: 3,805,509, PUB. 4-6-2010. INT. CL. 45.
- BICO AG, 8718 SCHANIS, SWITZERLAND: 2,770,973, CANC. MULTIPLE CLASS, INT. CLS. 20 AND 24.
- BIG AMERICAN MAN, FORT COLLINS, CO: 2,353,232, REN. 5-20-10. INT. CL. 25.
- BIG BUCK BREWERY & SEAKHOUSE, INC., GAYLORD, MI, DBA BUCK BREWERY & STEAKHOUSE TO BIG BUCK BREWERY & SEAKHOUSE, INC., GAYLORD, MI, DBA BUCK BREWERY & STEAKHOUSE: 2,284,327, CANC. INT. CL. 32.
- BIG DADDY, CULVER CITY, CA: 1,560,205, CANC. INT. CL. 41.
- BIG GEYSER INC., MASPETH, NY: 3,806,968, PUB. 4-6-2010. INT. CL. 35.
- BIG RIVER INDUSTRIES, INC., ATLANTA, GA: 3,805,301, PUB. 4-6-2010. INT. CL. 19.
- BIG TIMBER LTDA, SANTA CATARINA, BRAZIL: 2,772,172, CANC. INT. CL. 12.
- BIGFOOT COMMUNICATIONS (HONG KONG) LIMITED, HONG KONG, HONG KONG, BIGFOOT INTERNATIONAL, INC., NEW YORK, NY: 2,353,041, REN. 5-18-10. MULTIPLE CLASS, INT. CLS. 35 AND 38.
- BILL MARSH MOTORS, INC., TRAVERSE CITY, MI: 2,285,569, CANC. INT. CL. 37.
- BILSTEIN GMBH & CO., D-58119 HAGEN, FED REP GERMANY: 2,365,726, REN. 5-17-10. INT. CL. 6.
- BIO HUMA NETICS, INC., CHANDLER, AZ: 3,806,902, PUB. 4-6-2010. INT. CL. 1.
3,806,948, PUB. 4-6-2010. INT. CL. 1.
3,806,950, PUB. 4-6-2010. INT. CL. 5.
- BIO-BOTANICA, INC., HAUPAUGGE, NY: 2,352,531, REN. 5-18-10. INT. CL. 1.
- BIO-RAD LABORATORIES, INC., HERCULES, CA: 2,286,154, CANC. INT. CL. 9.
- BIOCARE LABS, INC., BEDFORD PARK, IL: 3,806,677, PUB. 4-6-2010. INT. CL. 3.
- BIOCHEM TECHNOLOGY, INC., MALVERN, PA: 1,559,582, CANC. INT. CL. 9.
- BIOCHEM ZUSATZSTOFFE HANDELS- UND PRODUKTIONSGESELLSCHAFT MBH, LOHNE, FED REP GERMANY: 2,771,152, CANC. INT. CL. 31.
- BIOCHEMFUSION APS, DENMARK: 3,807,296, PUB. 4-6-2010. MULTIPLE CLASS, INT. CLS. 9 AND 42.
- BIOETT AB, SE.227 30 LUND, SWEDEN: 2,771,041, CANC. INT. CL. 9.
- BIOGEN IDEC MA INC., CAMBRIDGE, MA: 2,771,341, CANC. INT. CL. 42.
- BIOHITECH INTERNATIONAL, INC., SECAUCUS, NJ AND KOH, CHUN IL, SECAUCUS, NJ: 3,807,652, INT. CL. 11.
- BIOIMAGE A/S, SOBORG, DENMARK: 2,771,551, CANC. MULTIPLE CLASS, INT. CLS. 1, 5 AND 42.
- BIOLITEC, INC., EAST LONGMEADOW, MA: 2,285,689, CANC. INT. CL. 10.
- BIOLOGICS, INC., CLEARWATER, FL: 3,808,666, INT. CL. 10.

BIONICHE LIFE SCIENCES INC., BELLEVILLE, ONTARIO, CANADA:
2,772,016, CANC. INT. CL. 5.

BIOPRACTIC GROUP II, INC., THE, BETHLEHEM, PA:
1,559,497, CANC. INT. CL. 3.

BIOSAFE SYSTEMS LLC, HARTFORD, CT:
3,808,192, INT. CL. 5.

BIOTECHNOLOGY INSTITUTE, S.L., SPAIN:
3,807,358, PUB. 4-6-2010. INT. CL. 10.

BIRD INCORPORATED, DEDHAM, MA:
1,559,839, CANC. INT. CL. 19.

BIRDWELL, JANE, PENSACOLA, FL:
3,806,735, PUB. 4-6-2010. INT. CL. 24.

BISCUITS LECLERC LTEE, QUEBEC, CANADA, AKA BISCUITS LECLERC LTD.:
3,805,553, PUB. 4-6-2010. INT. CL. 30.

BIZERBA GMBH & CO. KG, FED REP GERMANY:
3,807,320, PUB. 4-6-2010. MULTIPLE CLASS, INT. CLS. 7, 9 AND 16.

BLACK DIAMOND STONERWORKS, INC., SAN CLEMENTE, CA:
3,807,784, INT. CL. 21.

BLACK HAWKS HOCKEY, INC., WATERLOO, IA:
3,805,846, PUB. 12-29-2009. MULTIPLE CLASS, INT. CLS. 25 AND 41.

BLACK OPS ENTERTAINMENT, LLC, SANTA MONICA, CA:
2,772,536, CANC. INT. CL. 9.

BLACKIE'S HOUSE OF BEEF, INC., WASHINGTON, DC:
2,771,467, CANC. INT. CL. 43.

BLACKLINE GPS INC., CALGARY, CANADA:
3,807,637, INT. CL. 9.

BLACKWAVE INC., ACTON, MA:
3,807,522, INT. CL. 9.

BLAM! VENTURES, LLC, WAPPINGERS FALLS, NY:
3,808,603, INT. CL. 9.

BLAST YOUR PAST, LLC, LAGUNA NIGUEL, CA:
3,806,449, PUB. 4-6-2010. INT. CL. 42.

BLING NATION, LTD., HAMILTON, BERMUDA:
3,806,131, PUB. 4-6-2010. INT. CL. 36.

BLOCKBUSTER INC., DALLAS, TX:
2,771,627, CANC. MULTIPLE CLASS, INT. CLS. 35 AND 41.

BLOCKJOCKS.COM LLC, DURHAM, NC:
3,806,649, PUB. 4-6-2010. INT. CL. 38.

BLOGWIRE HUNGARY SZELLEMI ALKOTAST HASZNOSITO KFT, BUDAPEST, HUNGARY:
3,805,741, PUB. 4-6-2010. INT. CL. 41.

BLUE ALPACA, SAC, LIMA, PERU:
3,807,544, INT. CL. 25.

BLUE MAN PRODUCTIONS, INC., NEW YORK, NY:
3,807,668, MULTIPLE CLASS, INT. CLS. 16 AND 41.

BLUE MOUNTAIN WALLCOVERINGS CANADA INC., BOUCHERVILLE, QUEBEC, CANADA:
2,771,070, CANC. INT. CL. 27.

BLUEDESERT, LTD., KFAR MONASH 42875, ISRAEL:
2,772,411, CANC. INT. CL. 12.

BLUEDOORWAY, LLC, AUSTIN, TX:
3,806,647, PUB. 4-6-2010. INT. CL. 35.

BLUEFLY, INC., NEW YORK, NY:
2,285,615, CANC. INT. CL. 35.

BLUELINX SERVICES INC., ATLANTA, GA:
2,772,176, CANC. INT. CL. 19.

BLUEPRINT GROWTH INSTITUTE, INC., OVERLAND PARK, KS:
3,807,565, INT. CL. 36.

BLUMER, MARC, CHICAGO, IL:
3,808,454, INT. CL. 35.

BLUWIRE GROUP LLC, PALM BEACH GARDENS, FL:
3,805,863, PUB. 4-6-2010. INT. CL. 35.

BMA HOLDINGS, LLC, CLEVELAND, OH:
2,771,781, CANC. INT. CL. 35.
2,771,782, CANC. INT. CL. 38.
2,771,783, CANC. INT. CL. 45.

BMC SOFTWARE, INC., SUGAR LAND, TX:
1,560,283, CANC. INT. CL. 9.

BMI AUTOMATION, INC., DOTHAN, AL TO BMI AUTOMATION, INC., DOTHAN, AL:
2,286,282, CANC. MULTIPLE CLASS, INT. CLS. 7 AND 42.

BMSI INSTITUTE L.L.C., OVERLAND PARK, KS:
2,285,031, CANC. INT. CL. 41.

BNL ENTERTAINMENT INC., TORONTO, ONTARIO:
2,357,056, REN. 5-19-10. MULTIPLE CLASS, INT. CLS. 25 AND 41.
2,357,056, CANC. INT. CL. 16.

BNP MEDIA, INC., TROY, MI:
2,363,455, REN. 5-14-10. INT. CL. 16.
3,805,153, PUB. 4-6-2010. INT. CL. 16.

BNY ESI & CO., INC., NEW YORK, NY TO BNY BROKERAGE LLC, NEW YORK, NY:
2,285,978, CANC. INT. CL. 36.

BOARD OF REGENTS OF THE UNIVERSITY SYSTEM OF GEORGIA, ATLANTA, GA:
3,806,101, PUB. 4-6-2010. MULTIPLE CLASS, INT. CLS. 16, 18, 21, 25 AND 41.
3,806,974, PUB. 4-6-2010. MULTIPLE CLASS, INT. CLS. 16, 18, 21, 25 AND 41.

BOB EVANS RESTAURANTS OF MICHIGAN, LLC, ANN ARBOR, MI:
3,732,146, COR. INT. CL. 4.

BOB'S STORES CORP., MERIDEN, CT:
3,805,982, PUB. 4-6-2010. INT. CL. 25.

BOBER, MARK EDWARD, ALLENTOWN, PA:
2,771,462, CANC. INT. CL. 41.

BOCANEGRA, ALFREDO, SYLMAR, CA:
3,806,261, PUB. 4-6-2010. INT. CL. 41.

BOCCI ENGINEERING, HOUSTON, TX:
3,806,679, PUB. 4-6-2010. MULTIPLE CLASS, INT. CLS. 35 AND 42.

BODAMER CONSULTING, LLC, ALPHARETTA, GA:
3,806,834, PUB. 4-6-2010. INT. CL. 38.

BODEGAS BARBADILLO, S.L., CÁDIZ, SPAIN:
3,807,462, INT. CL. 33.

BODEGAS DE AMERICA, S.A., JUAN DIAZ, CIUDAD DE PANAMA, PANAMA:
2,286,264, CANC. INT. CL. 33.

BODEGAS LAVAQUE S.A., BUENOS AIRES, ARGENTINA:
2,887,433, CANC. INT. CL. 33.

BODIFRESH, INC., WELLINGTON, FL:
3,805,143, PUB. 4-6-2010. INT. CL. 3.

BODYONICS, LTD., HICKSVILLE, NY:
2,772,719, CANC. INT. CL. 32.

BOEGER, WADE P., BANGOR, PA:
3,805,791, PUB. 4-6-2010. INT. CL. 41.

BOEHRINGER INGELHEIM VETMEDICA GMBH, FED REP GERMANY:
3,807,277, PUB. 4-6-2010. INT. CL. 16.

BOEHRINGER INGELHEIM VETMEDICA, INC., ST. JOSEPH, MO:
697,713, REN. 5-18-10. U.S. CL. 18 (INT. CL. 5).
2,350,046, REN. 5-18-10. INT. CL. 5.

BOH BROS. CONSTRUCTION CO., L.L.C., NEW ORLEANS, LA:
3,806,223, PUB. 4-6-2010. INT. CL. 37.

BOHEMIAN CLUB, SAN FRANCISCO, CA:
3,806,089, PUB. 4-6-2010. INT. CL. 41.

BOLA CORPORATION, HOUSTON, TX:
2,286,339, CANC. INT. CL. 25.

BOLD CITY BREWERY, LLC, JACKSONVILLE, FL:
3,806,620, PUB. 4-6-2010. MULTIPLE CLASS, INT. CLS. 40 AND 43.

BOLEY CORPORATION, LOS ANGELES, CA:
2,353,602, REN. 5-19-10. INT. CL. 28.

BOLLINGER, INC., SHORT HILLS, NJ:
3,806,663, PUB. 4-6-2010. MULTIPLE CLASS, INT. CLS. 35 AND 36.

BOLNER'S FIESTA PRODUCTS, INC., SAN ANTONIO, TX:
2,358,603, REN. 5-19-10. INT. CL. 30.

BOMAC VETS PLUS, INC., KNAPP, WI:
3,805,355, PUB. 4-6-2010. INT. CL. 5.

BOMBARDIER INC., MONTREAL, QUEBEC H3B 1Y8, CANADA:
2,770,564, CANC. MULTIPLE CLASS, INT. CLS. 12, 25

- AND 28.
- BOMIK, INC., JOHNSTON, IA:
2,285,942, CANC. INT. CL. 9.
- BOND LABORATORIES, INC., OMAHA, NE:
3,806,430, PUB. 4-6-2010. INT. CL. 5.
- BONSAL AMERICAN, INC., TOWSON, MD:
2,771,313, CANC. INT. CL. 19.
- BOOMERANG ACQUISITION COMPANY, LLC, CINCINNATI, OH:
2,284,647, CANC. INT. CL. 36.
- BOOMERANG BARTER EXCHANGE, INC., OAKDALE, MN:
3,806,263, PUB. 4-6-2010. INT. CL. 35.
3,806,409, PUB. 4-6-2010. INT. CL. 35.
- BOOTS RETAIL HOLDINGS (USA) INC., STAMFORD, CT:
3,808,058, INT. CL. 3.
- BORDEN CO., (PTE) LTD., SINGAPORE, DBA WILHELM HAUFFMAN & CO.:
1,641,011. REN. 5-19-10. INT. CL. 5.
- BORDER STATES INDUSTRIES, INC., FARGO, ND:
3,805,516, PUB. 4-6-2010. INT. CL. 35.
- BORDER STATES INDUSTRIES, INC., NORTH FARGO, ND:
3,805,838, PUB. 4-6-2010. MULTIPLE CLASS, INT. CLS. 35 AND 39.
- BORGHESE TRADEMARKS, INC., WILMINGTON, DE:
3,806,960, PUB. 4-6-2010. INT. CL. 3.
- BORLAND INTERNATIONAL, INC., SCOTTS VALLEY, CA:
1,559,790, CANC. INT. CL. 16.
- BOROUGH OF COLUMBIA, COLUMBIA, PA, DBA COLUMBIA HISTORIC MARKET HOUSE:
3,808,309, INT. CL. 36.
- BORRERO ART MATERIALS (BAM) CORP., BAYAMON, PUERTO RICO:
3,805,992, PUB. 4-6-2010. INT. CL. 35.
- BOSCHERT, KENNETH R., DR., BALLWIN, MO:
2,340,015. REN. 5-17-10. INT. CL. 42.
- BOURGALT INDUSTRIES LTD., SASKATCHEWAN S0K 3V0, CANADA:
2,353,552. REN. 5-20-10. INT. CL. 7.
- BOVIE SCREEN PROCESS PRINTING CO., INC., BOW, NH:
3,806,051, PUB. 4-6-2010. INT. CL. 9.
- BOX BUDDY SHIPPING LLC, SOUTH RIDING, VA:
3,806,367, PUB. 4-6-2010. INT. CL. 39.
3,806,368, PUB. 4-6-2010. INT. CL. 35.
- BOY SCOUTS OF AMERICA, IRVING, TX:
3,805,536, PUB. 4-6-2010. INT. CL. 41.
- BOYDS COLLECTION, LTD, THE, MCSHERRYSTOWN, PA:
2,772,184, CANC. INT. CL. 20.
- BOYK, JAMES, LOS ANGELES, CA, DBA PERFORMANCE RECORDINGS:
1,568,118. REN. 5-17-10. INT. CL. 9.
- BOYMOM, LLC, DALLAS, TX:
3,807,925, MULTIPLE CLASS, INT. CLS. 14 AND 16.
- BP P.L.C., LONDON, UNITED KINGDOM, BRITISH PETROLEUM COMPANY P.L.C., THE, LONDON, ENGLAND:
1,595,887. REN. 5-17-10. INT. CL. 4.
- BPB UNITED KINGDOM LIMITED, COVENTRY, UNITED KINGDOM:
2,349,279. REN. 5-15-10. MULTIPLE CLASS, INT. CLS. 17 AND 19.
- BPSI HOLDINGS, LLC., WILMINGTON, DE:
3,808,291, INT. CL. 1.
- BR CONSULTING, INC., SEDONA, AZ:
3,807,503, INT. CL. 41.
3,807,514, INT. CL. 41.
- BRADBURY, RHONDA, VALLEY CENTER, CA:
3,805,302, PUB. 4-6-2010. INT. CL. 29.
- BRADFORD TECHNOLOGIES, INC., SAN JOSE, CA:
3,808,034, INT. CL. 42.
- BRADLEY, ROBYN, FRAMINGHAM, MA:
3,806,523, PUB. 4-6-2010. INT. CL. 35.
- BRADY WORLDWIDE, INC., MILWAUKEE, WI:
1,623,271. REN. 5-20-10. INT. CL. 6.
- BRAINJUICER LTD, LONDON, UNITED KINGDOM:
3,537,101, COR. INT. CL. 35.
- BRAINSTORM MEDIA, INC., COLUMBUS, OH:
2,772,605, CANC. INT. CL. 41.
- BRANAN MEDICAL CORPORATION, IRVINE, CA:
2,771,248, CANC. INT. CL. 10.
- BRAND IMPORTS, LLC, SCOTTSDALE, AZ:
2,771,336, CANC. INT. CL. 9.
2,771,337, CANC. INT. CL. 16.
2,771,338, CANC. INT. CL. 28.
- BRANDED LLC, DALLAS, TX:
2,286,164, CANC. INT. CL. 28.
- BRANDING EMPIRE, LLC, MIAMI, FL:
3,806,239, PUB. 4-6-2010. MULTIPLE CLASS, INT. CLS. 9, 16, 25 AND 41.
- BRANDOLOGY, INC., PLEASANTON, CA:
2,434,061. REN. 5-14-10. INT. CL. 35.
- BRANDON E. FLOWERS AND RICKY C. CAPUTO PARTNERSHIP, THE, PASADENA, CA, DBA THE DYNAMIC ADVANTAGE: YOUR PROFESSIONAL FITNESS TEAM:
2,770,573, CANC. INT. CL. 41.
- BRAUN, WILLIAM C., IRVING, CA:
3,807,088, PUB. 4-6-2010. INT. CL. 36.
- BRAVO! MARKETING, INC., SAN FRANCISCO, CA:
2,770,619, CANC. INT. CL. 35.
- BRAZABRA CORP., NEW YORK, NY:
1,559,925, CANC. INT. CL. 25.
- BRAZOS WINE IMPORTS, HILTON HEAD, SC:
3,807,934, INT. CL. 33.
- BRBAGELS & MORE INC., SMITHSBURG, MD, DBA ZI PANI BREADS CAFÉ:
3,805,410, PUB. 4-6-2010. INT. CL. 43.
- BRC IP PTY LIMITED, ULTIMO SYDNEY NSW, AUSTRALIA:
3,808,680, MULTIPLE CLASS, INT. CLS. 9 AND 44.
- BRD SUPPLY, INC., BRISTOL, IN:
3,805,801, PUB. 4-6-2010. MULTIPLE CLASS, INT. CLS. 6 AND 20.
- BREATHABLEBABY, LLC, EAGAN, MN:
3,806,732, PUB. 4-6-2010. INT. CL. 24.
- BRENNAN VINEYARDS, L.L.C., COMANCHE, TX:
3,805,648, PUB. 4-6-2010. INT. CL. 33.
- BRENT R.W. MOELLEKEN, BEVERLY HILLS, CA:
3,806,346, PUB. 4-6-2010. INT. CL. 44.
- BRETON ENTERPRISES, INC., HUNTINGTON, NY:
3,808,703, INT. CL. 30.
- BRIAN BOUCHARD, ALGONQUIN, IL, DBA CHI-STAR TECHNOLOGY:
3,807,480, INT. CL. 9.
- BRIDGEPORT LABORATORIES, LLC, PLANTATION, FL:
2,771,834, CANC. INT. CL. 5.
- BRIGHTSTORM, INC., SAN FRANCISCO, CA:
3,807,730, MULTIPLE CLASS, INT. CLS. 9, 35, 38, 41 AND 42.
- BRILLIANT LEARNING INC., PHILADELPHIA, PA:
3,805,417, PUB. 4-6-2010. INT. CL. 41.
3,805,420, PUB. 4-6-2010. INT. CL. 41.
3,805,421, PUB. 4-6-2010. INT. CL. 41.
3,805,422, PUB. 4-6-2010. INT. CL. 41.
3,805,423, PUB. 4-6-2010. INT. CL. 41.
- BRINKER INTERNATIONAL HOLDINGS, LP, DALLAS, TX:
2,285,504, CANC. INT. CL. 32.
- BRINKER INTERNATIONAL PAYROLL COMPANY, L.P., DALLAS, TX:
2,285,087, CANC. INT. CL. 29.
- BRINKMANN INSTRUMENTS, INC., WESTBURY, NY:
2,284,444, CANC. INT. CL. 9.
- BRITE MANUFACTURING INC., BOLTON, ONTARIO, CANADA:
2,770,618, CANC. INT. CL. 19.
- BROADCAST MUSIC, INC., NEW YORK, NY:
3,806,887, PUB. 4-6-2010. INT. CL. 41.
- BROADCOM CORPORATION, IRVINE, CA:
3,808,572, INT. CL. 9.
- BROADSOURCE, INC., ATLANTA, GA:
2,770,640, CANC. MULTIPLE CLASS, INT. CLS. 38 AND 42.
- BROADVIEW INVESTMENTS, LLC, ROYSTON, GA:
3,808,422, INT. CL. 40.

BROADWING COMMUNICATIONS, LLC, WASHINGTON, DC:
2,771,971, CANC. INT. CL. 38.

BROCADIANT PLLC, ALEXANDRIA, VA:
3,806,671, PUB. 4-6-2010. INT. CL. 41.

BROCK CABINETS INCORPORATED, FAYETTEVILLE, NC:
3,563,160, AM. INT. CL. 20.

BRONCO WINE COMPANY, CERES, CA:
3,808,598, INT. CL. 33.

BRONFMAN, MARK C., BETHESDA, MD:
3,806,978, PUB. 4-6-2010. INT. CL. 36.

BROTHER HOLDINGS CO., LTD, ZHEJIANG, CHINA:
3,805,945, PUB. 4-6-2010. INT. CL. 28.

BROWN BROADCASTING SERVICE, INC., PROVIDENCE, RI:
2,772,687, CANC. INT. CL. 41.

BROWN, CHIQUITA, MEMPHIS, TN:
2,772,643, CANC. INT. CL. 11.

BROWN, DAVID H, VISTA, CA:
3,808,316, MULTIPLE CLASS, INT. CLS. 18, 25 AND 28.

BROWN, MAKELAIE, LOS ANGELES, CA:
2,261,832, REN. 5-20-10. INT. CL. 9.

BROWN, MICHAEL W., ZANESVILLE, OH:
2,770,892, CANC. INT. CL. 16.

BROWN, NOEL, WILMINGTON, NC:
3,807,398, INT. CL. 41.

BROWNS CANYON CORPORATION, WILMINGTON, DE, MANAGEMENT RECRUITERS INTERNATIONAL, INC., CLEVELAND, OH:
891,390, REN. 5-19-10. U.S. CL. 101 (INT. CL. 35).

BROWNS CANYON CORPORATION, WILMINGTON, DE:
3,806,138, PUB. 4-6-2010. U.S. CL. 200.
3,806,140, PUB. 4-6-2010. U.S. CL. 200.

BROWNSTONE MARKETING, LLC, WATERLOO, IA:
3,805,871, PUB. 4-6-2010. INT. CL. 35.

BRUCKMAN, DAVID B., RYE BROOK, NY:
3,808,242, MULTIPLE CLASS, INT. CLS. 35 AND 36.

BRUGMAN, MARJOLEIN, CAMBRIDGE, MA:
3,806,003, PUB. 4-6-2010. INT. CL. 44.

BRUSH ENGINEERED MATERIALS, INC., MAYFIELD HEIGHTS, OH:
3,807,561, MULTIPLE CLASS, INT. CLS. 1 AND 2.

BRUSH WELLMAN INC., MAYFIELD HEIGHTS, OH:
1,597,170, REN. 5-19-10. INT. CL. 6.

BSH BOSCH UND SIEMENS HAUSGERATE GMBH, MUNICH, FED REP GERMANY:
2,770,734, CANC. MULTIPLE CLASS, INT. CLS. 7, 9 AND 11.

BUCATINI, LLC., SANTA BARBARA, CA:
3,806,943, PUB. 4-6-2010. INT. CL. 43.

BUCCANEER LANDSCAPE MANAGEMENT CORPORATION, ST. PETERSBURG, FL:
3,806,163, PUB. 4-6-2010. MULTIPLE CLASS, INT. CLS. 31, 37 AND 44.

BUCK KNOB PUBLISHING LLC, LOOGOOTEE, IN:
3,808,766, MULTIPLE CLASS, INT. CLS. 9 AND 41.

BUDDHA FOODHA INC., ONTARIO, CANADA:
3,805,188, PUB. 4-6-2010. MULTIPLE CLASS, INT. CLS. 25, 29, 30 AND 43.

BUFFALO JOE'S, LLC, SAN DIEGO, CA, DBA WHISKEY GIRL:
3,806,307, PUB. 4-6-2010. INT. CL. 43.

BUILD RIGHT PRODUCTS, LLC, OVERLAND PARK, KS:
3,806,474, PUB. 4-6-2010. INT. CL. 17.

BUILDERMARTS OF AMERICA, INC., GREENVILLE, SC:
2,285,181, CANC. INT. CL. 35.

BUILDING MATERIALS CORPORATION OF AMERICA, WAYNE, NJ, DBA GAF MATERIALS CORPORATION:
2,362,748, REN. 5-20-10. INT. CL. 19.

BUKANG SEMS CO., LTD., REPUBLIC OF KOREA:
3,807,246, PUB. 4-6-2010. MULTIPLE CLASS, INT. CLS. 7 AND 11.

BULL GUARD LIMITED, LONDON, UNITED KINGDOM:
3,808,027, INT. CL. 9.
3,808,029, INT. CL. 42.

BULL PATH CAPITAL MANAGEMENT LLC, NEW YORK, NY:
3,808,178, INT. CL. 36.

BUNGE OILS, INC., ST. LOUIS, MO:
2,374,882, REN. 5-17-10. INT. CL. 29.

BUNN-O-MATIC CORPORATION, SPRINGFIELD, IL:
3,807,686, MULTIPLE CLASS, INT. CLS. 7, 11 AND 21.

BURDETTE, KOEHLER, MURPHY & ASSOCIATES, INC., BALTIMORE, MD, AKA BKM:
3,806,562, PUB. 4-6-2010. INT. CL. 42.

BURGER FUEL INTERNATIONAL LIMITED, AUCKLAND, NEW ZEALAND:
3,805,304, PUB. 4-6-2010. MULTIPLE CLASS, INT. CLS. 29, 30 AND 43.

BURGER KING CORPORATION, MIAMI, FL:
2,771,092, CANC. INT. CL. 43.
3,808,360, INT. CL. 43.

BURGER LOUNGE OF AMERICA LLC, SAN DIEGO, CA:
3,808,502, INT. CL. 43.

BURGHOFF, DAVID R., NORTH GRANBY, CT:
1,559,798, CANC. INT. CL. 16.

BURKE, THOMAS J., LAKESIDE PARK, KY:
2,772,712, CANC. INT. CL. 42.

BURKET, DONALD REX, KOKOMO, IN:
2,286,167, CANC. INT. CL. 25.

BURMA-BIBAS, INC., NEW YORK, NY:
704,008, REN. 5-19-10. U.S. CL. 39 (INT. CL. 25).

BURNHAM SERVICES, INC., WILMINGTON, DE:
2,343,871, REN. 5-14-10. INT. CL. 11.

BURNS, ROBERT, JUDE, SACRAMENTO, CA, DBA REGULAR ROB:
3,806,567, PUB. 4-6-2010. INT. CL. 25.

BURR, RICKY, HUGO, MN, DBA RICKY BURR:
3,808,630, INT. CL. 7.

BURROUGHS, MICHAEL R., FRANKLIN, TN:
3,806,869, PUB. 4-6-2010. INT. CL. 42.

BURWELL INDUSTRIES, INC., ENGLEWOOD, CO:
3,807,448, INT. CL. 3.

BUSH JR, JEROME T, NEW ORLEANS, LA, DBA JONT VENTURE:
3,805,378, PUB. 4-6-2010. INT. CL. 25.

BUSINESS INCENTIVES, INC., MINNEAPOLIS, MN:
1,560,121, CANC. INT. CL. 35.

BUSINESS INTELLIGENCE SOLUTIONS SAFE B.V., 1062HH AMSTERDAM, NETHERLANDS:
3,805,318, PUB. 4-6-2010. MULTIPLE CLASS, INT. CLS. 9 AND 35.

BUTH, FREDRICK A., SHAWANO, WI:
3,807,392, INT. CL. 10.

BUYRITE AUTOGLASS, INC., COON RAPIDS, MN, DBA RAPID GLASS:
3,805,614, PUB. 4-6-2010. MULTIPLE CLASS, INT. CLS. 19 AND 21.

BUYSELLADS.COM, SOUTH BOSTON, MA:
3,808,739, INT. CL. 35.

BV/CJUF MIDTOWN VENTURES, LLC, MILWAUKEE, WI:
2,771,037, CANC. INT. CL. 36.

BVS, INC., CEDAR RAPIDS, IA, DBA BVS PERFORMANCE SYSTEMS:
2,771,247, CANC. MULTIPLE CLASS, INT. CLS. 35 AND 41.

BWC, INC., PORTLAND, OR:
3,806,469, PUB. 4-6-2010. INT. CL. 37.
3,806,478, PUB. 4-6-2010. INT. CL. 9.
3,806,483, PUB. 4-6-2010. INT. CL. 9.

BY THE BEACH PRODUCTIONS, L.L.C., SANTA CLARA, CA, DBA MERMAID SERIES:
3,805,371, PUB. 4-6-2010. INT. CL. 41.

BYRD, PAUL A., FOUNTAIN VALLEY, CA:
3,806,054, PUB. 4-6-2010. INT. CL. 25.

B4MARKET GROUP, INC., LONDON, ONTARIO, CANADA:
3,808,197, INT. CL. 24.

BÜHLER PARTEC GMBH, 66123 SAARBRÜCKEN, FED REP GERMANY:
3,807,161, PUB. 4-6-2010. MULTIPLE CLASS, INT. CLS. 1 AND 25.

- C. & J. CLARK INTERNATIONAL LIMITED, STREET, SOMERSET, UNITED KINGDOM:
3,808,136, INT. CL. 25.
- C. V. STARR & CO., INC., NEW YORK, NY:
3,806,194, PUB. 4-6-2010. INT. CL. 36.
3,806,195, PUB. 4-6-2010. INT. CL. 36.
- C.A.N. INDUSTRIES, INC., SAN ANTONIO, TX:
2,770,672, CANC. INT. CL. 37.
- C.R. BARD, INC., MURRAY HILL, NJ:
2,284,984, CANC. INT. CL. 5.
- C.S.F. CORP., WILMINGTON, DE:
2,772,258, CANC. INT. CL. 25.
- C-U-C SIGNS, INC., COLUMBIA, SC, AKA CAN-U-CEE SIGNS:
3,805,474, PUB. 4-6-2010. INT. CL. 20.
- C/HCA, INC., NASHVILLE, TN:
3,805,161, PUB. 4-6-2010. INT. CL. 44.
- CA GARDEN SHOW LLC, LIVERMORE, CA, DBA SAN FRANCISCO FLOWER & GARDEN SHOW:
2,347,997. REN. 5-14-10. MULTIPLE CLASS, INT. CLS. 35 AND 41.
- CABIN CREEK, LLC, PLEASANT GROVE, UT:
3,805,898, PUB. 4-6-2010. MULTIPLE CLASS, INT. CLS. 6, 16, 26 AND 35.
- CABLE MANAGEMENT SOLUTIONS, INC., BAYSHORE, NY:
2,445,477. REN. 5-20-10. INT. CL. 9.
- CABLE NEWS NETWORK, INC., ATLANTA, GA:
2,378,868. REN. 5-18-10. INT. CL. 8.
- CABLETRON SYSTEMS, INC., E. ROCHESTER, NH:
1,560,277, CANC. INT. CL. 9.
- CABO RICO YACHTS, INC., FORT LAUDERDALE, FL:
2,284,982, CANC. INT. CL. 12.
- CABRERA, PEDRO AVELINO, SANTA CRUZ, BOLIVIA:
3,807,996, INT. CL. 16.
- CADEN, JODI E., BIRMINGHAM, MI:
3,806,402, PUB. 4-6-2010. INT. CL. 25.
- CADENCE DESIGN SYSTEMS, INC., SAN JOSE, CA:
1,559,672, CANC. INT. CL. 9.
- CADORNIGA, DENNIS, VANCOUVER, WA AND EWING, MARK, VANCOUVER, WA AND SAWYER, CHRISTOPHER, VANCOUVER, WA:
3,806,484, PUB. 4-6-2010. INT. CL. 35.
- CAFES LA VIRGINIA S.A., ROSARIO, PROVINCE OF SANTA FE, ARGENTINA:
2,348,003. REN. 5-17-10. INT. CL. 30.
- CAL TAX GROUP, INC., LOS ANGELES, CA:
3,806,114, PUB. 4-6-2010. INT. CL. 35.
- CALDWELL, CHRISTINA L., CINCINNATI, OH:
3,806,070, PUB. 4-6-2010. INT. CL. 42.
- CALDWELL, MICHAEL, SANTA CLARA, CA:
3,808,113, INT. CL. 45.
- CALIFORNIA LIFESTYLES DIVISION OF THE TRICRAFT GROUPS, LTD., COMPTON, CA:
1,559,990, CANC. INT. CL. 25.
- CALIFORNIA STATE AUTOMOBILE ASSOCIATION, WALNUT CREEK, CA:
2,443,911. REN. 5-18-10. MULTIPLE CLASS, INT. CLS. 37, 39 AND 42.
- CALIFORNIA TAN, INC., INDIANAPOLIS, IN:
3,805,338, PUB. 4-6-2010. INT. CL. 3.
- CALIP HOLDINGS INC., BRONX, NY:
3,808,568, INT. CL. 30.
- CALLCATCHERS, INC., ENCINITAS, CA:
3,806,268, PUB. 4-6-2010. INT. CL. 38.
3,807,017, PUB. 4-6-2010. INT. CL. 38.
- CALLIPER LIFE SCIENCES, INC., ALAMEDA, CA:
2,377,934. REN. 5-20-10. INT. CL. 9.
- CALPOP.COM, INC., LOS ANGELES, CA:
3,806,215, PUB. 4-6-2010. INT. CL. 25.
- CALVARY DESIGN TEAM INC., WEST HENRIETTA, NY:
3,805,144, PUB. 4-6-2010. MULTIPLE CLASS, INT. CLS. 7 AND 12.
- CAMACHO, ANGELA, SAN FRANCISCO, CA, DBA SPOTTED DOG GRAPHICS:
2,285,212, CANC. INT. CL. 42.
- CAMDEN BASEBALL, LLC, CAMDEN, NJ:
2,771,558, CANC. INT. CL. 16.
- CAMELOT COMMUNICATIONS GROUP, INC., NEW YORK, NY:
3,808,220, MULTIPLE CLASS, INT. CLS. 37 AND 42.
- CAMERON NURSERY, ELTOPIA, WA:
3,807,562, INT. CL. 31.
- CAMFIL FARR, INC., RANCHO DOMINGUEZ, CA:
2,286,669, CANC. INT. CL. 42.
- CAMI-RINGS, LLC, MIAMI, FL:
3,805,760, PUB. 4-6-2010. INT. CL. 14.
3,805,761, PUB. 4-6-2010. INT. CL. 18.
- CAMP KOREY, CARNATION, WA:
3,806,016, PUB. 4-6-2010. INT. CL. 41.
- CAMPBELL KYLE PROFFITT LLP, NOBLESVILLE, IN:
2,440,804. REN. 5-20-10. INT. CL. 42.
- CAMPBELL, MARCIE, SHERMAN OAKS, CA:
3,807,589, MULTIPLE CLASS, INT. CLS. 39, 43 AND 44.
3,807,590, MULTIPLE CLASS, INT. CLS. 39, 43 AND 44.
- CAMPBELL, MELANIE, BROOKLYN, NY:
3,806,614, PUB. 4-6-2010. INT. CL. 35.
- CAMPINA NEDERLAND HOLDING B.V., 5301 LB ZALT-BOMMEL, NETHERLD ANTILLES:
2,359,621. REN. 5-18-10. INT. CL. 1.
- CAMPISI, JAMES, PAUL, ROCKAWAY, NJ:
2,771,674, CANC. INT. CL. 9.
- CANADIAN IMPERIAL BANK OF COMMERCE, TORONTO, CANADA:
3,805,316, PUB. 4-6-2010. INT. CL. 36.
- CANADIAN MINERAL WATER; DEVELOPMENT S.A., LUXEMBOURG:
3,807,210, PUB. 4-6-2010. MULTIPLE CLASS, INT. CLS. 32 AND 33.
3,807,216, PUB. 4-6-2010. MULTIPLE CLASS, INT. CLS. 32 AND 33.
- CANANDAIGUA WINE COMPANY, INC., CANANDAIGUA, NY:
2,286,098, CANC. INT. CL. 33.
- CANDY & CANDY LIMITED, ESHER, SURREY, UNITED KINGDOM:
3,805,216, PUB. 4-6-2010. INT. CL. 36.
3,805,217, PUB. 4-6-2010. INT. CL. 42.
- CANNONE, JOSEPH A., CRANFORD, NJ, DBA FUM RECORDS.:
2,771,818, CANC. INT. CL. 9.
- CANOPY ACQUISITION, LLC, OMAHA, NE:
2,770,866, CANC. MULTIPLE CLASS, INT. CLS. 36 AND 44.
- CANTERBURY ENTERPRISES, INC., CORONA, CA, DBA: CANTERBURY ENTERPRISES, INC:
2,686,950, AM. INT. CL. 11.
- CANVAS S CO., LTD., JAPAN:
3,807,217, PUB. 4-6-2010. INT. CL. 9.
- CAP TECHNOLOGIES GMBH, FED REP GERMANY:
3,807,190, PUB. 4-6-2010. MULTIPLE CLASS, INT. CLS. 6, 20, 21 AND 42.
- CAPITAL CONTROLS COMPANY, INC., COLMAR, PA:
2,772,321, CANC. INT. CL. 11.
- CAPITAL ENHANCEMENT, L.L.C., MORRISON, NJ:
2,284,985, CANC. INT. CL. 36.
- CAPITAL RESOURCES & CONSULTING, INC., LOS ANGELES, CA:
2,380,082. REN. 5-19-10. INT. CL. 35.
- CAPLAN INDUSTRIES INC., DELTA, BRITISH COLUMBIA, CANADA:
3,131,616, CANC. MULTIPLE CLASS, INT. CLS. 7 AND 8.
- CAPOEIRA VOLTA AO MUNDO, INC., SARASOTA, FL:
3,806,612, PUB. 4-6-2010. INT. CL. 41.
- CAPT BILLY'S CRAB HOUSE, INC., PORT TOBACCO, MD:
2,285,189, CANC. INT. CL. 42.
- CARASOLVA, INC., BOULDER, CO:
3,806,530, PUB. 4-6-2010. INT. CL. 42.
- CARAVAN CANOPY INTERNATIONAL, INC., LA MIRADA, CA:
3,807,708, INT. CL. 22.
- CARBON ZERO CLOTHING, LLC, REDONDO BEACH, CA:
3,807,877, INT. CL. 25.
- CARBONE SABRINA, ITALY:
3,807,336, PUB. 4-6-2010. INT. CL. 18.

CARDARELLI, VENANZIO, PLYMOUTH, MA:
3,807,681, INT. CL. 28.

CARDIAC PACEMAKERS, INC., ST. PAUL, MN:
3,807,401, INT. CL. 44.

CARDINAL SOFTWARE, INC., AUSTIN, TX:
2,424,920, REN. 5-20-10. INT. CL. 9.

CARE COMMONS, INC., NEWTON, MA:
3,806,347, PUB. 4-6-2010. INT. CL. 44.

CARE REHAB & ORTHOPAEDIC PRODUCTS, INC.,
MCLEAN, VA:
2,771,277, CANC. INT. CL. 10.

CAREY G. MUMFORD, CROSSVILLE, TN:
3,806,086, PUB. 4-6-2010. INT. CL. 41.

CARFX, INC., OVERLAND PARK, KS:
3,808,086, MULTIPLE CLASS, INT. CLS. 35 AND 45.

CARGILL, INCORPORATED, MINNETONKA, MN:
880,665, REN. 5-19-10. U.S. CL. 105 (INT. CL. 39).

CARHARTT, INC., DEARBORN, MI:
3,805,359, PUB. 4-6-2010. INT. CL. 25.

CARIBBEAN FOOD DELIGHTS, INC., TAPPAN, NY:
2,284,582, CANC. INT. CL. 31.

CARL KÄRCHER ENTERPRISES, INC., CARPINTERIA, CA:
3,807,406, INT. CL. 43.

CARL MARKS & CO. INC., NEW YORK, NY:
2,772,066, CANC. INT. CL. 36.

CARL OPPEDAHL, DILLON, CO:
3,806,355, PUB. 4-6-2010. INT. CL. 45.

CARL ZEISS AG, 73447 OBERKOCHEN, FED REP GER-
MANY:
3,807,941, INT. CL. 9.

CARL ZEISS MEDITEC AG, JENA, FED REP GERMANY:
2,770,583, CANC. INT. CL. 10.
3,805,999, PUB. 4-6-2010. INT. CL. 5.
3,806,000, PUB. 4-6-2010. INT. CL. 5.
3,806,001, PUB. 4-6-2010. INT. CL. 5.
3,806,002, PUB. 4-6-2010. INT. CL. 5.
3,806,024, PUB. 4-6-2010. INT. CL. 5.

CARL ZEISS VISION INC., SAN DIEGO, CA:
2,286,541, CANC. INT. CL. 9.

CARLSBAD CHAMBER OF COMMERCE, CARLSBAD, CA:
3,806,078, PUB. 4-6-2010. INT. CL. 35.

CARMEN CARTER, THOUSAND OAKS, CA:
3,806,780, PUB. 4-6-2010. INT. CL. 41.

CARNIVAL PLC, LONDON, UNITED KINGDOM:
2,375,492, REN. 5-19-10. INT. CL. 39.

CAROUSEL CAPITAL MANAGEMENT COMPANY, LP,
CHARLOTTE, NC:
3,805,705, PUB. 4-6-2010. INT. CL. 36.
3,805,706, PUB. 4-6-2010. INT. CL. 36.

CARPE DATUM, INC., HENRIETTA, NY:
2,349,565, REN. 5-15-10. INT. CL. 42.

CARRAGINO, ROBERT, RANDOLPH, NJ:
3,806,165, PUB. 4-6-2010. INT. CL. 35.

CARRIER CORPORATION, SYRACUSE, NY:
1,559,696, CANC. INT. CL. 11.

CARTER AND COMPANY, LLC, INDIANAPOLIS, IN, DBA
ADDRESSTWO:
3,806,241, PUB. 4-6-2010. INT. CL. 42.

CARTER HOLT HARVEY LIMITED, ONEHUNGA, AUCK-
LAND, NEW ZEALAND:
2,390,789, REN. 5-18-10. INT. CL. 16.

CARTER'S, INC., CHARLOTTE, MI:
2,284,864, CANC. INT. CL. 35.

CARTRONICS, MIAMI, FL:
2,771,145, CANC. MULTIPLE CLASS, INT. CLS. 35 AND
37.

CAS MEDICAL SYSTEMS, INC., BRANFORD, CT:
1,597,307, REN. 5-20-10. INT. CL. 10.

CASA DEL BIANCO FINE LINENS, INC., NEW YORK, NY:
2,772,138, CANC. INT. CL. 24.

CASA VINICOLA SARTORI S.P.A., ITALY:
3,807,293, PUB. 4-6-2010. INT. CL. 33.

CASCADE COIL DRAPERY, INC., TUALATIN, OR:
3,806,676, PUB. 4-6-2010. INT. CL. 6.

CASCADOO, LLC, MIAMI, FL:
3,806,672, PUB. 4-6-2010. INT. CL. 35.

CASE-ARI, TUCKER, GA, DBA CASE-MATE:
3,807,897, INT. CL. 9.

CASESTACK, INC., LOS ANGELES, CA:
2,771,725, CANC. MULTIPLE CLASS, INT. CLS. 35 AND
39.

CASHEL PRODUCTS, INC., CHEHALIS, WA:
2,772,633, CANC. INT. CL. 18.

CASTELPRILE; DI FEDERICA MASCHERONI STIANTI,
ITALY:
3,807,147, PUB. 4-6-2010. INT. CL. 33.

CASTLE KEEPERS OF CHARLESTON, INC., NORTH
CHARLESTON, SC:
2,771,539, CANC. INT. CL. 37.

CAT EYE CO., LTD., OSAKA-SHI, OSAKA, JAPAN:
3,807,394, INT. CL. 11.

CATALYST COUNCIL INC., KANSAS CITY, MO:
3,805,610, PUB. 4-6-2010. INT. CL. 35.

CATCHLIGHT ENERGY, LLC, SAN RAMON, CA:
3,808,528, MULTIPLE CLASS, INT. CLS. 4, 16, 18, 25 AND
40.
3,808,545, MULTIPLE CLASS, INT. CLS. 4, 18, 25 AND 40.
3,808,546, MULTIPLE CLASS, INT. CLS. 4, 16, 18, 25 AND
40.

CATHAY PACIFIC AIRWAYS LIMITED, 88 QUEENSWAY,
HONG KONG:
2,770,700, CANC. MULTIPLE CLASS, INT. CLS. 39 AND
42.

CATHOLIC FLOWERS, LLC, PHOENIX, AZ:
3,807,814, INT. CL. 31.
3,807,815, INT. CL. 31.

CATHOLIC HEALTH INITIATIVES COLORADO, ENGLE-
WOOD, CO, DBA ST. ANTHONY CENTRAL HOSPITAL:
3,806,442, PUB. 4-6-2010. INT. CL. 41.

CAUDALIE USA, INC., RICHARDSON, TX:
2,772,680, CANC. INT. CL. 3.

CAUSE DIRECT EDUCATION, BATH, UNITED KINGDOM,
FORMERLY CAUSE DIRECT EDUCATION LTD.:
3,805,240, PUB. 6-30-2009. MULTIPLE CLASS, INT. CLS. 9
AND 41.

CAUSE TV, INC., POTOMAC, MD:
3,807,463, MULTIPLE CLASS, INT. CLS. 41, 42 AND 45.

CBL & ASSOCIATES MANAGEMENT, INC., CHATTANOO-
GA, TN:
3,806,825, PUB. 4-6-2010. INT. CL. 35.

CBR SYSTEMS, INC., SAN BRUNO, CA:
3,808,713, INT. CL. 35.

CBS INTERACTIVE INC., NEW YORK, NY:
3,808,695, INT. CL. 9.
3,808,696, INT. CL. 42.

CBS RADIO INC., NEW YORK, NY:
2,770,586, CANC. INT. CL. 35.

CCV SOFTWARE INC., CHARLESTON, WV:
2,284,555, CANC. INT. CL. 35.

CD DIMENSIONS, INC., DEEP RIVER, CT:
2,363,742, REN. 5-17-10. INT. CL. 35.

CD ROAM LLC, LOS ANGELES, CA:
2,772,682, CANC. INT. CL. 9.

CD-ROM-WORKS, LLC, PORTLAND, OR:
2,771,507, CANC. INT. CL. 40.

CDC ENTERPRISES, INC., ROGERS, MN:
3,487,267, COR. MULTIPLE CLASS, INT. CLS. 37 AND
42.

CDI SEALS, INC., HUMBLE, TX:
2,350,512, REN. 5-17-10. INT. CL. 17.

CDOC, INC., CARMEL, IN:
2,771,055, CANC. INT. CL. 36.

CDRE TM LLC, MISSION VIEJO, CA:
2,771,791, CANC. INT. CL. 36.

CEDARCHEM, LLC, CEDARTOWN, GA:
3,808,128, INT. CL. 1.
3,808,130, INT. CL. 1.

CELEBRITY BABY SCOOP, LLC, SPARTA, NJ:
3,806,243, PUB. 4-6-2010. INT. CL. 41.

CELEMONY SOFTWARE GMBH, FED REP GERMANY:
3,807,316, PUB. 4-6-2010. MULTIPLE CLASS, INT. CLS. 9
AND 42.

CELLEX THERAPEUTICS, INC., NEEDHAM, MA:
2,286,254, CANC. INT. CL. 40.

- CELLOMETRICS INC., HAMILTON, ONTARIO, CANADA, FORMERLY 2158141 ONTARIO INC.:
3,805,427, PUB. 4-6-2010. INT. CL. 10.
- CELLULAR & WIRELESS WHOLESALE CORP., MIAMI, FL:
2,771,332, CANC. INT. CL. 9.
- CELTIC SEAWEED BATH PRODUCTS LTD., CO. SLIGO, IRELAND:
3,805,412, PUB. 11-3-2009. INT. CL. 3.
- CENDANT FINANCE HOLDING COMPANY LLC, PARSIPPANY, NJ:
2,772,561, CANC. MULTIPLE CLASS, INT. CLS. 35 AND 42.
- CENTENNIAL MORTGAGE AND FUNDING, INC., EDEN PRAIRIE, MN:
2,771,925, CANC. INT. CL. 36.
- CENTER FOR ECOLITERACY, BERKELEY, CA:
3,807,771, INT. CL. 16.
3,807,794, INT. CL. 38.
- CENTER FOR GREEN STUDIES, INC., ISLAMORADA, FL:
3,806,970, PUB. 4-6-2010. INT. CL. 41.
- CENTER ROCK, INC., BERLIN, PA:
3,806,510, PUB. 4-6-2010. INT. CL. 7.
- CENTERSTONE INSURANCE AND FINANCIAL SERVICES, INC., DALLAS, TX, DBA BENEFITMALL:
3,808,704, MULTIPLE CLASS, INT. CLS. 35, 36 AND 42.
- CENTRACARE HEALTH SYSTEM, ST.CLOUD, MN:
2,404,121, REN. 5-18-10. MULTIPLE CLASS, INT. CLS. 36 AND 42.
- CENTRAL BENEFITS MUTUAL INSURANCE COMPANY, WESTERVILLE, OH:
2,770,930, CANC. INT. CL. 36.
- CENTRAL COMPUTERS, INC., SANTA CLARA, CA:
3,806,350, PUB. 4-6-2010. INT. CL. 9.
- CENTRAL GARDEN & PET COMPANY, A DELAWARE CORPORATION, LAFAYETTE, CA:
2,772,735, CANC. INT. CL. 28.
- CENTRAL GROCERY COMPANY, LLC, NEW ORLEANS, LA:
1,608,394, REN. 5-20-10. INT. CL. 29.
- CEPEDA, DANIEL, GLENDALE, CA AND CEPEDA, PATRICIA, GLENDALE, CA, DBA NATURAL WAY PRODUCTS:
2,284,804, CANC. MULTIPLE CLASS, INT. CLS. 3 AND 21.
- CEPIA, LLC, ST. LOUIS, MO:
3,808,405, INT. CL. 28.
3,808,406, INT. CL. 28.
- CEPORT, LLC, SKOKIE, IL:
3,807,545, MULTIPLE CLASS, INT. CLS. 9, 35, 38, 42 AND 45.
- CEPSTRAL, LLC, PITTSBURGH, PA:
2,770,987, CANC. INT. CL. 9.
- CEPTARA CORP, MILL CREEK, WA:
3,806,197, PUB. 4-6-2010. INT. CL. 35.
- CERAMICAS INDUSTRIALES CISA S.A., CERRO NAVIA, SANTIAGO, CHILE:
3,805,715, PUB. 4-6-2010. INT. CL. 11.
- CEREAL INGREDIENTS, INC., LEAVENWORTH, KS:
2,286,135, CANC. INT. CL. 30.
- CERTAINTED CORPORATION, VALLEY FORGE, PA:
2,771,930, CANC. INT. CL. 42.
3,805,690, PUB. 4-6-2010. INT. CL. 41.
- CEU.COM, OLD SAYBROOK, CT:
3,087,313, COR. INT. CL. 41.
- CEVDET DOGAN, ISTANBUL, TURKEY:
2,772,510, CANC. INT. CL. 25.
- CGBS INTERNATIONAL S.A., SWITZERLAND:
3,807,270, PUB. 4-6-2010. INT. CL. 3.
- CHAFAER, JOSE LUIS JOSE, 46220 PICASSENT (VALENCIA), SPAIN:
2,771,410, CANC. INT. CL. 3.
- CHAIKEN HOLDINGS, L.P., SAN FRANCISCO, CA:
2,771,954, CANC. INT. CL. 18.
- CHAIN SEQUENCE, INC., BARRINGTON, IL:
3,806,799, PUB. 4-6-2010. INT. CL. 35.
- CHALLENGE ONLINE GAMES, INC., AUSTIN, TX, FORMERLY OXYGEN GAMES:
3,808,688, INT. CL. 41.
- CHAMPION PERFORMANCE PRODUCTS, INC., SUNRISE, FL:
3,807,610, INT. CL. 29.
- CHAN, HOWARD, IRVINE, CA:
2,772,564, CANC. INT. CL. 9.
- CHANCE-I USA CORP., IRVINE, CA:
3,807,064, PUB. 1-31-2006. INT. CL. 42.
- CHANCELLOR, MASTERS AND SCHOLARS OF THE UNIVERSITY OF OXFORD, THE, OXFORD OX2 6DP, UNITED KINGDOM, DBA OXFORD UNIVERSITY PRESS:
2,349,300, REN. 5-18-10. INT. CL. 16.
2,349,409, REN. 5-18-10. INT. CL. 9.
- CHANDARIA, SACHEN, NAIROBI, KENYA:
2,772,137, CANC. INT. CL. 16.
- CHANGYOU.COM LIMITED, GEORGE TOWN, GRAND CAYMAN, CAYMAN ISLANDS:
3,808,066, MULTIPLE CLASS, INT. CLS. 41 AND 42.
- CHANNEL V MEDIA, NEW YORK, NY, TA CHANNEL V BOOKS:
3,808,385, MULTIPLE CLASS, INT. CLS. 16 AND 42.
- CHAO, D.D.S., JOHN, ALHAMBRA, CA:
3,807,882, INT. CL. 44.
- CHAOZHOU NEW POWER CO., LTD., CHAOZHOU, GUANGDONG, CHINA:
3,808,410, INT. CL. 21.
- CHAP A NOSH OF CEDARHURST, CEDARHURST, NY AND CHAP A NOSH OF BROOKLYN, BROOKLYN, NY:
3,806,619, PUB. 4-6-2010. INT. CL. 43.
- CHAPPELLET WINERY, INC., ST. HELENA, CA:
3,806,804, PUB. 4-6-2010. INT. CL. 33.
- CHARITYUSA.COM, LLC, SEATTLE, WA:
2,360,022, REN. 5-20-10. INT. CL. 35.
- CHARLES SCHWAB & CO., INC., SAN FRANCISCO, CA:
2,772,263, CANC. INT. CL. 9.
- CHARLIN PRODUCTIONS INC., RIVER EDGE, NJ:
2,772,128, CANC. INT. CL. 28.
- CHARTWELL FAMILY OFFICE, LLC, LOS ANGELES, CA:
3,806,731, PUB. 4-6-2010. INT. CL. 36.
- CHASKI BUSINESS SOLUTIONS, LLC, CHARLOTTE, NC:
2,771,595, CANC. INT. CL. 39.
- CHATFIELD, DEBRA J, LUTZ, FL, DBA LUTZ NUTZ COMPANY:
3,806,105, PUB. 4-6-2010. INT. CL. 30.
- CHATMETER, SAN DIEGO, CA:
3,806,471, PUB. 4-6-2010. INT. CL. 35.
- CHAUCER GROUP, INC., MACON, GA:
2,771,282, CANC. INT. CL. 42.
- CHEER BRANDS, INC., ROUND ROCK, TX:
3,808,201, INT. CL. 41.
- CHEESE LAND, INC., SEATTLE, WA:
3,808,252, INT. CL. 29.
3,808,253, INT. CL. 29.
- CHEM-PAK, INC., MARTINSBURG, WV:
2,285,012, CANC. INT. CL. 2.
- CHEMPLEX INDUSTRIES, INC., PALM CITY, FL:
3,806,842, PUB. 4-6-2010. INT. CL. 9.
- CHEMTURA CORPORATION, MIDDLEBURY, CT, UNIROYAL, INC., NEW YORK, NY:
1,134,920, REN. 5-18-10. INT. CL. 1.
- CHEN, CHONGWEI, HANGZHOU, ZHEJIANG, CHINA:
3,808,767, MULTIPLE CLASS, INT. CLS. 9 AND 42.
- CHEREN, MEL, NEW YORK, NY:
2,772,448, CANC. MULTIPLE CLASS, INT. CLS. 9 AND 25.
- CHERKAS SOFTWARE CONSULTANTS, INC., JAMAICA, NY, AKA WEBGRAPHING.COM:
3,805,479, PUB. 4-6-2010. INT. CL. 42.
- CHESAPEAKE HOSPITAL AUTHORITY, NORTH CHESAPEAKE, VA:
3,808,629, INT. CL. 43.
- CHESTANG, BOBBY J., MCINTOSH, AL:
2,286,576, CANC. INT. CL. 30.
- CHEVIN COMPUTER SYSTEMS LTD, UNITED KINGDOM:
3,807,215, PUB. 4-6-2010. INT. CL. 9.
- CHEW, CHERYL Y., BREA, CA:
2,771,838, CANC. INT. CL. 41.
- CHI-SAN, LLC, SAN RAFAEL, CA:
3,808,127, INT. CL. 10.

CHICAGOLAND GAMES, LLC, CHICAGO, IL:
3,806,299, PUB. 4-6-2010. INT. CL. 35.

CHICALOGIC INC, FRESNO, CA:
3,806,412, PUB. 4-6-2010. INT. CL. 35.

CHICKADVISOR INC., TORONTO, CANADA:
3,807,837, MULTIPLE CLASS, INT. CLS. 9, 35, 38 AND 41.

CHIFFONNERIE INC., CHICAGO, IL:
1,559,830, CANC. MULTIPLE CLASS, INT. CLS. 18 AND 22.
1,559,831, CANC. MULTIPLE CLASS, INT. CLS. 18, 22 AND 24.

CHILDHELP, INC., SCOTTSDALE, AZ:
2,285,508, CANC. INT. CL. 41.

CHILDREN'S HEALTHCARE OF ATLANTA, INC., ATLANTA, GA:
3,806,918, PUB. 4-6-2010. INT. CL. 44.
3,806,935, PUB. 4-6-2010. INT. CL. 16.

CHILDREN'S HEART FOUNDATION, PRAIRIE VIEW, IL:
3,806,250, PUB. 4-6-2010. INT. CL. 36.

CHILTON PEN, LLC, HOWELL, NJ:
3,805,961, PUB. 2-6-2010. INT. CL. 16.
3,806,128, PUB. 4-6-2010. INT. CL. 16.

CHINA NATIONAL SAMKWONG FIREWORKS COMPANY LIMITED, CAUSEWAY BAY, HONG KONG:
2,383,940. REN. 5-17-10. INT. CL. 13.

CHING SHAN FOOD PRODUCTS FACTORY LIMITED, 172-176, WING LOK STREET, HONG KONG:
2,356,558. REN. 5-19-10. INT. CL. 30.

CHIPOTLE MEXICAN GRILL, INC., DENVER, CO, CHIPOTLE MEXICAN GRILL, INC., DENVER, CO:
2,350,578. REN. 5-17-10. INT. CL. 42.

CHIPPERY, INC., MARKHAM, ON, CANADA, CHIPPERY POTATO CHIP FACTORY, INC., THE, TORONTO, ONTARIO:
2,349,432. REN. 5-20-10. MULTIPLE CLASS, INT. CLS. 29, 30 AND 42.

CHOPPERS CUSTOM SALADS, INC., VAIL, CO:
3,808,426, INT. CL. 43.

CHOSEN PEOPLE MINISTRIES, INC., NEW YORK, NY:
3,805,547, PUB. 4-6-2010. INT. CL. 36.
3,805,548, PUB. 4-6-2010. INT. CL. 39.
3,805,549, PUB. 4-6-2010. INT. CL. 41.
3,805,550, PUB. 4-6-2010. INT. CL. 45.
3,805,552, PUB. 4-6-2010. INT. CL. 45.

CHOU, JENNIFER, IRVINE, CA:
3,806,570, PUB. 4-6-2010. INT. CL. 25.

CHRISTIAN BROTHERS SERVICES, ROMEOVILLE, IL:
3,808,305, MULTIPLE CLASS, INT. CLS. 36 AND 42.
3,808,306, MULTIPLE CLASS, INT. CLS. 36 AND 42.

CHRISTIAN COPYRIGHT LICENSING INTERNATIONAL, INC., PORTLAND, OR:
3,806,681, PUB. 4-6-2010. MULTIPLE CLASS, INT. CLS. 35 AND 45.

CHRISTIAN COPYRIGHT LICENSING INTERNATIONAL, INC., PORTLAND, OR:
3,806,873, PUB. 4-6-2010. MULTIPLE CLASS, INT. CLS. 35 AND 45.

CHRISTIAN LACROIX, SNC, PARIS, FRANCE:
3,807,680, INT. CL. 16.

CHRISTIE, SHARON K., HUNTINGTON STATION, NY:
3,807,740, INT. CL. 40.

CHRISTINA MÜHLE, FED REP GERMANY:
3,807,230, PUB. 4-6-2010. MULTIPLE CLASS, INT. CLS. 10, 18 AND 25.

CHRISTOPHER J. BACLAWSKI ENTERPRISES, INC., NEWPORT BEACH, CA:
3,805,757, PUB. 4-6-2010. INT. CL. 36.

CHRISTOPHER LIAPIS, POTOMAC, MD:
3,805,738, PUB. 4-6-2010. INT. CL. 42.

CHRONOPOST, 92795 ISSY LES MOULINEAUX, FRANCE:
2,284,810, CANC. MULTIPLE CLASS, INT. CLS. 16, 35, 38 AND 39.

CHRYSLER GROUP LLC, AUBURN HILLS, MI:
3,806,969, PUB. 4-6-2010. INT. CL. 12.

CHU, YOUNG, FULLERTON, CA:
2,771,193, CANC. INT. CL. 25.

CHUBB INTERNATIONAL HOLDINGS LIMITED, SUNBURY-ON-THAMES, MIDDLESEX TW16 7AR, ENGLAND:
1,559,846, CANC. INT. CL. 20.
1,559,847, CANC. INT. CL. 20.

CHUN AN LAI, POMONA, CA:
3,806,678, PUB. 4-6-2010. INT. CL. 17.

CHUNG SEOK SEO, BUENA PARK, CA:
3,806,747, PUB. 4-6-2010. INT. CL. 3.

CHUNG, MARY, HOUSTON, TX:
2,772,133, CANC. INT. CL. 14.

CHUO BUSSAN INTERNATIONAL CO., LTD., TOKYO 107-0062, JAPAN:
3,807,761, INT. CL. 3.

CHUO BUSSAN INTERNATIONAL CO., LTD., TOKYO, JAPAN:
3,807,767, INT. CL. 3.

CHURCH & DWIGHT CO., INC., PRINCETON, NJ:
3,808,495, MULTIPLE CLASS, INT. CLS. 5 AND 31.

CHURCH INITIATIVE, INC., THE, WAKE FOREST, NC:
2,329,382. REN. 5-14-10. MULTIPLE CLASS, INT. CLS. 9 AND 16.

CIGLER, RENEE, JANE, EMERYVILLE, CA:
2,772,577, CANC. INT. CL. 25.

CIM GROUP, LLC, HOLLYWOOD, CA:
3,807,567, MULTIPLE CLASS, INT. CLS. 35, 36 AND 37.

CINDEX HOLDINGS LIMITED, KOWLOON BAY, HONG KONG:
2,352,210. REN. 5-18-10. INT. CL. 28.
2,352,210, CANC. INT. CL. 11.

CINEMA DESIGNS, INC., SANFORD, FL:
2,771,678, CANC. INT. CL. 9.

CINETIC LANDIS CORP., HAGERSTOWN, MD:
378,705. REN. 5-18-10. U.S. CL. 4 (INT. CL. 3).

CISCO TECHNOLOGY, INC., SAN JOSE, CA:
3,808,557, INT. CL. 9.

CISSEL, SCOTT A., RALEIGH, NC:
3,808,364, INT. CL. 9.

CITI TAX SERVICES INC., LOS ANGELES, CA:
3,806,669, PUB. 4-6-2010. INT. CL. 35.
3,806,923, PUB. 4-6-2010. INT. CL. 35.

CITIWELL INTERNATIONAL INC., CONCORD, ONTARIO, CANADA:
2,770,536, CANC. INT. CL. 9.

CITIZENS EQUITY FIRST CREDIT UNION, PEORIA, IL:
2,368,575. REN. 5-19-10. INT. CL. 36.
2,370,982. REN. 5-19-10. INT. CL. 36.

CITIZENS FINANCIAL GROUP, INC., PROVIDENCE, RI:
3,807,007, PUB. 4-6-2010. INT. CL. 35.

CITIZENS LEAGUE, ST. PAUL, MN:
3,806,650, PUB. 4-6-2010. INT. CL. 42.

CITRIX ONLINE, LLC, GOLETA, CA:
3,806,963, PUB. 4-6-2010. INT. CL. 42.

CITRIX ONLINE, LLC, SANTA BARBARA, CA:
3,807,572, MULTIPLE CLASS, INT. CLS. 9, 38 AND 42.

CITROMAX FLAVORS, INC., CARLSTADT, NJ:
3,808,351, INT. CL. 31.

CITY HARVEST, INC., NEW YORK, NY:
3,805,570, PUB. 4-6-2010. INT. CL. 36.
3,805,716, PUB. 4-6-2010. INT. CL. 41.

CITY OF FARMERS BRANCH, TEXAS, FARMERS BRANCH, TX:
3,805,976, PUB. 4-6-2010. MULTIPLE CLASS, INT. CLS. 39 AND 41.

CITY OF GLENDALE, GLENDALE, AZ:
3,806,185, PUB. 4-6-2010. INT. CL. 35.

CITY OF NEW BERN, NEW BERN, NC:
3,808,503, INT. CL. 25.

CITYCENTER LAND, LLC, LAS VEGAS, NV:
3,807,606, INT. CL. 43.
3,807,607, INT. CL. 45.

CJ CHEILJEDANG CORPORATION, SEOUL, REPUBLIC OF KOREA:
3,805,210, PUB. 4-6-2010. INT. CL. 30.
3,805,251, PUB. 4-27-2010. INT. CL. 30.
3,805,252, PUB. 4-6-2010. INT. CL. 32.

- CKV VERMOGENSVERWALTUNG GMBH, MUNICH 80686, FED REP GERMANY:
2,770,635, CANC. MULTIPLE CLASS, INT. CLS. 9, 16, 35, 36, 37, 38 AND 42.
- CLAR, RICHARD, ENCINO, CA:
2,386,820. REN. 5-20-10. INT. CL. 42.
- CLARIANT AG, CH-4132 MUTTENZ, SWITZERLAND:
2,349,316. REN. 5-17-10. MULTIPLE CLASS, INT. CLS. 1 AND 2.
- CLARIANT AG, MUTTENZ, SWITZERLAND:
2,771,647, CANC. INT. CL. 2.
- CLARK EQUIPMENT COMPANY, WELLS FARGO, ND:
1,595,106. REN. 5-20-10. INT. CL. 9.
- CLARK EQUIPMENT COMPANY, WOODCLIFF LAKE, NJ:
1,598,690. REN. 5-14-10. INT. CL. 25.
- CLARK STREET CAPITAL MANAGEMENT, LLC, CHICAGO, IL:
3,805,839, PUB. 4-6-2010. INT. CL. 36.
- CLARK, JAMES, MILLTOWN, NJ AND BRUMBERG, DAVID, EAST BRUNSWICK, NJ:
3,805,389, PUB. 4-6-2010. MULTIPLE CLASS, INT. CLS. 9, 25 AND 41.
- CLARKE ENGINEERING TECHNOLOGIES, INC., ROSELLE, IL:
2,349,852. REN. 5-17-10. INT. CL. 7.
- CLASSONE ORTHODONTICS, INC., LUBBOCK, TX:
3,805,812, PUB. 4-6-2010. MULTIPLE CLASS, INT. CLS. 5 AND 10.
- CLAUDE'S SAUCES, INC, EL PASO, TX:
2,771,675, CANC. INT. CL. 30.
- CLAVIS PHARMA ASA, NORWAY:
3,807,302, PUB. 4-6-2010. INT. CL. 5.
- CLAY, JONATHAN, MIDDLETOWN, NJ:
3,806,287, PUB. 4-6-2010. INT. CL. 25.
- CLAYBORN JR., JOHN, CHICAGO, IL, DBA JOHN CLAYBORN DESIGNS:
3,806,542, PUB. 4-6-2010. INT. CL. 14.
- CLAYTON, MARK J., GRAND PRAIRIE, TX:
3,807,376, INT. CL. 25.
- CLBY, INC., LOS ANGELES, CA, DBA D&M FLOORING:
3,808,198, INT. CL. 19.
- CLEARLY CLEAN LLC, SOUTH WINDSOR, CT:
3,808,026, INT. CL. 16.
- CLEATSKINS, INC., ENCINITAS, CA:
3,808,129, INT. CL. 25.
- CLEMENTINE ART KITS, INC., BOULDER, CO:
3,805,397, PUB. 4-6-2010. MULTIPLE CLASS, INT. CLS. 16, 28 AND 35.
- CLIFF, MARY LOU, HILBERT, WI AND CLIFF, TANYA, WAUNAKEE, WI:
2,772,315, CANC. INT. CL. 16.
- CLINICAL CARE OPTIONS, LLC, RESTON, VA:
3,808,131, INT. CL. 41.
3,808,132, INT. CL. 41.
- CLINICAL, CULTURAL, AND CONSULTING SERVICES, P.C., WASHINGTON, DC:
2,771,983, CANC. INT. CL. 42.
- CLOCKWORK IP, LLC, SARASOTA, FL:
3,808,576, INT. CL. 37.
3,808,577, INT. CL. 37.
- CLOMP CORPORATION, THE, ANAHEIM, CA:
2,770,514, CANC. MULTIPLE CLASS, INT. CLS. 40 AND 42.
- CLOSE ENCOUNTERS WITH MUSIC, INC., SPENCERTOWN, NY:
2,332,908. REN. 5-14-10. INT. CL. 41.
- CLOVER FAST FOOD, INC., LINCOLN, MA:
3,806,427, PUB. 4-6-2010. INT. CL. 43.
- CLOWNANTICS LLC, NEW YORK, NY:
3,806,300, PUB. 4-6-2010. INT. CL. 35.
- CLUB LIBBY LU, INC., BIRMINGHAM, AL:
3,807,084, PUB. 2-13-2007. INT. CL. 3.
- CLUB MEDITERRANEE, 75019 PARIS, FRANCE:
2,770,592, CANC. MULTIPLE CLASS, INT. CLS. 9, 14, 16, 18, 24, 25, 28, 35, 38, 39, 41 AND 42.
- CLUBCORP, INC., DALLAS, TX:
3,805,881, PUB. 4-6-2010. INT. CL. 41.
3,805,883, PUB. 4-6-2010. INT. CL. 43.
3,805,884, PUB. 4-6-2010. INT. CL. 36.
3,805,888, PUB. 4-6-2010. INT. CL. 25.
3,805,889, PUB. 4-6-2010. INT. CL. 43.
3,805,951, PUB. 4-6-2010. MULTIPLE CLASS, INT. CLS. 35 AND 41.
- CLUBFACE GOLF LLC, SAN CLEMENTE, CA:
3,806,380, PUB. 4-6-2010. INT. CL. 28.
- CMG CHELSEA, LLC, FANWOOD, NJ:
2,284,738, CANC. INT. CL. 42.
- CMN COMPONENTS INC, NEW LENOX, IL:
3,806,827, PUB. 4-6-2010. INT. CL. 12.
- CN FINANCIAL SERVICES, LLC, BOWLING GREEN, KY:
3,807,999, INT. CL. 42.
- CNA FINANCIAL CORPORATION, CHICAGO, IL:
3,805,535, PUB. 4-6-2010. INT. CL. 41.
3,805,902, PUB. 4-6-2010. INT. CL. 36.
3,805,903, PUB. 4-6-2010. INT. CL. 36.
3,805,904, PUB. 4-6-2010. INT. CL. 36.
3,805,926, PUB. 4-6-2010. INT. CL. 36.
- CNL INCOME NORTHSTAR, LLC, ORLANDO, FL:
3,807,058, PUB. 4-6-2010. MULTIPLE CLASS, INT. CLS. 36, 37 AND 41.
- CNW GROUP LTD., TORONTO, ONTARIO, CANADA:
3,807,059, PUB. 4-6-2010. MULTIPLE CLASS, INT. CLS. 35, 36, 38 AND 41.
- COAL SERVICES PTY LIMITED, AUSTRALIA:
3,807,218, PUB. 4-6-2010. MULTIPLE CLASS, INT. CLS. 9, 41 AND 42.
3,807,219, PUB. 4-6-2010. MULTIPLE CLASS, INT. CLS. 9, 41 AND 42.
3,807,220, PUB. 4-6-2010. MULTIPLE CLASS, INT. CLS. 9, 41 AND 42.
3,807,221, PUB. 4-6-2010. MULTIPLE CLASS, INT. CLS. 9, 41 AND 42.
- COAST TO COAST ENGINEERING SERVICES, INC., PORTLAND, ME:
1,603,100. REN. 5-19-10. INT. CL. 42.
- COATS VIYELLA INDIA LIMITED, MADURAI, INDIA:
1,559,876, CANC. INT. CL. 24.
- COCALO, INC., IRVINE, CA:
3,808,510, MULTIPLE CLASS, INT. CLS. 16, 24, 27 AND 28.
- CODA, INC., NAHWAH, NJ:
1,131,542. REN. 5-14-10. MULTIPLE CLASS, INT. CLS. 1, 7 AND 16.
- CODEGA, LLC, HOUSTON, TX:
3,807,661, MULTIPLE CLASS, INT. CLS. 9 AND 38.
3,807,662, INT. CL. 16.
3,807,663, MULTIPLE CLASS, INT. CLS. 38 AND 41.
- COENEN BROS. INC., MINNEAPOLIS, MN:
3,806,356, PUB. 4-6-2010. INT. CL. 35.
- COFRESCO FRISCHHALTEPRODUKTE GMBH & CO. KG, MINDEN, FED REP GERMANY:
3,756,521, COR. MULTIPLE CLASS, INT. CLS. 6, 16 AND 21.
- COGENT COMMUNICATIONS, INC., WASHINGTON, DC:
2,285,234, CANC. MULTIPLE CLASS, INT. CLS. 38 AND 42.
- COHEN, FRED J., MANHASSET, NY:
3,806,102, PUB. 4-6-2010. INT. CL. 39.
- COHEN, JEFFREY A., MARINA DEL REY, CA:
3,807,087, PUB. 4-6-2010. INT. CL. 5.
- COIN-MATE INC, CHICAGO, IL:
3,807,654, INT. CL. 9.
- COKER TIRE COMPANY, CHATTANOOGA, TN:
3,806,999, PUB. 4-6-2010. INT. CL. 12.
3,807,000, PUB. 4-6-2010. INT. CL. 12.
3,807,018, PUB. 4-6-2010. INT. CL. 12.
- COLCHESTER GLOBAL INVESTORS LIMITED, LONDON, UNITED KINGDOM:
3,805,684, PUB. 4-6-2010. INT. CL. 36.
3,805,689, PUB. 4-6-2010. INT. CL. 36.
- COLDER PRODUCTS COMPANY, ST. PAUL, MN:
2,349,071. REN. 5-14-10. INT. CL. 17.

COLE SYSTEMS ASSOCIATES, INC., NEW YORK, NY:
 3,806,067, PUB. 4-6-2010. INT. CL. 9.

COLGATE-PALMOLIVE COMPANY, NEW YORK, NY:
 3,807,912, INT. CL. 3.

COLHOC LIMITED PARTNERSHIP, COLUMBUS, OH:
 3,806,141, PUB. 4-6-2010. INT. CL. 25.

COLITA BEVERAGE CORP., HOWARD BEACH, NY:
 1,560,084, CANC. INT. CL. 32.

COLLAR GUARD LTD., HODDESDON, UNITED KING-
 DOM:
 3,805,394, PUB. 4-6-2010. MULTIPLE CLASS, INT. CLS. 1
 AND 16.

COLLAXA CORPORATION, REDWOOD SHORES, CA:
 2,772,423, CANC. INT. CL. 9.

COLLE DI BOASI S.A., MENDOZA, ARGENTINA:
 3,807,847, INT. CL. 33.

COLLIER, CHARLES, COLUMBUS, OH:
 2,771,799, CANC. INT. CL. 25.

COLONY GIFT CORPORATION LIMITED, ULVERSTON,
 UNITED KINGDOM:
 3,805,919, PUB. 4-6-2010. MULTIPLE CLASS, INT. CLS. 3,
 4, 11 AND 21.

COLUMBIA INSURANCE COMPANY, OVERLAND PARK,
 KS:
 852,718, AM. U.S. CL. 28.

COLUMBIA INSURANCE COMPANY, OMAHA, NE, DEX-
 TER SHOE COMPANY, BOSTON, MA:
 1,137,437, REN. 5-20-10. INT. CL. 25.

COLUMBIA INSURANCE COMPANY, OMAHA, NE:
 2,286,409, CANC. INT. CL. 2.
 3,805,551, PUB. 4-6-2010. INT. CL. 19.
 3,807,832, INT. CL. 19.

COLUMBIA PARCAR CORP., REEDSBURG, WI:
 1,643,537, REN. 5-17-10. INT. CL. 12.

COLUMBIA SPORTSWEAR NORTH AMERICA, INC.,
 PORTLAND, OR:
 3,807,528, INT. CL. 25.

COM TEK WORKPLACE SOLUTIONS, LLC, RANDOLPH,
 NJ:
 2,284,893, CANC. INT. CL. 9.

COMCAST CORPORATION, PHILADELPHIA, PA:
 3,808,469, INT. CL. 42.

COMERCIAL DE UTILES Y MOLDES, S.A., 08960-SANT
 JUST DESVERN (BARCELONA), SPAIN:
 2,325,327, REN. 5-20-10. INT. CL. 7.

COMET SYSTEMS, INC., NEW YORK, NY:
 2,772,700, CANC. INT. CL. 9.

COMFORT IN A CUP, INC., GIG HARBOR, WA:
 3,807,518, MULTIPLE CLASS, INT. CLS. 30 AND 35.

COMFORTLAND MEDICAL, INC. CHAPEL HILL, NC:
 3,806,708, PUB. 4-6-2010. INT. CL. 10.

COMMERCIAL PRINT GROUP, INC., NORTH MANKATO,
 MN:
 2,771,846, CANC. INT. CL. 41.

COMMERCIAL PROPERTY EXPERTISE HOLDINGS LTD,
 BROOKLYN, NY:
 3,807,872, INT. CL. 36.

COMMERCIAL TEXAS, LLC, AUSTIN, TX, SPACEDIRECT,
 LLC, AUSTIN, TX:
 2,322,178, REN. 5-18-10. INT. CL. 36.

COMMISSARIAT IMPORTS, INC., LOS ANGELES, CA:
 2,405,113, REN. 5-19-10. MULTIPLE CLASS, INT. CLS. 29
 AND 30.

COMMONWEALTH TOOL SPECIALTY INC., ROANOKE,
 VA:
 2,772,704, CANC. INT. CL. 35.

COMMUNICATIONS SUPPLY CORPORATION, CAROL
 STREAM, IL:
 2,349,513, REN. 5-15-10. INT. CL. 35.

COMPAÑIA TEQUILERA DE JALISCO SA DE CV, VILLA
 HIDALGO, MEXICO:
 3,807,886, INT. CL. 33.

COMPACT INDUSTRIES, INC., ST. CHARLES, IL:
 2,358,257, REN. 5-14-10. INT. CL. 32.

COMPACT SPECIAL EUROPE B.V., NETHERLANDS:
 3,807,162, PUB. 4-6-2010. INT. CL. 21.

COMPAGNIE DE LA FECHT ET DU GOUT SAS, COLMAR,
 FRANCE:
 3,808,378, INT. CL. 21.

COMPANY CORPORATION, THE, WILMINGTON, DE:
 2,367,822, REN. 5-18-10. INT. CL. 35.

COMPASS GROUP USA, INC., CHARLOTTE, NC:
 2,447,751, REN. 5-20-10. INT. CL. 35.

COMPASSION INTERNATIONAL, INC., COLORADO
 SPRINGS, CO:
 3,806,533, PUB. 4-6-2010. MULTIPLE CLASS, INT. CLS. 44
 AND 45.

COMPONENT HARDWARE GROUP, INC., LAKEWOOD,
 NJ:
 3,806,169, PUB. 4-6-2010. INT. CL. 6.

COMPOSED OF VIACOM, NEW YORK, NY:
 2,349,310, REN. 5-14-10. INT. CL. 25.

COMPREHENSIVE CONSULTING SOLUTIONS, INC., NEW
 BERLIN, WI:
 2,771,101, CANC. MULTIPLE CLASS, INT. CLS. 9, 35
 AND 42.

COMPTROL TECHNOLOGIES, INC., TEMPE, AZ:
 3,805,625, PUB. 4-6-2010. INT. CL. 35.
 3,805,626, PUB. 4-6-2010. INT. CL. 35.

COMROAD AG, D-85716 UNTERSCHLEISSHEIM MUNCH-
 EN, FED REP GERMANY:
 2,772,183, CANC. MULTIPLE CLASS, INT. CLS. 9, 38
 AND 42.

COMSCORE, INC., RESTON, VA:
 2,771,833, CANC. INT. CL. 35.

CONAGRA FOODS RDM, INC., OMAHA, NE:
 3,808,501, MULTIPLE CLASS, INT. CLS. 29 AND 30.

CONAL INTERNATIONAL TRADING, INC., SOUTH EL
 MONTE, CA:
 3,805,160, PUB. 4-6-2010. INT. CL. 25.

CONCERTENT, LLC, WICHITA, KS:
 3,808,052, INT. CL. 42.

CONCERIA GHERBER S.P.A., ITALY:
 3,807,188, PUB. 4-6-2010. MULTIPLE CLASS, INT. CLS. 18
 AND 25.

CONCERN WORLDWIDE, DUBLIN 2, IRELAND:
 3,807,755, INT. CL. 36.

CONCURRENT TECHNOLOGIES CORPORATION, JOHNS-
 TOWN, PA:
 3,807,949, INT. CL. 9.

CONDO SHARKS, INC., MIAMI, FL:
 3,806,593, PUB. 4-6-2010. INT. CL. 36.

CONDOMI AG, COLOGNE, FED REP GERMANY:
 2,770,990, CANC. MULTIPLE CLASS, INT. CLS. 3, 5 AND
 10.

CONENZA, INC., SEATTLE, WA:
 3,807,431, INT. CL. 42.

CONFITES ECUATORIANOS C.A. CONFITECA, QUITO,
 ECUADOR:
 2,285,649, CANC. INT. CL. 30.

CONGREGATIONAL HEALTH RESOURCE, LLC, WOOD-
 BRIDGE, VA:
 3,807,959, INT. CL. 44.

CONIFER HEALTH SOLUTIONS, INC., DALLAS, TX:
 3,807,831, MULTIPLE CLASS, INT. CLS. 35 AND 36.

CONIFEX INC., VANCOUVER, BRITISH COLUMBIA, CA-
 NADA:
 3,805,231, PUB. 4-6-2010. MULTIPLE CLASS, INT. CLS. 4,
 19 AND 31.

CONIFEX INC., VANCOUVER, CANADA:
 3,805,232, PUB. 4-6-2010. MULTIPLE CLASS, INT. CLS. 4,
 19 AND 31.

CONLIN, LYNN M., AURORA, CO:
 3,806,419, PUB. 4-6-2010. INT. CL. 30.

CONNECTICUT VALLEY CORPORATION, SHELTON, CT:
 2,771,947, CANC. INT. CL. 20.

CONNERY INVESTMENTS A.V.V., ORANJESTAD, ARUBA:
 2,772,255, CANC. INT. CL. 17.

CONNOR SPORT COURT INTERNATIONAL, INC., SALT
 LAKE CITY, UT:
 3,805,650, PUB. 4-6-2010. INT. CL. 19.
 3,808,284, INT. CL. 19.
 3,808,285, INT. CL. 19.
 3,808,286, INT. CL. 19.

- CONOPCO, INC., ENGLEWOOD CLIFFS, NJ:
3,807,991, INT. CL. 3.
- CONSELLE LC, PROVO, UT:
2,772,737, CANC. INT. CL. 16.
- CONSERVE BY COMPETING, LLC, MARINA DEL REY, CA:
3,808,142, INT. CL. 35.
- CONSIGLIO NAZIONALE DELLE RICERCHE; (CNR), ITALY:
3,807,263, PUB. 4-6-2010. MULTIPLE CLASS, INT. CLS. 1, 10 AND 42.
- CONSOLIDATED COATINGS CORPORATION, DELTA, CANADA:
3,805,183, PUB. 8-25-2009. INT. CL. 2.
- CONSOLIDATED ELECTRIC COOPERATIVE, INC., MOUNT GILEAD, OH:
2,285,236, CANC. INT. CL. 38.
- CONSOLIDATED PROPERTY HOLDINGS, INC., LAS VEGAS, NV:
2,770,594, CANC. INT. CL. 8.
- CONSORZIO DEL SAO CAFE', MODENA, ITALY:
1,560,270, CANC. U.S. CL. 200.
- CONSTELLAR CORPORATION, REDWOOD SHORES, CA TO INTERNATIONAL BUSINESS MACHINES CORPORATION, ARMONK, NY, AKA IBM CORPORATION:
2,285,938, CANC. INT. CL. 9.
- CONSULTING & MEDIATION SERVICES OF TEXAS, HOUSTON, TX:
3,805,150, PUB. 4-6-2010. INT. CL. 45.
- CONSUMERS UNION OF UNITED STATES, INC., YONKERS, NY:
2,285,248, CANC. INT. CL. 42.
- CONTAINMENT SOLUTIONS, INC., CONROE, TX:
2,285,498, CANC. INT. CL. 37.
- CONTEMPORARY COCKTAILS, INC., LONG BEACH, NY:
3,806,536, PUB. 4-6-2010. MULTIPLE CLASS, INT. CLS. 41 AND 43.
- CONTEX CORPORATION, JAPAN:
3,807,154, PUB. 4-6-2010. INT. CL. 9.
- CONTINENTAL CORPORATION, THE, NEW YORK, NY:
771,288, CANC. U.S. CL. 102.
- CONTINENTAL GIRBAU, INC., OSHKOSH, WI:
2,770,834, CANC. INT. CL. 11.
- CONTRACTORS WARDROBE, INC., VALENCIA, CA:
2,422,579, REN. 5-18-10. INT. CL. 20.
- CONTROL COMPONENTS INC, RANCHO SANTA MARGARITA, CA:
2,771,935, CANC. MULTIPLE CLASS, INT. CLS. 6, 7 AND 9.
- CONTROL TECHNIQUES LIMITED, POWYS, UNITED KINGDOM:
3,807,553, INT. CL. 9.
- CONVATEC INC., SKILLMAN, NJ:
3,807,020, PUB. 4-6-2010. INT. CL. 10.
- CONVE LTD., WEST PERTH, WESTERN AUSTRALIA 6005, AUSTRALIA:
2,770,846, CANC. INT. CL. 5.
- CONVENEER AB, LOS ALTOS, CA:
3,808,368, INT. CL. 42.
- CONVERGENT WEALTH ADVISORS, LLC, ROCKVILLE, MD:
3,808,199, INT. CL. 36.
- COOK, SUZANNE, TAMPA, FL:
2,771,304, CANC. INT. CL. 35.
2,771,308, CANC. INT. CL. 35.
- COOKIE JAR ENTERTAINMENT INC., TORONTO, ONTARIO, CANADA:
3,807,977, INT. CL. 38.
3,807,978, INT. CL. 41.
- COOKIES A LA MAIN, WEST CHESTER, PA:
3,806,187, PUB. 4-6-2010. INT. CL. 30.
- COOL BEANS INC, HOUSTON, TX, DBA JENNI'S NOODLE HOUSE:
3,805,542, PUB. 4-6-2010. INT. CL. 43.
3,805,543, PUB. 4-6-2010. INT. CL. 43.
3,805,544, PUB. 4-6-2010. INT. CL. 43.
3,805,546, PUB. 4-6-2010. INT. CL. 43.
- COOL ROOF RATING COUNCIL, INC., OAKLAND, CA:
3,805,311, PUB. 4-6-2010. U.S. CL. B.
- COOLWEAR, INC., NEW YORK, NY:
2,381,639, REN. 5-20-10. INT. CL. 25.
- COOPER, SANDRA D, DETROIT, MI:
3,808,041, INT. CL. 14.
- COPAN HOLDING, S.A., L-2233, LUXEMBOURG:
2,286,145, CANC. INT. CL. 25.
2,286,146, CANC. INT. CL. 25.
- COPELAND, MARTY, FORT WORTH, TX:
3,808,591, MULTIPLE CLASS, INT. CLS. 9, 16 AND 25.
- CORAL RIDGE MINISTRIES MEDIA, INC., FORT LAUDERDALE, FL:
2,771,151, CANC. INT. CL. 16.
- CORE SYSTEMS (NI) LIMITED, BELFAST, NORTHERN IRELAND:
3,807,640, MULTIPLE CLASS, INT. CLS. 9 AND 42.
- CORINTHIAN HOMES, LLC, PLANO, TX:
2,771,097, CANC. INT. CL. 37.
- CORKYS FOOTWEAR, INC., NORTH LITTLE ROCK, AR:
3,806,479, PUB. 4-6-2010. INT. CL. 25.
3,806,481, PUB. 4-6-2010. INT. CL. 25.
- CORMAN S.P.A., ITALY:
3,807,103, PUB. 4-6-2010. MULTIPLE CLASS, INT. CLS. 5 AND 10.
- CORNER-EDGE PRODUCTS LTD., SCARBOROUGH, ONTARIO, CANADA:
3,805,132, PUB. 4-6-2010. INT. CL. 16.
3,805,133, PUB. 4-6-2010. INT. CL. 16.
3,805,136, PUB. 4-6-2010. INT. CL. 16.
- CORNERSTONE WALL SOLUTIONS INC., COQUITLAM, CANADA:
3,805,326, PUB. 4-6-2010. INT. CL. 19.
- CORNETTE, DANIEL J., SCOTTSDALE, AZ:
2,772,615, CANC. INT. CL. 16.
- CORNING CONSUMER PRODUCTS COMPANY, CORNING, NY TO WORLD KITCHEN, LLC, RESTON, VA:
2,285,663, CANC. INT. CL. 21.
- CORNING INCORPORATED, CORNING, NY:
3,806,656, PUB. 4-6-2010. INT. CL. 9.
- CORPORATE EXECUTIVE BOARD COMPANY, ARLINGTON, VA:
3,806,156, PUB. 4-6-2010. MULTIPLE CLASS, INT. CLS. 16, 35 AND 41.
- CORPORATE HOUSING BY OWNER, INC., HIGHLANDS RANCH, CO:
3,806,724, PUB. 4-6-2010. INT. CL. 35.
- CORPORATE SYSTEMS ENGINEERING, LLC, INDIANAPOLIS, IN:
3,805,693, PUB. 4-6-2010. MULTIPLE CLASS, INT. CLS. 9, 35 AND 42.
- CORPORATE TRAVEL SAFETY, LLC, CALABASAS, CA:
3,805,824, PUB. 4-6-2010. INT. CL. 35.
- CORPORATE WEB SERVICES, INC., BIRMINGHAM, MI:
2,770,674, CANC. INT. CL. 42.
- CORVUS INTERNATIONAL, LLC, FAYETTVILLE, GA:
2,772,180, CANC. MULTIPLE CLASS, INT. CLS. 9, 41 AND 42.
- COSCO INTERNATIONAL INC., WANCHAI, HONG KONG:
2,285,658, CANC. INT. CL. 32.
- COSMEDICS, INC., MIAMI SHORES, FL:
3,805,939, PUB. 4-6-2010. INT. CL. 3.
- COSMETIC DERMATOLOGY, INC., MIAMI, FL:
2,285,902, CANC. INT. CL. 3.
- COSMETIC, TOILETRY, AND FRAGRANCE ASSOCIATION, THE, WASHINGTON, DC AND WOMEN WORK! THE NATIONAL NETWORK FOR WOMEN'S EMPLOYMENT, WASHINGTON, DC:
2,284,682, CANC. INT. CL. 41.
- COSMICLAND CO., LTD., TOKYO, JAPAN:
2,286,016, CANC. INT. CL. 25.
- COSNET, INC., HUNTINGTON BEACH, CA:
3,805,974, PUB. 4-6-2010. INT. CL. 42.
- COTHRAN, HERMAN, LAS VEGAS, NV:
2,771,826, CANC. INT. CL. 43.
- COTLEUR HEARING DESIGN BUILD, INC., JUPITER, FL:
2,772,267, CANC. INT. CL. 42.
- COTT BEVERAGES INC., TAMPA, FL:
2,285,500, CANC. INT. CL. 32.

COTTER, DANIEL M., ARLINGTON, VA:
2,772,264, CANC. INT. CL. 42.

COUNTRY FARE LLC, DERBY, CT:
3,806,949, PUB. 4-6-2010. INT. CL. 31.

COUNTRY RADIO BROADCASTERS, INC., NASHVILLE, TN:
2,437,795. REN. 5-19-10. INT. CL. 41.

COURBOI, INC., NEW YORK, NY:
2,771,099, CANC. INT. CL. 33.

COURTESY BUILDING SERVICES, INC., DALLAS, TX:
2,349,884. REN. 5-18-10. INT. CL. 37.

COVERCRAFT INDUSTRIES, INC., PAULS VALLEY, OK:
1,559,735, CANC. INT. CL. 12.

COVERMYMEDS LLC, CHAGRIN FALLS, OH, AKA COVERMYMEDS:
3,806,358, PUB. 4-6-2010. INT. CL. 35.

COZY FOAM, LLC, CONROE, TX:
3,807,737, INT. CL. 17.

CPEX PHARMACEUTICALS, INC., EXETER, NH:
3,807,419, INT. CL. 5.

CPM WOLVERINE PROCTOR, LLC, HORSHAM, PA:
3,807,090, PUB. 2-5-2008. MULTIPLE CLASS, INT. CLS. 7 AND 11.

CRA LABS, INC., ESCONDIDO, CA:
3,806,750, PUB. 4-6-2010. INT. CL. 21.

CRAFTY PRODUCTIONS, INC., SAN MARCOS, CA:
3,805,845, PUB. 4-6-2010. INT. CL. 28.

CRAIG BACHMAN IMPORTS, INC., FRANKFORT, IL:
2,286,279, CANC. INT. CL. 21.

CRATEX MANUFACTURING CO., INC., ENCINITAS, CA:
1,623,195. REN. 5-19-10. MULTIPLE CLASS, INT. CLS. 3 AND 7.

CRAWFORD GROUP, INC., THE, WASHINGTON, DC:
2,772,260, CANC. INT. CL. 35.

CRAWLSPACE, INC., VISALIA, CA:
2,771,754, CANC. INT. CL. 30.

CRCM L.P., SAN FRANCISCO, CA:
3,807,423, INT. CL. 36.

CREANOVA INC., PARSIPPANY, NJ:
2,770,680, CANC. INT. CL. 5.

CRESCENT FROG, WILMINGTON, VT, DBA DILLON WALSH CREATIVE:
3,807,963, MULTIPLE CLASS, INT. CLS. 16 AND 35.

CRESSI-SUB S.P.A., GENOVA, ITALY:
1,135,594. REN. 5-17-10. MULTIPLE CLASS, INT. CLS. 9, 25 AND 28.

CREXUS INVESTMENT CORP., NEW YORK, NY:
3,808,361, INT. CL. 36.

CRISTA MINISTRIES, SEATTLE, WA:
3,805,585, PUB. 4-6-2010. MULTIPLE CLASS, INT. CLS. 36 AND 41.

CRISTA MINISTRIES, SEATTLE, WA:
3,805,792, PUB. 4-6-2010. INT. CL. 38.

CROCKETT HOMES, INC., CANTON, OH:
3,806,408, PUB. 4-6-2010. INT. CL. 37.

CROSBY GROUP, INC., THE, TULSA, OK:
2,351,845. REN. 5-19-10. INT. CL. 6.

CROSS COUNTRY TRAVCORPS, INC., BOCA RATON, FL:
3,805,203, PUB. 4-6-2010. INT. CL. 35.

CROSS CURRENT RESEARCH LLC, PRINCETON, NJ:
3,808,287, INT. CL. 36.
3,808,288, INT. CL. 36.

CROSSROADS COMPLIANCE, INC., MANSFIELD, IL:
3,806,988, PUB. 4-6-2010. INT. CL. 39.

CROWE HORWATH LLP, SOUTH BEND, IN:
2,772,731, CANC. INT. CL. 35.

CROWLEY, PATRICK S., CHELMSFORD, MA:
3,806,924, PUB. 4-6-2010. INT. CL. 40.

CROWN ELITE TENNIS LLC, TAMPA, FL:
3,806,192, PUB. 4-6-2010. INT. CL. 41.

CRYOPRAXIS CRIOBIOLOGIA LTDA., RIO DE JANEIRO / RJ, BRAZIL:
3,808,519, MULTIPLE CLASS, INT. CLS. 42 AND 44.

CRYSTAL CRUISES, INC., LOS ANGELES, CA:
3,808,283, INT. CL. 39.

CRYSTAL GROUP LIMITED, HAMILTON HM12, BERMUDA:
2,803,902, CANC. INT. CL. 38.

CRYSTAL WORLD, INC., LINCOLN PARK, NJ:
1,559,860, CANC. INT. CL. 21.

CRYSTONE, HOLLYWOOD, FL:
3,806,981, PUB. 4-6-2010. INT. CL. 42.

CS UNITEC, INC., NORWALK, CT:
2,771,315, CANC. INT. CL. 7.

CSC GEORGIAN TERRACE LIMITED PARTNERSHIP, SAN FRANCISCO, CA:
3,806,829, PUB. 4-6-2010. INT. CL. 43.
3,806,846, PUB. 4-6-2010. MULTIPLE CLASS, INT. CLS. 30 AND 35.

CSG SYSTEMS, INC., ENGLEWOOD, CO:
2,771,201, CANC. MULTIPLE CLASS, INT. CLS. 35 AND 42.

CSIDENTITY CORPORATION, AUSTIN, TX:
3,807,658, INT. CL. 45.

CSTA/NA CRANIOSACRAL THERAPY ASSOCIATION OF NORTH AMERICA, SCARBOROUGH, ONTARIO, CANADA:
2,771,007, CANC. U.S. CL. B.

CTG ATHLETICS, LLC, BRONX, NY:
3,808,581, MULTIPLE CLASS, INT. CLS. 25 AND 28.

CUBAN CIGAR BRANDS, N.V., FORT LAUDERDALE, FL:
3,805,893, PUB. 12-29-2009. INT. CL. 34.

CUBE OPTICS, AG, D-55129 MAINZ, FED REP GERMANY:
2,843,464, CANC. INT. CL. 17.

CUGGLY, LLC, BERLIN, MD:
3,807,942, INT. CL. 26.

CULLIGAN INTERNATIONAL COMPANY, ROSEMONT, IL, LA FRAMBOISE WELL DRILLING, INC., THOMPSON, CT:
1,596,838. REN. 5-19-10. INT. CL. 40.

CULP, DONALD E., N. KINGSTOWN, RI:
2,343,137. REN. 5-19-10. INT. CL. 18.

CULVER EDUCATIONAL FOUNDATION, THE, CULVER, IN:
1,608,525. REN. 5-20-10. INT. CL. 41.

CUNA MUTUAL INSURANCE SOCIETY, MADISON, WI:
3,807,933, INT. CL. 42.

CUPP, TRAVIS, KNOXVILLE, TN:
3,808,647, INT. CL. 25.

CUPS LJ, INC., LA JOLLA, CA, DBA CUPS:
3,808,347, INT. CL. 35.

CURBELL ELECTRONICS, INC., ORCHARD PARK, NY:
3,807,766, INT. CL. 9.

CURRENT C CREATIVE, LLC, TULSA, OK:
3,805,430, PUB. 4-28-2009. INT. CL. 9.
3,805,431, PUB. 4-28-2009. INT. CL. 35.
3,805,432, PUB. 4-28-2009. INT. CL. 41.

CURTIS, JOHN B., SHORELINE, WA, DBA HOMESTAR GAMES:
2,772,657, CANC. INT. CL. 28.

CUSTOM BUILDING PRODUCTS, INC., SEAL BEACH, CA:
3,805,686, PUB. 4-6-2010. INT. CL. 19.

CUSTOM FIT GUTTER, INC., DALLAS, TX:
2,770,874, CANC. INT. CL. 6.

CUSTOM MUSIC INTERNATIONAL, LLC, FERNDALE, MI:
2,284,895, CANC. INT. CL. 15.

CUSTOM STONE WOOD, LLC, AVON, MN:
3,807,780, INT. CL. 19.

CUSTOM-PAK, INC., CLINTON, IA:
2,361,365. REN. 5-18-10. INT. CL. 16.

CUSTOMER INSIGHT COMPANY, ENGLEWOOD, CO:
1,559,654, CANC. INT. CL. 9.

CUTIE PIE BABY, INC., NEW YORK, NY:
2,394,174. REN. 5-18-10. MULTIPLE CLASS, INT. CLS. 24 AND 25.

CW TRAVEL HOLDINGS, N. V., DIEMEN, NETHERLANDS:
2,771,695, CANC. MULTIPLE CLASS, INT. CLS. 39 AND 43.

CWD FOUNDATION, INC., DEL NORTE, CO:
2,771,555, CANC. INT. CL. 25.

CYBERLINK CORPORATION, TAIPEI 231, TAIWAN:
2,439,936. REN. 5-17-10. INT. CL. 9.

CYBERLUX CORPORATION, DURHAM, NC:
3,808,584, INT. CL. 11.

CYCLACEL LIMITED, UNITED KINGDOM:
3,807,292, PUB. 4-6-2010. INT. CL. 5.

- CYGNUS BUSINESS MEDIA, INC., FORT ATKINSON, WI:
2,836,900, AM. MULTIPLE CLASS, INT. CLS. 35 AND 41.
- CYMER, THOMAS X., RESTON, VA:
3,808,289, INT. CL. 36.
- CYTOGENIX LABORATORIES SRL, ST. MICHAEL, BARBADOS:
3,807,804, INT. CL. 5.
3,807,805, INT. CL. 5.
- CYTOMATRIX, LLC, CHELMSFORD, MA:
2,772,191, CANC. INT. CL. 5.
- CYTOSKELETON, INC., DENVER, CO:
2,285,182, CANC. INT. CL. 42.
- C2IT, LLC, MODESTO, CA:
3,807,432, INT. CL. 12.
3,807,433, INT. CL. 12.
- C5 ADVISORS, LLC, BIRMINGHAM, AL:
3,808,062, MULTIPLE CLASS, INT. CLS. 35 AND 36.
- D M HASTON HOLDINGS, MOBILE, AL:
3,808,171, INT. CL. 25.
- D.C. HUMPHRYS CO., INC., PHILADELPHIA, PA, DBA HUMPHRYS TEXTILE PRODUCTS, INC.:
3,808,338, INT. CL. 27.
- D-BODHI PTE. LTD., SINGAPORE 249674, SINGAPORE:
3,807,144, PUB. 4-6-2010. INT. CL. 20.
- D'ADDARIO & COMPANY, INC., FARMINGDALE, NY:
1,599,507, AM. INT. CL. 15.
- D'ANGELO BRANDS LTD., MISSISSAUGA, ONTARIO, CANADA:
3,805,209, PUB. 4-6-2010. INT. CL. 32.
- D'ARENBERG PTY LTD, SOUTH AUSTRALIA, AUSTRALIA:
3,808,350, INT. CL. 33.
- DACOR CORPORATION, NORTHFIELD, IL:
1,559,621, CANC. INT. CL. 9.
- DADA CORPORATION, SEOUL, REPUBLIC OF KOREA:
2,285,146, CANC. INT. CL. 25.
- DAE-IL USA, INC., MORGAN HILL, CA, CUSTOM CHROME, INC., MORGAN HILL, CA:
1,596,268, REN. 5-17-10. INT. CL. 12.
- DAI, EDWARD, BROOKLYN, NY:
3,806,256, PUB. 4-6-2010. INT. CL. 37.
- DAIHATSU MOTOR CO LTD, OSAKA, JAPAN, DAIHATSU KOGYO KABUSHIKI KAISHA, OYODO, OSAKA, JAPAN:
698,893, REN. 5-20-10. U.S. CL. 19 (INT. CLS. 7, 12, 22 AND 27).
- DAILY PLAN-IT, LLC, THE, MANTECA, CA:
2,286,011, CANC. INT. CL. 16.
2,286,012, CANC. INT. CL. 16.
- DAIMLER AG, STUTTGART, FED REP GERMANY:
2,770,660, CANC. INT. CL. 12.
2,770,858, CANC. MULTIPLE CLASS, INT. CLS. 12, 28 AND 37.
2,771,236, CANC. MULTIPLE CLASS, INT. CLS. 12 AND 28.
- DAIMLER AG, 70327 STUTTGART, FED REP GERMANY:
3,805,914, PUB. 4-6-2010. INT. CL. 36.
- DAIRYGOLD CO-OPERATIVE SOCIETY LIMITED, DUBLIN 2, IRELAND:
2,770,658, CANC. INT. CL. 29.
- DAKAR, SONYA, BEVERLY HILLS, CA:
2,436,250, REN. 5-17-10. MULTIPLE CLASS, INT. CLS. 3 AND 42.
- DAKO DENMARK A/S, DENMARK:
3,807,228, PUB. 4-6-2010. MULTIPLE CLASS, INT. CLS. 9, 37, 41 AND 42.
- DALLAS COWBOYS FOOTBALL CLUB, LTD., IRVING, TX:
2,770,630, CANC. MULTIPLE CLASS, INT. CLS. 25, 38 AND 41.
3,806,073, PUB. 4-6-2010. MULTIPLE CLASS, INT. CLS. 35, 38 AND 41.
- DALPS & LEISURE PRODUCTS SUPPLY CORPORATION, TAIPEI, TAIWAN:
2,770,854, CANC. INT. CL. 28.
- DAMELECIA, INC., FORT LAUDERDALE, FL:
3,806,752, PUB. 4-6-2010. INT. CL. 36.
- DAN A. BAKER, DUBLIN, CA, DBA HUMORSOFT:
3,808,418, INT. CL. 9.
- DAN HILTS EVANGELISTIC ASSOCIATION, SARASOTA, FL:
2,363,648, REN. 5-14-10. INT. CL. 36.
- DAN KARALIS, ROSEMONT, IL:
3,807,908, INT. CL. 36.
- DANCE INSTITUTE OF WASHINGTON, WASHINGTON, DC:
3,806,728, PUB. 4-6-2010. INT. CL. 41.
3,806,734, PUB. 4-6-2010. INT. CL. 41.
- DANIEL INDUSTRIES, INC., HOUSTON, TX:
2,389,141, REN. 5-17-10. MULTIPLE CLASS, INT. CLS. 9 AND 40.
- DANIEL J. STEIN, LOS ANGELES, CA:
3,806,638, PUB. 4-6-2010. INT. CL. 5.
- DANIELI & C. OFFICINE MECCANICHE S.P.A., 33042 BUTTRIO (U.D), ITALY:
2,770,565, CANC. INT. CL. 11.
- DANIELLE'S DESSERTS, LLC, ALEXANDRIA, VA:
3,806,894, PUB. 4-6-2010. MULTIPLE CLASS, INT. CLS. 30 AND 43.
- DANIELS AGROSCIENCES, LLC, PROVIDENCE, RI:
2,364,795, REN. 5-18-10. INT. CL. 1.
- DANISCO A/S, COPENHAGEN K, DENMARK:
2,285,860, CANC. INT. CL. 1.
- DANNEMANN AG, SWITZERLAND:
3,807,291, PUB. 4-6-2010. INT. CL. 34.
- DARE MUSIC GROUP, LLC, AUSTIN, TX:
3,805,947, PUB. 4-6-2010. INT. CL. 15.
- DARKHORSE CO., LTD., SEOUL 151-050, REPUBLIC OF KOREA:
3,807,353, PUB. 4-6-2010. MULTIPLE CLASS, INT. CLS. 9 AND 16.
- DARLING, RICHARD, PALM DESERT, CA:
2,771,289, CANC. INT. CL. 41.
- DAS DISTRIBUTION INC., EAST GRANBY, CT:
3,805,729, PUB. 4-6-2010. INT. CL. 9.
- DASZIGN CLOTHING INC., STATEN ISLAND, NY:
2,772,333, CANC. MULTIPLE CLASS, INT. CLS. 25 AND 35.
- DATA BECKER CORPORATION, NEEDHAM, MA:
2,772,217, CANC. INT. CL. 9.
- DATA CONVERSION SYSTEMS LIMITED, SAFFRON WALDEN, ESSEX, UNITED KINGDOM:
3,805,473, PUB. 4-6-2010. MULTIPLE CLASS, INT. CLS. 9, 41 AND 42.
- DATADATA INC., PALM SPRINGS, CA, DBA DATA ASSURANCE TECHNOLOGY ASSOCIATES:
2,771,552, CANC. INT. CL. 9.
- DATATRAX TECHNOLOGIES INC., TORONTO, CANADA:
3,808,590, MULTIPLE CLASS, INT. CLS. 35, 36 AND 42.
- DATAWEST GROUP, INC., WATSONVILLE, CA:
3,806,308, PUB. 4-6-2010. INT. CL. 41.
- DAVDEZ ARTS, INC., DELRAY BEACH, FL AND BLAIR, BARRY L., DELRAY BEACH, FL:
2,286,717, CANC. INT. CL. 16.
- DAVID ANDERSON, APPLETON, WI:
3,808,547, INT. CL. 9.
- DAVID BEGG ASSOCIATES USA, LLC, ANN ARBOR, MI:
3,805,571, PUB. 4-6-2010. INT. CL. 41.
- DAVIDOFF & CIE SA, SWITZERLAND:
3,807,356, PUB. 4-6-2010. INT. CL. 34.
- DAVIES, PETER N.C., LOS ANGELES, CA, DBA DAZRISK:
3,806,719, PUB. 4-6-2010. INT. CL. 9.
- DAVIS KINARD & CO, PC, ABILENE, TX:
3,808,470, INT. CL. 45.
- DAVIS VISION, INC., PLAINVIEW, NY:
3,805,215, PUB. 4-6-2010. INT. CL. 9.
- DAVIS, KEITH L., EVANS, GA:
3,805,805, PUB. 4-6-2010. INT. CL. 44.
- DAWNBREAKER, INC., ROCHESTER, NY:
3,805,560, PUB. 4-6-2010. INT. CL. 16.
- DAWSON, DENNIS B., HENDERSON, NV:
2,284,533, CANC. INT. CL. 25.
- DAY, SHANNON, PORTLAND, OR AND BROWN, STEPHEN, PORTLAND, OR:
2,771,677, CANC. INT. CL. 41.

DAYTON SUPERIOR DELAWARE CORPORATION, DAYTON, OH, DBA DAYTON SUPERIOR CORPORATION: 2,770,741, CANC. INT. CL. 9.

DBIQ.COM INC., SAN DIEGO, CA: 2,772,556, CANC. INT. CL. 9.

DBS MARKETING, INC., ORLANDO, FL: 2,758,490, COR. INT. CL. 11.

DCG SYSTEMS, INC, FREEMONT, CA: 2,771,660, CANC. INT. CL. 9.

DCH MANAGEMENT SERVICES INC., SOUTH AMBOY, NJ: 3,807,709, MULTIPLE CLASS, INT. CLS. 35 AND 41.

DDA HOLDINGS, INC., LOS ANGELES, CA: 3,808,451, INT. CL. 25.

DE MAIO, VICTORIA A., SCOTTSDALE, AZ: 2,771,118, CANC. INT. CL. 16.

DEAN INTELLECTUAL PROPERTY SERVICES II, L.P., DALLAS, TX: 3,805,320, PUB. 11-25-2008. INT. CL. 29.

DEANNA A. HUBBARD, OSWEGO, NY: 3,807,651, INT. CL. 14.

DEATH ADDERS INC., BROOKLYN, NY, DBA MISHKA NYC: 3,805,373, PUB. 4-6-2010. INT. CL. 25.

DEBIOTECH S.A., 1004 LAUSANNE, SWITZERLAND: 2,771,107, CANC. INT. CL. 10.

DEBRA DAVIS, STONE MOUNTAIN, GA: 3,806,503, PUB. 4-6-2010. INT. CL. 35.

DECATHLON, FRANCE: 3,807,360, PUB. 4-6-2010. INT. CL. 18.

DECON LABORATORIES, INC., KING OF PRUSSIA, PA: 3,806,149, PUB. 4-6-2010. INT. CL. 1.

DECOVERLY KENNELS, INC., FACTORYVILLE, PA: 2,284,574, CANC. MULTIPLE CLASS, INT. CLS. 41 AND 42.

DECUIR, TIMOTHY, PALM DESERT, CA: 3,806,881, PUB. 4-6-2010. MULTIPLE CLASS, INT. CLS. 14 AND 25.

DEER STAGS, INC., NEW YORK, NY: 3,808,380, INT. CL. 25.

DEERE & COMPANY, MOLINE, IL: 2,286,824, CANC. INT. CL. 35.
3,806,188, PUB. 4-6-2010. INT. CL. 35.

DEES COMMUNICATIONS, INC., MONTGOMERY, AL: 3,806,512, PUB. 4-6-2010. INT. CL. 16.

DEFEUDIS, WENDY, NEW YORK, NY: 2,771,599, CANC. INT. CL. 42.

DEFINITIVE LOGIC CORPORATION, ARLINGTON, VA: 3,805,856, PUB. 4-6-2010. INT. CL. 42.

DEL NORTE TECHNOLOGY, INC., EULESS, TX: 2,771,325, CANC. INT. CL. 9.

DEL PALMA ORTHOPEDICS, LLC, COLUMBIA CITY, IN: 3,807,638, INT. CL. 10.
3,807,639, INT. CL. 10.

DELAWARE CAPITAL FORMATION, INC., WILMINGTON, DE: 3,805,403, PUB. 4-6-2010. INT. CL. 7.
3,807,010, PUB. 4-6-2010. INT. CL. 9.
3,807,012, PUB. 4-6-2010. INT. CL. 9.
3,808,013, INT. CL. 9.

DELCA CORPORATION, LAGUNA NIGEL, CA: 3,807,420, INT. CL. 28.

DELL'S INSURANCE AGENCY, INC., ALAMOSA, CO: 3,806,164, PUB. 4-6-2010. INT. CL. 35.

DELO INDUSTRIAL ADHESIVES LLC, HAUPPAUGE, NY: 3,808,218, INT. CL. 1.

DELONG EQUIPMENT COMPANY, ATLANTA, GA, DE-LONG, HAROLD C., ATLANTA, GA: 1,599,106, REN. 5-17-10. INT. CL. 3.

DELSTAR GROUP, PHOENIX, AZ: 2,284,525, CANC. INT. CL. 35.

DELTA APPAREL, INC., DULUTH, GA: 3,808,089, INT. CL. 25.

DELTA BLUES BBQ, INC., BOLINGBROOK, IL: 3,806,527, PUB. 4-6-2010. INT. CL. 29.

DELTA EDUCATION, LLC, NASHUA, NH: 2,370,886, REN. 5-18-10. MULTIPLE CLASS, INT. CLS. 9 AND 16.

DELTA GALIL USA, INC., SEACAUCUS, NJ: 3,808,458, INT. CL. 25.

DELTA PERFORMANCE PRODUCTS, LLC, COVINGTON, GA: 3,806,977, PUB. 4-6-2010. INT. CL. 19.

DEMELLO, CINDIE, BARRINGTON, RI: 3,805,556, PUB. 4-6-2010. INT. CL. 41.

DEMIVISION, LLC, DOVER, DE: 2,772,625, CANC. INT. CL. 9.

DENO, DENNIS D, AUMSVILLE, OR: 2,286,851, CANC. INT. CL. 37.

DENOMME, ADAM JAMES, CARDIFF BY THE SEA, CA AND HAER, TIMOTHY MURPHY, ATLANTIC BEACH, FL AND FRAMNESS, DYLAN ROBERT, NEPTUNE BEACH, FL AND TIMM, TRAVIS RICHARD, NEPTUNE BEACH, FL: 3,808,611, INT. CL. 25.

DENSO CORPORATION, KARIYA-CITY, AICHI-PREF. 448-8661, JAPAN: 2,771,036, CANC. INT. CL. 9.

DENTAL MANAGEMENT SCIENCES, LLC, VIRGINIA CITY, NV: 2,360,009, REN. 5-17-10. MULTIPLE CLASS, INT. CLS. 35 AND 41.

DENTAL ONE CARE, STERLING HEIGHTS, MI: 3,808,208, INT. CL. 44.

DENTALSERVE.NET; PROFESSIONAL SERVICES LTD., UNITED KINGDOM: 3,807,281, PUB. 4-6-2010. MULTIPLE CLASS, INT. CLS. 3, 5 AND 10.

DENVER INVESTMENT ADVISORS LLC, DENVER, CO: 3,807,909, INT. CL. 36.

DEPARTMENT OF THE ARMY, WASHINGTON, DC: 3,807,034, PUB. 4-6-2010. MULTIPLE CLASS, INT. CLS. 9 AND 42.
3,807,035, PUB. 4-6-2010. MULTIPLE CLASS, INT. CLS. 9 AND 42.

DEPUY, INC., WARSAW, IN: 3,807,461, INT. CL. 10.
3,807,623, INT. CL. 10.

DER GRIUNE PUNKT - DUALES SYSTEM DEUTSCHLAND AKTIENGESELLSCHAFT, COLOGNE, FED REP GERMANY: 2,770,817, CANC. MULTIPLE CLASS, INT. CLS. 16, 35, 36, 37, 39, 40, 41 AND 42.

DERMAMED INTERNATIONAL, INC., LENNI, PA: 3,805,799, PUB. 4-6-2010. INT. CL. 10.

DEROYAL INDUSTRIES, INC., POWELL, TN: 1,596,216, REN. 5-20-10. INT. CL. 10.

DESC AUTOMOTRIZ, S.A. DE C.V., FRACC. BOSQUES DE LAS LOMAS, MEXICO: 2,770,755, CANC. INT. CL. 12.
2,770,756, CANC. INT. CL. 7.

DESERET BOOK COMPANY, SALT LAKE CITY, UT: 2,284,623, CANC. INT. CL. 9.

DESERT WHALE JOJOBA COMPANY, TUCSON, AZ: 3,209,825, CANC. INT. CL. 4.

DESIGN ENTERPRISES, LLC, SAN FRANCISCO, CA: 2,771,031, CANC. MULTIPLE CLASS, INT. CLS. 26 AND 41.
2,771,033, CANC. INT. CL. 26.

DESIGNER SKIN, LLC, INDIANAPOLIS, IN: 3,808,273, INT. CL. 3.

DESIGNI, INC., BEVERLY HILLS, CA: 3,807,402, INT. CL. 25.

DESIGNING HEALTH, INC., VALENCIA, CA: 3,808,328, INT. CL. 5.

DESSER TIRE & RUBBER CO., INC., MONTEBELLO, CA: 2,772,639, CANC. INT. CL. 12.

DEUTSCHE BÖRSE AG, FED REP GERMANY: 3,807,368, PUB. 4-6-2010. INT. CL. 36.

DEVINE FOODS, INC., MEDIA, PA: 2,285,829, CANC. INT. CL. 5.

DEVONIAN INDUSTRIES, INC., MORGANTOWN, WV: 3,806,697, PUB. 4-6-2010. INT. CL. 39.

DFINE, INC., SAN JOSE, CA: 3,807,789, MULTIPLE CLASS, INT. CLS. 5 AND 10.

- DGM S.P.A., I-62012 CIVITANOVA MARCHE (MACERATA), ITALY:
2,340,820. REN. 5-19-10. INT. CL. 25.
- DI'S KITCHEN, WOODLAND HILLS, CA:
3,806,777. PUB. 4-6-2010. INT. CL. 30.
- DIAGEO BRANDS B.V., AMSTERDAM, NETHERLANDS:
3,805,913. PUB. 4-6-2010. INT. CL. 33.
- DIAGEO BRANDS B.V., 1014 BG AMSTERDAM, NETHERLANDS:
3,807,086. PUB. 4-6-2010. INT. CL. 33.
- DIAGEO NORTH AMERICA, INC., NORWALK, CT:
3,805,205. PUB. 4-6-2010. INT. CL. 33.
3,806,931. PUB. 4-6-2010. INT. CL. 41.
- DIAGEO SINGAPORE PTE. LTD., SINGAPORE, SINGAPORE:
3,805,219. PUB. 4-6-2010. INT. CL. 33.
- DIAGNOSTICA STAGO, FRANCE:
3,807,338. PUB. 4-6-2010. MULTIPLE CLASS, INT. CLS. 5, 38 AND 42.
- DIAKONIA INC., BREWSTER, NY:
2,285,397. CANC. INT. CL. 41.
- DIAL-A-WAITER, INC., WICHITA, KS:
2,284,850. CANC. INT. CL. 39.
- DIAMINTANGIBLES INTERNATIONAL, LTD., NASSAU, BAHAMAS:
3,808,331. INT. CL. 14.
- DIAMOND AUTO GLASS CORP., BRENTWOOD, NY:
1,559,728. CANC. INT. CL. 12.
- DIAMOND H RECOGNITION, L.P., FORT WORTH, TX:
3,805,249. PUB. 4-6-2010. MULTIPLE CLASS, INT. CLS. 35 AND 41.
- DIAMOND H RECOGNITION, LLC, FORT WORTH, TX:
3,805,248. PUB. 4-6-2010. MULTIPLE CLASS, INT. CLS. 35 AND 41.
- DIAMOND RESORTS HOLDINGS, LLC, LAS VEGAS, NV:
3,808,531. INT. CL. 43.
- DIAMOND STAINLESS, INC., RIVERTON, UT:
1,560,036. CANC. INT. CL. 29.
- DIAPERS ETC. FACTORY OUTLET STORES, LLC., HIALEAH, FL:
2,771,564. CANC. INT. CL. 42.
- DIAZ, OSCAR G. BOCA RATON, FL:
3,808,081. INT. CL. 25.
- DICKEY-JOHN CORPORATION, AUBURN, IL:
1,150,254. REN. 5-19-10. INT. CL. 9.
- DICKSON, RUSSELL T., BROADALBIN, NY:
3,805,223. PUB. 4-6-2010. U.S. CL. 200.
- DIESEL SPA, MOLVENA 36060, ITALY:
2,361,005. REN. 5-18-10. INT. CL. 25.
- DIETERBAKICENTERPRISES GMBH, 81829 MUNCHEN, FED REP GERMANY:
3,808,594. MULTIPLE CLASS, INT. CLS. 16, 20, 21, 35 AND 42.
- DIGICON CORPORATION, HERNDON, VA:
3,808,669. MULTIPLE CLASS, INT. CLS. 38 AND 42.
- DIGITAL & WIRELESS GROUP, INC., NEW YORK, NY:
3,805,604. PUB. 4-6-2010. INT. CL. 9.
- DIGITAL EYE RESEARCH LLC, FORT LAUDERDALE, FL:
3,805,942. PUB. 4-6-2010. INT. CL. 35.
- DIGITAL HORIZON SOLUTIONS, LLC, FRISCO, TX:
3,808,558. INT. CL. 9.
- DIGITAL SOLUTIONS GROUP, INC., THE, NEW YORK, NY:
2,772,272. CANC. INT. CL. 9.
- DIGITAL-TELEPATHY, SAN DIEGO, CA:
3,806,585. PUB. 4-6-2010. INT. CL. 9.
- DIMATTIA SOLD RIGHT AUCTION CO., PC, POCOMOKE, MD:
3,807,800. MULTIPLE CLASS, INT. CLS. 35 AND 36.
- DINASTIA, INC., RANCHO CUCAMONGA, CA:
3,807,400. INT. CL. 41.
- DINOBITES L.L.C., GLEN BURNIE, MD:
3,805,714. PUB. 4-6-2010. INT. CL. 30.
- DIOPTRICS MEDICAL PRODUCTS INCORPORATED, SAN LUIS OBISPO, CA:
2,771,937. CANC. INT. CL. 9.
- DIREVO BIOTECH AG, D-50829 COLOGNE, FED REP GERMANY:
2,770,867. CANC. MULTIPLE CLASS, INT. CLS. 1, 5, 9 AND 42.
- DIRK HAYHURST, CANTON, OH:
3,806,939. PUB. 4-6-2010. INT. CL. 16.
- DISCINNET LABS, FRANCE:
3,807,267. PUB. 4-6-2010. MULTIPLE CLASS, INT. CLS. 38, 41 AND 42.
- DISCOVER AS, N-1322 HOVIK, NORWAY:
2,770,549. CANC. INT. CL. 9.
- DISCOVERY COMMUNICATIONS, LLC, SILVER SPRING, MD:
2,286,757. CANC. MULTIPLE CLASS, INT. CLS. 16, 25 AND 38.
3,805,611. PUB. 4-6-2010. INT. CL. 41.
- DISCOVERY INSTITUTE OF MEDICAL EDUCATION, INC., CHICAGO, IL:
3,808,658. INT. CL. 9.
3,808,659. INT. CL. 42.
- DISINTEGRATED COMMUNICATION SYSTEMS, LLC, TIGER, GA:
3,808,429. INT. CL. 42.
- DISON, CHERYL CAROLINE, NEWPORT BEACH, CA:
3,806,584. PUB. 4-6-2010. INT. CL. 44.
- DISPLAYLINK CORP, PALO ALTO, CA:
3,805,180. PUB. 4-6-2010. MULTIPLE CLASS, INT. CLS. 9 AND 42.
- DISTELL LIMITED, STELLENBOSCH, SOUTH AFRICA:
3,807,410. INT. CL. 33.
- DISTRIBUIDORA SYMON & CO, C.A., CARACAS, VENEZUELA:
2,772,179. CANC. MULTIPLE CLASS, INT. CLS. 16 AND 18.
- DISTRIBUTED VENDING COMPANY, LOS ANGELES, CA:
2,770,720. CANC. MULTIPLE CLASS, INT. CLS. 35 AND 42.
- DISTRIGAS OF MASSACHUSETTS LLC, BOSTON, MA:
2,825,875. AM. INT. CL. 39.
- DISYS KOREA. CO., LTD., GANGNAM-GU, SEOUL, REPUBLIC OF KOREA:
3,807,705. INT. CL. 25.
- DISZNOKÓ RT, TOKAJ, HUNGARY:
3,806,296. PUB. 4-6-2010. INT. CL. 33.
- DITKA, MICHAEL K., DEERFIELD, IL:
3,805,334. PUB. 11-3-2009. INT. CL. 25.
- DIVERSIFIED COMPOSITE WORKS, INC., HAMPSHIRE, IL:
3,805,749. PUB. 4-6-2010. INT. CL. 19.
- DIVERSIFIED MARKETING STRATEGIES, INC., CROWN POINT, IN:
3,806,604. PUB. 4-6-2010. INT. CL. 35.
- DIVERSINET CORP., TORONTO, CANADA:
3,805,195. PUB. 4-6-2010. MULTIPLE CLASS, INT. CLS. 9 AND 45.
- DIX, BARRY W., COCOA BEACH, FL:
2,771,703. CANC. MULTIPLE CLASS, INT. CLS. 25 AND 28.
- DIXIE CONSUMER PRODUCTS LLC, ATLANTA, GA:
3,807,467. MULTIPLE CLASS, INT. CLS. 16 AND 21.
- DL INDUSTRIES, LP, HOUSTON, TX:
2,771,798. CANC. INT. CL. 6.
- DMV FRONTERRA EXCIPIENTS GMBH & CO KG, 47574 GOCH, FED REP GERMANY, D.M.V. CAMPINA B.V., VEGHEL, NETHERLANDS, TA DE MELKINDUSTRIE VEGHEL:
1,595,897. REN. 5-18-10. MULTIPLE CLASS, INT. CLS. 1 AND 5.
- DNP DENMARK A/S, 2690 KARSLUNDE, DENMARK:
2,834,346. CANC. INT. CL. 41.
- DO IT BEST CORP., FORT WAYNE, IN:
2,396,053. REN. 5-14-10. INT. CL. 35.
2,404,890. REN. 5-18-10. INT. CL. 35.
3,806,602. PUB. 4-6-2010. INT. CL. 35.
- DOC PREP PLUS, INC., MCLEAN, VA, DBA MORTGAGE BANKING SYSTEMS:
2,350,852. REN. 5-19-10. INT. CL. 36.

DOCAUTO, INC., NORCROSS, GA:
3,808,382, MULTIPLE CLASS, INT. CLS. 9, 41 AND 42.

DOCTATIONS, INC., GARDEN CITY, NY:
3,807,563, INT. CL. 35.
3,807,564, INT. CL. 42.

DOCTORS OF THE WORLD-USA, NEW YORK, NY, FORMERLY DOCTORS OF THE WORLD-USA:
3,805,337, PUB. 4-6-2010. MULTIPLE CLASS, INT. CLS. 35, 43, 44 AND 45.

DOCUCORP INTERNATIONAL, INC., DALLAS, TX:
2,770,793, CANC. MULTIPLE CLASS, INT. CLS. 35 AND 42.

DOCUMENT TECHNOLOGIES, LLC, ATLANTA, GA:
2,772,554, CANC. INT. CL. 42.

DOG EAT DOG, LLC, WELLINGTON, FL:
3,806,688, PUB. 4-6-2010. INT. CL. 41.

DOGS D'RULE, HIGH SPRINGS, FL:
3,806,337, PUB. 4-6-2010. INT. CL. 44.

DOLBY LABORATORIES LICENSING CORPORATION, SAN FRANCISCO, CA:
2,361,147, REN. 5-14-10. INT. CL. 9.

DOLES, ANTOINETTE T., PHOENIX, AZ, AKA TONY GASS DOLES:
1,559,776, CANC. MULTIPLE CLASS, INT. CLS. 16, 25 AND 28.

DOLEX DOLLAR EXPRESS, INC., ARLINGTON, TX:
2,372,659, REN. 5-19-10. INT. CL. 36.

DOLLAMUR, LP, NASHVILLE, TN:
3,807,951, INT. CL. 28.

DOLLARS INSIDE FRANCHISING LLC, CAPE CORAL, FL:
3,808,096, INT. CL. 35.

DOMESTIC INVESTMENT GROUP, LLC, CHANDLER, AZ:
3,806,017, PUB. 4-6-2010. INT. CL. 12.
3,806,018, PUB. 4-6-2010. INT. CL. 12.

DOMO RECORDS, INC., LOS ANGELES, CA:
3,807,734, INT. CL. 9.

DON CARLO VENTURES, INC., ATHENA, OR:
3,807,379, INT. CL. 33.

DONALD L. ARMSTRONG, WYOMING, OH:
3,805,710, PUB. 4-6-2010. INT. CL. 22.

DONALD W. GORDON, SPRINGVILLE, UT:
3,806,897, PUB. 4-6-2010. INT. CL. 28.

DONALDSON COMPANY, INC., MINNEAPOLIS, MN:
2,354,020, REN. 5-19-10. INT. CL. 35.

DONEN, JOSH, BEVERLY HILLS, CA:
3,807,608, INT. CL. 41.

DONGHUI INTERNATIONAL DEVELOPMENT CO.,LTD, KOWLOON, HONG KONG:
3,806,154, PUB. 4-6-2010. INT. CL. 18.

DONY (L.A.) CORP., VERNON, CA:
2,771,704, CANC. INT. CL. 18.

DOOLEY, ROBERT M., GLADSTONE, VA:
2,286,588, CANC. INT. CL. 25.

DOPPLER E. DOPPLER & CO. GMBH, BRAUNAU-RANSHOFEN, AUSTRIA:
3,807,874, INT. CL. 18.

DORIS MAVIS LLC, MINNEAPOLIS, MN:
3,808,618, MULTIPLE CLASS, INT. CLS. 25 AND 28.

DOS - DIALOG ORIENTIERTE SOFTWARE GMBH, 22393 HAMBURG, FED REP GERMANY:
2,770,512, CANC. MULTIPLE CLASS, INT. CLS. 36, 38 AND 42.

DOSKOCIL MANUFACTURING COMPANY, INC., ARLINGTON, TX:
3,806,921, PUB. 4-6-2010. INT. CL. 28.

DOTERRA HOLDINGS, LLC, OREM, UT:
3,806,204, PUB. 4-6-2010. MULTIPLE CLASS, INT. CLS. 3 AND 5.

DOTRONIX, INC., ST. PAUL, MN:
2,771,936, CANC. INT. CL. 9.

DOUBLE EAGLE BRANDS 2 N.V., NETHERLD ANTILLES:
3,807,179, PUB. 4-6-2010. INT. CL. 33.

DOUGHERTY, MAUREEN, OAKLAND, CA:
3,806,480, PUB. 4-6-2010. INT. CL. 25.

DOUGHERTY, PATRICK S., BOISE, ID:
3,807,580, INT. CL. 12.

DOUGLAS FURNITURE OF CALIFORNIA, LLC, REDONDO BEACH, CA:
2,771,188, CANC. MULTIPLE CLASS, INT. CLS. 20 AND 40.

DOWN'N DIRTY BBQ, INC., MANCHESTER, NH:
2,285,540, CANC. MULTIPLE CLASS, INT. CLS. 30 AND 42.

DOWNHOME PRODUCTIONS, INC., NIXA, MO:
2,357,443, REN. 5-14-10. INT. CL. 41.

DOWNS, PAUL, BEVERLY HILLS, CA, DBA FLYWHEEL MUSIC:
2,284,572, CANC. INT. CL. 9.

DOWNTOWN BUSINESS IMPROVEMENT DISTRICT CORPORATION, WASHINGTON, DC, DC:
2,284,771, CANC. MULTIPLE CLASS, INT. CLS. 16, 37 AND 42.
2,284,772, CANC. MULTIPLE CLASS, INT. CLS. 37 AND 42.

DR. ING. H.C. F. PORSCHE AG, 70435 STUTTGART-ZUFFENHAUSEN, FED REP GERMANY:
2,285,779, CANC. INT. CL. 34.

DR. ING. H.C. F. PORSCHE AKTIENGESELLSCHAFT, STUTTGART-ZUFFENHAUSEN D-70435, FED REP GERMANY:
2,823,420, CANC. MULTIPLE CLASS, INT. CLS. 4 AND 28.

DR. LISA COONEY, SAN FRANCISCO, CA, DBA LEI - LIFE EMPOWERMENT INSTITUTE:
3,807,542, INT. CL. 41.

DR. SUESS ENTERPRISES, L.P., LA JOLLA, CA:
2,359,493, REN. 5-14-10. INT. CL. 16.

DR.'S SOLUTIONS, LLC, GRAND PRAIRIE, TX:
3,808,349, INT. CL. 5.

DRÄGER SAFETY AG & CO. KGAA, LÜBECK, FED REP GERMANY:
3,805,754, PUB. 4-6-2010. INT. CL. 9.

DRAINLOCK, LLC, BAY SHORE, NY:
3,808,733, MULTIPLE CLASS, INT. CLS. 6, 11, 19 AND 21.

DRAMBUIE LIQUEUR CO. LTD., THE, BROXBURN, SCOTLAND:
2,770,528, CANC. INT. CL. 33.

DREAMWELL, LTD., LAS VEGAS, NV:
2,349,540, REN. 5-20-10. INT. CL. 20.

DREAMWITHME, L.L.C., IOWA CITY, IA:
3,806,847, PUB. 4-6-2010. INT. CL. 45.

DRILBOX GMBH, SCHILLINGSFUERST, FED REP GERMANY, KNOBLAUCH, GEORG, 7928 GIENGEN, FED REP GERMANY, DBA DRIBOX GEORG KNOBLAUCH WERZEUGKASSETTENFABRIK:
1,135,378, REN. 5-18-10. INT. CL. 6.

DRIPPING WET WATER, INC., FAIR OAKS RANCH, TX:
3,806,157, PUB. 4-6-2010. INT. CL. 7.

DROWN CORP., EAST AMHERST, NY:
3,808,064, INT. CL. 33.

DRS. SOLUTIONS, LLC, GRAND PRAIRIE, TX:
3,808,301, INT. CL. 5.
3,808,315, INT. CL. 5.

DRS.SOLUTIONS, LLC, GRAND PRAIRIE, TX:
3,808,300, INT. CL. 5.

DRUG DETECTION DEVICES, LTD., ALPHARETTA, GA:
3,806,828, PUB. 4-6-2010. INT. CL. 10.

DRUMELLER PROPERTIES, LLC, WAYNESBORO, VA:
3,806,642, PUB. 4-6-2010. INT. CL. 36.

DSHEALTHCARE INC., YORK, PA:
2,370,617, REN. 5-18-10. INT. CL. 5.

DUALSTAR ENTERTAINMENT GROUP, LLC, CULVER CITY, CA:
2,284,799, CANC. MULTIPLE CLASS, INT. CLS. 9 AND 16.

DUBE JR., JOSEPH A., BROOKSVILLE, FL:
3,805,488, PUB. 4-6-2010. INT. CL. 9.

DUCA DI SALAPARUTA S.P.A., ITALY:
3,807,286, PUB. 4-6-2010. INT. CL. 33.

DUCA, ELEFTERIA LO, WESTBURY, NY, AKA RIETSA:
3,805,920, PUB. 4-6-2010. MULTIPLE CLASS, INT. CLS. 9 AND 41.

- DUCHY INVESTMENTS LIMITED, WITHAM, ESSEX, UNITED KINGDOM:
 2,771,519, CANC. INT. CL. 19.
- DUKAVICIUS, KEITH, CHICAGO, IL:
 2,772,140, CANC. INT. CL. 41.
- DUKE'S FIREHOSE COMPANY, INC., FRAZER, PA:
 2,286,225, CANC. INT. CL. 37.
- DUN & BRADSTREET, INC., SHORT HILLS, NJ:
 3,805,448, PUB. 4-6-2010. MULTIPLE CLASS, INT. CLS. 9, 35 AND 41.
 3,805,450, PUB. 4-6-2010. MULTIPLE CLASS, INT. CLS. 9, 35 AND 41.
- DUNCAN ENTERPRISES, FRESNO, CA:
 3,807,032, PUB. 4-6-2010. MULTIPLE CLASS, INT. CLS. 38 AND 41.
- DUNCAN MCINTOSH COMPANY, INC., IRVINE, CA, EDITOR & PUBLISHER CO., THE, NEW YORK, NY:
 270,786, REN. 5-19-10. U.S. CL. 38 (INT. CL. 16).
- DUNCAN, KATHLEEN, WINSTON SALEM, NC:
 3,806,945, PUB. 4-6-2010. INT. CL. 36.
- DUNDEE ENTERPRISES, INC., WALLED LAKE, MI:
 3,806,161, PUB. 4-6-2010. MULTIPLE CLASS, INT. CLS. 21, 26 AND 28.
- DUNGAREES U.S.A., INC., MONTREAL, QUEBEC, CANADA:
 2,770,830, CANC. INT. CL. 25.
- DUNNING GROUP MARKETING SERVICES, INC., CORONA DEL MAR, CA:
 2,285,188, CANC. INT. CL. 35.
- DUOS TECHNOLOGIES, INC., JACKSONVILLE, FL:
 3,808,084, INT. CL. 9.
- DURA-METRICS, INC., SANTA ROSA, CA:
 3,808,219, INT. CL. 10.
- DURAMAX MARINE, LLC, HIRAM, OH:
 2,501,329, AM. INT. CL. 12.
- DURHAM, STACEY, AUSTIN, TX:
 3,808,641, MULTIPLE CLASS, INT. CLS. 25 AND 28.
- DUROX COMPANY, STRONGSVILLE, OH:
 1,559,516, CANC. INT. CL. 4.
- DUSHMAN, CHARLES J, DEERFIELD, IL:
 3,806,840, PUB. 4-6-2010. INT. CL. 9.
- DUTCH & DUTCHESS CHRISTIAN FELLOWSHIP, INC., ANCHORAGE, AK:
 3,808,211, INT. CL. 45.
- DUTCH BIKE COMPANY LTD, LONDON, UNITED KINGDOM, TA DUTCHIE:
 3,806,691, PUB. 4-6-2010. INT. CL. 12.
- DUYNHOVEN, DEBRA VAN, TORONTO, ONTARIO, CANADA:
 2,771,546, CANC. INT. CL. 2.
- DVD INTERNATIONAL, LLC, MOUNTAIN LAKES, NJ:
 2,771,002, CANC. MULTIPLE CLASS, INT. CLS. 35 AND 41.
- DWELL HOME FURNISHINGS LLC, NEW YORK, NY:
 3,808,514, MULTIPLE CLASS, INT. CLS. 20, 24 AND 27.
- DWIGHT, DANA L, VISTA, CA, DBA FORBIDDEN LEAF HEMP SEED OIL LOTION AND SOAP COMPANY:
 3,805,148, PUB. 4-6-2010. INT. CL. 3.
- DWT INTERNATIONAL, INC., SUGAR LAND, TX:
 3,808,490, INT. CL. 14.
- DWYER PRODUCTS CORPORATION, WOOD DALE, IL:
 3,805,135, PUB. 4-6-2010. INT. CL. 11.
- DYNACRAFT BSC, INC., AMERICAN CANYON, MA:
 3,808,492, INT. CL. 12.
- DYNACRAFT BSC, INC., AMERICAN CANYON, CA:
 3,808,493, INT. CL. 12.
- DYNALENE, INC., WHITEHALL, PA:
 3,806,118, PUB. 4-6-2010. INT. CL. 1.
- DYNAMIC BRANDS, LLC, RICHMOND, VA:
 3,805,629, PUB. 4-6-2010. MULTIPLE CLASS, INT. CLS. 12 AND 18.
- DYNAMIC ESSENTIALS (DE), INC., BOHEMIA, NY:
 2,771,049, CANC. INT. CL. 35.
- DYNAMIC MOBILE DATA SYSTEMS, INC., SOMERSET, NJ:
 2,770,510, CANC. INT. CL. 9.
- DYNAMIC TEAM SPORTS, INC., DOWNINGTOWN, PA:
 DYNAMIC TEAM SPORTS, INC., DOWNINGTOWN, PA:
 2,433,925, REN. 5-20-10. INT. CL. 25.
- DYNAMIC VENDING, INC., HAZELWOOD, MO:
 3,806,103, PUB. 4-6-2010. MULTIPLE CLASS, INT. CLS. 35 AND 37.
- DYNAMICS RESEARCH CORPORATION, ANDOVER, MA:
 2,286,481, CANC. INT. CL. 16.
- DYN0 SEASONAL SOLUTIONS, LLC, POMPANO BEACH, FL:
 3,805,517, PUB. 4-6-2010. MULTIPLE CLASS, INT. CLS. 20 AND 22.
- D2M DANCE ACADEMY, TRACY, CA:
 3,806,315, PUB. 4-6-2010. INT. CL. 41.
- E & H DISTRIBUTING CO., NORTH LAS VEGAS, NV:
 3,805,959, PUB. 4-6-2010. INT. CL. 30.
- E. D. BULLARD COMPANY, CYNTHIANA, KY:
 3,808,072, INT. CL. 9.
- E. I. DU PONT DE NEMOURS AND COMPANY, WILMINGTON, DE:
 2,771,741, CANC. INT. CL. 24.
- E. J. WESSEL, NAPA, CA:
 3,806,316, PUB. 4-6-2010. INT. CL. 12.
- E.H. PRICE LIMITED, WINNIPEG, CANADA:
 3,805,313, PUB. 4-6-2010. MULTIPLE CLASS, INT. CLS. 9, 11, 37 AND 42.
- E.K. SUCCESS, LTD., CLIFTON, NJ:
 2,397,552, REN. 5-18-10. INT. CL. 16.
- E.LAND WORLD LIMITED, REPUBLIC OF KOREA:
 3,807,304, PUB. 4-6-2010. INT. CL. 18.
- E! ENTERTAINMENT TELEVISION, INC., LOS ANGELES, CA:
 2,771,488, CANC. INT. CL. 41.
 2,771,510, CANC. INT. CL. 41.
 2,771,511, CANC. INT. CL. 41.
 2,771,512, CANC. INT. CL. 41.
- E-GLUE SOFTWARE TECHNOLOGIES, INC., HOBOKEN, NJ:
 3,807,519, INT. CL. 9.
 3,807,520, MULTIPLE CLASS, INT. CLS. 35 AND 42.
- E-MARKETINGUSA, INC., WENATCHEE, WA:
 3,807,803, INT. CL. 14.
- E-ONEHUNDRED GROUP, LLC, SOUTHWINGTON, CT:
 2,771,517, CANC. MULTIPLE CLASS, INT. CLS. 35, 41 AND 42.
- E-Z MART STORES, INC., TEXARKANA, TX:
 3,805,137, PUB. 4-6-2010. INT. CL. 30.
- EA DIGITAL ILLUSIONS CE AB, STOCKHOLM, SWEDEN:
 3,806,031, PUB. 2-9-2010. INT. CL. 16.
 3,806,032, PUB. 2-9-2010. INT. CL. 9.
 3,806,033, PUB. 2-9-2010. INT. CL. 41.
- EADS SPACE TRANSPORTATION GMBH, D-28199 BREMEN, FED REP GERMANY:
 3,808,625, MULTIPLE CLASS, INT. CLS. 6, 7, 9, 11, 12, 13, 16, 17, 19, 37, 40, 41 AND 42.
 3,808,626, MULTIPLE CLASS, INT. CLS. 6, 7, 9, 11, 12, 13, 16, 17, 19, 37, 40, 41 AND 42.
- EAGLE TAX SERVICES GROUP, LLC, PHILADELPHIA, PA, FORMERLY EAGLE TAX SERVICES GROUP, INC.:
 3,806,290, PUB. 4-6-2010. INT. CL. 35.
- EAGLE TELECONFERENCING SERVICES, INC., RUSHVILLE, IL:
 2,771,034, CANC. INT. CL. 38.
- EAGLEPICHER INCORPORATED, PHOENIX, AZ:
 1,559,815, CANC. INT. CL. 17.
- EARL MAY SEED & NURSERY L.P., SHENANDOAH, IA:
 1,560,068, CANC. INT. CL. 31.
- EARLES FAMILY L.L.C., ELLETTSVILLE, IN:
 3,807,541, INT. CL. 38.
- EARLYBIRD VENTURE CAPITAL GMBH & CO. KG, 20359 HAMBURG, FED REP GERMANY:
 2,359,257, REN. 5-18-10. MULTIPLE CLASS, INT. CLS. 35 AND 36.
- EARNEST MACHINE PRODUCTS COMPANY, CLEVELAND, OH:
 3,805,852, PUB. 4-6-2010. INT. CL. 6.
- EARTH DAY NETWORK, INC., WASHINGTON, DC:
 3,806,351, PUB. 4-6-2010. INT. CL. 36.

EARTH RELEASE, ASHLAND, OR:
2,772,231, CANC. INT. CL. 3.

EARTH-LIST, LLC, SAN DIEGO, CA, AKA EARTH-LIST-COM:
3,806,861, PUB. 4-6-2010. INT. CL. 41.

EARTHWORKS SYSTEM, LLC, SOLON, OH:
3,462,902, COR. MULTIPLE CLASS, INT. CLS. 9, 16 AND 17.
3,681,569, COR. INT. CL. 17.

EAST BAY TIRE CO., FAIRFIELD, CA:
3,806,839, PUB. 4-6-2010. INT. CL. 12.

EASTERN IDAHO ECONOMIC DEVELOPMENT PARTNERS, INC., IDAHO FALLS, ID:
3,805,820, PUB. 4-6-2010. INT. CL. 35.

EASTERN SEABOARD PACKAGING, INC., HUNTERS-VILLE, NC:
2,285,408, CANC. INT. CL. 16.

EASTMAN, ANDRE L., MODESTO, CA:
3,807,416, INT. CL. 9.

EASTSTAR SOLUTIONS LTD, WEST ALLIS, WI:
3,806,395, PUB. 4-6-2010. MULTIPLE CLASS, INT. CLS. 18 AND 25.

EASTSTAR SOLUTIONS, LTD., WEST ALLIS, WI:
3,806,013, PUB. 4-6-2010. MULTIPLE CLASS, INT. CLS. 18 AND 25.

EASYGROUP IP LICENSING LIMITED, LONDON, ENGLAND:
2,771,547, CANC. MULTIPLE CLASS, INT. CLS. 16, 39 AND 42.

EATON AEROQUIP LLC, CLEVELAND, OH, AMERICAN BILTRITE RUBBER CO., INC., CHELSEA, MA:
892,042, REN. 5-19-10. U.S. CL. 35 (INT. CL. 17).

EATON CORPORATION, CLEVELAND, OH:
890,855, REN. 5-18-10. U.S. CL. 23 (INT. CL. 7).

ECA WORLD FITNESS ALLIANCE, LONG BEACH, NY:
3,806,084, PUB. 4-6-2010. INT. CL. 41.

ECHOMETRICS CORPORATION, ROCHESTER, MN:
3,806,906, PUB. 4-6-2010. INT. CL. 44.
3,806,907, PUB. 4-6-2010. INT. CL. 44.

ECLIPSE MEDICAL INC., DELTA, CANADA:
3,805,299, PUB. 2-9-2010. MULTIPLE CLASS, INT. CLS. 12, 35, 36 AND 37.

ECO-COMMAND, INC., WITTMAN, MD:
3,808,452, INT. CL. 5.
3,808,453, INT. CL. 5.

ECO-PLAN CO., LTD., JAPAN:
3,647,745, COR. INT. CL. 37.

ECOBUSINESS INSTITUTE, INC., DOVER, DE:
2,772,262, CANC. INT. CL. 41.

ECOINSIGHT, INC., ATLANTA, GA:
3,806,830, PUB. 4-6-2010. INT. CL. 35.

ECOLAB INC., ST. PAUL, MN:
2,771,731, CANC. INT. CL. 21.

ECOLO+, LLC, CHATSWORTH, GA:
3,806,177, PUB. 4-6-2010. INT. CL. 1.

ECOLOGY-LAWN USA LLC, HOWELL, NJ:
3,806,489, PUB. 4-6-2010. INT. CL. 44.

ECOPAY, LOS ANGELES, CA:
3,807,788, MULTIPLE CLASS, INT. CLS. 36 AND 42.

ECOSMART TECHNOLOGIES, INC., FRANKLIN, TN:
2,772,462, CANC. INT. CL. 5.

ECUBE SOLUTIONS, LLC, MENDHAM, NJ:
3,805,518, PUB. 9-22-2009. INT. CL. 9.

EDGEcombe, ETHAN, TUCSON, AZ, DBA FORTUNA RECORDS:
1,577,432, REN. 5-19-10. INT. CL. 9.

EDISON BROTHERS STORES, INC., ST. LOUIS, MO:
1,559,835, CANC. MULTIPLE CLASS, INT. CLS. 18 AND 25.
1,559,997, CANC. INT. CL. 26.

EDISON WELDING INSTITUTE, INC., COLUMBUS, OH:
3,808,028, INT. CL. 1.

EDMONTON MANUFACTURING CO., ROCHESTER, IN:
1,559,893, CANC. INT. CL. 25.

EDUCARUNO, ASOCIACION CIVIL, SAN PEDRO GARZA GARCIA, MEXICO:
3,805,361, PUB. 4-6-2010. INT. CL. 36.

EDUCATION FOUNDATION OF COTATI-ROHNERT PARK, ROHNERT PARK, CA:
2,770,956, CANC. INT. CL. 36.

EDUCATION MANAGEMENT LLC, PITTSBURGH, PA:
1,604,098, AM. INT. CL. 41.
2,772,749, CANC. INT. CL. 41.

EDUCATIONAL TESTING SERVICE, PRINCETON, NJ:
2,363,333, REN. 5-19-10. MULTIPLE CLASS, INT. CLS. 9, 16, 41 AND 42.

EDUCATIONAL WEB ADVENTURES, ST. PAUL, MN:
2,285,470, CANC. INT. CL. 42.

EDWARD D. JONES & CO. LP, ST. LOUIS, MO:
3,806,096, PUB. 4-6-2010. INT. CL. 36.

EDWARDS LIMITED, CRAWLEY, WEST SUSSEX, ENGLAND:
3,805,826, PUB. 4-6-2010. MULTIPLE CLASS, INT. CLS. 7 AND 11.

EDWARDS, NYALA MARIE, WADMALAW ISLAND, SC:
2,772,316, CANC. INT. CL. 41.

EDX WIRELESS, LLC, EUGENE, OR:
2,364,935, REN. 5-14-10. INT. CL. 9.

EGGSPUEHLER, JACK J., DUBLIN, OH:
2,379,536, REN. 5-18-10. INT. CL. 42.

EHLERT PUBLISHING GROUP, INC., MAPLE GROVE, MN:
3,805,372, PUB. 4-6-2010. MULTIPLE CLASS, INT. CLS. 16 AND 41.

EHRIG, NANCY, HENDERSON, NV:
3,808,233, INT. CL. 35.

EHRlich, PETER D., PAHRUMP, NV:
3,808,329, INT. CL. 5.

EHW-RESEARCH, FRANCE:
3,807,354, PUB. 4-6-2010. INT. CL. 40.

EIDOS INTERACTIVE LIMITED, WIMBLEDON, LONDON, UNITED KINGDOM:
3,805,817, PUB. 4-6-2010. INT. CL. 9.

EIGHTSHAPES, LLC, FAIRFAX, VA:
3,805,401, PUB. 4-6-2010. INT. CL. 42.

EISENHART & POINCARE, EDGEWATER, NJ:
2,772,528, CANC. INT. CL. 9.

ELAM, KEITH R., SPRINGFIELD, OR:
3,808,701, INT. CL. 16.

ELANIS INC., NEW YORK, NY:
3,807,481, INT. CL. 25.

ELANTAS PDG, INC., ST. LOUIS, MO:
133,047, REN. 5-19-10. U.S. CL. 21 (INT. CL. 17).

ELAUT USA, INC., LAKEWOOD, NJ:
3,806,090, PUB. 4-6-2010. INT. CL. 28.

ELBIT VISION SYSTEMS LTD., YOKNEAM 20692, ISRAEL:
2,285,662, CANC. INT. CL. 9.

ELDERTRUST, CHICAGO, IL:
2,438,771, REN. 5-20-10. INT. CL. 36.

ELDO S.R.L., 59100 PRATO, ITALY:
3,805,121, PUB. 4-6-2010. INT. CL. 25.

ELECTRIC MOBILITY CORPORATION, SEWELL, NJ:
3,807,713, INT. CL. 12.

ELECTROFUEL, INC., MISSISSAUGA, ONTARIO, CANADA:
2,772,314, CANC. INT. CL. 9.

ELECTRONIC ARTS INC., REDWOOD CITY, CA:
2,772,100, CANC. INT. CL. 9.

ELECTRONIC IMAGING SERVICES, INC., LITTLE ROCK, AR, DBA VESTCOM RETAIL SOLUTIONS:
3,808,055, INT. CL. 42.
3,808,056, INT. CL. 20.
3,808,057, INT. CL. 35.

ELECTRONIC NETWORK HOLDINGS, INC., LAS VEGAS, NV:
2,771,890, CANC. INT. CL. 42.

ELEGANT COLLECTION, MUMBAI, INDIA:
3,806,280, PUB. 4-6-2010. INT. CL. 14.

ELEGANT EVENT ENTERTAINMENT, INC., THOUSAND OAKS, CA:
3,805,659, PUB. 4-6-2010. INT. CL. 41.

ELITE FORMS SERVICES, INC., MUNCIE, IN:
2,770,731, CANC. INT. CL. 16.

ELITE INTERNATIONAL, INC., BROOKLYN, NY:
2,772,150, CANC. INT. CL. 20.

- ELITE INVESTMENT PORTFOLIO LLC, MIAMI BEACH, FL:
2,403,489. REN. 5-17-10. INT. CL. 41.
- ELITE SOUTHERN CONSTRUCTION, ROSWELL, GA:
3,806,964, PUB. 4-6-2010. INT. CL. 37.
- ELKINTON, HEIDI, STEVENSVILLE, MT:
3,806,229, PUB. 4-6-2010. INT. CL. 44.
- ELLIS, ANTHONY G., SAN DIEGO, CA:
2,285,088, CANC. INT. CL. 35.
- ELOMATIC LTD, FI - 20810 TURKU, FINLAND:
2,349,247. REN. 5-20-10. INT. CL. 42.
- EMA ELECTROMECHANICA, S.A., BUENOS AIRES, ARGENTINA:
3,806,035, PUB. 4-6-2010. INT. CL. 9.
- EMERALD ENVIRONMENTAL SERVICES, INC., KENT, OH:
2,355,778. REN. 5-17-10. INT. CL. 42.
- EMERSON, ERNEST, TORRANCE, CA AND EMERSON, MARY, TORRANCE, CA:
2,772,566, CANC. INT. CL. 8.
- EMILS PIZZA, INCORPORATED, WATERTOWN, WI:
2,771,364, CANC. INT. CL. 30.
- EMINENT SPINE LLC, TEMPLE, TX:
3,806,212, PUB. 4-6-2010. INT. CL. 10.
- EMPIRIX, INC., WALTHAM, MA:
2,772,275, CANC. INT. CL. 9.
- EMPLOYER HEALTH CARE ALLIANCE COOPERATIVE, MADISON, WI:
3,807,676, INT. CL. 35.
3,807,677, INT. CL. 35.
- EMSA GMBH, EMSDETTEN, FED REP GERMANY:
3,807,238, PUB. 4-6-2010. MULTIPLE CLASS, INT. CLS. 11, 19, 20 AND 21.
- EMUGE-WERK RICHARD GLIMPEL GMBH & CO KG FABRIK FÜR PRÄZISIONSWERKZEUGE, FED REP GERMANY:
3,807,193, PUB. 4-6-2010. INT. CL. 7.
- EN VAN, LLC, BIRMINGHAM, AL:
2,772,430, CANC. INT. CL. 10.
- ENAME EQUITY INC., BROOKLINE, ME:
2,770,662, CANC. INT. CL. 35.
- ENCORE PAPER COMPANY, INC., SOUTH GLENS FALLS, NY:
2,770,697, CANC. INT. CL. 16.
- ENDERS, JÜRGEN, MELLE, FED REP GERMANY:
2,771,676, CANC. INT. CL. 20.
- ENDICOTT, WILLIAM L., WILMINGTON, DE:
3,808,601, INT. CL. 9.
- ENDOCHOICE, INC., ALPHARETTA, GA:
3,805,875, PUB. 4-6-2010. INT. CL. 10.
- ENERGIZE FINANCIAL, INC., OTTAWA, CANADA:
3,807,083, PUB. 12-22-2009. MULTIPLE CLASS, INT. CLS. 9, 36 AND 41.
- ENERGY ACE, INC., DECATUR, GA:
3,805,454, PUB. 4-6-2010. MULTIPLE CLASS, INT. CLS. 35, 37 AND 42.
- ENERGY SAVED BY 1, LLC, CHARLOTTE, NC:
3,806,884, PUB. 4-6-2010. INT. CL. 35.
- ENERGY SCIENCES, INC., WILMINGTON, MA:
2,444,313. REN. 5-19-10. INT. CL. 11.
- ENGINEERED INTELLIGENCE CORPORATION, FORT COLLINS, CO:
2,771,715, CANC. INT. CL. 9.
- ENGINEERING SPA, ITALY:
3,737,113, COR. MULTIPLE CLASS, INT. CLS. 9 AND 42.
- ENOITALIA S.P.A., (VP), ITALY:
3,805,609, PUB. 4-6-2010. INT. CL. 33.
- ENOUNCE, INCORPORATED, PALO ALTO, CA:
3,806,349, PUB. 4-6-2010. MULTIPLE CLASS, INT. CLS. 9 AND 42.
- ENTACT, LLC, GRAPEVINE, TX:
2,333,244. REN. 5-17-10. INT. CL. 42.
- ENTERPRISE HOLDINGS, INC., ST. LOUIS, MO:
3,808,480, INT. CL. 39.
- ENTRAVISION COMMUNICATIONS CORPORATION, SANTA MONICA, CA:
2,771,430, CANC. INT. CL. 38.
2,771,450, CANC. INT. CL. 38.
- ENTWICKLUNGSGESELLSCHAFT FÜR AKUSTIK (EFA) MIT BESCHRÄNKTER HAFTUNG, WITTEN, FED REP GERMANY:
2,817,079, CANC. MULTIPLE CLASS, INT. CLS. 1 AND 27.
- ENVIRONNE', INC., BANDON, OR:
2,772,020, CANC. INT. CL. 3.
- ENVIROTECH SERVICES, INC., GREELEY, CO:
3,807,943, INT. CL. 1.
- ENZO LIFE SCIENCES, INC., FARMINGDALE, NY:
3,805,905, PUB. 4-6-2010. INT. CL. 1.
- EPIC OFF ROAD, LLC, SCOTTSDALE, AZ:
3,806,486, PUB. 4-6-2010. MULTIPLE CLASS, INT. CLS. 25 AND 39.
- EQUEBE TECHNOLOGY AND SOFTWARE INC., EDMONTON, CANADA:
3,805,298, PUB. 1-26-2010. MULTIPLE CLASS, INT. CLS. 35, 41, 42 AND 45.
- EQUIDRY BEDDING PRODUCTS, INC., MESA, AZ:
2,771,463, CANC. INT. CL. 31.
- EQUINE GOLD, INC., SALISBURY, VT:
2,772,256, CANC. INT. CL. 5.
- EQUINOX LEARNING, LLC, MORGANVILLE, NJ:
3,806,411, PUB. 4-6-2010. INT. CL. 41.
- EQUISOLVE, LLC, FORT LAUDERDALE, FL:
3,806,050, PUB. 4-6-2010. INT. CL. 42.
- ERBA, KATHLEEN E., BODEGA BAY, CA, DBA COLDWELL BANKER COAST PROPERTIES:
3,808,474, INT. CL. 35.
- ERGO WORKS INC., BELMONT, CA:
2,770,920, CANC. INT. CL. 42.
- ERIE JAMES LTD., LEAMINGTON, CANADA:
3,805,444, PUB. 4-6-2010. INT. CL. 31.
- ERNIE BALL, INC., COACHELLA, CA:
3,807,006, PUB. 4-6-2010. INT. CL. 15.
- ERWEKA GMBH, FED REP GERMANY:
3,807,289, PUB. 4-6-2010. MULTIPLE CLASS, INT. CLS. 9 AND 16.
- ESAB GROUP, INC., FLORENCE, SC:
3,806,652, PUB. 4-6-2010. INT. CL. 7.
- ESAOTE, S.P.A., MILANO, ITALY:
3,806,985, PUB. 4-6-2010. MULTIPLE CLASS, INT. CLS. 9 AND 10.
- ESCO TECHNOLOGIES (ASIA) PTE LTD, 486777, SINGAPORE:
3,808,404, INT. CL. 9.
- ESKA IMPLANTS GMBH & CO., LUBECK, FED REP GERMANY:
2,770,704, CANC. MULTIPLE CLASS, INT. CLS. 6 AND 10.
- ESPN, INC., BRISTOL, CT:
3,805,494, PUB. 4-6-2010. INT. CL. 41.
- ESRMCO, WILMINGTON, DE:
1,559,619, CANC. INT. CL. 9.
- ESSAR STEEL ALGOMA INC., SAULT STE MARIE, ONTARIO, CANADA:
2,356,339. REN. 5-14-10. INT. CL. 40.
- ESSELTE CORPORATION, MELVILLE, NY:
3,806,234, PUB. 4-6-2010. INT. CL. 16.
- ESTEE LAUDER INC., NEW YORK, NY:
2,359,629. REN. 5-14-10. INT. CL. 3.
3,805,242, PUB. 4-6-2010. INT. CL. 3.
3,808,423, INT. CL. 44.
- ESTHETIQUES SANS FRONTIÈRES INC., CITY OF ANJOU, QUEBEC:
3,807,425, INT. CL. 3.
- ETA SA MANUFACTURE HORLOGÈRE SUISSE, CH-2540 GRENCHEN, SWITZERLAND:
3,807,268, PUB. 4-6-2010. INT. CL. 14.
- ETHICAL PRODUCTS, INC., NEWARK, NJ:
2,772,385, CANC. INT. CL. 28.
- ETONIC WORLDWIDE LLC, WALTHAM, MA:
2,285,407, CANC. INT. CL. 28.
- ETRON TECHNOLOGY INC., HSINCHU, TAIWAN:
3,806,305, PUB. 4-6-2010. INT. CL. 9.
- EUREKA GROWTH CAPITAL II, L.P., PHILADELPHIA, PA:
3,807,062, PUB. 4-6-2010. INT. CL. 36.

EURO RSCG HEALTHVIEW, INC., NEW YORK, NY:
2,772,714, CANC. INT. CL. 41.

EUROCLEAR SA/NV, 1210 BRUSSELS, BELGIUM:
3,805,297, PUB. 4-6-2010. MULTIPLE CLASS, INT. CLS. 9,
36 AND 38.

EUROPASTRY, S.A., VALLES, BARCELONA, SPAIN:
3,805,671, PUB. 4-6-2010. INT. CL. 30.

EUROPTEC USA INC., CLARKSBURG, WV:
3,805,804, PUB. 4-6-2010. INT. CL. 9.

EVAN SERVICES, INC, MIAMISBURG, OH:
2,349,521. REN. 5-15-10. INT. CL. 37.

EVARIANT, WILMINGTON, DE:
3,805,927, PUB. 4-6-2010. INT. CL. 9.

EVARIANT, LLC, WILMINGTON, CT:
3,805,439, PUB. 4-6-2010. INT. CL. 42.

EVCARCO, INC., FORT WORTH, TX, DBA EVCARCO.COM:
3,808,446, INT. CL. 35.
3,808,447, INT. CL. 35.
3,808,448, INT. CL. 35.

EVE SZU-JU CHEN, DIAMOND BAR, CA:
3,806,899, PUB. 4-6-2010. INT. CL. 33.

EVELYN & COMPANY LLC, BLOOMFIELD HILLS, MI:
3,806,837, PUB. 4-6-2010. INT. CL. 25.

EVERDRY MARKETING & MANAGEMENT, INC., MACE-
DONIA, OH:
2,711,738, COR. INT. CL. 19.

EVEREADY BATTERY COMPANY, INC., ST. LOUIS, MO:
3,808,184, INT. CL. 11.
3,808,386, INT. CL. 11.

EVERGREEN ALLIANCE GOLF LIMITED, L.P., DALLAS,
TX:
3,807,570, MULTIPLE CLASS, INT. CLS. 35 AND 37.

EVERHART, ANTHONY R, EL CAJON, CA:
3,805,607, PUB. 4-6-2010. INT. CL. 37.

EVERNOTE CORPORATION, SUNNYVALE, CA:
2,772,562, CANC. INT. CL. 42.

EVERSHED, JANE, SPRINGBROOK, WI, AKA JANE
EVERSHED ART COLLECTION:
3,806,439, PUB. 4-6-2010. INT. CL. 16.

EVERT-FRESH CORPORATION, KATY, TX:
3,808,722, INT. CL. 3.

EVERYCALL COMMUNICATIONS, INC., BATON ROUGE,
LA:
2,354,234. REN. 5-20-10. INT. CL. 35.

EVERYPLAY LTD., HELSINKI, FINLAND:
3,805,962, PUB. 4-6-2010. MULTIPLE CLASS, INT. CLS. 9,
28 AND 41.

EVIEW 360 CORPORATION, NORTHVILLE, MI:
2,772,611, CANC. INT. CL. 42.

EVOLUTION INTERNATIONAL, LLC, DEL MAR, CA:
2,771,082, CANC. INT. CL. 25.

EVOTEC AG, HAMBURG, FED REP GERMANY:
3,807,073, PUB. 9-18-2007. MULTIPLE CLASS, INT. CLS. 1
AND 5.

EVOTEC ANALYTICAL SYSTEMS GMBH, D-40699 ERK-
RATH, FED REP GERMANY:
2,770,689, CANC. MULTIPLE CLASS, INT. CLS. 1, 5 AND
42.

EVY OF CALIFORNIA, INC., LOS ANGELES, CA:
1,559,981, CANC. INT. CL. 25.

EWALD DÖRKEN AG, 58313 HERDECKE, FED REP GER-
MANY:
3,591,369, COR. MULTIPLE CLASS, INT. CLS. 17, 19
AND 22.

EXÁGO, INC., SHELTON, CT:
3,808,668, INT. CL. 9.

EXCLUSIVE GENETICS, LP, ORCHARD, TX:
3,806,306, PUB. 4-6-2010. INT. CL. 41.

EXPERIENCE BASED LEARNING, INC, ROCKFORD, IL:
2,430,568. REN. 5-20-10. MULTIPLE CLASS, INT. CLS. 35
AND 41.

EXPERIENCE BASED LEARNING, INC., ROCKFORD, IL:
2,351,558. REN. 5-20-10. MULTIPLE CLASS, INT. CLS. 35
AND 41.

EXPERIENCE LEARNING COMMUNITY, SEATTLE, WA,
FORMERLY EXPERIENCE LEARNING PROJECT:
2,285,706, CANC. INT. CL. 18.

EXPERIENCE WORKS, INC., ARLINGTON, VA:
3,806,326, PUB. 4-6-2010. MULTIPLE CLASS, INT. CLS. 35
AND 41.

3,806,327, PUB. 4-6-2010. MULTIPLE CLASS, INT. CLS. 35
AND 41.

3,806,328, PUB. 4-6-2010. MULTIPLE CLASS, INT. CLS. 35
AND 41.

EXPERT CLINICAL SYSTEMS, INC., PHOENIX, AZ:
2,311,077. REN. 5-17-10. INT. CL. 9.

EXPERT FOODS, INC., ELLICOTT CITY, MD:
2,771,563, CANC. INT. CL. 30.

EXPLOREX TECHNOLOGIES INC., MISSISSAUGA, ON-
TARIO, CANADA:
3,808,004, INT. CL. 5.

EXPONATION, L.L.C., ROSWELL, GA:
3,805,587, PUB. 4-6-2010. INT. CL. 35.
3,805,588, PUB. 4-6-2010. INT. CL. 35.

EXPRESS TUNNEL INC., MIDLAND, TX:
3,806,418, PUB. 4-6-2010. INT. CL. 35.

EXPRO AMERICAS INC., HOUSTON, TX:
2,771,505, CANC. INT. CL. 40.

EXTREME RECYCLING INC., PLACENTIA, CA:
3,806,866, PUB. 4-6-2010. INT. CL. 40.

EYE SUPPLY, INC., WANTAGH, NY:
1,560,268, CANC. INT. CL. 42.

EYEBLASTER LTD. (ISRAEL), RA'ANANA, ISRAEL:
3,808,126, INT. CL. 42.

EYEDOODLE, INC., WATERLOO, ONTARIO:
2,771,633, CANC. INT. CL. 42.

EZ ENTRY DOORS, INC, LOCKPORT, NY:
2,771,322, CANC. INT. CL. 9.

E2 & ME CATERING, LLC, LEESBURG, VA:
2,770,942, CANC. INT. CL. 43.

E5 PHARMA, INC., CORAL SPRINGS, FL:
3,806,052, PUB. 4-6-2010. INT. CL. 5.

F.A.B. INC., ALPHARETTA, GA:
3,808,524, INT. CL. 30.

F.A.S.S.T. COMPANY, LONG BEACH, CA:
3,806,115, PUB. 4-6-2010. INT. CL. 12.

F+W MEDIA, INC., CINCINNATI, OH:
2,771,437, CANC. INT. CL. 35.

F-D-C REPORTS, INC., CHEVY CHASE, MD:
697,138. REN. 5-20-10. U.S. CL. 38 (INT. CL. 16).

FAB X FRAME SYSTEMS, LLC, PETOSKEY, MI:
3,807,932, INT. CL. 20.

FABASOFT AG, LINZ, AUSTRIA:
2,770,813, CANC. MULTIPLE CLASS, INT. CLS. 9, 35, 37,
41 AND 42.

FABERGE LIMITED, GEORGE TOWN, CAYMAN IS-
LANDS:
3,805,294, PUB. 4-6-2010. MULTIPLE CLASS, INT. CLS.
14, 21, 35, 41, 42, 43 AND 44.

FABRICA DE JABON LA CORONA, S.A. DE C.V., MEXICO
CITY, MEXICO:
1,603,311. REN. 5-18-10. INT. CL. 3.

FADA INDUSTRIES, INC., LONG ISLAND CITY, NY:
2,772,443, CANC. INT. CL. 14.

FAIRWAY GROUP ACQUISITION COMPANY, NEW
YORK, NY:
3,808,727, INT. CL. 35.

FAISON, ASHLEE D., HAMPTON, VA, DBA DEANA FAI:
3,806,222, PUB. 4-6-2010. MULTIPLE CLASS, INT. CLS. 9
AND 41.

FAME IP HOLDING, LLC, HOLLYWOOD, FL:
3,808,511, INT. CL. 9.
3,808,512, INT. CL. 9.
3,808,515, INT. CL. 16.
3,808,525, INT. CL. 25.

FAMILIE PORSCHE AG BETEILIGUNGSGESELLSCHAFT,
A-5020 SALZBURG, AUSTRIA:
2,771,584, CANC. MULTIPLE CLASS, INT. CLS. 14 AND
34.

FAMILY BRIDGES HOME CARE, INC., CINCINNATI, OH:
3,806,464, PUB. 4-6-2010. INT. CL. 45.

FANCL CORPORATION, SAKAE-KU, YOKOHAMA-SHI,
KANAGAWA, JAPAN:
2,770,969, CANC. INT. CL. 5.

- FANDANGO, INC., LOS ANGELES, CA:
3,808,046, INT. CL. 41.
- FANTASYPROTECT.COM, LLC, WOODRIDGE, IL:
3,806,822, PUB. 4-6-2010. INT. CL. 36.
- FANZLAW, BRUCE, OCALA, FL AND FANZLAW, NANCY,
OCALA, FL:
3,808,139, INT. CL. 15.
- FARESE FAMILY FOUNDATION, THE, SAN FRANCISCO,
CA:
3,805,851, PUB. 4-6-2010. INT. CL. 36.
- FARLEY'S & SATHERS CANDY COMPANY, INC., ROUND
LAKE, MN, DBA FARLEY'S & SATHERS CANDY COM-
PANY:
2,286,508, CANC. INT. CL. 30.
- FARMACEUTICA INTERNACIONAL S.A. DE C.V., MIAMI,
FL:
2,770,958, CANC. INT. CL. 3.
- FAROUK SYSTEMS, INC., HOUSTON, TX:
3,807,956, INT. CL. 11.
- FARRELL, JEREMIAH, MR., INDIANAPOLIS, IN:
2,399,853, REN. 5-17-10. INT. CL. 16.
- FASHION CHEMICALS GMBH & CO. KG, 40589 DUESSEL-
DORF, GERMAN DEM REP, JACQUES WOLF & CO.,
PASSAIC, NJ:
688,149, REN. 5-19-10. U.S. CL. 6 (INT. CLS. 1 AND 2).
- FASHION SHOE LICENSING LLC, NEW HYDE PARK, NY:
1,559,927, CANC. INT. CL. 25.
- FASIG-TIPTON RACING CLUB MANAGEMENT, LLC,
LEXINGTON, KY:
3,806,191, PUB. 4-6-2010. MULTIPLE CLASS, INT. CLS. 35
AND 39.
3,806,233, PUB. 4-6-2010. MULTIPLE CLASS, INT. CLS. 35
AND 39.
- FAST CLOTHING, INC., BELLEVUE, MA:
1,559,948, CANC. INT. CL. 25.
- FAUSTO COLATO S.R.L., ITALY:
3,807,198, PUB. 4-6-2010. MULTIPLE CLASS, INT. CLS. 18
AND 25.
- FAVEO LIMITED, UNITED KINGDOM:
3,807,099, PUB. 4-6-2010. INT. CL. 25.
- FCODER GROUP, INC., ALEXANDRIA, VA:
3,805,995, PUB. 4-6-2010. MULTIPLE CLASS, INT. CLS. 9
AND 42.
- FEATHERLITE COACHES, INC., SANFORD, FL:
2,285,094, CANC. INT. CL. 12.
- FEATURE-TEC (WUXI) FILTRATION TECHNOLOGY CO.,
LTD., WUXI, JIANGSU, CHINA:
3,806,596, PUB. 4-6-2010. MULTIPLE CLASS, INT. CLS. 7
AND 11.
- FEDERAL EXPRESS CORPORATION, MEMPHIS, TN:
2,929,575, CANC. INT. CL. 25.
- FEDERAL HOME LOAN MORTGAGE CORPORATION,
MCLEAN, VA:
2,711,256, CANC. INT. CL. 36.
3,808,677, INT. CL. 9.
- FEDERAL NATIONAL MORTGAGE ASSOCIATION, WA-
SHINGTON, DC:
1,560,132, CANC. INT. CL. 36.
- FEDERAL SCHEDULES, INC., HERNDON, VA:
3,806,539, PUB. 4-6-2010. INT. CL. 35.
- FEDERATED GROUP, INC., THE, ARLINGTON HEIGHTS,
IL:
2,772,274, CANC. MULTIPLE CLASS, INT. CLS. 29 AND
30.
- FEDERATED MEDIA PUBLISHING, INC., SAN FRANCIS-
CO, CA:
3,808,645, MULTIPLE CLASS, INT. CLS. 9, 35 AND 41.
- FEDERATION MONDIALE DE KARATE, 75014 PARIS,
FRANCE:
2,285,682, CANC. MULTIPLE CLASS, INT. CLS. 16 AND
41.
- FEDREG E-LERT, WINSTON-SALEM, NC:
2,771,556, CANC. INT. CL. 38.
- FELDMAN, J. DREW, ATLANTA, GA:
3,805,938, PUB. 4-6-2010. INT. CL. 35.
- FELL, MICHAEL, MURRIETA, CA:
3,807,382, INT. CL. 37.
- FELSKE, COERTE, NEW YORK, NY:
3,808,205, INT. CL. 16.
- FEMAR VINI S.R.L., ITALY:
3,807,262, PUB. 4-6-2010. INT. CL. 33.
- FEMINIST MAJORITY FOUNDATION, ARLINGTON, VA:
3,805,343, PUB. 4-6-2010. MULTIPLE CLASS, INT. CLS. 36
AND 41.
- FERRARI S.P.A., MODENA, ITALY:
3,807,063, PUB. 4-6-2010. MULTIPLE CLASS, INT. CLS. 21
AND 22.
- FERRARI S.P.A., ITALY:
3,807,204, PUB. 4-6-2010. MULTIPLE CLASS, INT. CLS. 25
AND 28.
- FERRIS & MOR CORP., ARCADIA, CA:
3,806,814, PUB. 4-6-2010. INT. CL. 18.
- FESKE JR., DAVID, A., CANOGA PARK, CA:
3,807,070, PUB. 4-6-2010. INT. CL. 25.
- FEY INDUSTRIES, INC., EDGERTON, MN:
2,351,616, REN. 5-18-10. INT. CL. 25.
- FFERRONE DESIGN LTD., CHICAGO, IL:
3,806,242, PUB. 4-6-2010. INT. CL. 21.
- HOME S.R.L., ITALY:
3,807,195, PUB. 4-6-2010. MULTIPLE CLASS, INT. CLS.
11, 20 AND 42.
- FIA CARD SERVICES, NATIONAL ASSOCIATION, WIL-
MINGTON, DE:
3,808,165, INT. CL. 36.
- FIBER-TECH ENGINEERING, INC., ESCONDIDO, CA:
2,286,230, CANC. INT. CL. 20.
2,286,231, CANC. INT. CL. 20.
- FIDO FRIENDLY, INC., MARSING, ID:
3,808,137, INT. CL. 35.
- FIELDPOINT B.V., NETHERLANDS:
3,807,240, PUB. 4-6-2010. MULTIPLE CLASS, INT. CLS. 3,
14, 16, 18, 24 AND 25.
- FIELDSTONE MORTGAGE COMPANY, COLUMBIA, MD:
2,771,445, CANC. INT. CL. 36.
- FIFTH THIRD BANK, KENTUCKY, INC., LEXINGTON,
KY:
2,771,132, CANC. INT. CL. 41.
- FIGHTING WHITES SCHOLARSHIP FUND, INC., GREE-
LEY, CO:
2,771,568, CANC. INT. CL. 25.
- FIGI'S INC., MARSHFIELD, WI:
2,359,870, REN. 5-20-10. INT. CL. 29.
- FIGONE TRAVEL GROUP, INC., SAN CARLOS, CA:
2,771,398, CANC. INT. CL. 39.
- FILTRONA PLASTICS, LLC, ERIE, PA:
3,805,246, PUB. 4-6-2010. MULTIPLE CLASS, INT. CLS.
17, 20, 22, 35 AND 42.
- FINANCIAL ENGINEERING ASSOCIATES, INC., BERKE-
LEY, CA:
2,286,566, CANC. INT. CL. 9.
- FINANCIAL INDUSTRY REGULATORY AUTHORITY,
INC., WASHINGTON, DC, FORMERLY NATIONAL AS-
SOCIATION OF SECURITIES DEALERS, INC.:
3,805,725, PUB. 4-6-2010. MULTIPLE CLASS, INT. CLS. 42
AND 45.
- FINGER, DEBORAH, HARTSDALE, NY AND LEBOWITZ,
LYNN, SCARSDALE, NY:
3,808,160, INT. CL. 16.
- FINK, ROBERT, PHILADELPHIA, PA AND FINK II,
RICHARD, PHILADELPHIA, PA:
3,806,422, PUB. 4-6-2010. INT. CL. 41.
- FINNANGER, TONE, HVASSER, NORWAY:
3,805,478, PUB. 4-6-2010. MULTIPLE CLASS, INT. CLS. 6,
16, 20, 23, 24, 26 AND 28.
- FIREOVED, THOMAS, DALLAS, TX:
3,807,451, INT. CL. 35.
- FIRST & GOAL INC., SEATTLE, WA:
2,771,202, CANC. MULTIPLE CLASS, INT. CLS. 35 AND
41.
2,771,203, CANC. MULTIPLE CLASS, INT. CLS. 35 AND
41.
2,771,204, CANC. MULTIPLE CLASS, INT. CLS. 35 AND
41.

FIRST ADVANTAGE CORPORATION, ST. PETERSBURG, FL:
3,805,204, PUB. 4-29-2008. MULTIPLE CLASS, INT. CLS. 35, 36, 42 AND 45.

FIRST AMERICAN PRIME CARE, INC., ROSWELL, NM:
3,805,524, PUB. 4-6-2010. INT. CL. 45.

FIRST CHOICE ARMOR & EQUIPMENT, INC., BRAINTREE, MA:
3,805,388, PUB. 4-6-2010. INT. CL. 9.

FIRST HOPE BANK, HOPE, NJ:
2,771,441, CANC. INT. CL. 35.

FIRST INSURANCE COMPANY OF HAWAII, LTD., HONOLULU, HI:
3,806,879, PUB. 4-6-2010. INT. CL. 36.

FIRST LINE TECHNOLOGY, LLC, CHANTILLY, VA:
3,806,235, PUB. 4-6-2010. INT. CL. 12.

FIRST WATCH RESTAURANTS, INC., BRADENTON, FL:
3,806,703, PUB. 4-6-2010. INT. CL. 43.

FIRST WAVE PRODUCTS GROUP, LLC, BATAVIA, NY:
3,807,974, INT. CL. 10.

FISHER SCIENTIFIC COMPANY L.L.C., PITTSBURGH, PA:
3,805,356, PUB. 4-6-2010. INT. CL. 9.

FIT HAIR, INC., LONG BEACH, CA:
3,807,393, INT. CL. 3.

FITCH, INC., NEW YORK, NY:
2,771,458, CANC. INT. CL. 36.

FITLAB METABOLIC SERVICES, PEACHTREE CITY, GA:
3,806,240, PUB. 4-6-2010. INT. CL. 44.

FITZGERALD, J. DOUGLAS, WEST BEND, WI:
3,807,969, MULTIPLE CLASS, INT. CLS. 36 AND 45.

FIVESON'S FOODS, INC., MERRICK, NY:
2,770,723, CANC. INT. CL. 29.

FIX-A-DENT, INC., AUSTIN, TX:
2,771,408, CANC. INT. CL. 37.

FKP ARCHITECTS, INC., HOUSTON, TX:
3,807,585, MULTIPLE CLASS, INT. CLS. 35 AND 42.

FLAHERTY, MONIQUE MORIMOTO, NORTH QUINCY, MA, DBA SOULWORKS COACHING:
2,770,937, CANC. INT. CL. 41.

FLAMING RIVER INDUSTRIES, INC., BEREA, OH:
3,805,176, PUB. 4-6-2010. INT. CL. 12.

FLAP HAPPY, INC., SANTA MONICA, CA:
2,362,356, REN. 5-20-10. INT. CL. 25.

FLATH, CARL, ELKHORN, WI:
3,808,375, INT. CL. 41.

FLAY, ROBERT, NEW YORK, NY:
2,771,913, CANC. MULTIPLE CLASS, INT. CLS. 8, 21, 25 AND 30.

FLEXFORM TECHNOLOGIES, LLC, ELKHART, IN:
2,772,230, CANC. INT. CL. 17.

FLIGHTCOM CORP., PORTLAND, OR:
2,367,099, REN. 5-19-10. INT. CL. 9.

FLINT HYDRAULICS INC., MEMPHIS, TN:
3,808,473, INT. CL. 7.

FLIP TECHNOLOGIES LIMITED, DANGAN, GALWAY, IRELAND:
3,805,314, PUB. 4-6-2010. INT. CL. 10.

FLIPPERATO, INC., ATHERTON, CA:
3,806,008, PUB. 4-6-2010. MULTIPLE CLASS, INT. CLS. 39 AND 42.

FLOODMAN, STEPHEN ROBERT, PORTLAND, OR, DBA HANDYMANLINK:
3,805,779, PUB. 4-6-2010. INT. CL. 37.

FLORACOPEIA, INC., NEVADA CITY, CA:
3,806,657, PUB. 4-6-2010. INT. CL. 3.

FLORES-CASTANO IMPORTS FROM MEXICO II, L.P., LAREDO, TX:
3,808,564, INT. CL. 21.

FLORIDA WIRE & RIGGING SUPPLY, INC., CASSELBERRY, FL:
3,805,155, PUB. 4-6-2010. INT. CL. 35.

FLORIO FOOD CORP., WYANDANCH, NY:
3,807,573, INT. CL. 30.

FLOWIL INTERNATIONAL LIGHTING (HOLDING) B.V., AMSTERDAM, NETHERLANDS:
2,318,102, REN. 5-20-10. INT. CL. 11.

FLOYD, JOHN B., CALABASAS, CA:
3,506,432, CANC. INT. CL. 42.

FLUIDALL, LLC, DELANO, MN:
2,357,558, REN. 5-18-10. INT. CL. 20.

FLY-RITE LLC, MIKADO, MI:
3,805,404, PUB. 4-6-2010. MULTIPLE CLASS, INT. CLS. 5 AND 28.

FLYING HORSE COMMUNICATION, INC., BOZEMAN, MT:
3,807,836, MULTIPLE CLASS, INT. CLS. 35, 41 AND 42.

FLYING MEAT INC., EVERETT, WA:
3,806,230, PUB. 4-6-2010. INT. CL. 9.

FLYNN, PAUL R., NEWARK, NJ:
2,771,999, CANC. MULTIPLE CLASS, INT. CLS. 9, 16 AND 35.

2,772,000, CANC. INT. CL. 35.

2,772,001, CANC. INT. CL. 35.

FMR LLC, BOSTON, MA:
2,772,678, CANC. INT. CL. 36.

FMTM DISTRIBUTION LTD., TORTOLA, BR. VIRGIN ISLANDS:
2,356,520, REN. 5-18-10. INT. CL. 14.

FOAMEX INNOVATIONS OPERATING COMPANY, MEDIA, PA:
2,402,718, REN. 5-17-10. INT. CL. 27.

FOAMEX L.P., LINWOOD, PA:
2,771,625, CANC. MULTIPLE CLASS, INT. CLS. 20 AND 24.

FOCUS PRODUCTS GROUP, LLC, VERNON HILLS, IL:
2,356,174, REN. 5-19-10. INT. CL. 20.

2,383,767, REN. 5-18-10. INT. CL. 11.

2,383,768, REN. 5-18-10. INT. CL. 11.

2,444,827, REN. 5-19-10. INT. CL. 20.

FOGMASTER CORPORATION, THE, DEERFIELD BEACH, FL:
2,354,882, REN. 5-20-10. INT. CL. 9.

FOLDCRAFT CO., KENYON, MN, AKA FOLDCRAFT COMPANY:
3,805,787, PUB. 4-6-2010. MULTIPLE CLASS, INT. CLS. 19, 20 AND 21.

FONEPAYS, LLC, COLUMBIA, SC, FORMERLY JOWERS AND KING, LLC:
3,806,687, PUB. 4-6-2010. INT. CL. 9.

FONT DINER, INC., EAU CLAIRE, WI:
3,806,424, PUB. 4-6-2010. INT. CL. 9.

FONTANA FOOD AB, SWEDEN:
3,807,311, PUB. 4-6-2010. MULTIPLE CLASS, INT. CLS. 29 AND 30.

FOODMARK, INC., WELLESLEY, MA:
3,808,513, INT. CL. 29.

3,808,539, INT. CL. 29.

FOOTBALL NORTHWEST LLC, RENTON, WA:
2,375,925, REN. 5-20-10. INT. CL. 41.

2,378,690, REN. 5-18-10. INT. CL. 41.

FOPE SRL, 36100 VICENZA, ITALY:
2,353,914, REN. 5-19-10. INT. CL. 14.

FOR WORLD PEACE PTE LTD, SINGAPORE, SINGAPORE:
3,805,358, PUB. 4-6-2010. INT. CL. 9.

FORD MOTOR COMPANY, DEARBORN, MI:
3,807,444, INT. CL. 35.

FORD SIGNS, INC., SIOUX FALLS, SD:
2,284,868, CANC. INT. CL. 20.

FORD, MADELINE CELESTE, NEW YORK, NY, DBA CELESTE FORD:
3,806,245, PUB. 4-6-2010. INT. CL. 41.

FOREMOST FURNITURE SHOWROOMS, INC., NEW YORK, NY:
1,560,309, CANC. INT. CL. 35.

FORESIGHT CORPORATION, DUBLIN, OH:
3,808,729, INT. CL. 9.

FORETHOUGHT FINANCIAL SERVICES, INC., BATESVILLE, IN:
1,560,120, CANC. INT. CL. 35.

2,770,924, CANC. INT. CL. 35.

FOREVERLAST HUNTING PRODUCTS, INC., HALLETTSVILLE, TX:
3,805,175, PUB. 4-6-2010. INT. CL. 9.

FORIS AG, 53113 BONN, FED REP GERMANY:
3,805,428, PUB. 8-25-2009. MULTIPLE CLASS, INT. CLS. 35, 36, 41 AND 45.

- FORMFIBER DENMARK APS, DENMARK:
3,807,186, PUB. 4-6-2010. MULTIPLE CLASS, INT. CLS. 7, 17 AND 22.
- FORTIFIBER CORPORATION, LOS ANGELES, CA:
1,559,797, CANC. INT. CL. 16.
- FORTOP INDUSTRIAL CO., LTD., TAINAN, TAIWAN:
2,433,131. REN. 5-18-10. INT. CL. 11.
- FORTUNE FASHIONS INDUSTRIES LLC, SANTA BARBARA, CA:
3,807,853, INT. CL. 25.
- FORTUNE HI-TECH MARKETING, INC., LEXINGTON, KY:
3,807,483, INT. CL. 18.
- FOSS MARITIME COMPANY, SEATTLE, WA:
3,806,558, PUB. 4-6-2010. INT. CL. 36.
- FOSTER, DARYL, LOS ANGELES, CA:
3,807,795, INT. CL. 25.
- FOTOLEC TECHNOLOGIES PLC, THETFORD, NORFOLK, UNITED KINGDOM:
2,771,518, CANC. INT. CL. 11.
- FOUR ACE INTERNATIONAL LIMITED, WANCHAI, HONG KONG:
3,807,092, PUB. 4-6-2010. MULTIPLE CLASS, INT. CLS. 12, 18, 25, 28, 29, 41 AND 44.
- FOUR GATES LLC, GERMANTOWN, MD:
3,805,533, PUB. 4-6-2010. MULTIPLE CLASS, INT. CLS. 9 AND 42.
- FOUR PEAS CONSULTING, LLC, HOLLYWOOD, FL:
3,806,064, PUB. 4-6-2010. INT. CL. 35.
- FOUR TRUCKERS, INC., VALDESE, NC:
3,807,506, INT. CL. 39.
- FOWLER, STACY J., GOLDEN, CO:
2,771,471, CANC. INT. CL. 41.
- FOX TELEVISION STATIONS, INC., LOS ANGELES, CA:
2,285,307, CANC. INT. CL. 41.
2,377,636. REN. 5-18-10. INT. CL. 41.
- FOX, DAVID, SYOSSET, NY:
3,808,753, INT. CL. 42.
- FOXWOOD GROUP, INC., FAYETTEVILLE, AR:
3,691,660, AM. INT. CL. 16.
- FOXP2 INC., COCONUT GROVE, FL:
3,808,529, MULTIPLE CLASS, INT. CLS. 9 AND 41.
- FPL GROUP, INC., JUNO BEACH, FL:
3,808,549, INT. CL. 39.
- FRAME MATRIX, INC., BOISE, ID:
2,772,086, CANC. MULTIPLE CLASS, INT. CLS. 9, 35 AND 42.
- FRANCE TELECOM, PARIS, FRANCE:
2,771,545, CANC. MULTIPLE CLASS, INT. CLS. 9, 38 AND 42.
- FRANCO, MOISES JACOBO, AVENTURA, FL:
3,808,318, INT. CL. 14.
- FRANK W. MOSELEY CO., INC., ROELAND PARK, KS, DBA SWEET TIDINGS:
2,771,869, CANC. INT. CL. 30.
- FRANK, GARVEY WILLIAM, MIDDLESEX, UNITED KINGDOM, TA RIFIFI:
3,808,359, INT. CL. 25.
- FRANKLIN, ELDER, ALICE P, WORTHINGTON, OH:
2,346,687. REN. 5-18-10. INT. CL. 16.
- FRANZ KALDEWEI GMBH & CO. KG, AHLEN, FED REP GERMANY:
3,808,158, INT. CL. 11.
- FRANZ PLASSER BAHNBAUMASCHINEN-; INDUSTRIE-GESELLSCHAFT MBH, WIEN, AUSTRIA:
3,807,197, PUB. 4-6-2010. MULTIPLE CLASS, INT. CLS. 7, 12 AND 37.
- FRATERNITE NOTRE DAME, INC., CHICAGO, IL:
2,350,166. REN. 5-18-10. INT. CL. 35.
- FREAKIES COMPANY, THE, EDISON, NJ, FREAKIES COMPANY, THE, EDISON, NJ:
2,444,754. REN. 5-18-10. INT. CL. 25.
- FRED M. LAWRENCE CO., INC., L.I.C., NY:
2,374,179. REN. 5-14-10. INT. CL. 20.
- FREDERIC ROBINSON LIMITED, CHESHIRE, UNITED KINGDOM:
2,771,656, CANC. INT. CL. 32.
- FREE & CLEAR, INC., SEATTLE, WA:
3,808,563, INT. CL. 44.
- FREE GREEN CAN LLC, AURORA, IL:
3,807,049, PUB. 4-6-2010. INT. CL. 35.
- FREEBIT CO., LTD., TOKYO, JAPAN:
3,805,722, PUB. 4-6-2010. MULTIPLE CLASS, INT. CLS. 9 AND 42.
3,805,723, PUB. 4-6-2010. MULTIPLE CLASS, INT. CLS. 9 AND 42.
- FREEDOM TAX RELIEF, LLC, SAN MATEO, CA:
3,805,375, PUB. 4-6-2010. MULTIPLE CLASS, INT. CLS. 35 AND 45.
- FREEFORALL, INCORPORATED, VOORHEES, NJ:
3,805,981, PUB. 4-6-2010. INT. CL. 35.
- FREEMAN, JERRY K.M., EWA BEACH, HI:
2,771,363, CANC. INT. CL. 20.
- FREEWAY EYEWEAR INC., LOS ANGELES, CA:
3,807,508, INT. CL. 9.
- FREEWINGS INTERNATIONAL LLC, WILMINGTON, DE:
2,772,640, CANC. INT. CL. 9.
- FRENCH OIL MILL MACHINERY COMPANY, THE, PIQUA, OH:
2,350,021. REN. 5-16-10. INT. CL. 7.
- FRESH CUTT, INC., SHERMAN OAKS, CA:
3,805,586, PUB. 4-6-2010. INT. CL. 43.
- FRESH FOODS CAFE LLC, LONG BEACH, CA:
3,806,397, PUB. 4-6-2010. INT. CL. 43.
- FRESHER FOOTWEAR LLC, EVANSTON, IL:
3,806,721, PUB. 4-6-2010. INT. CL. 1.
- FRIA BRÖD AB, SWEDEN:
3,807,248, PUB. 4-6-2010. INT. CL. 30.
- FRIENDS OF ISRAEL GOSPEL MINISTRY, INC., DEPT-FORD TOWNSHIP, NJ:
2,284,697, CANC. INT. CL. 41.
- FRIENDS OF NICU, FOLSOM, CA:
3,806,493, PUB. 4-6-2010. INT. CL. 36.
- FRITO-LAY NORTH AMERICA, INC., PLANO, TX:
3,805,212, PUB. 4-6-2010. INT. CL. 30.
- FRONT DOOR REALTY, LEESBURG, VA:
3,807,039, PUB. 4-6-2010. INT. CL. 36.
- FRONTIER FASHION, INC., CITY OF INDUSTRY, CA:
3,808,257, INT. CL. 9.
- FRONTIER WIND, LLC, WEST CONSHOHOCKEN, PA:
3,807,479, INT. CL. 7.
- FROST INCORPORATED, GRAND RAPIDS, MI, C. L. FROST & SON, INC., GRAND RAPIDS, MI:
1,138,210. REN. 5-17-10. INT. CL. 7.
- FROUDE HOFMANN LIMITED, UNITED KINGDOM:
3,807,113, PUB. 4-6-2010. MULTIPLE CLASS, INT. CLS. 9 AND 37.
- FRY, STEVEN A., LAGUNA NIGUEL, CA, DBA TRICKS DESIGN:
2,771,902, CANC. INT. CL. 35.
- FRYER, DAVID T., FLEETWOOD, PA:
2,771,755, CANC. INT. CL. 1.
- FT 245 CORPORATION, NEW YORK CITY, NY:
3,807,947, INT. CL. 43.
- FTI GROUP, INC., KELLER, TX:
3,808,407, U.S. CL. 200.
- FU, CHRISTOPHER, MONTEREY PARK, CA AND ALMO, STEVEN, ROWLAND HEIGHTS, CA:
2,772,185, CANC. INT. CL. 28.
- FUCHS PETROLUB AG, D-68169 MANNHEIM, FED REP GERMANY:
2,770,688, CANC. MULTIPLE CLASS, INT. CLS. 4, 35, 39, 40 AND 42.
- FUHRMAN, GREGORY A., FORT COLLINS, CO:
3,806,900, PUB. 4-6-2010. INT. CL. 37.
- FUHU, INC., EL SEGUNDO, CA:
3,807,888, INT. CL. 42.
- FUJIFILM MANUFACTURING EUROPE B.V., TILBURG, NETHERLANDS:
3,807,598, INT. CL. 16.
- FUJITSU LIMITED, KANAGAWA-KEN, JAPAN:
2,286,466, CANC. INT. CL. 9.
- FUJITSU LIMITED, KAWASAKI-SHI, KANAGAWA, JAPAN:
3,805,554, PUB. 4-6-2010. MULTIPLE CLASS, INT. CLS. 9

- AND 42.
 FULL SERVICE NETWORK LP, FORT LAUDERDALE, FL:
 3,806,309, PUB. 4-6-2010. INT. CL. 38.
- FULLBLOOM BAKING COMPANY, INC., NEWARK, CA:
 3,806,295, PUB. 4-6-2010. INT. CL. 30.
 3,806,301, PUB. 4-6-2010. INT. CL. 30.
- FUNCTIONAL ESTHETICS DENTAL LAB, INC., FARM-
 INGTON, MO:
 3,805,158, PUB. 4-6-2010. INT. CL. 41.
- FUNKY METERS, INC., NASHVILLE, TN:
 3,805,147, PUB. 4-6-2010. INT. CL. 41.
- FUNRAISERS LLC, TULSA, OK:
 3,806,852, PUB. 4-6-2010. INT. CL. 36.
 3,806,854, PUB. 4-6-2010. INT. CL. 36.
- FUNSHERPA LLC, BROADVIEW, IL:
 3,808,485, INT. CL. 35.
- FURNACE DESIGN TECHNOLOGY, WESTFIELD, IN:
 3,805,924, PUB. 4-6-2010. INT. CL. 11.
- FURNITURE BUY CONSIGMENT, INC., LEWISVILLE, TX:
 3,806,415, PUB. 4-6-2010. INT. CL. 35.
- FUSHUN YONGMAO CONSTRUCTION MACHINERY CO.,
 LTD, CHINA:
 3,807,178, PUB. 4-6-2010. INT. CL. 7.
- FUSION FACTOR CORPORATION, SAN MARCOS, CA:
 3,805,211, PUB. 4-6-2010. INT. CL. 42.
- FUSION MULTISYSTEMS, INC., SALT LAKE CITY, UT,
 DBA FUSION-IO, INC.:
 3,487,616, COR. INT. CL. 9.
- FUTURE CIRCUS, INC., SANTA MONICA, CA:
 3,806,273, PUB. 4-6-2010. INT. CL. 25.
 3,806,282, PUB. 4-6-2010. INT. CL. 35.
- FUTUREGARDEN INC., FARMINGDALE, NY:
 3,806,274, PUB. 4-6-2010. INT. CL. 21.
- G.K. SCOTT, LLC, LOS ANGELES, CA:
 3,805,869, PUB. 4-6-2010. INT. CL. 35.
- G&G INVESTMENTS, CINCINNATI, OH:
 2,771,427, CANC. INT. CL. 9.
- G'DAY! PET CARE, LLC, ENGLEWOOD, CO:
 3,805,527, PUB. 4-6-2010. MULTIPLE CLASS, INT. CLS.
 35, 37, 39, 44 AND 45.
- GA MODEFINE S.A., MENDRISIO, SWITZERLAND:
 3,805,703, PUB. 4-6-2010. INT. CL. 3.
- GAGNE, JOSH, PROVIDENCE, RI:
 3,806,696, PUB. 4-6-2010. MULTIPLE CLASS, INT. CLS. 9
 AND 25.
- GALAN, MARIA, WAYNE, NJ:
 3,808,390, INT. CL. 35.
- GALARDI GROUP FRANCHISE & LEASING, INC., IRVINE,
 CA, DER WIENERSCHNITZEL INTERNATIONAL, INC.,
 TORRANCE, CA:
 888,422. REN. 5-19-10. U.S. CL. 100 (INT. CL. 42).
- GAMACHE PRODUCTIONS LLC, KENNEWICK, WA:
 3,806,928, PUB. 4-6-2010. INT. CL. 35.
- GAME EQUIPMENT, L.L.C., NAPOLEONVILLE, LA:
 3,807,727, INT. CL. 7.
- GAMEFORGE AG, FED REP GERMANY:
 3,807,257, PUB. 4-6-2010. MULTIPLE CLASS, INT. CLS. 9,
 28 AND 41.
- GAMEWICH, INC., PONTE VEDRA BEACH, FL:
 2,293,709. REN. 5-17-10. MULTIPLE CLASS, INT. CLS. 16
 AND 28.
- GANNETT SATELLITE INFORMATION NETWORK, INC.,
 MCLEAN, VA:
 2,357,757. REN. 5-18-10. INT. CL. 35.
- GANTON TECHNOLOGIES INC., STUTEVANT, WI:
 1,559,541, CANC. MULTIPLE CLASS, INT. CLS. 6 AND 9.
- GANZ, WOODBRIDGE, ONT, CANADA:
 3,808,411, INT. CL. 28.
- GANZONI & CIE AG, 9014 ST. GALLEN, SWITZERLAND:
 2,771,223, CANC. MULTIPLE CLASS, INT. CLS. 10 AND
 25.
- GARANTI BILISIM TEKNOLOJISI; VE TICARET TÜRK
 ANONIM SIRKETI, GÜNEŞLİ; İSTANBUL, TURKEY:
 3,807,196, PUB. 4-6-2010. MULTIPLE CLASS, INT. CLS. 9,
 36 AND 42.
- GARCOA, INC, CALABASAS, CA:
 3,805,177, PUB. 4-6-2010. INT. CL. 3.
- GARDNER DENVER INC., QUINCY, IL:
 2,362,047. REN. 5-19-10. INT. CL. 7.
- GARDNER RESOURCES, INC., HIGHLANDS, NJ:
 2,351,089. REN. 5-18-10. INT. CL. 30.
- GARLOCK SEALING TECHNOLOGIES LLC, PALMYRA,
 NY, GARLOCK INC., NEW YORK, NY:
 1,602,289. REN. 5-18-10. INT. CL. 17.
- GARMIN INTERNATIONAL, INC., OLATHE, KS:
 3,807,526, INT. CL. 9.
- GARRAMONE, CHARLES, SUNRISE, FL:
 3,808,749, INT. CL. 44.
- GARRARD HOLDINGS LIMITED, LONDON W1S 4AS,
 UNITED KINGDOM:
 2,771,200, CANC. MULTIPLE CLASS, INT. CLS. 3, 8, 9, 11,
 13, 18, 20, 21, 25, 28, 33, 34 AND 35.
- GARY TALBERT, ATLANTA, GA, DBA BOY JEWELS:
 3,805,935, PUB. 4-6-2010. INT. CL. 14.
- GARZA, SANDRA, CHICAGO, IL:
 3,808,008, INT. CL. 25.
- GASPARILLA PASS, LLC, TAMPA, FL:
 3,806,926, PUB. 4-6-2010. MULTIPLE CLASS, INT. CLS. 37
 AND 42.
- GASTROSOFT INC., IRVING, TX:
 1,559,636, CANC. INT. CL. 9.
- GATEWAY ELECTRONIC MEDICAL MANAGEMENT SYS-
 TEMS, LLC, INDIANAPOLIS, IN:
 2,771,268, CANC. INT. CL. 9.
- GAUGHAN, MARTINA, BOHEMIA, NY:
 3,807,995, INT. CL. 25.
- GAULME S.A., 75012 PARIS, FRANCE:
 2,770,895, CANC. INT. CL. 28.
- GAZZOTTI SPA, BOLOGNA, ITALY:
 3,806,410, PUB. 4-6-2010. INT. CL. 19.
- GBG, LLP, BLOOMINGTON, MN:
 3,808,122, INT. CL. 43.
 3,808,123, INT. CL. 41.
- GE HEALTHCARE NIAGARA INC., ONTARIO, CANADA:
 2,772,218, CANC. INT. CL. 9.
- GE-NE ASSOCIATES, INC., DALLAS, TX:
 1,560,118, CANC. INT. CL. 35.
- GEDALIAH, ROBERT, NEW YORK, NY, DBA GEDALIAH
 COMMUNICATIONS:
 3,805,498, PUB. 4-6-2010. INT. CL. 41.
- GEEYEE, INC., CHICAGO, IL:
 3,806,341, PUB. 4-6-2010. INT. CL. 42.
- GEFFEN CANCER CENTER AND RESEARCH INSTITUTE,
 VERO BEACH, FL:
 2,285,058, CANC. INT. CL. 42.
- GEIGER, KIMBERLY, SPOKANE, WA:
 3,806,492, PUB. 4-6-2010. INT. CL. 35.
- GENERAL CHEMICAL PERFORMANCE PRODUCTS LLC,
 PARSIPPANY, NJ:
 1,560,100, CANC. INT. CL. 35.
- GENERAL ELECTRIC COMPANY, SCHENECTADY, NY:
 2,771,951, CANC. MULTIPLE CLASS, INT. CLS. 7, 9, 11
 AND 20.
 2,772,003, CANC. INT. CL. 35.
- GENERAL LABOR STAFFING SERVICES INC., MARGATE,
 FL:
 3,805,988, PUB. 4-6-2010. INT. CL. 35.
- GENERAL MILLS IP HOLDINGS II, LLC, MINNEAPOLIS,
 MN:
 3,807,611, INT. CL. 30.
- GENERAL MILLS, INC., MINNEAPOLIS, MN:
 2,771,844, CANC. INT. CL. 30.
 2,772,663, CANC. INT. CL. 8.
 2,772,664, CANC. INT. CL. 8.
- GENERAL MOTORS COMPANY, DETROIT, MI:
 1,559,740, CANC. INT. CL. 12.
- GENERAL MOTORS LLC, DETROIT, MI:
 2,349,822. REN. 5-15-10. INT. CL. 16.
- GENERAL WELDING & FABRICATING, INC., ELMA, NY:
 2,350,472. REN. 5-18-10. INT. CL. 12.
- GENERATION POWER, LLC, LOS ANGELES, CA:
 3,805,808, PUB. 4-6-2010. MULTIPLE CLASS, INT. CLS. 35
 AND 41.

- GENESEEEK, INC., LINCOLN, NE:
3,805,948, PUB. 4-6-2010. INT. CL. 42.
3,805,949, PUB. 4-6-2010. INT. CL. 42.
- GENESIS INTERNATIONAL LLC, SEATTLE, WA:
2,770,785, CANC. INT. CL. 36.
- GENKI SUSHI CO., LTD., TOCHIGI 320, JAPAN:
2,284,481, CANC. MULTIPLE CLASS, INT. CLS. 30 AND 42.
- GENOME BIOSCIENCES, INC., TEMECULA, CA:
2,771,498, CANC. INT. CL. 42.
- GENTEX CORPORATION, CARBONDALE, PA, GENTEX CORPORATION, CARBONDALE, PA:
1,138,809, REN. 5-20-10. INT. CL. 24.
- GENTING INTERNATIONAL MANAGEMENT LIMITED, DOUGLAS, ISLE OF MAN:
3,805,492, PUB. 4-6-2010. INT. CL. 41.
- GENUITY FINANCIAL GROUP, TORONTO, CANADA:
3,807,077, PUB. 4-6-2010. INT. CL. 36.
- GENWORTH LIFE INSURANCE COMPANY, RICHMOND, VA:
2,356,718, REN. 5-17-10. INT. CL. 36.
- GENZYME CORPORATION, CAMBRIDGE, MA:
3,808,664, INT. CL. 42.
- GEO STUDIO TECHNOLOGY, BELO HORIZONTE, BRAZIL:
3,808,391, MULTIPLE CLASS, INT. CLS. 9 AND 42.
3,808,392, MULTIPLE CLASS, INT. CLS. 9 AND 42.
- GEO. L. SMITH II GEORGIA WORLD CONGRESS CENTER AUTHORITY, ATLANTA, GA:
2,771,366, CANC. INT. CL. 41.
- GEO. T. SCHMIDT, INC., NILES, IL:
2,397,214, REN. 5-20-10. INT. CL. 7.
- GEOBRA BRANDSTATTER GMBH & CO KG, D-90513 ZIRNDORF, FED REP GERMANY:
2,286,055, CANC. INT. CL. 28.
- GEODESIC LIMITED., MUMBAI, INDIA:
3,805,578, PUB. 4-6-2010. MULTIPLE CLASS, INT. CLS. 9 AND 38.
3,805,579, PUB. 4-6-2010. MULTIPLE CLASS, INT. CLS. 9 AND 38.
3,805,580, PUB. 4-6-2010. MULTIPLE CLASS, INT. CLS. 9 AND 38.
3,805,581, PUB. 4-6-2010. MULTIPLE CLASS, INT. CLS. 9 AND 38.
3,805,582, PUB. 4-6-2010. MULTIPLE CLASS, INT. CLS. 9 AND 38.
- GEOPIER FOUNDATION COMPANY, INC., MOORESVILLE, NC:
3,806,888, PUB. 4-6-2010. MULTIPLE CLASS, INT. CLS. 37 AND 42.
- GEORGE M. RAJACICH, M.D., INC., VAN NUYS, CA:
3,808,560, INT. CL. 36.
- GEORGE, GEORGE, YONKERS, NY:
2,772,145, CANC. INT. CL. 25.
- GEORGES, MARTIN, BOLTON, CT AND GEORGES, ELEANOR, BOLTON, CT:
3,806,374, PUB. 4-6-2010. INT. CL. 41.
- GERBER GROUP LP, NEW YORK, NY, FORMERLY AFTER MIDNIGHT MANAGEMENT COMPANY LP:
3,806,045, PUB. 4-6-2010. INT. CL. 43.
- GERDAU AMERISTEEL US INC., TAMPA, FL:
2,772,319, CANC. INT. CL. 6.
- GERHARD D. WEMPE KG, HAMBURG, FED REP GERMANY:
3,335,750, AM. INT. CL. 14.
- GERM FREE REMOTES, LLC, AUSTIN, TX:
3,806,664, PUB. 4-6-2010. INT. CL. 9.
- GEROLSTEINER BRUNNEN GMBH & CO. KG, FED REP GERMANY:
3,807,290, PUB. 4-6-2010. INT. CL. 32.
- GESCHMAY WET FELTS, INC., WILMINGTON, DE:
1,559,547, CANC. INT. CL. 7.
- GESTIONI PICCINI S.R.L., CASTELLINA IN CHIANTI (SI), ITALY:
2,771,057, CANC. INT. CL. 33.
- GETLOOSE, LLC, NEW YORK, NY:
3,807,477, INT. CL. 25.
- GF HEALTH PRODUCTS, INC., ATLANTA, GA:
3,806,403, PUB. 4-6-2010. INT. CL. 10.
- GFC BRANDS, INC., WILMINGTON, DE:
2,655,719, AM. INT. CL. 35.
- GFM AKTIENGESELLSCHAFT, A-4403 STEYR, AUSTRIA:
1,559,568, CANC. INT. CL. 7.
- GHAM LIMITED, GIBRALTAR:
3,807,111, PUB. 4-6-2010. MULTIPLE CLASS, INT. CLS. 14, 18 AND 25.
- GHCH LLC, HONOLULU, HI, DBA HULA PLEASURES:
3,808,433, INT. CL. 3.
- GHIADA CORPORATION, MACON, GA:
3,806,466, PUB. 4-6-2010. INT. CL. 25.
- GHOST BRAND LIMITED, LONDON, UNITED KINGDOM:
1,559,884, CANC. INT. CL. 25.
- GHP GROUP, INC., SKOKIE, IL:
1,559,704, CANC. INT. CL. 11.
- GIACALONE, PAUL, MASSAPEQUA, NY:
3,806,420, PUB. 4-6-2010. INT. CL. 41.
- GIANT BRANDS, INC., WILMINGTON, DE:
2,771,847, CANC. INT. CL. 35.
2,771,848, CANC. INT. CL. 35.
- GIANT GOLF COMPANY, IRVINE, CA:
2,771,794, CANC. INT. CL. 28.
- GIANT HAT CORPORATION, TYLER, TX:
3,805,858, PUB. 4-6-2010. INT. CL. 43.
3,805,859, PUB. 4-6-2010. INT. CL. 43.
- GIBSON GUITAR CORP., NASHVILLE, TN:
3,807,374, INT. CL. 9.
- GIBSON, JOAN HENRIETTA, SOUTH WOODHAM FERRERS, UNITED KINGDOM:
3,805,230, PUB. 4-6-2010. MULTIPLE CLASS, INT. CLS. 3, 9, 14, 16, 18, 25, 28, 35 AND 41.
- GIDION'S LLC, KENT, CT:
2,771,997, CANC. MULTIPLE CLASS, INT. CLS. 3 AND 4.
- GIGGLES COMEDY CLUBS, INC., PORT RICHEY, FL:
2,771,160, CANC. INT. CL. 41.
- GILMOUR, INC., NEWARK, DE:
1,559,577, CANC. INT. CL. 8.
- GIMBAL BROTHERS, INC., SOUTH SAN FRANCISCO, CA:
3,806,083, PUB. 4-6-2010. INT. CL. 30.
- GIMME THAT SOUND RECORDS, LLC, STONE RIDGE, NY:
3,805,633, PUB. 4-6-2010. INT. CL. 9.
- GINA WISSMILLER, PORTLAND, OR:
3,805,922, PUB. 4-6-2010. INT. CL. 25.
3,805,923, PUB. 4-6-2010. INT. CL. 25.
- GIORGIO ARMANI S.P.A., MILAN, SWISS BRANCH MENDRISIO, MENDRISIO, SWITZERLAND:
2,781,150, CANC. MULTIPLE CLASS, INT. CLS. 3, 9, 18, 24 AND 35.
3,807,785, INT. CL. 3.
- GISH BIOMEDICAL, INC., RANCHO SANTA MARGARITA, CA:
3,805,327, PUB. 4-6-2010. INT. CL. 10.
- GITHUB, LLC, SAN FRANCISCO, CA, DBA GITHUB.COM:
3,805,847, PUB. 4-6-2010. INT. CL. 42.
3,805,848, PUB. 4-6-2010. INT. CL. 42.
- GLAM CANDY, INC., JACKSONVILLE, FL:
3,806,603, PUB. 4-6-2010. INT. CL. 35.
- GLANCE NETWORKS, INC., ARLINGTON, MA:
3,806,952, PUB. 4-6-2010. INT. CL. 9.
- GLAXOSMITHKLINE BIOLOGICALS, S.A., RIXENSART, BELGIUM:
3,805,434, PUB. 4-6-2010. INT. CL. 5.
- GLC ADVISORS & CO., LLC, SAN FRANCISCO, CA:
3,808,295, INT. CL. 36.
3,808,296, INT. CL. 36.
- GLEMSEER TECHNOLOGIES CORPORATION, BETHLEHEM, PA:
3,805,493, PUB. 4-6-2010. MULTIPLE CLASS, INT. CLS. 9, 41 AND 42.
- GLENHAVEN HEALTH CARE ORGANIZATION, GLEN COVE, NY:
2,284,793, CANC. INT. CL. 42.
- GLENN, BEN, J. CARMEL, IN, DBA CHALKGUY MEDIA INTERNATIONAL, INC:
3,805,530, PUB. 4-6-2010. INT. CL. 41.

GLOBAL BRAND HOLDINGS, LLC, NEW YORK, NY:
2,436,377. REN. 5-20-10. INT. CL. 25.

GLOBAL FASHIONS INC., NEW YORK, NY:
3,805,616. PUB. 4-6-2010. INT. CL. 25.

GLOBAL GAMING GROUP INC., LAS VEGAS, NV:
3,808,605. INT. CL. 9.

GLOBAL MED TECHNOLOGIES, INC., LAKEWOOD, CO,
DBA WYNDGATE TECHNOLOGIES:
3,807,450. MULTIPLE CLASS, INT. CLS. 9 AND 42.

GLOBAL ORTHOPAEDIC TECHNOLOGY PTY LTD,
BAULKHAM HILLS NSW 2153, AUSTRALIA:
3,807,236. PUB. 4-6-2010. INT. CL. 10.
3,807,239. PUB. 4-6-2010. INT. CL. 9.

GLOBAL STRATEGIES FOR HIV PREVENTION, SAN
RAFAEL, CA:
3,806,954. PUB. 4-6-2010. MULTIPLE CLASS, INT. CLS.
35, 36 AND 41.

GLOBAL WIRELESS SOLUTIONS, INC., DULLES, VA:
3,808,206. INT. CL. 9.

GLOBAL 1 ENTERPRISES, INC., HOUSTON, TX:
3,807,592. INT. CL. 36.

GLOBE WHITE PAGE LIMITED, LONDON, UNITED KING-
DOM:
3,805,480. PUB. 4-6-2010. MULTIPLE CLASS, INT. CLS.
16, 35 AND 41.

GLORY CREATION PTE LTD, SINGAPORE CITY, SINGA-
PORE:
3,807,975. INT. CL. 26.

GLV FINANCE HUNGARY KFT., MUNSBACH, LUXEM-
BOURG:
3,806,376. PUB. 4-6-2010. MULTIPLE CLASS, INT. CLS. 7
AND 11.

GLYNN, JOSEPH M, SANTA CLARA, CA, DBA JOSEPH M
GLYNN:
3,808,399. INT. CL. 9.

GML COATINGS, LLC, SARASOTA, FL:
3,808,104. MULTIPLE CLASS, INT. CLS. 2 AND 37.

GN NETCOM, INC., NASHUA, NH:
2,367,905. REN. 5-15-10. INT. CL. 9.

GN OTOMETRICS A/S, DENMARK:
3,807,134. PUB. 4-6-2010. MULTIPLE CLASS, INT. CLS. 9
AND 10.

GOD'S PIT CREW, INC., DANVILLE, VA:
3,806,390. PUB. 4-6-2010. INT. CL. 35.

GODEVENT AB, SWEDEN:
3,807,309. PUB. 4-6-2010. INT. CL. 35.

GOLD PEAK INDUSTRIES (HOLDINGS) LIMITED, KWAI
CHUNG, NEW TERRITORIES, HONG KONG:
2,771,911. CANC. INT. CL. 16.

GOLD RUSH CURE FOUNDATION INC., LAGUNA NI-
GUEL, CA:
3,806,048. PUB. 4-6-2010. INT. CL. 36.

GOLD STANDARD ENTERPRISES, INC., SKOKIE, IL:
2,350,261. REN. 5-17-10. MULTIPLE CLASS, INT. CLS. 32,
33 AND 34.

GOLD VILLAGE ENTERTAINMENT INC., LOS ANGELES,
CA:
3,808,617. INT. CL. 35.

GOLDDIGGA BRANDS LIMITED, SHIREBROOK, MANS-
FIELD, UNITED KINGDOM:
3,807,080. PUB. 4-6-2010. MULTIPLE CLASS, INT. CLS. 3
AND 14.

GOLDEN DELTA ENTERPRISES, INC., FULLERTON, CA,
DBA PLEASER USA, INC.:
3,807,972. INT. CL. 25.

GOLDEN PEANUT COMPANY, ALPHARETTA, GA:
1,641,756. REN. 5-20-10. INT. CL. 31.

GOLDEN SHORE INVESTMENT, LAS VEGAS, NV, DBA
MR. FUZZY:
3,806,745. PUB. 4-6-2010. INT. CL. 28.

GOLDEN SOL, INC., CONYERS, GA:
3,806,504. PUB. 4-6-2010. INT. CL. 44.
3,806,505. PUB. 4-6-2010. INT. CL. 44.

GOLDENWEST LUBRICANTS, INC., POMONA, CA:
2,358,448. REN. 5-19-10. MULTIPLE CLASS, INT. CLS. 3
AND 16.

GOLDFINE, MARK C., CARMEL, NY:
2,772,666. CANC. INT. CL. 9.

GOLDMAN, SACHS & CO., NEW YORK, NY:
3,805,537. PUB. 4-6-2010. INT. CL. 41.
3,805,584. PUB. 4-6-2010. INT. CL. 41.

GOLFLOGIX, INC., SCOTTSDALE, AZ:
2,771,290. CANC. INT. CL. 41.

GOMEZ, ROBERT LOUIS, GARNER, NC:
3,808,421. MULTIPLE CLASS, INT. CLS. 35 AND 36.

GONZALEZ, JOSE, VERNON, CA, TADIN HERB & TEA CO.,
LOS ANGELES, CA:
1,623,867. REN. 5-17-10. INT. CL. 30.

GOOD DEAL MAGAZINE, ANCHORAGE, AK:
3,806,277. PUB. 4-6-2010. INT. CL. 16.

GOOD FAITH, INC., MILL CREEK, WA, DBA GOOD FAITH
MORTGAGE:
2,772,291. CANC. INT. CL. 36.

GOOD PEOPLE CO., LTD., SEOUL, REPUBLIC OF KOREA:
3,807,493. INT. CL. 25.

GOODMAIL SYSTEMS, INC., MOUNTAIN VIEW, CA:
3,807,440. INT. CL. 45.

GORDON, RICHARD S., MONTGOMERY VILLAGE, MD:
2,408,613. REN. 5-17-10. INT. CL. 41.

GORE, DAVID, LOUISVILLE, KY:
3,807,384. INT. CL. 8.

GOSS INTERNATIONAL CORPORATION, BOLINGBROOK,
IL, ROCKWELL INTERNATIONAL CORPORATION,
PITTSBURGH, PA:
1,135,512. REN. 5-20-10. INT. CL. 7.

GOSS INTERNATIONAL CORPORATION, BOLINGBROOK,
IL:
2,285,914. CANC. MULTIPLE CLASS, INT. CLS. 7 AND 9.

GOTTUNEZ.COM, LLC, ANTIOCH, CA:
3,806,497. PUB. 4-6-2010. INT. CL. 35.

GOVERNMENT OF THE NORTHWEST TERRITORIES,
YELLOWKNIFE, CANADA:
3,761,342. COR. MULTIPLE CLASS, INT. CLS. 9, 14, 16
AND 35.

GOYA FOODS, INC., SECAUCUS, NJ:
3,808,543. MULTIPLE CLASS, INT. CLS. 35 AND 41.

GP INDUSTRIES, LLC, OMAHA, NE:
3,807,021. PUB. 4-6-2010. INT. CL. 6.
3,807,046. PUB. 4-6-2010. INT. CL. 6.

GRACE ADVISORY M&A/CORPORATE FINANCE GMBH,
MÜNCHEN, FED REP GERMANY:
3,805,899. PUB. 4-6-2010. MULTIPLE CLASS, INT. CLS. 35
AND 36.

GRACE I CAPILITAN AND RICHARD ZINNE, SAN DIEGO,
CA:
2,771,638. CANC. INT. CL. 35.

GRACELAND FRUIT, INC., FRANKFORT, MI:
2,409,695. REN. 5-14-10. INT. CL. 29.

GRACIE'S RESTAURANT, INC., STOWE, VT:
2,284,413. CANC. MULTIPLE CLASS, INT. CLS. 21, 25
AND 42.

GRACO MINNESOTA INC., MINNEAPOLIS, MN:
3,806,516. PUB. 4-6-2010. INT. CL. 39.

GRAFF DIAMONDS LIMITED, UNITED KINGDOM:
3,807,279. PUB. 4-6-2010. INT. CL. 14.
3,807,280. PUB. 4-6-2010. INT. CL. 14.

GRAFICO, INC., SANTA FE SPRINGS, CA:
2,284,575. CANC. INT. CL. 40.

GRAHAM, ARAN S. NMB, FL, DBA FOTOBOT:
3,806,655. PUB. 4-6-2010. INT. CL. 41.

GRAND, DAVID, MASSAPEQUA PARK, NY:
2,284,768. CANC. INT. CL. 9.

GRANDE CHEESE COMPANY, BROWNSVILLE, WI:
2,424,543. REN. 5-19-10. INT. CL. 29.

GRANDMA GEBHARD COMPANY, THE, EDINA, MN:
1,599,028. REN. 5-20-10. INT. CL. 42.

GRANGE MUTUAL CASUALTY COMPANY, COLUMBUS,
OH:
3,723,459. COR. INT. CL. 36.
3,723,460. COR. INT. CL. 36.

GRANT, GEORGE, POCATELLO, ID:
2,284,449. CANC. INT. CL. 41.

GRASAR PTY LTD, AUSTRALIA:
3,807,229. PUB. 4-6-2010. MULTIPLE CLASS, INT. CLS. 7,
37, 40, 41 AND 42.

- GRAVENSTEIN UNIFIED SCHOOL DISTRICT, SEBASTOPOL, CA, DBA GUSD:
3,805,319, PUB. 4-6-2010. INT. CL. 41.
- GRAY MOUNTAIN TOOL COMPANY, CLARKSTON, WA:
1,559,575, CANC. INT. CL. 8.
- GRAYPEL, ERNEST A., ST. LOUIS, MO:
3,807,469, INT. CL. 5.
- GREASE GRIP GLOVES USA, LLC, POWHATAN, VA:
3,806,788, PUB. 4-6-2010. INT. CL. 9.
3,806,836, PUB. 4-6-2010. INT. CL. 9.
3,806,911, PUB. 4-6-2010. INT. CL. 30.
3,806,912, PUB. 4-6-2010. INT. CL. 30.
- GREAT AMERICAN DUCK RACES, INC., SCOTTSDALE, AZ, DBA "GAME: GREAT AMERICAN MERCHANDISE AND EVENTS":
2,772,632, CANC. INT. CL. 36.
- GREAT AMERICANS HOLDINGS, INC., VIENNA, VA:
3,807,802, INT. CL. 42.
- GREAT COMPUTER CORP., HSI CHIH CITY, TAIPEI HSIEN, TAIWAN:
2,771,429, CANC. INT. CL. 9.
- GREAT LAKES SERVICES, LLC, MADISON, WI:
3,806,214, PUB. 4-6-2010. INT. CL. 41.
- GREAT LENGTHS HAARVERTRIEBS GMBH, AUSTRIA:
3,807,271, PUB. 4-6-2010. MULTIPLE CLASS, INT. CLS. 3, 8, 10, 21, 26, 41 AND 44.
- GREAT MOOSE LAKE CORPORATION, SCARBOROUGH, ME:
2,284,784, CANC. INT. CL. 35.
- GREAT NECK ARTS CENTER, GREAT NECK, NY:
3,808,731, INT. CL. 41.
- GREAT NORTHERN CONSULTING SERVICES, INC., COLUMBUS, OH:
2,382,593, REN. 5-18-10. INT. CL. 35.
2,382,594, REN. 5-18-10. INT. CL. 35.
2,382,606, REN. 5-18-10. INT. CL. 35.
- GREAT STUFF, INC., AUSTIN, TX:
3,808,573, MULTIPLE CLASS, INT. CLS. 7 AND 9.
- GREAT-WEST LIFE & ANNUITY INSURANCE COMPANY, GREENWOOD VILLAGE, CO:
3,805,997, PUB. 4-6-2010. INT. CL. 36.
3,806,225, PUB. 4-6-2010. INT. CL. 36.
- GREATBATCH INC., CLARENCE, NY:
3,261,870, CANC. MULTIPLE CLASS, INT. CLS. 10, 35, 40 AND 42.
- GREATER PHOENIX CONVENTION & VISITORS BUREAU, PHOENIX, AZ:
2,285,335, CANC. INT. CL. 35.
- GREEN AMERICA, WASHINGTON, DC:
3,808,646, MULTIPLE CLASS, INT. CLS. 9, 35 AND 41.
- GREEN CIRCLE GROWERS, INC., OBERLIN, OH:
3,808,215, INT. CL. 31.
- GREEN ENTERPRISES, LLC, COLD SPRINGS, NV:
3,805,862, PUB. 4-6-2010. INT. CL. 35.
- GREEN NURTURE, LLC, TEMPE, AZ:
3,806,227, PUB. 4-6-2010. INT. CL. 35.
- GREENBALL CORPORATION, ANAHEIM, CA:
2,770,829, CANC. INT. CL. 12.
- GREENFIELD WORLD TRADE, INC., FT. LAUDERDALE, FL:
3,806,127, PUB. 4-6-2010. INT. CL. 11.
- GREENTREE LENDING, INC., IRVINE, CA:
3,097,246, CANC. INT. CL. 36.
- GREENWICH CARTOONS, GREENWICH, CT:
3,806,865, PUB. 4-6-2010. INT. CL. 16.
- GREENWOOD, GREG T., WEST CHESTER, OH:
3,808,638, INT. CL. 36.
- GREINER BIO-ONE GMBH, AUSTRIA:
3,807,212, PUB. 4-6-2010. MULTIPLE CLASS, INT. CLS. 1 AND 5.
- GRETAGMACBETH HOLDING AG, CH-8150 REGENSDORF, SWITZERLAND:
2,286,065, CANC. INT. CL. 16.
2,286,069, CANC. MULTIPLE CLASS, INT. CLS. 9 AND 11.
- GREULACH, JEANA, SANTA MONICA, CA, DBA J CLAY POTTERY:
3,806,467, PUB. 4-6-2010. INT. CL. 21.
- GREYHAWK NORTH AMERICA, L.L.C., WOODBURY, NY:
2,372,304, REN. 5-20-10. INT. CL. 42.
- GRIFFDOG RECORDS, INC., HUNTINGTON BEACH, CA:
3,808,045, MULTIPLE CLASS, INT. CLS. 9 AND 41.
- GRIFFIN PROTECTION GROUP, INC., O'FALLON, MO:
3,807,692, INT. CL. 45.
- GRIFFITH, STEVEN, LOS ANGELES, CA:
2,771,611, CANC. INT. CL. 41.
- GRIFFITHS FAMILY FINANCIAL LTD, FOREST CITY, PA, DBA ENDLESS MOUNTAINS COFFEE COMPANY:
3,805,683, PUB. 4-6-2010. INT. CL. 30.
- GRIFFITHS, MARTYN HAVARD, SUNNYVALE, CA:
3,805,909, PUB. 4-6-2010. INT. CL. 9.
- GRIFFMARK, INC., NEW YORK, NY:
2,285,732, CANC. INT. CL. 41.
- GRIJALVA, ROBERT, BAKERSFIELD, CA:
3,807,605, INT. CL. 25.
- GRIZELLA CORPORATION, HEBRON, ND:
3,805,656, PUB. 4-6-2010. INT. CL. 35.
3,805,657, PUB. 4-6-2010. INT. CL. 35.
- GROUPE DYNAMITE INC., MONT-ROYAL, QUEBEC, CANADA:
3,805,182, PUB. 9-11-2007. MULTIPLE CLASS, INT. CLS. 25 AND 35.
- GROUSE INDUSTRIES, INC., CONCORD, NC:
3,806,915, PUB. 4-6-2010. INT. CL. 35.
- GROWNUP KIDSTUFF, INC., CHICAGO, IL:
3,806,698, PUB. 4-6-2010. INT. CL. 30.
- GRUPO BIMBO, S.A. B. DE C.V., MEXICO CITY, MEXICO:
3,806,174, PUB. 4-6-2010. INT. CL. 30.
- GRUPO BOOCHI, S.A., GUATEMALA CITY, GUATEMALA:
3,806,262, PUB. 4-6-2010. INT. CL. 25.
- GRUPO OSBORNE S.A., CADIZ, SPAIN:
3,806,196, PUB. 4-6-2010. INT. CL. 33.
- GRUPO RADIO CENTRO, S.A. B DE C.V., MEXICO, D.F., MEXICO:
3,805,802, PUB. 4-6-2010. INT. CL. 38.
- GRUPPO ALMA S.P.A., BAREGGIO (MILAN), ITALY:
1,133,675, CANC. INT. CL. 18.
- GRUPPO ALMA S.P.A., BAREGGIO (MILANO), ITALY:
1,394,987, CANC. INT. CL. 25.
- GRUPPO LA PIADINERIA S.R.L., ITALY:
3,807,237, PUB. 4-6-2010. MULTIPLE CLASS, INT. CLS. 29, 30, 35, 42 AND 43.
- GRYNKIV, ANTON, BROOKLYN, NY:
3,808,775, INT. CL. 35.
- GSD MANUFACTURING, LLC, MOYOCK, NC:
2,771,241, CANC. INT. CL. 28.
- GSF SYSTEMS, LLC, KATY, TX:
3,806,933, PUB. 4-6-2010. INT. CL. 41.
- GSI GROUP CORPORATION, BILLERICA, MA:
2,772,375, CANC. INT. CL. 9.
- GUAJOME PARK ACADEMY, VISTA, CA:
2,771,753, CANC. INT. CL. 41.
- GUARD ENTERPRISES, INC., FAYETTEVILLE, AR:
1,559,492, CANC. INT. CL. 3.
- GUARDIAN CORPORATION, ALBUQUERQUE, NM:
1,559,609, CANC. INT. CL. 9.
- GUDNI GUNNARSSON, ENCINO, CA:
3,807,656, INT. CL. 41.
- GUELF, AIDO, ALBUQUERQUE, NM:
3,807,993, INT. CL. 30.
- GUERBET, 93420 VILLEPINTE, FRANCE:
2,770,911, CANC. INT. CL. 5.
- GUERLAIN S.A., 75008 PARIS, FRANCE:
2,379,207, REN. 5-19-10. INT. CL. 3.
- GUERNSEY, JOAN, FEEDING HILLS, MA:
2,772,227, CANC. INT. CL. 35.
- GUERRERO, DIEGO LEIVA, LEON, GTO., C.P. 37200, MEXICO:
2,771,451, CANC. INT. CL. 30.
2,771,452, CANC. INT. CL. 1.
2,771,453, CANC. INT. CL. 1.
2,771,454, CANC. INT. CL. 30.
- GUIDE DOGS OF THE DESERT, PALM SPRINGS, CA:
3,807,901, MULTIPLE CLASS, INT. CLS. 25, 35 AND 41.
- GUIDEPOSTS A CHURCH CORPORATION, CARMEL, NY:
3,805,652, PUB. 4-6-2010. INT. CL. 41.

GUIDEWIRE SOFTWARE, INC., SAN MATEO, CA:
3,808,035, INT. CL. 9.

GUILBERT, RICHARD T., HILTON HEAD ISLAND, SC:
2,385,974, REN. 5-20-10. INT. CL. 16.

GULF OIL LIMITED PARTNERSHIP, NEWTON, MA:
2,284,495, CANC. INT. CL. 35.

GULF STATES HEALTH SERVICES, INC., BATON ROUGE,
LA:
3,807,061, PUB. 3-21-2006. INT. CL. 44.

GULFSTREAM AEROSPACE CORPORATION, SAVAN-
NAH, GA:
3,808,383, INT. CL. 12.

GULLIVER'S TRAVEL SERVICE, INC., FORT WORTH, TX:
2,351,778, REN. 5-14-10. INT. CL. 39.

GUMP'S CORP., SAN FRANCISCO, CA:
3,808,534, INT. CL. 3.

GUNBY, WILLIAM W., PALM CITY, FL:
2,771,917, CANC. INT. CL. 9.

GUPTA, LAXMI, LOS ALAMITOS, CA:
3,806,667, PUB. 4-6-2010. INT. CL. 2.

GURWITCH PRODUCTS, L.L.C., STAFFORD, TX, DBA
GURWITCH PRODUCTS, L.L.C.:
2,350,939, REN. 5-17-10. MULTIPLE CLASS, INT. CLS. 16
AND 42.

GUSTO MARKETING SERVICES, LLC, DAVIE, FL:
2,772,741, CANC. INT. CL. 9.

GUTIERREZ, JOSE A., SAN JOSE, CA, DBA TIEMPOS
FINALES TELEVISION:
3,806,276, PUB. 4-6-2010. INT. CL. 41.

GUTTENTAG, JACK, VALLEY FORGE, PA:
3,805,679, PUB. 4-6-2010. MULTIPLE CLASS, INT. CLS. 16
AND 41.

GUY GAUTHIER, ST-NICOLAS, CANADA:
3,808,037, INT. CL. 37.

GWEI TING INTERNATIONAL FASHION CORPORATION,
TAIPEI, TAIWAN:
3,548,168, CANC. INT. CL. 35.
3,548,168, AM. INT. CL. 18.

GYNZY 500 BV, EINDHOVEN, NETHERLANDS:
3,806,167, PUB. 4-6-2010. MULTIPLE CLASS, INT. CLS. 38
AND 41.

GYPSY IDEATION LLC, CHASKA, MN:
3,807,835, INT. CL. 25.

GYRUS ENT L.L.C., INC., BARTLETT, TN:
2,285,512, CANC. INT. CL. 10.

H. MUEHLSTEIN & CO., INC., NORWALK, CT:
3,807,979, MULTIPLE CLASS, INT. CLS. 1 AND 35.

H.C. BRILL COMPANY, INC., TUCKER, GA:
890,990, REN. 5-18-10. U.S. CL. 46 (INT. CL. 30).

H&L WHOLESALE FOOD CORPORATION, ALHAMBRA,
CA, DBA BL TRADING:
3,806,783, PUB. 4-6-2010. INT. CL. 30.

HAAG, JESSE C, TROY, MT:
3,808,310, INT. CL. 41.

HAAS OUTDOORS, INC., WEST POINT, MS:
2,336,499, REN. 5-14-10. MULTIPLE CLASS, INT. CLS. 24
AND 25.

HABAND COMPANY, INC., OAKLAND, NJ:
3,808,389, INT. CL. 25.

HABITAT FOR HUMANITY INTERNATIONAL, INC.,
AMERICUS, GA:
3,806,920, PUB. 4-6-2010. INT. CL. 36.
3,806,922, PUB. 4-6-2010. INT. CL. 37.

HABITAT OF HUMANITY INTERNATIONAL, INC., AMER-
ICUS, GA:
3,806,919, PUB. 4-6-2010. INT. CL. 35.

HADALA, ANTHONY J., SAGAMORE HILLS, OH:
2,772,602, CANC. INT. CL. 9.

HAEMONETICS CORPORATION, BRAINTREE, MA:
3,806,940, PUB. 4-6-2010. INT. CL. 35.

HAGAN, ROBERT R., ST. LOUIS, MO:
3,807,846, INT. CL. 44.

HAGGAR APPAREL COMPANY, DALLAS, TX:
1,559,917, CANC. INT. CL. 25.

HAHNEMUHLE USA, INC., WOODSTOCK, IL:
2,287,618, REN. 5-18-10. INT. CL. 16.

HAINAN LITREE; PURIFYING TECHNOLOGY CO., LTD.,
CHINA:
3,807,189, PUB. 4-6-2010. INT. CL. 11.

HALCYON BUSINESS PUBLICATIONS, INC., WESTBURY,
NY:
2,771,499, CANC. INT. CL. 36.
2,771,500, CANC. INT. CL. 36.
2,771,501, CANC. INT. CL. 36.
2,771,502, CANC. INT. CL. 36.

HALL, JAY, ANNAPOLIS, MD:
3,807,690, MULTIPLE CLASS, INT. CLS. 9 AND 42.

HALLIBURTON ENERGY SERVICES, INC., CARROLL-
TON, TX, BAROID TECHNOLOGY, INC., HOUSTON, TX:
1,644,153, REN. 5-20-10. INT. CL. 1.

HALLIBURTON ENERGY SERVICES, INC., CARROLL-
TON, TX:
3,807,507, INT. CL. 41.

HALLMARK LICENSING, INC., KANSAS CITY, MO:
3,808,509, INT. CL. 28.

HALLUM, INC., FLAGSTAFF, AZ, DBA HALLUM STORES:
3,805,901, PUB. 4-6-2010. INT. CL. 35.

HALOGEN SOFTWARE INC., OTTAWA ONTARIO, CANA-
DA:
3,808,352, MULTIPLE CLASS, INT. CLS. 9, 35 AND 42.

HAMBRECHT WINE GROUP, L.P., HEALDSBURG, CA:
3,806,904, PUB. 4-6-2010. INT. CL. 33.

HAN GROUP LLC, MCLEAN, VA:
3,807,704, INT. CL. 35.

HAN, LY M., IRVINE, CA:
2,284,950, CANC. MULTIPLE CLASS, INT. CLS. 16 AND
35.

HANKOOK LATEX GONGUP CO., LTD, CHUNCHON-
CITY, KANGWON-DO, REPUBLIC OF KOREA:
2,404,341, REN. 5-17-10. INT. CL. 10.

HANKOOK LATEX GONGUP CO., LTD., YORBA LINDA,
CA:
2,414,030, REN. 5-17-10. INT. CL. 10.

HANMI, INC., VERNON, CA:
2,771,473, CANC. INT. CL. 29.

HANNAH GAMES, LLC, ST. LOUIS, MO:
3,806,502, PUB. 4-6-2010. INT. CL. 41.

HANSCAN IP B.V., AMSTERDAM, NETHERLANDS:
3,805,667, PUB. 4-6-2010. INT. CL. 9.
3,805,670, PUB. 4-6-2010. INT. CL. 42.

HANSEN, ANOTHAI, BROOKLYN, NY:
2,771,614, CANC. MULTIPLE CLASS, INT. CLS. 14, 18
AND 25.

HANSEN, DALE, PORTLAND, OR:
2,772,211, CANC. INT. CL. 3.

HANSEN, SUMMER LOVE, LONG BEACH, CA:
2,349,000, REN. 5-17-10. INT. CL. 41.

HANS GROHE, INC., ALPHARETTA, GA:
2,772,419, CANC. INT. CL. 11.
2,772,472, CANC. INT. CL. 11.

HANSO CORPORATION, BETHESDA, MD:
3,807,657, INT. CL. 35.

HARBOR CAPITAL GROUP, HOUSTON, TX:
3,807,076, PUB. 4-6-2010. INT. CL. 36.

HARMON JR., E. CLAUDE, HENDERSON, NV:
2,397,470, REN. 5-20-10. MULTIPLE CLASS, INT. CLS. 25
AND 41.

HARMONIC INC., SUNNYVALE, CA:
3,808,179, INT. CL. 9.

HARMONICS INTERNATIONAL, LLC, RENO, NV:
2,284,881, CANC. INT. CL. 5.

HARPERCOLLINS PUBLISHERS LTD., GLASGOW, UNI-
TED KINGDOM:
2,294,109, REN. 5-20-10. INT. CL. 16.

HARPO, INC., CHICAGO, IL:
3,805,726, PUB. 4-6-2010. INT. CL. 41.

HARRAH'S LICENSE COMPANY, LLC, LAS VEGAS, NV:
2,432,163, REN. 5-18-10. MULTIPLE CLASS, INT. CLS. 41
AND 42.
2,771,335, CANC. INT. CL. 41.

HARRELL, BOYD L., BELLAIRE, TX:
2,772,541, CANC. INT. CL. 25.

- HARRELL'S EQUIPMENT & SUPPLY CO., INC., INDIANAPOLIS, IN:
3,807,754, INT. CL. 37.
- HARRIS CONSULTING, INC., LAKE OSWEGO, OR, DBA VANTAGE MORTGAGE GROUP, INC.:
3,805,790, PUB. 11-10-2009. INT. CL. 36.
- HARRIS CORPORATION, MELBOURNE, FL:
3,807,687, INT. CL. 9.
- HARRIS STRATEX NETWORKS (NZ) LIMITED, WELLINGTON, NEW ZEALAND:
2,285,888, CANC. INT. CL. 9.
- HARRIS WILLIAMS LLC, RICHMOND, VA, DBA HARRIS WILLIAMS & CO.:
3,806,029, PUB. 4-6-2010. INT. CL. 36.
- HARRIS, JAMES H, HIGHLANDS RANCH, CO:
3,806,423, PUB. 4-6-2010. INT. CL. 9.
- HARRISON, BOB, TULSA, OK:
3,806,394, PUB. 4-6-2010. MULTIPLE CLASS, INT. CLS. 9 AND 41.
- HARRISON, REX H., ALLEN, TX:
2,772,261, CANC. INT. CL. 42.
- HARTLEY, ANN, Alys BEACH, FL:
3,805,925, PUB. 4-6-2010. MULTIPLE CLASS, INT. CLS. 35 AND 43.
- HARVATEK CORPORATION, HSINCHU, TAIWAN:
2,771,747, CANC. INT. CL. 9.
- HARVE BENARD, LTD., NEW YORK, NY:
2,286,442, CANC. INT. CL. 25.
2,286,473, CANC. INT. CL. 25.
- HARWIL CORPORATION, OXNARD, CA:
2,422,569, REN. 5-17-10. INT. CL. 9.
- HASBRO, INC., PAWTUCKET, RI:
2,772,488, CANC. INT. CL. 28.
- HAUCK, BARBARA, CORONA, CA:
3,808,640, MULTIPLE CLASS, INT. CLS. 16 AND 25.
- HAYERLY SYSTEMS, INC., DENVER, NJ:
2,349,707, REN. 5-14-10. INT. CL. 9.
- HAWAII ASSOCIATION OF PHYSICIANS FOR INDEMNIFICATION, HONOLULU, HI:
2,329,521, REN. 5-14-10. INT. CL. 36.
- HAWAII CALLS, INC., KAILUA, HI:
1,607,327, REN. 5-20-10. INT. CL. 9.
- HAWAII PACIFIC HEALTH, HONOLULU, HI:
3,806,454, PUB. 4-6-2010. INT. CL. 44.
3,806,456, PUB. 4-6-2010. MULTIPLE CLASS, INT. CLS. 41 AND 44.
- HAWAII'S OWN, LLC, SUMNER, WA, RUTH CORP., HONOLULU, HI, DBA HAWAIIAN JUICE INDUSTRIES:
1,616,961, REN. 5-20-10. INT. CL. 32.
- HAWK'S LANDING, LLC, SEATTLE, WA:
3,807,791, INT. CL. 37.
- HAWKEYE COMMUNICATION INC., NEW YORK, NY:
2,770,909, CANC. INT. CL. 35.
- HAWKING TECHNOLOGIES, INC., IRVINE, CA:
2,285,085, CANC. INT. CL. 9.
- HAWKINS COOKERS LIMITED, BOMBAY, 400 005, INDIA:
2,337,324, REN. 5-19-10. INT. CL. 21.
- HAWLEY & HAZEL (BVI) CO., LTD., TORTOLA, BR. VIRGIN ISLANDS:
3,805,460, PUB. 4-6-2010. MULTIPLE CLASS, INT. CLS. 3 AND 21.
- HAWORTH, INC., HOLLAND, MI:
2,772,442, CANC. INT. CL. 20.
- HAYES, CHARLES S., SOUTH BEND, IN:
2,450,365, REN. 5-20-10. INT. CL. 37.
- HAYS ENTERTAINMENT LLC, NEW YORK, NY:
3,760,097 NEW CERT. 6-22-2010. INT. CL. 39.
- HAYS, TIM, MATTHEWS, NC:
3,806,581, PUB. 4-6-2010. INT. CL. 7.
- HAYSE BLACK, LLC, NEW YORK, NY:
3,807,954, MULTIPLE CLASS, INT. CLS. 18, 20, 21 AND 28.
- HAYTT CORPORATION, JEFFERSONVILLE, IN:
1,560,288, CANC. INT. CL. 12.
- HBI BRANDED APPAREL ENTERPRISES, LLC, WINSTON-SALEM, NC:
2,772,598, CANC. INT. CL. 25.
3,807,628, INT. CL. 25.
- HDLOGIX, INC., EDISON, NJ:
3,808,472, MULTIPLE CLASS, INT. CLS. 9 AND 42.
- HDM FURNITURE INDUSTRIES, INC., HIGH POINT, NC:
3,806,725, PUB. 4-6-2010. INT. CL. 20.
- HEAD TECHNOLOGY GMBH, AUSTRIA:
3,807,327, PUB. 4-6-2010. INT. CL. 28.
- HEADWATERS INCORPORATED, SOUTH JORDAN, UT, JTM INDUSTRIES, INC., KENNESAW, GA:
1,601,725, REN. 5-19-10. INT. CL. 1.
- HEALTH BY DESIGN MANAGEMENT, LLP, SAN ANTONIO, TX:
3,807,040, PUB. 4-6-2010. INT. CL. 44.
- HEALTH CARE SERVICE CORPORATION, CHICAGO, IL:
3,807,002, PUB. 4-6-2010. INT. CL. 36.
3,807,022, PUB. 4-6-2010. INT. CL. 36.
3,807,023, PUB. 4-6-2010. INT. CL. 36.
- HEALTH ENTERPRISES, INC., NORTH ATTLEBORO, MA:
3,808,393, INT. CL. 10.
- HEALTH INDUSTRY BUSINESS COMMUNICATIONS COUNCIL, PHOENIX, AZ:
1,601,702, REN. 5-19-10. INT. CL. 42.
- HEALTH INFORMATION DESIGNS, INC., AUBURN, AL:
3,805,973, PUB. 4-6-2010. INT. CL. 9.
- HEALTH MANAGEMENT RESOURCES, INC., SALISBURY, NC:
3,805,797, PUB. 12-29-2009. INT. CL. 35.
- HEALTH MEDIA LAB, INC., WASHINGTON, DC:
2,771,813, CANC. INT. CL. 9.
- HEALTH PLUS INCORPORATED, CHINO, CA:
3,808,736, INT. CL. 5.
- HEALTH PRODUCTS, LLC, MILTON, MA:
3,805,504, PUB. 4-6-2010. INT. CL. 16.
- HEALTH RISK PARTNERS LLC, RICHMOND, VA:
3,806,407, PUB. 4-6-2010. INT. CL. 42.
- HEALTH VALLEY COMPANY, IRWINDALE, CA:
2,771,060, CANC. INT. CL. 30.
- HEALTHCARE FINANCIAL MANAGEMENT ASSOCIATION, WESTCHESTER, IL:
3,805,734, PUB. 4-6-2010. MULTIPLE CLASS, INT. CLS. 41 AND 42.
3,805,735, PUB. 4-6-2010. MULTIPLE CLASS, INT. CLS. 41 AND 42.
3,805,736, PUB. 4-6-2010. MULTIPLE CLASS, INT. CLS. 41 AND 42.
- HEALTHGOODS, LLC, DERRY, NH:
3,806,624, PUB. 4-6-2010. INT. CL. 24.
- HEALTHSPRING, NASHVILLE, TN:
2,772,756, CANC. INT. CL. 36.
- HEALTHWON, INC., WILLIAMSVILLE, NY:
3,807,796, MULTIPLE CLASS, INT. CLS. 35 AND 36.
- HEALTHY DISCOUNTS, INC, SHERMAN OAKS, CA:
3,805,173, PUB. 4-6-2010. MULTIPLE CLASS, INT. CLS. 35 AND 43.
- HEARST COMMUNICATIONS INC., NEW YORK, NY, DBA HEARST MAGAZINES:
2,771,666, CANC. INT. CL. 35.
- HEARST HOLDINGS, INC., NEW YORK, NY AND FLEISCHER STUDIOS, INC., BEVERLY HILLS, CA:
2,374,258, REN. 5-19-10. INT. CL. 9.
2,376,545, REN. 5-19-10. INT. CL. 9.
2,378,474, REN. 5-19-10. INT. CL. 16.
- HEARST NEWSPAPERS, LLC, BEAUMONT, TX:
2,381,558, REN. 5-18-10. INT. CL. 42.
- HEARTLAND PAYMENT SYSTEMS, INC., PRINCETON, NJ:
3,808,022, INT. CL. 42.
- HEARTLAND TANNING, INC., LEE'S SUMMIT, MO:
2,373,820, REN. 5-14-10. INT. CL. 35.
- HEARTSMART WINE, LLC, LONG BEACH, CA:
3,808,251, INT. CL. 33.
- HEELING SPORTS LIMITED, CARROLLTON, TX:
3,805,558, PUB. 4-6-2010. MULTIPLE CLASS, INT. CLS. 25 AND 28.
- HEGLUND, RYAN L, LEXINGTON, MN, TA SILVERMERE AMERICA LLC:
3,806,670, PUB. 4-6-2010. INT. CL. 11.

HEINEKEN BROUWERIJEN B.V., 1017 ZD AMSTERDAM, NETHERLANDS:
2,285,509, CANC. INT. CL. 32.

HEINEMAN, GEORGE T. FRAMINGHAM, MA:
3,806,061, PUB. 4-6-2010. MULTIPLE CLASS, INT. CLS. 9 AND 41.

HELEN OF TROY LIMITED, ST. MICHAEL, BARBADOS:
2,771,601, CANC. INT. CL. 11.
2,772,469, CANC. INT. CL. 11.

HELEN OF TROY LIMITED (BARBADOS), ST.MICHAEL, BARBADOS:
2,403,656, REN. 5-17-10. MULTIPLE CLASS, INT. CLS. 8, 9 AND 21.

HELENA HOLDING COMPANY, WILMINGTON, DE:
3,807,594, INT. CL. 1.

HELIOS KLINIKEN GMBH, FULDA, FED REP GERMANY:
3,807,074, PUB. 4-6-2010. MULTIPLE CLASS, INT. CLS. 35, 37, 38, 39, 42, 43 AND 44.

HELIX GROUP PLC, WEST MIDLANDS, UNITED KINGDOM:
3,807,685, MULTIPLE CLASS, INT. CLS. 9 AND 16.

HENDERSON, RICHARD A., JR., HOLMDEL, NJ:
2,771,586, CANC. INT. CL. 16.

HENDON, STAMFORD HILL & CO., INC., TEANECK, NJ:
3,806,793, PUB. 4-6-2010. INT. CL. 41.

HENNY PENNY CORPORATION, EATON, OH:
3,807,914, INT. CL. 11.
3,807,915, INT. CL. 11.

HENRY FLEMING CO, CORNELIUS, NC:
3,808,425, INT. CL. 35.

HENSLEY FONTANA, LLC, CHARLOTTE, NC:
3,808,768, INT. CL. 35.

HER MAJESTY THE QUEEN IN RIGHT OF CANADA,, HULL QC, CANADA:
2,372,819, REN. 5-19-10. INT. CL. 9.

HERBSMITH INC., HARTLAND, WI, DBA HERBSMITH INC.:
3,805,730, PUB. 4-6-2010. INT. CL. 5.

HERMANAS, INC., AUSTIN, TX:
3,808,354, INT. CL. 30.

HERMÈS INTERNATIONAL, 75008 PARIS, FRANCE:
3,805,685, PUB. 4-6-2010. MULTIPLE CLASS, INT. CLS. 14, 16, 18 AND 25.

HERO ARTS RUBBER STAMPS, INC., RICHMOND, CA:
2,838,809, CANC. INT. CL. 20.

HERO-GEAR, LLC, WINCHESTER, TN:
3,805,745, PUB. 11-3-2009. INT. CL. 35.

HESMER, WILLIAM RUSSELL, WILSON, NC:
3,808,394, INT. CL. 11.

HESS & CLARK, INC., LANSING, MI:
2,772,049, CANC. INT. CL. 5.

HESS, STEPHEN W., DALLAS, TX:
2,285,926, CANC. INT. CL. 3.

HETTICH MARKETING- UND VERTRIEBS; GMBH & CO. KG, FED REP GERMANY:
3,807,269, PUB. 4-6-2010. MULTIPLE CLASS, INT. CLS. 6, 20 AND 21.

HEXBG, LLC, PAWLET, VT:
3,806,601, PUB. 4-6-2010. INT. CL. 11.

HHCS HAND HELD COMPUTER SPECIALISTS AB, 531 31 LIDKOPING, SWEDEN:
3,805,484, PUB. 4-6-2010. INT. CL. 9.

HIDALGO, PAET, FALLBROOK, CA:
2,422,517, REN. 5-18-10. INT. CL. 25.

HIDDEN MANNA CORP., DIAMOND BAR, CA:
2,772,146, CANC. INT. CL. 42.

HIGGINS, NATALIE, MAGNOLIA, TX:
3,806,616, PUB. 4-6-2010. INT. CL. 14.

HIGHLAND SUPPLY CORPORATION, HIGHLAND, IL:
2,284,733, CANC. INT. CL. 16.

HIGHLANDS OVERRIDE, INC., PORTSMOUTH, NH:
3,808,102, MULTIPLE CLASS, INT. CLS. 35 AND 37.

HILCO TRADING, LLC, NORTHBROOK, IL:
3,807,057, PUB. 4-6-2010. INT. CL. 36.

HILL-CHRISTIAN, SHEILA R, RICHMOND, VA:
3,805,813, PUB. 4-6-2010. INT. CL. 4.

HIMES, DAVID, DURANGO, CO:
2,771,693, CANC. INT. CL. 9.

HINDERBERGER, FRIEDEL REINHARD, BERLIN, FED REP GERMANY:
2,771,616, CANC. INT. CL. 12.

HINDS INTERNATIONAL, INC., HILLSBORO, OR, DBA HINDS INSTRUMENTS, INC.:
2,446,919, REN. 5-17-10. INT. CL. 9.

HINKLE, MARGARETHA J., CALDWELL, ID:
2,402,496, REN. 5-19-10. INT. CL. 19.

HIPAA BOX INC., HIGHLAND PARK, CA:
3,806,893, PUB. 4-6-2010. INT. CL. 42.

HISAMITSU PHARMACEUTICAL CO., INC., SAGA, JAPAN:
2,771,622, CANC. INT. CL. 5.
2,771,623, CANC. INT. CL. 5.
2,771,624, CANC. INT. CL. 5.

HISAMITSU PHARMACEUTICAL CO., INC., TOSU-SHI, SAGA, JAPAN:
3,805,295, PUB. 4-6-2010. INT. CL. 5.

HISPANIC JOURNAL L.L.C., DALLAS, TX:
2,284,870, CANC. INT. CL. 16.

HISTORICAL RESEARCH CENTER, INC., THE, BOYNTON BEACH, FL:
2,771,255, CANC. INT. CL. 16.

HITTITE MICROWAVE CORPORATION, CHELMSFORD, MA, TA HITT:
3,808,457, INT. CL. 9.

HLADECEK LLC, ALBANY, CA:
3,806,252, PUB. 4-6-2010. INT. CL. 35.

HMH PUBLISHERS LLC, WILMINGTON, DE:
3,805,187, PUB. 8-19-2008. INT. CL. 42.

HO, MAN KWONG, ARCADIA, CA:
3,805,672, PUB. 4-6-2010. INT. CL. 25.

HOBBY LOBBY INTERNATIONAL, INC., BRENTWOOD, TN:
3,806,173, PUB. 4-6-2010. INT. CL. 28.

HOCEAN INC., COMMERCE, CA:
3,805,933, PUB. 4-6-2010. MULTIPLE CLASS, INT. CLS. 29 AND 30.

HOCHMAN, MARCELO, CHARLESTON, SC:
3,805,674, PUB. 4-6-2010. INT. CL. 3.

HOECHST GMBH, 65926 FRANKFURT AM MAIN, FED REP GERMANY:
1,597,013, REN. 5-20-10. INT. CL. 1.

HOEFLER, CHRISTINA, CHARDON, OH:
3,808,530, MULTIPLE CLASS, INT. CLS. 9, 14 AND 25.

HOFFMANN-LA ROCHE INC., NUTLEY, NJ:
2,348,447, REN. 5-14-10. INT. CL. 42.

HOIKE SERVICES, INC., HONOLULU, HI:
3,808,279, INT. CL. 42.

HOJO RECORDS, L.L.C., WEST HOLLYWOOD, CA:
2,771,220, CANC. INT. CL. 41.

HOLDTEX INDUSTRIAL CORPORATION (USA), PICO RIVERA, CA:
1,559,968, CANC. INT. CL. 25.

HOLLAND, PAMELA, NORTHPORT, NY:
2,772,708, CANC. MULTIPLE CLASS, INT. CLS. 29 AND 30.

HOLY G WEAR LLC, DENVER, CO:
3,806,345, PUB. 4-6-2010. INT. CL. 25.

HOME ACCESS REHABILITATION, DEVON, PA:
3,808,455, INT. CL. 44.

HOME BOX OFFICE, INC., NEW YORK, NY:
3,808,527, INT. CL. 25.

HOME CARE DENTURES, INC., FEDERAL HEIGHTS, CO:
2,772,760, CANC. INT. CL. 44.

HOME SHOPPING CLUB, LLC, ST. PETERSBURG, FL TO AST LLC, ST. PETERSBURG, FL:
2,284,399, CANC. INT. CL. 38.

HOMELITE TECHNOLOGIES, LTD., HAMILTON, BERMUDA:
2,771,814, CANC. INT. CL. 7.
2,771,815, CANC. INT. CL. 7.

HOMER TLC, INC., CLAYMONT, DE:
2,284,402, CANC. INT. CL. 8.

HOMER TLC, INC., WILMINGTON, DE:
3,805,440, PUB. 4-6-2010. INT. CL. 35.
3,806,610, PUB. 4-6-2010. INT. CL. 19.
3,806,611, PUB. 4-6-2010. INT. CL. 20.

- HOMERWOOD HARDWOOD FLOORING COMPANY, TITUSVILLE, PA:
3,806,701, PUB. 4-6-2010. MULTIPLE CLASS, INT. CLS. 19 AND 35.
- HOMEWORKS - COLLABORATE, COACH, CONTRACT, LLC, ANNAPOLIS, MD:
3,805,463, PUB. 4-6-2010. INT. CL. 37.
- HOMIESHOP PROPERTIES, L.L.C., FAIRFIELD, CA:
2,772,659, CANC. INT. CL. 28.
- HONDA GIKEN KOGYO KABUSHIKI KAISHA (HONDA MOTOR CO., LTD.), TOKYO 107, JAPAN:
2,285,785, CANC. MULTIPLE CLASS, INT. CLS. 16, 25 AND 28.
- HONEY DON'T COUGH LLC, GRAND RAPIDS, MI, DBA HONEY DON'T COUGH:
3,805,630, PUB. 4-6-2010. INT. CL. 5.
3,805,631, PUB. 4-6-2010. INT. CL. 5.
- HONEYWELL INTERNATIONAL INC., MORRISTOWN, NJ:
3,808,387, INT. CL. 9.
- HONGSAM NARA CO., LTD., SEOCHO-GU, SEOUL 137-879, REPUBLIC OF KOREA:
2,772,154, CANC. INT. CL. 35.
- HOOFBEATS TO HEALING, PALMYRA, UT:
3,805,642, PUB. 4-6-2010. INT. CL. 41.
- HOOVER MATERIALS HANDLING GROUP, INC., ALPHARETTA, GA:
2,772,039, CANC. INT. CL. 6.
- HOP BREEDING COMPANY, L.L.C., YAKIMA, WA:
3,807,712, INT. CL. 30.
- HOPE, RONALD W., FRANKLIN, TN:
2,771,535, CANC. INT. CL. 37.
- HOPJACKS, INC., PENSACOLA, FL:
3,805,876, PUB. 4-6-2010. INT. CL. 43.
- HOPKINS FISHING GEAR INC., NORTHUMBERLAND, PA:
2,395,729, REN. 5-20-10. INT. CL. 28.
- HOPKINS MANUFACTURING CORPORATION, EMPORIA, KS:
1,150,839, REN. 5-19-10. INT. CL. 8.
- HORIZONTAL LLC, NEW YORK, NY:
3,806,313, PUB. 4-6-2010. INT. CL. 9.
- HORN, ROBERT C., MIDWAY, KY, HORN, ROBERT C., LAGRANGE, KY AND HORN, PAMELA, LAGRANGE, KY, DBA THE ROBINS NEST:
1,601,210, REN. 5-20-10. INT. CL. 30.
- HORNADY MANUFACTURING COMPANY, GRAND ISLAND, NE:
3,805,424, PUB. 4-6-2010. INT. CL. 3.
- HORWITZ, LEWIS P., CENTURY CITY, CA:
2,771,425, CANC. INT. CL. 36.
- HOSPIRA, INC., LAKE FOREST, IL:
702,654, REN. 5-17-10. U.S. CL. 44 (INT. CL. 10).
2,353,562, REN. 5-20-10. INT. CL. 5.
2,373,381, REN. 5-20-10. INT. CL. 10.
- HOSPITALITY SALES & MARKETING ASSOCIATION INTERNATIONAL, MCLEAN, VA:
2,404,022, REN. 5-17-10. INT. CL. 35.
- HOSSHIN-SHA INC., TOKYO, JAPAN:
2,352,143, REN. 5-20-10. INT. CL. 41.
- HOSUNG NEW YORK TRADING INC., BROOKLYN, NY:
2,770,768, CANC. INT. CL. 28.
- HOT SPOT, INC., ROGERS, AR:
2,770,886, CANC. INT. CL. 41.
- HOT STUFF FOODS, LLC, SIOUX FALLS, SD:
2,355,343, REN. 5-19-10. INT. CL. 30.
- HOT TOPIC, INC., CITY OF INDUSTRY, CA:
2,771,873, CANC. INT. CL. 16.
- HOTELES CHARLESTON S.A., BOGOTÁ, COLOMBIA:
3,806,030, PUB. 4-6-2010. INT. CL. 43.
3,806,036, PUB. 4-6-2010. INT. CL. 43.
- HOTSCHEDULES.COM, INC, AUSTIN, TX:
3,805,170, PUB. 4-6-2010. INT. CL. 42.
- HOUGHTON MIFFLIN HARCOURT PUBLISHING COMPANY, BOSTON, MA:
3,807,396, INT. CL. 16.
- HOUGHTON MIFFLIN HARCOURT PUBLISHING COMPANY, BOSTON, MA:
3,807,388, INT. CL. 16.
- HOUSTON, ANDREA JACALYN, LOUISVILLE, KY:
2,770,876, CANC. INT. CL. 41.
- HOWARD ROCKETT INC., RALEIGH, NC, AKA HRI:
3,806,384, PUB. 4-6-2010. INT. CL. 35.
- HOWARD WRIGHT LIMITED, NEW PLYMOUTH, NEW ZEALAND:
3,805,379, PUB. 4-6-2010. INT. CL. 10.
- HOWLEY, JOHN P, ST PAUL, MN, DBA GREAT LAKES WATERPROOFING:
3,806,359, PUB. 4-6-2010. INT. CL. 40.
- HOWMEDICA OSTEONICS CORP., MAHWAH, NJ, OSTEONICS CORP., ALLENDALE, NJ:
1,615,583, REN. 5-20-10. INT. CL. 10.
- HPC PROJECT SA, MONTPELLIER CEDEX 2, FRANCE:
3,807,223, PUB. 4-6-2010. MULTIPLE CLASS, INT. CLS. 9, 38 AND 42.
- HQ AERO MANAGEMENT INC., MISSISSAUGA, CANADA:
3,805,472, PUB. 4-6-2010. INT. CL. 35.
- HRLS LLC, LAS VEGAS, NV:
3,807,066, PUB. 4-6-2010. INT. CL. 43.
- HSI IP, INC., GEORGE TOWN, GRAND CAYMAN, CAYMAN ISLANDS:
2,285,074, CANC. MULTIPLE CLASS, INT. CLS. 35 AND 40.
- HSI IP, INC., GRAND CAYMAN, CAYMAN ISLANDS:
2,285,364, CANC. INT. CL. 35.
- HSM ENTERPRISES, INC., PACOIMA, CA, DBA UTILITY REFRIGERATOR:
3,806,744, PUB. 4-6-2010. INT. CL. 11.
- HSPIN YOYO GMBH, ZURICH, SWITZERLAND:
3,806,518, PUB. 4-6-2010. INT. CL. 28.
- HSR GROUP, INC., NEW ORLEANS, LA, DBA THE MARKETING CENTER FOR SOCIAL SECURITY LAW PRACTICES:
3,806,741, PUB. 4-6-2010. INT. CL. 35.
- HTZ INVESTMENT CORP., WILMINGTON, DE:
2,770,877, CANC. MULTIPLE CLASS, INT. CLS. 1, 3, 5, 11, 16, 19, 20 AND 21.
- HUBBELL INCORPORATED, ORANGE, CT:
1,595,041, REN. 5-18-10. INT. CL. 9.
- HUF TOOLS GMBH, 42551 VELBERT, FED REP GERMANY:
2,770,722, CANC. INT. CL. 7.
- HUGHES, KIMBERLY DOSS, BOULDER, CO, DBA TKDESIGNS:
2,379,634, REN. 5-18-10. INT. CL. 28.
- HUGRUN S.F., IS-105 REYKJAVIK, ICELAND:
1,560,280, CANC. INT. CL. 9.
- HUMMINGBIRD LTD., NORTH YORK, ONTARIO M2H 2W1, CANADA:
2,770,507, CANC. INT. CL. 9.
- HUNEEUS VINTNERS LLC, RUTHERFORD, CA:
3,808,542, INT. CL. 41.
- HUNT, JOHN, BELLEVUE, WA:
2,772,153, CANC. INT. CL. 42.
- HUNTER INDUSTRIES, INC., SAN MARCOS, CA:
3,808,030, INT. CL. 9.
- HUNTLEIGH TECHNOLOGY LIMITED, LUTON, BEDFORDSHIRE, UNITED KINGDOM:
1,596,207, REN. 5-17-10. INT. CL. 10.
1,596,213, REN. 5-17-10. INT. CL. 10.
2,771,266, CANC. INT. CL. 10.
2,771,267, CANC. INT. CL. 10.
- HURST, TRACEY L, ANNAPOLIS, MD:
3,805,264, PUB. 4-6-2010. INT. CL. 35.
- HUT METALLVERARBEITUNG GMBH & CO., 34431 MARSBERG, FED REP GERMANY:
2,771,903, CANC. MULTIPLE CLASS, INT. CLS. 6, 9, 10, 14 AND 21.
- HWAL'BAY BA:J ENTERPRISES, INC, PEACH SPRINGS, AZ:
3,805,654, PUB. 4-6-2010. INT. CL. 41.
- HY GORGEOUS, LLC, BLOOMFIELD, NJ:
3,806,514, PUB. 4-6-2010. MULTIPLE CLASS, INT. CLS. 25 AND 44.
- HY-KO PRODUCTS COMPANY, NORTHFIELD, OH:
3,806,941, PUB. 4-6-2010. INT. CL. 36.
- HYANNIS YACHT CLUB, HYANNIS, MA:
2,349,524, REN. 5-19-10. INT. CL. 25.

HYDRATECH ENGINEERED PRODUCTS, LLC, CINCINNATI, OH:
3,805,538, PUB. 4-6-2010. INT. CL. 17.

HYDRO SYSTEMS, INC., SUNRISE BEACH, MO:
1,641,051. REN. 5-18-10. INT. CL. 7.

HYDROLVE LLC, REDDING, CA:
3,807,994, INT. CL. 1.

HYGIEA MESSENGER, LLC, PARKLAND, FL:
3,808,047, INT. CL. 14.

HYLER, CURTIS, LEE, GREENVILLE, NC:
2,771,768, CANC. INT. CL. 41.

H20 PLUS, L.P., CHICAGO, IL:
2,285,726, CANC. INT. CL. 21.

I AM BEYOND LLC, BEVERLY HILLS, CA:
3,807,992, MULTIPLE CLASS, INT. CLS. 18, 21, 25, 35 AND 41.

I EXECUTIVE ENERGY, LLC, BOSSIER CITY, LA:
2,772,635, CANC. MULTIPLE CLASS, INT. CLS. 35 AND 41.

I LOVE PRODUCE, LLC, WEST GROVE, PA:
3,805,599, PUB. 4-6-2010. MULTIPLE CLASS, INT. CLS. 29 AND 31.

I VILLAGE, INC., NEW YORK, NY:
2,339,820. REN. 5-18-10. INT. CL. 42.
2,351,211. REN. 5-20-10. INT. CL. 42.

I.D.M. IMMUNO-DESIGNED MOLECULES, F-75011 PARIS, FRANCE:
2,771,163, CANC. MULTIPLE CLASS, INT. CLS. 1 AND 5.
2,771,166, CANC. MULTIPLE CLASS, INT. CLS. 1 AND 5.

I.L.A.R. S.P.A., ITALY:
3,807,171, PUB. 4-6-2010. INT. CL. 33.

I.P. CREATIONS ENTERPRISES LIMITED, CYPRUS:
3,807,166, PUB. 4-6-2010. INT. CL. 43.

I-DEP, L.L.C., CHICAGO, IL:
2,770,824, CANC. INT. CL. 39.

IACQUIRE, LLC, PHOENIX, AZ:
3,806,758, PUB. 4-6-2010. INT. CL. 35.

IBASIS, BURLINGTON, MA:
3,806,113, PUB. 4-6-2010. INT. CL. 16.

IBENA TEXTILWERKE GMBH, 46395 BOCHOLT, FED REP GERMANY:
2,855,552, CANC. MULTIPLE CLASS, INT. CLS. 9, 10, 20 AND 22.

IBET SYSTEMS, LTD., NEW YORK, NY:
3,807,424, INT. CL. 28.

IBIO INSTITUTE, CHICAGO, IL:
3,806,606, PUB. 4-6-2010. INT. CL. 41.

IBIOPHARMA, INC., NEWARD, DE:
2,349,423. REN. 5-18-10. INT. CL. 5.

IBITTA ENTERPRISES, INC., SHERMAN OAKS, CA, DBA NATURAL AND HEALTHY PRODUCTS:
3,808,665, INT. CL. 29.

ICE STEW LLC, LONG BEACH, CA:
3,808,188, INT. CL. 35.

ICEBOX, LLC, LAKE FOREST, IL:
2,770,561, CANC. INT. CL. 9.

ICON BURGER DEVELOPMENT COMPANY, LLC, DENVER, CO:
3,531,675, AM. INT. CL. 43.

ICORIA, INC., RESEARCH TRIANGLE PARK, NC:
2,771,543, CANC. INT. CL. 42.

IDAYO INTERNATIONAL, INC., CARSON CITY, NV:
3,805,268, PUB. 10-21-2008. INT. CL. 36.

IDEA OUTPOST, LLC, APPLETON, WI:
2,771,784, CANC. INT. CL. 35.

IDEAMAX CORPORATION, ALHAMBRA, CA:
2,771,513, CANC. INT. CL. 38.

IDEAS LLC, PARKER, CO:
3,806,244, PUB. 4-6-2010. INT. CL. 9.

IDEAS TO INK, LLC, MINNEAPOLIS, MN:
3,806,637, PUB. 4-6-2010. INT. CL. 41.

IDENTIGEN CYF, WEST GLAMORGAN SA12 9EJ, UNITED KINGDOM:
2,770,667, CANC. MULTIPLE CLASS, INT. CLS. 1, 5, 40 AND 42.

IDENTIX INCORPORATED, BLOOMINGTON, MN:
2,770,812, CANC. INT. CL. 9.

IFA INDUSTRIELLE WIEGETEchnik GMBH, 86641 RAIN AM LECH, FED REP GERMANY:
3,730,442, COR. MULTIPLE CLASS, INT. CLS. 6, 7, 9, 20, 37 AND 42.

IFILL, FRED, BRONX, NY:
2,772,170, CANC. INT. CL. 25.

IGNITE MEDIA SOLUTIONS, LLC, OLDSMAR, FL:
3,805,385, PUB. 4-6-2010. INT. CL. 35.

IGT, RENO, NV:
3,807,436, INT. CL. 9.
3,807,496, INT. CL. 9.
3,807,787, INT. CL. 9.
3,808,169, INT. CL. 9.

IKANO THERAPEUTICS INC., SADDLE BROOK, NJ:
3,805,575, PUB. 4-6-2010. INT. CL. 42.

IKON AUDIO INTERNATIONAL, INC., CHATSWORTH, CA:
3,807,405, INT. CL. 9.

ILIAD LICENSING LLC, CARDIFF, CA:
3,806,748, PUB. 4-6-2010. INT. CL. 25.
3,806,751, PUB. 4-6-2010. INT. CL. 25.
3,807,043, PUB. 4-6-2010. INT. CL. 25.

ILLINOIS DEPARTMENT OF COMMERCE AND ECONOMIC OPPORTUNITY, CHICAGO, IL:
3,806,366, PUB. 4-6-2010. INT. CL. 35.

ILLINOIS TOOL WORKS INC., GLENVIEW, IL:
2,285,511, CANC. INT. CL. 10.

ILLINOIS TOOL WORKS INC., GLENVIEW, IL, LPS LABORATORIES, INC., TUCKER, GA:
2,386,039, REN. 5-18-10. INT. CL. 4.

ILLINOIS TOOL WORKS INC., GLENVIEW, IL:
2,772,574, CANC. INT. CL. 1.

ILLINOIS TOOL WORKS, INC., GLENVIEW, IL, ILLINOIS TOOL WORKS, INC., GLENVIEW, IL:
2,375,670, REN. 5-18-10. INT. CL. 7.
2,386,759, REN. 5-19-10. MULTIPLE CLASS, INT. CLS. 7 AND 9.

ILLNESSPROTECTION.COM INC., MARKHAM, CANADA:
3,805,226, PUB. 1-26-2010. MULTIPLE CLASS, INT. CLS. 35 AND 36.

IMAGWEAR APPAREL CORP., WILMINGTON, DE:
2,286,374, CANC. INT. CL. 25.

IMAGINE SOLUTIONS, INC., FARMERS BRANCH, TX:
3,807,710, INT. CL. 42.

IMAJEN, LLC, WILSONVILLE, OR, DBA CHEZ GOURMET:
3,807,776, INT. CL. 29.

IMMINENT SUCCESS ENTERPRISES, LLC, MORRISTOWN, NJ:
3,806,622, PUB. 4-6-2010. MULTIPLE CLASS, INT. CLS. 41 AND 45.

IMMITEC HOLDING AB, FALKENBERG, SWEDEN:
3,807,234, PUB. 4-6-2010. INT. CL. 5.

IMMUNOLOGY MEDICAL EDUCATION AND RESEARCH CONSULTANTS, INC., GRAYSLAKE, IL:
3,807,833, INT. CL. 9.

IMPACTIV, INC., GIBSONIA, PA, DBA INNKEEPER'S ADVANTAGE:
3,805,636, PUB. 4-6-2010. INT. CL. 42.

IMPEDIMED LIMITED, AUSTRALIA:
3,807,160, PUB. 12-29-2009. MULTIPLE CLASS, INT. CLS. 9, 10 AND 44.

IMPERIAL FOOD SERVICES, INC., ELGIN, IL:
2,772,588, CANC. INT. CL. 30.

IMPLUS FOOTCARE, LLC, DURHAM, NC:
3,805,864, PUB. 4-6-2010. INT. CL. 25.

IMS COMPANY, CHAGRIN FALLS, OH:
1,574,151. REN. 5-18-10. MULTIPLE CLASS, INT. CLS. 2, 3 AND 4.

IN MARJOLEIN'S MEMORY INC., HARTSDALE, NY:
3,807,769, INT. CL. 36.

IN TOUCH MINISTRIES, INC., ATLANTA, GA:
3,805,502, PUB. 4-6-2010. INT. CL. 9.

INA CORPORATION, CITY OF PHILADELPHIA, PA:
2,772,744, CANC. INT. CL. 36.

INBEV S.A., 1000 BRUSSELS, BELGIUM:
2,770,863, CANC. MULTIPLE CLASS, INT. CLS. 32, 35 AND 41.

- INC INTERNATIONAL CORPORATION, KENNETT SQUARE, PA:
3,808,133, INT. CL. 25.
- INDELIQ, INC., CHICAGO, IL:
2,772,151, CANC. MULTIPLE CLASS, INT. CLS. 41 AND 42.
- INDEPENDENT FILM & TELEVISION ALLIANCE, LOS ANGELES, CA:
2,771,258, CANC. INT. CL. 16.
- INDEPENDENT INSURANCE AGENTS & BROKERS OF AMERICA, INC., ALEXANDRIA, VA:
2,863,176, AM. INT. CL. 36.
- INDEPENDENT MITIGATION & CLEANING CONSERVATION NETWORK, CORP., NAPERVILLE, IL, DBA IMACC:
3,808,261, INT. CL. 35.
- INDEPENDENT SCHOOL DISTRICT NO. 535, ROCHESTER, MN:
2,376,996, REN. 5-18-10. INT. CL. 41.
- INDESIT COMPANY SPA, ITALY:
3,807,283, PUB. 4-6-2010. MULTIPLE CLASS, INT. CLS. 7, 9 AND 11.
- INDESIT IP S.R.L., 47-60044 FABRIANO (AN), ITALY:
3,801,436 NEW CERT. 6-22-2010. MULTIPLE CLASS, INT. CLS. 7, 9, 11 AND 37.
- INDIAN INDUSTRIES, INC., EVANSVILLE, IN:
2,772,390, CANC. INT. CL. 28.
- INDIAN SUMMER CARPET MILLS, INC., DALTON, GA, DBA CHEROKEE CARPET INDUSTRIES:
2,285,133, CANC. INT. CL. 22.
- INDIANA PRODUCTIONS, LTD., NEW YORK, NY:
2,771,191, CANC. INT. CL. 41.
- INDIANAPOLIS COLTS, INC., INDIANAPOLIS, IN:
3,808,119, INT. CL. 41.
- INDIEPOWER LLC, LAS VEGAS, NV:
3,806,022, PUB. 4-6-2010. INT. CL. 35.
- INDUSTRIA DE DISEÑO TEXTIL, S.A.; (INDITEX, S.A.), E-15142 ARTEIXO (A CORUÑA), SPAIN:
3,807,114, PUB. 4-6-2010. MULTIPLE CLASS, INT. CLS. 25, 35, 39 AND 42.
- INDUSTRIA FARMACEUTICA ANDROMACO, S.A. DE C.V., MEXICO D.F. 11520, MEXICO:
3,806,005, PUB. 4-6-2010. INT. CL. 5.
- INDUSTRIA LA POPULAR, SOCIEDAD ANONIMA, GUATEMALA CITY, GUATEMALA:
2,349,628, REN. 5-14-10. INT. CL. 3.
- INDUSTRIAL TECHNOLOGY RESEARCH INSTITUTE, HSIN-CHU, TAIWAN:
3,805,243, PUB. 4-6-2010. MULTIPLE CLASS, INT. CLS. 10, 16, 41 AND 42.
- INDUSTRIAL TELEVISION SERVICES, INC., FRANKLIN PARK, IL:
3,806,253, PUB. 4-6-2010. INT. CL. 39.
- INDUSTRIAS OVARB, S.A. DE C.V., IZTAPALAPA, MEXICO:
3,807,459, INT. CL. 30.
3,807,460, INT. CL. 30.
- INDY JET HOLDINGS, LLC, GREENFIELD, IN:
3,808,759, INT. CL. 37.
- INERGY PROPANE, LLC, KANSAS CITY, MO:
3,807,492, MULTIPLE CLASS, INT. CLS. 4 AND 39.
- INFINEON TECHNOLOGIES AG, MUNICH, FED REP GERMANY:
2,771,180, CANC. INT. CL. 9.
- INFINITI MEDICAL, LLC, MALIBU, CA:
3,806,340, PUB. 4-6-2010. INT. CL. 10.
- INFOGROUP NORTHWEST, INC., EUGENE, OR:
2,353,258, REN. 5-17-10. INT. CL. 42.
- INFORMATION, ETC., SAN MARCOS, TX:
2,404,070, REN. 5-14-10. INT. CL. 35.
- INFRANOR S.A., COPPET, SWITZERLAND:
1,559,548, CANC. INT. CL. 7.
- INFRASTRUCTURE TECHNOLOGY SOLUTIONS LLC ("ITS"), SPRING, TX:
1,559,517, CANC. INT. CL. 5.
- INGENIOUS GENES, INC., PALATINE, IL:
3,807,763, INT. CL. 25.
- INGRID & ISABEL, LLC, SAN FRANCISCO, CA:
3,807,671, INT. CL. 25.
- INNER KNOWING, INC., LOS ANGELES, CA:
3,808,690, MULTIPLE CLASS, INT. CLS. 9, 16 AND 41.
3,808,691, MULTIPLE CLASS, INT. CLS. 9, 16 AND 41.
- INNOMED INTERNATIONAL AG, 9495 TRIESEN, LIECHTENSTEIN:
2,770,983, CANC. INT. CL. 10.
- INNOVATIVE BEVERAGE GROUP, INC., HOUSTON, TX:
3,807,903, INT. CL. 32.
- INNOVATIVE BEVERAGE GROUP, INC., HOUSTON, TX:
3,807,672, INT. CL. 32.
- INNOVATIVE SALON PRODUCTS INC., MONROE, WA:
3,808,702, INT. CL. 3.
- INNOVATIVE TAPE SOLUTIONS, INC., CHARLOTTE, NC:
3,808,745, MULTIPLE CLASS, INT. CLS. 16 AND 17.
- INNOVATIVE U.S.A., INC., NORWALK, CT:
2,767,736, AM. INT. CL. 16.
- INNOWAVE USA LLC, OMAHA, NE:
2,349,569, REN. 5-18-10. INT. CL. 11.
- INOXCROM, S.A., BARCELONA, SPAIN:
1,559,775, CANC. INT. CL. 16.
- INRAD, INC., KENTWOOD, MI:
2,362,956, REN. 5-14-10. INT. CL. 10.
- INSIGHT AGENTS GMBH, FED REP GERMANY:
3,807,164, PUB. 4-6-2010. MULTIPLE CLASS, INT. CLS. 5, 35 AND 42.
- INSIGHT PHARMACEUTICALS LLC, LANGHORNE, PA, JOSEPH E. SEAGRAM & SONS, INC., NEW YORK, NY:
709,543, REN. 5-18-10. U.S. CL. 18 (INT. CL. 5).
- INSIGHT PHARMACEUTICALS LLC, LANGHORNE, PA, U.S. VITAMIN & PHARMACEUTICAL CORPORATION, NEW YORK, NY:
714,075, REN. 5-18-10. U.S. CL. 18 (INT. CL. 5).
- INSPECT-UR GADGET INC., GILBERT, AZ:
3,806,116, PUB. 4-6-2010. INT. CL. 37.
- INSTITUTE FOR DISABILITIES RESEARCH AND TRAINING, INC., WHEATON, MD:
2,447,349, REN. 5-17-10. INT. CL. 9.
2,447,349, CANC. MULTIPLE CLASS, INT. CLS. 16 AND 25.
- INSTITUTE FOR JUSTICE, ARLINGTON, VA:
3,805,500, PUB. 12-29-2009. INT. CL. 16.
- INSTITUTE OF MANAGEMENT ACCOUNTANTS, MONTEVALE, NJ:
2,771,907, CANC. MULTIPLE CLASS, INT. CLS. 41 AND 42.
- INSURANCE EXCHANGE, INC., THE, ROCKVILLE, MD:
2,715,295, AM. INT. CL. 36.
- INTAGRA, INC., MINNEAPOLIS, MN:
2,772,476, CANC. MULTIPLE CLASS, INT. CLS. 1 AND 31.
- INTEGRATED CORPORATION, HONG KONG:
2,770,661, CANC. INT. CL. 9.
- INTEGRATED DEVICE TECHNOLOGY, INC., SAN JOSE, CA:
3,808,614, INT. CL. 9.
- INTEGRITY ENTERPRISE SOLUTIONS, INC., CHANTILLY, VA:
3,807,586, MULTIPLE CLASS, INT. CLS. 35 AND 42.
- INTEGRITY SOLUTIONS HOLDINGS, LLC, SCOTTSDALE, AZ:
2,363,163, REN. 5-17-10. INT. CL. 41.
- INTEGRITY WATERPROOFING INC., LAKEWOOD, OH, DBA INTEGRITY WATERPROOFING:
3,806,770, PUB. 4-6-2010. INT. CL. 37.
- INTELEK, SPOL.S.R.O., 602 00 BRNO, CZECH REPUBLIC:
2,771,063, CANC. INT. CL. 9.
- INTELLIGENT BEAUTY, LLC, EL SEGUNDO, CA, DBA KRONOS, LLC:
3,805,682, PUB. 4-6-2010. INT. CL. 3.
- INTELLIGENT SYSTEMS SOFTWARE, INC., BOCA RATON, FL:
2,772,534, CANC. INT. CL. 9.
- INTELLUM, INC., ATLANTA, GA:
3,806,092, PUB. 4-6-2010. MULTIPLE CLASS, INT. CLS. 41 AND 42.
3,806,093, PUB. 4-6-2010. MULTIPLE CLASS, INT. CLS. 41 AND 42.
3,806,094, PUB. 4-6-2010. INT. CL. 42.

INTER BASIC RESOURCES, INC., GRASS LAKE, MI:
 1,599,356. REN. 5-19-10. MULTIPLE CLASS, INT. CLS. 9
 AND 42.

INTER-MARK CORPORATION, LAS VEGAS, NV:
 3,807,013, PUB. 4-6-2010. INT. CL. 35.

INTERACTIVE INTELLIGENCE, INC., INDIANAPOLIS, IN:
 3,805,534, PUB. 4-6-2010. INT. CL. 9.

INTERCESSIONS WORD MINISTRY, INC., ROYAL OAK,
 MI:
 3,808,654, INT. CL. 45.

INTERCO INCORPORATED, ST. LOUIS, MO:
 1,560,302, CANC. INT. CL. 25.

INTERCONTROLLERS, INC., TARPON SPRINGS, FL:
 2,771,533, CANC. INT. CL. 35.

INTERFACE CABLE ASSEMBLIES AND SERVICES CORP.,
 LONG ISLAND CITY, NY:
 2,284,460, CANC. MULTIPLE CLASS, INT. CLS. 35, 37
 AND 42.

INTERNATIONAL ASSOCIATION OF MISSIONARY AVIA-
 TION, WORTHINGTON, MN:
 3,805,897, PUB. 4-6-2010. INT. CL. 35.

INTERNATIONAL BUSINESS MACHINES CORPORATION,
 ARMONK, NY, AKA IBM CORPORATION:
 2,771,173, CANC. MULTIPLE CLASS, INT. CLS. 41 AND
 42.

INTERNATIONAL BUSINESS MACHINES CORPORATION,
 ARMONK, NY:
 3,628,739, AM. MULTIPLE CLASS, INT. CLS. 16, 35, 36, 41
 AND 42.

INTERNATIONAL CENTERS FOR SPIRITUAL LIVING,
 SPOKANE, WA:
 3,808,656, INT. CL. 41.

INTERNATIONAL ENVIRONMENTAL CORPORATION,
 OKLAHOMA CITY, OK:
 2,449,571. REN. 5-20-10. INT. CL. 11.

INTERNATIONAL FLORA TECHNOLOGIES, LTD.,
 CHANDLER, AZ:
 3,807,604, INT. CL. 1.

INTERNATIONAL GATEWAY ASSOCIATES, SAN DIEGO,
 CA:
 2,772,338. CANC. MULTIPLE CLASS, INT. CLS. 14, 16, 18,
 21, 25, 28, 36 AND 37.

INTERNATIONAL INSTITUTE OF CERTIFIED PUBLIC
 ACCOUNTANTS INCORPORATED, WILMINGTON, DE:
 3,806,160, PUB. 4-6-2010. INT. CL. 41.

INTERNATIONAL NEWSPAPER MARKETING ASSOCI-
 ATES, INC., DALLAS, TX:
 1,560,218, CANC. INT. CL. 42.

INTERNATIONAL TRUCK INTELLECTUAL PROPERTY
 COMPANY, LLC, WARRENVILLE, IL:
 2,771,566, CANC. INT. CL. 37.

INTERNET BILLING COMPANY, LLC, DEERFIELD
 BEACH, FL:
 2,771,893, CANC. MULTIPLE CLASS, INT. CLS. 35, 36
 AND 42.

INTERO FRANCHISE SERVICES, INC., CUPERTINO, CA:
 3,807,731, INT. CL. 35.
 3,807,732, INT. CL. 36.

INTERPRET-EARS, CORP, VALRICO, FL:
 3,806,385, PUB. 4-6-2010. INT. CL. 41.

INTERQUANTUM, LLC, ENCINO, CA:
 3,808,441, INT. CL. 3.

INTERSTATE AUTO GROUP, INC., EDINA, MN:
 3,806,507, PUB. 4-6-2010. MULTIPLE CLASS, INT. CLS. 35
 AND 36.

INTERWOVEN, INC., SAN JOSE, CA:
 2,350,958. REN. 5-17-10. INT. CL. 9.

INTEX RECREATION CORP., LONG BEACH, CA:
 3,805,300, PUB. 4-6-2010. MULTIPLE CLASS, INT. CLS.
 11, 12, 19 AND 28.

INTLINE.COM, INC., ATLANTA, GA, DBA MEDIA1ST-
 COM, INC.:
 2,770,686, CANC. INT. CL. 42.

INTRAOP MEDICAL CORPORATION, SUNNYVALE, CA:
 3,808,115, INT. CL. 44.

INTRINSIC SOLUTIONS, L.P., SEABROOK, TX:
 3,808,651, INT. CL. 38.

INTUNE CORPORATION, VENTURA, CA:
 2,771,938, CANC. INT. CL. 21.

INVENSYS SYSTEMS, INC., FOXBORO, MA:
 3,805,608, PUB. 4-6-2010. INT. CL. 9.

INVENTORY SALES CO., ST. LOUIS, MO:
 3,806,271, PUB. 4-6-2010. INT. CL. 35.
 3,806,272, PUB. 4-6-2010. INT. CL. 35.

INVERSIONES SANTA SOFIA, S.L., MADRID, SPAIN:
 2,771,636, CANC. INT. CL. 33.

INVICTA WATCH COMPANY OF AMERICA, INC., HOLLY-
 WOOD, FL:
 3,808,356, INT. CL. 14.

INVITROGEN CORPORATION, CARLSBAD, CA:
 2,286,587, CANC. INT. CL. 1.

ION MEDIA ENTERTAINMENT, INC., WEST PALM
 BEACH, FL:
 2,285,386, CANC. INT. CL. 41.

IOXUS, INC., ONEONTA, NY:
 3,808,150, INT. CL. 42.

IP HOLDINGS, LLC, VANCOUVER, WA, DBA IP HOLD-
 INGS, LLC:
 2,322,209. REN. 5-14-10. INT. CL. 11.

IP PATHWAYS, LLC, URBANDALE, IA:
 3,806,283, PUB. 4-6-2010. INT. CL. 42.

IPASS, INC., REDWOOD SHORE, CA:
 3,805,934, PUB. 4-6-2010. INT. CL. 38.

IPENSTORE, LLC, SALINE, MI:
 3,808,177, INT. CL. 16.

IPSOLON LLP, PORTLAND, OR:
 2,285,537, CANC. INT. CL. 42.

IPUSA, PLLC, WASHINGTON, DC:
 3,808,746, INT. CL. 45.

IRIDESCENCE BRIDAL COUTURE, INC., SAN JOSE, CA:
 3,806,344, PUB. 4-6-2010. INT. CL. 25.

IRIS RUBBER COMPANY INC, CICERO, IN:
 3,806,628, PUB. 4-6-2010. INT. CL. 8.

IROBOT CORPORATION, BEDFORD, MA:
 2,771,548, CANC. INT. CL. 9.

IRONCLAD, INC., TUSTIN, CA:
 1,559,810, CANC. INT. CL. 16.

IRRRI*TECH OF TEXAS, LLC, DALLAS, TX:
 2,428,224. REN. 5-15-10. INT. CL. 37.

IRV MALVIN, INC., FORT LAUDERDALE, FL:
 2,284,309, CANC. INT. CL. 14.

ISAAC BUSINESS SERVICES LLC, COLUMBUS, OH:
 3,805,978, PUB. 4-6-2010. INT. CL. 35.

ISATORI TECHNOLOGIES, LLC, GOLDEN, CO:
 3,806,776, PUB. 4-6-2010. INT. CL. 32.
 3,806,779, PUB. 4-6-2010. INT. CL. 5.

ISCO INTERNATIONAL, LLC, ELK GROVE VILLAGE, IL:
 3,807,945, INT. CL. 9.

ISCOA USA CORPORATION, NEW YORK, NY:
 2,286,477, CANC. INT. CL. 16.

ISCOTEC AB, STOCKHOLM, SWEDEN:
 2,362,467. REN. 5-19-10. INT. CL. 5.

ISENSE CORPORATION, WILSONVILLE, OR:
 2,285,908, CANC. INT. CL. 10.

ISHRED, LLC, AVON, MA:
 3,808,633, MULTIPLE CLASS, INT. CLS. 20, 36 AND 39.

ISI BRANDS INC., GRAND RAPIDS, MI:
 1,597,123. REN. 5-18-10. INT. CL. 5.

ISLAND ABBEY FOODS, LTD., CHARLOTTETOWN, PE,
 CANADA:
 3,806,203, PUB. 4-6-2010. INT. CL. 30.

ISLE OF CAPRI CASINOS, INC., BILOXI, MS:
 2,770,843, CANC. INT. CL. 41.

ISOPAY, L.L.C., IRVING, TX:
 3,805,890, PUB. 12-29-2009. INT. CL. 36.

ISTARTSCHOOL, INC., PASADENA, CA:
 2,772,199, CANC. INT. CL. 9.

ISU EMPLOYER SERVICES, INC., SAN FRANCISCO, CA:
 3,805,415. PUB. 4-6-2010. MULTIPLE CLASS, INT. CLS.
 35, 36 AND 41.

3,805,416, PUB. 4-6-2010. MULTIPLE CLASS, INT. CLS.
 35, 36 AND 41.

IT'S GREEK TO ME, INC., MANHATTAN, KS:
 3,806,901, PUB. 4-6-2010. INT. CL. 35.

- ITALICS&BOLD LLC, NEWPORT BEACH, CA:
3,808,163, INT. CL. 25.
- ITALTOONS CORPORATION, NEW YORK, NY:
2,771,928, CANC. MULTIPLE CLASS, INT. CLS. 9 AND 16.
- ITD INCORPORATED, SHARON, MA:
3,805,918, PUB. 4-6-2010. INT. CL. 31.
- ITRIM SVERIGE AB, SWEDEN:
3,807,117, PUB. 4-6-2010. MULTIPLE CLASS, INT. CLS. 5, 30, 32, 41 AND 44.
- ITT WATER & WASTEWATER AB, EMMABODA, SWEDEN:
3,805,207, PUB. 4-6-2010. INT. CL. 7.
- ITXC CORPORATION, NORTH BRUNSWICK, NJ:
2,285,137, CANC. INT. CL. 38.
- IVEX OF DELAWARE INC., HOUSTON, TX:
1,559,855, CANC. INT. CL. 20.
- IVY TECH COMMUNITY COLLEGE, INDIANAPOLIS, IN:
3,806,761, PUB. 4-6-2010. INT. CL. 41.
- IWI LTD., MARKHAM, ONTARIO, CANADA:
2,338,708, REN. 5-20-10. INT. CL. 10.
- IXORAA MEDIA LLC, MILPITAS, CA:
3,805,261, PUB. 8-11-2009. MULTIPLE CLASS, INT. CLS. 35, 39 AND 41.
- IXP CORP., CRANBURY, NJ:
2,771,365, CANC. INT. CL. 42.
- IZZARD, EDDIE, LONDON, W1V 5DE, UNITED KINGDOM:
2,781,022, CANC. MULTIPLE CLASS, INT. CLS. 3, 18, 21 AND 34.
- IZZO, JAMES, RIVER FOREST, IL, AKA DREAMFUNDER'S INC.:
3,805,861, PUB. 4-6-2010. INT. CL. 35.
- J & A RESTAURANTS, INC., KATY, TX:
2,771,117, CANC. INT. CL. 43.
- J & M SALES, INC, GARDENA, CA:
3,808,479, INT. CL. 25.
- J & S ENTERPRISES, LLC, WAYNE, NJ:
3,806,269, PUB. 4-6-2010. INT. CL. 41.
- J DAY, SAXTONS RIVER, VT, DBA MEDITERRANEAN DELIGHTS:
2,772,032, CANC. INT. CL. 29.
- J. LLOYD INTERNATIONAL, INC., CEDAR RAPIDS, IA, DBA J. LLOYD INTERNATIONAL:
2,772,187, CANC. INT. CL. 28.
- J. S. STAEDTLER GMBH & CO., D-90427 NUERNBERG, FED REP GERMANY:
2,285,350, CANC. INT. CL. 16.
- J.A. WOOLLAM CO. INC., LINCOLN, NE:
2,428,378, REN. 5-17-10. MULTIPLE CLASS, INT. CLS. 9 AND 16.
- J.C. NEWMAN CIGAR CO., TAMPA, FL:
2,349,624, REN. 5-18-10. INT. CL. 34.
- J.C. NEWMAN CIGAR COMPANY, TAMPA, FL:
2,349,971, REN. 5-17-10. INT. CL. 34.
- J.H. HARE & ASSOCIATES, LTD., WINNIPEG, MANITOBA, CANADA:
3,805,258, PUB. 4-6-2010. INT. CL. 5.
- J.M. HUBER CORPORATION, EDISON, NJ:
2,772,044, CANC. INT. CL. 36.
- J.R. SIMPLOT COMPANY, BOISE, ID:
2,940,524, CANC. INT. CL. 1.
- J&J SNACK FOODS CORP., PENNSAUKEN, NJ:
3,806,548, PUB. 4-6-2010. INT. CL. 30.
- J&J SPIRITS, C X A., SANTO DOMINGO, DOMINICAN REP:
3,805,665, PUB. 4-6-2010. INT. CL. 33.
- JACHIMOWICZ, BRIAN, ENDICOTT, NY:
2,771,269, CANC. INT. CL. 35.
- JACKIE NAGEL, INC., SAN PEDRO, CA:
3,807,056, PUB. 4-6-2010. INT. CL. 35.
- JACKSON, DAMIAN B., VISTA, CA:
3,808,326, INT. CL. 35.
- JACKSON, JEFFREY, FAR HILLS, NJ:
3,807,952, INT. CL. 41.
- JACOBSON INTERNATIONAL IMPORTS, INC., LOS ANGELES, CA:
2,770,878, CANC. INT. CL. 12.
- JAFER LIMITED, HAMILTON, BERMUDA:
3,805,192, PUB. 4-6-2010. INT. CL. 3.
- JAIPUR AVENUE, INC., SEATTLE, WA:
3,808,183, INT. CL. 30.
- JAKKS PACIFIC, INC., MALIBU, CA:
3,807,913, INT. CL. 28.
- JAMBA JUICE COMPANY, EMERYVILLE, CA:
3,808,348, INT. CL. 29.
3,808,554, INT. CL. 30.
- JAMES DIEFENTHAL, MANDEVILLE, LA:
3,807,574, INT. CL. 17.
- JAMES DOBSON, INC., PSYCHOLOGIST, PROFESSIONAL CORPORATION, COLORADO SPRINGS, CO:
2,439,928, REN. 5-17-10. INT. CL. 16.
- JAMES HARDIE TECHNOLOGY LIMITED, DUBLIN 2, IRELAND:
3,808,238, INT. CL. 19.
3,808,239, INT. CL. 19.
3,808,249, INT. CL. 19.
3,808,250, INT. CL. 19.
3,808,254, INT. CL. 19.
- JAMES HOTEL MANAGEMENT COMPANY, LLC, NEW YORK, NY:
3,808,622, INT. CL. 25.
- JAMES, LESLIE, MOBILE, AL:
3,806,515, PUB. 4-6-2010. INT. CL. 5.
- JAMEY YON, CHARLOTTE, NC:
3,806,892, PUB. 4-6-2010. INT. CL. 6.
- JAN DILS ATTORNEY AT LAW, LC, PARKERSBURG, WV:
3,806,713, PUB. 4-6-2010. INT. CL. 45.
3,806,716, PUB. 4-6-2010. INT. CL. 45.
- JANN YEI INDUSTRY CO., LTD., TAICHUNG, TAIWAN:
2,770,736, CANC. INT. CL. 7.
- JANSPORT APPAREL CORP., WILMINGTON, DE:
2,772,072, CANC. INT. CL. 18.
2,772,073, CANC. INT. CL. 18.
- JAQK, INC., SAN FRANCISCO, CA:
3,808,053, INT. CL. 33.
- JARED D. LEE STUDIO, INC., LEBANON, OH:
2,771,411, CANC. INT. CL. 28.
- JASON ALEXANDER INTERNATIONAL CORP., MISSISSAUGA, ONTARIO, CANADA:
2,285,831, CANC. INT. CL. 25.
- JASTER, BRENT, DENVER, CO:
3,808,761, INT. CL. 44.
- JAY FRANCO & SONS, INC., NEW YORK, NY:
3,807,378, INT. CL. 28.
- JAYR ETVART AGOPIAN, BULGARIA:
3,807,359, PUB. 4-6-2010. INT. CL. 33.
- JAZZ D'ELEGANCE, LLC, HARRISON, NY:
3,806,023, PUB. 4-6-2010. INT. CL. 41.
- JD & ASSOCIATES, LLC, GAITHERSBURG, MD:
2,286,607, CANC. INT. CL. 24.
- JDR FRANCHISES LLC, EDMONDS, WA:
3,805,574, PUB. 4-6-2010. INT. CL. 39.
- JEFFEREY BERARDELLI, MIAMI BEACH, FL:
3,808,643, INT. CL. 42.
- JEFFERSON FRINGE LAND, L.P., CLEVELAND, OH:
2,772,377, CANC. INT. CL. 37.
- JEFFERSON, ROSALIE, DALLAS, TX:
3,808,216, INT. CL. 41.
- JEFFRIES & ASSOCIATES, NASHVILLE, TN:
3,807,390, INT. CL. 28.
- JENNIFER BOWERS BAHNEY, CIRCLEVILLE, OH:
3,806,823, PUB. 4-6-2010. INT. CL. 44.
- JENNIFER CLARK, SANTA CRUZ, CA:
2,771,537, CANC. INT. CL. 3.
- JENNIFER FONTAINE, LOS ANGELES, CA:
3,805,247, PUB. 4-6-2010. INT. CL. 41.
- JENNIFER LYNN SCHAEFER, NASHVILLE, TN:
3,806,329, PUB. 4-6-2010. INT. CL. 14.
3,806,330, PUB. 4-6-2010. INT. CL. 25.
3,806,331, PUB. 4-6-2010. INT. CL. 21.
- JENSEN INDUSTRIES INCORPORATED, NORTH HAVEN, CT:
3,805,481, PUB. 4-6-2010. INT. CL. 5.
- JEREMY, GANSE JOHN, LANCASTER, PA, DBA INFRA-HOST MANAGED SERVICE INC.:
2,772,608, CANC. INT. CL. 42.

JHHA CORPORATION, NEW YORK, NY:
3,807,603, MULTIPLE CLASS, INT. CLS. 39, 41, 42, 43, 44 AND 45.

JIANGSU ABLE; TEXTILES & GARMENTS CO., LTD., 213003 JIANGSU PROVINCE, CHINA:
3,807,241, PUB. 4-6-2010. MULTIPLE CLASS, INT. CLS. 18 AND 25.

JIANGSU HUNING STEEL; MECHANISM CO., LTD, CHINA:
3,807,100, PUB. 4-6-2010. INT. CL. 6.

JIANGSU TONGYE INDUSTRY CO., LTD., CHINA:
3,807,200, PUB. 4-6-2010. INT. CL. 24.

JIFFY PRODUCTS OF AMERICA, INC., NORWALK, OH:
3,808,671, INT. CL. 44.

JO'GEE IMPRESSIONS, INC., LINDENHURST, NY:
2,286,614, CANC. INT. CL. 25.

JOBPARTNERS PLC, LONDON, UNITED KINGDOM:
3,805,747, PUB. 4-6-2010. MULTIPLE CLASS, INT. CLS. 9, 35 AND 38.

JOE OCHOA ROOFING, INC, STAFFORD, TX:
3,805,600, PUB. 4-6-2010. INT. CL. 37.

JOE'S BLACKBOOK, INC., BROOKLYN, NY:
3,806,765, PUB. 4-6-2010. INT. CL. 35.

JOEL CLARK, SALT LAKE CITY, UT:
3,806,284, PUB. 4-6-2010. INT. CL. 30.

JOFFE, PAUL, BROOKLYN, NY:
3,807,014, PUB. 4-6-2010. INT. CL. 36.

JOHN BOURQUE, CRANSTON, RI:
3,807,876, INT. CL. 9.

JOHN CHAO, D.D.S., ALHAMBRA, CA:
3,807,883, INT. CL. 44.

JOHN CUTH ENGINEERING, INC., MARQUETTE, MI:
2,772,489, CANC. INT. CL. 42.

JOHN HANCOCK LIFE INSURANCE COMPANY (U.S.A.), BOSTON, MA:
2,770,978, CANC. INT. CL. 36.

JOHN L. BURLESON, DANDRIDGE, TN:
3,807,434, INT. CL. 32.

JOHN LETTERS GOLF LIMITED, WEST YORKSHIRE, UNITED KINGDOM:
2,306,475, REN. 5-18-10. INT. CL. 28.

JOHN M. CRAWLEY, LLC, THE WOODLANDS, TX:
3,805,501, PUB. 4-6-2010. INT. CL. 35.

JOHN MAHASSEL, WORDCESTER, MA, DBA DIVERSIFIED SPECIALTIES:
3,808,714, INT. CL. 9.

JOHN MEZZALINGUA ASSOCIATES, INC., EAST SYRACUSE, NY, DBA PPC:
3,808,505, INT. CL. 9.
3,808,506, INT. CL. 9.

JOHN MICHAELS, INC., VERONA, WI, DBA MICHAEL'S FROZEN CUSTARD:
2,349,945, REN. 5-18-10. INT. CL. 42.

JOHN RICH & SONS INVESTMENT HOLDING COMPANY, WILMINGTON, DE:
3,807,413, INT. CL. 25.

JOHN SNELL & ASSOCIATES, INC., MONTPELIER, VT:
3,807,698, MULTIPLE CLASS, INT. CLS. 16, 37, 41 AND 42.

JOHN SWAN LTD., FINGLAS DUBLIN, IRELAND:
2,286,603, CANC. INT. CL. 25.

JOHN W. DAVIS, SAN DIEGO, CA:
3,806,107, PUB. 4-6-2010. INT. CL. 45.

JOHNSON & JOHNSON, NEW BRUNSWICK, NJ:
2,770,842, CANC. INT. CL. 41.
2,772,112, CANC. INT. CL. 10.
3,807,556, INT. CL. 3.
3,807,581, INT. CL. 5.
3,807,965, MULTIPLE CLASS, INT. CLS. 9 AND 42.

JOHNSON CONTROLS TECHNOLOGY COMPANY, HOLLAND, MI:
2,398,524, REN. 5-19-10. INT. CL. 9.

JOHNSON, BRIAN, TUCSON, AZ:
3,807,916, INT. CL. 42.

JOHNSON, CHARLES DEAN, PINEY FLATS, TN, DBA TRUSTFIRST FINANCIAL:
3,805,985, PUB. 4-6-2010. INT. CL. 36.

JOICO LABORATORIES, INC., GARDENA, CA:
1,559,498, CANC. INT. CL. 3.

JOLLIE SALES, LTD., SILVER SPRING, MD:
2,285,825, CANC. MULTIPLE CLASS, INT. CLS. 30 AND 42.

JON'S NURSEY, INC., EUSTIS, FL:
2,285,527, CANC. INT. CL. 31.

JONAS BROTHERS PROPERTIES LLC, NEW YORK, NY:
3,808,504, MULTIPLE CLASS, INT. CLS. 16, 25 AND 41.

JONATHAN PRODUCT LLC, LINTHICUM HEIGHTS, MD:
3,808,569, INT. CL. 11.

JONES EMPORIUM, INC., WILMINGTON, DE:
1,560,215, CANC. INT. CL. 41.

JONES, IAN GERAINT, NEW ORLEANS, LA:
2,771,702, CANC. INT. CL. 42.

JONES, RICHARD L., TROY, IL:
3,806,475, PUB. 4-6-2010. INT. CL. 35.

JONTI-CRAFT, INC., WABASSO, MN:
2,407,496, REN. 5-18-10. INT. CL. 20.

JORDAN, DARREN P., NEW YORK, NY:
2,771,620, CANC. INT. CL. 41.

JORDYN TAYLOR PROPERTIES, INC., WEST PALM BEACH, FL:
2,770,905, CANC. INT. CL. 36.

JORO MARKETING LTD., CAMBRIDGE, CANADA:
3,808,583, INT. CL. 11.

JOSEPH ENTERPRISES, INC., SAN FRANCISCO, CA:
3,807,371, INT. CL. 28.

JOVITO'S FRANCHISE SYSTEM, INC., KANSAS CITY, MO:
2,771,444, CANC. INT. CL. 30.

JOWOOD PRODUCTIONS SOFTWARE AG, EBENSEE, AUSTRIA:
2,770,783, CANC. INT. CL. 9.

JPMORGAN CHASE & CO., NEW YORK, NY:
2,772,515, CANC. INT. CL. 36.

JPS MANUFACTURING LLC, SCOTTSDALE, AZ, DBA AMERICAN SPIRIT ARMS LLC:
2,246,677, REN. 5-18-10. INT. CL. 13.

JT SPORTS LLC, BENTONVILLE, AR:
2,772,167, CANC. INT. CL. 13.

JUDD FAMILY VINEYARDS, L.P., KARNES CITY, TX:
3,806,889, PUB. 4-6-2010. INT. CL. 33.

JUMPIN' JACKS JAVA CORP., HAMPTON, NH:
3,805,752, PUB. 4-6-2010. MULTIPLE CLASS, INT. CLS. 35 AND 43.

JUNE BUG ENTERPRISES, INC., BEVERLY HILLS, CA:
3,807,468, INT. CL. 43.

JUNGPFLANZEN GRÜNEWALD GMBH, FED REP GERMANY:
3,807,319, PUB. 4-6-2010. INT. CL. 31.

JUNIOR SENSE CORP., NEW YORK, NY:
2,771,333, CANC. INT. CL. 14.
2,771,334, CANC. INT. CL. 14.

JURGENSEN, CHRISTIAN A., III, MT. VERNON, VA:
2,771,655, CANC. INT. CL. 34.

JUST BORN, INC., BETHLEHEM, PA:
3,805,453, PUB. 4-6-2010. INT. CL. 16.
3,808,521, INT. CL. 35.

JUST WHEELS & TIRES CO., HUNTINGTON BEACH, CA:
3,808,401, INT. CL. 12.

JUSTIN, LINDA, MULLICA HILL, NJ, DBA JUSTIN TIME AUCTION:
2,284,907, CANC. INT. CL. 35.

JYSKE GLOOBAL ASSET MANAGEMENT FONDSMAEGLERSELSKAB A/S, 1780 COPENHAGEN V, DENMARK:
3,805,134, PUB. 4-6-2010. INT. CL. 36.

K. HANSOTIA & CO., INC., MIAMI, FL:
3,808,274, INT. CL. 34.

KABUSHIKI KAISHA HITACHI SEISAKUSHO, CHIYODAKU, TOKYO, JAPAN, DBA HITACHI, LTD.:
1,559,611, CANC. INT. CL. 9.

KABUSHIKI KAISHA KURETAKE SEISHODO, 7-CHOME NARA-SHI, JAPAN:
2,770,664, CANC. INT. CL. 1.

KABUSHIKI KAISHA NARUTO SCISSORS (NARUTO SCISSORS CO., LTD.), NISHIAWAJI, HIGASHIYODOGAWAKU, OSAKA, JAPAN:
2,772,445, CANC. INT. CL. 8.

- KABUSHIKI KAISHA NIBARIKI, TOKYO, JAPAN:
3,808,566, MULTIPLE CLASS, INT. CLS. 9 AND 16.
- KABUSHIKI KAISHA PIETRO, FUKUOKA-SHI, FUKUOKA, JAPAN:
2,402,543, REN. 5-20-10, INT. CL. 42.
- KABUSHIKI KAISHA SAZABY LEAGUE, TOKYO, JAPAN:
1,559,833, CANC. INT. CL. 18.
- KABUSHIKI KAISHA SEGA D/B/A SEGA CORPORATION, OHTA-KU, TOKYO, JAPAN:
3,808,107, INT. CL. 9.
- KABUSHIKI KAISHA SHINSEI GINKO A/T/A SHINSEI BANK, LIMITED, TOKYO, JAPAN:
2,772,021, CANC. INT. CL. 36.
- KABUSHIKI KAISHA SONY COMPUTER ENTERTAINMENT, TOKYO, JAPAN, TA SONY COMPUTER ENTERTAINMENT INC.:
3,807,081, PUB. 1-16-2007, MULTIPLE CLASS, INT. CLS. 9 AND 36.
- KABUSHIKI KAISHA SQUARE ENIX (ALSO TRADING AS SQUARE ENIX CO. LTD.), TOKYO, JAPAN:
3,808,413, INT. CL. 9.
- KABUSHIKI KAISHA SUNRISE, SUGINAMI-KU, TOKYO, JAPAN:
2,770,675, CANC. INT. CL. 41.
- KABUSHIKI KAISHA TANITA, ITABASHI-KU, TOKYO, JAPAN:
2,770,807, CANC. MULTIPLE CLASS, INT. CLS. 9 AND 10.
- KABUSHIKI KAISHA TOSHIBA, TOKYO, JAPAN, DBA TOSHIBA CORPORATION:
2,359,518, REN. 5-18-10, INT. CL. 9.
- KABUSHIKI KAISHA WACOM; (ALSO TRADING AS WACOM CO., LTD.), JAPAN:
3,807,350, PUB. 4-6-2010, INT. CL. 15.
- KABUSHIKI KAISHA; SONY COMPUTER ENTERTAINMENT; (ALSO TRADING AS; SONY COMPUTER ENTERTAINMENT INC.), JAPAN:
3,807,275, PUB. 4-6-2010, MULTIPLE CLASS, INT. CLS. 35, 41 AND 42.
- KABUSHIKIGAISYA GOTO KOGAKU KENKYUJYO, TOKYO, JAPAN:
3,806,982, PUB. 4-6-2010, INT. CL. 9.
- KAI DI, ROSEMEAD, CA:
3,806,556, PUB. 4-6-2010, INT. CL. 41.
- KAIROS AUTONOMI, INC., SANDY, UT:
3,806,645, PUB. 4-6-2010, INT. CL. 12.
- KAKEN PHARMACEUTICAL CO., LTD., TOKYO, JAPAN:
3,807,069, PUB. 4-6-2010, INT. CL. 5.
- KALAHARI PEPPER COMPANY, INC., SIGNAL MOUNTAIN, TN:
2,285,993, CANC. INT. CL. 30.
- KALRA, RAJ, ACWORTH, GA:
3,806,795, PUB. 4-6-2010, INT. CL. 39.
- KALYAAN MARKET, JACKSONVILLE, FL:
3,806,984, PUB. 4-6-2010, INT. CL. 35.
- KAMISORI INC., MARKHAM, ONTARIO, CANADA:
3,808,430, INT. CL. 11.
- KAMMER, CHARLES, PARIS, FRANCE:
1,559,931, CANC. INT. CL. 25.
- KANARI WORLD, PARIS, FRANCE:
2,770,676, CANC. MULTIPLE CLASS, INT. CLS. 9, 38 AND 42.
- KANE, JOSHUA, NEW YORK, NY:
2,285,109, CANC. INT. CL. 41.
- KANE, JOSHUA, BROOKLYN, NY:
2,285,110, CANC. INT. CL. 41.
- KAO KABUSHIKI KAISHA TA KAO CORPORATION, CHUO-KU, TOKYO 103-8210, JAPAN:
2,770,566, CANC. INT. CL. 3.
- KAPLAN, ARI DAVID, CHICAGO, IL:
3,805,459, PUB. 12-29-2009, INT. CL. 41.
- KAPOW TECHNOLOGIES HOLDINGS, INC., PALO ALTO, CA:
3,807,693, MULTIPLE CLASS, INT. CLS. 9, 38 AND 42.
3,807,694, MULTIPLE CLASS, INT. CLS. 9, 38 AND 42.
- KARBON KINETICS LIMITED, LONDON, UNITED KINGDOM:
3,805,455, PUB. 4-6-2010, INT. CL. 12.
- KARL PRATTES, FED REP GERMANY:
3,807,282, PUB. 4-6-2010, INT. CL. 25.
- KARO BIO AB, NOVUM, S-141, SWEDEN:
2,772,603, CANC. INT. CL. 1.
- KASGO, LLC, LOS ANGELES, CA:
3,805,220, PUB. 4-6-2010, INT. CL. 43.
- KASIA DE GELAUQUE, INC., MIAMI, FL:
3,806,743, PUB. 4-6-2010, INT. CL. 25.
- KATENA PRODUCTS INC., DENVER, NJ:
1,559,683, CANC. INT. CL. 10.
- KATHERINE FLEMING, LLC, NEW YORK, NY:
3,807,502, INT. CL. 18.
- KAWAI MUSICAL INSTRUMENTS MANUFACTURING CO., LTD., SHIZUOKA-KEN, JAPAN:
3,807,917, INT. CL. 15.
- KAYAKO, INC., BOISE, ID:
3,806,460, PUB. 4-6-2010, INT. CL. 42.
- KAYLOR OF COLORADO, GREELEY, CO:
3,806,605, PUB. 4-6-2010, INT. CL. 31.
- KBSH CAPITAL MANAGEMENT INC., TORONTO, ONTARIO M5C2V6, CANADA:
2,772,387, CANC. INT. CL. 36.
- KCH CORPORATION, BROOKLYN, NY:
3,805,296, PUB. 4-6-2010, INT. CL. 6.
- KEEGAN, TIMOTHY J, POMONA, CA:
3,806,183, PUB. 4-6-2010, INT. CL. 32.
- KEETSA, INC., SAN FRANCISCO, CA:
3,806,791, PUB. 4-6-2010, INT. CL. 20.
3,806,796, PUB. 4-6-2010, INT. CL. 20.
3,806,875, PUB. 4-6-2010, INT. CL. 20.
- KEI SING MA, BAYSIDE, NY:
3,806,802, PUB. 4-6-2010, INT. CL. 30.
- KELLOGG NORTH AMERICA COMPANY, BATTLE CREEK, MI, SUNSHINE BISCUITS, INC., LONG ISLAND CITY, NY:
709,731, REN. 5-20-10, U.S. CL. 46 (INT. CLS. 1, 5, 29, 30, 31 AND 32).
- KELLY KATE, INC., NEW YORK, NY:
3,805,451, PUB. 4-6-2010, INT. CL. 3.
- KELLY, DONALD GRANT, ALEXANDRIA, VA:
3,806,414, PUB. 4-6-2010, INT. CL. 45.
- KELTER-THORNER INC. OF MICHIGAN, BIRMINGHAM, MI:
2,286,381, CANC. INT. CL. 36.
- KENAMEA, INC., SAN FRANCISCO, CA:
2,772,168, CANC. MULTIPLE CLASS, INT. CLS. 38 AND 42.
- KENEXA CORPORATION, WAYNE, PA:
3,808,021, MULTIPLE CLASS, INT. CLS. 9 AND 35.
- KENNALEY, MARK, LOS GATOS, CA:
3,806,211, PUB. 4-6-2010, INT. CL. 42.
- KENNETH LIVINGSTON, REDONDO BEACH, CA:
3,806,190, PUB. 4-6-2010, MULTIPLE CLASS, INT. CLS. 32 AND 33.
- KENRICO LTD., SHIMADA, SHIZUOKA, JAPAN:
3,806,477, PUB. 4-6-2010, INT. CL. 10.
- KENT FEEDS, INC., MUSCATINE, IA:
3,807,411, INT. CL. 31.
- KENT INTERNATIONAL INC., PARSIPPANY, NJ:
2,772,452, CANC. INT. CL. 12.
- KENT NUTRITION GROUP, INC., MUSCATINE, IA:
1,135,448, REN. 5-17-10, INT. CL. 5.
2,352,719, REN. 5-17-10, INT. CL. 5.
- KERNER, MARC M., NORTHRIDGE, CA:
2,831,483, AM. INT. CL. 44.
2,924,758, AM. INT. CL. 44.
- KERR, COLIN CHARLES, BURLINGTON, VT:
3,807,085, PUB. 4-6-2010, INT. CL. 7.
- KERSHAWHEALTH, CAMDEN, SC:
3,805,775, PUB. 4-6-2010, MULTIPLE CLASS, INT. CLS. 41 AND 44.
- KERZNER INTERNATIONAL RESORTS, INC., PLANTATION, FL:
3,807,415, INT. CL. 43.
- KESPELHER WINE SHIPPERS GMBH, HEIDENROD, FED REP GERMANY:
3,805,197, PUB. 4-6-2010, INT. CL. 33.

KETTLE MAID, LLC, INDIANAPOLIS, IN:
3,807,666, INT. CL. 43.

KEVMAR VENTURES, LLC, SPEARFISH, SD:
3,806,080, PUB. 4-6-2010. INT. CL. 16.

KEY CLUB ASSOCIATES, LP, LONGBOAT KEY, FL:
3,806,224, PUB. 4-6-2010. MULTIPLE CLASS, INT. CLS.
39, 41 AND 43.

KEY INDUSTRIES, INC., FORT SCOTT, KS:
1,615,828. REN. 5-18-10. INT. CL. 25.

KFORCE GOVERNMENT SOLUTIONS, INC., TAMPA, FL:
2,284,488, CANC. MULTIPLE CLASS, INT. CLS. 37 AND
42.

KIA MOTORS CORPORATION, SEOCHO-GU, SEOUL, RE-
PUBLIC OF KOREA:
2,351,320. REN. 5-19-10. INT. CL. 12.

KIDDE FIRE FIGHTING INC., EXTON, PA:
2,349,669. REN. 5-19-10. INT. CL. 9.
2,354,803. REN. 5-18-10. INT. CL. 9.

KIDDESIGNS, INC., RAHWAY, NJ:
1,559,627, CANC. MULTIPLE CLASS, INT. CLS. 9 AND
11.

KIDROBOT, INC., NEW YORK, NY:
3,808,010, INT. CL. 35.

KIEFEL EXTRUSION GMBH, D-67547 WORMS, FED REP
GERMANY:
2,770,989, CANC. MULTIPLE CLASS, INT. CLS. 7, 9 AND
42.

KIEMELE, ALVIN RAY, VANCOUVER, WA TO RALPH
AND JOAN KROUT OF ACTION PRODUCTS, INC.,
VANCOUVER, WA:
1,560,016, CANC. INT. CL. 28.

KIKI HOLDINGS LLC, NEW YORK, NY:
3,808,621, MULTIPLE CLASS, INT. CLS. 3, 4, 5, 10, 14, 16
AND 24.

KILGORE, KENNETH B, CHARLESTON, TN:
3,806,293, PUB. 4-6-2010. INT. CL. 16.

KIM CHEE PRIDE, INCORPORATED, MASPETH, NY:
3,808,154, INT. CL. 30.

KIM LAUBE & COMPANY, INC., OXNARD, CA:
3,806,491, PUB. 4-6-2010. MULTIPLE CLASS, INT. CLS. 3,
8, 11 AND 21.

KIM, HYUN TAE, LOS ANGELES, CA:
3,805,213, PUB. 10-14-2008. INT. CL. 44.
3,805,214, PUB. 10-14-2008. INT. CL. 44.

KIMBERLY-CLARK WORLDWIDE, INC., NEENAH, WI:
1,559,690, CANC. INT. CL. 10.

KINDERJAM LLC, SEASIDE, CA:
3,805,152, PUB. 4-6-2010. INT. CL. 41.

KINDLE ENTERTAINMENT LTD., UNITED KINGDOM:
3,807,125, PUB. 4-6-2010. MULTIPLE CLASS, INT. CLS. 9,
16, 25, 28, 38 AND 41.

KINESYS PHARMACEUTICAL INC., RICHMOND, CANA-
DA:
3,808,540, INT. CL. 3.

KING BISCUIT ENTERTAINMENT GROUP, NEW YORK,
NY:
2,770,509, CANC. INT. CL. 16.

KING COAL FURNACE CORPORATION, BISMARCK, ND:
3,805,669, PUB. 4-6-2010. INT. CL. 11.

KING KOIL LICENSING COMPANY, INC., WILLOW-
BROOK, IL:
3,077,116, CANC. INT. CL. 20.

KING OF FANS, INC., FT. LAUDERDALE, FL:
2,396,757. REN. 5-18-10. INT. CL. 11.

KINGMAN INTERNATIONAL CORPORATION, BALDWIN
PARK, CA:
3,807,871, INT. CL. 28.

KINGRY, TERI BROXSON, NAVARRE, FL:
2,771,187, CANC. INT. CL. 5.

KINGSDOWN, INC., MEBANE, NC:
3,808,164, INT. CL. 20.

KIRK, BEN, CALGARY, CANADA:
3,806,630, PUB. 4-6-2010. INT. CL. 36.

KIRKWOOD, PETER S, SHAWNEE, PA:
3,806,311, PUB. 4-6-2010. INT. CL. 32.

KIRSCHNER MEDICAL CORPORATION, TIMONIUM, MD:
1,559,684, CANC. INT. CL. 10.

KISS NAIL PRODUCTS, INC., PORT WASHINGTON, NY:
3,807,817, MULTIPLE CLASS, INT. CLS. 9 AND 11.

KITCHEN ON THE STREET, INC, PHOENIX, AZ:
3,805,418, PUB. 4-6-2010. INT. CL. 43.

KITCHENRITE, LLC, SARASOTA, FL, DBA THE COUN-
TERTOP SHOP:
3,808,699, INT. CL. 19.

KITTAS, PAUL, NEW YORK, NY:
3,807,927, INT. CL. 30.

KITZ CORPORATION, JAPAN:
3,807,122, PUB. 4-6-2010. MULTIPLE CLASS, INT. CLS. 6,
7, 9, 11, 12, 17, 20 AND 37.

KLA-TENCOR CORPORATION, MILPITAS, CA:
3,807,865, INT. CL. 9.

KLEIN, FRANK, MUNICH, FED REP GERMANY:
3,805,435, PUB. 11-10-2009. MULTIPLE CLASS, INT. CLS.
10, 28 AND 41.

KLEIN, FRANK, REDWOOD CITY, CA:
3,806,625, PUB. 4-6-2010. INT. CL. 43.

KLEIN, JAMES C., LAS VEGAS, NV:
3,808,428, INT. CL. 22.

KLINE, PHIL, NEW YORK, NY:
3,806,757, PUB. 4-6-2010. INT. CL. 41.

KLUTZ, PALO ALTO, CA:
3,808,090, INT. CL. 16.

KMR HARTNACK INC., DALLAS, TX:
2,770,702, CANC. INT. CL. 37.

KNEEBONE INC., TORONTO, ONTARIO, CANADA:
3,805,598, PUB. 4-6-2010. INT. CL. 35.

KNOPP, WERNER, BERNE, NY:
2,771,561, CANC. INT. CL. 9.

KNOTT MECHANICAL, INC., TIMONIUM, MD:
3,807,793, INT. CL. 42.

KNOWLEDGE ADVENTURE, INC., TORRANCE, CA:
2,356,767. REN. 5-14-10. INT. CL. 41.

KNOWLEDGE ARCHITECTURE, SAN FRANCISCO, CA:
3,805,753, PUB. 4-6-2010. INT. CL. 42.

KNUCKLEHEADS INC., AGOURA HILLS, CA:
3,808,610, MULTIPLE CLASS, INT. CLS. 35 AND 41.

KOA SPEER ELECTRONICS, INC., WILLINGTON, DE:
2,340,831. REN. 5-18-10. INT. CL. 9.

KOBRAY, DENNIS, MILLBURN, NJ:
2,285,161, CANC. INT. CL. 41.

KODI KLIP CORPORATION, LEBANON, TN:
3,807,386, MULTIPLE CLASS, INT. CLS. 7 AND 20.

KOELNMESSE GMBH, FED REP GERMANY:
3,807,153, PUB. 4-6-2010. MULTIPLE CLASS, INT. CLS. 9,
14, 16, 18, 21, 25, 28, 29, 32, 35, 41 AND 42.

KOFRICA ENTERTAINMENT INC., MALIBU, CA:
2,770,545, CANC. INT. CL. 41.

KOHAN CORPORATION, JAPAN:
3,807,137, PUB. 4-6-2010. MULTIPLE CLASS, INT. CLS.
14, 18, 21, 25 AND 26.

KOHLER CO., KOHLER, WI:
3,808,003, INT. CL. 11.

KOHN GALE, LILA, HIGHWOOD, IL:
3,806,228, PUB. 4-6-2010. INT. CL. 35.

KOK, STEVEN WILLEM, AMSTERDAM 1017 EV, NETHER-
LANDS:
3,805,235, PUB. 8-25-2009. INT. CL. 35.

KOM NETWORKS INC., KANATA, ONTARIO, CANADA:
2,772,129, CANC. INT. CL. 9.

KOMPOGAS, 8152 GLATTBRUGG, SWITZERLAND:
2,772,136, CANC. MULTIPLE CLASS, INT. CLS. 7 AND
42.

KOMVOORT B.V., NL-7701 BW DEDEMSVAART, NETHER-
LANDS:
3,686,150, COR. MULTIPLE CLASS, INT. CLS. 1, 9 AND
35.

KONINKLIJKE JUMBO B.V., NETHERLANDS:
3,807,203, PUB. 4-6-2010. MULTIPLE CLASS, INT. CLS.
16, 28 AND 41.

KONINKLIJKE PHILIPS ELECTRONICS N.V., NETHER-
LANDS:
3,807,201, PUB. 4-6-2010. INT. CL. 21.
3,807,202, PUB. 4-6-2010. INT. CL. 21.
3,807,225, PUB. 4-6-2010. INT. CL. 21.

- KONSTANTINE BAKALIS, BROOKLYN, NY:
3,807,426, INT. CL. 3.
- KOOL AS NERDZ INC, RANCHO CUCAMONGA, CA:
3,805,867, PUB. 4-6-2010. INT. CL. 16.
- KOPOTIC, ROBERT J., JAMUI, CA, DBA KAIR MEDICAL INNOVATIONS:
2,284,624, CANC. INT. CL. 10.
- KOREA TIMES NEW YORK, INC., THE, LONG ISLAND CITY, NY:
2,354,338. REN. 5-18-10. INT. CL. 16.
- KORLOFF S.A., LYON, FRANCE:
1,596,305. REN. 5-18-10. INT. CL. 14.
- KORNBLUE KICKING SCHOOL, INC., BONITA SPRINGS, FL:
3,806,251, PUB. 4-6-2010. INT. CL. 41.
- KORNS, JEFFREY L., POTOMAC, MD:
3,805,129, PUB. 4-6-2010. INT. CL. 43.
- KOSS CORPORATION, MILWAUKEE, WI:
1,602,016. REN. 5-17-10. INT. CL. 9.
- KOTTMANN GOSLA GMBH, ISERLOHN, FED REP GERMANY:
3,807,184, PUB. 4-6-2010. MULTIPLE CLASS, INT. CLS. 6, 11 AND 17.
- KP STYLE LTD., DMITROVSKOE SHOSSE, RUSSIAN FED.:
3,807,655, INT. CL. 35.
- KRAUSE, JOSHUA J, KIRKLAND, WA:
2,770,870, CANC. INT. CL. 12.
- KRISH ENTERPRISES LLC, STERLING HEIGHTS, MI, DBA KNR IMPORTS LLC:
3,805,561, PUB. 4-6-2010. INT. CL. 30.
- KRISTEN GALICH, PASADENA, CA, DBA UNITED WORLD UNLIMITED AND VICTORIA ZAKRZEWSKI, PASADENA, CA, DBA UNITED WORLD UNLIMITED:
3,805,960, PUB. 4-6-2010. INT. CL. 41.
- KRISTIANE BACKER, LONDON SW 10, ENGLAND:
2,770,580, CANC. MULTIPLE CLASS, INT. CLS. 3, 4, 5 AND 31.
- KRUGER PRODUCTS L.P., MISSISSAUGA, ON, CANADA:
3,805,200, PUB. 8-25-2009. INT. CL. 16.
- KRUPS GMBH, FEDERAL REPUBLIC, FED REP GERMANY:
2,770,523, CANC. INT. CL. 7.
- KRÜGER GMBH & CO. KG, 51469 BERGISCH GLADBACH, FED REP GERMANY:
3,807,245, PUB. 12-8-2009. MULTIPLE CLASS, INT. CLS. 11, 21 AND 30.
- KRÜGER GMBH & CO. KG, FED REP GERMANY:
3,807,367, PUB. 4-6-2010. INT. CL. 29.
- KT & G CORPORATION, TAEJON, REPUBLIC OF KOREA:
2,295,951. REN. 5-15-10. INT. CL. 34.
- KTV EQUIPMENT, LLC, BREA, CA:
3,806,121, PUB. 4-6-2010. INT. CL. 9.
- KUBOTEK CORPORATION, OSAKA, JAPAN:
2,772,299, CANC. INT. CL. 9.
2,772,300, CANC. INT. CL. 9.
- KUGLER OIL COMPANY, MCCOOK, NE:
1,632,069. REN. 5-20-10. INT. CL. 1.
- KUHN RIKON CORPORATION, NOVATO, CA:
3,807,537, MULTIPLE CLASS, INT. CLS. 8, 9, 21 AND 25.
- KUMKANG SHOE CO., LTD, KYEYANG-GU, INCHEON, REPUBLIC OF KOREA:
2,285,956, CANC. INT. CL. 18.
- KURASHIKI BOSEKI KABUSHIKI KAISHA; (TRADING ALSO AS KURABO INDUSTRIES LTD.), JAPAN:
3,807,146, PUB. 4-6-2010. MULTIPLE CLASS, INT. CLS. 24 AND 25.
- KURETAKE CO., LTD., NARA-SHI, 630, JAPAN:
2,369,124. REN. 5-14-10. INT. CL. 16.
- KURODA PRECISION INDUSTRIES LTD., SAIWAI-KU, KAWASAKI-SHI, KANAGAWA-KEN, JAPAN:
1,131,264. REN. 5-19-10. INT. CL. 9.
- KUROS BIOSURGERY AG, SWITZERLAND:
3,807,132, PUB. 4-6-2010. MULTIPLE CLASS, INT. CLS. 5 AND 10.
- KURT MANUFACTURING COMPANY, INC., FRIDLEY, MN:
2,364,967. REN. 5-17-10. INT. CL. 8.
- KURT NOBLE, INC., SAN FRANCISCO, CA:
2,772,437, CANC. INT. CL. 42.
- KUTLUS, LOUIS M. JR., BROOKHAVEN, PA:
2,284,580, CANC. INT. CL. 42.
- KWON, YOONJOUNG, LOS ANGELES, CA:
3,805,165, PUB. 4-6-2010. INT. CL. 18.
- KWV INTELLECTUAL PROPERTIES (PTY) LIMITED, PAARL 7624, SOUTH AFRICA:
3,805,196, PUB. 4-6-2010. INT. CL. 33.
- KYAZMA B.V., NETHERLANDS:
3,807,341, PUB. 4-6-2010. MULTIPLE CLASS, INT. CLS. 9 AND 16.
- KYNEN, LLC, SEVERNA PARK, MD:
3,807,724, INT. CL. 9.
- KYST CORPORATION, THE, DRACUT, MA:
2,286,213, CANC. INT. CL. 14.
- K2 NETWORK, IRVINE, CA:
3,807,911, INT. CL. 41.
- K9 NATURAL FOOD LTD., CHRISTCHURCH, NEW ZEALAND:
3,807,509, INT. CL. 31.
- L & H OF CALIFORNIA, INC., CERRITOS, CA:
2,284,911, CANC. MULTIPLE CLASS, INT. CLS. 25 AND 35.
- L.A.M. S.R.L., ITALY:
3,807,206, PUB. 4-6-2010. MULTIPLE CLASS, INT. CLS. 11, 12 AND 42.
- L.C. INDUSTRIES, INC., CHICAGO, IL:
2,772,352, CANC. MULTIPLE CLASS, INT. CLS. 20 AND 25.
- L.O.T. LOW OXYGEN TECHNOLOGY GMBH, FED REP GERMANY:
3,754,824, COR. MULTIPLE CLASS, INT. CLS. 9, 11, 37, 41, 42, 43 AND 44.
- L'ART DE LA MODE INC., CARLSTADT, NJ:
2,286,620, CANC. INT. CL. 25.
- L'OREAL, PARIS, FRANCE:
2,770,997, CANC. INT. CL. 3.
2,771,199, CANC. INT. CL. 3.
3,808,522, INT. CL. 3.
- L'OREAL USA CREATIVE, INC., NEW YORK, NY:
2,772,379, CANC. INT. CL. 3.
- LA MONTRE HERMES S.A., 2555 BRUGG, SWITZERLAND:
2,772,372, CANC. INT. CL. 14.
- LA PREFERIDA, INC., CHICAGO, IL:
891,325. REN. 5-20-10. U.S. CL. 46 (INT. CLS. 1, 5, 29, 30, 31 AND 32).
- LABORATOIRE GARNIER & CIE, 75008 PARIS, FRANCE:
2,771,309, CANC. INT. CL. 3.
- LABORATOIRE NATIONAL DE METROLOGIE ET D'ESSAIS, 75015 PARIS, FRANCE:
3,805,127, PUB. 4-6-2010. U.S. CL. B.
- LABORATOIRES SCIENCE ET MER SA, 29480 LE RELECQ KERHUON, FRANCE:
2,770,552, CANC. MULTIPLE CLASS, INT. CLS. 3, 5 AND 42.
- LABORATORIOS FARMACEUTICOS; ROVI, S.A., E-28037 MADRID, SPAIN:
3,807,235, PUB. 4-6-2010. MULTIPLE CLASS, INT. CLS. 5, 10 AND 42.
- LABPLAS INC., QUEBEC, CANADA:
2,405,857. REN. 5-18-10. INT. CL. 9.
- LAFFORT, BORDEAUX, FRANCE:
2,372,150. REN. 5-14-10. MULTIPLE CLASS, INT. CLS. 1 AND 30.
- LAGUNA DEVELOPMENT CORPORATION, ALBUQUERQUE, NM:
3,807,050, PUB. 4-6-2010. INT. CL. 43.
- LAIHO, SHANNON, PARRISH, FL:
3,808,707, INT. CL. 42.
- LAKE LUCIANA LLC, ST. HELENA, CA:
3,807,484, INT. CL. 43.
- LAKE-COOK FARM SUPPLY, WAUCONDA, IL, DBA CONSERV FS:
2,772,139, CANC. INT. CL. 2.
- LAKWOOD PROPERTY OWNERS ASSOCIATION, INC., LEE'S SUMMIT, MO:
1,560,155, CANC. INT. CL. 37.

LAL, DEV, C., AKRON, OH:
2,772,568, CANC. INT. CL. 16.

LAMBERTI S.P.A., ITALY:
3,807,095, PUB. 4-6-2010. MULTIPLE CLASS, INT. CLS.
24, 25 AND 40.

LAMPO LICENSING, LLC, BRENTWOOD, TN:
3,806,519, PUB. 4-6-2010. INT. CL. 35.

LAMSA CORPORATION, CHULA VISTA, CA:
3,808,204, INT. CL. 31.

LANCE MFG. LLC, CHARLOTTE, NC:
2,771,878, CANC. INT. CL. 30.

LANCETTI COSMETICS, DEERFIELD BEACH, FL, DBA
PRESTIGE COSMETICS:
2,770,796, CANC. INT. CL. 3.

LANCOME PARFUMS ET BEAUTE & CIE, PARIS, FRANCE:
2,770,982, CANC. INT. CL. 3.
2,771,306, CANC. INT. CL. 3.
2,771,307, CANC. INT. CL. 3.

LAND O'LAKES, INC., ARDEN HILLS, MN:
3,805,520, PUB. 4-6-2010. INT. CL. 31.
3,808,398, INT. CL. 43.

LAND TEJAS COMPANIES, L.L.C., HOUSTON, TX:
2,771,359, CANC. INT. CL. 37.
2,771,360, CANC. INT. CL. 37.
2,771,361, CANC. INT. CL. 37.

LAND VISTA LLC, NORTHFIELD, MN:
3,805,733, PUB. 4-6-2010. INT. CL. 36.

LANDAIRSEA SYSTEMS, INC., WOODSTOCK, IL:
3,805,618, PUB. 4-6-2010. INT. CL. 9.

LANDMARK CREDIT UNION, WAUKESHA, WI:
3,807,060, PUB. 4-6-2010. INT. CL. 36.

LANDMARK PLASTIC CORPORATION, AKRON, OH:
1,559,863, CANC. INT. CL. 21.

LANDRY'S DOWNTOWN AQUARIUM, INC., HOUSTON,
TX:
2,371,765. REN. 5-18-10. INT. CL. 25.

LANDSCAPE STRUCTURES, INC., DELANO, MN:
3,808,750, INT. CL. 28.

LANDUCCI SABRINA, ITALY:
3,807,231, PUB. 4-6-2010. MULTIPLE CLASS, INT. CLS.
12, 18 AND 25.

LANE EKBERG, WEST JORDAN, UT:
3,807,418, INT. CL. 21.

LANE INVESTMENT COMPANY, MOUNT JOY, PA:
2,771,714, CANC. INT. CL. 37.

LANGVA, MARC D., PLYMOUTH, MN:
3,806,112, PUB. 4-6-2010. INT. CL. 36.

LANNA, LLC, NEW YORK, NY:
3,808,194, INT. CL. 25.

LANTHUM PRODUCTS, LLC, LOS ALTOS, CA:
3,805,128, PUB. 4-6-2010. MULTIPLE CLASS, INT. CLS. 5
AND 28.

LANXESS DEUTSCHLAND GMBH, LEVERKUSEN, FED
REP GERMANY:
878,014, CANC. U.S. CL. 6.

LARATRO, JOSEPH, HALLANDALE, FL:
3,805,557, PUB. 4-6-2010. INT. CL. 35.

LARKIN MORTUARY, SALT LAKE CITY, UT:
2,441,923. REN. 5-18-10. INT. CL. 35.

LARRY MAHAN, INC., CAMP VERDE, TX:
2,286,122, CANC. INT. CL. 3.

LARRY PAUL, LTD., TERRE HAUTE, IN:
3,808,048, INT. CL. 44.
3,808,049, INT. CL. 44.
3,808,050, INT. CL. 44.
3,808,051, INT. CL. 44.

LARRY WARD ENTERPRISES, INC., WESTERVILLE, OH:
2,771,177, CANC. INT. CL. 39.

LAS VEGAS CHAMBER OF COMMERCE LLC, LAS VEGAS,
NV:
3,807,529, INT. CL. 35.

LASER CLEANSER LLC, LITTLETON, CO:
2,771,711, CANC. INT. CL. 44.

LASER ENERGETICS, INC., MERCERVILLE, NJ:
3,807,582, INT. CL. 13.

LASSEN AG INC., FRESNO, CA:
2,349,299. REN. 5-18-10. INT. CL. 16.

LATIN AMERICAN FINANCIAL PUBLICATIONS, INC.,
CORAL GABLES, FL:
1,560,295, CANC. INT. CL. 16.

LAUNCH PAD 39A, LLC, PERRY, GA:
3,806,623, PUB. 4-6-2010. INT. CL. 28.

LAURA KAEHLER ARCHITECTS, L.L.C., GREENWICH,
CT:
3,806,531, PUB. 4-6-2010. INT. CL. 35.

LAUREN ZAHNER, OAKLAND, CA:
3,806,848, PUB. 4-6-2010. INT. CL. 35.

LAUTSPRECHER TEUFEL GMBH, BERLIN, FED REP
GERMANY:
3,806,989, PUB. 4-6-2010. MULTIPLE CLASS, INT. CLS. 9,
35 AND 41.
3,806,990, PUB. 4-6-2010. MULTIPLE CLASS, INT. CLS. 9
AND 35.

LAVISHEA LLC, ELIZABETH, CO:
3,806,015, PUB. 4-6-2010. INT. CL. 3.

LAW, TIMOTHY DAVID, ROSWELL, GA:
3,806,339, PUB. 4-6-2010. INT. CL. 9.

LAX, CHRISTOPHER M, SOUTHLAKE, TX:
3,808,234, INT. CL. 28.

LAZY DAYS' R.V. CENTER, INC., SEFFNER, FL:
3,806,800, PUB. 4-6-2010. MULTIPLE CLASS, INT. CLS. 41
AND 43.

LAZZARA, TONY, NEW YORK, NY:
3,806,304, PUB. 4-6-2010. INT. CL. 41.

LBG ENTERTAINMENT, LLC, BROOKLYN, NY:
3,806,465, PUB. 4-6-2010. INT. CL. 3.

LCFH VENTURES, LLC, SAN DIEGO, CA:
3,805,993, PUB. 4-6-2010. INT. CL. 42.

LDE LOG LLC, CHESTERTOWN, NY:
1,565,916. REN. 5-18-10. INT. CL. 17.

LDSAGENTS, LLC, NACOGDOCHES, TX, DBA LDSAGEN-
TS.COM:
3,806,091, PUB. 4-6-2010. INT. CL. 35.

LE CROBAG GMBH & CO. KG, FED REP GERMANY:
3,807,101, PUB. 4-6-2010. MULTIPLE CLASS, INT. CLS.
29, 30, 35, 41, 42 AND 43.

LEADERSHIP III, LLC, EDINA, MN:
3,808,420, INT. CL. 35.

LEAFWARE LLC, FOLSOM, CA:
3,808,754, INT. CL. 21.

LEARNING TREE INTERNATIONAL, INC., RESTON, VA:
3,807,494, INT. CL. 41.

LEATHERMAN TOOL GROUP, INC., PORTLAND, OR:
3,806,135, PUB. 4-6-2010. MULTIPLE CLASS, INT. CLS. 8,
11 AND 25.

LEBANON SEABOARD CORPORATION, LEBANON, PA:
1,560,074, CANC. INT. CL. 31.

LEBHAR-FRIEDMAN, INC., NEW YORK, NY:
2,770,963, CANC. INT. CL. 16.

LEE FASHION FABRICS, INC., GLOVERSVILLE, NY:
2,770,587, CANC. INT. CL. 24.

LEE, HEATHER A., CHARLOTTESVILLE, VA:
2,771,650, CANC. INT. CL. 41.

LEE, RAYMOND SHU TAK, HUNG HOM, KOWLOON,
HONG KONG:
2,772,356, CANC. INT. CL. 9.

LEE, SHANYAO, SOUTH EL MONTE, CA AND EN, DAVID,
SOUTH EL MONTE, CA:
3,808,256, INT. CL. 13.
3,808,258, INT. CL. 13.
3,808,259, INT. CL. 13.
3,808,260, INT. CL. 13.
3,808,264, INT. CL. 13.
3,808,266, INT. CL. 13.
3,808,267, INT. CL. 13.

LEHIGH OUTFITTERS, LLC, NELSONVILLE, OH:
3,805,900, PUB. 4-6-2010. INT. CL. 42.

LEHIGH PRESS, INC., THE, PENNSAUKEN, NJ:
2,771,358, CANC. INT. CL. 42.

LEHRER BRILLENPERFEKTIONWERKS, INC., CHATS-
WORTH, CA:
2,362,115. REN. 5-18-10. INT. CL. 9.

LEICA CAMERA AG, 35606 SOLMS, FED REP GERMANY:
3,807,307, PUB. 4-6-2010. INT. CL. 9.

- LEIFER, MICHAEL, FAIRFAX, CA:
3,807,822, INT. CL. 35.
- LEINONEN, PETER E., SEATTLE, WA:
2,284,370, CANC. INT. CL. 41.
- LEISURE CARE LLC, SEATTLE, WA:
3,807,531, INT. CL. 37.
- LEITER REALTY GROUP, LLC, BROOKLYN, NY:
3,806,146, PUB. 4-6-2010. INT. CL. 36.
- LEMKEN GMBH & CO. KG, FED REP GERMANY:
3,807,118, PUB. 4-6-2010. INT. CL. 7.
- LEMOPTIX SA, SWITZERLAND:
3,807,310, PUB. 4-6-2010. MULTIPLE CLASS, INT. CLS. 9 AND 42.
- LENBURG, AARON, BOSTON, MA:
3,806,699, PUB. 4-6-2010. INT. CL. 42.
- LENDINGTREE, LLC, CHARLOTTE, NC:
3,807,609, MULTIPLE CLASS, INT. CLS. 35, 36 AND 41.
- LEOADVENTURES, LLC, MILL CREEK, WA:
3,806,134, PUB. 4-6-2010. INT. CL. 35.
- LEONARD, JAMES K., DUBLIN, OH:
2,357,464, REN. 5-19-10. INT. CL. 16.
- LERNER NEW YORK, INC., NEW YORK, NY:
3,805,887, PUB. 4-6-2010. INT. CL. 35.
- LES EDITIONS ALBERT RENE, 75116 PARIS, FRANCE,
DARGAUD S.A. EDITEUR, NEUILLY-SUR-SEINE,
HAUTS DE SEINE, FRANCE:
899,235, REN. 5-14-10. U.S. CL. 38 (INT. CL. 16).
- LESAFFRE ET COMPAGNIE, PARIS, FRANCE:
3,805,281, PUB. 10-20-2009. MULTIPLE CLASS, INT. CLS. 1 AND 5.
- LETNES RESTAURANT GROUP, INC., WAITE PARK, MN:
3,807,885, INT. CL. 43.
- LETS GET LIT CANDLES, INC, MARIETTA, PA:
3,806,074, PUB. 4-6-2010. INT. CL. 21.
- LEUPOLD & STEVENS, INC., BEAVERTON, OR:
905,886, REN. 5-19-10. U.S. CL. 26 (INT. CL. 13).
- LEVETON-JONES, BARBARA, FT. LAUDERDALE, FL:
3,807,738, MULTIPLE CLASS, INT. CLS. 18 AND 25.
- LEVI STRAUSS & CO., SAN FRANCISCO, CA:
1,135,196, REN. 5-18-10. INT. CL. 25.
- LEVINE, MICHAEL, WOODLAND HILLS, CA:
3,807,744, INT. CL. 21.
- LEVITON MANUFACTURING CO., INC., MELVILLE, NY:
3,808,559, INT. CL. 9.
- LEVITY RECORDS, LLC, KNOXVILLE, TN:
3,772,522, COR. INT. CL. 25.
- LEVY, LUC, NEW YORK, NY:
2,771,250, CANC. INT. CL. 35.
- LF, LLC, WILMINGTON, DE:
3,807,806, MULTIPLE CLASS, INT. CLS. 8, 9, 21 AND 25.
3,807,807, MULTIPLE CLASS, INT. CLS. 6, 7, 8, 12, 17 AND 21.
3,808,224, INT. CL. 11.
- LG ELECTRONICS INC., SEOUL, REPUBLIC OF KOREA:
3,805,201, PUB. 1-19-2010. MULTIPLE CLASS, INT. CLS. 7 AND 11.
- LGC WIRELESS, INC., SAN JOSE, CA:
1,559,604, CANC. INT. CL. 9.
- LHG ENTERPRISES-GENERAL CONTRACTORS, INC.,
LUBBOCK, TX, DBA LHG, INC.:
3,806,986, PUB. 4-6-2010. INT. CL. 37.
- LI ZHONGKUI, CHINA:
3,807,306, PUB. 4-6-2010. INT. CL. 18.
- LIBERTY BANKERS LIFE INSURANCE COMPANY, WEST
DES MOINES, IA:
2,771,836, CANC. INT. CL. 36.
- LIBERTY BANKERS LIFE INSURANCE COMPANY, INC.,
WEST DES MOINES, IA:
2,771,077, CANC. INT. CL. 36.
- LIBERTY BRANDS, MELVILLE, NY:
2,772,706, CANC. INT. CL. 34.
- LIBERTY HARDWARE MFG. CORP., BOCA RATON, FL:
2,772,135, CANC. INT. CL. 21.
- LIBERTY MUTUAL INSURANCE COMPANY, BOSTON,
MA:
3,805,332, PUB. 4-6-2010. MULTIPLE CLASS, INT. CLS. 35, 41 AND 42.
- LIBERTY SAFE AND SECURITY PRODUCTS, INC., PAY-
SON, UT:
3,807,702, INT. CL. 20.
- LIBERTYVILLE SADDLE SHOP, INC., LIBERTYVILLE, IL:
1,559,828, CANC. INT. CL. 18.
- LICENSELOGIC, LLC, WASHINGTON, DC:
3,806,322, PUB. 4-6-2010. INT. CL. 41.
- LIEBERT, MARY ANN, NEW ROCHELLE, NY:
3,807,381, INT. CL. 25.
- LIEBHERR-INTERNATIONAL AG, SWITZERLAND:
3,807,119, PUB. 4-6-2010. INT. CL. 11.
- LIEN HWA INDUSTRIAL CORP., TAIPEI, TAIWAN:
2,772,099, CANC. INT. CL. 12.
- LIFE INNOVATIONS, INC., ROSEVILLE, MN:
3,806,117, PUB. 4-6-2010. MULTIPLE CLASS, INT. CLS. 16 AND 45.
- LIFE MASTERY CENTER, INCORPORATED, COCKESY-
VILLE, MD:
1,560,232, CANC. INT. CL. 42.
- LIFE'S RESOURCES, INC., ADDISON, MI:
1,559,715, CANC. INT. CL. 11.
- LIFEBRIDGE CHRISTIAN CHURCH, LONGMONT, CO:
3,806,392, PUB. 4-6-2010. INT. CL. 45.
- LIFELINES LIMITED, HAMPSHIRE, UNITED KINGDOM:
3,805,317, PUB. 4-6-2010. MULTIPLE CLASS, INT. CLS. 9 AND 10.
- LIFENET HEALTH, VIRGINIA BEACH, VA:
3,805,678, PUB. 4-6-2010. MULTIPLE CLASS, INT. CLS. 5, 37 AND 44.
3,805,680, PUB. 4-6-2010. MULTIPLE CLASS, INT. CLS. 37 AND 44.
- LIFETHERAPY, L.L.C., ADDISON, IL:
3,807,549, INT. CL. 3.
- LIFETIME BRANDS, INC., GARDEN CITY, NY, TEXTRON
INC., PROVIDENCE, RI:
1,529,356, REN. 5-20-10. INT. CL. 8.
1,531,672, REN. 5-20-10. INT. CL. 8.
- LIFETIME BRANDS, INC., GARDEN CITY, NY:
3,807,005, PUB. 4-6-2010. INT. CL. 35.
3,808,195, INT. CL. 8.
- LIFTED RESEARCH GROUP INC., IRVINE, CA:
3,808,565, MULTIPLE CLASS, INT. CLS. 18 AND 25.
- LIGHT PRESCRIPTIONS INNOVATORS, LLC, ALTADENA,
CA:
3,807,715, INT. CL. 11.
- LIGHT, MARY ALICE, EAU CLAIRE, WI AND KRUGER,
SUSAN K., EAU CLAIRE, WI:
2,771,246, CANC. INT. CL. 25.
- LIMITED LIABILITY COMPANY; "BTK TRADING LTD",
MOSKVA, RUSSIAN FED.:
3,807,175, PUB. 4-6-2010. MULTIPLE CLASS, INT. CLS. 7, 9 AND 11.
- LIMITLESS SOLUTIONS LLC, LIMA, OH:
3,773,834, COR. INT. CL. 44.
- LIMON PIEL INTERNATIONAL, LLC, COCKEYSVILLE,
MD:
3,806,453, PUB. 4-6-2010. INT. CL. 18.
- LINCOLN GLOBAL, INC., CITY OF INDUSTRY, CA:
3,807,848, INT. CL. 7.
3,808,317, INT. CL. 9.
- LINDA RILEY, BELTON, TX:
3,807,439, INT. CL. 35.
- LINDAL CEDAR HOMES, INC., SEATTLE, WA:
2,351,827, REN. 5-19-10. INT. CL. 19.
- LINDE, INC., MURRAY HILL, NJ:
3,805,380, PUB. 4-6-2010. INT. CL. 9.
- LINDQUIST, PHILIP V., NAPLES, FL AND OLSEN, DOU-
GLAS B., NAPLES, FL:
2,771,466, CANC. INT. CL. 3.
- LINDSAY, RICHARD PAUL, SANTA FE, NM, DBA RI-
CHARD LINDSAY DESIGNS:
1,559,757, CANC. INT. CL. 14.
- LINSTROM CORPORATION, EDDY, TX:
3,807,821, INT. CL. 30.
- LION APPAREL, INC., DAYTON, OH:
3,808,189, INT. CL. 9.

LIONS GATE ENTERTAINMENT INC., SANTA MONICA, CA. AKA LIONSGATE ENTERTAINMENT INC.:
3,806,218, PUB. 4-6-2010. INT. CL. 9.

LIQUID LIGHTNING CORPORATION, POMPTON LAKES, NJ:
3,807,869, INT. CL. 32.

LIQUID WEB, INC., LANSING, MI:
3,808,362, MULTIPLE CLASS, INT. CLS. 38 AND 42.

LISA TIRONE, BLAIRSTOWN, NJ, DBA CHEF IT UP & CHEF IT UP 2 GO:
3,806,508, PUB. 4-6-2010. INT. CL. 41.

LISCO, INC., CHICOPEE, MA:
2,770,524, CANC. INT. CL. 25.

LIST INDUSTRIES INC., DEERFIELD BEACH, FL:
2,327,645, REN. 5-14-10. INT. CL. 20.

LITANI, INC., VAN NUYS, CA:
3,806,673, PUB. 4-6-2010. INT. CL. 3.
3,806,674, PUB. 4-6-2010. INT. CL. 3.

LITTLE GUYS MOVERS, INC., DENTON, TX:
2,286,198, CANC. INT. CL. 39.

LITTLE KIDS, INC., PROVIDENCE, RI:
2,772,721, CANC. INT. CL. 28.

LITTLE MONSTERZ, REDONDO BEACH, CA:
3,806,496, PUB. 4-6-2010. INT. CL. 35.

LITTLE, ANTHONY, D, II, RALEIGH, NC, DBA PUNCH WORX:
3,806,707, PUB. 4-6-2010. INT. CL. 37.

LIU, WINNIE, PITTSBURGH, PA:
3,808,134, INT. CL. 25.
3,808,135, INT. CL. 25.

LIVE OAK LICENSING GROUP, LLC, KATY, TX:
3,805,335, PUB. 4-6-2010. INT. CL. 25.

LIVING RIBBON, SANTA CLARA, CA:
3,808,124, INT. CL. 31.

LIXIVIAN, INC., WAYZATA, MN:
3,806,433, PUB. 4-6-2010. INT. CL. 35.
3,806,434, PUB. 4-6-2010. INT. CL. 40.
3,806,435, PUB. 4-6-2010. INT. CL. 42.

LJC CUTS FOR KIDS II INC., ROSLYN HEIGHTS, NY:
3,808,373, INT. CL. 3.
3,808,374, INT. CL. 3.

LKQ CORPORATION, CHICAGO, IL:
3,807,601, INT. CL. 12.

LMN SOLUTIONS, INC., RESTON, VA:
3,805,921, PUB. 4-6-2010. INT. CL. 42.

LOBOI, JOHN, WINCHESTER, VA:
3,806,588, PUB. 4-6-2010. INT. CL. 35.

LOCAL INSIGHT MEDIA HOLDINGS, INC., ENGLEWOOD, CO:
3,805,367, PUB. 4-6-2010. INT. CL. 16.
3,808,653, MULTIPLE CLASS, INT. CLS. 16, 35, 41 AND 42.

LOCARB5, LLC, LARGO, FL:
3,502,379, CANC. INT. CL. 5.

LOCHINVAR CORPORATION, LEBANON, TN, LOCHINVAR CORPORATION, NASHVILLE, TN:
1,590,749, REN. 5-14-10. INT. CL. 11.

LOCKHEED MARTIN CORPORATION, BETHESDA, MD:
3,807,008, PUB. 4-6-2010. INT. CL. 9.
3,807,025, PUB. 4-6-2010. INT. CL. 6.
3,807,026, PUB. 4-6-2010. INT. CL. 14.
3,807,027, PUB. 4-6-2010. INT. CL. 21.
3,807,028, PUB. 4-6-2010. INT. CL. 22.
3,807,029, PUB. 4-6-2010. INT. CL. 25.
3,807,030, PUB. 4-6-2010. INT. CL. 28.

LODIX CORPORATION, PALM COAST, FL:
3,806,778, PUB. 4-6-2010. INT. CL. 35.

LOEW-CORNELL, LLC, ERLANGER, KY:
1,603,706, REN. 5-17-10. INT. CL. 16.

LOEW'S HOTELS, INC., NEW YORK, NY:
3,807,648, MULTIPLE CLASS, INT. CLS. 35, 41, 43 AND 44.

LOGAN IP HOLDINGS, LLC, LOGAN, UT:
3,807,823, INT. CL. 16.
3,807,824, INT. CL. 25.

LONDON LUXURY LLC, NEW ROCHELLE, NY:
3,808,145, MULTIPLE CLASS, INT. CLS. 20, 24 AND 25.

LONG, MICHAEL, LAKEWOOD, CO AND LONG, CHARLOTTE, LAKEWOOD, CO:
2,285,826, CANC. INT. CL. 36.

LONG'S AMUSEMENT COMPANY, INC., NEWPORT NEWS, VA, TA BILLIARDS EXPRESS:
2,284,591, CANC. INT. CL. 35.

LONGABERGER COMPANY, THE, NEWARK, OH:
2,349,607, REN. 5-19-10. MULTIPLE CLASS, INT. CLS. 6, 9 AND 20.
2,770,577, CANC. MULTIPLE CLASS, INT. CLS. 20, 21 AND 24.

LONNON, CHRISTY L, LARGO, FL, DBA SOBER CAMEL:
3,806,332, PUB. 4-6-2010. INT. CL. 35.

LOOKCLICKPRINT, INC., LOS LUNAS, NM:
2,771,230, CANC. MULTIPLE CLASS, INT. CLS. 16 AND 35.

LOOKSLIKE, INC., LAS VEGAS, NV:
3,805,274, PUB. 8-25-2009. INT. CL. 35.

LOOPT, INC., MOUNTAIN VIEW, CA:
3,806,323, PUB. 4-6-2010. MULTIPLE CLASS, INT. CLS. 38 AND 45.

LOPEZ, GASPAR JORGE GARCIA, MARBELLA (MALAGA), SPAIN:
2,772,089, CANC. INT. CL. 41.

LORD DANIEL SPORTSWEAR, INC., SUNRISE, FL:
2,284,680, CANC. INT. CL. 25.

LORDAN LABORATORIES, INC., CHESTNUT HILL, MA:
2,771,480, CANC. INT. CL. 10.

LOS ANGELES INFRASTRUCTURE ACADEMY, THE, LOS ANGELES, CA:
3,805,748, PUB. 4-6-2010. MULTIPLE CLASS, INT. CLS. 35 AND 41.

LOS ANGELES TIMES COMMUNICATIONS, LLC, LOS ANGELES, CA:
3,808,088, MULTIPLE CLASS, INT. CLS. 16 AND 45.

LOS ANGELES TRADING CO., LOS ANGELES, CA:
2,415,199, REN. 5-18-10. INT. CL. 14.

LOTUS BIO INC, WILMINGTON, DE:
3,806,816, PUB. 4-6-2010. INT. CL. 10.

LOUISIANA ONLINE, INC., BATON ROUGE, LA:
2,772,011, CANC. INT. CL. 38.

LOUISIANA-PACIFIC CORPORATION, PORTLAND, OR:
1,559,843, CANC. INT. CL. 19.

LOVA LLC, NEW YORK, NY:
3,806,298, PUB. 4-6-2010. INT. CL. 30.

LOVE HEALS INC., NEW YORK, NY:
3,805,260, PUB. 4-6-2010. INT. CL. 41.

LOVE SYSTEMS, INC., HOLLYWOOD, CA:
3,806,065, PUB. 4-6-2010. MULTIPLE CLASS, INT. CLS. 9, 16, 35 AND 41.

LOVER'S LANE I.P., LTD., PLYMOUTH, MI:
3,807,576, INT. CL. 30.

LOWER CAPE FEAR HOSPICE INC., WILMINGTON, NC:
3,808,419, INT. CL. 35.

LOYALTYONE US, INC., WILMINGTON, DE:
3,807,973, MULTIPLE CLASS, INT. CLS. 35, 38 AND 44.

LPS IP HOLDING COMPANY, LLC, JACKSONVILLE, FL:
3,806,178, PUB. 4-6-2010. MULTIPLE CLASS, INT. CLS. 35, 36 AND 45.

LRF SLATER COMPANIES, INC., LIVINGSTON, NJ:
1,135,339, REN. 5-17-10. INT. CL. 42.

LUBECKI TECHNICAL HOLDINGS INC., GRANBY QC. J2G 8Y4, CANADA:
2,771,207, CANC. INT. CL. 17.

LUBRIZOL ADVANCED MATERIALS, INC., CLEVELAND, OH:
2,285,976, CANC. INT. CL. 8.

LUCAS, NANCY J., LANSING, IL AND LUCAS, LANCE, LANSING, IL:
3,806,718, PUB. 4-6-2010. INT. CL. 30.

LUCASEY, JOHN, OAKLAND, CA:
3,806,635, PUB. 4-6-2010. INT. CL. 41.

LUCASFILM LTD., SAN FRANCISCO, CA:
2,284,759, CANC. INT. CL. 21.

LUCE, FORWARD, HAMILTON & SCRIPPS LLP, IRVINE, CA:
3,805,655, PUB. 4-6-2010. INT. CL. 45.

- LUCKY GROUP (H. K.) LIMITED, TSIMSHATSUI E. KOWLOON, HONG KONG:
3,807,826, INT. CL. 28.
- LULLABY MOUNTAIN, CEDAR CITY, UT:
2,771,244, CANC. INT. CL. 16.
- LUMIETTE INC., CUPERTINO, CA:
3,808,067, INT. CL. 11.
- LUMINATION LLC, CLEVELAND, OH:
3,807,841, INT. CL. 11.
- LUMINIS USA, INC., FT. LAUDERDALE, FL:
3,806,201, PUB. 4-6-2010. INT. CL. 11.
- LUNA INNOVATIONS INCORPORATED, BLACKSBURG, VA:
2,771,969, CANC. MULTIPLE CLASS, INT. CLS. 1, 9 AND 42.
- LUND, INC., SUWANEE, GA:
2,772,166, CANC. MULTIPLE CLASS, INT. CLS. 6 AND 12.
- LUSH JEWELS LTD., NEW YORK, NY:
3,808,168, INT. CL. 14.
- LUSTIG, DAN A, NEW YORK, NY:
3,806,764, PUB. 4-6-2010. INT. CL. 35.
- LUSTRE-CAL NAMEPLATE CORPORATION, LODI, CA:
2,772,628, CANC. INT. CL. 17.
- LUSTRELAB LXR, INCORPORATED, GREENVILLE, SC:
2,776,648, COR. INT. CL. 3.
- LUTRONIC, INC, PRINCETON JUNCTION, NJ:
3,805,395, PUB. 4-6-2010. INT. CL. 10.
- LUXEON INTERNATIONAL HOLDING LIMITED, TORTOLA, BR. VIRGIN ISLANDS:
3,807,851, INT. CL. 9.
- LUXURIA, S.R.O., PRAHA, CZECH REPUBLIC:
3,807,259, PUB. 4-6-2010. MULTIPLE CLASS, INT. CLS. 25, 32 AND 33.
- LVMH SWISS MANUFACTURES SA, SWITZERLAND:
3,807,272, PUB. 4-6-2010. INT. CL. 14.
- LX NETWORKS LLC, NEW YORK, NY:
3,807,412, INT. CL. 38.
- LYNXXIT, INC., RESTON, VA:
3,808,553, INT. CL. 35.
- M H F C LLC, PASSAIC, NJ:
2,772,397, CANC. INT. CL. 35.
- M. & B. MARCHI E BREVETTI S.R.L., FABRIANO (AN), ITALY:
3,019,624, AM. MULTIPLE CLASS, INT. CLS. 7, 9, 11, 20 AND 37.
- M. SPRAGUE, INC., PORTLAND, OR:
2,294,021, REN. 5-20-10. INT. CL. 11.
- M.A.X. 2001 SPORTMARKETING GMBH, 10587 BERLIN, FED REP GERMANY:
3,807,091, PUB. 4-6-2010. MULTIPLE CLASS, INT. CLS. 14, 16, 18, 21, 24, 25, 28, 35 AND 41.
- MA, CHI, TEMPLE CITY, CA:
3,807,011, PUB. 4-6-2010. INT. CL. 30.
- MACE SECURITY INTERNATIONAL, INC., BENNINGTON, VT:
3,808,019, MULTIPLE CLASS, INT. CLS. 6, 9 AND 13.
- MACERICH PARTNERSHIP, L.P., THE, SANTA MONICA, CA:
2,770,639, CANC. MULTIPLE CLASS, INT. CLS. 35 AND 36.
- MACKAY MITCHELL ENVELOPE COMPANY, LLC, MINNEAPOLIS, MN:
3,806,937, PUB. 4-6-2010. INT. CL. 16.
- MACROSERVE PTE. LTD., SINGAPORE, SINGAPORE:
3,806,055, PUB. 4-6-2010. INT. CL. 35.
- MACROVISION, SUNNYVALE, CA:
2,772,378, CANC. INT. CL. 9.
- MACY'S MERCHANDISING GROUP, INC., NEW YORK, NY:
1,559,949, CANC. INT. CL. 25.
- MADETOORDER, INC., PLEASANTON, CA:
3,806,739, PUB. 4-6-2010. INT. CL. 42.
- MAGDESIAN BROS., INC., CITY OF INDUSTRY, CA:
2,291,898, REN. 5-17-10. INT. CL. 25.
- MAGEBA S.A., SWITZERLAND:
3,807,116, PUB. 4-6-2010. MULTIPLE CLASS, INT. CLS. 6 AND 19.
- MAGEE SCIENTIFIC CORPORATION, BERKELEY, CA:
2,405,685, REN. 5-14-10. INT. CL. 9.
- MAGNA MEASURE, LOS ANGELES, CA:
2,772,459, CANC. INT. CL. 9.
- MAGNUM SEMICONDUCTOR, INC., MILPITAS, CA:
3,805,344, PUB. 2-10-2009. INT. CL. 9.
- MAGWALL LLC, RENO, NV:
3,806,992, PUB. 4-6-2010. INT. CL. 19.
- MAHAR MANUFACTURING CORP., VERNON, CA, DBA FIEST CONCESSION CORP.:
3,808,321, INT. CL. 28.
- MAHLE ENGINE COMPONENTS USA, MUSKEGON, MI:
1,560,275, CANC. INT. CL. 7.
- MAINFRAME ENTERTAINMENT, INC., VANCOUVER, B.C., CANADA:
2,286,197, CANC. INT. CL. 9.
- MAIRDUMONT GMBH & CO. KG, OSTFILDERN, FED REP GERMANY:
2,850,049, AM. MULTIPLE CLASS, INT. CLS. 35, 38, 39 AND 42.
- MAJESCO ENTERTAINMENT COMPANY, EDISON, NJ:
3,806,853, PUB. 4-6-2010. INT. CL. 9.
3,807,003, PUB. 4-6-2010. INT. CL. 9.
- MAJOR LEAGUE SOCCER, L.L.C., NEW YORK, NY:
2,286,762, CANC. MULTIPLE CLASS, INT. CLS. 16 AND 41.
- MAKE WAY ENTERTAINMENT LLC, TROY, MI:
3,806,753, PUB. 4-6-2010. INT. CL. 41.
- MAKI MAKI, INC., IRVINE, CA:
2,771,009, CANC. INT. CL. 43.
- MALDONADO-MONSANTO, VIVIAN, MIDDLETOWN, NY:
3,806,438, PUB. 4-6-2010. INT. CL. 35.
- MALT-O-MEAL COMPANY, MINNEAPOLIS, MN:
3,807,584, INT. CL. 30.
3,808,268, INT. CL. 43.
- MAMA MARIA'S TORTILLAS, INC., MIDVALE, UT:
2,285,634, CANC. INT. CL. 30.
- MAMIYE BROTHERS, INC., KEASBEY, NJ:
1,559,921, CANC. INT. CL. 25.
- MANAGEMENT COMPUTER CONTROLS, INC., MEMPHIS, TN:
3,808,033, INT. CL. 9.
- MANAGEMENT SPECIALTIES LLC, SALT LAKE, UT:
2,770,849, CANC. INT. CL. 21.
- MANDRAKESOFT, 75002 PARIS, FRANCE:
2,770,652, CANC. MULTIPLE CLASS, INT. CLS. 9, 16, 35, 38, 41 AND 42.
- MANHATTAN, LLC, MINNEAPOLIS, MN:
3,808,635, INT. CL. 43.
3,808,636, INT. CL. 43.
- MANLEY LABORATORIES INCORPORATED, CHINO, CA:
3,806,560, PUB. 4-6-2010. INT. CL. 9.
- MANLEY TOYS (USA) LTD., NEW YORK, NY:
1,560,009, CANC. INT. CL. 28.
- MANN MANN APPAREL GROUP LLC, NEW YORK, NY:
3,806,147, PUB. 4-6-2010. INT. CL. 25.
- MANNINGTON MILLS, INC., SALEM, NJ:
2,772,513, CANC. INT. CL. 19.
- MANYWORLDS CONSULTING, INC., HOUSTON, TX:
2,772,601, CANC. INT. CL. 16.
- MANZEN, LLC, LAS VEGAS, NV:
3,808,176, INT. CL. 5.
- MARBLE SPORTSWEAR, INC., BEVERLY HILLS, CA:
2,772,638, CANC. INT. CL. 25.
- MARBORNE S.L., SANLUCAR DE BARRAMEDA (CADIZ), SPAIN:
2,285,975, CANC. INT. CL. 30.
- MARC DELORME, FRANCE:
3,807,139, PUB. 4-6-2010. MULTIPLE CLASS, INT. CLS. 3, 14 AND 25.
- MARC, ROBERT, NEW YORK, NY:
2,375,137, REN. 5-18-10. MULTIPLE CLASS, INT. CLS. 9 AND 35.
- MARCO POLO EXPLORERS, INC., CINCINNATI, OH:
2,772,269, CANC. INT. CL. 16.
- MARGARET A. CARGILL FOUNDATION, CRYSTAL BAY, MN:
3,807,016, PUB. 4-6-2010. INT. CL. 36.

MARGARET L. WENDT FOUNDATION HOLDINGS, INC., BUFFALO, NY:
 3,805,118, PUB. 10-11-1994. INT. CL. 3.
 3,805,119, PUB. 9-17-1996. INT. CL. 21.
 3,805,122, PUB. 7-28-1998. INT. CL. 20.

MARGARET L. WENDT FOUNDATION HOLDINGS, INC., BUFFALO, NY:
 3,805,123, PUB. 3-16-1999. INT. CL. 20.

MARIA POWELL, SAN PABLO, CA:
 3,808,357, INT. CL. 44.

MARIE BRIZARD ET ROGER INTERNATIONAL, 33000 BORDEAUX, FRANCE:
 2,718,407, COR. INT. CL. 33.

MARINE METAL PRODUCTS CO., CLEARWATER, FL:
 3,805,345, PUB. 4-6-2010. INT. CL. 7.

MARITZ HOLDINGS INC., FENTON, MO:
 3,807,653, INT. CL. 35.

MARKEL CORPORATION, GLEN ALLEN, VA:
 3,806,553, PUB. 4-6-2010. INT. CL. 36.
 3,806,929, PUB. 4-6-2010. INT. CL. 36.

MARKER VÖLKL (INTERNATIONAL) GMBH, SWITZERLAND:
 3,807,094, PUB. 4-8-2008. MULTIPLE CLASS, INT. CLS. 9, 25 AND 28.

MARKET AMERICA, INC., GREENSBORO, NC:
 2,364,699, REN. 5-19-10. INT. CL. 5.

MARKET OF AMERICA, INC., IRVINE, CA:
 3,808,710, INT. CL. 8.

MARKET PLACE CLOTHING, INC., CHAMPLAIN, NY:
 3,805,198, PUB. 4-6-2010. INT. CL. 25.

MARKETING ANALYTICS, INC., EVANSTON, IL:
 3,805,490, PUB. 4-6-2010. INT. CL. 35.

MARKOWITZ, MICHAEL, NEW YORK, NY:
 2,772,571, CANC. INT. CL. 28.

MARKZWARE, SANTA ANA, CA:
 3,656,969, AM. INT. CL. 9.

MARKZWARE, SANTA ANA,, CA:
 3,656,970, AM. INT. CL. 9.

MARKZWARE, SANTA ANA, CA:
 3,671,950, AM. INT. CL. 9.

MARLENE GUMMO, WASHINGTON, DC, DBA 3PSOURCING:
 3,807,840, INT. CL. 35.

MARQUIS WHO'S WHO LLC, NEW PROVIDENCE, NJ, A. N. MARQUIS COMPANY, THE, CHICAGO, IL:
 378,389, REN. 5-17-10. U.S. CL. 38 (INT. CL. 16).

MARQUIS WHO'S WHO LLC, NEW PROVIDENCE, NJ, MACMILLAN INFORMATION COMPANY, INC., NEW YORK, NY:
 1,599,566, REN. 5-19-10. INT. CL. 16.

MARRIOTT INTERNATIONAL, INC., BETHESDA, MD:
 899,900, REN. 5-18-10. U.S. CL. 100 (INT. CL. 42).
 2,387,870, REN. 5-18-10. INT. CL. 41.
 3,808,481, INT. CL. 43.

MARS, INCORPORATED, MCLEAN, VA:
 2,284,438, CANC. INT. CL. 30.

MARSHALLS OF NEVADA, INC., NORTH LAS VEGAS, NV:
 3,807,045, PUB. 4-6-2010. INT. CL. 35.

MARTECH MEDICAL PRODUCTS, INC., HARLEYSVILLE, PA:
 3,808,673, INT. CL. 5.

MARTEK BIOSCIENCES CORPORATION, COLUMBIA, MD:
 3,806,958, PUB. 4-6-2010. INT. CL. 29.
 3,806,959, PUB. 4-6-2010. INT. CL. 29.

MARTIN MARIETTA MAGNESIA SPECIALTIES, LLC, RALEIGH, NC:
 2,285,220, CANC. INT. CL. 1.

MARTIN PORTER ASSOCIATES, INC., PORT WASHINGTON, NY:
 3,808,631, INT. CL. 35.

MARTIN, EMMIT, NASHVILLE, TN:
 3,806,037, PUB. 4-6-2010. INT. CL. 41.

MARTIN,STEPHEN,A, SANTA BARBARA, CA:
 3,806,357, PUB. 4-6-2010. INT. CL. 14.

MARTINREA INTERNATIONAL INC., VAUGHAN, ONTARIO, CANADA:
 3,805,190, PUB. 10-13-2009. MULTIPLE CLASS, INT. CLS. 40 AND 42.

MARUF, SITARA N., ROCKVILLE, MD AND MARUF, NIZAMUDDIN J., ROCKVILLE, MD:
 2,772,546, CANC. INT. CL. 41.

MARY KESEL WILLIS, NEWPORT, NC:
 3,806,406, PUB. 4-6-2010. INT. CL. 28.

MARZOLI S.P.A., PROVINCE OF BRESCIA, ITALY:
 2,770,591, CANC. INT. CL. 7.

MASCO CORPORATION OF INDIANA, INDIANAPOLIS, IN:
 2,772,398, CANC. INT. CL. 11.

MASERATI S.P.A., ITALY:
 3,807,258, PUB. 4-6-2010. INT. CL. 28.

MASON LANCE E, THERESA, NY:
 3,805,489, PUB. 12-29-2009. U.S. CL. 200.

MASON, BARBARA J, FRISCO, TX:
 3,808,144, INT. CL. 16.

MASS GROUP, INC., CHATSWORTH, CA, AKA MASS GROUP:
 3,806,014, PUB. 4-6-2010. INT. CL. 35.

MASSACHUSETTS INSTITUTE OF TECHNOLOGY, CAMBRIDGE, MA:
 3,806,607, PUB. 4-6-2010. INT. CL. 41.

MASSAVE PRODUCE, INC., POMPANO BEACH, FL:
 1,560,031, CANC. MULTIPLE CLASS, INT. CLS. 29, 30, 31 AND 42.

MAST DRUG CO., INC., HENDERSON, NC:
 3,806,097, PUB. 4-6-2010. INT. CL. 35.

MASTER DATA CENTER, INC., SOUTHFIELD, MI:
 2,413,847, REN. 5-17-10. INT. CL. 9.

MATEO, QUEENCY D., SAN MARCOS, CA:
 3,806,071, PUB. 4-6-2010. INT. CL. 5.

MATERIALS MANAGEMENT MICROSYSTEMS, MEQUON, WI:
 3,806,153, PUB. 4-6-2010. INT. CL. 9.

MATHEMATICALLY SPEAKING, INC., YARDLEY, PA:
 3,808,412, INT. CL. 16.

MATRIX TECHNOLOGIES CORPORATION, HUDSON, NH:
 2,770,569, CANC. INT. CL. 9.

MATTEL, INC., HAWTHORNE, CA:
 1,560,000, CANC. INT. CL. 28.

MATTEL, INC., EL SEGUNDO, CA:
 2,772,539, CANC. INT. CL. 28.
 2,772,559, CANC. INT. CL. 28.
 3,807,554, INT. CL. 28.
 3,807,850, INT. CL. 28.
 3,807,855, INT. CL. 28.
 3,807,856, INT. CL. 28.
 3,807,857, INT. CL. 28.
 3,807,866, INT. CL. 28.
 3,807,867, INT. CL. 28.
 3,807,868, INT. CL. 28.
 3,807,910, INT. CL. 28.
 3,808,207, INT. CL. 28.
 3,808,212, INT. CL. 28.
 3,808,226, INT. CL. 28.
 3,808,241, INT. CL. 28.
 3,808,262, INT. CL. 28.
 3,808,263, INT. CL. 28.
 3,808,292, INT. CL. 28.
 3,808,482, INT. CL. 28.

MATTHEW WALTON, UNITED KINGDOM:
 3,807,183, PUB. 4-6-2010. MULTIPLE CLASS, INT. CLS. 16 AND 41.

MATTHEWS RESOURCES, INC., WILMINGTON, DE:
 2,351,288, REN. 5-18-10. INT. CL. 42.

MATTHEWS STUDIO EQUIPMENT, INC., BURBANK, CA:
 2,772,171, CANC. INT. CL. 9.

MATTHEWS, RILEY G, LAS VEGAS, NV:
 2,771,523, CANC. U.S. CL. 200.

MATTIOLI, PAUL T., CORONA, CA:
 2,770,887, CANC. INT. CL. 41.

MATTRESS ADVANTAGE, LLC, ROCHESTER, NY:
 2,771,412, CANC. INT. CL. 35.

MATTRESS FIRM, INC., HOUSTON, TX:
 3,806,555, PUB. 4-6-2010. INT. CL. 35.
 3,806,973, PUB. 4-6-2010. INT. CL. 35.
 3,806,995, PUB. 4-6-2010. MULTIPLE CLASS, INT. CLS. 35

- AND 42.
- MAUCK, K. JOAN, LEE'S SUMMIT, MO:
2,284,507, CANC. INT. CL. 25.
- MAUI JIM, INC., LAHAINA, MAUI, HI:
2,251,175, AM. INT. CL. 9.
- MAUI TOYS, INC., YOUNGSTOWN, OH:
3,808,689, INT. CL. 28.
- MAX INTERNATIONAL CONVERTERS, INC., LANCASTER, PA:
3,805,941, PUB. 4-6-2010. INT. CL. 16.
3,805,943, PUB. 4-6-2010. INT. CL. 16.
- MAXAMCORP HOLDING, S.L., SPAIN:
3,807,328, PUB. 4-6-2010. INT. CL. 13.
3,807,331, PUB. 4-6-2010. INT. CL. 13.
- MAXIM INTEGRATED PRODUCTS, INC., SUNNYVALE, CA:
3,807,919, MULTIPLE CLASS, INT. CLS. 9 AND 35.
- MAXIS CORPORATION, TOKYO, JAPAN:
3,805,661, PUB. 4-6-2010. INT. CL. 7.
- MAYNARD MULLEN'S FUR FARM LIMITED, WEYMOUTH, NOVA SCOTIA, CANADA:
1,559,823, CANC. INT. CL. 18.
- MAZDA MOTOR CORPORATION, HIROSHIMA, JAPAN:
2,770,789, CANC. INT. CL. 12.
- MAZUNTE LLC, SANTA MONICA, CA, DBA CIRCLE OF FRIENDS:
2,771,198, CANC. INT. CL. 3.
- MAZUR-HICKS, KARINA, MALIBU, CA:
3,808,325, INT. CL. 25.
- MBSC SECURITIES CORPORATION, NEW YORK, NY:
2,770,957, CANC. INT. CL. 36.
- MICALISTER'S CORPORATION, RIDGELAND, MS:
3,808,174, INT. CL. 30.
- MCCABE PRODUCTIONS, INC., LUTZ, FL:
3,807,818, INT. CL. 28.
- MCCALL FARMS, INC., EFFINGHAM, SC:
3,805,843, PUB. 4-6-2010. INT. CL. 29.
3,805,844, PUB. 4-6-2010. INT. CL. 29.
- MCCLAIN, STEPHANIE A, SLIDELL, LA:
3,806,641, PUB. 4-6-2010. INT. CL. 41.
- MCCLATCHY MANAGEMENT SERVICES, INC., SACRAMENTO, CA:
2,284,978, CANC. INT. CL. 16.
- MCCLERNON, TERRI, CHAPEL HILL, NC:
3,806,559, PUB. 4-6-2010. INT. CL. 9.
3,806,561, PUB. 4-6-2010. INT. CL. 8.
3,806,860, PUB. 4-6-2010. INT. CL. 16.
3,806,864, PUB. 4-6-2010. INT. CL. 43.
- MCCLURE, SAMANTHA ARZONETTI, AUSTIN, TX:
2,383,761, REN. 5-19-10. INT. CL. 39.
- MCCRACKEN EDUCATIONAL SERVICES USA, INC., BLAINE, WA:
2,771,030, CANC. MULTIPLE CLASS, INT. CLS. 16 AND 41.
- MCCREADE SYSTEMS, LLC, WAYNE, NJ:
2,285,370, CANC. INT. CL. 35.
- MCDONALD CORPORATION, COLORADO SPRINGS, CO:
3,805,759, PUB. 11-3-2009. INT. CL. 25.
- MCGRAW-HILL COMPANIES, INC., THE, NEW YORK, NY:
2,771,889, CANC. INT. CL. 42.
- MCILHENNY COMPANY, AVERY ISLAND, LA:
1,560,055, CANC. INT. CL. 30.
- MCKENZIE RIVER CORPORATION, SAN FRANCISCO, CA:
3,808,734, INT. CL. 32.
- MCKINLEY MEDIA, LLC, EAU CLAIRE, WI:
3,807,449, INT. CL. 35.
- MCKINNEY ROGERS INTERNATIONAL LIMITED, LONDON, UNITED KINGDOM:
3,753,760, COR. MULTIPLE CLASS, INT. CLS. 9, 16, 35 AND 41.
- MCLAUGHLIN GORMLEY KING COMPANY, MINNEAPOLIS, MN:
3,806,044, PUB. 4-6-2010. INT. CL. 5.
3,807,745, INT. CL. 5.
3,807,746, INT. CL. 5.
- MCMERLIN DENTAL PRODUCTS, LP, GRAND PRAIRIE, TX, DBA MCMCP:
3,806,426, PUB. 4-6-2010. INT. CL. 5.
- MCMULLIN, SCOTT G, CAPE ELIZABETH, ME:
2,771,732, CANC. INT. CL. 35.
2,771,733, CANC. INT. CL. 35.
2,771,734, CANC. INT. CL. 35.
- MCNALLY-SCHOEN, DAWN L, AURORA, CO, DBA SIMPLY-SAID-SENTIMENTS, INC:
3,806,377, PUB. 4-6-2010. INT. CL. 21.
- MCPHERSON, MATHEW A., NORWALK, WI:
3,807,739, INT. CL. 28.
- MCRAE'S, INC., BIRMINGHAM, AL:
2,772,645, CANC. INT. CL. 21.
- MCS (U.S.A.) MARKETING, COMMERCE & SERVICE, INC., HIGHLAND PARK, IL:
2,771,495, CANC. INT. CL. 30.
- MDI ACHIEVE, INC., ST. LOUIS, MO:
3,806,220, PUB. 4-6-2010. INT. CL. 9.
3,806,221, PUB. 4-6-2010. INT. CL. 9.
- MDS ANALYTICAL TECHNOLOGIES (US) INC., SUNNYVALE, CA:
3,805,370, PUB. 4-6-2010. MULTIPLE CLASS, INT. CLS. 1 AND 9.
- MDSC, INC., EUREKA SPRINGS, AZ, AKA CONNECTED IN CHRIST:
2,771,245, CANC. INT. CL. 41.
- ME MARKETING AND ADVERTISING SERVICES, INC, HOUSTON, TX:
3,808,632, INT. CL. 38.
- MEA MEISINGER STAHL UND KUNSTSTOFF GMBH, AICHACH, FED REP GERMANY:
2,772,033, CANC. MULTIPLE CLASS, INT. CLS. 6 AND 19.
- MEADWESTBACO CORPORATION, STAMFORD, CT:
2,285,312, CANC. INT. CL. 1.
- MEADWESTVACO CORPORATION, RICHMOND, VA:
2,354,773, REN. 5-14-10. INT. CL. 16.
- MEADWESTVACO CORPORATION, STAMFORD, CT:
2,772,486, CANC. INT. CL. 18.
- MEAGHAN WALKER, JEFFENY HUGHES AND MICHELLE ALEXANDER, LONG BEACH, CA, DBA PRIVATE ARTS:
3,807,961, INT. CL. 25.
- MEASUREMENT SPECIALISTS, HUNTSVILLE, AL:
2,772,082, CANC. INT. CL. 9.
- MECENA FINANCE LTD., ZUG, SWITZERLAND:
3,480,580, AM. INT. CL. 35.
- MECKLENBURG BAR FOUNDATION, CHARLOTTE, NC:
3,805,567, PUB. 4-6-2010. INT. CL. 36.
- MECKLENBURG COUNTY BAR, CHARLOTTE, NC:
3,805,565, PUB. 4-6-2010. INT. CL. 41.
- MED-EL ELEKTROMEDIZINISCHE GERATE GES. M.B.H., 6020 INNSBRUCK, AUSTRIA:
3,747,993, COR. MULTIPLE CLASS, INT. CLS. 9, 10, 16 AND 41.
- MEDEA CORPORATION, WESTLAKE VILLAGE, CA:
2,772,107, CANC. INT. CL. 9.
- MEDELA HOLDING AG, CH-6340 BAAR, SWITZERLAND:
3,807,180, PUB. 4-6-2010. MULTIPLE CLASS, INT. CLS. 3, 5, 9, 10, 11, 18, 21, 25, 40, 41 AND 44.
- MEDI-DYNE HEALTHCARE PRODUCTS, LTD., COLLEYVILLE, TX:
2,285,365, CANC. INT. CL. 28.
- MEDI-REJUVENATION CORPORATION, TORRANCE, CA:
3,807,602, MULTIPLE CLASS, INT. CLS. 3 AND 44.
- MEDIA SOLUTIONS (PVT.) LTD., COLOMBO 5, SRI LANKA:
2,770,645, CANC. INT. CL. 9.
- MEDIANT HEALTH, INC, TAMPA, FL:
3,806,552, PUB. 4-6-2010. INT. CL. 44.
- MEDIAWHIZ HOLDINGS, INC., NEW YORK, NY:
3,806,976, PUB. 4-6-2010. INT. CL. 35.
3,807,009, PUB. 4-6-2010. INT. CL. 35.
- MEDICAL ADVISORS, INC., PLYMOUTH MEETING, PA:
1,595,814, REN. 5-19-10. INT. CL. 42.
- MEDICAL COMMUNICATIONS MEDIA, WRIGHTSTOWN, PA:
2,771,801, CANC. INT. CL. 41.
- MEDICAL DEPOT, INC., PORT WASHINGTON, NY:
3,807,550, INT. CL. 12.

- MEDICAL MUTUAL OF OHIO, CLEVELAND, OH:
2,352,997. REN. 5-18-10. INT. CL. 36.
- MEDICAL SPECIALISTS OF THE PALM BEACHES, INC.,
LAKE WORTH, FL:
3,806,798, PUB. 4-6-2010. INT. CL. 44.
- MEDIDATA FT, INC., NEW YORK, NY:
2,286,593, CANC. INT. CL. 9.
- MEDIGENE AG, FED REP GERMANY:
3,807,191, PUB. 4-6-2010. INT. CL. 5.
- MEDIVIR AB, HUDDINGE, SWEDEN:
3,805,983, PUB. 2-16-2010. INT. CL. 5.
- MEDPRO SYSTEMS, LLC, MT. ARLINGTON, NJ:
3,806,302, PUB. 4-6-2010. INT. CL. 35.
3,806,303, PUB. 4-6-2010. INT. CL. 35.
- MEDSERV GROUP, INC., VISTA, CA:
3,807,441, INT. CL. 10.
- MEEBO, INC., MOUNTAIN VIEW, CA:
3,805,519, PUB. 4-6-2010. INT. CL. 38.
- MEESH CLOTHING COMPANY LLC, TROY, MI:
3,808,777, INT. CL. 25.
- MEGA BRANDS INTERNATIONAL, LUXEMBOURG, ZUG
BRANCH, ZUG, SWITZERLAND:
2,284,955, CANC. MULTIPLE CLASS, INT. CLS. 3 AND
28.
- MEGA FORTRIS (MALAYSIA) SDN BHD, MALAYSIA:
3,807,300, PUB. 4-6-2010. INT. CL. 35.
- MEGADYNE MEDICAL PRODUCTS, INC., DRAPER, UT:
2,356,350. REN. 5-20-10. INT. CL. 10.
- MEGATRANS LOGISTICS, INC., DORAL, FL, DBA ORION
INTERNATIONAL MEGA LOGISTIC:
3,805,601, PUB. 4-6-2010. INT. CL. 39.
- MEGAWINE, INC., VAN NUYS, CA:
3,808,155, INT. CL. 33.
- MEGTEC SYSTEMS, INC., DEPERE, WI:
1,559,716, CANC. INT. CL. 11.
- MEHYPE, LLC, DAYTONA BEACH, FL:
3,807,863, INT. CL. 35.
- MEIJER, INC., GRAND RAPIDS, MI:
1,608,007. REN. 5-17-10. INT. CL. 10.
- MEKPONGSATORN, JOHN SURAPOL, ALHAMBRA, CA:
3,808,196, INT. CL. 43.
- MELITTA HAUSHALTSPODUKTE GMBH AND CO. KG,
32427 MINDEN, FED REP GERMANY:
2,349,107. REN. 5-18-10. INT. CL. 16.
- MELODIE HAYS, COCOA, FL:
3,807,843, INT. CL. 43.
- MELTEC GMBH & CO. KG, 39120 MAGDEBURG, FED REP
GERMANY:
2,770,826, CANC. MULTIPLE CLASS, INT. CLS. 1, 5, 9, 16
AND 42.
- MELVIN D. PLUMMER, LOS ANGELES, CA:
3,807,719, INT. CL. 28.
- MEMORIAL BLOOD CENTERS, ST. PAUL, MN:
3,806,723, PUB. 4-6-2010. INT. CL. 44.
- MENARD, INC., EAU CLAIRE, WI:
3,807,534, INT. CL. 6.
- MENDEZ, MICHAEL, BALTIMORE, MD:
2,770,787, CANC. INT. CL. 25.
- MENDEZ, ROQUE, CORONA, NY, AKA CHIKO MENDEZ
AND AYALA, JIMMY, CENTRAL VALLEY, NY:
3,805,383, PUB. 4-6-2010. INT. CL. 9.
- MENTICE AB, GOTENBORG, SWEDEN:
3,807,430, MULTIPLE CLASS, INT. CLS. 9 AND 41.
- MEPHISTO S.A.; (SOCIÉTÉ ANONYME À DIRECTOIRE ET;
CONSEIL DE SURVEILLANCE), SARREBOURG,
FRANCE:
3,807,141, PUB. 4-6-2010. MULTIPLE CLASS, INT. CLS. 25
AND 35.
- MERA MARCAS SA DE CV, ARLINGTON, VA:
3,805,351, PUB. 4-6-2010. INT. CL. 43.
3,805,352, PUB. 4-6-2010. INT. CL. 43.
- MERCADO LATINO, INC., CITY OF INDUSTRY, CA, DBA
FARAON FOODS:
1,590,089. REN. 5-14-10. INT. CL. 30.
- MERCK SHARP & DOHME CORP., WHITEHOUSE STA-
TION, NJ:
2,771,472, CANC. INT. CL. 44.
- MERCURY INTERNATIONAL TRADING CORPORATION,
NORTH ATTLEBORO, MA:
3,806,432, PUB. 4-6-2010. INT. CL. 25.
- MEREDITH CORPORATION, DES MOINES, IA:
1,559,806, CANC. INT. CL. 16.
- MERIDIAN LIFEFORCE INC., SCARBOROUGH, ONTAR-
IO, CANADA AND OHENHEN, KINGSLEY, SCARBOR-
OUGH, ONTARIO, CANADA:
3,808,748, INT. CL. 44.
- MERIT PROPERTY MANAGEMENT, INC., ALISO VIEJO,
CA:
3,807,987, INT. CL. 36.
- MERKEL JAGD- UND SPORTWAFFEN GMBH, 98527
SUHL, FED REP GERMANY:
3,807,128, PUB. 4-6-2010. MULTIPLE CLASS, INT. CLS. 8
AND 13.
- MERLE FREED, INC., ST. LOUIS, MO:
2,771,102, CANC. INT. CL. 35.
- MERLE-SMITH, EDMUND L., KEENE VALLEY, NY:
2,285,738, CANC. INT. CL. 28.
- MERRELL, JOHN, WELLINGTON, FL, DBA XTREME
TAEKWONDO:
3,805,507, PUB. 4-6-2010. INT. CL. 25.
- MERRILL LYNCH & CO., INC., NEW YORK, NY:
2,772,693, CANC. INT. CL. 36.
- MESIROW FINANCIAL HOLDINGS, INC., CHICAGO, IL:
1,560,128, CANC. INT. CL. 36.
2,772,337, CANC. INT. CL. 36.
3,806,342, PUB. 4-6-2010. INT. CL. 36.
- MESOPHASE TECHNOLOGIES INC., SINSHIH TOWNSHIP,
TAIWAN:
3,774,343, COR. MULTIPLE CLASS, INT. CLS. 3, 5 AND
7.
- METACAUSE SOLUTIONS LIMITED, SWANSEA, W. GLA-
MORGAN, UNITED KINGDOM:
3,805,256, PUB. 4-6-2010. MULTIPLE CLASS, INT. CLS. 9,
16, 35, 41 AND 42.
- METAL FORMS CORPORATION, MILWAUKEE, IL:
3,807,714, INT. CL. 6.
- METALLWARENFABRIK MARKTOBERDORF; GMBH &
CO. KG, FED REP GERMANY:
3,807,108, PUB. 12-29-2009. MULTIPLE CLASS, INT. CLS.
8, 9 AND 21.
- METRA ELECTRONICS CORPORATION, HOLLY HILL, FL:
3,808,416, INT. CL. 9.
- METRAFLEX COMPANY, THE, CHICAGO, IL:
2,364,076. REN. 5-19-10. MULTIPLE CLASS, INT. CLS. 6
AND 17.
- METREX RESEARCH CORPORATION, ORANGE, CA:
2,285,824, CANC. INT. CL. 5.
- METROPOLITAN MANAGEMENT CORPORATION, NAR-
BERTH, PA:
2,383,300. REN. 5-14-10. INT. CL. 36.
- METROPOLITAN WATER DISTRICT, LOS ANGELES, CA:
3,805,628, PUB. 4-6-2010. MULTIPLE CLASS, INT. CLS.
35, 39 AND 44.
- METSO MINERALS INDUSTRIES, INC., WAUKESHA, WI,
SVEDALA INDUSTRIES, INC., WAUKESHA, WI:
2,441,792. REN. 5-19-10. INT. CL. 6.
- MEXICAN HERITAGE CORPORATION OF SAN JOSE, SAN
JOSE, CA:
2,771,531, CANC. INT. CL. 41.
- MEYER MANUFACTURING COMPANY LIMITED, KOW-
LOON, HONGKONG, CHINA:
3,808,025, INT. CL. 21.
- MGA ENTERTAINMENT, INC., VAN NUYS, CA:
3,808,516, INT. CL. 28.
- MHZ HACHTEL GMBH, MUSBERG, FED REP GERMANY:
1,559,694, CANC. MULTIPLE CLASS, INT. CLS. 11, 20, 22
AND 24.
- MI MADRE'S MEXICAN RESTAURANT, INC., AUSTIN,
TX:
3,805,166, PUB. 4-6-2010. INT. CL. 43.
- MICHAEL DRESCHER, FED REP GERMANY:
3,807,151, PUB. 4-6-2010. MULTIPLE CLASS, INT. CLS. 35
AND 41.

- MICHAEL ENGEL INDUSTRIES, INC., HILLSBOROUGH, NJ, TA LITTLE JOE INDUSTRIES:
2,389,914, REN. 5-20-10. INT. CL. 9.
- MICHAEL FOODS OF DELAWARE, INC., MINNEAPOLIS, MN:
3,808,487, INT. CL. 29.
- MICHAEL GRAVES DESIGN GROUP, INC., PRINCETON, NJ:
2,770,554, CANC. MULTIPLE CLASS, INT. CLS. 6 AND 11.
2,770,576, CANC. MULTIPLE CLASS, INT. CLS. 20 AND 21.
- MICHAEL J NAPOLI JR, PALM SPRINGS, CA, DBA PERFORMING ARTS LIVE:
3,808,725, INT. CL. 41.
- MICHAEL J. CURTIN & ASSOCIATES, INC., PARKLAND, FL:
3,807,931, INT. CL. 36.
- MICHAEL LIM, KANEOHE, HI, DBA EVENT HORIZON:
3,806,876, PUB. 4-6-2010. INT. CL. 35.
- MICHAEL WALSH, INC., BURNSVILLE, MN:
3,806,947, PUB. 4-6-2010. INT. CL. 9.
- MICHAEL, DAVID, POINT ROBERTS, WA:
3,807,898, INT. CL. 25.
3,807,918, INT. CL. 25.
- MICHAUD, LOIS, PUEBLO WEST, CO:
3,808,304, INT. CL. 25.
- MICHELE AUDIO CORPORATION OF AMERICA, MASSENA, NY:
2,401,831, REN. 5-18-10. INT. CL. 9.
- MICRO ELECTRONICS, INC., HILLIARD, OH:
2,351,726, REN. 5-19-10. INT. CL. 35.
- MICROSOFT CORPORATION, REDMOND, WA:
3,807,907, INT. CL. 9.
- MICROVENTION, INC., TUSTIN, CA:
3,808,079, INT. CL. 10.
- MID PAC PETROLEUM, LLC., HONOLULU, HI:
3,807,809, INT. CL. 35.
- MIKROMASCH EESTI LTD., 11313 TALLINN, ESTONIA:
2,770,879, CANC. MULTIPLE CLASS, INT. CLS. 9 AND 42.
- MILES-BRAMWELL EXECUTIVE SERVICES LIMITED, DERBYSHIRE, UNITED KINGDOM:
3,805,199, PUB. 4-6-2010. MULTIPLE CLASS, INT. CLS. 16, 41 AND 44.
- MILHOUS, MARIA M., LOOMIS, CA:
3,807,575, INT. CL. 7.
- MILL CREEK BANK INC., SALT LAKE CITY, UT:
2,771,497, CANC. INT. CL. 36.
- MILLER INTERNATIONAL, INC., DENVER, CO:
3,808,508, INT. CL. 25.
- MILLER OIL CO., INC., NORFOLK, VA:
2,771,924, CANC. INT. CL. 35.
- MILLER, JAMES TIMOTHY, NORMAN, OK:
2,771,011, CANC. INT. CL. 16.
- MILLERCOORS LLC, WILMINGTON, DE:
3,807,659, INT. CL. 32.
- MILLERCOORS LLC, CHICAGO, IL:
3,808,735, INT. CL. 32.
- MILLIKEN & COMPANY, SPARTANBURG, SC:
2,772,688, CANC. INT. CL. 27.
3,807,579, INT. CL. 40.
3,807,845, INT. CL. 5.
- MILNOR, WALKER I., MEMPHIS, TN:
3,806,632, PUB. 4-6-2010. INT. CL. 36.
- MILWAUKEE ELECTRIC TOOL CORPORATION, BROOKFIELD, WI:
3,707,242, CANC. INT. CL. 7.
3,707,244, CANC. INT. CL. 7.
- MINARDI BEAUTY PRODUCTS, INC., NEW YORK, NY:
3,808,550, INT. CL. 3.
- MINDGIFTS, LLC, CHICAGO, IL:
2,772,667, CANC. INT. CL. 41.
- MINDLEADERS, INC., DUBLIN, OH:
1,559,671, CANC. INT. CL. 9.
- MINISTER MACHINE COMPANY, THE, MINSTER, OH:
2,285,940, CANC. INT. CL. 9.
- MINNESOTA ONCOLOGY HEMATOLOGY, P.A., ST. PAUL, MN:
3,807,924, INT. CL. 44.
- MINNESOTA PUBLIC RADIO, ST. PAUL, MN:
3,806,541, PUB. 4-6-2010. INT. CL. 41.
- MINNESOTA SCIENTIFIC, INC, ST PAUL, MN:
2,772,720, CANC. INT. CL. 10.
- MINOO TRADING CO., IRVINE, CA:
2,771,491, CANC. INT. CL. 30.
- MINOPHAGEN PHARMACEUTICAL CO., TOKYO 160-0004, JAPAN:
2,770,538, CANC. INT. CL. 5.
- MINT SALON, LLC, NEW YORK, NY:
3,806,144, PUB. 4-6-2010. INT. CL. 44.
- MIRATREK, INC., SAN DIEGO, CA:
3,805,279, PUB. 4-6-2010. INT. CL. 9.
- MIS QUALITY MANAGEMENT CORP., WILMINGTON, DE:
2,359,120, REN. 5-18-10. INT. CL. 9.
- MISSAL LLC, ANCHORAGE, AK, DBA JILL MISSAL:
3,806,312, PUB. 4-6-2010. INT. CL. 41.
- MISSION SPOTLIGHT, DECATUR, GA:
2,771,385, CANC. INT. CL. 9.
- MISSION: FREEDOM'S CHILDREN, AMARILLO, TX:
3,808,006, INT. CL. 36.
- MISSISSIPPI TODAY, INC., JACKSON, MS:
2,772,752, CANC. MULTIPLE CLASS, INT. CLS. 9 AND 45.
- MISSOURI INNOVATION CENTER, INC., COLUMBIA, MO:
2,771,459, CANC. INT. CL. 35.
2,771,460, CANC. INT. CL. 35.
- MISTY MOUNTAIN DESIGNS, KNOXVILLE, TN, DBA WALLPRAISE:
3,805,623, PUB. 4-6-2010. INT. CL. 16.
- MITCHELL, LAURA LOUISE, HOUSTON, TX:
2,770,589, CANC. INT. CL. 16.
- MITCHELL, PACE & ASSOCIATES, INC., WAUKESHA, WI:
3,807,631, INT. CL. 35.
- MITO CORPORATION, ELKHART, IN:
3,806,762, PUB. 4-6-2010. INT. CL. 9.
- MITSUBISHI CABLE INDUSTRIES, LTD., TOKYO, JAPAN:
3,807,471, MULTIPLE CLASS, INT. CLS. 7 AND 17.
- MITSUBISHI HEAVY INDUSTRIES, LTD., TOKYO 108-8215, JAPAN:
3,807,340, PUB. 4-6-2010. INT. CL. 7.
- MITSUBISHI PLASTICS, INC., TOKYO, JAPAN:
1,603,747, REN. 5-18-10. INT. CL. 17.
- MITSUBISHI RAYON CO., LTD., JAPAN:
3,807,313, PUB. 4-6-2010. INT. CL. 28.
3,807,314, PUB. 4-6-2010. INT. CL. 28.
3,807,315, PUB. 4-6-2010. INT. CL. 28.
- MITSUI TAKEDA CHEMICALS, INC., MINATO-KU, TOKYO, JAPAN:
2,770,757, CANC. INT. CL. 1.
- MIZA PHARMACEUTICALS, INC., TORONTO, ONTARIO, CANADA:
2,771,573, CANC. INT. CL. 42.
- MIZUNO CORPORATION, OSAKA, 541-8538, JAPAN:
3,808,324, INT. CL. 25.
- MJ SPECIALTY RETAIL, LLC., WALNUT SHADE, MO:
3,806,648, PUB. 4-6-2010. INT. CL. 10.
- MJM INTERNATIONAL LIMITED, GLASGOW, UNITED KINGDOM:
3,807,067, PUB. 10-14-2008. INT. CL. 25.
- MKS INSTRUMENTS, INC., WILMINGTON, MA:
2,286,265, CANC. INT. CL. 9.
- MNS CORPORATION, SEATTLE, WA:
2,368,087, REN. 5-20-10. MULTIPLE CLASS, INT. CLS. 16 AND 20.
- MOBEZE, INC., SAN DIEGO, CA:
3,805,229, PUB. 4-6-2010. MULTIPLE CLASS, INT. CLS. 38 AND 39.
- MOBILITY ELECTRONICS, INC., SCOTTSDALE, AZ TO IGO, INC., SCOTTSDALE, AZ:
2,286,166, CANC. INT. CL. 9.
- MOD SYSTEMS INCORPORATED, SEATTLE, WA:
3,807,510, INT. CL. 9.

MODULOC CONTROLS LIMITED, ST ALBANS, GREAT BRITAIN:
 3,805,402, PUB. 4-6-2010. INT. CL. 9.

MOGG CONSTRUCTIVE INC., MISSISSAUGA ON, CANADA:
 3,806,885, PUB. 4-6-2010. INT. CL. 6.

MOHAWK CARPET DISTRIBUTION, INC, CALHOUN, GA:
 2,770,871, CANC. INT. CL. 19.
 2,771,594, CANC. INT. CL. 27.
 2,772,114, CANC. INT. CL. 27.

MOLL ANDERSON HOME, LLC, KNOXVILLE, TN:
 3,808,561, MULTIPLE CLASS, INT. CLS. 2, 24, 41, 42, 43 AND 44.

MOLNLYCKE HEALTH CARE AB, GOTEBURG, SWEDEN:
 3,807,728, MULTIPLE CLASS, INT. CLS. 5 AND 10.

MOMATT, S.A. DE C.V., COL. MOCTEZUMA 2A SECCION, MEXICO:
 2,771,950, CANC. INT. CL. 7.

MOMENTIVE PERFORMANCE MATERIALS INC., ALBANY, NY:
 3,807,521, INT. CL. 1.

MOMENTUM BICYCLE GROUP LIMITED, AUCKLAND, NEW ZEALAND:
 3,807,490, INT. CL. 12.

MOMENTUM SALES & MARKETING, INC., TAMPA, FL:
 3,808,186, INT. CL. 3.
 3,808,478, INT. CL. 11.

MOMENTUM 1 PRODUCTS, INC., DEL MAR, CA:
 3,805,781, PUB. 4-6-2010. INT. CL. 35.

MONAVIE, LLC, SOUTH JORDAN, UT:
 3,806,053, PUB. 4-6-2010. INT. CL. 25.
 3,808,270, INT. CL. 32.
 3,808,271, INT. CL. 5.

MONCADA, CARLOS, SALINAS, CA:
 3,807,930, INT. CL. 41.

MONEY MANAGEMENT INTERNATIONAL, INC., HOUSTON, TX:
 3,501,815, CANC. INT. CL. 36.

MONEY STORE INC., THE, UNION, NJ:
 1,560,291, CANC. INT. CL. 16.

MONEYBOOKERS LTD., EC1 M6EH LONDON, UNITED KINGDOM:
 3,805,446, PUB. 4-6-2010. MULTIPLE CLASS, INT. CLS. 35, 36 AND 38.
 3,805,447, PUB. 4-6-2010. MULTIPLE CLASS, INT. CLS. 35, 36 AND 38.

MONOSCOOP B.V., ALKMAAR, NETHERLANDS:
 3,805,224, PUB. 4-6-2010. INT. CL. 9.

MONOSCOOP, B.V., ALKMAAR, NETHERLANDS:
 3,805,227, PUB. 4-6-2010. INT. CL. 9.
 3,805,228, PUB. 4-6-2010. INT. CL. 9.
 3,805,236, PUB. 4-6-2010. INT. CL. 9.
 3,805,308, PUB. 4-6-2010. INT. CL. 9.
 3,805,309, PUB. 4-6-2010. INT. CL. 9.

MONROVIA NURSERY COMPANY, AZUSA, CA:
 3,805,815, PUB. 4-6-2010. INT. CL. 31.

MONSTER CABLE PRODUCTS, INC., BRISBANE, CA:
 3,807,024, PUB. 4-6-2010. INT. CL. 9.

MONTANA SILVERSMITHS, INC., COLUMBUS, MT:
 2,411,683. REN. 5-20-10. MULTIPLE CLASS, INT. CLS. 8 AND 14.

MONTE CRISTO MULTIMEDIA, PARIS, FRANCE:
 3,807,176, PUB. 4-6-2010. MULTIPLE CLASS, INT. CLS. 9 AND 41.

MONTEREY MUSHROOMS, INC., WATSONVILLE, CA:
 2,426,614. REN. 5-20-10. INT. CL. 31.

MONTERREY PROVISION COMPANY, SAN DIEGO, CA:
 3,807,679, INT. CL. 35.

MONTRES UNIVERSAL S.A., LES ACACIAS - GENEVE, SWITZERLAND:
 3,695,531, COR. INT. CL. 14.

MOONLIGHT SYSTEMS, INC., SAN MATEO, CA:
 2,772,054, CANC. MULTIPLE CLASS, INT. CLS. 9, 35, 41 AND 42.
 2,772,055, CANC. MULTIPLE CLASS, INT. CLS. 9, 35, 41 AND 42.
 2,772,056, CANC. MULTIPLE CLASS, INT. CLS. 9, 35, 41 AND 42.

MOOP LLC, PITTSBURGH, PA:
 3,806,335, PUB. 4-6-2010. INT. CL. 18.

MOORE PRODUCTS CO., SPRING HOUSE, PA:
 1,559,598, CANC. INT. CL. 9.

MOORE, JAMES, GRANBURY, TX:
 2,772,360, CANC. INT. CL. 28.

MOORE, KATHLEEN K., HILTON HEAD ISLAND, SC:
 2,770,784, CANC. INT. CL. 16.

MOORE, VANORRIS E., MACON, GA:
 3,807,875, INT. CL. 25.

MORGAN DYNAMIC PHONICS, INC., ALBUQUERQUE, NM:
 2,285,471, CANC. INT. CL. 16.

MORGAN JEWELERS OF SALT LAKE CITY, INC., SALT LAKE CITY, UT:
 3,807,456, INT. CL. 35.

MORGAN STANLEY, NEW YORK, NY:
 2,772,116, CANC. INT. CL. 9.

MORGAN STANLEY SMITH BARNEY HOLDINGS LLC, PURCHASE, NY:
 2,771,980, CANC. INT. CL. 36.

MORNINGFOREST, CHRIS, APACHE JUNCTION, AZ:
 3,806,754, PUB. 4-6-2010. INT. CL. 16.

MORRIS NATIONAL, INC., AZUSA, CA:
 2,772,425, CANC. INT. CL. 30.

MORRIS PUBLISHING GROUP, LLC, AUGUSTA, GA:
 2,836,265, AM. INT. CL. 16.

MORRIS, ANITA L., NEW HARTFORD, NY, DBA THE DANCE STORE:
 1,559,901, CANC. INT. CL. 25.

MORRIS, JACQUELINE, GLEN BURNIE, MD:
 2,771,603, CANC. INT. CL. 41.

MORRIS, MICHAEL, BETHEL, CT, DBA FRIENDLY CARDS AND GILLAIN-REGNEY, DOMINIQUE, BETHEL, CT, DBA FRIENDLY CARDS:
 3,805,872, PUB. 4-6-2010. INT. CL. 16.

MORRIS, RICHARD L JR, MIAMI BEACH, FL:
 3,807,072, PUB. 12-9-2008. INT. CL. 42.

MORTIMER TECHNOLOGY HOLDINGS LIMITED, LONDON, UNITED KINGDOM:
 2,772,163, CANC. U.S. CL. A.

MOSS ADAMS LLP, SANTA ROSA, CA:
 3,808,764, INT. CL. 16.

MOTOR CITY FLOORING, L.L.C., DETROIT, MI:
 2,771,080, CANC. INT. CL. 19.

MOTOROLA, INC., SCHAUMBURG, IL:
 2,771,536, CANC. INT. CL. 9.

MOTT, KATHLEEN, LARGO, FL:
 1,559,465, CANC. INT. CL. 1.

MOUNTAINBOARDS, LLC, COLORADO SPRINGS, CO:
 2,772,324, CANC. INT. CL. 28.

MOXIMED, INC., HAYWARD, CA:
 3,808,483, INT. CL. 10.

MOYES RESEARCH ASSOCIATES, LLC, COLORADO SPRINGS, CO:
 2,284,394, CANC. INT. CL. 35.

MP BIOMEDICALS, LLC, SANTA ANA, CA:
 3,806,473, PUB. 4-6-2010. INT. CL. 9.

MPR REVOCABLE TRUST, LAS VEGAS, NV:
 3,807,557, MULTIPLE CLASS, INT. CLS. 9, 14, 16, 20, 21, 25, 28, 35 AND 41.
 3,807,558, MULTIPLE CLASS, INT. CLS. 9, 14, 16, 20, 21, 25, 28, 35 AND 41.

MPS GROUP, INC., JACKSONVILLE, FL, MODIS LICENSING CORPORATION, JACKSONVILLE, FL:
 2,382,351. REN. 5-19-10. INT. CL. 42.

MRW HOLDINGS, LLC, BEVERLY HILLS, CA:
 3,807,899, INT. CL. 25.

MSC SERVICES CORP., MELVILLE, NY:
 2,771,918, CANC. INT. CL. 35.

MSIG HOLDINGS (AMERICAS) INC., WARREN, NJ:
 2,285,459, CANC. INT. CL. 36.

MT ROMANCE AUSTRALIA PTY LTD, AUSTRALIA:
 3,807,355, PUB. 4-6-2010. INT. CL. 3.

MTD PRODUCTS INC, VALLEY CITY, OH:
 3,808,456, INT. CL. 7.

- MTL INSURANCE COMPANY, OAK BROOK, IL:
3,805,528, PUB. 4-6-2010. INT. CL. 36.
3,805,529, PUB. 4-6-2010. INT. CL. 36.
- MTU AERO ENGINES GMBH, MUNICH, FED REP GERMANY:
3,805,185, PUB. 4-6-2010. MULTIPLE CLASS, INT. CLS. 7, 11, 16, 37, 40 AND 42.
- MUD SPRINGS GEOGRAPHERS, INC., TEMPLE, TX:
2,772,589, CANC. INT. CL. 9.
- MUDR. EUGEN JONÁS, SK-941 45 MANA, SLOVAKIA:
3,807,274, PUB. 4-6-2010. MULTIPLE CLASS, INT. CLS. 35 AND 44.
- MUEL-FOL. COMPANY, INC., NEW MILFORD, NJ:
1,559,528, CANC. INT. CL. 5.
- MUELLER, RICHARD W., SCOTTSDALE, AZ:
3,805,602, PUB. 4-6-2010. INT. CL. 9.
- MULSEN TRADING CO., LTD., SEATTLE, WA:
3,805,785, PUB. 4-6-2010. INT. CL. 29.
- MULTI-PLASTICS, INC., LEWIS CENTER, OH:
3,808,320, INT. CL. 17.
- MULTIBEAM SYSTEMS, INC, SANTA CLARA, CA, AKA MULTIBEAM CORPORATION:
3,805,606, PUB. 4-6-2010. INT. CL. 7.
- MULTIPLE SCLEROSIS RESOURCES OF CENTRAL NEW YORK, INC., EAST SYRACUSE, NY:
2,378,296, REN. 5-20-10. INT. CL. 16.
2,399,734, REN. 5-18-10. INT. CL. 36.
2,403,789, REN. 5-19-10. INT. CL. 36.
2,411,547, REN. 5-17-10. INT. CL. 36.
- MUNICHELLO, KATRINA AVILA, WESTFORD, MA:
3,806,213, PUB. 4-6-2010. INT. CL. 35.
- MURDERDOLLS, LLC, NEW YORK, NY:
2,771,824, CANC. INT. CL. 41.
- MUSCOGEE MOMS, LLC, COLUMBUS, GA:
3,808,755, INT. CL. 41.
- MUSECO MEDIA AND EDUCATION PROJECT, BILLINGS, MT:
3,806,126, PUB. 4-6-2010. INT. CL. 35.
- MVTEC SOFTWARE GMBH, 81765 MUNCHEN, FED REP GERMANY:
3,805,125, PUB. 5-15-2007. INT. CL. 9.
- MY FASHION DATABASE, LLC, ENCINO, CA:
3,807,864, INT. CL. 45.
- MY M FRUIT LLC, CHANDLER, AZ, DBA MBERRY:
3,808,149, INT. CL. 29.
- MY VIDEO MY VOICE, LLC, LOS ANGELES, CA:
3,806,529, PUB. 4-6-2010. INT. CL. 41.
- MYLES, DARNELL, ALAMEDA, CA:
3,806,320, PUB. 4-6-2010. MULTIPLE CLASS, INT. CLS. 16 AND 41.
- MYSONICTONIC, LLC, WESTMINSTER, CO:
3,805,259, PUB. 4-6-2010. MULTIPLE CLASS, INT. CLS. 9, 35, 38, 41 AND 42.
- M2 NETWORKS, INC., SAN DIEGO, CA:
2,772,164, CANC. INT. CL. 9.
- N.C. CAMERON & SONS LIMITED, MISSISSAUGA, CANADA:
2,771,680, CANC. INT. CL. 20.
- N.S. ENTERPRISES, INC., BERLIN, MD:
2,285,700, CANC. INT. CL. 25.
- N.ST. PATENTE UND MARKEN GMBH, FED REP GERMANY:
3,807,303, PUB. 4-6-2010. MULTIPLE CLASS, INT. CLS. 12, 35 AND 39.
- N.V.L.A., INC., CALABASAS, CA:
3,807,551, INT. CL. 41.
- NAGEL, RALF, CH-4055 BASEL, SWITZERLAND:
2,770,912, CANC. MULTIPLE CLASS, INT. CLS. 3, 5 AND 32.
- NAIDU L.P., POMONA, CA:
3,808,228, INT. CL. 5.
- NAKED JUICE CO. OF GLENDORA, INC., AZUSA, CA:
3,808,439, INT. CL. 32.
- NANCY M RICH, BLOOMINGTON SPRINGS, TN, DBA BLOOMING IDIOTS:
3,806,210, PUB. 4-6-2010. INT. CL. 31.
- NANJING TEXTILES IMPORT & EXPORT CORP LTD, NANJING, JIANGSU, CHINA:
2,771,775, CANC. INT. CL. 25.
- NANOFILM, LTD., VALLEY VIEW, OH:
2,771,681, CANC. INT. CL. 3.
- NAPLES FLATBREAD ORIGINAL LLC, NAPLES, FL:
3,805,702, PUB. 4-6-2010. INT. CL. 43.
- NASHVILLE HOCKEY CLUB LIMITED PARTNERSHIP, NASHVILLE, TN:
2,347,506, REN. 5-18-10. INT. CL. 25.
2,364,958, REN. 5-18-10. INT. CL. 25.
- NASSER RAZACK, BRADENTON, FL:
3,807,904, INT. CL. 43.
- NATALIE ELIASON, LITTLE COMPTON, RI:
3,807,989, INT. CL. 29.
- NATALIE M. SPILGER, SAN FRANCISCO, CA:
3,808,087, INT. CL. 41.
- NATALIE SLOBODIN & ASSOCIATES, INC., RESTON, VA:
2,772,294, CANC. INT. CL. 41.
- NATIC AUTO SALES, INC., MARLBOROUGH, MA:
3,806,021, PUB. 4-6-2010. MULTIPLE CLASS, INT. CLS. 35 AND 37.
- NATIONAL APARTMENT ASSOCIATION, ARLINGTON, VA:
3,805,721, PUB. 4-6-2010. MULTIPLE CLASS, INT. CLS. 16 AND 41.
3,805,724, PUB. 4-6-2010. INT. CL. 41.
- NATIONAL ASSOCIATION OF CONVENIENCE STORES, ALEXANDRIA, VA:
3,806,175, PUB. 4-6-2010. INT. CL. 35.
- NATIONAL ASSOCIATION OF PROFESSIONAL BASEBALL LEAGUES, INC., ST. PETERSBURG, FL:
3,805,120, PUB. 4-6-2010. MULTIPLE CLASS, U.S. CL. 200 INT. CL. 16.
- NATIONAL ASSOCIATION OF PROFESSIONAL EMPLOYER ORGANIZATIONS, ALEXANDRIA, VA:
2,367,052, REN. 5-14-10. U.S. CL. 200.
- NATIONAL ASSOCIATION OF REAL ESTATE INVESTMENT TRUSTS, INC., WASHINGTON, DC:
3,805,782, PUB. 4-6-2010. MULTIPLE CLASS, U.S. CL. 200 INT. CLS. 16, 18, 21, 25, 30, 35, 36, 38 AND 41.
- NATIONAL ASSOCIATION OF THEATRE OWNERS, INC., WASHINGTON, DC:
3,806,534, PUB. 4-6-2010. INT. CL. 35.
3,807,036, PUB. 4-6-2010. U.S. CL. 200.
- NATIONAL BEVERAGE CORP., FT. LAUDERDALE, FL:
2,286,729, CANC. INT. CL. 32.
- NATIONAL BIRCHWOOD CORPORATION, THE, MINEOLA, NY:
2,284,889, CANC. INT. CL. 37.
- NATIONAL BOARD OF OSTEOPATHIC MEDICAL EXAMINERS, INC., CHICAGO, IL:
2,299,777, REN. 5-20-10. INT. CL. 41.
- NATIONAL BREAST CANCER COALITION, WASHINGTON, DC:
2,368,009, REN. 5-14-10. MULTIPLE CLASS, INT. CLS. 41 AND 42.
- NATIONAL CITY CORPORATION, CLEVELAND, OH:
2,286,518, CANC. INT. CL. 36.
- NATIONAL CORVETTE RESTORERS SOCIETY, INC., CINCINNATI, OH:
3,805,159, PUB. 4-6-2010. INT. CL. 41.
- NATIONAL COUNCIL ON FAMILY RELATIONS, MINNEAPOLIS, MN, DBA NCFR:
3,805,387, PUB. 4-6-2010. U.S. CL. B.
- NATIONAL DISTRIBUTION & CONTRACTING, INC., NASHVILLE, TN:
2,771,443, CANC. INT. CL. 36.
- NATIONAL EXPRESS, INC., NORWALK, CT:
3,806,259, PUB. 4-6-2010. INT. CL. 8.
- NATIONAL FILM PRESERVATION FOUNDATION, SAN FRANCISCO, CA:
2,370,330, REN. 5-17-10. INT. CL. 42.
2,403,370, REN. 5-17-10. MULTIPLE CLASS, INT. CLS. 36 AND 42.
- NATIONAL FOOTBALL LEAGUE, NEW YORK, NY:
2,384,861, REN. 5-20-10. MULTIPLE CLASS, INT. CLS. 16 AND 36.

NATIONAL GEOGRAPHIC SOCIETY, WASHINGTON, DC:
1,152,395, REN. 5-18-10. INT. CL. 16.
3,808,538, INT. CL. 9.

NATIONAL GROCERS ASSOCIATION, ARLINGTON, VA:
2,374,708, REN. 5-17-10. INT. CL. 42.

NATIONAL HEALTH INFORMATION NETWORK, INC.,
FORTWORTH, TX, NATIONAL HEALTH INFORMA-
TION NETWORK, INC., FORTWORTH, TX:
2,327,063, REN. 5-20-10. INT. CL. 42.

NATIONAL HEARING AID SOCIETY, LIVONIA, MI:
1,560,269, CANC. U.S. CL. 200.

NATIONAL Optronics, INC., CHARLOTTESVILLE, VA:
3,808,069, INT. CL. 7.

NATIONAL PEDICULOSIS ASSOCIATION, INC., NEED-
HAM, MA:
2,771,904, CANC. INT. CL. 10.

NATIONAL PRENEED SERVICES, LLC, BLAIRSVILLE, GA:
2,772,763, CANC. INT. CL. 36.

NATIONAL PSORIASIS FOUNDATION, PORTLAND, OR:
3,805,835, PUB. 4-6-2010. MULTIPLE CLASS, INT. CLS. 36
AND 41.
3,805,836, PUB. 4-6-2010. MULTIPLE CLASS, INT. CLS. 36
AND 41.

NATIONAL RAILROAD PASSENGER CORPORATION,
WASHINGTON, DC:
2,294,517, REN. 5-20-10. INT. CL. 39.
2,294,518, REN. 5-20-10. INT. CL. 39.
2,771,464, CANC. INT. CL. 30.
2,771,465, CANC. INT. CL. 21.

NATIONAL RESEARCH FUND FOR TICK-BORNE DIS-
EASES, INC., WILTON, CT:
2,771,849, CANC. INT. CL. 41.

NATIONAL SOLAR PRODUCTS, LLC, FORT LAUDER-
DALE, FL:
3,808,471, INT. CL. 9.

NATIONAL STAFF DEVELOPMENT COUNCIL, OXFORD,
OH:
3,808,706, INT. CL. 41.

NATIONAL STEELCRAFTERS OF TEXAS, ARLINGTON,
TX:
3,808,117, INT. CL. 11.
3,808,118, INT. CL. 11.

NATIONAL STEELCRAFTERS OF TEXAS, LLC, ARLING-
TON, TX:
3,808,116, INT. CL. 11.

NATIONAL TAX INSTITUTE, INC., BURLINGTON, MA:
2,353,358, REN. 5-17-10. INT. CL. 41.

NATIONAL TOUR ASSOCIATION, INC., LEXINGTON, KY:
3,808,365, INT. CL. 35.

NATIONAL WILDLIFE FEDERATION, RESTON, VA:
3,805,508, PUB. 4-6-2010. MULTIPLE CLASS, INT. CLS.
18, 21, 24 AND 25.

NATURAL ENVIRONMENTAL SYSTEMS, LLC, DALLAS,
TX:
3,807,896, INT. CL. 40.

NATURE'S SUNSHINE PRODUCTS, INC., PROVO, UT:
3,808,302, INT. CL. 11.

NATURES IMAGE, INC., LAKE FOREST, CA:
3,807,470, MULTIPLE CLASS, INT. CLS. 37, 42 AND 44.

NAUGHTY CLOTHING COMPANY, LTD., LONDON W1T
3LW, UNITED KINGDOM:
2,771,182, CANC. INT. CL. 3.

NAVAL AVIATION MUSEUM FOUNDATION, INC., PEN-
SACOLA, FL:
3,805,796, PUB. 4-6-2010. INT. CL. 36.

NAVARRO, RONALD C., LAFAYETTE, LA:
2,770,703, CANC. INT. CL. 42.

NAVITAIRE INC., MINNEAPOLIS, MN:
2,770,797, CANC. INT. CL. 39.
2,770,798, CANC. INT. CL. 39.

NBC UNIVERSAL, INC., NEW YORK, NY:
3,808,182, INT. CL. 41.

NDM LLC, FAIRFAX, VA:
2,284,681, CANC. INT. CL. 35.

NEARBY BUDDY FINDER LLC, LOS ANGELES, CA:
3,806,576, PUB. 4-6-2010. INT. CL. 45.

NEBRASKA FINEST MEATS, LLC, RANDOLPH, NE:
3,808,756, INT. CL. 29.

NEDI CORPORATION, EDMONTON ALBERTA, CANADA:
2,772,563, CANC. INT. CL. 41.

NEENAH PAPER FR, LLC, ALPHARETTA, GA:
2,286,689, CANC. INT. CL. 16.

NEETU NIRDOSH (DR), LONDON, UNITED KINGDOM:
3,805,413, PUB. 4-6-2010. MULTIPLE CLASS, INT. CLS. 3,
5 AND 35.

NEGATIVE ON NICOTINE, INC., CARMEL, IN:
2,284,465, CANC. INT. CL. 16.
2,284,466, CANC. INT. CL. 16.

NEGONATION PLATFORM, S.L., VALLADOLID, SPAIN:
3,805,289, PUB. 1-26-2010. MULTIPLE CLASS, INT. CLS.
36, 38 AND 45.

NEHEMIAH, LUCIAN D., VAN NUYS, CA:
2,285,154, CANC. INT. CL. 25.

NEIGHBORHOOD HEALTH PLAN, INC., BOSTON, MA:
3,805,821, PUB. 4-6-2010. MULTIPLE CLASS, INT. CLS. 36
AND 44.
3,805,822, PUB. 4-6-2010. MULTIPLE CLASS, INT. CLS. 36
AND 44.

NELSON, CLAYTON, S, OVERLAND PARK, KS AND
HILLMAN, MARK, W, BUCYRUS, KS:
2,772,692, CANC. INT. CL. 43.

NELSON, HITCH, FALLS CHURCH, VA, DBA PIANO4LIFE:
3,806,264, PUB. 4-6-2010. INT. CL. 41.

NELSONQUICK GROUP, LLC, STILLWATER, OK:
3,807,504, MULTIPLE CLASS, INT. CLS. 35 AND 41.
3,807,505, INT. CL. 35.

NENG FENG WANG, WENZHOU, CHINA:
3,807,958, INT. CL. 9.

NEOSCAPE, INCORPORATED, CAMBRIDGE, MA:
2,771,167, CANC. INT. CL. 42.
2,771,168, CANC. INT. CL. 42.

NEPHRO-FRESH, INC., YONKERS, NY:
3,808,009, INT. CL. 32.

NEPHROCEUTICALS, LLC, DAYTON, OH:
3,808,395, INT. CL. 5.

NESTLE WATERS NORTH AMERICA INC., GREENWICH,
CT:
3,808,293, INT. CL. 32.

NET VISIBILITY, INC., NEWPORT BEACH, CA:
2,772,702, CANC. INT. CL. 42.

NETATTITUDE CORPORATION, BOCA RATON, FL:
2,391,619, REN. 5-19-10. INT. CL. 42.

NETCRAFT LTD., BATH BA1 5DZ, ENGLAND:
2,336,958, REN. 5-20-10. MULTIPLE CLASS, INT. CLS. 35
AND 42.

NETFLOWDATA LLC, SILVER SPRING, MD:
3,806,047, PUB. 4-6-2010. MULTIPLE CLASS, INT. CLS. 42
AND 45.

NETPATENTS.COM, INC., LINCOLN, MA:
2,770,542, CANC. INT. CL. 42.

NETUNE COMMUNICATIONS, INC., LOS ANGELES, CA:
2,772,002, CANC. INT. CL. 38.

NETWORK MEDICAL REVIEW COMPANY, LTD., ROCK-
FORD, IL:
2,380,002, REN. 5-18-10. INT. CL. 35.

NETWORK NEUROMETRICS, INC., OXFORD, MD:
2,771,015, CANC. INT. CL. 9.

NETZSCH-GERATEBAU GMBH, 95100 SELB, FED REP
GERMANY:
2,349,010, REN. 5-14-10. INT. CL. 9.

NEUDORFF, MARK G., WEST HILLS, CA:
2,350,459, REN. 5-18-10. INT. CL. 16.

NEUMA TATTOO MACHINES CORPORATION, CAMAR-
ILLO, CA:
3,806,832, PUB. 4-6-2010. INT. CL. 42.

NEUNABER, DEAN, GRAPEVINE, TX:
2,772,188, CANC. INT. CL. 35.

NEUTROGENA CORPORATION, LOS ANGELES, CA:
2,286,758, CANC. INT. CL. 3.

NEVER LIE TO YOUR HAIRDRESSER, LLC, MADISON,
WI:
3,805,728, PUB. 4-6-2010. INT. CL. 25.

NEW CLOUD TECHNOLOGIES, LLC, MCHENRY, MD:
3,805,366, PUB. 4-6-2010. INT. CL. 42.

- NEW ENGLAND DENTAL ADMINISTRATORS, LLC, CONCORD, NH:
2,771,663, CANC. INT. CL. 36.
- NEW GPC INC., GEORGETOWN, GUYANA:
2,771,597, CANC. INT. CL. 5.
- NEW IMAGE MAINTENANCE INC., TAMPA, FL:
3,806,232, PUB. 4-6-2010. INT. CL. 39.
- NEW JERSEY REDEVELOPMENT TRAINING INSTITUTE, TRENTON, NJ:
3,805,140, PUB. 4-6-2010. INT. CL. 36.
- NEW JERSEY SPORTS PRODUCTIONS, INC., TOTOWA, NJ:
3,806,011, PUB. 4-6-2010. INT. CL. 25.
3,806,012, PUB. 4-6-2010. INT. CL. 25.
- NEW LIBERTY HOSPITAL DISTRICT OF CLAY COUNTY, LIBERTY, MO:
3,806,644, PUB. 4-6-2010. INT. CL. 44.
- NEW MEDIA ARTS TRAINING CENTERS, INC., MADISON, WI:
3,808,778, INT. CL. 41.
- NEW YORK GOLD, INC., NEW YORK, NY:
1,559,785, CANC. INT. CL. 16.
- NEW YORK WALK & TRAIN, CHATHAM, NY:
3,805,595, PUB. 4-6-2010. INT. CL. 44.
- NEW YORK WRESTLING CONNECTION INC., NORTHPORT, NY, DBA NEW YORK WRESTLING CONNECTION:
3,806,043, PUB. 2-9-2010. INT. CL. 41.
- NEW YORK YACHT CLUB, NEW YORK, NY:
3,806,833, PUB. 4-6-2010. MULTIPLE CLASS, INT. CLS. 36, 41 AND 43.
- NEW ZEALAND WINE COMPANY LIMITED, THE, MARLBOROUGH, NEW ZEALAND:
2,302,242, REN. 5-19-10. INT. CL. 33.
- NEWCO RAI INTERNATIONAL S.P.A., I-00195 ROMA, ITALY:
3,807,252, PUB. 4-6-2010. MULTIPLE CLASS, INT. CLS. 9, 16, 38 AND 41.
- NEWFOCUS FINANCIAL GROUP, LLC, VANCOUVER, WA:
3,808,054, MULTIPLE CLASS, INT. CLS. 35 AND 36.
- NEWFRESHCO FOODS, LLC, NAPERVILLE, IL:
3,808,465, INT. CL. 30.
- NEWFREY LLC, NEWARK, DE:
2,772,644, CANC. INT. CL. 11.
- NEWGAME COMMUNICATIONS, INC., CHARLOTTE, NC:
2,772,612, CANC. INT. CL. 35.
- NEWO PLASTICS, LTD., CHICAGO, IL:
2,772,341, CANC. INT. CL. 10.
- NEWSOME INTERACTIVE, LLC, SIGNAL MOUNTAIN, TN:
3,808,760, INT. CL. 35.
- NEXION CORPORATION, TOKYO 100-0011, JAPAN:
2,835,754, CANC. MULTIPLE CLASS, INT. CLS. 39, 41 AND 42.
- NEXREV INC., PLANO, TX:
3,807,948, INT. CL. 7.
- NEXT MEDICAL STAFFING, LLC, BEAVERCREEK, OH:
3,805,991, PUB. 4-6-2010. INT. CL. 35.
- NEXT STEP GROUP, INC., NEW YORK, NY:
3,805,972, PUB. 4-6-2010. INT. CL. 25.
- NEXT STREET FINANCIAL LLC, ROXBURY, MA:
3,808,585, INT. CL. 36.
- NEXT-END, LLC, ROSEMONT, IL:
3,808,555, INT. CL. 40.
- NG FOOK FUNERAL SERVICES LLC, NEW YORK, NY:
3,805,486, PUB. 4-6-2010. INT. CL. 45.
- NGK INSULATORS, LTD., NAGOYA CITY, JAPAN:
2,770,745, CANC. MULTIPLE CLASS, INT. CLS. 9 AND 35.
- NHEW, INC., EAST RUTHERFORD, NJ:
2,771,087, CANC. INT. CL. 26.
- NICHELINI WINERY, INC., ST. HELENA, CA:
2,357,341, REN. 5-17-10. INT. CL. 33.
- NICHOLAA DE CARTERET, ST. HELLIER, JERSEY:
3,805,832, PUB. 4-6-2010. MULTIPLE CLASS, INT. CLS. 9, 16, 35, 38 AND 41.
- NICHOLAS REAL ESTATE AGENCY, INC., CLIFTON, NJ:
2,772,157, CANC. INT. CL. 36.
- NICOR PRODUCTS, INC., ORLANDO, FL:
2,771,658, CANC. INT. CL. 6.
- NIHON SPINDLE MFG. CO., LTD., HYOGO, JAPAN:
3,807,142, PUB. 4-6-2010. MULTIPLE CLASS, INT. CLS. 6, 7, 11 AND 19.
- NIKE, INC., BEAVERTON, OR:
3,807,031, PUB. 4-6-2010. INT. CL. 35.
- NIKON CORPORATION, TOKYO, JAPAN:
3,807,476, INT. CL. 9.
- NILES AUDIO CORPORATION, MIAMI, FL:
3,808,604, INT. CL. 9.
- NINE WEST DEVELOPMENT CORPORATION, WILMINGTON, DE:
2,354,092, REN. 5-20-10. INT. CL. 25.
2,771,726, CANC. INT. CL. 25.
- NINGBO RICH HARVEST FOOD CO., LTD., YUYAO CITY, ZHEJIANG PROVINCE, CHINA:
3,807,133, PUB. 4-6-2010. INT. CL. 30.
- NINTENDO OF AMERICA INC., REDMOND, WA:
3,807,047, PUB. 1-20-2009. INT. CL. 28.
- NIPPON SEISHI KABUSHIKI KAISHA, JAPAN:
3,807,322, PUB. 4-6-2010. INT. CL. 1.
- NIPPON SIGMAX CO., LTD., SHINJUKU-KU, TOKYO, JAPAN:
3,808,552, INT. CL. 10.
- NISSAN JIDOSHA KABUSHIKI KAISHA, YOKOHAMA-SHI, KANAGAWA, 220-8686, JAPAN:
686,586, REN. 5-20-10. U.S. CL. 19 (INT. CLS. 7, 12, 22 AND 27).
- NISSIM, NETALI, WOODBRIDGE, NJ:
3,805,162, PUB. 4-6-2010. INT. CL. 14.
- NITTA HAAS INCORPORATED, JAPAN:
3,807,284, PUB. 4-6-2010. MULTIPLE CLASS, INT. CLS. 1, 3 AND 7.
- NMG, INC., DALLAS, TX:
2,770,929, CANC. INT. CL. 42.
- NO LIMIT LLC, WESTPORT, CT:
3,597,982, COR. INT. CL. 30.
- NODAK SPUD, LLC, BLAINE, MN:
3,805,639, PUB. 4-6-2010. INT. CL. 13.
- NOE-SCHALTECHNIK GEORG MEYER-KELLER GMBH + CO, SÜSSEN, FED REP GERMANY:
3,805,709, PUB. 4-6-2010. MULTIPLE CLASS, INT. CLS. 6, 19, 37 AND 42.
- NOKIA CORPORATION, FINLAND:
3,807,102, PUB. 4-6-2010. INT. CL. 9.
- NOLL PRINTING COMPANY INCORPORATED, HUNTINGTON, IN:
1,560,119, CANC. INT. CL. 35.
- NOPALITO BROTHERS, DALLAS, TX:
2,770,738, CANC. INT. CL. 30.
- NOREALIS COMMUNICATIONS INC., VICTORIA, BC, CANADA:
2,771,103, CANC. MULTIPLE CLASS, INT. CLS. 35, 41 AND 45.
- NORFAST, INC., ST. PAUL, MN, DBA COLLETTI COMPANIES:
2,771,418, CANC. INT. CL. 3.
- NORM THOMPSON OUTFITTERS, INC., HILLSBORO, OR:
2,357,806, REN. 5-17-10. INT. CL. 25.
- NORMAN WILLIAM LIEFKE, SURREY, B.C., CANADA:
3,808,223, INT. CL. 6.
- NORPAC FOODS, INC., LAKE OSWEGO, OR:
2,284,439, CANC. INT. CL. 29.
- NORTH AMERICAN FREE TRADE CONSULTANTS INC., TECUMSEH, CANADA:
3,805,407, PUB. 4-6-2010. INT. CL. 41.
- NORTH AMERICAN MANUFACTURING ENTERPRISES, INC., STATEN ISLAND, NY:
3,808,269, MULTIPLE CLASS, INT. CLS. 11 AND 42.
- NORTH AMERICAN MEDICAL SERVICES, INC., VANCOUVER, BC, CANADA:
3,808,720, INT. CL. 3.
- NORTH AMERICAN PHILIPS CORPORATION, NEW YORK, NY TO PHILIPS ELECTRONICS NORTH AMERICA CORPORATION, NEW YORK, NY:
1,559,710, CANC. INT. CL. 11.
- NORTH CAROLINA STATE UNIVERSITY, RALEIGH, NC:
3,806,643, PUB. 4-6-2010. MULTIPLE CLASS, INT. CLS. 25 AND 41.

NORTH CAROLINA SUSTAINABLE ENTREPRENEURS GROUP, WAKE FOREST, NC, DBA ENTREDOT:
3,808,476, INT. CL. 41.

NORTH CONTINENTAL ENTERPRISES, INC., NILES, IL:
2,772,301, CANC. INT. CL. 9.

NORTH INTERNATIONAL HOLDING TIANJIN FOOD-STUFFS IMPORT & EXPORT CO., LTD., TIANJIN, CHINA:
2,351,595, REN. 5-14-10, INT. CL. 33.

NORTHGATEARINSO UK LIMITED, UNITED KINGDOM:
3,807,152, PUB. 4-6-2010, MULTIPLE CLASS, INT. CLS. 9, 35 AND 42.

NORTHWEST KIDNEY CENTERS, SEATTLE, WA:
3,807,729, MULTIPLE CLASS, INT. CLS. 9 AND 41.

NORTHWEST NATURAL GAS COMPANY, PORTLAND, OR, DBA NW NATURAL:
2,390,532, REN. 5-17-10, MULTIPLE CLASS, INT. CLS. 36 AND 39.

NORTHWESTERN UNIVERSITY, EVANSTON, IL:
3,808,711, INT. CL. 41.

NORTON, JOSEPH J., BRIGHTON, MI:
3,808,602, INT. CL. 30.

NOTHING HEAVY INC., NEW YORK, NY:
3,808,460, INT. CL. 43.

NOUVEAU EYEWEAR, INC., CARROLLTON, TX:
3,807,397, INT. CL. 9.

NOVANIX, LLC., HENDERSON, NV:
3,806,488, PUB. 4-6-2010, INT. CL. 42.

NOVARTIS AG, BASEL, SWITZERLAND:
2,771,554, CANC. INT. CL. 5.
2,771,608, CANC. INT. CL. 5.
2,771,830, CANC. INT. CL. 5.
2,771,879, CANC. INT. CL. 5.
2,772,594, CANC. INT. CL. 9.

NOVARTIS AG, CH-4002 BASEL, SWITZERLAND:
3,807,351, PUB. 4-6-2010, INT. CL. 5.

NOVATION CAPITAL, LLC, WEST PALM BEACH, FL:
3,806,689, PUB. 4-6-2010, INT. CL. 36.

NOVATION, LLC, IRVING, TX:
2,772,134, CANC. INT. CL. 42.

NOVATIONS GROUP, INC., BOSTON, MA:
2,286,834, CANC. INT. CL. 41.

NOVELL, INC., PROVO, UT:
2,394,453, REN. 5-17-10, MULTIPLE CLASS, INT. CLS. 16, 37, 41 AND 42.

NOVO NORDISK HEALTH CARE AG, ZURICH, SWITZERLAND:
2,346,862, REN. 5-20-10, INT. CL. 10.

NOVUS SCIENTIFIC PTE. LTD., SINGAPORE:
3,807,361, PUB. 4-6-2010, INT. CL. 10.

NRI, INC., WASHINGTON, DC, DBA THE NRI GROUP:
1,596,752, REN. 5-20-10, INT. CL. 35.

NRI, INC., ROCKVILLE PIKE, MD:
1,993,844, COR. INT. CL. 35.

NSF INTERNATIONAL, ANN ARBOR, MI:
3,808,681, U.S. CL. A.

NSS ENTERPRISES, INC., TOLEDO, OH, NATIONAL SUPER SERVICE COMPANY, THE, MAUMEE, OH:
1,600,410, REN. 5-20-10, INT. CL. 9.

NTFB COMBUSTION EQUIPMENT USA, INC., SAN MATEO, CA:
3,808,432, INT. CL. 7.

NTVB MEDIA, TROY, MI:
3,806,413, PUB. 4-6-2010, INT. CL. 16.

NU-PUTTIE CORPORATION, MAYWOOD, IL:
3,806,979, PUB. 4-6-2010, INT. CL. 17.

NU-STONE MANUFACTURING & DISTRIBUTING, LLC, STERLING, CT:
3,806,062, PUB. 4-6-2010, INT. CL. 19.

NUBIAN HEALTH PRODUCTS, INC., EGG HARBOR TWP., NJ:
2,772,130, CANC. INT. CL. 5.

NUCASA MILLING COMPANY LIMITED, BURNABY, BRITISH COLUMBIA, CANADA:
3,807,082, PUB. 4-6-2010, MULTIPLE CLASS, INT. CLS. 1, 2, 3, 19, 20, 35, 37, 40 AND 42.

NUMEROLOGIC IP HOLDINGS LLC, DALLAS, TX:
3,807,383, INT. CL. 42.

NUTRI-GREEN LAWN CARE, LONG LAKE, MN:
3,807,957, INT. CL. 44.

NUTRILAB CORPORATION, ST. PETERSBURG, FL:
3,807,615, MULTIPLE CLASS, INT. CLS. 5, 30 AND 32.

NV BIOMEDICAL, INC., LAS VEGAS, NV:
2,771,043, CANC. INT. CL. 5.

NY ARTISTS UNLIMITED, NEW YORK, NY:
3,806,771, PUB. 4-6-2010, INT. CL. 41.

NYFIX, INC., NEW YORK, NY TO BNY CONVERGEX EXECUTION SOLUTIONS LLC, NEW YORK, NY:
2,655,293, CANC. MULTIPLE CLASS, INT. CLS. 9 AND 36.

NYTEF PLASTICS, LTD., BENSLEM, PA:
2,284,845, CANC. INT. CL. 17.

O.A.R.S. COMPANIES, INC., ANGELS CAMP, CA:
2,277,224, CANC. MULTIPLE CLASS, INT. CLS. 39 AND 42.

O'LEARY, THOMAS, M., COVINA, CA:
2,771,894, CANC. INT. CL. 41.

O'NEIL SOFTWARE, INC., IRVINE, CA:
2,772,104, CANC. INT. CL. 9.

OAKDALE OBSTETRICS AND GYNECOLOGY, ROBBINS-DALE, MN:
3,806,700, PUB. 4-6-2010, INT. CL. 44.

OBERON MEDIA (UK) LIMITED, WATERLOO, LONDON, UNITED KINGDOM:
3,807,071, PUB. 4-6-2010, MULTIPLE CLASS, INT. CLS. 9, 38 AND 41.

OCE INTERACTIVE LLC, NEW YORK, NY:
3,805,471, PUB. 4-6-2010, INT. CL. 36.

OCEAN PERFORMANCE MANAGEMENT, LLC, ESSEX, CT:
3,808,313, INT. CL. 12.

OCONEE PUBLISHING, INC., SENECA, SC:
3,808,366, INT. CL. 9.

OCTOCLEAN FRANCHISING SYSTEMS, INC., RIVERSIDE, CA:
2,771,184, CANC. INT. CL. 37.

OCULAR INSTRUMENTS, INC., BELLEVUE, WA:
2,416,199, REN. 5-17-10, INT. CL. 10.

ODA, NATASHA K., HONOLULU, HI, DBA HUGS AND HONIS BY NATASHA:
3,806,266, PUB. 4-6-2010, INT. CL. 25.

OEC GRAPHIC, INC., OSHKOSH, WI, DBA OEC GRAPHICS, INC.:
3,805,675, PUB. 4-6-2010, INT. CL. 7.

OEHL PLUMBING AND HEATING, INC., AMANA, IA:
3,806,639, PUB. 4-6-2010, INT. CL. 37.

OERLIKON TRADING AG, TRÜBBACH, SWITZERLAND:
3,807,261, PUB. 4-6-2010, MULTIPLE CLASS, INT. CLS. 1, 7 AND 9.

OESTERREICHISCHE VIALIT GESELLSCHAFT M.B.H., BRAUNAU / INN, AUSTRIA:
3,808,017, MULTIPLE CLASS, INT. CLS. 1, 19, 37 AND 42.

OFFICE IMAGES, INC., NATICK, MA, DBA TRAINERS WAREHOUSE:
3,805,163, PUB. 4-6-2010, INT. CL. 9.

OFFICIAL PILLOWTEX LLC, COLUMBUS, OH:
2,772,396, CANC. INT. CL. 20.

OGC INVESTMENTS, LLC, WICHITA, KS:
2,440,690, REN. 5-19-10, MULTIPLE CLASS, INT. CLS. 29, 30 AND 33.

OGCI SOFTWARE, INC., HOUSTON, TX:
1,559,628, CANC. INT. CL. 9.

OH, NAM SIK, RIDGEFIELD, NJ:
2,771,154, CANC. INT. CL. 25.

OHIO ART COMPANY, THE, BRYAN, OH:
1,587,707, REN. 5-18-10, MULTIPLE CLASS, INT. CLS. 16, 21, 28 AND 42.

OHR AND ASSOCIATES, INC., BOCA RATON, FL:
2,771,253, CANC. INT. CL. 36.

OJON CORPORATION, NEW YORK, NY:
3,203,528, CANC. MULTIPLE CLASS, INT. CLS. 3 AND 26.

OLAF SCHMIEMANN, FED REP GERMANY:
3,807,298, PUB. 4-6-2010, MULTIPLE CLASS, INT. CLS. 14 AND 25.

- OLAMETER INC., MONTREAL, QUEBEC:
2,770,547, CANC. MULTIPLE CLASS, INT. CLS. 36 AND 42.
- OLD DOMINION TRANSIT MANAGEMENT COMPANY, RICHMOND, VA, DBA GRTC TRANSIT SYSTEM:
3,805,771, PUB. 4-6-2010. INT. CL. 39.
- OLD ELM CLUB, HIGHLAND PARK, IL:
2,285,293, CANC. MULTIPLE CLASS, INT. CLS. 21, 25, 28 AND 41.
- OLD EUROPEAN BREWERY COMPANY, SAN DIEGO, CA:
3,808,719, INT. CL. 32.
- OLD GOAT TRAVEL, LLC, WASHINGTON, DC:
3,808,299, INT. CL. 39.
- OLDER & BOLDER SENIOR STORE, INC., AUBURN, NY:
2,428,991, REN. 5-19-10. INT. CL. 35.
- OLEM SHOE CORP., MIAMI, FL:
2,772,673, CANC. INT. CL. 25.
- OLIN CORPORATION, ST. LOUIS, MO:
697,326, REN. 5-17-10. U.S. CL. 9 (INT. CL. 13).
- OLÉ MEXICAN FOODS, INC., NORCROSS, GA:
3,807,536, MULTIPLE CLASS, INT. CLS. 29 AND 30.
- OLSON ALUMINUM CASTING, LTD, ROCKFORD, IL:
3,806,459, PUB. 4-6-2010. INT. CL. 6.
- OLSON NUTRITIONAL SERVICES, INC., PAYSON, UT:
2,286,328, CANC. INT. CL. 5.
- OLSON URBAN HOUSING, LLC, SEAL BEACH, CA:
3,246,361, CANC. MULTIPLE CLASS, INT. CLS. 37 AND 42.
- OLYMPUS AMERICA, INC., ONE BROADWAY, NY:
2,771,949, CANC. INT. CL. 35.
- OLYMPUS CORPORATION, TOKYO, JAPAN:
3,807,447, INT. CL. 9.
- OME CORPORATION, TULSA, OK:
1,560,156, CANC. INT. CL. 37.
- OMEGA ENGINEERING, INC., STAMFORD, CT:
1,603,616, REN. 5-19-10. INT. CL. 11.
- OMICRON ELECTRONICS GMBH, 6833 KLAUS, AUSTRIA:
2,770,710, CANC. MULTIPLE CLASS, INT. CLS. 9 AND 42.
- OMNI-ID CAYMAN, LTD., KY1 1108, CAYMAN ISLANDS:
3,807,768, INT. CL. 42.
- OMNIMOUNT SYSTEMS, INC., PHOENIX, AZ:
3,807,981, INT. CL. 6.
- OMNISOLV, INC., SALISBURY, NC:
3,805,391, PUB. 4-6-2010. INT. CL. 9.
- OMNOVA SOLUTIONS INC., FAIRLAWN, OH:
3,806,903, PUB. 4-6-2010. INT. CL. 27.
- OMRON CORPORATION, KYOTO, 600-8530, JAPAN:
2,771,243, CANC. INT. CL. 9.
- ON RITE CO., INC, FORT LAUDERDALE, FL:
3,806,168, PUB. 4-6-2010. MULTIPLE CLASS, INT. CLS. 35 AND 41.
- ONDEO NALCO COMPANY, NAPERVILLE, IL:
2,771,367, CANC. INT. CL. 42.
- ONE EYED SPARK PRODUCTIONS, INC., LAUDERDALE BY THE SEA, FL:
3,805,906, PUB. 4-6-2010. INT. CL. 41.
- ONE MAN ARMY, INC., POMPAO BEACH, FL:
3,807,457, INT. CL. 25.
- ONEZONE GROUP, INC., EL SEGUNDO, CA:
2,770,574, CANC. INT. CL. 35.
- ONGUARD INDUSTRIES, LLC, HAVRE DE GRACE, MD:
3,805,743, PUB. 4-6-2010. MULTIPLE CLASS, INT. CLS. 9 AND 25.
- ONLINE OCCUPATIONAL DEVELOPMENT CENTER LLC, DALLAS, TX, AKA OODC:
3,808,752, INT. CL. 41.
- ONNOWTV.COM BROADCASTING ASSOCIATION, OKLAHOMA CITY, OK:
3,806,383, PUB. 4-6-2010. INT. CL. 38.
- OPEN APPLICATION GROUP, INC., MARIETTA, GA:
2,771,162, CANC. INT. CL. 42.
- OPEN RESOURCE GROUP, LLC, NEW YORK, NY:
2,772,036, CANC. INT. CL. 35.
- OPERATION OUTWARD REACH, INC., YOUNGWOOD, PA:
2,285,638, CANC. INT. CL. 41.
- OPERATIONAL MANAGEMENT SERVICES, INC., CARSON CITY, NV:
3,806,057, PUB. 4-6-2010. INT. CL. 35.
- OPI PRODUCTS, INC., NORTH HOLLYWOOD, CA:
2,772,389, CANC. INT. CL. 3.
- OPP JAYCEES, INCORPORATED, OPP, AL:
2,772,729, CANC. INT. CL. 36.
- OPRYLAND USA INC., NASHVILLE, TN:
1,560,188, CANC. INT. CL. 41.
- OPTASK INC., BURLINGAME, CA:
3,806,231, PUB. 4-6-2010. INT. CL. 35.
- OPTICAL METROLOGY INNOVATIONS LIMITED, COUNTY CORK, IRELAND:
2,771,075, CANC. INT. CL. 9.
- OPTICS LABORATORY, INC., EL MONTE, CA:
2,441,607, REN. 5-15-10. INT. CL. 5.
- OPTIGENEX INC., NEW YORK, NY:
2,771,211, CANC. INT. CL. 5.
- OPTIK K & R INC., MARKHAM, ONTARIO, CANADA:
2,772,334, CANC. INT. CL. 9.
- OPTIMAL BLUE, LLC, PLANO, TX:
3,806,717, PUB. 4-6-2010. INT. CL. 42.
- OPTIMUS FUNDING CORPORATION, CHICAGO, IL:
3,805,929, PUB. 4-6-2010. INT. CL. 36.
- OPTINETRICS, INC., TORRANCE, CA:
2,772,152, CANC. INT. CL. 9.
- OPTION COMPUTERS LIMITED, MILTON KEYNES, UNITED KINGDOM:
3,807,127, PUB. 4-6-2010. MULTIPLE CLASS, INT. CLS. 9, 35, 36, 38 AND 42.
- OPTION RESEARCH AND TECHNOLOGY SERVICES LLC, CHICAGO, IL:
2,771,610, CANC. MULTIPLE CLASS, INT. CLS. 36 AND 42.
- ORACLE INTERNATIONAL CORPORATION, REDWOOD CITY, CA:
1,633,011, REN. 5-17-10. INT. CL. 9.
- ORAGENICS, INC., ALACHUA, FL:
3,806,461, PUB. 4-6-2010. INT. CL. 3.
- ORATECH GROUP OF WEST ORANGE, THE, WEST ORANGE, NJ:
2,286,736, CANC. INT. CL. 42.
- ORCHARD YARN AND THREAD COMPANY, INC., NEW YORK, NY, DBA LION BRAND YARN COMPANY:
3,805,772, PUB. 4-6-2010. INT. CL. 23.
- ORDONEZ, ELIZABETH, MIAMI, FL, AKA ELIZABETH SKY, E.SKY:
3,805,539, PUB. 4-6-2010. INT. CL. 25.
- ORECK HOLDINGS, LLC, NASHVILLE, TN:
3,808,097, INT. CL. 7.
3,808,217, INT. CL. 7.
- OREGON FREEZE DRY, INC., ALBANY, OR:
3,808,468, INT. CL. 29.
- OREGON PHYSICS LLC, HILLSBORO, OR, DBA OREGON PHYSICS:
3,805,564, PUB. 4-6-2010. MULTIPLE CLASS, INT. CLS. 9 AND 42.
- ORGANIC HAIR COMPANY, MIAMI, FL:
3,805,540, PUB. 4-6-2010. MULTIPLE CLASS, INT. CLS. 3 AND 26.
- ORGILL, INC., MEMPHIS, TN:
2,435,822, REN. 5-20-10. INT. CL. 35.
- OROGRAIN BAKERIES PRODUCTS, INC., HORSHAM, PA:
2,770,690, CANC. INT. CL. 30.
3,807,988, INT. CL. 30.
- ORTECK INTERNATIONAL, INC., GAITHERSBURG, MD:
2,772,427, CANC. INT. CL. 12.
- ORTIZ, MIGUEL, NEW YORK, NY:
3,805,742, PUB. 4-6-2010. INT. CL. 35.
- OSBORNE & LITTLE LIMITED, LONDON, ENGLAND:
1,595,451, REN. 5-20-10. MULTIPLE CLASS, INT. CLS. 24 AND 27.
- OSPREY AVIATION, LLC, FORT MYERS, FL:
3,807,414, INT. CL. 39.
- OSTEOTECH, INC., EATONTOWN, NJ:
3,807,859, INT. CL. 5.

OSTER COMMUNICATIONS, INC., CEDAR FALLS, IA,
DBA FUTURES WORLD NEWS:
1,560,168, CANC. INT. CL. 38.

OTOPIO PTY LIMITED, FERN TREE, AUSTRALIA:
3,806,027, PUB. 4-6-2010. INT. CL. 16.

OTTO (GMBH & CO KG), FED REP GERMANY:
3,807,140, PUB. 4-6-2010. MULTIPLE CLASS, INT. CLS.
14, 18 AND 25.

OTTO BOCK HEALTHCARE GMBH, DUDERSTADT, FED
REP GERMANY:
3,807,159, PUB. 2-16-2010. INT. CL. 12.

OTTON, TERRY, NAPA, CA AND OTTON, NANCY, NAPA,
CA:
3,807,445, INT. CL. 33.

OUT OF YOUR MIND, LONG BEACH, CA AND OUT OF
YOUR MIND, LONG BEACH, CA:
2,772,587, CANC. MULTIPLE CLASS, INT. CLS. 35 AND
42.

OUTDOOR POWER EQUIPMENT INSTITUTE, INC., ALEX-
ANDRIA, VA:
2,285,566, CANC. INT. CL. 42.

OUTSIDE THE LENS, LA JOLLA, CA:
3,805,954, PUB. 4-6-2010. MULTIPLE CLASS, INT. CLS. 16
AND 41.
3,805,955, PUB. 4-6-2010. MULTIPLE CLASS, INT. CLS. 16
AND 41.

OUTSOURCE FINANCIAL SERVICES, TEMPE, AZ TO
OUTSOURCE FINANCIAL SERVICES, TEMPE, AZ:
2,284,968, CANC. INT. CL. 36.

OWENS, RICHIE, B., NASHVILLE, TN, DBA OWENS MUSIC
GROUP:
3,806,851, PUB. 4-6-2010. INT. CL. 15.

OXYGEN FINANCIAL, INC., MILTON, GA:
3,807,673, INT. CL. 36.

OY AJAT LTD., FINLAND:
3,807,168, PUB. 4-6-2010. INT. CL. 10.

O32 EHF., ICELAND:
3,807,143, PUB. 4-6-2010. MULTIPLE CLASS, INT. CLS. 30
AND 32.

P.AUDIO AMERICA, INC., ALPINE, CA:
2,771,526, CANC. INT. CL. 9.

P.C.N. CONSULTING, INC., 50 W. TECHNECENTER DR.,
OH, DBA ROTO-DISC:
2,405,684, REN. 5-20-10. INT. CL. 9.

P.L. THOMAS & CO., INC., MORRISTOWN, NJ:
3,807,044, PUB. 4-6-2010. INT. CL. 5.

P.Y. ASSOCIATES LTD., TEL AVIV 62091, ISRAEL:
2,772,738, CANC. INT. CL. 35.

PAASCHE AIRBRUSH COMPANY, CHICAGO, IL:
2,440,688, REN. 5-18-10. MULTIPLE CLASS, INT. CLS. 6
AND 7.

PACE, THOMAS A., OKLAHOMA CITY, OK:
3,805,755, PUB. 4-6-2010. INT. CL. 41.

PACIFIC ARCHITECTS AND ENGINEERS INCORPO-
RATED, LOS ANGELES, CA:
1,596,912, REN. 5-15-10. INT. CL. 42.

PACIFIC BUSINESS GROUP INC., SANTA FE SPRINGS, CA:
3,808,068, MULTIPLE CLASS, INT. CLS. 9 AND 11.

PACIFIC EQUIPMENT SALES, INC., TRAVELERS REST, SC:
3,808,016, INT. CL. 7.

PACIFIC NORTHWEST VEGETABLE ASSOCIATION, KEN-
NEWICK, WA:
3,805,353, PUB. 4-6-2010. INT. CL. 41.

PACIFIC SOUTHWEST MORTGAGE, SAN DIEGO, CA:
1,560,130, CANC. INT. CL. 36.

PACIFIC TELECOMMUNICATIONS COUNCIL, HONOLU-
LU, HI:
2,227,285, REN. 5-14-10. MULTIPLE CLASS, INT. CLS. 9,
16 AND 38.

PACIFIC TOWER, INC., ROSEVILLE, CA:
2,771,058, CANC. INT. CL. 37.

PACIFIC TRAIL CORPORATION, PORTLAND, OR:
2,911,167, CANC. MULTIPLE CLASS, INT. CLS. 14 AND
18.

PAGES, ERIK, ARLINGTON, VA:
3,806,975, PUB. 4-6-2010. INT. CL. 35.

PAI, NARENDRA M., LEWISTOWN, PA:
2,284,767, CANC. INT. CL. 41.

PAIN RELIEF TECHNOLOGY LLC, BOCA RATON, FL:
2,771,960, CANC. INT. CL. 20.

PALM BEACH LAND TITLE CORPORATION, PALM
BEACH, FL:
2,772,669, CANC. INT. CL. 36.

PALMER BIT CO., INC., WILLISTON, ND:
3,806,159, PUB. 4-6-2010. INT. CL. 7.

PALMER, ANDREW C, PALM DESERT, CA:
3,805,880, PUB. 4-6-2010. INT. CL. 28.

PALMER, GEOFFREY M, NEWTON, MA, DBA SUR-
VEYONTHESPOUT:
3,808,336, INT. CL. 42.
3,808,337, INT. CL. 42.

PALMIERI FOOD PRODUCTS, INC., NEW HAVEN, CT:
1,623,876, REN. 5-17-10. INT. CL. 30.

PALSIE'S, LLC, YOUNGSVILLE, NC, DBA PALSIE'S POP-
CORN & SWEETS:
3,808,417, INT. CL. 35.

PAMPLIN VINEYARDS LLC, SHERWOOD, OR:
3,808,667, INT. CL. 33.

PAN PACIFIC JOURNEYS INC., IRVINE, CA:
3,806,379, PUB. 4-6-2010. INT. CL. 39.

PANASONIC CORPORATION OF NORTH AMERICA, SE-
CAUCUS, NJ:
3,806,291, PUB. 4-6-2010. INT. CL. 9.

PANGAEA GROUP, INC., SANDY, UT:
2,770,642, CANC. MULTIPLE CLASS, INT. CLS. 35 AND
42.

PANGBORN CORPORATION, FAIRBURN, GA:
3,807,852, INT. CL. 7.

PANLINE, U.S.A., INC., NORTHVALE, NJ:
2,285,917, CANC. INT. CL. 16.

PANOR CORPORATION, HAUPPAUGE, NY:
3,808,330, INT. CL. 11.

PANTOFOLA D'ORO S.P.A., ASCOLI PICENO, ITALY:
3,805,681, PUB. 4-6-2010. MULTIPLE CLASS, INT. CLS. 18
AND 25.

PANVIVA PTY LTD, CAMBERWELL, VIC, AUSTRALIA:
3,806,362, PUB. 4-6-2010. INT. CL. 9.

PAPE, PIERCE J., ATLANTA, GA:
3,808,586, MULTIPLE CLASS, INT. CLS. 25 AND 26.

PAPER HOUSE PRODUCTIONS, INC., SAUGERTIES, NY:
2,298,074, REN. 5-17-10. INT. CL. 16.

PAR EMPRIZES INCORPORATED, SALINAS, CA:
3,807,665, INT. CL. 41.

PARAMETRIC TECHNOLOGY CORPORATION, NEED-
HAM, MA:
2,348,921, REN. 5-18-10. INT. CL. 9.

PARFUMS TED LAPIDUS, FRANCE:
3,807,339, PUB. 4-6-2010. INT. CL. 3.

PARISELLA, VINCELLI ASSOCIATES CONSULTING
GROUP INC., BOSTON, MA:
2,285,771, CANC. INT. CL. 35.

PARK, BRANDIE R., ATLANTA, GA:
3,808,114, INT. CL. 26.

PARKER SOFTWARE LIMITED, STOKE ON TRENT ST6
6BW, UNITED KINGDOM:
3,805,167, PUB. 4-6-2010. MULTIPLE CLASS, INT. CLS. 9
AND 42.

PARKER STATION, INC., LOS OLIVOS, CA:
3,805,208, PUB. 4-6-2010. INT. CL. 33.

PARLEY ENTERTAINMENT, INC., RALEIGH, NC:
3,807,902, INT. CL. 28.

PARTNERS IN PSYCHIATRY, LTD., DES PLAINES, IL:
1,560,226, CANC. INT. CL. 42.

PASAQUAN PRESERVATION SOCIETY, INC., BUENA
VISTA, GA:
3,805,514, PUB. 4-6-2010. INT. CL. 41.

PASENKO, GREG, CHICAGO, IL AND DELIN, DIANE,
CHICAGO, IL:
2,284,440, CANC. INT. CL. 9.

PASSAVANT DEVELOPMENT CORPORATION, PITTS-
BURGH, PA:
3,805,987, PUB. 4-6-2010. INT. CL. 35.

PASSPORT HEALTH COMMUNICATIONS, INC., FRANK-
LIN, TN:
3,805,986, PUB. 4-6-2010. INT. CL. 44.

- PATACHOU, INC., INDIANAPOLIS, IN:
3,808,335, INT. CL. 43.
- PATHWAYS INTERNATIONAL, INC., DALTON, GA:
2,286,530, CANC. INT. CL. 27.
- PATRICIA A. ALLEN ENTERPRISES, LLC, BLOOMFIELD TWP, MI:
3,807,560, INT. CL. 28.
- PATRICK, WILLIAM G., FAYETTEVILLE, NY:
2,284,966, CANC. INT. CL. 42.
- PATRIOT OUTDOORS, CLOVIS, NM:
3,807,407, MULTIPLE CLASS, INT. CLS. 35 AND 41.
- PATTERSON PUMP COMPANY, TOCCOA, GA:
3,807,937, INT. CL. 7.
- PAUL GREEN SCHOOL OF ROCK MUSIC, LLC, PHILADELPHIA, PA:
3,805,130, PUB. 4-6-2010. INT. CL. 41.
- PAUL INTERNATIONAL, INC., CARMEL, CA:
2,446,441, REN. 5-20-10. INT. CL. 42.
- PAUL LYONS ENTERPRISES, INC., TROY, MI:
3,806,482, PUB. 4-6-2010. INT. CL. 29.
- PAUL M HERTZ, RIVERDALE, NY:
3,806,720, PUB. 4-6-2010. INT. CL. 10.
- PAUL SCERRI SA, 1228 PLAN-LES-OUATES, SWITZERLAND:
2,835,703, CANC. MULTIPLE CLASS, INT. CLS. 10 AND 42.
- PAVALINE ENTERTAINMENT GROUP, NEW YORK, NY, DBA LVC INTERNATIONAL LLC:
3,805,521, PUB. 4-6-2010. INT. CL. 41.
- PAVLENKO, ALEX, KYIV, UKRAINE:
3,805,756, PUB. 4-6-2010. MULTIPLE CLASS, INT. CLS. 35 AND 41.
- PAVOL MUDRIK, MIAMI, FL:
3,808,409, INT. CL. 34.
- PAXTON AUTOMOTIVE CORP., OXNARD, CA:
2,349,774, REN. 5-17-10. INT. CL. 7.
- PBIGROUP, INC., DALLAS, TX:
3,806,557, PUB. 4-6-2010. INT. CL. 3.
- PBSJ CORPORATION, THE, TAMPA, FL:
3,807,042, PUB. 4-6-2010. INT. CL. 37.
- PCF MANAGAMENT GROUP, INC., HIALEAH, FL:
2,286,512, CANC. INT. CL. 35.
- PDB SPORTS, LTD., ENGLEWOOD, CO, DBA DENVER BRONCOS:
2,369,832, REN. 5-19-10. INT. CL. 41.
- PDP PROGRAM INC., HALIFAX, NOVA SCOTIA, CANADA:
3,805,287, PUB. 4-6-2010. MULTIPLE CLASS, INT. CLS. 9, 41 AND 44.
- PEACOCK, BRADLEY, PARK CITY, UT:
3,806,626, PUB. 4-6-2010. INT. CL. 37.
- PEAK RESORTS, INC., CORTLAND, NY:
3,806,238, PUB. 4-6-2010. INT. CL. 43.
- PECHANGA BAND OF LUISEÑO MISSION INDIANS OF THE PECHANGA RESERVATION, CALIFORNIA, TEMECULA, CA:
3,807,678, INT. CL. 43.
- PECOS TRADING, CORP., MIAMI LAKES, FL, DBA ARTISAN BRANDS:
3,807,752, INT. CL. 33.
- PEDERSEN, JOHN, BURBANK, CA:
3,807,984, INT. CL. 21.
- PEDERSEN, THOMAS C., FAR HILLS, NJ:
2,772,144, CANC. INT. CL. 4.
- PEDRE WATCH COMPANY, INC., NEW YORK, NY:
2,285,768, CANC. INT. CL. 14.
- PEER GIVING SOLUTIONS INC., VANCOUVER, BRITISH COLUMBIA, CANADA:
3,805,191, PUB. 4-6-2010. MULTIPLE CLASS, INT. CLS. 16, 35 AND 36.
- PEGASUS COMMUNICATIONS CORPORATION, BALA CYNWYD, PA:
2,770,814, CANC. MULTIPLE CLASS, INT. CLS. 38 AND 41.
- PELLICONI & C. S.P.A., OZZANO DELL'EMILIA (BO), ITALY:
2,770,584, CANC. MULTIPLE CLASS, INT. CLS. 6 AND 20.
- PENGUINS PARTNERS, NORTHRIDGE, CA:
1,504,198, CANC. INT. CL. 30.
- PENNEL ET FLIPO, 59100 ROUBAIX, FRANCE:
1,135,155, REN. 5-19-10. INT. CL. 20.
- PENTON MEDIA, INC., NEW YORK, NY:
3,805,469, PUB. 4-6-2010. MULTIPLE CLASS, INT. CLS. 9, 16, 35, 38 AND 41.
- PENTUCKET BANK, HAVERHILL, MA:
3,808,427, INT. CL. 36.
- PEOPLE BUSINESS, INC., FORT COLLINS, CO:
3,806,441, PUB. 4-6-2010. INT. CL. 41.
- PEOPLEMOVERS.COM, INC., DETROIT, MI:
3,808,747, MULTIPLE CLASS, INT. CLS. 35, 41 AND 42.
- PEP BOYS MANNY, MOE & JACK OF CALIFORNIA, THE, PHILADELPHIA, PA:
2,772,505, CANC. INT. CL. 27.
- PEPINIERES ET ROSERAIES GEORGES DELBARD, MALICORNE - 03600 COMMENTRY, FRANCE:
2,284,794, CANC. INT. CL. 31.
- PEPPER, JACK, CARTERSVILLE, GA:
3,805,765, PUB. 4-6-2010. INT. CL. 41.
- PERDUE HOLDINGS, INC., WILMINGTON, DE:
2,771,414, CANC. INT. CL. 29.
- 3,805,967, PUB. 4-6-2010. INT. CL. 29.
- PERFECT STRANGER ENTERPRISES PTY LTD., SOUTH AUSTRALIA, AUSTRALIA:
2,770,529, CANC. MULTIPLE CLASS, INT. CLS. 9, 16, 25, 28, 41 AND 42.
- PERFETTI VAN MELLE S.P.A., 20020 LAINATE (MILAN), ITALY:
3,805,241, PUB. 1-26-2010. INT. CL. 25.
- PERFETTI VAN MELLE SPA, MILAN, ITALY:
2,393,736, REN. 5-14-10. INT. CL. 30.
- PERFORMANCE FABRICS, INC., GRAND RAPIDS, MI:
3,808,187, INT. CL. 9.
- 3,808,450, INT. CL. 9.
- PERFORMANCE, INC., CHAPEL HILL, NC:
2,369,656, REN. 5-17-10. MULTIPLE CLASS, INT. CLS. 9, 12, 28 AND 35.
- 3,808,147, INT. CL. 35.
- PERLEGEN SCIENCES, INC., MOUNTAIN VIEW, CA:
2,770,855, CANC. INT. CL. 42.
- 2,770,856, CANC. INT. CL. 42.
- PERMAFIRM PAD COMPANY, LOS ANGELES, CA:
1,559,850, CANC. INT. CL. 20.
- PERONT, DERRICK, GARDEN GROVE, CA, DBA AIR RIDERS AVIATION, INC.:
3,805,522, PUB. 4-6-2010. INT. CL. 37.
- PERRY, KIMBERLY, NASHVILLE, TN AND PERRY, REID, NASHVILLE, TN AND PERRY, NEIL, NASHVILLE, TN:
3,806,592, PUB. 4-6-2010. INT. CL. 41.
- PERRY, LENORE E., LEO, IN:
2,384,489, REN. 5-14-10. INT. CL. 37.
- PERRY, RICHARD, LAKEPORT, CA, DBA BIO/CHEM RESEARCH, INC.:
2,868,298, COR. INT. CL. 5.
- PERSTORP AKTIEBOLAG, PERSTORP, SWEDEN:
3,806,202, PUB. 4-6-2010. INT. CL. 1.
- PER4MANCE PLUS, LLC, ORLANDO, FL:
3,807,675, INT. CL. 41.
- PET BISTRO, LLC, WAYNE, PA:
3,806,695, PUB. 4-6-2010. MULTIPLE CLASS, INT. CLS. 18 AND 31.
- PET HOME PRODUCTS, INC., WEST NYACK, NY:
3,805,531, PUB. 4-6-2010. INT. CL. 16.
- PET STOP MART, INC., SAVANNAH, GA:
3,808,551, INT. CL. 35.
- PET STOP SALES GROUP, LLC, NEWTOWN, OH:
3,806,786, PUB. 4-6-2010. INT. CL. 35.
- 3,807,019, PUB. 4-6-2010. MULTIPLE CLASS, INT. CLS. 35 AND 44.
- PETER C. KRAY, SANTA FE, NM:
3,807,799, INT. CL. 25.
- PETIT, MICHAEL, J. KENNESAW, GA:
2,771,572, CANC. INT. CL. 25.
- PETRA PRODUCTS, INC., MISSION VIEJO, CA, DBA BULLFROG SNOT:
3,806,472, PUB. 4-6-2010. INT. CL. 2.

PETROMATERIALS CORPORATION, TOKYO, JAPAN:
3,807,620, INT. CL. 42.

PETROWICH, THEODORE L., BATAVIA, IL:
2,772,544, CANC. INT. CL. 42.

PETSCAPE, LLC, HAZLETON, PA:
2,771,786, CANC. INT. CL. 28.
2,771,787, CANC. INT. CL. 28.

PETSMART STORE SUPPORT GROUP, INC., PHOENIX, AZ:
3,805,677, PUB. 4-6-2010. INT. CL. 35.

PFIP, LLC, NEWINGTON, NH:
2,377,662, REN. 5-20-10. INT. CL. 41.

PFIZER ENTERPRISES SARL, LUXEMBOURG:
2,353,074, REN. 5-17-10. INT. CL. 5.

PGA TOUR, INC., PONTE VEDRA BEACH, FL:
2,352,139, REN. 5-19-10. INT. CL. 28.

PH(X) GLASS, LLC, WOODSIDE, CA:
3,808,523, MULTIPLE CLASS, INT. CLS. 25 AND 34.

PHANTOM MFG. (INT'L) LTD, ABBOTSFORD, CANADA:
3,808,108, MULTIPLE CLASS, INT. CLS. 6 AND 19.
3,808,109, MULTIPLE CLASS, INT. CLS. 6 AND 19.
3,808,110, MULTIPLE CLASS, INT. CLS. 6 AND 19.
3,808,111, MULTIPLE CLASS, INT. CLS. 6 AND 19.
3,808,112, MULTIPLE CLASS, INT. CLS. 6 AND 19.

PHARMACURE HEALTH CARE AB, SE-400 16 GÖTEBORG, SWEDEN:
3,807,167, PUB. 4-6-2010. INT. CL. 5.
3,807,214, PUB. 4-6-2010. INT. CL. 5.

PHARMWEST, INC., MARINA DEL REY, CA:
3,808,757, INT. CL. 3.

PHEASANT MALL RESTAURANT GROUP, INC., NASHUA, NH:
3,805,868, PUB. 4-6-2010. INT. CL. 43.

PHENOMIX CORPORATION, SAN DIEGO, CA:
3,807,547, INT. CL. 5.

PHILADELPHIA NEWSPAPERS, LLC, PHILADELPHIA, PA, PHILADELPHIA INQUIRER CO., THE, PHILADELPHIA, PA:
270,787, REN. 5-20-10. U.S. CL. 38 (INT. CL. 16).

PHILMONT, INC., CHARLOTTE, NC:
3,805,382, PUB. 9-22-2009. MULTIPLE CLASS, INT. CLS. 9, 14, 16, 25, 26, 38 AND 41.

PHOENIX CONTACT GMBH & CO. KG, FED REP GERMANY:
3,807,110, PUB. 4-6-2010. MULTIPLE CLASS, INT. CLS. 9 AND 16.

PHOENIX ENVIRONMENTAL CARE, LLC, VALDOSTA, GA:
3,806,817, PUB. 4-6-2010. INT. CL. 5.
3,806,818, PUB. 4-6-2010. INT. CL. 5.
3,806,819, PUB. 4-6-2010. INT. CL. 5.
3,806,905, PUB. 4-6-2010. INT. CL. 5.

PHOENIX INK CORPORATION, SARASOTA, FL:
3,805,476, PUB. 4-6-2010. MULTIPLE CLASS, INT. CLS. 2 AND 37.

PHOENIX SOFTWARE INTERNATIONAL, INC., LOS ANGELES, CA:
3,805,186, PUB. 4-6-2010. MULTIPLE CLASS, INT. CLS. 9 AND 42.

PHOTOSPIN, INC., ROLLING HILLS ESTATES, CA:
2,285,790, CANC. INT. CL. 9.

PHOTOTIME, INC., PALO ALTO, CA:
2,772,070, CANC. INT. CL. 40.

PHP COMPANIES, INC., KNOXVILLE, TN:
2,771,229, CANC. INT. CL. 44.

PHYSICIANS FOR REFORM, HICKORY, NC:
3,808,499, INT. CL. 36.

PHYSICIANS MUTUAL INSURANCE COMPANY, OMAHA, NE:
2,771,956, CANC. INT. CL. 36.
2,771,957, CANC. INT. CL. 36.
2,771,958, CANC. INT. CL. 36.

PHYSIO-CONTROL, INC., REDMOND, WA:
2,409,673, REN. 5-20-10. INT. CL. 10.

PHYTO LAB GMBH & CO. KG, FED REP GERMANY:
3,807,138, PUB. 4-6-2010. MULTIPLE CLASS, INT. CLS. 5, 42 AND 44.

PICAYUNE RANCHERIA OF THE CHUKCHANSI INDIANS, COARSEGOLD, CA:
3,805,717, PUB. 4-6-2010. INT. CL. 41.

PICAZIO, HEATHER, MYSTIC, CT:
3,807,664, INT. CL. 25.

PIERROT CO., LTD., MITAKA-CUTY, TOKYO, JAPAN:
2,772,245, CANC. INT. CL. 28.
2,772,246, CANC. INT. CL. 28.
2,772,247, CANC. INT. CL. 28.
2,772,248, CANC. INT. CL. 28.

PILKINGTON NORTH AMERICA, INC., TOLEDO, OH:
2,373,107, REN. 5-17-10. INT. CL. 19.
2,373,760, REN. 5-18-10. INT. CL. 19.

PINEHILLS LLC, PLYMOUTH, MA:
2,770,904, CANC. INT. CL. 36.

PINKBUDDHA CO., LTD., KYOTO 600-8494, JAPAN:
3,807,299, PUB. 4-6-2010. INT. CL. 25.

PINNACLE CALL CENTER SOLUTIONS, INC., UPLAND, CA:
3,807,775, INT. CL. 9.

PINNACLE CONSULTING, LLC, MURAY, UT:
3,806,566, PUB. 4-6-2010. INT. CL. 35.

PINNACLE CONSULTING, LLC, MURRAY, UT:
3,806,568, PUB. 4-6-2010. INT. CL. 35.

PINNACLE EDUCATION, INC., TEMPE, AZ:
3,805,142, PUB. 4-6-2010. INT. CL. 41.

PINNACOLASSURANCE, DENVER, CO:
2,451,573, REN. 5-19-10. INT. CL. 36.

PINZONE, MICHAEL KEITH, GULF BREEZE, FL:
2,384,969, REN. 5-17-10. INT. CL. 42.

PIP-FUJIMOTO CO., LTD., CHUO-KU, OSAKA, JAPAN:
2,347,634, REN. 5-18-10. INT. CL. 9.

PIPEDREAM PRODUCTS, INC., CHATSWORTH, CA:
2,771,209, CANC. MULTIPLE CLASS, INT. CLS. 10 AND 25.

PIPINO, MARCO RIC, NEW YORK, NY:
2,772,500, CANC. INT. CL. 3.

PIRONTI, JOHN P., CHARLESTOWN, MA:
3,805,837, PUB. 4-6-2010. INT. CL. 35.

PISZKER, TRICIA A., RESTON, VA:
2,771,640, CANC. INT. CL. 41.

PITTSBURGH DOWNTOWN PARTNERSHIP, THE, PITTSBURGH, PA:
2,770,778, CANC. INT. CL. 41.

PIXEL POWER LTD, CAMBRIDGE, UNITED KINGDOM:
3,805,505, PUB. 4-6-2010. INT. CL. 9.

PIZZA HUT, INC., DALLAS, TX:
2,771,682, CANC. INT. CL. 43.

PLANET BULB, LLC, KANSAS CITY, KS:
3,806,930, PUB. 4-6-2010. INT. CL. 35.

PLASMA-THERM LLC, ST. PETERSBURG, FL:
3,806,343, PUB. 4-6-2010. INT. CL. 7.

PLATINUM PERFORMANCE INC., BUELLTON, CA:
2,862,918, AM. INT. CL. 5.

PLAYERS ONLY SPORTSWEAR, INC., DESTIN, FL:
2,770,531, CANC. INT. CL. 25.

PLAYMATES TOYS INTERNATIONAL LIMITED, TSM-SHATSUI, KOWLOON, HONG KONG:
3,807,535, MULTIPLE CLASS, INT. CLS. 16 AND 28.

PLUCINSKI, COLLEEN, PLAINFIELD, IL, DBA HARVEST HOUSE QUILTING:
3,807,893, INT. CL. 8.

PM INVESTIGATIONS, INC., ATLANTA, GA:
3,807,612, INT. CL. 18.
3,807,613, INT. CL. 21.

PMC BIOGENIX, INC., MT LAUREL, NJ:
3,806,364, PUB. 4-6-2010. INT. CL. 1.

PMC SPECIALTIES GROUP, INC., CINCINNATI, OH:
2,771,600, CANC. INT. CL. 1.

PMC STONECARE ENTERPRISES INC., SAN DIEGO, CA:
2,772,641, CANC. INT. CL. 3.

PNA BANK, DOWNERS GROVE, IL:
3,806,971, PUB. 4-6-2010. INT. CL. 36.
3,806,972, PUB. 4-6-2010. INT. CL. 36.

PO JEN PAI, TAICHUNG, TAIWAN:
3,805,777, PUB. 4-6-2010. INT. CL. 25.

POINTCLICK TECHNOLOGIES, LLC, RALEIGH, NC:
3,806,088, PUB. 4-6-2010. INT. CL. 42.

- POINTGREY DESIGN CO., VANCOUVER BC, CANADA:
3,808,332, INT. CL. 16.
- POINT2 TECHNOLOGIES INC., SASKATOON SASKATCH-
EWAN, CANADA:
2,381,146, REN. 5-14-10. MULTIPLE CLASS, INT. CLS. 9
AND 35.
- POLAR TECH INDUSTRIES, INC., GENOA, IL:
2,043,638, REN. 5-17-10. INT. CL. 1.
- POLTI S.P.A., BULGAROGRASSO, COMO, ITALY TO POLTI
S.P.A., BULGAROGRASSO, COMO, ITALY:
2,285,788, CANC. INT. CL. 9.
- POLYFLOR LIMITED, RADCLIFFE, MANCHESTER, UNI-
TED KINGDOM:
3,807,674, INT. CL. 27.
- POLYNORM N.V., 3751 LJ BUNSCHOTEN, NETHER-
LANDS:
2,771,991, CANC. INT. CL. 12.
- POLYTUF BRANDS, INC., CUYAHOGA FALLS, OH:
3,807,523, INT. CL. 22.
- PONIEWAZ, ERICKA, SIMI VALLEY, CA:
3,808,091, MULTIPLE CLASS, INT. CLS. 18, 24 AND 25.
- POOLMASTER, INC., SACRAMENTO, CA:
3,808,240, INT. CL. 22.
- POPCAP GAMES, INC., SEATTLE, WA:
3,808,093, INT. CL. 9.
- POPE, RAY, CAMANO ISLAND, WA:
3,808,312, INT. CL. 16.
- POPOOLA, DELE, TORRANCE, CA AND KOLTISOV, GREG,
TORRANCE, CA:
3,806,665, PUB. 4-6-2010. INT. CL. 35.
- POPULAR, INC., SAN JUAN, PUERTO RICO:
2,372,878, REN. 5-18-10. INT. CL. 36.
- PORT SALERNO COMMERCIAL FISHING DOCK
AUTHORITY, INC., PORT SALERNO, FL:
3,808,772, INT. CL. 41.
- PORTER CLASSIC CO., LTD., JAPAN:
3,807,250, PUB. 4-6-2010. MULTIPLE CLASS, INT. CLS.
18, 25 AND 35.
- PORTER, MATTHEW, TORRANCE, CA:
3,805,885, PUB. 4-6-2010. INT. CL. 16.
- PORTER, RONALD W., ATLANTA, GA:
3,806,521, PUB. 4-6-2010. INT. CL. 20.
- PORTO FRANCO RECORDS, LLC, SAN FRANCISCO, CA:
3,808,098, INT. CL. 9.
3,808,099, INT. CL. 35.
3,808,100, INT. CL. 41.
- POST APARTMENT HOMES, L.P., ATLANTA, GA:
1,560,137, CANC. MULTIPLE CLASS, INT. CLS. 36 AND
37.
- POWDER RIVER ENERGY CORPORATION, SUNDANCE,
WY:
3,806,736, PUB. 4-6-2010. INT. CL. 39.
3,806,740, PUB. 4-6-2010. INT. CL. 39.
- POWER BLOCK, INC., OWATONNA, MN:
3,806,651, PUB. 4-6-2010. INT. CL. 28.
- POWER KNOWLEDGE SOFTWARE, LLC, SAN LUIS OBIS-
PO, CA:
2,286,116, CANC. INT. CL. 9.
- POWER MEASUREMENT, EI, INC., SAANICHTON BC,
CANADA:
2,771,027, CANC. INT. CL. 9.
- POWERNOMICS CORPORATION OF AMERICA, INC.,
BETHESDA, MD:
2,770,683, CANC. INT. CL. 41.
- POWERS, DANIEL ALLEN, PORTAGE, MI AND POWERS,
SHEILA ANN, PORTAGE, MI:
2,285,851, CANC. MULTIPLE CLASS, INT. CLS. 10, 35, 37
AND 40.
- POWERS, RICHARD, WALNUT, CA:
2,284,937, CANC. INT. CL. 39.
- PPG INDUSTRIES OHIO, INC., CLEVELAND, OH:
1,596,497, REN. 5-20-10. INT. CL. 21.
- PPG INDUSTRIES OHIO, INC., CLEVELAND, OH:
3,807,998, INT. CL. 19.
- PQ CORPORATION, VALLEY FORGE, PA:
526,917, REN. 5-19-10. U.S. CL. 6 (INT. CL. 1).
- PRACTICE VELOCITY, LLC, BELVIDERE, IL:
3,805,878, PUB. 4-6-2010. INT. CL. 35.
- PRAECERE PUBLIC RELATIONS LLC, WASHINGTON, DC:
3,808,489, INT. CL. 35.
- PRAMAC AMERICA LLC, MEDLEY, FL:
3,807,758, INT. CL. 7.
- PRAXIS LANGUAGE LTD., GRAND CAYMAN, CAYMAN
ISLANDS:
3,806,738, PUB. 4-6-2010. INT. CL. 41.
- PRAXIS LANGUAGE LTD., GEORGE TOWN, CAYMAN
ISLANDS:
3,807,966, INT. CL. 41.
- PRECISIONIR GROUP HOLDINGS INC., RICHMOND, VA:
2,772,496, CANC. INT. CL. 36.
2,772,497, CANC. INT. CL. 38.
- PREMERA BLUE CROSS, SEATTLE, WA:
2,349,294, REN. 5-18-10. INT. CL. 36.
- PREMIER PAINT ROLLER MFG. CO., INC., RICHMOND
HILL, NY:
2,377,002, REN. 5-14-10. INT. CL. 16.
- PREMIER, INC., CHARLOTTE, NC:
3,806,820, PUB. 4-6-2010. MULTIPLE CLASS, INT. CLS.
35, 42 AND 44.
- PREMIERE FIBERS, INC., ANSONVILLE, NC:
3,807,819, MULTIPLE CLASS, INT. CLS. 22 AND 23.
- PREMIERE RADIO NETWORKS, INC., SAN ANTONIO, TX:
3,806,882, PUB. 4-6-2010. INT. CL. 38.
- PREPMD LLC, BOSTON, MA:
3,805,737, PUB. 4-6-2010. MULTIPLE CLASS, INT. CLS. 35
AND 41.
- PRESIDENT TOBACCO, LLC., AVENTURA, FL:
3,805,956, PUB. 4-6-2010. INT. CL. 34.
- PRESONUS AUDIO ELECTRONICS, INC., BATON ROUGE,
LA:
3,807,644, INT. CL. 9.
- PRESSCUT INDUSTRIES INC., CARROLLTON, TX:
2,286,854, CANC. INT. CL. 40.
- PRESSURE SYSTEMS, INC., HAMPTON, VA:
3,806,125, PUB. 4-6-2010. INT. CL. 9.
- PRESTON MEDIA, LLC, WELLESLEY, MA:
3,807,633, INT. CL. 41.
- PRICEFALLS, LLC, LAS VEGAS, NV:
3,807,860, INT. CL. 35.
3,807,861, INT. CL. 35.
- PRICELESS RENT -A-CAR, LLC, LAUREL, MD:
2,423,236, REN. 5-20-10. INT. CL. 39.
- PRICELESS RENT-A-CAR, LLC, LAUREL, MD:
2,346,127, REN. 5-14-10. INT. CL. 39.
- PRIDE TRAVEL, LONG BEACH, CA:
3,806,877, PUB. 4-6-2010. INT. CL. 39.
3,806,913, PUB. 4-6-2010. INT. CL. 39.
- PRIME RETAIL, L.P., BALTIMORE, MD:
3,806,066, PUB. 4-6-2010. INT. CL. 35.
3,806,069, PUB. 4-6-2010. INT. CL. 35.
- PRIMENTIA, INC., NEWTOWN, PA:
2,772,435, CANC. INT. CL. 42.
- PRIMERA FOOD CORPORATION, CAMERON, WI:
1,596,708, REN. 5-18-10. INT. CL. 30.
- PRIMESOURCE BUILDING PRODUCTS, INC., IRVING, TX:
3,807,546, MULTIPLE CLASS, INT. CLS. 4, 8, 17 AND 20.
- PRIMETECH S.P.A., ITALY:
3,683,262, COR. MULTIPLE CLASS, INT. CLS. 7, 12 AND
44.
- PRIMEX EHF., SIGLUFJORDUR, ICELAND:
3,807,112, PUB. 4-6-2010. MULTIPLE CLASS, INT. CLS. 1,
3 AND 5.
- PRIMO EMPORIO S.N.C.; DI GIOVANNI PROVITERA & C.,
ITALY:
3,807,369, PUB. 4-6-2010. MULTIPLE CLASS, INT. CLS. 9,
14, 18 AND 25.
- PRIMROSE SCHOOL FRANCHISING COMPANY, CAR-
TERSVILLE, GA:
2,771,476, CANC. INT. CL. 41.
- PRINCE DIMITRI LLC, NEW YORK, NY:
3,808,526, INT. CL. 35.
- PRINCE LIONHEART, INC., SANTA MARIA, CA:
1,559,849, CANC. INT. CL. 20.
- PRINCIPLE COATINGS INC., CONYERS, GA:
3,805,719, PUB. 4-6-2010. MULTIPLE CLASS, INT. CLS. 1,
2, 17 AND 19.

PRISMEDICAL CORP., NAPA, CA:
2,771,955, CANC. INT. CL. 10.

PRIUS ENERGY SLU, ALBACETE, SPAIN:
3,806,136, PUB. 4-6-2010. MULTIPLE CLASS, INT. CLS. 9,
11, 37 AND 42.

PRIVITY VENTURES, INC., CARSON CITY, NV:
2,446,971. REN. 5-20-10. INT. CL. 35.

PROCESS TYPE FOUNDRY LLC, GOLDEN VALLEY, MN:
3,806,775, PUB. 4-6-2010. INT. CL. 9.
3,806,785, PUB. 4-6-2010. INT. CL. 9.

PROCESSALL, INC., CINCINNATI, OH:
1,559,569, CANC. INT. CL. 7.
1,559,570, CANC. INT. CL. 7.

PROCREATE INC., ANACORTES, WA:
3,807,748, INT. CL. 9.

PROCTER & GAMBLE COMPANY, THE, CINCINNATI, OH:
3,806,792, PUB. 4-6-2010. INT. CL. 5.
3,808,185, INT. CL. 3.

PRODUCE MARKETING ASSOCIATION, INC., NEWARK,
DE:
3,805,966, PUB. 4-6-2010. MULTIPLE CLASS, INT. CLS. 35
AND 41.
3,805,969, PUB. 4-6-2010. MULTIPLE CLASS, INT. CLS. 35
AND 41.
3,805,994, PUB. 4-6-2010. INT. CL. 41.

PRODUCT PARTNERS, LLC, BEVERLY HILLS, CA:
2,853,244, COR. MULTIPLE CLASS, INT. CLS. 5, 9 AND
41.

PROFESSIONAL CREATIONS, LTD. CO., FAYETTEVILLE,
AR:
2,771,819, CANC. INT. CL. 30.

PROFESSIONAL GOLFERS' ASSOCIATION OF AMERICA,
PALM BEACH GARDENS, FL:
1,598,234. REN. 5-18-10. INT. CL. 9.
1,600,416. REN. 5-18-10. INT. CL. 9.

PROFESSIONAL MEDICAL SURGICAL SUPPLY, INC.,
NEW LENOX, IL:
3,805,293, PUB. 4-6-2010. MULTIPLE CLASS, INT. CLS. 3,
16 AND 41.

PROFESSIONAL NET IMAGES, LLC, WEST ORANGE, NJ:
3,806,789, PUB. 4-6-2010. INT. CL. 25.

PROGRAMMER'S PARADISE, INC., SHREWSBURY, NJ:
2,285,410, CANC. INT. CL. 35.
2,285,411, CANC. INT. CL. 35.

PROGRESS ENERGY SERVICE COMPANY, LLC, RA-
LEIGH, NC:
2,770,818, CANC. INT. CL. 38.

PROGRESSIVE COMPUTING, LLC, SAN DIEGO, CA:
2,771,712, CANC. INT. CL. 45.
2,771,713, CANC. INT. CL. 45.

PROGRESSIVE EMPLOYER SERVICES II, INC., SARASO-
TA, FL:
2,285,111, CANC. INT. CL. 35.

PROGRESSIVE REAL ESTATE, INC., MELBOURNE, FL:
3,805,828, PUB. 4-6-2010. MULTIPLE CLASS, INT. CLS. 35
AND 36.

PROJECT E INDIANA, INC., INDIANAPOLIS, IN:
2,772,050, CANC. INT. CL. 36.
2,772,051, CANC. INT. CL. 42.

PROJECT PERFORMANCE CORPORATION, MCLEAN, VA:
2,771,114, CANC. INT. CL. 9.

PROJECT SKATEBOARD HARDWARE, CYPRESS, CA:
2,772,522, CANC. MULTIPLE CLASS, INT. CLS. 25 AND
28.

PROLIANCE ENERGY LLC, INDIANAPOLIS, IN:
3,805,950, PUB. 4-6-2010. INT. CL. 35.

PROLMAN, MICHAEL, NEEDHAM, MA:
2,772,560, CANC. INT. CL. 16.

PROMEGA CORPORATION, MADISON, WI:
1,559,466, CANC. INT. CL. 1.

PROMGIRL, INC., NARBERTH, PA:
3,808,151, INT. CL. 25.

PROMISE TECHNOLOGY, INC., MILPITAS, CA:
3,806,594, PUB. 4-6-2010. INT. CL. 9.
3,806,595, PUB. 4-6-2010. INT. CL. 9.

PROMIUS PHARMA, LLC, BRIDGEWATER, NJ:
3,807,827, INT. CL. 5.

PROMO, INK, NEW YORK, NY:
2,772,479, CANC. INT. CL. 35.

PROMOTION IN MOTION, INC., CLOSTER, NJ:
2,286,653, CANC. INT. CL. 30.

PRONK TECHNOLOGIES, INC., SUN VALLEY, CA:
3,807,939, INT. CL. 9.

PRONTO SOFTWARE PTY LTD, EAST BURWOOD, VIC-
TORIA, AUSTRALIA:
3,806,925, PUB. 4-6-2010. MULTIPLE CLASS, INT. CLS. 9
AND 42.

PROPER MOLD & ENGINEERING, INC., WARREN, MI:
2,285,205, CANC. INT. CL. 42.
2,285,311, CANC. INT. CL. 42.

PROSEGUR, COMPAÑIA DE SEGURIDAD, S.A., SPAIN:
3,807,157, PUB. 4-6-2010. MULTIPLE CLASS, INT. CLS. 9
AND 39.

PROSPER INDEPENDENT SCHOOL DISTRICT, PROSPER,
TX:
3,805,559, PUB. 4-6-2010. MULTIPLE CLASS, INT. CLS. 25
AND 41.

PROSPERITAS CONSULTING, MILL VALLEY, CA:
2,772,694, CANC. INT. CL. 44.

PROSTATE NET, INC., THE, HACKENSACK, NJ:
3,807,595, INT. CL. 16.
3,807,596, MULTIPLE CLASS, INT. CLS. 16, 36 AND 41.

PROTHERA, INC., RENO, NV:
3,807,634, INT. CL. 5.

PROTOTEK SHEETMETAL FABRICATION, LLC, CONTOO-
COOK, NH:
3,805,169, PUB. 4-6-2010. INT. CL. 40.

PROVARE TECHNOLOGY, INC., ALPHARETTA, GA:
3,806,120, PUB. 4-6-2010. INT. CL. 42.

PROVIDENT CONSTRUCTION COMPANY, NAPLES, FL:
2,772,618, CANC. INT. CL. 37.

PROXIMITY SYSTEMS, INC., HOUSTON, TX:
2,355,206, REN. 5-19-10. INT. CL. 20.

PRUFTECHNIK DIETER BUSCH AG, D-85737 ISMANING,
FED REP GERMANY:
2,770,681, CANC. MULTIPLE CLASS, INT. CLS. 7 AND 9.

PS IMPORTS FL., INC., MIAMI BEACH, FL, DBA BEYA:
3,805,458, PUB. 4-6-2010. INT. CL. 14.

PSB SHOE GROUP LLC, MILL CREEK, WA:
3,518,316, COR. MULTIPLE CLASS, INT. CLS. 10 AND
25.

PULSE NETWORK LLC, HOUSTON, TX:
2,772,501, CANC. INT. CL. 35.
2,772,518, CANC. INT. CL. 35.

PUNDIT PRODUCTIONS, INC., WASHINGTON D.C., DC:
3,806,006, PUB. 4-6-2010. MULTIPLE CLASS, INT. CLS. 9,
35 AND 41.
3,806,007, PUB. 4-6-2010. MULTIPLE CLASS, INT. CLS. 9,
35 AND 41.

PURBLU BEVERAGES, INC., PITTSBURGH, PA:
3,807,600, INT. CL. 32.
3,807,870, INT. CL. 32.

PURE & NATURAL COMPANY, SCOTTSDALE, AZ:
2,772,690, CANC. INT. CL. 3.

PURE ENERGY SOLUTIONS, INC., BOULDER, CO:
3,807,543, INT. CL. 9.

PURRTOPIA ENTERPRISES LIMITED, SEATTLE, WA, AKA
THE CAT BEHAVIOR CLINIC:
3,805,789, PUB. 4-6-2010. INT. CL. 41.

PYRAMEX SAFETY PRODUCTS, LLC, COLLIERVILLE, TN:
3,807,891, INT. CL. 9.
3,808,438, INT. CL. 2.

PYRAMYD AIR LTD, WARRENSVILLE HEIGHTS, OH:
3,807,015, PUB. 4-6-2010. INT. CL. 13.

PYUA GMBH, FED REP GERMANY:
3,807,124, PUB. 4-6-2010. MULTIPLE CLASS, INT. CLS.
18, 25 AND 28.

Q'SO, INCORPORATED, FORT WORTH, TX:
3,805,874, PUB. 4-6-2010. INT. CL. 1.

QIAGEN GAITHERSBURG, INC., GAITHERSBURG, MD:
2,772,244, CANC. INT. CL. 1.

QIX INFORMATION TECHNOLOGY LLC, O'FALLON, MO,
DBA QIXIT:
3,807,472, INT. CL. 42.

- QSA LIMITED, HERTFORDSHIRE AL2 1HA, UNITED KINGDOM:
2,770,885, CANC. INT. CL. 9.
- QUADY WINERY INC, MADERA, CA:
3,807,887, INT. CL. 33.
- QUAKER STEAK & LUBE FRANCHISING CORPORATION, SHARON, PA:
2,771,493, CANC. INT. CL. 30.
- QUALCOMM INCORPORATED, SAN DIEGO, CA:
2,772,558, CANC. INT. CL. 9.
- QUALITY BAKERS OF AMERICA COOPERATIVE, INC., GREENWICH, CT:
2,772,410, CANC. INT. CL. 35.
- QUALITY CULVERT INCORPORATED, ASTATULA, FL:
3,806,039, PUB. 4-6-2010. INT. CL. 19.
- QUALSTAR CREDIT UNION, REDMOND, WA, SAFEWAY CREDIT UNION, REDMOND, WA:
2,388,520, REN. 5-18-10. INT. CL. 36.
- QUANTA ASSOCIATES L.P., HOUSTON, TX:
2,410,600, REN. 5-18-10. INT. CL. 37.
- QUANTA ASSOCIATES, L.P., HOUSTON, TX:
2,410,599, REN. 5-18-10. INT. CL. 42.
- QUANTUM FOODS LLC, BOLINGBROOK, IL:
3,807,587, INT. CL. 43.
3,807,588, INT. CL. 43.
- QUEST DIAGNOSTICS INVESTMENTS INCORPORATED, WILMINGTON, DE:
2,356,304, REN. 5-18-10. INT. CL. 42.
3,808,077, MULTIPLE CLASS, INT. CLS. 9 AND 42.
- QUICK CABLE CORPORATION, FRANKSVILLE, WI:
2,383,480, REN. 5-18-10. INT. CL. 9.
- QUILL LINCOLNSHIRE, INC., LINCOLNSHIRE, IL:
2,771,745, CANC. INT. CL. 35.
- QVC, INC., WEST CHESTER, PA:
2,772,485, CANC. INT. CL. 14.
3,806,957, PUB. 4-6-2010. MULTIPLE CLASS, INT. CLS. 20 AND 25.
- QWEST COMMUNICATIONS INTERNATIONAL INC., DENVER, CO:
3,805,426, PUB. 4-6-2010. INT. CL. 38.
- R & A BAILEY & CO, DUBLIN 12, IRELAND:
3,807,041, PUB. 4-6-2010. INT. CL. 30.
- R.H. PHILLIPS, INC., ESPARTO, CA:
2,285,580, CANC. INT. CL. 33.
2,285,606, CANC. INT. CL. 33.
- R.K. FABS & FASHIONS, INC., NEW YORK, NY:
2,286,288, CANC. INT. CL. 25.
- R.L. KUNZ, INC., GREENVILLE, SC:
3,808,018, MULTIPLE CLASS, INT. CLS. 6 AND 11.
- R.S. THOMPSON, AMSTERDAM, NETHERLANDS:
3,806,399, PUB. 4-6-2010. INT. CL. 35.
- RACE STAR INDUSTRIES, INC., KEARNEY, MO:
3,808,415, INT. CL. 12.
- RACINE FEDERATED, INC., RACINE, WI:
2,286,091, CANC. INT. CL. 9.
- RACKS UNLEASHED, LLC, GRANDVILLE, MI:
3,808,166, INT. CL. 25.
- RADIANT LOGISTICS, INC., BELLEVUE, WA:
3,806,746, PUB. 4-6-2010. MULTIPLE CLASS, INT. CLS. 35 AND 39.
- RADICE, DEBRA K., WIMBERLEY, TX, DBA SYNDICIT RE:
3,806,569, PUB. 4-6-2010. INT. CL. 42.
- RADIOLOGICAL HEALTH SERVICES, PC, PORT JEFFERSON, NY:
2,772,414, CANC. INT. CL. 44.
- RADIUS EINRICHTUNGSBEDARF GMBH, FED REP GERMANY:
3,807,260, PUB. 4-6-2010. MULTIPLE CLASS, INT. CLS. 4, 11, 18, 20, 21 AND 24.
- RADKO, CHRISTOPHER, ELMSFORD, NY:
2,772,208, CANC. INT. CL. 11.
- RAGE BEVERAGES INC., MONTREAL, QUEBEC, CANADA, FORMERLY PINNACLE EXCLUSIVES INC.:
- 3,806,059, PUB. 4-6-2010. INT. CL. 32.
3,806,060, PUB. 4-6-2010. INT. CL. 32.
- RAIFORD, KEVIN, SAMUEL, PALO ALTO, CA:
2,772,650, CANC. INT. CL. 16.
- RAIL EUROPE GROUP, INC., WHITE PLAINS, NY:
2,285,378, CANC. MULTIPLE CLASS, INT. CLS. 39 AND 42.
- RAINBOW LIGHT NUTRITIONAL SYSTEMS, INC., SANTA CRUZ, CA:
3,808,396, INT. CL. 5.
- RALPH MCELROY AND ASSOCIATES, LTD., AUSTIN, TX:
3,806,835, PUB. 4-6-2010. MULTIPLE CLASS, INT. CLS. 41 AND 42.
- RAM TRADING, LLC, BOZEMAN, MT:
3,806,646, PUB. 4-6-2010. INT. CL. 43.
- RAMSEY, RALPH, SYOSSET, NY AND HENRY, WAYNE, SYOSSET, NY:
3,806,587, PUB. 4-6-2010. MULTIPLE CLASS, INT. CLS. 25 AND 41.
- RANDOLPH JOHNSON DESIGN STORE, INC., SANTA ROSA, CA:
2,383,453, REN. 5-19-10. INT. CL. 2.
- RANGE OF LIGHT, LLC., ROSEVILLE, CA:
3,808,355, MULTIPLE CLASS, INT. CLS. 25 AND 35.
- RAPPORT SHAFT TECHNOLOGIES, LLC, WESTFIELD, IN:
2,285,484, CANC. INT. CL. 28.
- RARE HOSPITALITY MANAGEMENT, INC., ORLANDO, FL:
2,285,761, CANC. INT. CL. 42.
3,805,593, PUB. 4-6-2010. INT. CL. 29.
- RARITAN ENGINEERING COMPANY, INC., MILLVILLE, NJ:
3,807,742, INT. CL. 11.
- RASKIN, CYNTHIA, CHICAGO, IL:
3,806,883, PUB. 4-6-2010. INT. CL. 35.
- RATCLIFF JESSICA A., GRAND RAPIDS, MI, DBA REALITY-TYUNWIND SOCIAL MEDIA NETWORKING COMPANY:
3,805,803, PUB. 4-6-2010. INT. CL. 41.
- RATH AKTIENGESELLSCHAFT, AUSTRIA:
3,807,287, PUB. 4-6-2010. MULTIPLE CLASS, INT. CLS. 17 AND 19.
3,807,288, PUB. 4-6-2010. MULTIPLE CLASS, INT. CLS. 17 AND 19.
- RATH, MATTHIAS, NL-7609 KL ALMELO, FED REP GERMANY:
2,770,821, CANC. MULTIPLE CLASS, INT. CLS. 5, 16 AND 32.
- RAY DEPARTMENT STORE INC., BRONX, NY:
1,560,262, CANC. INT. CL. 42.
- RAY TUCK, D.C., P.C., BLACKSBURG, VA, DBA TUCK CHIROPRACTIC CLINIC:
3,806,129, PUB. 4-6-2010. INT. CL. 44.
3,806,130, PUB. 4-6-2010. INT. CL. 44.
- RAYMOND GUERRERO, SANTA ANA, CA:
3,806,142, PUB. 4-6-2010. MULTIPLE CLASS, INT. CLS. 41 AND 43.
3,806,143, PUB. 4-6-2010. MULTIPLE CLASS, INT. CLS. 41 AND 43.
- RAYMOND JAMES BANK, FSB, ST. PETERSBURG, FL:
2,387,618, REN. 5-18-10. INT. CL. 36.
- RAYMOND JAMES FINANCIAL, INC., ST PETERSBURG, FL, RAYMOND JAMES FINANCIAL, INC., ST PETERSBURG, FL:
2,432,664, REN. 5-18-10. MULTIPLE CLASS, INT. CLS. 39, 41 AND 42.
- RAYMOND O. BATCHELOR, UNION, NJ:
3,807,682, INT. CL. 9.
- RAYMOND, LARRY, BURBANK, CA:
3,807,862, INT. CL. 25.
- RAYONCHI, INC., MANHATTEN BEACH,, CA:
3,806,965, PUB. 4-6-2010. MULTIPLE CLASS, INT. CLS. 1 AND 24.
- RAYSPAN CORPORATION, SAN DIEGO, CA:
3,808,780, INT. CL. 9.
- RAYTHEON COMPANY, WALTHAM, MA, TA RTN:
3,807,900, INT. CL. 9.
- RAZOR USA LLC, CERRITOS, CA:
3,807,033, PUB. 4-6-2010. INT. CL. 28.
3,808,278, MULTIPLE CLASS, INT. CLS. 12 AND 28.
- RBR, LLC, VERNON, CA:
3,808,094, INT. CL. 25.

RCF TECHNOLOGIES, INC., VIDALIA, GA:
2,285,801, CANC. INT. CL. 6.

RCL PUBLISHING LLC, ALLEN, TX:
2,392,376. REN. 5-20-10. MULTIPLE CLASS, INT. CLS. 9,
16 AND 18.

REACH LLC, LOS ANGELES, CA:
2,771,705, CANC. INT. CL. 35.

READMETALS & MINERALS CORP., EAST PROVIDENCE, RI, DBA READE ADVANCED MATERIALS AND/OR READE INTERNATIONAL:
2,403,485. REN. 5-19-10. INT. CL. 35.

REAL ESTATE BUSINESS SERVICES, INC., LOS ANGELES, CA:
3,808,650, INT. CL. 9.

REALNETWORKS, INC., SEATTLE, WA:
2,771,522, CANC. INT. CL. 42.

REALTIME WORLDS LTD., DUNDEE, UNITED KINGDOM:
3,807,736, INT. CL. 41.

REALTY CONNECTION, INC., FRESNO, CA:
3,808,282, INT. CL. 36.

RECKITT BENCKISER INC., PARSIPPANY, NJ:
3,807,828, INT. CL. 30.
3,808,333, INT. CL. 30.

RECORDMAX, INC., JACKSON, MS:
2,285,242, CANC. INT. CL. 39.

RECREATION PRODUCTS, INC., PERRY, MO:
1,560,006, CANC. INT. CL. 28.

RECRO PHARMA, INC., MALVERN, PA:
3,807,920, INT. CL. 42.

RECRUITING HOUND, INC., WEST PALM BEACH, FL:
3,806,806, PUB. 4-6-2010. INT. CL. 35.

RECYCLING ASSOCIATION OF MINNESOTA, ST. PAUL, MN:
3,806,613, PUB. 4-6-2010. MULTIPLE CLASS, INT. CLS. 35
AND 40.

RED EARTH SOFTWARE, INC., CAMPBELL, CA:
3,806,310, PUB. 4-6-2010. INT. CL. 9.

RED ROBIN INTERNATIONAL, INC., GREENWOOD VIL-
LAGE, CO:
3,807,722, INT. CL. 29.
3,807,723, INT. CL. 30.

RED-WHITE VALVE CORP., LAKE FOREST, CA:
3,807,569, MULTIPLE CLASS, INT. CLS. 6 AND 11.

REDFLEX TRAFFIC SYSTEMS, INC., SCOTTSDALE, AZ:
3,807,435, INT. CL. 42.

REDHOSTING, INC., LAS VEGAS, NV:
3,807,552, INT. CL. 42.

REDIMD, LLC, HOUSTON, TX:
3,805,411, PUB. 4-6-2010. INT. CL. 44.

REEDER, MARK, JENKINTOWN, PA:
2,771,506, CANC. INT. CL. 41.

REEDHYCALOG, L.P., HOUSTON, TX:
3,808,606, INT. CL. 7.
3,808,607, INT. CL. 7.
3,808,608, INT. CL. 7.

REEKER, MAXINE, NORFOLK, NE:
2,772,169, CANC. INT. CL. 28.

REGAL PLASTIC COMPANY, ENGLEWOOD, CO:
1,559,844, CANC. INT. CL. 19.

REGAL WARE, INC., KEWASKUM, WI:
3,805,566, PUB. 4-6-2010. INT. CL. 21.

REGALADO, MANUAL, SOUTH GATE, CA, DBA EL COW-
BOY:
3,806,189, PUB. 4-6-2010. INT. CL. 16.

REGENT ENTERPRISES, LLC, ATLANTA, GA:
3,808,535, INT. CL. 25.

REGENTS OF THE UNIVERSITY OF MICHIGAN, ANN
ARBOR, MI:
3,805,577, PUB. 4-6-2010. INT. CL. 35.

REGIONS ASSET COMPANY, WILMINGTON, DE:
3,807,890, INT. CL. 36.

REGIS, INC., MINNEAPOLIS, MN:
3,592,548, CANC. INT. CL. 3.

REHAU INCORPORATED, LEESBURG, VA:
2,772,376, CANC. INT. CL. 17.

REIKO NAKAMA TOM, ARLINGTON, VA, AKA REIKO
EOH:
3,806,759, PUB. 4-6-2010. INT. CL. 41.

REILY FOODS COMPANY, NEW ORLEANS, LA:
2,772,173, CANC. INT. CL. 29.

REINHART, LEAH E., CASTRO VALLEY, CA, DBA KCR
RACING AND REINHART, MATTHEW C, CASTRO
VALLEY, CA, DBA KCR RACING:
3,806,206, PUB. 4-6-2010. INT. CL. 12.

REINWALD BROTHERS BAKERY CORP., HUNTINGTON,
NY:
3,806,749, PUB. 4-6-2010. INT. CL. 30.

REJUVENATION STATION, LLC, THE, MATTHEWS, NC:
3,806,400, PUB. 4-6-2010. INT. CL. 45.

RELIABLE SAFETY SOLUTIONS, INC., MONROE, NC,
FORMERLY RELIABLE SUPPLIES OF NORTH CAROLI-
NA, INC.:
3,806,455, PUB. 4-6-2010. INT. CL. 10.

RELIANT BUSINESS PRODUCTS INC., HOUSTON, TX:
2,771,868, CANC. INT. CL. 35.

RELIASTAR FINANCIAL CORP., MINNEAPOLIS, MN:
2,771,987, CANC. INT. CL. 41.

REMEDIES FOR READING DISABILITIES, INC.,
BOULDER, CO:
3,806,375, PUB. 4-6-2010. INT. CL. 41.

REMEDY DRUG STORE CO. INC., MARKHAM, CANADA:
3,808,661, INT. CL. 35.

RENAISSANCE CARPET & TAPESTRIES, INC., NEW
YORK, NY:
3,806,119, PUB. 4-6-2010. MULTIPLE CLASS, INT. CLS. 24
AND 27.

RENAISSANCE LEARNING , INC., WISCONSIN RAPIDS,
WI:
2,357,943, REN. 5-17-10. INT. CL. 9.

RENAISSANCE LEARNING, INC., WISCONSIN RAPIDS,
WI:
2,411,178, REN. 5-19-10. INT. CL. 9.
3,808,191, INT. CL. 41.

RENAISSANCE NUTRITION CENTER, INC., EAST NORRI-
TON, PA:
3,806,609, PUB. 4-6-2010. MULTIPLE CLASS, INT. CLS. 41
AND 44.

RENEE'S FITNESS, LLC, SKOKIE, IL:
2,284,578, CANC. INT. CL. 41.

RENKARA MEDIA GROUP, INVERNESS, IL:
3,808,314, INT. CL. 9.

RENNSPORT CLASSIC CARS LLC, SAN JOSE, CA:
3,808,687, INT. CL. 4.

RENNY REYNOLDS INCORPORATED, WRIGHTSTOWN,
PA, DBA HORTULUS FARM NURSERY AND GARDENS:
2,348,721, REN. 5-17-10. INT. CL. 31.

RENOSKY, JOSEPH F., INDIANA, PA:
2,770,706, CANC. INT. CL. 28.

RENOVATORS' PLACE, INC., WILMETTE, IL:
2,770,733, CANC. INT. CL. 42.

RENT-A-CENTER EAST, INC., PLANO, TX:
2,284,526, CANC. INT. CL. 35.

RENWOOD WINERY, INC., SACRAMENTO, CA:
2,173,991, CANC. INT. CL. 34.
2,202,169, CANC. INT. CL. 34.
3,327,003, CANC. INT. CL. 33.

REPUBLIC ENGINEERED PRODUCTS, INC., WILMING-
TON, DE, LTV STEEL COMPANY, INC., CLEVELAND,
OH:
1,597,155, REN. 5-20-10. INT. CL. 6.

REQUEST FOODS, INC., HOLLAND, MI:
3,806,236, PUB. 4-6-2010. MULTIPLE CLASS, INT. CLS. 29
AND 30.

RESEARCH CHEFS ASSOCIATION, ATLANTA, GA:
2,440,055, REN. 5-20-10. INT. CL. 16.

RETAIL LICENSING COMPANY, LAS VEGAS, NV:
3,808,578, MULTIPLE CLASS, INT. CLS. 3, 14, 18 AND 35.
3,808,783, INT. CL. 25.
3,808,784, INT. CL. 25.

RETAIL ROYALTY COMPANY, LAS VEGAS, NV:
2,393,861, REN. 5-20-10. INT. CL. 3.
3,808,619, INT. CL. 3.

- RETAIL SIGNSYSTEMS, INC., ADA, MI:
1,559,768, CANC. INT. CL. 16.
- RETAIL SYSTEMS B2B LLC, NEWTON UPPER FALLS, MA:
2,772,090, CANC. INT. CL. 38.
2,772,091, CANC. INT. CL. 16.
2,772,092, CANC. INT. CL. 35.
2,772,093, CANC. INT. CL. 41.
- RETAILERS CASUALTY INSURANCE COMPANY, BATON ROUGE, LA:
3,805,496, PUB. 4-6-2010. INT. CL. 36.
- REVO BRAND GROUP LLC, PLYMOUTH, MN:
3,808,073, INT. CL. 8.
- REXAM DISPENSING SYSTEMS, FRANCE:
3,807,136, PUB. 4-6-2010. MULTIPLE CLASS, INT. CLS. 3, 6, 20 AND 21.
- REXNORD INDUSTRIES, LLC, MILWAUKEE, WI:
2,350,782, REN. 5-20-10. INT. CL. 7.
- REYNOLDS INNOVATIONS INC., WINSTON-SALEM, NC:
1,560,098, CANC. INT. CL. 34.
- RHETECH, INC., COOPERSBURG, PA:
2,361,395, REN. 5-19-10. INT. CL. 37.
2,367,603, REN. 5-19-10. INT. CL. 37.
- RHINO TOYS, INC., SANTA CRUZ, CA:
3,808,414, INT. CL. 28.
- RHODES, HARRY H., III, CAMDEN-WYOMING, DE:
3,807,438, INT. CL. 14.
- RHODIA, FRANCE:
3,807,182, PUB. 4-6-2010. MULTIPLE CLASS, INT. CLS. 16, 35 AND 41.
- RHODIA ELECTRONICS AND CATALYSIS, F-17041 LA ROCHELLE CEDEX, FRANCE:
3,807,297, PUB. 4-6-2010. INT. CL. 1.
- RIB SOFTWARE AG, FED REP GERMANY:
3,807,249, PUB. 4-6-2010. MULTIPLE CLASS, INT. CLS. 9, 35, 38, 41 AND 42.
- RICCIO, RHONDA R., EASTPORT, NY:
2,286,517, CANC. INT. CL. 16.
- RICEGROWERS LIMITED, LEETON, AUSTRALIA:
3,805,464, PUB. 4-6-2010. INT. CL. 30.
- RICH, JOSHUA G., ANAHEIM, CA, DBA LAXPRESS:
3,805,711, PUB. 4-6-2010. INT. CL. 35.
- RICHARD FASHIONS, INC., EL MONTE, CA:
2,331,713, REN. 5-18-10. INT. CL. 25.
- RICHARDSON BRANDS COMPANY (FORMERLY CANAJO MANUFACTURING COMPANY), CANAJOHARIE, NY:
2,286,022, CANC. INT. CL. 30.
- RICHEMONT INTERNATIONAL SA, VILLARS-SUR-GLANE, SWITZERLAND:
3,807,756, INT. CL. 14.
- RICHFIELD, MORRIE, CONSHOHOCKEN, PA:
3,806,538, PUB. 4-6-2010. INT. CL. 9.
- RIDEOUT, BONNIE, ALEXANDRIA, VA:
2,437,039, REN. 5-20-10. INT. CL. 41.
- RIGOL TECHNOLOGIES INC., BEIJING, CHINA:
3,806,200, PUB. 4-6-2010. INT. CL. 9.
- RIO QUEEN CITRUS, INC., MISSION, TX:
3,806,660, PUB. 4-6-2010. INT. CL. 31.
- RISCO S.P.A., THIENE (VICENZA), ITALY, RISCO BREVETTI S.P.A., ZANE (VICENZA), ITALY:
1,608,031, REN. 5-19-10. INT. CL. 7.
- RIST, KENNETH G., BROOKFIELD, CT:
2,771,053, CANC. INT. CL. 20.
- RITZ HOTEL, LIMITED, THE, PARIS CEDEX, FRANCE:
3,805,605, PUB. 4-6-2010. INT. CL. 3.
- RIVERAERIE CELLARS LLC, PROSSER, WA:
3,807,452, INT. CL. 33.
- RIVEREDGE LLC, VOORHEES, NJ:
3,808,477, INT. CL. 30.
- RIVERGOOSE RECORDS, LLC, PORTLAND, OR:
3,805,873, PUB. 4-6-2010. MULTIPLE CLASS, INT. CLS. 9 AND 41.
- RIVERSIDE HOME THEATER AND AUTOMATION INC., RIVERSIDE, CA:
3,806,575, PUB. 4-6-2010. INT. CL. 37.
- RIVERSIDE SPECIALTY CHEMICALS, INC., NEW YORK, NY:
2,438,456, REN. 5-20-10. INT. CL. 1.
- RKIP, LLC, MIAMI BEACH, FL:
3,806,498, PUB. 4-6-2010. INT. CL. 41.
3,806,499, PUB. 4-6-2010. INT. CL. 41.
3,806,500, PUB. 4-6-2010. INT. CL. 41.
3,806,501, PUB. 4-6-2010. INT. CL. 41.
- RKW SE, FED REP GERMANY:
3,807,130, PUB. 4-6-2010. MULTIPLE CLASS, INT. CLS. 16, 17, 18, 22 AND 24.
- RMA CONSULTING GROUP, SANTA CLARA, CA:
3,806,257, PUB. 4-6-2010. INT. CL. 42.
- RMF DEVELOPMENT LLC, SAN DIEGO, CA, DBA ELIVE-LIFE.COM:
3,806,580, PUB. 4-6-2010. INT. CL. 35.
- RMJM LIMITED, EDINBURGH, GREAT BRITAIN:
3,805,369, PUB. 4-6-2010. INT. CL. 44.
- ROBBINS-HAMILTON, CHRISTINE, SPRINGFIELD, MA:
3,808,388, INT. CL. 18.
- ROBERT A. MERRY & COMPANY LIMITED, CO. TIPPERARY, IRELAND:
3,808,697, INT. CL. 33.
- ROBERT CAREY, BAYSIDE, NY, DBA MEETINGS & HOSPITALITY INSIGHT INC.:
3,807,842, INT. CL. 40.
- ROBERT D. RASH & ASSOCIATES, INC., ROWLETT, TX:
2,771,183, CANC. INT. CL. 35.
- ROBERT ETOLL PRODUCTIONS, INC., CULVER CITY, CA:
3,808,384, INT. CL. 41.
- ROBERT L. O'BLOCK REVOCABLE TRUST, SPRINGFIELD, MO:
2,381,984, REN. 5-14-10. INT. CL. 42.
- ROBERT TODD REUM, CARSON CITY, NV:
3,808,709, INT. CL. 5.
- ROBERTS, CANDICE, AUSTIN, TX:
3,808,082, INT. CL. 4.
- ROBINSON HOME PRODUCTS INC., BUFFALO, NY:
2,361,975, REN. 5-19-10. INT. CL. 20.
- ROCHELLE ORGANIZATION, INC., THE, WASHINGTON, DC:
2,285,834, CANC. INT. CL. 41.
- ROCK BOTTOM PROPERTY, INC., MIAMI, FL:
3,807,725, INT. CL. 35.
3,807,726, INT. CL. 35.
- ROCK N ROLL GANGSTAR, INC., REDONDO BEACH, CA:
3,805,233, PUB. 4-6-2010. MULTIPLE CLASS, INT. CLS. 25 AND 35.
- ROCK PILE, INC., THE, AVON, OH:
2,363,161, REN. 5-20-10. INT. CL. 35.
- ROCKET 12 CREATIVE, LLC, CHICKAMAUGA, GA:
3,808,397, INT. CL. 16.
- ROCKWELL COLLINS SIMULATION AND TRAINING SOLUTIONS LLC, CEDAR RAPIDS, IA:
2,285,879, CANC. INT. CL. 9.
3,808,571, INT. CL. 9.
- ROD MACPHERSON AND ASSOCIATES INC., OTTAWA, CANADA:
3,805,310, PUB. 9-1-2009. INT. CL. 41.
- ROD WORKS INC., LEHI, UT:
3,806,133, PUB. 4-6-2010. INT. CL. 35.
- RODEO WORLD, INC., GRAPEVINE, TX:
3,807,955, INT. CL. 18.
- RODOLFO BIANCO GONZÁLEZ, SPAIN:
3,807,165, PUB. 4-6-2010. MULTIPLE CLASS, INT. CLS. 9, 35 AND 38.
- RODRIGUEZ, TIFFANY MARIE, MIAMI, FL:
2,771,006, CANC. INT. CL. 41.
- ROGER CLEVELAND GOLF COMPANY, INC., HUNTINGTON BEACH, CA:
2,284,775, CANC. MULTIPLE CLASS, INT. CLS. 25 AND 28.
- ROGER J. BEST, EUGENE, OR:
3,806,659, PUB. 4-6-2010. INT. CL. 9.
- ROGERS, ROBERT CHARLES, KAILUA, HI:
2,286,253, CANC. MULTIPLE CLASS, INT. CLS. 9 AND 41.
- ROGUE SURFER LLC, LONGMONT, CO:
3,805,849, PUB. 12-29-2009. INT. CL. 42.
- ROHANI, DANIELLE, VENICE, CA:
3,806,621, PUB. 4-6-2010. INT. CL. 25.

ROLAND H. NOEL, WATERBORO, ME, DBA TUNNY-CRAFT INC.:
3,806,951, PUB. 4-6-2010. INT. CL. 12.

ROLANDO CURTIS FOODS MS, INC., UPPER MARLBORO, MD:
3,807,838, INT. CL. 32.

ROMA POMODORI, INC., MEMPHIS, TN:
2,284,844, CANC. INT. CL. 32.

ROMANO & SANFILIPPO, LLC, ESCONDIDO, CA:
3,808,146, MULTIPLE CLASS, INT. CLS. 9, 16, 35, 38 AND 41.

ROMANOFF PRODUCTS, INC., NEW YORK, NY:
2,354,744, REN. 5-15-10. INT. CL. 20.

ROMANOFF PRODUCTS, INC., CHATHAM, NY:
2,356,865, REN. 5-15-10. INT. CL. 20.

ROMDON MUSIC GROUP, LLC, MIAMI, FL:
3,806,550, PUB. 4-6-2010. INT. CL. 41.

ROMEX WORLD TRADE COMPANY, L.L.C., ALEXANDRIA, LA:
3,808,032, INT. CL. 19.

RONA INC., BOUCHERVILLE, PROVINCE OF QUEBEC, CANADA:
3,805,124, PUB. 4-6-2010. MULTIPLE CLASS, INT. CLS. 1, 2, 3, 4, 5, 6, 7, 8, 9, 11, 12, 13, 16, 17, 19, 20, 21, 22, 24, 27, 28, 31 AND 35.

RONALD D. HODGES, D.V.M., P.C., WHITEHALL, PA:
3,807,515, INT. CL. 14.
3,807,516, INT. CL. 14.
3,807,517, INT. CL. 14.

ROOM SOURCE, LLC, SACRAMENTO, CA:
2,286,103, CANC. INT. CL. 39.

ROPA SIETE LEGUAS S.A. DE C.V., LERDO, DURANGO, MEXICO:
3,807,387, INT. CL. 25.

ROSA MARÍA MIRAS ANTEL, SPAIN:
3,807,115, PUB. 4-6-2010. MULTIPLE CLASS, INT. CLS. 29, 30 AND 31.

ROSENSTOCK, DALE RICE, EL CAJON, CA:
2,285,637, CANC. INT. CL. 30.

ROSEVILLE FARMS, L.C., APOPKA, FL:
2,284,590, CANC. INT. CL. 31.

ROSS, ROBERT, DR., NEW YORK, NY:
3,806,871, PUB. 4-6-2010. INT. CL. 41.

ROSSI, VALENTINO, TAVULLIA PU, ITALY:
3,627,016, AM. MULTIPLE CLASS, INT. CLS. 9, 12, 14, 16, 18, 25, 28 AND 38.

ROTA, DAVID H., STERLING, MA:
2,771,317, CANC. INT. CL. 30.

ROTRONIC AG, BASSERSDORF, SWITZERLAND:
1,597,260, REN. 5-20-10. INT. CL. 9.

ROUNDGRILLE, INC., BOSTON, MA:
2,335,823, REN. 5-18-10. INT. CL. 42.

ROUSE COMPANY LP, THE, CHICAGO, IL:
1,560,292, CANC. INT. CL. 16.

ROVI DATA SOLUTIONS, INC., SANTA CLARA, CA:
2,770,707, CANC. INT. CL. 9.
2,770,713, CANC. INT. CL. 41.

ROWLAND READING FOUNDATION, INC., MIDDLETON, WI:
3,806,170, PUB. 4-6-2010. MULTIPLE CLASS, INT. CLS. 9 AND 16.

ROW2 TECHNOLOGIES, INC., PARSIPPANY, NJ:
2,771,018, CANC. INT. CL. 9.

ROYAL KANAPALI HOLDINGS, LLC, LOS ANGELES, CA:
3,807,717, INT. CL. 41.

ROYAL PURPLE, INC., PORTER, TX:
2,771,032, CANC. INT. CL. 4.

ROYAL VENDORS, INC., KEARNEYSVILLE, WV:
2,942,708, AM. INT. CL. 9.

ROYO-VILLANOVA IMPORT, S.L., MADRID, SPAIN:
3,806,104, PUB. 4-6-2010. INT. CL. 3.

RPC CONTAINERS LIMITED, NORTHAMPTONSHIRE, UNITED KINGDOM:
3,806,087, PUB. 4-6-2010. MULTIPLE CLASS, INT. CLS. 20, 40 AND 42.

RPS PRODUCTS, INC., HAMPSHIRE, IL:
2,772,661, CANC. INT. CL. 11.

RSCC WIRE & CABLE, INC., EAST GRANBY, CT:
3,806,868, PUB. 4-6-2010. INT. CL. 9.

RUBE P. HOFFMAN COMPANY, INC., MISSION VIEJO, CA, DBA HOFFMAN CALIFORNIA FABRICS:
2,446,133, REN. 5-20-10. INT. CL. 41.

RUFFINO S.P.A., BRESCIA, ITALY:
1,560,092, CANC. INT. CL. 33.

RUHANA FOODS USA INC., VALLEY STREAM, NY:
3,808,486, INT. CL. 30.

RUIZ FOOD PRODUCTS, INC., DINUBA, CA:
2,286,499, CANC. INT. CL. 30.

RUNCO INTERNATIONAL, INC., UNION CITY, CA:
2,772,733, CANC. INT. CL. 9.

RUNCO INTERNATIONAL, LLC, BEAVERTON, OR:
2,358,812, REN. 5-18-10. INT. CL. 9.

RUNNER'S ALLEY, LLC, PORTSMOUTH, NH:
3,806,111, PUB. 4-6-2010. INT. CL. 35.

RUSS RICE, LANCASTER, CA, DBA SIGNATURE FUNDRAISING, INC.:
3,806,166, PUB. 4-6-2010. INT. CL. 41.
3,806,198, PUB. 4-6-2010. INT. CL. 41.
3,806,199, PUB. 4-6-2010. INT. CL. 41.

RUTHERFORD, KENNETH M., ROSEVILLE, CA, DBA FISCH INSTRUMENTS:
3,805,666, PUB. 4-6-2010. INT. CL. 9.

RVU ALLIANCE, BEAVERTON, OR:
3,805,591, PUB. 4-6-2010. INT. CL. 35.

RWRB, LLC, MAUMEE, OH:
3,806,193, PUB. 4-6-2010. INT. CL. 43.

RYAN LAWN & TREE, INC., OVERLAND PARK, KS:
2,374,544, REN. 5-19-10. INT. CL. 42.

RYKO MANUFACTURING COMPANY, GRIMES, IA:
1,598,173, REN. 5-17-10. MULTIPLE CLASS, INT. CLS. 7 AND 9.

RYOHIN KEIKAKU CO., LTD., TOKYO, JAPAN:
2,351,072, REN. 5-17-10. MULTIPLE CLASS, INT. CLS. 3, 6, 8, 9, 11, 16, 18, 20, 21, 24, 25 AND 42.

S & B INDUSTRIAL MINERALS GMBH, FED REP GERMANY:
3,807,185, PUB. 4-6-2010. INT. CL. 1.

S & R ASSOCIATES, INC., ATLANTA, GA:
2,318,485, REN. 5-18-10. INT. CL. 35.

S. ROTHSCCHILD & CO., INC., NEW YORK, NY:
1,559,936, CANC. INT. CL. 25.

S.H.I. LIMITED, HONG KONG, CHINA:
3,807,474, INT. CL. 30.

S.L. START & ASSOCIATES, INC., SPOKANE, WA:
2,772,349, CANC. INT. CL. 42.
2,772,350, CANC. INT. CL. 41.
2,772,351, CANC. MULTIPLE CLASS, INT. CLS. 35 AND 41.

S.N. MOORE ENTERPRISES, L.L.C., HOWELL, MI:
3,807,844, INT. CL. 35.

S.S.D. CONTROL TECHNOLOGY, INC., SOUTH BEND, IN:
2,353,076, REN. 5-17-10. INT. CL. 9.

S.T.U.N., LOS ANGELES, CA:
2,772,413, CANC. MULTIPLE CLASS, INT. CLS. 9 AND 41.

S-B POWER TOOL COMPANY, CHICAGO, IL:
2,772,754, CANC. INT. CL. 7.

SAATI S.P.A., APPIANO GENTILE (CO), ITALY:
2,359,484, REN. 5-17-10. INT. CL. 24.

SABERT CORPORATION, SAYREVILLE, NJ:
2,349,017, REN. 5-14-10. INT. CL. 21.

SABERT CORPORATION, SAYREVILLE, NJ:
3,807,395, MULTIPLE CLASS, INT. CLS. 8 AND 21.

SABINSA CORPORATION, PISCATAWAY, NJ:
3,806,859, PUB. 4-6-2010. INT. CL. 3.
3,806,996, PUB. 4-6-2010. INT. CL. 5.

SABORMEX EUROPA, S.L., BILBAO, SPAIN:
3,805,511, PUB. 4-6-2010. INT. CL. 30.

SABOSA INC., TROY, NY:
1,560,192, CANC. MULTIPLE CLASS, INT. CLS. 41 AND 42.

SADOWSKI, RICHARD A, MEDINA, OH, DBA JANI-LOTS, FORMERLY R.A.S. REPAIR SERVICE LLC:
3,805,255, PUB. 4-6-2010. INT. CL. 37.

- SAES GETTERS S.P.A., ITALY:
3,807,318, PUB. 4-6-2010. MULTIPLE CLASS, INT. CLS. 1 AND 9.
- SAFARILAND, LLC, JACKSONVILLE, FL:
3,808,402, INT. CL. 1.
- SAFEMONEYMETRICS, LLC, NEW YORK, NY:
2,770,754, CANC. INT. CL. 42.
- SAFETY IN MOTION, INC., PORTLAND, OR:
3,808,500, INT. CL. 16.
- SAFWAY SERVICES, LLC, WAUKESHA, WI:
3,806,737, PUB. 4-6-2010. MULTIPLE CLASS, INT. CLS. 6 AND 7.
- SAGAX DEVELOPMENT CORP., COS COB, CT:
3,805,409, PUB. 4-6-2010. INT. CL. 35.
- SAGE SOFTWARE SB, INC., IRVINE, CA:
1,559,663, CANC. INT. CL. 9.
- SAGE TECHNOLOGY, LLC., CEDAR HILL, TN:
3,805,510, PUB. 4-6-2010. INT. CL. 11.
- SAGEM-INTERSTAR, INC., MONTREAL, CANADA:
3,805,265, PUB. 12-29-2009. INT. CL. 9.
- SAINTY, HIRD & PARTNERS LIMITED, LONDON W1J 8LA, UNITED KINGDOM:
2,770,753, CANC. INT. CL. 35.
- SAKURA COLOR PRODUCTS CORPORATION, OSAKA-SHI, OSAKA-FU, JAPAN:
2,772,381, CANC. INT. CL. 16.
- SALANDRA, URSULA, HARRISON, NY:
3,805,157, PUB. 4-6-2010. INT. CL. 35.
- SALAZAR, ESTHER MARISOL, SOUTHGATE, CA:
3,806,405, PUB. 4-6-2010. INT. CL. 5.
- SALES CHAMPIONS, INC., BEND, OR:
2,353,283, REN. 5-18-10. MULTIPLE CLASS, INT. CLS. 35 AND 41.
- SALIH KOZLU, TURKEY:
3,807,255, PUB. 4-6-2010. INT. CL. 11.
- SALLY MILLER, MILLTOWN, NJ:
3,806,217, PUB. 4-6-2010. INT. CL. 41.
- SALMERON, CRISTINA NUÑEZ, GORGONZOLA (MILANO), ITALY:
3,805,957, PUB. 4-6-2010. MULTIPLE CLASS, INT. CLS. 41 AND 44.
- SALT CITY CANDLE COMPANY, INC., WEST JORDAN, UT:
3,808,655, INT. CL. 11.
- SALT LIFE HOLDINGS LLC, JACKSONVILLE, FL:
3,808,444, INT. CL. 43.
- SALTEC; EQUIPOS PARA LA CONSTRUCCION, S.A., SPAIN:
3,807,285, PUB. 4-6-2010. MULTIPLE CLASS, INT. CLS. 6, 7 AND 35.
- SAM ASHER COMPUTING SERVICES, INC., ROCHESTER, NY, DBA ASHER GROUP:
2,771,689, CANC. INT. CL. 38.
- SAM VILLA LLC, NOVATO, CA:
3,808,061, INT. CL. 9.
- SAMAY ELECTRONICS PVT. LTD, MORBI -363 641, GUJARAT, INDIA:
2,770,766, CANC. INT. CL. 14.
- SAMES TECHNOLOGIES, 38240 MEYLAN, FRANCE:
2,770,544, CANC. INT. CL. 7.
- SAMICK MUSIC CORPORATION, GALLATIN, TN:
2,411,649, REN. 5-15-10. INT. CL. 15.
- SAMSONITE IP HOLDINGS S.A.R.L., LUXEMBOURG, LUXEMBOURG:
2,772,565, CANC. INT. CL. 18.
- SAMSUNG ELECTRONICS CO., LTD., SUWON-CITY, KYUNGKI-DO, REPUBLIC OF KOREA:
2,771,874, CANC. INT. CL. 11.
- SAMUEL JACKSON, SAN FRANCISCO, CA, DBA VIBRANTSTILLNESS:
3,806,890, PUB. 4-6-2010. INT. CL. 41.
- SAN ANTONIO LIGHTHOUSE, SAN ANTONIO, TX:
3,805,638, PUB. 4-6-2010. INT. CL. 16.
- SAN MAR CORPORATION, PRESTON, WA:
3,805,253, PUB. 4-6-2010. INT. CL. 25.
- SANCHEZ, ANA, LANCASTER, CA:
3,805,795, PUB. 4-6-2010. INT. CL. 24.
- SANDERS, SUSAN S., LEWISBURG, WV:
3,808,280, INT. CL. 16.
3,808,281, INT. CL. 16.
- SANDY'S ASSOCIATES, INC., EVANSVILLE, IN:
2,770,962, CANC. INT. CL. 43.
- SANFORD BRYANT DESIGN LTD., NEW YORK, NY:
2,353,945, REN. 5-19-10. INT. CL. 25.
- SANFORD, CHARLES R., JR., DULUTH, GA:
2,770,657, CANC. INT. CL. 41.
- SANOFI-AVENTIS, PARIS, FRANCE:
3,805,727, PUB. 4-6-2010. INT. CL. 5.
3,805,816, PUB. 4-6-2010. INT. CL. 5.
3,805,818, PUB. 4-6-2010. INT. CL. 5.
3,805,819, PUB. 4-6-2010. INT. CL. 5.
3,806,246, PUB. 4-6-2010. INT. CL. 10.
3,806,247, PUB. 4-6-2010. INT. CL. 10.
3,806,248, PUB. 4-6-2010. INT. CL. 10.
- SANOFI-AVENTIS, FRANCE:
3,807,329, PUB. 4-6-2010. INT. CL. 5.
3,807,330, PUB. 4-6-2010. INT. CL. 5.
- SANOFI-AVENTIS, F-75013 PARIS, FRANCE:
3,807,362, PUB. 4-6-2010. INT. CL. 5.
3,807,363, PUB. 4-6-2010. INT. CL. 5.
3,807,365, PUB. 4-6-2010. INT. CL. 5.
- SANOFI-AVENTIS, FRANCE:
3,807,366, PUB. 4-6-2010. INT. CL. 5.
- SANTANA, SERGIO, SEFFNER, FL:
3,808,063, INT. CL. 41.
- SAP AMERICA, INC., PALO ALTO, CA:
3,805,768, PUB. 4-6-2010. INT. CL. 9.
- SAPIENT CAPITAL MANAGEMENT, LLC, WILSON, WY:
3,806,172, PUB. 4-6-2010. INT. CL. 36.
- SARA LEE BAKERY GROUP, INC., DOWNERS GROVE, IL:
2,771,642, CANC. INT. CL. 30.
- SARA LEE CORPORATION, DOWNERS GROVE, IL:
2,772,009, CANC. INT. CL. 30.
- SARAMAR, L.L.C., DOWNERS GROVE, IL:
2,771,788, CANC. INT. CL. 30.
2,771,789, CANC. INT. CL. 29.
- SARAMAX APPAREL GROUP, INC., NEW YORK, NY:
2,313,988, REN. 5-20-10. INT. CL. 25.
2,330,274, REN. 5-15-10. INT. CL. 25.
- SARATOGA SALSA COMPANY, SARATOGA SPRINGS, NY:
2,772,289, CANC. INT. CL. 30.
- SARL CRW DESIGN, F-06270 VILLENEUVE-LOUBET, FRANCE:
3,807,096, PUB. 10-20-2009. INT. CL. 25.
- SASOL GERMANY GMBH, HAMBURG, GERMAN DEM REP, HULS AKTIENGESELLSCHAFT, MARL, FED REP GERMANY:
1,598,020, REN. 5-18-10. INT. CL. 1.
- SATA GMBH & CO. KG, 70806 KORNWESTHEIM, FED REP GERMANY:
3,805,149, PUB. 4-6-2010. MULTIPLE CLASS, INT. CLS. 9, 16, 20 AND 42.
- SATIEN STAINLESS STEEL PUBLIC COMPANY LIMITED, BANGKOK, THAILAND, SATIEN STAINLESS STEEL CO., LTD., BANGKOK, THAILAND:
1,596,117, REN. 5-17-10. MULTIPLE CLASS, INT. CLS. 8 AND 21.
- SAUCONY, INC., LEXINGTON, MA:
3,806,956, PUB. 4-6-2010. INT. CL. 25.
- SAVE BABIES THROUGH SCREENING FOUNDATION, INC., DOUGLASVILLE, GA:
3,805,794, PUB. 4-6-2010. INT. CL. 35.
- SAVE 9 LLC, SEATTLE, WA:
3,808,308, INT. CL. 36.
- SAVE-A-LOT FOOD STORES, LTD., EARTH CITY, MO:
2,772,498, CANC. INT. CL. 29.
- SAVICORP, SANTA ANA, CA:
3,807,409, INT. CL. 7.
- SAVONA SPECIALTY PLYWOOD CO. LTD., SURREY, BRITISH COLUMBIA, CANADA:
2,378,703, REN. 5-17-10. INT. CL. 19.
- SAVORY SPICE SHOP, INC., DENVER, CO:
3,807,718, INT. CL. 35.

SAZERAC CO., INC., NEW ORLEANS, LA, DBA WIDE WORLD IMPORTERS:
1,596,734, REN. 5-18-10. INT. CL. 33.

SBLI USA MUTUAL LIFE INSURANCE COMPANY, INC., NEW YORK, NY:
3,806,046, PUB. 4-6-2010. MULTIPLE CLASS, INT. CLS. 36 AND 44.

SBS ENTERPRISES LLC, ALPINE, UT:
2,772,609, CANC. INT. CL. 7.

SCA PACKAGING NORTH AMERICA, INC., NEW BRIGHTON, PA:
1,559,812, CANC. INT. CL. 17.

SCA TISSUE NORTH AMERICA LLC, NEENAH, WI:
2,286,215, CANC. INT. CL. 16.

SCALETTA MOLONEY ARMORING CORPORATION, BEDFORD PARK, IL:
2,770,794, CANC. INT. CL. 12.

SCALISE BROTHERS, LLC, EMERYVILLE, CA:
3,806,807, PUB. 4-6-2010. INT. CL. 29.

SCANDIANVIAN LABORATORIES, INC., MT. BETHEL, PA:
2,771,905, CANC. INT. CL. 3.

SCANSCOUT, INC., BOSTON, MA:
3,806,520, PUB. 4-6-2010. INT. CL. 35.

SCENPRO, INC., RICHARDSON, TX:
2,772,280, CANC. INT. CL. 9.

SCENT A BRAND BVBA, BELGIUM:
3,807,233, PUB. 12-1-2009. MULTIPLE CLASS, INT. CLS. 3, 9, 14, 16, 18, 21, 24, 25, 28 AND 41.

SCHAEFFLER KG, FED REP GERMANY:
3,807,199, PUB. 4-6-2010. MULTIPLE CLASS, INT. CLS. 7 AND 12.

SCHAEFFLER KOREA CORPORATION, CHANGWON-SI, KYUNGSANGNAM-DO, REPUBLIC OF KOREA:
2,383,091, REN. 5-19-10. INT. CL. 12.

SCHAMET ANNIE MAE HORSFIELD, MERCER ISLAND, WA, DBA OM BABY:
3,807,940, INT. CL. 16.

SHEELS ALL SPORTS, INC., FARGO, ND:
3,806,565, PUB. 4-6-2010. INT. CL. 35.

SCHERING-PLOUGH HEALTHCARE PRODUCTS, INC., MEMPHIS, TN:
2,771,386, CANC. INT. CL. 11.

SCHLAGE LOCK COMPANY, CARMEL, IN:
3,805,392, PUB. 4-6-2010. INT. CL. 6.

SCHNEIDER ELECTRIC INDUSTRIES SAS, RUEIL-MALMAISON, FRANCE:
2,770,774, CANC. MULTIPLE CLASS, INT. CLS. 9, 37, 38 AND 42.

SCHNEIDER NATIONAL, INC., GREEN BAY, WI:
2,771,588, CANC. MULTIPLE CLASS, INT. CLS. 35 AND 39.

SCHNEIDER, WILLIAM E., ENGLEWOOD, CO:
2,771,990, CANC. INT. CL. 35.

SCHOEL, MARTIN M., BERLIN, FED REP GERMANY:
3,805,944, PUB. 4-6-2010. MULTIPLE CLASS, INT. CLS. 35, 41 AND 44.

SCHOENBAUM, MARK, FORT COLLINS, CO:
3,807,889, INT. CL. 28.

SCHOLASTIC INC., NEW YORK, NY:
3,806,381, PUB. 4-6-2010. INT. CL. 28.
3,806,382, PUB. 4-6-2010. INT. CL. 28.

SCHOOL JURIDICAL PERSON WASEDA UNIVERSITY, TOKYO, JAPAN:
3,805,687, PUB. 4-6-2010. MULTIPLE CLASS, INT. CLS. 41 AND 42.

SCHOOL SPECIALTY, INC., APPLETON, WI:
1,559,584, CANC. INT. CL. 9.

SCHORR, MELISSA, NEW YORK, NY:
3,807,980, INT. CL. 35.

SCHUMACHER ELECTRIC CORPORATION, MOUNT PROSPECT, IL:
3,806,182, PUB. 4-6-2010. INT. CL. 9.

SCHWAB, JODI L., HENDERSON, NV:
2,772,626, CANC. INT. CL. 35.

SCHWARTZ TEXTILE CONVERTING CO., BROOKLYN, NY:
2,286,825, CANC. INT. CL. 25.

SCHWEIDOP, SHIRLEY M., EASTON, PA, DBA YOYDA AND FRIENDS:
2,772,328, CANC. INT. CL. 42.

SCHWEIZER-EFFAX, GMBH, FED REP GERMANY:
3,807,211, PUB. 4-6-2010. INT. CL. 3.

SCIENTIFIC INDUSTRIES, INC., BOHEMIA, NY:
2,386,374, REN. 5-15-10. INT. CL. 9.

SCIENTIFIC INSTRUMENT SERVICES, INC., RINGOES, NJ:
2,430,975, REN. 5-18-10. INT. CL. 35.

SCIENTIFIC PHARMACEUTICALS, INC., POMONA, CA:
3,805,834, PUB. 4-6-2010. INT. CL. 5.

SCIOTO CERAMIC PRODUCTS, INC., GROVE CITY, OH:
1,560,233, CANC. INT. CL. 42.

SCOTT, MARGO, DURHAM, NC:
3,805,769, PUB. 11-3-2009. MULTIPLE CLASS, INT. CLS. 18 AND 25.

SCOTTO BROTHERS ENTERPRISES, INC., WOODBURY, NY:
3,808,424, INT. CL. 43.

SCRIBES, INC, VIRGINIA BEACH, VA:
2,285,449, CANC. INT. CL. 14.

SCRIPPS NETWORKS, LLC, KNOXVILLE, TN:
3,807,829, INT. CL. 41.

SCRIPTLOGIC CORPORATION, BOCA RATON, FL:
3,808,236, INT. CL. 9.

SCUBA SAN ANDRES, ST. LOUIS, MO:
2,771,700, CANC. INT. CL. 39.

SDI TECHNOLOGIES INC., RAHWAY, NJ, SOUNDESIGN CORPORATION, JERSEY CITY, NJ:
1,595,146, REN. 5-19-10. INT. CL. 9.

SDI TECHNOLOGIES INC., RAHWAY, NJ:
2,285,924, CANC. INT. CL. 9.

SEA SAVORY, INC., CAMBRIDGE, MD:
1,559,552, CANC. INT. CL. 7.

SEA WORLD LLC, WILMINGTON, DE:
2,286,638, CANC. INT. CL. 42.

SEABOURN CRUISE LINE LIMITED, MIAMI, FL:
2,771,181, CANC. INT. CL. 43.

SEAGHOST TECHNOLOGIES INC., JACKSONVILLE, FL:
3,808,140, INT. CL. 42.

SEAJAY EMPLOYEE LEASING, INC., LINCOLN, NE, DBA MAINSTREET FOODS, INC.:
1,566,161, REN. 5-20-10. INT. CL. 29.

SEALE, DALLYN, COOMERA WATERS, AUSTRALIA AND WALMSLEY, ROSS, COOMERA QUEENSLAND, AUSTRALIA:
3,805,798, PUB. 4-6-2010. INT. CL. 25.

SEALEMEDIA, INC., SAN FRANCISCO, CA:
2,770,604, CANC. MULTIPLE CLASS, INT. CLS. 9 AND 42.

SEAN SANGSOO LEE, LOS ANGELES, CA:
3,806,782, PUB. 4-6-2010. INT. CL. 5.
3,806,784, PUB. 4-6-2010. INT. CL. 5.

SEAN SANGSOON LEE, LOS ANGELES, CA:
3,806,787, PUB. 4-6-2010. INT. CL. 5.

SEARCH HOLISTIC, LLC, WASHINGTON CROSS, PA:
3,808,712, INT. CL. 35.

SEARCHONE, LLC, NEW YORK, NY:
3,806,653, PUB. 4-6-2010. INT. CL. 35.

SEARS BRANDS, LLC, HOFFMAN ESTATES, IL:
1,559,974, CANC. INT. CL. 25.
2,772,219, CANC. INT. CL. 42.

SEARS, ROEBUCK AND CO., HOFFMAN ESTATES, IL:
2,771,812, CANC. INT. CL. 4.
2,772,710, CANC. INT. CL. 9.

SEASONAL SPECIALTIES LLC, EDEN PRAIRIE, MN:
3,805,840, PUB. 4-6-2010. MULTIPLE CLASS, INT. CLS. 11 AND 28.
3,805,841, PUB. 4-6-2010. MULTIPLE CLASS, INT. CLS. 11 AND 28.

SEATTLE ORTHOPEDIC GROUP, INC., POULSBO, WA:
2,770,684, CANC. INT. CL. 10.

SEATTLE'S BEST COFFEE LLC, SEATTLE, WA, SEATTLE'S BEST COFFEE LLC, SEATTLE, WA:
2,296,622, REN. 5-20-10. INT. CL. 30.

SEATTLE'S BEST COFFEE, LLC, SEATTLE, WA:
3,808,575, MULTIPLE CLASS, INT. CLS. 21, 29 AND 32.

- SEAVIEW SOFTWARE, INC., SEATTLE, WA:
3,805,971, PUB. 4-6-2010. INT. CL. 9.
- SEC - SPORTS EQUIPMENT CANADA INC., LANGLEY, CANADA:
3,808,786, INT. CL. 28.
- SECO TOOLS AB, 82 FAGERSTA, SWEDEN:
3,805,206, PUB. 4-6-2010. INT. CL. 7.
- SECURITY STATE SAVINGS BANK, LAS VEGAS, NV:
2,772,468, CANC. INT. CL. 36.
- SEEPAGE CONTROL, INC. CHANDLER, AZ:
2,771,808, CANC. INT. CL. 1.
- SEEPAGE CONTROL, INC., TEMPE, AZ:
2,771,809, CANC. INT. CL. 1.
- SEGURIDAD XIXVISION, C.A, CARACAS, VENEZUELA:
3,805,485, PUB. 4-6-2010. INT. CL. 9.
- SEGUROS AZTECA S.A. DE C.V., MEXICO CITY, MEXICO:
3,805,336, PUB. 4-6-2010. INT. CL. 36.
- SEIKO EPSON KABUSHIKI KAISHA, SHINJUKU-KU, TOKYO, JAPAN, DBA SEIKO EPSON CORPORATION:
2,771,348, CANC. INT. CL. 9.
- SEISMIC SOLUTIONS, INC., GLEN ELLEN, CA:
2,771,086, CANC. INT. CL. 6.
- SEITZ, LAURENCE M., WESTFIELD, NJ:
2,286,187, CANC. INT. CL. 28.
- SEK, KOSOL P, ROSEVILLE, MN:
3,806,020, PUB. 4-6-2010. INT. CL. 41.
- SELECT INTELLECTUAL, LLC, PITTSBURGH, PA:
2,448,608, REN. 5-18-10. INT. CL. 35.
- SELECT OFFICE SOLUTIONS, INC., IRWINDALE, CA:
2,374,865, REN. 5-17-10. MULTIPLE CLASS, INT. CLS. 35 AND 37.
- SELECTAFLUSH, LLC, STUART, FL:
3,807,820, INT. CL. 11.
- SELECTHEALTH, INC., SALT LAKE CITY, UT:
3,808,620, INT. CL. 36.
- SELF REGIONAL HEALTHCARE, GREENWOOD, SC:
2,895,213, CANC. INT. CL. 41.
2,927,710, CANC. MULTIPLE CLASS, INT. CLS. 41 AND 44.
- SELTZER CAPLAN MCMAHON VITEK, SAN DIEGO, CA:
3,806,878, PUB. 4-6-2010. INT. CL. 45.
- SEMAIA PHARMACEUTICALS B.V., 3971 JD DRIEBERGEN, NETHERLANDS:
2,770,701, CANC. MULTIPLE CLASS, INT. CLS. 1, 3 AND 5.
- SEMICONDUCTOR INDUSTRY ASSOCIATION, SAN JOSE, CA:
2,348,642, REN. 5-14-10. INT. CL. 42.
- SENECA FOODS CORPORATION, MARION, NY:
3,807,578, INT. CL. 29.
3,807,697, INT. CL. 29.
3,807,825, INT. CL. 29.
- SENIORBRIDGE FAMILY COMPANIES, INC., NEW YORK, NY:
2,771,185, CANC. INT. CL. 44.
- SENSATIONAL SKIN CENTERS, PLLC, SCOTTSDALE, AZ:
3,806,081, PUB. 4-6-2010. INT. CL. 35.
- SENSEI, INC., BOCA RATON, FL:
3,808,507, MULTIPLE CLASS, INT. CLS. 38 AND 44.
- SEPHORA USA, INC., SAN FRANCISCO, CA:
3,808,376, INT. CL. 35.
3,808,377, INT. CL. 35.
- SER-MANUKYAN FAMILY HOLDINGS, GLENDALE, CA:
3,808,170, INT. CL. 7.
- SERVANT ENTERTAINMENT, UNIVERSAL CITY, CA AND LIFT UP AMERICA, UNIVERSAL CITY, CA:
3,805,306, PUB. 4-6-2010. INT. CL. 41.
- SERVICE OASIS, INC., WILLIMINGTON, DE:
3,805,940, PUB. 4-6-2010. INT. CL. 35.
- SERVICEMASTER BRANDS LLC, BURLINGTON, VT:
3,806,766, PUB. 4-6-2010. INT. CL. 37.
- SESAME WORKSHOP, NEW YORK, NY:
3,808,624, INT. CL. 41.
- SET STUFF, INC., LOS ANGELES, CA:
3,808,214, INT. CL. 35.
- SEVENTEENFLAT.COM, NIPOMO, CA:
3,805,374, PUB. 4-6-2010. INT. CL. 28.
- SEVILLE CLASSICS, INC., TORRANCE, CA:
3,805,168, PUB. 4-6-2010. INT. CL. 11.
- SF INVESTMENTS, INC., WILMINGTON, DE:
3,807,616, MULTIPLE CLASS, INT. CLS. 36 AND 41.
- SGM BIOTECH, INC., BOZEMAN, MT:
2,772,309, CANC. INT. CL. 9.
- SHADOW RECORDS CORPORATION, NEW YORK, NY:
2,285,710, CANC. INT. CL. 25.
- SHAFFER INSURANCE AGENCY, INC., KNOXVILLE, TN:
3,807,700, MULTIPLE CLASS, INT. CLS. 35 AND 36.
- SHAFI, INC., BRIGHTON, MI:
2,286,678, CANC. INT. CL. 9.
- SHAH DENTAL CLINIC, LLC, CENTRALIA, IL, DBA MT. VERNON MODERN DENTAL; NEXUS DENTAL; NEXUS DENTISTRY:
3,805,619, PUB. 4-6-2010. MULTIPLE CLASS, INT. CLS. 35 AND 44.
3,805,620, PUB. 4-6-2010. INT. CL. 40.
- SHAKESPEARE COMPANY, LLC, COLUMBIA, SC:
3,808,203, INT. CL. 28.
- SHAKLEE CORPORATION, PLEASANTON, CA:
1,596,726, REN. 5-18-10. INT. CL. 32.
- SHANGHAI GOLDLUCK ACCESSORIES CO., LTD., SHANGHAI, CHINA:
2,772,400, CANC. INT. CL. 11.
2,772,401, CANC. INT. CL. 11.
2,772,402, CANC. MULTIPLE CLASS, INT. CLS. 18 AND 25.
2,772,403, CANC. INT. CL. 25.
2,772,404, CANC. INT. CL. 18.
2,772,422, CANC. INT. CL. 14.
2,772,424, CANC. INT. CL. 14.
2,772,441, CANC. INT. CL. 20.
- SHANGHAI SAIYANG TECHNOLOGICAL EXPERIMENTALISM CO., LTD., SHANGHAI, CHINA:
2,772,204, CANC. INT. CL. 25.
- SHANTI GENERATION, LLC, LOS ANGELES, CA:
3,808,222, INT. CL. 9.
- SHANYAO LEE, SOUTH EL MONTE, CA AND DAVID EN, SOUTH EL MONTE, CA:
3,808,265, INT. CL. 13.
- SHAPIRO, LOUIS, LA JOLLA, CA, DBA GETHEALTHY.COM:
2,284,912, CANC. INT. CL. 5.
- SHARE PLUS FEDERAL CREDIT UNION, DALLAS, TX:
2,770,771, CANC. INT. CL. 36.
- SHAREMEISTER, LLC, FRESNO, CA:
3,807,773, INT. CL. 35.
3,807,774, INT. CL. 35.
- SHARON COATING, LLC, SHARON, PA:
2,771,982, CANC. INT. CL. 37.
- SHARPER IMAGE ACQUISITION LLC, NEW YORK, NY:
2,772,508, CANC. INT. CL. 35.
- SHAVEL ASSOCIATES INC., PRINCETON, NJ, DBA SHAVEL HOME PRODUCTS:
3,808,782, INT. CL. 24.
- SHAW, HARKEEM, HILLSIDE, NJ:
2,771,906, CANC. INT. CL. 21.
- SHAW'S SUPERMARKETS, INC., EAST BRIDGEWATER, MA:
2,286,640, CANC. INT. CL. 30.
- SHEET MUSIC PLUS, LLC, EMERYVILLE, CA:
3,806,205, PUB. 4-6-2010. INT. CL. 35.
3,806,207, PUB. 4-6-2010. INT. CL. 35.
- SHELBY GROUP INTERNATIONAL, INC., MEMPHIS, TN:
1,559,975, CANC. INT. CL. 25.
- SHELF TALKER PUBLICATIONS INC, NEW YORK, NY:
3,808,758, INT. CL. 16.
- SHELLEY, DOUGLAS P., SUMMIT, NJ:
3,808,679, INT. CL. 36.
- SHENG HANG INTERNATIONAL INCORPORATED, TEMPLE CITY, CA:
3,808,372, INT. CL. 25.
- SHENZHEN GODWING ELECTRONICS CO. LTD., SHENZHEN, GUANGDONG, CHINA:
2,771,300, CANC. INT. CL. 9.

SHENZHEN NANTIANHUI; IMP. AND EXP. CO., LTD., CHINA:
3,807,253, PUB. 4-6-2010. INT. CL. 18.

SHEPHERD, AVERY V., HOUSTON, TX:
2,772,715, CANC. INT. CL. 16.

SHERLOCK, RICK, LOS ANGELES, CA:
2,355,029, REN. 5-18-10. INT. CL. 37.

SHERRILL-LUBINSKI CORPORATION, CORTE MADERA, CA:
3,806,953, PUB. 4-6-2010. INT. CL. 9.

SHERWIN M. SERVILIA, WILLEMSTAD; CURAÇAO, NETHERLD ANTILLES:
3,807,337, PUB. 4-6-2010. INT. CL. 1.

SHERWOOD COUNTRY CLUB, THOUSAND OAKS, CA:
3,806,675, PUB. 4-6-2010. MULTIPLE CLASS, INT. CLS. 21, 24, 25 AND 28.

SHERWOOD, INC., TAIPEI, TAIWAN, CHINA:
2,285,869, CANC. INT. CL. 42.

SHIFFERAW, TESSEMA DOSHO, ALBANY, CA:
3,805,526, PUB. 4-6-2010. INT. CL. 28.

SHIMADZU CORPORATION, KYOTO, JAPAN:
3,805,916, PUB. 4-6-2010. INT. CL. 9.

SHIN ZU SHING CO., LTD., TAIPEI HSIEN, TAIWAN:
2,772,392, CANC. INT. CL. 28.

SHIRE HUMAN GENETIC THERAPIES, INC., LEXINGTON, MA:
3,808,488, INT. CL. 5.

SHIRE INTERNATIONAL LICENSING B.V., AMSTERDAM, NETHERLANDS:
3,806,139, PUB. 4-6-2010. INT. CL. 44.

SHOBLASKE, AARON, NEW YORK, NY:
2,771,605, CANC. INT. CL. 42.

SHOCK COFFEE LLC, WOODSIDE, NY:
2,441,395, REN. 5-17-10. INT. CL. 30.

SHOES 2 SHARE, INC., WILMINGTON, DE, AKA BARE-FOOT SUNDAY:
3,806,297, PUB. 4-6-2010. INT. CL. 35.

SHOPKO STORES OPERATING CO., LLC, GREEN BAY, WI:
2,841,380, CANC. MULTIPLE CLASS, INT. CLS. 18 AND 35.

SHORE MICROSYSTEMS, INC., LONG BRANCH, NJ:
3,807,757, INT. CL. 9.

SHORT COURSE PARTNERS, INC., OKEMOS, MI:
2,772,747, CANC. INT. CL. 41.

SI BARGHELAME, WOODINVILLE, WA:
3,806,955, PUB. 4-6-2010. INT. CL. 11.

SICHUAN CHANGHONG ELECTRONICS GROUP CORPORATION, MIANYANG, SICHUAN PROVINCE, CHINA:
2,771,072, CANC. INT. CL. 9.

SICPA HOLDING S.A., SWITZERLAND:
2,770,631, CANC. MULTIPLE CLASS, INT. CLS. 2, 9, 16, 38, 39 AND 42.

SICPA HOLDING SA, PRILLY, SWITZERLAND:
2,770,632, CANC. MULTIPLE CLASS, INT. CLS. 2, 9, 16, 38, 39 AND 42.

SIEMENS AKTIENGESELLSCHAFT, MUNICH, FED REP GERMANY:
2,407,990, REN. 5-17-10. MULTIPLE CLASS, INT. CLS. 7 AND 9.

SIEMENS AKTIENGESELLSCHAFT, FED REP GERMANY:
3,807,192, PUB. 4-6-2010. MULTIPLE CLASS, INT. CLS. 10 AND 36.

SIEMENS AKTIENGESELLSCHAFT, 80333 MÜNCHEN, FED REP GERMANY:
3,807,352, PUB. 4-6-2010. INT. CL. 9.

SIEMENS HEALTHCARE DIAGNOSTICS INC., DEERFIELD, IL:
3,773,730, AM. MULTIPLE CLASS, INT. CLS. 1 AND 5.

SIEMENS WATER TECHNOLOGIES HOLDING CORP., WARRENDALE, PA, ROYCE EQUIPMENT COMPANY, HOUSTON, TX:
1,134,975, REN. 5-20-10. INT. CL. 6.

SIEMON COMPANY, THE, WATERTOWN, CT:
1,559,668, CANC. INT. CL. 9.

SIERRA PACIFIC INDUSTRIES, ANDERSON, CA:
3,805,964, PUB. 4-6-2010. MULTIPLE CLASS, INT. CLS. 22 AND 31.

3,805,970, PUB. 4-6-2010. MULTIPLE CLASS, INT. CLS. 22 AND 31.

SIERRA TRADING POST, INC., CHEYENNE, WY:
2,772,531, CANC. INT. CL. 35.

SIGMA ALIMENTOS, S.A. DE C.V., SAN PEDRO GARCA GARCIA, MEXICO:
3,808,334, INT. CL. 29.

SIGMA DESIGN GROUP, SANTA MONICA, CA:
1,559,643, CANC. INT. CL. 9.

SIGN QUENCHER, LLC, MINDEN, NV:
3,807,488, INT. CL. 32.

3,807,489, INT. CL. 32.

SIGNEO LIMITED, GRAND CAYMAN, CAYMAN ISLANDS:
3,805,998, PUB. 4-6-2010. INT. CL. 9.

SIGNITECTURE LLC, CINCINNATI, OH:
3,806,577, PUB. 4-6-2010. INT. CL. 42.

SILICON LOGIC ENGINEERING, INC., EAU CLAIRE, WI:
2,375,434, REN. 5-20-10. INT. CL. 42.

SILICYCLE INC., QUEBEC (QUEBEC), CANADA:
2,770,746, CANC. MULTIPLE CLASS, INT. CLS. 9 AND 40.

SILVER PORTAL CAPITAL, LLC, SAN DIEGO, CA:
2,772,210, CANC. INT. CL. 36.

SIMA PRODUCTS CORPORATION, CHICAGO, IL:
1,560,281, CANC. INT. CL. 9.

SIMMONS ALLIED PET FOOD, INC., SILOAM SPRINGS, AR:
2,772,699, CANC. INT. CL. 20.

SIMPLE LEADERSHIP STRATEGIES, LLC, FORT WORTH, TX:
3,808,771, INT. CL. 41.

SIMPLY ASIA FOODS, LLC, SPARKS, MD:
2,771,651, CANC. MULTIPLE CLASS, INT. CLS. 16, 29 AND 30.

SIMPSON SENIOR SERVICES, BALA CYNWYD, PA:
3,806,122, PUB. 4-6-2010. MULTIPLE CLASS, INT. CLS. 36 AND 43.

SIMPSON STRONG-TIE COMPANY, INC., PLEASANTON, CA:
3,808,769, INT. CL. 6.

SIMPSON, JULIET H., ANNAPOLIS, MD:
2,285,245, CANC. INT. CL. 25.

SINCLAIR PHARMACEUTICALS LIMITED, GODALMING, SURREY, UNITED KINGDOM:
3,805,221, PUB. 7-28-2009. INT. CL. 5.

SINCLAIR PHARMACEUTICALS LIMITED, SURREY, UNITED KINGDOM:
3,805,237, PUB. 11-17-2009. MULTIPLE CLASS, INT. CLS. 3 AND 5.

SINELLI, JEFFREY, DALLAS, TX:
3,808,443, INT. CL. 30.

SINGLE POINT SYSTEMS, INC., PITTSBURGH, PA:
2,776,232, AM. INT. CL. 42.

SINGLETON FISHERIES, INC., VERNON, CA:
2,771,091, CANC. INT. CL. 29.

SINT, LLC, HICKSVILLE, NY:
3,808,339, INT. CL. 35.

3,808,340, INT. CL. 35.

3,808,341, INT. CL. 35.

3,808,342, INT. CL. 35.

3,808,343, INT. CL. 35.

3,808,344, INT. CL. 35.

3,808,345, INT. CL. 35.

3,808,346, INT. CL. 35.

SITIP S.P.A., 13 - 24020 CENE BG, ITALY:
2,770,622, CANC. MULTIPLE CLASS, INT. CLS. 7, 23, 24 AND 25.

SITV, INC., GLENDALE, CA:
3,808,684, INT. CL. 41.

SIX CONTINENTS PLC, LONDON, W1Y 1WE, UNITED KINGDOM:
2,770,666, CANC. MULTIPLE CLASS, INT. CLS. 16, 35, 41 AND 42.

SKANCARD APS, DENMARK:
3,807,254, PUB. 4-6-2010. MULTIPLE CLASS, INT. CLS. 5, 10 AND 35.

SKECHERS U.S.A., INC. II, MANHATTAN BEACH, CA:
3,807,037, PUB. 4-6-2010. INT. CL. 25.

- SKILLSMITH L.L.C., ALEXANDRIA, VA:
2,286,327, CANC. INT. CL. 41.
- SKIN DIAGNOSTICS GROUP, P.C., BIRMINGHAM, AL:
3,808,738, INT. CL. 44.
- SKUZA MOTORSPORTS, INC., BROADVIEW HEIGHTS, OH:
2,772,336, CANC. MULTIPLE CLASS, INT. CLS. 25 AND 42.
- SKY LAUNDROMAT, INC., JACKSON HEIGHTS, NY:
3,808,408, INT. CL. 37.
- SKYDATA COMMUNICATIONS CORP., CONROE, TX:
2,350,061, REN. 5-20-10, INT. CL. 9.
- SKYLEADER A.S., CZECH REPUBLIC:
3,807,232, PUB. 4-6-2010, MULTIPLE CLASS, INT. CLS. 12, 28, 37 AND 41.
- SKYLINE SOFTWARE SYSTEMS, INC., CHANTILLY, VA:
2,892,232, CANC. INT. CL. 38.
- SKYLINE THINKING, LLC, WINONA, MN:
3,808,698, INT. CL. 9.
- SL ENTERPRISES LLC, IDAHO FALLS, ID:
3,808,138, INT. CL. 44.
- SLAM BRANDS, INC., REDMOND, WA:
3,805,653, PUB. 4-6-2010, INT. CL. 20.
- SLAUGHTER, MAURICE D., PORTSMOUTH, VA:
2,772,707, CANC. MULTIPLE CLASS, INT. CLS. 14, 25 AND 35.
- SLEEPTech LLC, KINNELON, NJ:
2,770,888, CANC. INT. CL. 44.
- SLICKER, INC., CHARLESTON, SC:
2,348,861, REN. 5-14-10, INT. CL. 42.
- SLIMELIGHT LIMITED, LONDON EC1V 1NO, ENGLAND:
2,772,156, CANC. MULTIPLE CLASS, INT. CLS. 41 AND 42.
- SLIPPER HUT & CO., LOS ANGELES, CA:
2,771,542, CANC. INT. CL. 25.
- SLIPSAFE PROFESSIONAL PRODUCTS, INC., PHOENIX, AZ:
1,559,476, CANC. INT. CL. 1.
- SMALL PLANET FOODS, INC., SEDRO WOOLEY, WA:
2,771,989, CANC. INT. CL. 30.
- SMART INVENTIONS, INC., PARAMOUNT, CA:
2,772,483, CANC. INT. CL. 21.
- SMARTA ENTERPRISES LTD, LONDON, UNITED KINGDOM:
3,805,592, PUB. 4-6-2010, MULTIPLE CLASS, INT. CLS. 9, 16, 35, 36, 38, 41, 42 AND 45.
- SMARTPOWER, INC., WASHINGTON, DC, DBA SMART-POWER:
3,805,405, PUB. 4-6-2010, MULTIPLE CLASS, INT. CLS. 35, 39, 40 AND 41.
- SMG BRANDS, INC., WILMINGTON, DE:
2,772,446, CANC. INT. CL. 31.
- SMITH & NEPHEW, INC., MEMPHIS, TN, SMITH & NEPHEW UNITED, INC., ELK GROVE VILLAGE, IL:
1,612,598, REN. 5-17-10, INT. CL. 5.
- SMITH & ROGERS CONSULTING, LLC, MADISON, WI:
2,772,304, CANC. INT. CL. 9.
- SMITH AND FONG COMPANY, SAN FRANCISCO, CA:
3,808,039, INT. CL. 19.
- SMITH, BELINDA F., HOUSTON, TX:
3,807,372, INT. CL. 16.
- SMITH, DANIEL S., ALAMO, CA:
3,808,613, INT. CL. 5.
- SMITH, GORDON EDWARD, PHOENIX, AZ:
2,771,567, CANC. INT. CL. 16.
- SMITH, GWENDOLYN PATRICIA, RIALTO, CA:
2,771,279, CANC. INT. CL. 25.
- SMITH, HUGH ANTHONY, DEDHAM, MA:
2,771,972, CANC. INT. CL. 28.
- SMITH, RONALD, G., SAN FRANCISCO, CA, DBA BEO-WOLF CROW AND REINA, GINA M., SAN FRANCISCO, CA, DBA RAYVN SHADOW:
2,771,737, CANC. INT. CL. 41.
- SMITH, TODD WILLIAM, SAN FRANCISCO, CA, DBA STUNNER OF THE MONTH:
3,805,865, PUB. 4-6-2010, INT. CL. 9.
- SMITH, WAYNE AND SMITH, SYLVIA, HAMPTON, NJ TO W.R. SMITH & COMPANY, INC., ANNADALE, NJ:
1,560,318, CANC. INT. CL. 42.
- SMITH, Y.M., KESWICK, VA:
3,807,921, INT. CL. 41.
- SNAKE RIVER NUTRITION LLC, BOISE, ID:
3,808,400, INT. CL. 5.
- SNOW SHOE REFRACTORIES, LLC, SNOW SHOE, PA:
2,351,912, REN. 5-19-10, INT. CL. 19.
2,351,913, REN. 5-19-10, INT. CL. 19.
- SNYDER, LLC, WENATCHEE, WA:
2,364,869, REN. 5-17-10, INT. CL. 31.
- SO-NET M3 USA CORPORATION, WASHINGTON, DC:
3,807,499, INT. CL. 41.
- SOAP & GLORY LIMITED, LONDON, UNITED KINGDOM:
3,808,167, INT. CL. 3.
- SOCCER UNIVERSE, INC., BATON ROUGE, LA:
2,354,116, REN. 5-20-10, INT. CL. 35.
- SOCIAL MEDIA EXPLORER LLC, LOUISVILLE, KY:
3,805,850, PUB. 4-6-2010, INT. CL. 35.
- SOCIAL SERVICE COORDINATORS, INC., MIAMI LAKES, FL:
3,805,452, PUB. 12-29-2009, INT. CL. 35.
- SOCIETÀ AGRICOLA TERENCE S.R.L., SCANSANO, ITALY:
3,805,238, PUB. 4-6-2010, INT. CL. 33.
- SOCIETE CIVILE DU CHATEAU TROTANOY, F-33500 POMEROL, FRANCE:
3,807,276, PUB. 4-6-2010, INT. CL. 33.
- SOCIETE DES PRODUITS NESTLE S.A., VEVEY, SWITZERLAND:
2,772,079, CANC. INT. CL. 31.
- SOCIETE DES PRODUITS NESTLE S.A., 1800 VEVEY, SWITZERLAND:
3,805,800, PUB. 4-6-2010, INT. CL. 30.
3,805,854, PUB. 4-6-2010, MULTIPLE CLASS, INT. CLS. 11 AND 30.
3,805,855, PUB. 4-6-2010, MULTIPLE CLASS, INT. CLS. 11 AND 30.
3,807,079, PUB. 4-6-2010, INT. CL. 5.
- SOCIETE DES PRODUITS NESTLE, S.A., 1800 VEVEY, SWITZERLAND:
1,595,605, REN. 5-14-10, INT. CL. 32.
2,771,901, CANC. INT. CL. 5.
- SOCIETE GENERALE, FRANCE:
3,807,251, PUB. 4-6-2010, MULTIPLE CLASS, INT. CLS. 9, 36 AND 38.
- SOCIETE JAS HENNESSY & CO., 16100 COGNAC, FRANCE:
3,805,181, PUB. 4-6-2010, MULTIPLE CLASS, INT. CLS. 9, 25, 35 AND 41.
- SOCIETE NATIONALE INDUSTRIELLE AEROSPATIALE, PARIS, CEDEX, FRANCE AND FRAMATOME (S.A.), PARIS LA DEFENSE, CEDEX, FRANCE:
1,559,591, CANC. INT. CL. 9.
- SOCIETY OF HISPANIC PROFESSIONAL ENGINEERS, INC., THE, LOS ANGELES, CA:
2,771,129, CANC. INT. CL. 25.
- SODA-CLUB (CO2) ATLANTIC GMBH, CH-6300 ZUG, SWITZERLAND:
2,772,417, CANC. INT. CL. 7.
- SODEXO, INC., GAITHERSBURG, MD:
1,560,257, CANC. INT. CL. 42.
- SOFT AIR USA, INC, GRAPEVINE, TX:
3,806,421, PUB. 4-6-2010, INT. CL. 13.
- SOHO AMERICA, INC., BLOOMINGTON, MN:
2,284,722, CANC. INT. CL. 35.
- SOLACE INTERNATIONAL INC., RENO, NV:
3,807,627, INT. CL. 5.
- SOLAQUA, INC., EL PASO, TX:
2,771,880, CANC. INT. CL. 11.
- SOLAR ELECTRIC HYBRID, LLC, IDAHO FALLS, ID:
2,286,084, CANC. INT. CL. 7.
- SOLARROAD TECHNOLOGIES INC., TOWSON, MD:
3,808,579, INT. CL. 40.
- SOLARPOLY, INC., CAMPBELL, CA:
3,806,654, PUB. 4-6-2010, INT. CL. 37.
- SOLARWINDS WORLDWIDE, LLC, AUSTIN, TX:
3,805,774, PUB. 4-6-2010, U.S. CL. 200.
3,805,776, PUB. 4-6-2010, U.S. CL. 200.

SOLID GOLD HEALTH PRODUCTS FOR PETS, INC., EL CAJON, CA:
3,805,194, PUB. 4-6-2010. INT. CL. 31.

SOLINET GMBH TELECOMMUNICATIONS, D-70499 STUTTGART, FED REP GERMANY:
2,770,599, CANC. MULTIPLE CLASS, INT. CLS. 9, 16, 35, 38, 41 AND 42.

SOLIS BRANDS, INC., ALTAMONTE SPRINGS, FL:
3,807,812, MULTIPLE CLASS, INT. CLS. 5 AND 32.

SOLOFLEX, INC., HILLSBORO, OR:
3,807,478, INT. CL. 28.

SOLUTIA INC., ST. LOUIS, MO:
3,807,716, INT. CL. 17.

SOLUTION FOR HAIR, INC., HOUSTON, TX:
2,348,814, REN. 5-14-10. INT. CL. 42.

SOLYNDRA, INC., FREMONT, CA:
3,806,693, PUB. 4-6-2010. INT. CL. 9.

SONERA ZED OY, 00510 HELSINKI, FINLAND:
2,770,636, CANC. INT. CL. 41.

SONIC BOOM, INC., NEW YORK, NY:
3,807,684, MULTIPLE CLASS, INT. CLS. 9, 35, 38, 41 AND 42.

SONIC CHAIN LLC, CLEVELAND, OH:
2,770,896, CANC. INT. CL. 35.

SONNAX INDUSTRIES, INC., BELLOWS FALLS, VT:
3,806,056, PUB. 4-6-2010. MULTIPLE CLASS, INT. CLS. 7 AND 12.

SONOMA WINE COMPANY, LLC, GRATON, CA:
3,806,180, PUB. 4-6-2010. INT. CL. 35.

SONUS NETWORKS, INC., WESTFORD, MA:
3,806,662, PUB. 4-6-2010. INT. CL. 9.

SONY COMPUTER ENTERTAINMENT AMERICA LLC, FOSTER CITY, CA:
3,807,513, MULTIPLE CLASS, INT. CLS. 9 AND 41.

SONY PICTURES RELEASING CORPORATION, CULVER CITY, CA:
3,807,643, INT. CL. 41.

SOOKA, INC., MARINA DEL REY, CA:
3,805,784, PUB. 4-6-2010. INT. CL. 35.

SOOTHING TOUCH, LLC, SANTA FE, NM:
3,805,990, PUB. 4-6-2010. INT. CL. 5.

SOPRANZI, ANTHONY D., SANTA CLARA, CA:
3,806,733, PUB. 4-6-2010. INT. CL. 41.
3,806,838, PUB. 4-6-2010. INT. CL. 41.

SOPREMA INC., DRUMMONDVILLE, QC, CANADA:
3,807,892, INT. CL. 19.

SOSBUZZ, INC, GLENDALE, CA:
3,806,685, PUB. 4-6-2010. INT. CL. 35.

SOSRODJOJO, SOEKIANTO SOSRODJOJO, SOEWITO SOSRODJOJO, SOEJANI SOSRODJOJO, KUNIARTI SOSRODJOJO, SUKOWATI, KELAPA GADING, JAKARTA, INDONESIA:
3,808,367, MULTIPLE CLASS, INT. CLS. 30 AND 32.
3,808,369, MULTIPLE CLASS, INT. CLS. 30 AND 32.
3,808,370, MULTIPLE CLASS, INT. CLS. 30 AND 32.
3,808,371, INT. CL. 32.

SOUNDBLAZE MEDIA, LLC, NEW YORK, NY:
3,805,303, PUB. 4-6-2010. INT. CL. 42.

SOUP & SCOOP, LLC, SHELBY TOWNSHIP, MI:
3,807,593, INT. CL. 43.

SOUPER SALAD, INC., SAN ANTONIO, TX:
2,772,192, CANC. INT. CL. 42.

SOURCEMAN INTERNATIONAL PTY LTD, AUSTRALIA:
3,807,266, PUB. 4-6-2010. MULTIPLE CLASS, INT. CLS. 9 AND 35.

SOUTH CAROLINA DEPARTMENT OF PARKS, RECREATION & TOURISM, COLUMBIA, SC:
3,808,466, INT. CL. 35.

SOUTH CONE, INC., CARLSBAD, CA:
2,286,269, CANC. INT. CL. 25.

SOUTH DAKOTA SOYBEAN PROCESSORS, LLC, VOLGA, SD:
3,805,396, PUB. 4-6-2010. INT. CL. 29.
3,805,398, PUB. 4-6-2010. INT. CL. 31.

SOUTH FLORIDA WATER TREATMENT CORP., MAIMI, FL:
2,772,094, CANC. INT. CL. 32.

SOUTH RIVER RESTORATION, INC., UPPER MARLBORO, MD:
3,806,524, PUB. 4-6-2010. MULTIPLE CLASS, INT. CLS. 37 AND 40.

SOUTHEAST CARBON MANAGEMENT, LLC, NEW SMYRNA BEACH, FL:
3,808,774, INT. CL. 35.

SOUTHERN BULLION TRADING, LLC, DALLAS, TX:
3,808,765, INT. CL. 35.

SOUTHERN STAR MORTGAGE CORP., UNIONDALE, NY:
2,285,433, CANC. INT. CL. 36.

SOUTHERN STATES COOPERATIVE, INCORPORATED, RICHMOND, VA:
1,559,468, CANC. INT. CL. 1.

SOUTHERN SUPPLY & MANUFACTURING CO., INC., ST. PETERSBURG, FL:
2,770,936, CANC. INT. CL. 8.

SOUTHWEST CORPORATE FEDERAL CREDIT UNION, DALLAS, TX:
2,285,667, CANC. INT. CL. 36.

SOUTHWEST SPECIALTY FOOD, INC., GOODYEAR, AZ:
2,285,543, CANC. INT. CL. 32.

SP PRODUCTIONS, CHAPMANSBORO, TN:
3,808,644, INT. CL. 35.

SPA DEAL FINDER, ARVADA, CO:
3,808,741, MULTIPLE CLASS, INT. CLS. 16 AND 35.

SPA WEEK MEDIA GROUP LTD., NEW YORK, NY:
3,805,495, PUB. 4-6-2010. INT. CL. 41.

SPACE-TIME COMMUNICATIONS, INC., GASTONIA, NC:
3,808,036, INT. CL. 35.

SPANGLER, AMY K., ATLANTA, GA:
3,806,110, PUB. 4-6-2010. MULTIPLE CLASS, INT. CLS. 24, 25 AND 44.

SPANX, INC., ATLANTA, GA:
3,808,327, INT. CL. 25.

SPARK OFF ROSE, LLC, SANTA MONICA, CA:
3,807,905, MULTIPLE CLASS, INT. CLS. 9 AND 41.

SPARKPOINT, INC., WEST DES MOINES, IA:
3,707,440, COR. INT. CL. 35.

SPARRMAN, LISA, CALABASAS, CA AND SPARRMAN, KELLY, CALABASAS, CA:
2,771,179, CANC. INT. CL. 28.

SPAULDING BRICK CO., INC., SOMERVILLE, MA:
2,772,748, CANC. INT. CL. 19.

SPC RESOURCES, INC., HARTSVILLE, SC:
2,398,316, REN. 5-19-10. INT. CL. 9.

SPEAKLE LLC, AMENIA, NY:
3,807,408, INT. CL. 41.

SPECIALISED PETROLEUM SERVICIES GROUP LIMITED, ABERDEEN AB32 6TQ, UNITED KINGDOM:
2,771,570, CANC. INT. CL. 7.

SPECIALTY RETAILERS, INC., HOUSTON, TX:
3,805,141, PUB. 4-6-2010. INT. CL. 25.

SPECTRAREP, LLC, CHANTILLY, VA:
3,806,148, PUB. 4-6-2010. INT. CL. 9.

SPEEDSKIN LLC, AGOURA HILLS, CA, DBA SPEEDSKIN LLC:
3,807,834, INT. CL. 9.

SPEES, ROBERT M, PARKER, CO:
3,808,277, INT. CL. 14.

SPELLBINDERS, ASPEN, CO:
3,805,780, PUB. 4-6-2010. MULTIPLE CLASS, INT. CLS. 16 AND 41.

SPENCER'S INCORPORATED OF MOUNT AIRY, NORTH CAROLINA, MOUNT AIRY, NC:
1,559,902, CANC. INT. CL. 25.

SPENCERFIELD SPIRIT COMPANY LIMITED, UNITED KINGDOM:
3,807,256, PUB. 4-6-2010. INT. CL. 33.

SPERIAN PROTECTION GLOVES; PLANCHER BAS, FRANCE:
3,807,209, PUB. 4-6-2010. MULTIPLE CLASS, INT. CLS. 6, 9, 17 AND 21.

SPICE ENTERTAINMENT, INC., CHICAGO, IL:
2,770,673, CANC. INT. CL. 41.

SPINLIFE.COM, LLC, COLUMBUS, OH:
2,450,222, REN. 5-18-10. INT. CL. 35.

- SPITFIRE SUNGLASS DESIGN USA, INC., CHICAGO, IL:
3,808,437, INT. CL. 9.
- SPORT & HEALTH, INC., MCLEAN, VA:
1,603,238, REN. 5-18-10. INT. CL. 41.
- SPORT SUPPLY GROUP, INC., FARMERS BRANCH, TX:
2,778,839, CANC. MULTIPLE CLASS, INT. CLS. 24 AND 25.
- SPORTMASTERS, INC., NEWTON FALLS, OH:
2,771,260, CANC. INT. CL. 40.
- SPORTS AUTHORITY MICHIGAN, INC. THE, ROYAL OAK, MI TO TSA CORPORATE SERVICES, INC., ENGLEWOOD, CO:
2,284,347, CANC. MULTIPLE CLASS, INT. CLS. 35 AND 39.
- SPORTS DESIGN AND DEVELOPMENT, INC., ALEXANDRIA, LA:
2,285,403, CANC. INT. CL. 28.
- SPORTS WORLD ENTERPRISE CO., LTD., QUEI JEN HSIANG TAINAN HSIEN, TAIWAN:
2,285,392, CANC. INT. CL. 28.
- SPORTS55, SEVERNA PARK, MD:
3,805,632, PUB. 4-6-2010. INT. CL. 35.
- SPRAYGROUND LIMITED LIABILITY COMPANY, ELBERON, NJ:
3,805,977, PUB. 4-6-2010. INT. CL. 25.
- SPRINGBOARD RETAIL NETWORKS INC., KING CITY, ONTARIO, CANADA:
3,807,068, PUB. 4-6-2010. MULTIPLE CLASS, INT. CLS. 6, 9, 12, 21, 35, 36, 37, 38 AND 42.
- SPRINGMILL PRODUCTS, INC., LAWSONVILLE, NC:
2,771,860, CANC. INT. CL. 31.
- SPRINGS WINDOW FASHIONS, LLC, MIDDLETON, WI, WAUSAU METALS CORPORATION, WAUSAU, WI:
1,135,161, REN. 5-18-10. INT. CL. 20.
- SPRINGSTEEN, STEPHEN, MANHEIM, PA:
3,805,312, PUB. 4-6-2010. INT. CL. 35.
- SPRINGTREE WINE COMPANY (PTY) LIMITED, THE, RIEBEECK KASTEEL, SOUTH AFRICA:
3,806,711, PUB. 4-6-2010. INT. CL. 33.
- SQUADFITTERS, INC, URBANA, IL:
3,805,250, PUB. 4-6-2010. INT. CL. 35.
- SRI KABUSHIKI KAISHA, KOBE-SHI, HYOGO, JAPAN, TA SRI SPORTS LIMITED:
3,805,329, PUB. 4-6-2010. INT. CL. 28.
- SSANGYONG MATERIALS CORPORATION, DAEGUE, REPUBLIC OF KOREA:
1,596,094, REN. 5-19-10. INT. CL. 7.
- ST IP, LLC, NEWPORT BEACH, CA:
3,807,797, INT. CL. 25.
- ST MEDIA GROUP INTERNATIONAL, INC., CINCINNATI, OH:
2,771,503, CANC. INT. CL. 16.
- ST. LOUIS SCIENCE CENTER, ST. LOUIS, MO:
3,805,541, PUB. 4-6-2010. INT. CL. 41.
- STADION MONEY MANAGEMENT, INC., WATKINSVILLE, GA:
3,805,996, PUB. 4-6-2010. INT. CL. 36.
- STAFF PRO, HUNTINGTON BEACH, CA, AKA EVENT MANAGEMENT SERVICES, STAFFPRO SECURITY INC., STAFFPRO SERVICES INC., STAFFPRO INC., EVENT SECURITY MANAGEMENT, LLC.:
3,808,694, INT. CL. 35.
- STAGER, TODD, R., SCOTTSDALE, AZ:
2,772,243, CANC. INT. CL. 10.
- STAHL, DAVID, MOUND, MN:
3,806,680, PUB. 4-6-2010. INT. CL. 35.
- STANLEY, HENRY M. JR., ANDERSON, SC:
2,286,791, CANC. INT. CL. 35.
- STANLEY, NEIL, OMAHA, NE:
3,808,597, INT. CL. 36.
- STARBUZZ TOBACCO, INC., ANAHEIM, CA:
3,808,670, INT. CL. 34.
- STARCRAFT RV, INC., TOPEKA, IN:
1,559,722, CANC. INT. CL. 12.
1,559,724, CANC. INT. CL. 12.
- STARMORE, ALICE, ISLE OF LEWIS HS2 0NB, UNITED KINGDOM:
2,344,881, REN. 5-20-10. INT. CL. 23.
- STARPOINT ELECTRICS LIMITED, CHESSINGTON, SURREY KT9 1TT, ENGLAND:
2,770,985, CANC. INT. CL. 9.
- STARS IN THE EYES SARL, CH-1207 GENÈVE, SWITZERLAND:
3,807,312, PUB. 4-6-2010. MULTIPLE CLASS, INT. CLS. 28, 39 AND 41.
- STARWOOD CAPITAL GROUP L.L.C., GREENWICH, CT:
2,772,031, CANC. INT. CL. 41.
- STATACORP LP, COLLEGE STATION, TX:
3,806,028, PUB. 4-6-2010. MULTIPLE CLASS, INT. CLS. 9 AND 16.
- STATCOM, LLC, ALPHARETTA, GA:
3,806,627, PUB. 4-6-2010. INT. CL. 9.
- STATE ACADEMIC BOLSHOI THEATER OF RUSSIA, THE, 103009 MOSCOW, RUSSIAN FED.:
2,778,946, CANC. MULTIPLE CLASS, INT. CLS. 3, 14, 20, 21 AND 25.
- STATE AND FEDERAL EMPLOYEES BENEFITS CONSULTING GROUP LLP, WARREN, NJ:
3,805,360, PUB. 4-6-2010. INT. CL. 36.
- STATE BOARD OF AGRICULTURE, THE, FORT COLLINS, COUNTY OF LARIMER, CO:
1,560,185, CANC. INT. CL. 41.
- STATE ELECTRONICS PARTS CORP, EAST HANOVER, NJ:
3,808,431, INT. CL. 9.
- STATE OF NEBRASKA, DEPARTMENT OF REVENUE, LINCOLN, NE:
1,559,794, CANC. INT. CL. 16.
- STATE OF OREGON ACTING BY AND THROUGH THE STATE BOARD OF HIGHER EDUCATION ON BEHALF OF THE UNIVERSITY OF OREGON, EUGENE, OR:
3,807,512, INT. CL. 41.
- STATE ST PRODUCE, INC., SAN ANTONIO, TX:
3,806,812, PUB. 4-6-2010. INT. CL. 31.
- STATE UNIVERSITY OF NEW YORK UPSTATE MEDICAL UNIVERSITY, SYRACUSE, NY:
3,808,120, MULTIPLE CLASS, INT. CLS. 41, 42 AND 44.
- STATUSWORKS INTERNATIONAL, INC., ESTES PARK, CO:
2,352,961, REN. 5-18-10. INT. CL. 25.
- STAX SYSTEMS, LLC, SCOTTSDALE, AZ:
3,806,209, PUB. 4-6-2010. INT. CL. 21.
- STEED HAMMOND PAUL, INC., CINCINNATI, OH, DBA SHP LEADING DESIGN:
3,808,498, INT. CL. 9.
- STEEL CITY LANDSCAPE INC., PITTSBURGH, PA:
3,805,953, PUB. 4-6-2010. MULTIPLE CLASS, INT. CLS. 37 AND 44.
- STEELITE, INC., PITTSBURGH, PA:
878,025, CANC. U.S. CL. 12.
- STEELY DAN, VENICE, CA:
2,393,524, REN. 5-18-10. INT. CL. 41.
- STEFAN G. BUCHER, PASADENA, CA:
3,805,853, PUB. 4-6-2010. INT. CL. 41.
- STEFANEL S.P.A., PONTE DI PIAVE (TREVISO), ITALY:
1,559,483, CANC. MULTIPLE CLASS, INT. CLS. 3, 9, 14, 18 AND 42.
- STEINER, JOAN C., CLAVERACK, NY:
2,285,233, CANC. INT. CL. 16.
- STEMBERGER LARUSSA, ROSEMARY B, DELTONA, FL, DBA NUCLEAR OPTICS EYEWARE:
3,808,143, INT. CL. 9.
- STENS CORPORATION, JASPER, IN:
3,805,272, PUB. 4-6-2010. MULTIPLE CLASS, INT. CLS. 4, 7, 9 AND 12.
3,805,273, PUB. 4-6-2010. MULTIPLE CLASS, INT. CLS. 4, 7, 9 AND 12.
- STEPHEN M. AUERBACH, M.D., INC., NEWPORT BEACH, CA:
1,559,605, CANC. MULTIPLE CLASS, INT. CLS. 9 AND 16.
- STEPHEN SHELBY SAWYER, VERSAILLES, KY:
3,807,458, INT. CL. 25.
- STEPHEN TSAI, FULLERTON, CA, DBA INTERNATIONAL COLLEGE OF COMPLEMENTARY AND ALTERNATIVE MEDICINE:
3,807,983, INT. CL. 41.

STEPSTONE, INC., GARDENA, CA:
3,806,289, PUB. 4-6-2010. INT. CL. 19.

STERLING OF OHIO, INC., AKRON, OH:
3,806,370, PUB. 4-6-2010. INT. CL. 36.
3,806,371, PUB. 4-6-2010. INT. CL. 36.
3,806,372, PUB. 4-6-2010. INT. CL. 36.

STEVEN ERIC JOHNSON, GIBBON, NE:
3,808,210, INT. CL. 8.

STEVEN H. SALTZMAN, CANOGA PARK, CA, DBA RATIO INDUSTRIES, INC.:
3,807,960, INT. CL. 16.

STI/SPFA, LAKE ZURICH, IL:
1,610,251. REN. 5-19-10. U.S. CL. A.

STICHT, WALTER, A-4800 ATTNANG-PUCHHEIM, AUSTRIA:
2,396,939. REN. 5-17-10. MULTIPLE CLASS, INT. CLS. 7, 9, 37, 40 AND 42.

STMICROELECTRONICS N.V., GENEVA, SWITZERLAND:
3,807,642, INT. CL. 9.

STOCKER-EDWARDS, DODD, PHILADELPHIA, PA:
2,772,123, CANC. INT. CL. 25.

STONE CLIFF PRODUCTIONS, INC., WHEATON, IL:
3,805,513, PUB. 4-6-2010. INT. CL. 41.

STONEMAN, LYNN, GALAX, VA:
2,772,368, CANC. INT. CL. 16.

STOP-IT, LLC., FORT LEE, NJ:
2,285,096, CANC. INT. CL. 9.

STORA ENSO OYJ, 00160 HELSINKI, FINLAND:
2,770,647, CANC. MULTIPLE CLASS, INT. CLS. 1, 14, 16, 18, 19, 25, 28, 35, 39 AND 42.

STRATEGIC GLOBAL ADVISORS, LLC, NEWPORT BEACH, CA:
3,808,708, INT. CL. 36.

STRATEGIC PARTNERS, INC., PACOIMA, CA:
2,285,935, CANC. INT. CL. 25.

STRATFORD FOUNDATION, INC., NEEDHAM, MA, DBA READ MTI, THE MULTISENSORY TRAINING INSTITUTE:
3,808,737, INT. CL. 41.

STRATHMORE PARTNERS LP, CONCORD, NH:
2,285,640, CANC. INT. CL. 35.

STRATMAR SYSTEMS, INC., PORT CHESTER, NY, DBA STRATMAR RETAIL SERVICES:
3,806,338, PUB. 4-6-2010. INT. CL. 35.

STRAUBMUELLER, SUSIE, DALLAS, TX:
3,806,586, PUB. 4-6-2010. INT. CL. 18.

STRAWDOG STUDIOS LTD, DERBY, UNITED KINGDOM:
3,805,269, PUB. 1-19-2010. INT. CL. 9.

STREAMWORKS, INC., STOCKTON, CA:
3,805,720, PUB. 4-6-2010. INT. CL. 8.

STREET TUNERS, INC., MAYLENE, AL:
2,772,332, CANC. INT. CL. 37.

STRETCH-O-RAMA, INC., NEW YORK, NY:
1,559,923, CANC. INT. CL. 25.

STRIDER & CLINE, INC., KANSAS CITY, MO:
2,285,258, CANC. INT. CL. 35.

STRONG SATO CO., LTD., TOKYO 107-0052, JAPAN:
2,771,127, CANC. INT. CL. 43.

STROUD, TAMMARA A., SEATTLE, WA:
2,285,223, CANC. INT. CL. 25.

STUDEBAKER, ROBERT, TULSA, OK:
3,807,660, INT. CL. 12.

STUDENT LOAN FINANCE CORPORATION, ABERDEEN, SD:
2,771,927, CANC. INT. CL. 36.

STUDIO IP HOLDINGS LLC, WILMINGTON, DE:
2,772,523, CANC. INT. CL. 25.
2,772,524, CANC. INT. CL. 25.
2,772,525, CANC. INT. CL. 25.

STUDIO USA, LLC, SANTA MONICA, CA:
3,808,541, INT. CL. 35.

STURGIS AREA CHAMBER OF COMMERCE, STURGIS, SD TO MONAHAN, THOMAS, L., STURGIS, SD:
2,698,677, COR. INT. CL. 25.

STYLEX, INC., DELANCO, NJ:
2,360,271. REN. 5-20-10. INT. CL. 20.

SUAREZ, CARLOS, NEW YORK, NY:
3,806,095, PUB. 4-6-2010. INT. CL. 25.

SUCCESS FOR ALL FOUNDATION, INC., BALTIMORE, MD:
3,806,278, PUB. 4-6-2010. MULTIPLE CLASS, INT. CLS. 16 AND 41.

SUE LECRAW, ATLANTA, GA:
3,807,878, INT. CL. 35.

SUFFOLK COUNTY NATIONAL BANK, RIVERHEAD, NY:
3,806,867, PUB. 4-6-2010. INT. CL. 36.
3,806,870, PUB. 4-6-2010. INT. CL. 36.
3,807,038, PUB. 4-6-2010. INT. CL. 36.

SUGAR FACTORY, LLC, LAS VEGAS, NV:
3,807,688, MULTIPLE CLASS, INT. CLS. 35 AND 43.

SULICON INC., CONCORD, ONTARIO, CANADA:
2,770,621, CANC. INT. CL. 9.

SULLIVAN, DIANE L., NEWPORT BEACH, CA, DBA LUXECLIPS AND VAUGHAN, JENNIFER S., COSTA MESA, CA, DBA LUXECLIPS:
3,807,970, INT. CL. 26.
3,807,971, INT. CL. 14.

SULLIVAN, TOM, SAN MARCOS, CA:
3,806,997, PUB. 4-6-2010. INT. CL. 21.

SULZER METCO MANAGEMENT AG, WINTERTHUR, SWITZERLAND:
3,807,106, PUB. 4-6-2010. MULTIPLE CLASS, INT. CLS. 6, 37 AND 40.

SULZER METRO (US) INC., WESTBURY, NY, PERKIN-ELMER CORPORATION, THE, NORWALK, CT:
1,582,256. REN. 5-19-10. INT. CL. 7.

SUMMIT AUTOMATION, LLC, FENTON, MO:
3,808,020, MULTIPLE CLASS, INT. CLS. 6 AND 7.

SUMMIT AUTOMOTIVE, LLC, GREENWOOD VILLAGE, CO:
3,807,749, INT. CL. 35.

SUMMIT FINANCIAL GROUP, INC., LOVELAND, OH:
3,806,932, PUB. 4-6-2010. INT. CL. 41.

SUMSPOT, LLC, DALLAS, TX:
3,805,624, PUB. 4-6-2010. INT. CL. 43.

SUN CHEMICAL CORPORATION, PARSIPPANY, NJ:
880,734. REN. 5-17-10. U.S. CL. 11 (INT. CL. 2).

SUN CORPORATION, KONAN CITY, ALCHI 483-8555, JAPAN:
2,958,172, COR. INT. CL. 9.

SUN HARVEST FOODS, INC., SAN DIEGO, CA:
3,807,985, MULTIPLE CLASS, INT. CLS. 29 AND 31.
3,807,986, MULTIPLE CLASS, INT. CLS. 29 AND 31.

SUN LIFE ASSURANCE COMPANY OF CANADA (U.S.), WELLESLEY HILLS, MA, DBA SUN LIFE OF CANADA (U.S.) AND SUN LIFE ASSURANCE COMPANY OF CANADA, TORONTO, CANADA:
1,560,125, CANC. INT. CL. 36.

SUN SHUN FUK FOODS COMPANY LIMITED, HONG KONG, CHINA:
3,806,437, PUB. 4-6-2010. INT. CL. 30.

SUNAIR SALES CORPORATION, HALLANDALE BEACH, FL:
3,806,237, PUB. 4-6-2010. INT. CL. 37.

SUNBEAM CORPORATION, DOWNERS GROVE, IL:
1,559,678, CANC. INT. CL. 10.

SUNBEAM PRODUCTS, INC., BOCA RATON, FL, DBA JARDEN CONSUMER SOLUTIONS:
3,805,758, PUB. 4-6-2010. INT. CL. 7.
3,805,767, PUB. 4-6-2010. INT. CL. 7.
3,805,807, PUB. 4-6-2010. INT. CL. 11.

SUNCAST CORPORATION, BATAVIA, IL:
2,286,581, CANC. INT. CL. 20.

SUNDANCE CHANNEL LLC, NEW YORK, NY:
2,771,792, CANC. INT. CL. 41.

SUNDARA SPA, LLC, WISCONSIN DELLS, WI:
2,772,358, CANC. MULTIPLE CLASS, INT. CLS. 3, 25 AND 42.

SUNDAY LLC, NEW YORK, NY:
3,806,106, PUB. 4-6-2010. MULTIPLE CLASS, INT. CLS. 35 AND 45.

SUNDAY SCHOOL BOARD OF THE SOUTHERN BAPTIST CONVENTION, THE, NASHVILLE, TN:
1,559,784, CANC. INT. CL. 16.

- SUNESIS PHARMACEUTICALS, INC., SOUTH SAN FRANCISCO, CA:
3,807,428, INT. CL. 5.
3,807,429, INT. CL. 5.
- SUNFED PRODUCE, LLC, RIO RICO, AZ:
2,285,605, CANC. INT. CL. 31.
- SUNGARD PUBLIC SECTOR INC., LAKE MARY, FL:
3,807,649, INT. CL. 9.
- SUNGOLD ABRASIVES USA, INC., PORT WASHINGTON, NY:
2,371,212, REN. 5-18-10. INT. CL. 3.
- SUNKIST GROWERS, INC., SHERMAN OAKS, CA:
2,770,725, CANC. INT. CL. 31.
2,770,726, CANC. INT. CL. 31.
- SUNNY LEISURE INC, ST. JOHN'S, ANTIGUA & BARBUDA:
2,772,214, CANC. INT. CL. 41.
- SUNNY LEISURE INC., ST. JOHN'S, ANTIGUA & BARBUDA:
2,772,215, CANC. INT. CL. 41.
- SUNNY SLOPE FARMS, BRIDGETON, NJ:
3,806,967, PUB. 4-6-2010. MULTIPLE CLASS, INT. CLS. 29 AND 31.
- SUNS INTERNATIONAL, LLC, LEXINGTON, MA:
3,806,841, PUB. 4-6-2010. INT. CL. 9.
- SUNSET STRIP BUSINESS ASSOCIATION, WEST HOLLYWOOD, CA:
3,806,447, PUB. 4-6-2010. INT. CL. 25.
- SUNSHINE HEALTH ENTERPRISES L.L.C., BOULDER, CO:
2,771,544, CANC. INT. CL. 16.
- SUNSHINE RAISIN CORPORATION, FOWLER, CA, DBA NATIONAL RAISIN CO.:
3,807,964, INT. CL. 29.
- SUNSTREAM PACIFIC, LLC, PICO RIVERA, CA:
3,806,462, PUB. 4-6-2010. MULTIPLE CLASS, INT. CLS. 3 AND 18.
- SUNSTRIP AB, 612 44 FINSPANG, SWEDEN:
2,771,275, CANC. INT. CL. 9.
- SUNTEX INTERNATIONAL, INC., EASTON, PA:
2,448,022, REN. 5-19-10. INT. CL. 9.
- SUNTRUST BANKS, INC, ORLANDO, FL:
3,806,821, PUB. 4-6-2010. INT. CL. 36.
- SUPER COUPE CLUB OF AMERICA, INC., MEDINA, OH:
3,806,100, PUB. 4-6-2010. INT. CL. 35.
- SUPER DUPER, INC., GREENVILLE, SC, DBA SUPER DUPER PUBLICATIONS:
2,286,692, CANC. INT. CL. 16.
- SUPPLIQ, LLC, ST. AUGUSTINE, FL:
3,806,353, PUB. 4-6-2010. INT. CL. 35.
- SUPPLYMAN, INC., LOS ANGELES, CA:
2,771,081, CANC. INT. CL. 35.
- SUPPONOR OY, FINLAND:
3,807,158, PUB. 4-6-2010. MULTIPLE CLASS, INT. CLS. 35, 41 AND 42.
- SUPPORT SYSTEMS, L.L.C., POTTERSVILLE, NJ:
2,772,557, CANC. INT. CL. 42.
- SUR LA LUNE, INC., SAN JOSE, CA, DBA SUR LA LUNE, INC.:
3,805,770, PUB. 4-6-2010. INT. CL. 33.
- SUREFIRE, LLC, FOUNTAIN VALLEY, CA:
3,808,225, INT. CL. 11.
- SURF TACO COASTAL CUISINE, POINT PLEASANT BEACH, NJ:
3,806,983, PUB. 4-6-2010. INT. CL. 43.
- SURFDOG, INC., ENCINITAS, CA:
2,285,814, CANC. INT. CL. 35.
- SURTITIENDAS, MEDLEY, FL:
3,806,801, PUB. 4-6-2010. INT. CL. 39.
- SUSAN ALLEN DESIGNS, INC., GARRISON, NY:
1,559,954, CANC. INT. CL. 25.
- SUSAN BENNIS WARREN EDWARDS ENTERPRISES, NEW YORK, NY:
1,559,822, CANC. INT. CL. 18.
- SUSIES SOUTH FORTY CONFECTIONS, MIDLAND, TX:
3,805,429, PUB. 11-3-2009. INT. CL. 30.
- SUSTAINABLE SYSTEMS INTEGRATORS LLC, NEW ORLEANS, LA:
3,805,673, PUB. 4-6-2010. INT. CL. 37.
- SUTTERA LLC, LOS ANGELES, CA:
2,348,914, REN. 5-19-10. INT. CL. 5.
- SUZUKI MOTOR CORPORATION, SHIZUOKA-PREF., JAPAN:
3,807,669, INT. CL. 12.
- SWADESH ANIMATION PRIVATE LIMITED, BANGALORE, INDIA:
3,808,676, INT. CL. 41.
- SWAGGERTY'S SAUSAGE COMPANY, INC., KODAK, TN:
2,771,436, CANC. INT. CL. 29.
- SWANSON SERVICES CORPORATION, TALLEVAST, FL:
2,350,347, REN. 5-18-10. INT. CL. 36.
- SWANSON, KEITH T., LOS OSOS, CA AND BARR, KEVIN C., PINE MOUNTAIN CLUB, CA:
2,771,615, CANC. INT. CL. 9.
- SWANY AMERICA CORP., GLOVERSVILLE, NY:
1,569,851, REN. 5-18-10. INT. CL. 25.
1,569,852, REN. 5-18-10. INT. CL. 25.
- SWEDISH COVENANT HOSPITAL, CHICAGO, IL:
2,772,412, CANC. INT. CL. 44.
- SWEET CONCESSIONS, INC., NEW YORK, NY:
3,808,616, INT. CL. 30.
- SWENSON, NORMAN V., JR., CHARLOTTE, NC:
2,772,290, CANC. INT. CL. 25.
- SWIFTYBIKES, NAPLES, FL:
3,806,378, PUB. 4-6-2010. INT. CL. 12.
- SWINERTON INCORPORATED, SAN FRANCISCO, CA:
2,284,826, CANC. INT. CL. 36.
2,284,827, CANC. INT. CL. 36.
- SWISS AMERICAN WATCHMAKERS TRAINING ALLIANCE LLC, NEW YORK, NY:
3,807,683, INT. CL. 42.
- SWITCHEASY LIMITED, KOWLOON, HONG KONG:
3,808,518, INT. CL. 9.
3,808,520, INT. CL. 9.
- SWS GROUP, INC., DALLAS, TX:
2,772,239, CANC. INT. CL. 36.
- SYLVAN LEARNING, INC., BALTIMORE, MD:
3,805,930, PUB. 4-6-2010. INT. CL. 41.
3,805,931, PUB. 4-6-2010. INT. CL. 41.
3,805,932, PUB. 4-6-2010. INT. CL. 41.
- SYMWAVE, INC., LAGUNA NIGUEL, CA:
3,805,596, PUB. 4-6-2010. INT. CL. 9.
- SYNCEVOLUTION; (SOCIÉTÉ À RESPONSABILITÉ LIMITÉE), FRANCE:
3,807,174, PUB. 4-6-2010. MULTIPLE CLASS, INT. CLS. 9 AND 42.
- SYNDICATE SALES, INC., KOKOMO, IN, LANCASTER COLONY CORPORATION, COLUMBUS, OH:
1,576,402, REN. 5-18-10. INT. CL. 20.
- SYNERGY TECHNOLOGIES, INC., SHREVEPORT, LA:
3,806,369, PUB. 4-6-2010. INT. CL. 5.
- SYNERGY USA, LLC., MIAMI, FL:
3,807,753, INT. CL. 10.
3,807,760, INT. CL. 11.
- SYNOVUS TRUST CORP., BIRMINGHAM, AL:
2,336,176, REN. 5-18-10. INT. CL. 36.
- SYRACUSES' PIZZA PLANT INC., WILLIAMSVILLE, NY:
1,560,052, CANC. INT. CL. 30.
- SYSTEM IMPROVEMENTS, INC., KNOXVILLE, TN:
2,349,842, REN. 5-18-10. INT. CL. 9.
2,349,843, REN. 5-20-10. INT. CL. 41.
- SYSTEMS, INC., GERMANTOWN, WI:
2,286,203, CANC. INT. CL. 19.
- T. D. WILLIAMSON, INC., TULSA, OK:
890,766, REN. 5-19-10. MULTIPLE CLASS, U.S. CLS. 13 (INT. CLS. 6 AND 17) AND 23 (INT. CL. 7).
- T. EDWARD WINES LTD., NEW YORK, NY:
3,807,879, INT. CL. 33.
3,807,880, INT. CL. 33.
3,807,881, INT. CL. 33.
- T.E.I. INTERNATIONAL, INC., CUYAHOGA FALLS, OH:
2,771,738, CANC. INT. CL. 37.
- T.F.H. PUBLICATIONS, INC., NEPTUNE CITY, NJ:
3,807,928, MULTIPLE CLASS, INT. CLS. 28 AND 31.
- T.W. GARNER FOOD COMPANY, WINSTON-SALEM, NC:
2,297,498, REN. 5-18-10. INT. CL. 30.

T.Y.C. BROTHER INDUSTRIAL CO., LTD., TAINAN, TAIWAN:
2,391,064. REN. 5-19-10. MULTIPLE CLASS, INT. CLS. 7, 11 AND 12.

T.Y.C. BROTHER INDUSTRIAL CO., LTD., TAINAN, TAIWAN, CHINA:
2,391,071. REN. 5-19-10. MULTIPLE CLASS, INT. CLS. 7, 11 AND 12.

T-REX TRUCK PRODUCTS INC., CORONA, CA, AKA T-REX GRILLES:
3,806,150, PUB. 4-6-2010. INT. CL. 12.

T-SHIRT HELL INC., LAS VEGAS, NV:
2,772,249, CANC. INT. CL. 35.

TABUE TECHNOLOGY, LP, HUNTINGTON BEACH, CA:
3,808,556, INT. CL. 25.

TACO ENTERPRISES, INC., ARCADIA, CA:
3,806,590, PUB. 4-6-2010. INT. CL. 43.

TACONY CORPORATION, FENTON, MO:
2,349,901. REN. 5-18-10. INT. CL. 11.

TADA! CATERING, LLC, LOS ANGELES, CA:
3,806,927, PUB. 4-6-2010. INT. CL. 43.

TAILS & COMPANY, LLC, CHICAGO, IL:
3,807,626, INT. CL. 35.

TAILWAGGERS PET RESORT, LLC, RALEIGH, NC:
3,807,597, MULTIPLE CLASS, INT. CLS. 35, 41, 43 AND 44.

TAKAHASHI RENSEN CO. LTD., KYOTO, JAPAN:
3,806,365, PUB. 4-6-2010. INT. CL. 18.

TAKE TWO MARKETING AND EVENTS PTY. LTD., CLOVELLY, NSW, AUSTRALIA:
3,807,997, INT. CL. 7.

TAKEDA PHARMACEUTICAL COMPANY LIMITED, CHUO-KU, OSAKA, JAPAN:
3,713,994, COR. INT. CL. 5.
3,745,839, COR. INT. CL. 5.
3,779,971, COR. INT. CL. 5.

TAKEDA PHARMACEUTICAL COMPANY LIMITED, JAPAN:
3,807,333, PUB. 4-6-2010. INT. CL. 5.

TAKEDA PHARMACEUTICAL COMPANY LIMITED, CHUO-KU., OSAKA-SHI, OSAKA 540-8645, JAPAN:
3,807,334, PUB. 4-6-2010. INT. CL. 5.
3,807,342, PUB. 4-6-2010. INT. CL. 5.
3,807,343, PUB. 4-6-2010. INT. CL. 5.
3,807,344, PUB. 4-6-2010. INT. CL. 5.
3,807,345, PUB. 4-6-2010. INT. CL. 5.

TAKEFIVE DIETARY SUPPLEMENTS, LLC, SEATTLE, WA, DBA TAKEFIVE, LLC:
3,807,990, INT. CL. 5.

TALAMO, TANIA ALESSANDRA, WHITESTONE, NY:
3,808,600, INT. CL. 25.

TALENT INVESTMENTS, INC., LISLE, IL:
2,772,273, CANC. INT. CL. 35.

TALENTSOFT, FRANCE:
3,807,155, PUB. 12-29-2009. MULTIPLE CLASS, INT. CLS. 9, 35 AND 42.

TALPA CONTENT BV, LAREN, NETHERLANDS:
3,805,333, PUB. 4-6-2010. INT. CL. 41.

TALSABELL S.A.U., XIRIVELLA (VALENCIA), SPAIN:
3,806,511, PUB. 4-6-2010. INT. CL. 7.

TAMALEWOOD, LLC, SANTA FE, NM:
3,805,262, PUB. 4-6-2010. INT. CL. 25.

TAMARACK HABILITATION TECHNOLOGIES, INC., BLAINE, MN:
3,805,266, PUB. 4-6-2010. INT. CL. 10.
3,805,267, PUB. 4-6-2010. INT. CL. 10.

TANDBERG TELECOM AS, NORWAY:
3,807,207, PUB. 4-6-2010. MULTIPLE CLASS, INT. CLS. 9 AND 38.

TANDENT VISION SCIENCE, INC., SAN FRANCISCO, CA:
3,808,612, MULTIPLE CLASS, INT. CLS. 9, 35 AND 42.

TANGENT MEDIA, LLC, ATLANTA, GA:
3,806,393, PUB. 4-6-2010. INT. CL. 35.

TAO LONGEVITY LLC, RENO, NV:
2,382,967. REN. 5-18-10. INT. CL. 3.

TARGET BRANDS, INC., MINNEAPOLIS, MN:
2,771,806, CANC. INT. CL. 35.

TARGUS GROUP INTERNATIONAL, INC., ANAHEIM, CA:
2,349,241. REN. 5-19-10. INT. CL. 9.

TASKSTREAM, LLC, NEW YORK, NY:
3,806,961, PUB. 4-6-2010. INT. CL. 42.
3,806,962, PUB. 4-6-2010. INT. CL. 42.

TASTY BITES OF WISCONSIN, LLC, APPLETON, WI:
3,808,675, INT. CL. 30.

TASTYFOOD INDUSTRIES (S) PTE LTD, SINGAPORE, SINGAPORE:
3,806,324, PUB. 4-6-2010. INT. CL. 30.

TATTOO VANISH, INC., LAS VEGAS, NV:
3,806,058, PUB. 4-6-2010. INT. CL. 44.

TAUNTON CIDER PLC, TAUNTON SOMERSET TA2 6RD, ENGLAND:
1,560,094, CANC. INT. CL. 33.

TAURUS INTERNATIONAL MANUFACTURING, INC., MIAMI, FL:
2,771,810, CANC. INT. CL. 35.

TAXHAWK, INC., PROVO, UT, FORMERLY MY1040EZ-COM, INC.:
3,805,695, PUB. 4-6-2010. INT. CL. 42.
3,805,696, PUB. 4-6-2010. INT. CL. 42.

TAYCOR, L.L.C., LOS ANGELES, CA:
3,805,449, PUB. 4-6-2010. MULTIPLE CLASS, INT. CLS. 38, 42 AND 44.

TAYLOR DESIGN GROUP, INC., DALLAS, TX:
1,615,455. REN. 5-17-10. INT. CL. 8.

TB PROPRIETARY CORP., WILMINGTON, DE:
2,884,365, CANC. INT. CL. 37.

TBC BRANDS, LLC., RENO, NV:
2,771,402, CANC. INT. CL. 12.

TC OF YUMA, LLC, YUMA, AZ:
3,805,912, PUB. 3-2-2010. INT. CL. 29.

TD AMERITRADE IP COMPANY, INC., OMAHA, NE AND THE TORONTO-DOMINION BANK, TORONTO, ONTARIO, CANADA:
3,808,580, MULTIPLE CLASS, INT. CLS. 9, 16, 35, 36 AND 41.
3,808,588, MULTIPLE CLASS, INT. CLS. 9, 16, 35, 36 AND 41.

TEAM CONTINUUM, NEW YORK, NY:
3,805,615, PUB. 4-6-2010. INT. CL. 36.
3,805,647, PUB. 4-6-2010. INT. CL. 36.

TEAM HEALTH, INC., KNOXVILLE, TN:
3,805,651, PUB. 4-6-2010. INT. CL. 35.

TEAM 2 LEARN, INC., DACULA, GA:
3,807,711, INT. CL. 41.

TEAMWORK MEDIA S.R.L., VIA SICILIA 22/A, ITALY:
2,772,088, CANC. INT. CL. 16.

TECH M3, INC., ESCONDIDO, CA:
3,808,662, INT. CL. 12.

TECHNIC, INC., PROVIDENCE, RI:
1,559,472, CANC. INT. CL. 1.

TECHNOLOGIES COFFEA INC., QUEBEC (QUEBEC), CANADA:
3,808,637, MULTIPLE CLASS, INT. CLS. 11 AND 40.

TECHNOLOGY EDUCATION & COMMUNICATION INSTITUTE, BETHESDA, MD:
2,772,278, CANC. INT. CL. 41.

TECHNOLOGY ENGINEERS, INC., BATON ROUGE, LA:
2,772,740, CANC. INT. CL. 42.

TECHNOLOGY SOLUTIONS, INC., WATERLOO, IN:
3,808,015, INT. CL. 42.

TECHSOLVE, INC., CINCINNATI, OH:
3,806,450, PUB. 4-6-2010. INT. CL. 35.
3,806,457, PUB. 4-6-2010. INT. CL. 35.

TECHSONIC INDUSTRIES, INC., LAKE EUFALUA, AL:
1,559,669, CANC. INT. CL. 9.

TEE AND TEE CLOTHING, LLC, MURRIETA, CA:
3,805,644, PUB. 4-6-2010. INT. CL. 25.

TEGRANT DIVERSIFIED BRANDS, INC., ARLINGTON HEIGHTS, IL:
3,805,572, PUB. 4-6-2010. MULTIPLE CLASS, INT. CLS. 11 AND 21.

TEKNOR APEX COMPANY, PAWTUCKET, RI:
2,379,549. REN. 5-19-10. INT. CL. 17.
2,381,944. REN. 5-18-10. INT. CL. 17.

- TEKNOROT OTOMOTIV ÜRÜNLERİ; SANAYİ VE TİCAR-
ET A.S., TURKEY:
3,807,123, PUB. 4-6-2010. INT. CL. 12.
- TELADATA LLC, FREMONT, CA:
3,806,354, PUB. 4-6-2010. INT. CL. 41.
- TELALASKA, INC., ANCHORAGE, AK:
2,445,630. REN. 5-18-10. INT. CL. 38.
- TELAURUS COMMUNICATIONS LLC, CEDAR KNOLLS,
NJ:
3,808,200, INT. CL. 9.
- TELEBRANDS CORP., FAIRFIELD, NJ:
3,808,005, INT. CL. 8.
- TELECO, INC., GREENVILLE, SC:
2,771,064, CANC. INT. CL. 9.
- TELEFLEX INCORPORATED, LIMERICK, PA:
3,807,486, INT. CL. 10.
- TELEFLEX MEDICAL INCORPORATED, LIMERICK, PA:
1,559,682, CANC. INT. CL. 10.
- TELEGLOBE COMMUNICATIONS CORPORATION, RE-
STON, VA:
2,770,515, CANC. INT. CL. 38.
- TELEGRAPH PUBLISHING COMPANY, HUDSON, NH:
2,376,268, CANC. INT. CL. 16.
- TELEMATCH, INC., SPRINGFIELD, VA:
1,641,510. REN. 5-17-10. INT. CL. 35.
- TELEONE, INC., CHESTERFIELD, MO:
3,805,482, PUB. 4-6-2010. MULTIPLE CLASS, INT. CLS. 9,
35, 37, 38 AND 42.
- TELESCOPIC LLC, PALMDALE, CA:
3,395,555, CANC. INT. CL. 7.
- TELEVATOR CORPORATION, SAN DEIGO, CA:
2,772,029, CANC. MULTIPLE CLASS, INT. CLS. 9 AND
37.
- TELOS CORPORATION, ASHBURN, VA:
3,805,525, PUB. 4-6-2010. INT. CL. 42.
- TELUS CORPORATION, EDMONTON, ALBERTA, CANA-
DA:
2,770,521, CANC. MULTIPLE CLASS, INT. CLS. 9 AND
42.
- TELVENT DTN, INC., OMAHA, NE:
3,806,286, PUB. 4-6-2010. INT. CL. 9.
- TEMPLE CAVE JEWELRY, LOMPOC, CA:
3,807,583, INT. CL. 14.
- TENNANT COMPANY, MINNEAPOLIS, MN:
3,806,874, PUB. 4-6-2010. INT. CL. 3.
- TENNIS PROPERTIES B.V., AMSTERDAM, NETHER-
LANDS:
2,770,601, CANC. MULTIPLE CLASS, INT. CLS. 9, 18, 25
AND 28.
- TENNISON, DEONTAE, ARLINGTON, TX:
3,805,491, PUB. 4-6-2010. INT. CL. 41.
- TEORE, LISA C, DENVER, CO, DBA LCT ENTERPRISES,
LLC:
3,806,712, PUB. 4-6-2010. INT. CL. 28.
- TEQUILA JORONGO TRADERS LLC, SAN LEANDRO, CA:
3,805,952, PUB. 4-6-2010. INT. CL. 33.
- TEREX CORPORATION, WESTPORT, CT:
2,772,043, CANC. INT. CL. 35.
- TERMINUS DESIGN, INC, ELLENWOOD, GA:
2,771,766, CANC. INT. CL. 35.
- TERRA COTTA GARDENS, INC., LAS VEGAS, NV:
3,808,363, INT. CL. 16.
- TERRAMATER S.A., PROVIDENCIA SANTIAGO, CHILE:
2,348,965. REN. 5-17-10. INT. CL. 33.
- TERRANSOFT, INC., ENCINO, CA:
3,805,436, PUB. 4-6-2010. INT. CL. 35.
3,805,437, PUB. 4-6-2010. INT. CL. 35.
- TERREMARK TRADEMARK HOLDINGS, INC., MIAMI,
FL:
3,805,189, PUB. 4-6-2010. MULTIPLE CLASS, INT. CLS.
38, 39, 42 AND 45.
- TERUMO KABUSHIKI KAISHA, SHIBUYA-KU, TOKYO,
JAPAN, AKA TERUMO CORPORATION:
3,807,811, INT. CL. 10.
- TESSCO COMMUNICATIONS INCORPORATED, HUNT
VALLEY, MD:
3,807,453, INT. CL. 35.
- TEST LABORATORIES, INC., RESEDA, CA:
2,770,934, CANC. INT. CL. 5.
- TESTPREP.COM, LLC, NEW YORK, NY:
2,771,020, CANC. MULTIPLE CLASS, INT. CLS. 9 AND
16.
- TESTRUT SERVICE GMBH, 16766 KREMMEN, FED REP
GERMANY:
3,807,104, PUB. 4-6-2010. MULTIPLE CLASS, INT. CLS. 6,
7, 8, 11, 12, 17, 18, 19, 20, 21, 22, 24, 26, 27 AND 31.
- TEXAS CHRISTIAN UNIVERSITY, FORT WORTH, TX:
2,391,437. REN. 5-20-10. INT. CL. 41.
- TEXAS HEALTH RESOURCES, ARLINGTON, TX:
3,805,174, PUB. 4-6-2010. INT. CL. 44.
3,807,391, INT. CL. 9.
- TEXAS HEALTHCARE & BIOSCIENCE INSTITUTE, AUS-
TIN, TX AND CAPITAL NETWORK INC., THE, AUSTIN,
TX:
2,771,859, CANC. INT. CL. 41.
- TEXAS SCENIC COMPANY, INC., SAN ANTONIO, TX:
3,807,577, INT. CL. 9.
- TEXDOT AB, S-431 53 MOLNDAL, SWEDEN:
2,771,528, CANC. INT. CL. 2.
- TEXTRON INNOVATIONS INC., PROVIDENCE, RI:
2,772,311, CANC. INT. CL. 12.
- TG (U.S.A.) CORPORATION, PERRYVILLE, MO:
1,559,653, CANC. MULTIPLE CLASS, INT. CLS. 9 AND
12.
- THANKSGIVING COFFEE COMPANY, FORT BRAGG, CA:
1,560,060, CANC. INT. CL. 30.
- THE ACT 1 GROUP, INC., TORRANCE, CA:
3,805,145, PUB. 4-6-2010. MULTIPLE CLASS, INT. CLS. 35
AND 42.
- THE AFTER OWLS PEDIATRIC CARE, PC, DUBLIN, GA:
3,806,579, PUB. 4-6-2010. INT. CL. 44.
- THE AMERICAN BICYCLE GROUP, LLC, CHATTANOOGA,
TN, QUINTANA ROO, INC., SANTA ANA, CA:
1,596,274. REN. 5-17-10. INT. CL. 12.
- THE APPAREL SOURCE, INC., OAKLAND, CA:
3,805,764, PUB. 4-6-2010. MULTIPLE CLASS, INT. CLS. 35
AND 40.
- THE ARMORETTES, ATLANTA, GA:
3,806,582, PUB. 4-6-2010. INT. CL. 36.
- THE BANK OF NEW YORK MELLON CORPORATION,
NEW YORK, NY:
3,807,854, INT. CL. 16.
- THE BOK TOWER GARDENS FOUNDATION, INC., LAKE
WALES, FL, DBA BOK TOWER GARDENS:
3,806,618, PUB. 4-6-2010. INT. CL. 41.
- THE BOSTON CONSULTING GROUP, INC., BOSTON, MA:
3,808,779, INT. CL. 35.
- THE BRENNAN GROUP PERFORMANCE IMPROVEME-
NT INCORPORATED, HALIFAX, CANADA:
3,589,951, COR. INT. CL. 35.
- THE BRITISH COMPUTER SOCIETY, SWINDON SN2 1FA,
UNITED KINGDOM:
3,808,663, MULTIPLE CLASS, INT. CLS. 16, 35, 38, 41
AND 42.
- THE BUREAU OF NATIONAL AFFAIRS INC, ARLING-
TON, VA:
699,023. REN. 5-20-10. U.S. CL. 38 (INT. CL. 16).
- THE CARTOON NETWORK, INC., ATLANTA, GA:
3,808,075, INT. CL. 41.
- THE CARTOON NETWORK, LP, LLLP, ATLANTA, GA:
2,771,112, CANC. INT. CL. 20.
- THE CHEESECAKE FACTORY ASSETS CO. LLC, CALABA-
SAS HILLS, CA:
3,806,162, PUB. 4-6-2010. INT. CL. 29.
- THE CHILDREN'S MEMORIAL MEDICAL CENTER, INC.,
CHICAGO, IL:
3,552,055, COR. INT. CL. 35.
- THE CHRISTI HARRIS COMPANIES, INC., DALLAS, TX:
3,806,026, PUB. 4-6-2010. INT. CL. 41.
- THE CITY CHURCH, KIRKLAND, WA:
3,805,438, PUB. 4-6-2010. MULTIPLE CLASS, INT. CLS. 9,
16, 41 AND 45.
- THE CLIMATE GROUP, NEW YORK, NY:
3,806,666, PUB. 4-6-2010. MULTIPLE CLASS, INT. CLS. 35
AND 36.

THE COLMAN GROUP, INC., ELKHORN, WI:
2,286,675, CANC. MULTIPLE CLASS, INT. CLS. 5 AND 21.

THE CONTENT FACTOR, LLC, ATLANTA, GA:
3,806,535, PUB. 4-6-2010. INT. CL. 35.

THE COROMEGA COMPANY, INC., VISTA, CA:
3,808,464, INT. CL. 5.

THE DEI GROUP, INC., MILLERSVILLE, MD:
2,771,372, CANC. INT. CL. 42.

THE DELAWARE ACADEMY OF MEDICINE, INC., WILMINGTON, DE:
2,771,219, CANC. INT. CL. 41.

THE DIME GROUP CORPORATION, NEW YORK, NY:
3,807,473, INT. CL. 11.

THE EHRlich LAW FIRM, P.A., WEST PALM BEACH, FL:
3,696,493, CANC. INT. CL. 45.

THE ERWYN GROUP, MORGANVILLE, NJ:
3,808,157, INT. CL. 3.

THE ESTHETICIANS GARDEN, MIAMI SHORES, FL, DBA TERRA DOLCE SOAP:
3,807,929, INT. CL. 3.

THE EVANGELICAL FREE CHURCH OF AMERICA, MINNEAPOLIS, MN:
3,807,442, INT. CL. 45.

THE EVERCARE COMPANY, ALPHARETTA, GA:
3,808,085, INT. CL. 3.

THE EXECUTIVE DEN MENS HAIRSTYLIST LLC, NEW YORK, NY:
3,807,783, MULTIPLE CLASS, INT. CLS. 40 AND 42.
3,807,786, INT. CL. 10.
3,807,792, MULTIPLE CLASS, INT. CLS. 10, 40 AND 42.

THE FAMILY TRUST U/T/A DATED DECEMBER 8, 1995, HIGHLAND, IL:
3,807,591, INT. CL. 16.

THE FASHIONISTAS, DALLAS, TX:
3,807,810, INT. CL. 41.

THE FLORIDA GOLF SCHOOL, INC., PORT ST, LUCIE, FL, DBA UNITED STATES GOLF TEACHERS FEDERATION:
3,808,762, INT. CL. 41.
3,808,763, INT. CL. 41.

THE GILLETTE COMPANY, BOSTON, MA:
3,808,255, INT. CL. 3.

THE HARBOR OF SANTA BARBARA, INC., SANTA BARBARA, CA:
2,771,530, CANC. INT. CL. 42.

THE HEART EXCHANGE, LLC, BRIARCLIFF MANOR, NY:
3,805,691, PUB. 4-6-2010. INT. CL. 35.
3,805,692, PUB. 4-6-2010. INT. CL. 35.

THE HOUSE ON F STREET, LLC., CLEVELAND, OH:
2,772,765, CANC. MULTIPLE CLASS, INT. CLS. 35 AND 41.

THE INSPIRATIONAL NETWORK, INC., INDIAN LAND, SC:
3,808,533, MULTIPLE CLASS, INT. CLS. 41 AND 45.

THE INSTITUTE FOR REHABILITATION AND RESEARCH FOUNDATION, HOUSTON, TX:
3,805,773, PUB. 4-6-2010. MULTIPLE CLASS, INT. CLS. 41 AND 44.

THE INTERPUBLIC GROUP OF COMPANIES, INC., NEW YORK, NY:
2,770,960, CANC. INT. CL. 35.

THE IONA GROUP, INC., MORTON, IL:
3,805,515, PUB. 4-6-2010. INT. CL. 42.

THE IRVINE COMPANY, NEWPORT BEACH, CA:
2,771,108, CANC. INT. CL. 25.
2,771,109, CANC. INT. CL. 25.

THE JESKE COMPANY, INC., APPLETON, WI:
3,806,446, PUB. 4-6-2010. INT. CL. 35.

THE KERN ORGANIZATION, INC., WOODLAND HILLS, CA:
2,284,981, CANC. INT. CL. 35.

THE KROGER CO. OF MICHIGAN, LIVONIA, MI:
2,869,194, CANC. INT. CL. 35.

THE LARRY SCHWARZ COMPANY, INC., NEW YORK, NY:
3,807,373, MULTIPLE CLASS, INT. CLS. 9, 28 AND 41.

THE LIENSTAR GROUP, LLC, SAN ANTONIO, TX:
3,807,813, INT. CL. 42.
3,807,816, INT. CL. 42.

THE LOCAL CRITIC, INC., ATLANTA, GA:
3,807,926, INT. CL. 45.

THE LOS ANGELES LAKER, INC., EL SEGUNDO, CA:
3,805,583, PUB. 4-6-2010. INT. CL. 41.

THE LUBRIZOL CORPORATION, WICKLIFFE, OH:
2,359,234, REN. 5-20-10. INT. CL. 1.

THE MALNATI ORGANIZATION, INC., NORTHBROOK, IL:
3,808,381, INT. CL. 30.

THE MAN RAY TRUST, HICKSVILLE, NY:
2,771,641, CANC. INT. CL. 43.

THE MANUFACTURERS LIFE INSURANCE COMPANY, TORONTO, ONTARIO, CANADA:
2,771,353, CANC. INT. CL. 36.

THE MAY DEPARTMENT STORES COMPANY, ST. LOUIS, MO:
2,771,084, CANC. INT. CL. 35.

THE MCGRAW-HILL COMPANIES, INC., NEW YORK, NY:
1,596,392, REN. 5-19-10. INT. CL. 16.

THE MEAD CORPORATION, DAYTON, OH:
2,771,222, CANC. INT. CL. 16.

THE MOB, LITTLETON, CO:
3,808,307, INT. CL. 34.

THE MONTEVERDI RESIDENCE CLUB, CINCINNATI, OH:
3,807,770, MULTIPLE CLASS, INT. CLS. 36 AND 37.

THE MOSAIC PROJECT, OAKLAND, CA:
3,805,621, PUB. 4-6-2010. INT. CL. 41.
3,805,622, PUB. 4-6-2010. INT. CL. 41.
3,805,640, PUB. 4-6-2010. INT. CL. 16.
3,805,641, PUB. 4-6-2010. INT. CL. 16.
3,805,643, PUB. 4-6-2010. INT. CL. 25.

THE MRS. FIELDS' BRAND, INC., SALT LAKE CITY, UT:
3,806,710, PUB. 4-6-2010. INT. CL. 30.

THE MUSIC PEOPLE INC., BERLIN, CT:
3,805,234, PUB. 1-13-2009. INT. CL. 15.

THE NASDAQ OMX GROUP, INC., NEW YORK, NY:
3,808,076, INT. CL. 36.

THE NATIONAL UNDERWRITER COMPANY, ERLANGER, KY:
2,771,276, CANC. INT. CL. 41.

THE NAVIGATORS, COLORADO SPRINGS, CO:
3,805,506, PUB. 4-6-2010. INT. CL. 45.

THE NEW YORK HOSPITAL MEDICAL CENTER OF QUEENS, FLUSHING, NY:
3,806,325, PUB. 4-6-2010. INT. CL. 44.

THE NEXT COOL THING, INC., SANDY, UT:
3,807,437, INT. CL. 35.

THE OFFICE CLUB, INC., DELRAY BEACH, FL:
3,805,225, PUB. 4-6-2010. MULTIPLE CLASS, INT. CLS. 35 AND 42.

THE ONE PLANNER, LLC, RICHMOND, VA:
3,808,436, INT. CL. 42.

THE PACE COLLECTIVE, LLC, MADISON, MS:
3,807,747, INT. CL. 25.

THE PAIRS FOUNDATION, INC., WESTON, FL:
3,806,591, PUB. 4-6-2010. INT. CL. 41.

THE PASEOS PROPERTY OWNERS ASSOCIATION, INC., JUPITER, FL:
2,772,418, CANC. INT. CL. 37.

THE PENNY PROTEIN PLAN, LLC, LOS ANGELES, CA:
3,806,348, PUB. 4-6-2010. INT. CL. 30.

THE POLITICAL WINERY, LLC, ROYAL OAK, MI:
3,805,290, PUB. 4-6-2010. INT. CL. 33.
3,805,291, PUB. 4-6-2010. INT. CL. 33.
3,805,292, PUB. 4-6-2010. INT. CL. 33.

THE PRACTICAL EXPERT, LLC, AUGUSTA, ME:
3,808,724, INT. CL. 41.

THE PROCTER & GAMBLE COMPANY, CINCINNATI, OH:
3,806,917, PUB. 4-6-2010. INT. CL. 16.
3,808,152, INT. CL. 16.

THE PUNTA GORDA CHAMBER OF COMMERCE, INC., PUNTA GORDA, FL:
3,806,781, PUB. 4-6-2010. INT. CL. 35.

- THE READING FOUNDATION, KENNEWICK, WA, DBA NATIONAL CHILDREN'S READING FOUNDATION:
3,807,750, MULTIPLE CLASS, INT. CLS. 16 AND 41.
3,807,772, INT. CL. 16.
- THE ROSEN PUBLISHING GROUP INC., NEW YORK, NY:
3,806,506, PUB. 4-6-2010. INT. CL. 16.
- THE SAUL ZAENTZ COMPANY, BERKELEY, CA, DBA TOLKIEN ENTERPRISES:
3,808,587, INT. CL. 16.
- THE SHOKO CHUKIN BANK, LTD., TOKYO 104-0028, JAPAN:
3,805,270, PUB. 4-6-2010. INT. CL. 36.
- THE SINGULARITY INSTITUTE FOR ARTIFICIAL INTELLIGENCE, PALO ALTO, CA:
3,808,732, INT. CL. 41.
- THE SKIN CANCER FOUNDATION, INC., NEW YORK, NY:
3,375,185, COR. MULTIPLE CLASS, INT. CLS. 35, 41 AND 42.
- THE SOURCE VITAMIN COMPANY, INC., FORT LAUDERDALE, FL:
3,805,750, PUB. 4-6-2010. MULTIPLE CLASS, INT. CLS. 5, 35 AND 41.
3,805,751, PUB. 4-6-2010. MULTIPLE CLASS, INT. CLS. 5, 35 AND 41.
- THE ST. JOE COMPANY, JACKSONVILLE, FL:
3,808,190, INT. CL. 43.
- THE STAYWELL COMPANY, LLC, YARDLEY, PA:
3,807,839, INT. CL. 44.
- THE STEPHAN CO., FORT LAUDERDALE, FL:
3,807,404, INT. CL. 9.
- THE SUE WEAVER CAUSE, FLOWER MOUND, TX:
3,805,487, PUB. 4-6-2010. MULTIPLE CLASS, INT. CLS. 35 AND 42.
- THE SWISS COLONY, INC., MONROE, WI:
3,806,068, PUB. 4-6-2010. MULTIPLE CLASS, INT. CLS. 30 AND 35.
- THE TECHNICAL ADVANTAGE, INC., BOONTON, NJ:
3,806,151, PUB. 4-6-2010. INT. CL. 9.
- THE TORONTO-DOMINION BANK, TORONTO, CANADA:
3,805,325, PUB. 4-6-2010. INT. CL. 36.
3,805,442, PUB. 4-6-2010. INT. CL. 36.
3,805,443, PUB. 4-6-2010. INT. CL. 36.
- THE TRANZONIC COMPANIES, HIGHLAND HEIGHTS, OH:
1,559,499, CANC. MULTIPLE CLASS, INT. CLS. 3 AND 16.
- THE TRAVEL CHANNEL, L.L.C., CHEVY CHASE, MD:
3,807,624, MULTIPLE CLASS, INT. CLS. 39 AND 41.
- THE TRIANGLE X RANCH PARTNERSHIP, MOOSE, WY:
3,807,455, INT. CL. 43.
- THE TRUNK CLUB, INC., BEND, OR:
3,805,357, PUB. 4-6-2010. INT. CL. 35.
- THE TRUSTEES OF THE RETAIL PROPERTY TRUST, A MASSACHUSETTS BUSINESS TRUST, THE TRUSTEES COMPRISING MELVIN SIMON, HERBERT SIMON, DAVID SIMON, RICHARD S. SOKOLOV AND STEPHEN E. STERRETT, ALL US CITIZENS, INDIANAPOLIS, IN:
2,771,295, CANC. INT. CL. 36.
- THE TRUSTEES OF THE ROMAN CATHOLIC CHURCH FOR THE ARCHDIOCESE OF SYDNEY, SYDNEY NSW, AUSTRALIA:
3,807,150, PUB. 11-10-2009. MULTIPLE CLASS, INT. CLS. 35, 38, 42 AND 45.
- THE TYLENOL COMPANY, SOMERVILLE, NJ:
3,806,880, PUB. 4-6-2010. INT. CL. 5.
- THE UCAN COMPANY, WOODBRIDGE, CT:
3,806,767, PUB. 4-6-2010. MULTIPLE CLASS, INT. CLS. 5 AND 32.
3,806,769, PUB. 4-6-2010. INT. CL. 32.
- THE VASCULAR DISEASE FOUNDATION, INC., LAKEWOOD, CO:
3,805,461, PUB. 4-6-2010. MULTIPLE CLASS, INT. CLS. 16, 35, 36 AND 41.
3,805,465, PUB. 4-6-2010. MULTIPLE CLASS, INT. CLS. 16, 35, 36 AND 41.
3,805,466, PUB. 4-6-2010. MULTIPLE CLASS, INT. CLS. 16, 35, 36 AND 41.
3,808,672, MULTIPLE CLASS, INT. CLS. 16, 35, 36 AND 41.
- THE VON CORPORATION, BIRMINGHAM, AL:
3,807,689, INT. CL. 9.
- THE W SHOES COMPANY, MIAMI, FL:
3,808,615, INT. CL. 35.
- THE W.H. BROWN YARD CORPORATION, BAY SHORE, NY:
3,805,576, PUB. 4-6-2010. INT. CL. 36.
- THE W.W. HENRY COMPANY, ALIQUIPPA, PA:
2,772,177, CANC. INT. CL. 1.
- THE WASHINGTON WAVE, LLC, HOUSTON, TX, DBA THE WAVE:
3,806,563, PUB. 4-6-2010. INT. CL. 39.
- THE WECK CORPORATION, NEW YORK, NY:
3,807,720, INT. CL. 35.
- THE WELLNESS COMMUNITY OF SOUTHERN CONNECTICUT, BRANFORD, CT:
3,806,898, PUB. 4-6-2010. INT. CL. 36.
- THE WESTERN AND SOUTHERN LIFE INSURANCE COMPANY, CINCINNATI, OH:
3,807,967, INT. CL. 36.
- THE 100 MILE MAN LLC, NEW YORK, NY:
3,808,459, INT. CL. 41.
- THERMO FISHER SCIENTIFIC USA LLC, WALTHAM, MA:
2,772,155, CANC. INT. CL. 9.
- THERMOCAL MINES, LLC, DUBOIS, ID:
3,806,389, PUB. 4-6-2010. INT. CL. 1.
- THERMOCHILL UK, URMSTON / MANCHESTER, UNITED KINGDOM:
3,805,664, PUB. 4-6-2010. INT. CL. 9.
- THERMOGENESIS CORP., RANCHO CORDOVA, CA:
2,296,328, REN. 5-17-10. INT. CL. 10.
- THERMOGRAPHIC MEASUREMENTS LIMITED, BURTON, SOUTH WIRRAL L64 5TA, UNITED KINGDOM:
2,285,483, CANC. INT. CL. 2.
- THF EQUITIES, LP, WESTCHESTER, IL, AUNT JANE FOODS, INC., CROSWELL, MI:
1,597,652, REN. 5-20-10. MULTIPLE CLASS, INT. CLS. 29 AND 30.
- THOMAS & BETTS CORPORATION, WILMINGTON, DE:
2,286,350, CANC. INT. CL. 9.
- THOMAS & SKINNER, INC., INDIANAPOLIS, IN:
1,560,159, CANC. MULTIPLE CLASS, INT. CLS. 37 AND 42.
- THOMAS J. HUMPHREY, TULARE, CA, DBA HUMPHREY BIOTIC SOLUTIONS:
3,808,230, INT. CL. 1.
- THOMAS PUBLISHING COMPANY, NEW YORK, NY:
2,801,897, CANC. INT. CL. 42.
2,807,521, CANC. INT. CL. 35.
3,806,916, PUB. 4-6-2010. INT. CL. 35.
- THOMAS ROTH, LLC, WESTPORT, CT:
2,285,872, CANC. MULTIPLE CLASS, INT. CLS. 20, 24 AND 27.
- THOMAS, LORRIE, SANTA BARBARA, CA:
3,805,368, PUB. 4-6-2010. INT. CL. 35.
- THOMSON REUTERS (MARKETS) LLC, NEW YORK, NY:
3,805,594, PUB. 4-6-2010. INT. CL. 42.
- THOMSON REUTERS (SCIENTIFIC) INC., PHILADELPHIA, PA:
1,151,033, REN. 5-17-10. INT. CL. 16.
3,806,458, PUB. 4-6-2010. INT. CL. 42.
- THOROUGHbred REMEDIES MANUFACTURING LIMITED, NEWBRIDGE, COUNTY KILDARE, IRELAND:
1,600,330, REN. 5-18-10. INT. CL. 5.
- THREE DOGZ, LLC, LIVONIA, MI:
3,806,608, PUB. 4-6-2010. MULTIPLE CLASS, INT. CLS. 18 AND 25.
- THREE MOUNTAIN HOLDING COMPANY LLC, SAN ANTONIO, TX:
3,807,703, MULTIPLE CLASS, INT. CLS. 37, 39 AND 40.
- THREE TABLESPOONS, LLC, NEW YORK, NY:
3,806,363, PUB. 4-6-2010. INT. CL. 30.
- THRUBIT B.V., RIJSWIJK ZUID-HOLLAND, NETHERLANDS:
3,807,524, INT. CL. 42.

THUNDER BAY FASHIONS INC., MONTREAL, QUEBEC, CANADA, AKA LES MODES THUNDER BAY INC.:
3,805,419, PUB. 4-6-2010. INT. CL. 40.

TIANCHENG INTERNATIONAL INC, U.S.A., CITY OF INDUSTRY, CA:
2,770,995, CANC. INT. CL. 5.

TIDEL ENGINEERING, L.P., CARROLLTON, TX, SOUTHLAND CORPORATION, THE, DALLAS, TX:
1,135,046. REN. 5-20-10. INT. CL. 9.

TIGERLINE GOLF LIMITED, RAMSEY, ISLE OF MAN:
2,770,815, CANC. INT. CL. 9.

TIM RYAN ROUILLIER, FRANKLING, TN:
3,808,162, MULTIPLE CLASS, INT. CLS. 21 AND 25.

TIMBERLAND COMPANY, THE, STRATHAM, NH:
1,610,987. REN. 5-19-10. INT. CL. 3.

TIME WARNER ENTERTAINMENT COMPANY, L.P., NEW YORK, NY:
2,771,128, CANC. INT. CL. 25.
2,771,974, CANC. INT. CL. 9.

TIME-OUT, INC., CHARLOTTE, NC AND RLR ASSOCIATES, LTD., NEW YORK, NY:
3,807,380, INT. CL. 25.

TIMEKEEPING SYSTEMS, INC., CLEVELAND, OH:
1,581,248. REN. 5-20-10. INT. CL. 9.

TIMEKEEPING SYSTEMS, INC., SOLON, OH:
2,339,863. REN. 5-20-10. INT. CL. 9.

TIP TOP TIPS SARL, ROLLE, SWITZERLAND:
3,805,349, PUB. 2-2-2010. MULTIPLE CLASS, INT. CLS. 5 AND 10.

TISHCON CORP., WESTBURY, NY:
2,772,322, CANC. INT. CL. 3.

TISSUELINK MEDICAL, INC., DOVER, NH:
2,772,118, CANC. INT. CL. 10.

TJF USA, LLC., MAITLAND, FL:
3,805,968, PUB. 4-6-2010. INT. CL. 43.

TJS DMCC, DEIRA, DUBAI, UNITED ARAB EMIR., FORMERLY THE JEWELLERY STORE DMCC:
3,807,751, INT. CL. 9.

TMW MARKETING COMPANY, INC., FREMONT, CA:
2,772,344, CANC. MULTIPLE CLASS, INT. CLS. 14, 16 AND 25.

TOD'S S.P.A., I-63019 SANT'ELPIDIO A MARE (AP), ITALY:
3,807,213, PUB. 4-6-2010. MULTIPLE CLASS, INT. CLS. 9, 18 AND 25.

TODIA LTD., KWUN TONG, KOWLOON, HONG KONG:
3,806,980, PUB. 4-6-2010. INT. CL. 25.

TOHO KOKI CO., LTD., NARA, 639-11, 07435-2-4172, JAPAN:
2,351,732. REN. 5-18-10. INT. CL. 7.

TOLEDO AREA TELECOMMUNICATIONS SERVICES, INC., TOLEDO, OH:
2,771,977, CANC. INT. CL. 38.

TOM FLEMING, SAN DIEGO, CA:
3,805,637, PUB. 4-6-2010. INT. CL. 11.

TOMMY HILFIGER LICENSING LLC, NEW YORK, NY:
2,286,255, CANC. INT. CL. 42.

TOMY CORPORATION, NEWPORT BEACH, CA:
2,285,162, CANC. INT. CL. 28.

TONY MCMILLIAN, JOHN MASSIE AND HARRY MEANS, JR. PARTNERSHIP, THE, HOUSTON, TX:
2,771,256, CANC. INT. CL. 9.

TOP DIAMONDS INTL., INC., BRENTWOOD, TN:
2,772,268, CANC. INT. CL. 35.

TOP INNOVATIONS, INC., KANSAS CITY, MO:
1,560,282, CANC. INT. CL. 9.

TOP NOTCH TEACHER PRODUCTS, INC., KERRVILLE, TX:
3,805,342, PUB. 4-6-2010. INT. CL. 16.

TOP TOBACCO L.P., GLENVIEW, IL:
3,808,532, INT. CL. 34.

TOP TOBACCO, LP, GLENVIEW, IL:
3,808,517, INT. CL. 34.

TORAY KABUSHIKI KAISHA (TORAY INDUSTRIES, INC.), CHUO-KU, TOKYO, JAPAN:
1,609,141. REN. 5-20-10. INT. CL. 24.
3,805,126, PUB. 4-6-2010. MULTIPLE CLASS, INT. CLS. 18, 22, 23, 24 AND 25.

TORONTO-DOMINION BANK, THE, TORONTO, CANADA:
3,805,860, PUB. 4-6-2010. INT. CL. 36.

TORTI GALLAS AND PARTNERS, INC., SILVER SPRING, MD:
3,808,730, MULTIPLE CLASS, INT. CLS. 37 AND 42.

TOTAL ANESTHESIA SOLUTIONS, LLC, ELLICOTT CITY, MD:
3,805,688, PUB. 4-6-2010. INT. CL. 35.

TOTAL HOTTIE, INC., WEST PALM BEACH, FL:
3,807,625, INT. CL. 30.

TOTAL LIFE COMMUNITY EDUCATIONAL FOUNDATION, INC., SPRINGDALE, AR:
3,806,440, PUB. 4-6-2010. INT. CL. 41.

TOTAL TESTING SOLUTIONS, LLC, COLORADO SPRINGS, CO:
3,807,699, INT. CL. 44.

TOTHETOP LLC, LOCUST GROVE, GA:
3,808,294, INT. CL. 44.

TOUCH ENTERPRISES, LLC, RIVER ROUGE, MI:
3,806,038, PUB. 4-6-2010. INT. CL. 3.

TOWER SERVICES, INC., CHANDLER, AZ:
3,806,742, PUB. 4-6-2010. INT. CL. 37.

TOY STATE INDUSTRIAL LTD., TSTE KOWLOON, HONG KONG:
3,806,617, PUB. 4-6-2010. INT. CL. 28.

TOYNAMI, INC., VAN NUYS, CA:
3,807,636, INT. CL. 28.

TOYO TANSO CO., LTD., NISHIYODOGAWA-KU, OSAKA 555-0011, JAPAN:
2,771,042, CANC. INT. CL. 40.

TOYO TANSO CO., LTD., JAPAN:
3,807,348, PUB. 4-6-2010. MULTIPLE CLASS, INT. CLS. 11 AND 17.

TOYOTA JIDOSHA KABUSHIKI KAISHA, TOYOTA-SHI, AICHI-KEN, JAPAN, TA TOYOTA MOTOR CORPORATION:
3,805,350, PUB. 10-13-2009. MULTIPLE CLASS, INT. CLS. 9 AND 24.

TRACEN TECHNOLOGIES, INC., MANASSAS, VA:
3,806,987, PUB. 4-6-2010. INT. CL. 9.

TRACFONE WIRELESS, INC., MIAMI, FL:
3,808,180, INT. CL. 9.

TRACTMANAGER, INC., CHATTANOOGA, TN:
3,806,571, PUB. 4-6-2010. INT. CL. 35.
3,806,572, PUB. 4-6-2010. INT. CL. 42.

TRACTOR SUPPLY CO. OF TEXAS, LP, BRENTWOOD, TN:
3,806,658, PUB. 4-6-2010. INT. CL. 22.

TRADE PLUS AID, LONDON, UNITED KINGDOM:
3,805,193, PUB. 4-6-2010. MULTIPLE CLASS, INT. CLS. 6, 14, 16, 19, 20, 21, 25 AND 36.

TRAILTIMER CO., COTTAGE GROVE, MN:
2,771,845, CANC. INT. CL. 9.

TRAILWAYS TRANSPORTATION SYSTEM, INC., FAIRFAX, VA:
2,389,239. REN. 5-14-10. U.S. CL. 200.

TRAN, LINDA, CHINO, CA:
3,807,403, INT. CL. 44.

TRANERGY CORPORATION, BENSENVILLE, IL:
3,806,760, PUB. 4-6-2010. INT. CL. 7.

TRANS WORLD NEW YORK, LLC, ALBANY, NY:
2,448,231. REN. 5-17-10. INT. CL. 35.

TRANS WORLD PUBLISHING, INC., ATLANTA, GA:
2,771,841, CANC. INT. CL. 16.

TRANS-LUX CORPORATION, NORWALK, CT:
2,772,331, CANC. MULTIPLE CLASS, INT. CLS. 35, 37 AND 42.

TRANS-PACKERS SERVICES CORP., BROOKLYN, NY:
3,805,762, PUB. 4-6-2010. INT. CL. 39.

TRANSCO, INC., W. COLUMBIA, SC:
2,285,218, CANC. INT. CL. 9.

TRANSCONTINENTAL DIRECT U.S.A. INC., WARMINSTER, PA:
2,772,193, CANC. INT. CL. 42.
2,772,205, CANC. INT. CL. 35.

TRANSFINITY CORPORATION, DALLAS, TX:
2,772,393, CANC. INT. CL. 9.

TRANSITION US, SEBASTOPOL, CA:
3,805,589, PUB. 4-6-2010. INT. CL. 41.
3,805,590, PUB. 4-6-2010. INT. CL. 41.

- TRANSLAGO LTDA., BOGOTÁ, COLOMBIA:
3,808,105, INT. CL. 39.
- TRANSOFT INTERNATIONAL, INC., CARY, NC:
3,807,548, INT. CL. 36.
- TRANSPORTATION INTERMEDIARIES ASSOCIATION,
ALEXANDRIA, VA:
3,805,307, PUB. 4-6-2010. INT. CL. 38.
- TRASHBUSTERS INC., BLAINE, WA:
2,350,836, REN. 5-18-10. INT. CL. 39.
- TREACYFACES, INC., WEST HAVEN, CT:
1,595,284, REN. 5-19-10. MULTIPLE CLASS, INT. CLS. 16
AND 42.
- TREBOR BASSETT LIMITED, UXBRIDGE, MIDDLESEX,
UNITED KINGDOM:
3,808,038, INT. CL. 30.
- TREK 2000 INTERNATIONAL LTD, 508769, SINGAPORE:
3,807,670, INT. CL. 9.
- TRENDGRAPHIX, INC., SACRAMENTO, CA:
3,806,702, PUB. 4-6-2010. INT. CL. 9.
- TRENTON MAKES, LLC, TRENTON, NJ:
3,806,554, PUB. 4-6-2010. INT. CL. 37.
- TRI STATE DISTRIBUTION, INC, SPARTA, TN:
3,805,171, PUB. 4-6-2010. MULTIPLE CLASS, INT. CLS. 9
AND 35.
- TRI-STATE HEALTH CARE COALITION, INC., QUINCY,
IL, DBA TRI-STATE HEALTH CARE COALITION:
3,805,936, PUB. 4-6-2010. U.S. CL. A.
- TRI-STATE LOTTO COMMISSION, SOUTH BARRE, VT:
3,558,027, COR. INT. CL. 41.
3,641,623, COR. INT. CL. 41.
3,641,624, COR. INT. CL. 41.
3,641,625, COR. INT. CL. 41.
- TRIA BEAUTY, INC., PLEASANTON, CA:
3,807,647, INT. CL. 8.
- TRIAL LAWYERS FOR PUBLIC JUSTICE, P.C., WASHING-
TON, DC:
2,284,622, CANC. INT. CL. 42.
- TRIANGLE BRASS MANUFACTURING COMPANY, INC.,
LOS ANGELES, CA:
2,365,805, REN. 5-20-10. INT. CL. 6.
- TRIAx A/S, HORNSLYD, DENMARK:
1,624,559, REN. 5-20-10. INT. CL. 9.
- TRIDENT LABS, INC., HAWTHORNE, CA, DBA TRIDENT
DENTAL LABORATORIES:
3,805,390, PUB. 4-6-2010. INT. CL. 10.
- TRINITY FOODS, INC., ORLAND PARK, IL:
3,805,707, PUB. 4-6-2010. MULTIPLE CLASS, INT. CLS. 30
AND 32.
- TRINQUE, KENNETH C., PROVIDENCE, RI AND CEM-
BROLA, JOSEPH K., PROVIDENCE, RI, DBA ARLEN
CORP.:
2,285,013, CANC. INT. CL. 36.
- TRION INDUSTRIES, INC., WILKES-BARRE, PA:
2,772,203, CANC. INT. CL. 20.
- TRIPLE T TRADING, MARYSVILLE, WA:
2,771,661, CANC. INT. CL. 21.
- TRIRIGA INC., LAS VEGAS, NV:
2,770,823, CANC. INT. CL. 9.
- TRITHOR GMBH, D-53111 BOON, FED REP GERMANY:
2,770,605, CANC. INT. CL. 9.
- TROYER, KATHERINE EMURIAN, RAMSEY, NJ:
3,808,232, INT. CL. 18.
- TRS QUALITY, INC., FORT WORTH, TX:
2,772,717, CANC. INT. CL. 9.
- TRU JEWELLERY, INC., PITTSFORD, NY:
3,806,334, PUB. 4-6-2010. INT. CL. 14.
- TRUE BEANS COFFEE ROASTERS, LONG BEACH, CA:
3,806,396, PUB. 4-6-2010. INT. CL. 30.
- TRUE GAMES INTERACTIVE, INC., IRVINE, CA:
3,808,043, INT. CL. 41.
3,808,044, INT. CL. 9.
- TRUE LABEL, INC., TOLEDO, OH:
3,806,079, PUB. 4-6-2010. INT. CL. 35.
- TRUE ULTIMATE STANDARDS EVERYWHERE, INC., SAN
FRANCISCO, CA:
3,805,545, PUB. 4-6-2010. MULTIPLE CLASS, INT. CLS. 35
AND 45.
- TRUEBEGINNINGS, LLC, IRVING, TX:
3,808,648, INT. CL. 45.
- TRUEHEART GREETINGS, ATLANTA, GA:
2,771,142, CANC. INT. CL. 16.
- TRUST-MART CO., LTD., GUANGZHOU, 510665, CHINA:
2,772,158, CANC. INT. CL. 35.
- TRUSTEE OF THE D. DEAN RHOADS TRUST, THE
TRUSTEE COMPRISING OF D. DEAN RHOADS, A U.S.
CITIZEN, JUPITER, FL:
3,806,288, PUB. 4-6-2010. INT. CL. 16.
- TRUSTEES OF BOSTON UNIVERSITY, BOSTON, MA:
2,421,495, REN. 5-17-10. INT. CL. 16.
- TRUSTWAVE HOLDINGS, INC, CHICAGO, IL:
3,805,569, PUB. 4-6-2010. INT. CL. 42.
- TRX, INC., PORTLAND, OR:
2,770,820, CANC. INT. CL. 35.
- TSA STORES, INC., ENGLEWOOD, CO:
2,771,744, CANC. INT. CL. 35.
3,808,011, INT. CL. 35.
- TT & M MAI'S RESTAURANT, INC., HOUSTON, TX:
3,805,910, PUB. 4-6-2010. INT. CL. 43.
3,805,911, PUB. 4-6-2010. INT. CL. 43.
- TUBIGOMMA DEREGIBUS S.R.L., SACCOLONGO, PADO-
VA, ITALY:
3,805,975, PUB. 4-6-2010. INT. CL. 17.
- TUCKER-ROCKY CORPORATION, INC., WILMINGTON,
DE:
3,805,139, PUB. 4-6-2010. INT. CL. 25.
- TUI AG, FED REP GERMANY:
3,427,072, AM. MULTIPLE CLASS, INT. CLS. 39, 43 AND
44.
- TUPPERWARE PRODUCTS S.A., FRIBOURG CH-1700,
SWITZERLAND:
3,808,272, INT. CL. 3.
- TUPY S.A., BOA VISTA- JOINVILLE, S.C. 89227-901, BRAZIL,
FUNDICAO TUPY S.A., JOINVILLE SC, BRAZIL:
1,135,489, REN. 5-20-10. INT. CL. 6.
- TURBOCHEF TECHNOLOGIES, INC., CARROLLTON, TX:
3,808,570, INT. CL. 11.
- TURKOWITZ, NORMAN S., NEW YORK, NY:
3,808,589, MULTIPLE CLASS, INT. CLS. 3 AND 5.
- TURLEY INTERNATIONAL RESOURCE, L.L.C., MESA, AZ:
3,806,443, PUB. 4-6-2010. INT. CL. 19.
- TURNER, BRIANNE D., COHUTTA, GA AND CHAIVAR-
LIS, NICK, COHUTTA, GA:
3,806,216, PUB. 4-6-2010. MULTIPLE CLASS, INT. CLS. 9
AND 41.
- TURNER, DENNIS, BURBANK, CA, DBA TURNER MAN-
AGEMENT GROUP:
1,560,311, CANC. INT. CL. 35.
- TURNER, STEPHANIE, TEMPLETON, CA:
3,807,533, INT. CL. 25.
- TURNEY, MARK, LYNNWOOD, WA:
3,806,270, PUB. 4-6-2010. INT. CL. 4.
- TURTLE CREEK MANAGEMENT, INC., INDIANAPOLIS,
IN:
891,729, REN. 5-18-10. U.S. CL. 101 (INT. CLS. 35, 36, 38, 41
AND 42).
- TURTLE WAX, INC., CHICAGO, IL:
1,559,503, CANC. INT. CL. 3.
- TUSCAN LEVELING, INC., FAIRFIELD, IA:
3,807,938, INT. CL. 8.
- TUXTON CHINA INC., WALNUT, CA:
3,806,132, PUB. 4-6-2010. INT. CL. 21.
- TV GUIDE MAGAZINE GROUP, INC., LOS ANGELES, CA:
2,285,322, CANC. INT. CL. 41.
- TV ONE, LLC, SILVER SPRING, MD:
3,807,475, INT. CL. 41.
- TVBG LLC, PACIFIC PALISADES, CA:
3,807,559, MULTIPLE CLASS, INT. CLS. 29 AND 30.
- TWEEN, BRENDAN, J, BRONXVILLE, NY:
2,771,723, CANC. INT. CL. 42.
- TWENTY TEN, LLC, CLEVELAND, OH:
3,805,635, PUB. 4-6-2010. INT. CL. 40.
- TWETI, MIRA, PLAYA DEL REY, CA:
3,805,746, PUB. 4-6-2010. INT. CL. 35.
- TWIN COUNTY DORPERS, INC., HARPER, TX:
3,806,404, PUB. 4-6-2010. INT. CL. 29.

TWIN RIVERS GROUP, INC., FAYETTEVILLE, AR:
2,285,247, CANC. INT. CL. 29.

TWJ, INC., OXNARD, CA:
3,806,373, PUB. 4-6-2010. MULTIPLE CLASS, INT. CLS. 41
AND 44.

TWO LITTLE FISHIES, MIAMI, FL:
3,807,617, INT. CL. 21.

TWO NICKELS INCORPORATED, NEW YORK, NY:
3,805,732, PUB. 4-6-2010. INT. CL. 41.

TYCO HEALTHCARE GROUP LP, MANSFIELD, MA:
2,285,044, CANC. INT. CL. 10.

TYCO SAFETY PRODUCTS CANADA LTD., ONTARIO,
CANADA:
3,806,631, PUB. 4-6-2010. INT. CL. 9.

TYCO SAFETY PRODUCTS CANADA, LTD., CONCORD,
ONTARIO, CANADA:
3,807,944, INT. CL. 9.

TYCO VALVES & CONTROLS INC., HOUSTON, TX:
885,294, REN. 5-19-10. U.S. CL. 13 (INT. CL. 6).

TYGRIS COMMERCIAL FINANCE GROUP, INC., PARSIP-
PANY, NJ:
3,805,399, PUB. 4-6-2010. INT. CL. 36.

TYNDALE HOUSE PUBLISHERS, INC., CAROL STREAM,
IL:
2,353,389, REN. 5-20-10. MULTIPLE CLASS, INT. CLS. 9
AND 16.

TYSON FOODS, INC., SPRINGDALE, AR:
3,808,491, INT. CL. 29.

U.B. ELECTRIC INC., BROOKLYN, NY:
3,806,522, PUB. 4-6-2010. INT. CL. 11.

U.S. ENDOSCOPY GROUP, INC., MENTOR, OH:
3,807,895, INT. CL. 10.
3,808,235, INT. CL. 10.

U.S. GAMES SYSTEMS, INC., STAMFORD, CT:
1,644,495, REN. 5-19-10. INT. CL. 28.

U-HAUL INTERNATIONAL, INC., PHOENIX, AZ:
2,362,170, REN. 5-19-10. INT. CL. 39.

U-LINE CORPORATION, MILWAUKEE, WI:
3,806,797, PUB. 4-6-2010. INT. CL. 11.

U-MARQ LTD, MILTON KEYNES, UNITED KINGDOM:
3,805,763, PUB. 4-6-2010. MULTIPLE CLASS, INT. CLS. 7
AND 9.

UBISOFT ENTERTAINMENT, RENNES, FRANCE:
3,808,297, INT. CL. 9.

UBM IP LUXEMBOURG SARL, L-1723 LUXEMBOURG,
LUXEMBOURG:
3,808,692, INT. CL. 9.
3,808,693, INT. CL. 41.

UBS AG, CH-8001 ZURICH, SWITZERLAND:
2,770,716, CANC. MULTIPLE CLASS, INT. CLS. 35, 36
AND 41.

UCT, INC., BRISTOL, PA:
3,808,358, INT. CL. 9.

UHLIG, LLC, OVERLAND PARK, KS:
3,805,257, PUB. 4-6-2010. INT. CL. 16.

UHS OF DELAWARE, INC., KING OF PRUSSIA, PA:
2,772,751, CANC. INT. CL. 44.
3,808,070, INT. CL. 35.

ULEAD SYSTEMS, INC., TAIPEI, TAIWAN:
2,770,763, CANC. INT. CL. 9.

ULLICO, INC., WASHINGTON, DC:
3,806,574, PUB. 4-6-2010. INT. CL. 36.

ULTRA UNLIMITED, WILMINGTON, DE:
3,805,788, PUB. 4-6-2010. INT. CL. 42.

ULTRADENT PRODUCTS, INC., SOUTH JORDAN, UT:
3,808,095, INT. CL. 10.

ULTRINSIC MOTIVATOR INC., FAR ROCKAWAY, NY:
3,805,668, PUB. 4-6-2010. INT. CL. 41.

UMICORE, SOCIÉTÉ ANONYME, BELGIUM:
3,807,364, PUB. 4-6-2010. MULTIPLE CLASS, INT. CLS. 1
AND 3.

UNCLE SAM INTERNATIONAL, TONAWANDA, NY:
3,808,083, INT. CL. 10.

UNDER ARMOUR, INC., BALTIMORE, MD:
3,806,998, PUB. 4-6-2010. INT. CL. 25.

UNDERCOVER AGENTS, LLC, LOS ANGELES, CA:
2,771,283, CANC. INT. CL. 25.

UNDERHEAD LLC, DOBBS FERRY, NY:
3,806,525, PUB. 4-6-2010. INT. CL. 35.

UNEEDA DOLL COMPANY, LTD., NEW YORK, NY:
2,772,320, CANC. INT. CL. 28.
2,772,355, CANC. INT. CL. 28.

UNGAR, IRVIN D., BURLINGAME, CA, DBA HISTORICA-
NA:
2,771,718, CANC. INT. CL. 35.

UNICA CORPORATION, WALTHAM, MA:
2,286,704, CANC. INT. CL. 9.

UNICO, INC., FRANKSVILLE, WI:
2,770,816, CANC. INT. CL. 9.

UNICOMCONNECT, LLC, FREEDOM, WY:
3,808,156, INT. CL. 9.

UNIFIED BRANDS, INC., JACKSON, MS, DOVER COR-
PORATION, ELK GROVE VILLAGE, IL:
891,131, REN. 5-20-10. MULTIPLE CLASS, U.S. CLS. 2
(INT. CL. 6), 23 (INT. CL. 7) AND 34 (INT. CL. 11).

UNIFIED GROCERS, INC., COMMERCE, CA:
2,284,415, CANC. MULTIPLE CLASS, INT. CLS. 9, 35, 37,
41 AND 42.

UNILETE INCORPORATED, HUNTINGTON BEACH, CA:
2,353,847, REN. 5-18-10. INT. CL. 25.

UNILEVER SUPPLY CHAIN, INC., CLINTON, CT:
3,806,934, PUB. 4-6-2010. INT. CL. 30.
3,807,953, INT. CL. 3.
3,807,968, INT. CL. 3.

UNIMERCO FASTENING A/S, DENMARK:
3,807,325, PUB. 4-6-2010. MULTIPLE CLASS, INT. CLS. 6,
7 AND 37.

UNION SQUARE HOSPITALITY GROUP, LLC, NEW YORK,
NY:
3,805,568, PUB. 4-6-2010. INT. CL. 43.
3,807,858, INT. CL. 43.

UNIQUE TECHNOLOGIES, INC., DOWNEY, CA:
2,770,795, CANC. INT. CL. 42.

UNISON TECHNOLOGIES, INC., NEW YORK, NY:
3,805,331, PUB. 4-6-2010. MULTIPLE CLASS, INT. CLS. 9,
38, 39 AND 42.

UNITED AIRCONDITIONING CORP., LONG ISLAND
CITY, NY:
2,771,706, CANC. INT. CL. 37.

UNITED BRETHERN FOR CHRIST, INC, BALTIMORE,
MD:
3,805,172, PUB. 4-6-2010. INT. CL. 45.

UNITED BUSINESS MEDIA LLC, MANHASSET, NY:
3,807,798, INT. CL. 41.

UNITED CUTLERY CORPORATION, THOMASVILLE, GA:
2,771,375, CANC. INT. CL. 8.
2,771,378, CANC. INT. CL. 8.
2,771,380, CANC. INT. CL. 8.
2,771,382, CANC. INT. CL. 8.

UNITED FARMERS OF ALBERTA CO-OPERATIVE LIM-
ITED, CALGARY, ALBERTA, CANADA:
3,805,288, PUB. 12-15-2009. MULTIPLE CLASS, INT. CLS.
6, 11, 19 AND 21.

UNITED SPIRIT BRANDS LIMITED, LONDON, UNITED
KINGDOM:
3,805,477, PUB. 4-6-2010. MULTIPLE CLASS, INT. CLS. 16
AND 33.

UNITED STATES AVIATION UNDERWRITERS, INC., NEW
YORK, NY:
1,147,815, REN. 5-20-10. INT. CL. 36.

UNITED STATES COUNCIL FOR INTERNATIONAL BUSI-
NESS, NEW YORK, NY:
2,338,776, REN. 5-20-10. MULTIPLE CLASS, INT. CLS. 16,
41 AND 42.

UNITED STATES EVENTING ASSOCIATION, LEESBURG,
VA:
3,805,330, PUB. 4-6-2010. MULTIPLE CLASS, INT. CLS. 41
AND 42.

UNITED STATES FOUNDATION FOR INSPIRATION AND
RECOGNITION OF SCIENCE AND TECHNOLOGY,
MANCHESTER, NH:
2,436,090, REN. 5-17-10. INT. CL. 41.

UNITED STATES GYPSUM COMPANY, CHICAGO, IL:
3,808,743, INT. CL. 17.

- UNITED STATES POSTAL SERVICE, WASHINGTON, DC:
3,807,048, PUB. 4-6-2010. INT. CL. 28.
- UNITEDHEALTH GROUP INCORPORATED, MINNETONKA, MN:
3,807,511, MULTIPLE CLASS, INT. CLS. 9, 36 AND 42.
- UNITRACT SYRINGE PTY LTD, AUSTRALIA:
3,807,346, PUB. 4-6-2010. INT. CL. 10.
3,807,347, PUB. 4-6-2010. INT. CL. 10.
- UNIVERSAL COMMUNICATIONS NETWORK, INC., NEW YORK, NY, DBA NEW TANG DYNASTY TELEVISION:
3,805,222, PUB. 4-6-2010. INT. CL. 38.
- UNIVERSAL HOLDINGS I, LLC, SANTA MONICA, CA:
2,430,636. REN. 5-18-10. INT. CL. 5.
- UNIVERSAL PRODUCTORA, S.A. DE C.V., MÉXICO, D.F., MEXICO:
3,805,328, PUB. 4-6-2010. MULTIPLE CLASS, INT. CLS. 1 AND 5.
- UNIVERSITY OF CHICAGO, THE, CHICAGO, IL:
2,285,279, CANC. INT. CL. 16.
2,770,609, CANC. INT. CL. 9.
- UNIVERSITY OF NEW HAMPSHIRE, DURHAM, NH:
3,805,704, PUB. 4-6-2010. INT. CL. 31.
- UNIVERSITY OF NORTHERN IOWA, CEDAR FALLS, IA:
3,805,271, PUB. 4-6-2010. INT. CL. 25.
- UNIVERSITY OF NORTHERN IOWA FOUNDATION, THE, CEDAR FALLS, IA:
2,285,684, CANC. INT. CL. 7.
- UNIVERSITY OF ST. THOMAS, MINNEAPOLIS, MN:
2,772,746, CANC. INT. CL. 41.
- UNIWELD PRODUCTS, INC., FORT LAUDERDALE, FL:
2,439,790. REN. 5-17-10. INT. CL. 9.
- UNVERFERTH MANUFACTURING CO., INC., KALIDA, OH:
3,807,454, MULTIPLE CLASS, INT. CLS. 7 AND 12.
- UPLANDERS WAREHOUSE LLC, BOZEMAN, MT, DBA UPLANDERS WAREHOUSE:
3,806,076, PUB. 4-6-2010. INT. CL. 35.
- UPPER CANADA SOAP & CANDLE MAKERS CORPORATION, MISSISSAUGA, CANADA:
2,353,096. REN. 5-17-10. INT. CL. 3.
- UPPER DECK COMPANY, LLC, THE, CARLSBAD, CA:
2,772,326, CANC. INT. CL. 20.
- URBANESQUE, L.L.C., ORLANDO, FL:
2,771,073, CANC. MULTIPLE CLASS, INT. CLS. 9, 35 AND 41.
- URCULLU SALINAS, ÁNGEL, VILLA NUEVO PROGRESO, MEXICO:
3,805,778, PUB. 4-6-2010. INT. CL. 33.
- US AIRWAYS, INC., TEMPE, AZ:
2,354,120. REN. 5-15-10. INT. CL. 42.
- US INVESTIGATIONS SERVICES, LLC, FALLS CHURCH, VA:
2,771,912, CANC. INT. CL. 42.
- USA DANCE, INC., JACKSONVILLE, OR, AKA USA DANCE:
2,284,382, CANC. INT. CL. 41.
- USA MANAGED CARE ORGANIZATION, INC., PHOENIX, AZ:
2,284,944, CANC. INT. CL. 36.
3,806,260, PUB. 4-6-2010. INT. CL. 44.
- USA TECHNOLOGIES, INC., WAYNE, PA:
2,772,454, CANC. INT. CL. 9.
- USPLY TRADING COMPANY, POMPANO BEACH, FL:
3,806,966, PUB. 4-6-2010. INT. CL. 19.
- UTAH ASSOCIATED MUNICIPAL POWER SYSTEMS, SALT LAKE CITY, UT:
3,807,385, MULTIPLE CLASS, INT. CLS. 35, 36 AND 40.
- V M C PECHE, FRANCE:
3,807,294, PUB. 4-6-2010. INT. CL. 28.
- VACATION MOUSE, INC., NEWPORT, RI:
3,807,982, INT. CL. 43.
- VAISHALI DIAMOND CORPORATION, NEW YORK, NY:
3,805,806, PUB. 4-6-2010. INT. CL. 14.
- VALANGIMAN SESHAGIRI, SAN FRANCISCO, CA:
3,806,690, PUB. 4-6-2010. MULTIPLE CLASS, INT. CLS. 35 AND 42.
- VALCO INSTRUMENTS CO., INC., HOUSTON, TX:
3,806,285, PUB. 4-6-2010. INT. CL. 9.
- VALENTIN BIANCHI S.A.C.I.F., PROVINCE OF MENDOZA, ARGENTINA:
2,358,028. REN. 5-17-10. INT. CL. 33.
- VALIO LTD, FINLAND:
3,807,295, PUB. 4-6-2010. MULTIPLE CLASS, INT. CLS. 5, 29 AND 32.
- VALITA VENTURES CORPORATION, ALISO VIEJO, CA:
2,772,490, CANC. INT. CL. 25.
- VALPES, FRANCE:
3,807,264, PUB. 4-6-2010. MULTIPLE CLASS, INT. CLS. 6, 7, 9 AND 20.
- VALSPAR CORPORATION, THE, MINNEAPOLIS, MN:
2,352,571. REN. 5-17-10. INT. CL. 2.
- VALSPAR SOURCING, INC., MINNEAPOLIS, MN:
3,806,936, PUB. 4-6-2010. INT. CL. 2.
- VALSTAR S.P.A., ITALY:
3,807,242, PUB. 4-6-2010. INT. CL. 25.
- VALTERRA PRODUCTS, INC., A CALIFORNIA CORPORATION, MISSION HILLS, CA:
1,560,287, CANC. INT. CL. 12.
- VALUE ADDED SCIENCE & TECHNOLOGIES, LLC, MAISON CITY, IA:
3,805,475, PUB. 4-6-2010. MULTIPLE CLASS, INT. CLS. 5, 31 AND 44.
- VALUEVISION MEDIA, INC., EDEN PRAIRIE, MN:
3,806,942, PUB. 4-6-2010. INT. CL. 14.
- VAN STONE CONVEYOR INC., SAN DIMAS, CA:
3,806,098, PUB. 4-6-2010. INT. CL. 7.
- VANCE PUBLISHING CORPORATION, LINCOLNSHIRE, IL:
3,805,894, PUB. 4-6-2010. INT. CL. 35.
- VANCEINFO TECHNOLOGIES INC., GEORGE TOWN, CAYMAN ISLANDS:
3,807,500, INT. CL. 38.
3,807,501, INT. CL. 39.
- VANDENBORRE TECHNOLOGIES N.V., TURNHOUT, BELGIUM:
2,771,619, CANC. MULTIPLE CLASS, INT. CLS. 7 AND 11.
- VANDIA CORPORATION, FORT LAUDERDALE, FL:
2,772,186, CANC. INT. CL. 18.
- VANGARD INTERNATIONAL, NEPTUNE, NJ:
1,594,924. REN. 5-17-10. INT. CL. 9.
- VANITY FAIR, INC., BOWLING GREEN, KY:
2,772,064, CANC. INT. CL. 25.
2,772,630, CANC. INT. CL. 25.
2,772,672, CANC. INT. CL. 25.
- VANTREO INSURANCE BROKERAGE, SANTA ROSA, CA:
3,806,219, PUB. 4-6-2010. INT. CL. 35.
- VARDAMAN, PASADENA, TX:
3,806,895, PUB. 4-6-2010. INT. CL. 42.
3,808,776, INT. CL. 9.
- VARIFORM, INC., KANSAS CITY, MO:
3,805,712, PUB. 4-6-2010. INT. CL. 19.
- VASCULAR BIOGENICS LTD., 60376 OR YEHUDA, ISRAEL:
3,805,239, PUB. 4-6-2010. INT. CL. 42.
- VASCULAR BIOGENICS LTD., OR YEHUDA, ISRAEL:
3,805,245, PUB. 4-6-2010. INT. CL. 42.
- VASQUEZ, PABLITO, LOS ANGELES, CA:
3,808,623, INT. CL. 9.
- VAUCHER MANUFACTURE FLEURIER S.A., SWITZERLAND:
3,807,335, PUB. 4-6-2010. INT. CL. 14.
- VAUGHAN & BUSHNELL MFG. CO., HEBRON, IL:
895,466. REN. 5-20-10. U.S. CL. 23 (INT. CL. 8).
- VCAMPUT CORPORATION, RESTON, VA:
2,286,053, CANC. MULTIPLE CLASS, INT. CLS. 9, 16, 35, 41 AND 42.
- VEDANT INCORPORATED, NEWBURYPORT, MA:
3,806,692, PUB. 4-6-2010. INT. CL. 9.
- VEDANTE CORP, BOULDER, CO:
3,805,814, PUB. 4-6-2010. MULTIPLE CLASS, INT. CLS. 18 AND 25.
- VEE GEE SCIENTIFIC, INC., KIRKLAND, WA:
2,771,885, CANC. INT. CL. 35.
- VEHICLE INSPECTION SYSTEMS INC., LOUISVILLE, KY:
2,771,881, CANC. INT. CL. 35.

VEHICLE TRACKING SOLUTIONS, LLC, DEER PARK, NY:
3,807,759, INT. CL. 9.

VELA J-26, S.A. DE C.V., DISTRITO FEDERAL, MEXICO:
2,771,963, CANC. INT. CL. 33.

VELBON TRIPOD CO., LTD., TOKYO 160, JAPAN, VELBON
INTERNATIONAL CORPORATION, TORRANCE, CA:
1,600,583, REN. 5-19-10. INT. CL. 9.

VELLINO, JEAN JACQUES, BARCELONA, SPAIN:
3,806,176, PUB. 4-6-2010. INT. CL. 3.

VELOCITUDE, LLC, FORT LAUDERDALE, FL:
3,806,938, PUB. 4-6-2010. INT. CL. 42.

VELODYNE ACOUSTICS INC., SACRAMENTO, CA:
3,808,125, INT. CL. 9.

VELODYNE ACOUSTICS, INC., SACRAMENTO, CA:
3,808,213, INT. CL. 9.

VELOWIPES, INC., VIENNA, VA:
3,807,781, INT. CL. 3.

VERANDAGLOBAL.COM, INC., CLEARWATER, FL, DBA
FIRST PLACE INTERNET, INC.:
3,805,811, PUB. 4-6-2010. INT. CL. 36.

VERDOLINI, MICHAEL D., MERIDEN, CT:
3,805,483, PUB. 4-6-2010. INT. CL. 37.

VERICHIPO CORPORATION, DELRAY BEACH, FL:
2,772,634, CANC. INT. CL. 9.

VERICLEAN JANITORIAL SERVICES LLC, SAN ANTONIO,
TX, DBA VERICLEAN SERVICES:
3,805,708, PUB. 4-6-2010. INT. CL. 37.

VERISK HEALTH, INC., BOSTON, MA:
3,805,870, PUB. 4-6-2010. MULTIPLE CLASS, INT. CLS. 35
AND 36.
3,808,445, INT. CL. 42.

VERISYS REGISTRARS LLC, BROOKFIELD, WI:
3,807,466, MULTIPLE CLASS, INT. CLS. 35 AND 42.

VERITRUST FINANCIAL, L.L.C., AUSTIN, TX:
2,772,296, CANC. INT. CL. 36.

VERIZON COMMUNICATIONS INC., ARLINGTON, VA:
1,565,563, REN. 5-20-10. MULTIPLE CLASS, INT. CLS. 16,
35 AND 38.
1,565,563, CANC. MULTIPLE CLASS, INT. CLS. 9 AND
41.

VERRERIE CRISTALLERIE D'ARQUES, J.G. DURAND ET
CIE, 62510, ARQUES, FRANCE:
2,284,547, CANC. INT. CL. 21.

VERRERIE CRISTALLERIE D'ARQUES, J.G. DURAND ET
CIE, 62510, ARQUES, FRANCE:
2,284,550, CANC. INT. CL. 21.

VERSO PAPER CORP., MEMPHIS, TN:
3,805,164, PUB. 4-6-2010. INT. CL. 16.

VERTICAL COMMUNICATIONS, INC., CAMBRIDGE, MA:
2,286,294, CANC. INT. CL. 9.

VERYFINE PRODUCTS, INC., CINCINNATI, OH:
3,808,141, INT. CL. 32.

VESCENT LABS INC., OJAI, CA:
3,806,517, PUB. 4-6-2010. INT. CL. 5.

VETERINARY INFORMATION NETWORK, INC., DAVIS,
CA:
2,349,486, REN. 5-19-10. MULTIPLE CLASS, INT. CLS. 41
AND 42.

VETTOR CORPORATION OF AMERICA, POMPANO
BEACH, FL:
3,805,660, PUB. 4-6-2010. INT. CL. 35.

VHS ACQUISITION SUBSIDIARY NUMBER 9, INC., NASH-
VILLE, TN, TENET METROWEST HEALTHCARE SYS-
TEM, FRAMINGHAM, MA:
2,351,242, REN. 5-18-10. MULTIPLE CLASS, INT. CLS. 41
AND 42.

VIACOM INTERNATIONAL INC., NEW YORK, NY:
2,284,887, CANC. INT. CL. 16.
2,285,219, CANC. INT. CL. 9.
2,772,583, CANC. INT. CL. 16.

VIAGEN, INC., AUSTIN, TX:
3,808,593, MULTIPLE CLASS, INT. CLS. 31 AND 44.

VIANDER S.P.A., ITALY:
3,807,205, PUB. 4-6-2010. INT. CL. 29.

VIATRACK SYSTEMS, LLC, AUGUSTA, GA:
3,807,443, INT. CL. 9.

VICTA, ALESSANDRO K., WEST PALM BEACH, FL:
3,805,700, PUB. 4-6-2010. MULTIPLE CLASS, INT. CLS. 16
AND 25.

VICTIM RESPONSE, INC., MIAMI, FL:
3,805,512, PUB. 4-6-2010. INT. CL. 41.

VICTOR COMPANY OF JAPAN, KANAGAWA-KU, YOKO-
HAMA-CITY, JAPAN:
2,772,098, CANC. INT. CL. 9.

VICTOR EQUIPMENT COMPANY, ST. LOUIS, MO:
2,771,056, CANC. MULTIPLE CLASS, INT. CLS. 7 AND
11.

VICTOR, HUGH, HUNTINGTON WOODS, MI:
3,759,350, COR. INT. CL. 13.

VICTORIA'S SECRET STORES BRAND MANAGEMENT,
INC., REYNOLDSBURG, OH:
2,772,014, CANC. INT. CL. 25.
2,843,566, CANC. INT. CL. 4.
3,805,362, PUB. 4-6-2010. INT. CL. 25.

VIDEOMARKET CORPORATION, MIAMI, FL, DBA
POWERBASE:
3,806,494, PUB. 4-6-2010. INT. CL. 9.

VIGNEAULT CHOCOLATIER LTÉE, QUEBEC, CANADA:
3,805,892, PUB. 4-6-2010. INT. CL. 30.

VIGNETTE CORPORATION, AUSTIN, TX:
2,286,292, CANC. INT. CL. 9.

VIKING FOTTØY AS, NORWAY:
3,807,105, PUB. 12-29-2009. INT. CL. 25.

VILLAGE VETERINARY CENTERS, INC., VILLA RICA, GA,
DBA THE VILLAGE VETS:
3,806,891, PUB. 4-6-2010. MULTIPLE CLASS, INT. CLS. 35
AND 44.
3,806,896, PUB. 4-6-2010. MULTIPLE CLASS, INT. CLS. 35
AND 44.

VILLAGE VOGUE, INC. II, UPPER MONTCLAIR, NJ:
3,805,984, PUB. 4-6-2010. MULTIPLE CLASS, INT. CLS. 25
AND 35.

VILTER MANUFACTURING LLC, CUDAHY, WI, VILTER
MANUFACTURING CO., THE, MILWAUKEE, WI:
697,773, REN. 5-18-10. U.S. CL. 23 (INT. CL. 7).

VIM VENTURE INC., LOS ANGELES, CA:
3,808,716, INT. CL. 9.

VINA AQUITANIA LIMITADA, PENALOLEN SANTIAGO,
CHILE:
2,284,372, CANC. INT. CL. 33.

VINA CARTA VIEJA S.A., VII REGION, CHILE:
2,326,831, REN. 5-17-10. INT. CL. 33.

VINAY ATHMA, SUNNYVALE, CA, DBA SPICELOOP:
3,808,683, INT. CL. 9.

VINEBURG LLC, VINEBURG, CA:
3,806,275, PUB. 4-6-2010. INT. CL. 33.

VINTAGE PHARMACEUTICALS, LLC, HUNTVILLE, AL:
3,806,991, PUB. 4-6-2010. INT. CL. 40.

VINTAGE PHARMACEUTICALS, LLC, HUNTSVILLE, AL:
3,807,004, PUB. 4-6-2010. INT. CL. 42.

VINYL SIDING INSTITUTE, INC., WASHINGTON, DC:
3,805,739, PUB. 4-6-2010. U.S. CL. B.
3,805,740, PUB. 4-6-2010. U.S. CL. B.

VIRGO PUBLISHING, LLC, PHOENIX, AZ:
3,805,701, PUB. 4-6-2010. MULTIPLE CLASS, INT. CLS. 16
AND 35.
3,805,783, PUB. 4-6-2010. INT. CL. 35.

VIRIDIAN SPIRITS LLC, NEW YORK, NY:
3,807,935, INT. CL. 33.

VIROCO PORTUGAL -; INDÚSTRIAS DE MADEIRA E
CIMENTO, S.A., PORTUGAL:
3,771,761, COR. MULTIPLE CLASS, INT. CLS. 19 AND
37.

VIRTUON, INC., SCOTTSDALE, AZ:
3,806,279, PUB. 4-6-2010. INT. CL. 42.

VIÑA UNDURRAGA S.A., LAS CONDES, SANTIAGO,
CHILE:
2,348,388, REN. 5-17-10. INT. CL. 33.

VISA INC., CAGUAS, PUERTO RICO:
1,560,081, CANC. INT. CL. 32.

VISCONTI, LTD., BROOKLYN, NY:
3,808,494, INT. CL. 14.

VISION GROUP INTERNATIONAL LIMITED, TSUEN
WAN, HONG KONG:
3,662,575, COR. MULTIPLE CLASS, INT. CLS. 18, 25
AND 28.

- VISION REGENERATION INC., DALLAS, TX:
3,806,075, PUB. 4-6-2010. MULTIPLE CLASS, INT. CLS. 38 AND 45.
- VISIONARY BOWLING PRODUCTS, LLC, JENNINGS, MO:
2,285,981, CANC. INT. CL. 28.
- VISIONSYNC, INC., PALO ALTO, CA:
3,805,866, PUB. 4-6-2010. INT. CL. 42.
- VIST FINANCIAL, WYOMISSING, PA, FORMERLY LEE-SPORT FINANCIAL:
3,807,707, INT. CL. 36.
- VISUALIZE, INC., PHOENIX, AZ:
2,284,395, CANC. INT. CL. 9.
- VITA-MIX CORPORATION, CLEVELAND, OH:
3,808,435, INT. CL. 7.
- VITABIOTICS LTD, WEMBLEY, UNITED KINGDOM:
2,771,686, CANC. INT. CL. 3.
- VITACHLOR CORPORATION, INDIANAPOLIS, IN:
2,771,965, CANC. INT. CL. 30.
- VITACOST.COM INC., BOCA RATON, FL:
2,450,415. REN. 5-18-10. INT. CL. 5.
- VITAMINS PLAYWEAR, LTD., NEW YORK, NY:
1,362,018 NEW CERT. 6-22-2010. INT. CL. 25.
- VITASOY INTERNATIONAL HOLDINGS LIMITED, TUEN MUN NEW TERRITORI, HONG KONG:
3,805,499, PUB. 1-12-2010. MULTIPLE CLASS, INT. CLS. 5, 30 AND 32.
- VITORIA GEAR, EWA BEACH, HI:
3,806,249, PUB. 4-6-2010. INT. CL. 25.
- VITRA PATENTE AG, CH-4132 MUTTENZ, SWITZERLAND:
2,771,428, CANC. INT. CL. 20.
- VITROLIFE SWEDEN AB, SE-400 92 GÖTEBORG, SWEDEN:
3,807,194, PUB. 4-6-2010. INT. CL. 5.
- VIV & INGRID, CO., ALBANY, CA, DBA VIV & INGRID:
3,806,856, PUB. 4-6-2010. INT. CL. 14.
- VIX SWIMWEAR, INC., SAN DIEGO, CA:
3,806,583, PUB. 4-6-2010. INT. CL. 25.
- VIZYONTIME EGITIM VE DANISHMANLIK HIZMETLERI TICARET LIMITED SIRKETI, ISTANBUL, TURKEY:
3,805,254, PUB. 4-6-2010. INT. CL. 41.
- VODACI TECHNOLOGIES, INC., URBANDALE, IA:
2,771,237, CANC. INT. CL. 37.
- VOGELZANG INTERNATIONAL CORPORATION, HOLLAND, MI:
3,805,523, PUB. 4-6-2010. INT. CL. 11.
- VOICE-TECH, INC., VENICE, FL:
3,805,698, PUB. 4-6-2010. INT. CL. 42.
3,805,699, PUB. 4-6-2010. INT. CL. 42.
- VOLERA, INC., SAN JOSE, CA:
2,771,560, CANC. INT. CL. 9.
- VOLKSWAGEN AG, FED REP GERMANY:
3,807,273, PUB. 4-6-2010. INT. CL. 12.
- VOLT INFORMATION SCIENCES, INC., ORANGE, CA:
2,354,622. REN. 5-17-10. MULTIPLE CLASS, INT. CLS. 35, 37, 40, 41 AND 42.
2,354,622, CANC. INT. CL. 36.
- VOLVO CAR CORPORATION, GOTEBORG, SWEDEN:
2,837,705, CANC. INT. CL. 37.
- VOLVO COMMERCIAL FINANCE LLC THE AMERICAS, GREENSBORO, NC TO VOLVO COMMERCIAL FINANCE LLC THE AMERICAS, GREENSBORO, NC:
2,285,603, CANC. INT. CL. 36.
- VOLVO TRADEMARK HOLDING AB, SE-405 08 GÖTEBORG, SWEDEN:
1,605,427. REN. 5-18-10. INT. CL. 12.
- VONAGE MARKETING LLC, HOLMDEL, NJ:
3,808,379, MULTIPLE CLASS, INT. CLS. 35 AND 38.
- VOOZ CO., LTD., REPUBLIC OF KOREA:
3,807,131, PUB. 4-6-2010. MULTIPLE CLASS, INT. CLS. 3, 9, 14, 16, 18, 21, 24, 25, 28, 38 AND 41.
- VOTA, PAUL, PALM BEACH GARDENS, FL:
3,805,793, PUB. 4-6-2010. INT. CL. 32.
- VSOFT CORPORATION, NORCROSS, GA:
2,771,864, CANC. INT. CL. 9.
- VTS MEDICAL SYSTEMS, LLC, MELVILLE, NY, DBA VTS MEDICAL SYSTEMS, LLC:
3,805,627, PUB. 4-6-2010. INT. CL. 10.
- VUCUREVICH SIMONS ADVISORY GROUP, LLC, KENSINGTON, MD:
3,806,857, PUB. 4-6-2010. INT. CL. 43.
- VUEPOINT CORP., NEW YORK, NY:
2,284,349, CANC. INT. CL. 41.
- VULCAN TECHNOLOGIES LLC, SEATTLE, WA:
3,808,319, INT. CL. 9.
- W. H. MAZE COMPANY, PERU, IL:
3,806,317, PUB. 4-6-2010. INT. CL. 6.
- W. HAKING ENTERPRISES, LIMITED, NORTH POINT, HONG KONG:
1,559,606, CANC. INT. CL. 9.
- W. R. BERKLEY CORPORATION, GREENWICH, CT:
3,805,341, PUB. 4-6-2010. INT. CL. 36.
- W.E. HALL COMPANY, NEWPORT BEACH, CA:
2,772,004, CANC. INT. CL. 11.
2,772,005, CANC. INT. CL. 11.
- W.M. BARR & COMPANY, INC., MEMPHIS, TN:
3,805,830, PUB. 4-6-2010. MULTIPLE CLASS, INT. CLS. 1 AND 5.
3,805,831, PUB. 4-6-2010. MULTIPLE CLASS, INT. CLS. 1 AND 5.
- WACKER CHEMIE AG, 81737 MÜNCHEN, FED REP GERMANY:
3,807,226, PUB. 4-6-2010. MULTIPLE CLASS, INT. CLS. 1, 2 AND 16.
- WACKER-CHEMIE AG, MUNICH, FED REP GERMANY:
2,771,827, CANC. INT. CL. 17.
- WACKY WARRIORS INC., IMPERIAL, MO:
2,362,191. REN. 5-20-10. INT. CL. 41.
- WADE, MELVIN RONNELL, HAWTHORNE, CA:
2,771,225, CANC. INT. CL. 25.
- WADE, STUART, NEW HAW SURREY KT15 3N, UNITED KINGDOM:
2,391,124. REN. 5-20-10. MULTIPLE CLASS, INT. CLS. 9 AND 41.
- WAHL CLIPPER CORPORATION, STERLING, IL:
3,808,231, INT. CL. 8.
3,808,649, INT. CL. 8.
- WAKUNAGA OF AMERICA CO., LTD., MISSION VIEJO, CA:
1,559,525, CANC. INT. CL. 5.
2,770,596, CANC. INT. CL. 5.
- WAL-MART STORES, INC., BENTONVILLE, AR:
3,807,923, INT. CL. 20.
- WALDEN FORREST, BIRMINGHAM, AL:
3,806,448, PUB. 4-6-2010. INT. CL. 41.
- WALDOM ELECTRONICS CORPORATION, ROCKFORD, IL:
2,284,310, CANC. MULTIPLE CLASS, INT. CLS. 2, 3, 4 AND 9.
- WALIZADEH, MOHAMMAD, LOS ANGELES, CA:
2,771,692, CANC. INT. CL. 25.
- WALKER MANUFACTURING COMPANY, FORT COLLINS, CO:
2,286,785, CANC. INT. CL. 7.
- WALKER STAINLESS EQUIPMENT COMPANY, INC., NEW LISBON, WI:
2,284,655, CANC. INT. CL. 6.
- WALKER, LEN P., SACRAMENTO, CA:
2,285,108, CANC. INT. CL. 35.
- WALLNER, THOMAS, MOSS BEACH, CA:
2,771,931, CANC. INT. CL. 35.
- WALTER HNOT, PHILLIPSBURG, NJ:
3,808,718, INT. CL. 9.
- WALTON & POST, INC., MIAMI, FL:
3,805,877, PUB. 4-6-2010. MULTIPLE CLASS, INT. CLS. 29, 30 AND 32.
3,805,886, PUB. 4-6-2010. MULTIPLE CLASS, INT. CLS. 29, 30 AND 32.
- WAMBOLD CORPORATION, WILMINGTON, DE:
2,444,143. REN. 5-18-10. INT. CL. 2.
- WANG AND WANG, SAN FRANCISCO, CA:
1,560,316, CANC. INT. CL. 42.
- WANG, MARY, CHINO, CA:
3,806,099, PUB. 4-6-2010. MULTIPLE CLASS, INT. CLS. 16 AND 18.

WANZO, MIRACLE M, VALLEJO, CA, DBA NALA & COMPANY:
 3,808,682, INT. CL. 3.
 WARNACO U.S., INC., BRIDGEPORT, CT:
 2,771,910, CANC. INT. CL. 25.
 WARNER BROS. ENTERTAINMENT INC., BURBANK, CA:
 2,406,757. REN. 5-14-10. INT. CL. 9.
 2,771,973, CANC. INT. CL. 16.
 WARNER-LAMBERT COMPANY LLC, MORRIS PLAINS, NJ:
 2,772,597, CANC. INT. CL. 3.
 WARRE & COMPANHIA, S.A., VILLA NOVA DE AGIA, PORTUGAL, WARRE & CA. LIMITADA, VILLA NOVA DE GAIA, PORTUGAL:
 1,613,177. REN. 5-17-10. INT. CL. 33.
 WARRE & COMPANHIA, S.A., VILLA NOVA DE GAIA, PORTUGAL, WARRE & CA. LIMITADA, VILLA NOVA DE GAIA, PORTUGAL:
 1,614,136. REN. 5-17-10. INT. CL. 33.
 WARRICK, MERCEDES, LAS VEGAS, NV:
 3,805,406, PUB. 4-6-2010. INT. CL. 41.
 WARWICK GROUP, INC., THE, EAST PROVIDENCE, RI:
 1,620,329, AM. MULTIPLE CLASS, INT. CLS. 35 AND 42.
 WASABROD AB, STOCKHOLM, SWEDEN:
 3,805,503, PUB. 4-6-2010. INT. CL. 30.
 WASABRÖD AKTIEBOLAG, SWEDEN:
 3,807,169, PUB. 4-6-2010. MULTIPLE CLASS, INT. CLS. 29, 30 AND 43.
 WASHINGTON JR., CLYDE, COLUMBUS, MS:
 3,808,060, INT. CL. 25.
 WASSERMAN COMMERCIAL REAL ESTATE CORPORATION, SANTA MONICA, CA:
 3,808,175, INT. CL. 36.
 WATER'S EDGE AQUATIC DESIGN, LLC, LENEXA, KS:
 2,770,931, CANC. INT. CL. 42.
 WATERLOO INDUSTRIES, INC., OAK CREEK, WI:
 2,771,340, CANC. INT. CL. 6.
 WATHEN, BOYD J., LEHI, UT:
 3,808,582, INT. CL. 5.
 WATSON-NEIMY, SUSAN, CHARLESTON, SC:
 3,806,181, PUB. 4-6-2010. INT. CL. 44.
 WAUSAU PAPER TOWEL & TISSUE, LLC, MOSINEE, WI:
 2,371,333. REN. 5-18-10. INT. CL. 21.
 3,807,538, INT. CL. 21.
 WAVEDIVISION HOLDINGS, LLC, KIRKLAND, WA:
 3,806,490, PUB. 4-6-2010. INT. CL. 38.
 WAX RESEARCH, INC., CARLSBAD, CA:
 2,772,596, CANC. INT. CL. 25.
 WAY OF LIFE COACHING, LLC, RALEIGH, NC:
 3,805,842, PUB. 4-6-2010. INT. CL. 41.
 WAYMOUTH FARMS, INC., NEW HOPE, MN:
 1,560,059, CANC. INT. CL. 30.
 WAZANA BROTHERS INTERNATIONAL, INC., CHATSWORTH, CA, DBA MICRO SOLUTIONS ENTERPRISES:
 2,771,709, CANC. MULTIPLE CLASS, INT. CLS. 2, 16 AND 40.
 WAZEE GROUP, LLC, ERIE, CO:
 2,771,668, CANC. INT. CL. 9.
 WDAF-TV LOVE FUND FOR CHILDREN, INC., THE, KANSAS CITY, MO:
 1,631,868. REN. 5-14-10. INT. CL. 36.
 WDHB, INC., BERKELEY, CA:
 2,350,011. REN. 5-18-10. INT. CL. 35.
 WEATHER CENTRAL HOLDINGS, INC., MADISON, WI:
 2,772,354, CANC. MULTIPLE CLASS, INT. CLS. 9 AND 42.
 WEB CONTACT LENS CORPORATION, IRVINE, CA:
 2,772,265, CANC. MULTIPLE CLASS, INT. CLS. 5 AND 9.
 WEB TRICK, INCORPORATED, BERKELEY, CA:
 3,806,004, PUB. 4-6-2010. INT. CL. 41.
 WEBASTO AG, FED REP GERMANY:
 3,807,126, PUB. 4-6-2010. MULTIPLE CLASS, INT. CLS. 7, 9, 11 AND 12.
 WEBB CONSULTING INC., LAFAYETTE, CO:
 2,770,724, CANC. MULTIPLE CLASS, INT. CLS. 35 AND 42.
 WEBER, AMY, VALLEY VILLAGE, CA:
 2,772,703, CANC. INT. CL. 41.
 WECK CORPORATION, THE, NEW YORK, NY:
 2,284,659, CANC. MULTIPLE CLASS, INT. CLS. 2, 3, 4, 8, 11, 14, 16, 20, 21, 24, 25 AND 26.
 WEGO CHEMICAL & MINERAL CORP., GREAT NECK, NY:
 3,806,049, PUB. 4-6-2010. INT. CL. 35.
 WEIFANG YAXING CHEMICAL CO., LTD., SHANDONG PROVINCE, CHINA:
 3,806,686, PUB. 4-6-2010. INT. CL. 1.
 WEIGHTPACK S.P.A., ITALY:
 3,537,330, COR. MULTIPLE CLASS, INT. CLS. 7, 9 AND 42.
 WEINER, ADAM, PORTLAND, OR:
 2,772,216, CANC. INT. CL. 9.
 WEINREB, MICHAEL PETER, AVENTURA, FL:
 3,808,484, INT. CL. 25.
 WELDING INSTITUTE, THE, CAMBRIDGE, ENGLAND:
 2,358,399. REN. 5-19-10. MULTIPLE CLASS, INT. CLS. 40 AND 41.
 WELDINGHOUSE, INC., CORPUS CHRISTI, TX:
 3,805,617, PUB. 4-6-2010. MULTIPLE CLASS, INT. CLS. 1 AND 40.
 WELLEMENTS, LLC, SCOTTSDALE, AZ:
 3,805,563, PUB. 4-6-2010. INT. CL. 5.
 WELLPET LLC, TEWKSBURY, MA:
 3,808,209, INT. CL. 31.
 3,808,275, INT. CL. 31.
 WELLSPAN HEALTH CARE SERVICES, YORK, PA:
 1,570,391. REN. 5-17-10. INT. CL. 42.
 WELLTERN ENTERPRISE CO., LTD., SANCHONG CITY, TAIPEI COUNTY, TAIWAN:
 2,402,537. REN. 5-20-10. INT. CL. 26.
 WELLYTAILS, INC., GUELPH, ONTARIO N1G 4W, CANADA:
 3,808,434, INT. CL. 5.
 WENDY'S INTERNATIONAL, INC., DUBLIN, OH:
 2,353,060. REN. 5-17-10. INT. CL. 41.
 WENZHO FANTAI CASE CO., LTD; (CHINA CORPORATION), CHINA:
 3,807,187, PUB. 4-6-2010. INT. CL. 18.
 WESCAL INDUSTRIES, INC., RANCHO DOMINGUEZ, CA:
 1,559,545, CANC. INT. CL. 6.
 WESCHLER, BRADLEY R., SOUTH HUNTINGTON, NY:
 2,772,110, CANC. INT. CL. 8.
 WEST MILL CLOTHES, INC., WOODSIDE, NY:
 2,771,946, CANC. INT. CL. 25.
 WESTERN ASSET MANAGEMENT COMPANY, PASADENA, CA:
 2,427,117. REN. 5-17-10. INT. CL. 36.
 2,427,118. REN. 5-17-10. INT. CL. 36.
 2,427,119. REN. 5-17-10. INT. CL. 36.
 WESTERN MEDICAL INC., TENAFLY, NJ, DBA WESTERN MEDICAL LTD.:
 2,772,504, CANC. INT. CL. 10.
 WESTERN OILFIELDS SUPPLY COMPANY, BAKERSFIELD, CA:
 3,808,101, INT. CL. 11.
 WESTERN UNION HOLDINGS, INC., GREENWOOD VILLAGE, CO:
 2,286,033, CANC. INT. CL. 9.
 2,286,644, CANC. INT. CL. 36.
 WESTON, LOUANNE COLE, FAIR OAKS, CA:
 2,770,732, CANC. INT. CL. 42.
 WESTWIND SEEDS & GARDENSCAPES LLC, TUCSON, AZ:
 3,806,429, PUB. 4-6-2010. INT. CL. 31.
 WFMP-FM, LLC, SAINT PAUL, MN:
 3,805,263, PUB. 4-6-2010. INT. CL. 38.
 WHACK, JOSEPH, PHILADELPHIA, PA, DBA URBAN ENTERPRISES:
 3,808,627, INT. CL. 25.
 WHATABURGER PARTNERSHIP, SAN ANTONIO, TX, DOBSON, GRACE W., CORPUS CHRISTI, TX, DOING BUSINESS AS WHATABURGER DRIVE INNS:
 891,082. REN. 5-18-10. U.S. CL. 100 (INT. CL. 42).
 WHEATON VAN LINES, INC., INDIANAPOLIS, IN:
 1,604,074. REN. 5-20-10. INT. CL. 39.

- WHEELED COACH INDUSTRIES, INC., WINTER PARK, FL:
2,421,478. REN. 5-14-10. INT. CL. 12.
- WHERE TO EAT GUIDE AND ASSOCIATES LLC, BEND, OR:
3,806,108, PUB. 4-6-2010. MULTIPLE CLASS, INT. CLS. 16 AND 35.
- WHERE WOMEN CREATE INC., OGDEN, UT:
3,807,691, MULTIPLE CLASS, INT. CLS. 35 AND 41.
- WHIP-MIX CORPORATION, LOUISVILLE, KY:
3,808,442, INT. CL. 3.
- WHITE CASTLE PRODUCTIONS, INC., LOS ANGELES, CA:
2,771,626, CANC. INT. CL. 16.
- WHITE HAT VENTURES, LLC, AKRON, OH:
3,806,763, PUB. 4-6-2010. INT. CL. 41.
- WHITE STONE FOODS LLC, WESTON, FL:
3,808,031, INT. CL. 35.
- WHITEWAVE SERVICES, INC., DALLAS, TX:
3,808,103, INT. CL. 29.
- WHITEY'S ICE CREAM, INC., MOLINE, IL:
3,805,928, PUB. 4-6-2010. INT. CL. 30.
- WHITEY'S RESTAURANT, INC., RICHFIELD, OH:
3,805,744, PUB. 4-6-2010. INT. CL. 43.
- WHITFIELD, ANTHONY, CREVE COEUR, MO:
3,805,138, PUB. 4-6-2010. INT. CL. 32.
- WHITMIRE MICRO-GEN RESEARCH LABORATORIES, INC., ST. LOUIS, MO:
2,286,142, CANC. INT. CL. 7.
- WHITTINGTON, T. CLARK, WINSTON SALEM, NC:
2,363,307. REN. 5-17-10. INT. CL. 9.
- WHY NOT COCO, INC., SANTA MONICA, CA:
2,770,533, CANC. INT. CL. 41.
- WICHORUS, INC., SAN JOSE, CA:
3,806,756, PUB. 4-6-2010. INT. CL. 9.
- WICKS N MORE INC, TUPELO, MS:
3,806,532, PUB. 4-6-2010. INT. CL. 4.
- WIEGAND, BODO, 42115 WUPPERTAL, FED REP GERMANY:
2,770,627, CANC. MULTIPLE CLASS, INT. CLS. 16, 35 AND 42.
- WIESNER PRODUCTS, INC., NEW YORK, NY:
2,318,609. REN. 5-19-10. INT. CL. 25.
- WIJESIRIWARDANA, RAVINDRA, BENTONVILLE, AR:
3,807,571, MULTIPLE CLASS, INT. CLS. 9 AND 10.
- WIJNGAARD KAAS B.V., NETHERLANDS:
3,807,097, PUB. 4-6-2010. INT. CL. 29.
3,807,098, PUB. 4-6-2010. INT. CL. 29.
- WILD MARKS, INC., LAS VEGAS, NV:
2,771,882, CANC. INT. CL. 16.
- WILDER, JOHNNIE, DAYTON, OH:
2,770,668, CANC. INT. CL. 41.
- WILDFLOWER BREAD COMPANY, SCOTTSDALE, AZ:
3,806,487, PUB. 4-6-2010. INT. CL. 43.
- WILKENSON, JOHN, GRAND JUNCTION, CO:
3,808,634, INT. CL. 25.
- WILLAMETTE VALLEY COMPANY, EUGENE, OR:
2,352,300. REN. 5-18-10. INT. CL. 2.
- WILLIAM GRANT & SONS, INC., EDISON, NJ:
2,828,366, AM. INT. CL. 33.
- WILLIAM MARVY COMPANY, INC., ST. PAUL, MN:
1,629,800. REN. 5-14-10. INT. CL. 5.
- WILLIAM R. CATES, INC., LAUREL, MD:
3,806,564, PUB. 4-6-2010. MULTIPLE CLASS, INT. CLS. 9 AND 41.
- WILLIAM RAVEIS REAL ESTATE, INC., SHELTON, CT:
2,285,075, CANC. INT. CL. 36.
- WILLIAMSON, CYNTHIA, WASHINGTON, CT:
3,807,487, INT. CL. 3.
- WILSHIRE CLASSIFIEDS, LLC, LOS ANGELES, CA:
2,286,806, CANC. INT. CL. 16.
- WILSON & WILSON FOLK ART COMPANY, EUREKA SPRINGS, AR:
2,770,964, CANC. MULTIPLE CLASS, INT. CLS. 16, 20, 21 AND 24.
- WILSON, PENNY L, SUGAR LAND, TX, DBA EATING FOR PERFORMANCE:
3,805,882, PUB. 4-6-2010. INT. CL. 44.
- WILSON, PRESTON, CORAL GABLES, FL:
2,771,287, CANC. INT. CL. 36.
- WILTRON COMPANY, MORGAN HILL, CA:
1,559,632, CANC. INT. CL. 9.
- WIMAX FORUM, MOUNTAIN VIEW, CA:
3,805,280, PUB. 10-28-2008. INT. CL. 38.
- WINCHESTER HOMES, INC., GREENBELT, MD:
3,808,023, INT. CL. 37.
- WINDMILL HEALTH PRODUCTS, LLC., WEST CALDWELL, NJ:
3,808,562, INT. CL. 5.
- WINDSOR CAPITAL GROUP, INC., SANTA MONICA, CA:
3,806,294, PUB. 4-6-2010. INT. CL. 35.
- WINE GEEKS LLC, NEW YORK, NY:
3,808,074, INT. CL. 35.
- WINE GROUP LLC., THE, TRACY, CA:
3,806,292, PUB. 4-6-2010. INT. CL. 33.
- WINELIFE LIMITED, LONDON, UNITED KINGDOM:
3,805,573, PUB. 4-6-2010. MULTIPLE CLASS, INT. CLS. 16, 33, 35, 39 AND 41.
- WINFIELD SOLUTIONS LLC, SHOREVIEW, MN:
3,806,768, PUB. 4-6-2010. MULTIPLE CLASS, INT. CLS. 41 AND 44.
- WINGROUP S. COOP., SPAIN:
3,807,227, PUB. 4-6-2010. INT. CL. 28.
- WINN-DIXIE STORES, INC., JACKSONVILLE, FL:
2,284,334, CANC. INT. CL. 32.
- WINNER INTERNATIONAL ROYALTY LLC, SHARON, PA:
2,771,863, CANC. INT. CL. 9.
- WINNER TOYS MANUFACTORY LTD., KOWLOON, HONG KONG AND WNR INDUSTRIES LTD., KOWLOON, HONG KONG:
2,772,284, CANC. INT. CL. 28.
- WINSTON PRODUCTS LLC, CLEVELAND, OH:
3,805,381, PUB. 4-6-2010. INT. CL. 22.
- WINTICE GROUP, INC., WEST HOLLYWOOD, CA:
3,805,597, PUB. 4-6-2010. INT. CL. 35.
- WIPRO INVESTMENT LIMITED, BANGALORE - 560 001, INDIA:
2,771,922, CANC. INT. CL. 9.
- WIRELESSVOX, INC., SEATTLE, WA:
2,284,973, CANC. INT. CL. 35.
- WISCONSIN CHEESE COMPANY LLC, STOUGHTON, WI:
3,808,744, INT. CL. 29.
- WITTMAN ROBOT SYSTEME GMBH, SCHWAIG, FED REP GERMANY:
3,805,562, PUB. 4-6-2010. INT. CL. 7.
- WIZARD CO., INC., PARSIPPANY, NJ:
1,560,177, CANC. INT. CL. 39.
3,806,831, PUB. 4-6-2010. INT. CL. 39.
- WMF WÜRTEMBERGISCHE METALLWARENFABRIK; AKTIENGESELLSCHAFT, GEISLINGEN (STEIGE), FED REP GERMANY:
3,807,177, PUB. 4-6-2010. MULTIPLE CLASS, INT. CLS. 8 AND 21.
- WNBA ENTERPRISES, LLC, SECAUCUS, NJ:
2,448,132. REN. 5-18-10. INT. CL. 25.
- WOLF & COMPANY, P.C., BOSTON, MA:
3,806,597, PUB. 4-6-2010. INT. CL. 42.
3,806,598, PUB. 4-6-2010. INT. CL. 42.
3,806,599, PUB. 4-6-2010. INT. CL. 42.
3,806,600, PUB. 4-6-2010. INT. CL. 42.
- WOLF LAUREL OUTDOORS, LLC, MARS HILL, NC:
2,770,613, CANC. INT. CL. 41.
- WOLF, PAUL, MANDAN, ND:
3,808,227, INT. CL. 9.
- WOLFEDALE ENGINEERING LIMITED, BRAMPTON, CANADA:
2,772,197, CANC. INT. CL. 11.
- WOLTERS KLUWER FINANCIAL SERVICES, INC., ST. CLOUD, MN:
2,285,363, CANC. MULTIPLE CLASS, INT. CLS. 9 AND 35.
- WOLVERINE OUTDOORS, INC., ROCKFORD, MI:
2,772,308, CANC. INT. CL. 25.
- WOLVERINE WORLD WIDE, INC., ROCKFORD, MI:
3,808,024, INT. CL. 25.

WOMAN'S MISSIONARY UNION, AUXILIARY TO SOUTHERN BAPTIST CONVENTION, BIRMINGHAM, AL:
1,560,314, CANC. INT. CL. 39.

WONDERJUNK LTD., LONDON W9 1LY, UNITED KINGDOM:
3,806,546, PUB. 4-6-2010. INT. CL. 30.

WOO LOOT INTERNATIONAL, INC., TAMPA, FL:
3,806,886, PUB. 4-6-2010. INT. CL. 14.

WOODSMOKE PROVISIONS, LLC, ATLANTA, GA:
2,351,092. REN. 5-18-10. INT. CL. 29.

WOODSTOCK VENTURES LC, NEW YORK, NY, WOODSTOCK VENTURES, NEW YORK, NY:
1,596,132. REN. 5-20-10. INT. CL. 9.

WORLD AGAINST RACISM FOUNDATION, WASHINGTON, DC:
2,352,336. REN. 5-14-10. INT. CL. 41.

WORLD DRYER CORPORATION, BERKELEY, IL:
1,606,320. REN. 5-20-10. INT. CL. 11.

WORLD KITCHEN, LLC, RESTON, VA:
1,559,574, CANC. INT. CL. 8.

WORLD OF GOOD PETS, SAN FRANCISCO, CA:
3,808,781, INT. CL. 31.

WORLD TABLEWARE INTERNATIONAL, INC., WALLINGFORD, CT:
1,559,578, CANC. INT. CL. 8.

WORLD WRESTLING FEDERATION ENTERTAINMENT, INC., STAMFORD, CT:
2,771,592, CANC. INT. CL. 41.

WORLD'S FINEST CHOCOLATE, INC., CHICAGO, IL:
2,285,174, CANC. INT. CL. 30.

WORLDCELL, INC., SILVER SPRING, MD:
3,806,547, PUB. 4-6-2010. INT. CL. 38.

WORLDWIDE ACCESS SOLUTIONS, INC., OMAHA, NE:
3,806,470, PUB. 4-6-2010. INT. CL. 36.

WORSLEY OPERATING CORPORATION, WILMINGTON, NC:
3,805,131, PUB. 4-6-2010. INT. CL. 35.

WOW CAFE AND WINGERY, LLC, COVINGTON, LA:
3,805,178, PUB. 4-6-2010. INT. CL. 43.

WRANGLER APPAREL CORP., WILMINGTON, DE:
3,806,009, PUB. 4-6-2010. INT. CL. 25.
3,807,497, INT. CL. 25.

WRANGLER CLOTHING CORP., WILMINGTON, DE:
1,559,919, CANC. INT. CL. 25.

WRYMARK, INC., ST. LOUIS, MO:
3,806,152, PUB. 4-6-2010. MULTIPLE CLASS, INT. CLS. 40, 42 AND 44.

WSOL, INC., PLANO, TX:
3,805,156, PUB. 4-6-2010. INT. CL. 35.

WUHAN ADMIRAL TECHNOLOGY LTD., CHINA:
3,807,332, PUB. 4-6-2010. INT. CL. 9.

WUSTENROT HOLDING AG, 71630 LUDWIGSBURG, FED REP GERMANY:
2,770,526, CANC. INT. CL. 36.

WW ONE CORP., PHOENIX, AZ:
3,806,267, PUB. 4-6-2010. INT. CL. 35.

WWP PRODUCTIONS, LLC, PLYMOUTH, MN:
3,807,801, MULTIPLE CLASS, INT. CLS. 14, 18 AND 25.

WYATT, JOHN, PASADENA, CA:
3,806,862, PUB. 4-6-2010. INT. CL. 41.

WYETH (FORMERLY AMERICAN HOME PRODUCTS CORPORATION), MADISON, NJ:
2,772,670, CANC. INT. CL. 42.

WYETH HOLDINGS CORPORATION, MADISON, NJ, OHN MATHIESON CHEMICAL CORPORATION, NEW YORK, NY:
700,835. REN. 5-20-10. U.S. CL. 18 (INT. CL. 5).

WYETH HOLDINGS CORPORATION, MADISON, NJ, SALS-BURY LABORATORIES, CHARLES CITY, IA:
897,699. REN. 5-20-10. U.S. CL. 18 (INT. CL. 5).

WYETH HOLDINGS CORPORATION, MADISON, NJ:
2,450,024. REN. 5-20-10. INT. CL. 5.

WYETH LLC, MADISON, NJ, A.H. ROBINS COMPANY, INC., RICHMOND, VA:
700,821. REN. 5-20-10. U.S. CL. 18 (INT. CL. 5).

WYETH LLC, MADISON, NJ:
1,135,455. REN. 5-18-10. INT. CL. 5.
2,350,853. REN. 5-19-10. INT. CL. 5.

WYOMING WEST DESIGNS II, INC., JACKSON, WY:
3,805,179, PUB. 4-6-2010. INT. CL. 32.

W2007 MVP CORPORATE, LLC, SAN FRANCISCO, CA:
3,806,808, PUB. 4-6-2010. INT. CL. 43.
3,806,810, PUB. 4-6-2010. INT. CL. 43.
3,806,811, PUB. 4-6-2010. INT. CL. 43.
3,806,813, PUB. 4-6-2010. INT. CL. 43.

X CONCEPTS, LLC, ESCONDIDO, CA:
2,772,470, CANC. INT. CL. 28.

X-CALIBER, LLC, LAINGSBURG, MI:
3,808,012, INT. CL. 13.

X-TENDER BOATS, LLC, SEATTLE, WA:
3,806,682, PUB. 4-6-2010. INT. CL. 12.

XAAR PLC, UNITED KINGDOM:
3,807,109, PUB. 4-6-2010. MULTIPLE CLASS, INT. CLS. 2, 7 AND 9.

XCESSORY INTERNATIONAL LLC, NEW YORK, NY:
3,805,937, PUB. 4-6-2010. INT. CL. 28.

XEROX CORPORATION, NORWALK, CT:
2,771,135, CANC. INT. CL. 37.
2,772,175, CANC. INT. CL. 9.
2,772,570, CANC. INT. CL. 35.
3,808,237, MULTIPLE CLASS, INT. CLS. 41 AND 42.

XIAN TYPICAL INDUSTRIES CO., LTD., XI'AN, CHINA:
3,806,727, PUB. 4-6-2010. INT. CL. 7.

XPERTWEB TRUST, KANSAS CITY, MO:
2,771,967, CANC. INT. CL. 35.

XS ENGINEERING INCORPORATED, FULLERTON, CA:
2,770,953, CANC. MULTIPLE CLASS, INT. CLS. 7 AND 37.

XUE HENG, BEIJING, CHINA:
3,806,615, PUB. 4-6-2010. INT. CL. 9.

XYTEX INTERNATIONAL, LTD., AUGUSTA, GA:
3,808,193, MULTIPLE CLASS, INT. CLS. 39, 42 AND 44.

X3D TECHNOLOGIES CORP., NEW YORK, NY:
2,771,805, CANC. INT. CL. 9.

YAEGAKI SHUZO KABUSHIKI KAISHA, HYOGO, JAPAN:
1,560,095, CANC. INT. CL. 33.

YAGODA, MICHELLE R., NEW YORK, NY AND GANS, EUGENE H., NEW YORK, NY:
3,806,704, PUB. 4-6-2010. INT. CL. 3.

YAHOO, INC., SUNNYVALE, CA:
2,286,753, CANC. MULTIPLE CLASS, INT. CLS. 16, 25, 28 AND 35.

YALE UNIVERSITY, NEW HAVEN, CT:
3,808,544, MULTIPLE CLASS, INT. CLS. 9 AND 16.

YAMAHA CORPORATION, HAMAMATSU-SHI, SHIZUOKA, JAPAN:
2,286,393, CANC. INT. CL. 15.

YAMAHA HATSUDOKI KABUSHIKI KAISHA, SHIZUOKA-KEN, JAPAN:
3,807,646, INT. CL. 12.

YAMAHA HATSUDOKI KABUSHIKI KAISHA, SHIZOU-KA-KEN, JAPAN:
2,373,509, REN. 5-18-10. INT. CL. 12.

YANKEE DEVELOPMENT CORP., NEWPORT, RI:
3,805,354, PUB. 4-6-2010. INT. CL. 43.

YEH HUNG PLASTIC CO., LTD., LU TSAO HSIANG CHIA YI HSIEN, TAIWAN:
2,285,393, CANC. INT. CL. 18.

YELLOW ROSE FINANCIAL CORPORATION, NORTH PLATTE, NE:
2,770,923, CANC. MULTIPLE CLASS, INT. CLS. 31 AND 32.

YESETA, JOHN M., LOS ANGELES, CA:
2,772,406, CANC. MULTIPLE CLASS, INT. CLS. 9 AND 41.

YET2.COM, INC., CAMBRIDGE, MA:
2,772,240, CANC. INT. CL. 42.

YFYJUPITER, INC., CHICAGO, IL, AKA JUPITER GROUP, INC.:
3,807,950, INT. CL. 42.

YIWU CITY WENDY COSMETICS CO., LTD., YIWU, ZHEJIANG, CHINA:
3,808,007, INT. CL. 3.

YORK CARPET & RUG CARE, INC., UNION CITY, NJ:
3,808,071, INT. CL. 37.

- YORKVILLE ADVISORS, LLC, JERSEY CITY, NJ:
3,808,726, INT. CL. 36.
- YOSHIDA SHUZOTEN CO., LTD., JAPAN:
3,807,244, PUB. 4-6-2010. INT. CL. 33.
- YOUNG DISCOVERERS, LLC, BARABOO, WI:
3,806,537, PUB. 4-6-2010. MULTIPLE CLASS, INT. CLS. 25 AND 35.
- YOUNG, PATRICK, SUNNYVALE, CA:
3,808,106, INT. CL. 16.
- YOUNIE, BRADFORD A., DERRY, NH, DBA CARNIVORE GAMES:
3,806,352, PUB. 4-6-2010. INT. CL. 16.
- YOUNTS, CHARLETON D., MIAMI LAKES, FL:
3,805,634, PUB. 4-6-2010. INT. CL. 31.
- YOUR ANSWERING SERVICE, SACRAMENTO, CA:
2,285,379, CANC. INT. CL. 35.
- YOURTEL AMERICA, INC., KANSAS CITY, MO:
3,807,421, INT. CL. 38.
- YUZHOU GREEN-SHIP PLASTIC CORPORATION, YUZHOU: 461670 HENAN, CHINA:
3,807,093, PUB. 4-6-2010. INT. CL. 21.
- YZY INC, MIAMI, FL:
3,807,532, INT. CL. 3.
- Z LUXE GROUP, INC., LA JOLLA, CA:
3,805,662, PUB. 4-6-2010. INT. CL. 14.
- Z PRODUCTIONS, INC., ST. PETERSBURG, FL:
3,806,398, PUB. 4-6-2010. INT. CL. 16.
- ZADORA TIMEPIECES, LLC, MIAMI, FL:
3,805,393, PUB. 4-6-2010. MULTIPLE CLASS, INT. CLS. 14, 35, 40 AND 42.
- ZAKRYTOE AKTSIONERNOE OBSHESTVO; "AVA COMPANY", RUSSIAN FED.:
3,807,265, PUB. 4-6-2010. MULTIPLE CLASS, INT. CLS. 19, 20, 31, 35, 39 AND 40.
- ZAMENES, ANDREAS G., REDWOOD CITY, CA AND TINGEN, MICHAEL F., SAN FRANCISCO, CA AND DOLD, JAY, SAN FRANCISCO, CA:
2,770,555, CANC. MULTIPLE CLASS, INT. CLS. 9 AND 41.
- ZB IMPORTING, INC., CICERO, IL:
3,808,462, INT. CL. 43.
- ZD WINES, LLC, NAPA, CA:
2,354,995, REN. 5-20-10. INT. CL. 33.
- ZEBRA PROMOTIONS, INC., WESTBURY, NY:
2,772,059, CANC. INT. CL. 35.
- ZEBRA PUBLISHING INC., COLORADO SPRINGS, CO:
3,806,495, PUB. 4-6-2010. INT. CL. 16.
- ZEEP TRAVEL NETWORK, INC., HOUSTON, TX:
3,808,121, INT. CL. 39.
- ZEHR, MICHAEL R., WAUSEON, OH, DBA MAPLE ROW MANAGEMENT, LLC AND MCCLARREN, BRIAN K., DELTA, OH, DBA MAPLE ROW MANAGEMENT, LLC:
3,807,936, INT. CL. 1.
- ZEMNO LLC, ENCINO, CA:
3,807,764, INT. CL. 9.
3,807,765, INT. CL. 9.
- ZENITH ADMINISTRATORS, INC., SEATTLE, WA:
3,806,082, PUB. 12-29-2009. INT. CL. 42.
- ZENITH INFOTECH, INC., WARRENDALE, PA:
3,808,311, INT. CL. 38.
- ZEP IP HOLDING LLC, ATLANTA, GA:
3,805,645, PUB. 4-6-2010. INT. CL. 3.
- ZEPHERELLA, INC., CHAPEL HILL, NC:
3,806,540, PUB. 4-6-2010. INT. CL. 35.
3,806,544, PUB. 4-6-2010. INT. CL. 35.
- ZERBE CORNELSEN, RICHARD M., WINNIPEG, MANITOBA R3L 1M4, CANADA, DBA THE VILLAGE CASKET-MAKER:
3,807,976, INT. CL. 20.
- ZERO TECHNOLOGIES, LLC, BENSALEM, PA:
3,808,040, INT. CL. 11.
3,808,042, INT. CL. 11.
- ZEVO GOLF, TEMECULA, CA:
2,772,383, CANC. INT. CL. 28.
- ZHANG, YAN, FLUSHING, NY:
3,806,803, PUB. 4-6-2010. INT. CL. 9.
- ZHEJIANG CHUANGXIN; AUTO AIR CONDITIONER CO., LTD., LONGQUAN INDUSTRIAL ZONE; 323700 ZHEJIANG, CHINA:
3,807,357, PUB. 4-6-2010. INT. CL. 11.
- ZHEJIANG GIANT EAGLE GROUP CO., LTD., XIANGSHAN, ZHEJIANG, CHINA:
2,399,621, REN. 5-19-10. INT. CL. 25.
- ZHEJIANG GONGDONG; MEDICAL PLASTIC FACTORY, CHINA:
3,807,243, PUB. 4-6-2010. INT. CL. 10.
- ZHEJIANG RONGPENG AIR TOOLS CO., LTD, TAIZHOU CITY, ZHEJIANG, CHINA:
3,807,614, INT. CL. 7.
- ZHENPING HUAXIN; CARPET GROUP CO., LTD., CHINA:
3,807,181, PUB. 4-6-2010. INT. CL. 27.
- ZHU SONG NIAN, CHINA AND ZHU YI NIAN, 511400 GUANGDONG, CHINA:
3,807,323, PUB. 4-6-2010. INT. CL. 25.
- ZIGO INC., CAMBRIDGE, MA:
3,807,733, INT. CL. 43.
- ZIMBA, KELSY, LONG ISLAND, NY:
3,806,908, PUB. 4-6-2010. INT. CL. 42.
3,806,909, PUB. 4-6-2010. INT. CL. 42.
- ZIMNICKI, SANDRA, SCHAUMBURG, IL:
1,559,703, CANC. MULTIPLE CLASS, INT. CLS. 11 AND 20.
- ZIONS BANCORPORATION, SALT LAKE CITY, UT:
3,808,078, INT. CL. 36.
- ZITAN ENTERPRISES LLC, KAILUA KONA, HI:
3,808,660, INT. CL. 9.
- ZIV APLICACIONES Y TECNOLOGIA S.A., 48016 ZAMUDIO, VIZCAYA, SPAIN:
2,240,092, REN. 5-19-10. MULTIPLE CLASS, INT. CLS. 9, 37 AND 42.
- ZNYX NETWORKS, INC., FREMONT, CA:
2,771,014, CANC. INT. CL. 9.
- ZOE PRODUCTIONS, INC., ORANGE, CA:
3,806,425, PUB. 4-6-2010. INT. CL. 41.
- ZOLTANS POOL PRODUCTS PTY LTD, VICTORIA, AUSTRALIA:
2,771,529, CANC. INT. CL. 7.
- ZOMSTERS, LLC, SNOQUALMIE, WA:
3,806,428, PUB. 4-6-2010. INT. CL. 25.
- ZOO MED LABORATORIES, INC., SAN LUIS OBISPO, CA:
3,806,578, PUB. 4-6-2010. INT. CL. 11.
- ZOO TOO LLC, SECAUCUS, NJ:
3,806,123, PUB. 4-6-2010. INT. CL. 41.
- ZOTAC INTERNATIONAL (MCO) LTD., 16 ANDAR L., MACAO:
3,805,408, PUB. 4-6-2010. INT. CL. 9.
- ZOTOS INTERNATIONAL INC, DARIEN, CT, BEAUFIFAX, INC., MINNEAPOLIS, MN:
891,053, REN. 5-18-10. U.S. CL. 51 (INT. CL. 3).
- ZOTOS INTERNATIONAL, INC., DARIEN, CT:
2,772,653, CANC. INT. CL. 3.
- ZUCKERMAN SALES CORP., MONSEY, NY:
2,285,300, CANC. INT. CL. 14.
- ZUCKERMANN HARPSICHORDS INTERNATIONAL, LLC, STONINGTON, CT, ZUCKERMANN HARPSICHORDS INTERNATIONAL, LLC, STONINGTON, CT:
2,416,973, REN. 5-18-10. INT. CL. 15.
- ZUKU, LLC, DECATUR, GA:
3,806,451, PUB. 4-6-2010. INT. CL. 41.
- ZURSCHMIEDE, ELIZABETH, NEVILLE, GROSSE POINTE FARMS, MI, DBA LIBBIE Z:
3,805,384, PUB. 4-6-2010. INT. CL. 18.
- ZYBERTECH CONSTRUCTION SOFTWARE SERVICES LTD., RED DEER, ALBERTA T4N, CANADA:
3,806,755, PUB. 4-6-2010. INT. CL. 9.
- ZYNTEX, INC., CLARENDON HILLS, IL:
2,772,067, CANC. INT. CL. 35.
- ILIFE HEALTHCARE, INC., SAN FRANCISCO, CA:
3,808,181, INT. CL. 44.
- 1ST PHORM, LLC, SPRINGFIELD, MO:
3,806,573, PUB. 4-6-2010. INT. CL. 5.
3,806,773, PUB. 4-6-2010. INT. CL. 5.
3,806,774, PUB. 4-6-2010. INT. CL. 5.
3,806,794, PUB. 4-6-2010. INT. CL. 5.

1ST ROCHDALE COOPERATIVE GROUP, LTD., NEW YORK, NY:
2,772,572, CANC. MULTIPLE CLASS, INT. CLS. 35 AND 37.

100MC, LLC, LARKSPUR, CA:
3,808,674, INT. CL. 25.

101 LIVESTOCK MARKET, INC., AROMAS, CA:
1,602,724, REN. 5-20-10. INT. CL. 35.

12TH STREET ASSOCIATES, LLC, NEW YORK, NY:
3,808,161, INT. CL. 43.

2L ALLIANCE B.V., NETHERLANDS:
3,807,317, PUB. 4-6-2010. INT. CL. 9.

20/20 COMMUNICATIONS, INC., FORT WORTH, TX:
3,807,621, INT. CL. 35.

23ANDME, INC., MOUNTAIN VIEW, CA:
3,807,540, INT. CL. 45.
3,808,639, INT. CL. 42.

24 HOUR FITNESS USA, INC., SAN RAMON, CA:
2,350,909, REN. 5-17-10. INT. CL. 41.
3,806,844, PUB. 4-6-2010. INT. CL. 41.

3-T CORPORATION, BOARDMAN, OH:
1,153,498, REN. 5-18-10. INT. CL. 42.

3CIRCLE PARTNERS, LLC, MARYSVILLE, OH:
3,806,184, PUB. 4-6-2010. MULTIPLE CLASS, INT. CLS. 35 AND 41.
3,806,186, PUB. 4-6-2010. MULTIPLE CLASS, INT. CLS. 35 AND 41.

3M COMPANY, ST. PAUL, MN:
1,559,674, CANC. INT. CL. 10.

3243222 CANADA, INC., SCARBOROUGH, ONTARIO, MIX 1E6, CANADA:
2,355,643, REN. 5-19-10. INT. CL. 29.

360FUELCARD.COM LLC, SOUTH PORTLAND, ME, DBA INTEGRITY MARKETING:
3,806,034, PUB. 4-6-2010. INT. CL. 36.

4 VISUAL MEDIA GROUP, INC., CHATSWORTH, CA:
3,806,010, PUB. 4-6-2010. MULTIPLE CLASS, INT. CLS. 35 AND 40.

40 & BEYOND, INC., HAVERHILL, MA:
2,771,134, CANC. INT. CL. 41.

55DSL AG, ZURICH, SWITZERLAND:
2,352,794, REN. 5-20-10. INT. CL. 25.

58PHASES, LLC, ENCINITAS, CA:
3,806,041, PUB. 4-6-2010. INT. CL. 35.
3,806,042, PUB. 4-6-2010. INT. CL. 35.

6P CORPORATION, THE, CAPE CORAL, FL:
2,285,729, CANC. INT. CL. 28.

7029713 CANADA INC., TORONTO, ONTARIO, CANADA:
3,807,962, MULTIPLE CLASS, INT. CLS. 35 AND 42.

9001-6262QUÉBEC INC., SAINT-AUGUSTIN-DE-DESMANURES, QUEBEC, CANADA:
3,805,346, PUB. 4-6-2010. MULTIPLE CLASS, INT. CLS. 9, 12, 18, 25 AND 28.
3,805,347, PUB. 4-6-2010. MULTIPLE CLASS, INT. CLS. 9, 12, 18, 25 AND 28.

99WINGS, LLC, CARMEL, IN:
3,806,872, PUB. 4-6-2010. INT. CL. 40.

* * * * *